

NO. 41

\$2.50

OCTOBER 1981

MICRO™

THE 6502/6809 JOURNAL

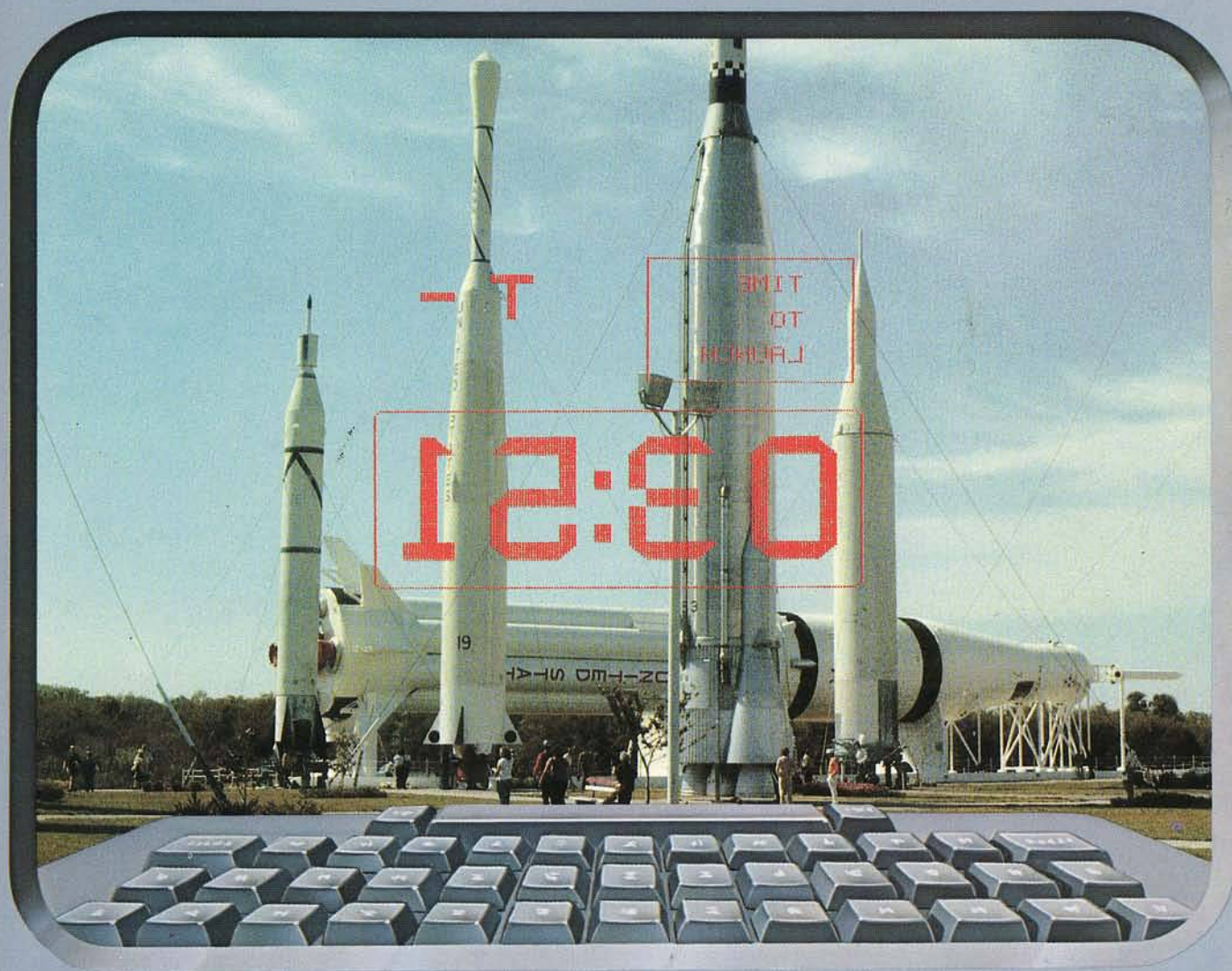

Special PET/VIC Feature

A Look at the TRS-80 Color Computer

Step Up to Programmable Motion

A to D Converters for Your Computer

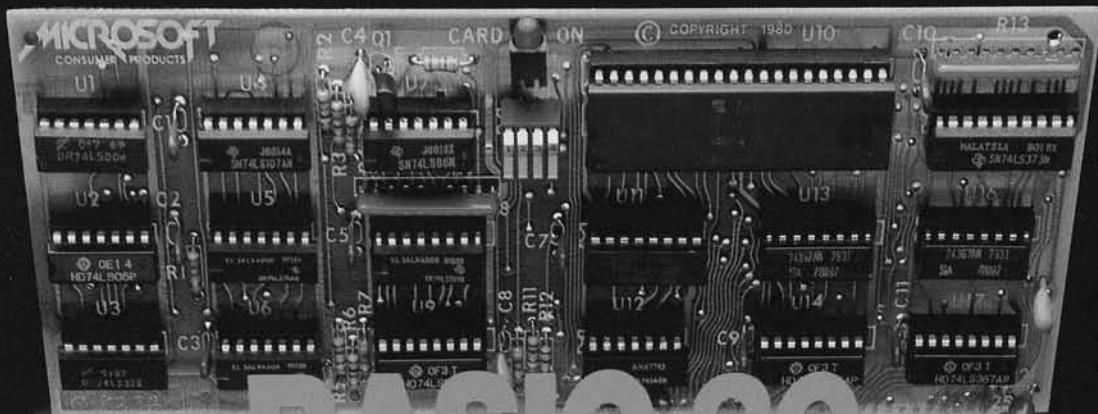

BASIC-80 CP/M Z-80

Turn your Apple into the world's most versatile personal computer.

The SoftCard™ Solution. SoftCard turns your Apple into two computers. A Z-80 and a 6502. By adding a Z-80 microprocessor and CP/M to your Apple, SoftCard turns your Apple into a CP/M based machine. That means you can access the single largest body of microcomputer software in existence. Two computers in one. And, the advantages of both.

Plug and go. The SoftCard system starts with a Z-80 based circuit card. Just plug it into any slot (except 0) of your Apple. No modifications required. SoftCard supports most of your Apple peripherals, and, in 6502-mode, your Apple is still your Apple.

CP/M for your Apple. You get CP/M on disk with the SoftCard package. It's a powerful and simple-to-use operating system. It supports more software than any other microcomputer operating system. And that's the key to the versatility of the SoftCard/Apple.

BASIC included. A powerful tool, BASIC-80 is included in the SoftCard package. Running under CP/M, ANSI Standard BASIC-80 is the most powerful microcomputer BASIC available. It includes extensive disk I/O statements, error trapping, integer variables, 16-digit precision, extensive EDIT commands and string functions, high and low-res Apple graphics, PRINT USING, CHAIN and COM-MON, plus many additional commands. And, it's a BASIC you can compile with Microsoft's BASIC Compiler.

More languages. With SoftCard and CP/M, you can add Microsoft's ANSI Standard COBOL, and FORTRAN, or

Basic Compiler and Assembly Language Development System. All, more powerful tools for your Apple.

Seeing is believing. See the SoftCard in operation at your Microsoft or Apple dealer. We think you'll agree that the SoftCard turns your Apple into the world's most versatile personal computer.

Complete information? It's at your dealer's now. Or, we'll send it to you and include a dealer list. Write us. Call us.

SoftCard is a trademark of Microsoft. Apple II and Apple II Plus are registered trademarks of Apple Computer. Z-80 is a registered trademark of Zilog, Inc. CP/M is a registered trademark of Digital Research, Inc.

MICROSOFT

CONSUMER PRODUCTS

Microsoft Consumer Products, 400 108th Ave. N.E.,
Bellevue, WA 98004. (206) 454-1315

The A2-GE1 Graphics Editor for the Apple II

The A2-GE1 Graphics Editor is a collection of programs designed to put the power of A2-3D1 and A2-3D2 graphics in your hands.

The A2-GE1 includes **Object Editor**, **Motion Programmer**, **Motion Playback**, **Slideshow Playback**, and a special A2-3D2 interface for BASIC programmers.

With **Object Editor** you can create whatever objects you want in the colors of your choice. You can also type in whatever 3D text you want, and in different sizes. And saving an object is as easy as naming it.

Then give the object names to **Motion Programmer** and see how the beautifully laid out keyboard controls will let you switch objects on or off, animate them, or add upper or lower case 2D text mixed right in.

You can also record your entire presentation, animation and all, for later use with **Motion Playback**, or just take "computer snapshots" of scenes with **Slide Show Playback**.

We've reached our goal of giving you the most sophisticated graphics utilities in the marketplace.

See them now at your dealer!

subLOGIC

Communications Corp.
713 Edgebrook Drive
Champaign, IL 61820
(217) 359-8482
Telex: 206995

Convenient graphics power...



A2-GE1 Graphics Editor

\$34.95 on disk (48K and
A2-3D2 required)

A2-3D1 with 3D2 Enhancement*

\$84.90 on disk (48K required)

*3D1 owners may update to 3D2 for \$24.95. Contact SubLOGIC for details.

Now available:
SYM Floppy Disc
Controller — \$139

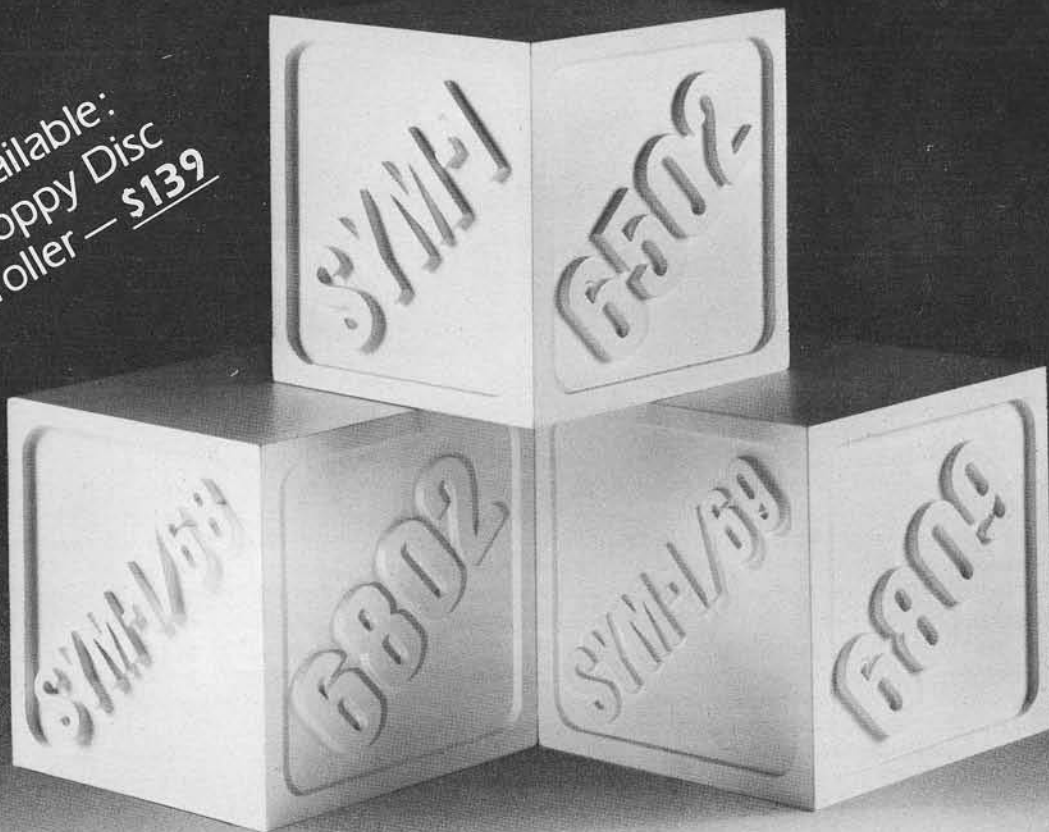

'Universality,' It's as easy as 1. 2. 3.

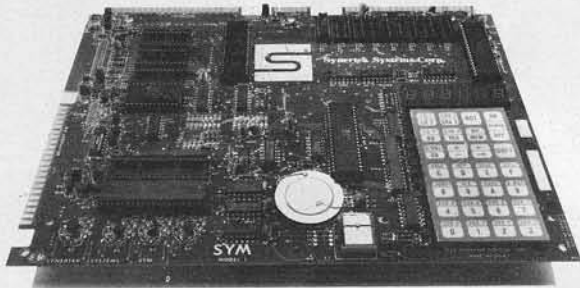

'Universality' can be found in three versions of Synertek Systems' SYM single board computer — the versatile, universal evaluation board.

Over 20,000 SYM-1 boards have been used for learning about and evaluating 6502 microprocessors for specific applications. OEM SYM boards are used in hundreds of products.

Now Synertek Systems presents the new SYM-1/68 for 6802 microprocessors, and the SYM-1/69 for 6809 microprocessors. These boards are designed to reliably perform the same functions as the SYM-1 board for these popular microprocessors. Each SYM board is complete and ready-to-use with its own version of the 4K byte ROM SUPERMON monitor firmware.

Modification kits are also available to quickly and easily convert existing SYM-1 boards to SYM-1/68 or SYM-1/69 microcomputers.

Build on your microprocessor knowledge with the 'universality' of SYM microcomputer boards from Synertek Systems.

Every SYM-1, SYM-1/68, and SYM-1/69 single board computer features:

- 28 double-function keypad with audio response
- 4K byte ROM resident SUPERMON with over 30 standard monitor functions and expandable for individual requirements
- Up to 24K bytes of available program memory
- Expansion to 4K bytes of on-board static RAM
- Expansion to 71 Input/Output lines
- Single +5V power supply required
- Standard interfaces for audio cassette with remote control, 185 bytes/second cassette format, TTY and RS-232-C, system expansion bus, four I/O buffers, and oscilloscope single-line display



P.O. Box 552 Santa Clara, CA 95052
Telephone: (408) 988-5689
TWX: 910-338-0135

Dealer inquiries invited.

MICRO™

THE 6502/6809 JOURNAL

STAFF

Editor/Publisher
ROBERT M. TRIPP

Associate Publisher
RICHARD RETTIG

Associate Editors
MARY ANN CURTIS
FORD CAVALLARI

Special Projects Editor
MARJORIE MORSE

Production Coordinator
PAULA M. KRAMER

Typesetting
EMMALYN H. BENTLEY

Advertising Manager
CATHI BLAND

Circulation Manager
CAROL A. STARK

Dealer Orders
LINDA HENSDILL

MICRO Specialists
APPLE: FORD CAVALLARI
PET: LOREN WRIGHT
OSI: PAUL GEFFEN

Comptroller
DONNA M. TRIPP

Bookkeeper
KAY COLLINS

Sales Representative
KEVIN B. RUSHALCO
603/547-2970

DEPARTMENTS

5 Editorial
6 Letterbox
15 From Here to Atari
35 New Publications
45 Microbes and Updates
98 PET Vet
118 Hardware Catalog
121 Software Catalog
123 6502 Bibliography
127 Advertisers' Index
128 Next Month in MICRO

ARTICLES

- 9 **The Radio Shack Color Computer**..... *John Steiner*
Features of this versatile 6809-based computer are highlighted
- 12 **Applesoft Mystery Parameter**..... *Sherm Ostrowsky*
An undocumented "booby trap" in Applesoft is utilized
- 18 **6522-Based Pot Position Digitizer**..... *Kenny Winograd*
Convert the position of a pot to a number your computer can use
- 24 **6502 Frequency Counter**..... *Phil Lindquist*
Make your computer an inexpensive frequency counter
- 29 **Step Up to Programmable Motion**..... *David S. Liscinsky*
Interfacing of a stepper motor to a KIM-1 is outlined
- 68 **The 6809 and the S-50 Bus**..... *Dale Puckett*
Who's doing what in the 6809 world is explained and the S-50 highlighted
- 76 **Handling Analog Signals with a Micro**..... *Richard Soltero*
Two techniques are given to handle analog signals..... *and Arthur Poulos*
- 100 **Interfacing Two 12-Bit A/D Converters to an AIM**..... *G. Roger Heal*
Give your computer extra precision..... *and J. Derek Openshaw*
- 108 **Solar System Simulation, Part 2**..... *Dave Partyka*
This geocentric program will print information about six planets

PET BONUS

- 48 **A Welcome to PET Users**..... *Loren Wright*
- 50 **Commodore ROM Genealogy**..... *Albert I. Reuss*
Find out about your PET through this history of Commodore configurations
- 54 **VIC Light Pen-manship**..... *David Malmberg*
Explanation of how a light pen works is presented with demonstration programs
- 60 **The PET from A to D**..... *John Sherburne*
Two inexpensive devices can convert analog signals to digital form
- 64 **Substitute Characters**..... *Loren Wright*
Create your own character set for your PET

APPLE BONUS

- 83 **Taming the Wild Reset**..... *Michael M. Seiy*
Easily make your old Apple reset key into a control-reset key
- 88 **Apple Byte Table**..... *Kim G. Woodward*
Help for decoding byte values in Apple's memory
- 94 **Apple Bits, Part 2**..... *Richard C. Vile*
This part discusses an Integer BASIC program for constructing patterns

GET FREE SOFTWARE FOR YOUR APPLE!

HOW? JUST ORDER ONE OF THE ITEMS BELOW, AND SELECT YOUR FREE SOFTWARE FROM THE BONUS SOFTWARE SECTION, USING THE FOLLOWING RULE: FOR THE FIRST \$100.00 WORTH OF MERCHANDISE ORDERED TAKE 1 ITEM; FOR THE NEXT \$200.00 WORTH OF MERCHANDISE ORDERED TAKE ANOTHER ITEM; FOR THE NEXT \$300.00 TAKE A THIRD ITEM, ETC. ALL AT NO COST.

HARDWARE BY APPLE

APPLE II PLUS, 48k	1199
DISK DRIVE+CONTROLLER (3.3)	535
DISK DRIVE only	455
Language System w. Pascal	397
Silentype Printer & Interface	360
Integer or Applesoft Firmware Card	159
Graphics Tablet	645
Parallel Printer Interface Card	149
Hi-Speed Serial Card	155
Centronics Parallel Intfco.	175

HARDWARE BY OTHERS

HAYES MICROMODEM II	300
HAYES SMART MODEM	239
HAYES S100 MODEM	339
VIDEX VIDEOTERM 80 W. GRAPHICS	275
MICROSOFT 280 SOFTCARD	299
MICROSOFT 16K RAMCARD	159
CORVUS 10MB HARD DISK	4750
SSM A10 SERIAL/PARALLEL A&T	189
MICRO-SCI Disk & Controller	495
TYMAC DOUBLE DOS 3.2/3.3	36

VIDEO MONITORS

Leedex-Video-100 12" B&W w/Cable	139
Leedex 12" Green w/Cable	165
Leedex 13" COLOR MONITOR & Cable	399
SUP-R-TERM RF MODULATOR	29

HARDWARE BY MOUNTAIN COMPUTER

Clock/Calendar Card	239
A/D & D/A Interface	319
Expansion Chassis	555
ROMplus Card	135
Mark Sense Card Reader	995
CPS Multifunction Bd.	239

SOFTWARE FOR APPLE

APPLE FORTRAN	159
APPLE PILOT	125
DOS 3.3	50
DOS TOOL KIT	65
APPLE PLOT	50
D. J. REPORTER	45
D. J. NEWS	45
PORTFOLIO	45
SHELL GAMES	25
ELEMENTARY DEAR APPLE	25

SOFTWARE BY OTHERS

APPLE FORTRAN by MICROSOFT	159
APPLE BASIC COMPILER by MICROSOFT	315
APPLE COBOL by MICROSOFT	599
VISICALC 3.3	169
VISIPLOT	155
VISIPLOT/VISITREND	199
VISIDEX	169
CCA DATA MGT.	79
DB MASTER by STONEWARE	189
DATACAPTURE 4.0	55
Z - TERM	65
ON-LINE APPLESOFT COMPILER	89

SOFTWARE BY PEACHTREE

GEN. LEDGER	219
A/R	219
A/P	219
PAYROLL	219
INVENTORY	219
MAIL LIST	219

WORD PROCESSING SOFTWARE FOR APPLE

PEN-ULTIMATE	235
WORD STAR	245
EZ WRITER Prof. Sys.	195
EZ WRITER	89
MUSE SUPER TEXT II	139
APPLE-WRITER	69
PROGRAMMA APPLE PIE 2.0	110
MAGIC WAND	345
WORDPOWER	50

EPSON PRINTERS

MX - 70 w/Graftrax	415
MX - 80	515
MX - 80 FT	615
MX - 80 w. GRAFTRAX	575
MX - 80 FT w. GRAFTRAX	675
MX - 100 FT w. GRAFTRAX	775
APPLE PAR. INTFCE (for all Epson)	75
MX - 70/80 FRICTION FEED Adaptor	75

OTHER PRINTERS

IDS 445 w. GRAPHICS + 2K Buff.	750
IDS 460 w. GRAPHICS	899
IDS 460	825
IDS 560	1099
IDS 560 w. GRAPHICS	1150
CENTRONICS 737	699
CENTRONICS 739	799
CCS Centronics Par. Intfco & Cable	135
NEC SPINWRITER 5510 RO	2795
C. ITOH 25 CPS DAISYWHEEL	1750
C. ITOH 45 CPS DAISYWHEEL	2025
WATANABE MI-PLOT PLOTTER	1150
DIABLO 630 DAISY w. P. Wheel & Rib.	2350

BONUS SOFTWARE SECTION!

Let us acquaint you with MESSAGE-MAKING SOFTWARE. Just place the disk in the APPLE, enter the text, and colorful, dynamic messages appear on the screens of TV sets connected to the computer. Use the software to broadcast messages on TV screens in schools, hospitals, factories, store window, exhibit booths, etc. The following program is our latest release:

SUPER MESSAGE: Creates messages in full-page "chunks". Each message allows statements of mixed types, typesizes and colors, in mixed upper and lower case. Styles range from regular APPLE characters, up to double-size, double-width characters with a heavy, bold font. Six colors may be used for each different typestyle. Vertical and horizontal centering are available, and word-wrap is automatic. Users can chain pages together to make multi-page messages. Pages can be advanced manually or automatically. Multi-page messages can be stored to disc or recalled instantly. REQUIRES 48K & ROM APPLESOFT \$50.

APPLE PLOTS YOUR DATA & KEEPS YOUR RECORDS TOO! APPLE DATA GRAPH 2.1: Plots up to 3 superimposed curves on the Hi-res Screen both X & Y axes dimensioned. Each curve consists of up to 120 pieces of data. Graphs can be stored to disc and recalled immediately for updating. Up to 100 graphs can be stored on the same disc. Great for Stock-market Charting, Business Management, and Classroom Instruction! REQUIRES 48K & ROM APPLESOFT \$35.

APPLE RECORD MANAGER: Allows complete files to be brought into memory so that record searches and manipulations are instantaneous. Records within any file can contain up to 20 fields, with user-defined headings. Information can be string or numeric. Users can browse thru files using page-forward, page-backward or random-search commands. Records can easily be searched, altered or sorted at will. Files can be stored on the same drive as the master program, or on another, if a second drive is available. Records of files can be printed, if desired. Additional modules coming are a STATISTICS INTERFACE, CHECKBOOK, MAILING LIST & DATA-ENTRY. REQUIRES 48K & ROM APPLESOFT \$40.

APPLE LITERATURE DATABASE: allows rapid retrieval (via keywords) of references from total APPLE literature thru 1980, on 5.25" disk. Each entry in the data base consists of the article, author-name, periodical-name, date of issue, & page nos. The database is intended to support large magazine files which would require lengthy manual searching to recover information. Annual updates will be available. REQUIRES 48K, ROM APPLESOFT \$60.

WORDPOWER: is a simple, powerful, low cost, line-oriented word-processor program. It offers a fast machine language FIND & REPLACE. Text can be listed to screen or printer, with or without line-numbers. Lower-case adaptors are supported. You can merge files, move groups of lines, and easily add, change, or delete lines. WORDPOWER can be used to create and maintain EXEC files. It can also be used as a rapid, unstructured, information-storage and retrieval system via its rapid search capabilities. REQUIRES: 48K, ROM APPLESOFT \$50.

LABELMAKER: allows users to quickly create address labels. A given label may be generated in any quantity from 1 to 32767. Space is allowed on labels for a personal and company name, but the space is automatically closed up if only a personal name is entered. Space is also allowed for foreign countries. The program can also generate labels for price-tags, part numbers and mail-messages such as "RUSH", "FRAGILE", etc. A self-incrementing feature allows theatre-tickets to be produced, with a date, and numbers running from 000 to 999. An editor is provided for editing labels prior to printing. All labels may be saved to disk for instant recall. REQUIRES 48K & ROM APPLESOFT \$35.

TO ORDER: Use phone or mail. We accept VISA, MASTERCARD, COD's, personal checks & money orders. Add 4% for credit card. Customer pays handling on COD orders, Foreign orders must be in American Dollars & include 10% for handling. Connecticut residents add 7.5% sales tax.



CONNECTICUT INFORMATION SYSTEMS CO.

218 Huntington Road, Bridgeport, CT 06608 (203) 579-0472

About the Cover

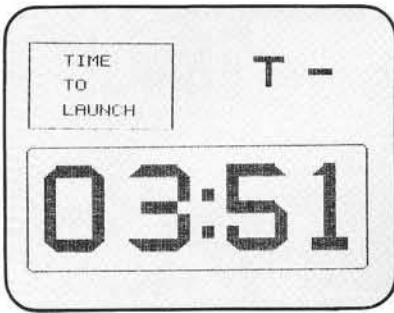

Our cover picture this month, taken at Kennedy Space Center, highlights the intensified space activity taking place this year. In April, the Space Shuttle Columbia successfully completed its historic first mission. In August, Voyager II completed its close encounter with Saturn. And this month, Columbia is getting its second run, marking the first re-use of a spacecraft.

The manufacturer of a popular data base manager for the PET has announced that its product, along with the PET, is being used by NASA to keep various logs for its ground-based vehicles. An Apple computer is scheduled to monitor experiments in an upcoming mission of the Shuttle-based Space Lab. As our knowledge of our cosmos and our world increases, we're sure that the role of the microprocessor will continue to increase, too.

MICRO is published monthly by:
MICRO INK, Inc., Chelmsford, MA 01824
Second Class postage paid at:
Chelmsford, MA 01824 and Avon, MA
02322
USPS Publication Number: 483470
ISSN: 0271-9002

Send subscriptions, change of address, USPS Form 3579, requests for back issues and all other fulfillment questions to

MICRO
P.O. Box 6502
Chelmsford, MA 01824
or call
617/256-5515

Subscription rates	Per Year
U.S.	\$18.00
Foreign surface mail	\$21.00
Air mail:	
Europe	\$36.00
Mexico, Central America	\$39.00
Middle East, North Africa	\$42.00
South America, Central Africa	\$51.00
South Africa, Far East, Australasia	\$60.00

Copyright © 1981 by MICRO INK, Inc.
All Rights Reserved

MICRO

Editorial

The analysis of the reader questionnaire has given the MICRO staff a good idea of the microcomputer systems our readers use. As mentioned last month, we were surprised at the large number of readers who have access to more than one 6502- or 6809-based system. One reason that this is an important statistic is that it underscores MICRO's role as a general 6502/6809 resource journal. While MICRO has presented, and will continue to present, quality system-specific articles and software, our main charge is to examine the similarities between the various systems we cover. These similarities manifest themselves at almost all levels, from the processor up to the high-level languages supported. For example, Applesoft, OSI, PET, and TRS-80 Color BASIC are all members of the popular Microsoft family of BASICs. And several other languages, including Pascal and FORTH, are generally compatible from system to system. Thus, most of the high level applications we receive, all of the discussions on programming technique, and most tutorials on programming languages, tend to be of as much universal interest as our articles on the 6502 and 6809 processors. Even some system-specific articles we publish can be generalized due to these compatibilities between systems.

Articles useful to more than one system are more valuable. Even though the bulk of articles received are written with one system in mind, that does not mean their usefulness stops with that one system. Most ideas, with the exception of some fancy I/O or screen-oriented tricks, can be transported from one system to the next. To implement this generalization you need access to several systems and knowledge of their basic characteristics.

Right now MICRO's lab has the hardware to generalize. We have an Apple, several PETs, an Atari, a TRS-80 Color, KIM, SYM, AIM, and an OSI, and soon they will all be communicating through a Flexi-Plus I/O board. Eventually, we'll be able to easily transfer files between systems. However, what the MICRO staff lacks is the time to generalize all but a few of the articles we receive. So we put it to the readers, especially those with two or more systems.... Are any of you interested in forming a "generalizing pool" which

would take useful, system-specific articles, and make the minor modifications that may be necessary for implementation on other systems?

In keeping with our policy of highlighting the similarities between the systems we cover, and recognizing the benefits to the readers of tighter organization, MICRO will be separating its editorial content into several, rotating categories starting in November. In the past we've been tempted to separate the articles by system, mainly because of the simplicity of that organization. However, such a categorization totally overlooks the Apple graphics program which may be useful to the Atari user, or the OSI BASIC program which will help the PET owner. Thus, starting next month, we will be placing articles into logical, subject-oriented groups which will be rotated from month to month in coordination with our feature sections. We think you'll find that the new organization will make MICRO more attractive and more readable than it has been in the past.

Each month, MICRO receives articles in a variety of lengths. This brings up several points on the presentation of articles in MICRO. Oftentimes, we will receive a short article describing some useful concept which does not really require a long write-up. And I'm sure for every one of these short articles we receive, there exist piles of user notes which are never published. We at MICRO want everyone to know that short articles and notes are not discouraged; in fact, they may provide information unavailable in any other form. Consequently, starting in December, we will be including a short subject section in MICRO. Material appropriate for this section may include short utilities, program modifications, or any good idea that is not well-suited to article format. The material appearing in this section will not receive payment, but authors will receive full acknowledgement.

MICRO feels that this section will fill an important gap. It will provide an opportunity for the computer enthusiast who does not particularly like to write to transmit ideas to the MICRO readership. It will permit short subject matter to appear quickly, without having to wait in our backlog of articles. Finally, it will act as a forum for our readers. So if you have any interesting material which is not suited for an article but important nonetheless, please send it in for this new section.

Fred Cavallari

Copyright Controversy

Dear Editor:

Today I actually lectured an innocent salesman at a local computer store on the evils of copy protected software. "Lectured" might be a bit mild — I yelled at him. But, so that we may all understand better how such things happen, let me relate a bit of history.

I'm an old hand at personal computing, having built and owned one of the first Altair 8800's. Since then, I've built, owned and used a Sol 20. I built my computers to save money, not because I get any special enjoyment out of soldering and debugging hardware. I am the same way about most software. Unless I wrote it, I want to use it as simply and easily as possible. I really don't want to help the author debug it and I want it to work when I need it, which, for the business software I buy, is all of the time.

Now, I know that there are folks out there who claim that anything can be copied. In fact, a youth at a local computer store mentioned such to me. But the fact is, I'm not interested in playing cryptographer. Sure, I'm amused by the people who get their jollies out of breaking a copy protected piece of software. But, I'm a business man who bought my computer to help me in serious business ventures. I don't have time to attempt to break copy protection codes or to hunt up those people.

So, I feel that when I lay down a lot of cash for a piece of software, I have a right to some security in the form of copiability (for backups) or at least two backup copies with each software package I purchase. Those backups should be delivered with the software when purchased, not held for ransom until the registration card is sent in.

My new motto is "If It's Copy Protected and No Backups Come With It, Don't Buy It." The software producers

must realize that they are not selling ROMs which are unlikely to be damaged. Instead, they are selling very fragile magnetic media. With a little bit of experience, no sensible business person is going to put up with this copy protection racket for long. Unless the software houses do something and do it soon on their own, they can be sure that government will be there momentarily to regulate their activities. The honest purchaser of software deserves a little consideration. Generally, he signs away his life when he fills out one of those little registration cards. The software producers have a responsibility to let us know what's in those tantalizing but uninformative packages.

Barry Gerber
Decision Points, Inc.
5339 Ventura Canyon Ave.
Van Nuys, CA 91401

Dear Editor:

In the June issue of MICRO, on page 6 in the Letterbox section, the reader states: "I freely admit there are many copyrighted programs in my library which I obtained through software swaps and from friends.... If I were using any of these for commercial gain or were reselling them *through any means*, I should be locked up." (Italics added.)

But the writer was reselling them! To sell is "to give up (property) to another for money or other valuable consideration for a price" (Webster's 7th Collegiate Dictionary). The selling price was other programs.

However, on my first software purchase (a \$100 program from one of the "name" software houses) I learned three valuable lessons:

1. Never buy a program that you cannot copy.

2. Never buy a program that you cannot modify.
3. Never buy a program until you have tried it out.

Lowell Ray Anderson
Box 67
Cody, WY 82414

Apple Bulletin Board

Dear Editor:

I would like to inform your readers of a free bulletin board for Apple users in Jacksonville, Florida. The "SEB Bulletin Board" is maintained from 6 p.m. - 8 a.m., seven days a week. The access number is 904-743-7050. The system is an Apple with 48K, one Disk Drive and a DC Hayes Micromodem.

Sam Bateh
SEB Computer
1705 University Blvd. North
Jacksonville, FL 32211

If you have a tip to share with our readers, a question for our editors or just an opinion you'd like to express, write to Letterbox.

We receive many letters and cannot answer each individually, but we try to publish some each month. When you write, please cover only one topic per letter and try to be brief. Also, address the letter to "Letterbox" on the envelope, and chances are, you'll be reading your own letter in MICRO.

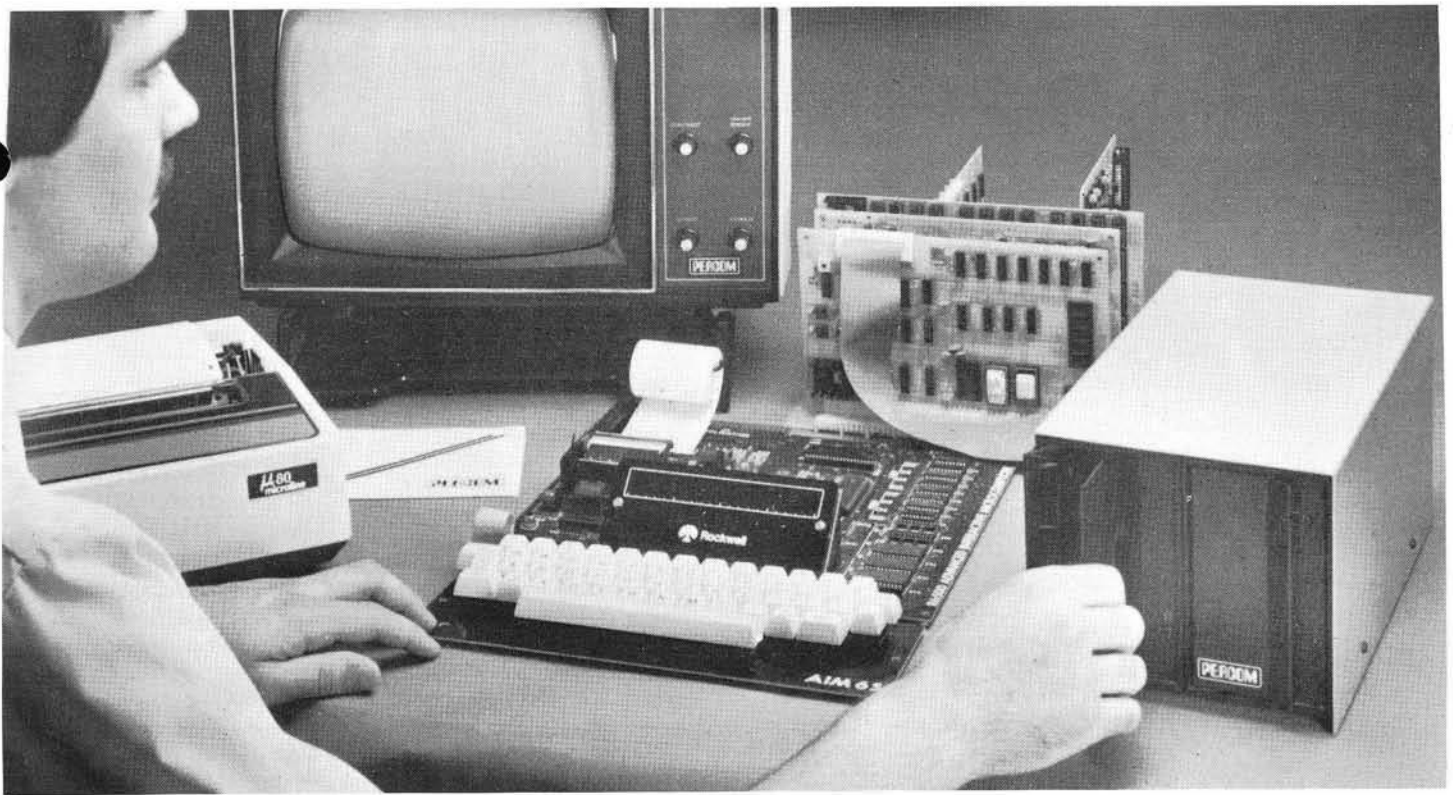

Introducing the M line . . .

Now! Drive Systems for AIM, KIM and SYM Computers — from PERCOM.

At last. Low-cost, quality mini-disk drive systems for your AIM-65, KIM or SYM from the leader: PERCOM.

Assembled and tested systems start at only **\$599.95**, including the drive controller circuit card, disk-operating system, interconnecting cable, drive and comprehensive users manual.

- **The right storage capacity** – Available in 1-, 2- and 3-drive systems, with either 40- or 80-track drives.
- **Flippy storage** – Flippy drives (optional) let you flip a diskette and store data and programs on the second recording surface.
- **High Storage Capacity** – Formatted, one-side storage capacity is 102 Kbytes (40-track drive), 205 Kbytes (80-track drive).
- **Proven Controller** – The drive controller design is the same as the design used in the Percom 680X LFD mini-disk system. This system – introduced in 1977 – has given reliable service in thousands of applications. Two versions are available: the MFD-C65 for the AIM-65 expansion bus, and the MFD-C50 for the System-50 (SS-50) bus.
 - Includes an explicit data separator circuit that's reliable even at the highest bit densities.
 - Provides for on-card firmware.
 - Includes a motor inactivity time-out circuit.
 - Capable of handling up to four drives.
 - Capable of reading both hard- and soft-sectored diskettes.

- **DOS included** – The MFD disk-operating system works with the AIM monitor, editor, assembler, Basic and PL/65 programs; interface is direct, through user I/O and F1, F2 keys.
- **Reliability assurance** – Drives are burned-in 48 hours, under operating conditions, to flag and remove any units with latent defects.
- **Full documentation** – Comprehensive hardware and software manuals are included with each system. These manuals cover details from design to operation and applications.

Available soon! The M-65/50 Interface Adapter. Only \$49.95. Expand your AIM-65, KIM or SYM with proven System-50 (SS-50) modules.

System Requirements: AIM-65, KIM or SYM computer with expansion bus and four Kbytes RAM (min).



PERCOM DATA COMPANY, INC.
211 N. KIRBY GARLAND, TEXAS 75042
(214) 272-3421

Toll-Free Order Number: **1-800-527-1592**

PRICES AND SPECIFICATIONS SUBJECT TO CHANGE WITHOUT NOTICE.

© 1981 PERCOM DATA COMPANY, Inc.
PERCOM, MFD-C50, MFD-C65 and M-65/40 are trademarks of Percom Data Company, Inc.
AIM-65 is a trademark of Rockwell International, Inc.
KIM is a trademark of MOS Technology Corporation
SYM is a trademark of Synertek, Inc.

Yes . . . I'd like to know more about Percom MFD drive systems.
Rush me free literature.

Send to
PERCOM DATA COMPANY, Inc., Dept. 65-M
211 N. Kirby St., Garland TX 75042

name _____
address _____
city _____ state _____
zip _____ phone number _____

MAIL TODAY!

Color computer owners, 32K PLUS DISKS* \$298.00

Yes, that's right - for as little as \$298.00 you can add 32K of dynamic RAM, and a disk interface, to your TRS-80 Color Computer! If you just want the extra memory it's only \$199.00, and you can add the disk interface later for \$99.00.

Just plug the *Color Computer Interface (CCI)*, from Exatron, into your expansion socket and "Hey Presto!" - an extra 32K of memory. No modifications are needed to your computer, so you don't void your Radio Shack warranty, and Exatron give both a 30 day money-back guarantee and full 1 year repair warranty on their interface.

The *CCI* also contains a 2K machine-language monitor, with which you can examine (and change) memory, set break-points, set memory to a constant and block-move memory.

So what about the *CCI Disk Card*? Well as we said it's only an extra \$99.00, but you'll probably want Exatron's *CCDOS* which is only \$29.95 - unless you want to write your own operating system. The *CCI Disk*

Card uses normal TRS-80 Model I type disk drives, and *CCDOS* will even load Model I TRSDOS disks into your color computer - so you can adapt existing TRS-80 BASIC programs.

As a further plus, with the optional *ROM Backup* adaptor, you can dump game cartridges to cassette or disk. Once the ROM cartridge is on cassette, or disk, you can reload, examine and modify the software. The *ROM Backup* adaptor is only \$19.95.

For more information, or to place an order, phone Exatron on their Hot Line 800-538 8559 (inside California 408-737 7111), or clip the coupon.



excellence in electronics

exatron

DEALER ENQUIRIES INVITED

Exatron,
181 Commercial Street,
Sunnyvale, CA 94086



- Please send a 32K Color Computer Interface for \$199.00
- Please send a CCI Disk Card for \$99.00
- Please include CCDOS and manual for \$29.95
- Also include a ROM Backup adaptor for \$19.95

Please add \$5.00 for shipping to all orders, and 6 percent sales tax in California.

Name

Address

City

State Zip

Charge my:

MasterCard Interbank Code

Visa Expiration Date

Card

Check enclosed for

Ship COD (\$2.00 extra)

Signature

The Radio Shack Color Computer: A 6809-Based System.

The Radio Shack TRS-80 Color Computer is one of the most popular and versatile 6809-based systems to date. This article outlines this system and highlights a few of its more interesting features.

John Steiner
508 Fourth Avenue NW
Riverside, ND 58078

When I left the Radio Shack store with my new TRS-80 Color Computer, I wasn't aware that I was carrying one of the most advanced 8-bit microprocessors available. A personal computer has been on my want list for a long time, but until the Color Computer came along, I didn't feel I could afford one. I wanted a full-feature BASIC system, rather than a PC board, and the Color Computer met those requirements. Radio Shack is marketing this machine as a home and personal computer, rather than a business or industrial system. However, the 6809 and its multiprocessing capacity should make an excellent smart terminal, with the right software.

After having some exposure to the 6800 and programming in assembly language, I was pleased to find that the 6809 is upwardly compatible. However, this is at the mnemonic level only, and the 6809 requires opcodes that are different from the 6800. For an excellent reference to the 6809, read *6809 Microcomputer Programming and Interfacing* by Andrew C. Staugaard, Jr., Howard W. Sams & Co., Inc., 1981.

Hardware

The Color Computer system uses the E version of the 6809. The 6809E does not have an on-chip clock. Addressing and RAM refresh is handled by an

LSI dynamic RAM controller chip. The Motorola 6847 video display generator IC is used as screen display through latch buffers. This display is fed to an internal video modulator, which also receives sound from one of four sound sources. (More on this later.)

There are two 6821 Motorola PIA's whose functions are: cassette interface (1500 baud), RS-232 interface (600 baud programmable to other rates), joystick interface, and keyboard interface. The keyboard uses calculator-style keys, and there is a 40-pin cartridge connector (that Radio Shack calls a ROMport) included. This ROMport makes available to external devices every major input and output line on the 6809. Maximum RAM capacity is 32K, though the basic machine comes with only a 4K by 8 chip set installed. Extended Color BASIC requires the 16K by 8 chip set. The Extended Color BASIC machine is a completely integrated system that is

designed for the computer beginner (read average consumer) and the manuals and ROM-based software help the novice to become a hard-core "hacker."

Firmware

There is a standard 8K ROM-resident BASIC that could be (comparatively) called more advanced than Radio Shack Level I BASIC, but less advanced than Level II. The optional Extended Color BASIC requires an additional 8K ROM chip, and is roughly comparable to Level II BASIC. This adaptation, written by Microsoft, is graphics- and sound-oriented, though it has several string handling and programming statements and functions.

This standard floating point BASIC comes with trig functions and square root. Programming aids include a full-feature line edit, and a renumber statement that completely rennumbers your BASIC program starting with any number specified, and incrementing by any number. This powerful command also rennumbers GOSUBs and GOTOs, and identifies any undefined lines. A USR function allows machine language software to be executed from BASIC.

Another feature is a software-resettable timer. String and data handling capabilities include cassette files, and the TRS-80 graphics characters, which can be set to any one of the eight available colors. These characters are manipulated and stored like text, but there is no provision for single key entry of the characters. You must place them into your program as CHR\$ statements.

Microsoft's Extended Color BASIC brings high-resolution graphics capability to the programmer. There are five modes that the color computer displays. Listed in table 1, are the five graphics modes. Any time text is output to the screen by the computer, or whenever

Table 1

PMODE #	GRID SIZE	COLOR MODE
0	128 by 96	two color
1	128 by 96	four color
2	128 by 192	two color
3	128 by 192	four color
4	256 by 192	two color

Table 2: List of Graphics and Audio Commands

AUDIO	PCOPY
CIRCLE	PLAY
COLOR	PMODE
DRAW	PPOINT
GET	PRESET
LINE	PSET
PAINT	PUT
PCLEAR	SCREEN
PCLS	SOUND

the programmer uses a print or input statement, the computer automatically enters the text mode. This represents one of the few shortcomings of the Color Computer: text and high resolution graphics are not available on the same screen.

To write text on the graphics screens you must "draw" the words on the screen. The highest resolution available is 256 by 192, requires a minimum of 4 1.5K "pages" of memory, and is a two-color mode. The only colors available in this mode are black and green or black and buff. There are two medium and two low-resolution modes.

In PMODE 3 there are two four color modes available. Depending upon the screen set chosen, you can select from green, yellow, blue and red; or buff, cyan, magenta, and orange. This mode sets two points at a time, rather than one as in the high-resolution mode. The medium and low-resolution modes have both a four- and two-color mode, and the Lo-Res mode sets four adjacent dots to the same color. All points are plotted on a 256 by 192 grid so you have the option of choosing the mode which offers the best compromise between resolution and color requirements without having to change line, draw, or circle plots.

The video display generator requires 1.5K blocks or pages of RAM to store in graphics data, and the higher the resolution, the greater the memory requirements. The programmer can reserve up to eight pages for graphics use, and can switch from one page to another by software command. This allows a limited form of animation, but there is a more versatile animation technique which will be explained later.

If the program that you are working on requires little or no graphics, you can reserve only one page for graphics and use the extra memory for your text program. Memory available for text at power up is 8.487K. By inputting a PCLEAR 1 command, you reserve one page for graphics and then 13.095K of memory for text programming. The remainder of the 16K is used by the computer for processing, as well as 200 bytes which are automatically cleared for handling strings.

While the computer accepts a SET command SET(X,Y,C), where XY are the coordinates, and C is the color number, there is a much faster way to draw objects on the graphics screen. The LINE(X,Y)-(X,Y),PSET will draw a line of an earlier specified color from the left

XY coordinates to the right XY coordinates. If the specified line is diagonal, and the PSET is followed by a ,B then the line is drawn as a rectangle with the leftmost XY as the upper left corner of the rectangle, and the rightmost XY as the opposite corner. One more option: an F after the B, fills this box with the pre-specified foreground color. The left XY coordinates are optional also, and if left out, the computer starts drawing from the last specified XY point, or the center of the screen if none other had been previously specified.

Another useful graphics command is CIRCLE. The syntax for CIRCLE is CIRCLE(X,Y),R,C,HW,START,END. XY is the center of the circle, and R specifies its radius. All the rest are optional. C specifies its color, and HW specifies the height/width ratio of the circle thus making it into an ellipse. START and END specify beginning and ending points for drawing an incomplete circle, as in making an arc.

PAINT (X,Y),C,B will paint the graphics screen with color C, starting at XY and ending at the border of color B.

Probably the most versatile graphics command is DRAW. It specifies a string of characters that allow the programmer to manipulate graphics with string functions, which may be constants or variables. For example, A\$="BM128,96;U25R25D25L25": DRAW A\$ executes a square which starts at 128,96, goes up 25 points, right 25 points, down 25 points, and left 25 points. The "BM" means blank move, and this moves the computer's last coordinate position to the new one without displaying the line on the screen. The start point can be made relative by stating "BM+25,+25" which starts drawing 25 units over and 25 units down from the last specified point. This feature is handy for creating graphics text strings to DRAW on the display. There are angle and scale options, a color specifier, a no update, and blank line option as well.

Two other useful graphics commands are GET and PUT. These graphics options set up a double dimensioned array that stores the particular colors of the specified screen location. For example, GET the rocket at the lower left corner of the screen, and PUT it at a higher location, then PUT it at a higher location, etc. There are options that allow you to AND or OR the array with the new location display. This technique is the fastest form of animation available to the Color Computer.

The audio capabilities are quite versatile in the computer. The basic 4K machine has a SOUND F,D command that sounds a tone of frequency F for a duration of D. Frequency and duration can be any number between 1 and 255, inclusive. Extended Color BASIC adds to this a PLAY command that allows the user to program the notes as written directly from a sheet of music in string format. There are several options, including tempo, length of note, pause, octave (five available), volume, and execute a substring.

I mentioned earlier that there were four sound sources. These include, a 6-bit D/A converter, a single bit sound source, which requires reprogramming the PIA, external sound from a ROM-PAK, or audio from cassette. Audio appears at the TV speaker, not from an internal speaker, as on the Apple. This necessitates that audio level be set at the TV, though the PLAY command can vary the volume of music, as long as the volume is up at the TV.

The TRS-80 Color Computer has a lot of power for the dollar, and with the 6809 microprocessors ability to use position-independent code, and its multiprocessing capability, there will be a degree of software compatibility heretofore not seen in the industry. Also terminal and Teletext applications will be more easily implemented.

Color Computer Cassette Interfacing

Editor's note: If you want to use your own cassette recorder with your Color Computer, your Radio Shack salesman may tell you you can't do it, since the only way to get the cable you need is with the Radio Shack cassette machine. They don't sell the cable or the connector separately!

The connector is available, however, on the printer end of the "Interface Cable" (part # 26-3009—\$4.95) for the Quick-printer II. Just cut the cable in half and add extra wires and appropriate connectors for your cassette machine on the other end. You can then use the other half of the cord to make your own (non-Radio Shack) printer interface cable. The pin-outs for these connectors are available in the back of the "TRS-80 Color Computer Operation Manual" (pp. 26-27.)

The connectors, by the way, are standard DIN 4- and 5-pin connectors and might be obtainable at another electronics store.

A TEAM OF 6809 SUPERSTARS: Smoke Signal's Chieftain™ Computer, and Software by Microware



HERE'S THE **TOTAL 6809-BASED SYSTEM** FOR THOSE WHO DEMAND UNSURPASSED POWER, FLEXIBILITY AND RELIABILITY

After years of worldwide use in diverse and challenging applications, the outstanding performers in 6809 computer operations are SMOKE SIGNAL and MICROWARE. These leading companies are recognized as the undisputed choices **when there is no room for compromises.**

WHY SMOKE SIGNAL AND MICROWARE LEAD THE 6809 FIELD

Smoke Signal began pioneering research and development on 6800/6809-based computer systems back in 1977. Microware worked three years to perfect OS-9 and BASIC09.

Both companies have evolved outstanding 6809-based products from early engineering research, **and both pay almost fanatical attention to detail.** For example . . .

SMOKE SIGNAL'S 6809-based Chieftain™ computer series has **proven** its superiority in hundreds of demanding tasks. From gold-plated connectors to highest-quality materials throughout, each Chieftain™ is built to deliver absolute dependability from day one, and **stay** that way through years of service.



Every Chieftain™ is meticulously **ENDURANCE-CERTIFIED** at 2.2 MHz. That's SMOKE SIGNAL's endorsement of product perfection.

MICROWARE's state-of-the-art OS-9 UNIX*-like operating system and the BASIC09 language have been developed in close coordination with computer manufacturers to maximize optimum system performance. The finest possible support and

*UNIX is a trademark of Bell Telephone Laboratories.



**SMOKE SIGNAL
BROADCASTING**



MICROWARE

31336 VIA COLINAS
WESTLAKE VILLAGE, CA 91362
TEL (213) 889-9340

documentation further ensure satisfaction. Microware software performance is best summed up in this remark by a 25-year computer veteran:

"BASIC09 IS THE FINEST HIGH-LEVEL LANGUAGE I'VE EVER SEEN IN THE INDUSTRY!"

Thousands of engineers and programmers use MICROWARE software products as their standard time-saving tool . . . to execute process-control applications . . . and for other vital functions. COBOL and PASCAL are also available under the OS-9 operating system.

HOW THIS REMARKABLE TEAM OF COMPUTER SUPERSTARS CAN SERVE YOU

SMOKE SIGNAL's Chieftain™ computer provides an array of configurations ranging from 5¼-inch drives for single-user applications to multi-user, multi-tasking capabilities. Winchester hard-disk drive systems are also available.

In other words, **breathhtaking power** with as little as 48k memory; Microware's OS-9 Level Two can access up to one full megabyte that your Chieftain™ can address!

One more sampling of the awesome processing potential at your fingertips with the Smoke Signal Chieftain™ computer:

MICROWARE'S Stylograph screen-oriented word processing package instantly makes Chieftain™ an easy-to-use document preparation system with comprehensive editing commands.

THERE'S MUCH, MUCH MORE! Call or write SMOKE SIGNAL for details on Chieftain™ computers and MICROWARE software. **SMOKE SIGNAL Dealer opportunities are still available . . . please request information.**

- Send information about Chieftain™ computers and Microware software.
- Provide information about Smoke Signal's Dealer program.

Name _____
Address _____
City _____ State _____ Zip _____
Telephone () _____

Applesoft Mystery Parameter

This zero page location in Applesoft can be used to prevent the listing of a program, and for automatic "load and run" of tapes.

Sherm Ostrowsky
291 Salisbury Ave.
Goleta, California 93117

There is an undocumented booby trap deliberately hidden in Applesoft. A "soft switch" lurks in zero page location \$D6 (decimal 214). If you POKE an appropriate number into this address, your Applesoft program will suddenly become inaccessible to you! You will still be able to run the program, but that's all you'll be able to do. No matter what valid or invalid Applesoft command you try to type in, the computer will interpret it as a "RUN" command and will restart the program from the beginning. You can neither list nor change the program. If you have the Autostart ROM, you can't even escape the trap by hitting RESET; this just puts you back into Applesoft, and any attempted command starts the program running again. When I first discovered this "switch" and tried it out, I finally had to turn off my Apple (thereby losing the program) before I could get out of this devastating situation.

Although I read almost all of the personal computer magazines, I have never seen anything written about this powerful, but hidden, feature of Applesoft. There is not a word about it in the various Apple reference manuals. In fact, the zero page memory map in the Apple II Reference Manual indicates that byte \$D6 is not used by Applesoft, thereby implying that it is free for use by other machine language programmers hungry for space on page zero. Well, if you did try to use this particular piece of real estate as a handy storage spot in your ML program, you might be in for a bit of a surprise.

I first became aware of this situation when I read a remark made by W.E. Dougherty in his valuable compendium *The Apple Monitor Peeled*. He stated that in an Applesoft TAPE-SAVE, the first record is three bytes long; the first two bytes give the length of the Applesoft program to follow, and the third byte is always set to the number \$55. But why are there three bytes, when two are sufficient to specify the length of any possible Apple program?

To find out about this third byte I began browsing through the disassembled ROM code. There I learned that the third byte was taken from memory location \$52 just before the TAPE-SAVE operation began, and that after a TAPE-LOAD operation, this byte, which had been in \$52, was deposited in memory location \$D6. Why was such an elaborate process provided to transfer a single byte from one zero page location before a tape-save to another zero page location after the tape-load, if the byte in question was always set to \$55?

It was then that I recalled having seen \$D6 referred to at a critical point in the Applesoft routine which examines every input line and converts valid keywords into tokens for later implementation. Looking at this routine more carefully, I saw that if the number in location \$D6 had bit seven set (i.e., it was greater than \$7F or decimal 127), the keyword interpretation routine would be short-circuited. Without even looking at any keyword, the routine instead jumps unconditionally to a command sequence, which is equivalent to CLEAR and RUN! So that is how the "switch" is implemented: if you put into location \$D6 any single-byte integer greater than \$7F, the switch will be activated.

Suppose you have just written an Applesoft program and are preparing to SAVE it onto tape. If you type

POKE 214,128

you will never be able to SAVE the program at all. You will be trapped by this switch. But if instead you were to type

POKE 82,128

you'll have no such trouble. The switch remains off, and you can list, alter, and eventually SAVE your program. But if you LOAD this tape you will not be so fortunate. Your switch will be on from the instant the tape leader was loaded — even before the program itself is read into the computer. The only thing you will be able to do with the program is run it.

When activated by the third byte of a tape leader, the switch has yet another trick up its sleeve. The tape has become an "auto-run." It starts running as soon as loading is complete, without waiting for any input from the keyboard. This is consistent with the other activities of the switch. All of its efforts are directed toward preventing anyone from looking at, listing, or in any way meddling with the program. Naturally, to do this most effectively it would be necessary for the tape to auto-run. Otherwise, the user might be able to use the time after loading, but before typing RUN, to find a way of getting into the program.

Well, I can think of circumstances under which a fool-proof auto-run program tape would be a pretty useful thing to have. For example, if it is to be used by people who know nothing about computers, it would be best if they have as little to do with it as possible. A load-and-go tape will provide less chance for something to go wrong. And you cannot doubt that another reason behind this gimmick is the idea of protecting proprietary program details.

All right, then, how good is the protection afforded by this switch? Can it be easily circumvented? If so, can a program be reinforced so as to defeat such circumvention? Obviously, it is not possible to give a final answer to

these questions. Yet some remarks can be made concerning the operation of the D6 switch as it has been described thus far.

First of all, if you have the old Monitor ROM you can defeat the switch by simply hitting RESET. In this version of the Apple computer, hitting RESET invariably dumps you into the system monitor, recognized by the asterisk prompt: *. Once in the monitor, you are free from the effects of the switch. As far as I have been able to ascertain, this switch only functions in Applesoft. From the Monitor, therefore, you can type D6 (RETURN) and the system will respond by showing you the contents of this location. If the switch is on, the contents will be a hexadecimal byte between \$80 and \$FF. Now you only need to type D6 : 55 (RETURN) to turn off the switch (instead of \$55; you can use any hexadecimal number less than \$80 if you wish), and return to Applesoft by typing CONTROL-C. Now the program will behave normally. You can list it, change it, or do anything you want with it.

A careful examination of the listing of the monitor ROM in the *Apple II Reference Manual* has not shown me any way that this RESET fix can be defeated. The fact that RESET will always cause a jump out of Applesoft into the monitor seems to have been cast in silicon in this ROM version. It would take a hardware change to alter it. However, if I am wrong, I hope an alert reader will let me know about it!

The Autostart ROM is far more common than the monitor ROM in those

Apples (especially the Apple II Plus) with Applesoft in ROM. As we have seen, hitting RESET in the autostart ROM usually dumps you right back into Applesoft with the program and all variables (including, of course, the contents of \$D6) unchanged. So you will be no better off than before. However, with the autostart ROM, it is possible to make a *software* change which will simulate the operation of the monitor ROM (i.e., RESET will place you in the monitor). This function is described in great detail on page 37 of the *Apple II Reference Manual*. Just remember that as soon as you turn on your Apple (before you try to LOAD the protected program), execute the following commands in immediate mode:

```
POKE 1010,105 : POKE 1011,255
: CALL - 1169
```

From then on, RESET will return you to the monitor, and you may be able to defeat the switch as described above. However, *this fix is not* cast in silicon — software made it, and software can overrule it. All the protected program needs as one of its early statement lines, is something like this:

```
10 POKE 1010,102 : POKE
1011,213
: CALL - 1169
```

Now, after you've fixed the RESET key to simulate the monitor ROM, you must hit RESET in the fraction of a second between the completion of the tape LOAD and the beginning of the program's auto-RUN. The program line listed above undoes software fix on the

RESET operation and even makes the situation worse. Now hitting RESET not only leaves you in Applesoft, but also jumps to the RUN command and starts running the protected program from the beginning again!

The alert reader has probably noticed one glaring omission from this article so far. I've said a lot about the TAPE-SAVE and TAPE-LOAD procedures, and about protected and auto-run tapes, but nothing about disks and DOS. This is because my system does not yet have a disk, so it has not been possible to check out the situation in DOS. Nevertheless, it seems unlikely that such a clever and useful gimmick would have been omitted from the DOS. This will be investigated as soon as I can get access to a disk system.

One more possible implication may be worth pointing out. Applesoft was written by the same Microsoft people who have produced versions of BASIC for several other computer systems. It seems likely to me that they might have incorporated a similar switch into some of these other versions, too. So you PET owners who are handy with 6502 assembly language might want to try hunting for it somewhere in one of the various different PET ROMs.

Sherm Ostrowsky, a physicist, has been working with computers since 1958. He spends much of his time exploring non-conventional computer architectures. Ostrowsky owns an Apple and is fluent in 6502 assembly language.

MICRO

DEPT. E-9 P.O. BOX 30160 EUGENE, OR 97403 (503) 345-3043/NOON-7 PM

AWANT
GARDE

SUPER DRAW & WRITE Fonts, drawing, and useful utilities. **19.95**

SUPER SHAPE DRAW & ANIMATE The best system yet, it works. . . create and/or animate shape tables like a dream. **39.95**

THE CREATIVITY TOOL BOX Draw, write poetry, music. Includes Action Sounds, Hi-Res Scrolling, routines, shape tables and shape view program, utilities, animation demo, and fonts. 3 diskfuls, 88 page manual. **44.95**

BLOCK SHAPES FOR APPLESOFT OR ASSEMBLY There is no package available today that gives computer customers what they want in the area of graphics. The crying need here, according to our customers, is for a learning package that quits ignoring the one subject that everyone seems to be trying to keep a deep dark secret; assembly & machine language graphics! The **BLOCK SHAPES FOR APPLESOFT OR**

ASSEMBLY package is chock full of programs to create and animate all types of shapes, such as vector shapes, block-shapes, H-plot-shapes, text file shapes, data array shapes, etc. Included in **BLOCK SHAPES FOR APPLESOFT OR ASSEMBLY** are shape examining, shape editing, shape drawing, music tone routines, violin sounds, noise creation, assembly language sounds, **SUPERFONT** and font using, and a **Y TABLE** for either page of hi-res that allows extra speed in machine language programs since you avoid the **HPOSN** subroutine. Plus colorful routines. You may never need to buy another graphics package again...because you'll finally *have a handle on what it's all about!!!!* **BLOCK SHAPES FOR APPLESOFT OR ASSEMBLY** available this fall (1981). 4 disks with over 200 pages of documentation. **Tentative price: 125.00**

Apple II 48K Applesoft ROM*

*Apple is a trademark of Apple Computer, Inc.

GARDE CREATIONS

PRICE BREAKTHROUGH

We've done it again! As a leader in small computer sales we must constantly find new ways to save customers money while offering quality products. Our most popular seller, the Apple II Plus, is now available with 64K of user RAM at the unbeatable price of only \$1249. This is possible because we manufacture the 16K RAM Card that expands the factory Apple II 48K to it's maximum capacity of 64K. The Ram Card allows use of Integer and Applesoft Basic and other languages like Pascal. It's a must for large data bases, Visicalc, and the Z-80 cards. The card is made from high quality components and has a full one year warranty.

64K APPLE II PLUS*

*48 K Apple II Plus with 16K Ram Card

ONLY \$1249

16K ONLY \$1025 **48K ONLY \$1089**

DISK II DRIVE WITH CONTROLLER CARD **\$499**

DISK II DRIVE ADD ON **\$439**



FREE SHIPPING*
*on all pre-paid cash orders

Apple Cards and Hardware

16K Ram Card by CCI	130
Language System w/Pascal	379
Silentye Printer w/Interface Card	349
Hayes Micromodem II	299
Novation Apple-Cat II	339
Videx Videoterm 80 Column w/Graphics	269
Z-80 Softcard by Microsoft	299
16K RamCard by Microsoft	159
ABT Numeric Keypad (old or new kybrd)	110
ALF 3 Voice Music Card	239
ALF 9 Voice Music Card	169
Lazer Lower Case Plus +	55
Micro-Sci Disk Drives (A-40 & A-70)	CALL
SSM AIO Serial/Parallel Card A&T	189
Sup-R-Terminal 80 Column Card	329
SVA 2VX4 Megabyte 8" Disk Controller	589
SVA 2+2 Single Den. 8" Disk Controller	345
ThunderClock Plus	119
Syntec Hi-Res Light Pen	210
Integer or Applesoft Firmware Card	145
Graphics Tablet	619
Parallel Printer Interface Card	135
Hi-Speed Serial Interface Card	135
Smarterm 80 Column Card	299
Joystick by Keyboard Co.	45
Music System (16 Voices)	479
A/D + D/A Interface	289
Expansion Chassis	599
Introl/X-10 Controller Card	169
Clock/Calendar Card	225
CPS Multi-function Card	189
Supertalker SD-200	239
Romplus + Card	135
Romwriter Card	149
Clock/Calendar Module	99
GPiB IEEE-488 Card	249
Asynchronous Serial Interface Card	129
Centronics Parallel Interface Card	99
Arithmetic Processor Card	299

We carry all CCS cards, please call for best prices.

Software for the Apple

Visicalc 3.3	169
CCA Data Management	85
DB Master	169
WordStar (Apple 80 col. version)	299
Applewriter	65
Easywriter	225
Peachtree Business Software	CALL
Visitem	129
Vistrend/Visplot	219
Real Estate Analyzer	89
Tax Preparer	99
DOS Toolkit	65
Tax Planner	99
Dow Jones Portfolio Evaluator	45
Dow Jones News & Quotes Reporter	85
Apple Fortran	165
Controller Gen. Bus. System	499

Printers

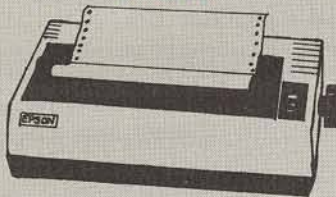

Epson MX-80 CALL

Anadex 9500/9501 w/2K Buffer	1299
C. Itoh Starwriter 25 CPS	1499
C. Itoh Starwriter 45 CPS	1899
Epson MX-70	CALL
Epson MX-80 F/T	CALL
Paper Tiger IDS-445	699
Paper Tiger IDS-460	949
Paper Tiger IDS-560	1249
Silentye w/Apple II interface card	349
Qume Sprint 5/45	2495

TOLL FREE ORDER LINE
800-854-6654

California and outside
Continental US
(714) 698-8088
TELEX 695000 BETA CCMO

Video Monitors

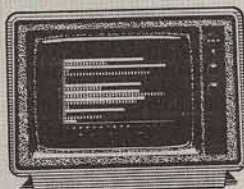

Amdek/Leedex Video 100 12" B&W	139
Amdek (Hitachi) 13" Color	359
NEC 12" Green Phosphor Screen	CALL
NEC 12" RGB Hi-Res Color	CALL
Panasonic 13" Color	449
Sanyo 9" B&W	185
Sanyo 9" Green Phosphor Screen	CALL
Sanyo 12" B&W	269
Sanyo 12" Green Phosphor Screen	285
Sanyo 13" Color w/excellent resolution	449

Atari Personal Computer



ATARI 800 16K \$749

Atari 400 16K	349
410 Program Recorder	65
810 Disk Drive	449
815 Dual Disk Drive (Dbl. Den.)	1295
822 Thermal Printer	349
850 Interface Module	159
16K Ram Memory Module	149
16K Ram Memory Module (by ConComp)	89

NEC Microcomputer



PC-8001A 32K Ram Computer	CALL
PC-8012A I/O Unit w/32K Ram	CALL
PC-8031A Dual Mini-Disk Drive Unit	CALL

Please write for more information about the NEC computer.

Ordering information: Phone orders using VISA, MASTERCARD, AMERICAN EXPRESS, DINER'S CLUB, CARTE BLANCHE, bank wire transfer, cashier's or certified check, money order, or personal check (allow ten days to clear). Unless prepaid with cash, please add 5% for shipping, handling and insurance. (minimum 5.00). California residents add 6% sales tax. We accept CODs. OEM's, Institutions and corporations please send for a written quotation. All equipment is subject to price change and availability without notice. All equipment is new and complete with manufacturer's warranty (usually 90 days). Showroom prices may differ from mail order prices.

Send Orders to:

consumer computers Mail Order

8314 Parkway Drive
La Mesa, California 92041

MICRO

From Here to Atari

James Capparell
297 Missouri
San Francisco, California 94107

My purpose in writing this column is to give potential microcomputer users enough information on the Atari 800 to provide a basis of comparison to other micros. I want to point out the features that convinced me that the 800 is perhaps the most-for-your-money machine on the market. I also think it is the best graphics machine in its price range. The smaller 400 unit, while possessing a difficult (for touch typists) keyboard, has so many of its bigger brother's features that I feel it may be the single best buy in the entire computer industry.

The following will apply to both 400 and 800 units unless noted.

When you look closely at this equipment, you'll notice that the design engineers went to considerable effort to put together a system that is sophisticated and versatile, yet easy to use for the novice. This system is modular and therefore easily expandable. The designers even built the TV modulator into the chassis. This device allows you to connect your television to your computer. Many manufacturers force you to pay extra for the modulator even though it's absolutely essential for proper connection to your home television.

A second video output is available (800 only), allowing the connection of another monitor. This second port provides composite color/luminance and therefore a generally better picture. The two pictures are handy in teacher/student situations or any place where two pictures are better than one.

While on the topic of video, Atari puts out a clean NTSC (National Television Systems Committee) standard video signal suitable for home video taping. This is accomplished via the DIN plug (800 only) on the side of the console. Other machines need special adapter boards to do the same thing.

Atari was one of the first companies to pass FCC RFI emission standards. You can safely use this machine at home and not fear your neighbor's wrath when he can't watch his favorite television show due to interference from your computer. Many manufacturers had to redesign equipment to meet these stringent requirements, at an added cost to buyers. Again, Atari engineers demonstrated their design foresight.

Another video feature not readily apparent to the casual observer is the allowance for misaligned televisions. By including a border around the displayable screen image, Atari engineers have assured us that when we use VisiCalc the numbers won't disappear into the invisible portion of the screen. This border is under programmer control.

One last design feature that even many Atari owners don't yet appreciate is something euphemistically called ATTRACT MODE. This is that strange habit that causes the Atari to begin to rotate through all of its colors when no one has pressed on the keyboard in the previous nine minutes. This feature was included to prevent any one phosphor from burning out.

I can't speak about this equipment without mentioning graphics. The incredible features are due to a trio of large-scale integrated circuits designed specifically by and for Atari. These chips make twenty different graphics/text combinations available (depending on memory available). The high-resolution mode is 320 horizontal dots by 192 vertical lines. Actually, there is a way to get more than this (recall the border), but I'll leave this technique for a future column.

There are two channels of DMA (direct memory access) video available. There are 128 color luminance combinations and all may be on the screen at one time. To be fair, there are constraints when using so many colors and the techniques will probably only be used by intermediate to advanced programmers. Also available are priority and collision registers that allow advanced animation techniques to be used.

The character set can be completely redefined by the user. This will allow creation of such things as foreign alphabets or special mathematics characters. Available to advanced users is hardware-controlled smooth scrolling in any direction, display list-driven playfield graphics, display list interrupts — all advanced techniques suitable for future columns.

Standard on these machines is a set of parallel ports usually referred to as the front jacks. These are ports A and B of a 6820 PIA. They allow the connection of a variety of input devices. Light pen, barcode reader, graphics tablets, and printers all have been implemented using these jacks. Also, the standard joystick and paddle controller plug in here. In addition, there is a serial port included to which a printer, disk, cassette, and modem may be added. To include all these peripherals, you must purchase an I/O expansion unit.

The console comes complete with an upper/lower case keyboard with a feel that touch typists seem to like. (Note that the 400 has a flat keyboard more appropriate for youngsters.) With this keyboard is an easy-to-use screen-oriented editor with full cursor control. This makes BASIC, assembler FORTH, Pascal or Pilot easy to enter and correct.

The 400 and 800 units also have four voices, or channels of sound, available. This allows you to play four-part harmony, or to include special sound effects in your latest program. The sound feature is readily available in BASIC. I've heard everything from Beethoven's *Fifth* to the latest in phaser sounds on my machine.

In conclusion, I'd recommend the Atari 800 to anyone really serious about using state-of-the-art graphics. This includes all game players, as well as experimenter/hacker types. Also, those of you interested in experimenting with video taping must consider this machine. For potential users looking for business software, I've seen and heard of some excellent packages to be released soon. These include a full general ledger system, word processor and data base system for starters. I would not hesitate

to suggest this equipment to those of you who would like to have a very flexible tool without becoming professional computer programmers. From the standpoint of ease-of-use, its modular design, and of course its state-of-the-art components, it's a machine you can live with.

The 400, since it has almost as much capability as its bigger brother, must be seriously considered, and in fact may be the only machine to consider in the under \$500 price range. If you are not sure about your needs and don't want to spend much, yet still want all the frills that the rest of us have come to expect, the 400 is perfect.

I hope I've managed to convey the excellent combination of features and price. More of us are discovering this and my intent here is to raise issues of comparison. Now, when your friendly dealer attempts to sway you to purchase some other equipment you will be able to do some intelligent comparison shopping. (Please see summary table for these features, as well as a few additional ones.)

I intend to be doing a regular column for MICRO. Some of these advanced features will make excellent articles. I welcome suggestions and questions.

Summary Table: Atari Features

1. Full screen editor
2. Full upper/lower case typewriter-like keyboard
3. Full cursor control: up, down, left, right
4. Complete RFI shielding
5. Built-in TV modulator
6. NTSC standard signal, suitable for video taping
7. Second video output (available on the 800)
8. Protection against phosphor burn on home TVs
9. 128 color/luminance combinations available
10. Twenty different graphics/text combinations available
11. Maximum resolution of 320 x 192
12. Two DMA video channels available
13. Capability of placing eight small objects on screen all with independent color, position, and priority control registers (known as player/missiles)
14. Hardware-controlled smooth scrolling
15. Built-in real time clock and four additional counters
16. Display is list-driven, bit-mapped video (known as playfield graphics)
17. Interrupt-driven system with many hooks available to programmer (e.g. vertical, blank, or scan line interrupts are accessible)
18. Four channels of sound are standard with frequency, volume, and distortion control in BASIC. Envelope shaping is possible from machine level code
19. The separate voice channel available on cassette recorder is suitable for educational purposes
20. Parallel port built in
21. Serial port built in

MICRO

EXTRAORDINARY INTRODUCTORY OFFER

FOR NEW SUBSCRIBERS

Alphabetical Index
Key Word Finder
Bulletin Boards
Users, User Groups & Associations

Contents

1981

1- Introduction

2- How to use & participate

3- Letters

4- White Pages (who's who?)

5- Yellow Pages (where's who?)

White Pages

Yellow Pages

FOR JUST \$10.00 YOU GET:

1) a Free copy of current issue

2) a One Year Subscription!

3) a Free 25 word White Page Listing!

4) \$5.00 Credit on a Yellow Page Listing!

5) \$10.00 Credit towards any size Display Ad!

Total Value = \$28.50

Save \$18.50 and Join the Information Revolution. **Subscribe Now**

VISA
 MASTER CHARGE
 AMERICAN EXP.

ACCOUNT NO.
 EXPIRES
 SIGNATURE
 CITY
 STATE
 ZIP

Send me Display ad rates store order form

ENCLOSED \$

the Computerist's Directory

PO BOX 405
FORESTVILLE, CA 95436
(707) 887-1857

Let your fingers do the talking

What is the Computerist's Directory?

It is a national "paper data base" in phone book format dedicated to all computer users including professionals, business people, hobbyists and prospective buyers. It is published twice annually in January and July with quarterly update dates planned for April '82.

ATARI® SOFTWARE PIRACY: THIS GAME IS OVER.

ATARI® has led the industry in the development of video games such as ASTEROIDS™ and MISSILE COMMAND.™ The outstanding popularity of these games has resulted from the considerable investment of time and resources which ATARI has made in their development. We appreciate the worldwide response from the videophiles who have made our games so popular.

Unfortunately, however, some companies and individuals have copied ATARI games in an attempt to reap undeserved profits from games that they did not develop. ATARI must protect its investment so that we can continue to invest in the development of new and better games. Accordingly, ATARI gives warning to both the intentional pirate and to the individuals simply unaware of the copyright laws that ATARI registers the audiovisual works associated with its games with the Library of Congress and considers its games proprietary. ATARI will protect its rights by vigorously enforcing these copyrights and by taking the appropriate action against unauthorized entities who reproduce or adapt substantial copies of ATARI games, regardless of what computer or other apparatus is used in their performance.

We ask that legitimate software developers cooperate with us to protect our property from any form of software piracy, imitation or infringement. ATARI is currently offering copyright licenses for a limited number of its games to selected software developers. If you happen to be selling a software product which performs a game similar to any ATARI game (such as a game created for a home computer), please contact us immediately. Write to the attention of: Patent Counsel, ATARI, Inc., 1265 Borregas Ave., Sunnyvale, Calif. 94086



 A Warner Communications Company

© 1981, ATARI, INC.

6522-Based Pot Position Digitizer

This article describes a simple method of converting the position of a potentiometer into a number that can be used by the programmer for control applications or games. The method uses the pulse-counting capability of a 6522 and almost any inexpensive VCO.

Figure 1: Block diagram of a simple Pot Position Digitizer (PPD).

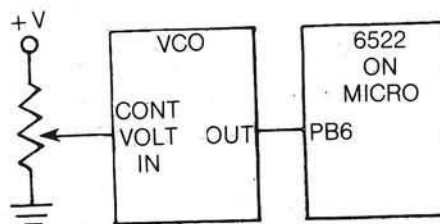

Kenny Winograd
Seven Greenbriar
N. Reading, Mass. 01864

This article will detail a basic method of digitizing the position of a pot (potentiometer). A Pot Position Digitizer (PPD), in its most general terms, is simply a device which converts the position of a pot to a number which can be used by a computer program.

Many quantities we deal with every day are often set by the turning of a knob, not by the inputting of an actual number. Examples include the volume setting on your stereo, the setting of a lamp dimmer, a steering wheel, the position of a paddle in a TV game, etc. Knowing that a quantity represents a minimum amount may be more important than knowing the exact quantity.

You may want a PPD that gives the number \$00 if the pot is turned fully counter-clockwise and the number \$FF if the pot is turned fully clockwise. This number may represent anything from the initial fuel on-board in a lunar lander game to the number of microseconds to remain in a delay loop. (Numbers that follow a dollar sign -\$ indicate hexadecimal numbers.)

A block diagram of the system is shown in figure 1. It is simply a variable

voltage from a potentiometer feeding a voltage controlled oscillator (VCO) which feeds a single input pin of a 6522 Versatile Interface Adapter chip (VIA). I've chosen the single input pin to be PB6 so I could take advantage of the external pulse counting capability of this pin on a 6522. (More on this later.)

The whole idea is this: first, write a short program that counts the number of pulses entering PB6 in, say, 10 milliseconds. Then adjust the VCO so that when the pot is at its maximum position, the VCO will send out 255 pulses in 10 milliseconds. When the pot is at its minimum position, the VCO doesn't send out any pulses. That's it. Every time we use this code (which I've made into a subroutine), we are left with a number which represents the position of the pot.

This article will introduce you to a simple VCO circuit, as well as take you through a bit of software. The software will be used to "read" (actually, count) the pulses produced by the VCO. Now let's get to some specifics.

Hardware

A VCO feeds pulses to the microcomputer. (VCOs are also called Voltage to Frequency Converters or V to Fs — same thing.) In order to get 255 pulses in 10 milliseconds, we'll need a top frequency of at least 25500 Hz. To give us a bit of leeway, let's say we try

for 26000 Hz. In this way we can be assured that when the pot is at its maximum position, in 10 milliseconds we will be able to count just a bit more than \$FF pulses. Otherwise you may turn the pot to maximum and never get to \$FF. \$FE might be the highest number obtainable.

We don't want to go too much higher than the calculated value of 25500 Hz, because we would end up with a large dead band. A dead band would mean that when adjusting the pot upward, we would reach \$FF and still have more rotation to go with the number remaining unchanged. As we'll find out later, this won't be much of a problem. I've included some software that will make calibration of the VCO simple.

Figure 2 shows the schematic of a VCO based on the CMOS chip 4046. The 4046 will run on +5 volts and requires virtually no current. This chip also incorporates a couple of phase detectors, a zener diode and more. These extra circuits on the chip we either leave disconnected or properly terminated.

With the pot at its minimum position (i.e. ground) the VCO produces no pulses... a frequency of 0 Hz. With the pot at its maximum position (i.e. 5 volts) the VCO produces its maximum frequency. This maximum frequency is determined by two things: the value of the capacitor connected between pins 6 and 7 of the chip, and the value of

resistance from pin 11 to ground. The components shown, permit a maximum frequency of 26000 Hz. If you want to be on the safe side, or just experiment a little, you can change the resistance on pin 11 to be a 10K fixed resistor and a 100K ten-turn trimmer. Now you'll have a

very large range of adjustment in the event of problems with capacitor tolerance. A .001 microfarad disk cap may actually measure out as a .002 microfarad cap, especially if you use old "junk-box" parts, which is fine, as long as we account for it. The equation for

the maximum frequency of the circuit shown in figure 2 (with the pot turned up to maximum) is as follows:

$$f_{\max} = \frac{1}{R(C + 32pF)}$$

If you feel like doing a little math (watch the units), you can verify that with the components shown (C = .001 microfarads and R = 38K with the trimmer at midpoint), the maximum frequency works out to be about 25500 Hz. If you do a little experimenting with this VCO, realize that even the CMOS data book states that this equation should only be used as a guide. It is also only valid if R is between 10K and 1M, and C is between 100 picofarads and .01 microfarads.

The 4046 VCO input resistance is very high, so virtually any value pot may be used. I've shown a 100K pot, but you can try anything from a 10K to a 1M pot.

Since the 4046 is a CMOS chip, we must make the output of the VCO compatible with the TTL input (PB6 on the 6522). I did this using a CMOS buffer. A 4049 or a 4050 may be used for this purpose.

Software

The code that I've written takes full advantage of the two interval timers within a 6522 VIA chip. Since I own a SYM-based microcomputer system, the code is perfectly compatible with a SYM. If you own any other 6502-based computer with a 6522, the code is again compatible as long as you change the addresses of the 6522 internal registers to fit your memory map. I used SYM VIA #2 (PB6 = pin AA-H).

The code is written in the form of a subroutine, and is fully relocatable and PROM-able. By PROM-able, I mean that there are no locations within the body of the subroutine that get written into, so that the code can reside in read only memory. The only internal registers in the 6502 used by the subroutine are the accumulator and the flag register, and these are preserved by the subroutine.

The basic functions that the POT-DIG subroutine must perform are as follows: 1) set up the T2 timer to count externally input pulses on PB6, 2) set up the T1 timer to count to 10 milliseconds (in this example), 3) after T1 times out, determine how many pulses were counted on PB6, and 4) make this number available for use by the main program. That's basically all there is to it, except for one thing.

Figure 2: Schematic of a VCO based on a CMOS phase-locked-loop chip, a 4046.

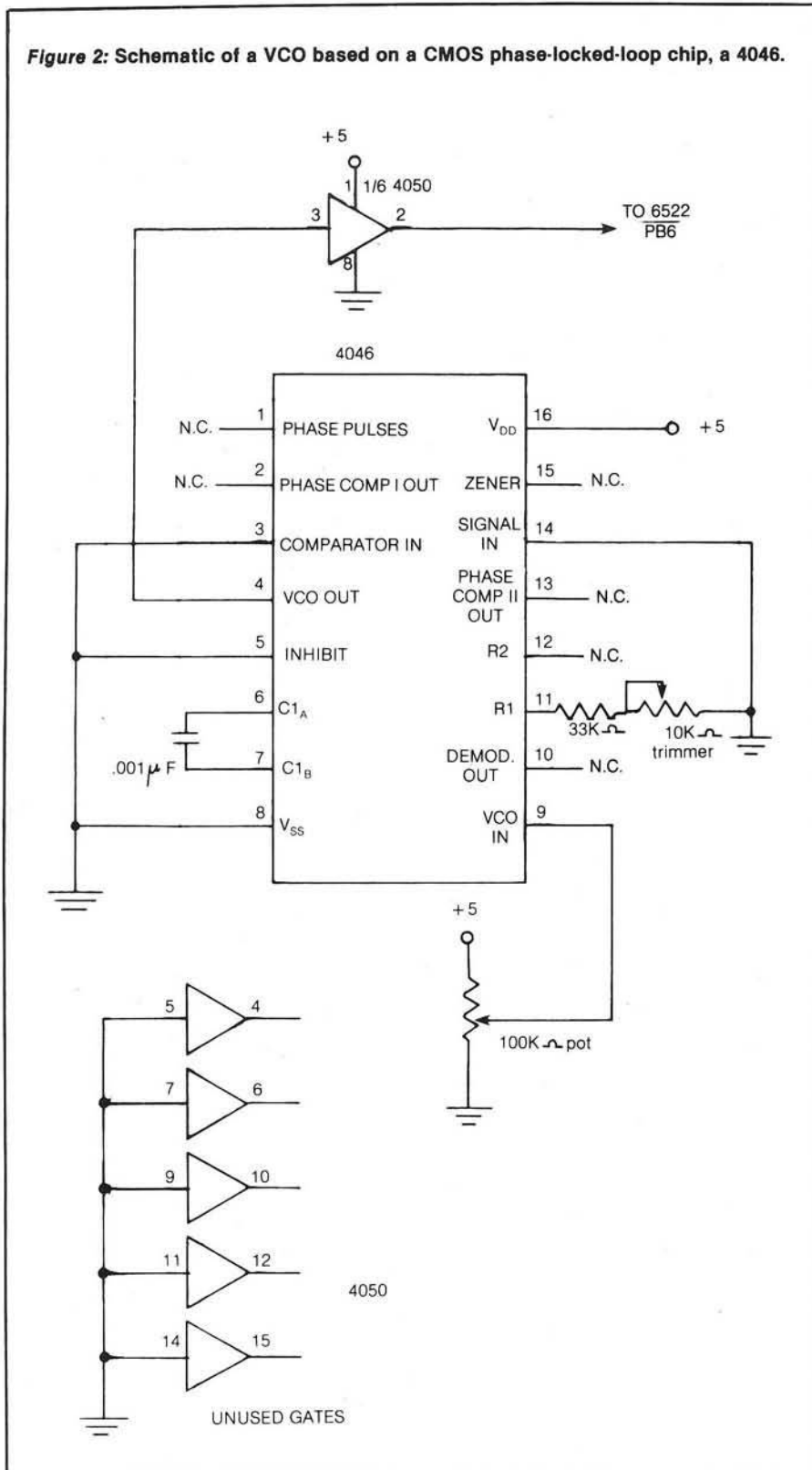

I've added a little code called OPTION. Here is where you can personalize the PPD to your heart's content. The code shown will only allow numbers from \$01 through \$FF. I chose to disallow \$00 since if I use the PPD output number (stored in HEXLO) in a delay loop and do a decrement before a test for zero, a \$00 decremented will become a \$FF and I may go through a loop \$100 times and not \$00 times. Your option code may only allow numbers from \$00 to \$FE because of trouble with increment before test for zero instructions.

You may also want to scale the numbers differently. For instance, if instead of \$01 to \$FF, you wanted numbers in the range of \$00 through \$0F, you could take the PPD output number and shift it to the right four places. (1111 1111 would become 0000 1111; that is, a \$FF would become a \$0F.)

One more example of a different OPTION code would be if only numbers from \$80 through \$FF were wanted. Take the PPD output number, shift it one bit to the right (which divides the number by two), and add it to \$80. This would result in numbers from \$80 through \$FF.

The subroutine POTDIG, after saving any registers that will be used, sets up bit 6 of port B (PB6) as an input pin. Then it puts PB6 (T2) in the external pulse counting mode by storing a one in bit 5 of the Auxiliary Control Register (ACR). Note that the same instruction (LDA #\$20) also stored a zero in bits 6 and 7 of the ACR putting the T1 timer in the mode that generates a single interrupt. The next pair of instructions clears the T1 and T2 interrupt enables. The interrupt ability of the 6522 chip is not required in this example.

The next section of code loads the two timers, clears the T1 and T2 interrupt flags and starts the counting. The T1 counter is used to "gate" the external pulses to PB6. Actually PB6 will always be looking at pulses, but they will only be counted until T1 times out. I've loaded \$270F into the latches of T1. If you recall, the timers actually count down and do not flag you until they count through zero, not at zero. Thus, T1 will not time out until \$2710 microseconds. (\$2710 microseconds = 10000 microseconds = 10 milliseconds.) I've loaded \$FF into T2LL and T2CH. This count, \$FFFF, will be decremented automatically by each incoming negative pulse on PB6. Later, after T1 times out, we'll calculate how far T2 has counted down to learn how many pulses arrived at PB6.

Listing 1

```

;* POT POSITION DIGITIZER SUBROUTINE *
;*
;*          BY KENNY WINOGRAD          *
PBDD EQU $A802      ;ALL ADDRESSES OF THE FORM $A8XX
T1LL EQU $A804      ; REFER TO THE INTERNAL REGISTERS
T1CL EQU $A804      ; OF THE SELECTED 6522 CHIP
T1LH EQU $A805
T2LL EQU $A808
T2CL EQU $A808
T2CH EQU $A809
ACR EQU $A80B
IFR EQU $A80D
IER EQU $A80E
HEXLO EPZ $00      ;FINAL POTDIG OUTPUT NUMBER LOC.
HEXHI EPZ $01      ;HI-ORDER WORKING STORAGE LOC.
;
;          ORG $300
;          OBJ $800
;
;
; POTDIG PHP          ;SAVE FLAGS
;          PHA          ;SAVE ACCUMULATOR
;          LDA PBDD     ;ENSURE PB6 IS SET AS INPUT BIT
;                   ;AND LEAVE OTHER BITS ALONE
;          AND #$10111111
;          STA PBDD
;          LDA #$00100000 ;SET PB6 (T2) TO PULSE COUNT MODE
;          STA ACR
;          LDA #$01100000 ;CLEAR T1 & T2 INTERRUPT ENABLES
;          STA IER
;
; NOTE: $270F+$0001=$2710 MICROSEC.=10 MILLISEC.
;
;          LDA #$0F          ;LOAD T1 COUNTER WITH $270F
;                   ;CLEAR T1
;                   ;INTERRUPT FLAG AND START COUNTING
;          STA T1LL
;          LDA #$27
;          STA T1LH          ;DOWN AT SYSTEM CLOCK RATE
;          LDA #$FF
;          STA T2LL          ;LOAD T2 COUNTER WITH $FFFF;
;                   ;CLEAR T2
;                   ;INTERRUPT FLAG & GO COUNT PB6
;                   ;PULSES
;                   ;CHECK IFR--HAS T1 TIMED OUT?
;                   ;NO, KEEP CHECKING
;                   ;YES, GO FIGURE # OF PB6 PULSES
;                   ;COUNTED
;                   ;PREPARE FOR SUBTRACTION
;                   ;GET LO-ORDER COUNT AND
;                   ;CLEAR T2 INTERRUPT FLAG.
;                   ;STORE LO AT HEXLO IN ZERO PAGE
;          LDA IFR
;          AND #$01000000
;          BEQ WAIT
;          SEC
;          LDA #$FF
;          SBC T2CL
;          STA HEXLO
;          NOP
;          LDA #$FF
;          SBC T2CH          ;FIGURE HI-ORDER COUNT
;          STA HEXHI        ;STORE IT IN HEXHI IN ZERO PAGE
;          NOP
;          LDA T1CL         ;CLEAR T1 INTERRUPT FLAG BEFORE
;                   ;LEAVING
;
; THE OPTION CODE THAT FOLLOWS ENSURES THAT ON LEAVING
; THIS SUBROUTINE, THE DIGITIZED POT COUNT WILL BE
; BETWEEN $01 AND $FF.
;          OPTION LDA HEXHI ;TEST FOR GREATER THAN $FF
;                   ;BY LOOKING
;          NOP
;          BEQ OPTA          ; FOR A NON-ZERO HI-ORDER BYTE
;          LDA #$FF          ; IF GREATER THAN $FF, SET TO $FF
;          STA HEXLO
;          NOP
;          BNE OKAY
;
;          ;
;          OPTA LDA HEXLO   ;IF LOW-ORDER BYTE EQUALS ZERO,
;          NOP
;          BNE OKAY        ; SET EQUAL TO $01. IF NOT,
;          LDA #$01        ; LEAVE AS IS.
;          STA HEXLO
;          NOP
;
;          ;
;          OKAY PLA          ;RESTORE ACCUMULATOR
;          PLP              ;RESTORE FLAGS
;          RTS              ;RETURN TO MAIN PROGRAM
;          END

```

The small loop, starting at WAIT, keeps checking to see when the T1 interrupt flag is set in the Interrupt Flag Register (IFR). When set, it's time to find out how many pulses got through. Since we are dealing with a counter that starts at \$FFFF and counts down, we subtract the numbers in the T2 counter from \$FFFF, leaving us with the proper count. I've stored this 16-bit number in zero page locations \$00 and \$01, also known as HEXLO and HEXHI. These two locations may be changed to two other locations somewhere else in zero page if they conflict with other program use. After each STA ZERO PAGE instruction, I've put a NOP instruction just in case you want to use a different addressing mode to store these numbers at the top of your RAM. At this point in the subroutine, the T1 interrupt flag is cleared by reading the contents of T1CL.

Let's review a bit. If all we want to get out of this routine is a number from \$01 through \$FF, why do we need two bytes to store it in? Well, remember I

recommended earlier that you set the maximum frequency of the VCO just slightly higher than the calculated frequency so as to be sure that you can get the maximum count by turning the pot to maximum. If we just used the low order counter of T2 and the VCO was a bit fast (on purpose or not), we may read a value of, say, \$03 and not know that what we really have is \$103. Now, in the code labelled OPTION, we test for just that kind of thing. If we find the high order byte to be anything other than zero, we know our final answer (in HEXLO), should be \$FF. If we find the high byte is zero, then we work on the low byte (which we know must be between \$00 and \$FF). Here, as previously mentioned, I chose to ensure that the lowest number possible is \$01, thus dis-allowing a \$00. If I find a \$00, I make it a \$01

The OPTION part of the code is personalized for an application of mine. You should make it compatible with what you'd like. Restore the previously saved registers and return to the calling program.

I've assumed in the previous discussion that you are already, at least, somewhat familiar with the workings of the two timers on the 6522. If this not be the case, try reading the article by Marvin L. DeJong in MICRO (17:27) called "6522 Timing and Counting Techniques." It reads a lot easier than the 6522 data sheet.

One reminder... if you change POT-DIG to use a VIA other than the one I used, be sure you connect the output of the VCO to the correct PB6 pin.

Calibration

If you own a frequency counter, calibration can be performed in about two seconds flat. Power up your VCO, connect the frequency counter to the output of the VCO, turn the PPD pot up to maximum and adjust the VCO trimmer until you read somewhere between 25500 Hz and 26000 Hz.

(continued)

K I M A I M S Y M T I M

END FRUSTRATION!!

FROM CASSETTE FAILURES
PERRY PERIPHERALS HAS
THE HDE SOLUTION
OMNIDISK SYSTEMS (5" and 8")

ACCLAIMED HDE SOFTWARE

- Assembler, Dynamic Debugging Tool, Text Output Processor, Comprehensive Memory Test
- HDE DISK BASIC NOW AVAILABLE PERRY PERIPHERALS S-100 PACKAGE

Adds Omnidisk (5") to
Your KIM/S-100 System

- Construction Manual—No Parts
- FODS & TED Diskette
- \$20. +\$2. postage & handling. (NY residents add 7% tax) (specify for 1 or 2 drive system)

Place your order with:
PERRY PERIPHERALS
P.O. Box 924
Miller Place, N.Y. 11764
(516) 744-6462

Your Full-Line HDE Distributor/Exporter

PANORAMAS!

with

GRAF-PAK

HI-RES GRAPHICS DUMP ROUTINES

Easy to Use! Multiple Scale Factors!
Precise Reproduction! Normal/Inverse Inking!

Dump either page one or page two, horizontally or vertically on the paper; or, dump both as a two page panorama with both pages butted in perfect registration. Compatible with I/O cards from Apple, Epson, SSM, Tymac, California Computer and Mountain Computer.

SCALE FACTORS PROVIDED

PRINTERS SUPPORTED	PANORAMIC or VERT					HORIZ			POST-PAID PRICE
	1X	2X	3X	4X	5X	1X	2X	3X	
DP9000	•	•				•	•		29.95
DP9001	•	•	•			•	•		39.95
DP9500	•	•	•	•		•	•		44.95
DP9501	•	•	•	•	•	•	•	•	49.95
MX70	•	•				•	•		29.95
MX80	•	•				•	•		29.95
MX100	•	•	•			•	•		44.95
IDS440	•	•				•	•		29.95
IDS445	•	•				•	•		29.95
IDS460	•	•	•			•	•	•	39.95
IDS560	•	•	•	•	•	•	•	•	49.95

SmartWare

2281 Cobble Stone Court

Dayton, Ohio 45431

513/426-3579

Dealer Inquiries Invited!

If you don't have a frequency counter, use a simple program that repetitively calls POTDIG, gets the final result from HEXLO, displays it for a while and then jumps back to the beginning. The program can be used for calibration. I've included the listing of a short program that does this for a SYM using some monitor subroutines (see listing 2).

When this code is executed, turn the pot back and forth and watch the displayed numbers go up and down. GO = \$0200. This code will work with either the SYM 7-segment display or the video monitor or TTY. The method of display will, of course, appear differently but calibration is easily done either way. The procedure is to turn the pot up to maximum and adjust the VCO trimmer a little bit higher than what is needed to get a solid display of \$F's. All of a sudden your display device will become very stable... it will look less like garbage. At first, you probably must have thought that either you entered something wrong or I was nuts. If you're using the SYM 7-segment display, you'll always note a little flicker because every time POTDIG is called, about 10 milliseconds go by before the display is scanned again for a while.

Listing 2

```

;*****
;*
;* A SIMPLE CALIBRATION AID-- *
;* MAIN PROGRAM FOR A SYM *
;* *
;* BY KENNY WINOGRAD *
;* *
;*****
;*
ACCESS EQU $8B86 ;UNWRITE-PROTECT SYSTEM RAM
CRLF EQU $834D ;CARRIAGE RETURN-LINE FEED
OUTBYT EQU $82FA ;OUTPUT ACC. AS TWO HEX DIGITS
SCAND EQU $8906 ;SCAN SYM 7-SEG DISPLAY
;
POTDIG EQU $300 ;POT POS. DIGITIZER SUBR. LOC.
;
TEMP EPZ $03 ;TEMPORARY STORAGE
HEXLO EPZ $00 ;POT DIG. NUMBER OUTPUT LOC.
;
0800 20868B CALIB JSR ACCESS
0803 200003 JSR POTDIG
0806 A500 LDA HEXLO ;GET POTDIG OUTPUT #
0808 EA NOP
0809 20FA82 JSR OUTBYT ;OUTPUT IT
080C 204D83 JSR CRLF
080F A9FF LDA #$FF
0811 8503 STA TEMP
0813 ;
0813 200689 LOOP JSR SCAND ;DISPLAY IT AND DELAY FOR A WHILE
0816 C603 DEC TEMP
0818 D0F9 BNE LOOP
081A F0E4 BEQ CALIB ;GO BACK AND DO THE SAME THING
END AGAIN.

```

MICRO

Higher Text II

from

Synergistic Software



Do your screen displays attract the attention they deserve? They will if you use Higher Text] [.

With Higher Text] [, your text displays can be **BIG, TALL, WIDE,**

COLORFUL, and in an unlimited variety of character styles.

OLD FASHIONED: A\$@

FUTURISTIC: AOO

FANCY: \$HQ

FOREIGN: Σ X ε φ

FUN: † @ @ †

UNUSUAL: LOOK

Higher Text] [allows you to display text (fanciful or businesslike) on the Apple II's* high resolution graphics screen. Full upper/lower case 96 character fonts (character sets) can easily be incorporated into other programs for applications as varied as: foreign language translation, labeling graphs or maps; creating eye catching, easy to read promotional messages, displaying scientific, mathematic or computer symbols (such as APL) which aren't available from the normal Apple keyboard; games; animation; and many, many more.

Enliven your programs with that extra touch of professionalism with Higher Text] [. Only \$40, it works on any Apple II or Apple II Plus with any DOS, 32K RAM, and one disk drive. Some of the fonts shown above are provided on Higher Fonts I. Higher Fonts I is available separately and provides 25 additional character sets for use with Higher Text or Higher Text II for just \$15.00.

Available at your local dealer or send check or inquiry to **Synergistic Software**, 5221 120th Ave. S.E., Bellevue, WA 98006, 206-226-3216. Washington residents add 5.4% sales tax.

*Apple II is a trademark of Apple Computer, Inc.

AARDVARK NOW MEANS BUSINESS!

WORD PROCESSING THE EASY WAY— WITH MAXI-PROS

This is a line-oriented word processor designed for the office that doesn't want to send every new girl out for training in how to type a letter.

It has automatic right and left margin justification and lets you vary the width and margins during printing. It has automatic pagination and automatic page numbering. It will print any text single, double or triple spaced and has text centering commands. It will make any number of multiple copies or chain files together to print an entire disk of data at one time.

MAXI-PROS has both global and line edit capability and the polled keyboard versions contain a corrected keyboard routine that make the OSI keyboard decode as a standard typewriter keyboard.

MAXI-PROS also has sophisticated file capabilities. It can access a file for names and addresses, stop for inputs, and print form letters. It has file merging capabilities so that it can store and combine paragraphs and pages in any order.

Best of all, it is in BASIC (OS65D 51/4" or 8" disk) so that it can be easily adapted to any printer or printing job and so that it can be sold for a measly price.

MAXI-PROS — \$39.95

NEW-NEW-NEW TINY COMPILER

The easy way to speed in your programs. The tiny compiler lets you write and debug your program in Basic and then automatically compiles a Machine Code version that runs from 50-150 times faster. The tiny compiler generates relocatable, native, transportable machine code that can be run on any 6502 system.

It does have some limitations. It is memory hungry — 8K is the minimum sized system that can run the Compiler. It also handles only a limited subset of Basic — about 20 keywords including FOR, NEXT, IF THEN, GOSUB, GOTO, RETURN, END, STOP, USR(X), PEEK, POKE, =, *, /, \, >, <, <>. Variable names A-Z, and Integer Numbers from 0-64K.

TINY COMPILER is written in Basic. It can be modified and augmented by the user. It comes with a 20 page manual.

TINY COMPILER — \$19.95 on tape or disk

THE AARDVARK JOURNAL

FOR OSI USERS — This is a bi-monthly tutorial journal running only articles about OSI systems. Every issue contains programs customized for OSI, tutorials on how to use and modify the system, and reviews of OSI related products. In the last two years we have run articles like these!

- 1) A tutorial on Machine Code for BASIC programmers.
- 2) Complete listings of two word processors for BASIC IN ROM machines.
- 3) Moving the Directory off track 12.
- 4) Listings for 20 game programs for the OSI.
- 5) How to write high speed BASIC — and lots more —

Vol. 1 (1980) 6 back issues - \$9.00

Vol. 2 (1981) 2 back issues and subscription for 4 additional issues - \$9.00.

ACCOUNTS RECEIVABLE — This program will handle up to 420 open accounts. It will age accounts, print invoices (including payment reminders) and give account totals. It can add automatic interest charges and warnings on late accounts, and can automatically provide and calculate volume discounts.

24K and OS65D required, dual disks recommended. Specify system.

Accounts Receivable. \$99.95

*** SPECIAL DEAL — NO LESS! ***

A complete business package for OSI small systems — (C1, C2, C4 or C8). Includes MAXI-PROS, GENERAL LEDGER, INVENTORY, PAYROLL AND ACCOUNTS RECEIVABLE — ALL THE PROGRAMS THE SMALL BUSINESS MAN NEEDS. \$299.95

P.S. We're so confident of the quality of these programs that the documentation contains the programmer's home phone number!

SUPERDISK II

This disk contains a new BEXEC* that boots up with a numbered directory and which allows creation, deletion and renaming of files without calling other programs. It also contains a slight modification to BASIC to allow 14 character file names.

The disk contains a disk manager that contains a disk packer, a hex/dec calculator and several other utilities.

It also has a full screen editor (in machine code on C2P/C4) that makes corrections a snap. We'll also toss in renumbering and program search programs — and sell the whole thing for — SUPERDISK II \$29.95 (5 1/4") \$34.95 (8").

AND FUN, TOO!

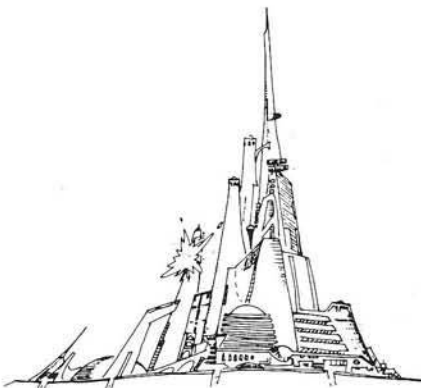

BOOKKEEPING THE EASY WAY — WITH BUSINESS I

Our business package 1 is a set of programs designed for the small businessman who does not have and does not need a full time accountant on his payroll.

This package is built around a **GENERAL LEDGER** program which records all transactions and which provides monthly, quarterly, annual, and year-to-date PROFIT AND LOSS statements. **GENERAL LEDGER** also provides for cash account balancing, provides a **BALANCE SHEET** and has modules for **DEPRECIATION** and **LOAN ACCOUNT** computation. **GENERAL LEDGER (and MODULES)** \$129.95.

PAYROLL is designed to interface with the **GENERAL LEDGER**. It will handle annual records on 30 employees with as many as 6 deductions per employee. **PAYROLL** - \$49.95.

INVENTORY is also designed to interface with the general ledger. This one will provide instant information on suppliers, initial cost and current value of your inventory. It also keeps track of the order points and date of last shipment. **INVENTORY** - \$59.95.

GAMES FOR ALL SYSTEMS

GALAXIAN - 4K - One of the fastest and finest arcade games ever written for the OSI, this one features rows of hard-hitting evasive dogfighting aliens thirsty for your blood. For those who loved (and tired of) Alien Invaders. Specify system — A bargain at \$9.95

NEW — NEW — NEW

LABYRINTH - 8K - This has a display background similar to MINOS as the action takes place in a realistic maze seen from ground level. This is, however, a real time monster hunt as you track down and shoot mobile monsters on foot. Checking out and testing this one was the most fun I've had in years! — \$13.95..

NIGHT RIDER - You've seen similar games in the arcades. You see a winding twisting road ahead as you try to make time and stay on the road. **NIGHT RIDER** uses machine code to generate excellent high speed graphics - by the same author as **MINOS**.

NIGHT RIDER — \$12.95 cassette only

THIEF - Another machine code goody for the C1P cassette only. You must use mobile cannon to protect the valuable jewels in the middle of the screen from increasingly nasty and trigger happy thieves. Fast action and fun for one or two players. **THIEF** \$13.95 on C1 cassette only!

SUPPORT ROMS FOR BASIC IN ROM MACHINES — C1S/C2S. This ROM adds line edit functions, software selectable scroll windows, bell support, choice of OSI or standard keyboard routines, two callable screen clears, and software support for 32-64 characters per line video. Has one character command to switch model 2 C1P from 24 to 48 character line. When installed in C2 or C4 (C2S) requires installation of additional chip. C1P requires only a jumper change. — \$39.95

C1E/C2E similar to above but with extended machine code monitor. — \$59.95

Please specify system on all orders

This is only a partial listing of what we have to offer. We now offer over 100 programs, data sheets, ROMS, and boards for OSI systems. Our \$1.00 catalog lists it all and contains free program listings and programming hints to boot.



OSI

AARDVARK TECHNICAL SERVICES, LTD.
2352 S. Commerce, Walled Lake, MI 48088
(313) 669-3110



OSI

6502 Frequency Counter

Turn your microcomputer into an inexpensive frequency counter using an A/D converter. Demonstration programs for OSI C2-8P are provided.

Phil Lindquist
8892 Cooley Lake Road
Union Lake, Michigan 48085

The Problem

My personal computer for the past year has been an Ohio Scientific Challenger C2-8P with dual floppy disks and an analog I/O board. Recently, while checking the operation of a new modem circuit, a need arose for some simple audio test equipment.

This article describes one of the programs subsequently developed: a frequency counter with a maximum theoretical count rate in excess of 10 KHz utilizing a 6502 microprocessor operating at 1 MHz. An assembly language listing of the actual frequency counting routine is provided, as well as a driver written in Microsoft BASIC that calls the counter as a USR(X) subroutine.

The Approach

The heart of the frequency counter is a machine code timed loop requiring 46 microprocessor cycles, which checks for positive signal transitions, and increments a counter whenever one is encountered. The program cycles through the loop 21739 times (54EB H), which requires one second with a 1 MHz microprocessor clock. The trick is to keep all possible paths through the loop (lines 410 to 770) equal in length.

The duration counter keeps track of the number of loop cycles remaining. Upon entering the program, the count is set to 21739. Note that to compensate for variations in microprocessor clock speeds, this value may have to be changed.

You can input to the system through an analog to digital (A/D) converter such as the new OSI CA-22 analog inter-

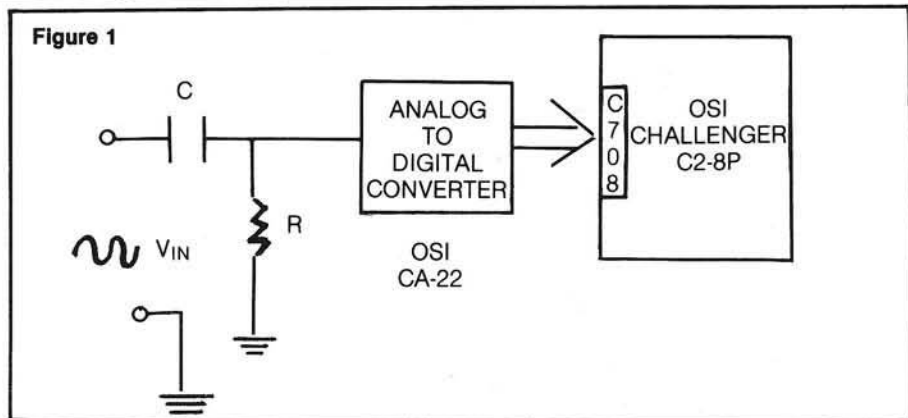

face board, or the older OSI 430B analog interface board (no longer available). The CA-22 analog I/O board is a high-performance interface that is capable of multiplexed 12- or 8-bit A/D conversion, using sample and hold and successive approximation techniques. In addition, the CA-22 will perform up to 66,000 8-bit A/D conversions each second. This capability is more sophisticated than is required for the frequency counter application, and alternative hardware implementations may include other A/D converters or even an op amp configured as a threshold detector and driving a single bit input. However, the alternates will require minor modifications to the programs I will describe here.

The CA-22 as delivered from OSI is set to transform an analog voltage input in the range of -10 volts to +10 volts into complementary offset binary (COB)

digital representation. Complementary offset binary is summarized in table 1.

The transition from a negative voltage to a positive voltage is reflected by a change from one to zero in the most significant binary digit.

The 6502 Branch on MINus (BMI) instruction is conditional, depending on the state of the most significant bit of the tested byte. Therefore, using this instruction we may easily determine if the signal input to the A/D converter is greater than or less than zero volts. An alternative, if a TTL signal is being counted, is to connect the signal directly into the most significant bit of a parallel input port.

The hardware configuration using an A/D converter is diagrammed in figure 1. The capacitor and resistor balance the signal input to the A/D around 0 volts.

Listing 1

```

10 ; *****
20 ; * Program F R E Q
30 ; * OSI 6500 Assembler Code for Frequency Counter
40 ; * Program by P. Lindquist, Union Lake, Michigan
50 ; * January 1980
60 ; *****
70 ;
80 ; Program monitors input and counts positive
90 ; transitions occurring during a fixed number
100 ; of cycles through the program as determined
110 ; by count entered into DR.
120 ;
130 ; EXTERNAL ADDRESSES AND VARIABLES:
140 ;
150 0000= CNTL = $0000 ;Frequency Count - lo byte
160 0001= CNTH = $0001 ;Frequency Count - hi byte
170 0002= DRCL = $0002 ;Duration Count - lo byte
180 0003= DRCH = $0003 ;Duration Count - hi byte

```

```

190 0004=      LAST  = %0004      ;Positive or Negative Signal
200 C708=      INPUT = %C708      ;CA-22 A/D Input Address
210 C70A=      MUX   = %C70A      ;CA-22 A/D Control Address
220 0020=      MUXSET = %20       ;Multiplexer control, eight
230            ;                ;bits, port zero, no flag
240 317E      *    = %317E
250            ;
260 317E EB54  DR     .WORD 21739   ;Duration count for 1 Sec
270 31B0 0000  RES    .WORD 0      ;Return location for results
280            ;
290 3182 DB      START  CLD         ;Entry, initialize
300 3183 20E131 JSR  SWAP       ;Store zero page locations
310 3186 A900    LDA  #0
320 3188 8500    STA  CNTL        ;Reset counter to zero
330 318A 8501    STA  CNTH
340 318C 8504    STA  LAST        ;Reset signal flag to zero
350 318E A920    LDA  *MUXSET      ;Set multiplexer control
360 3190 8D0AC7 STA  MUX
370 3193 AD7E31 LDA  DR          ;Set duration counter
380 3196 8502    STA  DRCL
390 3198 AD7F31 LDA  DR+1
400 319B 8503    STA  DRCH
410 319D AD08C7 FREQ6  LDA  INPUT      ;Input from A/D
420 31A0 3030    BMI  FREQ1        ;Check for Positive
430 31A2 A504    LDA  LAST
440 31A4 D030    BNE  FREQ2        ;Check for transition
450 31A6 E600    INC  CNTL        ;On transition
460 31AB D004    BNE  FREQ3        ; increment counter
470 31AA E601    INC  CNTH
480 31AC D005    BNE  FREQ8
490 31AE EA      FREQ3  NOP          ;Delay 7 machine cycles
500 31AF A901    LDA  #01
510 31B1 D000    BNE  FREQ8
520 31B3 A901    FREQ8  LDA  #01      ;Set signal flag (LOW)
530 31B5 8504    STA  LAST
540 31B7 C602    FREQ5  DEC  DRCL      ;Decrease duration count
550 31B9 D012    BNE  FREQ7
560 31BB C603    DEC  DRCH
570 31BD 10DE    BPL  FREQ6        ;Check for zero
580 31BF A500    LDA  CNTL        ; duration remaining
590 31C1 8DB031 STA  RES          ;At end, place frequency
600 31C4 A501    LDA  CNTH        ; count into RES
610 31C6 8DB131 STA  RES+1
620 31C9 20E131 JSR  SWAP       ;Restore zero page
630 31CC 60      RTS
640 31CD EA      FREQ7  NOP          ;And return
650 31CE A900    LDA  #0          ;Delay 8 machine cycles
660 31D0 F0CB    BEQ  FREQ6
670 31D2 A900    FREQ1  LDA  #0          ;6 cycles including JUMP
680 31D4 8504    STA  LAST        ;Reset Signal Flag (HIGH)
690 31D6 EA      FREQ2  NOP          ;Delay 25 machine cycles
700 31D7 EA      NOP
710 31D8 EA      NOP
720 31D9 EA      NOP
730 31DA EA      NOP
740 31DB EA      NOP
750 31DC EA      NOP
760 31DD A900    LDA  #0
770 31DF F0D6    BEQ  FREQ5        ;Then decrement duration
780            ;
790            ; Subroutine to store zero page locations
800            ; in STORE and to restore zero page
810            ; prior to return.
820            ;
830 31E1 A204    SWAP  LDX  #04
840 31E3 B500    NEXT  LDA  $0,X
850 31E5 AB      TAY
860 31E6 BDF331 LDA  STORE,X
870 31E9 9500    STA  $0,X
880 31EB 98      TYA
890 31EC 9DF331 STA  STORE,X
900 31EF CA      DEX
910 31F0 10F1    BPL  NEXT
920 31F2 60      RTS
930            ;
940            ;
950 31F3 00      STORE .BYTE 0,0,0,0,0 ;Zero page storage location
950 31F4 00
950 31F5 00
950 31F6 00
950 31F7 00

```

The values for the capacitor and the resistor should be kept large, but are not critical. The capacitor should be non-polarized.

The variable LAST is used to store the input state previously encountered. If a negative value is input, the variable LAST is set to 0. When the input is positive, LAST is checked. A value of LAST equal to zero indicates that a positive transition has occurred and the frequency count is incremented. If the input is not positive or if LAST is positive, the program enters a delay loop to equalize loop timing.

The Program

A listing of the assembly language program is presented in listing 1. Five zero page locations (\$00-\$04) are used for the flag LAST, and for counting, and to minimize the number of machine cycles in the longest path through the loop. Since this program was intended to be called as a USR(X) subroutine from a BASIC driver, the contents of the zero page locations used are saved in a temporary storage location by the subroutine SWAP (line 830). The input from the A/D converter is at C708H. This variable, called INPUT, will have to be changed to suit the user's specific equipment. Similarly, MUX is the address of an analog multiplexer, set to select port "0" in this program.

The assembly program is written with a starting location memory address of 317E H. This location was selected to correspond to the beginning of available work space for the Ohio Scientific OS65D V3.2 disk operating system provided with 8-inch floppy disk systems. The BASIC driver can be placed after the machine code in the workspace, which permits storage and recall of the object code and the BASIC driver in a single named disk file. Details of how this is accomplished are covered in the OSI disk operating system manual and will not be covered here.

However, the starting location for the assembly is not important; the machine code can be moved to any available memory locations that can be protected to prevent interference by the BASIC program. The execution cycles for some 6502 instructions used in the program depend on whether or not references are made across page boundaries. The program timing has been computed assuming that all branches occur within a single page. Therefore, if the program is relocated, be careful to place the entire program within a page of memory.

Table 1

	Approximate Voltage Level	8-Bit Binary Representation	Decimal Equivalent
+ Full Scale	+ 10 Volts	00000000	0
Mid Scale	0 Volts	01111111	127
- Full Scale	- 10 Volts	11111111	255

Listing 2

```

100 PRINT:PRINT:PRINT:PRINT:PRINT:PRINT
105 PRINTTAB(15);"*****"
110 PRINTTAB(15);"*
115 PRINTTAB(15);"* FREQUENCY COUNTER *"
120 PRINTTAB(15);"* Program by P. Lincolnist *"
125 PRINTTAB(15);"* Union Lake, Mich. *"
130 PRINTTAB(15);"* January 1980 *"
135 PRINTTAB(15);"*
140 PRINTTAB(15);"*****"
145 PRINT
150 REM SET USR SUBROUTINE ADDRESS TO $3182
155 POKE 8955,130:POKE 8956,49
160 S=0: S2=0: V=0
165 FOR I=1 TO 10:PRINT: NEXT
170 PRINT" Options available:"
175 PRINT" 1) Count"
180 PRINT" 2) Calibrate"
185 PRINT" 3) Return to monitor"
190 PRINT
195 INPUT" Option desired (1-3)";N
200 PRINT
205 N = INT(N+.5)
210 IF N=3 THEN RUN"BEXEC*
215 IF N=2 THEN 340
220 IF N=1 THEN 230
225 GOTO 170

230 PRINT"*** COUNT ***"
235 PRINT
240 INPUT" Input desired number of frequency samples";N
245 PRINT
250 IF N<1 THEN 170
255 PRINT:PRINT:PRINT:PRINT:PRINT
260 PRINT" SAMPLE","FREQUENCY","MEAN","STANDARD"
265 PRINT" NUMBER",TAB(42);"DEVIATION"
270 PRINT
275 REM FOR A DISCUSSION OF STATISTICAL APPROXIMATIONS SEE
280 REM JAN 79 BYTE ARTICLE BY A B FORSYTHE.
285 FOR I = 1 TO N
290 X=USR(X)
295 X=256*PEEK(12673)+PEEK(12672)
300 D=X-S
305 S=S+D/I
310 S2=S2+D*(X-S)
315 IF I>1 THEN V=S2/(I-1)
320 SD=SQR(V)
325 PRINTTAB(3);I,X,S,SD
330 NEXT I
335 GOTO 160

340 PRINT"*** CALIBRATE ***"
345 PRINT
350 N = PEEK(12670) + 256*PEEK(12671)
355 PRINT" Currently the program is set to count for ";N
360 PRINT" cycles through the machine code counter routine."
365 PRINT" Each count cycle requires 46 microprocessor cycles."
370 PRINT
375 INPUT" would you like to change this";A$
380 PRINT
385 IF LEFT$(A$,1)<>"Y" THEN 160
390 INPUT" Input new number of count cycles";N
395 PRINT
400 IF N<1 OR N>32767 THEN PRINT"*** RANGE PROBLEM ***";GOTO 160
405 S=INT(N/256):POKE 12671,S:POKE 12670,N-256*S
410 INPUT" would you like to update the disk file";A$
415 PRINT
420 IF LEFT$(A$,1)<>"Y" THEN 160
425 DISK!"PU FRCNT
430 GOTO 160

```

A pair of 2-byte variables is provided for communication with a driver routine. DR is an input to the program and determines the number of cycles through the count loop. This number must be less than 32767. RES is the return location for the frequency count. These locations may be accessed from the BASIC driver using PEEK and POKE statements.

The NOP's beginning in line 690 provide the delay necessary to balance the number of machine cycles in the two major program loops. There are, in addition, two shorter delay loops in program lines 490 and 640 which are entered when it is not necessary to increment the frequency count high byte or decrement the duration counter high byte, respectively.

The count program is written as a subroutine and is terminated by a RTS (return from subroutine). Zero page locations are restored, but the microprocessor registers are not saved.

The Driver

Listing 2 is a Microsoft BASIC driver program. Remember that the machine code counter is loaded with the BASIC driver by the OSI OS65D3 operating system, so that an independent load of the machine code by the BASIC program is not required. Loading of the machine code by the BASIC driver may be required by other operating systems, however.

The driver has three major sections: Initialization and menu (lines 150-225), count (lines 230-335), and calibrate (lines 340-430). Initialization consists of first POKEing the starting address 3182H (decimal 12674) into the memory locations that control the jump to subroutine from the BASIC USR(X) command (locations 8955 and 8956 for OSI'S OS65D3 system). Secondly, it initializes variables S, S2, and V, which are used for statistical analysis. The menu requests the user to select the count function (1), the calibrate function (2), or stop (3).

The count function will call (in line 290) the machine code frequency counter the number of times specified by the user. The frequency count is returned in memory locations 12672 (low byte) and 12673 (high byte) with the machine code assembled with a starting location of 12670 (317EH). For each sample, the sample number, the actual frequency count, the mean frequency count, and the standard deviation are printed. The statistical

Figure 2

```
*****
*                                     *
*   FREQUENCY COUNTER               *
*   Program by P Lindquist          *
*   Union Lake, Mich.              *
*   January 1980                    *
*                                     *
*****
```

Options available:

- 1) Count
- 2) Calibrate
- 3) Return to monitor

Option desired (1-3)? 1

COUNT ***

Input desired number of frequency samples? 8

SAMPLE NUMBER	FREQUENCY	MEAN	STANDARD DEVIATION
1	4807	4807	0
2	4808	4807.5	.707106781
3	4808	4807.66667	.577350407
4	4808	4807.75	.500000159
5	4808	4807.8	.447213782
6	4808	4807.83333	.408248548
7	4808	4807.85714	.377964795
8	4808	4807.875	.353553775

Option desired (1-3)? 2

CALIBRATE ***

Currently the program is set to count for 21739 cycles through the machine code counter routine. Each count cycle requires 46 microprocessor cycles.

Would you like to change this? Y

Input new number of count cycles? 21709

Would you like to update the disk file? N

Option desired (1-3)? 1

COUNT ***

Input desired number of frequency samples? 12

SAMPLE NUMBER	FREQUENCY	MEAN	STANDARD DEVIATION
1	4801	4801	0
2	4801	4801	0
3	4801	4801	0
4	4802	4801.25	.5
5	4802	4801.4	.547722623
6	4802	4801.5	.54722645
7	4802	4801.57143	.53452258
8	4801	4801.5	.534522548
9	4801	4801.44445	.527046346
10	4801	4801.4	.516397833
11	4801	4801.36364	.504525001
12	4801	4801.33334	.492065995

algorithms used are discussed in an article by A.B. Forsythe in the January 1979 issue of *Byte* magazine.

If the microprocessor clock speed is 1 MHz, 21739 cycles through the count routine will require one second. The frequency count returned will be in cycles per second or Hz. If the microprocessor clock speed is not a nominal 1 MHz, the loop count may be adjusted in the CALIBRATE section of the drive program. The count value to be adjusted is contained in memory locations 12670 (low byte) and 12671 (high byte). Line 425 resaves the program with the new frequency count utilizing the OS65D3 disk operating system command !" PUT FILENAME. The author's system, adjusted with a calibrated frequency generator, is set for a loop count of 21705.

The Results

Figure 2 demonstrates the statistical output provided by the BASIC driver routine. The frequency source used in this example was the 4800 Hz provided to an ACIA which, when divided by 16 results in 300 baud to a modem. The program has been useful on several occasions for measuring frequencies between 60 and 10,000 Hz. Success with this program has inspired other programs to simulate electronic test equipment. Audio oscillators and audible logic

probes (using the D to A output on the CA-22 board) are relatively straight forward. An oscilloscope simulator has also been developed, but its frequency response is limited by program speed. In each case the technique of combining machine code with BASIC drivers, as is permitted using the OSI disk operating system, has proven very beneficial. This technique allows a balance in program speed, programming ease, program flexibility, availability of high level mathematical functions, and display flexibility.

References

1. "Microprocessor-Based Analog/Digital Conversion", R. Frank, *Byte*, May 1976, page 70.
2. "Interfacing With An Analog World, Part 2", J. Carr, *Byte*, June 1977, page 54.
3. "Elements Of Statistical Computation", A. Forsythe, *Byte*, January 1979, page 182.

Note: Information concerning the CA-22 Analog to Digital Converter Module was provided courtesy of Ohio Scientific Inc.

MICRO

OHIO SCIENTIFIC

THE WIZARD'S CITY — search for gold in the dungeons beneath the Wizard's city or in the surrounding forest. A dynamic adventure allowing progress in strength and experience. All OSI — cassette \$12.95, disk \$15.95.

OSI HARDWARE 15% OFF RETAIL PRICES!

GALACTIC EMPIRE — a strategy game of interstellar conquest and negotiation. Compete to discover, conquer, and rule an empire with the computer or 1-2 other players. C4P, C8P cassette \$12.95, disk \$15.95.

AIR TRAFFIC ADVENTURE — a real time air traffic simulation. C4P, C8P disks \$15.95.

Plus S-FORTH, FAILSAFE +2, RPV CONTROL, ADVENTURE, TOUCH TYPING, INTELLIGENT TERMINAL and more. Send for our free catalog including photos and complete descriptions.

Aurora Software Associates

37 S. Mitchell
Arlington Heights
Illinois 60005



GRAPHICS FOR OSI COMPUTERS

- ☆ You Can Produce The Images Shown Or Yours And Program Motion With Our 256 By 256 High Resolution Graphics Kit. That's 65,536 Individually Controlled Points On Your TV Screen.
- ☆ Increase Column/Line Display. You Can Set Up Your Own Graphic Pixels Including Keyboard Characters And Unlimited Figures.
- ☆ This Kit Includes All Parts, Software And Assembly Instructions Required To Get Up And Running. The Included 8k Of 2114 Memory Is Automatically Available When Not Using The Graphics. Boot Up And See 8k More Memory.
- ☆ Adding The Kit Does Not Affect Your Existing OSI Graphics. Use Both At The Same Time Or Separately.
- ☆ Buy The Entire Kit, Including Memory, For \$185.00 Or A Partial Kit For Less If You Have Parts. Board And Instructions \$40.00. Instructions Include Software.

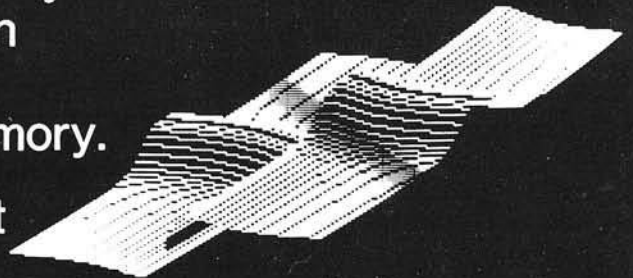
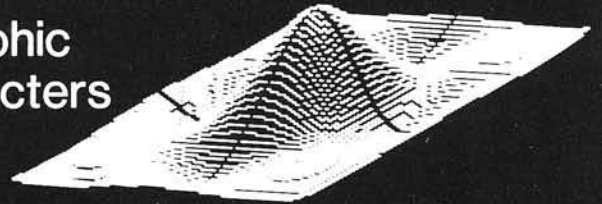
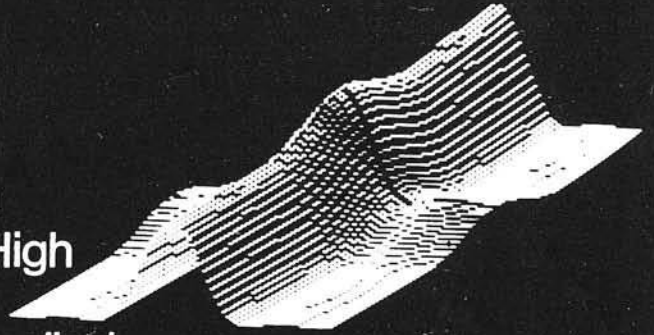

For This Kit Or A Catalog
Of Other Kits, Software
And Manuals Call Or Write:

MITTENDORF ENGINEERING
905 Villa Neuva Dr.
Litchfield Park, Az. 85340
(602)-935-9734

Step Up to Programmable Motion

Making objects move at the command of your computer is a simple and inexpensive proposition. This article describes the interfacing of a stepper motor to a KIM-1. The applicability is demonstrated in a programmable flow metering system.

David S. Liscinsky
Old Colony Lane
Cromwell, CT 06416

Many exciting computer applications require the ability to physically move objects. These applications particularly impress those who continually ask, "but what can it do?", referring to the microcomputer system you've been working with for months. One simple solution to programmable motion is a stepper motor interfaced to an I/O port of your computer. This approach is not only inexpensive, but allows the very precise movements necessary for many applications, such as: an x-y plotter, moveable "arms" for robots and interactive game playing, and the simple opening and closing of valves. This article will discuss how to go about hooking up a stepper motor(s) to your computer. Then an actual working system configured around a KIM-1 will be used as an example of how to cause movement at the command of your microcomputer.

Because stepper motors convert electrical pulses into discrete mechanical movements, it is easier to obtain very precise motion from a stepper motor than from any other type. Each move of the motor is controlled by switching the current to its windings on and off in the proper sequence. Figure 1 is a diagram of a typical stepper motor with four separate windings and a table of the appropriate switching sequence. Energizing the windings with each pattern in the sequence rotates (steps) the motor shaft

Figure 1: A typical unipolar stepper motor schematic and switching sequence.

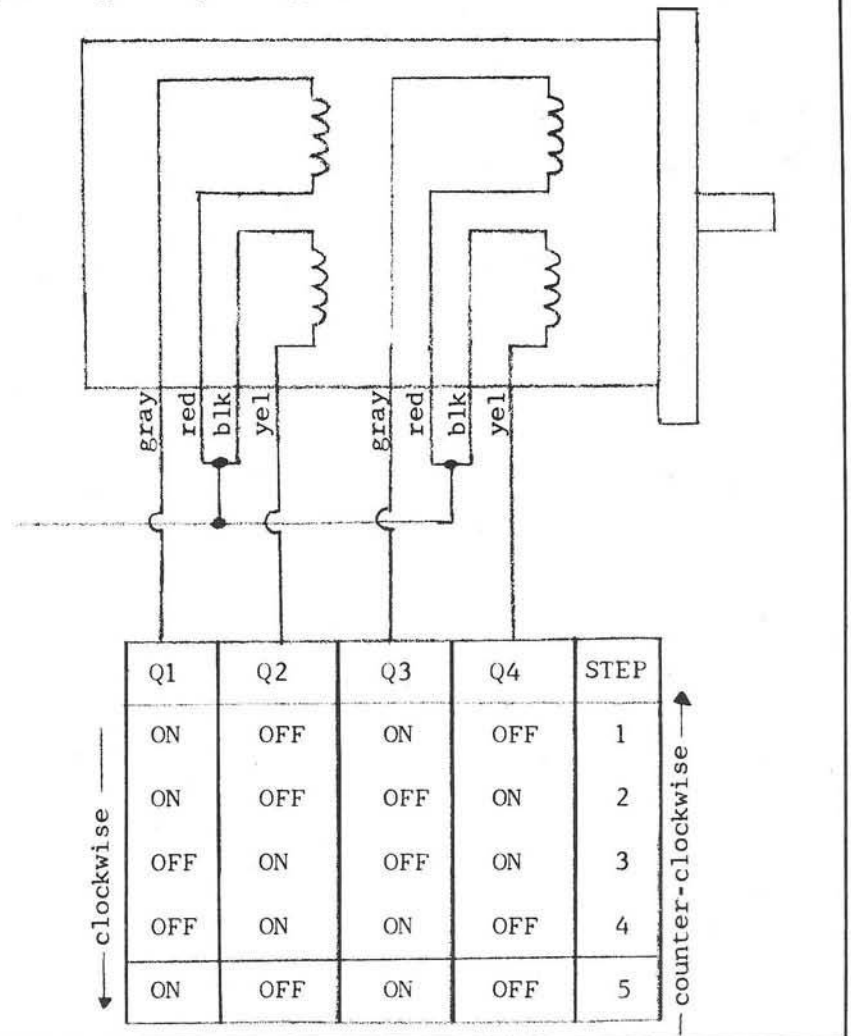

a predetermined angle from 3.75° to 90°. If bits from an output port of a microcomputer are used to control the current switching, the motor shaft can easily be rotated any number of steps in either direction by software commands. For an excellent discussion on the details of how stepper motors actually work, see reference 1.

Selection of the proper stepper motor can be difficult. However, for most applications, consideration of torque and step angle is all that is necessary. The

amount of torque required is determined by the application load, that is, how much energy it will take to budge the object you want to move. The torque developed by a specific motor is a function of how fast you try to turn it, the amount of current that is supplied to the windings, and the drive design. The speed/torque curves supplied by the manufacturers to describe their motors can aid in proper matching of a motor to your application. However, torque is not a function of cost. Therefore, it simplifies matters and is cost-effective

to get a motor that can supply more torque than you actually need.

The second consideration is step angle, or how precisely the rotation can be controlled. Typically the choice is 7.5° (48 steps/rev). In general, smaller step angles cost significantly more, but larger angles do not. So again, to simplify matters, the smallest step angle for the money is usually the best choice since it can be used in more applications. Applications that require more resolution than 7.5°/step can use gearing.

Figure 2 is an inexpensive drive interface between a parallel I/O port and a stepper motor with 4-coil unipolar windings. By writing the appropriate bit patterns to the port in the proper sequence, the motor shaft can be rotated clockwise or counter-clockwise. Listing 1 is a simple program to rotate the shaft clockwise, one revolution, using the two least significant bits of port B from the on-board 6530 of a KIM-1.

A Real Application

A particularly simple but quite useful application for a stepper motor is the programmable opening and closing of valves to control fluid flow. Although this application is probably of more interest to industrial process control than microcomputer hobbyists, it illustrates the simplicity of using stepper motors and software to control motion.

The Hardware

The first problem in controlling fluid flow is the mechanical coupling of a valve and the stepper motor shaft. One possible coupling is shown in photo 1. Other approaches would include "gear"-type drive systems. However, direct coupling is the simplest method.

The next problem is in knowing the flow at any given position of the valve. Ideally, flow control would be closed-loop. That is, a transducer would feed back a signal that is proportional to the flow to the computer. The executing program would then modify the flow by opening or closing the valve in order to maintain the desired flow. However, flow transducers are expensive and dependent on the type of fluid then are sensing.

An alternate technique is the execution of a preselected sequence of instructions, or open-loop control. Although this is a less flexible means of control, it is also less expensive. All that is required is calibration of the valve position vs. flow, or more specifically, steps

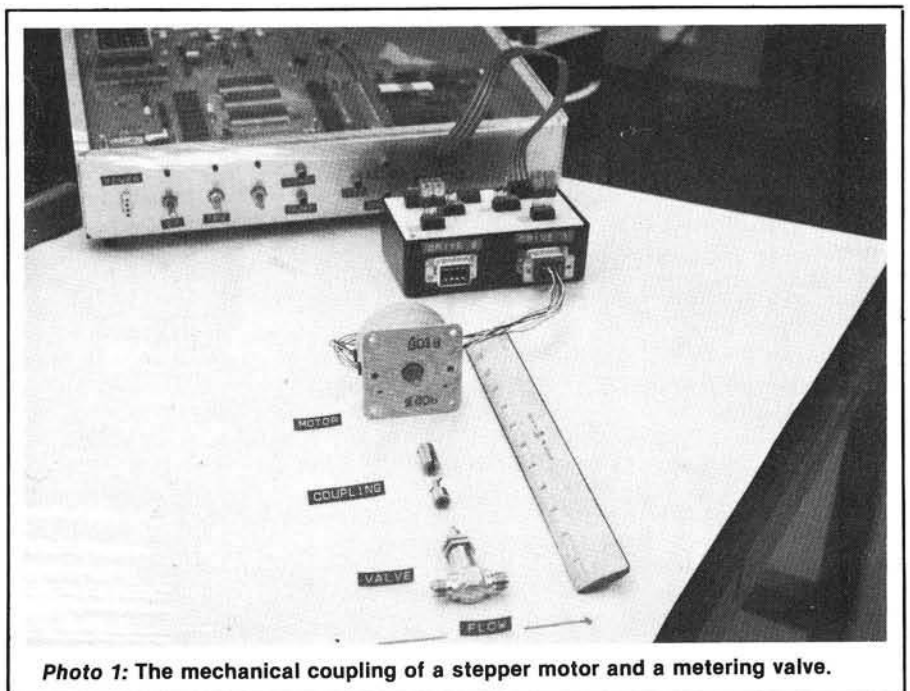
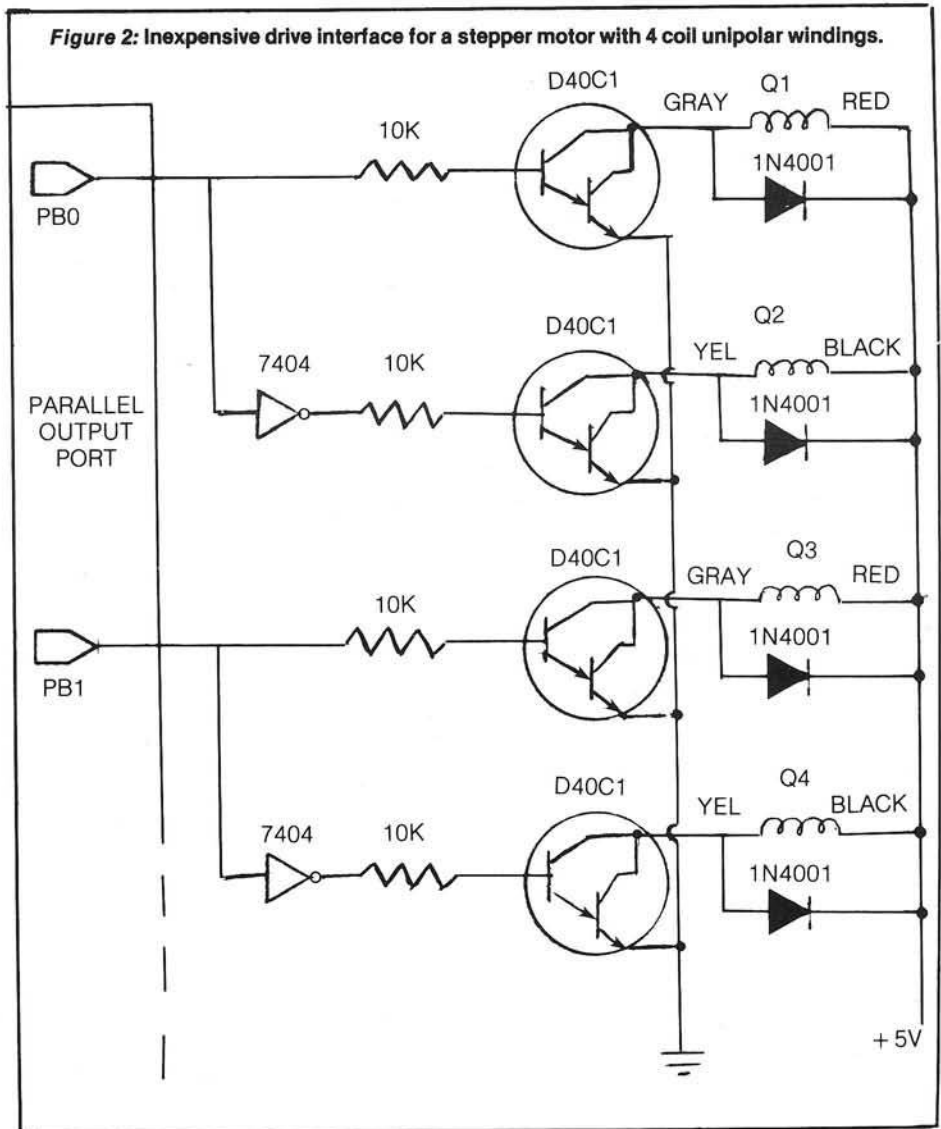

Photo 1: The mechanical coupling of a stepper motor and a metering valve.

of the motor vs. flow. These values can then be used as settings for various flow rates allowing almost any flow vs. time pattern to be generated.

The Software

Program development and user interaction (to produce complex flow patterns) is rather easy on a relatively powerful computer such as an AIM 65. However, an inexpensive, yet sophisticated, open-loop flow control system can be based on a single board computer like the KIM-1. The software presented here reflects a limited amount of computing power, and depends on the user precalculating and entering the command parameters. The driving program (listing 2) interprets and executes the entered table of instructions. The program is easy to use and illustrates the control over motion that can be inexpensively obtained.

The objective of the program is to allow almost any flow vs. time pattern to be generated. The user enters values in a table that can occupy up to 255 contiguous bytes in memory. The table is composed of up to 51 unique move commands (5 bytes each) that specify successive flow settings. Increasing the complexity of the desired curve increases the total number of commands that are required.

Table 1 defines the move command. In general, the arguments of the command specify:

1. how long to hold a given flow,
2. how many steps to rotate at the end of the hold time,
3. how many times to repeat a particular sequence of commands,
4. the starting address of a sequence to be repeated.

All entries are in hexadecimal. Loops may not be nested, but otherwise, anything goes.

Listing 1 also includes a sample command table which will open (1/2 rev.) and close (1/2 rev.) the valve 16 times at 5-second intervals, followed by a 10-second wait and two clockwise revolutions.

Conclusion

The interfacing of a stepper motor to a KIM-1 has been described. The concepts were implemented in a programmable flowmetering system. Throughout the discussion, low cost

Table 1: Definition of a Move Command

Address	Description
XXX0	HOLD time in minutes
XXX1	HOLD time in seconds
XXX2	Number of steps to ROTATE a. 00 = no steps b. 01 to 7F = number of CW steps c. 80 to FF = number of CCW steps + 7F _H
XXX3	Number of times to repeat (LOOP) a sequence a. 00 = no loop, go directly to the next HOLD time b. 01 to FE = number of times to loop c. FF = stop
XXX4	BRANCH ADDRESS a. 00 to FF = low order byte of the address of the next HOLD time

Listing 1: A KIM-1 program to rotate a stepper motor one clockwise revolution in 10 seconds.

```

;* FILE ROTCW
;*
DDR EQU $1703
PORT EQU $1702
;
; ORG $200
; OBJ $800
;
0200 A9FF LDA #$FF ;INITIALIZE PORT B FOR OUTPUT
0202 8D0317 STA DDR
0205 D8 CLD
0206 A900 LDA #$00
0208 8D3602 STA STEPS ;INITIALIZE STEP COUNT
020B A203 LP1 LDX #$03
020D BD3202 LP2 LDA TABL,X ;GET APPROPRIATE BIT PATTERN
0210 8D0217 STA PORT ;ROTATE 1 STEP
0213 A9CB LDA #$CB
0215 8D0717 STA $1707 ;DELAY 20.8 MSEC.
0218 AD0617 LP3 LDA $1706
021B D0FB BNE LP3
021D AD3602 LDA STEPS
0220 18 CLC
0221 6901 ADC #$01
0223 C930 CMP #$30 ;IF COUNT=48,
; THEN 1 REV. COMPLETED
; OTHERWISE,
; SET X FOR NEXT PATTERN
0225 F008 BEQ HALT
0227 8D3602 STA STEPS
;
022A CA DEX
022B 10E0 BPL LP2
022D 30DC BMI LP1
022F 20051C HALT JSR $1C05
0232 ;
0232 020001 TABL HEX 02000103
0235 03 ;
0236 ;
0236 00 STEPS BYT $00
END

```

and simplicity have been emphasized. However, the same concepts can be used for complex control situations in which many simultaneous movements are desired. This discussion is just the first step.

References

1. Bober, R.E. "Taking the First Step," *BYTE*, Feb. 1979, p. 35-112.
2. Margolin, Bob. "Stepping Motors," *Electronics Products Magazine*, Sept. 1979, p. 35-44.
3. Hill, John W. "Introducing the Mini-Mover 5," *Robotics Age*, Summer, 1980, p. 18-27.
4. *Stepper Motor Handbook*. North American Philips Controls Corp., Cheshire Industrial Park, Cheshire, CT 06410.

David Liscinsky is an Associate Research Scientist at United Technologies Research Center in East Hartford. His interests include real-time processing and optimization of experiments using computer control.

Listing 2: KIM-1 program to provide open-loop control of a one valve flowmetering system.

```

;* OPEN LOOP CONTROL
;* PROGRAM FOR KIM
;* BY DAVID LISCINSKY

0200 202002      MAIN  JSR INIT          ;INITIALIZE
0203 205302      NEXT  JSR TIME          ;HOLD FOR REQUESTED TIME
0206 207602      JSR MOVE          ;ROTATE REQUESTED NO. STEPS
0209 BD0003      LDA TABL,X        ;REPEAT A SEQUENCE?
020C F00A        BEQ CONT          ;NO
020E C9FF        CMP #$FF
0210 F00B        BEQ STOP
0212 202E02      JSR LOOP
0215 AEF102      LDX TX
0218 E8          CONT  INX
0219 E8          INX
021A 4C0302      JMP NEXT
021D 20051C      STOP  JSR $1C05
0220             ;
0220 A9FF        INIT  LDA #$FF          ;INITIALIZATION SUBROUTINE
0222 8D0317      STA $1703          ;PORT B DATA DIRECTION
0225 A200        LDX #$00
0227 8EEE02      STX PTR          ;OTHER POINTERS AND COUNTERS
022A 8EEF02      STX KNT
022D 60          RTS
022E             ;
022E 8DEF02      LOOP  STA KNT          ;COUNT FOR LOOP
0231 204A02      L10  JSR GOTO
0234 205302      L11  JSR TIME
0237 207602      JSR MOVE
023A BD0003      LDA TABL,X
023D F006        BEQ NX
023F CEEF02      DEC KNT
0242 D0ED        BNE L10
0244 60          RTS
0245             ;
0245 E8          NX   INX
0246 E8          INX
0247 4C3402      JMP L11
024A             ;
024A 8EF102      GOTO  STX TX          ;TRANSFER THE BRANCH ADDRESS
024D E8          INX          ; TO THE X REGISTER, THEREBY
024E BD0003      LDA TABL,X        ; RESETTING THE INDEX OF THE
0251 AA          TAX          ; THE NEXT TABLE LOCATION TO
0252 60          RTS          ; BE INTERPRETED
0253             ;
0253 BD0003      TIME  LDA TABL,X        ;GET NO. OF MINUTES TO WAIT
0256 F00B        BEQ PS1
0258 8DEC02      STA VAR
025B A93C        LDA #$3C
025D 8DF002      STA TEMP
0260 209102      JSR DELY          ;DELAY FOR 60 SECONDS
0263 E8          PS1  INX
0264 BD0003      LDA TABL,X        ;GET NO. OF SECONDS TO WAIT
0267 F00B        BEQ PS2
0269 8DEC02      STA VAR
026C A901        LDA #$01
026E 8DF002      STA TEMP
0271 209102      JSR DELY          ;DELAY FOR 1 SECOND
0274 E8          PS2  INX
0275 60          RTS
0276             ;
0276 BD0003      MOVE  LDA TABL,X
0279 F00A        BEQ RTRN
027B 8DEC02      STA VAR          ;VAR= TOTAL # STEPS TO TAKE
027E C980        CMP #$80
0280 B005        BCS BW          ;CCW IF >=$80
0282 20B102      JSR CW          ;OTHERWISE CW
0285 E8          RTRN  INX
0286 60          RTS
0287 4980        BW   EOR #$80
0289 8DEC02      STA VAR
028C 20C702      JSR CCW
028F E8          INX
0290 60          RTS
0291             ;
0291 ADF002      DELY  LDA TEMP          ;USES "DIVIDE BY 1024"
0294 8DED02      STA VAR2          ; INTERVAL TIMER TO DELAY
0297 A004        L2   LDY #$04          ; FOR NO. OF SECONDS IN

```

(Continued)

**6809
Software**

**WRITE
OR
CALL
FOR CATALOG**

(315) 474-7856

**Frank Hogg Laboratory, Inc.
130 Midtown Plaza
Syracuse, NY 13210**

Three IMPORTANT Books for your APPLE

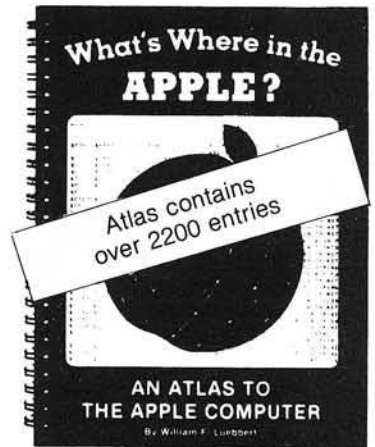

The **MOST Complete** MEMORY MAP of the Apple ever published. \$14.95*
128 pages

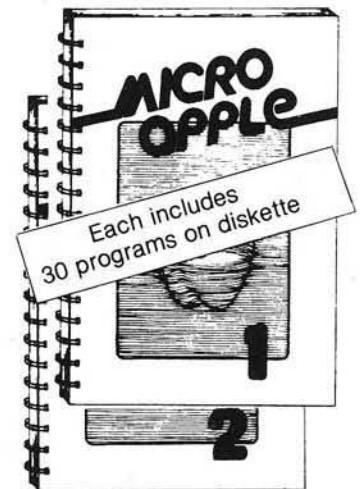

\$24.95* each Two **SUPERB** blends of articles and programs from MICRO magazine for the Apple.
224 pages w/DISK

To order, call toll-free
1-800-227-1617 Ext. 564
In California:
1-800-772-3545 Ext. 564

Master
Card &
VISA
Accepted

MICRO INK, Inc.
34 Chelmsford St.
P.O. Box 6502
Chelmsford, MA 01824

*Add \$2.00 for shipping.
Massachusetts residents add 5% tax.

```

0299 A9F4      L3      LDA #$F4          ; ACCUMULATOR
029B 8D0717
029E ADO617    L4      LDA $1706
02A1 DOFB      ENE L4
02A3 88        DEY
02A4 DOF3      ENE L3
02A6 CEED02    DEC VAR2
02A9 DOEC      ENE L2
02AB CEEO02    DEC VAR
02AE DOE1      ENE DELY
02B0 60        RTS
02B1           ;
02B1 ACEE02    CW      LDY PTR
02B4 20DB02    L5      JSR STEP      ;TAKE 1 STEP CW
02B7 C8        INY
02B8 C004      CPY #$04          ;AFTER 4 STEPS RESET Y REG. FOR
02BA D002      ENE L6          ; BEGINNING OF STEPPING SEQUENCE
02BC A000      LDY #$00
02BE CEEO02    L6      DEC VAR
02C1 DOF1      ENE L5          ;IF VAR=0, ROTATION IS FINISHED
02C3 8CEE02    STY PTR
02C6 60        RTS
02C7           ;
02C7 ACEE02    CCW     LDY PTR
02CA 88        L7      DEY
02CB 1002      BPL L8
02CD A003      LDY #$03          ;AFTER 4 STEPS RESET Y REG. FOR
02CF 20DB02    L8      JSR STEP      ; START OF STEPPING SEQUENCE
02D2 CEEO02    DEC VAR      ;TAKE 1 STEP CCW
02D5 DOF3      ENE L7
02D7 8CEE02    STY PTR
02DA 60        RTS
02DB           ;
02DB B9F202    STEP    LDA TURN,Y    ;USE Y REG. TO INDEX TURN TABLE
02DE 8D0217    STA $1702        ;TAKE 1 STEP
02E1 A90A      LDA #$0A
02E3 8D0717    STA $1707        ;DELAY ABOUT 0.01 SEC. TO
02E6 ADO617    L9      LDA $1706        ; ALLOW COILS TO RELAX
02E9 DOFB      ENE L9
02EB 60        RTS
02EC 00        VAR     BYT $00      ;TOTAL NO. OF STEPS TO TAKE
02ED 00        VAR2    BYT $00      ;SCRATCH
02EE 00        PTR     BYT $00      ;POINTER TO NEXT PATTERN IN SEQ.
02EF 00        KNT     BYT $00      ;NO. TIMES TO REPEAT A LOOP
02F0 00        TEMP    BYT $00      ;SCRATCH
02F1 00        TX      BYT $00      ;SCRATCH
02F2           ;
02F2           ;TURN: TABLE OF BIT PATTERNS TO PROVIDE
02F2           ;      THE APPROPRIATE STEPPING SEQUENCE
02F2           ;      FOR A 4-WINDING UNIPOLAR STEPPER MOTOR
02F2           ;
02F2 030100    TURN    HEX 03010002
02F5 02
02F6           ;

0300           ORG $300

0300           ;
0300 00        TABL    BYT $00      ;SAMPLE: HOLD 0 MIN.
0301 05        BYT $05          ;      5 SEC.
0302 10        BYT $10          ;      ROTATE 16 STEPS CW
                                (1/3 REV.)

0303 00        BYT $00          ;GO TO NEXT COMMAND
0304 00        BYT $00
0305 00        BYT $00          ;      HOLD 0 MIN.
0306 05        BYT $05          ;      5 SEC.
0307 90        BYT $90          ;      ROTATE 16 STEPS CCW
0308 10        BYT $10          ;LOOP 16 TIMES
0309 00        BYT $00          ; STARTING AT TABLE ADDR. $XX00
030A 00        BYT $00          ;      HOLD 0 MIN.
030B 0A        BYT $0A          ;      10 SEC.
030C 60        BYT $60          ;      ROTATE 96 STEPS
                                (2 REVS.)

030D FF        BYT $FF          ;STOP
030E           ;

                                END

```

MICRO™

OSI Disk Users

Double your disk storage capacity Without adding disk drives

Now you can more than double your usable floppy disk storage capacity—for a fraction of the cost of additional disk drives. Modular Systems' DiskDoubler™ is a double-density adapter that doubles the storage capacity of each disk track. The DiskDoubler plugs directly into an OSI disk interface board. No changes to hardware or software are required.

The DiskDoubler increases free user disk space from 50K to 120K for mini-floppies, from 201K to 420K for 8-inch floppies. With the DiskDoubler, each drive does the work of two. You can have more and larger programs, related files, and disk utilities on the same disk—for easier operation without constant disk changes.

Your OSI system is an investment in computing power. Get the full value from the disk hardware and software that you already own. Just write to us, and we'll send you the full story on the DiskDoubler, along with the rest of our growing family of OSI-compatible products.

™ DiskDoubler is a trademark of Modular Systems

Modular Systems

P.O. Box 16A Oradell, NJ 07649
201-262-0093

OSI COMPATIBLE HARDWARE

- IO-CA10X SERIAL PORT** \$125
ACIA based RS-232 serial printer port. DIP SWITCH selectable baud rates of 300-9600. Handshaking (CTS) input line is provided to signal the computer when the printer buffer is full. Compatible with OS-65U V1.2 and OS-65D.
- IO-CA9 PARALLEL PORT** \$175
Centronics Standard Parallel printer interface for OSI computers. The card comes complete with 10 ft. of flat ribbon cable. Compatible with OS-65D and OS-65U software.
- IO-CA9D DIABLO PARALLEL PORT** \$175
DIABLO 12 BIT WORD Parallel port for use with word processor type printers. Complete with 10 ft. cable. Compatible with OS-65U software.
- IO-LEVEL 3 MULTI-USER EXPANSION** \$450
Provides 3 printer interfaces currently supported by OSI-Serial, Centronics Parallel, Diablo Parallel, 4K of memory at D000 for Multi-user executive. 4 Port serial cluster. The LEVEL 3 card allows expansion of an OSI C3 machine up to 4 users with appropriate additional memory partitions.
- 24MEM-CM9...\$380** **16MEM-CM9...\$300** **8 MEM-CM9...\$210**
24K memory card is available at 3 different populated levels. All cards are fully socketed for 24K of memory. The card uses 2114-300ns chips. DIP SWITCH addressing is provided in the form of one 16K block and one 8K block. Also supports DIP SWITCH memory partition addressing for use in multi-user systems.
- FL470 FLOPPY DISK CONTROLLER** \$180
OSI-Type floppy disk controller and real time clock. Will Support 5 1/4" or 8". Single or double-sided drives. Requires drives with separated data and clock outputs.
- BIO-1600 BARE IO CARD** \$50
Super I/O Card. Supports 8K of 2114 memory in two DIP SWITCH addressable 4K blocks, 2 16 Bit Parallel Ports may be used as printer interfaces, 5 RS-232 Serial Ports with CTS & RTS handshaking. With manual and Molex connectors.
- BMEM-CM9 BARE MEMORY CARD** \$50
Bare 24K memory card, also supports OSI-type real time clock and floppy disk controller. With manual and Molex connectors.
- #96 PROTOTYPE CARD** \$35
Prototype board holds 96 14 or 16 pin IC's. Will also accommodate 18, 24, or 40 pin IC's. Row and column zone markings, easy layout. 1/8" epoxy glass P.C. board.
- C1P-EXP EXPANSION INTERFACE** \$65
Expansion for C1P 600 or 610 boards to the OSI 48 Pin Buss. Uses expansion socket and interface circuitry to expand to 48 Pin Backplane. Requires one slot in backplane.
- BP-580 BACKPLANE** \$47
Assembled 8-slot backplane with male Molex connectors and termination resistors.
- DSK-SW DISK SWITCH** \$29
A circuit when added to OSI Minifloppy systems extends the life of drives and media. Accomplish this by shutting off Minifloppy Spindle motor when system is not accessing the drive. Complete KIT and manual.
- PW-5-6 POWER SUPPLY** \$29
Power One brand supply 5V - 6 amps with overvoltage protection. Reg. \$49.95.

D&N MICRO PRODUCTS, INC.

3684 N. Wells Street Ft. Wayne, Indiana 46808
219/485-6414

TERMS: Check or money order Add \$2 Shipping, Outside U.S. add 10%.



THE INSPECTOR

These utilities enable the user to examine data both in the Apple's memory and on disks. Simple commands allow scanning through RAM and ROM memory as well as reading, displaying and changing data on disk.

Read and rewrite sections of Random Access files. Reconstruct a blown VTOC. Weed out unwanted control characters in CATALOG listings. UnDELETE deleted files or programs. Repair files that have erroneous data. All without being under program control. and more....

You may transfer sectors between disks. This allows you to transfer DOS from one disk to another thereby saving a blown disk when all that's blown is DOS itself, or to restore a portion of a blown disk from its backup disk.

Its unique NIBBLE read routine provides a Hi-Res graphical representation of the data on any track allowing you to immediately ascertain whether your disk is 13 sector or 16 sector. Get an I/O error...is it because you have the wrong DOS up? is it because of a bad address field? or a bad data field? or because a track was erased? This will allow you to tell in an instant without blowing away any program in memory.

APPLE DISK & MEMORY UTILITY

- Repairs Blown Disks
- Reads Nibbles
- Maps Disk Space
- Searches Disks
- Searches Memory
- Edits Disk Sectors
- Outputs Screen to Printer
- Displays Memory In HEX/ASCII

The INSPECTOR even lets you search through an entire disk or through on-board memory for the appearance of a string. Now you can easily add lower case to your programs (with LCA).

Do you want to add so-called illegal line numbers into your program? or have several of the same line numbers in a program (like the professional programmers do)? or input unavailable commands (like HIMEM to Integer Basic)? or put quotation marks into PRINT statements? Here's the easy way to do them all!

AND MORE

The INSPECTOR provides a USER exit that will interface your own subroutines with those of the INSPECTOR itself. For example, just put a screen dump routine (sample included in documentation) at HEX 0300 and press CTRL Z. The contents of the screen page will print to your printer.

ROM RESIDENT ROUTINES

The INSPECTOR utilities come on an easily installed EPROM. This makes them always available for instant use. No need to load a disk and run a program.

FULLY DOCUMENTED

Unlike other software of its kind, The INSPECTOR comes with an EASY to understand manual and reference card. Examples and graphics help even the uninitiated use the power of these utilities. And furthermore, we offer the kind of personal service which you have never experienced from a software vendor before.

See your LOCAL DEALER OR
Mastercard or Visa users call TOLL FREE 1-800-835-2246. Kansas residents call 1-800-362-2421. Or send \$49.95. Illinois residents add \$3 sales tax.

SYSTEM REQUIREMENTS

All Apple II configurations that have access to Integer Basic (either in ROM or RAM) will support The INSPECTOR. Just place the chip in empty socket D8 either on the mother board or in an Integer firmware card. Apple II+ systems with RAM expansion boards or language systems will receive the INSPECTOR on disk to merge and load with INTBASIC.

And...if you have an Apple II+, without either RAM or ROM access to Integer Basic, you will still be able to use The INSPECTOR because we are making available 16k RAM expansion boards at a very affordable price. Not only will you be able to use The INSPECTOR, but you will also have access to Integer Basic and other languages. Our price for BOTH the INSPECTOR and our 16k RAM board is \$169.95, less than most RAM boards alone. Call our office for details.

Another Quality Product from
Omega Software Products, Inc.
222 S. Riverside Plaza, Chicago, IL 60606
Phone (312) 648-1944

© 1981 Omega Software Products, Inc.
Apple is a registered trademark of Apple Computer, Inc.

MICRO

New Publications

Mike Rowe
New Publications
34 Chelmsford Street
P.O. Box 6502
Chelmsford, MA 01824

Software

Graphic Software for Microcomputers by B.J. Korites. Kern Publications (190 Duck Hill Road, P.O. Box 1029, Duxbury, MA 02332), 1981, 184 numbered pages, illustrations, listings, 11 x 8½ inches, cardstock cover with plastic comb binding. \$19.95

A self-teaching guide to writing computer graphics software on microcomputers. It contains 61 programs for 2 and 3 dimensional graphics ranging from elementary to advanced concepts. Theoretical concepts are presented next to actual program listings so that users can modify programs to suit their own applications. Because the book has been printed on only one side of each leaf, there are actually 368 pages, 184 of them blank. Students can use the blank page facing each text page for notes. All programs are in BASIC, written for the Apple II Plus 48K system and may be obtained on disk from the publisher for \$18.95. The author states that the programs are easily convertible to other languages, such as FORTRAN or Pascal.

CONTENTS: *Introduction; Basic Plotting Commands; Point Drawings; Line Drawings; 2D-Interactive Graphics; 2D-Translation; 2D-Scaling and Stretching; 2D-Clipping; 2D-Rotation; 3D-Rotation; 3D-Translation and Rotation; Perspective; Intersections; Hidden Line Removal; Shading; 3D-Shapes; Matrix Concatenations; Tablets; Applications; Practice Problems.*

Nailing Jelly to a Tree by Jerry Willis and William Danley, Jr. dilithium Press (P.O. Box 606, Beaverton, OR 97075), 1981, viii, 244 pages, diagrams, listings, 5½ x 8½ inches, paperbound. ISBN: 0-918398-42-8 \$12.95

This is a book on software for the person who is interested in using and adapting the many computer programs available in books and magazines and from software houses.

CONTENTS: *Introduction to the Care and Feeding of Small Computers—Who is this book for?; What you will read about; Levels of computer language. Two, Four, Six, Eight—What You Gonna Accumulate!—The binary number system; Binary math; Types of numbers; Boolean algebra; Computer codes. Software I Have Known and Loved—Starting options; Some typical monitor and operating systems software. Mr. Chips and the Machine Language—Chips and instruction sets; Registers and flags; Instruction sets; Hardware details and software operation; Important memory addresses; A sample machine language program. A Better Way—Assembly Language Programming—Steps in assembly language programming. Quick and Dirty BASIC—Getting acquainted; How to use this chapter; Introduction to BASIC. More Dirt—Making decisions and comparisons; Subscripted variables; Math functions; String functions. Converting from One BASIC to Another—Step 1. Is it possible?; Step 2. Make clerical changes; Step 3. Content changes. A Basic Glossary and Conversion Guide—Symbols and punctuation marks. Appendix Conversion Table. Index.*

Educational Software Directory — Apple II Edition by Sterling Swift Publishing Co. (P.O. Box 188, Manchaca, Texas 78652), 1981, viii, 104 pages, 5½ x 8½ inches, plastic comb binding with cardstock cover. ISBN: 0-88408-141-9 \$11.95 (Education price, \$9.95)

This directory lists hundreds of software packages available from 58 commercial publishers of educational software and from 7 noncommercial publishers. The publishers of the directory have listed programs in these areas: Computer Literacy (programs teaching BASIC or having anything to do with the Apple); Computer-Assisted Instruction (CAI) or programs which teach or instruct in any way (tutorial, drill and practice, simulation, problem solving, teaching aids, games); Administrative (teacher-grading programs, school registration programs, etc.); and Statistical Packages (for calculating mean, standard deviation, etc.).

Special annotation indicates if a program was designed for classroom use; represents a large number of hours of curriculum material; uses Applesoft or Integer BASIC; is available on disk or cassette; and the amount of memory required.

Programs are listed by publisher, with prices usually given. A comprehensive index lists programs by title under four school-level headings: Elementary; Middle School (Junior High); Secondary; and Community College, College/University, Continuing Education. A separate index heading, overlooked in preparing the

Table of Contents, lists titles of administrative software, courseware development, and utility software. The directory contains no advertising.

Fifty BASIC Exercises by Jean-Pierre Lamoitier. Sybex, Inc. (2344 Sixth Street, Berkeley, California 94710), 1981, xx, 232 pages, approximately 200 figures (charts, diagrams, listings), 7 x 9 inches, paperbound. ISBN: 0-89588-056-3 \$12.95

This tutorial is designed to teach BASIC through graduated exercises. It is written for persons with a minimum scientific or technical background. The programs in the book are written in Microsoft BASIC, which, the author says, "will execute directly on a TRS-80, and with occasional small changes, on a PET/CBM, APPLE, or any other popular computer equipped with Microsoft BASIC." Each exercise includes a statement of the problem to be solved, an analysis of the problem, a solution with flowchart and comments, the corresponding program, and a sample run.

CONTENTS: *Your First Program in BASIC—Introduction; Computing Taxable Income; Another Way to Calculate Taxable Income; Conclusion. Flowcharts—Introduction; The Purpose of the Flowchart; The Maximum of Two Numbers, A and B; Example of a Complete Flowchart: The Largest Element of an Array; How to Verify a Flowchart; Decision Points; A "Flip-Flop" Technique for Branching; The Implementation of a P-stage Round Robin; Conclusion. Exercises Using Integers—Introduction; Integers Satisfying $A^2 + B^2 = C^2$; Armstrong Numbers; Partitioning a Fraction into Egyptian Fractions; Prime Numbers; Decomposition into Prime Factors; Conversion from Base Ten to Another Base; Conclusion. Elementary Exercises in Geometry—Introduction; The Area and Perimeter of a Triangle; Determination of a Circle Passing Through Three Given Points; Computing the Length of a Fence; Plotting a Curve; Conclusion. Exercises Involving Data Processing—Introduction; Shell Sort; Merging Two Arrays; The Day of the Week; The Time Elapsed Between Two Dates; A Telephone Directory; Conclusion. Mathematical Computations—Introduction; Synthetic Division of a Polynomial by $(X - S)$; The Calculation of a Definite Integral; Calculation of π Using Regular Polygons; Solving an Equation by Dichotomy; Numerical Evaluation of Polynomials; Conclusion. Financial Computations—Introduction; Sales Forecasting; Repayment of Loans; Calculation of the Rate of Growth; More on Income Taxes; The Effect of Additional Income on Purchasing Power; Conclusion. Games—Introduction; The Game: TOO LOW/TOO HIGH; Finding an Unknown Number by Bracketing; The Matchstick Game; The Game of Craps;*

(Continued on next page)

New Publications

(Continued from page 35)

Conclusion. *Operations Research*—Introduction; Topological Sort; The Critical Path in a Graph; The Traveling Salesman Problem; Conclusion. *Statistics*—Introduction; The Average of a Sequence of Measurements; Mean, Variance and Standard Deviation; Linear Regression; The Distribution of Random Numbers Obtained from the Function RND; Conclusion. *Miscellaneous*—Introduction; The Signs of the Zodiac; The Eight Queens Problem; Conclusion. *Appendices*—A. The Alphabet in BASIC; B. Main Syntax Rules. *Index*.

PET/CBM

PET/CBM Personal Computer Guide, Second Edition, by Adam Osborne and Carroll S. Donahue. OSBORNE/McGraw-Hill (630 Bancroft Way, Berkeley, California 94710), 1980, x, 500 pages, photographs, drawings, listings, 6½ × 9 3/16 inches, paperbound. ISBN: 0-931988-55-1 \$15.00

This edition is a major revision of the original book of the same title, also published in 1980, but authored by Carroll S. Donahue and Janice K. Enger. Adam Osborne has transformed the book into a BASIC and CBM BASIC tutorial. The book describes all models of CBM computers as of publication date, as well as software products introduced by Commodore.

CONTENTS: *Introducing CBM Computers*—CBM Features. *Operating the CBM Computer*—Intermediate Mode; Program Mode; Operating the Cassette Units; Operating the Disk Unit; Operating the CBM Printer. *Screen Editing. Programming the CBM Computer*—Elements of a Programming Language; BASIC Statements; Functions. *Making the Most of CBM Features*—Hardware Features; String Concatenation; Input and Output Programming; Mathematical Programming; Graphics; The Real Time Clock; Random Numbers. *Peripheral Devices: Tape Cassette Drives, Diskette Drives and the Printer*—Storing Data on Magnetic Surfaces; Cassette Files; Diskette Files; Diskette Housekeeping Operations; Sequential Data Files; Relative Data Files (BASIC 4.0); Using GET# with Diskette Files; Program Files; Programming the Line Printer. *System Information. CBM BASIC*—BASIC Statements; Functions; CBM 8000 Editing Functions. *Appendices*—A. CBM Character Codes; B. CBM Error Messages; C. BASIC Bibliography; D. CBM Newsletters and References; E. Conversion Tables; F. Revision Level 2 ROMs. *Index*.

(Continued on page 47)

CBM/PET? SEE SKYLES ... CBM/PET?

PET? SEE SKYLES ... CBM/PET? SEE SKYLES

PET owners everywhere sing ♪♪ Thanks for the Memories ♪♪ to good old Bob Skyles

...they should...because Bob Skyles is the only complete source for memory boards for *any* PET ever sold. Old Bob won't forget you.

And the Skyles memory systems have the highest quality control of any computer product ever. Over 100 million bits of Skyles memory boards are already in the field; you can count the total number of failures on the fingers of one hand. First quality static and dynamic RAMS, solid soldered on first quality glass epoxy. That is why they are **guaranteed**—in spite of the new lower prices—for a full two years.

The boards connect directly to the data bus on your board with ribbon cable and 50 pin connectors that keep the data bus open to the outside world. Installs in minutes without special tools or equipment...just a screwdriver.

Because of our new dynamic memory design, and to celebrate the Skyles' Third Annual Survival Anniversary, here are the smashing new prices:

<i>The 8K Memory System</i>	originally \$250.00	now \$200.00	Save \$ 50.00
<i>The 16K Memory System</i>	originally \$450.00	now \$300.00	Save \$150.00
<i>The 24K Memory System</i>	originally \$650.00	now \$400.00	Save \$250.00

...For any PET ever made. When ordering, just describe your PET by model number and indicate the amount and type (or brand) of memory currently in the unit.

Shipping and Handling.....(USA/Canada) \$3.50 (Europe/Asia) \$15.00
California residents must add 6%/6½% sales tax, as required.



Skyles Electric Works
231E South Whisman Road
Mountain View, California 94041
(415) 965-1735

Visa/Mastercard orders: call tollfree
(800) 227-9998 (except California).
California orders: please call (415)
965-1735.

... CBM/PET? SEE SKYLES

L I S P

for the Apple II

Pegasys Systems' new P-LISP interpreter is a full implementation of the well-known Artificial Intelligence language. Written in machine code, this powerful interpreter includes the following features:

- Over 55 functions implemented
- Extensive 45-page User Manual
- Full function trace
- Function editor and pretty-printer
- Floating point math
 - ELIZA, TOWERS OF HANOI, and other sample programs included
- Break mode for function debugging
- Detailed error messages
- Lores and Hires graphics
- PROG construct, EXPRs, and FEXPRs
- Atom property lists

Also available: The P-LISP Tutorial, an introductory text designed to give the reader a complete understanding of the LISP language.

P-LISP is supplied on disk with User Manual for \$99.95 (specify DOS version). The manual is available separately for \$10.00. The P-LISP Tutorial is available for \$15.00. Requires a 48K Apple II or II+ with disk. Floating point math and Hires graphics require Applesoft in ROM.

PEGASYS SYSTEMS, INC.

4005 Chestnut Street
Philadelphia, PA 19104

Orders only: 800-523-0725

PA residents and inquiries: (215) 387-1500

Pennsylvania residents add 6% sales tax

Apple is a trademark of Apple Computer, Inc.



Good software is no longer a myth.

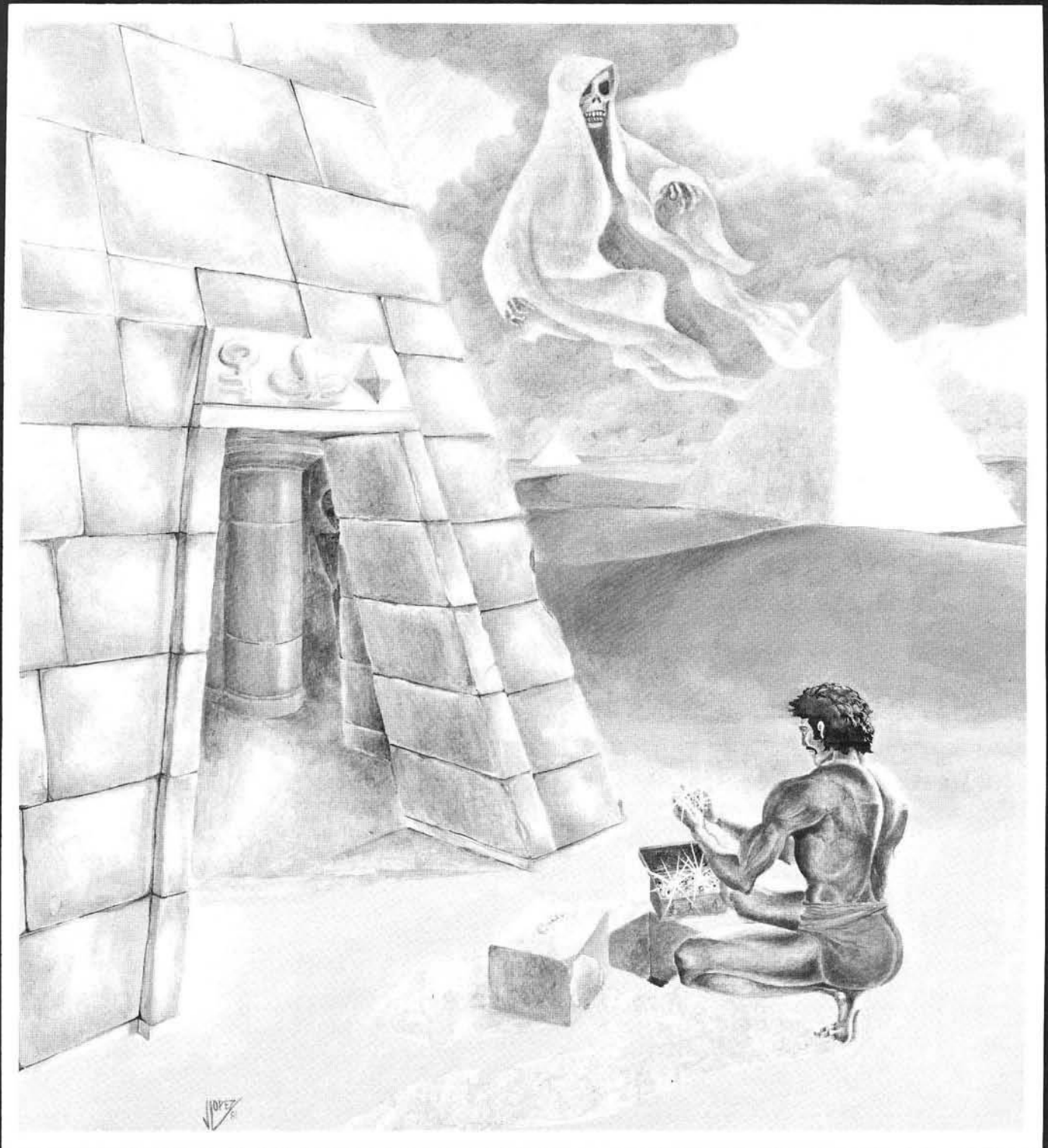

*Play Copts & Robbers
In The Tombs Of Ancient Egypt*



Copyright 1981 By Sirius Software, Inc.



***Where your secret weapon
is the fourth dimension...***



Copyright 1981 By Sirius Software, Inc.



ORBITRON

In the center of an orbiting space station you are protected only by a revolving force shield. Enemy forces are advancing from all directions and begin to place killer satellites in orbit around your station. And then, look out for the meteors!

Copyright 1981 By Sirius Software, Inc.

A "bloody" good game for the true-blue game freak. Your mission in this exploratory operation is to deliver whole blood to Hemophilia, a city in the sky, and return to Anemia Base before the Gamma Goblins overcome you. A real heart stopper!

Copyright 1981 By Sirius Software, Inc.



GAMMA GOBLINS

BY TONY AND BENNY NGO - A PRODUCT OF SIRIUS SOFTWARE, INC.

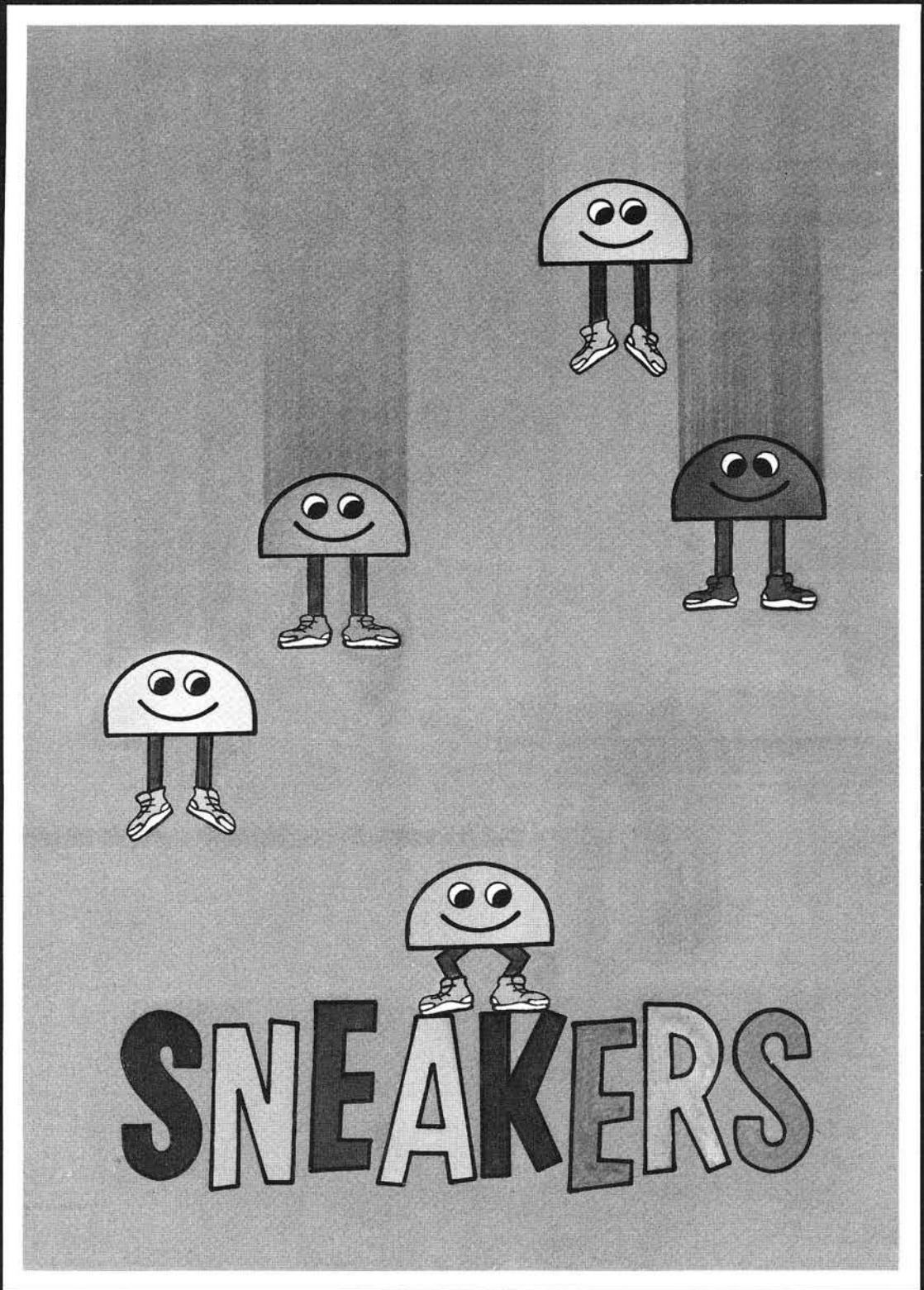

What say we go out and stomp a few???

Endless Excitement Stomping Sneakers And A Swarm Of Other Creatures



Copyright 1981 By Sirius Software, Inc.

PHANTOMS FIVE

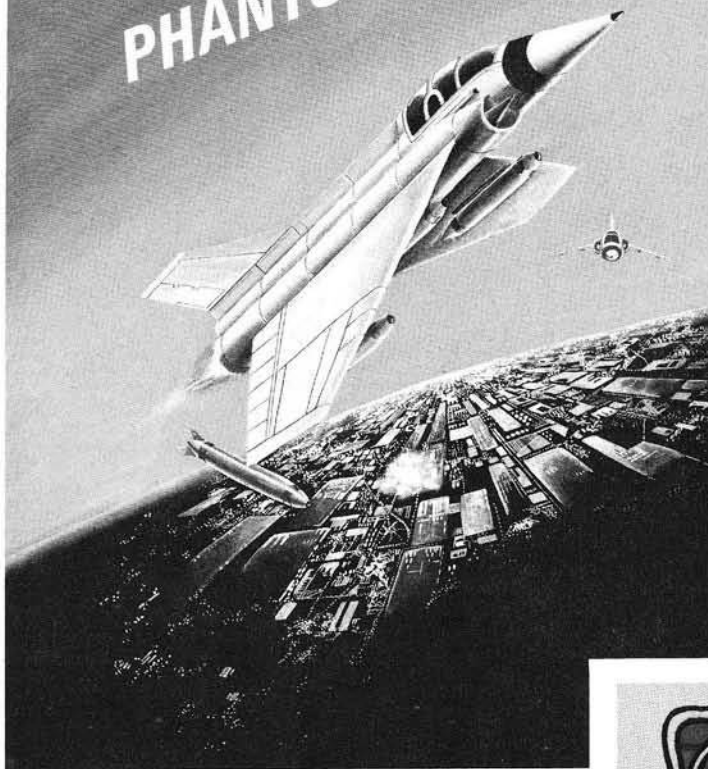

Phantoms Five simulates a fighter-bomber mission in real time, three dimensional color graphics. While you try to make your bombing run, you have to avoid being hit by anti-aircraft fire and fight off enemy aircraft as well.

Copyright 1980 By Sirius Software, Inc.

Hatch some fun with the Spiders, Wolves, Lips, and Fuzzballs. Space Eggs will crack you up! Each package includes a multi-color T-shirt iron-on that says "I FRIED THE SPACE EGGS."

Copyright 1981 By Sirius Software, Inc.

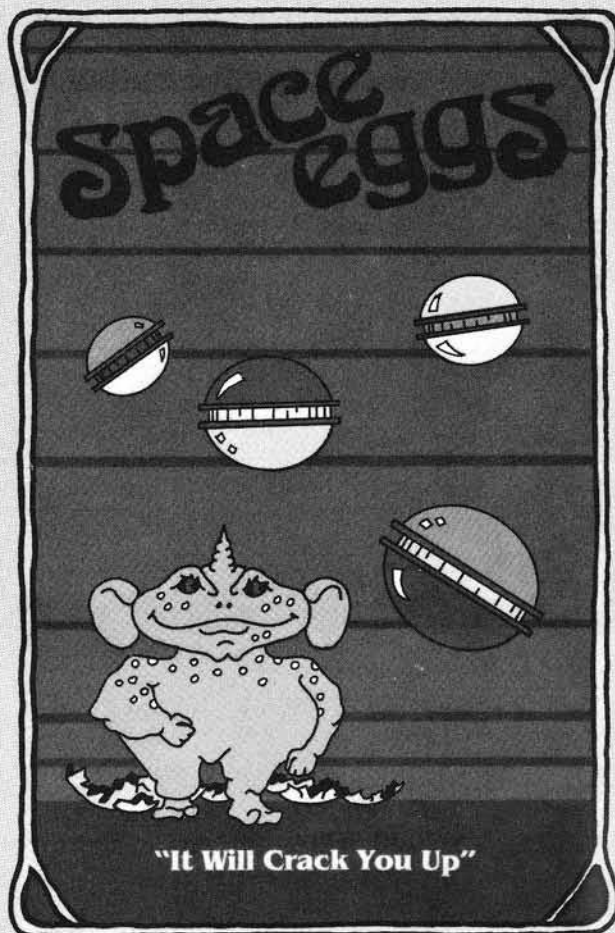

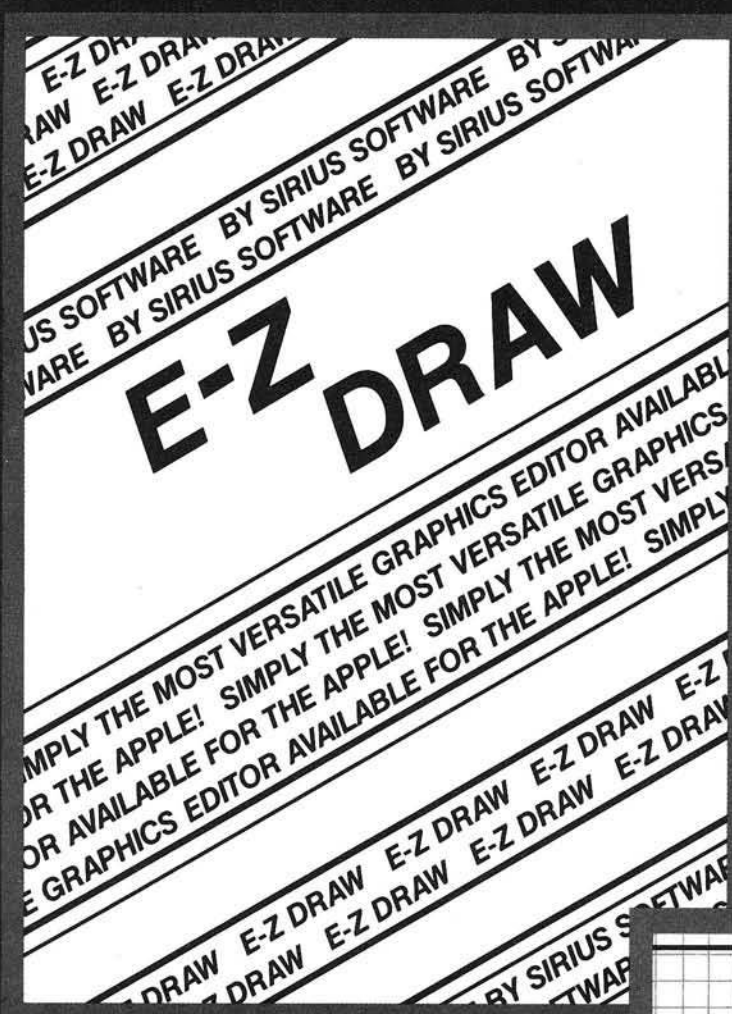

This is the graphics editing package we based our business on. Includes the Higher Text Character Generator by Ron & Darrell Aldrich and over 20 original and imaginative type styles.

Copyright 1980 By Sirius Software, Inc.

D2D0073

A Product Of Sirius Software, Inc.

**Pascal
Graphics
Editor**

PGE

The professional graphics editing package for use within the Pascal environment.

Copyright 1981 By Sirius Software, Inc.



GORGON is here...

THE EARTH HAS ENTERED A TIME WARP . . . AND THE BATTLE HAS JUST BEGUN



Copyright 1981 By Sirius Software, Inc.

BOTH BARRELS

STAR CRUISER

CYBER STRIKE

AUTOBAHN

PULSAR II

A two game pack featuring "High Noon" and "Duck Hunt" You'll love the bad guy that falls off the roof and the dogs fighting over the ducks. Fun for the young and the young at heart.

Copyright 1980 By Sirius Software, Inc.

Save yourself from the swooping aliens! This is a fast action arcade style game that can be played from ages three and up, but beware, the difficulty increases with each new wave of aliens.

Copyright 1980 By Sirius Software, Inc.

Interstellar challenge for the dedicated arcade game player. You are in command of a light transport ship equipped with Hyperspace Drive, Antimatter Torpedoes, Local and Galactic Sensors, Meteor Shields, and an Instrument Panel which continually tabulates all information vital to your mission. You alone can prevent the clone take over of the allied settlement bases. WARNING this game requires practice to play successfully.

Copyright 1980 By Sirius Software, Inc.

Hair raising excitement at 120, 160, and 200 kilometers per hour! Drive through heavy traffic, oil slicks, narrow roads, and dark tunnels (with headlights). Watch out for the fire trucks! Only on the Autobahn can you drive this fast.

Copyright 1981 By Sirius Software, Inc.

A unique two game series that provides scoring options for separate or combination game play. To destroy the "Pulsar" is no easy task. It is surrounded by spinning shields that send out orbs of energy aimed directly at you. "The Wormwall" places you in one of the strangest mazes ever created. The walls do not connect. Openings only occur temporarily as moving colored segments in the walls cross. In addition, there are munching mousers in each level of the maze ready to gobble you up should you misjudge the time and location an opening will occur.

Copyright 1981 By Sirius Software, Inc.

Contact Your Local Computer Dealer For More Information • Dealer Inquiries Invited



Sirius Software, Inc.

2011 Arden Way #2, Sacramento, California 95821

PROGRAMMING: Copts & Robbers was programmed by Alan Merrell and Eric Knopp. Epoch was programmed by Larry Miller. Orbitron was programmed by Eric Knopp. Gamma Goblins was programmed by Tony and Benny Ngo. E-Z Draw was programmed by Nasir Gebelli and Jerry W. Jewell. Pascal Graphics Editor was programmed by Ernie Brock. Sneakers was programmed by Mark Turmell. Gorgon, Phantoms Five, Space Eggs, Both Barrels, Star Cruiser, Cyber Strike, Autobahn, and Pulsar II were programmed by Nasir.

COPYRIGHT INFORMATION: All software mentioned in this advertisement are copyrighted products of Sirius Software, Inc. All rights re-

served. Apple and Applesoft are registered trademarks of Apple Computer Inc. Higher Text is a copyrighted product of Synergistic Software. We use Control Data disks for highest quality.

SYSTEM REQUIREMENTS: All software mentioned in this advertisement require an Apple II or II+ with 48K with the following exceptions. E-Z Draw requires a 48K Apple with Applesoft in ROM (or a 64K Apple II+) Pascal Graphics Editor requires an Apple II or II+ with Language System.

MICRO

Microbes and Updates

Here's a note from A. Penaloza in Morton Grove, Illinois:

For those C2 and C4P users having the Indirect Jump Vectors Mod, where the absolute address of INPUT, OUTPUT, CTRL/c, SAVE and LOAD routines are transferred from ROM into RAM (see PEEK 65, July 1981), use the following variation of Mr. Piot's "Step and Trace" (MICRO 38:79):

Instructions — Same as Mr. Piot's except that five commands are recognized.

Control-S execute next instruction

Control-T display the line number

Control-U execute next instruction and display the line number

Control-C same as always

To turn on TRACE, execute the following:

```
POKE 11,68: POKE 12,02:
X=USR(X)
```

Note: When TRACE is on, Control-S or Control-U must be pressed for you to be able to execute anything.

An update from Martin C. Foster of Virginia Beach, Virginia:

I have enclosed a listing of a modified version of the BASIC assembler program by Edward H. Carlson which you published in MICRO, March 1981.

I have modified it to run on the C1P and to accept hex numbers. Simply denote them by placing a "\$" directly in front of the number. I have also modified the input routine so that commas may now be used. It still runs in 4K.

Modified Single-Step and Trace

```
10 0000 ;SINGLE STEP AND TRACE
20 0000 ;
30 0000 GETCHR = $FFB8
40 0000 DISPLN = $B95A
50 0000 CNTRL/C = $FF99
60 0222 * = $0222
70 0222 20B8FF START JSR GETCHR ;CHARACTER IN ACC
80 0225 C902 CMP #02 ;IS IT A CNTRL/B?
90 0227 F026 BEQ TROFF ;YES, TURN OFF TRACE
100 0229 C903 CMP #03 ;IS IT A CNTRL/C?
110 022B F014 BEQ RTN ;YES, DO CNTRL/C
120 022D C913 CMP #13 ;IS IT A CNTRL/S?
130 022F F010 BEQ RTN ;YES, DO NEXT INSTRUCTION
140 0231 C914 CMP #14 ;IS IT A CNTRL/T?
150 0233 D005 BNE CTRLU ;NO, DO CNTRL/U
160 0235 205AB9 JSR DISPLN ;YES, DISPLAY LINE #
170 0238 D0E8 BNE START ;GET NEXT COMMAND
180 023A C915 CTRLU CMP #15 ;IS IT A CNTRL/U?
190 023C D0E4 BNE START ;NO, GET NEXT COMMAND
200 023E 205AB9 JSR DISPLN ;YES, DISPLAY LINE #
210 0241 4C99FF RTN JMP CNTRLC ;DO NEXT INSTRUCTION
220 0244 A922 TRON LDA #22 ;TURN ON TRACE, START LO
230 0246 8D1C02 STA #021C ;VECTOR LO OF CNTRL/C
240 0249 A902 LDA #02 ;ADDR HI OF START
250 024B 8D1D02 STA #021D ;VECTOR HI OF CNTRL/C
260 024E 60 RTS
270 024F A999 TROFF LDA #99 ;TURN OFF TRACE, CTRL/C LO
280 0251 8D1C02 STA #021C
290 0254 A9FF LDA #FF ;ADDR HI OF CNTRL/C
300 0256 8D1D02 STA #021D
310 0259 60 RTS
```

Modified Version of BASIC Assembler

```
0 FORX=1TO20:PRINT:NEXT
1 GOTO1990:REM ASSEMBLER
2 M1=INT(N/16):M2=M-M1*16:M1=FNH(M1):M2=FNH(M2)
3 Z=Z+1:POKEQ+Z,M1:Z=Z+1:POKEQ+Z,M2:RETURN
4 Z=Z+1:GOSUB2:POKEAD,M:AD=AD+1:RETURN
5 HI=INT(N/256):LO=N-256*HI:BY=3
7 II=INT(AD/256):JJ=AD-II*256:M=II:Z=1:GOSUB2
8 M=JJ:GOSUB2:M=OP:Z=Z+1:GOSUB4
10 IFBY>1THENM=LO:GOSUB4
11 IFBY=3THENM=HI:GOSUB4
12 GOTO100
20 FORZ=1TOLEN(C$):POKEN+Z,ASC(MID$(C$,Z,1)):NEXT:RETURN
99 C$="ERROR":N=Q+5:GOSUB20
100 PRINTAD:GOSUB1905:L$=LEFT$(C$,3):L=LEN(C$)
101 IFL>4THENC$=RIGHT$(C$,L-4):L=L-4:GOSUB110
102 IFL$="HEX"THENGOSUB4000:N=Q+5:GOSUB20:GOTO100
103 IFL$="ADD"THENAD=VAL(C$):GOTO100
104 IFL$="CON"THENC$=0:OP=VAL(C$):GOTO200
105 IFL$="DIS"THENAD=VAL(C$):OP=PEEK(AD):CA=0:GOTO200
106 IFL$="ASC"THENM=ASC(C$):Z=5:GOSUB2:GOTO100
109 GOTO124
110 IFASC(C$)=36THENC$=RIGHT$(C$,L-1):L=L-1:GOTO112
111 RETURN
112 C2$=RIGHT$(C$,2):IFC2$=","ORC2$=","ORC2$="X"THEN114
113 GOSUB4000:L=LEN(C$):RETURN
114 C$=LEFT$(C$,L-2):GOSUB4000:C$=C$+C2$:L=LEN(C$):RETURN
```

(Continued)

N.P. Herzberg of Princeton, New Jersey, sent us this microbe:

I just received the August issue and was pleased to see my article, "Sorting with Applesoft," on pages 92 - 94. However, there were several errors in the listing:

Line 555: Change

UP = I * I

to:

UP = I : I

Line 750: Change

R(J) = JS(TEMP) =

to:

R(J) = J : S(TEMP) =

Line 2000: Change

RENS OR T

to:

REM SORT

Line 5050 is a three-line DATA statement. The first line is correct. The second line begins:

3, 133, 132,

It should read:

3, 133, 133, 132,

The third line ends:

... 16,143,96,0.

It should read:

16, 243, 96, 0.

If you have a fix to a microbe or an updated version of an old program, share your knowledge. Send it to

Microbes @ Updates
34 Chelmsford Street
P.O. Box 6502
Chelmsford, MA 01824

```
115 C$=RIGHT$(C$,3):C$=MID$(C$,2,L-4):L=LEN(C$)
116 IFC3$="" ,Y"ORC3$="" ,X)"THENGOSUB110:C$=C1$+C$+C3$
    'L=LEN(C$):RETURN
117 C$=C$+C3$:C3$=RIGHT$(C$,1):C$=LEFT$(C$,LEN(C$)-1):L=LEN(C$)
118 IFC3$="" ,Y"ORC3$="" ,X)"THENGOSUB110:C$=C1$+C$+C3$:L=LEN(C$)
119 RETURN
124 FORI=1TO4:FORJ=1TO56STEP4
130 IFL$=MID$(C$(I),J,3)THENN=14*(I-1)+(J+3)/4:GOTO161
144 NEXTJ,I:GOTO99
161 CA=VAL(MID$(E$,N,1))
163 OP=VAL(MID$(F$(I),J,3))
200 BY=1:IFCA=0THEN7
210 IFC$="A"ANDCA=3THENOP=OP+8:GOTO7
213 IFC$="A"THEN99
220 BY=2:C1$=LEFT$(C$,1)
221 II=OP-8*(CA=1)
223 JJ=CA=1ORCA=4ORCA=5
224 IFC1$="#"ANDJJTHEN4060
228 IFC1$="#"THEN99
230 IFC1$<>" "THEN260
231 GOSUB115:LO=VAL(MID$(C$,2,L-4))
232 IFRIGHT$(C$,3)=" ,Y"ANDCA=1THENOP=OP+16:GOTO7
240 IFRIGHT$(C$,3)=" ,X"ANDCA=1THEN7
250 IFRIGHT$(C$,1)<>" "ORCA>6THEN99
254 N=VAL(MID$(C$,2,L-2))
258 OP=OP+32:GOTO5
260 IFRIGHT$(C$,2)<>" ,X"THEN280
262 N=VAL(LEFT$(C$,L-2))
264 IFN>255THEN274
266 LO=N:IFCA=2THENOP=OP+16:GOTO7
268 IFCA=1ORCA=3ORCA=5THENOP=OP+20:GOTO7
269 GOTO99
274 IFCA=2THENOP=OP+24:GOTO5
276 IFCA=1ORCA=3ORCA=5THENOP=OP+28:GOTO5
278 GOTO99
280 IFRIGHT$(C$,2)<>" ,Y"THEN300
282 N=VAL(LEFT$(C$,L-2))
284 IFN>255THEN292
286 LO=N
287 IFCA=2ORCA=5THENOP=OP+16-4*(CA=5):GOTO7
292 IFCA=1ORCA=5THENOP=OP+24-4*(CA=5):GOTO5
299 GOTO99
300 N=VAL(C$)
305 IFCA=8THEN340
310 IFN>255THEN332
312 LO=N
314 IFCA=2ORCA=7THEN7
316 IFCA=1ORCA=3ORCA=4ORCA=5THENOP=OP+4:GOTO7
332 IFCA=2ORCA=7THENOP=OP+8:GOTO5
334 IFCA=1ORCA=3ORCA=4ORCA=5THENOP=OP+12:GOTO5
336 IFCA=6ORCA=9THEN5
339 GOTO99
340 N=N-AD-2:IFN<-128ORN>127THENPRINT"CAN'T BRANCH":N:GOTO100
342 IFN<0THENN=N+256
344 LO=N:GOTO7
1900 RETURN
1905 C$=""
1910 X=USR(X):L=PEEK(531):PRINTCHR$(L)
1920 IFL=13THENPRINTCHR$(10):RETURN
1930 C$=C$+CHR$(L):GOTO1910
1990 DIMC$(5),F$(5):POKE11,0:POKE12,253
1992 DEFFNH(D)=D+48-7*(D>9)
1995 Q=54088
2000 C$(1)="ADC AND ASL BCC BCS BEQ BIT BMI BNE BPL BRK BVC BVS CLC"
2012 C$(2)="CLD CLI CLV CMP CPX CPY DEC DEX DEY EOR INC INX INY JMP"
2013 C$(3)="JSR LDA LDX LDY LSR NOP ORA PHA PHP PLA PLP ROL ROR RTI"
2016 C$(4)="RTS SBC SEC SED SEI STA STX STY TAX TAY TSX TXA TXS TYA"
2020 E$="11388878880880000144200120069155301000033001000122000000"
2021 F$(1)="097 033 002 144 176 240 036 048 208 016 000 080 112 024"
2023 F$(2)="216 088 184 193 224 192 198 202 136 065 230 232 200 076"
2025 F$(3)="032 161 162 160 066 234 001 072 008 104 040 034 098 064"
2027 F$(4)="096 225 056 248 120 129 134 132 170 168 186 138 154 152"
2029 G$="0123456789ABCDEF"
2030 AD=546:GOTO100
4000 N=0:L=1:FORI=1TOLEN(C$)
4020 M=ASC(RIGHT$(C$,I))-48:IFM>9THENM=M-7
4040 N=N+M*L:L=L*16:NEXT
4050 C$=STR$(N):RETURN
4060 IFMID$(C$,2,1)=" $"THEN4080
4070 LO=VAL(RIGHT$(C$,L-1)):OP=II:GOTO7
4080 C$=RIGHT$(C$,L-2):GOSUB4000
4090 LO=VAL(C$):OP=II:GOTO7
```

CBM/PET? SEE SKYLES ... CBM/PET?

PET? SEE SKYLES ... CBM/PET? SEE

SEE SKYLES ... CBM/PET? SEE SKYLES

"Should we call it Command-O or Command-O-Pro?"

That's a problem because this popular ROM is called the Command-O-Pro in Europe. (Maybe Command-O smacks too much of the military.)

But whatever you call it, this 4K byte ROM will provide your CBM BASIC 4.0 (4016, 4032) and 8032 computers with 20 additional commands including 10 Toolkit program editing and debugging commands and 10 additional commands for screening, formatting and disc file manipulating. (And our manual writer dug up 39 additional commands in the course of doing a 78-page manual!)

The Command-O extends Commodore's 8032 advanced screen editing features to the ultimate. You can now SCROLL up and down, insert or delete entire lines, delete the characters to the left or right of the cursor, select TEXT or GRAPHICS modes or ring the 8032 bell. You can even redefine the window to adjust it by size and position on your screen. And you can define any key to equal a sequence of up to 90 key strokes.

The Command-O chip resides in hexadecimal address \$9000, the rightmost empty socket in 4016 and 4032 or the rearmost in 8032. If there is a space conflict, we do have Socket-2-ME available at a very special price.

Skyles guarantees your satisfaction: if you are not absolutely happy with your new Command-O, return it to us within ten days for an immediate, full refund.

Command-O from Skyles Electric Works.....\$75.00
 Complete with Socket-2-Me..... 95.00
 Shipping and Handling..... (USA/Canada) \$2.50 (Europe/Asia) \$10.00
 California residents must add 6%/6½% sales tax, as required.



Skyles Electric Works
 231E South Whisman Road
 Mountain View, California 94041
 (415) 965-1735

Visa/Mastercard orders: call tollfree
 (800) 227-9998 (except California).
 California orders: please call (415)
 965-1735.

... CBM/PET? SEE SKYLES ... CBM/PET?

DIGITAL STORAGE OSCILLOSCOPE INTERFACES

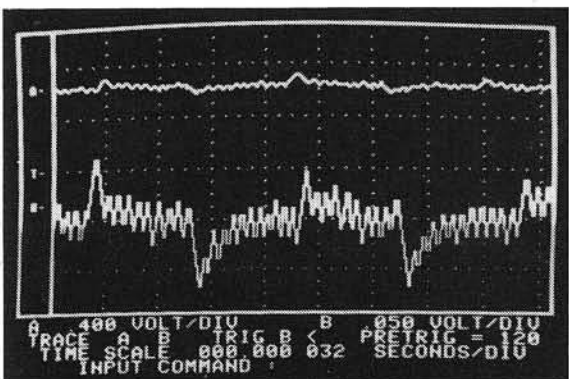

APPLESCOPE

Interface for the Apple II Computer

The APPLESCOPE system combines two high speed analog to digital converters and a digital control board with the high resolution graphics capabilities of the Apple II computer to create a digital storage oscilloscope. Signal trace parameters are entered through the keyboard to operational software provided in PROM on the DI control board.

- DC to 3.5 Mhz sample rate with 1024 byte buffer memory
- Pretrigger Viewing up to 1020 Samples
- Programmable Scale Select
- Continuous and Single Sweep Modes
- Single or Dual Channel Trace
- Greater than or less than trigger threshold detection

Price for the two board Applescope system **\$595**

*Dealer Inquiries Invited

Combine an Apple II or S100 based computer system with our interface circuit boards to create a digital storage oscilloscope at a fraction of the cost of other storage scopes.

The S100 interface provides an additional 1024 bytes of buffer memory in place of the PROM. The user must supply the graphics display and driving software. Price of the single board is **\$495**.

The SCOPEDRIVER is an advanced software package for the Applescope system. It provides expanded waveform manipulation and digital signal conditioning. The SCOPEDRIVER is available on 5¼" floppy disks for **\$49**.

For further information contact:

RC Electronics Inc.
 7265 Tuolumne Street
 Goleta, CA 93117
 (805) 968-6614

New Publications

(Continued from page 36)

Computer Literacy

Computer Literacy: Problem-Solving with Computers by Carin E. Horn and James L. Poirot. Sterling Swift Publishing Company (1600 Fortview Road, Austin, Texas 78704), 1981, viii, 304 pages, photographs, diagrams, 7¼ × 9 1/8 inches, paperbound.
 ISBN: 0-88408-133-8 \$13.95

This is a textbook for classroom use at the high school or possibly junior high level.

CONTENTS: *Introduction; Computer jargon; The History of Computing; Computer Applications; Computers in Government; The Value of Information in Society; Computer-Related Occupations; Computers and Humans; Computer Systems; Computer Components; Algorithms and Flowcharting; Computer Programming and Design Logic; Beginning BASIC; Bibliography; Glossary; Index.*

Owning Your Home Computer: The Complete Illustrated Guide by Robert L. Perry (Everest House Publishers (1133 Avenue of the Americas, New York, New York 10036), 1980, 224 pages, photographs, diagrams, 7 3/8 × 10 inches, paperbound.
 ISBN: 0-89696-093-5 \$10.95

This introductory work on personal computing for the layman not only covers common home computer applications, but focuses extensively on the home computer as an instrument for communicating with other computers and with data banks. In this area, the subjects covered include Teletext, Viewdata, QUBE, EIES, and DIGICAST.

CONTENTS: *The World at Your Fingertips—The Home Information Explosion; What Is a Home Computer?; The First Generation; Chips off an Old Block; How to Buy a Home Computer. The New Generations—1980 and Beyond—The Newest Home Computers; The Handiest Home Computers; Putting the World at Your Fingertips—Easily; The Mind Appliance: The Once and Future Computer. What Do You Do with a Mind Machine?—Ninety-nine Common Things to Do with a Home Computer; The Three Rs and a C; Division of Labor: Home Computers in Your Work; The Next Step Beyond: An Introduction to Home Computer Programming; Help for the Handicapped; Mother's and Father's Little Helper. The Thinking Computer of the Future—The Thinking Computer of the Future. Appendix—1,050 Home Computer Programs. Glossary; Bibliography; Index.*

MICRO

A Welcome to PET Users

By Loren Wright

Every Issue

Because of our PET feature this month many of you PET owners will be reading MICRO for the first time. While there is normally only one PET article per issue, you will find there is more to MICRO than articles. For instance, there's the PET Vet column, which I have been writing regularly now for more than a year. It includes product announcements and other news useful to PET owners, programming and hardware notes, answers to reader questions and occasional product reviews. Other departments, although not specifically PET oriented, offer information for PET and other microcomputer users.

Unlike other magazines, MICRO is aimed at readers with more intermediate computer ability. MICRO readers are generally very comfortable with BASIC, and many are accomplished in assembly language. In the

coming months we will be making more of an effort to convert novices to intermediates, by presenting more tutorial-type articles on higher level languages, structured programming, and concepts of assembly language programming.

This Issue

This issue offers a variety of articles for the CBM computer family. David Malmberg (author of "PRINT USING for the PET") discusses how to make a light pen work with the VIC and presents two demonstration programs. Programming a light pen is made particularly easy by the VIC's CRT controller and there are now two light pens available that work on the VIC.

Albert Reuss has compiled a series of tables that show all the various ROM configurations of Commodore products — no more question as to what kind of PET you have! In "The PET from A to D," John Sherburne describes the use of two different inexpensive devices that can convert analog signals to digital signals, which are understandable to the

PET. Incidentally, there are two other articles in the issue dealing with analog to digital conversion for microcomputers.

The fourth article (which I wrote) covers how the PET handles character information, and presents three ideas for substitute character sets, which may be applied on PET, VIC, or OSI systems. Most PETs can have their character ROMs directly replaced by a custom EPROM, and with the decrease in EPROM prices in recent years, EPROM programming is now within the reach of nearly everyone.

Previous Issues

Following is a list of the PET articles that have appeared in MICRO back to December, 1980:

PET/CBM IEEE 488 to Parallel Printer Interface	(39)
PET Interface to Bit Pad	(38)
Programmable Character Generator for the CBM 2022 Printer	(37)
Horizontal Screen Scrolling on the CBM/PET	(37)
An Inexpensive Word Processor	(36)
PRINT USING for the PET	(35)
"Unassembler" for the PET	(34)
A Second Cassette for PET	(34)
PET String Flip	(33)
PET Symbolic Disassembler	(32)
Drawing a Line on PET's 80 x 50 Grid	(31)
STUFFIT: A Time-Saving Utility Program for PET BASIC Files	(31)

Future Issues

The future offers many interesting articles. A sampling: Tiny Pilot in machine language, memory protection for old PETs, a useful sound device that lets you listen to tapes load, and an audible disk alarm.

I believe MICRO has a lot to offer the PET, CBM, or VIC owner. If you want to learn more about other high level languages to improve your programming techniques, to get ideas for applications, to learn more of the workings of your computer, or to build useful add-on devices, then MICRO should be among the magazines you read regularly.

MICRO



commodore
ROM Genealogy - p. 50



VIC Light Pen - p. 54

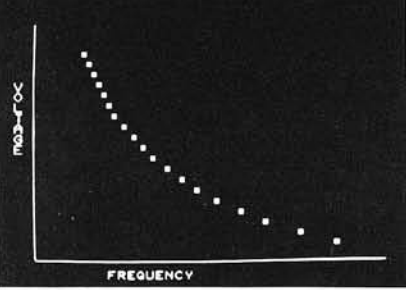

PET from A to D - p. 60

$R_1 = 2.03 \text{ K}\Omega$
 $R_2 = 156 \Omega$

Substitute Characters - p.64

JINSAM™ 8.0

space
age
micro
software

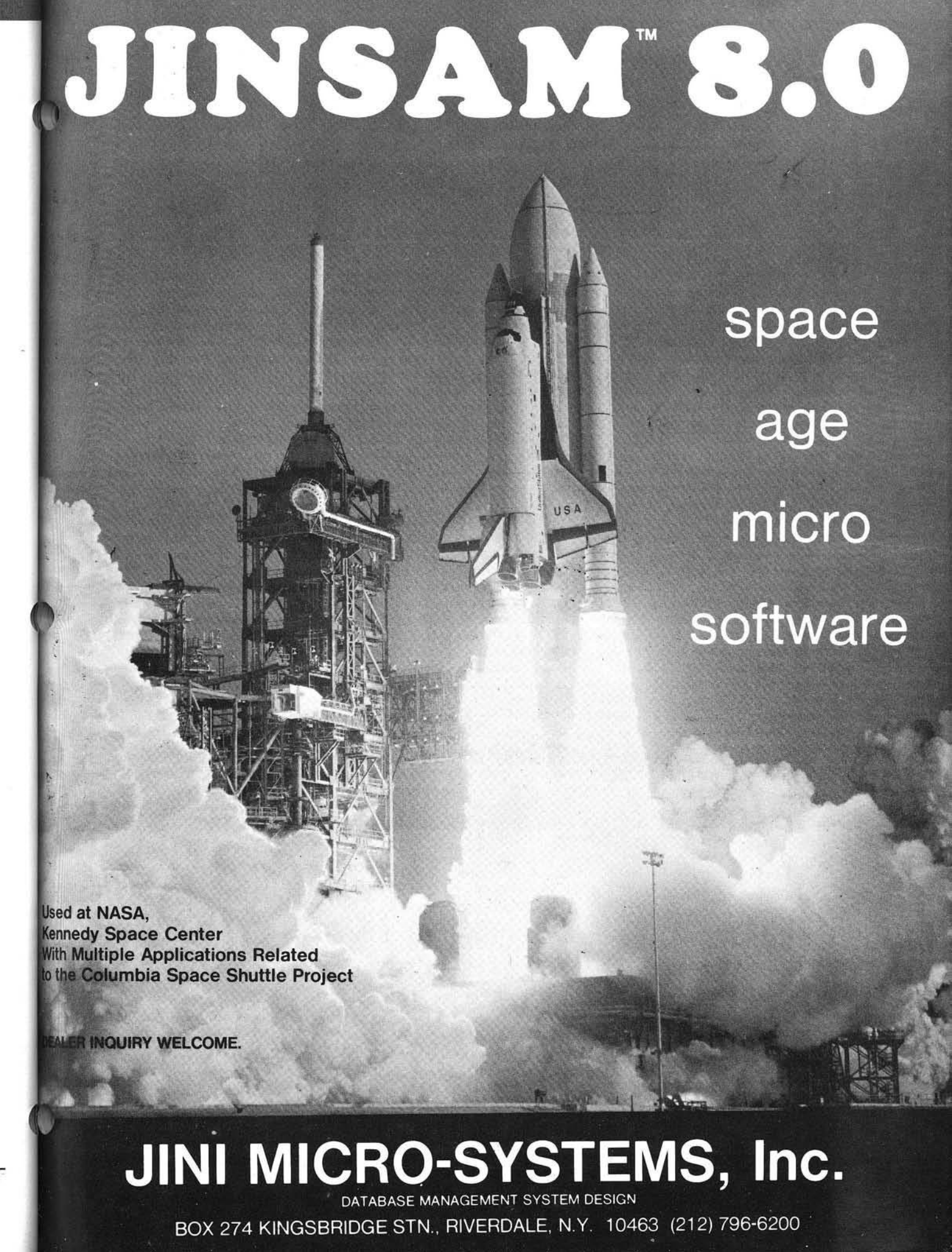
A black and white photograph of the Space Shuttle Columbia being launched from the Kennedy Space Center. The shuttle is ascending vertically, leaving a large, billowing plume of white smoke and fire from its engines. To the left of the shuttle, the complex launch pad service structure is visible, including a tall tower and various support beams. The background shows a clear sky and some ground-level structures.

Used at NASA,
Kennedy Space Center
With Multiple Applications Related
to the Columbia Space Shuttle Project

DEALER INQUIRY WELCOME.

JINI MICRO-SYSTEMS, Inc.

DATABASE MANAGEMENT SYSTEM DESIGN

BOX 274 KINGSBRIDGE STN., RIVERDALE, N.Y. 10463 (212) 796-6200

Commodore ROM Genealogy

What kind of PET do you have? Use these tables to find the ROM configuration, logic board, and character generator of your PET, CBM, disk drive, or printer. The author presents a brief history of Commodore configurations.

Albert I. Reuss
Box 151
Berkeley, California 94701

When the Commodore Personal Electronic Transactor (PET) first went into production in September 1977, it incorporated BASIC Level I. Some PETs used the 6540 28-pin ROM by MOS Technology, Inc., and others used the more standard 2316B 24-pin ROM.

The next up-grade production was to BASIC Level II. This corrected an intermittent bug in the edit software, and improved the garbage collection.

The next two production ROM sets were BASIC Level III, which allowed use of the Commodore disk drive. It also cleared up a bug which limited the dimensions to 256. At this time, the CBM "Professional Computers" with larger keyboards came into being. One set of ROMs was for the graphic (PET) keyboard CBM, and the other was for the business keyboard CBM.

Series 2001 Static RAM Versions

6540 (28-pin) ROM ROM 1.0 BASIC Level I			2316B (24-pin) ROM ROM 1.0 BASIC Level I	
Location	ROM	Part Number	ROM	Part Number
H1	6540-011	901439-01	901447-01	901447-01
H2	6540-013	901439-02	901447-03	901447-03
H3	6540-015	901439-03	901447-05	901447-05
H4	6540-016	901439-04	901447-06	901447-06
H5	6540-012	901439-05	901447-02	901447-02
H6	6540-014	901439-06	901447-04	901447-04
H7	6540-018	901439-07	901447-07	901447-07
A2	6540-010	901439-08	901447-08	901447-08
Logic Board		320008		320081

ROM 2.0 BASIC Level II		
H1	6540-019	901439-09
H2	6540-013	901439-02
H3	6540-015	901439-03
H4	6540-016	901439-04
H5	6540-012	901439-05
H6	6540-014	901439-06
H7	6540-018	901439-07
A2	6540-010	901439-08
Logic Board		320132

ROM 2.0 BASIC Level II	
901447-09	901447-09
901447-03	901447-03
901447-05	901447-05
901447-06	901447-06
901447-02	901447-02
901447-04	901447-04
901447-07	901447-07
901447-08	901447-08
	320137

ROM 3.0 Up-Grade Retrofit BASIC Level III		
H1	6540-020	901439-13
H2	6540-022	901439-15
H3	6540-024	901439-17
H4	6540-025	901439-18
H5	6540-021	901439-14
H6	6540-023	901439-16
H7	6540-026	901439-19
A2	6540-010	901439-08
Logic Board		320132 or 320008

ROM 3.0 Up-Grade Retrofit BASIC Level III	
901465-01	901465-01
901465-02	901465-02
901447-24	901447-24
901465-03	901465-03
Blank	
Blank	
Blank	
901447-08	901447-08
	320137 or 320081

The next up-grade, known as BASIC Level IV, adds disk commands to the BASIC and further improves garbage and string handling. This has since been up-graded from ROM 4.0 to 4.1 to correct minor errors in the 4.0

At the same time, Commodore brought out the new 80-column business machines with some additional word-processing functions built in.

The 40-column business machines were dropped from production in 1981. 8K units were also dropped. However, there was a limited production of 3.0 BASIC, small keyboard, dynamic 8Ks.

The current production graphic keyboard model uses the legible 12", 40-column screen. It uses the same logic board that the 8000 series uses, and includes built-in sound, and a repeat key. All 40-column machines prior to this model used the 9" screen.

BASIC Level I through III are known as the 2001 Series. BASIC Level IV with 40-column screen is known as the 4000 series.

There have been three different character generator ROMs installed over these generations. In the early production runs through BASIC Level II, location A2 contained either a 6540 or 2316B ROM.

In BASIC Level III and IV in location F10, you have 901447-10 (p/n 901447-10).

The 901447-10 ROM can replace the 901447-08 ROM in the up-grade from BASIC II to BASIC III. There is no replacement ROM for the 6540-010 28-pin ROM.

The 2023 Printer was discontinued in 1980. This was the friction feed model of the printer. The 2022 Printer (traction feed) was replaced by the 4022 Printer. The VIC-20 Color Computer was introduced in 1981.

This information has been compiled from a number of sources, including *Cursor #18*; and *Commodore Newsletter*, Vol. 1, No. 10.

**Dynamic RAM Versions
Graphic Keyboard
ROM 3.0 — BASIC Level III
Series 2001**

Hex Address	Location	ROM	Part Number
\$9000	D3	Blank	
\$A000	D4	Blank	
\$B000	D5	Blank	
\$C000	D6	901465-01	901465-01
\$D000	D7	901465-02	901465-02
\$E000	D8	901447-24	901447-24
\$F000	D9	901465-03	901465-03
Character Generator Logic Board	F10	901447-10	901447-10 320351

**ROM 4.0 — BASIC Level IV
Up-grade retrofit 3.0 to 4.0 ROM's
Series 2001**

\$9000	D3	Blank	
\$A000	D4	Blank	
\$B000	D5	901465-19	901465-19
\$C000	D6	901465-20	901465-20
\$D000	D7	901465-21	901465-21
\$E000	D8	901447-29	901447-29
\$F000	D9	901465-22	901465-22
Character Generator Logic Board	F10	901447-10	901447-10 320351

**ROM 4.0 — BASIC Level IV
Series 4000**

\$9000	D3	Blank	
\$A000	D4	Blank	
\$B000	D5	901465-19	901465-19
\$C000	D6	901465-20	901465-20
\$D000	D7	901465-21	901465-21
\$E000	D8	901447-29	901447-29
\$F000	D9	901465-22	901465-22
Character Generator Logic Board	F10	901447-10	901447-10 320351

**ROM 4.1 — BASIC Level IV
Series 2001 & 4000**

\$9000	D3	Blank	
\$A000	D4	Blank	
\$B000	D5	901465-23	901465-23
\$C000	D6	901465-20	901465-20
\$D000	D7	901465-21	901465-21
\$E000	D8	901447-29	901447-29
\$F000	D9	901465-22	901465-22
Character Generator Logic Board	F10	901447-10	901447-10 320351

**ROM 4.1 — BASIC Level IV
Series 4000 — 12" Screen**

\$F000	UD6	901465-22	901465-22
\$E000	UD7	901499-01	901499-01
\$D000	UD8	901465-21	901465-21
\$C000	UD9	901465-20	901465-20
\$B000	UD10	901465-23	901565-23
\$A000	UD11	Blank	
\$9000	UD12	Blank	
Character Generator Logic Board	UA3	901447-10	901447-10 8032030 or 8032080

Business Keyboard

**ROM 3.0 — BASIC Level III
Series 2001**

Hex Address	Location	ROM	Part Number
\$9000	D3	Blank	
\$A000	D4	Blank	
\$B000	D5	Blank	
\$C000	D6	901465-01	901465-01
\$D000	D7	901465-02	901465-02
\$E000	D8	901447-01	901447-01
\$F000	D9	901465-03	901465-03
Character Generator Logic Board	F10	901447-10	901447-10 320351

**ROM 4.0 — BASIC Level IV
Up-grade retrofit 3.0 to 4.0 ROM's
Series 2001**

\$9000	D3	Blank	
\$A000	D4	Blank	
\$B000	D5	901465-19	901465-19
\$C000	D6	901465-20	901465-20
\$D000	D7	901465-21	901465-21
\$E000	D8	901447-02	901447-02
\$F000	D9	901465-22	901465-22
Character Generator Logic Board	F10	901447-10	901447-10 320351

**ROM 4.0 — BASIC Level IV
Series 4000**

\$9000	D3	Blank	
\$A000	D4	Blank	
\$B000	D5	901465-19	901465-19
\$C000	D6	901465-20	901465-20
\$D000	D7	901465-21	901465-21
\$E000	D8	901447-02	901447-02
\$F000	D9	901465-22	901465-22
Character Generator Logic Board	F10	901447-10	901447-10 320351

**ROM 4.1 — BASIC Level IV
Series 2001 & 4000**

\$9000	D3	Blank	
\$A000	D4	Blank	
\$B000	D5	901465-23	901465-23
\$C000	D6	901465-20	901465-20
\$D000	D7	901465-21	901465-21
\$E000	D8	901447-02	901447-02
\$F000	D9	901465-22	901465-22
Character Generator Logic Board	F10	901447-10	901447-10 320351

VIC-20

Location	ROM	Part Number
D5	901486-01	901486-01
D6	901486-06	901486-06
C7	901460-03	901460-03 1001008

PRINTERS

2022 Printer (continuous feed)

Location	ROM	Part Number
U11	901472-03 Logic Board	901472-03 320311

2023 Printer (friction feed)

U11	901472-02 Logic Board	901472-02 320311
-----	--------------------------	---------------------

**2023 Printer
Interim Fix**

U11	901472-03 Logic Board	901472-03 320311
-----	--------------------------	---------------------

**2022 & 2023 Printers
Interim Fix**

U11	901472-04 Logic Board	901472-04 320311
-----	--------------------------	---------------------

**2022 Printer
??? Fix ???**

U11	901472-07 Logic Board	901472-07 320311
-----	--------------------------	---------------------

4022 Printer

U11	901472-07 Logic Board	901472-07 4022004
-----	--------------------------	----------------------

**Audio-Visual
Club
International**



- For Men and Women of All Ages
- Works Like a Pen Pal Club or a Conversation Via Amateur Radio
- Meet other people with mutual interests.
- Exchange conversation and programs using cassette tape, videotape, slide projector film, movie film, or computer disc.
- Create your own show, music, or TV picture.
- Play computer games.
- Enjoy travel sights and sounds without traveling.
- Copyright and postal laws must be observed.

Through Audio-Visual Club International you may exchange conversation, music, computer programs, slides, or television pictures on cassette tape with other members from around the world for mutual interest and enjoyment using your cassette tape recorder and home computer. Other equipment may also be used such as video recorders, photographic equipment, or computer discs. The minimum equipment needed is a cassette recorder.

Members receive a Directory of Members which lists name, age, address, occupation, equipment, and up to ten interests. You will be given an application to submit this information. It is not important that all information be supplied. Initial contact is made by postcard or letter. If a contact is agreed upon, the initiator supplies a cassette and mails it to the other member. The same cassette is sent back and forth. If you accidentally destroy another member's cassette in your machine, it must be replaced at your expense.

A periodic newsletter keeps you informed of current happenings in the club and is a means of making announcements to all members from any one member. Profit, if any, goes toward research and development of new products.

Dues are \$16.00/year.

Money-back guarantee if requested within 60 days.

For application, write: Audio-Visual Club International, Dept. A
16 Sycamore Street
Chelmsford, MA, U.S.A. 01824

**AUDIO-VISUAL CLUB INTERNATIONAL IS
A DIVISION OF XEVEX CORPORATION.**

**Series 8000 — 12" Screen
ROM 4.0 — BASIC Level IV**

Hex Address	Location	ROM	Part Number
\$F000	UD6	901465-22	901465-22
\$E000	UD7	901474-03	901474-03
\$D000	UD8	901465-21	901465-21
\$C000	UD9	901465-20	901465-20
\$B000	UD10	901465-19	901565-19
\$A000	UD11	Blank	
\$9000	UD12	Blank	
Character Generator	UA3	901447-10	901447-10
Logic Board			8032030 or 8032080

**Series 8000 — 12" Screen
ROM 4.1 — BASIC Level IV**

Hex Address	Location	ROM	Part Number
\$F000	UD6	901465-22	901465-22
\$E000	UD7	901474-03	901474-03
\$D000	UD8	901465-21	901465-21
\$C000	UD9	901465-20	901465-20
\$B000	UD10	901465-23	901465-23
\$A000	UD11	Blank	
\$9000	UD12	Blank	
Character Generator	UA3	901447-10	901447-10
Logic Board			8032030 or 8032080

DISKS

DOS 1.0 — 2040 Disk

Location	ROM	Part Number
UL1	901468-06	901468-06
UK1	Blank	
UH1	901468-07	901468-07
UK3	901466-02	901466-02
UK6	901467	901467
	Logic Board	320820
	Logic Board	320817

**DOS 2.1 — 4040 Disk
Up-grade retrofit 2040 to 4040**

UL1	901468-12	901468-12
UK1	901468-11	901468-11
UH1	901468-13	901468-13
UK3	901466-04	901466-04
UK6	901467	901467
	Logic Board	320820
	Logic Board	320817

DOS 2.5 — 8050 Disk

UL1	901482-03	901482-03
UH1	901482-04	901482-04
UK3	901483-03	901483-03
UK6	901467	901467
	Logic Board	8050002
	Logic Board	8050006

MICRO

PET BITES VIC!

VIC/PET programmers: How would you like to be able to connect all of your PET peripherals, through your PET, to your VIC? Print VIC programs, save or load on disk, or use a VIC joystick on the PET. Basic programs can call HESCOM subroutines to transfer any amount of memory in either direction between two VICs, two PETs, or a PET and a VIC.

For example, a 3.5K Basic program can be transferred in half a second! Or, you could use an existing PET disassembler to look at the VIC ROMs by simply changing the input routine to get single bytes via HESCOM. Similarly, three-voice VIC sound can be used by PET programs. Full handshaking ensures reliability in block transfers; another mode allows real-time sampling of the user port for applications like two-machine games! Includes 5' cable, machine language software for PET and VIC, demo program, and documentation.

(VIC or 8K PET) \$49.95

by Jay Balakrishnan

NEW RELEASES

HESEDIT: change 22 lines of data by merely over-typing and insert, delete, and even duplicate lines—all at once! Scroll forwards or backwards by any amount — it's also easy to edit files bigger than your memory. Why code a program to maintain each file? Use HESEDIT for mailing lists, notes or prepare assembler source for HESBAL. All keys repeat. FAST - written in BASIC and assembler. \$12.95

6502 ASSEMBLER PACKAGE: HESBAL, a full-featured assembler with over 1200 bytes free (8K) & HESEDIT; for less than \$25! HESBAL is THE best 8K assembler available: it uses only 1 tape or disk, yet includes variable symbol sizes, pseudo-opcodes, over 25 error messages and more than 70 pages of documentation. \$23.95

HESCOUNT by Jerry Bailey. A totally new concept in debugging! Machine language monitor aids debugging of any Basic program by counting the number of times each line is executed. Pinpoints bottlenecks to help you improve run times up to 50%. Shows code that was never executed, and lets you verify that loops and conditional statements are working as expected. (VIC or 8K PET) \$23.95

HESLISTER 2.0 by Cy Shuster. Now 35% faster, reveals program structure by untangling complicated Basic lines and indenting IF, FOR..NEXT statements, etc. Inputs from disk; outputs to screen or printer. (8K PET) \$15.95 (includes disk)

GUARANTEED to load or replaced FREE. Order from your dealer or direct from us. Add \$2 postage, Cal. res. - 6% sales tax. Disk versions - add \$3 (disk included).



Human Engineered Software
3748 Inglewood Blvd. Room 11
Los Angeles, California 90066

24 HOUR ORDER LINE (M/C OR VISA)

(213) 398-7259

VIC Light Pen-manship

The video interface chip used in the VIC constantly keeps track of the position of a light pen, making software for it easy to write. There are two light pens available that work with the VIC. This author explains how they work, and gives two demonstration programs: "Light Pen Scribe" and "Light Pen Artist".

David Malmberg
43064 Via Moraga
Fremont, California 94538

Most implementations of light pens on personal computers use an artificial technique to simulate a real light pen. This is done by setting up a table of possible pen screen locations that are to be tested and blinking them on and off very quickly with a lighted cursor space. The light pen is able to detect the change in light caused by the blink. By matching the pen's positive reading against which specific location is being blinked at that moment, the computer is able to determine the correct screen location. This technique has a number of significant drawbacks. For instance, it requires a great deal of memory, programming effort, and processor time to set up and test even a limited number of locations. If you want to test a large number of possible locations, the benefits seldom justify the necessary effort or the design compromises required.

The new Commodore Video Interface Chip (VIC) has alleviated this problem. Now, personal computer owners can have a *real* light pen whose location on the screen can be determined by the hardware — not by software gimmicks. The VIC light pen can detect any point on the screen instantly and automatically. It does not require time- and

memory-consuming table look-ups and individual screen location testing. A light pen on the VIC is fun and easy to use; it can produce dramatic enhancements to games, educational programs, and menu-driven applications.

The VIC owner has several light pen options. The VIC was specifically designed to work with the Atari light pen (as well as the Atari joystick and game paddles). The Atari light pen retails for about \$75. Systems Formulate is also marketing a light pen which was developed in Japan and costs about \$35. The authoritative voice on the other end of the Commodore telephone "Hotline" said that Commodore will have its own VIC light pen on the market by Christmas (price unknown). Their pen will be essentially identical to the Atari pen. All of these pens work the same way and software written for any one pen should run using the others (with only one slight difference which will be described later).

How It Works

The VIC was specifically designed to handle color video graphics on a monitor or home TV. This chip shares the workload with a 6502 chip which handles most of the processing and the operating system. This design philosophy is similar to that of the Atari computer which also has a 6502 for its main processor and a separate chip to handle its video.

Among the functions this special video chip performs is controlling and tracking the electronic beam that actually "paints" the picture on the screen. This beam sweeps from left to right across the screen and from top to bottom — painting a completely new picture on the screen 60 times each second. This speed is certainly faster than the eye can detect, but slow enough so that the VIC can track the beam's location as it moves through every dot on the screen.

To demonstrate just how the VIC knows the exact location of the beam, let's assume you have plugged your light pen into the VIC game port and have entered and run the following short program:

```
10 X = PEEK(36870)
20 Y = PEEK(36871)
30 LT = -((PEEK(37151)AND4)
=0)
40 PRINT "CLEAR"X;Y;LT
50 GOTO 10
```

As the electronic beam moves around the screen and the light pen senses the light from the beam, the VIC captures the screen's horizontal and vertical coordinates at that instant and stores them in locations 36870 and 36871, respectively.

As you experiment by running your light pen over the screen surface you should notice the following points:

1. The value of X will vary from approximately 30 on the extreme left side of the screen to approximately 122 on the extreme right. Similarly, Y will vary from about 17 at the top of the screen to about 121 at the bottom. Your own readings may differ slightly from these. The X and Y values change linearly with the corresponding horizontal and vertical movement of the pen.
2. Inside the screen border, X varies from 32 on the left to 119 on the right — a length of 88 (counting zero as the left-most value). This corresponds with 4 light pen values per screen space (there are 22 columns). The Y values vary from 24 at the top border to 115 at the bottom border. This is a length of 92 light pen values or 4 for each of the 23 screen rows.
3. If you are using an Atari light pen or (presumably) its Commodore equivalent, you should notice that the value of LT changes from 0 to 1 whenever the tip of the pen is pressed against the screen. The Atari pen has

a spring-loaded switch in its tip which can be read by the VIC using statement 30 above. This is a very nice feature and will enhance your light pen applications.

4. You will also notice that the pen is probably more sensitive than you might have imagined. For example, the Atari light pen I use can be detected as far as six inches away from the screen. And yet, it can be controlled fairly accurately even from that distance. It makes you wonder when someone might come out with a light "gun" that could be "shot" at the screen from several feet away. Just think of the games you could write!
5. Even though the pen is fairly sensitive, it is subject to "noise." As a demonstration, if you try to hold the pen absolutely still in one place, you will see the values of X and Y flickering to nearby values — and occasionally to a more distant value. This is caused by "noise" in the pen. This "noise" seems to be partly a function of color. Reading a location that is a dark color, especially if nearby locations are light colors, may cause problems. One of the routines I will present later will solve these problems.
6. The last thing you should notice is that the pen always shows the last value of X and Y that it read. If you take the pen completely away from the screen it still indicates a specific location. Because of this, you should be very careful in the design of your applications; do not mistake an old pen reading for a new one. This potential problem is another good reason for the Atari's tip switch.

Light Pen Scribe

As an example of how the light pen might be used in a VIC program, let's examine the BASIC program in listing 1. This program displays the normal upper case character set including numbers and punctuation symbols on the top three lines of the VIC screen. The next two lines contain normal "cursor" control words such as CLEAR, HOME, RETURN, UP, etc. The sixth line displays the seven color options (excluding white) available for the VIC. By putting the light pen on various characters, cursor commands, or colors in these first six lines, the program generates written text in whatever color combinations you wish on the remainder of the VIC screen. In essence, the program totally replaces keyboard input with light pen input.

Listing 1

```

100 REM LIGHT PEN SCRIBE
110 REM BY DAVID MALMBERG
120 DIM CC(7) : POKE36879,27 : CL=3 : SS=7680 : IC=30720
130 DEF FNA(Z)= SS+CN+22*RW : DEF FNB(Z)= FNA(Z)+IC :
    DEF FNC(Z)=PEEK(FNA(Z))

140 FOR I=1TO7 : READ CC(I) : NEXT
150 DATA 144,28,159,156,30,31,158
160 PRINT"J"
170 FOR I=0TO63 : POKESS+I,I : POKESS+IC+I,CL : NEXT
180 PRINT"HOME RETURN JUMP DOWN"
190 PRINT"CLEAR ERASE LEFT RIGHT"
200 FOR I=1TO7 : PRINTCHR$(CC(I))" " : NEXT
210 RW=6 : CN=0
220 IF CN<0 THEN CN=21 : RW=RW-1
230 IF CN>21 THEN CN=0 : RW=RW+1
240 IF RW<6 THEN RW=6
250 IF RW>22 THEN RW=22
260 IF FNC(0)=32 THEN POKE FNB(0),CL
270 IF FNC(0)<128 THEN POKE FNA(0),FNC(0)+128
280 REM TEST LIGHT PEN TIP SWITCH
290 LT=-((PEEK(37151)AND4)=0) : IF LT=0 THEN 290
300 REM SWITCH ON - NOW READ AND TRANSLATE PEN LOCATION
310 X=PEEK(36870) : Y=PEEK(36871)
320 IF X<32 THEN X=32
330 IF X>119 THEN X=119
340 IF Y<24 THEN Y=24
350 IF Y>115 THEN Y=115
360 X=X-32 : Y=Y-24
370 C=INT(X/4) : R=INT(Y/4)
380 L=SS+C+22*RW : LC=PEEK(L)
390 REM CHECK COMMAND - TAKE ACTION
400 IF R<5 THEN 290
410 IF R<5 THEN 470
420 REM COLOR ROW
430 X=INT((C+1.1)/3) : Y=(C+1)/3
440 IF X<>Y THEN 290 : REM INVALID COLOR LOCATION
450 IF X=1 THEN X=0
460 POKE 36879,24+X : CL=X : GOT0640
470 IF R<4 THEN 540
480 REM ROW 4 COMMANDS
490 IF C=0 THEN POKE FNA(0),FNC(0)-128 : GOT0 160 : REM CLEAR
500 IF C=6 THEN POKE FNA(0),32 : CN=CN-1 : GOT0 640 : REM ERASE
510 IF C=12 THEN POKE FNA(0),FNC(0)-128 : CN=CN-1 : GOT0640 :
    REM RIGHT
520 IF C=17 THEN POKE FNA(0),FNC(0)-128 : CN=CN+1 : GOT0640 :
    REM LEFT
530 GOT0 290 : REM INVALID LOCATION
540 IF R<3 THEN 620
550 REM ROW 3 COMMANDS
560 IF C=0 THEN POKE FNA(0),FNC(0)-128 : CN=0 : RW=6 : GOT0640 :
    REM HOME
570 IF C=5 THEN POKE FNA(0),FNC(0)-128 : CN=0 : RW=RW+1 :
    GOT0640 : REM RETURN
580 IF C=12 THEN POKE FNA(0),FNC(0)-128 : RW=RW-1 : GOT0640 :
    REM UP
590 IF C=15 THEN POKE FNA(0),FNC(0)-128 : RW=RW+1 : GOT0640 :
    REM DOWN
600 GOT0290 : REM INVALID LOCATION
610 REM WRITE CHARACTER AT PEN LOCATION
620 POKEFNA(0),LC : POKEFNB(0),CL : CN=CN+1
630 REM FLASH PEN LOCATION
640 S=0 : IF LC>127 THEN S=LC : LC=LC-128
650 POKE36878,15 : FOR I=1TO10
660 POKEL,LC+128 : POKE36876,225
670 POKEL,LC : POKE36876,195
680 NEXT : IF S<>0 THEN POKEL,S
690 POKE36878,0 : POKE36876,0 : GOT0220 READY.

```

By way of further explanation, here are some of the functions being performed in various parts of the program.

Line 120 sets the color combination to a white screen with a light blue border by POKE36879,27. CL is the variable denoting the current color of the text and of the screen border. CL is initialized to light blue by setting it to 3. SS is the address of the start of screen memory (equivalent to 32768 on the PET). IC is the constant you must add to a particular screen location to get that location's corresponding color matrix location. For example, if we POKED 7680 with a 1 (an A), we would also have to POKE 7680 + IC with a 3 to make that "A" light blue.

Line 130 sets up three functions: FNA returns the screen location corresponding to row RW and column CN; FNB gives the corresponding color matrix location; FNC returns the PEEKed value of FNA.

Lines 140 and 150 read the character values corresponding to various color print commands. For example, the third value of the array CC contains the character value that, when printed as CHR\$(CC(3)), would cause the material printed next to be printed in light blue.

Lines 170 to 200 print the characters, commands and color options in the top six rows of the screen.

Lines 220 to 250 assure that the location where the text is being printed on the bottom part of the screen (current row RW and current column CN) is always within the proper bounds. These lines also assure that the text properly wraps around from the end of one row to the beginning of the next.

Lines 260 and 270 print the "cursor" where the text is to be written next.

Line 290 waits until the tip switch on the light pen has been depressed. If you are using a light pen that does not have a tip switch (or something similar), you should substitute the following line:

```
290 A$="" : GET A$ : IF
    A$="" THEN 290
```

This line will let you indicate that you are ready to have the light pen read a location by just touching any key on the keyboard. This is obviously a less elegant approach than using a tip switch.

Lines 310 to 380 read the current light pen horizontal and vertical values and translate them into the appropriate

screen row and column. The variables L and LC are the screen location that the pen is pointing to, and the character at that location, respectively.

Lines 430 to 460 edit color commands from the pen and change the text and border colors accordingly.

Lines 490 to 600 edit "cursor" control commands and cause the proper action to be taken.

Line 620 writes the character (that the light pen is pointing to in the top three lines of the screen) where the current "cursor" position is on the bottom text area of the screen.

Lines 640 to 690 flash the location the pen is pointing to on and off, and sound a "buzzer" to indicate that the location was actually read, passed the edit, and was processed properly. Then the program loops back to line 220 and waits for the next light pen reading.

Light Pen Artist

Listing 2 contains another light pen application called "Light Pen Artist." It is a program that enables you to use the light pen to "paint" on the screen using

(LABEL), Y (LABEL,X) LABEL + INDX-1

LDA STA LDX STX LDY STY

6502 Assembler/Editor

- APPLE
- ATARI
- PET
- KIM
- SYM

SET IFM IFP IFN IFE

Before you buy that off-brand Assembler/Text Editor, note that EHS is the only company that provides a line of **compatible** ASM/TED's for the PET/APPLE/ATARI/SYM/KIM and other microcomputers. When you make the transition from one of these 6502-based microcomputers to another, you no longer have to relearn peculiar Syntax's, pseudo ops, and commands. Not only that, EHS ASM/TED's are the **only resident 6502 Macro Assemblers** available and they have been available for several years. Thus you can be sure **they work**. Our ASM/TED's may cost a little more but do the others provide these **powerful features**: Macros, Conditional Assembly, String Search and Replace, or even up to 31 characters per label? Before you spend your money on that other ASM/TED, **write for our free detailed spec sheet.**

MACRO ASM/TED

- For APPLE/ATARI/PET/SYM/KIM
- Other than our MAE, no other assembler is as powerful.
- Macros/Conditional Assembly.
- Extensive text editing features
- Long Labels
- Designed for Cassette-based systems.

\$49.95

MAE ASM/TED

- For APPLE/ATARI/PET
- The most powerful ASM/TED
- Macros/Conditional and Interactive Assembly
- Extensive text editing features
- Long Labels
- Control files
- Designed for Disk-based Systems.

\$169.95



EASTERN HOUSE SOFTWARE
 3239 Linda Drive
 Winston-Salem, N. C. 27106 USA
 (Dealer Inquiries Invited)

PHONE ORDERS
 (919) 924-2889
 (919) 748-8446



.EN .BY .OS .BA .DE .CE

the VIC graphic character set and a palette of seven colors. You can paint a single screen location or paint a "line" of the current graphic character between any two points on the screen.

The program works like the previously described "Light Pen Scribe." The top three lines on the screen contain the graphic characters. The fourth line has these command words: CLR, POINT, LINE and (reverse) ON or OFF. The fifth line has the seven colors in the VIC artist's palette. By simply pointing the pen at the color, the command options, and the character, you are ready to paint on the bottom portion of the screen by using your pen as if it were an artist's brush. It is easy, fun and a very impressive demonstration of the VIC's capabilities.

The basic program structure and even the variable names are almost identical to "Light Pen Scribe."

Noise Elimination

The artist program does have one significant difference. Lines 660 to 970 contain a machine language program (in the form of BASIC POKES) that eliminates the "noise" from the pen readings. This is a general subroutine that could be appended to and used in other light pen programs. It loads into the VIC's cassette buffer, so you should be careful not to do any input/output that would destroy the routine when using it in other programs.

The best way to describe what the routine does is to look at the BASIC code in lines 310 to 370 in the Scribe program (listing 1). The machine language code performs the same calculations that these BASIC statements do to "normalize" the horizontal (X) and vertical (Y) values to begin with zero and not exceed 87 for X and 91 for Y. It also calculates the pen's column and row (also beginning with zero). All of these values are obtained by PEEKing locations 982 to 985, respectively.

Besides just making the arithmetic faster, the routine eliminates the noise by taking seven separate readings (at 1 jiffy intervals so they will correspond to different sweeps of the electronic beam), sorting them, and returning the median reading (i.e., fourth). Taking the median reading eliminates the "noisy" readings, because when sorted, these strange readings would certainly be at one extreme (or the other) of the list. The median value, on the other hand, is almost guaranteed to be "noise" free.

Listing 2

```

100 REM LIGHT PEN ARTIST
110 REM BY DAVID MALMBERG
120 DIM CC(7) : POKE36879,27 : CL=3 : SS=7680 : IC=30720
130 DEF FNA(Z)=SS+CN+22*RW : DEF FNB(Z)=FNA(Z)+IC :
DEF FNC(Z)=PEEK(FNA(Z))
140 FOR I=1TO7 : READ CC(I) : NEXT
150 DATA 144,28,159,156,30,31,158
160 GOSUB760
170 PRINT"O" : PC=32 : RV=0 : LN=0 : LX=0 : LY=0
180 FOR I=64TO127 : POKESS+I-64,I : POKESS+I+IC-64,CL : NEXT
190 PRINT"00000CLR 0POINT 0LINE 0ON 0OFF"
200 FOR I=1TO7 : PRINTCHR$(CC(I)) " 0" : NEXT
210 REM TEST LIGHT PEN TIP SWITCH
220 LT=-(PEEK(37151)AND4)=0 : IF LT=0 THEN 220
230 REM SWITCH ON - NOW READ AND TRANSLATE PEN LOCATION
240 SYS(828) : CN=PEEK(984) : RW=PEEK(985)
250 L=FNA(0) : LC=FNC(0)
260 REM CHECK PEN LOCATION - TAKE APPROPRIATE ACTION
270 IF RW&4 THEN 520 : REM DRAW ROUTINE
280 IF RW&4 THEN 340
290 REM CHANGE COLOR
300 X=INT((CN+1)/3) : Y=(CN+1)/3
310 IF X>Y THEN 320 : REM INVALID COLOR LOCATION
320 IF X=1 THEN X=0
330 POKE36879,24+X : CL=X : GOTO450
340 IF RW&3 THEN 430
350 REM ROW 3 COMMANDS
360 IF CN=0 THEN 170 : REM CLEAR
370 IF CN=4 THEN LN=0 : GOTO450 : REM POINT
380 IF CN=10 THEN LN=1 : GOTO450 : REM LINE
390 IF CN=15 THEN RV=1 : GOTO450 : REM REVERSE ON
400 IF CN=18 THEN RV=0 : GOTO450 : REM REVERSE OFF
410 GOTO220 : REM INVALID COMMAND LOCATION
420 REM UPDATE CURRENT CHARACTER
430 PC=LC
440 REM FLASH PEN LOCATION
450 S=0 : IF LC>127 THEN S=LC : LC=LC-128
460 POKE36878,15 : FOR I=1TO10
470 POKEL,LC+128 : POKE36876,225
480 POKEL,LC : POKE36876,195
490 NEXT : IF S<0 THEN POKEL,S
500 POKE36878,0 : POKE36876,0 : GOTO220
510 REM DRAW ROUTINES USING CURRENT OPTIONS
520 V=PC : IF RV=1 THEN V=PC+128 : REM REVERSE IF APPROPRIATE
530 IF LN<0 THEN 590
540 REM DRAW POINT
550 POKE FNA(0),V : POKE FNB(0),CL
560 LX=CN : LY=RW : REM UPDATE LAST POINT
570 GOTO220
580 REM DRAW LINE FROM LAST POINT TO CURRENT POINT
590 DX=CN-LX : DY=RW-LY
600 Z=ABS(DX) : IF ABS(DY)>Z THEN Z=ABS(DY)
610 IF Z=0 THEN IX=0 : IY=0 : GOTO630
620 IX=DX/Z : IY=DY/Z
630 FOR I=0TOZ : RW=INT(LY+IY*I+0.5) : CN=INT(LX+IX*I+0.5)
640 POKE FNA(0),V : POKE FNB(0),CL
650 NEXT : LX=CN : LY=RW : GOTO220
660 REM MACHINE LANGUAGE ROUTINE THAT TAKES 7 CONSECUTIVE
READINGS
670 REM OF THE LIGHT PEN LOCATION AND SORTS THEM TO ELIMINATE
680 REM LIGHT PEN "NOISE" BY RETURNING THE MEDIAN READING
(4TH OF 7).
690 REM THE READING IS "NORMALIZED" TO BEGIN WITH ZERO.
700 REM THE VALUES FOR THE READING CAN BE FOUND BY PEEKING
THESE LOCATIONS:
710 REM 982 - HORIZONTAL VALUE (RANGES FROM 0 TO 87)
720 REM 983 - VERTICAL VALUE (RANGES FROM 0 TO 91)
730 REM 984 - SCREEN COLUMN (0 TO 21)
740 REM 985 - SCREEN ROW (0 TO 22)
750 REM*****CAUTION*****THE ROUTINE WILL BE DESTROYED IF
ANY TAPE I/O IS DONE
760 FOR I= 828 TO 986 :READDC:POKEI,DC:NEXTI
770 DATA162,0,160,3,132,152,173,6,144
780 DATA201,32,176,2,169,32,201,120,144
790 DATA2,169,119,56,233,32,160,219,132
800 DATA151,32,179,3,165,151,24,109,218
810 DATA3,133,151,144,2,230,152,173,7
820 DATA144,201,24,176,2,169,24,201,116

```

(Continued)

Listing 2 (Continued)

```

830 DATA144,2,169,115,56,233,24,32,179
840 DATA3,232,236,218,3,240,9,165,162
850 DATA197,162,240,252,76,62,3,173,218
860 DATA3,74,168,177,151,141,215,3,169
870 DATA219,133,151,169,3,133,152,177
880 DATA151,141,214,3,173,214,3,74,74
890 DATA141,216,3,173,215,3,74,74,141
900 DATA217,3,96,142,214,3,172,214,3
910 DATA192,0,240,22,136,209,151,200
920 DATA176,16,136,141,214,3,177,151
930 DATA200,145,151,136,173,214,3,56
940 DATA176,230,145,151,96,0,0,0,0,7
950 RETURN
READY.
    
```

The assembly source for this routine is given in listing 3. This routine is my adaptation for the VIC of a similar routine in the Atari Light Pen Operators Manual. The credit for the idea and the majority of the code should go to some anonymous programmer at Atari. The assembly source is very well commented and should be easy to follow. Pay particular attention to the logic of the "insert sort" in locations \$03B3 to \$03D5 of the source listing. This is a very clever routine that performs the sort as the data is being read, by making sure that each reading is inserted in its appropriate place in the table.

Listing 3

```

;*****
;*
;* VIC LIGHT PEN ROUTINE
;*
;* ADAPTED FOR THE VIC BY DAVID MALMBERG
;* FROM A SIMILAR ROUTINE FOR THE ATARI
;* AS DOCUMENTED IN THE ATARI LIGHT PEN MANUAL
;*
;*****
TBLPTR    .DE #97
JIFFY.CTR .DE #A2
PEN.HOR   .DE #6870
PEN.VER   .DE #6871
;
; .BA #33C      ; IN CASSETTE BUFFER
; .OS
;
033C- A2 00      LDX #0      ; INITIALIZE COUNTER
033E- A0 03      LOOP      LDY #H, TABLES ; STORE TABLE HI-BYTE POINTER
0340- 84 98      STY *TBLPTR+1
;
; LOAD X VALUE AND CONVERT
;
0342- AD 06 90   X.LOAD   LDA PEN.HOR   ; GET LIGHT PEN X COORD
0345- C9 20      CMP #32      ; PEN READING >= 32 ?
0347- B0 02      BCS HERE   ; IF YES
0349- A9 20      LDA #32      ; IF NO - SET TO 32 MINIMUM
034B- C9 78      HERE      CMP #120     ; PEN READING =< 119 ?
034D- 90 02      BCC HERE1  ; IF YES
034F- A9 77      LDA #119    ; IF NO - SET TO 119 MAXIMUM
0351- 38        HERE1     SEC
0352- E9 20      SBC #32      ; X VALUE NOW RANGES FROM 0 TO 87
; CALL SORT ROUTINE
0354- A0 DB      LDY #L, TABLES
0356- 84 97      STY *TBLPTR
0358- 20 B3 03   JSR SORT
;
; FIND AND STORE ADDRESS OF YTABLE
;
035B- A5 97      LDA *TBLPTR
035D- 18        CLC
035E- 6D DA 03   ADC FRAMES   ; ADD TABLE SIZE TO X TABLE TO
0361- 85 97      STA *TBLPTR  ; FIND YTABLE ADDRESS
0363- 90 02      BCC Y.LOAD
0365- E6 98      INC *TBLPTR+1
;
; LOAD Y VALUE AND CONVERT
;
0367- AD 07 90   Y.LOAD   LDA PEN.VER   ; GET LIGHT PEN Y COORD
036A- C9 18      CMP #24      ; PEN READING >= 24 ?
036C- B0 02      BCS HERE2  ; IF YES
036E- A9 18      LDA #24      ; IF NO - SET TO 24 MINIMUM
0370- C9 74      HERE2    CMP #116     ; PEN READING =< 116 ?
0372- 90 02      BCC HERE3  ; IF YES
0374- A9 73      LDA #115    ; IF NO - SET TO 115 MAXIMUM
    
```

David Malmberg is Director of Management Systems for Foremost-McKesson in San Francisco. He has a PET, as well as a VIC, and is interested in machine language utilities, strategy games, and writing his own "Adventures." He'd like to hear from anyone who develops interesting VIC applications (with or without the light pen).

(Continued)

```

0376- 38          HERE3      SEC
0377- E9 18          SBC #24      ; Y VALUE NOW RANGES FROM 0 TO 91

; CALL SORT ROUTINE
0379- 20 B3 03          JSR SORT
;
; REPEAT NUMBER OF TIMES SPECIFIED BY FRAMES
;
037C- E8          INX
037D- EC DA 03      CPX FRAMES
0380- F0 09          BEQ FINISH
0382- A5 A2          LDA *JIFFY.CTR ; LOAD CURRENT JIFFY CYCLE
0384- C5 A2          WAIT     CMP *JIFFY.CTR ; TEST FOR NEXT JIFFY
0386- F0 FC          BEQ WAIT
0388- 4C 3E 03      JMP LOOP
;
; X,Y READING DONE - MOVE MEDIANS (CENTER VALUES)
; TO LOCATIONS "XCOORD" AND "YCOORD"
;
038E- AD DA 03      FINISH  LDA FRAMES ; LOAD SIZE OF TABLE
038E- 4A          LSR A ; DIVIDE BY 2 FOR MEDIAN
038F- A8          TAY ; LOAD MEDIAN OFFSET IN Y REG
0390- B1 97          LDA (TBLPTR),Y ; LOAD Y MEDIAN
0392- 8D D7 03      STA YCOORD
0395- A9 DB          LDA #L, TABLES
0397- 85 97          STA *TBLPTR
0399- A9 03          LDA #H, TABLES
039B- 85 98          STA *TBLPTR+1
039D- B1 97          LDA (TBLPTR),Y ; LOAD X MEDIAN
039F- 8D D6 03      STA XCOORD
;
; CONVERT X,Y COORDS TO COLUMN AND ROW
;
03A2- AD D6 03      LDA XCOORD ; LOAD X MEDIAN
03A5- 4A          LSR A ; DIVIDE BY 2
03A6- 4A          LSR A ; DIVIDE BY 2 AGAIN (IE, BY 4)
03A7- 8D D8 03      STA COL
03AA- AD D7 03      LDA YCOORD ; LOAD Y MEDIAN
03AD- 4A          LSR A ; DIVIDE BY 2
03AE- 4A          LSR A ; DIVIDE BY 2 AGAIN (IE, BY 4)
03AF- 8D D9 03      STA ROW
03B2- 60          RTS ; BACK TO BASIC
;
; PERFORM INSERT SORT OF READINGS INTO
; TABLE SPECIFIED IN TBLPTR
;
03B3- 8E D6 03      SORT     STX XCOORD ; TRANSFER X REG TO Y REG
03B6- AC D6 03      LDY XCOORD ; USING XCOORD AS TEMP STORAGE
03B9- C0 00          INSLOOP  CPY #0 ; HIT BOTTOM??
03BB- F0 16          BEQ INSERT ; IF SO, INSERT
03BD- 88          DEY ; MOVE POINTER DOWN
03BE- D1 97          CMP (TBLPTR),Y ; COMPARE TO NEXT ENTRY
03C0- C8          INY ; RESTORE POINTER
03C1- B0 10          BCS INSERT ; IF A>M, NEW ENTRY'S SLOT FOUND
03C3- 88          DEY ; MOVE INDEX TO NEXT ENTRY
; MOVE Y TABLE ENTRY TO Y+1
03C4- 8D D6 03      STA XCOORD ; TEMPORARILY SAVE ACC
;
03C7- B1 97          LDA (TBLPTR),Y
03C9- C8          INY ; MOVE POINTER FORWARD
03CA- 91 97          STA (TBLPTR),Y
03CC- 88          DEY ; RESTORE POINTER
03CD- AD D6 03      LDA XCOORD ; RESTORE ACC
03D0- 38          SEC
03D1- B0 E6          BCS INSLOOP ; LOOP AGAIN
; NEW VALUE'S PROPER PLACE FOUND - DROP IT IN
03D3- 91 97          INSERT  STA (TBLPTR),Y
03D5- 60          RTS ; FROM SORT
;*****
;*
;* RESULTS STORED HERE
;*
03D6- 00          XCOORD .BY 0 ; X VALUE (0 TO 87)
03D7- 00          YCOORD .BY 0 ; Y VALUE (0 TO 91)
03D8- 00          COL .BY 0 ; SCREEN COLUMN (0 TO 21)
03D9- 00          ROW .BY 0 ; SCREEN ROW (0 TO 22)
;*
;*****
03DA- 07          FRAMES .BY 7 ; NUMBER OF READINGS TAKEN
;*****
03DB- 00          TABLES .EN

```

The PET from A to D

The author describes two inexpensive devices that can be used to convert analog signals to digital form. PET demonstration programs are included.

John Sherburne
4418 Andes Dr.
Fairfax, Virginia 22030

The idea of connecting real-world sensors to my PET and capturing outside data has intrigued me for a long time. Unfortunately, finding a way to convert analog sensor data to digital form can be a problem. Commercial A to D converters are too expensive for my limited budget, and the build-it-yourself kind are usually too complicated for my limited talents. Recently, however, I found a technique that makes A to D conversion simple and inexpensive. A converter costing less than \$5 can provide good results and can be constructed in under an hour! The key is to make the PET do most of the work.

The process of converting a real-world value to a computer-usable form involves several steps. First, the value being measured must be changed into some electrical form. This electrical analog can be anything — voltage, resistance, capacitance — as long as it can be measured and made to change as the real-world value changes. The most commonly used sensors are of the voltage or resistance type. After the sensor makes the conversion to electrical form, the electrical value must be measured and put in digital form. Then the digital value usually must be mathematically converted into a standard scale of measurement. An A to D converter can do all or part of the work between sensor and the final result.

At one extreme, the converter can do all measurement and scaling and pass the result to the PET as a digital value with 4, 6, 8 or more bits. The circuitry required to do all of these functions and to accomplish any required handshaking can be quite complex.

Near the other extreme, the converter may only change the sensor value to a form that the PET can accept, and let the PET do the work of measurement and mathematical manipulation.

The latter method is far less expensive, since the only external circuitry is a single IC to convert the sensor changes to a PET-acceptable form. The technique I have tried uses changes in the sensor to control the frequency of a square wave oscillator or multivibrator. The square wave is then passed to one of the PET user port pins. By using the timer associated with the user port to measure the duration of a single pulse of the square wave, it is possible to arrive at a digital value which represents the

original sensor measurement. This digital value can then be manipulated in BASIC to come up with a reading in standard measurement units. The process is quite simple and the results have been encouraging in terms of both resolution (the ability to distinguish between voltage or resistance values which are close together), and in consistency (the ability to get the same result on successive measurements of the same value). I have used two different circuits to convert sensor changes into frequency changes. They are the 74LS235 and the NE555. Each has its own advantages and disadvantages.

The 74LS235 is a voltage controlled oscillator (VCO), while the NE555 is a multivibrator. The 74LS235 provides much better consistency than the NE555 and it can be used with either voltage- or resistance-type sensors. The NE555 can only be used with the resistance type. On the other hand, the output (pulse width) of the NE555 is linear with respect to sensor resistance,

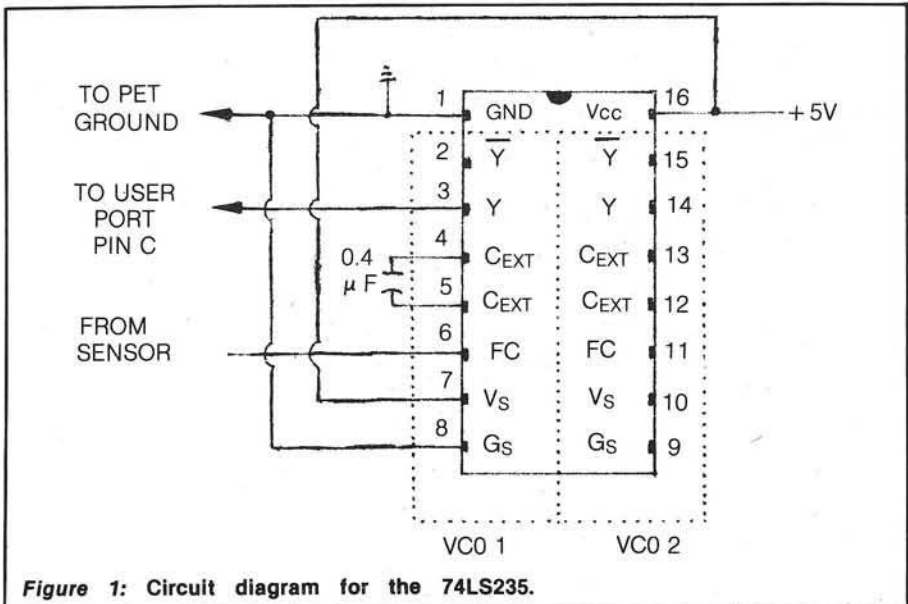

Figure 1: Circuit diagram for the 74LS235.

while the 74LS235's is not. With a linear output, the resolution of the circuit remains constant throughout its output range. Finally, the NE555 costs much less than the 74LS235.

The 74LS235

The 74LS235, made by Texas Instruments, contains two separate VCOs and costs about \$4. The output of the circuit is a square wave with a frequency determined by the voltage applied to the Frequency Control (FC) pin, (pin 6 for VCO 1 or pin 11 for VCO 2). The circuit is capable of operating at frequencies from .12Hz to 30MHz. The actual operating range at any time is determined by a capacitor, C_{ext} , connected to pins 4 and 5 (or pins 12 and 13). For example, a C_{ext} of $.4\mu f$ will produce an output of around 150Hz to 750Hz. Other pin connections are:

- Gnd — Power supply ground
- Y, \bar{Y} — Output of VCO, alternate (inverse) output
- V_s — Signal voltage, connect to V_{cc}
- G_s — Signal ground, connect to Gnd
- V_{cc} — +5V power supply

Figure 1 is a wiring diagram for measuring an external voltage with the 74LS235. A resistance can be measured in the same way by connecting the resistance between V_{cc} and the FC pin in place of the external voltage. The output curve of the VCO is shown in figure 2. The horizontal axis is labeled frequency but more correctly represents pulse duration, the inverse of frequency. The points on the curve are readings taken at .25V increments from .5V to 5V. The fact that the points are farther apart at lower voltages means that the circuit provides better resolution for lower sensor voltages (or higher sensor resistances).

A highly desirable characteristic of the 74LS235 is its consistency of output. If the circuit is calibrated and then turned off, it does not need to be recalibrated the next time it is turned on. Figure 3 illustrates this consistency. The points on the graph represent several trial runs made over a period of days. Actual voltage was measured by a voltmeter; test voltage by the PET/74LS235. Ideally, the actual and test voltages will be the same and all points will fall on the 45 degree diagonal. In fact, the largest deviation between actual and test values is .08V!

The NE555

When connected as shown in figure 4, the NE555 operates in the astable mode and produces a continuous square wave output. The shape of the square wave is determined by R_a and R_b . The "output low" portion of the wave is proportional to R_b . The "output high" portion is proportional to $R_a + R_b$. The sensor should go in the R_a location and R_b should be a resistor large enough (typically 10K) to insure that the output pulse stays low long enough for the measurement program to detect the change in state. The output frequency can be kept in a desired range by proper selection of C_{ext} . The relationship between C_{ext} and the output is that the output is designed to stay high for a time equal to $.69 \times C_{ext} \times (R_a + R_b)$. C_{ext} should be chosen for a high-pulse duration of about 1 millisecond. For example, if $R_a + R_b = 140K$ C_{ext} should be about $.01\mu f$. The pulse duration of the circuit is quite linear with respect to sensor resistance and it thus avoids the variable resolution problem of the 74LS235. On the other hand, it does not have the consistency of the 74LS235 and should be recalibrated with each use.

Figures 5a and 5b are oscilloscope traces which show how the square wave output of the NE555 changes as R_a and R_b are changed. An interesting point is that this relationship makes it possible to measure both R_a and R_b at the same time. R_b can be measured by timing the output low portion of the wave and R_a can then be measured by timing the output high portion and then subtracting the output low time from the output high time. This makes it possible to measure two sensors on a single user port pin. A joystick, for example, can be connected so that one potentiometer is used as R_a and the other for R_b on the same NE555. This is a distinct improvement over the use of the NE555 in the monostable mode which requires three pins. A suitable resistor must be placed in series with the R_b potentiometer so that the output low pulse does not get too short to detect.

The Measurement Program

Timer T1 is used to measure the output frequency of the 74LS235 or NE555. Here are the required steps:

1. Set timer T1 latch to the maximum value, decimal 255.
2. Wait until the circuit output is low.
3. When the circuit output goes high, start the count-down on T1.
4. When the output returns to low, stop timing. The final timer value subtracted from the original value is the duration of the output high pulse of the square wave.

You need to use assembly language programming to be able to sample the

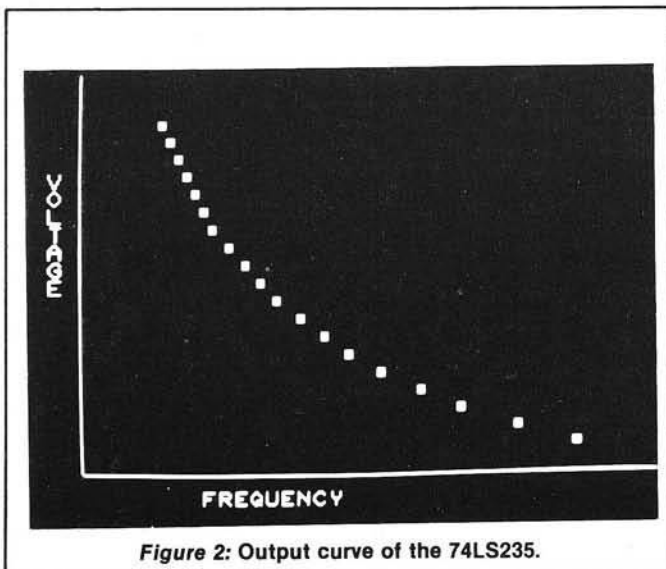

Figure 2: Output curve of the 74LS235.

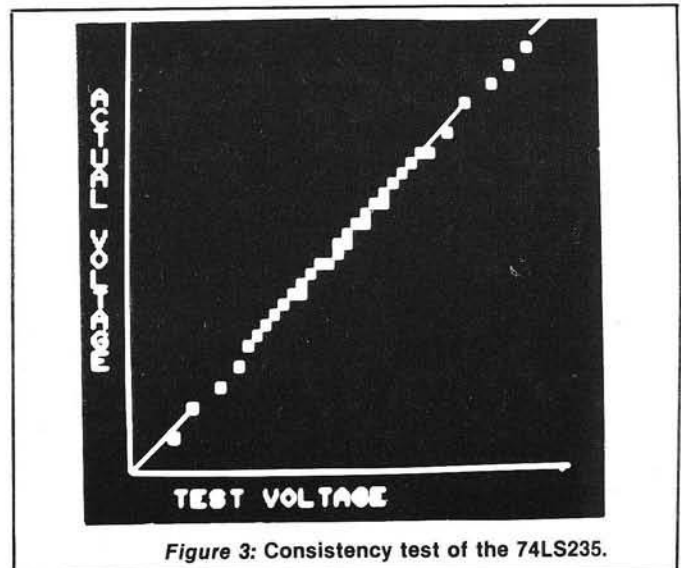

Figure 3: Consistency test of the 74LS235.

output rapidly enough for accurate timing; but even with assembly language the resolution capability of the process is limited by the fact that it takes 7 microseconds to check the output, find out whether it is high or low, and then check again. Therefore, pulse duration can only be measured in increments of 7 microseconds or more. If the pulse duration is considerably longer than this 7 microsecond sampling time, resolution should not be a serious problem. For frequencies above about 2KHz, however, it could be a major source of error.

The accompanying BASIC program loads an assembly language routine to measure output frequency. When the program is run, it first makes the top 256 bytes of RAM inaccessible to BASIC. It then loads the assembly language routine into that space. After the BASIC program has been run, another BASIC program may be loaded over it. The assembly language routine is entered with the statement SYS (7937). After the assembly language routine has been run, the final timer value is stored in bytes 8190 and 8191 (low order byte, high order byte). Since each timer byte is counted down from 255, the pulse duration can be returned with

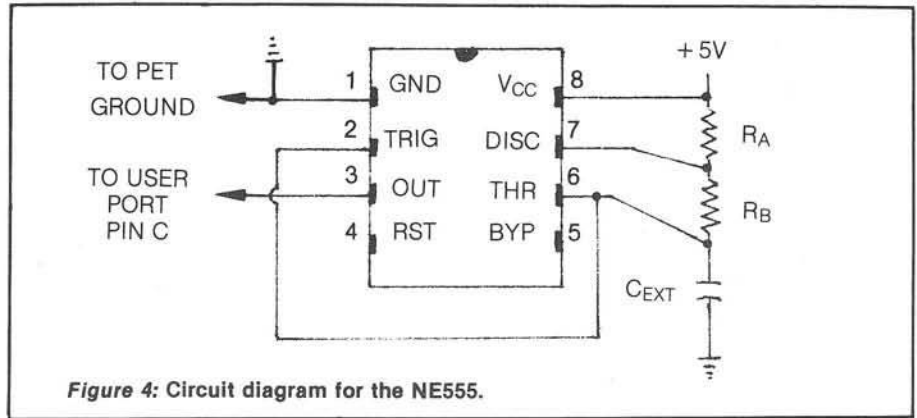

Figure 4: Circuit diagram for the NE555.

the statement:

```
PRINT 255 - PEEK(8190) + 256*
(255 - PEEK (8191))
```

The program is written for the old ROM, 8K PET. For upgrade ROM, the top of memory address — bytes 134 and 135 in lines 100, 110, and 120, should be changed to 052 and 053. User port and timer addresses are the same for either ROM. For PETs with more than 8K RAM, the values in lines 292 and 294 should be changed to indicate the top two bytes of RAM. The SYS and PEEK commands should be changed to refer to

the top of RAM minus 254 and the last two bytes of RAM, respectively. The program assumes the circuit output is connected to pin PA0 of the user port. A different pin can be used by changing line 320 of the program to replace 001 with 2ⁿ for pin PAn. The program will return a timer reading of zero if the timer limit of 65536 microseconds is exceeded.

In line 470, the program adjusts the timer value to "correct" for the time previously consumed in checking its value. Jitter and other minor timing problems are corrected by waiting until

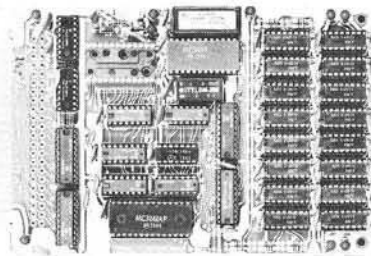

BETA 32K BYTE EXPANDABLE RAM FOR 6502 AND 6800 SYSTEMS

AIM 65 KIM SYM PET S44-BUS

- Plug compatible with the AIM-65/SYM expansion connector by using a right angle connector (supplied).
- Memory board edge connector plugs into the 6800 S44 bus.
- Connects to PET using an adaptor cable.
- Uses +5V only, supplied from the host computer.
- Full documentation. Assembled and tested boards are guaranteed for one full year. Purchase price is fully refundable if board is returned undamaged within 14 days.

Assembled with 32K RAM.....	\$349.00
& Tested with 16K RAM.....	329.00
Bare board, manual & hard-to-get parts...	99.00
PET interface kit. Connects the 32K RAM board to a 4K or 8K PET.....	\$ 69.00

See our full page ad in *BYTE* and *INTERFACE AGE*.

wabash



8" or 5 1/4" flexible diskettes certified 100% error free with manufacturers 5 year limited warranty on all 8" media. Soft sectored in tilt-back* boxes of 10. 5 1/4" available in 10 Sector. (Add \$3.00 for plastic library cases)

8" single sided, single density.....	\$29.95
8" single sided, double density.....	37.95
8" double sided, double density.....	48.95
5 1/4" single sided, single density.....	27.95
5 1/4" single sided, double density.....	29.95

*Tilt-Back is a trademark of Wabash, Inc.

8" DISK DRIVES

Shugart 801R.....	\$390.00
NEC FD1160 (double sided).....	595.00
Memorex MRX-101 8" Winchester style, hard disk drive, 10 megabytes.....	\$2,000.00

TERMS: Minimum order \$15.00. Minimum shipping and handling \$3.00. Calif. residents add 6% sales tax. Cash, checks, Mastercard, Visa and purchase orders from qualified firms and institutions are accepted. Product availability and pricing are subject to change without notice.

INTERNATIONAL ORDERS: Add 15% to purchase price for all orders. Minimum shipping charge is \$20.00. Orders with insufficient funds will be delayed. Excess funds will be returned with your order. All prices are U.S. only.

16K MEMORY EXPANSION KIT \$29.00

For Apple, TRS-80 keyboard, Exidy, and all other systems using 4116 dynamic rams or equivalent. All IC's are prime Mitsubishi MK 4116-3.

- 200 NSEC access, 375 NSEC cycle
- Burned-in and fully tested
- 1 full year parts replacement guarantee

ROCKWELL AIM 65



AIM 65 with 1K ram.....	\$425.00
AIM 65 with 4K ram.....	485.00
AIM power supply.....	125.00
Professional AIM enclosure.....	169.00
Budget AIM enclosure.....	50.00
KIM enclosure.....	40.00
SYM enclosure.....	30.00

BETA
COMPUTER DEVICES

**1230 W. COLLINS AVE.
ORANGE, CA 92668
(714) 633-7980**



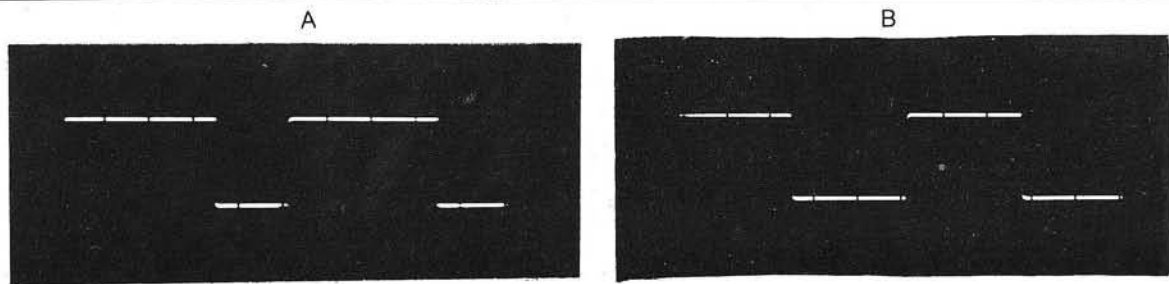

Figure 5: Oscilloscope traces showing relationship of R_a , R_b and the output waveform. At A, $R_a = R_b$ and the output is high twice as long as it is low. At B, $R_a = 0$ and the high pulse is the same length as the low pulse.

three consecutive pulse measurements with the same value are obtained. If the circuit is very jittery it may take a while to get three consecutive identical readings. The problem becomes more severe with long pulse durations, i.e. frequencies below about 100Hz. Thus, resolution one way and jitter the other establish a desired operating range of 100Hz to 2000Hz.

The timer measurement can be reconverted to voltage or resistance value by use of either curve fitting or table look-up. With curve fitting, a series of measurements is fit to a mathematical equation. The equation will be of the form $Y = A/X + B$ for the 74LS235 and the form $Y = AX + B$ for the NE555. With the table look-up technique, a table of actual/test measurement pairs is kept in memory and an unknown test measurement is found by comparison with the stored values. Table look-up has the advantage of allowing simultaneous conversion of the resistance or voltage reading to the outside world value being measured.

Miscellaneous Notes

The ground connections shown in the circuit diagrams assume that an external power source is used. It is also possible to tap +5V from the PET second cassette interface. This source is commonly used although Commodore does not recommend it. If the PET power supply is used, the IC ground needs to be connected only to the PET ground.

A more complete discussion of the NE555 can be found in the *TTL Cookbook* by Don Lancaster (Howard W. Sams & Co.). I have not found a similar reference for the 74LS235.

```

100 SL=PEEK(135)-1
110 POKE135,SL
120 SL=256*SL+PEEK(134)+1
130 POKE59459,0
290 REM-----MAIN PROGRAM
292 DATA141,254,031:REM STA $1FFE
294 DATA142,255,031:REM STX $1FFF
296 DATA160,002 :REM LDY #$02
300 DATA162,255 :REM LDX #$FF
310 DATA142,068,232:REM STX $E844
320 DATA169,001 :REM LDA #$01
330 DATA044,079,232:REM BIT $E84F
340 DATA208,251 :REM BNE $FB
350 DATA044,079,232:REM BIT $E84F
360 DATA240,251 :REM BEQ $FB
370 DATA142,069,232:REM STX $E845
380 DATA044,079,232:REM BIT $E84F
390 DATA208,251 :REM BNE $FB
400 DATA174,069,232:REM LDX $E845
410 DATA169,064 :REM LDA #$40
420 DATA044,077,232:REM BIT $E84D
430 DATA240,006 :REM BEQ $06
450 DATA162,000 :REM LDX #$00
460 DATA169,000 :REM LDA #$00
470 DATA240,006 :REM BEQ $06
480 DATA173,068,232:REM LDA $E844
490 DATA024 :REM CLC
500 DATA105,013 :REM ADC #$0D
510 DATA236,255,031:REM CPX $1FFF
520 DATA208,196 :REM BNE $C4
530 DATA205,254,031:REM CMP $1FFE
540 DATA208,191 :REM BNE $BF
550 DATA136 :REM DEY
560 DATA208,196 :REM BNE $C4
570 DATA096 :REM RTS
590 DATA999
1000 REM-----LOAD ASSEMBLY LANGUAGE
1010 READ A
1020 IF A > 255 THEN END
1030 POKE SL,A
1040 SL= SL+1
1050 GOTO 1010
    
```

Substitute Characters

By Loren Wright

The PET, unlike many home computers, can display 128 different characters on the screen at the same time. For many PET owners, this capability is adequate compensation for the lack of color or high-resolution graphics. For most serious applications, the convenience of manipulating screen information in the form of characters is very important.

The real bonus, though, is that there are actually two different 128-character sets in every PET, but only one of the two sets can be used at a time. One set has the full array of PET graphic characters (POKE 59468,12), while the other provides lower case at the expense of several graphic characters (POKE 59468,14). Many of us program primarily in one of these two sets. Business programmers need the lower case, and game programmers need the graphic characters. That other set remains unused most of the time.

What if you could change that dormant character set to any set of 128 characters you want? Let's say you want to type foreign language documents, complete with umlauts and cedilles. Your second character set could include these special characters. If you want to display calculus equations, it would help to have an integral or sigma character available. Fortunately substitute character ROMs are commercially available for foreign language and math applications. The ROM includes the standard character set along with the alternate math or foreign language set.

West River Electronics R & D (P.O. Box 605, Stony Brook, New York 11790) offers a math character set ROM and a foreign language ROM for \$60 each. These substitute ROMs directly replace the 24-pin character ROM. Only the lower case (POKE 59468,14) character set has been replaced; the graphics set has been retained in its entirety. With a Spacemaker you can switch back and forth between the standard ROM and either or both of the West River substitutes. (See figure 1 for sample screen displays using these characters.)

West River Electronics now has printer (CBM 2022, 2023, 4022) ROMs available with these character sets to match the screen display.

This article is for those who have special needs in a character set. Much work is involved in planning your extra character set, coding it and programming an EPROM, so it is a good idea to know what you want before you start.

The idea of substituting character sets is not limited to the PET. The VIC has a configuration similar to the PET's, but it has the added capability of reading a character set programmed in RAM. OSI and PET/CBM machines normally read characters programmed in a mask-programmed ROM called the character generator. This ROM can be replaced with an erasable ROM (or EPROM) programmed exactly to your needs. The 2716 EPROM has dropped considerably in price in recent years, and EPROM programmers are now priced well within the reach of most professionals and many hobbyists.

The PET's character ROM can be substituted directly with a 2716. In

Figure 1: Foreign language and math character sets for PET from West River Electronics. (Photos of PET screen.)

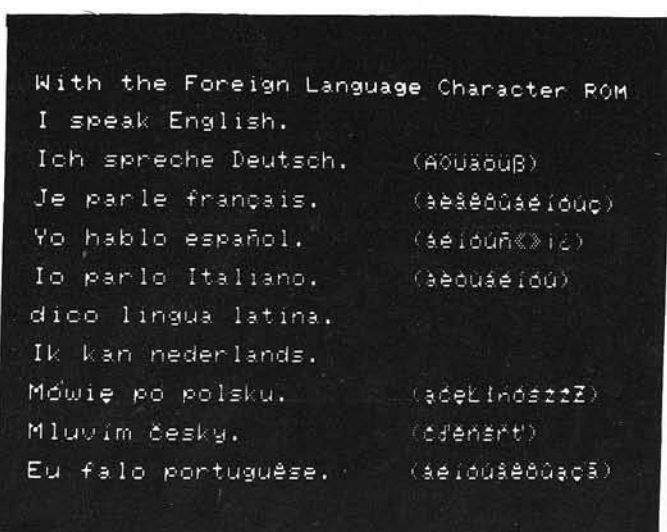
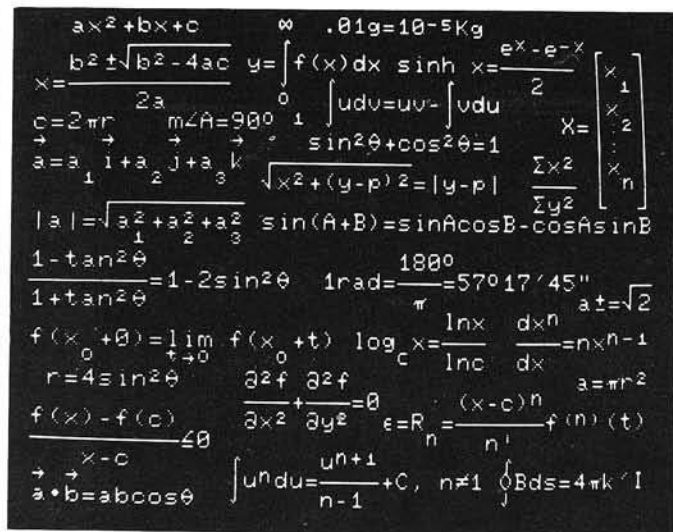

Figure 2: How characters are coded.

Binary	Hex
0001 1100	1C
0010 0010	22
0100 1010	4A
0101 0110	56
0100 1100	4C
0010 0000	20
0001 1110	1E
0000 0000	00

order to substitute a 2716 for an OSI character generator, though, you must pull two of the 2716's pins (18 and 20) out of the socket and ground them. Normally you would choose one of the standard sets for half of the EPROM and replace the other set with your own, custom-designed character set.

How the PET Displays Characters

The PET screen holds 1000 characters in a 25 x 40 array. Each character is actually an 8 x 8 array of little dots called pixels, which can be either on or off to comply with requirements of a particular character. The information regarding which dots are on and which are off for a particular character is stored in the character generator. Since the image on the screen deteriorates quickly, it is refreshed every 1/60 second by the PET.

Every character position on the screen has a corresponding memory location in RAM. These start at \$8000 (32768), and end at \$83D7 (33767). Each RAM location contains the PET/CBM screen code (not ASCII) corresponding to a character on the screen.

To demonstrate this character representation switch to the graphics character set (POKE 59468,12), move the cursor to the upper left hand corner, and type "ABC012". Move the cursor down one line and type "FORI=0T05: PEEK(32768 + I); : NEXT" and <RETURN>. This displays the screen codes for the six characters you typed on the first line. The digits' codes are the same as in ASCII, but the letters' codes start at 1 rather than 65. Another way to demonstrate the relationship of screen and the display is to enter the monitor and display memory starting at \$8000. Changing the contents of these locations will make instant changes in characters on the screen. OSI machines have different screen RAM locations and a different (also non-ASCII) character coding scheme.

After the proper character is looked up in display RAM, the character generator is consulted for the appropriate pattern of pixels, and the electron beam is turned on or off appropriately on its way across the screen. Actually it's a little more complicated than that, since printing a line of characters requires eight passes of the beam. The pixel patterns for the first row of each of the 40 characters in the line are displayed on the first pass, followed by the second row's patterns, and ending with the eighth's. A character is not completed until the eighth pass. Meanwhile, the other characters on the line will get completed, too.

Each character in the character generator is coded by eight bytes: one for each row of pixels. Within the byte, a 1 indicates that pixel will be on, and a 0 indicates off. Figure 2 shows an '@' sign enlarged so that the pixel patterns can be seen. To the right of each row is the corresponding byte in the character generator, represented in both binary and hexadecimal. You should see the pattern clearly. Incidentally, '@' is the first character in the generator ROM, represented by the first eight bytes. The next eight bytes represent the letter 'A'.

Big Letters

Physics professors at University of California Berkeley lecture to undergraduate classes of 100 to 600 students. Many demonstrations, particularly in electricity and magnetism, require the display of various meter readings to the students. Projection analog meters, with their low accuracy and limited ranges, had been used for this purpose. Looking for a way to display readings of our new digital multimeter to a large class, I went to the department's electrical engineer. I expected to walk away with a bank of large LED digits, but ended up designing a character set for the PET!

Two of the five lecture rooms we used had large TV monitors, and we had a pair of portable ones. The idea was to use the PET to process the meter readings and display its screen on the lecture room monitors. However, even with these large monitors, standard size PET characters were unreadable more than a few feet away. We needed characters that were four or five times larger than the normal ones, and the only way to do it, short of serious hardware modification, was to use four standard characters to form one big character.

It is possible to design a set for this purpose with relatively few interchangeable component characters, but, as you can see, we ended up with something a lot better. Figure 3 shows the components of a big 'A', with a standard 'A' for comparison.

These characters cannot be conveniently used from the keyboard, since four different characters are required for each large character displayed. Also, extensive repositioning of the cursor is required. It is therefore desirable to write a display routine, preferably in machine language.

Figure 3: Comparison of standard and "big" letters.

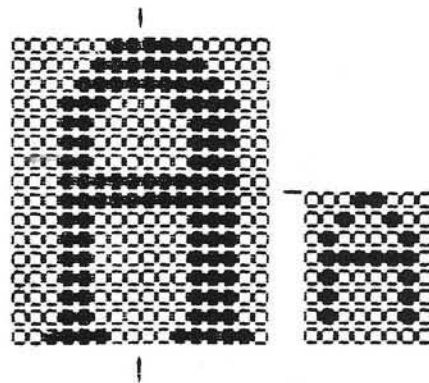
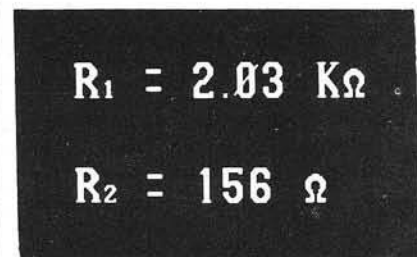

Figure 4: Sample of "Big Letter" characters on screen. Small 1 and 2 are standard characters.



The one I wrote searched specifically for the BASIC variables X, Y, and LS\$ (for large string). X and Y determine the position from the upper left origin, and LS\$ the desired output in large characters. All of the capital letters and numbers were available, as well as a few special purpose (physics) characters like mu, rho, omega, small m, n, and z, and small 0, 1, and 2. The latter were assigned convenient keyboard representations, such as shift 'O' for omega.

The machine language routine looked up the component characters in a table and displayed them with cursor controls properly inserted. Of course BASIC program listings are unreadable. That's why you keep the other character set in the ROM pretty standard!

High-Resolution Plotting

With this character set (we called it PPLOT), you can plot a single pixel anywhere on the screen. This is a little misleading, though, since only one dot can be displayed at a time in a given character space. It is high-resolution plotting, but of a rather low density. This set is most effective when used in the dynamic mode. That is, each dot is erased (if necessary) before the next is plotted, and it appears that a single point is moving across the screen. With a proper machine language driver, you can even do an imitation of an oscilloscope. We used it in the classroom for drawing circles, ellipses and electric potential lines.

Since only 64 characters are required to represent the 64 possible positions of a single dot within a character, all the letters and numbers can retain their original positions. It is important, however, to keep all 64 together in a logical order, so that the display software is easy to write. As a result, some

Figure 5: Sample of PPLOT characters.

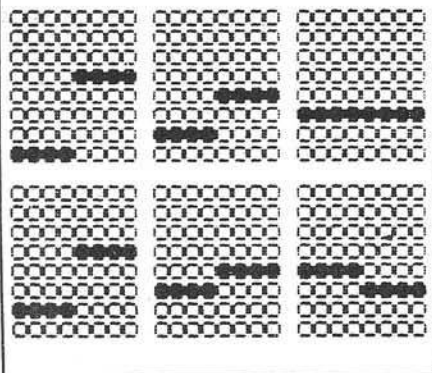

of the characters used to display origins and axes had to displace some of the punctuation characters.

200 x 80 Resolution Plotting

In the normal PET graphics character set, all 16 horizontal and vertical line characters are available. This means that you can plot with the horizontal lines and achieve 40 x 200 resolution (8 lines in each of 25 characters). This character set increases the horizontal resolution from 40 to 80 by using, as characters, all the possible combinations of horizontal lines which are half the width of a character. There are 81 of them, including the 17 where half or all of a character is blank. I already had a routine to plot with the full-width horizontal lines which I called 'HPLOT', so a logical name for this character set was 'FPLOT' since the lines are only 'F' a character in width! The appearance of a plotted curve is considerably better than the equivalent HPLOT version, and much better than the QPLOT version (quarter boxes).

Again, it is important that all 81 characters remain together and in a logical order. This does foul up the appearance of BASIC listings somewhat, since allocating a continuous run of 81 characters without touching the letters or numbers is impossible. Programming in this character set is a bit more of a challenge, since you must look ahead to find out what's already in the position you want to plot. I wrote a machine language routine to handle this, with the BASIC variables X and Y as input.

More Ideas

One project (never completed) in the electronics shop of University of California Berkeley physics department, involved using the PET to lay out printed circuit boards on the PET screen. The board could be larger than the screen, and it could be flipped over. When the layout was completed, it was output to a digital plotter, which drew the pattern on paper or directly onto the PC board. A very large special character set was required for this.

To get 256 different characters on the screen, a hardware change was made which resulted in the sacrifice of reverse field. Many people will want to add characters for tanks, robots, or space invaders. Musical notes, drafting symbols, and many other special characters are possible.

Figure 6: Sample of FPLOT characters.

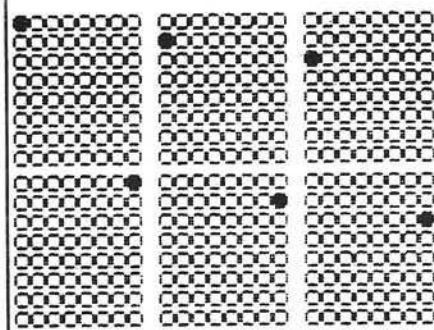

Programming Considerations

If you're going to use your character set from the keyboard, give a lot of thought to which keys will be used. There's no point in having characters available which you can't find! Remember that the space is a character, even if it has no pixels on.

Graph paper is very handy for designing the characters. Or, you could use a modification of Roger Crites' character dictionary program (MICRO 37:11). The printer characters he used are 5 x 7 and were stored in columns rather than rows.

Finally, I can't overemphasize the value of good, continuously updated documentation.

Acknowledgements

Several current and former members of the U.C. physics department contributed significantly to this project. Kim Rubin was responsible for the big letters concept and did most of the design of those characters. Prof. Leroy Kerth came up with the PPLOT character set. John Davis and John Girard were responsible for considerable engineering and technical support.

Loren Wright is a member of the MICRO staff, serving not only as "PET Specialist," but also in a number of other roles. Before coming to MICRO, he served as instructional technician for the physics department at the University of California, Berkeley. He is also a trained marine biologist and a railroad enthusiast.

80 x 25

On The
Built-in
Display

PET/CBM™ 2000/3000/4000 Series

\$275.00 *

Select either **80 x 25** or **40 x 25** display format

From the keyboard or program

Features the same memory map and subroutines from the Basic ROMs [specify which version of Basic when ordering] * *, for standard programming. You also gain the use of **1023** extra memory locations in the 40 column mode, or **47** extra locations in the 80 column mode. [These locations are available only to machine language programs, or peek & poke from Basic].

Displays the full, original character set, including graphics characters in either mode.

All utility software, firmware, like Toolkit™, Dos Support [Wedge], Extra-mon, etc., is compatible in both modes of operation.

The complete enhancement consists of: 1 dual 24-pin socket [one socket for the 40 column screen editor, and one for the 80 column screen editor], and a circuit board that replaces the existing screen RAM. Each circuit board is registered to the original owner. There is also an 80 column reference ROM that plugs in one of the expansion sockets [specify the address when ordering]. An option board is available [\$25.00] that allows the ROM to be used with any other 2K ROM, in any of the expansion sockets.

Available from your local dealer or:

EXECOM CORP.

1901 Polaris Ave.
Racine, WI 53404
Ph. 414-632-1004

* Plus appropriate installation charges. This requires some circuit modification.
[available from the factory for \$75.00 plus shipping]

* * If power-on message = **### COMMODORE BASIC ###** you have 3.0 Basic.
[Available only for Basic 3.0 & Basic 4.0 at the present].

PET™ & CBM are trademarks of Commodore Business Machines.

We will ship via Master Charge, VISA, C.O.D., or pre-paid.

Toolkit™ is a trademark of Palo Alto IC's, Inc.

Installation may void your Commodore 90 day warr.

The Execom™ board is guaranteed for 1 year.

The 6809 and the S-50 Bus

Editorial note: The author presents a brief history of the S-50 bus and a list of supporting manufacturers. Those listed under "Major Hardware Manufacturers" and "Support Manufacturers" are only those which relate to the S-50 bus. Other bus systems are supported by Motorola (the manufacturer of the 6800 and 6809) and by Radio Shack in its TRS-80 Color Computer. The Computerist supports the KIM-4 bus, a standard in the 6502 world, and there are numerous manufacturers supporting the S-100 bus system. The software available from the manufacturers listed is relatively bus-independent.

Dale L. Puckett
14753 Endsley Turn
Woodbridge, Virginia 22193

I was happy to see MICRO Editor Robert Tripp decide to publish information about the Motorola 6809. I am also glad that he has given me the opportunity to share information about 6809 systems with MICRO readers.

I switched over to the 6809 from the 6800 about 18 months ago and I now find it very hard to go back. Don't get me wrong, the 6800 is not difficult to program, it's just that the 6809 is much easier to work with.

When I started using the 6809, my programs became about 30 percent shorter and ran about 30 to 40 percent faster. I wound up with a much better product and had less work to do. Features like the auto-increment instructions make routine programming chores a breeze. And, position-independent code is so easy to generate that you really don't have an excuse for not writing state-of-the-art programs.

This article will deal with equipment and software that is already available in the 6809 world. Hopefully, it will help you decide to start using this excellent processor right away.

Dale Puckett is a professional writer who contributes regularly to *Info World* and *68 Micro Journal*. He owns 6800 and 6809 systems, and is the author of several software packages available from Frank Hogg Labs.

Major Hardware Manufacturers

Products

Southwest Technical Products
219 West Rhapsody
San Antonio, TX 78216
512-344-0241

complete computer systems
disk systems
terminals

GIMIX, Inc.
1337 West 37th Place
Chicago, IL 60609
312-927-5510

complete computer systems
disk systems
memory mapped video boards

Midwest Scientific Instruments
220 W. Cedar
Olathe, KS 66061
913-764-3273

complete computer systems
disk systems

Smoke Signal Broadcasting
31336 Via Colinas
Westlake Village, CA 91361
213-889-9340

complete computer systems

Percom Data Company, Inc.
211 North Kirby
Garland, TX 75042
214-272-3421

disk systems
various CPU and memory
mapped video cards

Support Manufacturers

Thomas Instrumentation
168 Eighth Street
Avalon, NJ 08202
609-967-4280

modem card
motherboard and memory cards
memory mapped video board

Boaz Co.
Box 18081
San Jose, CA 95158

dynamic memory card

(continued)

The Standard Bus

We should look first at the roots of the 6809. To do this, we must go back to 1974 and meet a San Antonio businessman named Dan Meyer. During that year his company, Southwest Technical Products Company (SWTPC) started building an inexpensive microcomputer based on a design supplied by Motorola. It used a 6800 microprocessor and featured what the company called the S-50 bus.

Over the past seven years that bus has become a standard that is supported by a dozen major manufacturers and software houses. A few dozen more companies are on the bus now, supplying peripherals and writing applications software.

There is a good reason for the popularity of this bus, and it is one you should consider when you think about moving up to the 6809. Any board designed for the standard S-50 motherboard will run in a box built by every other manufacturer. Until very recently, even the I/O addresses and monitor jump tables were the same on all the machines. Still, there is only one maverick. This is important because it allows software written for one brand of machine to run on the others with no patching.

The S-50 manufacturers really started getting it together at several computer shows in 1980. It began at the West Coast Computer Faire when they adopted the slogan, "Take the S-50 Bus — the Choice is Great!" Then at Philadelphia in August, fifteen S-50 exhibitors got together and reserved a large area of the show exclusively for S-50 products. They also set up a mini-auditorium and presented speakers describing the features of all the new hardware and software. Everyone in the crowd got his or her questions answered.

The Philadelphia gathering was the idea of Richard Don, president of Gimix, Inc., in Chicago. He says it best.

People assume that the S-100 bus is better because there are more manufacturers on it. But they don't realize that many of the companies define some of the bus lines differently. This creates a number of different S-100 buses. There is only one S-50 bus.

Don also noted that the S-50 bus has better development software and its operating systems are superior to those available on other buses. A quick trip around the exhibit area in Philadelphia proved his point. Applications packages

were already appearing at several booths — a direct result of the ease of programming the 6809.

The 6800 chip got a bad name early in the competitive game because of its first BASIC interpreter. It was an excellent language and even had ten-digit precision while everyone else was settling for six. It was cheap too, (only \$10 for the 8K version), but it was slow.

Because this BASIC was slow everyone thought, (or at least those who lived to program in BASIC), that the 6800 was a slow processor. Those who were faithful to the S-50 bus got in the last word though when Technical Systems Consultants (TSC) released their 6800 BASIC. It turned out to be the fastest BASIC on any 8-bit processor. The 6809 version released a year later was even faster (by 30 percent).

When the 6809 appeared, things seemed to come together for the S-50 crowd. The processor is fast, powerful and lends itself to multiprogramming and multitasking. Yet, it is still simple to use and to understand.

There are now S-50 systems with as little as 4K of memory and others with as much as 384K. You can find hard storage units holding several dozen

megabytes and systems that will support a large number of users.

S-50 systems have always had a ROM monitor and have worked with an external CRT terminal. Now, most manufacturers also sell video boards, and you can put together a system which will fit in one box. At the same time, the system is expandable. As long as you have slots left on your motherboard (some have as many as 15 slots) you can add memory or peripherals to your heart's content.

At this point, a survey of the major hardware manufacturers of the S-50 bus is in order. SWTPC is still in business. They sell 6809 computers ranging from kits with 8K of memory, to assembled and tested units containing 256K. They also sell 5¼-inch disk systems that will store from 720K to 1.4 million bytes on two drives, a dual drive 8-inch system featuring a direct memory access controller, and a Winchester-type hard disk. SWTPC's 8209 and 8212 terminals have become standards in the 68XX world.

The Cadillac of the 6809 world is the system sold by Gimix, Inc., in Chicago. Richard Don has nicknamed his mainframe "The Classy Chassis" and not without good reason. It has a 25 amp constant voltage power supply for full

CBM/PET? SEE SKYLES ... CBM/PET?

"They laughed when I sat down at my PET and immediately programmed in machine language... just as easily as writing BASIC."

With the new Mikro, brought to you from England by Skyles

Electric works, always searching the world for new products for PET/CBM owners. A 4K machine language assembler ROM that plugs into your main board. At just \$80.00 for the Mikro chip, it does all the machine language work for you; all you have to do is start laying down the code.

The Mikro retains all the great screen editing features of the PET...even all the Toolkit commands. (If you own a Toolkit, of course.) Sit down and write your own machine language subroutine. The program you write is the source code you can save. And the machine language monitor saves the object code. The perfect machine language answer for most PET owners and for most applications. (Not as professional as the Skyles MacroTeA...not as expensive, either.)

A great learning experience for those new to machine language programming but who want to master it easily. Twelve-page manual included but we also recommend the book, "6502 Assembler Language Programming," by Lance A. Leventhal at \$17.00 direct from Skyles.

Skyles guarantees your satisfaction: if you are not absolutely happy with your new Mikro, return it to us within ten days for an immediate, full refund.

Skyles Mikro Machine language assembler.....\$80.00

"6502 Assembler Language Programming" by Leventhal..... 17.00

Shipping and Handling.....(USA/Canada) \$2.50 (Europe/Asia) \$10.00

California residents must add 6%/6½% sales tax, as required.



Skyles Electric Works
231E South Whisman Road
Mountain View, California 94041
(415) 965-1735

Visa/Mastercard orders: call tollfree
(800) 227-9998 (except California).
California orders: please call (415)
965-1735.

PET? SEE SKYLES ... CBM/PET? SEE SKYLES ... CBM/PET? SEE SKYLES ... CBM/PET? SEE SKYLES

protection from brownouts, a 15-slot motherboard, and is packaged in a heavy-duty aluminum cabinet. Every card in the GIMIX system is completely decoded and may be addressed quickly with built-in dip switches.

The GIMIX memory boards are fully decoded to use the four extended address lines on the S-50C bus. This allows you to address them anywhere in the first one million bytes of memory. Gold connectors are used on every board, and every card is guaranteed to run at 2 Mhz. The GIMIX 80 x 24 video board is the most versatile on the market, and when used with a good word processing package like Bob Bundy's Stylograph, it makes writing very easy. Don's latest addition is a 64K memory card which uses CMOS RAM. It comes complete with a battery back-up and will hold your data for several months.

Other major hardware manufacturers of the S-50 bus include Smoke Signal Broadcasting in Westlake Village, California, Midwest Scientific in Olathe, Kansas and Percom Data Company in Garland, Texas.

Midwest Scientific was one of the first companies to introduce a disk system for the bus. They entered the field in 1976 with an 8-inch dual drive system and have been adding to their product line ever since. They provide full software support and sell a line of application packages for businesses.

The popular BFD-68 disk system was the catalyst that got Smoke Signal into the S-50 business. A few years later this triple drive system had evolved into the Chieftain, a complete microcomputer with 32K of user memory and built-in disk drives. The latest entries from Smoke Signal include a 6809 CPU card and a double-density disk controller card that will let you store 366K bytes on one 5-inch floppy disk. Smoke Signal is the only major supplier that has moved its I/O slots from the set of standard addresses used by all other companies.

Percom's main business is in the 5-and 8-inch disk market. But the company does supply a motherboard and both 6800 and 6809 CPU cards. They also sell a video display board called the Electric Window.

There are a number of smaller companies around that sell motherboards and inexpensive components. Two of them, Thomas Instrumentation in Avalon, NJ, and "febe" in York, PA, can supply anything you need to build a custom system.

Support Manufacturers

Febe Group
51 Hamilton Ave.
York, PA 17404
717-854-0481

Star-Kits
P.O. Box 209
Mt. Kisco, NY 10549

Microdyne
P.O. Box 1707
Greenville, MS 38701
601-335-9321

JPC Products Co.
12021 Palsano Ct.
Albuquerque, NM 87112
505-294-4623

Hazelwood Computer Systems
7413 North Lindbergh
Hazelwood, MO 63042
314-837-3466

Wave Mate, Inc.
18005 Adria Maru Lane
Carson, CA 90746
213-532-4532

F & D Associates
1210 Todd Road
New Plymouth, OH 45654
614-592-5721

Compuware Corporation
P.O. Box 2710
Cherry Hill, NJ 08003
609-428-2309

Digital Research Computers
P.O. Box 401565
Garland, TX 75040
214-271-3538

Digital Service and Design
P.O. Box 741
Newark, OH 43055
614-366-6314

Newtech Computer Systems
230 Clinton Street
Brooklyn, NY 11201

Peripheral Technology Assoc.
290 Lamplighter Lane
Marietta, GA 30067

Optimal Technology, Inc.
Blue Wood 127
Earlsville, VA 22936
804-973-5482

Southeastern Microsystems
P.O. Box 293
Conveyers, GA 30207
404-922-1620

Products

motherboard with power supply and case

single board 6802 computer software

active bus terminator

tape units
cassette interface
analog/digital converter board

high resolution video graphics board

Stand-alone 6800 computer with video terminal and disk drives

single board computers
memory mapped video boards
and various CPU cards

hardware calendar and clock with interval timer

RAM memory

memory cards

music and
analog/digital cards

disk controllers

EPROM Programmer

dynamic RAM cards

Thomas has an impressive new card on the market that will give you an auto answer/originate modem using the Bell 103 standard, a real time clock, two serial ports, two parallel ports, and automatic telephone answering. The software supplied will also give you automatic dial pulse or touch-tone dialing.

Software

No matter how good the hardware, you can't do anything without the software to run it. This, too, is a big plus for the 6809 user. Just as the manufacturers chose to stick with the same bus definition, most of the software houses stuck with one disk operating system.

FLEX, written by Technical Systems Consultants, Inc., in Lafayette, Indiana, became the standard on both the 6800 and 6809 systems and is wholeheartedly supported by all but one hardware manufacturer. This common operating system has given independent software houses a chance to write software that will run on any manufacturer's equipment, including the Motorola Exorcisor.

TSC has just released a new generation of operating system for use on 6809 and 68000 systems. Called UniFlex, it is a multiuser, multitasking system similar to the Bell System's UNIX. It uses a hierarchical file system and device-independent I/O. Since it requires a minimum of 96K of memory, TSC continues to support FLEX for single user systems.

Major Software Manufacturers

AAA Chicago Computer Center
120 Chestnut Lane
Wheeling, IL 60090
312-459-0450

Roberts Control Equipment
3640 Western Road, Unit 3
Weston, Ontario M9L 1W2
Canada
716-631-8178

Blue Hat Software Co.
Box 4127
Flint, MI 48504
313-738-2863

Technical Systems Consultants
Box 2570
West Lafayette, IN 47906
317-463-2502

Microware Systems Corp.
5835 Grand Avenue
Des Moines, IA 50304
515-279-8844

Frank Hogg Laboratory
130 Midtown Plaza
Syracuse, NY 13210
315-474-7856

Alford and Associates
P.O. Box 6743
Richmod, VA 23230
804-320-6722

Products

text processor
plus some hardware
and mailing list program

dynamic RAM cards

DOS for Percom disks

disk operating systems
BASIC, Pascal, C, and
application programs

OS-9 disk operating system
BASIC09, Pascal and various
systems programs

FORTH, job control program,
data base management program,
remote terminal program,
English text analysis and
artificial intelligence demo

screen editor, real time TREK

(continued)

6809 SYSTEMS ☺ 6809 SYSTEMS ☺ 6809 SYSTEMS ☺ 6809 SYSTEMS

Featuring the GIMIX mainframe with 30 amp C.V. ferro-resonant power supply; fifteen 50 pin and eight 30 pin slot Mother Board; 2 Mhz CPU with time of day clock & battery back-up, 1K RAM; 6840 programmable timer, provisions for 9511A or 9512 Arithmetic processors, and 4 PROM/ROM/RAM sockets that can hold up to 32KB of monitor or user software.

VARIETY: you can have 32KB, 56KB, 128KB and up of static RAM. You can use 5" and/or 8" disk drives, single or double density, single or double sided, and single or double tracking with GIMIX disk controllers. You have a wide choice of serial or parallel I/O cards.

EXPANDABILITY: You can add memory, I/Os, Video or Graphics cards, Arithmetic processors, additional drive capacity, and other hardware now or in the future to this SS50 bus structured system from GIMIX or other SS50 bus compatible manufacturers.

SOFTWARE VERSATILITY: GIMIX systems can use TSC's FLEX or UNIFLEX and MICROWARE'S OS-9 operating systems. A wide variety of software and languages is available for these systems.

QUALITY: All boards are assembled, burred-in, and tested and feature **GOLD PLATED BUS CONNECTORS**. Only top quality components are used and all boards are fully buffered for maximum system expansion. All boards come complete with bus connectors and all necessary instruction and documentation.

GIMIX designs, manufactures and tests, in-house, their complete line of products. Complete systems are available to fit your needs. Please contact the factory if you have any special requirements.



GIMIX inc.

The Company that delivers
Quality Electronic products since 1975.

1337 WEST 37th PLACE, CHICAGO, IL 60609
(312) 927-5510 • TWX 910-221-4055

GIMIX* and GHOST* are registered trademarks
of GIMIX inc.

Flex and Uniflex are trademarks of Technical Systems
Consultants Inc. OS9 is a trademark of Microware Inc. See
their ads for other GIMIX compatible software

On the 6809, FLEX may be getting some very stiff competition from a new operating system written by Microware Systems Corporation, of Des Moines, Iowa. OS-9 also uses UNIX-like files and is a real-time, multitasking hardware-dependent system. It comes in two versions: Level One, which requires 32K to 56K of memory, and Level Two, which is designed to use up to a million bytes of memory on a system with memory management hardware. Both OS-9 systems give you complete timesharing capability and a device-independent I/O that can handle almost any number and combination of devices, ranging from 5¼-inch floppies to Winchester hard disks, and from standard serial and parallel ports to memory-mapped video displays.

OS-9 was written by Microware, under a contract with Motorola, to provide an operating system to support the company's BASIC09. This compiler/interpreter will run standard BASIC programs or slightly modified Pascal code. It contains all the control statements needed for structured programming and gives you defined data types and complex data structures.

Frank Hogg Laboratory in Syracuse, New York, has become the major international distributor of applications and systems software for the 6809. Hogg presently supplies all programs for the FLEX system, but will soon be adding OS-9 formatted disks.

Hogg also sells a FORTH interpreter that is totally compatible with FLEX systems. It even uses standard FLEX formatted files instead of the hybrid FORTH file design. It is very fast, contains an excellent full screen editor, and is shipped with a 400-page manual that will soon become the basis of a book about FORTH released by a major publisher.

Another Hogg program that is very popular is DATAMAN, a complete Database Management System. It is one of the most complete packages on the market and is made up of 16 menu-driven programs. It allows, among other things, any number of fields and any number of bytes in a record. Many DBM programs limit you to 254 bytes or one sector per record. A companion package called DATARAND converts DATAMAN sequential files into fast random access files which use hashed keys.

Hogg also features a Job Control Program that lets you automate your S-50 bus computer's operation, an intelligent

Software Manufacturers

Computerware Software Services
1512 Encinitas Blvd.
Encinitas, CA 92024
404-483-1717

Talbot Microsystems
5030 Kensington Way
Riverside, CA 92507
714-781-0464

Tallgrass Technologies Corp.
7623 West 86th Street
Overland Park, KS 66212
913-381-5588

Dugger's Growing Systems
P.O. Box 305
Solana Beach, CA 92075

MicroPower
1418 West Thorndale
Chicago, IL 60660
312-989-8585

Micropi
2445 North Nugent
Lummi Island, WA 98262
206-734-8248

Micro Works
P.O. Box 1110
Del Mar, CA 92014
714-942-2400

Washington Computer Services
3028 Silvern Lane
Bellingham, WA 98225
206-734-8248

Hemenway Associates, Inc.
101 Tremont St.
Boston, MA 02108
617-426-1931

HHH Enterprises
Box 493
Laurel, MD 20820
301-953-1155

Mark Data Products
23802 Barquilla
Mission Viejo, CA 92691
714-768-1551

Omegasoft
P.O. Box 70265
Sunnyvale, CA 94086
408-733-6979

Programma International
3400 Wilshire Blvd.
Los Angeles, CA 90010

Software Dynamics
2111 West Crescent
Anaheim, CA 92801

Application Services Company
P.O. Box 12227
Wichita, KS 67277

Products

operating systems
BASICS

tFORTH
firmFORTH

complete UCSD Pascal system

small C compiler

Juggler, a graphics game

PILOT, and BLITZ screen editor

editor debugger, monitor and
disassembler for TRS-80 color
computer

RMS data base management
system

systems software

SPIRIT, a FORTH-like
language and various hardware
systems

various adventures

Pascal compiler

SPL/M compiler
and PIE editor

disk operating system
and BASIC compiler

Adventure for 6800 and 6809
(the original version)

terminal program, a clever program that analyzes your English text and an interesting artificial intelligence demonstration program called ESTHER which will amaze your friends for hours. Hogg is adding applications programs almost monthly, and plans to release a spelling check program this fall.

Other Systems

And, if a truly standard bus isn't enough to lure you into the 6809 world, the big names are coming. Sony is said to be working on a 6809 computer, and Canon is reported to be building two models, one designed to compete with Tandy's TRS-80 Color Computer. Apple is rumored to be working on a 68000 design, and Commodore has announced the Super PET (or Micro Mainframe) which adds a 6809 card to the 6502-based machine.

A listing of all the major manufacturers and software houses is provided here to give you a head start in your search for a 6809 system. I have listed each firm's major product and, where available, have provided the telephone numbers.

Software Manufacturers

Sonex Systems
Box 238
Williamsville, NY 14221
716-634-2466

Universal Data Research, Inc.
2457 Wehrle Drive
Buffalo, New York 14221
716-631-3011

Westchester Applied Business Systems
P.O. Box 187
Briarcliff Manor, NY 10501
914-941-3552

Computer Systems Center
13461 Olive Blvd.
Chesterfield, MO 63017
314-576-5020

Dynasoft Systems Ltd.
P.O. Box 51
Windsor Jct.
Nova Scotia, Canada B0N 2V0
902-861-2202

Lucidata, Ltd.
P.O. Box 128
Cambridge CB2 5EZ
England

Products

Stylograph interactive word processing system

Data Base Manager

Data Base Manager

disassembler for 6800 and 6809

tiny Pascal

Pascal compiler for 6800/6809

MICRO

Your Apple too slow? Not anymore...

Now you too can write 6809 programs for your Apple II that are DOS 3.3 compatible. But you don't have to stop there, you can also program your Apple II's 6502 and the 6809 of THE MILL to run SIMULTANEOUSLY.

THE ASSEMBLER DEVELOPMENT KIT, including THE MILL, is a full feature assembler, designed to use the text editing system of your choice. The system will also boost your computer programming productivity, since the 6809 is today's easy to learn and program computer. Take advantage of the 8-bit 6502 and the 16-bit abilities of the 6809 running at the same time, create your own MULTIPROCESSING ENVIRONMENT on the Apple II.

Put THE MILL into your Apple II and get power, performance and price matched by no other personal computer. STELLATION TWO offers a full 1 year warranty and a 60 day money back guarantee, if you're not completely satisfied with the power of THE MILL.

Shop around, then compare the service, quality, price and power of THE MILL. Take this ad to your local Apple Dealer and see the endless possibilities of adding THE MILL to your Apple II.

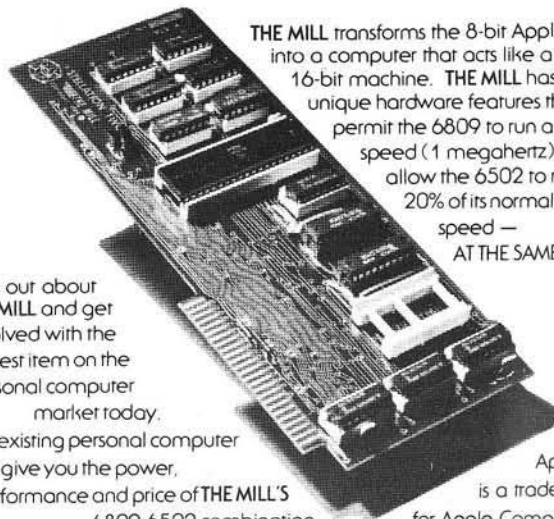

THE MILL transforms the 8-bit Apple II into a computer that acts like a 16-bit machine. THE MILL has unique hardware features that permit the 6809 to run at full speed (1 megahertz) and allow the 6502 to run at 20% of its normal speed —
AT THE SAME TIME!

Find out about THE MILL and get involved with the hottest item on the personal computer market today.

No existing personal computer can give you the power, performance and price of THE MILL'S 6809-6502 combination.

Apple II is a trademark for Apple Computer, Inc.

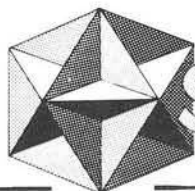

**STELLATION
TWO**

P.O. BOX 2342 - N4
SANTA BARBARA, CA. 93120
(805) 966-1140

COMPUTER SYSTEMS CONSULTANTS, INC.

1454 Latta Lane, Conyers, GA. 30207
Telephone 404-483-1717 or 483-4570

SOFTWARE DEPARTMENT

(ALL PROGRAMS PROVIDED IN SOURCE ON DISK SPECIFY 5 1/8")

SUPER SLEUTH Disassembler System (for FLEX* systems)		\$ 99 00
—runs on 6800/1/9, analyzes 6800/1/5/9 and 6502		
—easy to use, self-instructive, with 42-page manual		
—automatic labels, optional FCB, FCC, FDBs		
—input binary file from disk or from memory		
—memory changes to program thru full-screen editor		
—output disk file may be source or new binary file		
—commands from menu or from and to disk file		
—generates FLEX* and user-defined names		
—includes assembler language XREF program		
—contact SMOKE or CER-COMP for non-FLEX* systems		
Z-80/8080/8085 Disassembler (Similar to SLEUTH)		\$ 99 00
—runs on 6800/1/9, analyzes Z-80/8080/8085		
6800/1.6805, 6502, Z-80, 8080/5 Cross-assemblers	EACH	\$ 50 00
—macro sets for TSC 6809 Macro Assembler		
FULL-SCREEN FORMS DISPLAY for TSC 6809 X-BASIC	ANY 3	\$ 100 00
—display and edit for terminals and video displays		
—complete cursor control for screen input/output		
—interactive forms generator/documentor provided		
FULL SCREEN MAILING LIST System for TSC 6809 X-BASIC		\$ 100 00
—full screen update and selection to print or labels		
TABULA RASA Tabular Calculation Program		\$ 100 00
—similar to VISICALC (T.M. Personal Software)		
TSC BASIC Resequencing and XREF Programs		\$ 25 00
—processes TSC BASIC, X-BASIC, PC, XPC programs		
—partial and blank-resequence capabilities		
—alphabetized xref of all variables and BASIC verbs		
TSC X-BASIC DISK SORT/MERGE Generator		\$ 25 00
—generates TSC XPC BASIC sort/merge programs		

HARDWARE DEPARTMENT

(ALL BOARDS BARE WITH FULL DOCUMENTATION PROVIDED)

I/O SELECTRIC INTERFACE BOARD (serial or parallel)		\$ 35 00
—ASCII (TTL or RS-232-CTS) in, 26-50v solenoids out		
—2708 PROM with Correspondence ball codes		
SS-50 WIRE-WRAP BOARD (52-16 pin equivalent)		\$ 15 00
SS-30 WIRE-WRAP BOARD (32-16 pin equivalent)		\$ 25 00
SS-30 DUAL ACIA BOARD (modem control + Baud rate gen)		\$ 15 00
SS-50 FRONT PANEL DISPLAY BOARD (16 decoded LEDs)		\$ 30 00
		\$ 10 00

VISA and MASTER CARD preferred; account, exp date, phone no.
US funds only; Add 7.5% (15% Foreign) for postage & handling.
For Catalog or dealer discount information contact Bud Pass
*FLEX is a trademark of Technical Systems Consultants

computer
case
company

COMP
CASE



• AP103

• AP101	Apple II with Single Disk Drive	\$109
• AP102	Apple II with Double Disk Drives	119
• AP103	Apple II, 9 inch Monitor & Double Drives	...	129
• AP104	Apple III, two additional Drives & Silentype		139
• AP105	12 inch monitor plus accessories	99
• RS201	TRS-80 Model I, Expansion Unit & Drives	109
• RS202	TRS-80 Monitor or TV set	84
• RS204	TRS-80 Model III	129
• RS205	Radio Shack Color Computer	89
• P401	Paper Tiger 440/445/460	99
• P402	Centronics 730/737 - Line Printer II/IV	89
• P403	Epson MX70 or MX80	89
• CC90	Matching Attaché Case	75

computer case company

5650 INDIAN MOUND CT. COLUMBUS, OHIO 43213 (614) 868-9464



Z-FORTH IN ROM by Tom Zimmer

5 to 10 times faster than Basic. Once you use it, you'll never go back to BASIC!
source listing add

\$ 75.00
\$ 20.00

OSI FIG-FORTH True fig FORTH model for OS65D with fig editor named files, string
package & much more

\$ 45.00

TINY PASCAL Operates in fig-FORTH, an exceptional value when purchased with forth.
TINY PASCAL & documentation

\$ 45.00
\$ 65.00

SPACE INVADERS 100% machine code for all systems with 64 chr. video. Full color & sound
on C2, 4P & 8P systems. The fastest arcade program available.

\$ 14.95

PROGRAMMABLE CHARACTER GENERATOR

Use OSI's graphics or make a complete set of your own! Easy to use, comes assembled & tested.
2 Mhz. boards

\$ 99.95

PROGRAMMABLE SOUND BOARD

Complete sound system featuring the AY-3-8910 sound chip. Bare boards available.

\$ 74.95

\$ 29.95

32/64 CHARACTER VIDEO MODIFICATION

Oldest and most popular video mod. True 32 chr. C1P, or 32/64 chr. C4P video display.
Also adds many other options.

\$ 39.95

ROMS!!!

Augment Video Mod with our Roms. Full screen editing, print at selectable scroll, disk support and many more
features. Basic 4 & Monitor

\$ 49.95

Basic 3

\$ 18.95

All 3 for

\$ 65.00

65D DISASSEMBLY MANUAL. by Software Consultants. First Class throughout.

A must for any 65D user.

\$ 24.95

NUMEROUS BASIC PROGRAMS, UTILITY PROGRAMS AND GAMES ALONG WITH HARDWARE PROJECTS. ALL
PRICES ARE U S FUNDS. Send for our \$1.50 catalogue with free program (hardcopy) Memory Map and Auto Load
Routine.



OSI Software & Hardware

3336 Avondale Court
Windsor, Ontario, Canada N9E 1X6
(519) 969-2500

3281 Countryside Circle
Pontiac Township, Michigan 48057
(313) 373-0468



progressive computing

The most important book ever published for the Apple.

The most comprehensive description of Apple II firmware and hardware ever published — all in one place.

What's Where in the Apple?

- Guides you — with a numerical Atlas and an alphabetical Gazetteer — to over **2,000** memory locations of **PEEKs**, **POKEs**, and **CALLs**.
- Gives names and locations of various **Monitor**, **DOS**, **Integer BASIC**, and **Applesoft** routines — and tells you what they're used for.
- Helps BASIC users to speed up their programs.
- Enables assembly language programmers to simplify coding and interfacing.

All Apple users will find this book helpful in understanding their machine, and essential for mastering it!

Ask for it at your computer store

128 pages, 8½ × 11 inches, cardstock cover, Wire-O binding.

\$14.95

ISBN: 0-938222-07-4

What's Where in the APPLE?

HEX	LOCN	(DEC LOCN)	[NAME]	USE-TYPE	DESCRIPTION
\$0000	\$FFFF	(0-65535)			ADDRESS RANGE OF APPLE II (\$0000-\$FFFF)
\$0000	\$0000	(0)			START OF APPLE II (NO)
\$0000	\$0001	(0-1)			START OF APPLE II (NO)
\$0000	\$0002	(0-2)			START OF APPLE II (NO)
\$0000	\$0003	(0-3)			START OF APPLE II (NO)
\$0000	\$0004	(0-4)			START OF APPLE II (NO)
\$0000	\$0005	(0-5)			START OF APPLE II (NO)
\$0000	\$0006	(0-6)			START OF APPLE II (NO)
\$0000	\$0007	(0-7)			START OF APPLE II (NO)
\$0000	\$0008	(0-8)			START OF APPLE II (NO)
\$0000	\$0009	(0-9)			START OF APPLE II (NO)
\$0000	\$000A	(0-10)			START OF APPLE II (NO)
\$0000	\$000B	(0-11)			START OF APPLE II (NO)
\$0000	\$000C	(0-12)			START OF APPLE II (NO)
\$0000	\$000D	(0-13)			START OF APPLE II (NO)
\$0000	\$000E	(0-14)			START OF APPLE II (NO)
\$0000	\$000F	(0-15)			START OF APPLE II (NO)
\$0000	\$0010	(0-16)			START OF APPLE II (NO)
\$0000	\$0011	(0-17)			START OF APPLE II (NO)
\$0000	\$0012	(0-18)			START OF APPLE II (NO)
\$0000	\$0013	(0-19)			START OF APPLE II (NO)
\$0000	\$0014	(0-20)			START OF APPLE II (NO)
\$0000	\$0015	(0-21)			START OF APPLE II (NO)
\$0000	\$0016	(0-22)			START OF APPLE II (NO)
\$0000	\$0017	(0-23)			START OF APPLE II (NO)
\$0000	\$0018	(0-24)			START OF APPLE II (NO)
\$0000	\$0019	(0-25)			START OF APPLE II (NO)
\$0000	\$001A	(0-26)			START OF APPLE II (NO)
\$0000	\$001B	(0-27)			START OF APPLE II (NO)

AN ATLAS TO THE APPLE COMPUTER

By William F. Luebbert

ORDER TOLL-FREE TODAY **800-227-1617** EXT. 564 (in California 800-772-3545 Ext. 564)

Yes! Please send me _____ copies of *What's Where in the Apple?* at \$14.95 each (in U.S. plus shipping).

Name _____

Address _____

City _____

State _____ Zip _____

Check for \$_____ enclosed. (Add \$2.00 surface shipping for each copy.) Massachusetts residents add 5% sales tax.

VISA MasterCard

Acct. # _____ Expires _____

Signature _____

MICRO INK, Inc., 34 Chelmsford Street, P.O. Box 6502, Chelmsford, MA 01824

Apple is a registered trademark of Apple Computer, Inc.

Handling Analog Signals with a Micro

Problems of handling analog signals are discussed, and two techniques are presented.

Richard Soltero
Ciba-Geigy Corp.
556 Morris Ave.
Summit, NJ 07901

Arthur Poulos
Rutgers University
Newark, NJ 07102

Establishing a dialogue with a 6502 microprocessor is an important process which is facilitated by numerous varieties of terminals and keyboards. Some microcomputers, such as the AIM 65, support their own alphanumeric keyboard and a printer or display. Other micros, like the KIM and SYM, have an on-board hex keypad and LED display. By far the most popular, however, are CRT's and hard copy terminals which can communicate over RS-232 or 20mA current loop hook-ups.

These communication links can be used to write programs with the micro or to read the contents of various memory locations. When the microprocessor is used to talk directly to a data collecting instrument, the real potential of the small 6502-based systems is demonstrated. A micro such as the SYM can be set up in a wide variety of configurations to do any number of data transfer tasks. This is due to its 63 programmable I/O lines, eight control lines and five internal timers. This versatility also accounts for a degree of complexity in solving a communication problem. This article steps through several methods of getting alien information into a micro.

If the task is to bring in data from a measuring device such as a thermometer or a voltmeter, then several steps are involved. Since we are living in an analog world and wish to interface to a digital world, the first step is to put an analog to digital convertor (ADC) be-

```

;*****
;
; ASSEMBLY ROUTINE FOR AN ICL7109 ADC
; ATTACHED TO A SYM-1 MICROPROCESSOR
;*****
;
.BA $B10
.OS
.LS
TEMP .DE $80F ;STORAGE FOR HI BYTE
LAD .DE $F000 ;LOW ORDER BYTE
HAD .DE $F001 ;HI ORDER BYTE
;
0810- AD 01 F0 LDA HAD ;LOAD HI BYTE
0813- 29 20 AND #$20 ;MASK FOR POLARITY BIT
0815- F0 0B BEQ NEG ;IF POLARITY IS NEGATIVE,
; THEN 2'S COMPLIMENT IS NEEDED
0817- AD 01 F0 LDA HAD ;LOAD HI BYTE
081A- 29 BF AND #$BF ;MASK HIGH NIBBLE + 4
081C- AC 00 F0 LDY LAD ;LOAD LOW BYTE FOR TRANSFER
; TO BASIC
081F- 4C 4C D1 JMP $D14C ;RETURN TO BASIC WITH A
; POSITIVE NUMBER
0822- 18 NEG CLC
0823- AD 01 F0 LDA HAD ;LOAD HI BYTE
0826- 8D 0F 0B STA TEMP
0829- AD 00 F0 LDA LAD ;LOAD LOW BYTE
082C- 69 01 ADC #01 ;ADD 1
082E- 90 03 BCC CHKC ;IF CARRY CLEAR,
; DON'T ADD 1 TO HI BYTE
0830- EE 0F 0B INC TEMP ;ADD 1 TO HI BYTE
0833- 49 FF CHKC EOR #$FF ;2'S COMPLIMENT ON LOW BYTE
0835- AB TAY ;LOAD LOW BYTE FOR TRANSFER
; TO BASIC
0836- AD 0F 0B LDA TEMP ;LOAD HI BYTE
0839- 29 BF AND #$BF ;MASK HIGH NIBBLE + 4
083B- 49 FF EOR #$FF ;2'S COMPLIMENT ON HI BYTE
083D- 4C 4C D1 JMP $D14C ;RETURN TO BASIC
; WITH A NEGATIVE NUMBER
;
.EN

```

tween the device and the micro. Once the ADC is in place, then the microprocessor must be somehow alerted to its presence so it can interact with it to bring the data into memory. After this, the programmer can write a program in a high level language like BASIC to crunch the data and print out tables or reports.

An example of setting up an ADC was presented by J.C. Williams in

MICRO (12:25). He used a 100 microsec 16-channel ADC tied directly to the data bus of the 6502. Another example of this process will be described later in this article using a single channel 12-bit ADC tied to the data and address buses of a SYM. Dr. Marvin DeJong used a 6530 PIA to interface an 8-bit 75703 ADC to a KIM (MICRO 15:40).

Not all data must come from an ADC though. Dr. DeJong (MICRO

24:19) showed how a temperature could be measured and the data transferred through a 6522 VIA. In another article (MICRO 27:68), a method was described using the 6522 VIA to input binary coded decimal (BCD) digits from the digital panel meters of a spectrophotometer.

Not all ADC's can be used for all applications, therefore this article will show a way to deal with slow analog signals and very fast analog signals. An instrument or measuring device puts out a voltage level which is proportional to a property being measured (i.e. air temperature, wind velocity, etc.). If the property does not change appreciably over a 1/10 of a second period, then an integrating ADC like the ICL 7109 can easily be used. If the property changes in less than a microsecond, then a very fast ADC is required. A fast 8-bit ADC is packaged inside a commercially available unit called the Biomation Waveform recorder, Model 8100. This unit will record the digitized information in 2K of RAM and then the entire block of memory can be read by a micro using the handshake routine described here.

One of the problems commonly faced in an analytical laboratory is to interface analog instruments with a computer. Ideally, a simple ADC with sufficient versatility and resolution for handling a variety of applications is part of the answer. The rest of the answer is a computer that can effectively provide the communication between the ADC, the CPU, and the operator. We have solved this dilemma with a few relatively inexpensive components. A SYM-1 with 4K RAM and BASIC ROM is used in conjunction with a T.I. Silent 700 terminal for operator-computer communication. An Intersil 7109 ADC is used for communication between our instruments and the 6502 MPU.

The Intersil ICL7109 is a single channel ± 12 -bit integrating ADC with polarity and overrange signals. It is tied onto the data bus with tristate logic so that either the low order bits or high order bits (+ polarity and overrange) can be selectively read on the same eight bus lines. The unit has latched outputs and was set in a free running mode where it will do 30 conversions a second. By just reading two addresses (at \$F000 and \$F001) the low and high order bits can be transferred into another memory location. An LS138 is used to decode the address of the low and high order bits. The 7109 needs a clock signal for its operation. This is provided by bringing in phase 2 of the SYM's clock signal and dividing it by 4 in a 74LS93.

```

;*****
;
;   ASSEMBLY ROUTINE FOR TRANSFER OF DATA FROM
;   BIOMATION MODEL 8100 TO ROCKWELL AIM-65
;
;*****
;
DRB .DE $A00    ;DATA REGISTER B
DRAH .DE $A001 ;DATA REGISTER A WITH HANDSHAKE
DDR8 .DE $A002 ;DATA DIRECTION REGISTER B
DDRA .DE $A003 ;DATA DIRECTION REGISTER A
ACR .DE $A00B  ;AUXILIARY CONTROL REGISTER
PCR .DE $A00C  ;PERIPHERAL CONTROL REGISTER
IFR .DE $A00D  ;INTERUPT FLAG REGISTER
IER .DE $A00E  ;INTERUPT INABLE REGISTER
TABLE .DE $0F00 ;DATA TABLE
DSTRT .DE $90  ;DATA TAKEN CHECK
;
;BA $0E90
;***** REGISTER INITIALIZATION *****
.LS
0E90- A9 0B LDA #$0B
0E92- 8D 0C A0 STA PCR ;CA1 ACTIVE ON POSITIVE TRANSITION
;CB1 ACTIVE ON NEGATIVE TRANSITION
;CA2 IN PULSE OUTPUT MODE
0E95- 8D 90 00 STA DSTRT ;CLEAR DATA TAKEN FLAG
0E98- A9 00 LDA #0
0E9A- 8D 03 A0 STA DDRA ;MAKE PORT A INPUTS
0E9D- 8D 0E A0 STA IER ;DISABLE ALL INTERUPTS
0EA0- 8D 02 A0 STA DDRB ;MAKE PORT B INPUTS
0EA3- 60 RTS ;RETURN TO BASIC
;
;BA $0EB0
;***** DATA TRANSFER SECTION *****
0EB0- A9 03 LDA #$03
0EB2- 8D 90 00 STA DSTRT ;SET DATA TAKEN FLAG
0EB5- A9 0B LDA #$0B
0EB7- 8D 0C A0 STA PCR ;RELOAD PERIPHERAL CONTROL
REGISTER
0EBA- AD 00 0A LDA DRB ;CLEAR CB1 FLAG IN IFR
0EBD- AD 0C A0 LDA PCR
0EC0- 09 C0 ORA #$C0
0EC2- 8D 0C A0 STA PCR ;HOLD CB2 (OPT) LOW
0EC5- A2 00 LDX #0
0EC7- A0 08 WDSTR LDY #08 ;LOAD WORD COUNTERS
0EC9- AD 0D A0 NXTWRD LDA IFR
0ECC- 29 02 AND #02 ;CHECK IF CA1 (FLAG) IS HIGH
0ECE- F0 F9 BEQ NXTWRD ;IF NOT CHECK AGAIN
0ED0- AD 01 A0 LDA DRAH ;READ PORT A
;CLEAR CA1 FLAG
;SEND PULSE ON CA2
0ED3- 8B DEY ;DECREMENT WORD COUNTER
0ED4- D0 F3 BNE NXTWRD ;IF NOT 0, GET NEXT WORD
0ED6- 9D 00 0F STA TABLE,X ;STORE EIGHTH WORD IN TABLE
0ED9- EB INX
0EDA- F0 07 BEQ OFF ;AFTER 255 STORES, GO TO OFF
0EDC- AD 00 0A LDA DRB ;CHECK OFF FLAG
0E1F- 29 20 AND #$20
0EE1- D0 E4 BNE WDSTR ;IF NOT 0, GET NEXT WORD
0EE3- AD 0C A0 OFF LDA PCR
0EE6- 09 20 ORA #$20
0EE8- 8D 0C A0 STA PCR ;HOLD CBS (OPT) HIGH
0EEB- A9 02 LDA #02
0EED- 8D 90 00 STA DSTRT ;RESET DATA FLAG
0EF0- 60 RTS ;RETURN TO BASIC
;EN

```

The 12-bit word that is generated by this ADC allows a 1 in 4096 resolution as compared to an 8-bit ADC which allows only a 1 in 255 resolution. Voltage inputs, in this setup, can range between +5 and -5 volts. A schematic of the circuit shows how to hook up the address and data bus lines through the expansion (E) connector of the SYM.

The address lines are decoded in this circuit to put the data in high memory of the 4K version (at \$F000 and \$F001). The assembly program also resides in high memory (\$810-\$840) so that most of the RAM is free for a user-oriented BASIC program.

The assembly listing shows how the two address locations are manipulated

so that the polarity and overrange functions can be isolated from the low nibble of the high byte.

If the polarity bit is set, then the program returns a positive number to BASIC through the USR entry routine. If the polarity bit is low, then the assembly program branches to a routine where the high and low order bytes undergo a 2's complement. This allows a negative number to be returned to BASIC through the USR function.

The BASIC program listed below is all that is necessary once the connections have been made and an analog signal has been attached to the input of the ADC.

```
10 INPUT A
20 IF A #1 THEN 50
30 PRINT USR (2064,00)
40 GO TO 10
50 END
```

Each time a 1 is input in response to the question mark, the digital value of the ADC will be printed. Since the ADC converts continuously in the free running mode (about 30 times a second), all the programmer has to do is write a BASIC program which will invoke the USR function any time he wants to read a value of the analog signal.

The BASIC program can be designed to provide all of the delays, loops or massaging that the programmer may desire. This concept allows users who have had little or no hardware or software experience to control the routines and data in a more understandable high level language.

For handling fast analog signals, a waveform recorder like the Biomation Model 8100 is more suitable. The problem here is to transfer data from the recorder to a micro like the Rockwell's AIM 65. In this application, we have used a 4K version of the AIM 65 with BASIC ROM installed to transfer and process data from a Biomation. The Biomation will sequentially dump each of the 8-bit words in its memory onto eight pins of its output connector. These eight lines were connected to the eight pins of port A of the AIM's 6522 VIA. The four control lines of the VIA were also connected for control of other functions on the Biomation. The operation of the VIA was controlled by setting the correct bits in several of the registers associated with the VIA.

Table 1 shows the connections between the Biomation's output connector (J-10) and the application (J-1) edge connector of the AIM 65.

```
10 REM BASIC PROGRAM FOR CONTROLLING DATA TRANSFER FROM
20 REM BIOMATION MODEL 8100 TO AIM-65
30 REM
40 TABLE=3840
50 GOSUB 100:REM ARM THE BIOMATION
60 GOSUB 200:REM INITIALIZE REGISTERS IN ASSEMBLY ROUTINE
   AT $B90
70 PRINT"TRIGGER THE BIOMATION TO LOAD A SIGNAL"
80 GOSUB 300:REM WAIT FOR SIGNAL TO BE STORED, THEN TAKE DATA
90 GOSUB 400:REM PRINT OUT OF DATA TABLE
99 END
100 POKE 40962,144:POKE 40960,0:POKE40960,1
110 RETURN
200 POKE 4,144:POKE 5,14
210 X=USR(N)
220 RETURN
300 PRINT" ** WAIT **"
310 IF PEEK(40973) <> 16 THEN 310
320 POKE 4,176
330 X=USR(N)
340 IF PEEK(144)=3 THEN PRINT" ** DATA TAKEN **"
350 RETURN
400 FOR A = 0 TO 255 STEP 4
410 FOR B = 0 TO 3:PRINT PEEK(TA+A+B);
420 NEXT B:NEXT A
430 RETURN
500 END
```

After a fast analog signal is stored by the Biomation, 2K bytes of data are transferred into the microprocessor. A line diagram (figure 1) showing the voltage levels on each of the control lines is used to demonstrate how to transfer data over the eight data lines tied from the Biomation to Port A of the 6522.

CB1 is an input from the Biomation which indicates when the recording of a signal is finished. CB1 has been initiated as an input which will cause bit 4 of the IFR to be set when the recording has finished (negative transition). CB2 must then be held low to let the Biomation know that data is going to be taken. This is done by writing a %1100 0000 into the PCR, which puts CB2 into the manual output mode. CA1 has been programmed to set its flag (bit 1) in the IFR every time the Biomation drives that

line high. The active transition from low to high causes an interrupt flag to be set because a 0 was put into bit 0 of the PCR.

The program waits for the CA1 flag to go high in the IFR. When this happens, Port A is read by loading it into the accumulator. At the same time as Port A is read, the flag is automatically cleared and an output strobe appears on CA2. The output strobe indicates to the Biomation that a word was taken and it can make the next word available on the data pins. CA2 was initially set up by ORing the PCR with a %0000 1010.

The handshake data transfer technique is operated 2048 times until all of the data is transferred. After the last word is taken, CB2 is driven high to let

Table 1

BIOMATION J-10 Connector			AIM 65 J-1 Connector	
Name	Pin #		Pin #	Name
Y0	36	→	14	PA0
Y1	37	→	4	PA1
Y2	38	→	3	PA2
Y3	39	→	2	PA3
Y4	40	→	5	PA4
Y5	41	→	6	PA5
Y6	42	→	7	PA6
Y7	43	→	8	PA7
RMA	9	←	13	PB4
OFF	34	→	16	PB5
PPB	8	←	15	PB7
FLG	45	→	20	CA1
WDC	44	←	21	CA2
RECORD	50	←	18	CB1
OPT	7	→	19	CB2
GRND	1	-	1	GRND



BOX 120
ALLAMUCHY, N.J. 07820
201-362-6574

HUDSON DIGITAL ELECTRONICS INC.

THE TASK* MASTERS

HDE supports the *TIM, AIM, SYM and KIM (TASK) with a growing line of computer programs and peripheral components. All HDE component boards are state-of-the-art 4½" x 6½", with on board regulation of all required voltages, fully compatible with the KIM-4 bus.

OMNIDISK 65/8 and 65/5

Single and dual drive 8" and 5¼" disk systems. Complete, ready to plug in, bootstrap and run. Include HDE's proprietary operating system, FODS (File Oriented Disk System).

DM816-M8A

An 8K static RAM board tested for a minimum of 100 hours and warranted for a full 6 months.

DM816-UB1

A prototyping card with on-board 5V regulator and address selection. You add the application.

DM816-P8

A 4/8K EPROM card for 2708 or 2716 circuits. On board regulation of all required voltages. Supplied without EPROMS.

DM816-CC15

A 15 position motherboard mounted in a 19" RETMA standard card cage, with power supply. KIM, AIM and SYM versions.

DISK PROGRAM LIBRARY

Offers exchange of user contributed routines and programs for HDE Disk Systems. Contact Progressive Computer Software, Inc. for details.

HDE DISK BASIC

A full range disk BASIC for KIM based systems. Includes PRINT USING, IF . . . THEN . . . ELSE. Sequential and random file access and much more. \$175.00

HDE ADVANCED INTERACTIVE DISASSEMBLER (AID)

Two pass disassembler assigns labels and constructs source files for any object program. Saves multiple files to disk. TIM, AIM, SYM, KIM versions. \$95.00

HDE ASSEMBLER

Advanced, two pass assembler with standard mnemonics. KIM, TIM, SYM and KIM cassette versions. \$75.00 (\$80.00 cassette)

HDE TEXT OUTPUT PROCESSING SYSTEM (TOPS)

A comprehensive text processor with over 30 commands to format and output letters, documents, manuscripts. KIM, TIM and KIM cassette versions. \$135.00 (\$142.50 cassette)

HDE DYNAMIC DEBUGGING TOOL (DDT)

Built in assembler/disassembler with program controlled single step and dynamic breakpoint entry/deletion. TIM, AIM, SYM, KIM AND KIM cassette versions. \$65.00 (\$68.50 cassette)

HDE COMPREHENSIVE MEMORY TEST (CMT)

Eight separate diagnostic routines for both static and dynamic memory. TIM, AIM, SYM, KIM and KIM cassette versions. \$65.00 (\$68.50 cassette)

AVAILABLE DIRECT OR FROM THESE FINE DEALERS:

Progressive Computer Software
405 Corbin Road
York, PA 17403
(717) 845-4954

Johnson computers
Box 523
Medina, Ohio 44256
(216) 725-4560

Falk-Baker Associates
382 Franklin Avenue
Nutley, NJ 07110
(201) 661-2430

Perry Peripherals
P.O. Box 924
Miller Place, NY 11764
(516) 744-6462

Lux Associates
20 Sunland Drive
Chico, CA 95926
(916) 343-5033

Laboratory Microcomputer Consultants
P.O. Box 84
East Amherst, NY 14051
(716) 689-7344

Figure 1

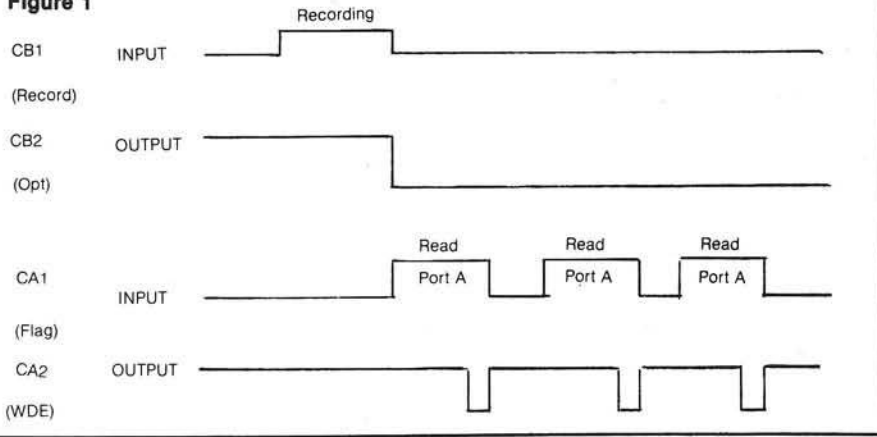

the Biomatron know that no more data will be read. The entire data transfer process normally requires about 0.2 seconds. This is an asynchronous data transfer because it is not under control of a clock.

The assembly listing shows the initialization of the different registers. The first part of the program at \$E90 is accessed from BASIC through a USR entry and then returns to BASIC by a RTS command. The BASIC program is used

for operator interaction so that the user can start the waveform recorder and the data transfer at any time. The recording and the assembly program beginning at \$EA3 can be started within seconds or minutes of each other and the data transfer will occur automatically. At the end of the transfer, program control will return to BASIC.

It should be apparent that this communication technique could easily be adapted for transferring information be-

tween two computers or between a computer and any instrument that has a resident ADC. As more and more of the analytical instruments become digital, binary word transfer mechanisms will become more prevalent. It is hoped that this model can be used to introduce the primary tools and information necessary to implement similar information transfers.

For those instrument applications where there are only analog signals to detect, the ADC scheme presented in figure 2, or in the other articles cited, should provide a method of communicating data to a microprocessor. The hardware outlined in the schematic requires some basic electronic knowledge and skills to get started. The hardware available on the SYM and AIM 65 can make any of these data transfers simpler if the programmer is aware of all of the available tools in these systems. There are many different ways to transfer data in and out of the MPU, with all of the equipment for doing this residing on the same board.

We'd like to thank Mr. Bill Stein for providing the hardware and software for the ICL7109.

Figure 2

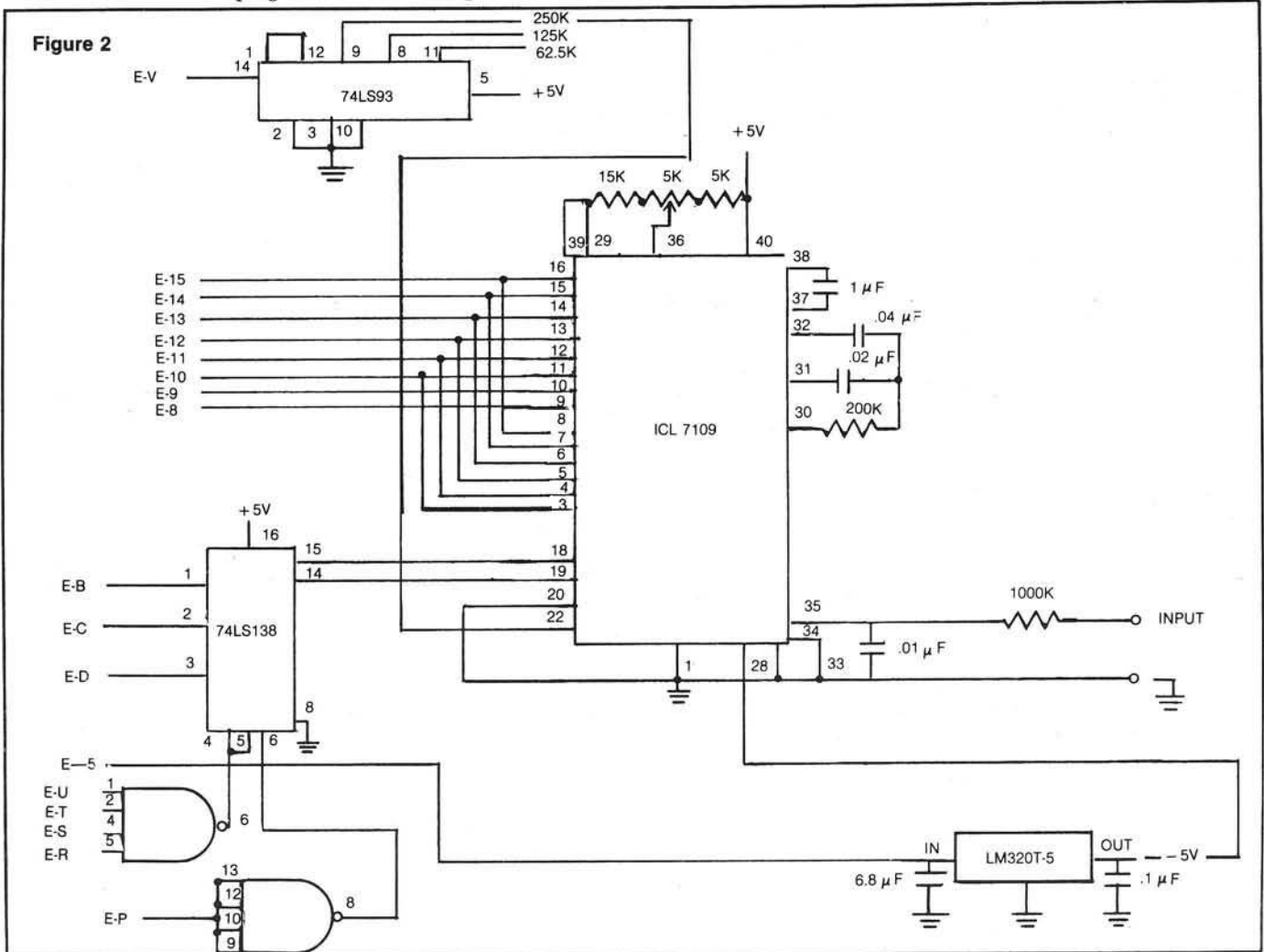

Innovative Design Software, Inc.

ANNOUNCES
SHUFFLEBOARD
for your APPLE II.™
only \$29.95



NEW

- Real time HIRES Color Graphics

- Play Against your APPLE or another opponent

- An accurate and challenging game following in the tradition of Pool 1.5

POOL 1.5 features

- Realistic, life-like motion
- HIRES Color Graphics
- Choice of 4 popular pool Games
- You've Got to see it to believe it!
- Only \$34.95

— Another first from IDSI

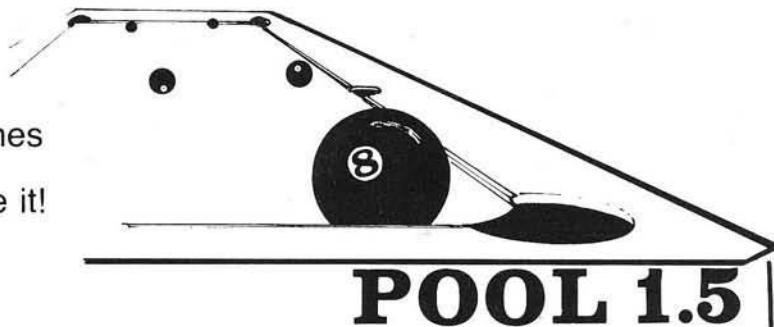

POOL 1.5

"IT (Pool 1.5) is so realistic, you begin filling in the details of the pool hall yourself"

— Softalk Magazine

Both of these excellent games require a 48K APPLE II/Plus and a DISK II. Pool 1.5 requires a set of game paddles or Joystick. Order directly from IDSI or see your nearest APPLE dealer.



P.O. BOX 1658
Las Cruces N.M. 88004
(505) 522-7373

• Apple II/Plus is a Trademark of Apple Computer Inc. Pool 1.5 is a trademark of IDSI



We accept Visa, MasterCard, Check or Money Order.



VersaWriter

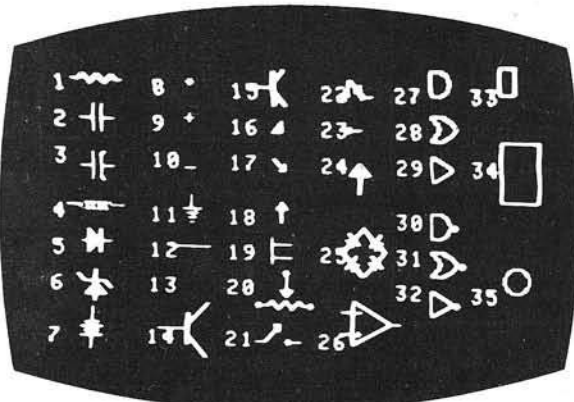

What is VersaWriter?

- VersaWriter is an inexpensive drawing tablet for the APPLE II that lets you trace a picture and have it appear on TV display.
- VersaWriter is a comprehensive software drawing package which lets you color in drawings with over 100 different colors.
- VersaWriter is a shape compiler that converts anything on the screen automatically into a standard shape table.
- VersaWriter is a text writer for labeling pictures with text in six colors and five sizes. Use English or Greek, upper or lower case letters.
- VersaWriter is much more! Draw with brush, create schematic drawings, compute area and distance, edit pictures, save, recall and more.

VersaWriter requires ROM APPLESOFT and 48K memory.

\$299 Suggested Retail

UNIQUE OFFER

Send us YOUR disk and \$1. We will promptly return the disk with a slide package of 10 color pictures drawn with VersaWriter.

- Enclosed is \$1 and my disk. Send me the slide package.
- Send more information including VersaWriter dealers in my area.

DEALER INQUIRIES INVITED.

NAME

ADDRESS

CITY STATE ZIP

Send To: Versa Computing, Inc. • 887 Conestoga Circle • Newbury Park, CA 91320 • (805) 498-1956

Taming the Wild Reset

Cut two traces, add two wires, and your old Apple reset key becomes a new Apple control-reset key!

Michael M. Seiy
Sytran One Inc.
1242 Home Avenue
Fort Wayne, IN 46807

This article describes a hardware modification of the Apple keyboard which will undoubtedly void any warranties. Neither the author nor the publisher will bear any liability for any damage you may do to your Apple while making these modifications. On the plus side, these modifications have been made on several Apples with no ill effects and in fact, are very similar to the changes which Apple has made to newer Apples.

These instructions, which show you how to cut two traces and add two jumper wires, are written so that a novice who barely knows what a piece of wire is can tackle this project with confidence.

Once installed, your Apple will ignore all normal RESETS and acknowledge only a CONTROL-RESET with the deadly "BEEP *" we all dread.

You'll need the following tools to procede with these instructions:

- A #2 Phillips head screwdriver
- A sharp, small knife such as an X-acto
- A small soldering iron (25-40 watt)
- A short piece of electronic rosin core solder
- 12-15 inches of #22 or #24 insulated wire

Figure 1: Bottom view of Apple II.

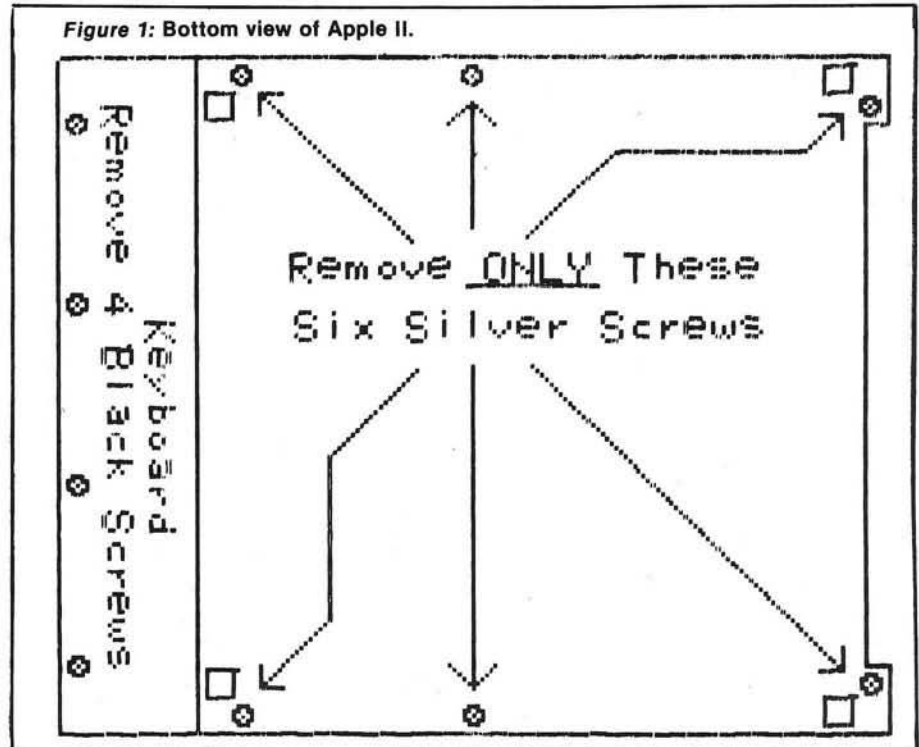

The following are not necessary but may come in handy:

- A small (1/8") flat blade screwdriver
- Small needle-nose pliers

Step 1. Unplug the Apple and remove the cord from the case.

Step 2. Remove all cables from the back, such as the video and cassette cable.

Step 3. Remove the top cover of the Apple and remove all peripheral cards.

Step 4. Put the Apple upside down on a table top large enough to provide some elbow room.

Step 5. Refer to figure 1 and remove the six flat-head, silver-colored Phillips head screws which hold the case to the

bottom plate. They are all on the edge as shown. Do not remove any screws from the center.

Step 6. Remove the four Phillips screws at the front of the Apple.

Step 7. While holding the case and the bottom plate together, carefully turn the Apple rightside up, keyboard away from you. Look through the top of the case toward the front of the Apple and lift the case about two inches. You should spot the keyboard ribbon cable going to its connector on the main board. Gently rock the connector and ease it out of its socket. A small screwdriver may be used to pry the connector up. If you bend any pins, they should be straightened with needle nose pliers.

Step 8. Set the base plate aside for now and concentrate on the keyboard. Turn the case upside down, keyboard facing you, and remove the two screws on the left edge and the two screws on

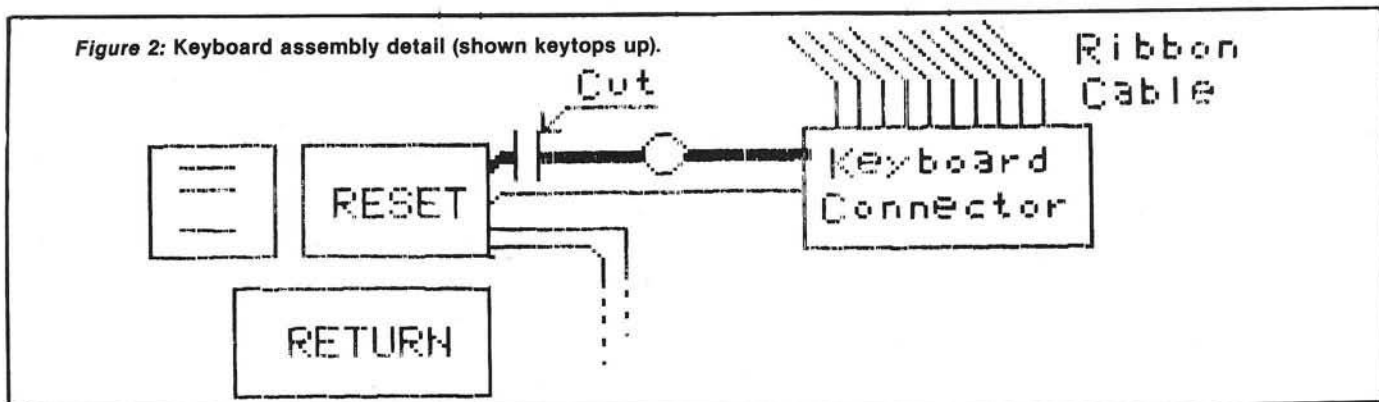

the right edge which hold the keyboard in the case. Remove the keyboard and set the case aside for now.

Step 9. With the keytops up (refer to figure 2), examine the area between the RESET key and the ribbon cable connector. You should see four printed circuit traces going under the RESET key on its right side. Using a sharp knife, cut through the larger upper (or rearward) trace as close to the reset key as possible. Be sure to cut all the way through the trace to break the electrical connection, but be careful not to damage any other traces.

Step 10. Turn the keyboard keytops down and refer to figure 3. Some Apples are equipped with an insulator taped at the lower left corner. This needs to be carefully peeled back. Locate the heavy circuit trace which runs along the bottom of the PC board. At the left edge it connects to a 40-pin I.C. Follow this trace up past the upper row of I.C. pins through contact #53, past three screws to the right side of contact #13. Cut this trace about 1/4" from the right contact of #13.

Step 11. Warm up a small soldering iron. Be sure to use rosin core solder for electronic applications and not the acid core solder used for plumbing.

Step 12. Cut a 9" piece of wire and strip no more than 1/8" of insulation from each end. Pre-tin the ends by heating them and applying small amounts of solder. Avoid melting the insulation as much as possible and if necessary, cut off some of the bare wire to keep its length at 1/8".

Step 13. Cut and prepare a 3" piece of wire the same as in step 12.

Step 14. Solder one end of the 9" wire to the right contact of #13. This contact was connected to the circuit trace on the bottom of the board before the trace was cut in step 10.

Step 15. Locate the circuit trace at the bottom of the board again and this time follow it to the right. You should end up at the left contact of #28, which is on the back of the control key. Solder the other end of the 9" wire to the empty right contact of #28.

Step 16. Solder one end of the 3" wire to the center contact of #53, thus connecting it to the circuit trace which runs along the bottom of the board.

Step 17. Between the contact pair #13 (used in steps 10 and 14) and the top row of contacts of the keyboard connector are two contacts. The right one has a trace connected to it. Solder the other end of the 3" wire to the left, empty contact.

Step 18. Examine all of your solder connections for shorts to any nearby traces or terminals. Check for loose solder droplets and make sure the bare portion of the jumper wires does not touch any other circuit or terminal.

Step 19. Reposition the keyboard into its original place in the upper case. Be sure the ribbon cable is coming out from the top of the printed circuit card. Loosely fit each of the four screws which hold the keyboard into their respective holes and only then tighten them.

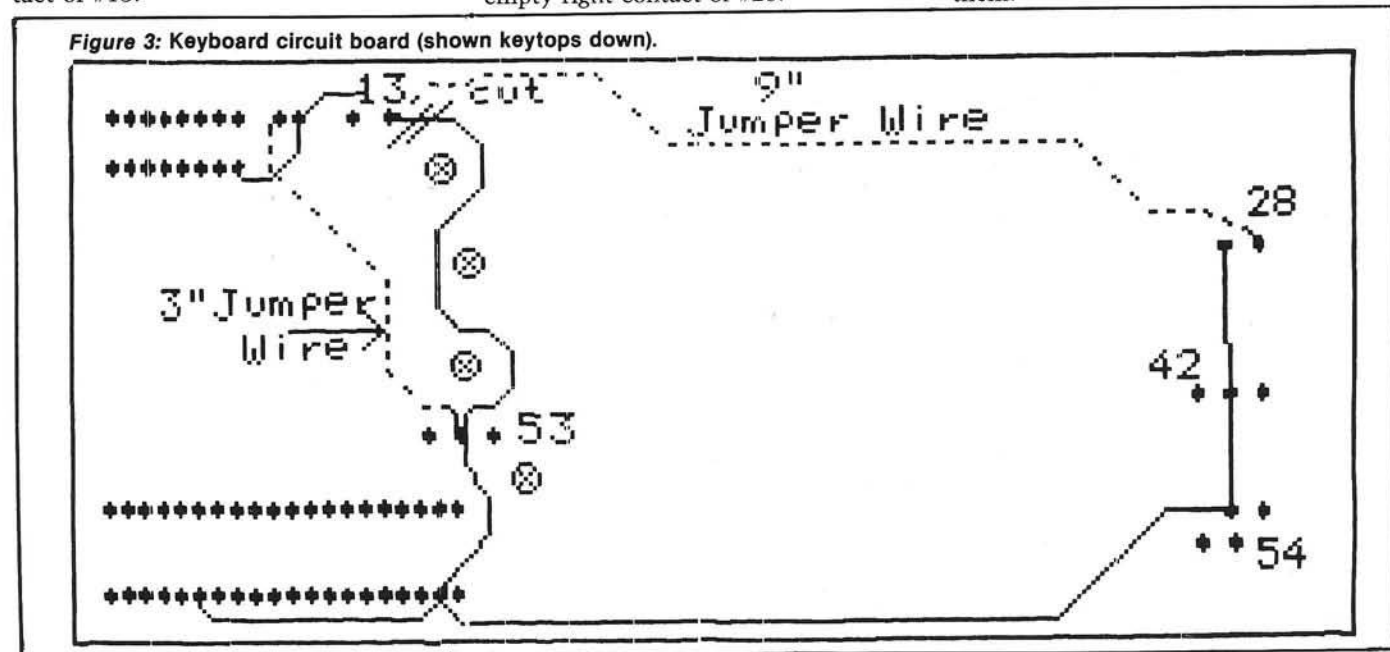

Step 20. Position the upper case over the main base and plug in the keyboard. Make sure that each pin goes into its place in the socket without bending and that the connector is not offset such that pins hang over the top or bottom of the socket.

Step 21. While holding the case and base together, turn the Apple upside down and refasten the case to the baseplate with the four black and six silver screws.

Step 22. Turn the Apple rightside up and reconnect the line cord. Do not, as yet, install any peripheral cards.

Step 23. Plug in the cord and turn on the Apple. You should hear the familiar RESET beep. Verify that pushing RESET does not produce a beep and that

pushing CONTROL-RESET does. If you note any changes from this, turn off your Apple and recheck all jumper wires and cut traces. If the RESET key alone still does a RESET, one of the traces has not been cut all the way through or you cut the wrong one. If CONTROL-RESET does nothing, then the 9" wire has a problem. If the entire keyboard does not respond, the 3" wire has a problem.

Step 24. Turn the Apple off, re-install all of your peripheral cards and cables and you're back in business!

Theory of Operation

If you glance at the keyboard schematic on page 101 of the new *Apple Reference Manual*, you will see that the function of the RESET key is to connect the reset line from the Apple to ground. The control key also ties a line to

ground. The two cut traces on the keyboard circuit card isolate the RESET key from circuit ground. The 9" wire ties the RESET key to the floating side of the control key so that both keys must now be pressed to provide a path from the RESET line to ground.

Unfortunately, the cut traces also isolate the entire keyboard circuitry. The 3" jumper wire restores ground to the rest of the keyboard.

Michael Seiy, a digital design engineer, has incorporated his own company which specializes in custom hardware and software for the Apple II. He owns a 48K Apple with two disk drives, an Applesoft card, a serial card, a parallel card, M.C. clock card, and an Epson printer.



NEW
DEALER INQUIRIES INVITED!!

DOUBLE DOS PLUS
for Apple Computers
\$39.00

201-839-3478

DOUBLE DOS Plus—a piggyback board that plugs into the disk-controller card so that you can switch select between DOS 3.2 and DOS 3.3. Works with the language system eliminating the need in many cases to boot the BASICs disk. Also eliminates the chore of converting all of your 3.2 disks to 3.3

NOTE: APPLE is a registered trademark of APPLE Computer, Inc., Cupertino, CA.

WHY IS DOUBLE DOS PLUS better?

- Nothing needs to be soldered, just plug in and go.
- Since all four ROMs are used, all software will work, even early 3.1 DOS.
- Because the ROMs fit on the back of the board, it has the thinnest configuration allowing full use of slot #7
- One set of ROMs is powered up at a time, thus saving power. DOUBLE DOS Plus requires APPLE DOS ROMS
- Full 90-day warranty from TYMAC.

MICRO-WARE DISTRIBUTING INC.
P.O. BOX 113
POMPTON PLAINS, N.J. 07444

OTHER UNIQUE PRODUCTS FROM MICRO-WARE DISTRIBUTING INC.

THE APPLE CARD—Two sided 100% plastic reference card for the Apple computer. Loaded with information of interest to all Apple owners **\$3.98**

PARALLEL PRINTER CARD—PPC-100—A Universal Centronics type parallel printer board complete with cable and connector. This unique board allows you to turn on and off the high bit so that you can access additional features in many printers. Use with EPSON, ANADIX, STARWRITER, NEC, SANDERS, OKI, and other with standard Centronics configuration **\$139.00**

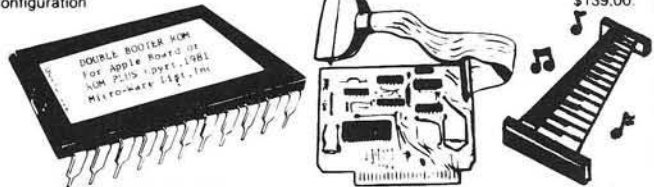

THE DOUBLE BOOTER ROM—Plugs into the empty D8 Socket on the Apple motherboard or the Integer ROM Card to provide a 13 sector boot without using the BASICs Disk. DoubleBooter may also be used in the MOUNTAIN HARDWARE ROM PLUS board. This chip will not work in a plus machine unless it contains an Integer board or a ROM Plus board **\$29.00**

DISK STIX—Contains 10 dozen diskette labels with either 3.3 or 3.2 designation. Room for program names and type also **\$3.98**

*****SOFTWARE*****

SUPER SEA WAR—Hires battleship type simulation **\$13.95**

ULTIMATE XFER—A telephone software transfer program, uses DC Hayes Assoc. micromodem **\$25.00**

ROAD RALLYE—Hires driving game with 5 different full screen tracks **\$15.00**

MISSILE CHALLENGER—Hires arcade type game where you defend your cities from falling missiles. 8 levels & writes name & high score to disk **\$19.95**

SUPER PIX—Hires screen dump for the EPSON MX-80, inverse or normal, larger than full page graphics in 2 orientations. Needs Tymac PPC-100 Printer board or we will upgrade your EPSON board for \$25 **\$39.95**

GRAPH-FIT—A hires graphing program that produces bar charts, pie charts and line graphs. Has auto scaling feature too **\$25.00**

STILL MORE APPLE GOODIES

- APPLE KEYBOARD SYNTHESIZER**—49 note (C to C) AGO Keyboard with 3 sawtooth sq wave shapers, 3 audio oscillators, 3 low pass filters, 4-64 point shape controllers, 2 envelope generators. Complete system **\$995**
- KEYBOARD ONLY** with Apple Interface **\$649**
- GRAPHIC NOTEWRIER**—Hires note write for synthesizer system **\$99**
- SUPER PIX OKI**—Hires screen dump for OKI Microline 80, 82, 83 Printers. Same features as super pix. Needs Tymac PPC-100 Board **\$24.95**
- NIBBLES AWAY**—The best disk back up program to date. Allows you to make backups of most every disk ever produced for the Apple. Over 10 user defined parameters including synchronized & unsynchronized copies as well as automatic half tracking and raw date transfer **\$59**

Call 201-839-3478 for Dealer & Distributor Inquiries



SENSIBLE SOFTWARE, INC. IS PLEASED TO INTRODUCE...
OUR 1981 COLLECTION OF SUPERIOR SOFTWARE FOR THE APPLE COMPUTER...

APPLESOFT-PLUS STRUCTURED BASIC [APLUS]

\$25.00

32K +, Disk II, ROM/RAM Applesoft, Apple II/Apple II +

APLUS is a 4K machine language utility that adds the following structured programming commands to Applesoft basic: 1) WHEN...ELSE...FIN, 2) UNTIL, 3) WHILE, 4) UNLESS, 5) CASE, 6) SELECT (variable), and 7) (OTHERWISE). Multi-line IF...THEN statements are also supported. APLUS allows the use of "named" subroutines or "procedures". The programmer can now instruct a program to "DO CURVE-FIT" without worrying about the location of the subroutine. APLUS automatically indents "&LIST"ed programs to clarify the logic flow. The APLUS "&CONVERT" command replaces the above structured programming commands with "GOTO"s and "GOSUB"s to provide a standard Applesoft program as output. New programs can now be written using "GOTO"-less logic.

APPLESOFT PROGRAM OPTIMIZER [AOPT]

\$20.00

32 +, Disk II, ROM/RAM APPLESOFT, Apple II/Apple II +

AOPT is a 2.2K machine language utility that will substantially reduce the size of an Applesoft program without affecting the operation of the program. AOPT automatically: 1) Shortens variable names, 2) Removes unreferences lines, 4) Appends short lines together, 5) Removes extra colons, and 6) Renumbers line numbers. AOPT will convert a verbose, well documented, development version of a program into a memory-efficient, more secure, production version of the same program. This is the ORIGINAL and the BEST optimizer on the software market today!

DOS PLUS

\$25.00

32 +, Disk II, DOS 3.3, Apple II/Apple II +

DOS PLUS is the software solution for living with both 13-sector (DOS 3.1, 3.2, and 3.2.1) and 16 sector (DOS 3.3) Apple diskettes, DOS PLUS adds 8 new commands to Apple DOS. Three of these are built-in and five are user definable. The built in commands include: 1) ".F" to "flip" between DOS 3.2 and 3.3 (The user need not re-boot and any program that resides in memory will not be affected by the flip. The DOS version can even be changed within a program!), 2) ".S" status command informs you what DOS version is currently active, and 3) ".B" BLOAD- analysis is also provided to inform the user of the starting address and length of the last accessed binary file. DOS PLUS also includes a DOS COMMAND CHANGER program to allow easy customization of Apple DOS commands to suit individual tastes.

DISK ORGANIZER II

—NEW—

\$30.00

48K, Disk II, Apple II/Apple II +

DO II is the fastest and friendliest utility available today for organizing files on an Apple II diskette. DO II provides the following functions: 1) TITLING in Normal, Inverse, Flashing, Lower case, and other characters normally not available, 2) CUSTOM REORDERING of the directory, 3) ALPHABETIZING, 4) DYNAMIC DISPLAY of ALL filenames on a diskette (including deleted files), 5) RENAMING files with the same character options as TITLING, 6) UNDELETING, 7) DELETING, 8) PURGING deleted files, 9) LOCKING (all or some), 10) UNLOCKING (all or some), 11) USE of DOS sectors for increased data storage, and 12) a SIMULATED CATALOG to show the modified directory before it is written to the diskette. DO II is completely MENU DRIVEN and attains it's speed by altering a RAM version of the catalog. DO II uses a very powerful SMART KEY to automatically locate the next valid filename for any specified disk operation. Compatible with DOS 3.1, 3.2, 3.2.1, and 3.3 as well as MUSE DOS to allow manipulation of SUPER TEXT files! (Note: Updates available for \$5.00 and original diskette.)

PASCAL LOWER CASE

—NEW—

\$25.00

48K +, Disk II, Apple II/Apple II +, Language System

This is the most recent commercially available LOWER CASE MOD for Pascal for the Apple II. It is the only currently available modification that is compatible with both versions of Pascal (1.0 and 1.1). The Pascal version is automatically checked prior to updating system Apple. If you have any of the hardware lower case adapters you can now input the following characters directly from the keyboard: | ~ ^ < > _ and \. This modification does NOT interfere with any of the 'Control' character functions implemented by the Pascal environment and will 'undo' any alterations made by other commercially released modifications.

QUICKLOADER

\$25.00

48K +, Disk II, Apple II/Apple II + . . . (2 Disks)

If you find yourself doing the same things over and over -- QL will help you do it faster! QL is a unique disk that lets you load DOS, a language card (optionally), and an application program of your choice extremely rapidly. QL boots as a 13 or 16 sector diskette and is easy to set up and use. To change the setup, you merely load your Apple RAM with the new data and use the "RECONFIGURE" option of QL. The next time you boot your QL disk, it will quickly load your new setup (Language Card, DOS, Application program) into your Apple! QL can reduce the time to perform these functions by up to 80%! Now that you've read this, you say "But I can already do all of that!" QL doesn't do anything new -- it just does it MORE CONVENIENTLY and FASTER! Try it, you'll like it!

DISK RECOVERY ("THE SCANNER")

\$30.00

48K +, Disk II, Apple II/Apple II +

This program is long overdue. You need no longer be concerned with the problem of physically damaged disks. Just as "Apple Pascal" provides a "BAD BLOCK SCAN", DISK RECOVERY will do a complete scan of your Apple diskettes' recording surface. Damaged areas will be "marked" as used in the disk directory so that no attempts will be made to "WRITE" to a bad sector. The VTOC will be completely redone to reflect both the bad sectors and actual disk usage. A complete report is generated advising the user of all corrections. A resulting "DISK MAP" is presented for your review. The greatest advantage of this program over the other versions is that it can be used on either NEWLY INITIALIZED DISKS or disks that ALREADY CONTAIN PROGRAMS as well as the SPEED of analysis. THE SCANNER is fully compatible with both 13 and 16 sector diskettes. This is a must for all Disk II owners!

ALSO AVAILABLE:

- SUPER DISK COPY III** **\$30.00**
- MULTI-DISK CATALOG III** **\$25.00**
- THE NEW PROTECTOR** **\$250.00**
- (Call or Write for Information)
- LUNAR LANDER II** **\$15.00**
- MASTER MAZE** **\$15.00**

SENSIBLE SOFTWARE, INC.

6619 PERHAM DRIVE / W. BLOOMFIELD, MICHIGAN 48033
313-399-8877

VISA and MASTERCARD WELCOME

Michigan Residents add 4% Sales Tax
Please add \$1.00 postage & handling for each item ordered.

A BRIGHT NEW STAR FROM
ANDROMEDA!

ROM * RAM

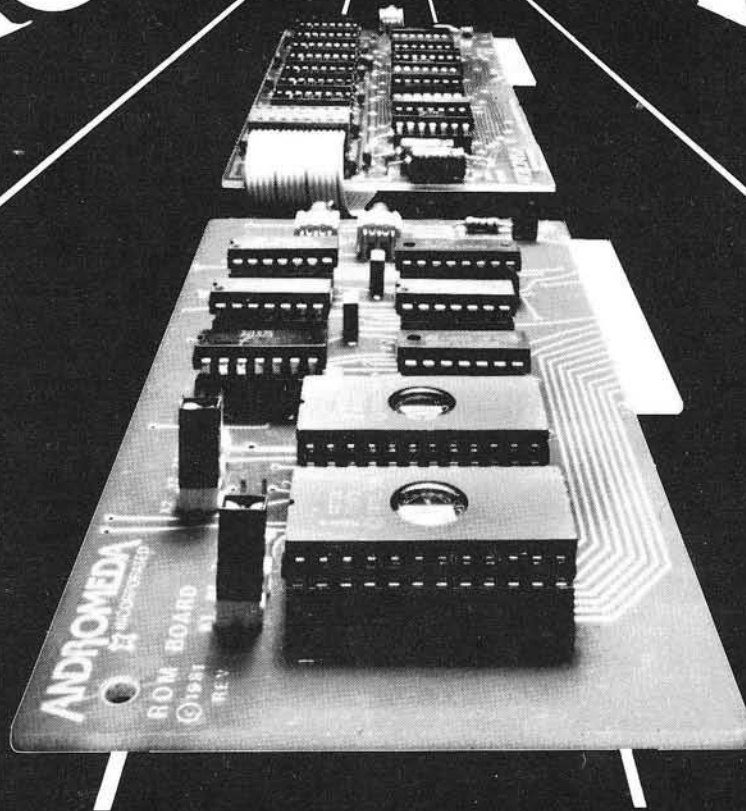

**NEW ROM BOARD FOR THE APPLE II*
\$125.00 WITH UTILITY ROM.**

With Andromeda's new ROM Board, you can plug many useful utility programs into your Apple II. Because ROM memory never forgets, you can access these utilities instantly without having to load them from disk.

The ROM Board comes with the utility ROM, which gives you five powerful options to apply to your Applesoft* programs. With the Utility ROM, you can do automatic line numbering, control a program list with a page mode, restore a crashed Applesoft* program in memory, alphabetize a disk catalogue and create a disk without DOS, giving you an extra 8K on your disk. Any of Soft Control Systems' other ROMS can be used, such as the Dual DOS in ROM, and Your'ple ROM.

You can install 2K PROMS, 4K PROMS, or even 2K RAM chips in each of the two memory sockets. So you can even have the Read - Write capability of RAM to develop PROM Programs yourself, or just have an extra 2K RAM for your machine - Language programs. Two 2732 PROMS allow a total of 8K of memory on the Board.

Now with One Year Warranty.

**Don't forget the Andromeda 16K RAM
Expansion Board \$195.00**

ANDROMEDA



INCORPORATED

P.O. Box 19144
Greensboro, NC. 27410
919 852-1482

Distributed By:



**COMPUTER
DATA
SERVICES**

P.O. Box 696
Amherst, NH. 03031
603 673-7375

*Apple II and Applesoft are trademarks.

Apple Byte Table

This useful reference table will simplify the task of decoding byte-values in the Apple's memory. For all numerical values, hex or decimal, each possible meaning is listed, ranging from ASCII to Applesoft token. If you ever tackle a hex-dump, the Apple byte table will prove invaluable.

Kim G. Woodward
6526 Delia Drive
Alexandria, Virginia 22310

If you look at a single byte in the Apple or any other 8-bit microcomputer, it will mean different things at different times. Data and instructions are represented in the same manner in the computer: one byte may be data, an address, a token, or a command. I have put together a simple table which will be of use no matter what the relationship of the byte is to your software. (Columns F, G, H, and I will be especially useful to the Apple owner.) The table is composed of 10 columns which represent:

- A. The equivalent decimal value of the byte (assuming the byte is not signed).
- B. The equivalent hex value of the byte.
- C. The equivalent binary value of the byte (very useful for assembly language masking).
- D. The value of the byte if it is looked at as the high byte of an address.
- E. The corresponding ASCII character for the byte (if there is one).
- F. The equivalent displayed screen character. (I-Inverse, F-Flashing, N-Normal.)

G. The equivalent key to be pressed to get the byte. (If there is one, note all keys > \$7F, C after character means CTRL key held down.)

H. The corresponding Integer BASIC token for the byte. The Integer BASIC tokens can be found by keying:

> CALL -155	Go to monitor
*CA:00 10	Set program start
*4C:14 10	Set program end
*1000:13	Set length byte
*1001:0A 00	Set line number
*1003:	16 bytes of your choice
*1013:01	End of line token
*	Return via CTRL-C
> LIST	

I. The corresponding Applesoft BASIC token for the byte. The Applesoft tokens can be found by keying:

CALL -155	Go to monitor
*67:01 08	Set program start
*AF:16 08	Set program end
*801:16 08	Pointer to next line
*803:0A 00	Set line number
*805:	16 bytes of your choice
*815:00	End of line token
*816:00 00 00	End of program pointer
*0G	Back to BASIC
LIST	

J. The corresponding 6502 machine language opcode.

Let's note some of the subtleties in the table's usage. First of all, if a particular pattern for a mask operation is needed, then it is a simple matter of looking down the table until the correct binary (column 3) pattern is found. Then on the same line, read the decimal equivalent for a POKE command, or the hex equivalent for assembly language use. In like manner you can do the following:

A. Decimal to hexadecimal conversion — scan the table in column 4 to find the highest number not exceeding the decimal number. If the number is negative (such as addresses in Integer BASIC larger than 32767), add 65536 before the conversion. Write down the hex value and subtract the decimal number just found. Then find the decimal remainder in the table and write down the hex value for it. The first hex value is the high byte and the second is the low byte. For example, find the hex equivalent of -936 (clear).

$-936 + 65536 = 64600$: the number to find. Find 64512 (\$FC) : highest number less than 64600
 $-64512 = 88$: find difference. Find 88 (\$58) : remainder. Value of -936 decimal is \$FC58.

B. Hexadecimal to decimal conversion — separate the hex number into two bytes. Scan the table for the value of the high order byte in column 4. Then scan the table for the value of the low order byte in column 1, add the two numbers together and get the result. For negative addresses (> \$7FFF) simply subtract 65536 from the number.

C. Relative addressing — the formula for relative addressing on the 6502 is: address of branch to address - address of branch inst. - 2. For example, to branch from location \$345 to \$313 you could find the decimal equivalent of \$345 as per (A) above, 837, and of \$313, 787. Thus $787 - 837 - 2$ is -52. Add 256 to -52 giving 204. Look up 204 in the table as \$CC. \$CC is then the relative address offset.

Columns F and G in the table can be found in the *Apple Reference Handbook* by Apple Computer, Inc. If these tables have been of some benefit, let me know; write to the address at the beginning of the article.

The Apple Byte Table

Dec	Hx	Binary	High	Asc	Sc	Ky	Int Bs	Aps Bs	6502
000	00	00000000	0	NUL	@I		HIMEM:	NUL	BRK
001	01	00000001	256	SOH	AI		EOS	SOH	DRAIX
002	02	00000010	512	STX	BI		-	STX	
003	03	00000011	768	ETX	CI		:	ETX	
004	04	00000100	1024	EOT	DI		LOAD	EOT	
005	05	00000101	1280	ENQ	EI		SAVE	ENQ	DRAZ
006	06	00000110	1536	ACK	FI		CON	ACK	ASLZ
007	07	00000111	1792	BEL	GI		RUN	BEL	
008	08	00001000	2048	BS	HI		RUN	BS	PHP
009	09	00001001	2304	HT	II		DEL	HT	DRAIM
010	0A	00001010	2560	LF	JI		,	LF	ASLA
011	0B	00001011	2816	VT	KI		NEW	VT	
012	0C	00001100	3072	FF	LI		CLR	FF	
013	0D	00001101	3328	CR	MI		AUTO	CR	ORA
014	0E	00001110	3584	SO	NI		,	SO	ASL
015	0F	00001111	3840	SI	OI		MAN	SI	
016	10	00010000	4096	DLE	PI		HIMEM:	DLE	BPL
017	11	00010001	4352	DC1	QI		LOMEM:	DC1	DRAIY
018	12	00010010	4608	DC2	RI		+	DC2	
019	13	00010011	4864	DC3	SI		-	DC3	
020	14	00010100	5120	DC4	TI		*	DC4	
021	15	00010101	5376	NAK	UI		/	NAK	DRAZX
022	16	00010110	5632	SYN	VI		=	SYN	ASLZX
023	17	00010111	5888	ETB	WI		#	ETB	
024	18	00011000	6144	CAN	XI		>=	CAN	CLC
025	19	00011001	6400	EM	YI		>	EM	GRAY
026	1A	00011010	6656	SUB	ZI		<=	SUB	
027	1B	00011011	6912	ESC	[I		<>	ESC	
028	1C	00011100	7168	FS	\I		<	FS	
029	1D	00011101	7424	GS]I		AND	GS	ORAX
030	1E	00011110	7680	RS	^I		OR	RS	ASLX
031	1F	00011111	7936	US	_I		MOD	US	
032	20	00100000	8192	SPC	I		^	SPC	JSR
033	21	00100001	8448	!	!I		+	!	ANDIX
034	22	00100010	8704	"	"I		("	
035	23	00100011	8960	#	#I		,	#	
036	24	00100100	9216	\$	\$I		THEN	\$	BITZ
037	25	00100101	9472	%	%I		THEN	%	ANDZ
038	26	00100110	9728	&	&I		,	&	ROLZ
039	27	00100111	9984	'	'I		,	'	
040	28	00101000	10240	((I		"	(PLP
041	29	00101001	10496))I		")	ANDIM
042	2A	00101010	10752	*	*I		(*	ROLA
043	2B	00101011	11008	+	+I		!	+	
044	2C	00101100	11264	,	,I		!	,	BIT
045	2D	00101101	11520	-	-I		(-	AND
046	2E	00101110	11776	.	.I		PEEK	.	ROL
047	2F	00101111	12032	/	/I		RND	/	
048	30	00110000	12288	0	OI		SGN	0	BMI
049	31	00110001	12544	1	1I		ABS	1	ANDIY
050	32	00110010	12800	2	2I		PDL	2	
051	33	00110011	13056	3	3I		RNDX	3	
052	34	00110100	13312	4	4I		(4	
053	35	00110101	13568	5	5I		+	5	ANDZX
054	36	00110110	13824	6	6I		-	6	ROLZX
055	37	00110111	14080	7	7I		NOT	7	
056	38	00111000	14336	8	8I		(8	SEC
057	39	00111001	14592	9	9I		=	9	ANDY
058	3A	00111010	14848	:	:I		#	:	
059	3B	00111011	15104	;	;I		LEN(;	
060	3C	00111100	15360	<	<I		ASC(<	
061	3D	00111101	15616	=	=I		SCRN(=	ANDX
062	3E	00111110	15872	>	>I		,	>	ROLX
063	3F	00111111	16128	?	?I		(?	
064	40	01000000	16384	@	@F		*	@	RTI

(Continued)

Dec	Hx	Binary	High	Asc	Sc	Ky	Int Bs	Aps Bs	6502
065	41	01000001	16640	A	AF		*	A	EORIX
066	42	01000010	16896	B	BF		(B	
067	43	01000011	17152	C	CF		,	C	
068	44	01000100	17408	D	DF		;	D	
069	45	01000101	17664	E	EF		;	E	EORZ
070	46	01000110	17920	F	FF		;	F	LSRZ
071	47	01000111	18176	G	GF		;	G	
072	48	01001000	18432	H	HF		,	H	PHA
073	49	01001001	18688	I	IF		,	I	EORIM
074	4A	01001010	18944	J	JF		,	J	LSRA
075	4B	01001011	19200	K	KF		TEXT	K	
076	4C	01001100	19456	L	LF		GR	L	JMP
077	4D	01001101	19712	M	MF		CALL	M	EOR
078	4E	01001110	19968	N	NF		DIM	N	LSR
079	4F	01001111	20224	O	OF		DIM	O	
080	50	01010000	20480	P	PF		TAB	P	BVC
081	51	01010001	20736	Q	QF		END	Q	EORiy
082	52	01010010	20992	R	RF		INPUT	R	
083	53	01010011	21248	S	SF		INPUT	S	
084	54	01010100	21504	T	TF		INPUT	T	
085	55	01010101	21760	U	UF		FOR	U	EORZX
086	56	01010110	22016	V	VF		=	V	LSRZX
087	57	01010111	22272	W	WF		TO	W	
088	58	01011000	22528	X	XF		STEP	X	CLI
089	59	01011001	22784	Y	YF		NEXT	Y	EORY
090	5A	01011010	23040	Z	ZF		,	Z	
091	5B	01011011	23296	[CF		RETURN	[
092	5C	01011100	23552	\	CF		GOSUB	\	
093	5D	01011101	23808]	CF		REM]	EORX
094	5E	01011110	24064	^	CF		LET	^	LSRX
095	5F	01011111	24320	_	CF		GOTO	_	
096	60	01100000	24576	'	F		IF	'	RTS
097	61	01100001	24832	a	F		PRINT		ADCIX
098	62	01100010	25088	b	"F		PRINT		
099	63	01100011	25344	c	#F		PRINT		
100	64	01100100	25600	d	%F		POKE		
101	65	01100101	25856	e	%F		,		ADCZ
102	66	01100110	26112	f	%F		COLOR=		RORZ
103	67	01100111	26368	g	'F		PLOT		
104	68	01101000	26624	h	(F		,		PLA
105	69	01101001	26880	i)F		HLIN		ADCIM
106	6A	01101010	27136	j	*F		,		RORA
107	6B	01101011	27392	k	+F		AT		
108	6C	01101100	27648	l	,F		VLIN		JMPI
109	6D	01101101	27904	m	-F		,		ADC
110	6E	01101110	28160	n	.F		AT		ROR
111	6F	01101111	28416	o	/F		VTAB		
112	70	01110000	28672	p	OF		=		BVS
113	71	01110001	28928	q	1F		=		ADCiy
114	72	01110010	29184	r	2F)		
115	73	01110011	29440	s	3F)		
116	74	01110100	29696	t	4F		LIST		
117	75	01110101	29952	u	5F		,		ADCZX
118	76	01110110	30208	v	6F		LIST		RORZX
119	77	01110111	30464	w	7F		POP		
120	78	01111000	30720	x	8F		NODSP		SEI
121	79	01111001	30976	y	9F		NODSP		ADCY
122	7A	01111010	31232	z	:F		NOTRACE		
123	7B	01111011	31488	{	:F		DSP		
124	7C	01111100	31744	{	<FF		DSP		
125	7D	01111101	32000	}	=F		TRACE		ADCX
126	7E	01111110	32256	~	>F		PR#		RORX
127	7F	01111111	32512	RUB	?F		IN#		
128	80	10000000	32768		ON		NUL	END	
129	81	10000001	33024		AN	AC	SOH	FOR	STAIX
130	82	10000010	33280		BN	BC	STX	NEXT	
131	83	10000011	33536		CN	CC	ETX	DATA	
132	84	10000100	33792		DN	DC	EOT	INPUT	STYZ
133	85	10000101	34048		EN	EC	ENQ	DEL	STAZ
134	86	10000110	34304		FN	FC	ACK	DIM	STXZ
135	87	10000111	34560		GN	GC	BEL	READ	

Dec	Hx	Binary	High	Asc	Sc	Ky	Int Bs	Aps Bs	6502
136	88	10001000	34816	HN	HC	BS	GR	DEY	
137	89	10001001	35072	IN	IC	HT	TEXT		
138	8A	10001010	35328	JN	JC	LF	PR#	TXA	
139	8B	10001011	35584	KN	KC	VT	IN#		
140	8C	10001100	35840	LN	LC	FF	CALL	STY	
141	8D	10001101	36096	MN	MC	CR	PLOT	STA	
142	8E	10001110	36352	NN	NC	SD	HLIN	STX	
143	8F	10001111	36608	ON	OC	SI	VLIN		
144	90	10010000	36864	PN	PC	DLE	HGR2	BCC	
145	91	10010001	37120	QN	QC	DC1	HGR	STAIY	
146	92	10010010	37376	RN	RC	DC2	HCOLOR=		
147	93	10010011	37632	SN	SC	DC3	HPLT		
148	94	10010100	37888	TN	TC	DC4	DRAW	STYZX	
149	95	10010101	38144	UN	UC	NAK	XDRAW	STAZX	
150	96	10010110	38400	VN	VC	SYN	HTAB	STXZY	
151	97	10010111	38656	WN	WC	ETB	HOME		
152	98	10011000	38912	XN	XC	CAN	ROT=	TYA	
153	99	10011001	39168	YN	YC	EM	SCALE=	STAY	
154	9A	10011010	39424	ZN	ZC	SUB	SHLOAD	TXS	
155	9B	10011011	39680	[N	ESC	ESC	TRACE		
156	9C	10011100	39936	\N		FSS	NOTRACE		
157	9D	10011101	40192]N	MCU	GS	NORMAL	STAX	
158	9E	10011110	40448	^N	^C	RS	INVERSE		
159	9F	10011111	40704	_N		US	FLASH		
160	A0	10100000	40960	N	SPC	SPC	COLOR=	LDYIM	
161	A1	10100001	41216	!N	!	!	POP	LDAIX	
162	A2	10100010	41472	"N	"	"	VTAB	LDXIM	
163	A3	10100011	41728	#N	#	#	HIMEM:		
164	A4	10100100	41984	\$N	\$	\$	LOMEM:	LDYZ	
165	A5	10100101	42240	%N	%	%	ONERR	LDAZ	
166	A6	10100110	42496	&N	&	&	RESUME	LDXZ	
167	A7	10100111	42752	'N	'	'	RECALL		
168	A8	10101000	43008	(N	((STORE	TAY	
169	A9	10101001	43264)N))	SPEED=	LDAIM	
170	AA	10101010	43520	*N	*	*	LET	TAX	
171	AB	10101011	43776	+N	+	+	GOTO		
172	AC	10101100	44032	,N	,	,	RUN	LDY	
173	AD	10101101	44288	-N	-	-	IF	LDA	
174	AE	10101110	44544	.N	.	.	RESTORE	LDX	
175	AF	10101111	44800	/N	/	/	&		
176	B0	10110000	45056	ON	0	0	GOSUB	BCS	
177	B1	10110001	45312	1N	1	1	RETURN	LDAIY	
178	B2	10110010	45568	2N	2	2	REM		
179	B3	10110011	45824	3N	3	3	STOP		
180	B4	10110100	46080	4N	4	4	ON	LDYZX	
181	B5	10110101	46336	5N	5	5	WAIT	LDAZX	
182	B6	10110110	46592	6N	6	6	LOAD	LDXZY	

(Continued)

Send for FREE Control Page
Also Available soon on Atari

EDIT 6502 T.M. LJK

Two Pass Assembler, Disassembler, and Editor Single Load Program
DOS 3.3., 40/80 Columns, for Apple II or Apple II Plus*

A MUST FOR THE MACHINE LANGUAGE PROGRAMMER. Edit 6502* is a two pass Assembler, Disassembler and text editor for the Apple computer. It is a single load program that only occupies 7K of memory. You can move freely between assembling and disassembling. Editing is both character and line orientated, the two pass disassemblies create editable source files. The program is so written so as to encompass combined disassemblies of 6502 Code, ASCII text, hex data and Sweet 16 code. Edit 6502 makes the user feel he has never left the environment of basic. It encompasses a large number of pseudo opcodes, allows linked assemblies, software stacking (single and multiple page) and complete control of printer (paganation and tab setting). User is free to move source, object and symbol table anywhere in memory. Requirements: 48K of RAM, and ONE DISK DRIVE. Optional use of 80 column M&R board, or lower case available with Paymar Lower Case Generator.

TAKE A LOOK AT JUST SOME OF THE EDITING COMMAND FEATURES. Insert at line # n Delete a character Insert a character Delete a line # n List line # n1, n2 to line # n3 Change line # n1 to n2 "string" Search line # n1 to n2 "string".

LJK Enterprises Inc. P.O. Box 10827 St. Louis, MO 63129 (314)846-6124
*Edit 6502 T.M. of LJK Ent. Inc. — *Apple T.M. of Apple Computer Inc.

LOOK AT THESE KEY BOARD FUNCTIONS: Copy to the end of line and exit: Go to the beginning of the line: abort operation: delete a character at cursor location: go to end of line: find character after cursor location: non destructive backspace: insert a character at cursor location: shift lock: shift release: forward copy: delete line number: prefix special print characters. Complete cursor control: home and clear, right, left down up. Scroll a line at a time. Never type a line number again.

All this and much much more — Send for FREE information.

Introductory Price \$50.00.

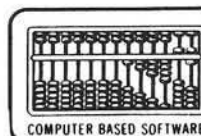

COMPUTER BASED SOFTWARE

ENTERPRISES

Dec	Hx	Binary	High	Asc	Sc	Ky	Int Bs	Aps Bs	6502
183	B7	10110111	46848		7N	7	7	SAVE	
184	B8	10111000	47104		8N	8	8	DEF	CLV
185	B9	10111001	47360		9N	9	9	POKE	LDAY
186	BA	10111010	47616		:N	:	:	PRINT	TSX
187	BB	10111011	47872		;N	;	;	CONT	
188	BC	10111100	48128		<N	<	<	LIST	LDYX
189	BD	10111101	48384		=N	=	=	CLEAR	LDAX
190	BE	10111110	48640		>N	>	>	GET	LDXY
191	BF	10111111	48896		?N	?	?	NEW	
192	C0	11000000	49152		@N	@	@	TAB(CPYIM
193	C1	11000001	49408		AN	A	A	TO	CMPIX
194	C2	11000010	49664		BN	B	B	FN	
195	C3	11000011	49920		CN	C	C	SPC(
196	C4	11000100	50176		DN	D	D	THEN	CPYZ
197	C5	11000101	50432		EN	E	E	AT	CMPZ
198	C6	11000110	50688		FN	F	F	NOT	DECZ
199	C7	11000111	50944		GN	G	G	STEP	
200	C8	11001000	51200		HN	H	H	+	INY
201	C9	11001001	51456		IN	I	I	-	CMPIM
202	CA	11001010	51712		JN	J	J	*	DEX
203	CB	11001011	51968		KN	K	K	/	
204	CC	11001100	52224		LN	L	L	^	CPY
205	CD	11001101	52480		MN	M	M	AND	CMP
206	CE	11001110	52736		NN	N	N	OR	DEC
207	CF	11001111	52992		ON	O	O	>	
208	D0	11010000	53248		PN	P	P	=	BNE
209	D1	11010001	53504		QN	Q	Q	<	CMPIY
210	D2	11010010	53760		RN	R	R	SGN	
211	D3	11010011	54016		SN	S	S	INT	
212	D4	11010100	54272		TN	T	T	ABS	
213	D5	11010101	54528		UN	U	U	USR	CMPZX
214	D6	11010110	54784		VN	V	V	FRE	DECZX
215	D7	11010111	55040		WN	W	W	SCRN(
216	D8	11011000	55296		XN	X	X	PDL	CLD
217	D9	11011001	55552		YN	Y	Y	POS	CMFY
218	DA	11011010	55808		ZN	Z	Z	SQR	
219	DB	11011011	56064		[N		[RND	
220	DC	11011100	56320		\N		\	LOG	
221	DD	11011101	56576]N	MCU]	EXP	CMPX
222	DE	11011110	56832		^N	^	^	COS	DECX
223	DF	11011111	57088		_N		_	SIN	
224	E0	11100000	57344		N			TAN	CPXIM
225	E1	11100001	57600		!N			ATN	SBCIX
226	E2	11100010	57856		"N			PEEK	
227	E3	11100011	58112		#N			LEN	
228	E4	11100100	58368		\$N			STR\$	CPXZ
229	E5	11100101	58624		%N			VAL	SBCZ
230	E6	11100110	58880		&N			ASC	INCZ
231	E7	11100111	59136		'N			CHR\$	
232	E8	11101000	59392		(N			LEFT\$	INX
233	E9	11101001	59648)N			RIGHT\$	SBCIM
234	EA	11101010	59904		*N			MID\$	NOP
235	EB	11101011	60160		+N				
236	EC	11101100	60416		,N			SYNTAX	CPX
237	ED	11101101	60672		-N			RWO GSB	SBC
238	EE	11101110	60928		.N			OUT DTA	INC
239	EF	11101111	61184		/N			ILL QNT	
240	F0	11110000	61440		0N			OVERFLW	BEQ
241	F1	11110001	61696		1N			OUT MEM	SBCIY
242	F2	11110010	61952		2N			UNF STM	
243	F3	11110011	62208		3N			BD SUBS	
244	F4	11110100	62464		4N			RDM ARY	
245	F5	11110101	62720		5N			DIV ZER	SBCZX
246	F6	11110110	62976		6N			ILL DIR	INCZX
247	F7	11110111	63232		7N			TYP MIS	
248	F8	11111000	63488		8N			STR LNG	SED
249	F9	11111001	63744		9N			FRM CPX	SBCY
250	FA	11111010	64000		:N			CANTCNT	
251	FB	11111011	64256		;N			UNDFNC	
252	FC	11111100	64512		<N			ERROR	
253	FD	11111101	64768		=N			(SBCX
254	FE	11111110	65024		>N			(INCX
255	FF	11111111	65280		?N			(



SBCS PUTS YOU ON TOP

Organize your business with accounting software from SBCS:

- General Ledger
- Accounts Receivable
- Accounts Payable

The above programs can be used alone or integrated. They include extensive error checking and data entry prompting, numerous reports, departmentalizing, and budgeting. Detailed documentation included.

Get on top of things! Call or write today.

SMALL BUSINESS COMPUTER SYSTEMS

4140 Greenwood, Lincoln, NE 68504 (402) 467-1878



A STATISTICAL ANALYSIS AND FILE MAINTENANCE SYSTEM FOR THE APPLE II™ MICROCOMPUTER

As a Subset Language of P-STAT™ 78...
A-STAT™ 79 computes:

FREQUENCIES
BI-VARIATE TABLES - CHI SQUARES
CORRELATION MATRICES
MULTIPLE REGRESSION
RESIDUALS
APPLE PLOT INTERFACE
APPLE FILE CABINET INTERFACE
FILE SORT
AGGREGATION
REPORT WRITING
COMPLETE TRANSFORMATION LANGUAGE
READS VISICALC FILES

A-STAT™ 79

Uses Standard DOS Text File and EXEC's
48K Version — All programs in Applesoft™

A-STAT™ 79 is available from:

ROSEN GRANDON ASSOCIATES
7807 Whittier Street
Tampa, Florida 33617
(813) 985-4911

A-STAT™ 79 on disk with 80-page manual... \$145.00

Apple II™ is a trademark of the Apple Computer Inc.
P-STAT™ 78 is a trademark of P-STAT Inc., Princeton, N.J.
A-STAT™ 79 is copyrighted by Gary M. Grandon, Ph.D.

Terrapin Turtle

Be one of the first persons to own your own robot. It's fun, and unlike other pets, the Turtle obeys your commands. It moves, draws, blinks, beeps, has a sense of touch, and doesn't need to be housebroken. You and your Turtle can draw pictures, navigate mazes, push objects, map rooms, and much, much more. The Turtle's activities are limited only by your imagination, providing a challenge for users of all ages. Interfaces, including software for easy control of the Turtle, are available for the Apple, Atari, and S-100 bus computers.

Terrapin will give a free Turtle to the person or persons who develop the best program for the Turtle by March 31, 1982. In addition, Terrapin will pay royalties. For more information, write or call;

Terrapin, Inc.
678 Massachusetts Avenue
Cambridge, MA 02139
(617) 492-8816

Books available from Terrapin

Turtle Geometry by Abelson and diSessa
An innovative book using Turtle Graphics to explore geometry, motion, symmetry and topology. MIT Press \$20.00

Mindstorms by Seymour Papert
An exciting book about children, computers, and learning. Explains the philosophy of the new LOGO language. Basic Books \$12.95

Artificial Intelligence by Patrick Winston
Explores several issues including analysis of vision and language. An introduction to the LISP language is incorporated in the second section. Addison-Wesley \$18.95

Katie and the Computer by Fred D'Ignazio
A children's picture book adventure about a young girl's imaginary trip inside a computer. Creative Computing \$6.95

Small Computers by Fred D'Ignazio
A book about the future of small computers and robots, aimed at adolescents. Franklin Watts \$9.95



The Perfect Pet™

Apple Bits, Part 2

Part 1 of last month's article, "Apple Bits," (40:75) presented a machine language program for plotting low resolution graphics patterns from encoded data. This part will present an Integer BASIC program for constructing the patterns used by the machine language driver. Next month's part will give detailed instructions on how to create low resolution animations using these tools.

Richard C. Vile
3467 Yellowstone Drive
Ann Arbor, MI 48105

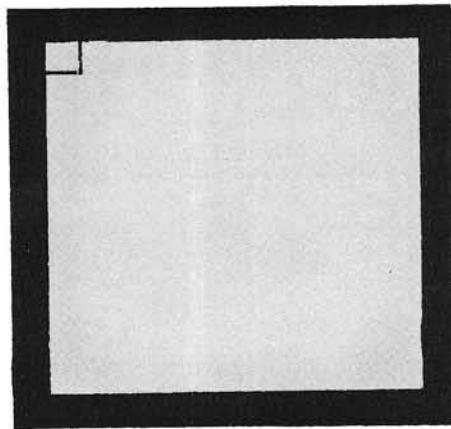

Figure 1: Building the pattern.

The Pattern Maker Program

The program allows you to create patterns and store them in tables for subsequent use by animation programs. It begins by asking a couple of questions:

HEIGHT AND WIDTH OF
PATTERNS?
TABLE ADDRESS IN DECIMAL?

The patterns created may be up to 8 rows high by 8 columns wide, but may be smaller than that as well. For example, one set of patterns that I use consists of 7 rows by 5 columns. They form a "giant" character set that may be used to create billboard messages on the Apple screen. The table of patterns is stored in Apple RAM and manipulated by PEEKs and POKEs. Thus, it is necessary to tell the program where in memory the table is located. This is the reason for the second question. I typically store tables at 3072 (\$C00). The tables must be saved on tape or disk for eventual use by animation programs.

The program will display a rectangular border enclosing an area equal in size to the patterns specified, as shown in figure 1. Inside the pattern border, a blinking cursor will be seen. The user may move this cursor about, inside the border, and either add or delete parts of a pattern in the process.

The pattern maker will respond to any of the following commands:

PATTERN
VERIFY
MODIFY
RECORD
SAME
HELP
QUIT,BYE,STOP,EXIT

The commands are typed in full, or abbreviated to the first letter. If you forget what the commands are, simply type "HELP" or "H" and the menu of commands will be listed for you. (Note: You will probably lose any pattern in progress if you do that.)

The commands have the following effects:

PATTERN: The area inside the border is erased, the cursor appears inside, and the user may begin creating a new pattern.

MODIFY: Recalls a given pattern from the table, so the user may modify it.

SAME: Returns to the same pattern as the one most recently created or modified (allows the user to recover from accidentally striking "ENTER" while creating a pattern.)

VERIFY: Displays the numeric codes for the pattern under construction or modification. Mainly included for debugging the pattern maker program itself.

HELP: Displays the menu of commands.

QUIT,BYE,STOP,EXIT: Cause the termination of the program. Note that the screen is cleared and returned to TEXT mode.

The program operates in mixed low resolution graphics mode and uses the bottom four lines of the screen for entering commands and prompts. The program will prompt the user by typing:

COMMAND?

and then waiting for a response. If any of the above commands are entered, the program will take the corresponding action, otherwise it simply re-prompts the user. The "P", "M", and "S" commands will cause the cursor to be transferred inside the rectangle on the graphics portion of the screen. While there, the user may enter "cursor control keys" or "pattern control keys" to shift the cursor around the pattern and create or erase parts of the pattern.

The cursor control keys and their results are listed in table 1 and the pattern control keys and their results are listed in table 2.

Table 1

KEY	EFFECT
→	Move the cursor one column to the right. If the cursor is already at the far right of the rectangle, then "wrap" around to the far left of the pattern, but one row further down. If at the extreme bottom right of the pattern, then "wrap" around to the extreme top left of the pattern.
R	Same as →
←	Move the cursor one column to the left. At the extreme positions "wrap" around in a fashion analogous to that described above for the → or R keys.
L	Same as ←
U	Move the cursor up one row. (Wrap around also)
D	Move the cursor down one row. (Wrap also)
ENTER	Return the cursor to the command area of the screen.
ESC	Same as for "ENTER".

Table 2

KEY	EFFECT
+	Add a solid blob to the pattern in the position indicated by the current location of the cursor.
-	Erase the part of the pattern (if any) located at the current position of the cursor.

WANTED

SOFTWARE AUTHORS!
for Apple, Atari, TRS-80, NEC, Hitachi. . .

Brøderbund Software is looking for new authors to join its international team of programmers. If you have a product for the micro market, let us show you the advantages of working with our team of design, production and distribution specialists.

Call or write for our free Authors Kit today or send us a machine readable copy of your work for prompt review under strictest confidence.

Brøderbund Software
 #2 Vista Wood Way, San Rafael, CA 94901 (415) 456-6424

```

Pattern Creation Utility

0 REM PATTERN MAKER PROGRAM FOR APPLE LORES GRAPHICS
1 DIM PTERN(7),BITS(7),A$(25)
2 FOR I=0 TO 7:PTERN(I)=BITS(I)=0: NEXT I
4 KBD=-16384:CLR=-16368:WAIT=3000
5 GOSUB 10000
10 INPUT "COMMAND? ",A$
11 IF A$="P" OR A$="PATTERN" THEN GOSUB 50
12 IF A$="V" OR A$="VERIFY" THEN GOSUB 1000
13 IF A$="M" OR A$="MODIFY" THEN GOSUB 1500
14 IF A$="R" OR A$="RECORD" THEN GOSUB 2000
15 IF A$="S" OR A$="SAME" THEN GOSUB 52
16 IF A$="H" OR A$="HELP" THEN GOSUB 2500
17 IF A$="Q" OR A$="QUIT" OR A$="BYE" OR A$="STOP" OR A$="EXIT"
    THEN GOTO 3025
45 GOTO 10
50 FOR I=0 TO 7:PTERN(I)=0: NEXT I: GR
51 COLOR=1: HLINE 14,14+WIDTH+1 AT 14: HLINE 14,14+WIDTH+1 AT 14+
HEIGHT+1: VLINE 14,14+HEIGHT+1 AT 14: VLINE 14,14+HEIGHT+1 AT
14+WIDTH+1
52 SAVCOLR= SCRN(15+COL,15+ROW):KEY= PEEK (KBD): IF KEY>=128 THEN
58
54 COLOR=15: PLOT 15+COL,15+ROW: FOR I=0 TO 10: NEXT I: COLOR=0
: PLOT 15+COL,15+ROW: FOR I=0 TO 10: NEXT I: IF SAVCOLR#15 THEN
52
56 COLOR=15: PLOT 15+COL,15+ROW: COLOR=0: GOTO 52
58 IF KEY=141 OR KEY=155 THEN RETURN : POKE CLR,0: COLOR=15
60 IF KEY# ASC("R") AND KEY#149 THEN 70:COL=COL+1: IF COL<WIDTH
    THEN 52:ROW=ROW+1:COL=0: IF ROW<HEIGHT THEN 52:ROW=0: GOTO 52
70 IF KEY# ASC("L") AND KEY#136 THEN 80:COL=COL-1: IF COL>=0 THEN
52:COL=WIDTH-1:ROW=ROW-1: IF ROW>=0 THEN 52:ROW=HEIGHT-1:COL=
WIDTH-1: GOTO 52
80 IF KEY# ASC("U") THEN 90:ROW=ROW-1: IF ROW>=0 THEN 52:ROW=
HEIGHT-1:COL=COL-1: IF COL>=0 THEN 52:COL=WIDTH-1: GOTO 52
90 IF KEY# ASC("D") THEN 100:ROW=ROW+1: IF ROW<HEIGHT THEN 52:ROW=
0:COL=COL+1: IF COL<WIDTH THEN 52:COL=0: GOTO 52
100 IF KEY# ASC("+") THEN 110:VALUE=1: GOSUB 500: GOTO 52
110 IF KEY# ASC("-") THEN 120:VALUE=0: GOSUB 500: GOTO 52
120 VTAB 23: PRINT "INVALID KEY": FOR K=1 TO 25: NEXT K: VTAB 23
: TAB 1: PRINT " ": GOTO 52
  
```

When RECORDing or MODIFYing patterns, the program will request a KEY to associate with the pattern. The user should respond to this request by simply striking the desired key (do not hit ENTER, unless that is the desired key). Control keys (except for Control-c) are included. The association that is made "internally" by this is as follows: The program converts the ASCII value of the key struck to a table offset. This offset is then used when storing or retrieving the corresponding pattern from memory. The same idea will be used by animation programs in order to point the machine language driver at the correct positions in memory for a given pattern.

The pattern maker program does not LOAD and SAVE the pattern tables itself. This is the responsibility of the user. For example, suppose you have created a table which starts at location \$C00 and extends as far as \$FFF. After exiting the pattern maker program and returning to the Integer BASIC command level, you would give the following command:

```
> BSAVE PATTERN TABLE XYZ,
  $C00,L$7FF
```

assuming that you have a disk-based system. To save the same table on tape, you would enter the monitor and (after setting up your recorder, etc.) type:

```
*C00.FFFW
```

and wait for the monitor to write it all out to the cassette.

Below is the listing of the program in Integer BASIC. *Note:* If you store your tables in low memory, be sure to protect them from the BASIC program itself. For example, when I use the area from \$C00 (decimal 3072) to \$FFF, I first issue the command:

```
LOMEM: 4096
```

Final Note

The pattern maker program uses the machine language driver program (in order to support the Modify command). Thus, the following complete sequence of commands would be used to run the pattern maker to add or modify patterns previously saved in file BPATS:

```
> BLOAD BPATS
> BLOAD APPLE-BITS
> LOMEM: 4096
> RUN PATTERN MAKER
```

If no previous file of patterns, such as BPATS, is being used, then the first command in the sequence may be omitted.

```
500 TEMP=PTTERN(COL)
510 FOR B=0 TO 7:BITS(B)=TEMP MOD 2:TEMP=TEMP/2: NEXT B
515 BITS(ROW)=VALUE
517 TEMP=BITS(7)
520 FOR B=6 TO 0 STEP -1
530 TEMP=2*TEMP+BITS(B)
540 NEXT B
550 PTTERN(COL)=TEMP
551 IF VALUE=0 THEN COLOR=0
555 PLOT 15+COL,15+ROW
557 COLOR=15
560 RETURN
1000 FOR I=0 TO 7: PRINT PTTERN(I); " ";: NEXT I
1010 RETURN
1500 INPUT "WHICH KEY?"
1505 KEY= PEEK (KBD): IF KEY<128 THEN 1505
1510 POKE CLR,0:OFFSET=(KEY-128)*WIDTH
1512 POKE 2048,WIDTH: POKE 2049,HEIGHT
1515 POKE 60,(ADDR+OFFSET) MOD 256
1520 POKE 61,(ADDR+OFFSET)/256
1522 GR
1525 POKE 36,15: POKE 37,15
1530 COLOR=15: CALL 2058
1532 POKE 36,0: POKE 37,23
1535 COLOR=1: HLIN 14,14+WIDTH+1 AT 14: HLIN 14,14+WIDTH+1 AT 14+
  HEIGHT+1
1540 VLIN 14,14+HEIGHT+1 AT 14: VLIN 14,14+HEIGHT+1 AT 14+WIDTH+1

1545 FOR I=0 TO WIDTH-1
1550 PTTERN(I)= PEEK (ADDR+OFFSET+I)
1555 NEXT I
1560 GOTO 52
2000 PRINT "WHICH KEY?"
2001 KEY= PEEK (KBD): IF KEY<128 THEN 2001
2002 POKE CLR,0:KEY=KEY-128:OFFSET=KEY*WIDTH
2005 FOR I=0 TO WIDTH-1
2010 POKE ADDR+OFFSET+I,PTTERN(I)
2020 NEXT I
2030 RETURN
2500 REM HELP SUBROUTINE
2501 REM
2510 TEXT : CALL -936
2515 VTAB 2: TAB 2: PRINT "COMMAND";: TAB 12: PRINT "EFFECT"
2520 TAB 2: PRINT "=====";: TAB 12: PRINT "====="
2525 VTAB 5: TAB 2: PRINT "PATTERN";: TAB 12: PRINT "STARTS A NEW
  PATT ERN"
2526 PRINT
2527 TAB 2: PRINT "MODIFY";: TAB 12: PRINT "CALLS UP AN OLD PATTERN
  FO R"
2529 TAB 12: PRINT "MODIFICATIONS."
2530 PRINT
2531 TAB 2: PRINT "RECORD";: TAB 12: PRINT "SAVES CURRENT PATTERN
  IN THE"
2533 TAB 12: PRINT "PATTERN TABLE. IT WILL BE"
2535 TAB 12: PRINT "ASSOCIATED WITH A KEY."
2536 PRINT
2537 TAB 2: PRINT "SAME";: TAB 12: PRINT "RETURNS TO PATTERN AREA"

2539 TAB 12: PRINT "WITHOUT DESTROYING THE"
2541 TAB 12: PRINT "CURRENT PATTERN."
2542 PRINT
2543 TAB 2: PRINT "HELP";: TAB 12: PRINT "DISPLAYS THIS MESSAGE."

2585 PRINT : TAB 2: PRINT " TO QUIT, TYPE ANY OF THE FOLLOWING:"

2587 TAB 2: PRINT " 'QUIT','Q','STOP','BYE', OR 'EXIT'"
2590 GOSUB WAIT
2599 RETURN
3000 REM WAIT SUBROUTINE
3001 REM
3005 POKE CLR,0
3010 KEY= PEEK (KBD): IF KEY<128 THEN 3010
3015 POKE CLR,0
3020 IF KEY# ASC("Q") THEN RETURN
3025 TEXT : CALL -936: END
10000 TEXT : CALL -936
10005 KBD=-16384:CLR=-16368
10010 INPUT "HEIGHT OF PATTERNS ",HEIGHT
10015 INPUT "WIDTH OF PATTERNS ",WIDTH
10020 INPUT "TABLE ADDRESS IN DECIMAL",ADDR
10030 RETURN
```

WHY THE MICROSOFT RAMCARD™ MAKES OUR SOFTCARD™ AN EVEN BETTER IDEA.

Memory — you never seem to have quite enough of it.

But if you're one of the thousands of Apple owners using the SoftCard, there's an economical new way to expand your memory dramatically.

16K ON A PLUG-IN CARD.

Microsoft's new RAMCard simply plugs into your Apple II®, and adds 16k bytes of dependable, buffered read/write storage.

Together with the SoftCard, the RAMCard gives you a 56k CP/M® system that's big enough to take on all kinds of chores that would never fit before (until now, the only way to get this much memory was to have an Apple Language Card installed).

GREAT SOFTWARE: YOURS, OURS, OR THEIRS.

With the RAMCard and SoftCard, you can tackle large-scale business and scientific computing with our COBOL and FORTRAN languages. Or greatly increase the capability of CP/M

applications like the Peachtree Software accounting systems. VisiCalc™ and other Apple software packages can take advantage of RAMCard too.

And RAMCard gives you the extra capacity to develop advanced programs of your own, using the SoftCard and CP/M. *Even with the RAMCard in place, you can still access your ROM BASIC and monitor routines.*

JOIN THE SOFTCARD FAMILY.

The RAMCard is just the latest addition to the SoftCard family — a comprehensive system of hardware and software that can make your Apple more versatile and powerful than you ever imagined.

Your Microsoft dealer has all the exciting details. Visit him soon, and discover a great idea that keeps getting better.

Microsoft Consumer Products, 400 108th Ave. N.E., Suite 200, Bellevue, WA 98004. (206) 454-1315.

16k

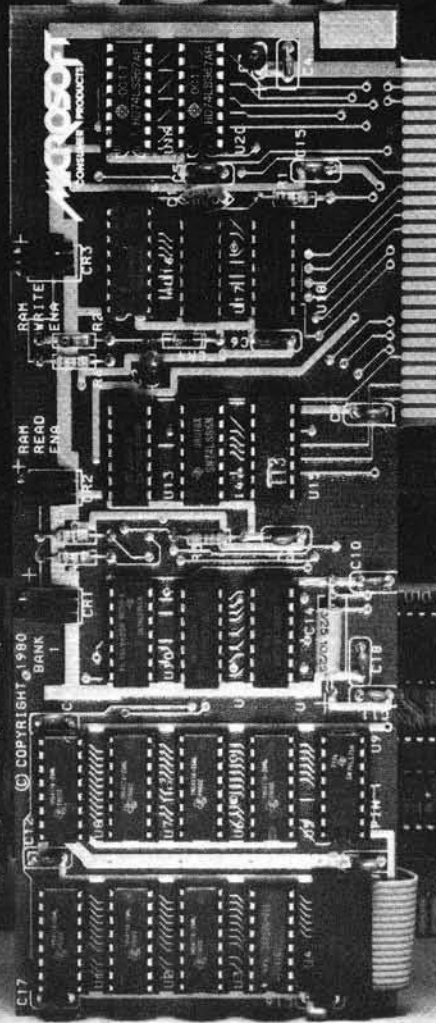

SoftCard, RAMCard and Microsoft are trademarks of Microsoft, Inc. Apple II is a registered trademark of Apple Computer, Inc. Z-80 is a registered trademark of Zilog, Inc. CP/M is a registered trademark of Digital Research, Inc. VisiCalc is a registered trademark of Personal Software, Inc. Microsoft Consumer Products is a division of Microsoft, Inc.

MICROSOFT™

MICRO

PET Vet

By Loren Wright

It seems that many of those accessories promised for the VIC are really going to appear in October. The VIC 1515 graphic printer is now available, and at a relatively low price — \$395. It is based on the Seikosha printer. The Seikosha printer, mentioned in its Axiom GP-80M implementation in our printer overview in August (MICRO 39:33), is a dot matrix with an interesting design. A single hammer strikes rapidly against splines on a platen, which rotate freely beneath the paper. This printer prints the entire PET/VIC character set, and any programmable characters you might come up with. It is also pin programmable so you can produce high resolution, dot graphic printouts. The design compromises made, perhaps accounting for the low price, are slow printing speed (30 characters per second) and its re-

quirement for a special, narrower paper (8" pin to pin). Fortunately, the paper shouldn't be too expensive since it is plain, not heat sensitive or aluminum coated.

A number of expansion cartridges and games will be released in September and October. Some of the games have working names like "VIC Slot," "Jupiter Lander," and VIC Avenger." On the more serious side, there will be a programmable character generator program, a machine language monitor, a Toolkit-like "Programmer's Aid," and a package called "Super Expander." The "Super Expander" expands VIC BASIC to include things like convenient color, circle-drawing, and music-playing commands. Prices start at \$30 for some of the games.

Also in October, the 3K and 8K RAM expansion cartridges will be available. The 16K expansion will require the expansion module, which probably won't be available until early next year. The *Programmer's Reference Manual*, which contains memory maps and a more thorough documentation of BASIC, is now available for \$14.95. The Commodore light pen, mentioned in David Malmberg's article (page 54, this issue)

will not be available in the near future, so people wanting to try Mr. Malmberg's programs will have to use the Systems Formulate or Atari light pens.

My previous VIC announcements apparently gave some people the false impression that MICRO is involved in selling the VIC. We received a few letters asking for information but, unfortunately, no checks!

Commodore Hotlines

Apple tried having a toll-free hot line number, but when they were deluged with calls in the first few months, the company was forced to cancel the service and change to a system where the numbers are available only to dealers. I called Commodore to find out if they, too, were having second thoughts, but I was encouraged to publicize the two numbers.

For technical information only:

1-800-523-5622

For all other information:

1-800-523-5614

MICRO

ABBS 4.0

It was worth the wait!

The original Apple Bulletin Board System is now the ultimate personal message system.

Compatible with many large disk systems and Disk II.

Add-on modules for customization.

For details contact:

Software Sorcery, Inc.
7927 Jones Branch Dr. 400
Mc Lean, VA 22102
(703) 385-2944

See for yourself! Dial
(703) 255-2192

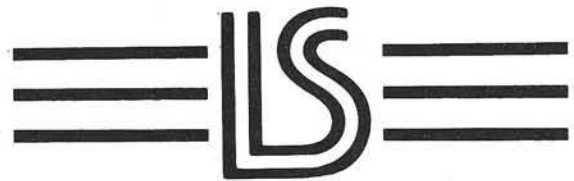

LOGICAL SOFTWARE, INC.

PROUDLY PRESENTS:

MAIL EXPRESS

A MAIL LIST PROGRAM FOR THE APPLE II.

An easy to use, powerful mailing list utility that can be used by companies or individuals to store the Name, Address, Telephone number of clients or friends.

MAIL EXPRESS provides User Definable Codes for City, State and Zip. These Codes shorten the time required by you to type in names to your mailing list and save room on the disk!

- Store up to 2,200 names per disk
- Sort a file in 30 seconds
- Prints Return Addresses
- Machine Language Find Routine will search for any Information included in the file in seconds.

This is an easy to use professional quality mail list able to handle large or small files.

Price \$49.95
\$2.00 Postage & Handling

Logical Software, Inc.
P.O. Box 354
Farmington, MI 48024
(313) 474-8774



® Apple and Apple II are registered trademarks of Apple Computer Inc.

we beat the price...

Exclusive One Year Warranty Included



800™ \$779

WITH ONE YEAR EXTENDED WARRANTY



ATARI 810 DISC DRIVE



\$444

Available without warranty for even less.

ATARI SOFTWARE

CX401 General Accounting	\$399.00
CX402 Accounts Receivable	\$399.00
CX403 Inventory Control	\$399.00
CX404 Word Processor	\$119.00
CX405 PILOT	\$68.00
CX413 MICROSOFT BASIC	\$68.00
CX4101 Invitation to Programming 1	\$17.00
CX4102 Kingdom	\$13.00
CX4103 Statistics	\$17.00
CX4104 Mailing List	\$17.00
CX4105 Blackjack	\$13.00
CX4106 Invitation to Programming 2	\$20.00
CX4107 Biorhythm	\$13.00
CX4108 Hangman	\$13.00
CX4109 Graph II	\$17.00
CX4110 Touch Typing	\$20.00
CX4111 Space Invaders	\$17.00
CX4112 States & Capitals	\$13.00
CX4114 European Countries & Capitals	\$13.00
CX4115 Mortgage & Loan Analysis	\$13.00
CX4116 Personal Fitness Prog	\$59.00
CX4117 Invitation to Programming 3	\$20.00
CX4118 Conversational French	\$45.00
CX4119 Conversational German	\$45.00
CX4120 Conversational Spanish	\$45.00
CX4121 Energy Czar	\$13.00
CX4125 Conversational Italian	\$45.00

CX6001 U.S. History	\$23.00
CX6002 U.S. Government	\$23.00
CX6003 Supervisory Skills	\$23.00
CX6004 World History	\$23.00
CX6005 Basic Sociology	\$23.00
CX6006 Counseling Proced.	\$23.00
CX6007 Principal of Act.	\$23.00
CX6008 Physics	\$23.00
CX6009 Great Classics	\$23.00
CX6010 Business Comm.	\$23.00
CX6011 Basic Psychology	\$23.00
CX6012 Effective Writing	\$23.00
CX6014 Principals of Econ	\$23.00
CX6015 Spelling	\$23.00
CX6016 Basic Electricity	\$23.00
CX6017 Basic Algebra	\$23.00
CX8106 Bond Analysis	\$20.00
CX8107 Stock Analysis	\$20.00
CX8108 Stock Charting	\$20.00
CXL4001 Education System Master	\$21.00
CXL4002 Basic Computing Language	\$46.00
CXL4003 Assembler Editor	\$46.00
CXL4004 Basketball	\$24.00
CXL4005 Video Easel	\$24.00
CXL4006 Super Breakout	\$30.00
CXL4007 Music Composer	\$45.00
CXL4009 Chess	\$30.00
CXL4010 3-D Tic-Tac-Tow	\$24.00

CXL4011 Star Raiders	\$32.00
CXL4012 Missile Command	\$32.00
CXL4013 Asteroids	\$32.00

CXL4015 TeleLink	\$20.00
CompHome	\$74.95
Visicalc	\$149.00
Letter Perfect (Word Processor)	\$119.00
Source	\$89.00

Atari® Peripherals:

400 16K	\$329.00
410 Recorder	\$59.00
822 Printer	\$359.00
825 Printer	\$ CALL
830 Modem	\$159.00
850 Interface	\$ CALL

Atari® Accessories

New DOS 2 System	\$21.00
CX70 Light Pen	\$64.00
CX30 Paddle	\$18.00
CX40 Joy Stick	\$18.00
CX853 16K RAM	\$89.00
Microtek 16K RAM	\$75.00
Microtek 32K RAM	\$169.00



CBM 8032 \$1099

4016	\$799.00
4032	\$999.99
8096	\$1795.00
CBM4022 Printer	\$629.00
Tally 8024	\$1699.00
CBM C2N Cassette Drive	\$69.00
CBM4040 Dual Disk Drive	\$999.00
CBM8050 Dual Disk Drive	\$1349.00



commodore

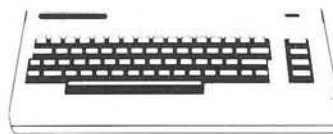

**VIC 20
\$259**

Vic-TV Modul	\$19.00
Vic Cassette	\$69.00
Vic Disk Drive	\$ Call
Vic 6 Pack program	\$44.00

CBM Software

WordPro3 Plus	\$199.00
WordPro4 Plus	\$299.00
Commodore Tax Package	\$399.00
Visicalc	\$149.00
EBS Accts. Rec./Inventory Interactive Syst.	\$595.00
BPI General Ledger	\$329.00
OZZ Information System	\$329.00
Dow Jones Portfolio	\$129.00
Pascal	\$239.00
Legal Time Accounting	\$449.00
World Craft 80	\$289.00
World Check	\$180.00
Create-A-Base	\$219.00
Power	\$89.00
Socket-2-Me	\$20.00
Jinsam	Call

Disks

CX8100 Blank Disk (5)	\$22.00
Sycorn Blank Disk (10)	\$29.00
Maxell Blank Disk (10)	\$36.00
Maxell Blank Disk (10)	\$46.00

Printers

Epson MX-70	} Call for Prices
Epson MX-80	
Epson MX-80 FT	
Diablo 630	
Nec 5530	\$2495.00
TEC 1500 Starwriter 25cps	\$1495.00
TEC 1500 Starwriter 45cps	\$1795.00

No Risk, No Deposit On Phone Orders, COD or Credit Card, Shipped Same Day You Call *

* on all in stock units

IN PA, CALL (717) 327-9575

(800) 233-8950



To Order:

Phone orders invited (800 number is for order desk only). Or send check or money order and receive free shipping. Pennsylvania residents add 6% sales tax. Add 3% for Visa or M.C. Equipment is subject to price change and availability without notice. Please call between 11 AM & 6 PM.

COMPUTER MAIL ORDER
501 E. 3RD ST., WILLIAMSPORT, PA 17701

Interfacing Two 12-Bit A/D Converters to an AIM

Use 12-bit A/D converters for extra precision. A BASIC program on AIM 65 may be used to call a machine code routine to run the converters for logging applications.

G. Roger Heal and
J. Derek Openshaw
Department of Chemistry and
Applied Chemistry
University of Salford
Salford M5 4WT, England

An important application of microprocessors is in data logging systems where analog signals representing temperature, pressure, flow, weight, etc., are converted into digital codes and stored or displayed. The AIM 65 microcomputer is a particularly useful device for these systems because the timers in the on-board VIA (versatile interface adaptor) can be used to control the logging interval, and the built-in printer is ideal for recording the data.

The subject of A/D converters has been introduced by Marvin De Jong, MICRO 15:40. His device was of the 8-bit type. This gives a precision of readings of 1 in 256 or approximately 0.4%. For many purposes this may be sufficiently accurate, but for scientific use, higher precision is usually required. Twelve bits gives a precision of 1 in 4096 or approximately 0.025%. The 7570 J device, described by De Jong, uses the successive approximations method of conversion and is fast. In general, the price of A/D converters increases with number of bits and with the speed of operation. For our purpose, speed of conversion was unimportant, but precision was. If calculations with the logged data are to be carried out in BASIC, between the logging operations, this executes relatively slowly and the value of a fast A/D converter may be lost.

For these reasons we chose to use an ICL 7109 manufactured by INTERSIL. This is a 12-bit device with tri-state buffers for direct connection to microprocessor data lines. It uses the dual slope integrating technique and so the conversion is not particularly fast. It is quoted as working at up to 30 conversions per second, but we ran it much slower than that. It has the advantage of only costing about L10 in the United Kingdom. The manufacturer's data sheet on the device helpfully gives several methods of interfacing to microprocessors. Since the AIM 65 has eight data lines, the 12 bits from the converter have to be transferred in two bytes, first as an 8-bit byte followed by 4 bits in a second operation. The first 8 bits transferred are the least significant bits (right-hand part of the number) or lo-byte, and the remaining four bits are the most significant bits or hi-byte. With these four bits are a polarity signal, POL, which is high if the voltage being converted is negative, and an over-range signal, OR, which is high if the voltage applied to it is too high for the device to convert.

In our application we required two analog signals representing temperature and weight to be recorded. We could have used a multiplexing system feeding to one A/D converter. However, since the devices described are so cheap, we decided to use separate converters for each channel. Since our analog signals were changing very slowly, we avoided the need for sample and hold amplifiers before the converters. Thus, since we had to deal with two converters and two blocks of data from each, the interface wiring and controlling program had to be carefully designed to sequence the operations in the correct order. The interface controlling subroutine is written in 6502 assembly language, entered via the AIM editor and assembled using the on-board ROM assembler. This machine code subroutine is called from a BASIC main program with the BASIC USR function. The assembled machine code program is, in practice, stored on a cassette tape, as is the main BASIC program.

Wiring the Interface

The ICL 7109 is in a 40-pin dual-inline package and is wired using a 40-pin socket and supplied with the required ± 5 volt power leads. The interface between the two A/D converters and the AIM 65 is shown in figure 1. The connections are via J1, the user interface plug on the AIM 65 board, which is linked directly to the user VIA, R6522 (Z1 on the AIM board). Some connections are the same on both 7109s and are shown once on the left-hand part of the diagram. These connections include the power supplies (GND, +5V, -5V), integrating capacitor C_{INT} , auto-zero capacitor C_{AZ} , reference capacitor C_{ref} , and oscillator components C_o and R_o . A built-in reference voltage is taken out from pin 29 to a 10-turn potentiometer to provide the reference voltage to pin 39 for the second, de-integration stage of conversion. An external reference voltage could be provided, but this reference from pin 29 was found to be stable enough for most purposes. Several modes of operation are possible with these converters. With pin 21 taken to ground, the "direct" mode is selected. This causes the output data bits to be only latched into the data lines under the control of $\overline{CE/LOAD}$ (chip select) and HBEN and LBEN (byte enable signals).

The internal oscillator may also be controlled in two ways. With pin 24 taken to the +5V line, an RC configuration is used. (With pin 24 taken to ground, crystal control is selected.) The RC values shown give an oscillator frequency of about 70 KHz, which allows about 10 conversions per second if run at full speed continuously. The exact conversion time depends upon the magnitude of the signal and the operation of the RUN/HOLD line on pin 26.

If RUN/HOLD is taken high for at least seven periods of the oscillator, the first stage of conversion (integration) starts and RUN/HOLD may then be taken back to a low level. If RUN/

Figure 1: Control and Data Lines

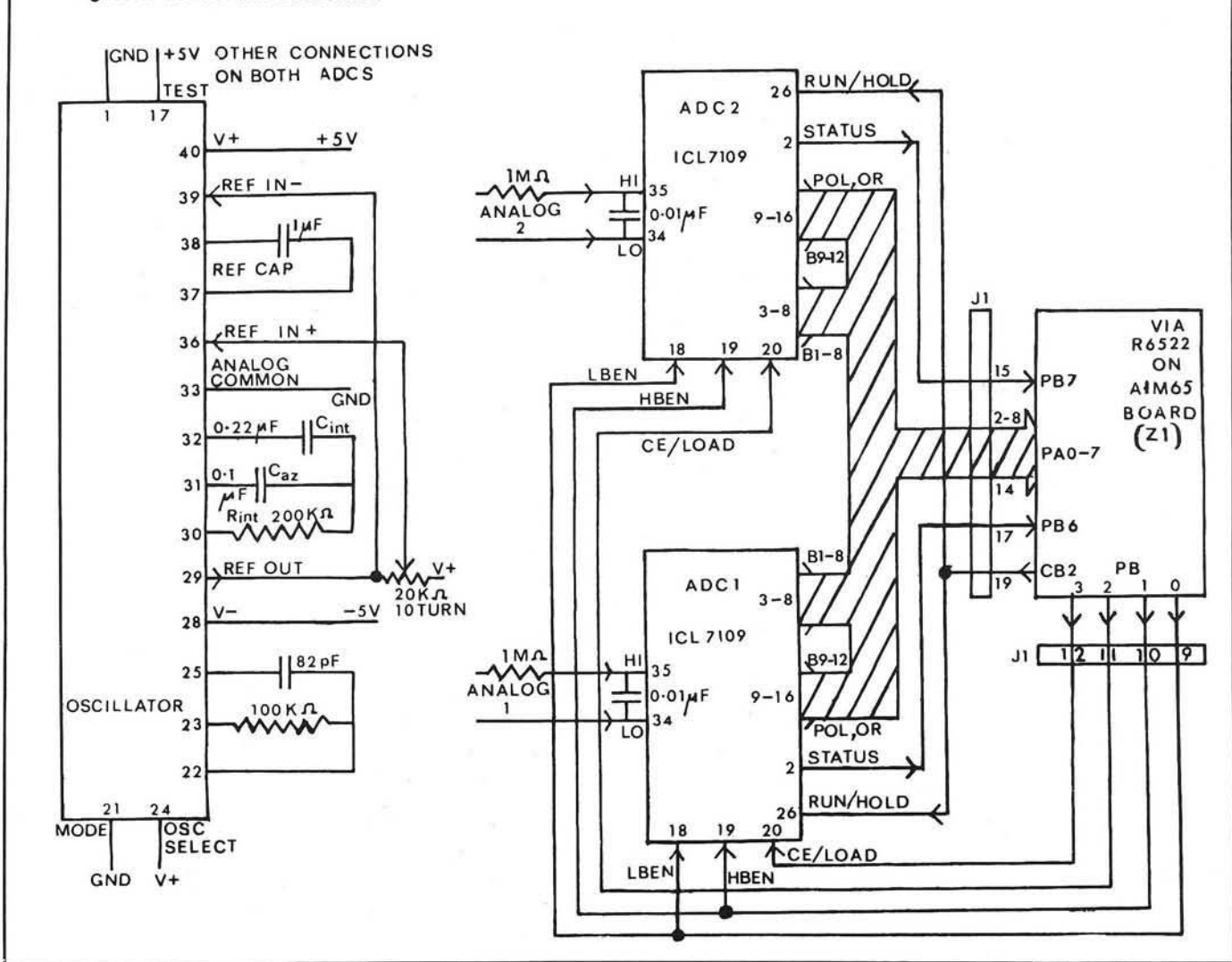

HOLD is held continuously high, the converter will cycle continuously, i.e. starting a new conversion as soon as the previous one has finished. If, however, RUN/HOLD is taken low after the conversion has started, the conversion is finished and the device will halt in an auto-zero mode, with the digital data ready for access. In the layout shown, the RUN/HOLD lines for both A/D converters, pin 26, are linked to the control output CB2 of the VIA. The machine code program is set up to take CB2 to high (binary 1) for a short period and back to low (binary 0) again.

The microcomputer must be able to determine if the A/D converters have finished their separate conversions. To do this their STATUS lines (pin 2) are linked to the input port lines PB6 and PB7 for converter 1 and converter 2 respectively. The STATUS signal goes high when conversion starts (integration) and goes low again when the conversion has finished and the data has been

stored in the output latches. The program is arranged to check PB6 and PB7 until they are both low, before continuing on to read the data from the latches.

When the data is available from both converters, the four steps of data transfer start. The lo-byte (B1-B8), hi-byte (B9-B12), POL and OR lines from both converters are linked together into data lines PA0-PA7 on the VIA. The wiring pattern is shown in table 1. The data lines PB0-PB3 are used to apply chip enable and byte enable signals to the converters. These lines are normally all held high and no data is transferred. When both converters are ready the first converter is selected by taking PB3 low. Therefore its CE/LOAD is taken low. Simultaneously lo-byte is selected by taking PB0 low. The first data byte is then read off from lines PA0-PA7 and stored in RAM. If PA0-PA7 are configured as input lines, then the microcomputer reads then as if they were ordinary memory at address

\$A001. Thus, LDA \$A001 puts the data into the accumulator, where it may be stored or operated upon.

Next PB0 is restored to high and PB1 is taken low to transfer hi-byte, POL and OR. Note that lines PA4, PA5 are not connected at this moment, so their signals are redundant. POL and OR are deliberately connected to PA7, PA6 respectively, because there are convenient program instructions for checking the state of these lines using the N and V flags in the PSR (program status register). The second converter is now selected by PB2 and the same two steps for PB0 and PB1 are used for the transfer of its data.

The analog signals are connected to pins 34 and 35, with pin 34 normally at ground potential, and should be provided with the 1MΩ resistor and 0.01μF capacitor to filter out AC noise. The analog signal amplitude may be up to twice the reference voltage applied to

Table 1: Data bus connections.

Data Bit or Function	ICL 7109 Pin Number	Connector J1 Pin Number	VIA Port Connection
1	16	14	PA0
2	15	4	PA1
3	14	3	PA2
4	13	2	PA3
5	12	5	PA4
6	11	6	PA5
7	10	7	PA6
8	9	8	PA7
9	8	14	PA0
10	7	4	PA1
11	6	3	PA2
12	5	2	PA3
OR (overrange)	4	7	PA6
POL (polarity)	3	8	PA7

pin 39 to produce a full scale reading. In the circuit shown, adjustment of the 10 turn potentiometer gives full scale readings in the range 1-2 volts with reasonable accuracy.

Assembly Program

The machine code program is to be stored at the top end of the available RAM, leaving the rest for the BASIC program. The starting address is set to \$0F00 (highest address \$0FE6). The

listing in assembly language is given in listing 1. The first part, entered at E1, is an initializing routine and only needs to be entered once. A second entry point, labelled E2, is the normal entry point to start the converters and read their data. Timer 1, in the VIA, is used to determine the period between conversions and makes use of the internal AIM interrupt line IRQ. This causes a jump to a routine addressed by an interrupt vector. The entry point for this interrupt

routine is at VEC. From this point the processor runs through four instructions to RTI and then returns to the normal program. The address for this entry point VEC has to be set in \$A400 (lo-byte) and \$A401 (hi-byte). The initializing routine carries this out automatically. The instructions ·BYT<VEC and ·BYT>VEC load the low byte and high byte parts of the address of VEC into the locations VEC1 and VEC2 respectively. The first steps of the initializing routine then load VEC1 into \$A400 and VEC2 into \$A401. This method also has the advantage that, if the program instructions are changed during development work, the new entry point address of VEC is automatically re-calculated.

Next a \$00 is put into \$A003 (DDRA, Data Direction Register A) which configures all the PA lines of the VIA as inputs. The pattern of bits %0011 1111 represented by \$3F is then put into \$A002 (DDRB, Data Direction Register B) to configure PB6 and PB7 as inputs, but PB0 to PB5 as outputs (PB4 and PB5 are actually not used). The converters are started by RUN/HOLD going high then low after a short delay, as explained above. If the oscillator frequency is about 70 KHz, a time of 100 μs is required to span 7 cycles. This may be conveniently achieved by the use of the delay routine in the AIM monitor, located at \$EC0F.

AIM-65/SYM-PET-KIM-6800

Universal Interface Board Converts AIM-65/SYM Into Professional Data Logger

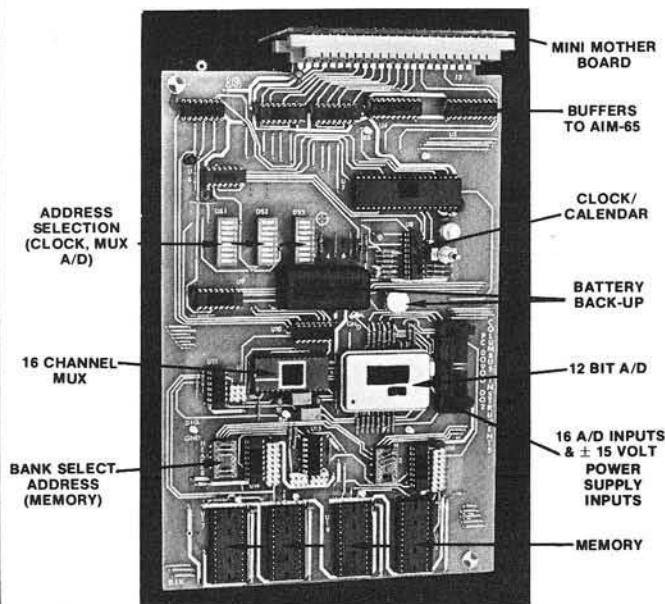

(Also connects to PET or KIM with adapter cable. Adaptable to other 6502 and 6800 systems)

CONTAINS:

- ★ 12 bits, 16 channels, fast A/D converter
- ★ space for additional 16K RAM memory or 32K EPROM (or combination)
- ★ real time clock/calendar with real time interrupt capability and 10-year lithium battery backup
- ★ plugs directly into AIM-65 expansion connector with the help of a mini-mother board which supports up to three interface boards
- ★ supplied with supportive demonstration and control programs

AVAILABLE MODELS:

- ★ IB-902 Additional Memory Space (only)\$ 390.00
 - ★ IB-902-A Calendar/Clock plus memory space.....\$ 690.00
 - ★ IB-902-B A/D (12 bits, 16 channels plus memory space)\$ 960.00
 - ★ IB-902-AB A/D, plus memory space and calendar/clock\$1,270.00
- Mini mother board to support up to three (3) interface boards \$65.00

Quantity Discounts Available



COLUMBUS INSTRUMENTS INTERNATIONAL CORPORATION
Supplier of individual instruments and total measuring systems

950 N. HAGUE AVE., COLUMBUS, OHIO 43204 U.S.A.
PHONE: (614) 488-6176 TELEX: 246514

This routine uses an on-board timer in the R6522 monitor VIA (Z32) and the timing period has to be set in \$A418 (lo-byte) and \$A417 (hi-byte) in multiples of the AIM clock time (1 μ s approximately). In the initializing routine a time of \$0060 96 decimal is set. It appears that this period, 96 μ s, is slightly too short, but in practice the instructions before and after the delay is called, take up additional time themselves, so the real delay is well over 100 μ s. It should be noted that this timer on the R6522 monitor VIA is the one used to time the width of bits on the serial interface to peripherals from the AIM. Therefore a teletype could not be used with this arrangement.

The next instruction sets the bit pattern %0100 0000 (\$40) in \$A00B (ACR, Auxiliary Control Register) which sets the timer T1 on the R6522 user VIA to free running mode and allows continuous interrupts, without output pulses from PB7. The basic timing period for T1 now has to be set by writing into \$A004 (T1L-L, lo-byte) and \$A005 (T1L-H, hi-byte). If the maximum value of \$FFFF were used this would correspond to 65, 535 μ s (decimal) or 65.535 ms. It was decided to shorten this to exactly 50 ms for convenience. The hexadecimal pattern corresponding to this, \$C350, was loaded and the period of the timer was measured using an accurate frequency meter attached to the IRQ interrupt line on the AIM. It was found that the period was slightly too long, presumably because the crystal on our particular AIM gave a period slightly higher than the nominal 1 μ s. In the interests of accuracy, trial and error were used to lower the timer period to exactly 50 mS. A final setting of \$C33F (49983 decimal) was arrived at and \$C3 and \$3F are set in \$A005 and \$A004 respectively. Actually, writing to \$A004 puts the low byte into a latch and writing to \$A005 puts the high byte into a second latch and transfers both latch values into the timer itself and starts the timer. At the same time the T1 interrupt flag is cleared. The 50 mS period is too short on its own, so multiples of this are required, produced by a counter in the program. A suitable example would be to count 40 interrupts, which would produce a 2-second interval.

When the machine code routine is entered from the BASIC instruction USR (N), the value of N is left in the FPA (floating point accumulator). Calling the routine at \$BEFE converts this number into an integer in a single byte at \$AD. This value may be put into COUNT and COUNTB. COUNTB is used for the actual counting, but may be reset from the value held in COUNT.

Listing 1

```

;* ASSEMBLY LANGUAGE VERSION
;* OF USR SUBROUTINE
;*
        ORG $0F00
;
;INITIAL ENTRY
;
E1      LDA VEC1          ;IRQ ENTRY
        STA $A400        ;ADDR LO
        LDA VEC2          ;ADDR HI
        STA $A401
        LDA #$00
        STA $A003        ;PA AS INPUT
        LDA #$3F          ;PB6,PB7-IN
        STA $A002        ;REST PB OUT
        LDA #$60          ;SET DELAY
        STA $A418        ;TIME FOR
        LDA #$00          ;SUB $ECOF
        STA $A417
        LDA #$40          ;T1 FREE RUN
        STA $A008        ;CONT. INT., PB7 DISABLE
        LDA #$3F          ;WRITE T1L-L
        STA $A004
        LDA #$C3          ;WRITE T1L-H,T1C-H
        STA $A005        ;T1L-L-T1C-L,CLR T1 INT.FLAG
        JSR $BEFE        ;FLOAT TO
        LDA $AD           ;INTEGER
        STA COUNT        ;AND STORE
        STA COUNTB
        CLI              ;CLEAR INTERRUPT
        LDA #$C0          ;ENABLE T1
        STA $A00E        ;INTERRUPTS
        JMP $COD1        ;RETN BASIC
;
;NORMAL ENTRY
;
E2      JSR $BEFE        ;NORMAL ENTRY
        LDA $AD           ;SEE IF 1/2
        BNE L4           ;READ
        LDA COUNTB       ;IS IT DOWN
        BEQ LOG          ;TO ZERO
        JMP RETN         ;LOOP BACK
        LDA COUNT        ;RUN ADCS
        STA COUNTB       ;RESET
        LDA #$E0         ;TAKE CB2 HI
        STA $A00C
        JSR $ECOF        ;DELAY SUB
        LDA #$C0         ;TAKE CB2 LO
        STA $A00C
        BIT $A000        ;TEST IF ADCS FIN
        BVC L2           ;IF PB6=0
        JMP L1
        BIT $A000        ;IF PB7=0
        BPL L3
        JMP L2
        LDA #$06         ;SET ADC1,
        STA $A000        ;LO BYTE
        LDY $A001        ;READ PA
        STY NUM          ;MAYBE NEG
        LDA #$05         ;SET ADC1,
        STA $A000        ;HI BYTE
        BIT $A001        ;TEST PB6,PB7
        BVS ERR          ;IF PA6 SET
        BMI NEG          ;IF PA7 SET
        LDA $A001        ;READ PA
        AND #$0F         ;MASK 4 BIT
        JMP $COD1       ;RETN BASIC
        LDA #$0A         ;2ND READ:SET ADC2,
        STA $A000        ;LO BYTE
        LDY $A001        ;READ PA
        STY NUM
        LDA #$09         ;SET ADC2,
        STA $A000        ;HI BYTE
        BIT $A001        ;TEST PA6,PA7
        BVS ERR          ;IF PA6 SET
        BMI NEG          ;IF PA7 SET
        LDA $A001        ;READ PA
        AND #$0F         ;MASK 4 BIT
        JMP $COD1       ;RETN BASIC
        JSR $E9F0        ;OUT CR/LF
ERR

```

(Continued)

The initializing routine now clears all interrupts on the AIM and enables T1 interrupts by writing the pattern %1100 0000 (\$C0) to \$A00E. Finally a return to BASIC is made via the routine \$COD1 (within the BASIC interpreter).

Each time the timer T1 (which counts downwards) reaches zero, an interrupt occurs. This causes the program control to finish the present instruction and transfer to the program instructions at VEC. Here, the accumulator is saved on the stack then \$A004 (T1C-L) is read. This is a dummy read to clear the T1 interrupt. Note that when T1 reaches zero the count in the latches is reset into the counter and counting continues. The value of COUNTB is also reduced by 1 and the accumulator pulled back from the stack. Finally a return is made from the interrupt to the original program.

The main BASIC program enters the second routine at E2. The parameter of USR, left in the FPA again, is converted to integer using \$BEFE and the value in \$AD is tested. If it is zero, it is assumed

```

OFB6 A956          LDA #56          ;ASCII V
OFB8 20BCE9       JSR $E9BC       ;OUT CHAR
OFBB 20FOE9       JSR $E9F0       ;OUT CR/LF
OFBE 4CD1C0       JMP $COD1       ;RETN BASIC
OFC1 AD01A0       NEG LDA $A001     ;NEG NUM READ-READ PA
OFC4 290F         AND #50F        ;MASK 4 BIT
OFC6 8DE20F       STA NUM2        ;STORE
OFC9 38          SEC           ;SET CARRY
OFCB A900         LDA #500
OFCF EDE10F       SBC NUM         ;TWOS COMPL.
OFCF A8          TAY           ;PUT IN Y
OFD0 A900         LDA #500
OFD2 EDE20F       SBC NUM2        ;TWOS COMPL.
OFD5 4CD1C0       JMP $COD1       ;WITH BORROW
OFD5 4CD1C0       JMP $COD1       ;RETN BASIC
OFD8              ;
OFD8              ;IRQ ENTRY
OFD8              ;
OFD8 48          VEC PHA         ;STORE A
OFD9 AD04A0       LDA $A004       ;READ TIC-L
OFDC CEE40F       DEC COUNTB     ;CLEARS T1 INTERRUPT
OFDF 68          PLA           ;RESTORE A
OFE0 40          RTI           ;RETN FROM IRQ
OFE1              ;
OFE1              ;VARIABLE AREA
OFE1              ;
OFE1 00          NUM BYT $00
OFE2 00          NUM2 BYT $00
OFE3 00          COUNT BYT $00
OFE4 00          COUNTB BYT $00
OFE5 D8          VEC1 BYT VEC     ;LO BYTE OF VEC ADDRESS
OFE6 0F          VEC2 HBY VEC     ;HI BYTE OF VEC ADDRESS
                                END

```

WE'VE GOT YOU COVERED

Attractive Functional Packaging for the KIM-1, SYM-1 and AIM-65

- VITAL COMPONENTS PROTECTED
- ALL FASTENERS PROVIDED
- EASILY ASSEMBLED

DESIGNED AND ENGINEERED SPECIFICALLY FOR YOUR MICROCOMPUTER:

- High Quality Thermoformed Plastic*
- Molded In Color
- Available From Stock

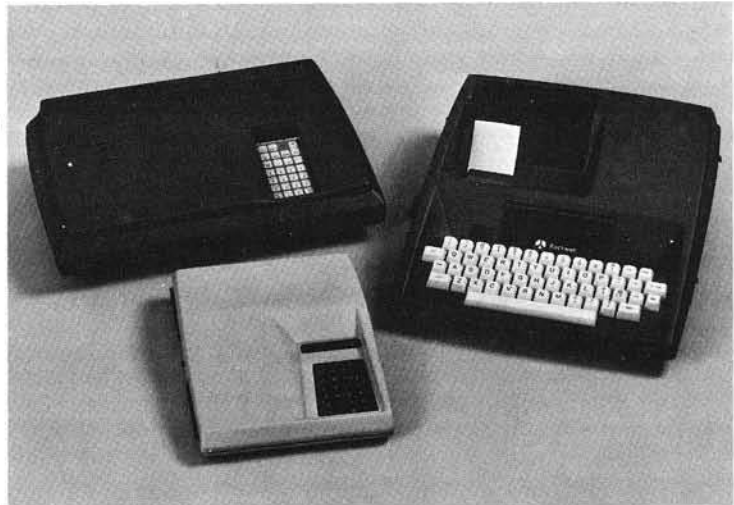

SSE 1-1 for SYM-1 SAE 1-1 for AIM-65
SKE 1-1 for KIM-1

enclosures group

786 bush street
san francisco, california 94108

TO ORDER: 1. Fill in this coupon (Print or Type Please).
2. Attach Check or Money Order.

___ SSE 1-1(s) (Blue) @ \$39.50 each ___ SAE 1-1(s) (Grey/Black) @ \$46.50 each

___ SKE 1-1(s) (Beige) @ \$29.50 each ___ SAE 1-2(s) (Deep Base) @ \$49.50 each

TOTAL ENCLOSED: \$ _____

California Residents Please Add 6½% State Sales Tax To Total.

MAIL TO: NAME _____

STREET _____ CITY _____ STATE _____ ZIP _____

Dealer Inquires Invited. — No C.O.D.'s Please. — Allow 2-3 Weeks for Processing and Delivery.

that the converters have not been started and there is no data available. The program then tests COUNTB for zero. If it is not, the small loop via RETN is cycled continuously until the interrupt routine has reduced COUNTB to zero, then a jump to LOG is made. At this point COUNTB is reset to the value in COUNT so a new timer period is started immediately. Writing the pattern %1110 0000 (\$E0) to \$A00C (peripheral control register) takes CB2 high, hence RUN/HOLD high. The delay via \$ECOF is now called. Then the pattern %1100 0000 (\$C0) is written to \$A00C to take CB2 low again. Note, only 1 bit has been changed, but the others have to be held with the values shown to give CB2 this particular configuration, leaving CA1, CA2, CB1 unused.

A small loop is now entered at L1, looking at \$A000 (port B data register). When PB6 (linked to STATUS of converter 1) has gone low, this is detected because the instruction BIT causes the bit 6 to be loaded into the overflow flag V of the PSR (processor status register). When bit 6 is zero the instruction BVC causes a branch to L2. A second loop here tests PB7, because bit 7 is loaded into the negative flag N of the PSR and a zero is registered as a positive number, so that BPL causes a branch to L3. Both converters have now stopped and the data may be read.

The pattern %0000 0110 (\$06) is now written to \$A000 (port B data register) to cause the lo-byte data from the first converter to appear on the PA lines. The data is read from \$A001 (port A data register) and put into the Y register.

Next the pattern %0000 0101 produces the most significant bits on the PA lines. The BIT instruction first tests for over-range or a negative number. These conditions cause a jump to routines to either print a letter V to show overflow, or to take the two's complement of the number (hi and lo-byte). This latter routine produces a normal negative number on return to BASIC. If there is no special condition, then the hi-byte data is read, the lower four bits masked off and left in the accumulator. With the lo-byte data still in Y, a jump to \$COD1 converts to a standard floating point BASIC number and also returns to BASIC interpretation. A second call of USR causes entry at E2 again. If the parameter is not zero (e.g. 1) the converters are not started, but a branch to L4 then reads the data from the second converter by writing suitable bit patterns to \$A000. The entry point E1 is set at \$0F00 and, after assembly, the entry E2 is found to be at \$0F43.

Listing 2: Example of a BASIC program.

```

10 N=20
20 POKE4,0:POKE5,15
30 M=USR(N)
40 POKE4,67
50 X=USR(0)/400
60 Y=USR(1)/400
70 PRINT X,Y
80 GOTO 50
90 END

```

BASIC Program

The POKE instructions set the entry points to the machine code program and require addresses in decimal. Thus 0 (decimal) is \$00 and 15 (decimal) is \$0F. Also 67 (decimal) is \$43.

A simple example of a BASIC program is shown in listing 2. Line 20 sets the first entry point for the USR routine called in line 30 to initialize the interface. The assignment of a value to X here is a dummy, but N sets the timing period in multiples of 50 ms. Line 40 resets the entry point to E2, then line 50 starts the converters and transfers the first result to X. Next, line 60 transfers the value from the second converter to Y. The two values are then printed or displayed and the program cycles back to read two more values. There will, of course, be an accurately timed delay in line 50 until 20X 50 ms (1 second) have elapsed.

The BASIC program used is very much under the control of the user. Other variations could be to print only every ten readings, say, to slow the timing, or to use polynomial smoothing on a set of pairs of points to remove random noise, only printing the midpoint of the set. If the reference voltage is adjusted so that the maximum voltage to be read produces a reading of 4000, then division of 400 gives values printed ranging up to 10.000 for convenience.

In our application we preceded the A/D converters by operational amplifiers to amplify 10 mV (max) signals to the 2-volt level. The reference voltage was then set at 1 volt. The two signals being logged were from a thermocouple which produced about 10 mV at 1000°C and an output from the control unit of a thermal balance, which produced 10 mV corresponding to 10 mg. Thus the 10.000 printed by the program represented 10 mV for channel and 10 mg weight for the other. Later variations were to convert the thermocouple EMF to temperature in degrees and,

since the temperature was continuously raised, to print rate of change of temperature and weight.

It should be noted that entering BASIC by instruction 5 (initial) and replying with a RETURN to the question MEMORY SIZE? will cause all available store to be filled with the character A. Thus the machine code program should be loaded first, then BASIC should be entered and a memory size to prevent the overwriting of the machine code should be specified. A value of 2000 (decimal) is sufficient for a small BASIC program, but the maximum (up to \$0EFF) 3839 (decimal) could be entered for larger ones.

Roger Heal is a lecturer in physical chemistry at Salford and teaches applications of microprocessors in chemistry to undergraduate courses. He has had experience over many years in the use of mainframe and minicomputers. Derek Openshaw is the scientific officer in charge of the Chemistry Department's electronic workshop and has worked on linking microprocessors to many chemical instruments.

MICRO™

Need a solution for
Floppy Disk or
R/W Head problems?

FDL
Floppy Disk Lube

Just THREE drops can:

- Prolong useful disk life.
- Increase head life.
- Allow initialization of "problem" disks.
- Save 'unbootable' disks.
- Reduce 'glitching' problems.
- Cut nuisance problems.

FLOPPY DISK LUBE - 1/2 oz. **\$4.00**
WITH APPLICATOR.

Add \$1.50 shipping and handling. Ohio residents add 5 1/2% sales tax.

DOSWARE, INC.
P.O. Box 10113
Cleveland, Ohio 44110

Dithertizer

II™



...the eye of your apple.®

Though it is very simple to use, the Dithertizer II represents the ultimate in video digitizing using the Apple II computer. The Dithertizer is an interface card which converts video input into digitized images. Because the Dithertizer II is a frame grabber, DMA type digitizer, it offers extreme high speed in the conversion process (it grabs an entire frame in 1/60th of a second). The camera supplied with the package is the Sanyo model VC1610X. Cabling is supplied for this camera so as to have the Dithertizer II system up and running in minutes. The video camera used for input must have external sync to allow for the frame grabber technology employed for digitizing. If a camera other than the model recommended is used, wiring adaptations by the user may be required. Software is supplied with the board to allow you to display up to 64 pseudo grey levels on your Apple's screen. The number of grey levels may be changed with one keystroke. The intensity and contrast of the image are controllable via game paddles. Also supplied is software for image contouring for those interested in movement detection or graphic design applications.

The Dithertizer II package is available ready to run with camera, interface card and the software described above for only: \$650.00

Dithertizer II interface card and software (without camera): \$300.00

Computer Station
11610 Page Service Dr.
St. Louis, MO 63141
(314) 432-7019

Apple II is a registered trademark of Apple Computer, Inc.
Dithertizer II is a trademark of Computer Station, Inc.

THE ultimate in SPEED and language POWER for the APPLE II:

THE INTEGER BASIC COMPILER

- SPEED IMPROVEMENT BY A FACTOR OF 10 TO 20 OVER APPLE'S BASIC INTERPRETER - 15 TO 30 OVER APPLESOFT!
- NO LANGUAGE CARD NECESSARY!
- OPTIMIZE CODE FOR YOUR SPEED/SPACE REQUIREMENTS.
- OBJECT CODE AND RUN-TIME SYSTEM ARE COMPLETELY RELOCATABLE - USE MEMORY THE WAY YOU WANT TO!
- MANY POWERFUL BASIC LANGUAGE EXTENSIONS:
 - FULL STRING LENGTH OF 32767 - NO 255 LIMIT!
 - CHR\$, GET AND KEY FUNCTIONS.
 - DIRECT HI-RES GRAPHICS SUPPORT.
 - HOME, INVERT, NORMAL, FLASH, AND MORE!
- MANY APPLICATIONS - EXISTING INTEGER PROGRAMS CAN BE EASILY CONVERTED TO RUN ON ANY APPLE II!
- COMPILER REQUIRES: APPLE II (OR II PLUS WITH INTEGER OR LANGUAGE CARD), 48 K AND DOS 3.3.
- SUPPLIED ON 2 DISKS WITH COMPLETE DOCUMENTATION.

PRICE: \$ 149.50

Dealer inquiries invited.
(Calif. add 6.5% sales tax. Foreign add \$5.00 air mail)

GALFO SYSTEMS 6252 CAMINO VERDE
SAN JOSE, CA 95119

* Apple, Applesoft - Trademarks of Apple Computer Co.

Decision Systems

Decision Systems
P.O. Box 13006
Denton, TX 76203

SOFTWARE FOR THE APPLE II*

ISAM-DS is an integrated set of Applesoft routines that gives indexed file capabilities to your **BASIC** programs. Retrieve by key, partial key or sequentially. Space from deleted records is automatically reused. Capabilities and performance that match products costing twice as much.
\$50 Disk, Applesoft.

PBASIC-DS is a sophisticated preprocessor for structured **BASIC**. Use advanced logic constructs such as **IF...ELSE...**, **CASE**, **SELECT**, and many more. Develop programs for Integer or Applesoft. Enjoy the power of structured logic at a fraction of the cost of **PASCAL**.
\$35. Disk, Applesoft (48K, ROM or Language Card).

DSA-DS is a dis-assembler for 6502 code. Now you can easily dis-assemble any machine language program for the Apple and use the dis-assembled code directly as input to your assembler. Dis-assembles instructions and data. Produces code compatible with the S-C Assembler (version 4.0), Apple's Toolkit assembler and others.
\$25 Disk, Applesoft (32K, ROM or Language Card).

FORM-DS is a complete system for the definition of input and output forms. **FORM-DS** supplies the automatic checking of numeric input for acceptable range of values, automatic formatting of numeric output, and many more features.
\$25 Disk, Applesoft (32K, ROM or Language Card).

UTIL-DS is a set of routines for use with Applesoft to format numeric output, selectively clear variables (Applesoft's **CLEAR** gets everything), improve error handling, and interface machine language with Applesoft programs. Includes a special load routine for placing machine language routines underneath Applesoft programs.
\$25 Disk, Applesoft.

SPEED-DS is a routine to modify the statement linkage in an Applesoft program to speed its execution. Improvements of 5-20% are common. As a bonus, **SPEED-DS** includes machine language routines to speed string handling and reduce the need for garbage clean-up. Author: Lee Meador.
\$15 Disk, Applesoft (32K, ROM or Language Card).

(Add \$4.00 for Foreign Mail)

*Apple II is a registered trademark of the Apple Computer Co.

Story Time and Don't Fall

Disk CS-4702 \$24.95

Requires 16K Apple II or Apple II Plus



Story Time

What's your name? Please name someone you like. What are you afraid of? Name a food you don't like. Using the answers to these questions, the computer makes up a delightful story presented with sound and full-color graphics. Over 100,000 variations are possible which incorporate different locales (desert, mountain, seashore, school yard), weather, time of day, and surprise events (find a creepy cave, haunted house, pink flying saucer and much more).



Don't Fall

Several new features make this adaptation of hangman better than ever. You can choose words from nine categories (sports, countries, etc.). Every letter you guess that is not in the words brings you one step closer to falling in the water. In the second part of each round you give the computer a word which it must guess, otherwise it falls in. Three skill levels.

Available 5/81

Know Yourself

Cassette CS-4301 \$11.95

5 Programs

Requires 16K Integer Basic

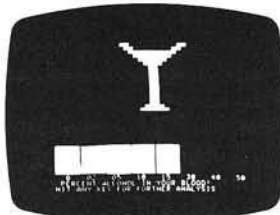

Alcohol Using body weight, time drinking, and type and number of drinks the program predicts your likely behavior.

Sex Role Are you androgynous? Examine your nature, behavior and attitudes in light of society's changing concept of sex roles.

Life Expectancy The computer analyzes your responses to 20 questions and estimates your life expectancy. Find out the influence of where you live, smoking or exercise with this program.

Psychotherapy Feelings, phobias and mental health are analyzed in this program. The computer makes no judgements but helps you decide if you might benefit from a psychotherapist.



Computer Literacy 5 questions per round on history, technology and practices in the computer field.



3 Adventures

Disk CS-4513 \$39.95

Requires 48K Apple II or Apple II Plus



Adventureland (by Scott Adams)

You'll encounter wild animals, dwarfs and many other puzzles and perils as you wander through an enchanted world, trying to rescue the 13 lost treasures. Can you rescue the Blue Ox from the quicksand? Or find your way out of the maze of pits? Happy Adventuring!

Pirate Adventure (by Scott Adams)

Yo Ho Ho and a bottle of rum. . . You'll meet up with the pirate and his daffy bird along with many strange sights as you attempt to go from your London flat to Treasure Island. Can you recover Long John Silver's lost treasures? Happy sailing matey. . .

Mission Impossible Adventure (by Scott Adams)

Good Morning. Your mission is to. . . and so it starts. Will you be able to complete your mission in time? Or is the world's first automated nuclear reactor doomed? This one's well named, its hard, there is no magic but plenty of suspense.

Good Luck. . .

Voodoo Castle The Count and Ghost Town

Voodoo Castle (by Scott Adams)

Count Cristo has had a fiendish curse put on him by his enemies. There he lies, you are his only hope. . . will you be able to rescue him—or is he forever doomed? Beware the Voodoo man.

The Count (by Scott Adams)

You wake up in a large brass bed somewhere in Transylvania. Who are you, what are you doing here, and why did the postman deliver a bottle of blood? You'll love this Adventure. In fact, you might say it's Love at First Byte. . .

Ghost Town (by Scott Adams)

Explore a deserted western mining town in search of 13 treasures. From rattlesnakes to runaway horses, this Adventure has them all! Just remember, pardner, they don't call them Ghost Towns for nothin'! (Also includes a new bonus scoring system.)

Disk CS-4514 \$39.95

Requires 48K Apple II or Apple II Plus



Adventures on Cassette

Five adventures are available singly on cassette. Each requires a 16K Apple II or Apple II Plus and costs \$14.95.

- CS-4011 Adventureland
- CS-4012 Pirate Adventure
- CS-4013 Mission Impossible
- CS-4014 Voodoo Castle
- CS-4015 The Count

Story Time

Cassette CS-4207, \$11.95

Requires 16K Apple II or Apple II Plus

Available 5/81

Apple is the registered trademark of Apple Computer, Inc.

Order Today

To order any of these software packages, send payment plus \$2.00 postage and handling per order to Creative Computing, Morris Plains, NJ 07950. Attn: Colleen. Visa, MasterCard and American Express orders may be called in toll-free.

Order today at no risk. If you are not completely satisfied, your money will be promptly and courteously refunded.

Creative Computing Software
Morris Plains, NJ 07950
Toll-free 800-631-8112
In NJ 201-540-0445

Solar System Simulation

Part 2

Dave Partyka
1707 N. Nantuckett Drive
Lorain, Ohio 44053

This program will print information, or plot positions about the first six planets of the Solar System. In the printing mode, information such as distance from the earth and sun, and other data about the earth and planet relation is printed. In the plot mode, the planets' positions against the zodiac, as seen from the earth, are plotted, using Hi-Res graphics and scaling factors. Each mode uses planet choices, starting date, length of time, and time intervals to give any desired simulation.

The last program I wrote, "Solar System Simulation With or Without an Apple II" in the August '80 issue of MICRO (27:33) dealt with the orbits of the first six planets of the solar system. Their positions were plotted in reference to the sun, as seen from a point located quite a distance above the solar system. This was OK if you wanted to see the relation of each planet at specific times, or for various lengths of time. However, watching that simulation didn't show what was happening as seen from the earth. After phone calls from many users of that program who asked if I had other programs dealing with astronomy, I decided to write another one.

This program also deals with the first six planets, but instead of being heliocentric (sun centered) it's geocentric (earth centered). It uses calculations that I had in the first program, along with other ones, to give a display of the planets as seen from the earth. The planets are displayed against a star background and their motions through the zodiac are very good representations of the actual positions of the planets. Using this program, you can watch as a planet makes its retrograde loop through

a constellation, see how close two or more planets come to each other, or watch how close a planet comes to a bright star.

I won't go into detail about the calculations used in this program. Some are the same as in the other program, and I have explained them there. What I will do is explain what this program does, the questions that it asks, describe the star table and how to expand it, and explain the splitting of this program to make another.

The program is set up in two parts. One part prints values on the screen for each planet and the sun, and the other plots the positions of the planets against a star background. If you choose to print, at the top of the screen is the starting date and the number of days that the display is for. The program then prints the following data for each planet:

- D-S; the distance, in million miles that the planet is from the sun.
- A-S; the angle in degrees that the planet is located around the sun.
- D-E; the distance in million miles that the planet is from the earth.
- R.A.; the right ascension in hours and minutes that the planet appears from the earth.
- DEC.; the declination in degrees and minutes that the planet appears from the earth.

You can display the values for all the planets, or for specific ones. You can display a single day, or a range of days with any number of days between the displays. The program will pause after each display, and then wait for you to press RETURN to continue with the display, or with a set of questions for a new display.

If you choose to plot, another set of questions will be asked. These are needed to set the limits for the star display and to determine if you want point or continuous plots. Just like printing, you can plot for single or multiple days, with any number of days between plots. You can plot single

points, (with the previous plot erased before the current one is plotted), or continuous plots, (where the points aren't erased but remain on the screen). After that you'll be asked for a scaling factor: 0 or 1-20. A scaling factor of zero will display the full star field, right ascension 0 to 24 hours, and declination 90 to -90 degrees. A scaling factor equal to or greater than 1 (a factor between zero and one is not allowed) displays another question, "Enter center coordinates for R.A. and DEC." This will determine the center coordinates of the display, and is in hours and decimal hours, degrees and decimal degrees. The scaling factor you entered, along with the center coordinates, will determine the right and left, top and bottom limits of the display. The higher the scaling factor, the less of a constellation you'll see, but the greater the movement of the planet per plot. A scaling factor of 1 displays approximately 18 hours in right ascension and 180 degrees in declination, and a factor of 10 displays, approximately 2 hours in right ascension and 19 degrees in declination.

The only constellations in the star table are for the zodiac. If you want to increase the number of stars within the zodiac, or if you want to add more constellations, it's an easy process. The table is set up with four values per star. The first two are for right ascension in hours, minutes; the next two are for declination in degrees, minutes. The stars in the table don't have to be in any particular order. The whole table is read when the plot portion of the program is used. The only table requirements are the two values for right ascension and two values for declination. If the declination is negative, then both values for declination have to be negative. To end the table, four zeros are necessary — 0.0,0,0.

You may want to split this program to make one that just displays the stars on the screen. Just begin where the question for a scaling factor is asked, and delete everything else that isn't used. You can add more tables to the new program: one for galaxies, another for star clusters, another for nebulae, or even one for the Messier objects. The tables

you add will be whatever you need, and by adding more questions, you can display the different tables, either alone or combined.

Let's go through two examples of the program, first for figure 1, and second for figure 2. The first question that will be asked is if you want to display the same planets as your last run. Since this is the first run, enter N. Then it will ask "What planets do you want to display?" Enter a 1 for each planet. Then a starting date is asked. Use 11,1,1979. After that, it says "Enter the number of days to plot." Enter 150. Then it asks to print or plot. Enter a 1 to print. The screen will then clear, print the starting date and the plot day's value at the top of the screen, and then continue to print for the planets and the sun.

After finishing the page, it will pause and display "Press return for next display." After you press return it will start printing again, changing the plot day's value at the top of the page and the values for the planets and the sun. It will continue to do this until the plot day's value is equal to or greater than the day's that you wanted to print for. After that, it will ask you to press return to start again. When you press return, it will ask if you want to display the same planets as your last run.

For example 2, enter an N to the last question so that it will ask you which planets you want to display. Enter a 0 (zero) for all the planets except Mars. Enter 11,1,1979 for the starting date, 240 for the number of days to plot, and 10 for the number of days between plots. When it asks to print or plot, enter a 0 (zero) to plot. Three requests will then be made: the first, "enter 0 for point, or 1 for continuous plots." Since we want all the points to remain on the screen, enter 1 for continuous plots. The next question is the scaling factor. Enter a 5. After that will be the center coordinates. Since I already know that the planet Mars will be in the constellation Leo, enter 10.5 for right ascension, and 18 for declination.

When you do plots for other planets and you don't know where they will be, do the print program first and get the right ascension and declination from there. After entering the center coordinates, the screen will clear and a window will appear on the screen. After a few seconds the constellation Leo will appear as the star table is read, and any stars within the display limits will be plotted. A few more seconds will pass as the rest of the table is read. Once the end of the table is found, the program will beep to signal the start of the calculations.

Figure 1: Example of the print routine for all planets, starting date 11/1/1979 for 240 days at 50-day intervals at the 150th day.

		Starting Date 11/1/1979	Plot Days 150		
Earth	D-S.	92.8887	Sun	D-E.	92.8887
	A-S.	189.4489		R.A.	0 34.7
Mercury	D-S.	43.1581	Venus	D-S.	66.8181
	A-S.	245.1156		A-S.	140.7176
	D-E.	77.2616		D-E.	70.0302
	R.A.	22 55.3		R.A.	3 28.3
	DEC.	-8 7.1		DEC.	21 55
Mars	D-S.	154.4251	Jupiter	D-S.	502.2398
	A-S.	170.2956		A-S.	158.0192
	D-E.	73.2592		D-E.	425.652
	R.A.	9 56.5		R.A.	10 15.9
	DEC.	16 7		DEC.	12 9.5
Saturn	D-S.	875.6875			
	A-S.	174.1555			
	D-E.	785.842			
	R.A.	11 35.7			
	DEC.	5 15			

Press return for next display.

Figure 2: Example of the plot routine for Mars, starting date 11/1/1979 for 240 days at 10-day intervals, continuous plots.

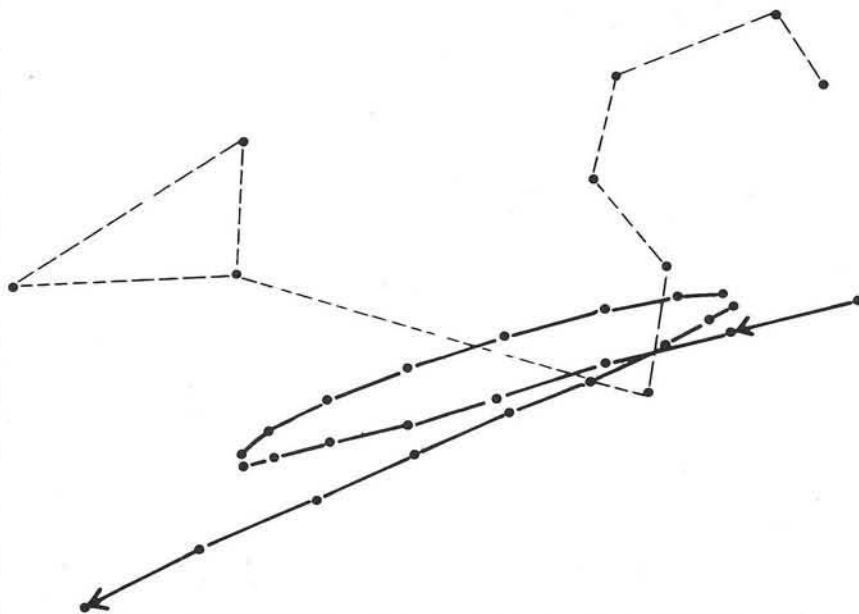

Since the planet Mars was the only planet picked, the program will calculate the positions of the earth and Mars. The position of the earth is always calculated, but only printed during the print option, (if you choose to print it). The program will continue to plot the position of Mars, beeping each time it starts a new sequence of calculations. It will plot 25 times — one for the starting date and 24 for 240 days, at 10-day intervals.

The program will then do a double beep to signal the end of the simulation and wait until you press return before starting a new sequence of questions. The purpose of the single beep at the beginning of the calculations is to identify what planet is being plotted. The planets are plotted in their order from the sun. If you plot more than one planet in the same display, you can figure out which is which by the plotting order.

Since the date doesn't appear anywhere on the display for plotting, you can do a CNTL-C to stop the program, type "TEXT", and then return to see the starting date and the plot day's value. To continue, do POKEs to set graphics mode (-16304) and display the secondary page (-16299), type "CONT" and return. The program will pick up where you left off. If you follow these examples, the results you get should match figure 1 at day 150 for printing, and figure 2 at the end of the plotting sequence. The solid and dotted lines in figure 2 were used to show the motion of Mars and the stars of the constellation Leo, and will not be in the actual display. Once you run the two examples to become familiar with the program, then you can enter any values for the questions to display whatever for whenever you want.

If you use the last program I wrote, you'll notice a difference. I don't have the assembler subroutines to do the plotting that I had done in the other one. Since writing the last program, I have gotten a disk drive and the disk version of floating point BASIC. If you have an Apple II Plus, this program should work as is. If you use the disk version of floating point BASIC you'll have to make minor changes.

Change the program loading address from \$3000 to \$6000, just beyond page 2 for Hi-Res graphics. This is done by getting into monitor, "reset" after bringing up your floating point BASIC. Change memory locations \$67 and \$68 to 01 60 (*67:01 60). Then change three locations at \$6000 to zeros (*6000:00 00 00). *3D0G should get you back to floating point BASIC where you can enter the program. You can load this program at the normal location, (\$3000), but the size of the program (approximately 9K) will put the end of it in the second page of Hi-Res graphics. Once you execute this program and hit the HGR2 command, the second page of Hi-Res graphics will clear, and so will whatever portion of the program is there. On the Apple II Plus, the end of the program will lie in page one of Hi-Res graphics, and since the program uses page two, no changes are needed.

For those Apple users who have the cassette version of floating point BASIC, all the necessary changes for using the assembler subroutines for plotting are in the article I wrote in the August '80 issue of MICRO. You'll have to set

up a plotting subroutine and do a GOSUB where there is an HPLOT. Where there is an HCOLOR, you'll have to do a POKE 812,0 for a 0, or 255 for a 3.

Then for those users who don't have an Apple II or Hi-Res graphics, you can still use the print portion of this program. As I stated in the last article, if you have any problems or questions don't hesitate to call or write. (If you write please include an SASE to guarantee a response.)

Dave Partyka works as a programmer for The May Department Stores Co. Having worked for them for nine years, he finds programming the Apple II a relaxing diversion from programming the larger systems of the retail environment. He has had five articles published, this one being his third for MICRO. He uses the articles to buy accessories for his Apple II, offsetting the cost of expanding his system.

VIGIL FOR THE PET/CBM

VIGIL is an exciting, new interactive language for your PET/CBM. It's easy to learn and lets you quickly create games and graphics applications.

- * More than 60 powerful commands for manipulating graphics figures.
- * Double density graphics give you 80 X 50 plot positions.
- * Large number displays, two timers and tone (with ext. speaker).
- * LOADING and SAVING of VIGIL programs to cassette or diskette.
- * Nine complete programs included - Breakout, SpaceWar, AntiAircraft, U.F.O., SpaceBattle, Concentration, Maze, Kaleidoscope & FortuneTeller.
- * Comprehensive 50+ page manual.
- * For OLD, NEW or 4.0 Poms.



	U.S. & CANADA	FOREIGN
VIGIL for PET/CBM on cassette or diskette w/9 programs.....	\$35.....	\$40.....
VIGIL User's Manual (refundable with software order).....	\$10.....	\$12.....
VIGIL Interpreter Listing (6502 Assembler Language).....	\$25.....	\$30.....
PET MACHINE LANGUAGE GUIDE (OLD, NEW, or 4.0 ROMS).....	\$9.....	\$11.....

PET & APPLE II USERS TINY PASCAL

Plus+ GRAPHICS

The TINY Pascal System turns your PET or APPLE II into a P-machine with:

- * LINE EDITOR - creates, modifies and maintains source language
- * COMPILER - produces P-code, the assembly language of the P-machine
- * INTERPRETER - executes compiled P-code. Features built-in TRACE.
- * STRUCTURED PROGRAMMING - (CASE-OF, WHILE-DO, IF-THEN-ELSE, REPEAT-UNTIL, FOR-TO/DOWNTO, BEGIN-END, PROC, FUNC.
- * GRAPHICS version has more - GRAPHICS, PLOT, POINT, TEXT, INKEY, ABS, SQR. PET/CBM has double density plotting and APPLE II has LORES and HIRRES (with ROM AppleSoft) - COLOR, HGRAPHICS, HCOLOR, HPLOT, PDL and TONE



	U.S. & CANADA	FOREIGN
TINY Pascal PLUS+ GRAPHICS VERSION includes manual		
PET 32K NEW/4.0 ROMS diskette.....	\$50.....	\$60.....
PET 32K NEW/4.0 ROMS cassette.....	\$55.....	\$65.....
APPLE II 48K and DOS 3.2/3.3.....	\$50.....	\$60.....
TINY Pascal NON-GRAPHICS VERSION includes manual		
PET 16K/32K NEW ROMS diskette.....	\$35.....	\$45.....
PET 16K/32K NEW ROMS cassette.....	\$40.....	\$50.....
APPLE II 32K and DOS 3.2/3.3.....	\$35.....	\$45.....
TINY Pascal User's Manual (refundable with software order).....	\$10.....	\$12.....
TINY Pascal 6502 Interpreter Listing-GRAPHICS version.....	\$25.....	\$30.....
TINY Pascal 6502 Interpreter Listing-NON-GRAPHICS version.....	\$15.....	\$20.....
PET MACHINE LANGUAGE GUIDE for OLD, NEW or 4.0 ROMS.....	\$9.....	\$11.....





ABACUS SOFTWARE
P. O. Box 7211
Grand Rapids, Michigan 49510
616 / 241-5510

Prices include postage. Orders must be prepaid via check, money order or bank card. Foreign orders may be paid for via international money order or bank card. (Access, Eurocard, Barclaycard)

```

10 REM SOLAR SYSTEM SIMULATOR # 2
40 REM DAVE PARTYKA
45 REM 1707 N. NANTUCKETT DR.
50 REM LORAIN, OHIO 44053

100 GOTO 650
110 IF TY = 1 THEN 210
120 IF H > TP OR H < BT THEN 210
130 HCOLOR= 0
140 IF RG > LF THEN 180
150 IF F < RG OR F > LF THEN 210
160 HPLOT 279 - (F - RG) * SC, (TP - H) * SC
170 GOTO 210
180 IF F > LF AND F < RG THEN 210
190 IF F = < LF THEN F = F + 360
200 HPLOT 279 - (F - RG) * SC, (TP - H) * SC
210 IF G > TP OR G < BT THEN RETURN
220 HCOLOR= 3
230 IF RG > LF THEN 270
240 IF B < RG OR B > LF THEN RETURN
250 HPLOT 279 - (B - RG) * SC, (TP - G) * SC
260 RETURN
270 IF B > LF AND B < RG THEN RETURN
280 IF B = < LF THEN B = B + 360
290 HPLOT 279 - (B - RG) * SC, (TP - G) * SC
300 RETURN
310 D = ZZ - INT (ZZ / SRD) * SRD
320 B = Q - (D / SRD * Q2)
330 IF Y > 0 THEN RA = 270
340 RV = A - (P / (1 + E * COS (B)))
350 V = PE / RV - EZ
360 IF V = > 1 THEN V = VL
370 IF V = < - 1 THEN V = - VL
380 VA = - ATN (V / SQR (- V * V + 1)) + T
390 IF D > SRD / 2 THEN VA = Q2 - VA
400 VA = VA + J
410 ZX = VA * T1 - C
420 IF ZX > 360 THEN ZX = ZX - 360
430 IF ZX < 0 THEN ZX = 360 + ZX

```



```

440 ZX = ZX / T1
450 LA = SIN (ZX) * I
460 XA = RV * COS (LA) * COS (VA)
470 YA = RV * COS (LA) * SIN (VA)
480 ZA = RV * SIN (LA)
490 XB = XA - X3:YB = YA - Y3:ZB = ZA - Z3
500 VA = VA * T1
510 IF VA > 360 THEN VA = VA - 360
520 IF EE = 0 THEN RETURN
530 ED = SQR (XB * XB + YB * YB)
540 X = XB
550 Y = YB * COS (IN) - ZB * SIN (IN)
560 Z = YB * SIN (IN) + ZB * COS (IN)
570 RA = 90
580 IF Y < 0 THEN RA = 270
590 IF X < > 0 THEN RA = ATN (Y / X) * T1
600 IF X < 0 THEN RA = RA + 180
610 IF X > 0 AND Y < 0 THEN RA = RA + 360
620 DZ = Z / ED
630 DC = ATN (DZ / SQR (1 - DZ * DZ)) * T1
640 RETURN
650 T = 1.5708:T1 = 57.2957795
660 IN = 23.434 / T1
670 Q = 3.14159265
680 Q2 = 6.2831853
690 VL = .99999999
700 HOME
710 PRINT "DO YOU WANT TO DISPLAY "
720 PRINT : PRINT "THE SAME PLANETS AS YOUR LAST RUN"
730 PRINT : INPUT "Y OR N ";A$
740 IF A$ = "N" THEN 790
750 IF A$ < > "Y" THEN 710
760 IF S1 < > 0 THEN 1590
770 IF SC < > 0 THEN 2785
780 PRINT : PRINT "YOU HAV'NT PICKED THE PLANETS YET": PRINT :
PRINT : GOTO 800
790 HOME
800 PRINT "CHOOSE THE PLANETS YOU WANT TO DISPLAY"
810 PRINT
820 PRINT "ENTER A 1 FOR YES, 0 FOR NO"
830 PRINT
840 REM SPECIFIC VALUES FOR EACH PLANET
850 REM S1=ORBITAL PERIOD: P1=A1*(1-E1*E1)/2
860 REM E1=ECCENTRICITY: U1=P1/E1: K1=1/E1
870 REM A1=MINIMUM + MAXIMUM DISTANCE FROM SUN
880 REM J1=LONGITUDE OF PERIHELION IN RADIANS
890 REM W1=DAYS FROM 0 DEGREES TO PERIHELION FOR 1980
892 REM C1=ASCENDING NODE IN DEGREES
894 REM I1=INCLINATION IN DEGREES / T1 TO CONVERT TO RADIANS
900 INPUT "DISPLAY MERCURY ";ME
910 S1 = 87.969
920 E1 = .2056
930 A1 = 43.403 + 28.597
940 P1 = A1 * (1 - E1 * E1) / 2
950 K1 = 1 / E1
960 U1 = P1 / E1
970 J1 = 77.1 * Q / 180
980 W1 = 37.53
990 C1 = 48.1
1000 I1 = 7 / T1
1010 INPUT "DISPLAY VENUS ";VE
1020 S2 = 224.701
1030 E2 = .0068
1040 A2 = 67.726 + 66.813
1050 P2 = A2 * (1 - E2 * E2) / 2
1060 K2 = 1 / E2
1070 U2 = P2 / E2
1080 J2 = 131.3 * Q / 180
1090 W2 = 140.5
1100 C2 = 76.5

```

(Continued on page 113)

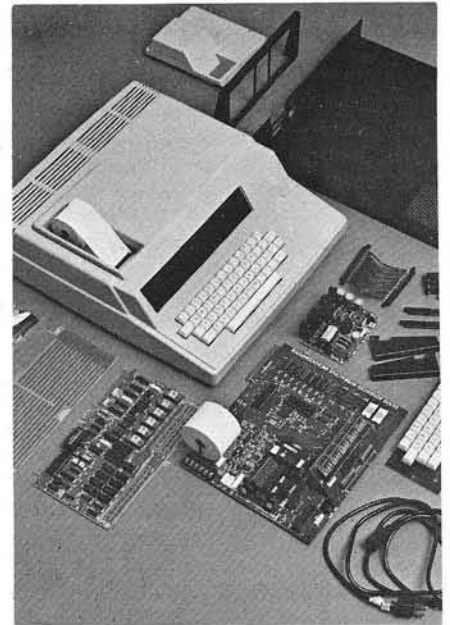

TAKE AIM.

Unique Data Systems has. We've taken Rockwell's AIM 65 Microcomputer, packaged it in a professional enclosure and turned it into a versatile, higher capacity microcomputer system. Complete with a memory-I/O board, a modem board or wire wrap prototyping board, power supply, cables and connectors. It makes the AIM 65 a joy to work with, and there's even space inside for your own special circuitry. We'll sell you the whole package or just the bits and pieces you need for your application. We're AIM 65 specialists. We're Unique Data Systems.

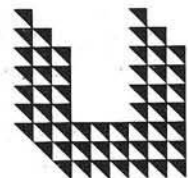

Unique Data Systems
15041 Moran Street
Westminster, CA 92603
(714) 895-3455

INTRODUCING:

IN DEPTH

136 pages of timeless reference material on heavy duty stock.

- **APPLESOFT FROM BOTTOM TO TOP**
- **APPLESOFT INTERNALS**
- **PROGRAM SPLITTER**
- **AMPLIFYING APPLESOFT**
- **HI-RES NOTES**
- **and more**

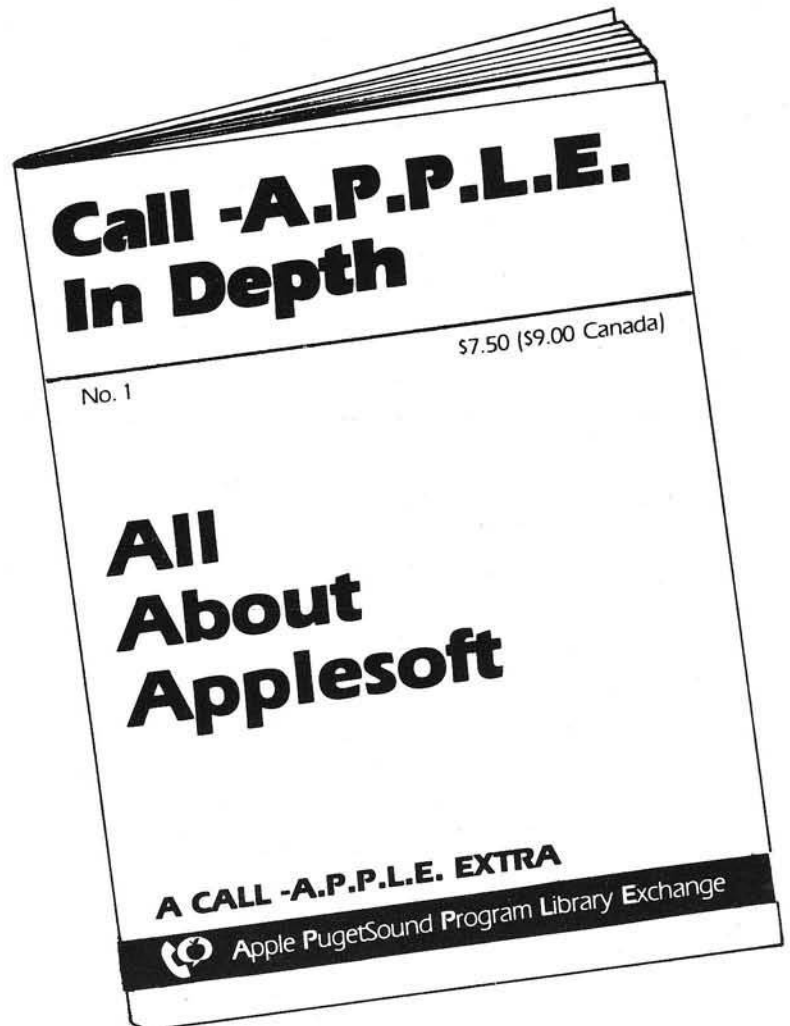

AVAILABLE AT DISCRIMINATING APPLE DEALERS WORLD-WIDE

Dealer Inquiries Invited

Membership and dealer information:

Apple Pugetsound Program Library Exchange

304 Main Ave. S., Suite 300-M

Renton, WA 98055

(206) 271-4514

```

1110 I2 = 3.4 / T1
1120 INPUT "DISPLAY EARTH" ;EA
1130 S3 = 365.256
1140 E3 = .0167
1150 A3 = 94.555 + 91.445
1160 P3 = A3 * (1 - E3 * E3) / 2
1170 K3 = 1 / E3
1180 U3 = P3 / E3
1190 J3 = 102.6 * Q / 180
1200 W3 = - 3.82
1210 C3 = 0
1220 I3 = 0
1230 INPUT "DISPLAY MARS" ;MA
1240 S4 = 686.980
1250 E4 = .0934
1260 A4 = 154.936 + 128.471
1270 P4 = A4 * (1 - E4 * E4) / 2
1280 K4 = 1 / E4
1290 U4 = P4 / E4
1300 J4 = 335.7 * Q / 180
1310 W4 = 287
1320 C4 = 49.4
1330 I4 = 1.85 / T1
1340 INPUT "DISPLAY JUPITER" ;JU
1350 S5 = 4332.125
1360 E5 = .0478
1370 A5 = 507.046 + 460.595
1380 P5 = A5 * (1 - E5 * E5) / 2
1390 K5 = 1 / E5
1400 U5 = P5 / E5
1410 J5 = 13.6 * Q / 180
1420 W5 = 1608
1430 C5 = 100.24
1440 I5 = 1.3 / T1
1450 INPUT "DISPLAY SATURN" ;SA
1460 S6 = 10825.863
1470 E6 = .0555
1480 A6 = 937.541 + 838.425
1490 P6 = A6 * (1 - E6 * E6) / 2
1500 K6 = 1 / E6
1510 U6 = P6 / E6
1520 J6 = 95.5 * Q / 180
1530 W6 = 2090
1540 C6 = 113.51
1550 I6 = 2.49 / T1
1590 HOME
1600 PRINT "ENTER BEGINNING DATE? MM,DD,YYYY": INPUT "
";MM,DD,YY
1610 DF = (MM = 2) * 31 + (MM = 3) * 59 + (MM = 4) * 90 + (MM
= 5) * 120 + (MM = 6) * 151 + (MM = 7) * 181 + (MM = 8) * 212
+ (MM = 9) * 243 + (MM = 10) * 273 + (MM = 11) * 304 + (MM
= 12) * 334
1620 ZY = INT (YY * 365 + INT (YY / 4) + DD + DF + 1 - INT
(YY / 100) + INT (YY / 400) / 1)
1630 IF INT (YY / 4) < > YY / 4 THEN 1680
1640 IF INT (YY / 400) = YY / 400 THEN 1660
1650 IF INT (YY / 100) = YY / 100 THEN 1670
1660 IF MM > 2 THEN 1680
1670 ZY = ZY - 1
1680 ZY = ZY - 723180
1690 ZT = - ZY
1700 PRINT : PRINT : INPUT "ENTER # OF DAYS TO PRINT/PLOT ";D
N
1710 PRINT : PRINT : PRINT
1720 INPUT "ENTER # OF DAYS BETWEEN PRINT/PLOTS ";DA
1730 IF DA < > 0 THEN 1760
1740 PRINT : PRINT
1750 PRINT "0 NOT ALLOWED": GOTO 1710
1760 HOME

```

MICRO

Classified

Ohio Scientific C1P, C4P COLOR

Earthship has GREAT programs. C1P, C4P — Animated Lunar Lander, Catchword, real-time Scrabble, graphics designer, analytical plotter, single disk copier; C1P — animation and shape table graphics, BASIC tutor, add and multiply tutor, information processing simulation and tutor. Send for catalog.

Earthship
17 Church Street #28
Nutley, New Jersey 07110

Spanish Hangman

2,000 SPANISH words and sentences taught in a fun way on the Apple. Send for your school's free 30-day evaluation diskette, from:

George Earl
1302 South General McMullen
San Antonio, TX 78237

SYM-1 Expansions

Bare W7AAY 4K RAM board: \$8.00 plus SASE. Assembled W7AAY ROM board: \$16.00. RAE symbolic disassembler source on cassette: \$15.00. Instruction packet to add floppy disks to SYM -\$15.00. RAE/KMMM software interface on 5¼" diskette: \$15.00. SASE for more information.

John M. Blalock
Blalock & Associates
P.O. Box 39356
Phoenix, AZ 85069

Business Software by ADS

For the Apple II and Atari/800. Why pay more for a bunch of unrelated programs? Business Plus will handle invoices, statements, credit memos and more, much more! Just \$299 complete or \$25 for demo disk (credited towards purchase). VISA, Mastercharge accepted.

Advanced Data Systems
7468 Maple Avenue
St. Louis, MO 63143
314/781-9388

(Continued on next page)

Ohio Scientific

Tune Player — Play music easily on your C4P. Hours of fun! Special features: computer plays your songs, organ effect, save feature creates data statement, and more! \$8.75 cassette only. Other programs available: Rigel's Raiders, Money Handler, Auto Race, more. Write:

Ron Lashley
2934 W. Missionwood Circle
Miramar, FL 33025

Apple Computer Dust Cover

Want to protect that big investment? Then why not buy a PEEL for your Apple II? This custom-fit dust cover comes in beige fabric with a decorative apple on front. Send \$10.00 to protect your computer today.

D. Poppelaars
5236 Lochley Drive
Edina, Minnesota 55436

Timestack — A Programmable Controller

Expand your KIM-1 into a general-purpose machine. 80-page manual documents Clock/Port/RAM/PROM Expansion Board and controller software. Subroutine library includes user interaction routines, I/O, and clock controls. Complete manual — \$15.00. SASE for more information and newsletter.

Hunter Services
P.O. Box 359
Elm Grove, WI 53122

Assembly Language Newsletter

Bob Sander-Cederlof's monthly newsletter devoted to Apple assembly language: beginner's tutorials, advanced techniques, super subroutines for your programs, commented listing of and improvements to standard products, and much more. Learn faster, benefit more from assembly language! \$12/year.

Apple Assembly Line
S-C Software
P.O. Box 280300
Dallas, TX 75228

(Continued on next page)

```

1770 INPUT "ENTER 1 TO PRINT, 0 TO PLOT ";PL
1780 IF PL < > 0 AND PL < > 1 THEN 1760
1785 IF PL = 0 THEN PRINT : PRINT "DO YOU WANT": PRINT : INP
UT "POINT (0) OR CONTINUOUS (1) PLOTS ";TY
1786 IF TY < > 0 AND TY < > 1 THEN 1785
1790 IF PL = 0 THEN GOSUB 2750
1800 REM EARTH
1810 HOME :EE = 0
1830 A = A3:P = P3:E = E3:PE = U3:EZ = K3:SRD = S3:J = J3:W =
W3:ZZ = ZY + W:C = C3:I = I3
1840 GOSUB 310:EE = 1
1845 X3 = XA:Y3 = YA:Z3 = ZA:R3 = RV:V3 = VA
1848 HOME
1850 VTAB 1: HTAB 1: PRINT "STARTING DATE ";MM;"/";DD;"/";YY;
" PLOT DAYS ";ZT + ZY
1855 IF PL = 0 THEN VTAB 23: PRINT "STARTING DATE ";MM;"/";D
D;"/";YY;" PLOT DAYS ";ZT + ZY: PRINT "": GOTO 1980: REM EM
PTY PRINT IS A CNIL-G (BELL)
1870 IF EA = 0 THEN 1980
1880 VTAB 2: HTAB 1: PRINT "EARTH D-S. "; INT (RV * 10000) /
10000
1890 VTAB 3: HTAB 7: PRINT "A-S. "; INT (V3 * 10000) / 10000
1900 REM SUN
1910 XB = - X3:YB = - Y3:ZB = - Z3:ED = R3
1920 GOSUB 540
1930 VTAB 2: HTAB 21: PRINT "SUN D-E. "; INT (ED * 10000)
/ 10000
1940 VTAB 3: HTAB 28: PRINT "R.A. "; INT (RA / 15);" "; INT
((RA - INT (RA / 15) * 15) * 40) / 10
1950 IF DC < 0 THEN DC = - DC:DB = 1
1960 VTAB 4: HTAB 28: PRINT "DEC. "; INT (DC);" "; INT ((DC
- INT (DC)) * 600) / 10
1970 IF DB = 1 THEN VTAB 4: HTAB 32: PRINT "-":DB = 0
1980 REM MERCURY
1990 IF ME = 0 THEN 2130
2000 A = A1:P = P1:E = E1:PE = U1:EZ = K1:SRD = S1:J = J1:W =
W1:ZZ = ZY + W:C = C1:I = I1
2010 GOSUB 310: IF PL = 1 THEN 2050
2020 F = F1:H = H1:B = RA:G = DC: GOSUB 110
2030 F1 = RA:H1 = DC: GOTO 2130
2040 IF PL = 0 THEN GOSUB 110
2050 VTAB 6: HTAB 1: PRINT "MERC D-S. "; INT (RV * 10000) /
10000
2060 VTAB 7: HTAB 7: PRINT "A-S. "; INT (VA * 10000) / 10000
2070 VTAB 8: HTAB 7: PRINT "D-E. "; INT (ED * 10000) / 10000
2080 VTAB 9: HTAB 7: PRINT "R.A. "; INT (RA / 15);" "; INT (
(RA - INT (RA / 15) * 15) * 40) / 10
2090 IF DC < 0 THEN DC = - DC:DB = 1
2100 VTAB 10: HTAB 7: PRINT "DEC. "; INT (DC);" "; INT ((DC
- INT (DC)) * 600) / 10
2110 IF DB = 1 THEN VTAB 10: HTAB 11: PRINT "-":DB = 0
2120 REM VENUS
2130 IF VE = 0 THEN 2260
2140 A = A2:P = P2:E = E2:PE = U2:EZ = K2:SRD = S2:J = J2:W =
W2:ZZ = ZY + W:C = C2:I = I2
2150 GOSUB 310: IF PL = 1 THEN 2180
2160 F = F2:H = H2:B = RA:G = DC: GOSUB 110
2170 F2 = RA:H2 = DC: GOTO 2260
2180 VTAB 6: HTAB 21: PRINT "VENUS D-S. "; INT (RV * 10000)
/ 10000
2190 VTAB 7: HTAB 28: PRINT "A-S. "; INT (VA * 10000) / 10000
2200 VTAB 8: HTAB 28: PRINT "D-E. "; INT (ED * 10000) / 10000
2210 VTAB 9: HTAB 28: PRINT "R.A. "; INT (RA / 15);" "; INT
((RA - INT (RA / 15) * 15) * 40) / 10
2220 IF DC < 0 THEN DC = - DC:DB = 1
2230 VTAB 10: HTAB 28: PRINT "DEC. "; INT (DC);" "; INT ((DC
- INT (DC)) * 600) / 10
2240 IF DB = 1 THEN VTAB 10: HTAB 32: PRINT "-":DB = 0
2250 REM MARS

```

(Continued on next page)

```

2260 IF MA = 0 THEN 2390
2270 A = A4:P = P4:E = E4:PE = U4:EZ = K4:SRD = S4:J = J4:W =
W4:ZZ = ZY + W:C = C4:I = I4
2280 GOSUB 310: IF PL = 1 THEN 2310
2290 F = F4:H = H4:B = RA:G = DC: GOSUB 110
2300 F4 = RA:H4 = DC: GOTO 2390
2310 VTAB 12: HTAB 1: PRINT "MARS D-S. "; INT (RV * 10000) /
10000
2320 VTAB 13: HTAB 7: PRINT "A-S. "; INT (VA * 10000) / 10000

2330 VTAB 14: HTAB 7: PRINT "D-E. "; INT (ED * 10000) / 10000
2340 VTAB 15: HTAB 7: PRINT "R.A. "; INT (RA / 15);" "; INT
((RA - INT (RA / 15) * 15) * 40) / 10
2350 IF DC < 0 THEN DC = - DC:DB = 1
2360 VTAB 16: HTAB 7: PRINT "DEC. "; INT (DC);" "; INT ((DC
- INT (DC)) * 600) / 10
2370 IF DB = 1 THEN VTAB 16: HTAB 11: PRINT "-":DB = 0
2380 REM JUPITER
2390 IF JU = 0 THEN 2520
2400 A = A5:P = P5:E = E5:PE = U5:EZ = K5:SRD = S5:J = J5:W =
W5:ZZ = ZY + W:C = C5:I = I5
2410 GOSUB 310: IF PL = 1 THEN 2440
2420 F = F5:H = H5:B = RA:G = DC: GOSUB 110
2430 F5 = RA:H5 = DC: GOTO 2520
2440 VTAB 12: HTAB 21: PRINT "JUPTER D-S. "; INT (RV * 10000)
/ 10000
2450 VTAB 13: HTAB 28: PRINT "A-S. "; INT (VA * 10000) / 1000
0
2460 VTAB 14: HTAB 28: PRINT "D-E. "; INT (ED * 10000) / 1000
0
2470 VTAB 15: HTAB 28: PRINT "R.A. "; INT (RA / 15);" "; INT
((RA - INT (RA / 15) * 15) * 40) / 10
2480 IF DC < 0 THEN DC = - DC:DB = 1
2490 VTAB 16: HTAB 28: PRINT "DEC. "; INT (DC);" "; INT ((DC
- INT (DC)) * 600) / 10
2500 IF DB = 1 THEN VTAB 16: HTAB 32: PRINT "-":DB = 0
2510 REM SATURN
2520 IF SA = 0 THEN 2640
2530 A = A6:P = P6:E = E6:PE = U6:EZ = K6:SRD = S6:J = J6:W =
W6:ZZ = ZY + W:C = C6:I = I6
2540 GOSUB 310: IF PL = 1 THEN 2570
2550 F = F6:H = H6:B = RA:G = DC: GOSUB 110
2560 F6 = RA:H6 = DC: GOTO 2640
2570 VTAB 18: HTAB 1: PRINT "SATN D-S. "; INT (RV * 10000) /
10000
2580 VTAB 19: HTAB 7: PRINT "A-S. "; INT (VA * 10000) / 10000
2590 VTAB 20: HTAB 7: PRINT "D-E. "; INT (ED * 10000) / 10000
2600 VTAB 21: HTAB 7: PRINT "R.A. "; INT (RA / 15);" "; INT
((RA - INT (RA / 15) * 15) * 40) / 10
2610 IF DC < 0 THEN DC = - DC:DB = 1
2620 VTAB 22: HTAB 7: PRINT "DEC. "; INT (DC);" "; INT ((DC
- INT (DC)) * 600) / 10
2630 IF DB = 1 THEN VTAB 22: HTAB 11: PRINT "-":DB = 0
2640 ZY = ZY + DA
2650 IF ZT + ZY > DN THEN 2700
2660 IF PL = 0 THEN 2690
2670 VTAB 23: HTAB 1: PRINT "PRESS RETURN FOR NEXT DISPLAY":
GET A$
2680 VTAB 23: HTAB 1: PRINT " "
2690 GOTO 1830
2700 ZY = 0:DE = 0
2710 PRINT " "; " "; REM EMPTY PRINTS CNTL-G
2720 INPUT "PRESS ENTER TO START AGAIN";A$
2730 TEXT : RESTORE
2740 GOTO 650
2750 HCOLOR= 3
2760 PRINT : INPUT "ENTER FACTOR: 0 OR 1 - 20 ";SC
2770 IF SC < > 0 THEN 2785
2780 RG = 0:LF = 360:BT = - 90:TP = 110:SC = .75: GOTO 2890
2785 IF SC < 1 THEN 2760

```

Classified (continued)

Extended SYM-BASIC

Adds 30 commands, requires 16K, \$85 US/\$95 Can., object on cassette, manual, and source listing. SYM-FORTH 1.0: fig-FORTH for 16K SYM-1. Editor, assembler, cassette interface \$135 US/\$155 Can., object on cassette, manual and source listing.

Saturn Software Limited
8246 116A St.
Delta, B.C., V4C 5Y9
Canada

PET Arcade Software

Astroidz and *Munchman* games for your 8K old-new ROMS. *Astroidz* are invading the galaxy. Four levels of play. *Munchman* is based on arcade game Pac-Man. ZIP and ZAP are out to get you. Fantastic graphics. \$9.95 each cassette.

ComputerMat
Box 1664M
Lake Havasu, AZ 86403

OSI BASIC LOAD + SAVE w/filename

Tired of LOAD-SAVE times, tape documentation? Fret no more. Now SAVE with filenames on your cassette programs. LOAD by filename. Gives directory of tape as you go. Employs a token I/O system to decrease tape I/O by 50%.

Computer Science Engineering
57 Beals Street, Rm. 57-12
Brookline, MA 02145

Contour Mapping for your Apple (or other computer)

Uses printer plotter or CRT. Other software available.

Geosystems
802 East Grand River
Williamston, MI 48895
(517) 655-3726

PASCAL LEVEL 1

This Pascal system allows the development of BRUNable programs. The system supports IF-THEN-ELSE, REPEAT-UNTIL, FOR-TO/DOWNTO-DO, WHILE-DO, CASE-OF-ELSE, FUNCTION, PROCEDURE, PEEK, POKE as well as disk I/O via DOS (specify 3.2 or 3.3). Price \$35.00. Send SASE for more information.

On-Going Ideas
RD #1, Box 810
Starksboro, VT 05487

Classified

Each classified ad costs only \$10.00 per insertion, pre-paid with typewritten copy. These ads are limited to one per company/individual per month. Please limit these entries to less than 40 words. (Oversized ads will be rejected and returned.) Title line, name and address are not considered in count. Ads received before the 20th of the second month preceding the month of publication will be published in next issue, i.e. October 20th for the December issue. For further information call:

(617) 256-5515

MICRO



Micro Co-op

Micro Co-op is a software co-operative. We publish a bi-monthly newsletter describing various new and useful software products as they become available. We also try to give reasonable comparisons of existing products that help you make more educated buying decisions. Our members may purchase most software through us below retail price.

For more information, write for a free copy of our newsletter.
Micro Co-op
(Specify Apple or Atari) Newsletter
P.O. Box 432
West Chicago, IL 60185
(312) 231-0912

```
2800 PRINT : PRINT "ENTER CENTER COORDINATES": PRINT
2810 PRINT " R.A. DEC.": PRINT
2820 INPUT "HH.HH , DD.DD " ;R,D
2830 RG = R * 15 - 139 / SC
2840 LF = R * 15 + 139 / SC
2850 BT = D - 95 / SC
2860 TP = D + 95 / SC
2870 IF RG < 0 THEN RG = RG + 360
2880 IF LF > 360 THEN LF = LF - 360
2890 HGR2
2900 HPLOT 0,0 TO 279,0
2910 HPLOT TO 279,191
2920 HPLOT TO 0,191
2930 HPLOT TO 0,0
2940 READ B,B1,G,G1
2950 B = B * 15 + B1 * .25:G = G + G1 / 60
2960 IF B = 0 AND G = 0 THEN RETURN
2970 GOSUB 210:GOTO 2940
2980 REM PISCES
2990 DATA 1,11,24,19,1,17,27,0,1,18,28,29,1,9,29,49,0,55,28,
43,0,47,27,26,0,53,26,56,1,28,15,5,1,43,8,54,1,59,2,31
3000 DATA 1,39,5,14,1,28,5,53,1,11,7,19,1,0,7,37,0,46,7,19,2
3,57,6,35,23,37,5,21,23,40,1,30,23,25,6,6,23,18,5,6,23,15,3,1,
2,3,24,0,59
3010 REM ARIES
3020 DATA 1,51,19,3,1,52,20,34,2,1,25,42
3030 REM PLEIADES
3040 DATA 3,42,24,8,3,42,23,57,3,42,24,18,3,43,24,13,3,43,24
,24,3,45,23,57,3,43,23,48
3050 REM TAURUS
3060 DATA 5,23,28,34,4,39,22,52,5,35,21,7,5,4,18,35,4,33,16,
25,4,26,15,51,4,17,15,31,4,23,17,49,4,26,19,4
3070 REM GEMINI
3080 DATA 6,12,22,31,6,20,22,32,6,41,25,11,7,8,30,20,7,31,32,0,7,42,28,9,7,17,
22,5,7,1,20,39,6,35,16,27,6,42,12,57
3090 REM CANCER
3100 DATA 8,14,9,20,8,18,24,11,8,30,20,37,8,29,18,16,8,42,18,20,8,40,21,39,8,
56,12,3,8,44,28,57
3110 REM LEO
3120 DATA 9,43,24,0,9,50,26,15,10,14,23,40,10,17,20,6,10,5,17
,0,10,6,12,13,11,11,20,48,11,47,14,51,11,12,15,42
3130 REM VIRGO
3140 DATA 11,43,6,49,11,48,2,3,12,17,-0,-23,12,39,-1,-11,12,
53,3,40,13,0,11,14
3200 DATA 13,7,-5,-16,13,23,-10,-54,14,13,-5,-46,14,40,-5,-2
7,14,44,2,6,13,59,1,47,13,32,-0,-20
3270 REM LIBRA
3280 DATA 14,48,-15,-50,15,10,-19,-28,15,14,-9,-12,15,33,-14
,-37
3320 REM SCORPIUS
3330 DATA 15,56,-25,-28,15,57,-22,-29,16,3,-19,-40,16,18,-25,-28,16,
28,-26,-19,16,33,-28,-7,16,47,-34,-12,16,48,-37,-58,16,50,-42,-17
50,-42,-17
3420 DATA 17,9,-43,-11,17,34,-42,-58,17,44,-40,-7,17,39,-39,-0,17,30,
-37,-4
3470 REM SAGITTARIUS
3480 DATA 18,3,-30,-26,18,14,-36,-47,18,21,-34,-25,18,18,-29
,-51,18,25,-25,-27,18,43,-27,-3,18,52,-26,-22,18,59,-29,-57,19
,4,-27,-45
3570 REM CAPRICORNUS
3580 DATA 20,15,-12,-40,20,24,-18,-23,20,36,-15,-8,21,3,-17,
-26,21,19,-17,-3,21,37,-16,-53,21,44,-16,-21
3650 DATA 21,40,-19,-6,21,34,-19,-41,21,26,-22,-2,21,24,-22,
-38,21,4,-25,-12,20,49,-27,-6,20,43,-25,-27
3720 REM AQUARIUS
3740 DATA 22,3,-0,-34,22,23,1,7,22,26,-0,-17,22,33,-0,-23,22
,50,-7,-51,22,47,-13,-51,22,52,-16,-5,23,12,-6,-19,23,13,-9,-2
2,23,16,-9,-53,23,40,-14,-49
3830 REM END OF TABLE (ZEROS)
3840 DATA 0,0,0,0
```

MICRO™

the BEST keyboard buffer

Lazer
MICRO SYSTEMS, INC.



KEYBOARD BUFFER & SHIFT KEY UPPER/LOWER CASE CONTROL \$119.95

- + More buffer than others.
- + Clear buffer control.
- + SHIFT key entry of upper/lower case.
- + Easy CTL key access to special chars " | - ` { } _ \ \ \ ` ".
- + Allows BASIC programs with standard INPUT to support Lower Case without software modification.
- + A lower case adapter is required to display lower case.

◀ AND ▶

Separately, they have more features and out perform all the rest. But together as a team they perform even better. Look for the Graphics +Plus soon. It's a RAM based character generator to compliment the Lower Case +Plus. It will allow you to define the character set to your needs. You could load German, French, Scientific, Engineering or any other special characters into the Graphics +Plus and use it as if the Apple II was designed specially for that application. And that's not all. If you define the characters as graphics, you can do extremely fast HI-RES type graphics on the text screen without all those cumbersome and slow HI-RES routines and 8K screen. For all the details on this triad of products, send for our free booklet "Lower case adapters and keyboard buffers from the inside out". This booklet gives all the details about lower case adapters and keyboard buffers in general. It also has a section on the Graphics +Plus (RAM based character generator).

the BEST lower case adapter

Lazer
MICRO SYSTEMS, INC.

lower case +plus



GRAPHICS & LOWER CASE CHARACTER GENERATOR
FOR THE APPLE II COMPUTER

\$69.95

- + Normal & Inverse Lower Case.
- + 2 complete character sets on board.
- + Graphics character font built in.
- + Expansion socket allows access to external character sets.
- + 2716 EPROM compatible char generator.
- + More supporting software. (on diskette)
- + Keyboard +Plus & Graphics +Plus designed around the Lower Case +Plus.

Lazer
MICRO SYSTEMS INC.
1791-G Capital
Corona, CA 91720
(714)735-1041

DOSOURCE 3.3 for the Apple II

A source listing of DOS 3.3 Disassembled & commented by Randy Hyde

We took our DISASM/65 disassembler program, disassembled Apple's DOS 3.3, and added meaningful labels and comments to create DOSOURCE 3.3, a perfect companion to "Beneath Apple DOS" by Don Worth and Pieter Lechner*. DOSOURCE clearly lists each routine used by Apple DOS.

DOSOURCE is a LISA 2.5 compatible source listing of DOS 3.3. LISA 2.5 owners can load and reassemble DOS at other locations for special applications (such as in a RAM card). DOSOURCE is also a text file that can be loaded into your favorite assembler and converted for use with it. DOSOURCE is also an assembled listing that you can dump to a printer for reference purposes.

With DOSOURCE you can:

- > Reassemble DOS 3.3 at different addresses.
- > Utilize several useful routines found within DOS, such as decimal input and output. Many routines within DOS are as useful as routines found within the Apple monitor...only you didn't know about them until now!!
- > Remove portions of DOS, that you may not need, freeing memory for program use. Most programs do not need the "RENAME", "INIT", "BSAVE", "BRUN", "BLOAD", "CATALOG", etc. commands while they are running. As much as 4K can be removed from DOS without affecting your programs operation. Think about it the next time you get a MEM FULL error or need to declare an array that's just a little bit too big.
- > Learn lot's of 6502 programming tricks - DOS 3.3 is full of 'em. And you can learn them by studying the source listing.
- > Make "Patches" to DOS 3.3 and understand exactly what's going on. No more "guessing game" resulting in unreliable software.

SPECIAL INTRODUCTORY PRICE \$39.95
with "Beneath Apple DOS" \$55.00

* Beneath Apple DOS is published by Quality Software. Suggested list \$19.95

DISASM/65 by Randy Hyde

DISASM/65 is a LISA compatible 6502 disassembler for the Apple II. DISASM/65 takes unadorned machine code and converts it to an understandable assembly language text file. DISASM/65 allows users to disassemble 6502 instruction codes, HEX data, string data, address data, stack data, and more! DISASM/65 is by far the most powerful 6502 disassembler available for the Apple II. In fact, we used it to disassemble DOS 3.3 for our DOSOURCE package. Over 500 happy users bought DISASM/65 for \$24.95 without the source listing (The source listing was available for \$35.00 extra). Now, for a limited time, you get both the DISASM/65 program and the source listing for \$29.95 (DISASM/65 sources are in a LISA 2.x compatible format). Complete documentation included.

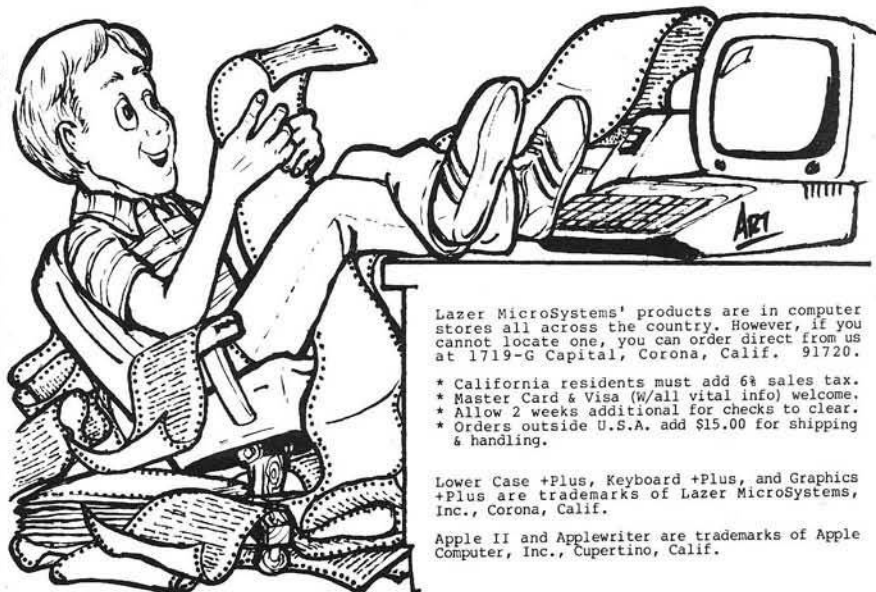

Lazer MicroSystems' products are in computer stores all across the country. However, if you cannot locate one, you can order direct from us at 1719-G Capital, Corona, Calif. 91720.

- * California residents must add 6% sales tax.
- * Master Card & Visa (w/all vital info) welcome.
- * Allow 2 weeks additional for checks to clear.
- * Orders outside U.S.A. add \$15.00 for shipping & handling.

Lower Case +Plus, Keyboard +Plus, and Graphics +Plus are trademarks of Lazer MicroSystems, Inc., Corona, Calif.

Apple II and Applesoft are trademarks of Apple Computer, Inc., Cupertino, Calif.

MICRO

Hardware Catalog

Name: **AME 1000**
Microcomputer System

Memory: 32K bytes of RAM, 22K bytes of ROM, 280K bytes of floppy storage

Language: BASIC with disk operating software, optional Assembler, FORTH, PL/65

Description: The AME 1000 AIM 65-based, includes an enclosure, special motherboard, CRT controller (80x25) and Video 100 monitor, 2 single-sided double-density 5 1/4" floppy drives, controller and integrated disk operating software, Centronics-type printer controller and software driver, 32K bytes of dynamic RAM, 22K bytes of ROM-based operating software and a 5V-5A, ± 12V-1A power supply. Supports one additional Exorciser board and 6 RM 65 modules. Includes interface to 2 Braemar cassettes.

Price: \$3,595 including AIM 65

Available: DYNATEM
20881 Paseo Olma
El Toro, CA 92630

Name: **Game Plus**

System: Apple II and II+

Hardware: Multi-Paddle/Joystick Adapter/multiplexer

Description: *Game Plus* is a hardware adapter which is plugged into the game I/O socket and allows the user to connect up to four sets of paddles or joysticks simultaneously. The unit features ultra-low current drain and is compatible with all existing software and hardware.

Price: \$49.95

Available: Syntronics, Inc.
P.O. Box 601
St. Clair Shores, MI
48080

Name: **ColorMate**

System: SYM-1, KIM-1, AIM 65

Memory: 3K bytes 2114 static RAM

Description: A color video board based on the Motorola 6847 video display generator, the *ColorMate* offers nine modes of operation, ranging from alphanumeric to full graphic.

Price: \$50.00 for PC board and manual (other options)

Available: MicroMate
P.O. Box 50111
Indianapolis, IN 46256

Name: **ZVM-121**

Description: Video monitor with 12" green display. Styling and color compatible with Apple II and Apple III microcomputers. Display of 25 lines with 8x10 character matrix (640x250 pixels). Monitor uses standard NTSC video signal and connection to micro-computer is made via phono plug. Exterior controls include power, black level, contrast, horizontal and vertical adjustment, horizontal and vertical size.

Price: \$160.00

Available: Zenith Data Systems
dealers nationwide

Name: **I/O Selectric Interface Board**

System: Any system with serial or parallel I/O

Description: Input from serial or parallel I/O, output to I/O selectric. Board converts from ASCII and provides all timing.

Price: \$35.00 (\$15.00 for correspondence PROM)

Available: Computer Systems
Consultants
1454 Latta Lane
Conyers, GA 30207
(404) 483-1717/4570

Name: **High Density Static RAM/EPROM Module, GMS 6508**

Memory: Up to 24K bytes static RAM, sockets for up to 16K bytes EPROM/ROM

Description: Low cost, high density memory module. Write protect, over voltage and reverse polarity connection, 1 MHz or 2 MHz operation. Compatible with Rockwell System 65, AIM 65, Motorola Exorciser. 24,576 bytes static RAM addressable in 8K-byte segments. Available in 8K, 16K, 24K versions. 6" x 9.75", +5 VDC power.

Price: \$560.00, single piece quantity, 1 MHz

Available: General Micro Systems
1320 Chaffey Ct.
Ontario, Canada 91767

Name: **Model 2101**

Memory: Standard 2K buffer memory; 4K option

Description: The *Model 2101* is a quiet, bi-directional, electrothermal printer that prints at 160 cps, so the user has 120 cps throughput with 1200 baud communications. The model's 1x11 dot printhead generates 5x9 dot matrix characters with true upper/lower case and true underscore/overscore. A standard 80/132 selectability is great for multiple column formatting for financial and statistical applications. Only weighing 8.5 lbs, the printer can be used by OEM and end users alike.

Price: \$1385

Available: Computer Devices Inc.
25 North Avenue
Burlington, MA 01803
1-800-225-1230

Name: **W7AAY ROM Board**

System: Synertek SYM-1

Description: Supplied completely assembled with instructions, this board plugs into the SYM's U23 socket. Two 24-pin ROMs or EPROMs can be plugged into the two sockets on the board. All addressing and selection jumpers are contained in the SYM's standard jumper area. Ideal for putting the two-chip versions of BAS or RAE into only one socket, or for adding two 2716 EPROMs.

Price: \$16.00 each, ppd in USA

Available: John M. Blalock
Blalock & Associates
P.O. Box 39356
Phoenix, AZ 85069

Name: **MI-J1 User Applications Connector**

System: Rockwell International
AIM 65

Description: The MI-J1 applications connector is a compact printed circuit board that plugs directly into the J1 connector on the AIM 65 by a dual 22-pin gold plated edge connector. MI-J1 offers a number of convenient and necessary connections to the AIM 65, and it also converts the 20 mA serial port to RS-232C signals. Connections to and from a cassette tape recorder are provided via audio plugs. Remote control lines are provided via solder pads. All of the user VIA signals (plus +5 and +24 VDC and GND) are provided via a 24-pin dip socket. Two serial ports (20 mA and RS-232C) are also offered via a 9-pin connector.

Price: \$29.95 assembled and tested; \$13.95 bare P.C. board

Available: Micro Interfaces, Inc.
P.O., Box 14520
Minneapolis, MN 55414

SOFTWARE FOR OHIO SCIENTIFIC

VIDEO EDITOR

Video Editor is a powerful full screen editor for disk-based OSI systems with the polled keyboard (except CIP). Allows full cursor-control with insertion, deletion and duplication of source for BASIC or OSI's Assembler/Editor. Unlike versions written in BASIC, this machine-code editor is co-resident with BASIC (or the Assembler), auto-loading into the highest three pages of RAM upon boot. Video Editor also provides single-keystroke control of sound, screen format, color and background color. Eight-inch or mini disk: \$14.95. Specify amount of RAM.

SOFT FRONT PANEL

Soft Front Panel is a software single-stepper, slow-stepper and debugger-emulator that permits easy development of 6502 machine code. SFP is a fantastic monitor, simultaneously displaying all registers, flags, the stack and more. Address traps, opcode traps, traps on memory content and on port and stack activity are all supported. This is for disk systems with polled keyboard and color (b&w monitor ok). Uses sound and color capabilities of OSI C2/C4/C8 systems (not for CIP). Eight-inch or mini disk \$24.95. Specify amount of RAM. Manual only, \$4.95 (May be later credited toward software purchase). Six page brochure available free upon request.

TERMINAL CONTROL PROGRAM

OSI-TCP is a sophisticated Terminal Control Program for editing OS-6503 files, and for uploading and downloading these files to other computers through the CPU board's serial port on OSI C2, C4 and C8 disk-based systems with polled keyboards. Thirteen editor commands allow full editing of files, including commands for sending any text out the terminal port and saving whatever text comes back. INDUTIL utility included for converting between BASIC source and TCP file text. Eight-inch or mini disk \$39.95. Manual only, \$2.95.

OSI-FORTH 2.0 / FIG-FORTH 1.1

OSI-FORTH 2.0 is a full implementation of the FORTH Interest Group FORTH, for disk-based OSI systems (C1,C2,C3,C4,C8). Running under OS6503, it includes a resident text editor and 6502 assembler. Over one hundred pages of documentation and a handy reference card are provided. Requires 24K (20K CIP). Eight-inch or mini disk \$79.95. Manual only, \$9.95. "OSI-FORTH Letters" software support newsletter \$4.00/year.

All prices postpaid. Florida residents add 4% tax. Dealer inquiries are invited. Allow 30 days for delivery.

WRITE FOR FREE CATALOG
OF SOFTWARE AND HARDWARE
FOR OHIO SCIENTIFIC !!

Technical Products Company
P.O. Box 12983 Univ. Station
Gainesville, Florida 32604

OHIO SCIENTIFIC

ONE TIME CLOSE OUT

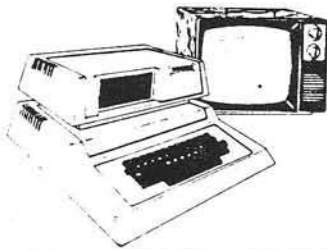

CIDMF 20 K
SERIES 2
LIST 1399.00
CLOSE OUT
999.00

*Closing out only on
Personal Comp.*

Discontinuing our personal computer line

	LIST	CLOSE OUT
C-4P Color Computer	995.00	740.00
CD3P Add on mini floppy	450.00	350.00
C4P DF 48 K Dual 8"	3199.00	2400.00
Micro Line 80 Printer	699.00	450.00
TV Monitors	149.00	99.00

*Will ship the same day UPS
C.O.D. collect*

Fessenden Computer Service
116 N. 3rd Street Ozark, MO 65721
Phone: 417 485-2501

HIGHLANDS

COMPUTER

SERVICES

CRAE 2.0 — A fast co-resident Applesoft Editor for Applesoft Programmers. Now perform global *changes & finds* to anything in your Applesoft program. Quote (*copy*) a range of lines from one part of your program to another. A fully optimized stop-list command that lists your program to the screen with no spaces added and forty columns wide. Append Applesoft programs on disk to program in memory. Formatted memory dump to aid debugging. Powerful renumber is five times faster than most available renumber routines. Auto line numbering. Crae need be loaded only once and changes your Applesoft program right in memory. 48K APPLE II or PLUS & Applesoft Rom & Disk.

CRAE on disk with 20 page manual **\$24.95**

MCAT 2.0 — MCAT 2.0 is a fast binary utility which creates a sorted master catalog which is saved on disk as a binary file (Fast). The master catalog can be easily updated a whole diskette at a time (Add, Delete, Replace), List/Print have global search capability and one or two columns. Provisions for duplicate volume numbers. Approximately 1200 file names. 48K or 32K, 13 or 16 sectors DOS supported.

MCAT on disk with 10 page manual **\$19.95**

CRAE and MCAT on one disk **\$39.95 with manuals**

EROM #1 — Requires Applesoft ROM & ROMPLUS. CRAE'S powerful Global change/find, optimizes List Command, Hex to Decimal and Decimal to Hex conversion now available on a 2716 EPROM.

EROM #1 with manual **\$49.95**

EROM #2 — (Requires Applesoft ROM and Romplus) CRAE'S Autoline numbering, formatted memory Dump, Append, Number conversion (Hex/Dec) on one 2716 EPROM.

EROM #2 with manual **\$34.95**

EROM #3 — CRAE'S powerful Renumber and Quote function now on two 2716 EPROMS.

EROM #3 with manual **\$34.95**

EROM 1, 2, 3 **\$99.95**

Note: All Eproms are compatible with P.L.E.
Note: Append only requires 48K and DOS.

OLDORF'S REVENGE — OLDORF is a well done and exciting HI-Res game using over 100 HI-Res pictures. OLDORF requires 48K, Applesoft Rom, and Disk. As you explore the caverns and castles (each locale is done in HI-Res) looking for treasure, you must battle the one-eyed, two thumbd torkie; find the grezzlerlips' sword; visit the snotgurgle's palace and get through the domain of the three-nosed ickyup — Plus MORE!

OLDORF on disk **\$19.95**

TARTURIAN — The TARTURIAN requires 48K RAM Applesoft ROM, and disk. As you explore the 160 rooms (each done in HI-Res) gathering weapons and treasure that will prepare you for the final battle against the TARTURIAN, you will encounter deadly KROLLS, battle the MINOTAUR, decipher the YUMMY YAKKY'S secret, make friends with the TULIE-SWEEP, avoid GHOULS, explore the PILLAR tombs, discover secret passages and more. 5 interlocking programs.

TARTURIAN on disk **\$24.95**

CREATURE VENTURE — You have just inherited your Uncle Stashback's mansion but first you must rid it of the horrible creatures that have taken it over and find your uncle's buried treasure.

Directing the computer with two word commands such as 'Go North', 'Get Key', 'Look Room', 'Punchout Boogeyman' etc. you will need to explore deep into the mansion to finally find the Stashback fortune.

There are tons of High Resolution graphics plus some clever animation just for fun. Required 48K Ram, Applesoft Rom and disk. All High Resolution characters generated with Higher Graphics II by Robert Clardy.

CREATURE VENTURE on disk **\$24.95**

See Your Local Dealer or Send Checks to

HIGHLANDS COMPUTER SERVICES

14422 S.E. 132nd * Renton, WA 98056 * (206) 228-6691

Washington residents add 5.4% sales tax. Applesoft and Apple

are registered trademarks of Apple Computers, Inc.

ROMPLUS is a trademark of Mountain Computers, Inc.

(Dealer inquiries invited)

VISA, MasterCharge, C.O.D.

The only thing you can do with a baked Apple is eat it.

*Apple II is a trademark of Apple Computer, Inc.

The more you stuff your Apple II™ with plug-in boards, the more of a chance it has to overheat. And once that happens, it won't do anybody any good. Your program bombs and you start losing time and money.

The solution? Simple. Take two minutes to install the Dana Industries fan in the back of your Apple, and you'll practically never have to worry about overheating again.

So pick up the Dana Industries fan at your local computer store. And your Apple will have a long and fruitful life.

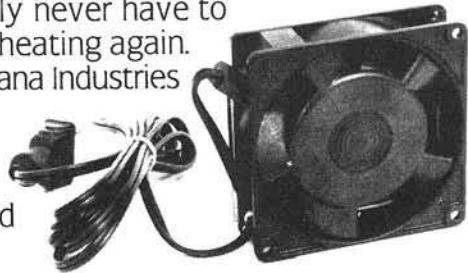

EVER WONDER HOW YOUR APPLE II WORKS?

QUICKTRACE will show you! And it can show you WHY when it doesn't!

This relocatable program traces and displays the actual machine operations, while it is running and without interfering with those operations. Look at these FEATURES:

Single-Step mode displays the last instruction, next instruction, registers, flags, stack contents, and six user-definable memory locations.

Trace mode gives a running display of the Single-Step information and can be made to stop upon encountering any of nine user-definable conditions.

Background mode permits tracing with no display until it is desired. Debugged routines run at near normal speed until one of the stopping conditions is met, which causes the program to return to Single-Step.

Price: \$50

QUICKTRACE was written by John Rogers. QUICKTRACE is a trademark of Aurora Systems, Inc.

QUICKTRACE allows changes to the stack, registers, stopping conditions, addresses to be displayed, and output destinations for all this information. All this can be done in Single-Step mode while running.

Two optional display formats can show a sequence of operations at once. Usually, the information is given in four lines at the bottom of the screen.

QUICKTRACE is completely transparent to the program being traced. It will not interfere with the stack, program, or I/O.

QUICKTRACE is relocatable to any free part of memory. Its output can be sent to any slot or to the screen.

QUICKTRACE is completely compatible with programs using Applesoft and Integer BASICs, graphics, and DOS. (Time dependent DOS operations can be bypassed.) It will display the graphics on the screen while QUICKTRACE is alive.

QUICKTRACE is a beautiful way to show the incredibly complex sequence of operations that a computer goes through in executing a program

QUICKTRACE requires 3548 (\$E00) bytes (14 pages) of memory and some knowledge of machine language programming. It will run on any Apple II or Apple II Plus computer and can be loaded from disk or tape. It is supplied on disk with DOS 3.3.

FLIPPER

This long overdue device will switch any electrical signals, either from two inputs into a single output, or from a single input into either of two outputs.

The **FLIPPER** is usually used to switch between 40 and 80 column video displays. (Our word processor, The Executive Secretary, supports it automatically.)

The **FLIPPER** can switch your monitor between the Apple display and video tape, disc, or tuner. (Great enhancement for sorting routines!)

The **FLIPPER** mounts on the 'game bus', yet leaves it free.

The **FLIPPER** is available with the Apple shift key modification already in place. It requires no soldering, does not void your warranty, and mounts in seconds.

price, without shift key mod: \$50
with shift key mod: \$55

OMNISCAN™



The interface that provides the most revolutionary means of information retrieval since the printing press by combining these important technologies:

- 1) the Apple II computer,
- 2) the Pioneer VP-1000 Laser Video Disc,
- 3) and the Color Television.

The **OMNISCAN** interface is used to control the Pioneer LaserDisc player in an interactive way, with software running on the Apple II computer. The system can display information with color, motion, and stereo or bilingual sound under program control. It can teach, review, test, and grade material while allowing for individual learning rates. The branching capability of the computer gives unlimited flexibility in programming a learning sequence.

Price: \$ 250

Also from Aurora...

Versacalc (a Visicalc enhancement)

The Executive Secretary
(word processor extraordinaire)

The Rental Manager
(rental property management)

The Performance Manager
(an assessment of your work)

Hebrew II (עברית)

Educational Programs
(with emphasis on high school)

aurora systems, inc.

2040 East Washington Ave.

Madison, WI 53704

(608) 249-5875

QuickTrace, Omniscan, and The Performance Manager are trademarks of Aurora Systems, Inc. The Rental Manager is a trademark of Money Tree Systems, Inc. The Executive Secretary is a trademark of Personal Business Systems, Inc. Visicalc is a trademark of Personal Software, Inc. Flipper is a trademark of Instrument Interfaces, Inc. Apple II is a trademark of Apple Computer, Inc. VP-1000 LaserDisc is a trademark of Pioneer USA, Inc.

MICRO

Software Catalog

Name: Write-On III
System: Apple III
Memory: 96K
Language: Applesoft
Description: This word processor is designed to be easy to learn and use. *Write-On* has easy-to-remember commands; data can be inserted into the document as it is being printed, either from the keyboard or from *Write-On's* data files; margin settings can be altered with a single keystroke. Up to 99 files can be merged at the time of printing to create large documents. The program can read, edit, and print text files created by other programs. In addition, a formatted "screen draft" can be examined on the video monitor before printing a document.
Price: \$249.00
Author: Speicher Systems
Available: Rainbow Computing, Inc.
 Mail Order Dept.
 19517 Business Center Dr.
 Northridge, CA 91324
 (213) 349-0300

Name: COMAL Starter Kit
System: PET/CBM 8032 or 4032
Memory: 32K
Language: New
Hardware: Standard PET/CBM
Description: Complete 3-pass COMAL interpreter, user's manual, handbook, reference guide, diskette of sample programs, diskette of HELP files, and a one-year subscription to the *COMAL Companion* newsletter, complete with updates on COMAL. A complete package to get you started with COMAL.
Price: \$47.95 includes COMAL interpreter, 2 disks, manual, handbook, guide.
Author: Borge Christensen and Len Lindsay
Available: COMAL Users Group
 5501 Groveland Terrace
 Madison, WI 53716

Name: PFS Software Series
System: Apple II
Memory: 48K
Language: Pascal/Assembly
Description: *PFS*, the first program in the series, is an easy-to-use program that solves information storage and retrieval problems. The user designs a form on the screen and then uses that

form to enter, retrieve, modify, and print items of interest. *PFS: Report*, the second program in the series, is designed to work hand-in-hand with *PFS* to produce tabular reports from existing *PFS* files. It sorts, calculates, totals, formats, and prints the information in your *PFS* files. And, like *PFS*, all of these features can be used without any programming.

Price: PFS - \$95.00
PFS: Report - \$95.00 includes program diskette, user's manual, and backup certificate
Author: John Page and Jean Seal
Available: Software Publishing Corporation
 2021 Landings Drive
 Mountain View, CA 94043

Name: Aviculturist II Bird Classification Program
System: Apple II, II+
Memory: 48K with DOS 3.3 or 3.2 and FP installed
Language: Applesoft BASIC
Hardware: Apple II or II+ computer, DOS 3.2 or 3.3 with controller card. Printer optional.

Description: Retrieve single or groups of birds from more than 1,000 species. 150 U.S. bird data included as sample file. Output selection menu gives 3 choices of known data (26 U.S. habitat zones, size in inches and # of colors). Program will retrieve name of bird, order, size in inches, status (protected, endangered, historical), and delete command. Up to 9 colors, diets, zone of habitat around U.S.A., nest sight, nest structure and number of eggs. Intended for junior high to high school students for biology and other ornithological studies. Any bird watchers can store findings, retrieve or compare with others.

Price: \$35.00 for sample listing of 125 entries. \$50.00 for complete data listing of 1000 U.S. birds.
Author: American Avicultural Art & Science Inc.
Available: American Avicultural Art & Science Inc.
 3268 Watson Road
 St. Louis, MO 63143

Name: HSD STATS
System: Apple II or II+, DOS 3.2
Memory: 48K
Language: Applesoft
Hardware: Optional — printer with serial or parallel interface, Silentype or graphics printer

Description: A menu driven statistics package which accepts 7 samples of 200 points each. The package offers descriptive statistics, 10 data transformations, frequency distribution, percentile ranks and points, 1 or 2 variable Chi-Square, Correlation Matrix for up to 7 variables, 3 t-tests file creation from single or combined samples, arithmetic inter-sample manipulations, printing of raw data and results, Hi-Res bargraph and scattergram. Easy to use.

Price: \$99.95 includes disk, complete documentation, 3-ring binder
Author: Stephen Madigan, Ph.D.
 Virginia Lawrence, Ph.D.
Available: Selected computer stores or
 Human Systems Dynamics
 9249 Reseda Boulevard
 Suite 107
 Northridge, CA 91324
 (213) 993-8536

Name: Grafpak.MX100
System: Apple II
Memory: 32K minimum
Language: BASIC and 6502 ASM
Hardware: Disk II, Epson MX-100
Description: Dump either Hi-Res page horizontally at 1x or 2x, and vertically at 1x-4x. Dump both pages in perfect registration vertically at 1x-4x. Use normal or inverse inking, specify indent in inches. Compatible with most current I/O cards. Easy to use. Grafpaks available for Anadex, Integral Data, and other Epson printers.
Price: \$44.95 for disk and guide
Author: Robert Rennard
Available: Your dealer or SmartWare
 2281 Cobble Stone Ct.
 Dayton, Ohio 45431

Name: Hayden Applesoft Compiler
System: Apple II
Memory: 48K of RAM
Language: Applesoft
Hardware: Disk
Description: The *Hayden Applesoft Compiler* translates a standard Applesoft BASIC program into true machine code that runs from three to more than 12 times faster than normally interpreted code. The longer and more complex the original program, the greater

the increase in execution speed.
Price: \$200.00 includes binder with complete documentation, disk and protection device
Author: Jonathan Eiten
Available: The Hayden Book Co.
50 Essex Street
Rochelle Park, NJ 07662

Name: **0-2. Option Strategy Tables**
System: PET
Memory: 8K
Language: BASIC
Hardware: PET/CBM
Description: Tables are printed giving prices of various option strategies of puts and calls, and their combinations, for a list of underlying stock prices at three times to expiration.
Price: \$15.00
Author: Claud E. Cleeton
Available: Claud E. Cleeton
122-109th Ave., S.E.
Bellevue, WA 98004

Name: **BASIC A +**
System: Atari 800/400
Memory: 32K, but 48K strongly recommended
Language: Extended BASIC for the Atari
Hardware: Atari 810 disk drive(s)
Description: *BASIC A +* maintains compatibility with Atari BASIC while adding simple but powerful access to the unique Atari system of Player/Missile Graphics. The serious programmer will appreciate capabilities of *BASIC A +* which are unmatched on most micros: business-oriented features such as PRINT USING, RECORD I/O, and BINARY I/O, structured programming through IF... ELSE... ENDIF, etc.; and much more.
Price: \$80.00 BASIC A + ;
\$150.00 BASIC A + ,
OS/A + , Assembler/
Editor, and more
Author: Authors of Atari BASIC
Available: Your local Atari dealer or Optimized Systems Software
10379-M Lansdale Ave.
Cupertino, CA 95014
(408) 446-3099

Name: **Integer BASIC Compiler**
System: Apple II or II+ with Integer or Language Card, DOS 3.3
Memory: 32K or 48K
Language: 6502 machine code
Hardware: Disk II (preferably two drives)
Description: The *Integer BASIC Compiler* is a fully optimized compiler/run-time system for Apple's Integer BASIC.

Numerous extensions include: CHR\$, GET KEY functions, HOME, CLEAR, INVERT, NRML, FLASH, and 8 other new keywords for Hi-Res graphics. Supports a string length of 32767 (instead of 255). Compiler generates a mix of 6502 and 'GSL' code (more efficient than P-code). Speed/Space optimization selection — IBC is the fastest compiler/run-time system available for the Apple. Existing BASIC programs can be easily converted to run on any Apple II.

Price: \$149.50 includes complete documentation. Software supplied on two disks.
Author: Christopher Galfo
Available: Galfo Systems
6252 Camino Verde
San Jose, CA 95119

Name: **Catalog**
System: PET/CBM
Memory: 8K and data storage
Language: BASIC
Hardware: No extra
Description: Keeps a catalog of books, records, stamps, etc. on tape and retrieves selectively by fields. Five fields provided, including one that holds up to 5 "category" identifiers for later retrieval.
Price: \$16.95 includes cassette and manual
Available: Optimized Data Systems
P.O. Box 595
Placentia, CA 92670

Name: **Orbitron**
System: Apple II or II+
Memory: 48K
Language: Machine
Hardware: Disk drive, 13 or 16 sector controller
Description: This game places you in the center of an orbiting space station protected by a revolving force shield. The object is to fight off enemy forces which attempt to place killer satellites in orbit around your station. The game has seven levels of play, easy-to-use keyboard control, and super-fast high-resolution color graphics. The sound effects are incredible.
Price: \$29.95 includes disk and documentation

Author: Eric Knopp - Presented by Sirius Software, Inc.
Available: Your local Apple dealer or software store

Name: **TransFORTH II**
System: Apple II, II+, and III
Memory: 48K/Apple II
Language: 6502 Machine Language
Hardware: Disk drive required
Description: TransFORTH II is an extended, fully compiled version of the FORTH language. It features floating

point arithmetic; transcendental functions; strings and arrays; Hi-Res, Lo-Res, Turtlegraphics; and music.
Price: \$125/introductory offer includes disk and manual
Author: Paul Lutus
Available: Insoft
259 Barnett Road, Unit #3
Medford, Oregon 97501

Name: **Compu-Read 3.0**
System: Apple II, II+; Atari 800
Memory: 48K
Language: Applesoft; Atari BASIC
Description: Contains a series of instructional modules which build learners' skills by strengthening the perceptual processes essential to competent reading.
Price: \$29.95 each, includes documentation
Available: EDU-WARE Services
22222 Sherman Way,
Suite 203
Canoga Park, CA 91303

Name: **SwordThrust**
System: Apple II or II+
Memory: 48K
Language: Applesoft
Hardware: One disk drive
Description: *SwordThrust* is an exciting new fantasy role-playing system designed for the Apple II. Unlike previous adventure series, *SwordThrust* is an integrated system of quests. The battles you fight and the gold you gather in one cave will affect you in the next. *SwordThrust* currently consists of the Master Diskette (which includes *Adventure #1* and must be used to run any other adventure) and *Adventures #2 through #4*.
Price: \$29.95 for the Master Diskette, \$24.95 for the Adventure Diskettes
Author: Donald Brown
Available: CE Software
801 73rd Street
Des Moines, Iowa 50312

Name: **SEGS**
System: OSI
Memory: 24K
Software: OS65D
Hardware: Disk
Description: Adds segmentation commands to BASIC. Allows segment calls (like GOSUBs) to subroutines stored on disk. By nesting calls, large programs may be written and will run in 24K memory. Write to address below for more information.
Price: \$25.00
Available: Universal Systems
2020 W. County Rd. B
Minneapolis, Minnesota
55113

6502 Bibliography: Part XXXVII

1077. *Recreational Computing* 9, No. 5, Issue 50 (March/April, 1981)

- Berggren, Stephen R., "Dozo," pg. 6-7.
An Apple Pascal program in Turtle graphics.
- Conlan, Jim, "Programs, Problems and Solutions,"
pg. 29-31.
A collection of short routines for Atari micros.

1078. *Apple-Dillo* (February, 1981)

- Teas, George, "Short Notes on Pascal," pg. 4.
Technique to get a PRINTER:list on your Pascal disk files.
- Pickens, Rodney, "A Lagniappe," pg. 5.
Notes for Pascal users.
- Teas, George, "Pascal Primer," pg. 6.
A library of special disks for Pascal users.
- Bartley, David, "A Formatting Lister For Applesoft Programs," pg. 7-9.
A prettyprint routine for the Apple, with an accompanying example listing for a cryptogram program.

1079. *KB Microcomputing* 3, No. 5, Issue 51 (March, 1981)

- Baker, Robert W., "Pet-Pourri," pg. 8-11.
Discussion of the Pro Kit #1 for the PET; Word Pro utility; etc.
- Derfler, Frank J., "Dial-Up Directory," pg. 18-20.
More on the ABBS and PMS systems for bulletin boards based on the Apple.
- Hubbard, Bill, "Cheap, Dumb Apple," pg. 65-66.
How to use an inexpensive modem board with the Apple.
- Miles, Kenneth, "Auto-Menu for the Apple II," pg. 68-70.
Make the access to your programs on Apple Disks a little easier.
- Antonelli, James A., "Faster Baud Rate for the Superboard II Cassette," pg. 112-114.
A simple hardware mod to allow you to save and load at 600 baud.
- Ratliff, Gary L., "PET Shorthand Complete,"
pg. 144-148.
Abbreviated keywords for early PETs.

1080. *The Target* (November/December, 1980)

- Sellers, George, "Music," pg. 2-3.
A translation for the AIM from a KIM routine, showing how to use the 6522 timer in place of the KIM's 6530 timer. With two song tables.
- Kaynor, Doug, "Tape Recorder," pg. 3.
A hardware mod for the AIM tape system.
- Hall, Dale L., "Memory Test," pg. 9.
A dynamic memory test in zero page for the Aim-65.

1081. *The Apple Barrel* 4, No. 1 (January, 1981)

- Gilbreth, Lee, "File Cabinet Valid Feature," pg. 4-6.
Some further additions for this useful utility.

1082. *L.A.U.G.H.S.* 3, No. 2 (February, 1981)

- Roe, David, "There is a Better Way," pg. 3-7.
All about saving a Hi-Res picture in Pascal on the Apple.
- Finn, Mike, "Outputting Strings in Assembly Language Programs," pg. 8-11.
An instructional article on machine language.

1083. *Interface Age* 6, Issue 3 (March, 1981)

- Baker, Al, "Game Corner," pg. 22-26.
Music program for the Atari microcomputer.
- Moore, Herb, "Sounds of the Atari... In BASIC,"
pg. 56-60.
Fundamentals of programming the Atari for music generation.

1084. *Creative Computing* 7, No. 3 (March, 1981)

- Greenberg, Gary, "Wordpro 1 vs. CMC," pg. 26-27.
Two programs for the PET on word processing.
- Ripin, Peter and Narayan, Krishna, "A PET Lizard," pg. 78.
A hand-eye coordination game for the PET.

1085. *The Apple Orchard* 1, No. 3 (Winter, 1980-1981)

- Golding, Val J., "Print FRE(ed)," pg. 7.
Comments on copying copyrighted software.
- Rowe, Pete, "A BASIC to Machine Language Interface,"
pg. 11-19.
Joining an interactive BASIC language shell to a machine language, computational viscera.
- Clardy, Robert C., "Applesoft Program Listing Formatter," pg. 21-27.
Tidy up your program listings and make them easier to read.
- Hyde, Randy, "Locations of Interest to Pascal and 6502 Users," pg. 28.
The listed addresses should be of interest to Apple/Pascal users.
- Haines, Ron, "Some Notes About the UCSD Assembler,"
pg. 35, 39.
Notes for Apple/Pascal users.
- Eisenberg, J.D. and Hertzfeld, A.J., "Inside the Silentype Firmware," pg. 43-52.
Useful information for Silentype printer users, interface routines, etc.
- Wozniak, Steve, "Binary-To-Decimal Shortcut,"
pg. 52-53.
A better and faster conversion routine for the Apple.
- Crossley, John, "Tabbing with Apple Peripherals," pg. 55.
Tabbing routines for Apple printers.
- Hoyt, Jim, "Apple Writer and the Telephone," pg. 56-57.
A quick and easy way for transmitting Apple Writer files over the telephone to another Apple.
- Kellner, Jo and Kellner, Charles, "Converting Strings to Numeric Variables," pg. 59-61.
A unit for the Apple/Pascal system.
- Kellner, Jo, "Pascal Run-Time Errors," pg. 62.
A simple program for Apple/Pascal users.

(Continued on next page)

Brown, Tom, "POKE Salad," pg. 69-71.

A formatter routine for the Apple.

Evans, Frank, "Using USR," pg. 75.

An instructional article on the USR function with an example program.

1086. Peek(65) 2, No. 2 (February, 1981)

Holt, Ken, "Assembler Programmer's Guide to OSI Board Interfacing," pg. 9-12.

Information for those designing I/O interfaces for the OSI systems.

Jones, David A., "Cassette Corner," pg. 15.

Notes on CHECKBYTE; viewing contents of another tape about to be loaded; terminal operations; etc.

1087. The G.R.A.P.E. Vine 2, No. 1 (February, 1981)

Lawson, Steve, "Direct Disk Read and Write," pg. 4-5.

Routines to directly write to and read back from specified disk sectors, including an example program "Verse by Verse," for the Apple.

Trusty, Doug, "GHR2 Fonts," pg. 6.

A program to convert a 'Higher Text' large-size font to a 'GHR2' large-size font, for the Apple.

1088. The Apple Peel 3, No. 3 (March, 1981)

Brown, Tom, "POKE Salad," pg. 6.

Telephone dialing routine; sorting phone lists; etc.

Donahue, Thomas D., "Printer Chatter," pg. 9.

How to interface the Apple II to a Radio Shack Daisy Wheel II printer using the Centronics Apple Parallel Board.

1089. Nibble 2, No. 1 (February, 1981)

Hill, Alan G., "Amper-Reader," pg. 23-37.

A machine language routine for ROM Applesoft that will improve the read time for string array variables. An instructional article and program, demo, etc.

Riley, Kevin D., "Apple Communicator for the Handicapped," pg. 47-51.

Program listing and hardware suggestion for allowing the handicapped to communicate via the Apple.

Reynolds, William III, "Tricks While Using Text Files with BASIC Programs," pg. 53.

Tips on using the text files.

Wagner, Roger, "Use of HGR vs. HGR2 on the Apple II," pg. 55.

How to decide which HGR page should be used on the Apple.

Harrell, Keith, "Pascal Pointers and Principles," pg. 63-69.

Procedures and functions and how they can be used in writing and debugging Pascal programs.

Szetela, David, "Auto Run and Tape Software Protection," pg. 73.

Information on techniques used to protect software.

Harrell, Keith, "An 80-Column Display for the Apple: A Reality or a Fantasy?," pg. 77-78.

A comparison of available 80-column boards for the Apple.

1090. Byte 6, No. 3 (March, 1981)

Zimmermann, Mark, "A Beginner's Guide to Spectral Analysis, Part 2," pg. 166-198.

A 6502 assembly language program for the PET in which any reasonable function may be expressed as a sum of sines and cosines of various frequencies.

1091. Apple/Sass (March, 1981)

Fan, Kenny, "Printing the Unprintables Within Print Statements," pg. 7-8.

Three approaches to this task on the Apple.

Norris, Paul, "Using Your Printer from Pascal," pg. 16-17.

A 'how-to' article for Apple/Pascal users.

Bromback, Randy, "Once Upon A Function," pg. 19-20.

An instructional article on the use of the Applesoft user-defined function, with examples.

Murdoch, David M., "Ampersand Catalog," pg. 21.

A short routine to catalog with just the ampersand key, on the Apple.

Hartley, T., "Extended Catalog," pg. 25.

A short program to continue the catalog on Apple Disks so up to 181 files can be entered on the disk.

1092. Dr. Dobb's Journal 6, Issue 3, No. 53 (March, 1981)

Whitlock, Howard W., "Analysis of the Use of the 6502's Opcodes," pg. 11-13.

Frequency of use of the 151 different opcodes of the 6502 microprocessor, based on the 6,355 or so instructions in PET BASIC.

1093. Microcomputer Index 1, No. 4 (October-December, 1980)

A subject index covering over 1,000 microcomputer magazine articles, many relating to the 6502 microprocessor.

1094. OKC Apple Times @ Issue 2 (February, 1981)

Simpson, David A., "Meet Special Characters."

Four ways to print those special characters (underline, backslash, left bracket) on your Apple.

1095. Call -A.P.P.L.E. 4, No. 2 (February, 1981)

Pump, Mark, "DOS Internals: An Overview," pg. 8-12.

The first part in a continuing major series on the Apple DOS.

Thompson, J.C., "Universal Update," pg. 14-16.

A routine that updates any 13-sector diskette so it will boot in either a 13- or 16-sector environment.

Balderson, Robert, "Converting Dakin's Patcher to DOS 3.3."

A patch for the Dakin's Patcher routine to enable it to read all 16 sectors of any DOS 3.3 diskette on the Apple.

Landsman, Richard and Horton, Richard, "DOS 3.3/3.2 Boot Switch," pg. 22.

A hardware mod that allows the CTRL key to be used to switch between Apple diskette controller prompts.

Crawford, Tom, "Applesoft Random Function," pg. 24-27.

An article dealing with a characteristic of the Applesoft Random function in which a malfunction was found after about 10,000 accesses.

DeGroat, Ron, "Seeing Double with Pascal Graphics," pg. 30-33.

MICRO

Now You Have "The Choice"

Reliability, Quality and Performance at a reasonable Price. Systems International, Inc. is pleased to offer an alternate to Ohio Scientific microcomputers. Our systems are 100% compatible to OSI OS-65D and OS-65U software to preserve your software development investment. Just load your present floppies and run; no conversion of software needed or required. Compare the Following Facts and Make "The Choice."

Ohio Scientific, Incorporated Standard Features C2-OEM

48K Memory, 1 MHz
One Serial Port
Dual 8" Single Sided Floppies
Plug in Boards with Many Connections
120 Volt 60, Hz Operation Only
90-Day Warranty
Weight 80 Pounds
Size W17" × H9½" × D23½"

Extra Cost Items

Second Serial Port
Parallel Port
2 MHz

Systems International, Incorporated Standard Features The Choice II

48K Memory, 2 MHz
2 Serial Ports, 1 Parallel Port
Dual 8" Double Sided Floppies
Single Board Construction for Reliability
120/240 Volt 50/60 Hz Operation
180-Day Warranty
Weight 40 Pounds
Size W12½" × H13½" × D16"
Shippable by UPS in Factory Carton

Extra Cost Items

None

Now Compare the Bottom Line and Make "The Choice"

Total Retail \$4,925.00 *

Total Retail \$4,525.00
240 Volt 50 Hz Operation add \$50.00

Future plans include the "Choice III" which is 100% compatible to the OSI C2-D 8" Winchester System. Also Multi-user Winchester Hard Disk System that is 100% compatible with Ohio Scientific OS-65U Level 3 Software.

REMEMBER — THERE IS "THE CHOICE" TO CHOOSE A BETTER SYSTEM!

Domestic and International Dealer and Distributor Inquiries are Invited. Discounts to 40%

* Ohio Scientific Price List June/July 1981

Systems International Incorporated

15920 Luanne Drive
Gaithersburg, Maryland 20760
U.S.A.
Tel. (301) 977-0100 Twx# 710-828-9703



500 Chesham House
150 Regent Street
London W1R 5.F.A England
Tel. 01-439-6288 Tlx 261426



NO NONSENSE BOOKS

A GENERAL LEDGER SYSTEM FOR THE APPLE COMPUTER

- ★ WE'VE KEPT IT SIMPLE FOR YOU
- ★ EASY TO LEARN AND USE
- ★ SETUP AND RUN IN 10 MINUTES
- ★ 50 SUGGESTED ACCOUNTS
- ★ 5 PROFIT CENTERS
- ★ 2 CHECKBOOK ACCOUNTS
- ★ JOURNAL AND CHECK RECORDS
- ★ BALANCES CHECKBOOKS
- ★ INSTANT PROFIT AND LOSS STATEMENTS
- ★ 1-7 MONTHLY REPORTS

APPLESOFT—2 DISK DRIVES,
132 COL. PRINTER, 48K MIN. REQ. \$225.00
HANDBOOK WITH SAMPLE REPORTS 5.00

VISA & M/C USERS—CALL MONEY DISK
(509) 943-0198 P.O. BOX 1531
RICHLAND, WA 99352



APPLE IS A REGISTERED TRADEMARK
OF APPLE COMPUTER, INC.
WA Residents, add 5% sales tax
DEALER INQUIRIES INVITED



SOFTWARE FOR OSI

- ★ **VIDEO GAMES 3** **NEW!** \$14.95
Three games. Meteor Mission is an asteroids game. Space Wars is a battle between two starships. Meteor Wars is a combination of the two above games. All three are in machine language with fast, real time action, and super graphics.
- ★ **ADVENTURE: IMMORTALITY** **NEW!** \$11.95
You are an intrepid explorer searching for the fabled "Dust of Immortality". This is the largest adventure yet available for 8K OSI! With hidden room load so you can't cheat.
- ★ **SUPER BUG!** \$6.95
Here's a super-fast, BASIC/Machine language hybrid race game. Ten levels of difficulty and a infinitely changing track will keep you challenged.
- ★ **STARGATE MERCHANT** \$9.95
You are a trader in the distant future, traveling through 'stargates' to get to various star systems. Part video game, part board game, always challenging.
- ★ **ADVENTURE: MAROONED IN SPACE** \$11.95
An adventure that runs in 8K! Save your ship and yourself from destruction.
- ★ **DUNGEON CHASE** \$9.95
A real-time video game where you explore a twenty level dungeon.
- ★ **DISASSEMBLER** \$11.95
Use this to look at the ROMs in your machine to see what makes BASIC tick. Reconstruct the assembler source code of machine language programs to understand how they work. Our disassembler outputs unique suffixes which identify the addressing mode being used, no other program has this!
- ★ **SUPER! BIORHYTHMS** \$14.95
A sophisticated biorhythm program with many unique features.



For all BASIC-in-ROM systems. Selected programs available on disk. Color and sound on video games.

Write for **FREE** catalog
(For International requests, please supply 2 oz. postage)



ORION SOFTWARE ASSO.
147 Main St. Ossining, NY 10562

PRICE BREAKTHROUGH

16K RAM BOARDS FOR

APPLE JUST \$129.95



HAVE YOU BEEN WAITING FOR THE COST OF EXPANSION BOARDS TO COME DOWN? YOUR WAIT IS OVER. UP UNTIL NOW RAM EXPANSION HAS COST AS MUCH AS \$195.00. NOW OMEGA MICROWARE IS PROUD TO ANNOUNCE THE ARRIVAL OF A TRULY AFFORDABLE EXPANSION CARD.

NOW YOU CAN RUN PASCAL, FORTRAN, 56K CPM WITH A Z80 SOFTCARD, INTEGER BASIC, APPLESOFT AND OTHER LANGUAGES ON YOUR APPLE. NOW YOU CAN INCREASE USUABLE MEMORY FOR VISICALC. NOW YOU DON'T HAVE TO PAY A FORTUNE TO HAVE ALL THIS.

AT \$129.95, OMEGA'S RAMEX 16 IS THE LOWEST PRICED CARD AVAILABLE TODAY.

WHAT DO YOU GIVE UP WHEN YOU PURCHASE THIS FIRST REALLY AFFORDABLE RAM EXPANSION CARD? WELL, YOU GIVE UP HAVING TO REMOVE ONE RAM CHIP FROM THE MOTHER BOARD OF YOUR APPLE. YOU GIVE UP HAVING TO STRAP A CABLE FROM THE CARD TO YOUR MOTHER BOARD. THAT'S IT. WHAT YOU GET IS A SIMPLE, RELIABLE, BOARD THAT JUST PLUGS IN. MEMORY REFRESH IS ACCOMPLISHED ON THE BOARD ITSELF.

THE RAMEX 16 IS GUARANTEED NOT JUST FOR 90 DAYS. NOT EVEN 6 MONTHS. OUR WARRANTY IS FOR ONE FULL YEAR FROM DATE OF PURCHASE. WE WILL REPAIR OR REPLACE ANY BOARD THAT IS DEFECTIVE THROUGH MANUFACTURE FOR A PERIOD OF ONE YEAR AFTER PURCHASE PROVIDED THIS DAMAGE IS NOT USER INFLICTED.

ORDER YOUR RAMEX 16 NOW BY CALLING TOLL FREE 1-800-835-2246. KANSAS RESIDENTS CALL 1-800-362-2421. MASTERCARD OR VISA ACCEPTED OR SEND \$129.95. ILLINOIS RESIDENTS ADD \$7.80 SALES TAX

ANOTHER QUALITY PRODUCT FROM OMEGA MICROWARE, INC. FORMERLY OMEGA SOFTWARE PRODUCTS, INC. 222 SO. RIVERSIDE PLAZA CHICAGO, IL 60606 PHONE 312-648-1944

©OMEGA MICROWARE, INC. APPLE AND APPLESOFT ARE REGISTERED TRADEMARKS OF APPLE COMPUTER, INC. PASCAL IS A REGISTERED TRADEMARK OF THE REGENTS OF THE UNIV. OF CA. SAN DIEGO. VISICALC IS A REGISTERED TRADEMARK OF PERSONAL SOFTWARE. CPM IS A REGISTERED TRADEMARK OF DIGITAL RESEARCH INC. Z80 IS A REGISTERED TRADEMARK OF ZILOG, INC. SOFTCARD IS A REGISTERED TRADEMARK OF MICROSOFT.

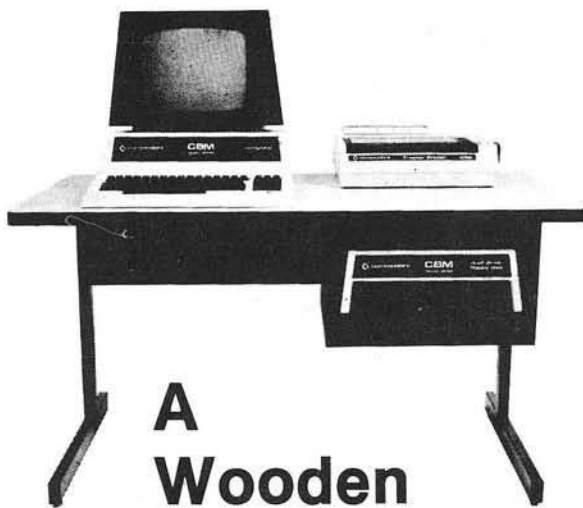

A Wooden Computer?

Not from Commodore!

So why should the desk look like wood? A pleasant cream and charcoal trimmed desk looks so much better with Commodore systems. One look and you'll see. Interlink desks are right. By design.

The specifications only confirm the obvious:

- Cream and charcoal color beautifully matches the Commodore hardware and blends with your decor.
- An ideal 710 mm (28") keyboard height yet no bumping knees because a clever cutout recesses the computer into the desk-top.
- High pressure laminate on both sides of a solid core for lasting beauty and strength.
- Electrostatically applied baked enamel finish on welded steel legs—no cheap lacquer job here.
- T-molding and rounded corners make a handsome finish on a durable edge that won't chip.
- Knocked down for safe, inexpensive shipment.
- Patented slip joints for quick easy assembly.
- Leveling glides for uneven floors.
- Room enough for a Commodore printer on the desk, yet fits into nearly any den or office niche—H: 660 mm (26") W: 1170 mm (46") D: 660 mm (26").
- Matching printer stand available with slot for bottom feeding.

PRICE: \$299

In short, as Commodore dealers, we won't settle for anything that looks good only in the catalog! Our customers won't let us. They don't buy pictures. And neither should you. This is why **we will let you use one of our desks for a week** and then decide. If for any reason you don't like it, just return it in good condition for a cheerful refund.

If your Commodore dealer doesn't carry our desks yet, send a check for \$299 and we will ship your desk freight paid!

Name

Address

City St Zip

Interlink, Inc., Box 134, Berrien Springs, MI 49103
Master Charge and Visa welcome. Call our order line:
616-473-3103

MICRO

Advertiser's Index

Aardvark Technical Services.....	23
Abacus Software.....	110
Advanced Operating Systems.....	IBC
Andromeda, Inc.....	87
Atari, Inc.....	17
Audio-Visual Club.....	52
Aurora Software Assoc.....	27
Aurora Systems.....	120
Avant-Garde Creations.....	13
Beta Computer Devices.....	62
Broderbund Software.....	95
Call A.P.P.L.E.....	112
Classified Ads.....	114, 115, 116
Columbus Instruments.....	102
Community Computerist's Directory.....	16
CompuTech.....	21
Computer Case Co.....	74
Computer Mail Order.....	99
Computer Station.....	106
Computer Systems Consultants.....	74
Connecticut Information Systems, Co.....	4
Consumer Computers.....	14
Creative Computing.....	107
Decision Systems.....	106
D&N Microproducts Inc.....	34
Dosware Inc.....	105
Eastern House Software.....	56
Enclosures Group.....	104
Exatron.....	8
Execom Corp.....	67
Fessenden Computer Service.....	119
Galfo Systems.....	106
Gimix, Inc.....	71
Highland Computer Service.....	119
Hogg Laboratory Inc.....	32
Hudson Digital Electronics.....	79
Human Engineered Software.....	53
Huntington Computing.....	BC
Innovative Design Software, Inc.....	81
Interlink, Inc.....	127
Jini Micro Systems.....	49
Lazer Systems.....	117
LJK Enterprises.....	91
Logical Software, Inc.....	98
Micro Co-Op.....	113
Micro Distributors.....	120
MICRO INK, Inc.....	33, 75
Microsoft Consumer Products.....	IFC, 97
Micro-Ware Distributing Inc.....	85
Mittendorf Engineering.....	28
Modular Systems.....	34
Money Disk.....	126
Nibble.....	99
Omega Microware.....	34, 126
Orion Software.....	126
Pegasys Systems.....	36
Percom Data Co., Inc.....	7
Perry Peripherals.....	21
Progressive Computing.....	74
R.C. Electronics.....	47
Rosen Grandon Associates.....	93
Sensible Software.....	86
Sirius Software.....	37-44
Skyles Electric Works.....	36, 47, 69
Small Business Computer Systems.....	93
Smoke Signal Broadcasting.....	11
Software Sorcery, Inc.....	98
Stellation Two.....	73
Sublogic Communications.....	1
Synergistic Software.....	22
Synertek Systems.....	2
Systems International.....	125
Technical Products.....	119
Terrapin, Inc.....	93
Unique Data Systems.....	111
Versa Computing.....	82

Next Month in MICRO

Games Bonus Section

- **Saucer Launch** — A game exploring the special hardware of the Atari 800. You as the gunner's apprentice and one of the few remaining survivors of the Starfleet patrol must destroy at least 60 percent of the attacking squadron of robot saucers while they are being launched.
- **Lunar Lander Animated Graphics in BASIC for the Color Computer** — This article on the TRS-80 Color Computer uses the game Lunar Lander to demonstrate high-speed animation through the use of Microsoft's Extended Color BASIC.
- **The Ultimate Ping-Pong for the PET** — This machine language version of the popular ping-pong game, playable on any PET, serves as an example of high-speed animation techniques.
- **Othello** — This game of strategy for two players using an Apple II was designed to simulate the popular board game of the same name.

Apple Bonus Section

- **Apple Bits: Part 3** discusses how to create "animations" for the low resolution screen.
- **ASCII Dump for the Apple** presents an assembly language program that extends the "Examine Memory" routine in the Apple monitor.
- **FDGEN** describes a program for building Applesoft subroutines to handle keyboard input, display output, file input/output/update, sorts and PRINT USING.
- **ROM Applesoft PRINT USING** helps readers easily format the output of numeric variables with decimals lined up, trailing zeros added, and commas inserted.

Other November Articles

Other articles scheduled for November include *OS-9 and the 6809: Revolutionary Tools*; *General BASIC-Machine Language Interface* (for the AIM); and *Pascal Tutorial*, the first in a three-part series designed with the beginner in mind.

40% OFF

More MICRO for Less Money When You Subscribe

Your money goes farther when you subscribe. During the course of a year, when you subscribe, you save 40% (in the U.S.).

Pay only \$18.00 (\$1.50 a copy) for 12 monthly issues of MICRO sent directly to your home or office in the U.S.

But on the newsstand — if you can locate the issue you want — you pay \$30.00 a year (\$2.50 a copy).

Save 40% **and** make sure you get every issue. Subscribe to MICRO today.

MICRO
34 Chelmsford Street
P.O. Box 6502
Chelmsford, MA 01824

Please send me MICRO for 1 year 2 years
 NOTE: Airmail subscriptions accepted for 1 year only.

Check enclosed \$ _____
 Charge my VISA account
 Mastercard account

No. _____

Expiration date _____

Name _____

Address _____

City/State _____ Zip _____

Subscription Rates

1 Year*

Country	Air	Surface
United States		\$18.00
Canada		21.00
Europe	\$36.00	21.00
Mexico, Central America	39.00	21.00
Middle East, N. Africa	42.00	21.00
S. America, Central Africa	51.00	21.00
S. Africa, Far East, Australasia	60.00	21.00

* Airmail subscriptions accepted for only 1 year. For U.S. and Canadian 2-year rates, multiply by 2.

Job Title: _____

Type of Business/Industry: _____

JUST LAUNCHED! VOYAGE OF THE VALKYRIE

BY LEO CHRISTOPHERSON

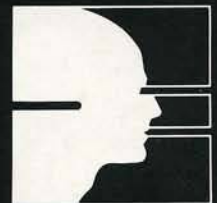
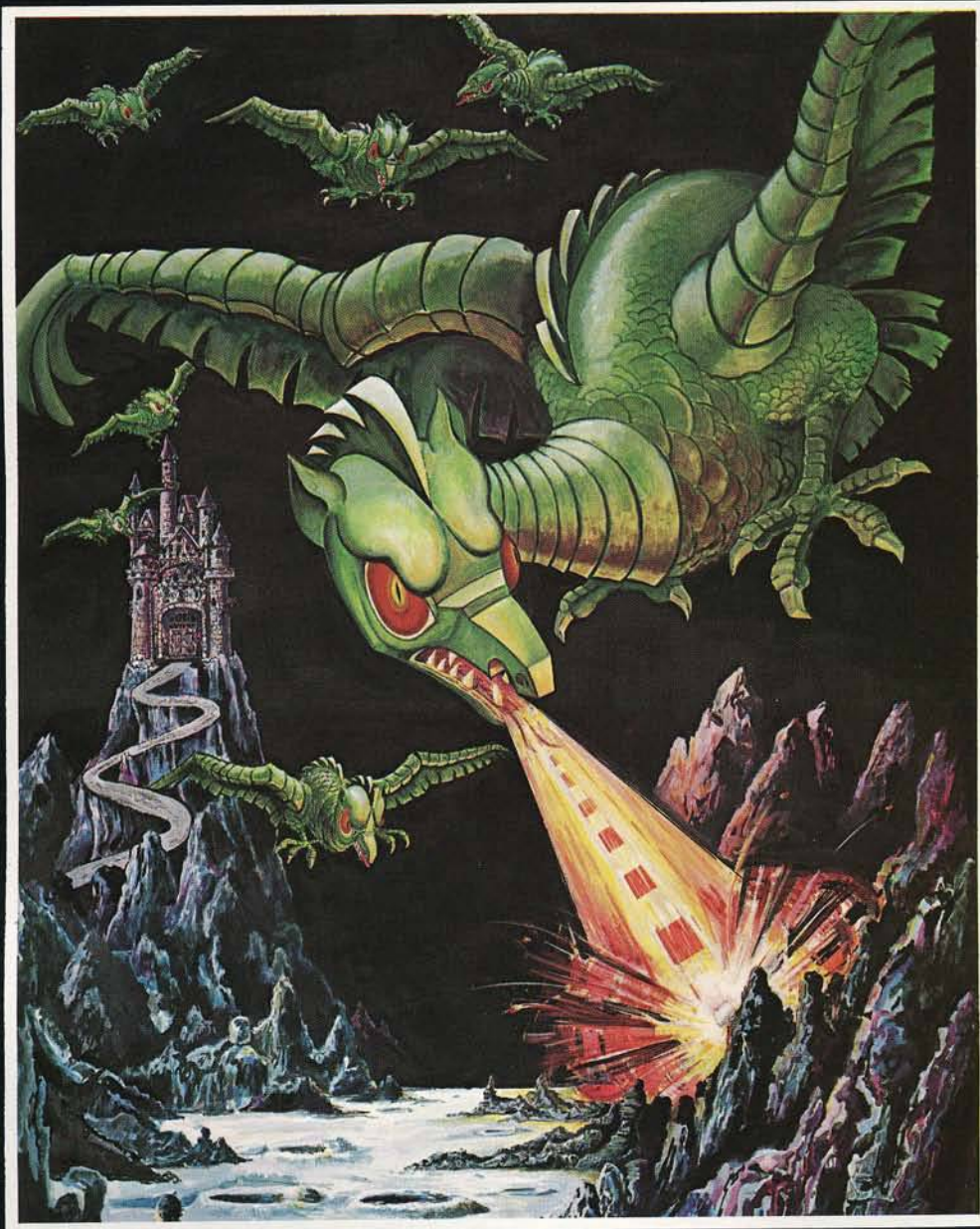

ADVANCED OPERATING SYSTEMS

450 St. John Road
Michigan City,
Indiana 46360

Now available
at your local
software retailer,
or call
1-800-348-8558
for the nearest
dealer.

The ancient Norse lords bravely sailed their ships across new waters in search of adventure. No obstacle was too great to overcome nor any force powerful enough to prevent their mighty advance. ■ Now you're in command. You are the pilot of the attack ship Valkyrie. Your mission: to wrestle the island Fugloy from the grasp of an army of laser-wielding war birds and secure the golden treasures hidden within the walls of the island castles. Success of the mission depends solely upon you. The castle Drage appears on the horizon when suddenly the air is alive with the flutter of giant wings. Your prize is in sight . . . do you dare accept the challenge and go on? ■ You can put yourself at the controls of the Valkyrie thanks to the genius of Leo Christopherson. As absolutely flickerless birds sail smoothly across the screen, strains of Wagner's "Ride of the Valkyries" are heard. The game offers 10 levels of difficulty which provide a challenge for players of all ages and skills. The game also provides one of the finest examples of computer cartoon-graphics presently available. Voyage of the Valkyrie is available for *TRS-80 and †Apple Microcomputers. Brave old worlds and battle new adversaries when you accept the challenge of the Valkyrie.

*Trademark of Tandy Corp.

†Trademark of Apple Computer, Inc.

HUNTINGTON COMPUTING

ONE OF THE WORLD'S LARGEST INVENTORIES

Limited Time Only

Visidex

List 200.00

Now **139⁰⁰**

(Please mention this ad when ordering) Expires Dec. 31, 1981

Personal Software, Brand New, Shrink Wrapped. Immediate Delivery. \$2.00 Shipping (for total Software order). No Hidden Charges. No Gimmicks.



Also

Atari®

Pet®

TRS-80®

Huge

Inventory

The World's Most Remote Computer Store! This is the Huntington Computing gang in the cotton field across the street from our 3300 square foot store in Corcoran, CA. We may be in the country but we believe we have the world's largest selection of microcomputer software. And, we accept School Purchase Orders.

SPECIALS

Visicalc List 200.00Now **\$149.00**
Pegasus II List \$29.95NOW **\$22.99**
S-C Assembler II List \$55.00NOW **\$46.69**
Microsoft Z-80 Card List \$395NOW **\$299.00**
D.C. Hayes Micromodem II List \$375 NOW **\$299.00**

NEC 12" Green/Black Monitor
List \$285, NOW **\$239.00**

**Andromeda or Microsoft
16K Expansion Board**
List \$195, NOW **\$169.00**

All Educational Software
15% off list

Call Toll-Free **800-344-4111** (Outside California)

HUNTINGTON COMPUTING, Dept. MC-1
Post Office Box 787
Corcoran, California 93212

Order by Phone 800-344-4111
In California (209) 992-5411

SUPER DISCOUNTS

 **apple** SOFTWARE



We take MasterCard or VISA (Include card # and expiration date). California residents add 6% tax. Include \$2.00 for postage. Foreign and hardware extra. Send for free catalog. Prices subject to change.

Apple is a registered trademark of Apple Computer Co.