

Official Monthly Publication of the Society for Information Display

INFORMATION DISPLAY

September 1988
Vol. 4, No. 9

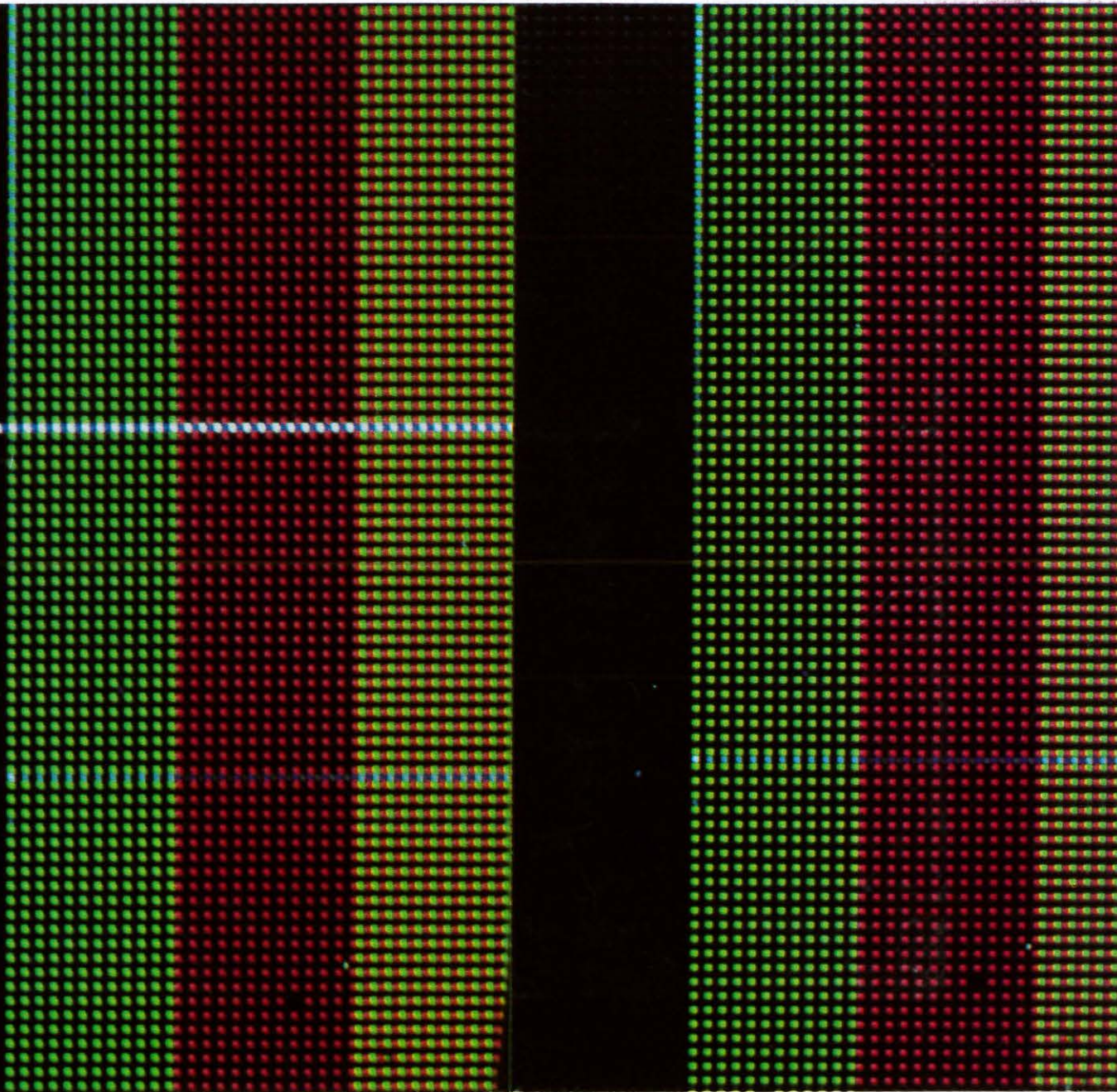

Industry directory
Laser repair of LCDs
Ruggedized color CRTs

Non-Profit Organization
U. S. Postage
PAID
Phillipsburg, N. J.
Permit No. 187

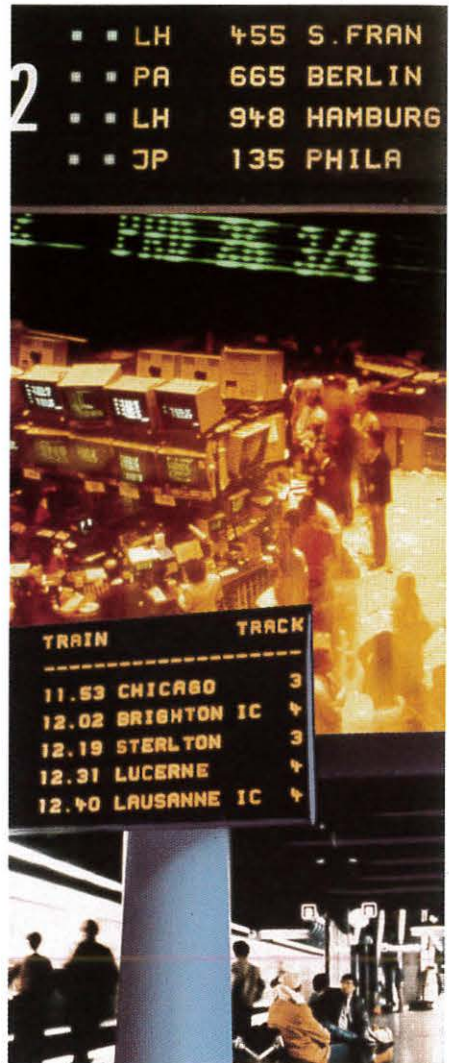

**LCDs from AEG...
any way you look
at them,
they're clearly
superior**

Engineers throughout the world have specified AEG custom designed LCDs when their display requirements demanded the best technology available. Our displays are highly engineered to perform under the most stringent environmental conditions.

Reliability and long life is provided by our chip-on-glass technology, eliminating the need for interconnecting to a PCB. The result is an LCD only 3mm in thickness that is completely shock and vibration resistant with an operational temperature range of -55°C to $+95^{\circ}\text{C}$ (w/heater).

If you are looking for the best in LCDs for automotive, for avionic/military or for public display applications, such as airports and financial centers (stock exchanges)... you should look to AEG where clear viewing, at any angle is superior...

For more information contact:
AEG Corporation, Route 22 — Orr Drive
PO Box 3800, Somerville, NJ 08876-1269
(201) 231-8300

*Instrument panel in first column,
courtesy of Borg Instruments

AEG

For Video Display Performance Testing,

Vii offers the
Best of Both Worlds...
so simple to use,
yet such flexibility!

You don't have to learn
a foreign language,
give up your lunch hour,
even sacrifice a coffee break
to get this unit "on line".



Vii Model 2701
Pattern Master™

- Full 8 bit color palette to 125 MHz.
- 2048 × 1024 —2 megabytes of active pattern memory.
- RGB Video at standard level and impedance.
- Operator, time and date overlay.
- Instant pattern and scan rate recall.
- Amazing low price—just \$7500.

Vii's Model 2701 offers you selection of patterns and scan rates right on the front panel, conspicuously marked. No searching, no tweaker knobs, no tiny front panel keypads or itty-bitty displays. Yet, a quick connection to a terminal or personal computer opens your world to **complete** flexibility, with all of this at your fingertips:

- Complete pattern directory.
- Complete raster directory.
- On-line instruction manual.
- Routines that walk you through each step of constructing your own rasters, or of designing your own patterns.

The price is equally amazing—just \$7500. Put a Pattern Master to work for you. Call Vii today for more information or a personal demonstration.



The Video Test Specialists

PO Box 33 • 719 Lower Bellbrook Road • Xenia, Ohio 45385-0033 • Telephone 513/376-4361

© Visual Information Institute, Inc., 1988

Circle no. 2

13 REASONS WHY THIS OPIX™ VIDEO SIGNAL GENERATOR BELONGS ON YOUR BENCH

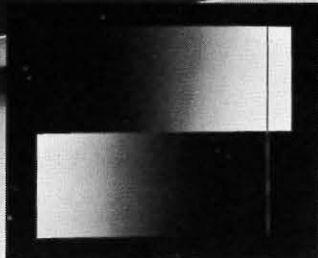

256 Level Gamma Pattern

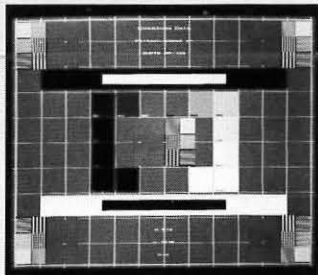

SMPTE RP-133

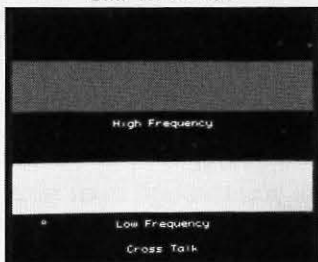

Cross Talk

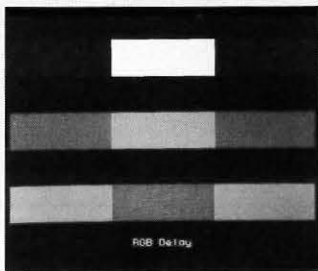

RGB Delay

- ① Full color graphics with programmable frequencies.
- ② A disk full of "Instant Expert™" test patterns that put the power of OPIX in your hands "right now" and cut hours off the learning curve.
- ③ A user interface designed for monitor testing.
- ④ Full text capability with fixed and proportional spacing.
- ⑤ 1.56–200 MHz pixel rate in monochrome and color.
- ⑥ Ultra fast precision analog outputs—256 levels.
- ⑦ Multiple outputs—differential TTL, ECL & analog.
- ⑧ An palette of 16 million colors to choose from.
- ⑨ Custom images you can design, use and store.
- ⑩ Terminal and system interfaces—RS232 & IEEE488.
- ⑪ Mass storage on floppy disks.
- ⑫ Four sync channels with programmable pixel time.
- ⑬ Flexible units—pixels, frequency and time.

CALL US FOR A FREE VIDEO TAPE ON OPIX.

We have an exciting video tape that demonstrates OPIX capabilities. Call for your copy and see how user-friendly a signal generator can be. You won't find a better signal generator anywhere! **QUANTUM DATA**, 2111 Big Timber Road, Elgin, IL 60123. Phone: (312) 888-0450 FAX: 888-2802 Telex 206725

 **QUANTUM DATA®**

Circle no. 3

≡ Official Monthly Publication of the Society for Information Display

INFORMATION DISPLAY

SEPTEMBER 1988
VOL. 4, NO. 9

*Cover: A 192 × 192 pixel
color liquid-crystal display
before and after repair
with a xenon laser.*

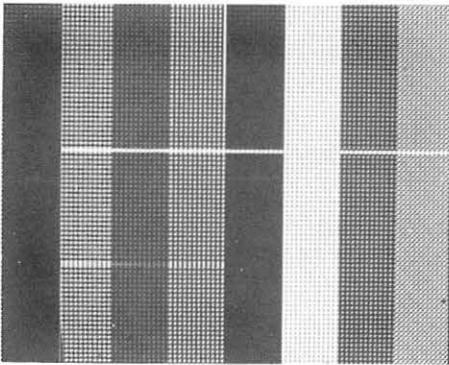

Photo: David Sarnoff Research Center

Next Month in Information Display

Color Hard Copy Issue

- Display to print and back—
can you get there from here?
- Continuous-tone color hard copy
- Hard copy in reverse—electronic image
scanning

-
- 5** Editorial
- 6** Laser repair of liquid-crystal displays
*When complex and expensive LCDs don't turn out right,
everything possible is done to save them.*
Lee Branst and Floyd Pothoven
- 10** Ruggedized color CRT assemblies
*How to maintain color purity in a harsh environment without
adding bulk.*
André Martin
- 14** Directory of the Display Industry
*"It's in there!" Over 400 companies, more categories, more
cross-references in our second annual directory.*
- 42** Sustaining Members
- 42** Index to Advertisers
- 43** Software Review

HOYA

Display Contrast Enhancement Filters

Maximize the luminous contrast of your CRT and LED displays with Hoya's specially developed optical-quality contrast-enhancement color glass filters. Sunlight readability as well as meeting other intense ambient cockpit conditions are satisfied by antireflection coatings on narrow-band monolithic color glass filters and combinations with polarizers.

GV Series—Green monochromatic CRT display filters of various thicknesses most effective in transmitting the P-43 phosphor emission in the 545–548 nm range. Highest contrast ratio is realized with 11–18% peak transmission.

AC Series—Color CRT display filters optimized for the blue-green-red emission of the P-22, P-43, and P-55 phosphors. Best contrast ratios are obtained in the 22–32% peak transmission range for these respective wavelengths.

HLF Series—Yellow, green, and red contrast-enhancement filters for sunlight viewable alphanumeric LED displays. Combines antireflection-coated colored glass filters with a circular polarizing interlayer for maximum luminous contrast.

Please contact Hoya Optics for additional information and quotation of such applications and your other optical/filter requirements.

HOYA OPTICS, INC. 3400 Edison Way, Fremont, CA 94538 (415) 490-1880, Telex 172-647
East Coast office: Route 131, Suite 3, Sturbridge, MA 01566 (617) 347-2671

Circle no. 4

DEFLECTION AMPLIFIERS

FOR PRECISE CRT BEAM CONTROL

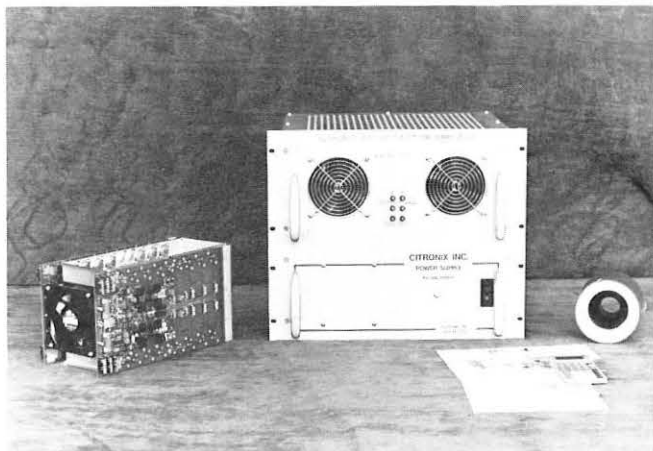

Can your deflection system retrace a beam in less than $2\mu\text{s}$ ($30\mu\text{h}$ yoke, 30APP)?
Then trace a geometrically corrected raster line? And then trace an image in a calligraphic mode, all in a single frame?

Ours can, and much more!

CITRONIX INC.
THE DEFLECTION AMPLIFIER COMPANY

Integrated Raster/Calligraphic System

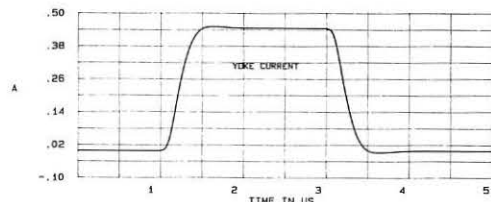
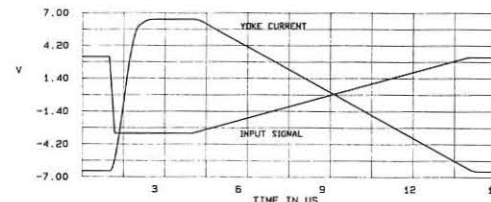
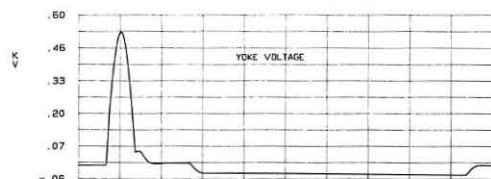

Contact: Al Pletz
CITRONIX INC.

Post Office Box 288
Orangevale, Ca. 95662
(916) 961-1398, TWX 9103506540

Circle no. 5

Editor: Kenneth I. Werner
Managing Editor: Hildegard Hammond
Contributing Editor: Ronald Cohen
Departments Editor: Lynne A. Henderson
Art Director: Hildegard Hammond
Advertising Manager: Jay Morreale
District Sales Managers: Ted Lucas (West), Stephen Steeves (Midwest), Becky Akers (East)

Editorial Advisory Board

Dr. Ifay F. Chang, Chairman
Director of Research
Institute of Systems Science
National University of Singapore

Dr. Frederic J. Kahn
Vice President
Greyhawk Systems, Inc.

Koh-Ichi Miyaji
Professor
Shibaura Institute of Technology

Ian Rajchman
Consultant

Aron Vecht
Director
Phosphor Consultants

INFORMATION DISPLAY (ISSN 0362-0972) is published monthly for the Society for Information Display by Palisades Institute for Research Services, Inc., 201 Varick Street, New York, NY 10014; David Slater, Chief Executive Officer; Leonard H. Klein, President; Harold R. Summer, Vice President; Hildegard Hammond, Secretary; Laura Mangone, Treasurer.

EDITORIAL AND BUSINESS OFFICES: Palisades Institute for Research Services, Inc., 201 Varick Street, New York, NY 10014; telephone 212/620-3371. Send manuscripts to the attention of the Editor, ID.

DISTRICT SALES OFFICES: WEST—Ted Lucas, P.O. Box 852, Cedar Glen, CA 92321; telephone 714/337-6627. MIDWEST—Stephen Steeves, Patis/3M, 4761 West Touhy Avenue, Lincolnwood, IL 60646; telephone 312/679-1100. EAST—Becky Akers, Patis/3M, 310 Madison Avenue, Suite 1804, New York, NY 10017; telephone 212/953-2121.

SID HEADQUARTERS, for correspondence on subscriptions and membership: Society for Information Display, 8055 West Manchester Avenue, Suite 615, Playa del Rey, CA 90293; telephone 213/305-1502.

SUBSCRIPTIONS: Information Display is distributed without charge to those qualified and to SID members as a benefit of membership (annual dues \$35.00 U.S. & Canada; \$50 elsewhere). Subscriptions to others: U.S. & Canada: \$36.00 one year, \$64.00 two years, \$90.00 three years, \$3.00 single copy; elsewhere: \$72.00 one year, \$128.00 two years, \$180.00 three years, \$6.00 single copy.

PRINTED by Sheridan Printing Company, 1425 Third Avenue, Alpha, NJ 08865. Third-class postage paid at Alpha, NJ.

POSTMASTER: Send address changes to Society for Information Display, 8055 West Manchester Avenue, Suite 615, Playa del Rey, CA 90293.

PERMISSIONS: Abstracting is permitted with credit to the source. Libraries are permitted to photocopy beyond the limits of the U.S. copyright law for private use of patrons, providing a fee of \$2.00 per article is paid to the Copyright Clearance Center, 21 Congress Street, Salem, MA 01970 (reference serial code 0362-0972/88/\$2.00+\$0.00). Instructors are permitted to photocopy isolated articles for noncommercial classroom use without fee. This permission does not apply to any special reports or lists published in this magazine. For other copying, reprint or republication permission, write to Society for Information Display, 8055 West Manchester Avenue, Suite 615, Playa del Rey, CA 90293.

Copyright © 1988 Society for Information Display. All rights reserved.



Everything you ever wanted to know?

Herein you will find *Information Display's* bigger and better Second Annual Directory of the Display Industry. It's bigger because virtually everyone who was a part of last year's premier edition quickly submitted their information forms for this year's version, and many additional companies have joined them. It's better because we listened to you. We have eliminated categories you told us weren't helpful. We've added categories you told us

you wanted. We've changed many categories to make looking up the information you need quicker and more natural. And we've provided cross-references to ease your way to what you are looking for, even if you don't think in exactly the same way we do.

Our departments editor Lynne Henderson and our managing editor Hildegard Hammond have put in long hours and late nights, and have held open this issue of *ID* much later than is usual so late entries could be included, thus making the Directory as complete as possible.

Does all this mean that the Directory contains *everything* you ever wanted to know about the display industry? We doubt it. It contains a lot, and we think you will find it an invaluable resource over the next 12 months, but the works of man are not perfect. Even so, those works can be very good and they can be made even better. You can help us do that. Please tell us what you find particularly helpful and useful about the Directory. More important, please tell us what you'd like to see there that isn't, and how we can make it easier to use. All suggestions will be carefully considered, and implemented next year if at all possible.

While Lynne and Hildegard have been occupied (obsessed?) with the Directory, none of us has forgotten that technical content is one thing most of our readers expect from *ID*. Our cover story, by Lee Branst and Floyd Pothoven, is a selective look at the history and practice of repairing with lasers faults in complex liquid-crystal displays.

Then, André Martin discusses the engineering of fully ruggedized color displays for industrial and military applications, and what can happen when system integrators try to cut corners. Finally, we present our second software review, this one of a package for symbolically solving algebraic equations. Our reviewer Richard Lee also comments on a book that does what the program's documentation doesn't.

—Kenneth I. Werner

Laser repair of liquid-crystal displays

BY LEE BRANST AND FLOYD POTHOVEN

HIGH-INFORMATION-CONTENT liquid-crystal displays (LCDs) for color television and avionic applications can contain as many as 1,000,000 pixels. Each of those pixels represents an opportunity for something to go wrong in the manufacturing process. When faults do occur with structures this complex and expensive, everything possible is done to save them. Currently, the use of lasers to repair active-matrix thin-film-transistor LCDs is attracting substantial interest.

Most faults that affect the actual display of an LCD are either pixel or row/column defects. In a large high-resolution display, isolated point (pixel) defects can be nearly invisible and are therefore often tolerable. On the other hand, row/column defects are rarely acceptable. An entire line that is nonfunctional is esthetically displeasing and may be downright dangerous if it causes the loss of critical information or delays quick reading of the display.

The defects themselves can generally be classified as either opens or shorts. Shorts between display lines, for example, are often caused when excess material is laid down during the deposition process. Such defects are most easily repaired with a pulse of laser light that vaporizes (or "zaps") the excess material, restoring the

display line's operation.

The repair of opens is not as simple since lasers, by their very nature, are more useful for removing material than for depositing it. Laser-enhanced chemical-vapor-deposition (CVD) systems are being developed, but we do not know of any now being used in a commercial manufacturing setting.

The best available solution, then, has been redundancy. Many large high-resolution displays include redundant display lines in both the vertical and horizontal directions. Some even incorporate transistor redundancy for each pixel [Fig. 1].

T. Peter Brody of Active Matrix Associates, Pittsburgh, Pennsylvania, has been a pioneer in the development of thin-film transistors (TFTs) for active-matrix addressing systems. He estimates that there are upwards of 70 firms involved in the development and manufacturing of active-

matrix LCDs, over half of them in Japan.

Some of these companies make relatively simple LCDs that are more sensibly scrapped than repaired when defects appear. For makers of more complex devices, however, laser repair is the only way to obtain acceptable manufacturing yields.

That laser-repair and redundancy techniques are widely used was demonstrated at the Society for Information Display's 1988 International Symposium (SID '88) held last May in Anaheim, California. In the three different sessions on active-matrix LCDs, at least half a dozen speakers referred to the topic of laser repair. This is significant because laser-repair techniques for LCDs, like other processing methods, are often not patentable. Most manufacturers would therefore be reluctant to discuss the matter in public unless the technology were already widespread.

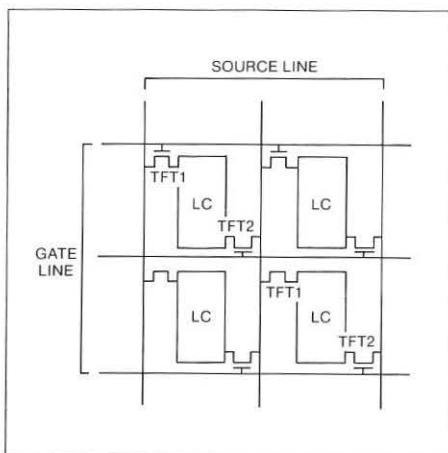

Fig. 1: A typical LCD pixel with redundant TFTs.

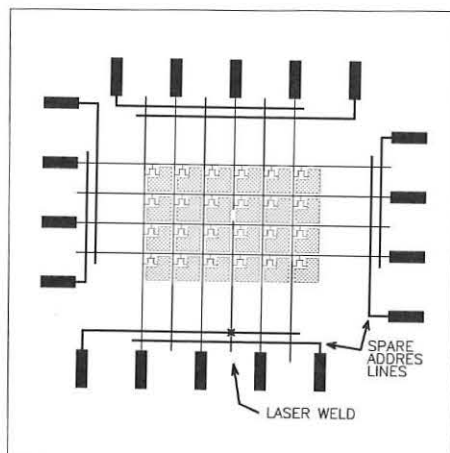

Fig. 2: Schematic of open line repair with spare address lines and laser welds.

Lee Branst is president of Caracal Communications, Redondo Beach, California. He was previously senior editor of Lasers and Optronics magazine. Floyd Pothoven is vice president of Florod Corporation, Gardena, California, which manufactures laser-based turnkey systems for microelectronics applications.

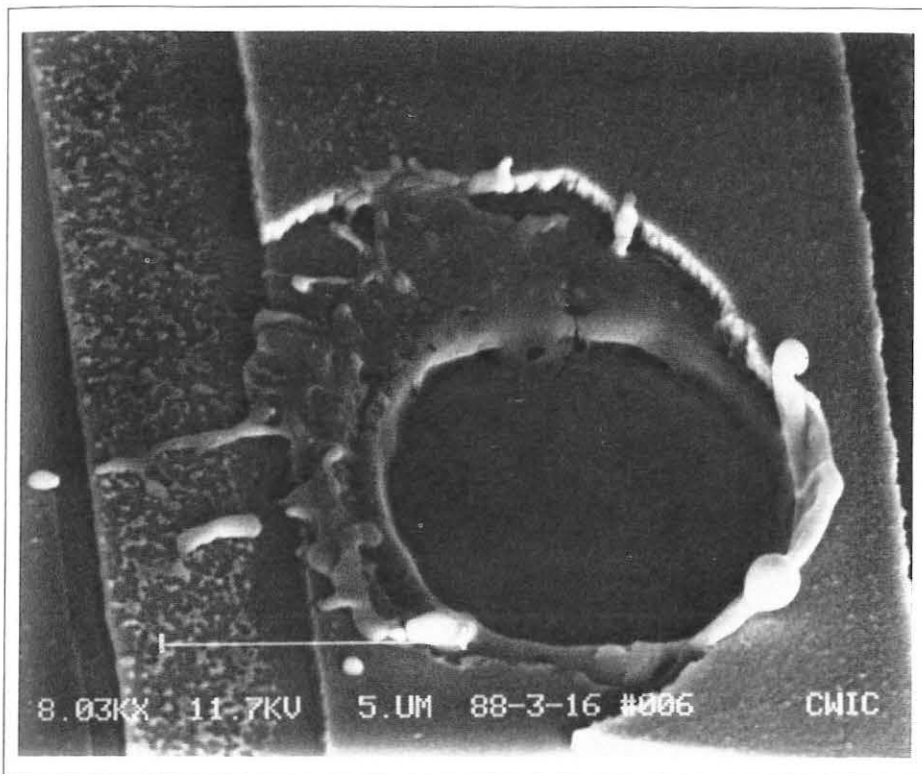

Photo: General Electric Corp., Schenectady, New York

Fig. 3: SEM photograph of a laser weld connecting a spare address line to an array address line.

Laser repair—a selective history

So where did the idea of laser repair originate? While most of those contacted for this article claim to have come upon the laser-repair process independently, there are a few whose work clearly predates the rest.

Since Brody's group was the first to pursue research and development of active matrices utilizing TFTs on an ongoing basis, it is not surprising that it was also the first to employ laser repair.¹

In commenting on this work, Brody told the authors, "In our work at Westinghouse, we demonstrated both active-matrix LCDs and active-matrix electroluminescent (EL) displays in the early 1970s. In both cases we used YAG lasers principally to repair shorted crossovers of buses and to remove debris between adjoining contact fingers. Since we used stencil masks in those days to define busbars, we did not have any problem with shorts between adjoining buses. To the best of my recollections, we introduced the laser-repair technique around 1977, when we obtained a major government manufacturing methods contract on active-matrix EL displays."

Brody said that Westinghouse got the idea to repair shorts with a laser from the then familiar work of repairing opaque defects on masks. In both cases the repair process involved zapping a deposition error on glass.

After Westinghouse gave up on active-matrix displays in 1979, Brody started Panelvision (now Litton Panelvision) in 1980. He said that in late 1981 or early 1982, the company purchased a Florod YAG laser-repair station, which incorporated a motorized X-Y stage.

"A computer-controlled test rig was used to interrogate the active-matrix circuit," said Brody. "This test gave the X and Y coordinates of a crossover short. If the number of such shorts fell below a cutoff number, the circuit was transferred to the repair station. The coordinates of each short were dialed up by the operator, who could visually see the defect through the microscope and more accurately locate it in the laser beam focus. The operator then triggered a laser burst of controlled energy that was sufficient to remove the short without damaging the rest of the metal busbars.

"This repair procedure was done even before the circuit was fully completed,

thus culling rejects at the earliest possible stage. After repair the circuit was completed, tested for TFT performance and, if accepted, passed on for LC processing. We did make some experiments on laser repair of completed displays (i.e., after LC filling and sealing) but, because of our concern about what the vaporized debris would do to LC resistivity and consequent leakage, this process was not installed into our production line at Panelvision during my time there from 1980 to 1985."

As far as the authors of this article are aware, Brody's group was the first to use lasers to repair LCDs. A similar story is told by Don Castleberry of General Electric in Schenectady, New York. "We were in the photomask repair business. This is probably where the idea of removing shorts came from. We were certainly aware of the use of lasers in that field. It was an obvious way to remove excess material. The first time I tried this was in 1982 or 1983."

General Electric's repair procedure for LCDs includes a novel way of handling opens, as Castleberry described it at SID '88:

"Open lines that are due to processing defects or deliberate cutting in the shorts repair process are repairable using spare address lines. These are extra lines along each edge of the display that cross over the ends of array address lines and are connected to their own connector pads. The array address lines are normally only connected to connector pads on alternating sides of the display. If a line is open, the open end segment can be connected to a spare address line by welding through the repair line crossover with the laser [Fig. 2]. The repair line is driven either by (1) connecting the spare lines to their own set of drivers or (2) connecting the driven end of a repaired line to a spare line and connecting the spare lines on opposite sides of the display together.

"The welding process consists of simply zapping a small spot in the repair line crossover. This removes both metal layers and the SiN_x/a-Si [silicon nitride and amorphous silicon layers] from the center of the spot and redeposits the gate metal on the walls of the hole [Fig. 3]. This technique produces very reliable and low-resistance connections.

"A gate-drain short in a TFT which affects both address lines can be changed to a one-pixel defect by disconnecting the gate of the TFT from the gate bus line with the laser. Shorts at the crossover can



Instead, Let Eagle Squelch The Problem

Solving your own EMI problems can be as difficult as killing seven flies with one blow. Using custom engineered magnetic shielding, Eagle can design and manufacture a dependable solution.

With over 18 years of continuous service, Eagle's technical experts offer support in custom and standard magnetic shield designs, engineering and proper material selection.

An Eagle solution is a superior technological investment that will save you both time and money. We're dedicated to solving your specific EMI problems with the most original and up-to-date design engineering available.

So, whether for prototype, small quantity or large volume capability, you can trust Eagle to respond with quality, reliable shields delivered on time.

Call Eagle at (317) 297-1030 for problem design assistance, or write for FREE engineering design information packet #03 and let us handle the squelching.



Eagle Magnetic Company, Inc. • P.O. Box 24283
Indianapolis, Indiana 46224 • (317) 297-1030 • FAX 317-299-1323

Circle no. 6

be repaired by cutting either address line at both sides of the crossover. This results in an open, which is repaired as described above.^{1,2}

These are not the only two methods of laser repair. On the contrary, there are probably as many different laser repair schemes as there are different LCDs.

All zaps are not equal

One of the major differences in the repair processes described by Brody and Castleberry is the kind of laser they used for the repair process. Brody used a solid-state Nd:YAG laser for his early work at Westinghouse and Panelvision. Castleberry at GE and the researchers at The David Sar-

noff Research Center who made the display illustrated on the cover used a gas-discharge xenon laser.

Technological evolution was a major determinant of these choices. The YAG laser is a well-known laser made by many manufacturers (including Florod) and has been used for many years in industrial applications. The xenon laser also is well established, but is made by just a handful of companies. Of these, only Florod has fully developed the xenon laser's attributes for microelectronic applications.

In an informal survey of LCD makers at SID '88, most who used YAG lasers were switching to xenon units when they needed new repair systems. Their reasons related both to the properties of the laser itself and the abilities of the enabling laser systems.

The xenon laser emits a combination of wavelengths ranging from 480 to 540 nm—in the center of the visible spectrum. The standard YAG emits at 1064 nm—well into the infrared region. Thus, the corresponding spot size is about twice as large unless additional frequency-doubling or beam-narrowing optics are included.

Another important reason for choosing the xenon laser relates to repair after assembly. As Brody reported above, most manufacturers would rather test and repair the structure after the active-matrix circuit is constructed but before the LCD "sandwich" is completed. The great majority of repairs can be accomplished at this time.

However, there are occasions when a fault does not show up until after the LCD is produced. In this case a repair may be effected by shooting the laser directly through the glass, the transparent conductors on the glass, and the LC material. This process often creates a bubble in the LC from the heat of the laser. However, the bubble created by the xenon laser nearly always dissipates, leaving a fully functioning LCD.

Most manufacturers report that using a YAG laser in this situation is a more uncertain proposition. Often the YAG leaves a permanent bubble in the LC material, a condition that may show up as a visible defect.

Xenon lasers are also generally capable of removing thinner layers of material than YAG lasers. For example, Florod's MEL-30 xenon laser, supplied with a programmable square aperture, can remove material from a roughly cubic volume measuring as little as $2 \times 2 \mu\text{m}$ on the surface and less than $1.5 \mu\text{m}$ deep. Be-

cause of their higher peak power, longer wavelength, and beam-shaping optics, YAG lasers generally produce a crater-like central pit that penetrates much deeper into substrates, possibly creating sub-level damage. The square aperture also produces a rectangular laser spot that is compatible with the rectangular pixel geometry common to LCD arrays and, therefore, allows material removal adjacent to straight edges. It is difficult to get a clean beam profile through an aperture with the YAG because of the complex optics required.

Besides the actual hole generated by the laser pulse, there is also a surrounding heat-affected zone, or "blast area," that is caused by the laser pulse. For a pulse in a square spot of $2 \times 2 \mu\text{m}$, the xenon laser generates a heat-affected zone only $10 \mu\text{m}$ across. The YAG laser generates a heat-affected zone some two to three times larger in diameter. Because the debris from the blast area contains metallic particles, larger blast areas are more likely to cause unintended shorts in the circuit.

YAG and xenon laser systems are not the only contenders. A European laser systems manufacturer is trying to apply its argon laser system to LCD repair. While the argon laser can ablate metal, it is of the continuous variety—not pulsed like xenon and YAG. The LCD manufacturers we surveyed felt this would make the system difficult to use in real-world situations.

The future of laser repair

Most manufacturers would naturally prefer to avoid the necessity for laser repair of LCDs. Some Japanese manufacturers of simple LCDs for consumer products claim their tightly controlled manufacturing processes do, in fact, achieve yield rates in excess of 90% without resorting to repair.

Nevertheless, color capability and higher pixel counts are adding ever increasing layers of complexity to modern LCDs. For these advanced displays, the attempt to manufacture perfect devices is increasingly difficult.

Attempts are under way to produce more fault-tolerant displays. At SID '88, both NTT of Japan and GEC of the U.K. described redundancy schemes that automatically activate the spare circuit line when there is an open on the primary line. However, even with these systems, shorts remain a problem that require repair by laser or some other means.

Despite these advances in manufacturing methods and fault tolerance, it will

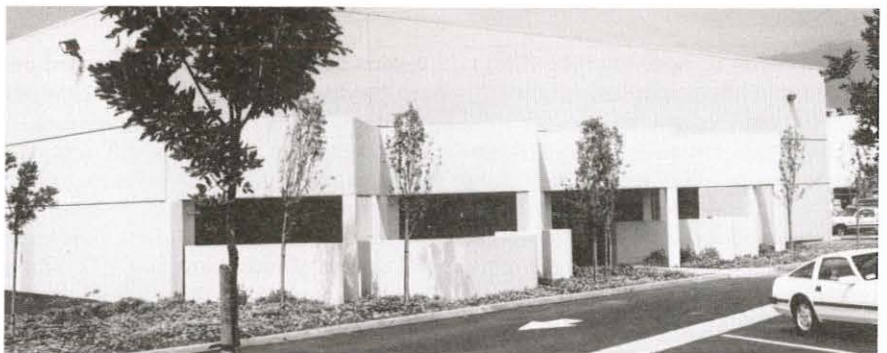
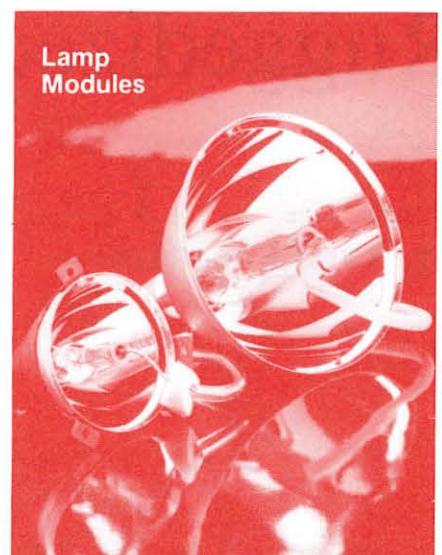
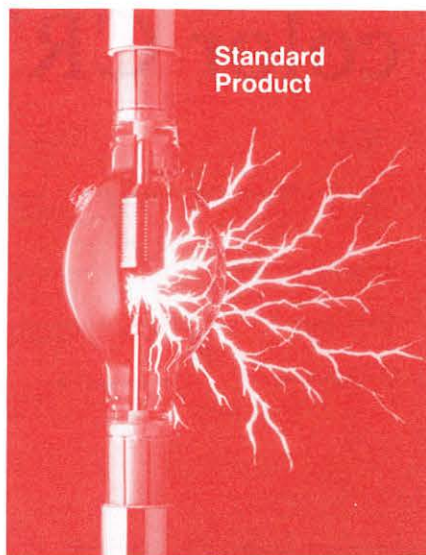

ORC — lighting the way to tomorrow

Optical Radiation Corporation/Lamp Division preparing today for your needs tomorrow... our state of the art facility is dedicated to the design, development and production of quality short arc lamp products. Standard product available off the shelf... or custom lamp modules combining ORC field proven short arc lamps and precision electroformed reflectors. Preparing for tomorrow — call us today.



Optical Radiation Corporation

Lamp Division

1300 Optical Drive, Azusa, CA 91702
818 969 3344
TWX 910 584 4851
FACS 818 969 3681

Circle no. 7

be some time before we outgrow the need for laser repair of LCDs.

Notes

¹Peter Brody's fascinating personal account of the beginnings of thin-film transistor development at Westinghouse and

elsewhere appears as "The Thin-Film Transistor—A Late Flowering Bloom," *IEEE Transactions on Electron Devices*, Vol. ED-31, No. 11 (Nov. 1984).
²D. E. Castleberry and G. E. Possin, "A 1 Mega-Pixel Color a-Si TFT Liquid-Crystal Display," *SID Digest*, Vol. 19 (1988), pp. 232-234. ■

Ruggedized color CRT assemblies

BY ANDRÉ MARTIN

JUST AS COLOR cathode-ray tube (CRT) displays are in increasing demand for commercial applications, so are they sought for industrial and military (I&M) applications where high resolution, color stability with time, tolerance of temperature extremes, and resistance to shock and vibration are essential. But progress in ruggedizing an evacuated glass bulb containing precisely located suspended elements has not been easy, and has come only with extensive research and development.

The monochrome model

Monochrome CRTs have been used in ruggedized industrial and military displays for many years. The best ruggedization is obtained by fully encapsulating the CRT within a magnetic shield, with its deflection coil, focus coil, and other drive elements potted in silicon resins [Fig. 1]. Encapsulated tubes of this type, which are called assemblies, have passed qualification at shock levels of over 120 g and at vibration levels of 12 g rms from 10 to 2,000 Hz. Such assemblies routinely survive temperature cycling from -65°C to $+95^{\circ}\text{C}$ and altitude tests up to 55,000 ft.

Pursuing rugged color

The first attempts to design rugged color displays were based on the color penetration tube. Such tubes vary the depth to which the electron beam penetrates a suc-

cession of phosphor layers deposited on the inside of the CRT's face by changing the accelerating voltage. Because each phosphor layer produces a different color, different accelerating voltages produce different colors. The mechanical structure of beam-penetration color CRTs is identical to that of monochrome CRTs, and assemblies made from these tubes have the same basic construction and ruggedness as monochrome CRT assemblies.

The penetration CRT requires a sequential presentation of color images and a high-voltage switch. It is not compatible with television standards, so it has been limited to vector-scanning displays or to displays using sequential raster modes. Within these limitations, the penetration tube has been widely employed to present high-resolution images in four to six colors.

Expanding the limits

When a larger number of colors and a raster display are required, the penetration color tube cannot be used and other approaches are needed. One of these is the beam-index tube. This tube uses a striped RGB color screen and a single electron beam. Additional "indexing phosphor stripes" produce light that is scattered back into the tube. Detecting this light permits the electron beam's position on the phosphor screen to be located precisely, and the single beam can be used to excite all three color phosphors sequentially. The beam-index tube inherently possesses the same sturdy structure as the monochrome CRT and can be mounted in comparable assemblies. However, the necessarily fast video switching between color stripes and the fast stripe-

position detection require high electronic bandwidth, and this generally limits the beam-index approach to tubes not exceeding a few inches on the diagonal. But these tubes are experiencing continuing development, and we are likely to see more application of beam-index tube assemblies in larger sizes.

The price of size

For the time being, the only CRT over 10-in. in diagonal capable of displaying raster images and resolving over 1,000 TV lines with a full range of color is the shadow-mask tube, well known for its commercial television applications.

The typical commercial shadow-mask color tube [Fig. 2] comprises within its envelope:

- *A thin perforated mask* of mild steel, which is generally suspended from the envelope at three points.
- *A precision in-line electron gun* that produces three independent electron beams in the same plane.
- *A phosphor screen* composed of RGB stripes or trios of RGB dots.
- *An internal magnetic shield* for isolating the electron trajectories from the earth's magnetic field while the electrons are in the driftspace between the deflection coil and the shadow mask.
- *A deflection coil*, precisely aligned on the tube neck and glued to the tube's flared section.
- *Convergence magnets* placed on the tube neck behind the deflection coil.
- *An antenna getter* that maintains the vacuum in the tube at the desired level.

The tube and deflection coil are made so each of the three electron beams corre-

André Martin is director of the Image Tube Department at Thomson Electron Tubes and Devices Corporation, Dover, New Jersey, where he leads the company's R&D effort on assemblies using color CRTs.

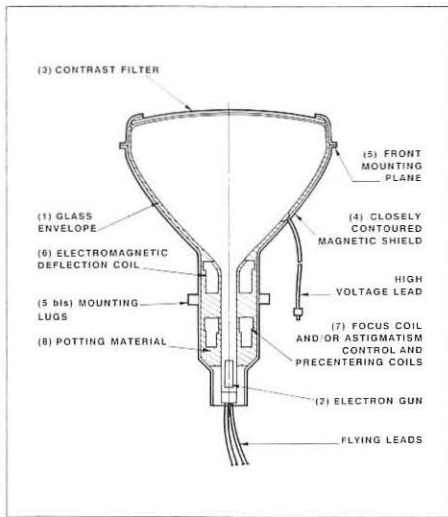

Fig. 1: A typical ruggedized mono-chrome CRT assembly consists of a CRT with its glass envelope (1) and electron gun (2). A contrast filter, usually with coatings to reduce reflections and suppress electromagnetic interference, is laminated to the CRT faceplate (3). A closely contoured magnetic shield (4) provides a front plane (5) and lugs (5 bis) for securely mounting the assembly. An electromagnetic deflection coil (6), focus coils, astigmatism control, and precentering coils (7) are between the tube neck and the magnetic shield. A potting material (8), usually consisting of a silicon resin, fills all voids between the various elements of the assembly. This material has enough elasticity and resiliency to protect against thermal stresses, vibration, and shock.

sponds to only one color—either red, green, or blue. But each beam is broad enough by the time it reaches the screen to illuminate several trios of phosphor dots or stripes, so the desired color is obtained by shadowing the unwanted phosphors from the beam by a mask—the shadow mask. With this method of color selection, the shadow mask, electron gun, deflection coil, and convergence magnets must be mounted with extreme accuracy in the high-precision glass envelope. Any relative movement of these components beyond specified tolerances, whether due to mechanical stresses or thermal expansion, will cause a loss of color purity. For a 19-in.-diagonal high-resolution color tube having a screen pitch of 0.31 mm, these tolerances are on the order of a few thousandths of an inch.

Magnetic protection

Shadow-mask tube and deflection-coil designs for providing proper electron-beam

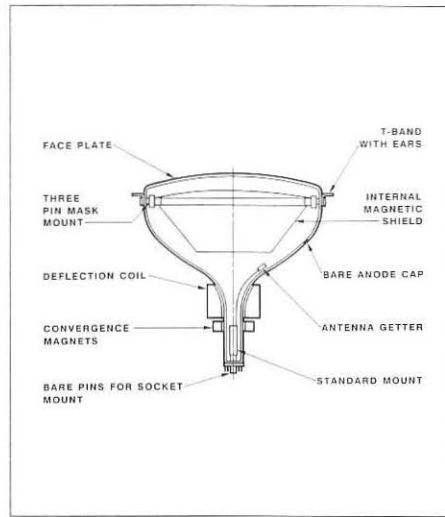

Fig. 2: Structure of a typical commercial shadow-mask color tube.

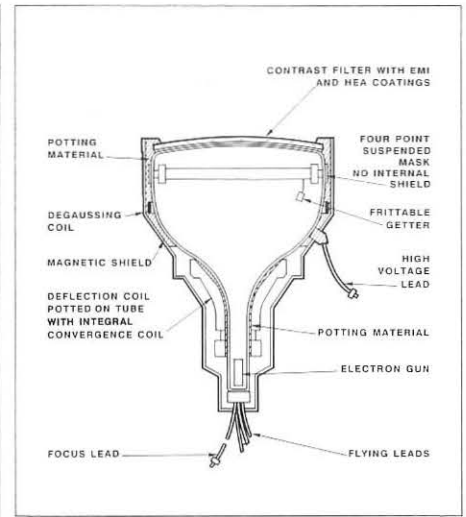

Fig. 3: Structure of a typical, fully shielded, ruggedized shadow-mask tube.

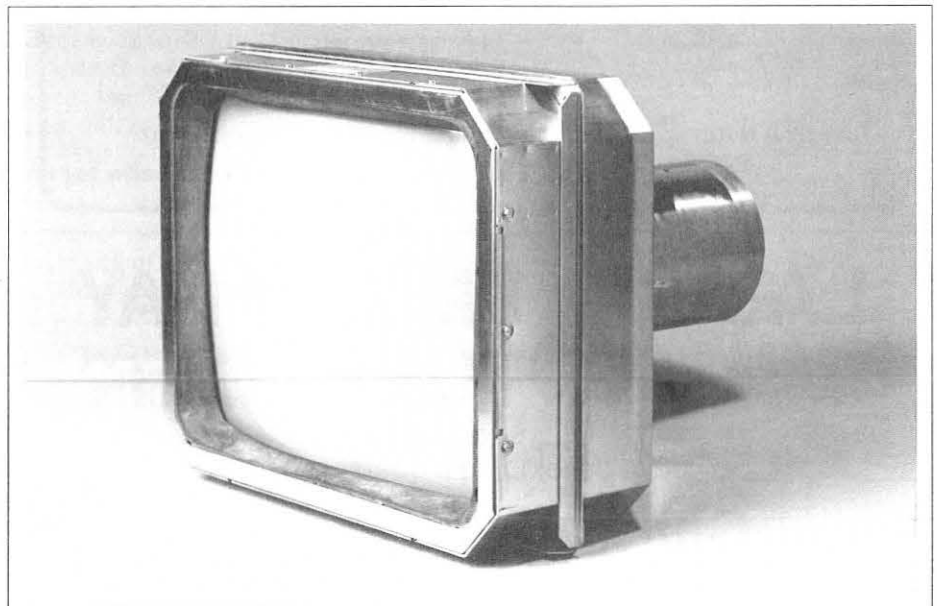

Fig. 4: A typical 19-in. ruggedized color shadow-mask tube assembly.

Photo: Michel Mathieu

trajectories normally incorporate the influence of the earth's magnetic field for tube operation in landscape mode—that is, when the tube face's largest dimension is horizontal. Any other orientation of the tube relative to the earth's magnetic field requires proper magnetic shielding.

In addition to this ever-present earth field, stray magnetic fields may exist near the display. A shield surrounding the whole tube provides good protection.

Ruggedizing shadow-mask tube assemblies

Fortunately, there are solutions to the technical difficulties of designing shadow-mask tube assemblies for the requirements

posed by demanding environments [Table 1].

To meet these specifications, the suspended weight of the mask and the internal magnetic shield must be reduced, and the attachment of the mask to its frame and of the frame to the envelope must be reinforced. Together, these modifications reduce the movement of the mask and shield during shock and vibration by increasing the mask's resonant frequency and reducing the transmissibility of the mask assembly. Usually, a four-point symmetrical suspension is adopted for the mask, and the internal magnetic shield is removed to reduce the suspended weight [Fig. 3].



**Total in-house design, manufacturing,
and testing capabilities**

**Magnetic shielding and shielding grade alloys
of all types...**

Send for our latest product literature

Magnetic **RADIATION
LABORATORIES, INC.**

92-A North Lively Boulevard • Elk Grove Village, Illinois 60007
Phone: 1-312-437-5200 • TWX 510-601-1013

Circle no. 8

LASER PMT X-RAY IMAGING TUBE CRT?

If you're developing a quality product,

Call 1-800 634-0740

to get the right high-voltage power supply.

We'll recommend the best, most cost-effective package with all the features you need. You can count on it.

IHVE has been manufacturing quality high-voltage power supply systems for display and medical applications in Danbury, Connecticut since 1977.

We are also exclusive North

American distributors for Bonar Wallis Hivolt, who have been manufacturing quality high-voltage devices in the UK since 1972. Some of the Bonar Wallis Hivolt packages are designed and approved for military and airborne environments.

Give us a call, and we'll do our best to make your system development succeed.

International High Voltage Electronics, Inc.

An affiliate of LORAD Medical Systems, Inc.

In Connecticut, 1-792-7820
FAX 1-203 743-3370

Finance Drive
Danbury, CT 06810

Circle no. 9

The antenna getter of a commercial tube moves during severe vibration and shock, which scratches the tube bulb's interior coatings. This produces particles that induce arcing and breakdown. The antenna getter also interferes with the deflection field for frequencies above 32 kHz, causing convergence errors. For I&M tubes, the antenna getter is therefore replaced with a frittable getter placed on the mask frame.

The electron gun can be ruggedized by using stiffer springs for locating the electron gun in the tube neck, and by repositioning the stem-to-gun connections so arcing between electrodes does not occur during vibration. Additional potting of the anode and stem leads helps prevent arcing during exposure to altitude or humidity.

Potting the package

Commercial tubes are attached to their monitors by means of "ears." For ruggedized applications, mounting points are provided on the external shield—the same technique successfully employed for years in monochrome assemblies.

The tube is encapsulated in the shield by means of a suitable potting material, usually a silicone resin or foam. The rigidity, disposition, and thickness of the potting material are adapted to each tube, deflection coil, and shield combination to obtain the dampening required for the shock and vibration levels specified. The dampening must be particularly effective at the shadow mask's self-resonant frequency, where loss of color purity appears at only a few g of acceleration.

When it's too darn hot

These potting techniques prevent glass breakage from temperature cycling over a 100°C range, but temperature is also of concern in relation to convergence errors—differences in the landing locations on the tube screen of the three electron beams.

All commercial tubes use convergence adjustment by means of permanent magnets, which produce magnetic fields that vary by about 20% over a temperature change of 100°C. Magnets with improved temperature stability have been developed for avionic color assemblies. They can maintain acceptable convergence over 100°C temperature cycles in small tubes but are not stable enough for large-screen CRTs with deflection angles of 90°.

Another approach is the use of convergence coils driven by temperature-compensated dc power supplies. This elegant

solution not only provides temperature-independent convergence, but also permits the use of other dynamic convergence signals to improve picture quality.

Adding mass and volume—but not too much

A shadow-mask tube assembly is generally used as a retrofit for a monochrome display, so it has to be installed in the same volume. Room must be provided within the monitor case for the heavier power supplies and additional printed-circuit boards required by a color display. Because of the high mechanical precision required, the thickness of a shadow-mask tube bulb is much greater than that of an equivalent monochrome bulb, which means additional weight, and even more weight results from the internally suspended mask. The internal magnetic shield of commercial tubes is usually removed to reduce the suspended weight and must be replaced by an external shield that covers the tube [Fig. 4].

Table 1: Typical Requirements for Industrial and Military Displays

Vibration	6-13 g rms from 10 to 2,000 Hz
Shock	30-120 g for 6 to 20 msec
Temperature	
Operating	-55°C to +75°C
Nonoperating	-65°C to +90°C

Closely contouring the shield to the tube and the deflection coil keeps the overall weight and volume down. But a closely contoured shield interferes with the deflection field generated by the standard toroidal or saddle-toroidal deflection coil employed on commercial television tubes, making it impossible to obtain good color purity and convergence. If such a coil were used, the shield would have to clear the deflection coil by approximately 2 in.

A better solution is the saddle-saddle shielded coil, which uses a long trumpet-like ferrite. This coil confines the deflection field to a small volume and permits the magnetic shield to be as close as 0.25 in. from the coil. Another benefit of the confined deflection field is improved coil deflection sensitivity.¹

A color shadow-mask CRT assembly using a saddle-saddle coil and a typical 0.040-in.-thick magnetic shield is fully protected against magnetic fields up to 1 Oe (80 amp-turns/m). Above that, additional protection is required.

A tense development

Flat tension shadow-mask (FTSM) tubes have been developed by Tektronix for military applications and by Zenith for the commercial sector.^{2,3} The mask is attached around its entire periphery to the tube faceplate or envelope, nearly eliminating suspended weight. Resistance of the tube to shock and vibration is comparable to that of a monochrome CRT, except for vibration near the taut mask's resonant frequency. Special mask damping can be provided for this frequency, or the potting in the shield can be designed to damp the vibration.

These FTSM tubes are now available in sizes ranging from 7 to 15 in. in diagonal. Their structure permits the design of very rugged assemblies, particularly when associated with saddle-saddle deflection coils.

You get what you pay for

There has been, in some segments of the market for industrial and military monitors, a lack of appreciation for how much specialized engineering and how many low-volume custom components go into a fully ruggedized I&M monitor. When the \$50,000 cost typical of such monitors is compared with the \$5,000 typical for enhanced commercial monitors, some managers have been tempted to use the apparently low-cost approach in mobile applications. The result can be a painful and costly development cycle culminating in a late switch to fully ruggedized monitors, or a failure of the system to pass qualification.

Notes

¹J. M. Perreaut, A. Dumesnil, R. Pieri, "Shielded Yoke for a High-Resolution Color CRT," *SID Digest*, Vol. 19 (1988), pp. 129-131.

²L. Dietch, K. Palac, W. Chiodi, "Performance of High Resolution Flat Tension Mask Colors CRTs," *SID Digest*, Vol. 17 (1986), pp. 322-323.

³R. Robinder, D. J. Bates, P. J. Green, G. D. Lewen, and D. R. Rath, "A High Brightness Shadow Mask Color CRT for Cockpit Displays," *SID Digest*, Vol. 14 (1983), pp. 72-73. ■

Approaching ZERO DEFECTS

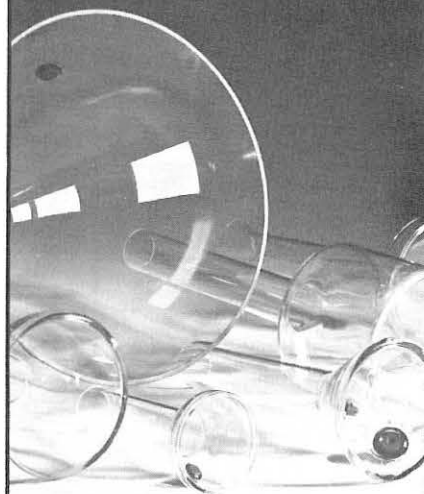

PEG CRT BULBS

- Continuous Process Control
- More Uniform Wall Thickness
- 1/2" to 7" Diameter Range
- Low Tooling Cost
- Prototype Design Work
- Better than Machine Made Round CRT Bulbs

The Leader in Hand-Crafted CRT Bulb Blanks

For details call 609/691-2234.

PEG

**PRECISION ELECTRONIC
GLASS, INC.**

1013 Hendee Road
Vineland, NJ 08360
FAX: 609/691-3090

Circle no. 10

ANTIREFLECTION COATINGS

See optical coatings

ANTIREFLECTION SCREENS

See filters

ANTISTATIC CHEMICALS AND DEVICES

□ Bates Mfg. □ Tech Spray

BACKLIGHTS FOR LCDs

□ Alphasil □ Bonar Kard-O-Lite □ Robert Busch □ Candian Marconi □ Crystop Display □ Data General □ Densitron □ Durel □ EEV □ Endicott Res. Group □ Futaba □ GTE □ Hewlett Packard □ Hoffman Engineering □ IEC □ Interface Prods. □ Lucas Duralith □ Lumitex □ Modutec □ NEC Elect. □ Pulseview □ Quantex □ Racal Micro. Sys. □ Regisbrook □ SAI Tech. □ David Sarnoff Res. Ctr. □ Scriptel □ Sharp Elec. □ Southwall Tech. □ 3M Indus. Optics □ Thin Film Device □ Transicoil □ Varitronix □ VL Elec. □ Voltarc Tubes □ World Prods.

BARCODE READERS

□ Citizen-CBM America □ Craft Data □ Hewlett Packard □ Interactive Computer Prods. □ Penny and Giles □ Pentax Teknologies □ PERCON □ Spectra-Physics □ Voice Connection

CCD IMAGERS AND CAMERAS

□ Burle Indus. □ Canon □ Dage MTI □ Data Copy □ Eastman Kodak □ EEV □ EG&G Reticon □ Ektron Applied Imaging □ El-Op Electro Optics □ Electronic Image Sys. □ EPIX □ Fairchild Weston Sys. □ Hitachi □ Ikegami Elec. □ Imaging and Sensing Tech. □ McMahan Electro-Optics □ Mito Fine Glass □ Photo Research □ Primagraphics □ PULNIX America □ Recognition Concepts □ David Sarnoff Res. Ctr. □ Sony □ Tektronix □ Texas Instruments □ Thomson-CSF/DTE

CHARACTER RECOGNITION DEVICES

□ Coreco □ Data Copy □ Ektron Applied Imaging □ Optigraphics □ David Sarnoff Res. Ctr. □ Scriptel □ Wacom

CONNECTORS AND SOCKETS

□ Connector □ Crystop Display □ Daburn Elec. and Cable □ Dale Elec. □ Elastomeric Tech. □ Elform □ Hoffman Engineering □ ITT Cannon EMC □ Worldwide □ Molex □ Panduit □ PCK Elastomerics □ PTK/Rantec □ Teledyne Kinetics □ Thin Film Device

CONSULTANTS

□ Leo Beiser □ Carroll Consulting □ Constellation □ Crystop Display □ DRB Tech. □ Electronic Image Sys. □ Financial Sys. of SC □ Ginsbury Elec. □ H. W. Grossbohl □ Hughett Res. □ IEC □ Int. Resource Development □ Levy Hill Labs □ Manitron Displays □ McMahan Electro-Optics □ Monterey Tech. □ National Res. Resources □ Phospor Prods. □ Pulseview □ David Sarnoff Res. Ctr. □ Stanford Resources □ Tannas Elec. □ Telic Optics □ UCE Liquid Crystal Displays □ V.I. Corp. □ Yencharis Consulting □ Westland Elec.

CONVERTERS, DIGITAL/ANALOG

□ Advanced Computer Sys. □ Canadian Marconi □ Data Translation □ Hewlett Packard □ Ikegami Elec. □ ISC Cardion Elec. □ C. Itoh Elec. □ NEC □ NES □ Optigraphics □ Recognition Concepts □ Sys. Res. Labs. □ Tektronix □ Texas Instruments

Directory Editors: Lynne A. Henderson, Hildegard Hammond

Product listings begin on this page; address and telephone listings start on page 27. Boldface listings denote advertisers in this issue. The editors wish to thank William Buxton of Rank Xerox EuroPARC, Cambridge, U.K., for allowing them to borrow freely from "A Directory of Sources for Interactive Technologies" (© 1988 Xerox Com), which appeared in the SID '88 Seminar Lecture Notes.

CONVERTERS, DIGITAL/VIDEO

□ Advanced Computer Sys. □ Texas Instruments

CONVERTERS, POWER

□ Babcock Display Prods. □ Canadian Marconi □ Craft Data □ Endicott Res. Group □ Int. High Voltage Elec. □ NES □ SAI Tech. □ Texas Instruments □ Toko America □ Venus Scientific □ Zenith Components

CRT DISPLAYS

See also large-screen displays, projection displays, simulator displays, 3D display systems, touch-interactive displays, deflection yokes, electron guns, glass for CRTs

CRT monitors, full color

□ Adex □ Advanced Computer Sys. □ Astronautics □ Aydin Controls □ Barco-Indus. □ Robert Busch □ Cadvision □ CalComp □ Canadian Marconi □ Carroll Touch □ Chromatics □ Circon □ Citronix □ Conrac Display Prods. □ Data Ray □ Display TEK □ Dotronix □ Eastman Kodak □ Electronic Image Sys. □ FIMI Philips □ GEC Avionics □ Ginsbury Elec. □ Hartman Sys. □ Hazeltine □ Hitachi □ Hitech Intl. □ HMW Enterprises □ Honeywell Defense Avionics □ Hughes Aircraft □ Ikegami Elec. □ Infodex □ IBM □ ISC Cardion Elec. □ C. Itoh Elec. □ KONE □ Manitron Displays □ Microvitec □ Mitsubishi Elec. America □ Mitsubishi Elec. Sales America □ Monitron □ NEC Home Elec. (USA) □ OI-NEG TV Prods. □ Omnicomp Graphics □ Orwin Assoc. □ Panasonic Indus. □ Philips Consumer Elec. □ Pixelink □ Princeton Graphic Sys. □ Rank Brimar □ RasterOps □ Recognition Concepts □ Regisbrook □ Relisys □ Sanders Assoc. □ David Sarnoff Res. Ctr. □ Sigmex □ Sony □ Systems Res. Labs. □ Tektronix □ Thomas Elec. □ Thomson Electron Tubes & Devices □ Toshiba America □ Totoku Elec. □ Video Monitors □ Wells-Gardner Elec. □ Xytron □ Zenith Components

CRT monitors, high-resolution (600 × 800 and over)

□ Adex □ Astronautics □ Aydin Controls □ Barco-Indus. □ Cadvision □ CalComp □ Canadian Marconi □ Carroll Touch □ Chromatics □ Citronix □ Conrac Display Prods. □ Cornerstone Tech. □ Craft Data □ Dage MTI □ Data Ray □ DataBeam □ Display TEK □ Dotronix □ El-Op Electro Optics □ Electronic Image Sys. □ FIMI Philips □ GEC Avionics □ Ginsbury Elec. □ Hartman Sys. □ Hazeltine □ Hitachi □ Hitech Intl. □ Honeywell Defense Avionics □ Hughes Aircraft □ Human Designed Sys. □ Ikegami Elec. □ Imaging and Sensing Tech. □ Infodex □ ISC Cardion Elec. □ KONE □ Manitron Displays □ McMahan Electro-Optics □ MegaScan Tech. □ Micro Display

Sys. □ Microvitec □ Mitsubishi Elec. America □ Monitron □ Monitronix □ NEC Home Elec. (USA) □ Omnicomp Graphics □ Orwin Assoc. □ Panasonic Indus. □ Philips Consumer Elec. □ Pixelink □ Princeton Graphic Sys. □ Rank Brimar □ RasterOps □ Recognition Concepts □ Relisys □ Sanders Assoc. □ David Sarnoff Res. Ctr. □ Sigma Designs □ Sigmex □ Sony □ Systems Res. Labs. □ Tektronix □ Thomas Elec. □ Thomson Electron Tubes & Devices □ Toshiba America □ Totoku Elec. □ Video Monitors □ Wells-Gardner Elec. □ Xytron □ Zenith Components

CRT monitors, monochrome

□ Adex □ Advanced Computer Sys. □ AEG □ Astronautics □ Barco-Indus. □ Robert Busch □ Canadian Marconi □ Citronix □ Conrac Display Prods. □ Cornerstone Tech. □ Craft Data □ CRT Scientific □ Dage MTI □ Data Ray □ Display TEK □ Dotronix □ Eastman Kodak □ El-Op Electro Optics □ Electronic Image Sys. □ FIMI Philips □ GEC Avionics □ Ginsbury Elec. □ Hartman Sys. □ Hazeltine □ Hitech Intl. □ Honeywell Defense Avionics □ Hughes Aircraft □ Human Designed Sys. □ Ikegami Elec. □ Infodex □ IBM □ ISC Cardion Elec. □ C. Itoh Elec. □ Kristel □ Manitron Displays □ McMahan Electro-Optics □ MegaScan Tech. □ Micro Display Sys. □ Mitsubishi Elec. Sales America □ Monitron □ NEC Home Elec. (USA) □ Norden Sys. □ OI-NEG TV Prods. □ Orwin Assoc. □ Panasonic Indus. □ Philips Consumer Elec. □ Pixelink □ Princeton Graphics Sys. □ Rank Brimar □ RasterOps □ Recognition Concepts □ Relisys □ Sanders Assoc. □ David Sarnoff Res. Ctr. □ Sigmex □ Sony □ Systems Res. Labs. □ Tektronix □ Teltron □ Thomas Elec. □ Thomson Electron Tubes & Devices □ Toshiba America □ Totoku Elec. □ TSD Display Prods. □ Video Monitors □ Wells-Gardner Elec. □ Xytron □ Zenith Components

CRTS, beam-index

□ Electronic Image Sys. □ GEC Avionics □ Ginsbury Elec. □ Imaging and Sensing Tech. □ Plessey Naval Sys. □ David Sarnoff Res. Ctr. □ Sony □ Thomas Elec. □ Thomson-CSF/DTE □ Thomson Electron Tubes & Devices □ Zenith Elec.

CRTS, conventional

□ Adex □ AEG □ Astronautics □ Aydin Controls □ Burle Indus. □ Robert Busch □ Canadian Marconi □ Chungwha Picture Tubes □ Citronix □ Clinton Elec. □ Craft Data □ EEV □ El-Op Electro Optics □ GEC Avionics □ General Atronics □ Ginsbury Elec. □ Hartman Sys. □ Hitachi □ Hughes Aircraft □ Ikegami Elec. □ Imaging and Sensing Tech. □ ISC Cardion Elec. □ C. Itoh Elec. □ Kristel □ Link Tech. □ Lit-

ton Electron Devices □ Microvitec □ Mitsubishi Elec. America □ NEC Elec. □ Norden Sys. □ OI-NEG TV Prods. □ Panasonic Indus. □ Philips Consumer Elec. □ Plessey Naval Sys. □ Princeton Graphic Sys. □ Rank Brimar □ Raytheon □ Richardson Elec. □ Rockwell Int. □ David Sarnoff Res. Ctr. □ Sony □ Teltron □ Thomas Elec. □ Thomson-CSF/C-SD □ Thomson-CSF/DTE □ Thomson Electron Tubes & Devices □ Toshiba America □ Wells-Gardner Elec. □ World Prods. □ Zenith Components □ Zenith Elec.

CRTs, flat

□ Adex □ Burle Indus. □ Canadian Marconi □ Chungwha Picture Tubes □ Citronix □ Clinton Elec. □ Craft Data □ CRT Scientific □ EEV □ El-Op Electro Optics □ Futaba □ Ginsbury Elec. □ Ikegami Elec. □ Imaging and Sensing Tech. □ C. Itoh Elec. □ Link Tech. □ Litton Electron Devices □ Mitsubishi Elec. America □ OI-NEG TV Prods. □ Panasonic Indus. □ Philips Consumer Elec. □ Richardson Elec. □ David Sarnoff Res. Ctr. □ Sigmex □ Scriptel □ Sonic Tech. □ Sony, Display Device Group □ Teltron □ Thomas Elec. □ Toshiba America □ Video Display □ Wells-Gardner Elec. □ Zenith Components □ Zenith Elec.

CRTs, miniature

□ Adex □ AEG □ Astronautics □ Robert Busch □ Chungwha Picture Tubes □ Circon □ Citronix □ CRT Scientific □ EEV □ El-Op Electro Optics □ GEC Avionics □ General Atronics □ Ginsbury Elec. □ Hughes Aircraft □ Imaging and Sensing Tech. □ Litton Electron Devices □ McMahan Electro-Optics □ OI-NEG TV Prods. □ Panasonic Indus. □ Rank Brimar □ Raytheon □ Richardson Elec. □ David Sarnoff Res. Ctr. □ Sony, Display Device Group □ Teltron □ Thomas Elec. □ Thomson-CSF/DTE □ Thomson Electron Tubes & Devices □ Toshiba America □ Video Display □ Wells-Gardner Elec.

CRTs, multibeam

□ Canadian Marconi □ Chungwha Picture Tubes □ Electronic Image Sys. □ General Atronics □ Ginsbury Elec. □ Hartman Sys. □ Image Amplification □ Litton Electron Devices □ Plessey Naval Sys. □ David Sarnoff Res. Ctr. □ Sonic Tech. □ Sony, Display Device Group □ Thomas Elec. □ Thomson-CSF/DTE □ Thomson Electron Tubes & Devices

CRT MATERIALS

See individual listings for filters, getters, glass, magnetic shielding, optical coatings, phosphors, polarizers

DEFLECTION AMPLIFIERS

□ Canadian Marconi □ CELCO □ CELCO Pacific □ Citronix □ El-Op Electro Optics □ Electronic Image Sys. □ Ginsbury Elec. □ Infodex □ Norden Sys. □ Orwin Assoc. □ Rank Brimar □ David Sarnoff Res. Ctr.

DEFLECTION YOKES

□ Broy Engineering □ CELCO □ Chungwha Picture Tubes □ DISCOM □ Ginsbury Elec. □ George D. Harris Assoc. □ K&R Engineering Sales □ Panasonic Indus. □ Penn-Tran □ Rank Brimar □ David Sarnoff Res. Ctr. □ Sony, Display Device Group □ Syntronic Instruments □ Toshiba America □ Totoku Elec. □ Zenith Components

DIGITAL FILM RECORDERS

□ CELCO □ CELCO Pacific □ Ektron Applied Imaging □ Imapro □ Korry Elec. □ Lasergraphics □ Matrix Instruments □ Photo Research

DIGITAL VIDEO SYSTEMS

□ Advanced Computer Sys. □ Colorado Video □ Crystop Display □ Datacube □ Eastman Kodak □ Electronic Image Sys. □ Fairlight Instruments □ Ikegami Elec. □ Image Amplification □ Matrox Elec. Sys. □ Norden Sys. □ Photonics Sys. □ Quantex □ Racal Micro. Sys. □ RasterOps □ Recognition Concepts □ David Sarnoff Res. Ctr.

DIGITIZING TABLETS

□ CalComp □ DataBeam □ Fairlight Instruments □ Houston Instruments □ Interactive Machines □ Kontron Elec. □ Numonics □ Omnicon Graphics □ Ovonic Imaging Sys. □ Pencept □ Personal Writer □ Scriptel □ Summagraphics

DISABLED DISPLAY USERS, AIDS FOR

□ Enabling Tech. □ ISCAN □ Optical Devices □ Personics □ David Sarnoff Res. Ctr. □ Voice Connection

DISPENSER CATHODES

□ Ceradyne Electron Sources □ Ginsbury Elec. □ David Sarnoff Res. Ctr. □ Sony

DISPLAY CONTROLLERS

□ Cornerstone Tech. □ Gennum □ IEE □ Scriptel □ Supertex

DISPLAY HOUSING, RUGGEDIZED

□ Audodisplay □ Robert Busch □ Canadian Marconi □ Carroll Touch □ El-Op Electro Optics □ Emerald Computers □ Hazeltine □ IEE □ Librascope □ NES □ Norden Sys. □ Phosphor Prods. □ Plessey Naval Sys. □ Pulseview □ David Sarnoff Res. Ctr. □ Sigmex □ Thomson-CSF/C-SD □ Thomson-CSF/DTE □ Transicoil

DISPLAY SIMULATION AND MODELING SYSTEMS

□ Alliant Computer Sys. □ Robert Busch □ Canadian Marconi □ Chromatics □ Computing Devices □ Electronic Image Sys. □ Hughes Aircraft □ Interactive Machines □ Matrox Elec. Sys. □ Norden Sys. □ Photonics Sys. □ Primagraphics □ RasterOps □ David Sarnoff Res. Ctr. □ Sigmex □ Star Tech. □ Systems Res. Labs. □ V.I. Corp.

DISPLAY SYSTEM INTEGRATORS

□ Advanced Computer Sys. □ Astronautics □ Autodisplay □ Leo Beiser □ Carroll Touch □ Computing Devices □ Craft Data □ Digital Elec. □ Electro Plasma □ Emerald Computers □ Global Imaging □ Hazeltine □ Honeywell Defense Avionics □ Hughes Aircraft □ Hycom □ IEE □ Interactive Machines □ Librascope □ Lucas Duralith □ Mantron Displays □ McMahan Electro-Optics □ MegaScan Tech. □ NES □ Norden Sys. □ Optical Elec. □ Photonics Sys. □ Primagraphics □ Racal Micro. Sys. □ Rediffusion Simulation □ Rockwell Int. □ David Sarnoff Res. Ctr. □ Systems Res. Labs. □ Thomson-CSF/C-SD □ Wacom

DISPLAYS

See listings under specific technology, i.e. CRT, plasma, electroluminescent

ELECTROMECHANICAL DISPLAYS

□ Advanced Computer Sys. □ AMETEK Aerospace Prods. □ Astronautics □ Ca-

nadian Marconi □ Densitron □ El-Op Electro Optics □ GEC Avionics □ Honeywell Defense Avionics □ IEE □ Interface Prods. □ Lucas Duralith □ NEI Ferranti-Packard Elec. □ Regisbrook □ Rockwell Int.

ELECTROCHROMIC DISPLAYS

□ Astronautics □ Comfuture □ Mito Fine Glass

ELECTROLUMINESCENT DISPLAYS

□ Acculex □ Astronautics □ Bonar Kard-O-Lite □ Canadian Marconi □ Carroll Touch □ Cherry Display Prods. □ Cherry Elec. Prods. □ Comfuture □ Computing Devices □ Craft Data □ Data General □ Densitron □ Digital Elec. □ Eaton □ Emerald Computers □ Epson America □ Finlux □ GTE □ Hoffman Engineering □ Hycom □ IEC □ IEE □ Infodex □ Interface Prods. □ Interstate Elec. □ Korry Elec. □ Levy Hill Labs □ Lohja, Finlux Display Elec. □ Lucas Duralith □ Mito Fine Glass □ National Res. Resources □ NEC Elec. □ Norden Sys. □ Phosphor Prods. □ Photonics Sys. □ Planar Sys. □ SAI Tech. □ David Sarnoff Res. Ctr. □ Scriptel □ Sharp Elec. □ Sigmatron Nova □ Texas Instruments □ Thin Film Device □ Thomson-CSF/C-SD □ UCE Liquid Crystal Displays

ELECTRON GUNS

□ Burle Indus. □ Chunghwa Picture Tubes □ General Atronics □ Ginsbury Elec. □ Hitachi □ Richardson Elec. □ David Sarnoff Res. Ctr. □ Sony □ Device Group □ Southwest Vacuum Devices □ Video Display □ Zenith Components □ Zenith Elec.

EYE AND HEAD MOVEMENT TRACKERS

□ El-Op Electro Optics □ GEC Avionics □ ISCAN □ Personics

FACSIMILE ("FAX") MACHINES

□ Canon □ Citizen-CBM America □ Data Copy □ IBM □ Pacific Basin Distributing □ Relisys □ Unlimited Sys.

FIBER-OPTIC FACEPLATES

□ Corning Glass Works □ Galileo Electro-Optics □ Incom □ Interface Prods. □ Scriptel □ Teltron □ Thomson-CSF/DTE

FILTERS

□ Babcock Display Prods. □ Bates Mfg. □ Brewer Science □ Robert Busch □ Canadian Marconi □ Chomerics □ Craft Data □ Dainippon Ink & Chemicals □ Dotech □ El-Op Electro Optics □ Ginsbury Elec. □ Hoya Elec. □ Hoya Optics □ Interface Prods. □ Int. Polarizer □ K&R Engineering Sales □ Kensington Microwave □ Kollmorgen □ LectroMagnetics □ Liberty Mirror □ Lucas Duralith □ Metavac □ Mito Fine Glass □ Norden Sys. □ O&S Res. □ OCLI □ Optical & Conductive Coatings □ Optical Devices □ Panelgraphic □ Pulseview □ Raytheon □ Regisbrook □ Rockwell Int. □ David Sarnoff Res. Ctr. □ Southwall Tech. □ Sun-Flex □ Thin Film Device □ 3M Indus. Optics □ Viratec Thin Films

FLAT-PANEL DISPLAYS

See individual listings for backlights, electro-mechanical displays, electrochromic displays, electroluminescent displays, large-screen displays, liquid-crystal displays, plasma displays, projection displays, touch interactive displays, vacuum fluorescent displays

FLAT-PANEL MATERIALS

See individual listings for masks, filters, glass, liquid-crystal materials, magnetic shielding, optical coatings, polarizers

FOCUS COILS

□ CELCO □ DISCOM □ Penn-Tran □ Syntronic Instruments

GETTERS

□ Burle Indus. □ SAES Getters

GLASS FOR CRTs

□ Corning Glass Works □ Displays □ Hoya Elec. □ Mito Fine Glass □ OCLI □ OI-NEG TV Prods. □ Panelgraphic □ Precision Electronic Glass □ Schott America □ Viratec Thin Films

GLASS FOR FLAT-PANEL DISPLAYS

□ Alphasil □ Applied Films Lab □ Babcock Display Prods. □ Cherry Display Prods. □ Civ-Chem Engineering □ Corning Glass Works □ Hoya Elec. □ Hoya Optics □ Liberty Mirror □ Micro Fusion □ National Res. Resources □ Norden □ OI-NEG TV Prods. □ Panelgraphic □ Planar Sys. □ Plasmaco □ Schott America □ UCE Liquid Crystal Displays

GRAPHICS BOARDS AND PROCESSORS

□ Aydin Controls □ C&C Tech. □ CalComp □ Canadian Marconi □ Computer Peripherals □ Cornerstone Tech. □ Crystop Display □ Data Translation □ Datacube □ Densitron □ Digital Elec. □ EPIX □ Human Designed Sys. □ Interactive Machines □ Interface Prods. □ KMW Sys. □ KONE □ Kontron Elec. □ Mantron Displays □ Matrox Elec. Sys. □ Norden Sys. □ Nth Graphics □ Omnicon Graphics □ Parallax Graphics □ Primagraphics □ Racal Micro. Sys. □ RasterOps □ Relisys □ David Sarnoff Res. Ctr. □ Sigma Designs □ Sigmex □ Sony of America □ Sony Graphic Display □ Star Tech. □ Verticom □ Yamaha □ Zenith Components

GRAPHICS WORKSTATIONS

□ Alliant Computer Sys. □ Aydin Controls □ Chromatics □ DataBeam □ Fairlight Instruments □ Hazeltine □ Hughes Aircraft □ Imapro □ Interactive Machines □ KONE □ Librascope □ Norden Sys. □ Primagraphics □ RasterOps □ SAI Tech. □ Sanders Assoc. □ David Sarnoff Res. Ctr. □ Sigma Designs □ Sigmex □ Sony □ Tektronix □ V.I. Corp.

HARD-COPY DEVICES

See individual listings for digital film recorders, facsimile machines, plotters, printers (impact, ink-jet, thermal-transfer, electrophotographic, color graphic), and printer supplies

IMAGE TUBES

□ Burle Indus. □ EEV □ Imaging and Sensing Tech. □ Litton Electron Devices □ Quantex □ David Sarnoff Res. Ctr. □ Sony □ Teltron □ Texas Instruments □ Thomson-CSF/DTE □ Thomson Electron Tubes & Devices

IMAGING BOARDS

□ Computer Peripherals □ Coreco □ Data Translation □ Datacube □ EPIX □ Imaging Tech. □ Imapro □ Mantron Displays □ Matrox Elec. Sys. □ Omnicon Graphics □ Parallax Graphics □ Primagraphics □ Princeton Graphic Sys. □ PULNIX America □ RasterOps □ 3M Comtal □ Vutek Sys.

IMAGING WORKSTATIONS

□ Alliant Computer Sys. □ Datacube □ Ektron Applied Imaging □ Global Imaging □ Hazeltine □ Imapro □ Kontron Elec. □ Primagraphics □ Quantex □ RasterOps □ Recognition Concepts □ David Sarnoff Res. Ctr. □ Tektronix □ 3M/Comtal

JOYSTICKS

□ Aydin Controls □ Robert Busch □ Interactive Machines □ Kraft Sys. □ Penny and Giles □ Recognition Concepts □ Sigmex □ Varitronix □ VL Elec. □ WICO Distribution

KEYBOARDS

□ Aydin Controls □ Robert Busch □ CAM Graphics □ Canadian Marconi □ Cherry Display Prods. □ Cherry Elec. Prods. □ Futaba □ Ginsbury Elec. □ Hitech Intl. □ HMW Enterprises □ Human Designed Sys. □ IEC □ IEE □ Interactive Machines □ Interface Prods. □ Korry Elec. □ Lucas Duralith □ Norden Sys. □ Omnicon Graphics □ Penny and Giles □ Regisbrook □ SAI Tech. □ Sigmex □ Transicoil

LARGE-SCREEN DISPLAYS, ALL TECHNOLOGIES

See also projection displays

□ Advanced Computer Sys. □ Comfuture □ Cornerstone Tech. □ Craft Data □ DataBeam □ Davis A/S □ EEV □ Electronic Image Sys. □ Emerald Computers □ FIMI Phillips □ Futaba □ Hughes Aircraft □ IEC □ Ikegami Elec. □ Image Amplification □ Interface Prods. □ ISE Elec. □ Librascope □ Lucas Duralith □ LCD □ Mantron Displays □ Magnavox Elec. Sys. □ Micro Display Sys. □ Mito Fine Glass □ Mitsubishi Elec. Sales America □ Norden Sys. □ Norsk LCD □ OI-NEG TV Prods. □ Omega □ Panasonic Indus. □ Phosphor Prods. □ Photonics Sys. □ Pulseview □ Quantum Elec. □ Racal Micro. Sys. □ RasterOps □ Rediffusion Simulation □ Regisbrook □ SAI Tech. □ David Sarnoff Res. Ctr. □ S.E.O.S. Displays □ Sigma Designs □ Sony, Display Device Group □ Systems Res. Labs. □ Thomson Electron Tubes & Devices □ Viratec Thin Films □ Zenith Components

LIGHT EMITTING DIODE DISPLAYS

□ Advanced Computer Syst. □ Bowmar/ Ali □ Craft Data □ Display Tech □ Eaton □ El-Op Electro Optics □ Epson America □ GEC Avionics □ Hewlett Packard □ IEE □ Interface Prods. □ Korry Elec. □ NES □ Norden Sys. □ Optotek □ Pulseview □ Racal Micro. Sys. □ Regisbrook □ Rohm □ David Sarnoff Res. Ctr. □ Sharp Elec. □ Texas Instruments □ Toshiba America

LIGHT PENS/POINTING SYSTEMS

□ Aydin Controls □ Hazeltine □ HMW Enterprises □ Interactive Computer Prods. □ Iscan □ Photonics Sys.

LIQUID-CRYSTAL DISPLAYS, ACTIVE-MATRIX

□ Advanced Computer Sys. □ Alphasil □ Astronautics □ Robert Busch □ Crystaloid Elec. □ EEV □ Epson America □ GEC Avionics □ General Elec. □ Hitachi □ Honeywell Defense Avionics □ Hughes Aircraft □ Ikegami Elec. □ Interface Prods. □ Litton Data Images □ OI-NEG TV Prods. □ Ovonic Imaging Sys. □ Photonics Sys. □ Racal Micro. Sys. □ David Sarnoff Res. Ctr. □ Scriptel □ Sharp Elec. □ Thin Film Device □ Toshiba America □ UCE Liquid Crystal Displays □ Varitronix □ Villa Precision □ World Prods.

LIQUID-CRYSTAL DISPLAYS, FERROELECTRIC

□ Acculex □ Autodisplay □ Crystop Display □ Hornell Elektroptik AB □ OI-NEG TV Prods. □ Polytronix □ Scriptor □ UCE Liquid Crystal Displays □ Villa Precision

LIQUID-CRYSTAL DISPLAYS, PASSIVE

□ Acculex □ AEG □ AMETEK Aerospace Prods. □ Autodisplay □ Robert Busch □ Clover Display □ Craft Data □ Crystaloid Elec. □ Crystop Display □ Davis A/S □ Densitron □ EEV □ Emerald Computers □ Hamlin □ Hercules Aerospace Display Sys. □ Hitachi □ Hornell Elektroptik AB □ IEE □ Interface Prods. □ Kyocera America □ Litton Data Images □ LXI □ Mito Fine Glass □ National Res. Resources □ Norsk LCD □ OI-NEG TV Prods. □ Photonics Sys. □ Polytronix □ Pulseview □ Racal Micro. Sys. □ Regisbrook □ SAI Tech. □ David Sarnoff Res. Ctr. □ Scriptor □ Sharp Elec. □ Sony □ Toshiba America □ Transcoil □ UCE Liquid Crystal Displays □ Varitronix □ Villa Precision □ VL Elec.

LIQUID-CRYSTAL MATERIALS

□ BDH □ Dainippon Ink & Chemicals

MAGNETIC SHIELDING

□ Ad-Vance Magnetics □ Amuneal Mfg. □ Daburn Elec. and Cable □ Eagle Magnetic □ El-Op Electro Optics □ Gerome Mfg. □ Ginsbury Elec. □ Hoya Elec. □ K&R Engineering Sales □ Magnetic Radiation Labs. □ Magnetic Shield □ David Sarnoff Res. Ctr. □ Southwall Tech. □ Sun-Flex

MANUFACTURING EQUIPMENT

□ ASET □ Brewer Science □ Southwall Tech. □ Tech Spray □ Tencor Instruments □ Villa Precision

MARKET RESEARCHERS/PUBLISHERS

□ Future Systems □ Int. Planning Information □ Int. Resource Development □ Microvitec □ David Sarnoff Res. Ctr. □ Stanford Resources

MASKS

□ Applied Image □ Hoya Elec. □ Microphase Labs □ Precision Photomask □ Thin Film Device □ Toshiba America

MICE

□ Asher Engineering □ Human Designed Sys. □ Kensington Microwave □ Kraft Sys. □ Numonics □ Omnicomp Graphics □ Penny and Giles □ Z-Nix

MICRO-CHANNEL PLATES

□ Galileo Electro-Optics

OPTICAL COATINGS

See also filters, polarizers

□ Andus □ Applied Films Lab □ Arconium Specialty Alloys □ Autodisplay □ Balzers □ Brewer Science □ Robert Busch □ Chomerics □ Civ-Chem Engineering □ Dotech □ El-Op Electro Optics □ Ginsbury Elec. □ Hoya Elec. □ Hoya Optics □ Interface Prods. □ Kollmorgen □ Liberty Mirror □ Litton Data Images □ Metavac □ Mito Fine Glass □ O&S Res. □ OCLI □ Optical & Conductive Coatings □ Optical Devices □ Panelgraphic □ Reynard Enterprises □ David Sarnoff Res. Ctr. □ Schott America □ Sierracin/Intrex □ Southwall Tech. □ Sun-Flex □ Thin Film Device

□ 3M Indus. Optics □ Viratec Thin Films

OPTICAL DISCS & SYSTEMS

□ Corning Glass Works □ Electronic Image Sys. □ Honeywell Defense Avionics □ IBM □ C. Itoh Elec. □ Mito Fine Glass □ Mitsubishi Kasei America □ Optigraphics □ Pentax Teknologies □ Primagraphics □ Reference Tech. □ David Sarnoff Res. Ctr. □ Sony, Display Device Group

PHOSPHORS

□ Ginsbury Elec. □ Hoya Elec. □ Levy Hill Labs □ Mitsubishi Kasei America □ Phosphor Prods. □ Quantex □ David Sarnoff Res. Ctr. □ Sony, Display Device Group □ Thin Film Device

PHOTOMASKS

See masks

PLASMA DISPLAYS, AC

□ Advanced Computer Sys. □ Craft Data □ Densitron □ Digital Elec. □ Electro Plasma □ Emerald Computers □ Interstate Elec. □ Librascope □ Magnavox Electronic Sys. □ Mito Fine Glass □ NEC Elec. □ Norden Sys. □ Photonics Sys. □ Photonics Tech. □ Plasmaco □ Plessey Naval Sys. □ SAI Tech. □ Scriptor □ Texas Instruments □ Thin Film Device □ Thomson-CSF/C-SD □ Thomson-CSF/DTE □ Thomson Electron Tubes & Devices □ Villa Precision □ World Prods.

PLASMA DISPLAYS, DC

□ Babcock Display Prods. □ Cherry Display Prods. □ Cherry Elec. Prods. □ Craft Data □ Dale Elec. □ Densitron

□ Displays □ DIXY □ Emerald Computers □ IEE □ Mito Fine Glass □ NEC Elec. □ Panasonic Indus. □ Photonics Sys. □ Scriptor □ Texas Instruments □ Villa Precision

PLOTTERS

□ CalComp □ Electrographics Int. □ John Fluke Mfg. □ Houston Instrument □ Insight Development □ IBM □ Numonics □ Pentax Teknologies

POLARIZERS

□ Robert Busch □ Chomerics □ Dana Enterprises Intl. □ El-Op Electro Optics □ Hoya Elec. □ Hoya Optics. □ Int. Polarizer □ Liberty Mirror □ Litton Data Images □ Norden Sys. □ Optical Devices □ Reynard Enterprises □ Homer Tilton Visonics

POWER SUPPLIES, HIGH-VOLTAGE

□ Canadian Marconi □ CELCO Pacific □ Data Translation □ Del Elec. □ Dynatech Computer Power □ DISCOM □ El-Op Electro Optics □ Endicott Res. Group □ Ginsbury Elec. □ Ikegami Elec. □ Int. High Voltage Elec. □ K&R Engineering Sales □ Keltron □ Kensington Microwave □ Librascope □ Murata-Erie North America □ Norden Sys. □ Optical Radiation □ Penn-Tran □ PTK/Rantec □ David Sarnoff Res. Ctr. □ Venus Scientific □ Wasatch High Voltage □ Zenith Components

PRINTER SUPPLIES

□ Bates Mfg. □ DeRex □ Eastman Kodak □ Imagen □ IBM □ C. Itoh Elec. □ Kensington Microwave □ Mitsubishi Kasei America □ QMS □ Syntest □ Zenith Components

CRT's by Imaging and Sensing Technology Corporation: Durable. Versatile. Dependable.

Whatever your requirements for display or recording systems, ISTC can build a CRT to meet them. We've used our design expertise to build durable, dependable CRT's for a wide range of applications including:

- Heads-up display
- Energy exploration

- Air traffic control
- Military monitor displays
- Phototypesetting
- Large screen projection systems
- Microfilm systems

- Medical & X-Ray
- Color recording
- Multi-function heads-down display

For solving your CRT display or recording application problems, call or write:

Imaging and Sensing
Technology Corporation
Westinghouse Circle
Horseheads, NY 14845
(607) 796-3283.



Imaging and Sensing Technology Corporation
Technology and Quality from People Who Care

Circle no. 11

PRINTERS, COLOR GRAPHIC

Canon Circon DeRex HMW Enterprises Howtek C. Itoh Elec. KONE QMS Sigmex Tektronix Test & Measurement Sys. Toshiba America Versatec

PRINTERS, ELECTROPHOTOGRAPHIC (LASER AND LED)

Canon DeRex Ektron Applied Imaging Hewlett Packard Imagen IBM C. Itoh Elec. Mitek Sys. NBS Southern Optotek Pentax Technologies QMS Qume Raytheon Texas Instruments

PRINTERS, IMPACT

DeRex Epson America HMW Enterprises IBM C. Itoh Elec. NBS Southern Relisys Syntest

PRINTERS, INK-JET

Canon DeRex Hewlett-Packard Howtek IBM C. Itoh Elec. Sigmex Tektronix

PRINTERS, THERMAL-TRANSFER

Acculex CalComp Circon Craft Data DH Print Eastman Kodak Eaton Printer Prods. Epson America Honeywell Imapro IBM C. Itoh Elec. Lasergraphics Librascope Matrix Instruments Mitsubishi Elec. Sales America Mitsubishi Elec. America Norden Sys. QMS Raytheon Seiko Instruments USA Sigmex Syntest Tektronix Test & Measurement Sys. Versatec

PRINTHEADS

Rohm

PROJECTION DISPLAYS**Liquid-crystal light-valve projectors**

Alphasil Autodisplay Davis A/S Hitachi Hughes Aircraft National Res. Resources David Sarnoff Res. Ctr. Scriptel Telex Communications Thin Film Device UCE Liquid Crystal Displays Varitronix

Projection CRTs

DataBeam EEV El-Op Electro Optics Electrohome Electronic Image Sys. General Atronics Ginsbury Elec. Hitachi Ikegami Elec. Imaging and Sensing Tech. Mitsubishi Elec. Sales America Panasonic Indus. Rank Brimar Raytheon Rediffusion Simulation David Sarnoff Res. Ctr. Scriptel Sonic Tech. Sony Systems Res. Labs. Thomson-CSF/DTE Thomson Electron Tubes & Devices Toshiba America Varitronix Video Display Xytron

REPAIR AND MAINTENANCE**Of computer systems**

Computing Devices DeRex GEC Avionics Hughes Aircraft NEI Ferranti-Packard Elec. Recognition Concepts

Of display systems

Aydin Controls Chromatics Computing Devices El-Op Electro Optics Florod GEC Avionics Hazeltine Hughes Aircraft HMW Enterprises IEE Librascope Microvitec Phosphor Prods. Photonics Sys. Pixelink Relisys Tech Spray

Of high-voltage power supplies

Computing Devices El-Op Electro Optics Int. High Voltage Elec.

SCAN CONVERTER TUBES

Raytheon

SCANNERS, DOCUMENT AND FILM (GRAPHICS)

Computer Aided Tech. Data Copy DataBeam Eikonix Ektron Applied Imaging Houston Instrument Howtek Imapro Mekel Engineering Mitsubishi Elec. America Optographics Ovonic Imaging Sys. Pentax Teknologies Primagraphics Princeton Graphic Sys. David Sarnoff Res. Ctr.

SCANNERS, DOCUMENT (TEXT)

Canon Computer Aided Tech. Data Copy DataBeam Ektron Applied Imaging Ovonic Imaging Sys. Pentax Teknologies Princeton Graphic Sys. David Sarnoff Res. Ctr.

SCOREBOARDS

Omega

SEALANTS

Dainippon Ink & Chemicals

SIMULATOR DISPLAYS

Astronautics CalComp Canadian Marconi Computing Devices DataBeam Electronic Image Sys. GEC Avionics Ginsbury Elec. Honeywell Defense Avionics Hughes Aircraft Interactive Machines Interface Prods. Primagraphics Rank Brimar Rediffusion Simulation David Sarnoff Res. Ctr.

S.E.O.S. Displays Ship Analytics Systems Res. Labs. Xytron

SOFTWARE FOR DISPLAYS**Design and optimization software**

Astronautics Aydin Controls Robert Busch Computing Devices GEC Avionics Honeywell Defense Avionics Hughes Aircraft IBM ISC Cardion Elec. Librascope Matrox Elec. Sys. Racal Micro. Sys. David Sarnoff Res. Ctr. Sound Decisions

Graphics systems software

Alliant Computer Sys. Astronautics Autodisplay Aydin Controls Robert Busch CADKEY Canadian Marconi CELCO Pacific Chromatics Comfuteur Computing Devices Data Copy Data Translation Digital Elec. GEC Avionics Hazeltine Honeywell Defense Avionics Hughes Aircraft Hughett Res. Human Designed Sys. Insight Development Interactive Machines IBM ISC Cardion Elec. Librascope Matrox Elec. Sys. Norden Sys. Parallax Graphics Personics Primagraphics RasterOps SAI Tech. Sanders Assoc. David Sarnoff Res. Ctr. Tektronix Z-Nix

Image processing software

Aydin Controls Robert Busch Canadian Marconi CELCO Pacific Computing Devices Coreco Data Copy Data Translation Eastman Kodak El-Op Electro Optics Eltime Vision Sys. EPIX GEC Avionics Global Imaging Honeywell Defense Avionics

MAKE FAST, COMPREHENSIVE, AUTOMATIC CRT MEASUREMENTS WITH THE SUPERSPOT 100 FROM MICROVISION

CRT MEASUREMENT SYSTEM FROM MICROVISION

The **SUPERSPOT 100** System coupled with the **SPOTSEEKER II** Positioning System (with Automatic Focus) allows fully automatic characterization of Color and Monochrome CRT Displays without operator intervention.

Measures:

- Luminance (Footlamberts & Nits) • Line Width, Including Color Line Width (Gaussian Fit) (1 Second)
- Color Misconvergence (2 Seconds) • Linearity, Pincushion and Focus • Line Jitter, Swim and Drift
- Contour Maps of Spots, Lines or Characters (10 Seconds) • Beam Landing & Crowding
- FFT for Discrete Frequency Spectra (1024 points in one second) • High Voltage Regulation Tests
- Real Time Display of Beam Intensity Profile (20 Frames/Second Display) • Disk Data Logging • MTF

Provides:

- Pattern Generation for Tests • Adjustable Cursors for Feature Analysis

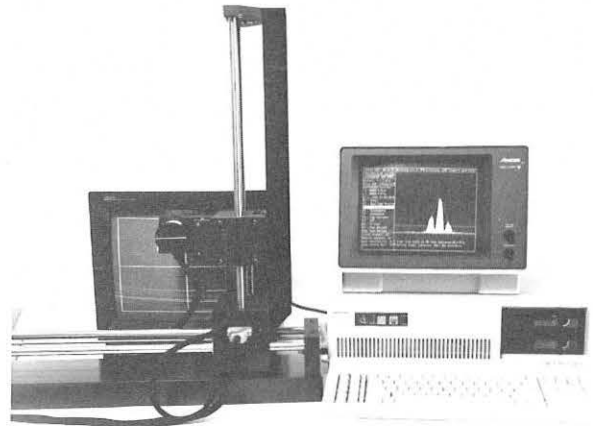

MICROVISION • 591 West Hamilton Avenue, Suite 250, Campbell, CA 95008 • Tel: 408/374-3158 • FAX: 408/374-9394

Hughes Aircraft Hughett Res.
 Image Amplification Imaging Tech.
 Insight Development IBM ISC
 Cardion Elec. Librascope Matrox
 Elec. Sys. Norden Sys. Recognition
 Concepts SAI Tech. David Sar-
 noff Res. Ctr. Ship Analytics 3M
 Comtal Videotex Sys. Z-Nix

Optical analysis software

Aydin Controls Robert Busch
 Computing Devices GEC Avionics
 IBM David Sarnoff Res. Ctr.
 Telic Optics

Signal processing software

Autodisplay Aydin Controls Ca-
 nadian Marconi Computing Devices
 Data Translation Dranetz Tech.
 Eastman Kodak El-Op Electro Op-
 tics EPIX GEC Avionics Honey-
 well Defense Avionics Hughes Air-
 craft Imaging Tech. IBM ISC
 Cardion Elec. Librascope Norden
 Sys. Primagraphics David Sarnoff
 Res. Ctr.

SONIC DIGITIZERS

Science Accessories

SPEECH INPUT/OUTPUT DEVICES

Autodisplay Robert Busch Ca-
 nadian Marconi Norden Sys. Pa-
 cific Basin Distributing Voice
 Connection

TEST AND MEASUREMENT EQUIP- MENT

Automatic convergence systems

Argo EG&G Gamma Scientific
 Electronic Image Sys. Ginsbury

Elec. Hoffman Engineering Honey-
 well Defense Avionics Ikegami Elec.
 McMahan Electro-Optics Microvi-
 sion Photo Research David Sarnoff
 Res. Ctr. Spectron Engineering

Automated test equipment

Argo Astronautics Control Sys-
 tem Tech. CR Tech. Crystop Dis-
 play Data Translation Dranetz
 Tech. EG&G Gamma Scientific El-
 Op Electro Optics Eltime Vision Sys.
 John Fluke Mfg. GEC Avionics
 McMahan Electro-Optics Meylan
 Microvision Optical Radiation
 Photo Research Photon Rock-
 well Int. David Sarnoff Res. Ctr.
 Spectron Engineering Tektronix
 Tencor Instruments United Detec-
 tor Tech. Vii

Gonioreflectometers

EG&G Gamma Scientific Hoffman
 Engineering McMahan Electro-Optics
 Photo Research

Photometers

EG&G Gamma Scientific Hoffman
 Engineering Labsphere LMT
 McMahan Electro-Optics Microvi-
 sion Minolta Photo Research
 David Sarnoff Res. Ctr. Spectron
 Engineering Tektronix United De-
 tector Tech.

Radiometers

EG&G Gamma Scientific Hoffman
 Engineering Labsphere Levy Hill
 Labs McMahan Electro-Optics
 Photo Research David Sarnoff Res.
 Ctr. Spectron Engineering Tektro-
 nix United Detector Tech.

Video generators

CELCO Pacific Leader Instruments
 Quantum Data David Sarnoff Res.
 Ctr. Test & Measurement Sys. Vii

Video oscilloscopes

John Fluke Mfg. Leader Instru-
 ments Tektronix

3D DISPLAY SYSTEMS

CADKEY Electronic Image Sys.
 Hughes Aircraft Interactive Ma-
 chines Matrox Elec. Sys. Norden
 Sys. Omnicomp Graphics Optical
 Elec. Primagraphics David Sarnoff
 Res. Ctr. Seiko Instruments USA
 Tektronix Homer Tilton Visonics

TOUCH-INTERACTIVE DISPLAYS

Advanced Computer Sys. Audodis-
 play Canadian Marconi Carroll
 Touch Computing Devices Craft
 Data Dale Elec. Digital Elec.
 Electro Mechanical Sys. Electro
 Plasma Futaba GEC Avionics
 IEE Interface Prods. Korry Elec.
 Matrox Elec. Sys. Microvitec
 Norden Sys. Omnicomp Graphics
 Phosphor Prods. Photonics Sys.
 SAI Tech. Sanders Assoc. David
 Sarnoff Res. Ctr. Talliq Thin Film
 Device UCE Liquid Crystal Displays
 Zenith Components

TOUCH SCREENS

Aydin Controls Babcock Display
 Prods. Robert Busch CAM Graph-
 ics Canadian Marconi Carroll
 Touch Craft Data Dale Elec.
 Densitron Digital Elec. Dranetz
 Tech. Electro Mechanical Sys.

Electro Plasma Emerald Comput-
 ers John Fluke Mfg. GEC Avionics
 HMW Enterprises Interface Prods.
 Korry Elec. Librascope Lucas
 Duralith Micro Touch Sys. Microvi-
 tec Norden Sys. Phosphor Prods.
 Photonics Sys. SAI Tech. Sierra-
 cin Transflex Southwall Tech. Sun-
 Flex Tektronix Thin Film Device
 TSD Display Prods. Varitronix
 VL Elec. Zenith Components

TOUCH TABLETS

Robert Busch Electro Plasma
 Lucas Duralith Sun-Flex Thin
 Film Device

TRACKBALLS

Asher Engineering Aydin Controls
 Interface Prods. Korry Elec. Li-
 brascope Penny and Giles Recog-
 nition Concepts

VACUUM EQUIPMENT

Balzers Leybold NEC Elec.
 David Sarnoff Res. Ctr.

VACUUM FLUORESCENT DISPLAYS

Babcock Display Prods. Craft Data
 Digital Elec. EEV Futaba IEE
 NEC Elec. Pulseview Regis-
 brook Texas Instruments Villa Pre-
 cision

VIDEO AMPLIFIERS

CELCO Pacific Circon El-Op
 Electro Optics Electronic Image Sys.
 Ginsbury Elec. Norden Sys. Op-
 tical Elec. David Sarnoff Res. Ctr.

X-RAY IMAGE STORAGE SCREENS

Levy Hill Labs

**To Backlight?
Or Not
To Backlight?**

With BKL EL lamps
the answer is simple,
inexpensive and FAST.
Call Eric Light. (215) 277-2910

BKL

Bonar KARD-O-LITE,™ Inc.
421 Fehleley Drive, King of Prussia, PA 19406
(215) 277-2910
FAX (215) 277-2956



To engineer low defect large blanks and masks, HOYA goes the extra micron.

Hoya goes far beyond minimum standards to guarantee quality large blanks and masks. They're now available up to 14" x 14". By applying years of extensive engineering and manufacturing improvements in I.C. photobank production, Hoya can offer volume large blanks and masks with extremely low defect and tight tolerance integrity for the glass substrate as well as chromium and resist film layers.

What does our technological progress mean to you? It means versatility, one-pass yield, quicker turnaround and long-lasting quality performance.

These large, hard-surface chromium on glass blanks and masks provide the thermal expansion stability of glass, the process reliability of chrome and uniformity of spin-coat resist for superior imaging needed in such precision circuit and pattern applications as large area electronics, surface-mount designs, fine-line printed circuit boards, flat panel displays and hybrid circuits.

Available also in rectangular or circular configuration applications, the

products are double-side polished with beveled edges. The outstanding uniformity of the chrome and resist film assures excellent dimension control. And Hoya's exclusive new edge-to-edge uniform resist coating delivers expanded imaging capability to 100 percent of the plate. Various image layers such as Al, ITO, MoSi₂ and others are provided upon request.

All Hoya large format masks/blanks are manufactured in Class 100 Clean Rooms. The precision and process monitors of Hoya's automated manufacturing line assures the yield of large masks/blanks that are particle and damage resistant due to reduction in physical handling, environment control and separation by our lightweight multi-carrier packaging.

So long-term, they won't take a big bite out of your budget. And short-term, their very low defect rate reduces repair, inspection, and delivery times from day one. That's what going the extra micron does for you.

For more information, call HOYA Electronics Corporation: In CA, (408) 435-1450; NJ, (201) 307-0003; TX, (214) 450-4410.

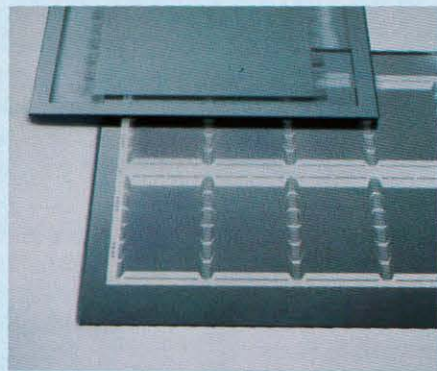

HOYA

The image of tomorrow.

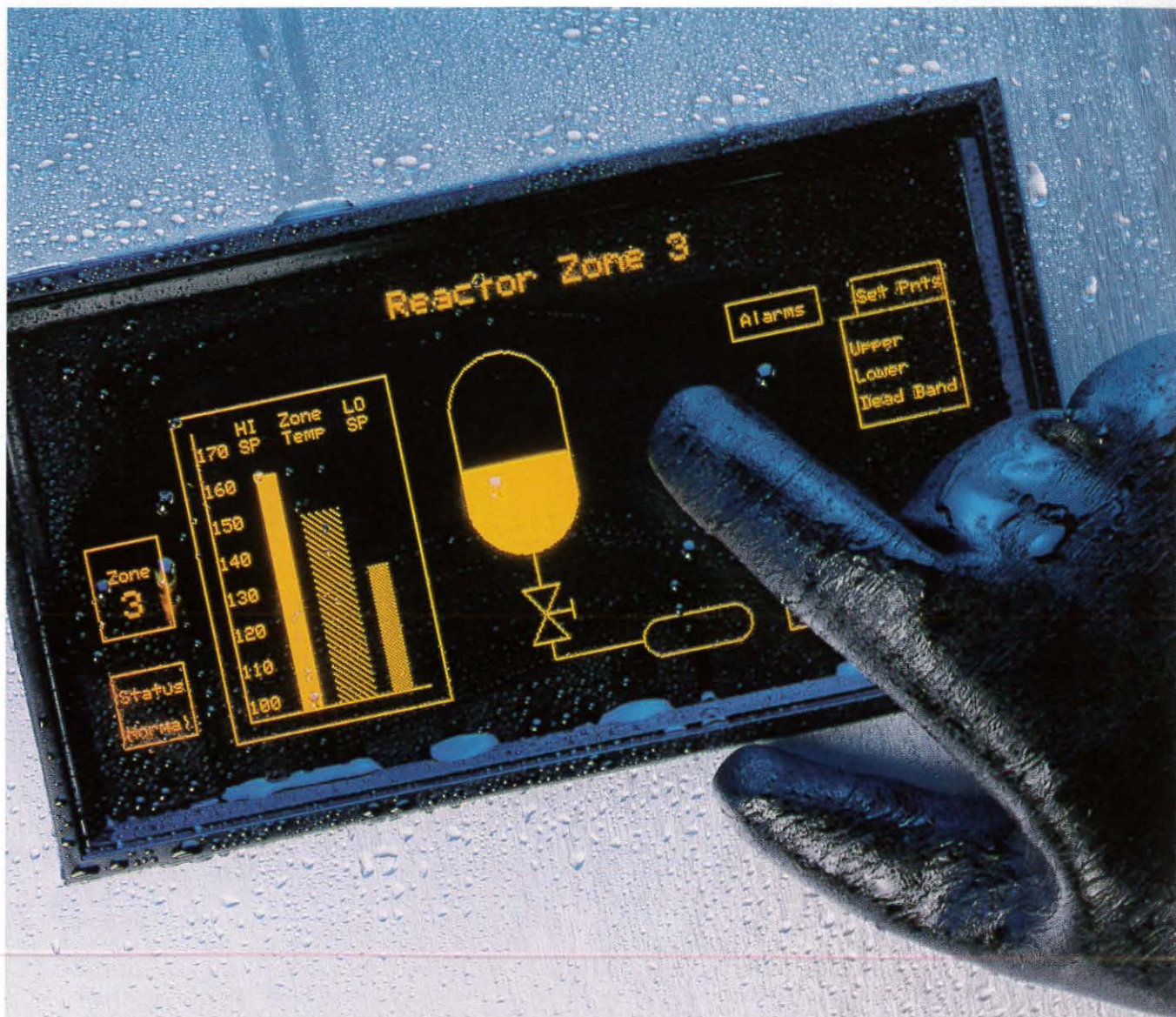

DEECO SEALTOUCH® DISPLAY SYSTEM. SEALS IN PERFORMANCE. SEALS OUT DIRT AND MOISTURE.

If there's one thing you don't need, it's dirt and moisture seeping into your display system and disrupting its performance. The DeeCO SealTouch display system is the best solution for your most demanding industrial applications.

Designed especially for harsh environments, SealTouch delivers consistently reliable performance under the most threatening conditions.

The SealTouch display system is a 3-part module consisting of flat-panel display and sealed I-R Touch panel, mounted on a controller card with VT100 text emulation and extensive drawing graphics. All within an absolute minimum footprint.

Easy-to-use touch software, pop-up menus and convenient button draw routines make SealTouch easy to design-in and simple to use. The system's programmable touch sensitivity allows you to easily implement protection against annoying false triggers. What's more, the SealTouch infra-red beam diagnostics continuously monitor system performance, assuring you of consistent reliability.

Don't take chances with any other display system. Call or write for full product information. Let SealTouch seal in performance for your design. And seal out dirt and moisture.

DeeCO

Digital Electronics Corporation, 31047 Genstar Road, Hayward, CA 94544-7831 (415) 471-4700

SealTouch and DeeCO are registered trademarks of Digital Electronics Corporation.

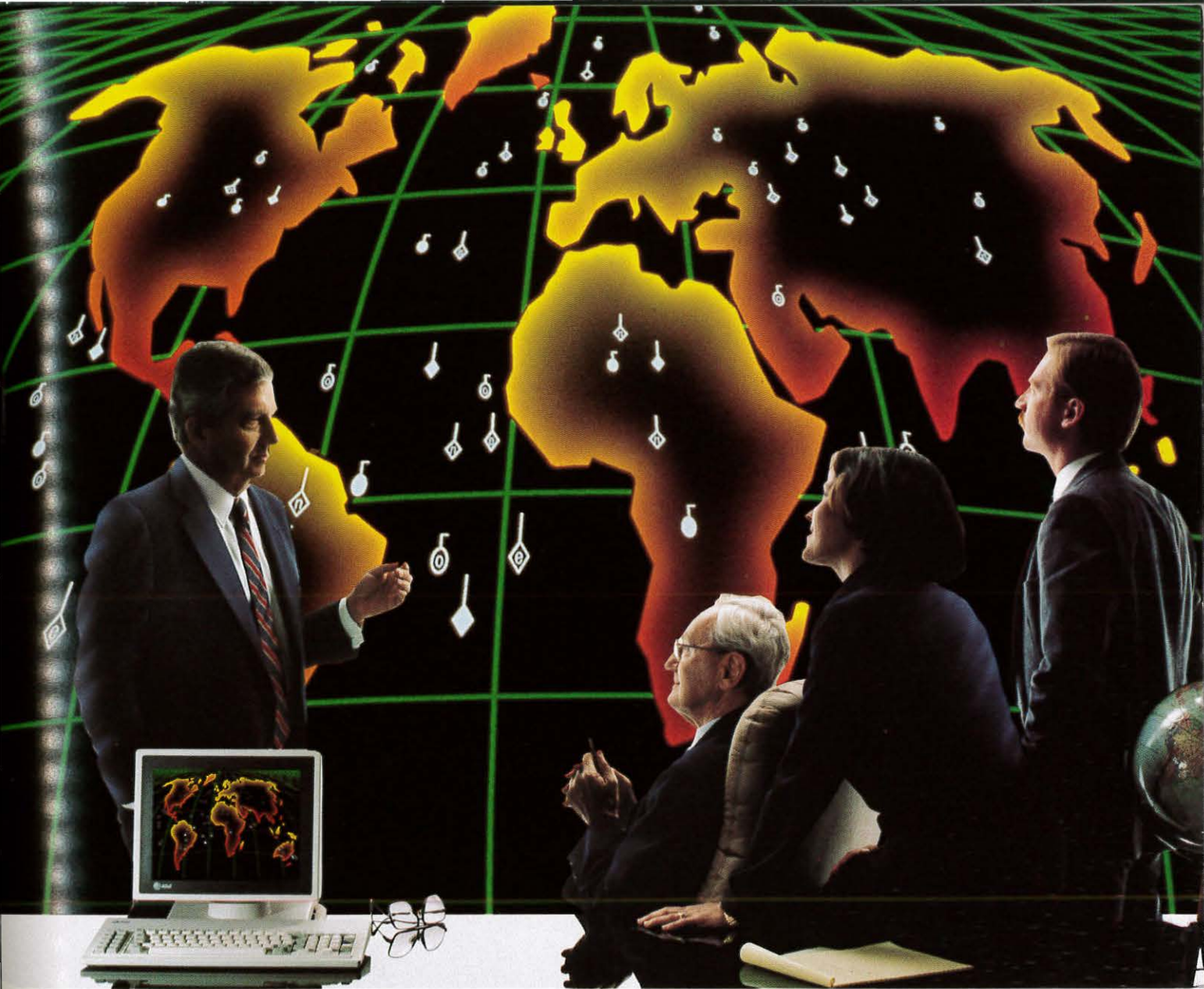

Introducing a whole new world of shared information. The new Hughes Superprojector.

From the world of aerospace command and control comes the Hughes Superprojector. Not for home or entertainment uses, it's the first full color professional graphics projection system designed to match the power of *any* computer, super to personal.

Its powerful 1000 lumens allow you to project brilliant 1000 line resolution computer graphic images up to 20 feet or more. Exclusive liquid crystal light valve technology provides clean, crisp color images, even in normally lighted rooms.

Until now, the ability to create real-time computer data outstripped the means to present it. But, now Hughes has made its patented liquid crystal light valve technology affordable for a

whole new range of real-time decision making applications: live situation and status display, configuration and design management, teleconferencing, routing and traffic control, financial management and more. It's the brightest, highest resolution professional graphics projection system available today.

Discover a whole new world of shared information. The model 1000 Superprojector from Hughes, the leader in information presentation technology. For a convincing free demonstration, write or call today. Hughes Aircraft Company, Projector Marketing, 6155 El Camino Real, Carlsbad, CA 92009. 619/931-3619



HUGHES

Subsidiary of
GM Hughes Electronics

Circle no. 16

Look at What's Happening in Imaging



PHOTO COURTESY 3M CONTAL

On October 4-6, 1988 the Electronic Imaging Exposition & Conference will give you an opportunity to look at what's happening in imaging. Held at the World Trade Center in Boston, MA, this premier show in the imaging field will feature the latest breakthrough products from leaders in the industry. A broad spectrum of products used in image capture, manipulation, storage and display will be on exhibit. And you'll find exhibitors with a real interest in discussing your needs, your problems and possible solutions.

During the four-day conference program, which starts on October 3 and then runs concurrently with the exhibits, world-renowned experts will explore such topics as image sensors and scanners, image

storage and processing, solid state cameras, image communications, and graphic displays. They will also discuss their wide variety of applications in science, aerospace, medicine, commerce, industry, military and consumer markets.

Don't miss this opportunity to find out what's happening in imaging. For more information contact MG Expositions Group, 1050 Commonwealth Avenue, Boston, MA 02215, (800) 223-7126, in MA (617) 232-3976 (9am-5pm Eastern Time).

Electronic Imaging East '88
World Trade Center
Boston, MA
October 4-6, 1988

ELECTRONIC EAST '88
IMAGING
International Electronic Imaging Exposition & Conference

The CRT is the User's First Impression of Your System.



Make it a Good One with Clinton CRTs

Let's face it, all the dramatic data processing innovations in a new product are worthless to your customer if the CRT screen doesn't perform.

That is why leading manufacturers have trusted Clinton CRTs for years. They know Clinton CRTs deliver reliability and performance every time.

Plus, Clinton's range of monochrome CRTs and phosphor types allow you to choose the most ergonomic end-user interface.

Clinton Responds to Market Demands.

Clinton is prepared to meet the ever changing demands of the computer and workstation industry. That means you'll get the high quality CRTs you need, and in the latest configurations that will give your product increased appeal.

Innovations like Flat Profile CRTs and Spectrum Segmented

Phosphor CRTs have contributed to Clinton's reputation as an industry leader.

And now Clinton has added a 17" and 20" CRT to their Flat Profile CRT Series. These new tubes are specially designed to meet the need for increased display area in workstation applications.



Clinton's 17" & 20" Flat Profile CRTs are ideal for Workstation Applications.

Team Up With Clinton.

Clinton is more than a CRT supplier. We are ready to team up with your company to provide a CRT that will enhance your new product design.

And with engineering and extensive manufacturing capabilities based in the United States, Clinton can accommodate the most stringent "Just-in-Time" delivery schedules with competitively priced CRTs.

When you are looking for a monochrome CRT and you want to ensure your new product's success, Clinton's the *only* choice.

Clinton Electronics Corporation
6701 Clinton Rd. • Rockford, IL 61111
815/633-1444
Telex: 687 1504 CECRCK
Telefax: 815/633-8712



**CLINTON
ELECTRONICS
CORPORATION**

For solutions to your smallest or largest display problems in demanding environments

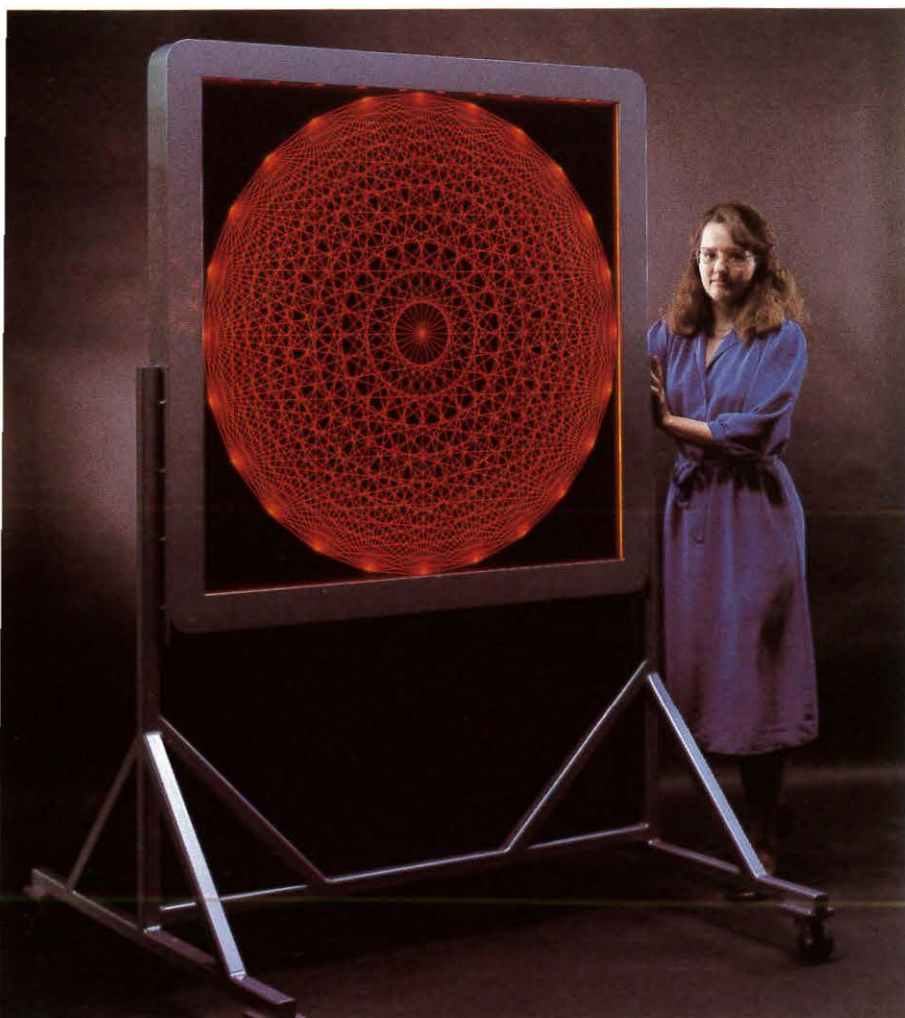

2048 x 2048 pixels
1.5 meters diagonal (59 inches)
World's Largest Fully-Populated,
Dot Matrix Display

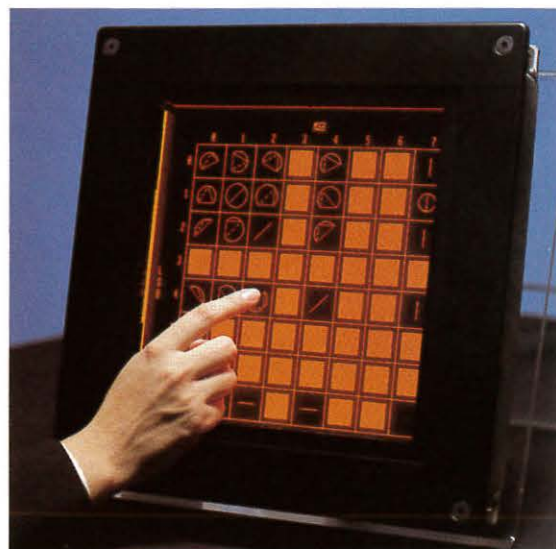

512 x 512 pixels
50 lines of 80 characters
8 x 8 inches



1024 x 1024 pixels
100 lines of 160 characters
12 x 12 to 17 x 17 inches
19 inch rack mountable

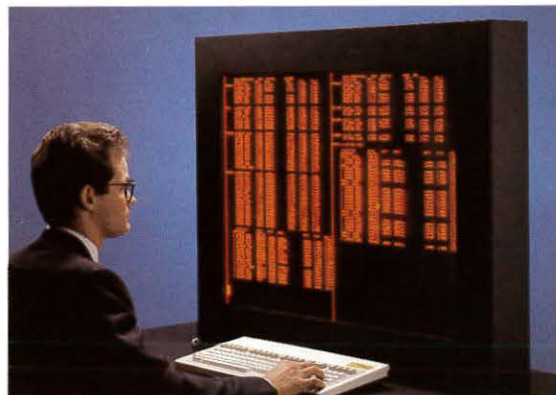

1596 x 1212 pixels
one-meter diagonal
(39.4 inches)

COMPLETE LINE OF FLAT PANEL DISPLAY PRODUCTS

- Terminals from 256 x 256 to 2048 x 2048 pixels with 32-bit microprocessor controllers and industry standard text, graphics and controls
- Display sizes from 10 centimeters to 1.5 meters
- Video monitors with digital and analog video inputs
- LED IR, membrane, and other touch entry technologies
- Compact power supplies with 28VDC or 110/220 VAC inputs

RUGGEDIZED & MILITARIZED FEATURES

- Designed for MIL Qualified Parts
- High shock and vibration resistance
- Wide temperature ranges
- Inherently high reliability and long life

Circle no. 19

wasatch

HIGH VOLTAGE, INC.

A COMMITMENT TO "NO PROBLEM" POWER.

Over seven years of growth with a commitment to "problem free" design and manufacturing has brought Wasatch to the forefront of High Voltage Power. Today we are one of the largest suppliers of CRT power supplies. In fact, it's very difficult to find a company that's more capable of modifying or customizing power supplies to fit your specific application, deliver units at low cost, and provide "just-in-time" deliveries.

High Voltage Power, No Problem...
it's the reason why Wasatch is the right choice for your high voltage needs.

Wasatch Engineers
develop custom solutions
on a regular basis.

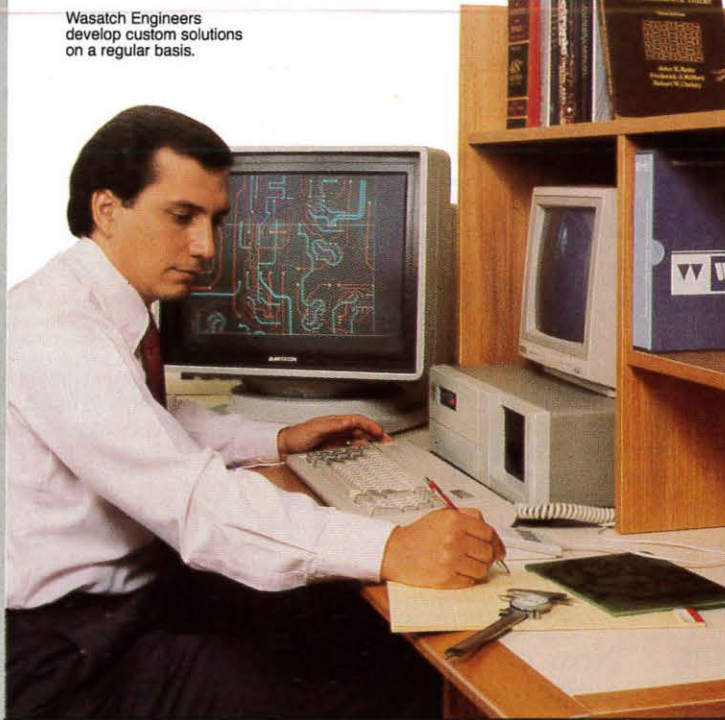

Need A Custom Unit?... No Problem.

On a regular basis, Wasatch Engineers work directly with the customer to turn standard power supplies into prototypes for specific applications. And if a specific "off-the-shelf" unit cannot be modified, we'll design an entirely new unit at a very reasonable cost. So give us your idea, and watch us develop a prototype.

Need Quick Turnaround?... No Problem.

Prototypes can be delivered as soon as ten days after placing an order. We will even design products to fit your own manufacturing needs, and provide "just-in-time" deliveries to help control your inventory.

Need Reliability?... No Problem.

Wasatch units are subjected to stringent quality control. All units feature 48 hour burn-in and are backed by a full one year warranty.

Need Low Cost?... No Problem.

Wasatch is a company small enough to meet your needs, yet large enough to stay cost competitive. It's difficult to find a vendor that offers more power supply for your dollar.

So try the advantage of "No Problem" high voltage power. If you compare, you'll find Wasatch offers a product line that is unparalleled in reliability, turnaround, and price.

Call us for an estimate today.

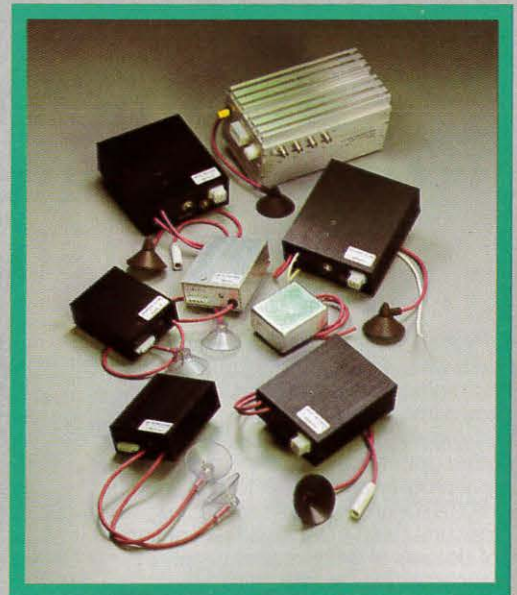

Custom and semi-custom units are available.

wasatch

High Voltage Inc.
4100 South West Temple
P.O. 15457
Salt Lake City, Utah 84115
1-801-265-9561

Rep Inquiries Welcome

Circle no. 20

LEADER



“At lunch today, I learned to use this programmable video generator. And still had time to eat.”

While other RGB video generators take weeks to learn, ours take minutes. No digital training needed. No countless key combinations to learn. No need to use your PC unless you want to. Unlike other generators, Leader's have an integral programmer (LVG-1604A and 1603A) or are available with a programmer unit (1601A). And you can get any of dozens of test patterns simply by touching one clearly marked key.

All the functions you need.

The LVG-1604A lets you test even the most advanced high-resolution CRT's and

wide-band video transmission systems. Present or future.

Analog, TTL and ECL outputs. 125 MHz. 64-color capability. Storage of up to 200 display formats. Wide range of raster architectures, and most common test patterns with both stock and user-designed characters. Ability to change format conditions. These features are easy to learn—but hard to beat.

that's right for you. Then, in just 30 minutes, we'll show you how to use it. It'll be up and running before you finish your lunch.

Call toll-free
1 800 645-5104
In NY State
516 231-6900



Select a Leader Video Generator with all the features you need.

Circle #21 for product demonstration

Now you can choose.

You shouldn't pay for more functions than you need. So call us for a free copy of our full-line catalog. Pick the video generator

Leader Instruments Corporation
380 Oser Avenue, Hauppauge, New York 11788
Regional Offices:
Chicago, Dallas, Los Angeles, Boston, Atlanta
In Canada call Omnitronix Ltd. 416 828-6221

LEADER
FOR PROFESSIONALS WHO KNOW
THE DIFFERENCE

Circle #22 for product information

ACCULEX, 440 Myles Standish Blvd., Taunton, MA 02780
Manufacturers and distributors of industrial process monitoring and display products. Surface mount technology designs, rugged digital panel meters (LCD and LED) for measuring temperature, pressure, voltage current, etc.
Brian Smothers, Prod. Mktg. Mgr.
508/880-3660 Telex: 503989
Fax: 508/880-0179

AD-VANCE MAGNETICS, INC., 625 Monroe St., Rochester, NY 46975
Manufacturers of custom-fabricated magnetic shields, magnetic tape and disk protectors, and magnetic-shielding alloy raw material, foil and sheet.
Kay Nixon, Sales Mgr. 219/223-3158
Telex: 810/290-0294 Fax: 219/223-2524

ADEX CORP., 1750 Junction Ave., San Jose, CA 95112
Designers and manufacturers of color and monochrome monitors spanning horizontal deflection rates from 31 to 90 kHz and vertical refresh rates from 40 to 120 Hz in sizes from cockpit displays to CAD/CAM/CAE applications.
Bill Wildera, Pres.
408/436-9700 Fax: 408/436-9700

ADVANCED COMPUTER SYSTEMS, INC., 3490 Far Hills Ave., Dayton, OH 45429
Systems integrator developing turnkey, computerized information display systems utilizing a variety of technologies such as LCD, LED, CRT, plasma, reflective disk, and split flap signs.
Gregory M. Rooney, Mgr. Sales, Info.
Dis. Sys. 513/294-4477
Fax: 513/294-4186

AEG CORP., Route 22, Orr Dr., P.O. Box 3800, Somerville, NJ 08876-1269
Manufacturers of LCDs for automotive dashboards, military/avionics, and sign boards with chip-on-glass and flex circuit interconnection technology; high-resolution electrostatic CRTs; and shadow-mask color military tubes and mini displays for thermal imaging and helmet-mounted applications.
G. Barone, LCD Sales Mgr.; P. Mikel, CRT Sales Mgr. 201/231-8300
Toll Free: 800/444-AEGL
Telex: 833409 Fax: 201/722-4905

ALLIANT COMPUTER SYSTEMS CORP., Raster Div., One Monarch Dr., Littleton, MA 01460
Manufacturers of raster graphics accelerator boards and 2- and 3D graphics terminals.
Donna Raimondi, Pub. Rel.
617/486-4950 Fax: 617/486-1398

ALPHASIL, INC., 1045 Mission Ct., Fremont, CA 94539
Manufacturers of custom and semi-custom monochrome and color active-matrix displays for military and high value commercial applications.
Thomas D. Stahl, Dir., Sales/Mktg.
415/651-3636 Fax: 415/651-5642

AMETEK AEROSPACE PRODUCTS, 900 Clymer Ave., Sellersville, PA 18960
Manufacturers of solid-state LC and electromechanical engine instruments; dichroic LCDs; data converters; fluid gauging and pressure indicating systems for the aerospace market.
G. Jerry Anderer, Sales Mgr.
215/257-6531, ext. 355 Telex: 84-7445
Fax: 215/257-1888

AMUNEAL MANUFACTURING CORP., 4737 Darrah St., Philadelphia, PA 19124
Manufacturers of custom and standard magnetic shields for CRTs, photo-multipliers, and transformers. Equipped with CNC Turret Punch Press (Amada) and hydrogen annealing, automated heliarc welding, hydroforming, and CMM inspection equipment.
Larry Maltin, Pres. 215/535-3000
Fax: 215/743-1715

ANDUS CORP., 21019 Osborne St., Canoga Park, CA 91304
Manufacturers of custom coatings on flexible substrates.
Linda A. Hoitt, Dir., Mktg./Sales
818/882-5744 Telex: 182374
Fax: 818/882-6519

APPLIED FILMS LAB, INC., 6797 Winchester Cir., Boulder, CO 80301
Manufacturers of sputtered thin-film components including ITO- and metal-coated front and rear display electrodes.
Cecil Van Alsburg, Pres.
303/530-1411 Telex: 450110 APPL FILM
Fax: 303/530-3214

APPLIED IMAGE, INC., 1653 E. Main St., Rochester, NY 14609
Manufacturers of high-resolution "hinged" glass phototools including large precision imaged chrome-on-glass artwork for automotive, flat-panel and CRT display applications.
Eduardo J. Navarro, Vice Pres., Sales/Mktg. 716/482-0300 Fax: 716/288-5989

ARCONIUM SPECIALTY ALLOYS, 400 Harris Ave., Providence, RI 02909
Producers of indium and fully integrated manufacturers of indium metal and indium oxides for thick- and thin-film applications.
David Sklarski, Mktg. Dir.
401/456-0800 Telex: 262298
Fax: 401/421-2419

ARGO CORP., 3-24-12-502 Tarumi-cho, Suita, Osaka 564, Japan
Distributors of the Superspot 100 CRT analysis system for Microvision USA.
Tsumoto Ouhori 06-339-3366
Fax: 06-339-3365

ASET, 6110 Variel Ave., Woodland Hills, CA 91367
Manufacturers of Model 1562 G-Line Substrate Stepper™ for flat-panel display circuit board, optical disk, and over-size glass plate reticle requirements.
Tom Kandris, Vice Pres., Sales
818/884-5050 Telex: 67-7143
Fax: 818/340-2070

ASHER ENGINEERING, 15115 Ramona Blvd., Baldwin Park, CA 91706
Manufacturers of mice and trackballs.
Kathleen Warnock, Mktg. Mgr.
818/962-4063 Toll Free: 800/824-3522
Fax: 818/338-1424

ASTRONAUTICS C.A. LTD., 23 Hayarkon St., Bnet-Brak, Israel 51261
Manufacturers of CRT monitors; electro-mechanical, electrochromic, EL, LC active-matrix, and simulator displays; software for displays; and automated test equipment.
Samuel Levy, Mgr., Dis. Sys.
972-3-5791555 Telex: 341294
Fax: 704404

AUTODISPLAY A.S., P.O. Box 240, Thoroja, Sandesfjord, Norway N-3201
Manufacturers of Polydisplay® integrated passive, free graphic, reprogrammable, flexible, color LCD systems for vehicles. Also, system analysis and consulting.
Thor G. Kamfjord, Mng. Dir.
47-34-58800 Telex: 21905 AUTOD N
Fax: 47-34-59400

AYDIN CONTROLS DIV., 414 Commerce Dr., Ft. Washington, PA 19034
Manufacturers of format/full graphic and image processing raster scan color terminals and color display computers; peripherals and software for the process control, computer, and CAD industries.
215/542-7800 Toll Free: 800/366-8889
Fax: 215/628-4372

BABCOCK DISPLAY PRODUCTS, INC., 1051 S. East St., Anaheim, CA 92805
Manufacturers of gas-discharge display components and subsystems; VFD display subsystems; filters, converters, and decoders/drivers.
Carl Cox, App. Eng. 714/491-5100
Telex: 249646 Fax: 714/490-1368

BALZERS, 8 Sagamore Park Rd., Hudson, NH 03051-4914
Manufacturers and marketers of high vacuum systems, components and thin films used for electronics, optics, information storage, metallurgy, research, and electron microscopy.
Emil Bickel, Sr. Prod. Mgr., Optical Sys.
603/889-6888

BARCO-INDUSTRIES, INC., 472 Amherst St., Suite 16, Nashua, NH 03063
Manufacturers of color and monochrome graphics displays; rugged and semi-rugged displays; cockpit displays; and broadcast displays.
Piet Lesage, Nat. Sales Mgr.
603/880-1430 Fax: 603/880-8918

THE BATES MANUFACTURING CO., Newburgh Rd., Hackettstown, NJ 07840
Manufacturers of CRT antiglare screens, media storage files, computer scales, and continuous form cards.
Eileen Magno, Dir. Sales
201/852-9300 Toll Free: 800/222-2837
Telex: 136-371 Fax: 201/852-7837

BDH, LTD., Advanced Materials Div., Broom Rd., Poole, Dorset, U.K. BH12 4NN
Manufacturers of LCs for electro-optic displays; thermochromic LCs; single crystals for UV and IR optics; scintillators; fluoride glass components for fiber optics; precursors for high TC superconductors.
M. G. Pellatt, Bus. Mgr., Adv. Mat. Div.
44-202-745520 Telex: 41186 TETRA G
Fax: 44-202-738299

LEO BEISER INC., 151-77 28 Ave., Flushing, NY 11354
R&D and consultation in image and data scanning and recording; laser-based printing, graphics, industrial, display and information systems; and CRT and discrete element devices. Patent expertise and in-company guidance and training.
Leo Beiser, Pres. 718/353-7298

BONAR KARD-O-LITE, INC., 421 Feheley Dr., King of Prussia, PA 19406
Manufacturers of EL lamps and materials; thinnest lamp (0.012-0.018 in.) encapsulated in Aclar. Quick turnaround from prototype to production.
Dean Smith, Vice Pres., Mktg.
215/277-2910 Fax: 215/277-2956

BOWMAR/ALI, INC., 531 Main St., Acton, MA 01720
Manufacturers of LED bargraphs and digital meters and display subsystems. Linear and circular bargraphs from 3 to 10 in. Worldwide commercial and military types.
Andrew Roeper, Prod. Line Mgr.
508/263-8365 Telex: 710/347-1441
Fax: 508/263-3358

BREWER SCIENCE, INC., 2401 High Tech Dr., P.O. Box GG, Rolla, MO 65401
Manufacturers of red, green, and blue polyimide coatings for color displays; black coating for contrast enhancement and light shielding/spacing in active-matrix LCDs; transparent polyimide alignment and planarization coatings.
Joseph J. Schlueter, Dir., U.S. Sales
314/364-0300 Telex: 361471
Fax: 314/364-7150

BROY ENGINEERING LTD., 92 Advance Rd., Toronto, Ont., Canada M8Z 2T7
Manufacturers of deflection yokes for video display equipment, including yokes for operation at 64 kHz.
Denis Roy, Pres. 416/231-5535
Fax: 416/231-6184

BURLE INDUSTRIES, INC., 1000 New Holland Ave., Lancaster, PA 17601
Manufacturers of high-resolution photorecording CRTs (3- and 5-in.) and projection CRTs (5- and 7-in.) for industrial, medical, and military applications.
Herk Rintz, Mgr. Mkt. Plng.
717/295-6027 Fax: 717/295-6097

ROBERT BUSCH GmbH, Neureuterstr. 55, D-7500 Karlsruhe 21, F.R.G.
Manufacturers of automotive information systems: trip computers; car telephone displays; cockpits; graphic displays; navigation systems; and telecommunication systems.
Peter M. Knoll 0721-751087
Fax: 0721-758172

C&C TECHNOLOGY, 708 Mandrake Dr., P.O. Box 280, Batavia, IL 60510
Distributors of very-high-resolution graphics boards for IBM PC/AT and VME bus based systems.
Randy Cochran 312/879-7003
Telex: 4974811 CC MKTG
Fax: 312/879-6438

CADKEY INC., 440 Oakland St., Manchester, CT 06040
Manufacturers of 3D CADD products for the PC in manufacturing, government, and education.
Marty Loschivo, Sales Mgr.
203/647-0220 Telex: 5106007223
Fax: 203/646-7120

CADVISION, A Division of Chugai International Corp., 365 Van Ness Way, Suite 510, Torrance, CA 90501
Manufacturers of the CADVISION 19 in. color display monitor with different screen resolutions; noninterlaced scanning, antiglare screens, and a tilt/swivel base. Ideal for high-resolution graphics applications.
Edward A. Rider, Sales Mgr.
213/618-8615 Fax: 213/618-9963

CALCOMP INC., P.O. Box 3250, Anaheim, CA 92803
Manufacturers of graphics subsystems that include boards and terminals using both raster-scan and vector-refresh technologies; computer graphics products including digitizers, plotters, and plotter/printers.
James Gowan, Vice Pres., Sales
714/821-2501 Toll Free: 800/CALCOMP
Telex: 188746 Fax: 714/821-2832

CAM GRAPHICS CO. INC., 15 Ranick Dr. W., Amityville, NY 11701
Manufacturers of keyboards and touch screens.
Tracy Deiorio, Mktg. Mgr.
516/842-3400 Telex: 510/224-6181
Fax: 516/842-1005

CANADIAN MARCONI CO., 415 Leggett Dr., P.O. Box 1330, Kanata, Ont., Canada K2K 2B2
Manufacturers of TFEL displays; military color CRTs (5 x 5 and 6 x 6 in.); commercial color CRTs (2.5 x 3 in. and 9-in.-diag.); and fiber-optic displays.
Angus Bell, Bus. Devel. Mgr.
613/592-6500 Telex: 0534805
Fax: 613/592-7427

CANON INC., c/o Canon USA Inc. ATD, 3191 Red Hill Ave., Costa Mesa, CA 92626
Manufacturers of business machines, cameras, video equipment, and optical products.
Hiroshi Hanada 714/556-1036

CARROLL CONSULTING CO., 15951 Los Gatos Blvd., Suite 9, P.O. Box 186, Los Gatos, CA 95031-0186
Consulting and design services in CRT systems; projection, recording, and test equipment; CRT circuits; cameras and solid-state imagers; project management; and new product development.
Gus Carroll, Pres. 408/358-0023
Fax: 408/356-4143

CARROLL TOUCH, INC., P.O. Box 1309, Round Rock, TX 78680
Manufacturers of scanning infrared and resistive overlay touch input systems for computer monitors, terminals and flat panel displays. OEM discounts available.
512/244-3500 Telex: 881906
Fax: 512/244-7040

CELCO (Constantine Engineering Labs Co.), 70 Constantine Dr., Mahwah, NJ 07430

Manufacturers of deflection yokes, deflection amplifiers, CRT test equipment, and CRT digital film-recording systems. Art Weirgen, Engrg. Sales Mgr. 201/327-1123

CELCO PACIFIC, 1150 E. 8th St., Upland, CA 91786

Manufacturers of CRT displays, deflection amplifiers, digital film recorders; high-voltage power supplies; graphics systems and image processing software; video generators, and video amplifiers. Pete Constantine, Engrg. Sales Mgr. 714/985-9868

CERADYNE ELECTRON SOURCES, 1081 Old Frankfort Pike, Lexington, KY 10510

Manufacturers of dispenser cathode assemblies for camera pick-up tubes and monochrome and color CRT applications.

Wayne Ohlinger, Prod. Mgr. 606/255-3664 TWX: 510/476-8888 Fax: 606/255-6829

CHERRY DISPLAY PRODUCTS, 15 Founders Blvd., El Paso, TX 79906

Manufacturers of high-resolution and dot matrix EL displays with interface and drivers; dot-matrix and segmented gas plasma displays; keyboards; SnOx coated glass; electronic assemblies; and integrated circuits.

Eric J. Olson, Prod. Mgr., El Dis. 312/662-9200 Fax: 312/360-3566

CHERRY ELECTRICAL PRODUCTS, 3600 Sunset Ave., Waukegan, IL 60087

Manufacturers of dc gas-plasma panels (segmented, bar graph, and dot matrix) and dc EL displays (640 x 200 and 640 x 480).

Bill Skelton, Gen. Mgr., Elec. 312/360-3463 Fax: 312/360-3566

CHOMERICS, INC., 77 Dragon Ct., Woburn, MA 01888

Manufacturers of contrast-enhancement filters (polarizing and night vision), EMI conductive/AR coatings, EMI/EMP/TEMPEST shielded windows, and special laminations.

W. Lionetta, Nat. Sales Mgr. 617/935-4850 Toll Free: 800/225-1936 Telex: 710/393-0173 Fax: 617/933-4318

CHROMATICS, INC., 2558 Mountain Industrial Blvd., Tucker, GA 30084

Manufacturers and designers of high-resolution color graphic computers and display systems for military and commercial applications. CX 2000 series features 1,000,000 vectors/sec; 50,000 flat shaded polygons/sec.

Peggy Grimm, Mgr., Mktg./Comm. 404/493-7000 TWX: 810/766-8099 Fax: 404/493-1314

CHUNGHWA PICTURE TUBES, LTD., 1127 Hopin Rd., Danan Village, Padah Hsiang, Taoyuan, Taiwan, R.C. 33409

Manufacturers of monochrome and color TV/monitor CRT displays, electron gun parts, and deflection yokes.

C. C. Liu, Sales Dir. 886-3-3675151 Telex: 34153 CPTTYTAI Fax: 886-3-3629441

CIRCON CORP., 460 Ward Dr., Santa Barbara, CA 93111

Manufacturers of small color video cameras; 1-in. black-and-white displays; 8-in. x 400-line high-resolution color CRT displays; and 300+ line 3- and 6-in. LCDs.

Jarry Bartz, Indus. Prod. Mgr. 805/967-0404 Telex: 658 472 Fax: 805/967-5035

CITIZEN, CBM AMERICA CORP., 2999 Overland Ave., Los Angeles, CA 90064

Manufacturers of barcode readers and fax machines, including the modular Citizen Fax.

Jim Ristow, Div. Mgr. 213/558-0916 Toll Free: 800/421-6516 Fax: 213/836-1140

CITRONIX, INC., 5342 Halsted Ave., Carmichael, CA 95608

Manufacturers of calligraphic and raster deflection amplifiers; video amplifiers; programmable TV raster generators with geomex correction; CRT test stations; and CRT monitors.

Al Pletz, Vice Pres., Engrg. 916/961-1398 Telex: 910/350-6540

CIV-CHEM ENGINEERING, INC., 919 W. Ross, Belen, NM 87002

Manufacturers of patterned glass faceplates for flat-panel displays; production prototypes; coarse and fine-line, low- or high-ohm patterned circuitry on TO and ITO coated glass.

John Castillo, Pres. 505/864-1641

CLINTON ELECTRONICS CORP., 6701 Clinton Rd., Rockford, IL 61131

Manufacturers of CRTs for data display, imaging, and consumer electronics; display-grade high-resolution CRTs with special phosphors; "Spectrum" segmented screens; antiglare options; and ultra-high-resolution CRTs.

Garry Gwaltney, Nat. Sales Mgr. 815/633-1444 Telex: 687/1504CECRK Fax: 815/633-8712

CLOVER DISPLAY, LTD., 166 Wai Yip St., 11/F, Karin Bldg., Kwun Tong, Hong Kong

Manufacturers of 7-segment LCD and 5 x 7 dot-matrix LCD modules; touch panels; and TN, STN, and guest-host LCDs.

C. L. Chou, Oper. Dir. 3-428228 Telex: 55322 KRN HK Fax: 3-7541121, 3-7640706

COLORADO VIDEO, INC., Box 928, Boulder, CO 80306

Manufacturers of stand-alone video frame stores, which can be used with any computer. Designers of high-resolution freeze-frame communication systems.

N. H. Bennett, Nat. Sales Mgr. 303/530-9580 Telex: 910/940-3248 COLO VIDEO BDR Fax: 303/530-9569

COMFUTURE LTD., 7 Habonim St., Ramat-gan, Israel 52521

Manufacturers of LED based electronic display systems including monochromatic alphanumeric displays and multicolor graphic displays; and networking support software packages. Eilon Ginsburg, Mgr. 03-7510-940 Telex: 361333 MLL Fax: 03-7516615

COMPUTER AIDED TECHNOLOGY, INC., 7411 Hines Pl., Suite 212, Dallas, TX 75235

Manufacturers of low-priced, high quality image scanners for text and graphics. Maximum resolution 300 x 300 dpi; 128 gray levels; auto-proportion; compatible with CAT, TIFF, PCX, and PFF formats.

Gina Lee, Vice Pres. 214/631-1640 Fax: 214/631-4059

COMPUTER PERIPHERALS, INC., 667 Rancho Conejo Blvd., Newbury Park, CA 91320

Manufacturers of font cartridges and expandable memory for the HP laser jet printer and enhancement board products for IBMs, PC/XT/AT/XT286/PS2, and true compatibles.

Susan Humpting, Mgr., Inside Sales 805/499-5751 Toll Free: 800/854-7600 Telex: 759299 CPI Fax: 805/498-8848

COMPUTING DEVICES CO., P.O. Box 8508, Ottawa, Ont., Canada K1G 3M9

Manufacturers of standard multisensor digital displays for naval applications; the Multimode Advanced Graphics and Imaging for Command and Control System (MAGIC²); and EL programmable display panels.

Gerry Tarum, Mgr., Dis. Sys. Mkt. Devel. 613/596-7001 Telex: 053-4139 Fax: 613/820-5081

CONNECTOR CORP., 6025 N. Keystone Ave., Chicago, IL 60646

Manufacturers of customized, high-reliability, JECC-compatible sockets for CRTs featuring Connector Corp.'s tube neck retaining clamp, spark gaps, HV connectors, in-line components, and combination PC and flying leads.

Diane Racana, Sales Mgr. 312/539-3108 Telex: 910/221-6059 Fax: 312/539-3825

CONRAC DISPLAY PRODUCTS GROUP, 1724 S. Mountain Ave., Duarte, CA 91010

Manufacturers of a variety of high-performance color and monochrome video monitors for broadcast and computer graphic displays.

W. Ems, Dir. Sales 818/303-0095 Fax: 818/303-5484

CONSTELLATION, Room 704, Trinity House, 165-171 Wan Chai Rd., Wan Chai, Hong Kong

Consultants in electronic information displays; product design and applications, and process and production line design and installation.

Jerry Garies, Mngng. Dir. HK-5-8336577 Telex: HK-85799 TIMOS HX Fax: HK-5-741977

CONTROL SYSTEMS TECHNOLOGY, 19045 Cherry Bend Dr., Germantown, MD 20874

Manufacturers of a data line monitor for diagnosing hardware/software data communications problems on RS-232 lines. Captures and displays data and signal status on 2 x 40 LCD. Runs up to 15 hours on internal battery.

T. Walker Lipscomb, Vice Pres., Mktg. 301/540-8614

CORECO INC., 6969 Trans-Canada Hwy., Suite 113, St-Laurent, Que., Canada H4T 1V8

Manufacturers of computer vision/image processing products and support; video digitizer boards and software for image processing and analysis; systems integration.

Pat Urbain, Sales Coord. 714/333-1301 Toll Free: 800/361-4914 (USA) Telex: 7601120 COR VC Fax: 514/333-1388

CORNERSTONE TECHNOLOGY, INC., 1883 Ringwood Ave., San Jose, CA 95131

Manufacturers of high-resolution page displays and other image management products for the IBM PC/XT/AT/386/PS/2 Model 30, compatibles, and the Mac II.

Ken Westrick, Dir. Sales 408/279-1600 Toll Free: 800/562-2552 Fax: 408/279-5603

CORNING GLASS WORKS, Materials Business, MP 21-3-3, Corning, NY 14831

Manufacturers of large and small CRT bulbs and components for industrial and military applications; core rod and tubing for fiber-optic faceplates; FOTO-FORM[®] glass and FOTOCERAM[®] glass ceramic materials for plasma displays, dot-matrix printers, and ink-jet nozzle applications.

Neil Izatt, Sr. Sales Eng. 607/974-4305 Telex: 932498 Fax: 607/974-7618

CORNING GLASS WORKS, Precision Flat Glass Business, MP 21-1-6, Corning, NY 14831

Manufacturers of 7059 and 1733 glass substrates for LCD, EL, and sensor applications.

Benjamin J. Garbowski, Sales Supv. 607/974-4308 Telex: 932498 Fax: 607/974-7618

CR TECHNOLOGY, INC., 23062 La Cadena Dr., Laguna Hills, CA 92653

Manufacturers of the CRT-480 Machine Test/Alignment System, automating the CRT production line or incoming test station.

Craig Crawford, Vice Pres., Sales 714/859-4011 Fax: 714/859-3214

CRAFT DATA, INC., 27022 Cordero La., Mission Viejo, CA 92691

Distributors for Dixy Corp. and Mitani plasma displays including standard and custom interfaces and IR touch panels. Representatives for Transicoil integrated keyboards, Polytronix LCDs, and Kristel CRT monitors.

F. W. Holstein, Pres. 714/582-8284 Telex: 751875 Fax: 714/582-8284, after hours: 714/556-8325

CRAFT DATA, LTD., 92 Broad St., Chesham, Bucks., U.K. HP5 3ED

Distributors of plasma, EL, LCD, vacuum fluorescent and LED displays, normally with drive electronics, standard interfaces, and power supplies. Custom designs welcome.

F. G. Tagg, Mngng. Dir. 0-494-778235 Telex: 838859 Fax: 0-494-773645

CRT SCIENTIFIC CORP., 14746 Raymer St., Van Nuys, CA 91405

Manufacturers of high-quality custom and production CRTs. Also offer application of phosphors to a wide range of substrates and lamination of EMI panels to any CRT.

818/989-4610 213/873-5107 Fax: 818/989-4617

CRYSTALOID ELECTRONICS, 1460 Winchell Dr., Hudson, OH 44236

Manufacturers of standard and custom twisted nematic, dichroic, and matrixed LCDs for commercial, military, and aviation use.

Sales Dept. 216/655-2429 Fax: 216/655-2176

CRYSTOP DISPLAY, Hansastrasse 29C, D-75 Karlsruhe 21, F.R.G.

Manufacturers of custom LCDs and LCD systems; automatic test equipment for LCDs. W. Pauls 0721-1-579048 Telex: 7-826-402 Fax: 0721-1-50-11-16

DABURN ELECTRONICS AND CABLE CORP., 70 Oak St., Norwood, NJ 07648

Manufacturers of electronic hardware, computer cables, shrink tubing, and modular retractable cords for installation.

Randy Hibshman, Nat. Sales Mgr. 201/768-5400 TWX: 710-991-9856 Fax: 201/768-9642

DAGE-MTI, INC., 701 N. Roeske Ave., Michigan City, IN 46360

Manufacturers of high-resolution auto-locking monochrome monitors and high-resolution video instrumentation cameras.

Paul Thomas, Vice Pres., Sales/Mktg. 219/872-5514 Telex: 532521 DAGEMTI Fax: 219/872-5559

DAINIPPON INK & CHEMICALS, INC., Imaging and Reprographic Products Div., 7-20, Nihonbashi 3 chome, Chuo-ku, Tokyo 102, Japan

Manufacturers of a variety of LC materials for LCDs and related products such as sealants and color filters.

T. Takahashi, Gen. Mgr. 03-272-4511 Telex: 222-2977 Fax: 03-272-1565

DALE ELECTRONICS, INC., P.O. Box 609, 1122 23 St., Columbus, NE 68601

Manufacturers of dc plasma (gas discharge) displays and display modules. Types include segmented numeric and alphanumeric, bar graph, dot matrix, and custom graphic displays.

Darrell Smejkal, Sales Mgr. 402/564-3131 Fax: 402/563-6418, -6296

DANA ENTERPRISES INTL. INC., 1440 So. Saratoga-Sunnyvale Rd., San Jose, CA 95129

Manufacturers of custom polarizers. Also offer a display repolarization service. Distributors for Sanritsu Electric Co., Japan, manufacturers of LCD polarizers.

402/257-6686 Telex: 352141 Fax: 408/973-9620

DATA COPY CORP., 1215 Terra Bella Ave., Mountain View, CA 94043
Manufacturers of high-resolution electronic digitizing scanners, imaging systems, facsimile cards for the IBM PC.
Mktg. Coord. 415/965-7900, ext. 358
Toll Free: 800/821-2898 Telex: 701994
DATACOPY UD Fax: 303/965-3474

DATA GENERAL CORP., 4400 Computer Dr., Westboro, MA 02146
Manufacturers of transmissive and transreflective backlit supertwist LCD and EL flat-panel displays.
Nancy Friedenthal, Pub. Rel. Spec.
508/898-4081 Toll Free: 800/DATAGEN

DATA RAY CORP., P.O. Box 368, 452 Burbank St., Broomfield, CO 80020
Manufacturers of high-performance monochrome and color CRT displays for the OEM market. Monochrome screen sizes: 7-23 in. (15.750-100 kHz); color screen sizes: 10-20 in. (15.750-80 kHz).
Ann Woodley, Sales Rep.
303/469-5173 Fax: 303/466-9524

DATA TRANSLATION, INC., Attn: Catherine Grady, 100 Locke Dr., Marlboro, MA 01752
Manufacturers of microcomputer analog I/O systems, image processing products, and array processing boards for the IBM PC and PS2, MicroVax III/Q-bus and Unibus, Mac II, VMEbus, Multibus, Multibus II.
Ellen Wirka, Dir. Sales 508/481-3700, ext. 600 Telex: 951646
Fax: 508/481-8620

DATABEAM CORP., 3256 Lochness Dr., Lexington, KY 40503
Manufacturers of high-resolution display and communication systems (1000 lines or better) for viewing and interacting with a full 8 1/2 x 11 in. document, providing error free communication, interactive pointers, and real-time handwriting annotation.
Peter G. Gammon, Dir. Sales
606/273-3204 Fax: 606/273-3619

DATACUBE, INC., 4 Dearborn Rd., Peabody, MA 01960
Manufacturers of the MaxVideo real-time DSP image processor frame buffer that displays high-resolution video up to 2 x 1K pixels on any monochrome or RGB high-resolution monitor.
Susan Snell Solomon, Mktg. Mgr.
617/535-6644 Telex: 710/347-0125
Fax: 617/535-5643

DAVIS A/S, P.O. Box 380, Erik Børresensgt 9, Drammen, Norway 3001
Manufacturers of Transview transmissive LCDs, interfaceable to PCs; and a high-resolution, backlit LCD monitor.
Jon Rortveit, Mktg. Mgr.
47-3-83-5590 Fax: 47-3-83-2252

DEL ELECTRONICS CORP., 250 E. Sandford Blvd., Mt. Vernon, NY 10550
Manufacturers of high-voltage CRT power supplies for commercial and military applications. Switching supplies available with ratings to 27-kV 40-W multioutput for shadow-mask color and monochrome modular construction.
Bob Michalak, Dir. Tech. Sales
914/699-2000 Fax: 914/699-4005

DENSITRON CORP., 2540 W. 237 St., Torrance, CA 90505
Manufacturers of flat-panel display products including LCDs and dc plasma displays.
Rob Turner, Sales Mgr. 213/530-3530
Telex: 910/349-6200 Fax: 213/534-8419

DeREX, INC., 7716 Wiles Rd., Coral Springs, FL 33067
Distributors of plug compatible printer systems from 200 cps through 8000 lpm. Impact and nonimpact for IBM, Unisys, HP, DEC, Prime, DG, and other mini and mainframe computers.
Robert Jamison, Vice Pres.
305/753-0840 Toll Free: 800/245-7282
Fax: 305/753-0944

DH PRINT (formerly Eaton Printer Products), Technical Research Park, Riverton, WY 82501
Manufacturers of the Cypher series of thermal barcode printers. Four models are available with a choice of two print resolutions.
Janet Jones, Mktg. Comm. Coord.
307/856-4821 Telex: 910/949-4864
Fax: 307/856-0412

DIGITAL ELECTRONICS CORP., 31047 Genstar Rd., Hayward, CA 94544
Manufacturers of VF modules; graphic and text terminal EL modules; graphic and text controllers for flat panels (EL, VF, plasma); IR touch panels; flat-panel PC adapter cards; and industrial terminals.
Bill Lepior, Nat. Sales Mgr.
415/471-4700 Telex: 172073 DIGELEC
HYWD Fax: 415/489-3500

DISCOM/DISPLAY COMPONENTS, INC., 334 Littleton Rd., Westford, MA 01886
Manufacturers of precision high-resolution CRT deflection yokes, high-voltage and specialized low-voltage power supplies, and high-voltage power supply test systems.
Ben C. Iannotta, Vice Pres., Mktg.
508/692-6000 Telex: 951888
Fax: 508/692-8489

DISPLAY TECH, INC., 2179 S. State St., Ann Arbor, MI 48104
Manufacturers of medium- to large-scale LED display signs in over 200 sizes. Fully trained staff to support unusual and custom applications.
Jim Bridges, Vice Pres., Sales
313/994-3460 Toll Free: 800/LED-DISP
Fax: 313/994-3952

DISPLAYTEK, INC., 1355 Holmes Rd., Elgin, IL 60123
Manufacturers of CRT display monitors: 5-9 in. units; 12-15 in., 90° and 110° medium-resolution units; 17- and 19-in. high-resolution units; a 4-million-pixel monochrome display; and a Trinitron-based 16-in. color display.
Carl Cobb, Dir., Sales and Mktg.
312/931-2133 Toll Free: 800/544-8823
Fax: 312/931-2120

DISPLAYS, INC., RD 4, Box 6AAA, Mifflin County Industrial Park, Lewistown, PA 17044
Manufacturers of standard and custom dc plasma displays including digital, alphanumeric, dot-matrix, and bargraph designs and combinations of these.
K. C. Kennedy, Pres. 717/242-2541
Telex: 842540 Fax: 717/248-8680

DIXY CORP., 5-5, Katsuradai, 1-chome, Yokohama 227, Japan
Manufacturers of plasma display units of real-time input with 16-level gray scale.
Kiichi Nagao, Mgr., Overseas Sales
045-962-1717 Telex: 3823574 DIXY
J Fax: 045-962-2547

DONTECH, INC., 700 Airport Industrial Blvd., P.O. Box 889, Doylestown, PA 18901
Manufacturers of EMI/TEMPEST windows/optical filters (CRT, LED, LCD, EL, plasma, and touch panel); shielded structural windows to 5 x 12 ft.; fleximetric shielding, narrow bandpass filters (P43, night-vision compatible) and antireflection contrast-enhancement panels.
Jordan Miller, Sales Mgr.
215/348-5010
Telex: WVVI 6851155DONTK
Fax: 215/348-9959

DOTRONIX, INC., 160 First St. S.E., New Brighton, MN 55112
Manufacturers of medium- and high-resolution 9-20 in. color and 3-25 in. monochrome CRT displays. Cabinet, chassis, and kit versions available. Some sizes available in multimodel/multisync.
Len Stewart, Sales Mgr.
612/633-1742 Fax: 612/633-7025

Gun Control.

At Southwest Vacuum Devices we solve gun control problems. Prototypes. Research. Design. Manufacturing.

We sole source guns and gun components for top U.S. OEMs.

Short runs cost you money, time, productivity. That's an area in which we excel.

Use us as an extension of your own engineering and production facilities.

As a domestic supplier we are only overnight, not oceans apart.

For solutions to your gun control problems, call or write us today.

Complete Guns, Stems, Cathodes, Other Components



SOUTHWEST VACUUM DEVICES, INC.

P.O. Box 50524/Tucson, Arizona 85703
(602) 887-7900 Telex 165-522

Circle no. 23

DRANETZ TECHNOLOGIES, INC., 1000 New Durham Rd., Edison, NJ 08818

Manufacturers of precision electronic measuring and monitoring instrumentation and software for analysis of electric power line and environmental disturbances.
E. McDonald, Dir. Sales
201/287-3680 Toll Free: 800/DRANTEC
Telex: 499-7808 Fax: 201/287-8627

DRB TECHNOLOGIES, INC., 630 Llewellyn Rd., Barwyn, PA 19312

Consulting services in electro-optic technology and management of high-technology organizations. Product and process expertise in displays, sensing, electronics.
David Baraff, Pres. 215/296-7588

DUREL CORP., 645 W. 24 St., Tempe, AZ 85282

Manufacturers of standard and custom EL lamps for backlighting LC and gas plasma displays.
R. C. Jodoin, Mktg. Mgr.
602/966-0624 Fax: 602/966-8851

DYNATECH COMPUTER POWER, INC., 5800 Butler La., Scotts Valley, CA 95066

Manufacturers and marketers of high quality power conditioning products and accessories for PCs and other micro-processor-based equipment.

Becky Hamilton, Mktg. Comm. Mgr.
408/438-5760 Toll Free: 800/638-9098
Telex: 887-247 Fax: 408/438-5793

EAGLE MAGNETIC CO., INC., P.O. Box 24283, Indianapolis, IN 46224

Manufacturers of electromagnetic shielding products from design through production. Consulting services available.

Robert Jackson, Sales Mgr.
317/297-1030 Fax: 317/299-1323

EASTMAN KODAK, 343 State St., 6th Fl., Bldg. 10, New Rochester, NY 14650

Manufacturers of the Kodak Still Video (SV) series of color video printers, color monitors, and the Kodak SV 5035 slide to video transfer unit.
Roger Smith, Dir., Mktg. Comm.
716/724-4748 Toll Free: 800/44KODAK, ext. 110

EATON CORP., 1640 Monrovia Ave., Costa Mesa, CA 92627

Manufacturers of the Series 900 Fiber Optic Readout displays offering maximum legibility and sunlight readability using incandescent lamps as light sources. Other light sources available.
J. Carpenter, Prod. Mgr. 714/642-2427
Telex: 6 78433 Fax: 714/645-5946

EATON PRINTER PRODUCTS (see DH PRINT)

EEV, Waterhouse La., Chelmsford, Essex, England CM1 2QU

Manufacturers of CRTs and modular CRT display systems for industrial and military applications; CCD cameras, sensors and systems; and LCDs for military and special applications.
D. Wickham, Mktg. Mgr. 0245-493493
Telex: 99103 Fax: 0245-492-492

EEV, INC., 4 Westchester Plaza, Elmsford, NY 10523

Manufacturers of Miniscan CRT display systems; magnetically deflected radar tubes; military and avionic tubes; monitor and projection TV tubes; miniature high-resolution electrostatic tubes; fiber-optic tubes; LCDs; video display boards; and CCD cameras.
Stu Hesselson, Sr. Mktg. Mgr.
914/592-6050 Toll Free: 800/431-1230
Telex: 6818096 Fax: 914/682-8922

EG&G GAMMA SCIENTIFIC, INC., 3777 Ruffin Rd., San Diego, CA 92123

Manufacturers of instrumentation for spectral and spatial analysis of all types of displays. Capabilities include automatic, dynamic "white line" convergence, MTF, linewidth, and geometric characteristics plus radiometric, colorimetric, and photometric analysis.

R. M. Ruff, Sales Mgr. 619/279-8034
Telex: 697938 Fax: 619/576-9286

EG&G RETICON, 345 Potrero Ave., Sunnyside, CA 94086

Manufacturers of solid-state image sensors and solid-state cameras.
John Skurla, Nat. Sales Mgr.
408/245-2060 Telex: 910/339-9343
Fax: 408/738-6979

EIKONIX, 15 Wiggins Ave., Bedford, MA 01730

Manufacturers of slide scanners for mounted and unmounted, positive and negative 35-mm slides and portions of 70- and 90-mm films at a resolution of 2800 dpi with up to 12 bits/color/pixel. Interfaces and software available for all popular computers.
John Miller, Mktg. Mgr.
617/276-7161 Fax: 617/276-5063

EKTRON APPLIED IMAGING, INC., 23 Crosby Dr., Bedford, MA 01730

Manufacturers of EKTRON Laser Image Recorder, Model 811, a high-resolution output device for generating continuous-tone 8-bit images onto dry-silver media. Input is via an IEEE-488 interface from user's host computer.
Glenn Coppelman, Mktg./Sales Mgr.
617/275-0475 Fax: 617/271-1977

EL-OP ELECTRO OPTICS INDUSTRIES LTD., P.O. Box 1165, Rehovot, Israel 76110

Manufacturers of avionics and tank fire control systems such as head-up displays, helmet-mounted displays and sights, multifunction displays, and up front control panels.
Ami Yachin, Dir., Corp. Intl. Mktg. and Sales 972-8-486448
Telex: 381344 Fax: 972-8-486748

ELASTOMERIC TECHNOLOGIES, INC. (formerly PCK Elastomers), 2940 Turnpike Dr., Hatboro, PA 19040

Manufacturers of high-density elastomeric connectors for flat-panel displays, including carbon stax for LCDs; and silver stax and MOEs for EL, gas, plasma, and VF types.
John Seibert, West. Reg. Sales Eng.; George Glatts, East. Reg. Sales Eng.
215/672-0787 Fax: 215/672-4633

ELECTRO MECHANICAL SYSTEMS, INC., 801 W. Bradley Ave., Champaign, IL 61820

Manufacturers of color and monochrome touch-interactive displays utilizing both CRTs and EL panels, all totally integrated. Custom touch panels also available.
Julie Redman, Sales Mgr.
217/359-7125 Fax: 217/359-2075

ELECTRO PLASMA, INC., 4400 Martin-Moline Rd., Millbury, OH 43447

Manufacturers of ac plasma displays; large-screen plasma displays; workstations; ruggedized display housings; and touch-interactive displays.
Wes Michael, Sales Supv.
419/255-5197 Telex: 241589
Fax: 419/242-9713

ELECTROGRAFICS INTL. CORP., 1825 Stout Dr., Warminster, PA 18974

Manufacturers of the Polychrome L.F.C. 7000, a large format stepper for direct imaging on chrome or iron oxide.
Ann Grossi, Vice Pres. 215/443-5190
Telex: 703653 Fax: 215/443-9564

ELECTROHOME LTD., 809 Wellington St. N., Kitchener, Ont., Canada N2G 4J6

Video Display Products Div.: Manufacturers of datagraphics projection systems, including single- and three-lens systems with microprocessor control, infrared remote control, and full-zone digital convergence.

Projection Products Div.: Manufacturers of color and monochrome datavideo projection systems for screen sizes from 5- to 25-ft.-diag. Scanning frequencies from 15 to 80 kHz with resolutions to

1024 x 1024 pixels.

Alan Caskey, Sales Mgr., No. Amer.
519/744-7111 Toll Free: 800/265-2171
Fax: 519/749-3131

ELECTRONIC IMAGE SYSTEMS, INC., 600 Bellbrook Ave., Xenia, OH 45385

Contract research and product development for advanced video systems including cockpit, helmet-mounted, and large-screen monochrome and color displays and color projectors for military and commercial applications.

Joe A. Mays, Vice Pres., Engrg.
513/372-7579 Telex: 910/380-4966
Fax: 513/372-8645

ELFORM, INC., P.O. Box 7362, Reno, NV 89510

Agent for Nippon Graphite Industries heat-seal connectors for circuit boards, LCDs, or membrane switches. Pitches as fine as 167 traces/in. are available.
Roger R. Reinke, Pres.
702/356-1734 Fax: 702/346-1742

ELTIME VISION SYSTEMS, 10/14 Hall Rd., Heybridge, Maldon, Essex, U.K. CM9 7LA

Manufacturers of frame stores, image-processing systems, video noise-reduction systems, automatic visual-inspection systems.

D.R. Hurst, Sales Dir. 0621-59500
Telex: 995548 Fax: 0621-56819

EMERALD COMPUTERS, INC., 7324 S.W. Durham Rd., Portland, OR 97224

Manufacturers of flat-panel display systems (EL, plasma, LC, and VF); terminals and monitors; assemblies; and board-level controllers and interfaces.
David Blass, Vice Pres., Mktg.
503/620-6094 Fax: 503/639-7932

ENABLING TECHNOLOGIES CO., 3102 S.E. Jay St., Stuart, FL 34997

Manufacturers of adaptive equipment for the blind and visually impaired: braille printers, speech systems, paperless braille devices, and optical scanners.
Bonnie L. Corley, Mktg. Admin.
407/283-4817

ENDICOTT RESEARCH GROUP, INC., 2601 Wayne St., P.O. Box 269, Endicott, NY 13760

Manufacturers of dc-dc converters for VFDs and gas-discharge plasma displays up to 25 W; dc-ac inverters to power EL lamps for backlighting LCDs, membrane switches.

Richard P. Burchill, Sales Mgr.
607/754-9187 Telex: 510-252-0155
Fax: 607/754-9255

EPIX, INC., 3691 Commercial Ave., Northbrook, IL 60062

Manufacturers and designers of image capture systems for IBM PC/XT/AT and PS2. Boards come with 1 Mbyte or 4 Mbyte of memory, and on-board DSP.
A.C. Petersen, Pres.
312/498-4002 Fax: 312/498-4321

EPSON AMERICA, INC., OEM Div., 3415 Kashiwa St., Torrance, CA 90505

Manufacturers of LCDs, LEDs, printer mechanisms, and disk drivers.
215/534-4500 Fax: 215/534-4449

FAIRCHILD WESTON SYSTEMS INC., CCD Imaging, 1801 McCarthy Blvd., Millpitas, CA 95035

Manufacturers of line-scan and area sensors; line-scan development boards and modules; and as line-scan and area cameras.
Patty Lippe, Adv. Mgr.
Toll Free: 800/325-6975

FAIRLIGHT INSTRUMENTS INC., 2945 Westwood Blvd., Los Angeles, CA 90064

Manufacturers of the Fairlight CVI PLUS real-time digital effects video and graphics workstation, suitable for corporate, industrial, and educational applications.

Michael Callen, Video Prod. Mgr.
213/470-6280 Fax: 213/474-9716

FIMI PHILIPS, IA S. Banfi 1, Saronno, Italy 21047

Manufacturers of high-resolution monochrome and color CRT monitors: 17-in. landscape, 17-in. portrait, 20-in. landscape monochrome; 16- and 20-in. color. Line-scan frequency from 40 to 105 kHz; resolution up to 1600 x 1400 pixels.
S. Bonfiglio, Sales Mgr. 39-2-9618 237
Telex: 330262 PHSEDE I
Fax: 39-2-9625254

FINANCIAL SYSTEMS OF S.C., INC., dba COMPUTER TIME, 187 No. Church St., Suite 106, Spartanburg, SC 29301

Consultants in Vidar Scanner, AutoCAD, Pafec, Cimatron, Iconnex and Grattler technology.
Cecil Powell, Vice Pres.
803/585-5004 Fax: 803/591-4255

FINLUX, INC., 20395 Pacifica Dr., Suite 109, Cupertino, CA 95014

Manufacturers of thin-film ac EL displays: Models 320 x 256, 512 x 256, 640 x 200, 640 x 350, and 640 x 400.
Richard Blair, Sales Mgr.
408/725-1972 Fax: 408/996-7547

FLOROD CORP., 17360 S. Gramercy Pl., Gardena, CA 90247

Manufacturers of programmable laser systems: MEL-30 (xenon) for repair of active-matrix TFTs for LCDs, thick-film trimming, automated latch-up; MEL-40 (YAG) quick changeover from thick- or thin-film trimming to drilling, scribing, and marking.

Jim Kessey, Mktg. Mgr. 213/532-2700
Telex: 698-363 Fax: 213/329-1015

JOHN FLUKE MFG CO., INC., P.O. Box C-9090, Everett, WA 98206

Manufacturers of electronic test and measurement equipment.
Ron Wambolt, Dir., Worldwide Sales
206/347-6100 Toll Free: 800/426-0361
Telex: 685102 FLUKE UT
Fax: 206/356-5116

FUTABA CORP., 629 Oshiba, Mobara, Chiba 297, Japan

Manufacturers of VFDs, VFD modules, and light elements for large-screen video displays.
T. Maeda, Mgr., Overseas Mktg. Dept.
0475-24-1111 Telex: 0475-23-1346
Fax: 0475-23-1346

FUTABA CORP. OF AMERICA, 14492 Sheldon Rd. (U.S.), Suite 370, Plymouth, MI 48170

Manufacturers and distributors of graphic displays for automotive applications; electronic instrument panels utilizing VF technology; and multicolor displays.
C. L. Slupek, Automotive Mktg. Mgr.
313/459-1177 Fax: 313/459-1268

FUTABA CORP. OF AMERICA, Electronic Components Div., 711 East State Pkwy., Schaumburg, IL 60173

Manufacturers of VFDs and VFD modules.
Bill Lichtner, Sales Mgr.
312/884-1444 Telex: 206-833
Fax: 312/884-1635

FUTURE SYSTEMS, INC., P.O. Box 26, Falls Church, VA 22046

Publishers of research and information on interactive video, videodisc, compact-disc technology, and related fields. Newsletters, reports, books, and market studies.
Rockley Miller, Pres.
703/241-1799 Telex: 4996279
Fax: 703/532-0529

GALILEO ELECTRO-OPTICS CORP., P.O. Box 550, Galileo Park, Sturbridge, MA 01566

Manufacturers of fiber-optic and electro-optic products.
Lawrence T. Guzowski, Dir., Intl. Sales/
Mktg. 508/347-9191
Telex: 4999014 Fax: 508/347-3849

GEC AVIONICS, INC., 2975 Northwoods Pkwy./Norcross, P.O. Box 81999, Atlanta, GA 30366

Manufacturers of heads-up display

systems for a range of U.S. military aircraft. Affiliate of GEC Avionics, Ltd., U.K.

Tim Taylor, Dir., Bus. Devel.
404/448-1947 Telex: 708447
Fax: 404/449-6128

GENERAL ATRONICS, 1200 E. Mermaid La., Wyndmoor, PA 19118

Manufacturers of high-performance special-purpose CRTs in electrostatic and magnetic deflection formats for military and industrial applications.
Carl Dibling, Mktg. Mgr.
215/233-4100 Telex: 834679
Fax: 215/233-4100, ext. 304

GENERAL ELECTRIC, 50 Fordham Rd., Mail Zone 57, Wilmington, MA 01887
Developers and manufacturers of twisted nematic LC a-Si TFT active-matrix flat panels for application in aerospace products.
Elias Haim, Mgr., Adv. LCD Dev.
508/937-4160 Fax: 508/937-4868

GENNUM CORP., 970 Fraser Dr., Burlington, Ont., Canada L7L 5P5
Manufacturers of bipolar integrated circuits for driving electromechanical displays.
Ken Scott, Mktg. R&D
416/632-2996 Toll Free: 800/263-9353
Telex: 061-8525

GEROME MANUFACTURING CO., Oliver Rd., P.O. Box 1089, Uniontown, PA 15401
Manufacturers of diversified technical specialties made from advanced magnetic alloys to provide efficient high attenuation shielding for CRTs, photomultiplier tubes, transformers, and sensitive instruments.
Ted Gerome, Sales Mgr.
412/438-8544 Fax: 412/437-5608

GEROME MANUFACTURING CO., 403 N. Main St., P.O. Box 737, Newberg, OR 97132

Manufacturers of diversified technical specialties made from advanced magnetic alloys to provide efficient high attenuation shielding for CRTs, photomultiplier tubes, transformers, and sensitive instruments.
Mike Stoyko, Plant Mgr. 503/538-8356
Fax: 503/538-1090

GINSBURY ELECTRONICS, LTD., 108 High St., Strood, Rochester, Kent, U.K. ME2 4TR

Distributors of CRT-based industrial and military display components, including CRTs, deflection yokes, HVPs, optical filters, and high-resolution monitors. Designers of CRT-based display systems.
Neville Milward, Dir. 0634-290040
Telex: 966431 Fax: 0634-290904

GLOBAL IMAGING, INC., 201 Lomas Santa Fe Dr., Solana Beach, CA 92075
Software and systems integration. Turnkey digital image-processing systems.
Michael Guberek, Tech. Dir.
619/481-5750 Toll Free: 800/345-4624
800/822-4624 (CA only)
Telex: 510/601-0611

GORDON INSTRUMENTS, INC., 3645 California Rd., Orchard Park, NY 14127
Manufacturers of CCTV systems; custom optic overhead projectors; high-intensity flat-field illumination systems designed for video capture.
James Chorazak, Vice Pres.
716/662-5353

H. W. GROSSBOHLIN, 3224 Crazy Horse Dr., Simi Valley, CA 93063
Consultant in CRTs and CRT displays.
805/581-1467

GTE PRODUCTS CORP., Flat Panel Displays Div., P.O. Box 548, Greenland, NH 03840

Manufacturers of 512 x 256 ac thin-film EL flat-panel displays and backlights for displays.
603/436-8900 Telex: 510/600-6701
Fax: 603/436-8483

HAMLIN, INC., 612 E. Lake St., Lake Mills, WI 53551

Manufacturers of standard and custom LCDs. Application assistance for custom designs at no charge. An advanced products group is available for assistance with non-traditional LCD designs and projects.
Walter Bruenger, Mktg. Mgr., LCD Div.
414/648-2361
TWX: 910/260-3740 Fax: 414/648-5244

GEORGE D. HARRIS ASSOC., INC., The Plaza Bldg., Fair Lawn, NJ 07410
Representatives for manufacturers of magnetic deflection components for CRTs: yokes, focus coils, stigmators, centering coils, precision in-line, and delta magnetic components.
George D. Harris, Pres.
201/796-5200 Fax: 201/796-0070

HARTMAN SYSTEMS, 360 Wolf Hill Rd., Huntington Station, NY 11746
Manufacturers of militarized and ruggedized high-resolution raster-scan monochrome and color monitors, from 5- to 19-in.-diag. screen size.
W. E. Lyske, Vice Pres., Bus. Devel.
516/427-7500
Telex: 510/226-6982 Fax: 516/351-1508

HAZELTINE CORP., Cuba Hill Rd., Greenlawn, NY 11742
Manufacturers of high-performance CRT-based graphic display systems for military command-and-control applications.
Lou D'Arco, Mktg. Dir.
516/262-8164 Telex: 6852118 HZLTN
UW Fax: 516/262-8002

HERCULES AEROSPACE DISPLAY SYSTEMS, INC., 2321 Topaz Dr., Hatfield, PA 19440

Manufacturers of LCDs, modules, smart modules, subsystems, and systems for commercial and military avionics and ground radio applications. Also custom and semicustom applications in dichroic LCD technology.
C.S. Davis, Vice Pres., Mktg.
215/822-6090 Telex: 84-6113
Fax: 215/822-7974

HEWLETT PACKARD CO., Optoelectronics Div., 370 W. Trimble Rd., San Jose, CA 95131
Manufacturers of visible LEDs, numeric and alphanumeric displays, electrophotographic printheads and erase bars, and motion control devices.
Jerry Kolansky, Mktg. Mgr.
408/435-6049 Telex: 910/373-1247
Fax: 408/435-7472

HITACHI, LTD., 5-1, 1-chome, Marunouchi, Chiyoda-ku, Tokyo 100, Japan
Manufacturers of color picture tubes; color display tubes; projection tubes; passive and active LCDs; imaging devices; and pickup tubes.
G. Watanabe, Mgr., Sales Engrg.
03-211-1111 Telex: 222-5511
Fax: 03-212-3857

HITECH INTERNATIONAL, 1435 McCandless Dr., Milpitas, CA 95035
Manufacturers and distributors of monochrome, color, EGA, and multisync monitors, as well as IBM XT and AT compatible microcomputers.
Jennifer Jimmerson, Sales Mgr.
415/263-3300 Telex: 501422 HITECH

HMW ENTERPRISES INC., 604 Salem Rd., Etters, PA 17319
Manufacturers of 14- and 19-in. color terminals (Rainbow series) and color

MINOLTA METERS THE MEASURE OF EXCELLENCE

© 1987 Minolta Corporation

FOR ACCURATE NON-CONTACT COLOR MEASUREMENT, NO OTHER METER COMES CLOSE.

Minolta's new CS-100 Chroma Meter achieves precision and comes close to everything else. Everything else, that is, in the way of light sources or surface colors that you might otherwise find difficult to measure.

Just point it and instantaneously read the luminance value of light sources or objects which are either too hot, too distant, too small, too inaccessible or for any reason simply not to be touched. Our spot colorimeter's built-in memory will also give you the difference between any two such sources or objects automatically.

And the CS-100 is just one of Minolta's full line of light and color measurement instruments. For more information, including our 21 page booklet "Precise Color Communications," please call (201) 825-4000 or write: Minolta Corporation Industrial Meter Division, 101 Williams Dr., Ramsey, New Jersey 07446.

When you need precise measurements, you just can't touch it. **ONLY FROM THE MIND OF MINOLTA.**

Circle no. 24



monitors packaged for industrial applications (oil- and watertight, Nema 4X&12, Class I, II, Div. 1,2). Monitors are either Rainbow or CGA, EGA, and VGA compatible.

H. M. Wutz, President 717/938-4691
Telex: 510/650-3536 Fax: 717/938-4095

HOFFMAN ENGINEERING CORP., 20 Acosta St., Stamford, CT 06902

Manufacturers of EL lamps, aircraft edgellit panel hardware (connectors, grommets, inserts, filters), tactile, snap-action switches; photometric/radiometric laboratory testing certified to mil-spec; photometers; radiometers; standards; calibration services.
Jim Bean, Sales Eng. 203/325-8933
Telex: 643621 Fax: 203/327-4812

HONEYWELL DEFENSE AVIONICS SYSTEMS DIV., 9201 San Mateo Blvd. N.E., Albuquerque, NM 87113-2227

Manufacturers of phosphor-based high-resolution monochrome and color displays and compact, lightweight, low power consumption flat-panel LCDs.
Roger Hornby, Dir. Mktg.
505/828-5182 Telex: 501-386
Fax: 505/828-5293

HONEYWELL TEST INSTRUMENTS DIV., P.O. Box 5227, Denver, CO 80217

Manufacturers of high-resolution, A- and B-size hard copy devices using thermal-transfer and dry-silver technologies. Video and digital interfaces and a vector-to-raster converter are available.
Bruce Norikane, Prod Mgr.
303/773-4745 Telex: 4322015 HONY UI
Fax: 303/773-4762

HORNELL ELEKTROOPTIK AB, Gagnef, S-78041, Sweden

Manufacturers of LCD shutters for use in welding filters and similar applications. Custom-designed optical components based on LC technology.
Ake Hornell, Pres. 46-241-62030
Telex: 74278 HORNEL S
Fax: 46-241-62107

HOUSTON INSTRUMENT, Div. of Ametek, Inc., 8500 Cameron Rd., Austin, TX 78753

Manufacturers of input and output devices for computer graphics systems, including digitizing tablets, pen plotters from A to E size, and an optical scanner accessory for HI plotters.
Rod Schaffner, Sales Mgr.
512/835-0900 Toll Free: 800/444-3425
Telex: 776438 Fax: 512/339-1490

HOWTEK INC., 21 Park Ave., Hudson, NH 03051

Manufacturers of high-resolution color input and output peripherals for the IBM PC and Mac II markets: digital color flatbed scanners and 35-mm film scanners; Pixelmaster plain paper, full-color, solid ink-jet printer.
Sally Carlson Keane, Pub. Rel. Mgr.
603/882-5200 Fax: 603/880-3843

HOYA ELECTRONICS CORP., 50 Tice Blvd., Woodcliff Lake, NJ 07675-7664

Manufacturers of glass plates, glass panels with thin-film, large-format masks and mask blanks for flat-panel displays; transparent and electroconductive ITO thin film on precision glass substrates up to 14 x 14 in.
Stephen E. Lierman, Dir. Mktg.
201/307-0003; Ken Kalya (San Jose, CA, office) 408/435-1450; Jack Smith (Dallas, TX, office) 214/450-4410
Fax: 201/307-1937

HOYA OPTICS, INC., 3400 Edison Way, Fremont, CA 94538

Manufacturers of contrast-enhancement filters for displays, PEG-3 photosensitive glass, ND filters and polarizers, low expansion sheet and L-11 laser system for LCD and mask repair, trimming, and cutting.
Donald L. Bailey, Sales Mgr.
415/490-1880 Telex: 172-647
Fax: 415/490-1988

HUGHES AIRCRAFT CO., Industrial Prod. Div., 6155 El Camino Real, Carlsbad, CA 92009

Manufacturers of special-purpose CRTs, direct-view storage tubes, LC light valves, large-screen computer graphics projectors, and infrared imaging equipment.
Carol Hahn, Mktg. Mgr.
619/931-3586 Telex: 910/322-1393
Fax: 619/931-3334

HUGHES AIRCRAFT CO., 7200 Hughes Terr., P.O. Box 45066, Los Angeles, CA 90045-0066

Manufacturers of military, air traffic control, and special purpose display systems; independent displays; large-screen LC light-valve projection displays; airborne cockpit displays; head-up and head-mounted digital map systems; monochrome and color panel displays.
W. A. Bishoff, Mktg. Mgr., Ground Sys. Gp. (Dis. Sys.) 714/732-5093; R. A. Hamnquist, Asst. Mgr., Mktg., Radar Sys. Gp. (Airborne Dis.) 213/578-4178; W. R. Clendinning, Mktg. Mgr., Indus. Elec. Gp. (Dis. Prod.)
619/931-3638 Telex: 910/328-6566
Fax: 213/568-7565

HUGHETT RESEARCH, P.O. Box 60, Palo Alto, CA 94302

Manufacturers of custom software for scientific applications in image processing and computer graphics.
Paul Hughett, 415/327-7285

HUMAN DESIGNED SYSTEMS, INC., 3440 Market St., Philadelphia, PA 19104

Manufacturers of integrated text and graphics terminals.
Michael Kantrowitz, Vice Pres., Mktg./Sales 215/382-5000
Toll Free: 800/437-1551
Telex: 710/670-1460 HDS PHA
Fax: 215/382-7008

HYCOM, INC., 16841 Armstrong Ave., Irvine, CA 92714

Manufacturers of flat-panel EL displays and integrated display systems. Specialists in shaded-picture video display for vehicles and portable equipment. Distributors of standard and customized Sharp TFEI products.
William O. Hedge, Sales Mgr., Dis.
714/261-6224 Fax: 714/261-9321

IEC COMPANY, 1450 E. 17 St., Suite 122, Santa Ana, CA 92701

Distributors of high-brightness VFDs, NVG compatible displays, EL lamps, and hardware for edgellit display panels. Consultants for display applications.
Gene Hu, Pres. 714/543-6295
Fax: 714/543-7383

IEE, INC./Industrial Electronic Engineers, Inc., 7740 Lemon Ave., Van Nuys, CA 91409-9234

Manufacturers of display components, intelligent display modules, and front-panel assemblies/subsystems. Stock and custom designs built to commercial and military standards.

Darryl Bloom, U.S. Sales Mgr., Indus. Prod. Div. 818/787-0311, ext. 210; Jack Hart, Sales Mgr., Component Prod. Div. ext. 375; Ed Motokane, Mktg. Mgr., Planar Prod. Div. ext. 236 Telex: 4720693 IEEIPD Fax: 818/901-9046
IEE Ltd. (U.K.): Athol Hendry, Eur. Sales Mgr. 0727-74376 Telex: 264992 Fax: 0727-74300

IKEGAMI ELECTRONICS, 37 Brook Ave., Maywood, NJ 07607

Manufacturers of high-resolution color and black-and-white monitors and large-screen projection systems.
David Mathias, Sales Asst., Dis. Monitor Div. 201/368-9171 Telex: 2190341TCNJUR Fax: 201/569-1626

IMAGE AMPLIFICATION/VIDIWALL, 30 Chapin Rd., P.O. Box 699, Pine Brook, NJ 07058

Manufacturers and distributors of Ultravision composite video three-tube

color projectors with audio; two monocular models and one with MTS stereo tuner, IR remote, and built-in stereo audio.

Arnie Ginsburg, Vice Pres./Gen. Mgr.
201/882-0584 Telex: 130 236
Fax: 201/882-0656

IMAGEN, 2650 San Tomas Expwy., Santa Clara, CA 95052-8108

Manufacturers of image-processing technology and printing systems for the publishing, printing, and document generation markets.
Kevin Cornelius, Dir. Sales/Mktg.
408/986-9400 Telex: 755-738
Fax: 408/727-3725

IMAGING AND SENSING TECHNOLOGY CORP. (formerly Westinghouse Imaging and Sensing Technology Div.), Westinghouse Circle, Horseheads, NY 14845

Manufacturers of I&M CRTs and image tubes.
Robert E. Baker, Mktg. Spec.
607/796-3283 Telex: 510/252-1588
Fax: 607/796-3490

IMAGING TECHNOLOGY, INC., 600 W. Cummings Park, Woburn, MA 01867

Manufacturers of image processing subsystems for the development of application-specific software.
Mark Manson, Sales Mgr.
617/938-8444 Toll Free: 800/532-3500
Telex: 948263 Fax: 617/938-1757

IMAPRO CORP., 2081 Business Centre Dr., Suite 171, Irvine, CA 92715

Distributors of the 386-based workstation line for high-resolution presentation graphics, graphic design, photo-retouching, and composition. Includes a 300- and 600-dpi scanner with transparency option and a 400-dpi slide scanner.
Jeanie Shafelt, Sales Rep.
714/752-2043 Fax: 714/752-2544
East Coast: A. F. Shufelt, Vice Pres., Mktg. 914/368-2787 Fax: 914/368-2789
Canada: Ingrid van Leeuwen, Sales Rep.
416/421-1811 Fax: 416/421-4854

INCOM, INC., Box G, Southbridge, MA 01550-0528

Manufacturers of fiber-optic faceplates for CRTs, image tubes, CCD and LCD arrays; flexible and rigid light guides; magnifiers (tapers); image conduits; and spot-to-line illuminators.
Jerry Burke, Cust. Serv. Mgr.
508/765-9151 Telex: 710/347-1604
Fax: 508/765-0041

INFODEX, INC., 10 Venus Dr., Wolcott, CT 06716

Manufacturers of ruggedized industrial and mil-spec CRT and flat-panel EL displays for aircraft, marine, and tracked vehicle monitors and simulators.
Roger Lemire 203/879-4944
Fax: 203/879-4944, ext. 230

INSIGHT DEVELOPMENT CORP., 1024 Country Club Dr., Suite 140, Moraga, CA 94556

Manufacturers of translation software matching printer requirements with capabilities for IBM and compatible PCs.
William Lange, Dir. Sales
415/376-9451 Fax: 415/631-0595

INTERACTIVE COMPUTER PRODUCTS, 23482 Peralta, Unit C, Laguna Hills, CA 92653

Manufacturers of electronic fiber-optic light pens with singlechannel actuation. Patented PenWand interfaces with PCI various systems. Remote switches with 1-50-million-cycle life expectancy.
Richard Griego, Sales Mgr.
714/770-5332

INTERACTIVE MACHINES, INC., 26588 Agoura Rd., Calabasas, CA 91302

Manufacturers of high-performance 3D visual systems for advanced interactive graphics; real-time flight simulation; heads-up displays; advanced cockpit displays; space flight and docking simulators.

Glen Cavanaugh, Vice Pres., Sales/Mktg. 818/707-1880 Fax: 818/880-5323

INTERFACE PRODUCTS, INC., 4630 North Ave., Oceanside, CA 92056

Manufacturers of custom displays utilizing state-of-the-art display technology. Custom-designed displays include LC, LED, EL, incandescent, and plasma displays.
Jim Iacono, Nat. Sales Mgr.
619/945-0230 Telex: 910/595-2569
Fax: 619/945-0239

INTERNATIONAL BUSINESS MACHINES CORP., Old Orchard Rd., Armonk, NY 10504

Manufacturers of a full line of main-frame interactive displays, personal computer displays, intelligent terminals, image and graphics displays, and a wide range of printers and display software. National organization. Please refer to your local telephone directory.

INTERNATIONAL HIGH VOLTAGE ELECTRONICS, INC., Commerce Park, Danbury, CT 06810

Manufacturers of OEM high-voltage dc and precision mil-spec and avionics power supplies. Applications include FO, CRTs, video display terminals, projection CRTs, and ELPS. Exclusive No. Amer. distributor for Bonar Wallis High-volt, U.K.
Doug Steers, Dir. Sales/Mktg.
203/792-7820 Toll Free: 800/634-0740
Fax: 203/743-3370

INTERNATIONAL PLANNING INFORMATION, INC., 465 Convention Way, Suite 1C, Redwood City, CA 94063

Technology, market, and business planning reports about the electronics and computer industries. Market research reports and newsletters about electronic displays.
Murray Disman, Pres.
415/364-9040 Telex: 371 6217

INTERNATIONAL POLARIZER, INC., 320 Elm St., Marlboro, MA 01752

Manufacturers of linear polarizing sheet, wave-retarder films, and polarized products for displays. High-transmittance high-efficiency polarizers and very-high-efficiency polarizers. Wave-retarder films up to 19 in. wide. Polarizing filters.
Richard Phillips, Pres. 617/481-7495
Telex: 6016454 INTL POLARIZ

INTERNATIONAL RESOURCE DEVELOPMENT, INC., P.O. Box 1716, New Canaan, CT 06840

High-tech market research and consulting firm which publishes multiclient research reports for vendors involved in several markets.
Elizabeth Hanscom, Client Serv. Dir.
203/966-2525 Telex: 64-3452

INTERSTATE ELECTRONICS CORP., 1001 E. Ball Rd., P.O. Box 3117, Anaheim, CA 92803

Manufacturers of military flat-panel display terminals, tactical severe environment and sheltered; console-mounted system components, touch panels, keyboards.
Russ Summers, Nat. Sales Mgr., Dis. Prod. 714/758-4032 Toll Free: 800/854-6979 800/422-4580 (CA only)
Telex: ITT 47-22046 Fax: 714/758-4245

THE INTER-TECHNICAL GROUP, INC., One Bridge St., P.O. Box 23, Irvington, NY 10533

U.S. marketers for Mag Shields, Ltd., U.K., manufacturers of CAD/CAM laser-cut mu-metal magnetic shielding, deep drawn cans, and magnetic shielding for special applications.
914/591-8822 Telex: 710/564-0802
Fax: 914/591-7336

ISC CARDION ELECTRONICS, Long Island Expwy., Woodbury, NY 11797

Manufacturers of air traffic control indicators, shipboard radar graphics indicators, shipboard indicators, miniature airborne TV cameras, solid-state digital

scan converters, BRANDS, and air traffic control display systems.
Francis Gareffa, Vice Pres., Bus.
Dev. 516/921-7300 Telex: 221683
CARD Fax: 516/921-7330

ISCAN INC., 125 Cambridgepark Dr.,
P.O. Box 2076, Cambridge, MA 02238
Manufacturers of ISCAN eye-tracking systems for advanced human/machine interface; OPTIMOUSE optical pointing system for rapid computer data entry; and real-time optical tracking equipment for automatic positioning of teleconferencing cameras.
Rikki Razdan, Mktg. Mgr.
617/868-5353 Fax: 617/868-9231

ISE ELECTRONICS CORP., P.O. Box 46,
Ise, Mie, Japan
Manufacturers of picture tube elements for large-screen, graphic and character displays, and "itron" VFDs and related products.
Keiji Aoyagi, Mngng. Dir. 0596-39-1111
Fax: 0596-39-0366, -1220

C. ITOH ELECTRONICS, INC., 2505 McCabe Way, Irvine, CA 92714
Manufacturers of computer peripherals including color, monochrome, impact and non-impact, and ion deposition printers; monochrome and color monitors and terminals for the DEC and IBM marketplace.
Harry Slam, Sr. Vice Pres., Sales
714/660-1421 Fax: 714/660-1408

ITT CANNON EMC WORLDWIDE, 10550 Talbert Ave., Fountain Valley, CA 92708
Manufacturers of electrical, electronic, and fiber-optic interconnect systems: switches, relays, and test accessories for defense/military and commercial markets.
Commercial Prods.: 714/964-7400
Military/Aerospace Div.: 714/557-4700
Telex: 655-358 Fax: 714/964-8324

K&R ENGINEERING SALES CORP., 354 Route 206, Flanders, NJ 07836
Product representatives for Ad-Vance Magnetics magnetic shields; Donteck optical and EMITEMPEST CRT filters; and DISCOM deflection yokes, focus coils, and high-voltage power supplies.
Robert J. Resker, Pres.
201/584-5235 Toll Free: 800/631-9362
800/452-9767 (NJ only)
Fax: 201/584-4375

KELTRON CORP., 225 Crescent St., Waltham, MA 02154
Manufacturers of high-voltage power supplies, both custom and standard, for applications with color and monochrome monitors, projection displays, beam-penetration displays, and high-speed dynamic focus supplies.
Ted Chadurjian, Mktg. Mgr.
617/894-8700 Fax: 617/899-9602

KENSINGTON MICROWARE, 251 Park Ave. S., New York, NY 10010
Manufacturers of antiglare filters, mice, high-voltage power supplies, and printer supplies.
April Lockhart, Vice Pres., Oper.
212/475-5200 Toll Free: 800/535-4242
Telex: 467 383 KMLNY
Fax: 212/475-5996

KMW SYSTEMS CORP., 6034 W. Courtyard Dr., Suite 100, Austin, TX 78730
Manufacturers of the VP-10 and Vexcel graphic element processors, and electrostatic and color thermal plotters.
Linda Lewis, Vice Pres., Sales
512/338-3000 Toll Free: 800/531-5167
Telex: 28-6532 Fax: 512/338-3199

KOLLMORGEN CORP., Electro-Optical Div., 347 King St., Northampton, MA 01060
Manufacturers of custom electro-optical systems, including display and control consoles.

James Murrone, Vice Pres., Mktg.
413/586-2330 Telex: 955409
Fax: 413/586-2359

KONE CORP., Industrial Div., Ruukintie 18, Espoo, Finland 02320
Manufacturers of industrial color video display boards and terminals; process control display systems; PC-graphics boards and video hard-copy printers.
Jouko Ala-Tuori, Mktg. Mgr.
358-0-8017011 Telex: 122441 OLLI SF
Fax: 358-0-8022499

KONTRON ELECTRONICS, 630 Clyde Ave., Mountain View, CA 94039
Manufacturers of high-resolution graphics boards for ATs and compatibles (1024 x 1280); and imaging workstations for commercial, medical, and development applications.
Greg Galat, Bus. Mgr. 415/965-7020
Toll Free: 800/227-8834
Fax: 415/965-3505

KORRY ELECTRONICS CO., 901 Dexter Ave. N., Seattle, WA 98109
Manufacturers of lighted push button switches, mil-qual annunciators, integrated thin-panel systems, and militarized keyboards.
Pauline Duncan, Mktg. Comm. Mgr.
206/281-1330 Telex: 285842 KORY UR
Fax: 206/281-3576

KRAFT SYSTEMS, INC., 450 W. California Ave., Vista, CA 92083
Manufacturers of computer joysticks and mice and a line of metal ball control sticks on an OEM basis for use in imaging equipment, test devices, etc.
Madeline Rutledge, Sales Admin. Mgr.
619/724-7146 Fax: 619/941-1770

KRISTEL CORP., 833 Industrial Dr., West Chicago, IL 60185
Manufacturers of 3-23 in. custom monochrome monitors with a frequency to

50 kHz horizontal, 90° deflection, 110° deflection electromechanically made to OEM specifications.
Don Matthiesen, Dir. Sales
312/293-0850 Fax: 312/293-1255

KYOCERA AMERICA, INC., 8611 Balboa Ave., San Diego, CA 92123
Manufacturers of LCDs featuring chip-on-glass technology, LCDs with CFL backlight, and thermal printheads featuring thin-film technology.
Rick Collins, Sales Mgr.
619/576-2651 Telex: 472-3069
Fax: 619/569-9412, -0396

LABSPHERE, INC., P.O. Box 70, Shaker St., North Sutton, NH 03260
Manufacturers of a standard line of integrating spheres and instrumentation; diffuse reflectance material and standards. Reflectance measurement and coating services. Custom orders welcome.
Douglas Baxter, Sales Mgr.
603/927-4266 Telex: 710/366-0064
Fax: 603/927-4694

LASERGRAPHICS, INC., 17671 Cowan Ave., Irvine, CA 92714
Manufacturers of color hard-copy systems incorporating printers, film recorders, and rasterizing computers, with over 1,000,000 colors and virtually unlimited software compatibility, PC to mainframe.
A. William Brown, Dir. Sales/Mktg.
714/660-9497 Telex: 753527
Fax: 714/660-8042

LEADER INSTRUMENTS CORP., 380 Oser Ave., Hauppauge, NY 11788
Manufacturers of high-resolution programmable RGB video generators; broadcast video test signal generators; and general test instrumentation such as oscilloscopes, meters, and RF generators.

MINOLTA METERS THE MEASURE OF EXCELLENCE

© 1987 Minolta Corporation

MINOLTA SOLVES THE PROBLEMS OF BALANCING YOUR MONITORS.

You'll know your colors are lined up perfectly when you adjust your computer monitors, TV sets or video projectors with Minolta's remarkable TV-Color Analyzer II.

No matter which white standard or reference color you input, Minolta gives you precise measurements in easily readable digital display. Plus, there are 3 ten-segment bar graphs to clearly show the nature of any deviations.

And the Color Analyzer is just one of Minolta's full line of light and color measurement instruments. For more information, including our 21 page booklet "Precise Color Communications," please call (201) 825-4000 or write: Minolta Corporation Industrial Meter Division, 101 Williams Drive, Ramsey, NJ 07446.

Because, on balance, the more information you have the better. **ONLY FROM THE MIND OF MINOLTA.**



TV-COLOR ANALYZER II

Circle no. 25



George Gonos, Prod. Mktg. Mgr.
516/231-6900 Toll Free: 800/645-5104
Fax: 516/231-5295

ELECTROMAGNETICS, INC., 6056 W. Jefferson Blvd., Los Angeles, CA 90016
Manufacturers of RF shielded enclosures, RF shielded anechoic chambers, and RFI/EMI power, signal, data and communication line filters.
Janet M. Nichols, Sales Admin.
213/870-9383 Toll Free: 800/325-9814
800/325-9815 (CA only)
Fax: 213/870-0828

LEVY HILL LABORATORIES, LTD., 5 Sheffield House, Fieldings Rd., Chestnut, Hertfordshire, U.K. EN8 9TJ
Manufacturers of fluorescent screens for x-ray, electron microscopes, particle beams, scintillators. Consultant services on CRT phosphors and screens.
Guy Hill, Mngng. Dir. 0-992-30808
Telex: 23977 SCINTI G
Fax: 0-992-21909

LEYBOLD, A. G., Postfach 1555, Hanau, F.R.G.

Suppliers of vacuum coating systems and vacuum processing technology (sputtering, PE-CVD, plasma-etching) for production of active-matrix LCD and color displays.
08181-340 Telex: 415208-0 LH D
Fax: 08181-34-1890

LEYBOLD TECHNOLOGIES, INC., 120 Post Rd., Enfield, CT 06082
See above for description.
203/741-2267 Telex: 955344
Fax: 203/745-7032

LIBERTY MIRROR, A Div. of Libbey-Owens-Ford Co., 851 Third Ave., Brack- enridge, PA 15014

Manufacturers of optical thin films and CRT filters for dichroic, contrast enhancement, infrared absorbing/reflecting, narrowband, neutral density, UV, RFI/EMI/shielding, and TEMPEST applications.

Terry W. Garrett, Mktg./Sales Mgr.
412/224-1800 Telex: 4932672
Fax: 412/224-8754

LIBRASCOPE CORP., A Subsidiary of Singer Co., 833 Sonora Ave., Glendale, CA 91201

Manufacturers of command-and-control, weapon-control, and fire-control systems and displays.
Theodore B. Aitken, Mktg. Dir., C&C Prog. 818/502-7645
Toll Free: 800/423-5844 Telex: 215620
Fax: 818/502-8145

LINK TECHNOLOGIES, INC., 47339 Warm Springs Blvd., Fremont, CA 94539
Manufacturers and distributors of multifunctional VDTs.
Phillip E. Graham, Vice Pres., Sales
415/651-8000 Fax: 415/651-8808

LITTON DATA IMAGES, 1283 Algoma Rd., Ottawa, Ont., Canada K1B 3W7
Manufacturers of high-reliability (-55 to +85°C) LCDs, guest-host dichroic and TNs backlighted to meet NVG. MIL-L (85762), glass only or the complete module (drive electronics).
Susann Smith, Sales Corresp.
613/744-3773 Fax: 613/744-1566

LITTON ELECTRON DEVICES, 215 S. 52 St., Tempe, AZ 85281
Manufacturers of high-resolution CRTs for a wide range of recording, scanning, and viewing applications, including typesetting, color graphics, medical imaging, and spot scanning.
John Kylander, Sales Mgr.
602/968-4471 Fax: 602/966-9055

LMT, P.O. Box 85666, MB116, San Diego, CA 92138

Sales and service representatives for LMT Lichtmesstechnik GmbH Berlin, manufacturers of display test and measurement equipment.
Robert B. Watson, Gen. Mgr.
619/271-7474 Telex: 697-5323
Fax: 619/693-3670

LOHJA CORP., FINLUX DISPLAY ELECTRONICS, P.O. Box 46, Otarinluoma 9, SF-02201 Espoo, Finland

Manufacturers of EL displays.
Jorma Antson, Mktg. Mgr.
358-0-42001 Telex: 125023 LDIS SF
Fax: 358-0-422143

LUCAS DURALITH CORP., 525 Orange St., Millville, NJ 08332

Manufacturers of static and dynamic human-machine interface products, mainly control and display panels, including keyboard type data-entry devices.
Chip Edstrom, Vice Pres., Sales/
Mktg. 609/825-6900 Telex:
510/687-7520 Fax: 609/825-6345

LUMITEX, INC., 11941-H Abbey Rd., North Royalton, OH 44133

Manufacturers of a woven, optical fiber LCD backlight capable of emitting heat and EMI free light operable to 2000 fL. Light source is easily replaced and can be intensity and color controlled.
Bruce Baunach, Vice Pres., Sales
216/237-5483

LXD, INC., 24500 Highpoint Rd., Beachwood, OH 44122

Manufacturers of standard and custom LCDs from 1 in. to very large area.
Sheila Thompson, Cust. Serv. Mgr.
216/292-3300 Fax: 216/292-4727

MAGNAVOX ELECTRONIC SYSTEMS CO., 1313 Production Rd., Fort Wayne, IN 46808

Manufacturers of militarized flat-panel plasma displays and terminals. Displays range from a 4 x 8 in. to a 42 x 42 in. display that accommodates video inputs and provides 2048 x 2048 resolution.
Ron Burman, Vice Pres., Bus. Dev.
219/429-6014 Telex: 23-8472
MAGNAVOX FWA Fax: 219/429-5459

MAGNETIC RADIATION LABORATORIES, INC., 92 N. Lively Blvd., Elk Grove Village, IL 60007

Manufacturers and designers of all forms of shielding; CRTs, monitors, transformers, PMTs, TEMPEST, projection displays, printers. Magnetic shielding materials available. Serving navigation, avionics, information display, instrumentation, radar, oscilloscope, and computer markets.
Kenneth Phillips, Mktg. Mgr.
312/437-5200 Telex: 510/601-1013
Fax: 312/437-0837

MAGNETIC SHIELD CORP., Perfection Mica Co., 740 N. Thomas Rd., Bensenville, IL 60106

Manufacturers of magnetic shielding (dc to 100 kHz) material in foil and sheet, lab kits, custom magnetic shields.
Art Mate, Sales Mgr.
312/766-7800 TWX: 910/256-4815

MANITRON DISPLAYS, LTD., Sandy Lane, Moston Rd., Sandbach, Cheshire, U.K. CW11 9HT

Manufacturers of monochrome and color video monitors with up to 125-kHz line rate; raster radar monitors (16- and 23-in. round; 20- and 30-in. square); and Scanpack drive electronics for high-brightness CRTs.
Alan Hesketh, Mngng. Dir.
44-270-764171 Telex: 367227
Fax: 44-270-763160

MATRIX INSTRUMENTS INC., 1 Ramland Rd., Orangeburg, NY 10962

Manufacturers of multiformat electronic digital film recorders for the production of hard-copy records of video images of medical scanning procedures.
Lewis H. Reed, Dir., No. Amer. Sales
914/365-0190 Toll Free: 800/852-8533
Telex: 178903 Fax: 914/359-3201

MATROX ELECTRONIC SYSTEMS LTD., 1055 St. Regis Blvd., Dorval, Que., Canada H9P 2T4

Manufacturers of high-performance computer video boards and systems for standard computer architectures such

as the PC bus, VMEbus, Q-bus, STD bus, and Multibus I and II.

Ed Dwyer, Vice Pres., Sales
514/685-2630 Toll Free: 800/361-4903
(literature only)
Telex: 05-822798 Fax: 514/685-2853

McMAHAN ELECTRO-OPTICS, INC., 2160 Park Ave. N., Winter Park, FL 32789

Systems and application assistance for the military certification of CRTs and flat-panel displays.
Robert H. Hart, App. Eng.
407/645-0463 Fax: 407/644-9000

MEGASCAN TECHNOLOGY, INC., 4000 Kenneth Dr., Gibsonia, PA 15044

Manufacturers of ultra-high-resolution monitors and controllers.
Edward J. Morton, Dir. Sales/Mktg.
412/443-5820 Telex: 510/600-9198
MEGASCAN UQ Fax: 412/443-5440

MEKEL ENGINEERING INC., 777 S. Penarth Ave., Walnut, CA 91789

Manufacturers of custom film, paper, and tape transport systems for industrial, scientific, medical, and defense applications in film analyzers, format converters, graphics cameras, animation tables, phototypesetters.
Maurice Amesbury, Pres.
714/594-5158 Telex: 910/584-1849
Fax: 714/594-1216

METAVAC, INC., 45-68 162 St., Flushing, NY 11358

Manufacturers of high-efficiency reflection reducing coating and transparent conductive coatings for contrast-enhancement filters; implosion panels; and glass cocers for displays.
Clifford E. Sisler, Sales Mgr.
718/445-0400 Fax: 718/358-5714

MEYLAN CORP., 264 W. 40 St., 20 fl., New York, NY 10018-1585

Manufacturers and distributors of time study equipment including stopwatches, counters, event loggers to chart downtime, productive time. Also tachometers, temperature probes, gas detectors, internal timers, hour meters, and vibration meters.
Stanley Mills, Sales Mgr.
212/391-9150, -9151, -9152

MICRO DISPLAY SYSTEMS, INC., 1310 Vermillion St., P.O. Box 455, Hastings, MN 55033

Manufacturers of full page high-resolution monochrome display systems compatible with over 230 software packages, plus all Macintosh software and future OS/2 applications.
Ronald L. Zylstra, Vice Pres., Sales
612/437-2233 Toll Free: 800/328-9524
Telex: 4938623 MDFS UI
Fax: 612/437-7325

MICRO FUSION, INC., 1129 Silver Beach Rd., Lake Park, FL 33403

Manufacturers of chromium or silicon coated glass substrates up to 24 x 30 in. photosensitized with customer choice of liquid or dry film photoresist coating.
Skip Pooler, Sales Mgr. 407/863-8116
Telex: 803486 Fax: 407/626-3505

MICRO TOUCH SYSTEMS, INC., 10 State St., Woburn, MA 01801

Manufacturers, designers, and marketers of touch-screen hardware and software products for the OEM and systems integrator marketplace.
William Keller, Vice Pres., Sales
617/935-0080 Telex: 530264 MTS
Fax: 617/935-0133

MICROPHASE LABORATORIES, 2709-I Pan American N.E., Albuquerque, NM 87107

Manufacturers of photomasks incorporating 2-µm features with sub-micron layer-to-layer precision, extending to 6.8 x 15 in. of active area.
James E. Shultz, Tech. Sales/Support
505/345-1677 Fax: 505/761-4902

MICROVISION, 591 W. Hamilton, Suite 250, Campbell, CA 95008

Manufacturers of automated flat-panel and CRT test equipment. Real-time measurements feature convergence, geometry, line width, jitter, drift, MTF, and MTFA. Beam of shadow-mask CRTs presented in 3D form.
Stan Buckstad, Pres. 408/374-3158
Fax: 408/374-9394

MICROVITEC INC., 1943 Providence Ct., Airport Perimeter Business Center, College Park, GA 30337

Manufacturers of high-performance color monitors, including the first 19-in. autoscans and 19-in. convertible 48-64 kHz high-definition monitor designs; 12, 14, and 19-in. products for OEMs and distributors.
Scott S. Spencer, Sales/Mktg. Mgr.
404/991-2246 Fax: 404/996-2387

MINOLTA CORP., 101 Williams Dr., Ramsey, NJ 07446

Manufacturers of light and color measurement instrumentation.
John McCasland, Mktg. Mgr.
201/825-4000 Telex: 642411
Fax: 201/423-0590

MITEK SYSTEMS, INC., 6225 Nancy Ridge Dr., San Diego, CA 92121

Manufacturers, designers and testers of TEMPEST computer peripherals, desktop laser printers, and multiplexers.
Glenn Ritzmann, Vice Pres., Sales
619/587-9157 Toll Free: 800/367-5660
or 800/342-4215 Fax: 619/587-0825

MITO FINE GLASS CO., LTD., 2-1-2 Marunouchi, Chiyodaku, Tokyo 100, Japan

Manufacturers of large polished substrates for displays.
Mgr., Sales Dept. 03-218-5861
Telex: J 24616 ASAGIAS
Fax: 03-213-5486

MITSUBISHI ELECTRIC SALES AMERICA, INC., 110 New England Ave. W., Piscataway, NJ 08854

Manufacturers of video copy processors for all imaging/hard-copy requirements; monitors; professional S-VHS VCRs; and video projectors. Most units are autoscans (15-35 kHz) capable.
Rich Williams, Reg. Sales Mgr.
201/981-1414 Fax: 201/981-9492

MITSUBISHI ELECTRONICS AMERICA, Computer Peripherals Div., 991 Knox St., Torrance, CA 90502

Manufacturers of mixed-frequency and multiple-frequency color monitors ranging from 12 to 37 in.; color thermal-transfer printers; and a scanner operable as a hand or sheetfed flatbed scanner.
Tamara Towse, Inq. Supv.
213/217-5732 Fax: 213/324-5478

MITSUBISHI KASEI AMERICA, INC., 5 Palo Alto Square, Suite 225, Palo Alto, CA 94306

Manufacturers of ink/dye-stuffs for ink-jet printers; dye-transfer and color-receiving sheets for thermal-transfer printers; transparent conductive film for flat-panel displays; hard-copy materials and parts; CRT phosphor materials; and optical and video disks.
Seishi Shishido, Mgr./Chief Rep.
415/855-9333 Fax: 415/855-9024

MODUTEK, INC., 920 Candia Rd., Manchester, NH 03103

Manufacturers of backlights for LCDs.
Chuck Davis, Vice Pres., Mktg./Sales
603/669-5121 TWX: 710/366-0005
Fax: 603/622-2690

MOLEX INC., 2222 Wellington Ct., Lisle, IL 60532

Manufacturers of connectors.
Ed Parkinson, Vice Pres., Sales
312/969-4550 Fax: 312/969-1352

MONITERM CORP., 5740 Green Circle Dr., Minnetonka, MN 55343

Manufacturers of the Viking line of high-resolution monochrome, gray-scale and color monitors compatible with both IBM and Macintosh computers. The

MAGNETIC SHIELDS ... FOR EVERY APPLICATION*

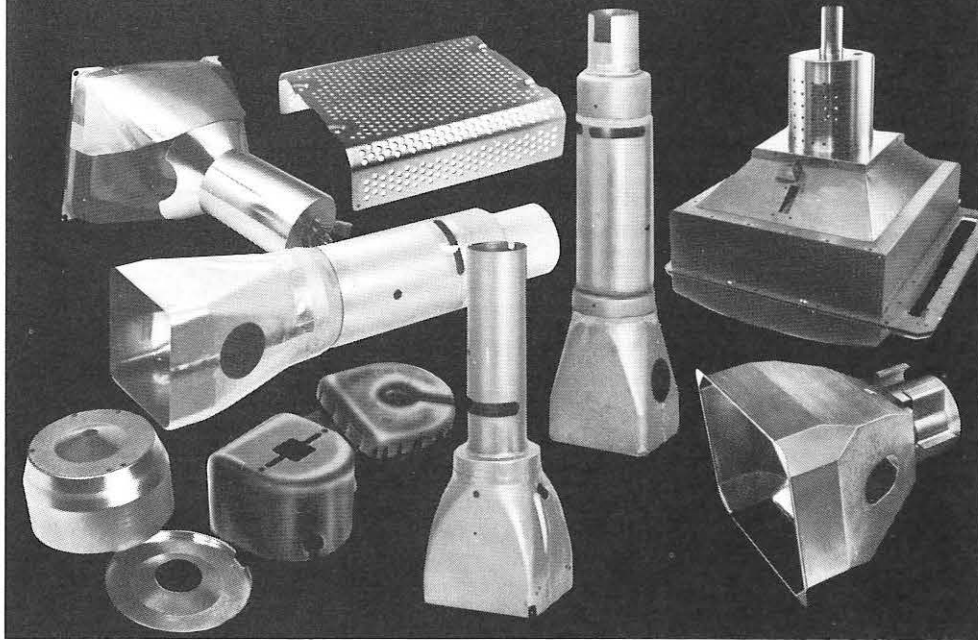

*CRT Shields • Photomultiplier Shields • Transformer Shields • Computer Shields • Power Supply Shields • Chassis Shields • Motor Shields • Printer Head Shields • Special Purpose Shields

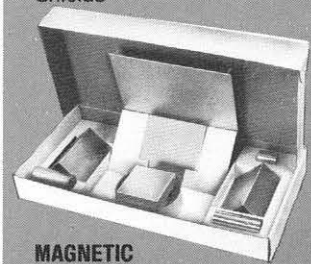

MAGNETIC SHIELDING DEVELOPMENT AND EXPERIMENTAL KIT

This kit provides design engineers with various sizes and shapes of am-metal shielding alloy. All nine components are fully hydrogen-annealed to provide optimum EMI shielding properties.

Ask for our FREE 64-page catalog and NEW FAST-DESIGN FORM that makes it easy to prepare drawings for prototypes or quotations.

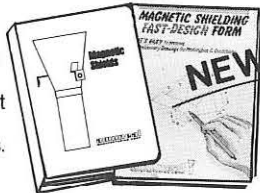

Immediate Delivery from Stock on Foil and Sheet.

Amumetal (80% nickel): Amunickel (49% nickel)
 Sheet Thicknesses014", .020", .025", .030", .040", .050", .060"
 Foil Thicknesses002", .004", .006", .010"

amuneal
MANUFACTURING CORP.

437 DARRAH STREET, PHILADELPHIA, PA 19124
 215/535-3000 FAX 215/743-1715

Circle no. 26

MONOCHROME & COLOR CRT DISPLAYS

DATA RAY'S HIGH PERFORMANCE MONITORS...



THERE'S MORE THAN THE EYE CAN SEE

- Custom Designs For OEM Applications (Specializing in medical & industrial equipment.)
- U.S. Engineering & Manufacturing
- Quality Workmanship
- Dedication to Customer Satisfaction
- Low/High Volume Production Capabilities

DATA RAY CORPORATION

P.O. Box 368/ 452 Burbank Street • Broomfield, CO 80020
 (303) 469-5173 • FAX (303) 466-9524

Circle no. 27

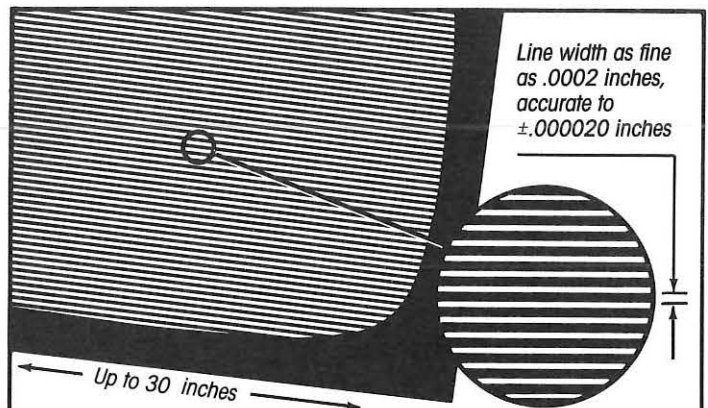

New From Applied Image Large Format Chrome Masks

Now, Applied Image is a new source for accurate large glass phototools. Line width resolution of .0002 inches, accurate to within ±.000020 inches is typical of our micro-imaging capabilities. Made of high grade chromium-coated glass, these phototools are produced under clean room conditions to assure maximum throughput and optimum end-product performance.

For flat panel, automotive, electro luminescent, plasma displays, or any other precision imaging applications, specify Applied Image. We do imaging...precisely.

**FOR MORE INFORMATION CONTACT US AT
 TEL 716-482-0300
 FAX 716-288-5989**



APPLIED IMAGE, Inc

1653 East Main Street
 Rochester, New York 14609

Circle no. 28

monitors are bundled with matching controllers and driver software.
Leslie Kosina, Sales Coord.
612/935-4151 Telex: 753626
Fax: 612/933-5701

MONITRONIX CORP., 929 Eastwind Dr., Suite 220, Westerville, OH 43081

Manufacturers of ultra-high-resolution color graphics monitors. Resolutions of 1600 x 1280, 1280 x 1024, 1024 x 768; bandwidths of 160 MHz, 120 MHz; scan rates of 48-90 kHz, 48-74 kHz modular design.

Kevin L. Gonor, Vice Pres., Mktg./Sales
614/891-3232 Fax: 614/891-2192

MONTEREY TECHNOLOGIES, INC., 26350 Carmel Rancho La., P.O. Box 223699, Carmel, CA 93922

Consulting services and research in vision and visual-display human factors.
Robert T. Hennessy, Pres.
408/625-4285 Fax: 408/625-8674

MURATA-ERIE NORTH AMERICA, 6338 Viscount Rd., Mississauga, Ont., Canada L4V 1H3

Custom designers and manufacturers of high-voltage (2-140 kV) power supplies for commercial, medical, and military display applications, including image intensifiers, CRTs, and heads-up viewing systems.

Fred Vaccari, Prod. Mgr. 416/676-9484
Telex: 06-968013 Fax: 416/673-1952

NATIONAL RESEARCH RESOURCES, B166 Centershore Rd., Centerport, NY 11721

Consultants and manufacturers in flat-panel displays with integrated lighting, heaters, assembly, and packaging with emphasis on LCD and EL applications.
J. A. Burns, Oper. Mgr. 516/754-0365

NBS SOUTHERN, INC., 11451 S. Belcher Rd., Largo, FL 34643

Manufacturers of impact printers, electrophotographic laser printers, and non-impact ion-deposition printers.
Charles Farthing, Vice Pres., Sales
813/541-2200 Toll Free: 800/327-5602
Telex: 522135 Fax: 813/546-8042

NEC ELECTRONICS INC., 401 Ellis St., P.O. Box 7241, Mountain View, CA 94039

Manufacturers of VFDs, 7- and 14-segment, dot-matrix, and graphic formats with multicolors; laser-based material processing equipment; and soldering, trimming, marking, and thin-metal-film repair.

Wayne Stewart, Prod. Mktg. Mgr.
415/965-6041 Toll Free: 800/632-3531
TWX: 910/379-6985 Fax: 415/965-6273

NEC HOME ELECTRONICS (USA), INC., 1255 Michael Dr., Wood Dale, IL 60191

Manufacturers of high-resolution color and monochrome monitors.
Monica Cielak, Mktg. Anal.
312/860-9500, ext. 4430
Toll Free: 800/447-4700
Telex: 910/222-1776 Fax: 312/860-5382

NEI FERRANTI-PACKARD ELECTRONICS, 6030 Ambler Dr., Mississauga, Ont., Canada L4W 2P1

Manufacturers of light-reflecting electromagnetic display components and systems including 7-segment digits, alphanumeric character matrices, and status indicators for outdoor displays, fault detectors, transient recorders.
Paul Manuel, Sales Mgr. 416/624-3020
Telex: 06-961437 Fax: 416/625-6197

NES INC., 3003 Wakefield Dr., Carpentersville, IL 60110

Manufacturers of electrical, time, temperature, process, counting, speed, and remote display meters featuring display only, display with dual set points, display with parallel data, and display with serial data.

Jerry Bestler, Dir. Sales 312/426-5900
Fax: 312/426-6630

NORDEN SYSTEMS, INC., Box 5300, Norwalk, CT 06856

Manufacturers of military displays for

application in airborne, shipboard, ground-based, and vehicular systems. Flat-panel technologies include system design, box design, and panel technology.

Al Hudson, Mktg. Mgr. 203/385-5604

NORSK LCD A/S, Eikhaugen Industrifelt, 30 36 Drammen, Norway

Manufacturers of very-large-area LCDs (100 cm² x 1264 cm²) using TN or STN technology. Custom design and engineering for wide temperature range and mil specs.

Tor Ottesen, Plant Mgr. 473-88-0450
Telex: 72975-LCD-N Fax: 473-88-0367

NTH GRAPHICS, 1807-C W. Braker, Austin, TX 78758

Manufacturers of display controllers capable of panning PC CAD drawings in 2 sec and producing true 3D graphics, including solid models, on PCs.
Harry Thomas, Dir. Sales
512/832-1944 Toll Free: 800/624-7552
Easylink: 62928609 Fax: 512/832-5954

NUMONICS CORP., 101 Commerce Dr., Montgomeryville, PA 18936

Manufacturers of high-performance digitizers and plotters fully compatible with most CAD systems using RS-232 or IEEE-488 interface for a full range of graphics applications.

Morris B. Bowles, Nat. Sales Mgr.
215/362-2766 Toll Free: 800/247-4517
Telex: 510/661-6585 Fax: 215/361-0167

O&S RESEARCH, INC., P.O. Box 221, 1912 Bannard St., Riverton, NJ 08077

Manufacturers and suppliers of aircraft instrument lighting wedges, cover glasses, and CRT contrast-enhancement filter glass. Line of antireflection coatings includes MIL-C-14806A, AMS 2521A, and MIL-C-675C.
Anderson L. McCabe, Pres.
609/829-2800

OCLI, OPTICAL COATING LABORATORY, INC., 2789 Northport Pkwy., Santa Rosa, CA 95407-7397

Manufacturers of high-efficiency antireflection coatings, bandpass filters, beamsplitters, high-performance mirrors, heat/light separators, transparent conductive coatings, optically variable coatings.

Clive Egerton, OEM Sales Mgr.
707/545-6440 Toll Free: 800/237-5538
Telex: 510-744-2083 Fax: 707/525-7410

OI-NEG TV PRODUCTS INC., 711 Southwood Ave., Columbus, OH 43207

Manufacturers of glass parts and bulbs used for CRT tubes. Sizes range from 1/2-in. diameter to 45-in. Sony.
James E. Kyle, Sales/Mktg. Mgr., Glass
614/443-6551 Telex: 4993701
Fax: 614/443-6551, ext. 346

OMEGA ELECTRONIC EQUIPMENT (U.S.) INC., P.O. Box 3008, 1817 William Penn Way, Lancaster, PA 17604

Representatives for Omega Electronics S.A., Switzerland, for color video replay, black-and-white matrix, alphanumeric, and numeric scoreboards.
John Finlayson, Vice Pres., Mktg.
717/393-4088 Fax: 717/393-9812

OMEGA ELECTRONICS, S.A., Rue Stampfli 96, Bienne, Switzerland 2504

Manufacturers of color video replay, black-and-white matrix, alphanumeric, and numeric scoreboards; and timing and judging equipment for all sports.
C. Calderera, Vice Pres., Mktg.
41-32-42-97-13 Telex: 931 207
Fax: 41-32-41-33-21

OMNIGRAPHICS CORP., 1734 West Belt N., Houston, TX 77043

Manufacturers and designers of graphic display controllers for a wide range of computing devices, from PCs to high-performance engineering workstations, minis, and mainframes.

Anthony G. Masruff, Pres.
713/464-2990 Telex: 285804 OMNICO
UR Fax: 713/827-7540

OPTICAL AND CONDUCTIVE COATINGS, 428 N. Buchanan Circle, Suite 8, Pacheco, CA 94553

Manufacturers of thin-film coatings for displays to provide EMI shielding, contrast enhancement, antireflection, and filtering.
Glenn G. Grupe, Mktg. Mgr.
415/798-6066

OPTICAL DEVICES, INC., 805 Via Alondra, Camarillo, CA 93010

Manufacturers of linear polarizers for use in LCDs; contrast-enhancement filters for alphanumeric displays, which incorporate circular polarizers and antireflection glass; and bandpass filters and EMIRFI layers.

Pamela Stanley, Mgr., Mil. Prod.
805/987-8801 Telex: 18-2233
Fax: 805/388-1123

OPTICAL ELECTRONICS, Box 11140, Tucson, AZ 85710

Manufacturers of hardware products for image processing of standard video signals.

Suzanne Gerdes, Pres. 602/889-8811
Telex: 2833-47 Fax: 602/889-8575

OPTICAL RADIATION CORP., 1300 Optical Dr., Azusa, CA 91702

Manufacturers of UV exposure equipment used in the production of printed circuit boards, flat-panel displays and hybrid circuits.

Robbi Beard, Mktg. Coord.
818/969-3344 Telex: 910/584-4851
Fax: 818/969-3681

OPTIGRAPHICS CORP., 9339 Carroll Park Dr., San Diego, CA 92009

Manufacturers of document scanning and conversion systems and document automation systems.

Tony Lolgu, Vice Pres., Sales/Mktg.
619/292-6060 Toll Free: 800/992-6784
800/523-8314 (CA only)
619/7112 UD Fax: 619/546-7671

OPTOTEK, LTD., 62 Steacie Dr., Kanata, Ont., Canada K2K 2A9

Manufacturers of custom LED displays in alphanumeric and matrix formats, integrated hybrid drive electronics, and test equipment.
David I. Kennedy, Pres. 613/591-0336
Telex: 053-3524 Fax: 613/591-0584

ORWIN ASSOCIATES, INC., 88 Seabro Ave., Amityville, NY 11701

Manufacturers of special-purpose random write displays. 21-in. high-speed vector display with 1-in. μ m writing speed and 3-MHz small-signal bandwidth. High-brightness 1000-line raster display for sunlight viewing.
Scott Bearce, Secy-Treas. 516/842-7177
TWX: 510/224-6114 Fax: 516/842-7410

OVONIC IMAGING SYSTEMS, INC., 1896 Barrett St., Troy, MI 48084

Manufacturers of active-matrix LCDs: black-and-white, gray-scale, and color.
Lionel Robbins, Vice Pres., Sales
313/362-3140 Fax: 313/362-4866

PACIFIC BASIN DISTRIBUTING CORP., 543 Avenida del Verdor, San Clemente, CA 92672

Manufacturers of software for point-of-purchase displays; communications products for office and home—fax, call router; multiline telephone adaptor for fax, PC; laptop computers.
Nancy Ristow, Vice Pres., Sales
714/498-0717 Toll Free: 800/498-0717
Fax: 714/498-8381

PANASONIC INDUSTRIAL CO., 2 Panasonic Way, Secaucus, NJ 07094

Manufacturers of CRTs, plasma displays, and monitor displays.
Alan Dragon, Mgr., App. Eng.
201/392-4578; Dave Thompson, CRTs, Deflection Yokes 201/348-5280; Paul Wasek, Plasma Displays 201/392-4710
Telex: USCCD Fax: 201/392-4815

PANDUIT CORP., 17301 Ridgeland Ave., Tinley Park, IL 60477-0981

Manufacturers of 2- and 3-position IDC

connectors for LED leads and wiring and identification products.

Chuck Schumacher, Prod. Mgr.
312/532-1800 Toll Free: 800/777-3300
Telex: 25-4560 Fax: 312/532-1811

PANELGRAPHIC CORP., 10 Henderson Dr., W. Caldwell, NJ 07006

Manufacturers of antiglare and contrast-enhancement display filter materials and complete display read-out windows for all types of optoelectronic and CRT displays.
James Cronin, Prod. Mgr. 201/227-1500
Toll Free: 800/222-0617, -0618
Fax: 201/227-7750

PARALLAX GRAPHICS, INC., 2500 Condensa St., Santa Clara, CA 95051

Manufacturers of high-resolution video and graphics display controllers for Q bus, VMF bus and PCIAT/PCI RT bus.
Stu Taylor, Mgr. Tech. Sales Supp.
408/727-2220 Telex: 550172
Fax: 408/980-5139

PARTICLE DATA, INC., Box 265, Elmhurst, IL 60126

Manufacturers of "Elzone" particle-size analyzer, using highest resolution electrozone method (3D sensing of displacement volume of each particle in an electric field), completely computerized.
R. J. Thompson, Dir. Sales
312/832-5653 Toll Free: 800/323-6140
Telex: 910/254-0180

PCK ELASTOMERICS (see Elastomeric Technologies, Inc.)

PENPECT DIV. OF NUMONICS, 460 Totten Pond Rd., Waltham, MA 02154

Manufacturers of penpad digitizers and intelligent tablets using artificial intelligence for graphics creation, text entry, and command execution.
Judy O'Brien, Sales Admin. 617/890-8877

PENN-TRAN CORP., P.O. Box 1321, WINGATE, PA 16880

Manufacturers of deflection yokes (stator, saddle, vidicon), high-voltage power supplies, flyback transformers, degaussing coils. Designers and manufacturers of horizontal sweep circuits and all associated coils. Match CRTs and deflection yokes.

William H. Holt, Vice Pres./Gen. Mgr.
814/355-1521 Telex: 706473
Fax: 814/355-1524

PENNY AND GILES, 1640 Fifth St., Santa Monica, CA 90401

Manufacturers of barcode readers, joysticks, hand held intelligent and dumb terminals, and trackerballs.
Christopher Thomson, Sales Mgr.
213/393-1497 Telex: 65-2337
Fax: 213/393-6040

PENTAX TECHNOLOGIES CORP., 880 Interlocken Pkwy., Suite 200, Broomfield, CO 80020

Manufacturers of precision optical equipment for computer peripherals.
Robert Ariniello, Mgr., Optical Prod. Mktg. 303/460-1600 Fax: 303/460-1628

PERCON (Peripheral Connections, Inc.), 2190 W. 11 Ave., Eugene, OR 97402

Manufacturers and marketers of E-Z READER barcode readers. Keyboard interface and multi-user RS-232C interface models emulate keyboard input with no software modification required.
Palmer Parker, Tech. Sales Supp.
503/344-1189 (call collect)
Fax: 503/344-1399

PERSONAL WRITER, INC., 1801 Ave. of the Stars, Suite 507, Los Angeles, CA 90067

Manufacturers of a graphics tablet with a resolution of 1000 dpi., a speed of 200 points, and an active area of 12 x 12. A pen replaces mouse and keyboard.
Paul Bloch, Pres. 213/556-1628
Toll Free: 800/322-4744 Telex: 298839
Fax: 213/556-0151

PERSONICS CORP., 2352 Main St., Concord, MA 01824

Manufacturers of aids for disabled display users.

Theresa Crowe, Mktg. Spec.
Toll Free: 800/445-3311
800/447-1196 (MA only)

PHILIPS CONSUMER ELECTRONICS CO., I-40 and Straw Plains Pike, Knoxville, TN 37914

Manufacturers of color and monochrome displays including the new PS2 compatible series. Product line available in domestic U.S. and European versions.
Eu Fleissner, OEM Sales Mgr.
214/323-8280 Fax: 214/245-1248

PHOSPHOR PRODUCTS CO., LTD., PPC House, No. 1 Factory Rd., Upton, Poole, Dorset, U.K. BH16 5SJ

Manufacturers of DCEL displays based on powder and hybrid technologies; 640 x 256, 256 x 256, and custom matrix display systems with SID standard interface and interactive touch input. Contract R&D in luminescent materials and optoelectronic applications.

P. J. F. Smith, Joint Mngng. Dir.
0202-632116 Telex: PHOSPHOR
CHACOMG 418297 Fax: 0202-631980

PHOTO RESEARCH, Division of Kollmorgen Corp., 9330 DeSoto Ave., Chatsworth, CA 91313-2192

Manufacturers of photometers, spectroradiometers, and task-oriented electro-optical systems and services for the measurement, inspection, alignment, calibration, sensing, and/or evaluation of light sources, radiant energy sources, optical patterns, and images.

Mary Lou Woolsey, Sales Mgr.
818/341-5151 Telex: 69-1427
Fax: 818/341-7070

PHOTON, INC., 970 University Ave., Los Gatos, CA 95030

Manufacturers of optical test equipment used in the measurement and analysis of spatial characteristics of sources of light.

J. Darchuk, Sales/Mktg. Dir.
408/354-5600 Telex: PHOT
Fax: 408/354-7138

PHOTONICS SYSTEMS, INC., 6975 Wales Rd., Northwood, OH 43619

Manufacturers of ac gas discharge (plasma) display video monitors and terminals with full graphics and alphanumeric, 10 cm (256 x 256 pixels) to 1.5 m (2048 x 2048 pixels). EL and LCD terminals in small display sizes. Interactive touch-entry devices.

Ray A. Stoller, Pres. 419/666-6325
Fax: 419/666-0785

PIXELINK CORPORATION, 9 Kane Industrial Dr., Hudson, MA 01749

Factory authorized repair center for Philips high-resolution monitors. Sales and service centers located in Hudson, MA, Los Gatos, CA, and Washington, DC.

Roger Trudeau, Vice Pres., Mktg./Sales
617/562-4803 Fax: 617/568-0514

PLANAR SYSTEMS, INC., 1400 N.W. Compton Dr., Beaverton, OR 97006

Manufacturers of EL flat-panel displays and custom glass products.

Jeff Hopkins, Sales Mgr.
503/690-1100 Telex: PLANAR 551961
Fax: 503/645-7024

PLASMACO, INC., 225P South St., Highland, NY 12528

Manufacturers of a broad range of low power consumption ac plasma display systems for OEMs.

James L. Kehoe, Pres. 914/883-6800
Fax: 914/883-6867

PLESSEY NAVAL SYSTEMS LTD., Command Systems Group, 241 Station Rd., Addlestone, Weybridge, Surrey, UK KT15 2PW

Manufacturers of naval command-and-control systems. Key element is the na-

val autonomous intelligent console (NAUTIC). Rugged ac plasma display terminals and cursor and raster displays for radar, sonar, and EW.

M. J. Brooks, Supp. Mgr., Sales/Mktg.
932-847282 XT
Telex: 262329 Fax: 932-847282 XT

POLYTRONIX, INC., 805 Alpha Dr., Richardson, TX 75069

Manufacturers of polymer-dispersed LC shutters and displays; standard and custom twisted nematic and dichroic LCDs in a variety of temperature ranges, shapes and mil-specs.

Kenneth Richardson, Vice Pres., Sales/Mktg.
214/238-7045 Telex: 325908
Fax: 214/644-0805

PRECISION ELECTRONIC GLASS, INC., 1013 Hendee Rd., Vineland, NJ 08360

Custom manufacturers of round and rectangular CRT bulb blanks, envelopes, necktubing (precision bore), flares, and glass-to-metal seals. Specializing in short runs to full production in up to 7-in. sizes, prototype services, and low-cost tooling.

Richard DiRenzo, Sales Mgr.
609/691-2234, -3090

PRECISION PHOTOMASK INC., 4950 Fisher St., St. Laurent, Que., Canada H4T 1J6

Manufacturers of large-area photomasks for LCDs and other applications. High-tolerance masks available up to 10 x 10 in. and regular-tolerance up to 20 x 24 in. Materials available are emulsion, chrome, and iron oxide.

Salim K. Juma, Mktg. Mgr.
514/737-7030 Fax: 514/737-9893

PRIMAGRAPHICS LTD., Melbourn Science Park, Melbourn, Royston, Hertfordshire, U.K. SG8 6EJ

Manufacturers of a range of modular graphics processing and image handling systems and subsystems including video frame grabbers.

Barry Challinor, Sales/Mktg. Dir.
0763 62041 Fax: 0763 62551

PRINCETON GRAPHIC SYSTEMS, 601 Ewing St., Bldg. A, Princeton, NJ 08540

Manufacturers of high-resolution color and monochrome monitors, scanners, and accessory products for IBM and Macintosh PCs.

T. Barbana, Nat. Sales Mgr.
609/683-1660 Telex: 821402 PGS PRIN
Fax: 609/924-6358

PTK/RANTEC DIV., Emerson Electric Co., 1173 Los Olivos Ave., Los Osos, CA 93402

Manufacturers of connectors, high-voltage power supplies, and high-voltage load testers to 30 kV at 3 MA.

Francesca Peterson, Mktg. Mgr.
805/528-5858
Toll Free: 800/235-4148 Telex: 88-8863
Fax: 805/528-8132

PULNIX AMERICA, INC., 770 Lucerne Dr., Sunnyvale, CA 94086

Manufacturers of CCD imagers and cameras and imaging boards.

Richard Hofmeister, Sales Mgr., Video Prod.
408/733-1560
Toll Free: 800/445-5444 Telex: 172541
Fax: 408/737-2966

PULSEVIEW, Units 1 & 2, Suffolk Way, Drayton Rd., Abingdon, Oxfordshire, U.K. OX14 5JY

Manufacturers of hardware, software, and optical design of display modules in all technologies, especially VFDs and LCDs; conventional and surface-mount manufacturing.

Sales Dept. 0235-554433 Telex: 83428
PULSE G Fax: 0235-28971

QMS, INC., One Magnum Pass, Mobile, AL 36618

Manufacturers of intelligent graphics controllers for dot-matrix printers and complete laser-printer systems for bar coding, WPI/CA, electronic publishing, CAD/CAE, and other applications.

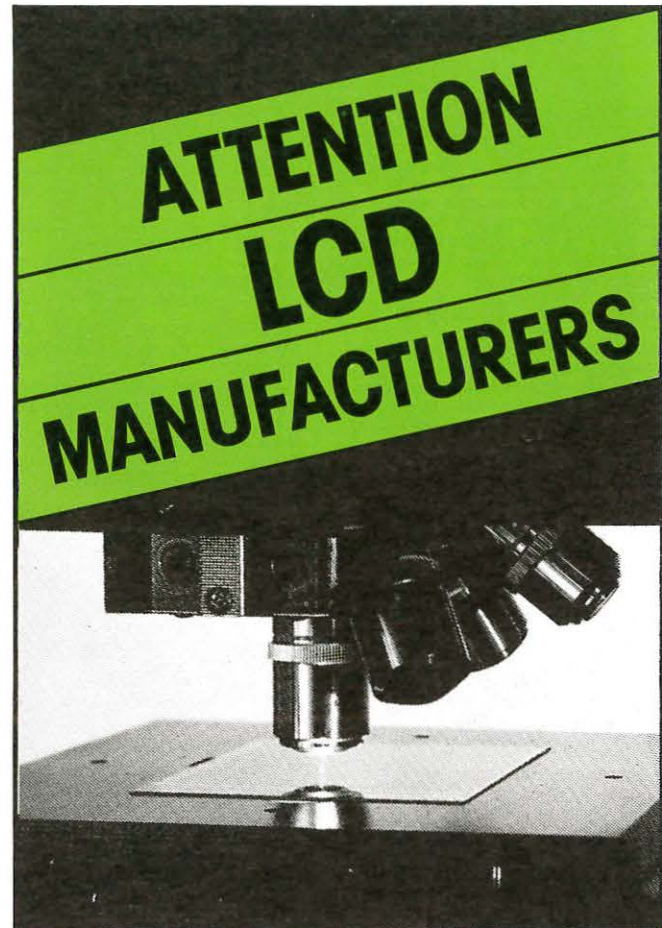

ATTENTION LCD MANUFACTURERS

LCD REPAIR

Increase your yield with the laser repair systems that have become the overwhelming choice of active-matrix liquid crystal display makers around the world—Florod xenon laser repair stations. These dependable systems include the fully programmable MEL-30, the semi-automatic MEL-31, the manual LFA, the tabletop LCM, and the large-area MEL-300.

Every Florod xenon laser provides spot sizes as small as less than 2 x 2 square microns, programmable rectangular apertures to match your geometries, and single and multiple layer isolation capabilities. You can even repair right through glass, ITO, and liquid crystal material.

Of course, these versatile lasers have many other uses in failure analysis, passivation removal, and wafer scale integration. So call or write today for complete information on the laser repair systems that will pay for themselves by helping you raise the manufacturing yield of your valuable active-matrix liquid crystal displays.

ADVANCING LASER TECHNOLOGY

 **FLOROD
CORPORATION**

17360 South Gramercy Place • Gardena, California 90247-5212
213/532-2700 • 800/323-7691 • TELEX 698-363 • FAX 213/329-1015

Circle no. 29

Allen Yuhas, Dir. U.S. Sales
205/633-4300 Fax: 205/633-0013

QUANTEX CORP., 252 N. Wolfe Rd.,
Sunnyvale, CA 94086
*Manufacturers of real-time digital im-
age processors for turnkey imaging sys-
tems with optional application-specific
software for industrial and life science
segments of the market.*
David A. Marr, Sales Eng.
408/733-6730 Fax: 408/733-3870

QUANTEX CORP., 2 Research Ct., Rock-
ville, MD 20850
*Manufacturers of optical sensors and
detectors, erasable optical memory, rad-
iation imaging, and EL lamps and display
systems.*
Elizabeth Stewart, Sales Eng.
301/258-2701 Fax: 301/258-9871

QUANTUM DATA, INC., 2111 Big Timber
Rd., Elgin, IL 60123
*Manufacturers of video signal gener-
ators with variable scan and pixel rates to
400 MHz, for manufacturers and users of
video monitors. Applications include
demonstration, design, manufacturing,
quality control, and servicing of video
monitors.*
312/888-0450 Telex: 206725 QUANTUM
CASM Fax: 312/888-2802

QUANTUM ELECTRONICS, INC., RD 4,
Box 6AAA, Lewistown, PA 17044
*Manufacturers of dc plasma display
systems. Specializing in modular units to
make large wall terminals.*
K. C. Kennedy, Pres. 717/242-1132
Fax: 717/248-8680

QUME CORP., 500 Yosemite Dr., Milpi-
tas, CA 95035
*Manufacturers of LC shutter and laser
page printers.*
Scott Cochran, Vice Pres., Sales
408/942-4000 Telex: 910/338-0232
Fax: 408/942-4052

RACAL MICROELECTRONICS SYS-
TEMS, LTD., Worton Dr., Worton Grange
Ind. Estate, Reading, Berkshire, U.K.
RG2 0SB
*Manufacturers of information display
systems based on LCD technology for
applications in airports, railways, finan-
cial institutions, and vehicles in a variety
of character formats. Military and cus-
tom LCD modules available.*
Ian Holt, Dir. 734-868601 Telex: 847043
Fax: 734-752300

RANK BRIMAR, INC., 227 Technology
Circle, Scotts Valley, CA 95066
*Manufacturers of monochrome and
color CRTs from 0.5 to 24 in. screen size
for civil and military applications. Rug-
ged packages include coils, shield, and
mounting. Also, deflection coils, ampli-
fiers, and power supplies.*
David A. Hurst, Chief Oper. Off.
408/438-6440 Fax: 408/438-6334

RANK BRIMAR LIMITED, Greenside
Way, Middleton, Manchester, U.K. M24
1SN
See above for description.
C. A. Brignell, Sales Mgr.
44-61-681-7072 Telex: 851-665326
Fax: 44-61-682-3818

RASTEROPS CORP., 10161 Bubb Rd.,
Cupertino, CA 95014
*Manufacturers of high-performance
color video display subsystems de-
signed for the Mac II, including 8- and
24-bit color displays.*
John Whitney, Dir. Sales 408/446-4090

RAYTHEON COMPANY, Microwave and
Power Tube Div., 465 Centre St., Quincy,
MA 02169
*Manufacturers of special-purpose
high-performance CRTs assemblies, cus-
tom-designed for military and air-traffic-
control system applications.*
Tom Holzel, Mktg. Mgr.
617/479-5300, ext. 2570
Fax: 617/479-5300, ext. 2227

RAYTHEON COMPANY, Submarine Signal
Div., 1847 W. Main Rd., Portsmouth,
RI 02871
*Manufacturers of both electro-sensi-
tive and direct thermal hard-copy recor-
ders.*
John Lorea, Mktg. Mgr. 401/847-8000,
ext. 5650 Telex: 0927787

RCA TUBE OPERATIONS
(see Burle Industries, Inc.)
RECOGNITION CONCEPTS, INC., 341
Ski Way, P.O. Box 8510, Incline Village,
NV 89450
*Manufacturers of high-performance
high-resolution full-color imaging and
graphics workstations.*
Steve Meaders, Sales Mgr.
702/831-0473 Telex: 753168
Fax: 702/831-8035

REDIFFUSION SIMULATION LTD., Visual
Business Unit—Plant 5, Jenner Rd.,
Crawley, West Sussex, U.K. RH10 6JY
*Manufacturers of monitor, projection,
and laser-based large-area displays, pri-
marily for the aviation industry. RSL's
WIDE is a collimated projection display
offering fields-of-view of up to 40° (V) x
200° (H).*
A. P. Usher, Tech. Sales Exec.
44-293-518941 Telex: 87327
Fax: 44-293-560231

REFERENCE TECHNOLOGY, 5700 Flati-
ron Pkwy., Boulder, CO 80301
*Distributors of CD-ROM products and
services including data preparation ser-
vices, software, and CD-ROM drives.*
Mike Befeler, Vice Pres., Strategic
Mktg. 303/449-4157
Telex: 316074 Fax: 303/442-1816

REGISBROOK, Units 1 & 2, Suffolk Way,
Drayton Rd., Abingdon, Oxfordshire, U.K.
OX14 5JY
*Distributors of displays, modules, and
graphic panels in VF, LC, LED, electro-
magnetic cold cathode and EL technol-
gies. Backlighting filters, and
laminating, and custom design of dis-
plays and modules also available.*
Sales Dept. 0235-554433 Telex: 83428
PULSE G Fax: 0235 28971

RELISYS, 320 S. Milpitas Blvd., Milpitas,
CA 95035
*Suppliers of multiscan, EGA/CGA, pa-
per-white, monochrome, VGA, and PS/2
monitors; 9- and 24-pin NLQ dot-matrix
printers; graphics boards; facsimile ma-
chines; and VDTs.*
408/945-9000 Fax: 408/945-0587

REYNARD ENTERPRISES INC., 26098
Getty Dr., Laguna Niguel, CA 92677
*Manufacturers of optical components,
thin-film coatings, beamsplitters, ND fil-
ters, dielectric filters, optical flats, len-
ses, mirrors, mounts, polarizers, prisms,
retarder plates, wedges, and windows.*
Forrest Reynard, Pres. 714/831-6026
Telex: 361519 REYNARD ENT
Fax: 714/498-9528

RICHARDSON ELECTRONICS, LTD.,
40W267 Keslinger Rd., LaFox, IL 60147
*Manufacturers of electronic display
tubes for use in scientific and medical
equipment and in various commercial
applications. Specializing in data display
and instrumentation tubes.*
Russell Dahl, CRT Prod. Mgr.
312/232-6400 Toll Free: 800/348-5580
Telex: 283461 Fax: 312/208-2550

ROCKWELL INTERNATIONAL CORP.,
Collins Avionics Divisions, 400 Collins
Rd. N.E., Cedar Rapids, IA 52498
*Manufacturers and designers of inte-
grated flight display systems and elec-
tronic flight instrument systems used in
Boeing and Fokker aircraft.*
C. M. Watts, Nat. Sales Mgr.
319/395-2841 Telex: 464-421
Fax: 319/395-5429

ROHM CORP., 8 Whatney, Irvine, CA
92718
Manufacturers of LED lamps in multi-

*ple shapes and colors (including dual),
with clear, transparent, and diffused len-
ses; IR emitters and detectors; single-
and multiple-digit and alphanumeric dis-
plays; light bars; LED and thermal print-
heads.*

Al Kirwan, Mktg. Dir. 714/855-2131
TWX: 910/595-1721 Fax: 714/855-1669
SAES GETTERS/S.P.A. Via Gallarate 215,
Milan, Italy 20151
*Manufacturers of a wide range of bar-
ium-releasing getters in ring and wire
form and mercury dispensing getters
based on a TiHg alloy.*
A. Passoni, Mktg. Dept. 02-30201
Telex: 331108 Fax: 02-3084524

SAES GETTERS/U.S.A., INC., 1122 E.
Cheyenne Mountain Blvd., Colorado
Springs, CO 80906
*Manufacturers of getter devices and
related products. Evaporable-barium-
based ring and wire getters for CRTs,
non-evaporable zirconium-based getters
for electronic devices. Mercury sources
for plasma displays.*
Lee Ramey, Sr. App. Eng.
719/576-3200 Telex: 45434
Fax: 719/576-5025

SAI TECHNOLOGY, 4224 Campus Point
Ct., San Diego, CA 92121-1513
*Manufacturers and distributors of mil-
litarized plasma display terminals and
workstations. Systems integrator provid-
ing rugged communications systems to
the Army and Navy.*
Carol Watson, Mktg. Supp.
619/450-2259 Toll Free: 800/447-4373
Telex: 619/546-6777

SANDERS ASSOCIATES, INC., A Lock-
heed Company, Information Systems
Div., P.O. Box 2035, Nashua, NH 03061-
2035
*Manufacturers of ruggedized and mil-
litarized displays, intelligent terminals,
and display workstations for applica-
tion in aircraft, ground vehicles, shelters,
ships, and submarines.*
Robert Perutz, Mgr. Bus. Devel.
603/885-3524 Telex: 94-3430
Fax: 603/885-4603

DAVID SARNOFF RESEARCH CENTER,
CN 5300, Princeton, NJ 08543-5300
*R&D in advanced CRTs, digital video
(DVI), ACTV, image processing, human
perception; MM&T for CRTs, phosphors,
TFEL, LCD, VLSI, microwave, and optoe-
lectronic devices; displays characteriza-
tion equipment for process control and
set-up/alignment.*
Joseph Volpe, Vice Pres., Mktg.
609/734-2178 Telex: 244020 or 843497
Fax: 609/734-2221

SCHOTT AMERICA GLASS & SCIEN-
TIFIC PRODUCTS, INC., 30 Odell Plaza,
Yonkers, NY 10701
*Manufacturers of CRT bulbs for indus-
trial and military displays; CRT monitor
panels and x-ray protection panels; sub-
strate glasses for LCDs; LCD spacers,
solder glasses, glass-to-metal seals, and
glass sleeves; contrast-enhancement fil-
ters, CRT faceplates, and colored filter
glass.*
William McLaughlin, Group Mktg. Mgr.
914/968-8900 Fax: 914/968-4422

SCIENCE ACCESSORIES CORP., 970
Kings Hwy. W., Southport, CT 06490
*Manufacturers of sonic digitizers with
an active area of 18 x 24 in. to 60 x 72
in. for any surface, including displays
and monitors, with a resolution of 0.01
cm.*
H. Cleveland, Vice Pres., Sales
203/255-1526 Telex: 964300
Fax: 203/254-7271

SCRIPTEL CORP., 4145 Arlington Plaza,
Columbus, OH 43228
*Manufacturers of PenWriter™, a trans-
parent digitizer integrated into a flat-
panel display—the electronic equivalent
of pencil and paper.*
Nick Venetis, Vice Pres. 614/276-8402
Fax: 614/451-1071

SEIKO INSTRUMENTS USA, INC., 1130
Ringwood Ct., San Jose, CA 95131
*Manufacturers of the CH-5300 Series
of thermal-transfer color hard copiers
and the GR-4400 series of advanced ras-
ter display systems.*
Cheryl Landman, Mktg. Comm. Mgr.
408/943-9100 Toll Free: 800/255-7617
Fax: 408/922-5840

S.E.O.S. DISPLAYS, LTD., Kendal House,
Victoria Way, Burgess Hill, West Sus-
sex, U.K. RH15 9NF
*Manufacturers of "out-of-the-window"
display systems for simulation; CRT-
monitor-based collimated displays; wide-
angle-edge matched multichannel pro-
jection displays; and unique laser-
scanned imaging and display systems.*
Owen Wynn, Mngng. Dir. 444-870888
Fax: 444-870777

SHARP ELECTRONICS CORP., Sharp
Plaza, Mahwah, NJ 07430
*Vendors of display products offering
many technologies from one source.
Sharp display products include EL, dou-
ble supertwist, supertwist, TN, and color
TFT active-matrix LCDs.*
Steve Sedaker, Prod. Mktg. Mgr.
201/529-8746 Telex: 426903
Fax: 201/529-8759

SHIP ANALYTICS, North Stonington Pro-
fessional Center, North Stonington, CT
06359
*Manufacturers of computer generated
shiphandling and tactical simulation im-
agery projected on screens.*
Steven Hargis, Mktg. Mgr.
203/535-3092 Telex: 643732
Fax: 203/535-0560

SIERRACIN/INTREX, 12780 San Fer-
nando Rd., Sylmar, CA 91342
*Manufacturers of transparent, conduc-
tive sputtered coatings of metals and
oxides, including gold and tin indium ox-
ide, on continuous flexible film materi-
als such as optical grade polyester.*
*Applications include touch screens, fil-
ters, and EMIRFI shielding.*
David Hayward, Vice Pres., Mktg.
818/362-9131 Toll Free: 800/521-1307
Telex: 497-6628 Fax: 818/367-5927

SIERRACIN/TRANSFLEX, 5600 Bandini
Bld., Bell, CA 90201-6407
*Manufacturers of flexible circuits and
sensors, touch panels, composite heat-
ers and anti-icing systems for com-
mercial and military applications, includ-
ing telecommunications equipment, point-
of-sale devices, and automotive controls.*
Kerry Miller, West. Reg. Sales Mgr.
213/269-9100 Fax: 213/264-8336

SIGMA DESIGNS, INC., 46501 Landing
Pkwy., Fremont, CA 94538
*Manufacturers of a 2,000,000-pixel
1664 x 1200 resolution monochrome
monitor for the IBM PC line and Mac II
and SE models. The system is capable
of 4 shades of gray on the PC and Mac
II versions. Targeted for desktop pub-
lishing and CAD/CAM applications.*
415/770-0100 Telex: 171240
Fax: 415/770-0110

SIGMATRON NOVA, INC., 1901 Oak Ter-
race La., Thousand Oaks, CA 91320
*Manufacturers of TFEL flat-panel dis-
plays, modules, and terminals; custom
displays including high brightness, AN-
VIS green, and Dark Field. Also, display
controllers, power supplies, and filters.*
Susan Adkins, Mktg. Admin.
805/498-4504 Fax: 805/498-2024
East Coast: Elliott Schlam, Vice Pres.,
Mktg./Sales 201/542-2909
Fax: 201/544-4306

SIGMEX, LTD., Sigma House, North
Heath La., Horsham, West Sussex, U.K.
RH12 4UZ
*Manufacturers of a range of high-reso-
lution, high-reliability full-color monitors,
including FST versions, designed for
end users, systems integrators and OEM
markets. Custom ruggedized monitors.*

Configurable between 32 and 65 kHz.
Tony Greatbatch, Int. Sales Mgr.
0403-50445 Telex: 877937
Fax: 0403-41121

SONY CORP., Display Device Group, 2-10-14 Osaki, Shinagawa-ku, Tokyo 141, Japan

Manufacturers of super-high-resolution Trinitron color CRTs, beam-index CRTs, and high-resolution image pickup tubes.

S. Morikawa, Mgr. 03-495-3630
Telex: 2466795 Fax: 03-495-3416

SONY CORP. OF AMERICA, Computer Peripheral Products Div., One Sony Dr., Park Ridge, NJ 07656

Manufacturers of microcomputer related displays; 9- to 25-in. multiscan projectors; multiscan 13-in. monitors; RGB analog or digital, multimedia RGB composite video; CAD/CAM 16- and 19-in., 1280 x 1024 and 1024 x 768.

C. Balchunas, Sales Coord.
201/930-7070 Toll Free: 800/222-SONY
Fax: 201/930-0877

SONY CORP. OF AMERICA, 16450 W. Bernardo Dr., San Diego, CA 92127

Manufacturers of 20 x 20 in. color monitors; 2048 x 2048 resolution beam-index monitors; 16- and 19-in. graphic display monitors; and a 45 in. color NTSC TV.

Tei Iki, Vice Pres. 619/673-2803
Fax: 619/451-0412

SONY GRAPHIC DISPLAY, 16450 W. Bernardo Dr., San Diego, CA 92127

Manufacturers of CAD/CAM and PC CRT displays.
Marko Baba, Dir./Gen. Mgr.
619/673-2676 Fax: 619/451-0412

SOUND DECISIONS, 6646 Clearhaven Circle, Dallas TX 75248

Manufacturers and distributors of the Multilayer Thin Film Interference Program (MIP) for the study of dielectric mirrors and AR coatings. The program runs on the IBM PC.

Raymond Whisnant, Pres. 214/404-9445

SOURCE TECHNOLOGY CORP., 14700 Winchester Blvd., Los Gatos, CA 95030

Research, design, and development of thin, planar matrix-addressed monochrome and color CRTs.
Charles Antony, Vice Pres.
408/378-9800 Fax: 408/378-9809

SOUTHWALL TECHNOLOGIES INC., 1029 Corporation Way, Palo Alto, CA 94303

Manufacturers of transparent conductive film for touch panels, plastic LCDs, EL lighting, and EMI/RFI shielding of VDTs.

Bruce Kuhlman, Prod. Mgr.
415/962-9115 Fax: 415/967-8713

SOUTHWEST VACUUM DEVICES INC. (see Video Display Corp. dba Southwest Vacuum Devices)

SPECTRA-PHYSICS RETAIL SYSTEMS, 959 Terry St., Eugene, OR 97402

Manufacturers of barcode readers.
John Lobsitz, Worldwide Sales Mgr.
503/683-5700 Toll Free: 800/547-2507
Telex: 910/459-2023 Fax: 503/345-7140

SPECTRON ENGINEERING, 800 W. 9 Ave., Denver, CO 80204

Manufacturers of the SE 1420 automatic CRT/HD display analyzer. Available for all display sizes with X/Y or ALTI azimuth transport systems. Uses customer's existing test generator.
Tom Hutchcroft, Mktg. Mgr.
303/623-8987

STANFORD RESOURCES, INC., 3150 Almaden Expwy., Suite 229, P.O. Box 20324, San Jose, CA 95160

Market researchers producing multi-client and custom studies of electronic display markets and technologies. Publishers of Electronic Display World and EDIS, a comprehensive database on the worldwide display market.

Joseph A. Castellano, Pres.
408/448-4440 Telex: 3718684
Fax: 408/723-7056

STAR TECHNOLOGIES, INC., Graphicon Products Div., P.O. Box 13049, Research Triangle Park, NC 27709

Manufacturers of the Graphicon family of high-performance 3D graphics processors for simulation, C/I, MCAE, and molecular modelling applications.
Brad Wyckoff, Mktg. Mgr. 919/361-3866
Fax: 919/361-3888

SUMMAGRAPHICS CORP., 777 State St. Ext., Fairfield, CT 06430

Manufacturers of computer graphics tablets for data input. Sizes from 6 x 9, 12 x 12, 12 x 18, to 17 x 24 and 42 x 60 free-standing models.
Lisa Shay, Comm. Spec. 203/384-1344
Toll Free: 800/243-9388 Telex: 964348
Fax: 203/333-4131

SUN-FLEX CO., INC., 73 Digital Dr., Novato, CA 94939

Manufacturers of antiglare filters and EMI shielding overlays for CRTs and other displays. Also, finger and pen touch screens.

Thomas Milo, Mgr., OEM Sales
415/883-1221, ext. 350
Toll Free: 800/321-1659 800/458-FLEX (CA only) Telex: 172208
Fax: 415/883-2742

SUPERTEX, INC., P.O. Box 3607, 1225 Bordeaux Dr., Sunnyvale, CA 94068-3607

Manufacturers of high-voltage monolithic display drive ICs for flat-panel displays; and high-voltage DMOS MOSFETs for high-voltage power supplies.
Customer Service 408/744-0100

SYNTEST CORP., 40 Locke Dr., Marlboro, MA 01752

Manufacturers of dot-matrix and thermal printers ranging from 21-column to 80-column. Design and engineering assistance is offered along with private label and custom paint.

Peter F. Pombo, Gen. Mgr.
508/481-7827 Fax: 508/481-5769

SYNTRONIC INSTRUMENTS, INC., 100 Industrial Rd., Addison, IL 60101

Manufacturers of deflection yokes for military, industrial, and medical displays; and deflection yokes and focus coils for projection CRTs and large-screen simulation.

Mallory P. Segal, Dir. Sales/Mktg.
312/543-6444 Fax: 312/543-0287

SYSTEMS RESEARCH LABORATORIES, 2800 Indian Ripple Rd., Dayton, OH 45440

Manufacturers of direct-view and optically corrected monochromatic and color CRT displays and projection displays for the airborne cockpit, training, simulation, and command-and-control applications.

Jerome J. Brouwer, Dir. Bus. Devel.
513/426-6000 Telex: 810/450-2621
Fax: 513/426-1984

TALIQ CORP., 1277 Reamwood Ave., Sunnyvale, CA 94089

Manufacturers of LC film technology based large-area color displays.
Mary Noordhoff, Mktg. Mgr.
408/745-0750 Toll Free: 800/722-6464
Fax: 408/745-1820

TANNAS ELECTRONICS, 1426 Dana Pl., Orange, CA 92666

Consulting services in electronic information displays; design of display components and products; evaluation of display companies and component sources; tours (Asia) and seminars; and marketing, human factors, and electro-optic studies.

Lawrence E. Tannas, Jr., Pres.
714/633-7874 Fax: 714/633-4174

TECH SPRAY, INC., P.O. Box 949, Amarillo, TX 79105

Manufacturers of chemical products used to coat and protect components

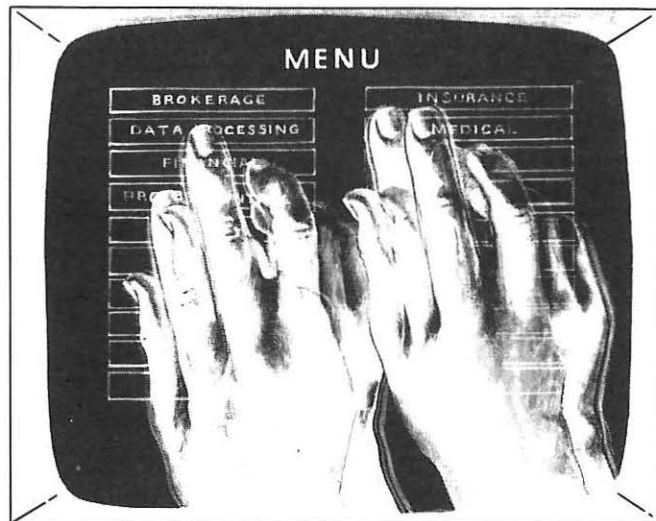

Soft to the touch...gentle to your wallet.

TSD, the leader in Touch Screen Technology, does it again!

From home computer user to OEM, our 9-, 12-, 13-, 15- and 19-inch Digitizers now put a Touch Screen within your reach.

And, of course, all models include the features and the quality that you have come to expect from TSD—ease of operation, high resolution, troublefree long life.

Easily mounted on existing displays, the excellent resolution of all models even permits the entry of graphic data.

Don't be caught short—enhance your system by including a Touch Screen display. Call or write for more information.



TSD DISPLAY PRODUCTS, INC.
35 ORVILLE DRIVE • BOHEMIA, NY 11716-2598
TEL (516) 589-6800 • INT'L SALES TEL (613) 592-1774
TELEX 14-4659 • FAX (516) 589-6858

Circle no. 30

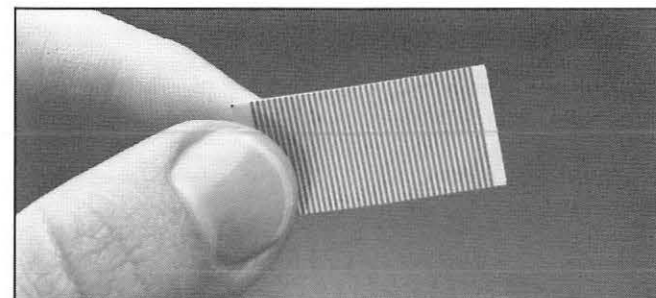

Imagine a connector this small.

So small it offers up to 126 lines of conductive ink per square inch. That's the Elform Heat Seal Connector. Perfect for high density terminations like pocket television sets or color LCDs. Free your design abilities and save on wire bonding and soldering. Think small. For details, call 702-356-1734.

P.O. Box 7362 Reno, Nevada 89510
Fax No. 702-356-1742

Circle no. 31

and finished products from moisture, mildew, fungus, acid, and caustic contaminants. RF/EMI shielding, static control products for carpets, glass, plastics. Don Schrowang, Nat. Accts. Mgr. 806/372-8523 Toll Free: 800/858-4043 800/692-4677 (TX only) Fax: 806/372-8750

TEKTRONIX, INC., P.O. Box 500, M/S 59-420, Beaverton, OR 97077

Manufacturers of graphics terminals; workstations; printers; CCD imagers; high-speed data converters; ultra-high-resolution CRT monitors; test and measurement CRTs; fiber-optic faceplate CRTs; and ultra-high-resolution, high-brightness color CRTs for aircraft and simulator use.

Customer Inquiries
503/627-7111 Toll Free: 800/835-9433, ext. 100 Telex: 151754 TEKTRONIX BEAV Fax: 503/627-5502

TELEDYNE KINETICS, 410 S. Cedros Ave., Solana Beach, CA 92075

Manufacturers of connectors for connecting flat-panel displays to printed circuit boards.

John Schuler, Nat. Mktg. Mgr.
619/755-1181 Toll Free: 800/344-4334 800/992-9988 (CA only)
Easylink: 6287770 Fax: 619/755-6163

TELEX COMMUNICATIONS, INC., 9600 Aldrich Ave. S., Minneapolis, MN 55420

Manufacturers of LCD electronic imaging systems for large-screen projection of computer images. IBM PC and Mac II compatible.

KimMaria Kramer, Sales/Mktg. Admin.
612/887-5531 Toll Free: 800/828-6107, ext. 531 Telex: 6879045
Fax: 612/884-0043

TELIC OPTICS, INC., 576 Boston Post Rd. E., Marlborough, MA 01752

Consultants in optical design and analysis including lens design, illumination systems analysis, and stray light analysis. Custom optical analysis software also provided.

Ed Freniere, Vice Pres. 617/485-4088
Fax: 617/485-4618

TELTRON INC., 2 Riga La., Birdsboro, PA 19508

Manufacturers of CRTs and CRT monitors, fiber-optic faceplates, and image tubes.

Michael A. Craig, Dir. Sales/Mktg.
215/582-2711 Toll Free: 800/835-8766
Telex: 4990805 TELTRON
Fax: 215/582-0851

TENCOR INSTRUMENTS, 2400 Charleston Rd., Mountain View, CA 94043

Manufacturers of high-precision computerized surface profilers with comprehensive surface analysis to measure general topography including roughness, form error, and step-height on substrates up to 10 in. on a side and 2.5 in. thick.

Richard Bates, Prod. Sales Mgr.
415/969-6767 Telex: 910/379-6436
Fax: 415/969-6371

TEST AND MEASUREMENT SYSTEMS, INC., 2934 Corvin Dr., Santa Clara, CA 95051

Distributors of fully programmable video generators for design engineering, testing, qualifying, and inspection of high-resolution display systems. High-resolution video printers with video interfaces, up to 64 gray levels and 4096 colors.

George Stoeppel, Mktg. Mgr.
408/720-8877 Telex: 297584 TEAM UR
Fax: 408/720-9643

TEXAS INSTRUMENTS, INC., P.O. Box 655303, Dallas, TX 75265

Manufacturers of display driver products for flat panel, automotive, and general application, based on Texas Instruments' new 250V patented silicon-gate BIFET™ process technology. Customer Response Center
Toll Free: 800/232-3200

THIN FILM DEVICE, INC., 1180 N. Tustin Ave., Anaheim, CA 92807

Manufacturers and distributors of transparent conductors, ceramic hybrids, and VHSIC packages; precision gauge blocks and reticules; custom optical filters and AR coatings; composite matrix fiber coatings; single or multilayered metals, semiconductors, insulators, carbides, and cermets.
Saleem Shaikh, Pres. 714/630-7127
Fax: 714/630-7119

THOMAS ELECTRONICS, INC., 100 Riverview Dr., Wayne, NJ 07470

Manufacturers of custom designed CRTs for industrial, military, and commercial applications.
Ben Selticase, Vice Pres., Mktg.
201/696-5200 Telex: 310/685-3326
Fax: 201/696-8298

THOMSON-CSF, Cimsa-Sintra Div., 160, Boulevard de Valmy, B.P. 82, Colombes, France 32704

Manufacturers of high-resolution, high-performance TV raster terminals and workstations for real-time applications (commercial and military versions); GKS, PHIGS, and real-time oriented graphics software (C, Pascal, ADA).
A. M. Cousin, Mktg. Mgr.
33-1-47-60-3000 Telex: TCSF204780F
Fax: 33-1-47-60-3357

THOMSON-CSF, Div. Tubes Electroniques, 38, rue Vauthier, BP 305, Boulogne-Billancourt, France F-92102

Manufacturers of CRTs for civil and military applications: very-high-resolution, head-up, head-down, helmet-mounted, projection, and beam-index CRTs. Rugged ac plasma display panels up to 1280 x 1280 pixels.
G. Sulpice, Dis. Sales/Mktg. Mgr.
33-1-49-09-2828 Telex: THOMTUB 200772F Fax: 33-1-46-04-5209

THOMSON ELECTRON TUBES AND DEVICES CORP., 550 Mount Pleasant Ave., Dover, NJ 07801

Manufacturers of CRTs and plasma panels for military and industrial applications including avionics, C³I, photorecording, projection, and ATC. Sizes from 0.5- to 30-in.-diam. Idiaq. Monochrome, color-penetration, beam index, and fully shielded mil-spec shadow-mask CRT assemblies.

George P. Petro, Mktg. Mgr.
201/328-1400 Fax: 201/328-1747

3M COMTAL, 1111 S. Arroyo Pkwy., Pasadena, CA 91105

Manufacturers of digital image processing systems and subsystems.
Ron Clouthier, Mktg. Sales Mgr.
818/441-7714 Toll Free: 800/423-4166
Telex: 287-688

3M INDUSTRIAL OPTICS, 3M Center, Bldg. 220-7W-06, St. Paul, MN 55105

Manufacturers of lowered filters for increased high-ambient-light readability, security viewing, contrast enhancement, and light directional control. Lighting systems for backlights and displays.
Martin Simonet, Mktg. Mgr.
612/733-4403, Cust. Serv.
Fax: 612/736-3305

HOMER TILTON VISONICS LAB, 8401 Desert Steppes Dr., Tucson, AZ 85710

Manufacturers of hologram oscilloscopes for real-time 3D images, and specialty analog modules.
Homer Tilton, Pres. 602/885-5840 or 602/794-3157

TOKO AMERICA, INC., 1250 Feehanville Dr., Mt. Prospect, IL 60056

Manufacturers of miniature dc-dc converters for powering VFDs, modems, RS-232 interfaces and other subsystems.
Jim Onodera, Nat. Sales Mgr.
312/297-0070 Fax: 312/699-7864

TOSHIBA AMERICA, INC., 1101A Lake Cook Rd., Deerfield, IL 60015

Manufacturers of CRTs, conventional flat-and-square, and miniature; mono-

chrome and color high-resolution 31-64 kHz variable-scan monitors; LCDs; fiber-optic products; and image tubes.
Craig Westcott, Asst. Mgr.
312/945-1500 Fax: 312/945-1044

TOTOKU ELECTRIC CO., LTD., 2-2-17, Kabukicho, Shinjuku, Tokyo, 160 Japan

Manufacturers of high-resolution, monochrome and color CRT monitors and deflection yokes.
T. Ogikubo, Mgr., For. Trade Dept.
03-202-2121 Telex: 2322757 TOTOKU J
Fax: 03-209-5057

TOTOKU ELECTRIC CO., LTD., 300, Oya, Ueda-city, Nagano, 386-01 Japan

See above for description.
K. Fujioka, Chief Eng., Design Dev.
02-68-35-5337 Telex: 2322757 TOTOKU J
Fax: 02-68-35-5692

TRANSICOIL INC., Trooper Rd., Worcester, PA 19490-0099

Manufacturers of twisted-nematic and dichroic custom LCDs; fiber-optic alpha-numeric displays; and displays integrated with switch panels for military crew station applications.
Mark LeMire, Sales Mgr. 215/277-1300
Telex: 510/660-0132 Fax: 215/277-1300

TSD DISPLAY PRODUCTS, INC., 35 Orville Dr., Bohemia, NY 11716

Manufacturers of high-resolution CRT display monitors (monochrome) and touch-screen digitizers (retrofit kits for existing systems).
Steven R. Sloan, Dir. Sales
516/589-6800 Telex: 14-4659

UCE LIQUID CRYSTAL DISPLAYS, 35 Rockland Rd., Norwalk, CT 06854

Manufacturers of custom LCDs and modules, clear heaters, backlighting, light valves and shutters. Product development support. Rapid response prototypes. TNFE, dye, dynamic scatter, EL, frit seal, and others.
Dave Schmidt, Sales Mgr.
203/838-7509 Fax: 203/838-2566

UNITED DETECTOR TECHNOLOGY, 12525 Chadron Ave., Hawthorne, CA 90250

Manufacturers of display measurement equipment including photometers, radiometers, spot-photometers, and spectroradiometers.
Debra Zimmer, Sales/App. Eng.
213/978-0516 Telex: 4949979
Fax: 213/978-3857

UNLIMITED SYSTEMS, 9225 Chesapeake Dr., San Diego, CA 92123

Manufacturers of computer and fax equipment.
Howard Gutzmer, Pres.
619/277-3300 Fax: 619/277-3305

VARITRONIX LTD., 4/F Liven House, 61-63 King Yip St., Kwun Tong, Kowloon, Hong Kong

Manufacturers of LCDs; dot-matrix LCD modules; touch-sensitive LCD overlay for LCDs and modules; OEM subassemblies; and turnkey projects.
C. C. Chang, Sales 852-3-894317
Telex: 36643 VTRAX Fax: 852-3-439555

VENUS SCIENTIFIC, INC., 399 Smith St., Farmingdale, NY 11787

Manufacturers of custom military and industrial power conversion systems.
Peter Jazwinski, Nat. Sales Mgr.
516/293-4100; Sylvester Meola, West. Reg. Sales Mgr. 602/991-9684
Telex: 510/224-6492 Fax: 516/752-7976

VERSATEC (A Xerox Co.), 2710 Walsh Ave., Santa Clara, CA 95051

Manufacturers of electrostatic, thermal-transfer, and laser plotters; plotting software packages; high-speed processors; micrographic scanners; supplies and other products for CAD, geophysical exploration, mapping, and imaging systems.
Annette Stransky, Adv. Mgr. Toll Free: 800/538-6477 800/341-6060 (CA only)

VERTICOM INC., 545 Weddell Dr., Sunnysvale, CA 94089

Manufacturers of high-performance graphics display controllers and subsystems for PC platforms for CAD/CAM, engineering and desktop applications.
Robert V. Dickinson, Pres.
408/747-1222 Toll Free: 800/433-5760
Telex: 754044 Fax: 408/747-1398

V. I. CORP., Amherst Research Park, Amherst, MA 01002

Development and sales of software primarily of UNIX, VMS, and AEGIS operating systems on hardware from Sun, Apollo, DEC MASSCOMP, HP, Silicon Graphics, IBM (PCI/AT only), Intel, and Intergraph.
Roger Howard, Dir., Corp. Sales
413/253-3482 Telex: 255079
Fax: 413/256-0574

VII (VISUAL INFORMATION INSTITUTE, INC.) P.O. Box 33, 719 Lower Bellbrook Rd., Xenia, OH 45385-0033

Manufacturers of video test instrumentation equipment. Products serve all facets of the video industry, especially the nonbroadcast realm of medical imaging, security and surveillance, production testing, education, military, and scientific R&D.
Karen Pellerin, Sales Coord.
513/376-4361 Telex: 501031
Fax: 513/376-2802

VIDEO DISPLAY CORP., 5530 E. Ponce de Leon Ave., Stone Mountain, GA 30086

Manufacturers and importers of display, projection, television CRTs, and electron guns and components.
Data Display Tube Div.: Manufacturers and importers of monochrome and color data display tubes.
Ronald D. Orway, CEO; Bob Liss, Vice Pres., Mktg., Data Dis. Tube Div.
404/938-2080 Toll Free: 800/241-5005
Fax: 404/493-3903

VIDEO DISPLAY CORP., dba SOUTH-WEST VACUUM DEVICES, 2310 W. Paradise La., Tucson, AZ 85705

Manufacturers of projection cathodes and metal stampings, state-of-the-art custom gun mounts for black-and-white, color, radar, monitor, and industrial types.
John McQueen, Mngng. Dir.
602/887-7900 Telex: 165-522
Fax: 602/887-7903

VIDEO DISPLAY CORP., Novatron Div., 12 Emily St., Cambridge, MA 02139

Manufacturers of projection tubes utilizing Schmidt optics for large-screen TVs and data display devices.
Frank Federman, Mgr. 617/661-3600
Fax: 617/661-0206

VIDEO MONITORS, INC., A Subsidiary of Dotronix, Inc., 3833 N. White Ave., Eau Claire, WI 54703

Manufacturers and designers of high-speed raster-scan CRT-type monitors in both monochrome and RGB color types.
Len Stewart, Sales Mgr. 715/834-7785
Telex: 510/100-1880 Fax: 715/834-5672

VIDEOTEX SYSTEMS INC., 8499 Greenville Ave., Suite 205, Dallas, TX 75231

Manufacturers of display terminals with digitized video pictures, featuring TV quality pictures. Sold as a complete terminal, or software only (T-VIEW).
Bob Gillman 214/343-4500
Telex: 4945693

VILLA PRECISION, INC., 3027 W. Indian School Rd., Phoenix, AZ 85017

Manufacturers of precision glass scribes for the flat-panel display industry.
Thomas L. Muir, Pres.
602/266-2366 Telex: 261974 VPI PHX
Fax: 602/266-2926

VIRATEC THIN FILMS INC./VIRATEC TRUVUE INC., 300 Depot Sq., Suite 109, Faribault, MN 55021

Manufacturers of nonglare and optical-coated glass products for the display

industry in sizes up to 40 x 80 in. in any thickness and color with bending and shaping available.

J. Alan Beatty, Vice Pres., Sales
507/334-0051 Fax: 507/334-0055

VL ELECTRONICS, INC., 3171 Los Feliz Blvd., Ste. 303, Los Angeles, CA 90039

Manufacturers of LCDs; dot-matrix LCD modules; touch-sensitive LCD overlays for LCDs and modules; customized LCDs and LCD modules; OEM subassemblies; and turnkey projects.
Chris Sieh, Sales 213/661-8883
Fax: 213/663-3711

THE VOICE CONNECTION, 17835 Sky Park Circle, Suite C, Irvine, CA 92714

Manufacturers of voice input and output speech recognition devices for IBM AT/PC/XT/30. Expansion card for MS/DOS with 500 words and 98%+ accuracy available.

Lani Kirkham, Adv. Mgr.
714/261-2366 Fax: 714/261-8563

VOLTARC TUBES, INC., 176 Linwood Ave., P.O. Box 688, Fairfield, CT 06430-0688

Manufacturers of a large range of small-diameter, miniature fluorescent lamps for backlighting of LCD displays.
Lou Winkler, Dir. Mktg.

203/265-2633 Telex: 964337
Fax: 203/259-1194

VUTEK SYSTEMS, INC., 10855 Sorrento Valley Rd., San Diego, CA 92121

Manufacturers of image capture and display products. Overlay text and graphics on captured or live video

(32,763 colors) using a single monitor. Compatible with DOD application software. NTSC and PAL input available.
Marshall Myrman, Mktg. Mgr.
619/587-2800 Fax: 619/455-0980

WACOM CO., LTD., 4-394-1 Ikebukuro, Toshima-ku, Tokyo 171, Japan

Manufacturers of flat-display integrated multifunction data terminals for paperless office systems. The system includes cordless stylus, telephone, modem, IC memory card, and handwriting recognition.

Masahiko Yamada, Export Mgr.
81-03-985-7911 Fax: 81-03-985-7934

WASATCH HIGH VOLTAGE, INC., 4100 S.W. Temple, Salt Lake City, UT 84107

Manufacturers of high-voltage and combination switching/high-voltage power supplies for CRT monitors.

Gary I. Tobian, Gen. Mgr.
801/265-9561 Fax: 801/265-9592

WELLS-GARDNER ELECTRONICS CORP., 2701 N. Kildare Ave., Chicago, IL 60639

Manufacturers of monochrome and color CRTs ranging from 9- to 13-in. (monochrome) and 9- to 25-in. (color) in size, and standard TV rates up to 100 kHz in resolution.

Lawrence J. Brady, Vice Pres./Sales Mgr.
312/252-8220 Telex: 25-3286
WGEC CGO Fax: 312/252-8072

WESTINGHOUSE IMAGING AND SENSING TECHNOLOGY DIV. (see Imaging and Sensing Technology Corp.)

WESTLAND ELECTRONICS LTD., P.O. Box 84, Old Chatham, NY 12136

Consultants in information display products and services. Perform studies in technologies and market forecasts. Edit books and present seminars.
Sol Sherr, Pres. 518/794-8151

WICO DISTRIBUTION CORP., 6400 W. Gross Point Rd., Niles, IL 60648

Manufacturers of joystick controls for video games and computers.

Michael M. Gordon, Vice Pres., Consumer Prod. 312/647-7500
Toll Free: 800/323-0765 Telex: 289413
Fax: 312/647-8526

WORLD PRODUCTS/NEC DISPLAY PRODUCTS, P.O. Box 517, Sonoma, CA 95476

Distributors of NEC dot-matrix plasma displays, active-matrix LCDs, EL backlight material, and color CRTs.

Systems Devices Group 707/996-5201
Telex: WORLDPRO SNOM 171715
Fax: 707/996-3380

XYTRON, LTD., 13010 San Fernando Rd., Sylmar, CA 91342

Manufacturers of CRT displays of all sizes. Stroke, raster, and multifunction, monochrome and color, direct view and projection, for simulated cockpits and trainers.

William P. Lockshaw, Pres.
818/362-8341 Fax: 818/367-2970

YAMAHA CORP. OF AMERICA, Systems Technology Div., 6600 Orangethorpe Ave., P.O. Box 6600, Buena Park, CA 90622-6600

Manufacturers of chip- and board-level display controllers for EL, plasma, LCDs, and CRTs at resolutions up to 1024 x 1024, including IBM graphics standards.
Robert Starr, Nat. Sales/Mktg. Mgr.
714/522-9223 Toll Free: 800/521-9074
Fax: 714/527-0155

THE YENCHARIS CONSULTING GROUP, 582 Hawthorne St., N. Massapequa, NY 11758

Consultants in market research, strategic planning, and market communications, specializing in CRTs and desktop systems.

Len Yencharis, Prop. 516/795-6325

ZENITH COMPONENTS GROUP, 1000 Milwaukee Ave., Glenview, IL 60025

Manufacturers of a 14-in. flat-tension-mask color display and monochrome displays in various screen sizes for computer, automotive, and other OEMs.

Steve Kish, Vice Pres., Mktg.
312/391-7000 Telex: 25-4396
Fax: 312/391-7253

ZENITH ELECTRONICS CORP., Rauland Div., 2407 W. North Ave., Melrose Park, IL 60160

Manufacturers of the flat-tension-mask display color picture tube.

Tony Del Vecchio, Vice Pres., Sales/Mktg. 312/450-8992 Telex: 721-488
Fax: 312/450-8393

Z-NIX CO., INC., 10527 Humbolt St., Los Alamitos, CA 90720

Manufacturers of PC input devices.
Frank Yeh, Sales Mgr. 213/493-2516
Fax: 213/493-2790

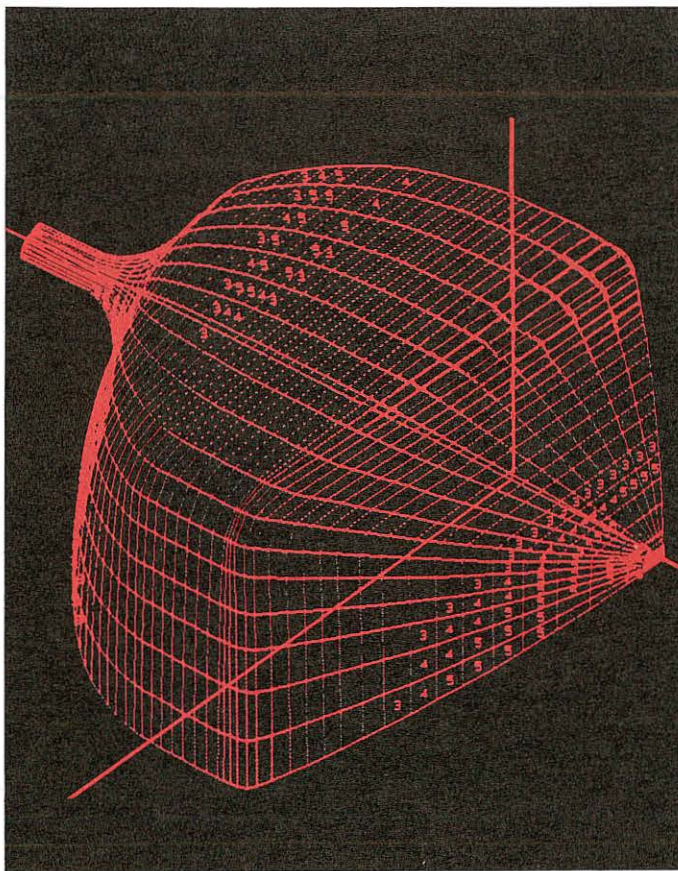

The Integrity of Your Supplier is as Important as the Integrity of Your Design

Introducing OI-NEG...one of the world's largest producers of CRT glass bulbs. Complete engineering, design, and fabricating capabilities. Both high volume and custom production runs. Unsurpassed quality and performance. Bulb sizes ranging from 0.5" to 45.0". Prototype turnaround just 90 days.

OI-NEG. New leadership...old fashioned business integrity.

To resolve your design requirements, call Jim Kyle at (614) 443-6551. For complete technical information, circle the reader service number.

OI-NEG

TV Products, Inc.

711 Southwood Avenue
Columbus Ohio 43207

(614) 443-6551

FAX: (614) 443-6551, x-346

sustaining members

Ad-Vance Magnetics, Inc.
AEG Corp.
Alphasil, Inc.
Amuneal Manufacturing Corp.
Applied Films Lab, Inc.

Babcock Display Products
BDH Ltd.
Bell-Northern Research, Ltd.
Bendix Corp.
Brewer Science, Inc.
Burl Industries, Inc.

Canon, Inc.
Capetronic USA (HK), Inc.
CELCO
Cherry Electrical Products Corp.
Chomerics, Inc.
Clifton Precision/Special Devices
Clinton Electronics Corp.
Computing Devices Co.
Connector Corp.
Corning Glass Works
CR Technology, Inc.

Dale Electronics
Data Images
David Sarnoff Research Center, Inc.
Digital Electronics Corp.
Displays Inc.
DISCOM/Display Components, Inc.

EEV, Inc.
EG&G Gamma Scientific
Electro-Plasma, Inc.
Endicott Research Group, Inc.

Ferranti-Packard Electronics, Ltd.
Futaba Corp.

GEC Avionics, Inc.
General Electric Co.
GML Information Services
GTE

George D. Harris Assoc., Inc.
Hartman Systems
Hazelton Corp.
Hercules Aerospace Display Systems
Hewlett-Packard Co.
Hitachi, Ltd.
F. Hoffmann La-Roche & Co., Ltd.
Hoya Optics, Inc.
Hughes Aircraft Co.
Hycom, Inc.

IBM Corp.
Imaging & Sensing Technology Corp.
Imapro Corp./Imaprint Design, Inc.
Incom, Inc.
Industrial Electronic Engineers, Inc.
Infodex, Inc.
Interstate Electronics Corp.
ISC Cardion Electronics, Inc.
ISE Electronics Corp.

K&R Engineering Sales Corp.
Kollmorgen Corp. Photo Research Div.

Litton Panelvision Corp.
Litton Systems Canada Ltd. (2)
Litton Systems, Inc.
Los Alamos National Laboratory
Lucas Corp.

Magnavox Government & Industrial Electronics Co.
Magnetic Radiation Laboratories
Microphase Laboratories
Microvision
Minolta Corp.
Mitsubishi Kasei America, Inc.
Mitsubishi Electronics America, Inc.
Monitronix Corp.
MRS Technology, Inc.
Murata-Erie North America, Ltd.

NEC Home Electronics (USA), Inc.
Norden Div. United Technologies Corp.
NYNEX Science & Technology

OKI Electric Industry Co., Ltd.
Optical Coating Lab., Inc.
Optical Radiation Corp.
Orwin Associates, Inc.
Ovonic Imaging Systems, Inc.

Particle Data, Inc.
Penn-Tran Corp.
Philips Electronics, Ltd.
Phosphor Products Co., Ltd.
Photonics Technology
Planar Systems, Inc.
Plasmaco, Inc.
Plessey Naval Systems
Precision Electronic Glass, Inc.
PTK/Rantec Div. Emerson Electric Co.
Quantum Data Inc.

Rank-Brimar, Ltd. (2)
Raytheon Co.
Regisbrook Group, Ltd.
Ricoh Co., Ltd.
Rogerson Kratos Corp.

SAI Technology Co.
Sanders Associates, Inc.
Schott America—Glass & Scientific Products, Inc.
Sigmatron Nova, Inc.
Singer-Librascope
Sony Corp.
Stanford Resources, Inc.
Supertex, Inc.
Syntronic Instruments, Inc.

Taliq Corp.
Tektronix, Inc.
Test & Measurement Systems, Inc.
Texas Instruments, Inc.
Thomas Electronics, Inc.
Thomson Electron Tubes & Devices Corp.
Toshiba America, Inc.

UCE Liquid Crystal Displays
United Enclosures, Inc.

Venus Scientific, Inc.
Video Monitors, Inc.
Villa Precision, Inc.
Visual Information Institute, Inc.

World Products, Inc.

Yamaha Corp. of America

Zenith Electronics Corp.

index to advertisers

	Page		Page
AEG Corp.....	C2	International High Voltage Electronics, Inc.	12
Amuneal Manufacturing Corp.	35	Leader Instruments Corp.	26
Applied Image, Inc.	35	Magnetic Radiation Laboratories	12
BKL Industries, Inc.	18	Microvision	17
CELCO (Constantine Engineering Labs. Co.).....	44	Minolta Corp.	31, 31
Citronix, Inc.	4	OI-NEG TV Products, Inc.	43
Clinton Electronics Corp.	23	Optical Radiation Corp.	9
Data Ray Corp.	35	Panasonic Industrial Co.	C3
Digital Electronics Corp.	20	Photo Research	C4
Eagle Magnetic Co., Inc.	8	Photonics Systems.....	24
Electronic Imaging '88	22	Precision Electronic Glass, Inc.	13
Elform, Inc.	39	Quantum Data	2
Florod Corp.	37	Southwest Vacuum Devices, Inc.	29
Hoffman Engineering	43	TSD Display Products, Inc.	39
Hoya Electronics Corp.	19	Visual Information Institute, Inc.	1
Hoya Optics, Inc.	4	Wasatch High Voltage, Inc.	25
Hughes Aircraft Co.	21		
Imaging and Sensing Technology Corp.	16		

Business and Editorial Offices Recruitment Advertising

Palisades Institute for Research Services, Inc.
201 Varick Street
New York, NY 10014
Jay Morreale, Advertising Manager
212/620-3371

District Sales Office—West

Ted Lucas
P.O. Box 852
Cedar Glen, CA 92321
714/337-6627

District Sales Office—Midwest

Stephen Steeves
Pattis/3M
4761 West Touhy Avenue
Lincolnwood, IL 60646
312/679-1100

District Sales Office—East

Becky Akers
Pattis/3M
310 Madison Avenue, Suite 1804
New York, NY 10017
212/953-2121

SID Executive Committee

President: L. E. Tannas, Jr.
Vice President: W. F. Goede
Treasurer: P. M. Heyman
Secretary: A. I. Lakatos
Past President: J. A. van Raalte

Regional Directors

Bay Area: H. Sherman
Canada: J. Wright
Dayton: R. Holmes
Delaware Valley: S. Filarsky
Detroit: Z. Yaniv
Europe: C. J. Gerritsma
Japan: M. Ashikawa
Los Angeles: P. Baron
Mid-Atlantic: H. Funk
Minneapolis/St. Paul: T. Werner
New England: D. Heller
San Diego: R.E. Thoman
U.K. & Ireland: A. Woodhead

Committee Chairmen

Academic: L. Weber, L. Todd, Jr.
Archives/Historian: R.C. Knepper
Bylaws: A. Silzars
Chapter Formation: J. Erskine
Conferences
IDRC—R. Durbeck
Symposium—T. Credelle
Definitions & Standards: P. Keller
Honors & Awards: W. Howard
Intersociety: W. Hamilton

Membership: T. Nelson
Nominations: J. A. van Raalte
Publications: T. Curran
Proceedings Editor: S. Sherr
Information Display Editor: K. I. Werner

Publicity: J. Price
Group Formation
Workstations—R. Schmah
Hard Copy—W. Lloyd

Chapter Chairmen

Bay Area: C. Infante
Canada: A. Moffat
Dayton: W. Watkins
Delaware Valley: R. Seifert
Detroit: J. Erskine
Japan: S. Kobayashi
Los Angeles: P. Baron
Mid-Atlantic: T. Nelson
Minneapolis/St. Paul: V. Born
New England: W. Hamilton
San Diego: J. Lipscombe
U.K. & Ireland: N. Bartlett

Office Administration

Headquarters Office Manager: Bettye Burdett

Society for Information Display

8055 W. Manchester Ave., Suite 615
Playa Del Rey, CA 90293
213/305-1502

muMATH-83

by Soft Warehouse, 3615 Harding Avenue, Suite 505, Honolulu, Hawaii 96816. \$300.

muMATH: A Microcomputer Algebra System

by C. Woof and D. Hodgkinson
176 pp. Academic Press, 1250 Sixth Avenue, San Diego, California 92101-9665. \$22.50 paper.

Reviewed by RICHARD LEE

The software

A by-product of the evolution of artificial intelligence is computer algebra—the symbolic, rather than numerical, solving of algebraic equations. Currently, several software packages for performing computer algebra are available, including FORMAC and REDUCE for the IBM 360; and REDUCE, MAPLE, and MACSYMA for DEC computers. These packages require anywhere from 150 kbytes to 2 Mbytes of memory.

MuMATH-83 comes on two 5¼-in. or 3½-in. floppy discs for IBM PCs, PS/2s, and compatibles having a graphics card and a monochrome or color monitor. It requires 128 kbytes of memory and MS-DOS 2.0 or higher. The program is written in the language muSIMP, which was developed specifically for it. I tested muMATH on an IBM PC/XT having 640 kbytes of memory.

The first of the two floppy discs contains three unprintable system image files; the second disc contains 22 printable source files. There is an automatic tutorial demo for each file which can be disabled if desired.

It took me several hours of use to become comfortable with the software. MuMATH is formatted in an interactive programming style, which requires the user to anticipate the program's logical flow. MuMATH readily handles algebra, matrix algebra, derivatives, integrals, or-

Richard Lee is project manager of imaging tubes at Amperex Electronic Corp., Slatersville, Rhode Island.

dinary differential equations (ODEs), and fractions. It has problems with factoring, symbolic fraction simplification, and "complex" differential equation problems. Another shortcoming: after each SYS file, the user must load each source file in order of priority to avoid syntax errors during use.

Documentation consists of a 248-page manual separated into one section on muMATH and a second on the language muSIMP. The manual tends to be disorganized and poorly written, and not all commands and techniques are indexed. For these reasons, it is necessary to read the entire manual before attempting any serious problems. There is no coverage whatsoever of error troubleshooting.

Despite these significant limitations, muMATH is tremendously useful in scientific and engineering analysis of problems. The software obtains analytical solutions to ODEs quickly, so a number of different conditions can be considered without spending an unreasonable amount of costly professional time. However, the program can not solve partial differential equations such as heat conduction in solids, or complex ODEs such as the solution for atomic energy levels—significant sets of problems in science and industry.

In its areas of effectiveness, the program is not user friendly but is enormously useful once mastered. To solve the



Color & Luminance



NOW
WITH ONE
READING



TOPCON BM-7 LUMINANCE COLORIMETER

Read luminance, chromaticity and color temperature automatically—without calculations or multiple readings—using the Topcon BM-7.

Hoffman Engineering Corporation exclusively sells and services the BM-7 in the U.S., Canada and all of the Americas. Compact, portable and microprocessor-based, the BM-7 gives the user accurate readings by simply focusing on the article to be measured.

And for convenient number crunching, the BM-7 can send data to your computer via IEEE-488 or RS-232C interface.

Call Hoffman Engineering today and see color and luminance readings in a whole new light.

H OFFMAN 20 Acosta Street
H E C Stamford, CT 06902
ENGINEERING CORP. TEL: 203/325-8933
FAX: 203/327-4812

SETTING THE STANDARD FOR LIGHT MEASUREMENT

YES

I am interested in learning more about the BM-7 Luminance Colorimeter. Please send me a copy of Hoffman's latest brochure.

Name _____

Company _____

Address _____

City _____ State _____ Zip Code _____

Phone No. _____

Circle no. 33

Celco YOKES



for
Best
Sensitivity

Celco
Mahwah, NJ 07430
201-327-1123

Circle no. 34

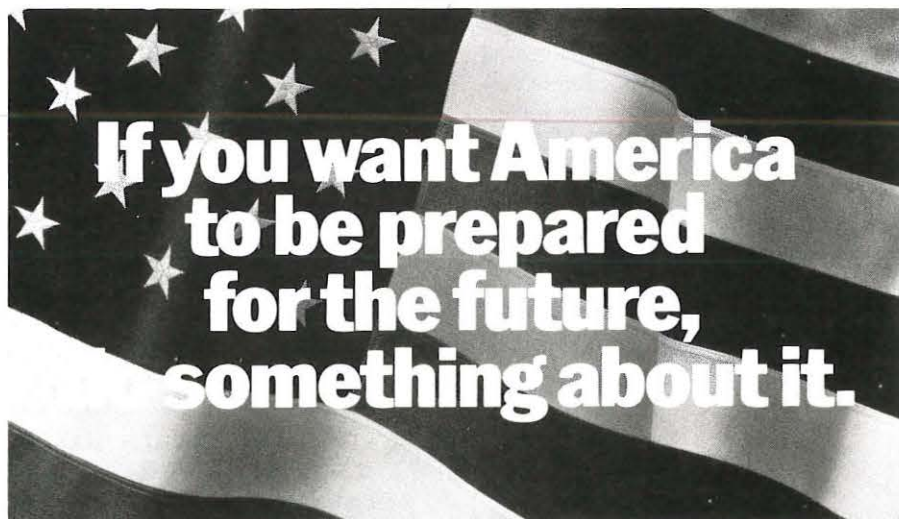

**If you want America
to be prepared
for the future,
something about it.**

Support America's colleges. Because college is more than a place where young people are preparing for their future. It's where *America* is preparing for *its* future.

If our country's going to get smarter, stronger—and more competitive—our colleges and universities simply must become a national priority.

It's an investment we all share in. Government. Private citizens. And the business community. After all, the future of American business depends on it.

So help America prepare for the future with a corporate gift to the college of your choice—and you'll know your company has done its part.

Give to the college of your choice.

Ad Council
A Public Service of This Publication

COUNCIL FOR AID TO EDUCATION **CEAE**

software notes

equation $d^2y/dx^2 + 4 dy/dx + 13y = 0$, for example, the user instructs the computer:

```
SOLN: SOLVE (DIF (Y,X,2) + DIF (Y,X) + 13Y,Y).
```

To this the machine replies:

```
@:{y= = ARB(1) SIN (3X)/  
#E^ (2X)+ ARB(2) COS (3X)/#E^ (2X)}
```

The software is mature. The current version is already five years old, with no more updates planned. When I called Soft Warehouse the staff was patient and helpful, and they had the answers to all my questions. For those solving the kinds of equations muMATH can handle, the package is well worth the price.

The book

There is a wonder drug for one of muMATH's more serious maladies, its poor documentation. The drug is Woof and Hodgkinson's book, which takes the reader on a structured and interesting journey through muMATH and covers all the major topics. The authors present sample problems exhibiting all the features of muMATH with a commentary on the program's strengths and weaknesses. Warning: the otherwise detailed examples do not include simple load commands, so the reader must remember to supply them. Since this information is also missing from the muMATH-83 documentation, the omission could pose a problem for inexperienced computer users.

The book, consisting of 11 chapters and five appendices, elaborates on the syntax used in muMATH and explains much that is missing from the manual. It is endorsed by Soft Warehouse, and the material it contains is well presented and well indexed.

The book is not bundled with the software, but it should be. I regard Woof and Hodgkinson's book as an essential adjunct to the program, and an inexpensive preview for those who are considering a muMATH purchase. It is also a good introduction to computer algebra in general. ■

The Convergence Factor.

Convergence: the single most critical factor in color CRT performance.

Until now, Delta-gun tubes were the best way to achieve near perfect convergence, but only with costly adjustment electronics. Meanwhile, many in-line tubes are plagued by perceptible misconvergence. Which can lead to poor picture quality. A poor quality image for your product. And poor, bleary-eyed operators.

The Panasonic achievement: low cost in-line color CRTs with better-than-Delta convergence performance.

Without complex adjustment electronics . . . and none of the convergence drift inherent in active correction systems. At last, high resolution in-line tubes with stable performance that stands up to the ravages of time and tough office/industrial environments.

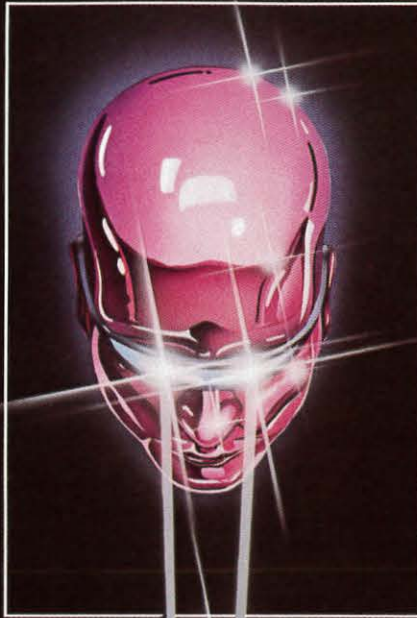

How did we do it? With a preconverged in-line tube/yoke combination unlike any other. Our precision S/ST (saddle/saddle toroidal) deflection yoke is ideally matched to each tube, for near perfect convergence, high repeatability and stability over a wide range of operating conditions.

We combine it with a specially-designed OLF (overlapping field lens) gun and unitized grid construction, providing spot uniformity across the entire screen and near-Delta resolution.

The result: a triumph over the convergence factor. Find out what it can do for your next color terminal or monitor, and ask about our full line of quality color and monochrome CRTs. Write or call: Panasonic Industrial Company, Computer Components Division, One Panasonic Way, Secaucus, N.J. 07094; (201) 348-5278.

**The
achievement of
Panasonic
high resolution
in-line
color CRTs.**



**Panasonic
Industrial Company**

Circle no. 35



Decisions. Decisions. Decisions. PR-900 makes them for you.

The world's leading light measurement people have developed a state-of-the-art Video Photometer that can make all your CRT and display test measurement pass/reject decisions for you. Automatically!

The PR-900 dramatically reduces measurement time, and improves the accuracy and repeatability over manual techniques. It virtually eliminates the possibility of operator error. And it provides NBS-traceable luminance measurements.

Only Photo Research could have brought you this special combination of capabilities in a single instrument. The system is so flexible it can operate in the lab, the production line, as a stand-alone or in a complete ATE environment. And it is so easy to operate it requires almost no training.

The PR-900 Video Photometer embodies the latest advances in solid-state video technology and image processing techniques. Call or write for all the facts today.



PHOTO RESEARCH®
The Light Measurement People®

Division of **KOLLMORGEN**
9330 DeSoto Avenue, PO Box 2192
Chatsworth, CA 91313-2192
(818) 341-5151 FAX: (818) 341-7070
TLX: 69-1427 Cable: SPECTRA

Please visit us at
Electronic Imaging—East,
Booths 541, 543, 545
Circle no. 36 (Please have salesman call)
Circle no. 37 (Please send literature)

AUSTRALIA LASEREX INTERNATIONAL, Ph: 08-2717966 • CANADA OPTIKON CORPORATION, Ph: 519-885-2551
FRANCE INSTRUMAT SA, Ph: 1-69 28 27 34 • HOLLAND INTECHMIJ BV, Ph: 020-56-96-611
WEST GERMANY OPTTEMA ENGINEERING GmbH, Ph: (0212) 67352 • JAPAN KYOKKO TRADING COMPANY, Ph: 03-586-5251
U.K. MICRON TECHNIQUES LTD, Ph: 0202-841261 • INDIA PHOTONICS INTERNATIONAL, Ph: 366665
ISRAEL DELTA FILM LTD, Ph: 052-521874 • ITALY ELETTRONIC/ELEONICA, Ph: 2-4982451 • SWEDEN SAVEN AB, Ph: 08-7921100
EUROPEAN HEADQUARTERS LUZERN, SWITZERLAND, PHOTO RESEARCH, Ph: 041-31-6194