

ELMARK HOLDING SE



CATALOGUE Q4 2021



ELMARK[®]

The Brand of Electricity

AUTOMATION



C40N-4,5kA
MCB
PAGE 36



C60N-6kA
MCB
PAGE 38



C100L-10kA
MCB
PAGE 45



VOLTAGE RELAY
DEVICES FOR MCB
PAGE 52



NT00
HIGH POWER DEVICE
PAGE 55



RT18
HIGH POWER DEVICE
PAGE 58



ISS
SWITCH DISCONNECTOR
PAGE 60



ISS2
SWITCH DISCONNECTOR
PAGE 62



EQ2M
MANUAL SWITCHING
PAGE 63



DS1 MAX
MCCB
PAGE 64



DW1
ACB
PAGE 78



EQ1
CHANGE-OVER SWITCH
PAGE 79



JEL1
RCD
PAGE 81



JEL5
RCBO
PAGE 84



SPD
SURGE ARRESTERS
PAGE 89



**LT1-D
CONTACTORS**
PAGE 93



**CJ19-43
CONTACTORS**
PAGE 97



**LT4-D
CONTACTORS**
PAGE 98



**LT01
AUXILIARY CONTACTS**
PAGE 99



**K20
MODULE CONTACTORS**
PAGE 100



**LT2-E
OVERLOAD RELAYS**
PAGE 102



**TM2
THERMOM. BREAKER**
PAGE 104



**LT5-D
STARTERS**
PAGE 108



**STAR/DELTA
STARTERS**
PAGE 110



**ELM 2000+
INVERTERS**
PAGE 113



**ELM 2500
SOFT STARTERS**
PAGE 115



**HY-RPCF
COSØ REGULATORS**
PAGE 119



**500W SET
SOLAR POWER**
PAGE 124



**ULTRACELL 100Ah
BATTERIES**
PAGE 127

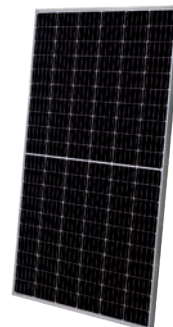

**HALF CUT CELL
SOLAR PANEL**
PAGE 129

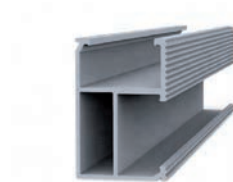

**RAILS
MOUNTING STRUCTURE**
PAGE 131



**INVERTERS
SOLAR SYSTEMS
PAGE 148**



**ELECTRICAL
GASOLINE GENERATORS
PAGE 156**



**TM 181
TIMERS
PAGE 158**



**EL-PMT-1
TIMERS
PAGE 159**



**EL-SDT-1
TIMERS
PAGE 162**



**CE2J
DIGITAL COUNTERS
PAGE 164**



**EVT5
TRANSFORMERS
PAGE 168**



**MESTYPE
TRANSFORMERS
PAGE 169**



**ELM60.2
RELAYS
PAGE 171**



**ELM90.22
RELAYS BASES
PAGE 171**



**EL-ED16R
MEASUREMENT DEVICES
PAGE 175**



**EL-100SA-U
KWH METERS
PAGE 176**



**AMPERE METER
ANALOGUE METERS
PAGE 179**



**CSA
LIMIT SWITCHES
PAGE 180**



**EL-CM
SENSORS
PAGE 187**



**DR-45
POWER SUPPLIES
PAGE 189**



LW26-GS
ROTARY SWITCHES
PAGE 192



EL-2211T
BUTTONS
PAGE 196



AD56-22-W
LED INDICATORS
PAGE 197



ASW-13
SWITCHES
PAGE 201



ELD-G-DIN
BUTTONS LED INDICATORS
PAGE 202



EL1-B174
BUTTONS
PAGE 203



MBP
TELPHER CONTROL
PAGE 204



LTE1101J
WARNING LIGHTS
PAGE 205



MS290
SIRENS
PAGE 206

INSTALLATION



HT-013
INDUSTRIAL PLUGS IP44
PAGE 207



HTN 2141
INDUSTRIAL PLUGS IP67
PAGE 212



EC69025
INDUSTRIAL BOARDS
PAGE 215



EC69025
ASSEMBLED BOARDS
PAGE 218

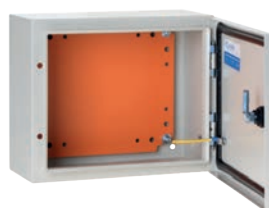

JXF
METAL BOARDS
PAGE 225



ATTIS
PLASTIC BOXES
PAGE 228



ELECTRICAL



C4XN

- └─ number of poles (1,2,3)
- └─ breaking capacity in (kA)
- └─ tripping curve C

C X

- └─ rated current in (A)
- └─ tripping curve C

Documents corresponding to the product:

Standard EN60898-1
EN60947-2

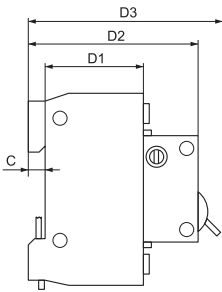
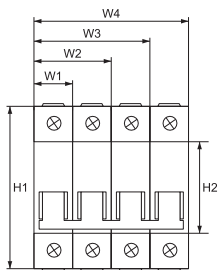
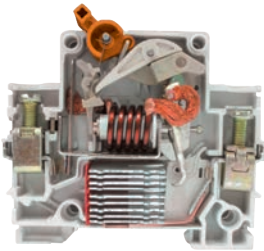

Dimensions (mm)

C	D1	D2	D3	H1
5	40	65	72	78
H2	W1	W2	W3	W4
45	18	36	54	72

NEW DESIGN

MINIATURE CIRCUIT BREAKERS (MCB) C40N

7+0 standard +extended **7** YEAR TOTAL WARRANTY *for industrial usage, 3 years warranty

FUNCTIONS:

- protection of the electrical circuits from overload or short circuits of the outer circuit
- it can be used as a device for commutation and control of electrical circuits
- in combination with auxiliary devices it allows remote control, commutation or indication of the protected circuit
- for mounting in residential and industrial buildings
- for mounting at a distance from the transformer post from 150 to 850 m
- allows protection of consumers generating short circuit currents up to 4500 A

TECHNICAL DATA:

- Rated voltage: 230/400V; 50/60Hz
- Breaking capacity (cycle O-CO) in accordance with standard EN 60 898-1: 4500A
- Rated breaking capacity Ics= 75% Icu
- Isolating voltage: ≥2000V
- Electrical wear resistance (number of cycles): 4000
- Mechanical (number of cycles): 20000
- Class of current limiting: 3
- IP code: IP>20
- Tripping:
 - C – the maximum current release breaks between 5 and 10 I_n; used to protect main power supply cables and conventional consumers
- Joining terminal: flat (tunnel) screw terminal with composition 1.5 coldly draw-plated plane Q235– A
- Plastic box – not keeping the burning material nylon PA66, UV rays wear resistance
- Box permittivity strength: >18MV/m

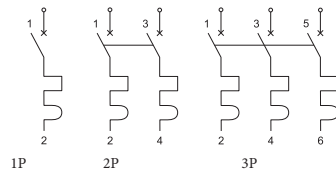

- Abnormal heating wear resistance and fire of the outer parts: 960°C / 3s
- Maximum current release containing:
 - copper coil - composition: pure copper T2 type
 - resistance: from 0.6 to 180m
 - welding effort: <150 000 N/mm
 - bimetal plate – composition: 5J158 to TB180 depending on the current
 - thickness: 0.6mm (up to 40A) and 0.8mm (up to 63A)
 - magnetic core – composition: coldly draw-plated metal wire (1Gr18Ni9)
 - thickness: 1.15 to 2.24µm
 - drawing effort: from 200 to 400N/mm
 - contact head of the movable contact – composition: silver graphite CAg(5)
 - dimension 3x3x0.8 (up to 40A) and 4x4x0.8 (up to 63A)
 - static contact – composition: pure copper T2Y2
 - composition of the contact head: silver graphite CAg(5)
- Power supply (conducting)
 - power supply busbar 1P63, 2P63, 3P63
 - rigid conductors up to 25 mm
 - flexible conductors up to 16 mm
- Tightening moment: 1.33Nm

MOUNTING:

- vertical
- DIN-rail
- for mounting in housing or industrial environment without serious interference
- ambient temperature: -5°C to + 65°C±2° C

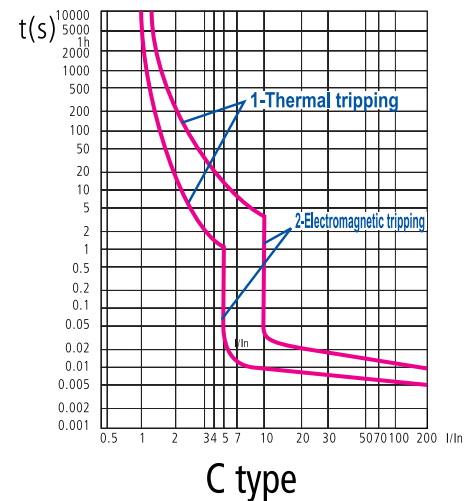



NEW DESIGN

Type	Number of poles	Rated current I _n (A)	Breaking capacity (kA)	Recommended conductor (mm ²)	Packing/Box (pcs)	Product category	Catalogue number Curve C
C41N / 2A	1P	2	4.5	1.0	12/240	B	41660C
C41N / 4A	1P	4	4.5	1.0	12/240	B	41661C
C41N / 6A	1P	6	4.5	1.0	12/240	B	41651C
C41N / 10A	1P	10	4.5	1.5	12/240	B	41652C
C41N / 16A	1P	16	4.5	2.5	12/240	B	41653C
C41N / 20A	1P	20	4.5	2.5	12/240	B	41654C
C41N / 25A	1P	25	4.5	4.0	12/240	B	41655C
C41N / 32A	1P	32	4.5	6.0	12/240	B	41656C
C41N / 40A	1P	40	4.5	10.0	12/240	B	41657C
C41N / 50A	1P	50	4.5	10.0	12/240	B	41658C
C41N / 63A	1P	63	4.5	10.0	12/240	B	41659C



NEW DESIGN

Type	Number of poles	Rated current I _n (A)	Breaking capacity (kA)	Recommended conductor (mm ²)	Packing/Box (pcs)	Product category	Catalogue number Curve C
C42N / 6A	2P	6	4.5	1.0	6/120	B	41670C
C42N / 10A	2P	10	4.5	1.5	6/120	B	41671C
C42N / 16A	2P	16	4.5	2.5	6/120	B	41672C
C42N / 20A	2P	20	4.5	2.5	6/120	B	41673C
C42N / 25A	2P	25	4.5	4.0	6/120	B	41674C
C42N / 32A	2P	32	4.5	6.0	6/120	B	41675C
C42N / 40A	2P	40	4.5	10.0	6/120	B	41676C
C42N / 50A	2P	50	4.5	10.0	6/120	B	41677C
C42N / 63A	2P	63	4.5	10.0	6/120	B	41678C



NEW DESIGN

Type	Number of poles	Rated current I _n (A)	Breaking capacity (kA)	Recommended conductor (mm ²)	Packing/Box (pcs)	Product category	Catalogue number Curve C
C43N / 6A	3P	6	4.5	1.0	4/80	B	41641C
C43N / 10A	3P	10	4.5	1.5	4/80	B	41642C
C43N / 16A	3P	16	4.5	2.5	4/80	B	41643C
C43N / 20A	3P	20	4.5	2.5	4/80	B	41644C
C43N / 25A	3P	25	4.5	4.0	4/80	B	41645C
C43N / 32A	3P	32	4.5	6.0	4/80	B	41646C
C43N / 40A	3P	40	4.5	10.0	4/80	B	41647C
C43N / 50A	3P	50	4.5	10.0	4/80	B	41648C
C43N / 63A	3P	63	4.5	10.0	4/80	B	41649C



C4XN

- └─ number of poles (1,2,3)
- └─ breaking capacity in (kA)
- └─ tripping curve C

CX

- └─ rated current in (A)
- └─ tripping curve C

Documents corresponding to the product:

Standard EN60898-1
EN60947-2

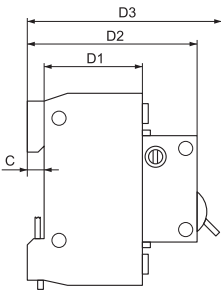
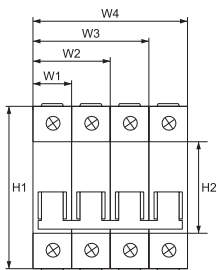
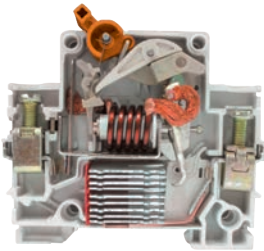

MINIATURE CIRCUIT BREAKERS (MCB) C40N

7+0 standard +extended **7** YEAR TOTAL WARRANTY *for industrial usage 3 years warranty

FUNCTIONS:

- protection of the electrical circuits from overload or short circuits of the outer circuit
- it can be used as a device for commutation and control of electrical circuits
- in combination with auxiliary devices it allows remote control, commutation or indication of the protected circuit
- for mounting in residential and industrial buildings
- for mounting at a distance from the transformer post from 150 to 850 m
- allows protection of consumers generating short circuit currents up to 4500 A

TECHNICAL DATA:

- Rated voltage: 230/400V; 50/60Hz
- Breaking capacity (cycle O-CO) in accordance with standard EN 60 898-1: 4500A
- Rated breaking capacity $I_{cs} = 75\% I_{cu}$
- Isolating voltage: $\geq 2000V$
- Electrical wear resistance (number of cycles): 4000
- Mechanical (number of cycles): 20000
- Class of current limiting: 3
- IP code: IP>20
- Tripping:
 - C – the maximum current release breaks between 5 and 10 In; used to protect main power supply cables and conventional consumers
- Joining terminal: flat (tunnel) screw terminal with composition 1.5 coldly draw-plated plane Q235– A
- Plastic box – not keeping the burning material nylon PA66, UV rays wear resistance
- Box permittivity strength: $>18MV/m$
- Abnormal heating wear resistance and fire of the outer parts: 960°C / 3s

- Maximum current release containing:
 - copper coil - composition: pure copper T2 type
 - resistance: from 0.6 to 180m
 - welding effort: $<150\,000\,N/mm$
 - bimetal plate – composition: 5J158 to TB180 depending on the current
 - thickness: 0.6mm (up to 40A) and 0.8mm (up to 63A)
 - magnetic core – composition: coldly draw-plated metal wire (1Gr18Ni9)
 - thickness: 1.15 to 2.24µm
 - drawing effort: from 200 to 400N/mm
 - contact head of the movable contact – composition: silver graphite CAg(5)
 - dimension 3x3x0.8 (up to 40A) and 4x4x0.8 (up to 63A)
 - static contact – composition: pure copper T2Y2
 - composition of the contact head: silver graphite CAg(5)
- Power supply (conducting)
 - power supply busbar 1P63, 2P63, 3P63
 - rigid conductors up to 25 mm
 - flexible conductors up to 16 mm
- Tightening moment: 1.33Nm

MOUNTING:

- vertical
- DIN-rail
- for mounting in housing or industrial environment without serious interference
- ambient temperature: -5°C to + 65°C±2° C

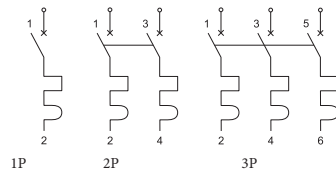

Dimensions (mm)

C	D1	D2	D3	H1
5	40	65	72	78
H2	W1	W2	W3	W4
45	18	36	54	72

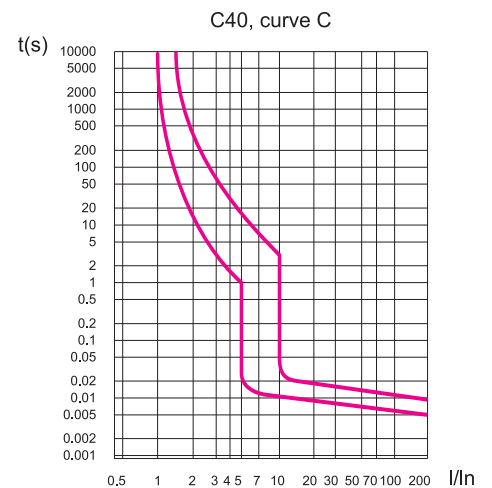

MINIATURE CIRCUIT BREAKERS (MCB)



Type	Number of poles	Rated current I _n (A)	Breaking capacity (kA)	Recommended conductor (mm ²)	Packing/Box (pcs)	Product category	Catalogue number Curve C
C41N / 2A	1P	2	4.5	1.0	12 / 240	B	41460C
C41N / 4A	1P	4	4.5	1.0	12 / 240	B	41461C
C41N / 6A	1P	6	4.5	1.0	12 / 240	B	41451C
C41N / 10A	1P	10	4.5	1.5	12 / 240	B	41452C
C41N / 16A	1P	16	4.5	2.5	12 / 240	B	41453C
C41N / 20A	1P	20	4.5	2.5	12 / 240	B	41454C
C41N / 25A	1P	25	4.5	4.0	12 / 240	B	41455C
C41N / 32A	1P	32	4.5	6.0	12 / 240	B	41456C
C41N / 40A	1P	40	4.5	10.0	12 / 240	B	41457C
C41N / 50A	1P	50	4.5	10.0	12 / 240	B	41458C
C41N / 63A	1P	63	4.5	16.0	12 / 240	B	41459C



Type	Number of poles	Rated current I _n (A)	Breaking capacity (kA)	Recommended conductor (mm ²)	Packing/Box (pcs)	Product category	Catalogue number Curve C
C42N / 6A	2P	6	4.5	1.0	6 / 120	B	41470C
C42N / 10A	2P	10	4.5	1.5	6 / 120	B	41471C
C42N / 16A	2P	16	4.5	2.5	6 / 120	B	41472C
C42N / 20A	2P	20	4.5	2.5	6 / 120	B	41473C
C42N / 25A	2P	25	4.5	4.0	6 / 120	B	41474C
C42N / 32A	2P	32	4.5	6.0	6 / 120	B	41475C
C42N / 40A	2P	40	4.5	10.0	6 / 120	B	41476C
C42N / 50A	2P	50	4.5	10.0	6 / 120	B	41477C
C42N / 63A	2P	63	4.5	16.0	6 / 120	B	41478C



Type	Number of poles	Rated current I _n (A)	Breaking capacity (kA)	Recommended conductor (mm ²)	Packing/Box (pcs)	Product category	Catalogue number Curve C
C43N / 6A	3P	6	4.5	1.0	4 / 80	B	41541C
C43N / 10A	3P	10	4.5	1.5	4 / 80	B	41542C
C43N / 16A	3P	16	4.5	2.5	4 / 80	B	41543C
C43N / 20A	3P	20	4.5	2.5	4 / 80	B	41544C
C43N / 25A	3P	25	4.5	4.0	4 / 80	B	41545C
C43N / 32A	3P	32	4.5	6.0	4 / 80	B	41546C
C43N / 40A	3P	40	4.5	10.0	4 / 80	B	41547C
C43N / 50A	3P	50	4.5	10.0	4 / 80	B	41548C
C43N / 63A	3P	63	4.5	16.0	4 / 80	B	41549C



C6XN

- number of poles (1,2,3,4)
- breaking capacity in (kA)
- tripping curve C
- C X** — rated current in (A)
- tripping curve C,B

Documents corresponding to the product:

Standard EN60898-1

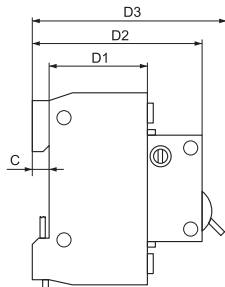
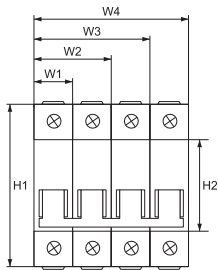
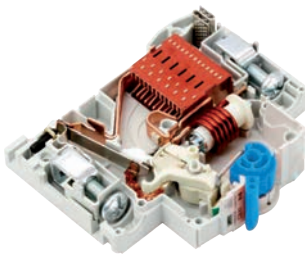

Dimensions (mm)

C	D1	D2	D3	H1
5	50	65	72	81
H2	W1	W2	W3	W4
45	18	36	54	72

NEW DESIGN

MINIATURE CIRCUIT BREAKERS (MCB) C60N

7+0 standard +extended **7** YEAR TOTAL WARRANTY *for industrial usage, 3 years warranty

FUNCTIONS:

- protection of the electrical circuits from overload or short circuits of the outer circuit
- it can be used as a device for commutation and control of electrical circuits
- in combination with auxiliary devices it allows remote control, commutation or indication of the protected circuit
- for mounting in industrial buildings with high contamination level of the electric systems
- for mounting at a distance from the transformer post from 150 to 850 m
- allows protection of consumers generating short circuit currents up to 6000 A

TECHNICAL DATA:

- Rated voltage: 230/400V; 50/60Hz
- Breaking capacity (cycle O-CO) in accordance with standard EN 60 898-1: 6000A
- Rated breaking capacity $I_{cs} = 75\% I_{cu}$
- Isolating voltage: $\geq 2000V$
- Electrical wear resistance (number of cycles): 8000
- Mechanical (number of cycles): 50000
- Class of current limiting: 3
- IP code: IP>20
- Tripping curve:
 - B – the maximum current release breaks between 3 and 5 I_n ; used to protect long circuits and generators
 - C – the maximum current release breaks between 5 and 10 I_n ; used to protect main power supply cables and conventional consumers
- Joining terminal: Combined screw clamp made of 1.5 cold extruded Q235-A material with additional coating
- Plastic box – nylon glass filled FR material
- Status indicator
- Box permittivity strength: >18MV/m
- Abnormal heating wear resistance and fire of the outer parts: 960°C / 3s

- Heat resistance of internal non-electrical components: 850°C / 10 s
- Maximum current release containing:
 - coil: solenoid
 - resistance: from 0.6 to 180m
 - welding effort: <150 000 N/mm
 - bimetal plate – composition: 5J158 to TB180 depending on the current
 - thickness: 0.6mm (up to 40A) and 0.8mm (up to 63A)
 - thickness: 1.15 to 2.24µm
 - drawing effort: from 200 to 400N/mm
 - contact head of the movable contact – composition: silver graphite CAg(5)
 - dimension 3x3x0.8 (up to 40A) and 4x4x0.8 (up to 63A)
 - static contact – composition: pure copper T2Y2
 - composition of the contact head: silver graphite CAg(5)
- Power supply (conducting)
 - power supply busbar 1P63, 2P63, 3P63
 - rigid conductors up to 25 mm
 - flexible conductors up to 16 mm
- Tightening moment: 1.33Nm

MOUNTING:

- vertical
- DIN-rail
- for mounting in housing or industrial environment without serious interference
- ambient temperature: -5°C to + 65°C±2° C

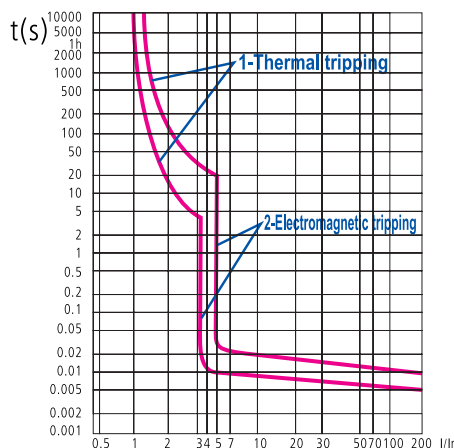
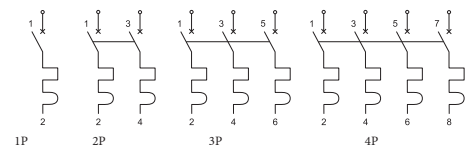

B type

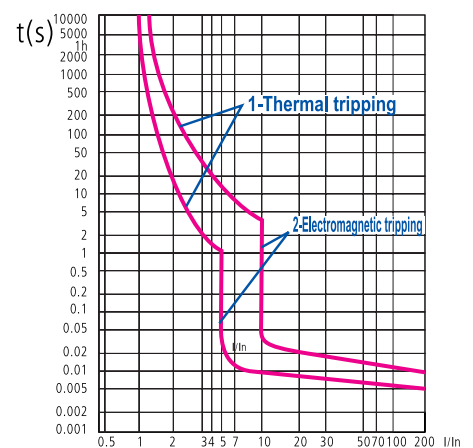

C type

In case of insufficient quantity in stock of any item listed on this page, the delivery time after order confirmation will be 90 days.

MINIATURE CIRCUIT BREAKERS (MCB)



NEW DESIGN

Type	Number of poles	Rated current I _n (A)	Breaking capacity (kA)	Recommended conductor (mm ²)	Packing/Box (pcs)	Product category	Catalogue number Curve C	Catalogue number Curve B
C61N / 1A	1P	1	6	1.0	12/240	B	41100C	41501C
C61N / 2A	1P	2	6	1.0	12/240	B	41102C	41502C
C61N / 4A	1P	4	6	1.0	12/240	B	41104C	41504C
C61N / 6A	1P	6	6	1.0	12/240	B	41106C	41506C
C61N / 10A	1P	10	6	1.5	12/240	B	41110C	41510C
C61N / 16A	1P	16	6	2.5	12/240	B	41116C	41516C
C61N / 20A	1P	20	6	2.5	12/240	B	41120C	41520C
C61N / 25A	1P	25	6	4.0	12/240	B	41125C	41525C
C61N / 32A	1P	32	6	6.0	12/240	B	41132C	41532C
C61N / 40A	1P	40	6	10.0	12/240	B	41140C	41540C
C61N / 50A	1P	50	6	10.0	12/240	B	41150C	41550C
C61N / 63A	1P	63	6	10.0	12/240	B	41163C	41563C



NEW DESIGN

Type	Number of poles	Rated current I _n (A)	Breaking capacity (kA)	Recommended conductor (mm ²)	Packing/Box (pcs)	Product category	Catalogue number Curve C	Catalogue number Curve B
C62N / 2A	2P	2	6	1.0	6/120	B	41202C	41602C
C62N / 4A	2P	4	6	1.0	6/120	B	41204C	41604C
C62N / 6A	2P	6	6	1.0	6/120	B	41206C	41606C
C62N / 10A	2P	10	6	1.5	6/120	B	41210C	41610C
C62N / 16A	2P	16	6	2.5	6/120	B	41216C	41616C
C62N / 20A	2P	20	6	2.5	6/120	B	41220C	41620C
C62N / 25A	2P	25	6	4.0	6/120	B	41225C	41625C
C62N / 32A	2P	32	6	6.0	6/120	B	41232C	41632C
C62N / 40A	2P	40	6	10.0	6/120	B	41240C	41640C
C62N / 50A	2P	50	6	10.0	6/120	B	41250C	41650C
C62N / 63A	2P	63	6	10.0	6/120	B	41263C	41663C





NEW DESIGN

Type	Number of poles	Rated current I _n (A)	Breaking capacity (kA)	Recommended conductor (mm ²)	Packing/Box (pcs)	Product category	Catalogue number Curve C	Catalogue number Curve B
C63N / 2A	3P	2	6	1.0	4/80	B	41302C	41702C
C63N / 4A	3P	4	6	1.0	4/80	B	41304C	41704C
C63N / 6A	3P	6	6	1.0	4/80	B	41306C	41706C
C63N / 10A	3P	10	6	1.5	4/80	B	41310C	41710C
C63N / 16A	3P	16	6	2.5	4/80	B	41316C	41716C
C63N / 20A	3P	20	6	2.5	4/80	B	41320C	41720C
C63N / 25A	3P	25	6	4.0	4/80	B	41325C	41725C
C63N / 32A	3P	32	6	6.0	4/80	B	41332C	41732C
C63N / 40A	3P	40	6	10.0	4/80	B	41340C	41740C
C63N / 50A	3P	50	6	10.0	4/80	B	41350C	41750C
C63N / 63A	3P	63	6	10.0	4/80	B	41363C	41763C



NEW DESIGN

Type	Number of poles	Rated current I _n (A)	Breaking capacity (kA)	Recommended conductor (mm ²)	Packing/Box (pcs)	Product category	Catalogue number Curve C	Catalogue number Curve B
C64N / 2A	4P	2	6	1.0	3/60	B	41402C	41802C
C64N / 4A	4P	4	6	1.0	3/60	B	41404C	41804C
C64N / 6A	4P	6	6	1.0	3/60	B	41406C	41806C
C64N / 10A	4P	10	6	1.5	3/60	B	41410C	41810C
C64N / 16A	4P	16	6	2.5	3/60	B	41416C	41816C
C64N / 20A	4P	20	6	2.5	3/60	B	41420C	41820C
C64N / 25A	4P	25	6	4.0	3/60	B	41425C	41825C
C64N / 32A	4P	32	6	6.0	3/60	B	41432C	41832C
C64N / 40A	4P	40	6	10.0	3/60	B	41440C	41840C
C64N / 50A	4P	50	6	10.0	3/60	B	41450C	41850C
C64N / 63A	4P	63	6	10.0	3/60	B	41463C	41863C



C6XN

- └─ number of poles (1,2,3,4)
 - └─ breaking capacity in (kA)
 - └─ tripping curve C
- C X**
- └─ rated current in (A)
 - └─ tripping curve C,B

Documents corresponding to the product:

Standard EN60898-1

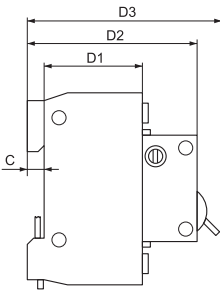
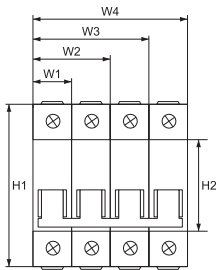
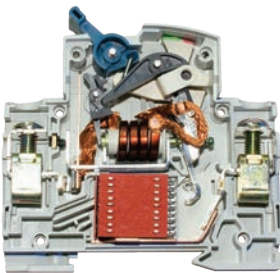

Dimensions (mm)

C	D1	D2	D3	H1
5	50	65	72	81
H2	W1	W2	W3	W4
45	18	36	54	72

MINIATURE CIRCUIT BREAKERS (MCB) C60N

7+0 standard +extended **7** YEAR TOTAL WARRANTY *for industrial usage 3 years warranty

FUNCTIONS:

- protection of the electrical circuits from overload or short circuits of the outer circuit
- it can be used as a device for commutation and control of electrical circuits
- in combination with auxiliary devices it allows remote control, commutation or indication of the protected circuit
- for mounting in industrial buildings with high contamination level of the electric systems
- for mounting at a distance from the transformer post from 150 to 850 m
- allows protection of consumers generating short circuit currents up to 6000 A

TECHNICAL DATA:

- Rated voltage: 230/400V; 50/60Hz
- Breaking capacity (cycle O-CO) in accordance with standard EN 60 898-1: 6000A
- Rated breaking capacity Ics= 75% Icu
- Isolating voltage: ≥2000V
- Electrical wear resistance (number of cycles): 8000
- Mechanical (number of cycles): 50000
- Class of current limiting: 3
- IP code: IP>20
- Tripping curve:
 - B – the maximum current release breaks between 3 and 5 In; used to protect long circuits and generators
 - C – the maximum current release breaks between 5 and 10 In; used to protect main power supply cables and conventional consumers
- Joining terminal: Combined screw clamp made of 1.5 cold extruded Q235-A material with additional coating
- Plastic box – not keeping the burning material nylon PA66, UV rays wear resistance
- Status indicator
- Box permittivity strength: >18MV/m
- Abnormal heating wear resistance and fire of the outer parts: 960°C / 3s

- Heat resistance of internal non-electrical components: 850°C / 10 s
- Maximum current release containing:
 - copper coil - composition: pure copper T2 type
 - resistance: from 0.6 to 180m
 - welding effort: <150 000 N/mm
 - bimetal plate – composition: 5J158 to TB180 depending on the current
 - thickness: 0.6mm (up to 40A) and 0.8mm (up to 63A)
 - magnetic core – composition: coldly draw-plated metal wire (1Gr18Ni9)
 - thickness: 1.15 to 2.24µm
 - drawing effort: from 200 to 400N/mm
 - contact head of the movable contact – composition: silver graphite CAg(5)
 - dimension 3x3x0.8 (up to 40A) and 4x4x0.8 (up to 63A)
 - static contact – composition: pure copper T2Y2
 - composition of the contact head: silver graphite CAg(5)
- Power supply (conducting)
 - power supply busbar 1P63, 2P63, 3P63
 - rigid conductors up to 25 mm
 - flexible conductors up to 16 mm
- Tightening moment: 1.33Nm

MOUNTING:

- vertical
- DIN-rail
- for mounting in housing or industrial environment without serious interference
- ambient temperature: -5°C to + 65°C±2° C

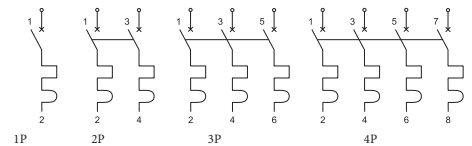

C60, curve B

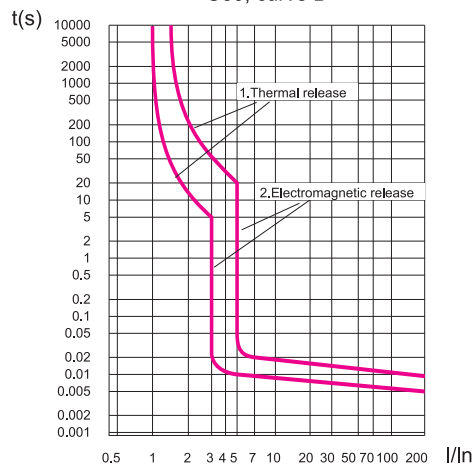

C60, curve C

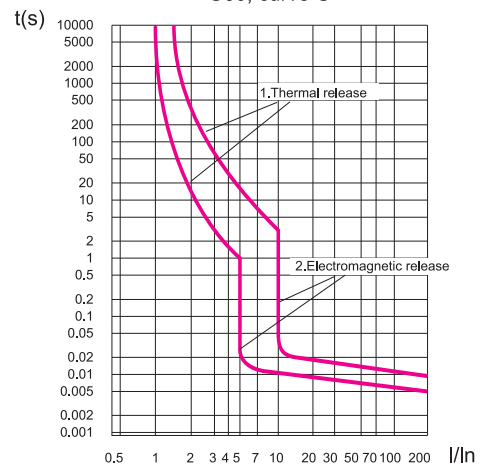

In case of insufficient quantity in stock of any item listed on this page, the delivery time after order confirmation will be 90 days.



Type	Number of poles	Rated current I _n (A)	Breaking capacity (kA)	Recommended conductor (mm ²)	Packing/Box (pcs)	Product category	Catalogue number Curve C	Catalogue number Curve B
C61N / 1A	1P	1	6	1.0	12 / 240	B	41100N	41501N
C61N / 2A	1P	2	6	1.0	12 / 240	B	41102N	41502N
C61N / 4A	1P	4	6	1.0	12 / 240	B	41104N	41504N
C61N / 6A	1P	6	6	1.0	12 / 240	B	41106N	41506N
C61N / 10A	1P	10	6	1.5	12 / 240	B	41110N	41510N
C61N / 16A	1P	16	6	2.5	12 / 240	B	41116N	41516N
C61N / 20A	1P	20	6	2.5	12 / 240	B	41120N	41520N
C61N / 25A	1P	25	6	4.0	12 / 240	B	41125N	41525N
C61N / 32A	1P	32	6	6.0	12 / 240	B	41132N	41532N
C61N / 40A	1P	40	6	10.0	12 / 240	B	41140N	41540N
C61N / 50A	1P	50	6	10.0	12 / 240	B	41150N	41550N
C61N / 63A	1P	63	6	16.0	12 / 240	B	41163N	41563N



Type	Number of poles	Rated current I _n (A)	Breaking capacity (kA)	Recommended conductor (mm ²)	Packing/Box (pcs)	Product category	Catalogue number Curve C	Catalogue number Curve B
C62N / 2A	2P	2	6	1.0	6 / 120	B	41202N	41602N
C62N / 4A	2P	4	6	1.0	6 / 120	B	41204N	41604N
C62N / 6A	2P	6	6	1.0	6 / 120	B	41206N	41606N
C62N / 10A	2P	10	6	1.5	6 / 120	B	41210N	41610N
C62N / 16A	2P	16	6	2.5	6 / 120	B	41216N	41616N
C62N / 20A	2P	20	6	2.5	6 / 120	B	41220N	41620N
C62N / 25A	2P	25	6	4.0	6 / 120	B	41225N	41625N
C62N / 32A	2P	32	6	6.0	6 / 120	B	41232N	41632N
C62N / 40A	2P	40	6	10.0	6 / 120	B	41240N	41640N
C62N / 50A	2P	50	6	10.0	6 / 120	B	41250N	41650N
C62N / 63A	2P	63	6	16.0	6 / 120	B	41263N	41663N



MINIATURE CIRCUIT BREAKERS (MCB)



Type	Number of poles	Rated current In (A)	Breaking capacity (kA)	Recommended conductor (mm ²)	Packing/Box (pcs)	Product category	Catalogue number Curve C	Catalogue number Curve B
C63N/2A	3P	2	6	1.0	4 / 80	B	41302N	41702N
C63N/4A	3P	4	6	1.0	4 / 80	B	41304N	41704N
C63N / 6A	3P	6	6	1.0	4 / 80	B	41306N	41706N
C63N / 10A	3P	10	6	1.5	4 / 80	B	41310N	41710N
C63N / 16A	3P	16	6	2.5	4 / 80	B	41316N	41716N
C63N / 20A	3P	20	6	2.5	4 / 80	B	41320N	41720N
C63N / 25A	3P	25	6	4.0	4 / 80	B	41325N	41725N
C63N / 32A	3P	32	6	6.0	4 / 80	B	41332N	41732N
C63N / 40A	3P	40	6	10.0	4 / 80	B	41340N	41740N
C63N / 50A	3P	50	6	10.0	4 / 80	B	41350N	41750N
C63N / 63A	3P	63	6	16.0	4 / 80	B	41363N	41763N



Type	Number of poles	Rated current In (A)	Breaking capacity (kA)	Recommended conductor (mm ²)	Packing/Box (pcs)	Product category	Catalogue number Curve C	Catalogue number Curve B
C64N / 2A	4P	2	6	1.0	3 / 60	B	41402N	41802N
C64N / 4A	4P	4	6	1.0	3 / 60	B	41404N	41804N
C64N / 6A	4P	6	6	1.0	3 / 60	B	41406N	41806N
C64N / 10A	4P	10	6	1.5	3 / 60	B	41410N	41810N
C64N / 16A	4P	16	6	2.5	3 / 60	B	41416N	41816N
C64N / 20A	4P	20	6	2.5	3 / 60	B	41420N	41820N
C64N / 25A	4P	25	6	4.0	3 / 60	B	41425N	41825N
C64N / 32A	4P	32	6	6.0	3 / 60	B	41432N	41832N
C64N / 40A	4P	40	6	10.0	3 / 60	B	41440N	41840N
C64N / 50A	4P	50	6	10.0	3 / 60	B	41450N	41850N
C64N / 63A	4P	63	6	16.0	3 / 60	B	41463N	41863N



In case of insufficient quantity in stock of any item listed on this page, the delivery time after order confirmation will be 90 days.

C10XL

- └─ number of poles (1,2,3)
- └─ breaking capacity in (kA)
- └─ tripping curve B, C
- C X** └─ rated current in (A)
- └─ tripping curve C, B

Documents corresponding to the product:

Standard EN60898-1
EN60947-2

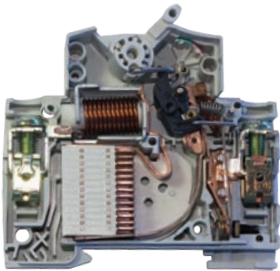

NEW DESIGN
MINIATURE CIRCUIT BREAKERS (MCB) C100L

7+0 standard +extended **7** YEAR TOTAL WARRANTY *for industrial usage, 3 years warranty

FUNCTIONS:

- protection of the electrical circuits from overload or short circuits of the outer circuit
- it can be used as a device for commutation and control of electrical circuits
- in combination with auxiliary devices it allows remote control, commutation or indication of the protected circuit

- Class of current limiting:3
- IP code: IP>20
- Tripping curve: C

MOUNTING:

- vertical
- DIN-rail
- possibility for labeling

TECHNICAL DATA:

- Rated voltage: 230/400V; 50/60Hz
- Breaking capacity (cycle O-CO) in accordance with standard EN 60 898-1: 10000A
- Rated breaking capacity Ics= 75% Icu
- Isolating volatage:≥2000V, 1 min at impulse wave 1.2/50µs
- Electrical wear resistance (number of cycles):≥4000
- Mechanical wear resistance (number of cycles): ≥20000

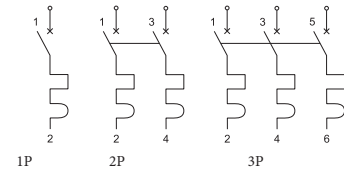

Type	Number of poles	Rated current In (A)	Breaking capacity (kA)	Recommended conductor (mm ²)	Packing/Box (pcs)	Product category	Catalogue number Curve C	Catalogue number Curve B
C101L/6A	1P	6	10	1.0	12 / 240	B	41101C	41101C/B
C101L/10A	1P	10	10	1.5	12 / 240	B	41103C	41103C/B
C101L/16A	1P	16	10	2.5	12 / 240	B	41105C	41105C/B
C101L/20A	1P	20	10	2.5	12 / 240	B	41107C	41107C/B
C101L/25A	1P	25	10	4.0	12 / 240	B	41108C	41108C/B
C101L/32A	1P	32	10	6.0	12 / 240	B	41109C	41109C/B
C101L/40A	1P	40	10	10.0	12 / 240	B	41111C	41111C/B
C101L/50A	1P	50	10	10.0	12 / 240	B	41112C	41112C/B
C101L/63A	1P	63	10	16.0	12 / 240	B	41113C	41113C/B



Type	Number of poles	Rated current In (A)	Breaking capacity (kA)	Recommended conductor (mm ²)	Packing/Box (pcs)	Product category	Catalogue number Curve C	Catalogue number Curve B
C102L/6A	2P	6	10	1.0	6/120	B	41201C	41201C/B
C102L/10A	2P	10	10	1.5	6/120	B	41203C	41203C/B
C102L/16A	2P	16	10	2.5	6/120	B	41205C	41205C/B
C102L/20A	2P	20	10	2.5	6/120	B	41207C	41207C/B
C102L/25A	2P	25	10	4.0	6/120	B	41208C	41208C/B
C102L/32A	2P	32	10	6.0	6/120	B	41209C	41209C/B
C102L/40A	2P	40	10	10.0	6/120	B	41211C	41211C/B
C102L/50A	2P	50	10	10.0	6/120	B	41212C	41212C/B
C102L/63A	2P	63	10	16.0	6/120	B	41213C	41213C/B



In case of insufficient quantity in stock of any item listed on this page, the delivery time after order confirmation will be 90 days.



NEW DESIGN

Type	Number of poles	Rated current In (A)	Breaking capacity (kA)	Recommended conductor (mm ²)	Packing/Box (pcs)	Product category	Catalogue number Curve C	Catalogue number Curve B
C103L/6A	3P	6	10	1.0	4 / 80	B	41301C	41301C/B
C103L/10A	3P	10	10	1.5	4 / 80	B	41303C	41303C/B
C103L/16A	3P	16	10	2.5	4 / 80	B	41305C	41305C/B
C103L/20A	3P	20	10	2.5	4 / 80	B	41307C	41307C/B
C103L/25A	3P	25	10	4.0	4 / 80	B	41308C	41308C/B
C103L/32A	3P	32	10	6.0	4 / 80	B	41309C	41309C/B
C103L/40A	3P	40	10	10.0	4 / 80	B	41311C	41311C/B
C103L/50A	3P	50	10	10.0	4 / 80	B	41312C	41312C/B
C103L/63A	3P	63	10	16.0	4 / 80	B	41313C	41313C/B



NEW DESIGN

Type	Number of poles	Rated current In (A)	Breaking capacity (kA)	Recommended conductor (mm ²)	Packing/Box (pcs)	Product category	Catalogue number Curve C	Catalogue number Curve B
C104L/6A	4P	6	10	1.0	3/60	B	41401C	41401C/B
C104L/10A	4P	10	10	1.5	3/60	B	41403C	41403C/B
C104L/16A	4P	16	10	2.5	3/60	B	41405C	41405C/B
C104L/20A	4P	20	10	2.5	3/60	B	41407C	41407C/B
C104L/25A	4P	25	10	4.0	3/60	B	41408C	41408C/B
C104L/32A	4P	32	10	6.0	3/60	B	41409C	41409C/B
C104L/40A	4P	40	10	10.0	3/60	B	41411C	41411C/B
C104L/50A	4P	50	10	10.0	3/60	B	41412C	41412C/B
C104L/63A	4P	63	10	16.0	3/60	B	41413C	41413C/B



MINIATURE CIRCUIT BREAKERS DP1N (1P + E)

7+0 standard+extended **7** YEAR TOTAL WARRANTY *for industrial usage, 3 years warranty



FUNCTIONS:

- protection of the electrical circuits from overload or short circuit of the outer circuit
- it can be used as a device for commutation and control of electrical circuits
- it breaks simultaneously the lead and the neutral conductor as the heat protection is only at the lead conductor

TECHNICAL DATA:

- Rated voltage: 230V; 50/60Hz
- Breaking capacity (cycle O-CO) in accordance with standard EN 60 898-1: 4500 A

- Rated breaking capacity I_{cs} = 50% I_{cu}
- Insulating voltage: ≥2000V
- Tripping curve: C – the maximum current release breaks between 5 and 10 I_n; used to protect main power supply
- cables and conventional consumers

CONNECTING:

- Joining terminal: flat (tunnel) screw terminal
- Power supply (conducting):
 - power supply busbar DP1N
 - flexible or rigid conductor
- Mounting: on DIN-rail

Type	Rated current In (A)	Breaking capacity (kA)	Recommended conductor (mm ²)	Packing/Box (pcs)	Product category	Catalogue number Curve C	Catalogue number Curve C NEW
DP1N / 6	6	4.5	1.0	12 / 240	B	41006	41006C
DP1N / 10	10	4.5	1.5	12 / 240	B	41010	41010C
DP1N / 16	16	4.5	2.5	12 / 240	B	41016	41016C
DP1N / 20	20	4.5	2.5	12 / 240	B	41020	41020C
DP1N / 25	25	4.5	4.0	12 / 240	B	41025	41025C
DP1N / 32	32	4.5	6.0	12 / 240	B	41032	41032C

NEW DESIGN



In case of insufficient quantity in stock of any item listed on this page, the delivery time after order confirmation will be 90 days.

C100M — constructive series
 L — number of poles (1;2;3;4)

D X — rated current
 L — tripping curve C, D, B

Documents corresponding to the product:

Standard EN60898-1
 EN 60947-2

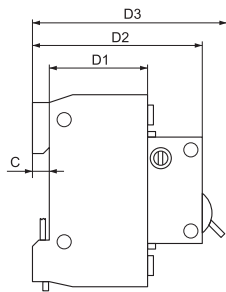
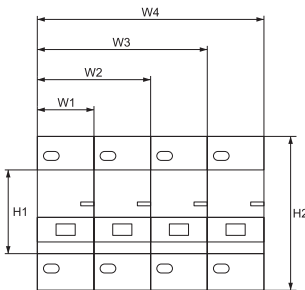
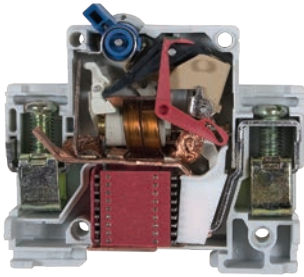

Dimensions (mm)

C	D1	D2	D3	H1
5	50	65	74	45
H2	W1	W2	W3	W4
81	27	54	81	108

MINIATURE CIRCUIT BREAKERS (MCB) C100M

7+0 standard +extended
7 YEAR TOTAL WARRANTY
*for industrial usage 3 years warranty

FUNCTIONS:

- protection of the electrical circuits from overload or short circuits of the outer circuit
- it can be used as a device for commutation and control of electrical circuits
- in combination with auxiliary devices it allows remote control, commutation or indication of the protected circuit

TECHNICAL DATA:

- Rated voltage: 230/400V; 50/60Hz
- Breaking capacity (cycle O-CO) in accordance with standard EN 60 898-1: 10000A
- Rated breaking capacity I_{cs}= 75% I_{cu}
- Isolating volatage: ≥2000V
- Electrical wear resistance (number of cycles): ≥4000
- Mechanical wear resistance (number of cycles): ≥20000
- Class of current limiting: 3
- IP code: IP>20
- Tripping curve: C,D
- Joining terminal: flat (tunnel) screw terminal with composition 1.5 coldly draw-plated plane Q235 – A
- Plastic box – not keeping the burning material nylon PA66, UV rays wear resistance
- Box permittivity strength: >18MV/m
- Abnormal heating wear resistance and fire of the outer parts: 960°C / 3s
- Maximum current release containing:
 - copper coil - composition: pure copper T2 type
 - resistance: from 148 to 230m
 - welding effort: <400 N/

- bimetal plate – composition: TB180/0.5
- thickness: 0.8mm
- magnetic core – composition: coldly draw-plated metal wire (1Gr18Ni9)
- thickness: 1.15 to 2.24µm
- drawing effort: 20N/mm²
- contact head of the movable contact – composition: silver graphite CAg(5)
- dimension 6x6x1
- static contact – composition: pure copper T2Y2
- composition of the contact head: silver graphite CAg(5)
- Power supply (conducting)
 - power supply busbar
 - rigid conductors up to 50
 - flexible conductors up to 35
- Tightening moment: 1.33Nm

MOUNTING:

- vertical
- DIN-rail
- possibility for labeling
- for mounting in industrial environment
- ambient temperature: -5°C to + 65°C±2° C

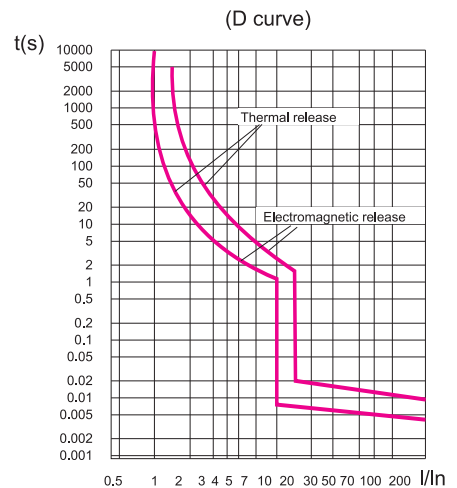
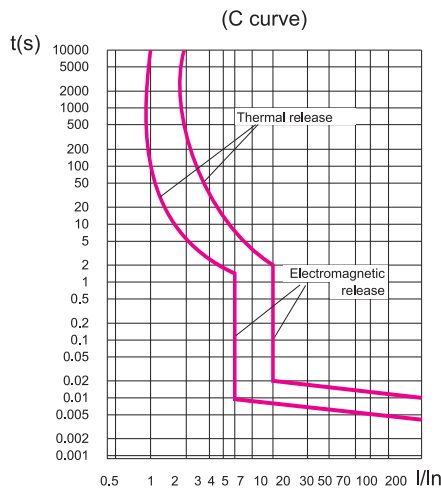
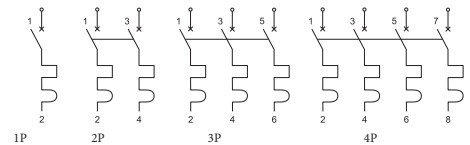

In case of insufficient quantity in stock of any item listed on this page, the delivery time after order confirmation will be 90 days.



Type	Number of poles	Rated current In (A)	Breaking capacity (kA)	Packing/Box (pcs)	Product category	Catalogue number Curve B	Catalogue number Curve C	Catalogue number Curve D
C100M	1P	80	10	9 / 180	B	41180B	41180	41180D
C100M	1P	100	10	9 / 180	B	41190B	41190	41190D
C100M	1P	125	10	9 / 180	B	41195B	41195	41195D



Type	Number of poles	Rated current In (A)	Breaking capacity (kA)	Packing/Box (pcs)	Product category	Catalogue number Curve B	Catalogue number Curve C	Catalogue number Curve D
C100M	2P	80	10	6 / 120	B	41282	41280	41281
C100M	2P	100	10	6 / 120	B	41292	41290	41291



Type	Number of poles	Rated current In (A)	Breaking capacity (kA)	Packing/Box (pcs)	Product category	Catalogue number Curve B	Catalogue number Curve C	Catalogue number Curve D
C100M	3P	80	10	4 / 60	B	41382	41380	41381
C100M	3P	100	10	4 / 60	B	41392	41390	41391



Type	Number of poles	Rated current In (A)	Breaking capacity (kA)	Packing/Box (pcs)	Product category	Catalogue number Curve B	Catalogue number Curve C	Catalogue number Curve D
C100M	4P	80	10	3 / 60	B	41482	41480	41481
C100M	4P	100	10	3 / 60	B	41492	41490	41491

C6XDC

- └─ number of poles (1,2)
 - └─ breaking capacity in (kA)
 - └─ tripping curve C
- C X**
- └─ rated current in (A)
 - └─ tripping curve C

Documents corresponding to the product:

Standard EN60898-1
EN60898-2

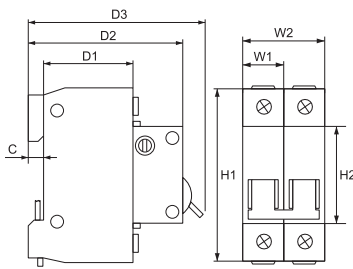
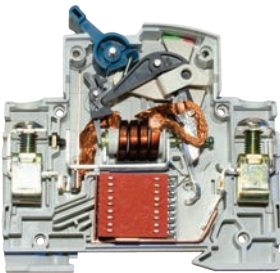

Dimensions (mm)

C	D1	D2	D3
5	49	65	72
H1	H2	W1	W2
78	45	18	36

NEW DESIGN

MINIATURE CIRCUIT BREAKERS (MCB) C60DC

7+0
standard
+extended

7 YEAR TOTAL WARRANTY

*for industrial usage, 3 years warranty

FUNCTIONS:

- for lowering constant current voltaic arc and use of the breaker at constant current consumer protection
- protection of the electrical circuits from overload or short circuit of the outer circuit at alternating current and constant current power supply circuits
- for commutation and control of electrical circuits
- in combination with auxiliary alternating current devices for remote control, commutation or indication of the protected circuit
- for mounting in industrial buildings
- for protection of consumers generating short circuit currents to 6000 A at alternating current power supply

TECHNICAL DATA:

- Rated voltage: 240V; AC/DC
- Breaking capacity (cycle O -CO) in accordance with standard EN 60 898- 1: 6000A
- Rated breaking capacity Ics=75% Icu
- Insulating voltage: ≥2000V
- Electrical wear resistance (number of cycles): ≥4000
- Mechanical wear resistance (number of cycles): ≥20000
- Class of current limiting: 3
- IP code: IP>20
- Tripping curve: C – the maximum current release breaks between 5 and 10 In; used to protect power supply cables and conventional consumers
- Joining terminal: flat (tunnel) screw terminal with composition 1.5 coldly draw-plated plane Q235– A
- Plastic box – nylon glass filled FR material
- Box permittivity strength: >18MV/m
- Abnormal heating wear resistance and fire of the outer parts: 960°C / 3s
- Maximum current release containing:
 - Coil: solenoid
 - resistance: from 0.6 to 180m

- welding effort: <150 000 N/mm
- bimetal plate – composition: 5J158 to TB180 according to the current
- thickness: 0.6mm (up to 40A) and 0.8mm (up to 63A)
- thickness: 1.15 to 2.24µm
- drawing effort: from 200 to 400N/mm
- contact head of the movable contact – composition: silver graphite CAg(5)
- dimension 3x3x0.8 (up to 40A) and 4x4x0.8 (up to 63A)
- static contact – composition: pure copper T2Y2
- composition of the contact head: silver graphite CAg(5)
- metal magnetic plate for lowering the constant current arc
- Conducting:
 - power supply busbar 1P63, 2P63
 - rigid conductors up to 25 mm
 - flexible conductors up to 16 mm
- Tightening moment: 1.33Nm

MOUNTING

- vertical
- DIN-rail
- for mounting in housing or industrial environment without serious current interference
- Ambient temperature: -5°C to + 65°C±2° C

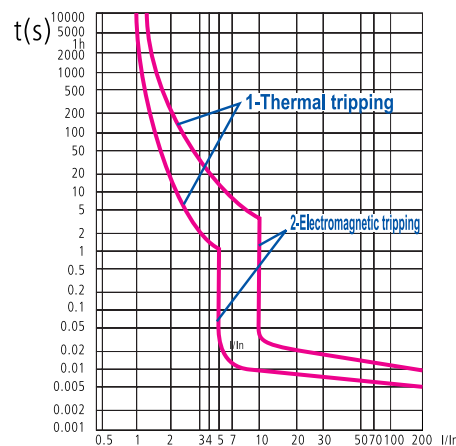
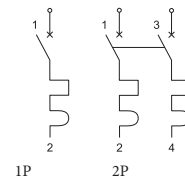

C type

MINIATURE CIRCUIT BREAKERS (MCB)



NEW DESIGN

Type	Number of poles	Rated current In (A)	Breaking capacity (kA)	Recommended conductor (mm ²)	Packing/Box (pcs)	Product category	Catalogue number Curve C
C61DC / 1A	1P	1	6	1.0	12/240	B	41164C
C61DC / 2A	1P	2	6	1.0	12/240	B	41165C
C61DC / 4A	1P	4	6	1.0	12/240	B	41166C
C61DC / 6A	1P	6	6	1.0	12/240	B	41167C
C61DC / 10A	1P	10	6	1.5	12/240	B	41168C
C61DC / 16A	1P	16	6	2.5	12/240	B	41169C
C61DC / 20A	1P	20	6	2.5	12/240	B	41170C
C61DC / 25A	1P	25	6	4.0	12/240	B	41171C
C61DC / 32A	1P	32	6	6.0	12/240	B	41172C
C61DC / 40A	1P	40	6	10.0	12/240	B	41173C
C61DC / 50A	1P	50	6	10.0	12/240	B	41174C
C61DC / 63A	1P	63	6	10.0	12/240	B	41175C



NEW DESIGN

Type	Number of poles	Rated current In (A)	Breaking capacity (kA)	Recommended conductor (mm ²)	Packing/Box (pcs)	Product category	Catalogue number Curve C
C62DC / 2A	2P	2	6	1.0	6/120	B	41176C
C62DC / 4A	2P	4	6	1.0	6/120	B	41177C
C62DC / 6A	2P	6	6	1.0	6/120	B	41178C
C62DC / 10A	2P	10	6	1.5	6/120	B	41179C
C62DC / 16A	2P	16	6	2.5	6/120	B	41181C
C62DC / 20A	2P	20	6	2.5	6/120	B	41182C
C62DC / 25A	2P	25	6	4.0	6/120	B	41183C



Type designation:
MN - constructive series
number of poles - 1
Documents corresponding to the product:
Standard EN60898-1



UNTIL SUPPLY
LAST

COMBINED VOLTAGE CIRCUIT-BREAKER MN2

7+0 standard+extended **7** YEAR TOTAL WARRANTY *for industrial usage, 3 years warranty

FUNCTIONS:

- when the voltage is reduced below 170V operation is initiated and the automatic switch is turned off
- when the voltage is increased above 280V operation is initiated and the automatic switch is turned off
- allows manual turning on of the switch after powering is restored
- indication of the position of the device

TECHNICAL CHARACTERISTICS:

- Rated voltage: 230V; 50/60Hz
- Insulation voltage: ≥2000V

• IP code: IP>20

CONNECTION METHOD:

- Double connector: flat (tunnel) screw connector
- Conductors: flexible up to 1.5mm²
- Tightening moment of the screw: 1.33Nm

MOUNTING:

- vertical, by means of two pins attached to the rivets of the circuit-breaker, while the operating mechanism is connected to the switching off mechanism of the circuit breaker after the sealing lid is demounted

Type	Rated voltage	Type breaker	Packing/Box (pcs)	Product category	Catalogue number
ELMARK MN 2 60	230V	C60	12 / 240	F	41909



SHUNT RELEASE MX

7+0 standard+extended **7** YEAR TOTAL WARRANTY *for industrial usage, 3 years warranty



NEW DESIGN

FUNCTIONS:

- remote circuit breaker switching off at voltage feed
- allows manual switching on of the breaker at voltage recovery
- indication of the device's location

TECHNICAL DATA:

- Rated voltage: 230V; 50/60Hz
- Isolating voltage: ≥2000V
- IP code: IP>20

CONNECTING:

- Joining terminal: flat (tunnel) screw terminal
- Conductors: flexible up to 1.5mm²
- Tightening moment: 1.33Nm
- The power supply of the release is accomplished at the outlet of the breaker

MOUNTING:

- vertical, clamps with two pins to the breaker's rivets and the executive mechanism is joined up to the switching mechanism of the breaker after dismantling the seal cover

Type	Rated voltage	Type breaker	Packing/Box (pcs)	Product category	Catalogue number
ELMARK MX 60	230V	C60	12 / 240	B	41902C



AUXILIARY CONTACT OF

7+0 standard+extended **7** YEAR TOTAL WARRANTY *for industrial usage, 3 years warranty



NEW DESIGN

FUNCTIONS:

- at circuit breaker switching off it sends a signal to the control or signalization system
- indication of the location of the auxiliary contact and the breaker

TECHNICAL DATA:

- Rated voltage: 230V
- Isolating voltage: ≥2000V
- IP code: IP>20

CONNECTING:

- Joining terminal: flat (tunnel) screw terminal
- Power supply (conducting): - flexible conductors up to 1.5mm

MOUNTING:

- vertical, clamps with two pins to breaker's rivets, and the executive mechanism is joined up to the switching mechanism of the breaker after dismantling the seal cover

Type	Rated voltage	Type breaker	Packing/Box (pcs)	Product category	Catalogue number
ELMARK OF 60	230V	C60	12 / 240	B	41901C



In case of insufficient quantity in stock of any item listed on this page, the delivery time after order confirmation will be 90 days.

Documents corresponding to the product:
EN 60255-1; IEC60947-5-1



SINGLE POLE MONITORING VOLTAGE RELAY MN1

7+0 standard +extended **7** YEAR TOTAL WARRANTY *for industrial usage, 3 years warranty

FUNCTIONS:

- Protect electrical equipment from over & under voltage
- Voltage measurement accuracy <1%
- Relay status is indicated by LED

TECHNICAL CHARACTERISTICS:

- Rated voltage: 220V AC; 50/60Hz
- Hysteresis: 0-20% adjustable

- Time delay: 0.1-10s adjustable
- Reset time: 0.2 sec max
- Current rating: 3A/AC-15
- Mechanical life: 1X10⁷
- Electrical life: 1X10⁵
- Ambiente temperature: -10C°/+55C°
- Dimensions: 90x18x64mm
- Mounting: on DIN rail

Type	Rated voltage	Hysteresis	Packing/Box (pcs)	Product category	Catalogue number
ELMARK MN1	220V AC	0-20% adjustable	12 / 240	B	41900



Documents corresponding to the product:
EN 60255-1; IEC60947-5-1



THREE POLE MONITORING VOLTAGE RELAY MN3

7+0 standard +extended **7** YEAR TOTAL WARRANTY *for industrial usage, 3 years warranty

FUNCTIONS:

- Protect electrical equipment from over & under voltage
- Voltage measurement accuracy <1%
- Relay status is indicated by LED

TECHNICAL CHARACTERISTICS:

- Rated voltage: 415V AC; 50/60Hz
- Hysteresis: 0-20% adjustable

- Time delay: 0.1-10s adjustable
- Reset time: 0.2 sec max
- Current rating: 3A/AC-15
- Mechanical life: 1X10⁷
- Electrical life: 1X10⁵
- Ambiente temperature: -10C°/+55C°
- Dimensions: 90x18x64mm
- Mounting: on DIN rail

Type	Rated voltage	Hysteresis	Packing/Box (pcs)	Product category	Catalogue number
ELMARK MN3	415V AC	0-20% adjustable	12 / 240	B	41927



SINGLE-PHASE DIGITAL VOLTAGE AND CURRENT PROTECTOR

3+2 standard +extended **5** YEAR TOTAL WARRANTY



FUNCTIONS:

- Under-voltage protection
- Over-voltage protection
- Over-current protection

TECHNICAL CHARACTERISTICS:

- Operated voltage range: 80-400V AC; 50/60Hz (Single-phase)
- Rated current: 63A
- Over-voltage protection value: 230-300V AC
- Under-voltage protection value: 140-230VAC
- Over-current protection value: 1-63A
- Voltage power off time: 0-400s
- Current power off time: 0-30s
- Voltage range setting step: 1V

- Time range setting step: 1s
- Power consumption: ≤ 1.5W
- Mechanical life: 100 000
- Relative humidity: 45-90% Rh
- Altitude: up to 2000m
- Pollution level: 2 class
- Dimensions: 36x80x66mm
- Mounting: on DIN rail

FACTORY SETTING:

- Over-voltage trip value: 270V
- Under-voltage trip value: 170V
- Over-current trip value: 63A
- Voltage power off time: 2s
- Starting delay time: 2s
- Current power off time: 2s

Type	Rated voltage	Over-voltage protection range	Under-voltage protection range	Over-current protection range	Packing/ Box (pcs)	Product category	Catalogue number
ELMARK MN4	220V AC	230-300V AC	140-230V AC	1-63A	1/100	B	41906



THREE-PHASE DIGITAL VOLTAGE AND CURRENT PROTECTOR

3+2 standard +extended **5** YEAR TOTAL WARRANTY



FUNCTIONS:

- Under-voltage protection
- Over-voltage protection
- Over-current protection

TECHNICAL CHARACTERISTICS:

- Operated voltage range: 140-500V AC; 50/60Hz (Three-phase)
- Rated current: 63A
- Over-voltage protection value: 390-500V AC
- Under-voltage protection value: 140-370VAC
- Over-current protection value: 1-63A
- Voltage power off time: 0-400s
- Current power off time: 0-30s
- Voltage range setting step: 1V

- Time range setting step: 1s
- Power consumption: ≤ 1.5W
- Mechanical life: 100 000
- Relative humidity: 45-90% Rh
- Altitude: up to 2000m
- Pollution level: 2 class
- Dimensions: 72x80x66mm
- Mounting: on DIN rail

FACTORY SETTING:

- Over-voltage trip value: 420V
- Under-voltage trip value: 210V
- Over-current trip value: 63A
- Voltage power off time: 2s
- Starting delay time: 2s
- Current power off time: 2s

Type	Rated voltage	Over-voltage protection range	Under-voltage protection range	Over-current protection range	Packing/ Box (pcs)	Product category	Catalogue number
ELMARK MN4	400V AC	390-500V AC	140-370V AC	1-63A	1/50	B	41907



Documents corresponding to the product:

Standard EN 60269-1



BASES FOR HIGH POWER SAFETY DEVICES

The series bases for high power safety device is manufactured of permittivity alloy with mounted contact jaws of electrolytic copper supplied with special springs for contact compression and easy fuse links taking out. All current leading parts are connected to inlet outlet terminals with bolts; the terminals also end with bolts, to which the power supply conductors are connected. The bases are offered in five type sizes corresponding to the five types of fuse links.

Remark : Fuse bases SIST are made of resin / **Remark :** Fuse bases SISP are made of porcelain

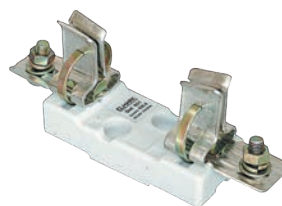
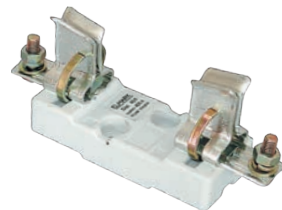
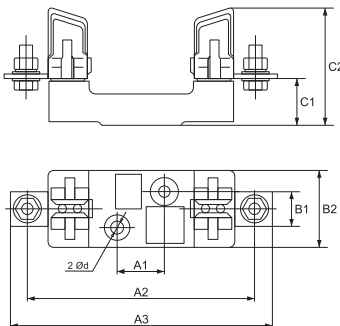

Base type	Overall dimensions (mm)							
	A1	A2	A3	B1	B2	C1	C2	Ød
SIST00	25	100	120	-	30	25	60	7.5
SIST 0	25	150	170	-	30	37	72	7.5
SIST1	25	175	200	30	58	38	84	10.5
SIST2	25	200	225	30	60	38	100	10.5
SIST3	25	210	250	30	60	40	105	10.5

Base type	Fuse link type	Rated current (A)	Rated voltage Un (V)	Weight (gr)	Packing / Box (pcs)	Product category	Catalogue number
SIST00	NT 00	up to 160	600	193	5 / 120	B	12001



Base type	Fuse link type	Rated current (A)	Rated voltage Un (V)	Weight (gr)	Packing / Box (pcs)	Product category	Catalogue number
SIST0	NT 0	up to 160	600	295	3 / 54	B	12010



Base type	Fuse link type	Rated current (A)	Rated voltage Un (V)	Weight (gr)	Packing / Box (pcs)	Product category	Catalogue number
SIST1	NT 1	up to 250	600	550	3 / 36	B	12100



Base type	Fuse link type	Rated current (A)	Rated voltage Un (V)	Weight (gr)	Packing / Box (pcs)	Product category	Catalogue number
SIST2	NT 2	up to 400	600	770	1 / 20	B	12200



Base type	Fuse link type	Rated current (A)	Rated voltage Un (V)	Weight (gr)	Packing / Box (pcs)	Product category	Catalogue number
SIST3	NT 3	up to 630	600	965	1 / 20	B	12300



In case of insufficient quantity in stock of any item listed on this page, the delivery time after order confirmation will be 90 days.

Documents corresponding to the product:

Standard EN 60269-1
EN 60269-2

FUSE LINKS FOR HIGH POWER SAFETY DEVICE

3+2
standard
+extended
5 YEAR TOTAL
WARRANTY

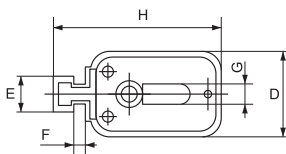
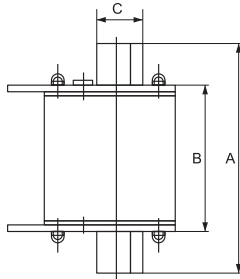

The series fuse links for high power safety devices is designed for short circuit protection. They are distinguished with high speed of operation and high reliability. The element is a ceramic (porcelain) body filled with fine quartz sand for voltaic arc lowering. In the ceramic body is mounted a fusible, specially profiled wafer connecting the current leading terminals. These terminals are manufactured of copper alloy with special nickel coating and have the form of knives to provide more contact surface. The fuse links correspond to "gL – gG" class which means that they are with common function and normal response time. NH Fuses

TWO OPERATING CLASSES OF NH FUSES ARE AVAILABLE:

- Operating class gL/gG – general purpose, line protection, slow acting

TECHNICAL DATA:

- Rated voltage: 500V
- Rated short circuit current: 120 kA
- IP code: IP 00
- Ambient temperature: -5 to +65°C
- Altitude: up to 2000m

Base type	Overall dimensions (mm)				
	A	B	C	D	H
NT00	78	40	15	29	56,5
NT 0	125	68	15	29	56,5
NT1	135	68	21	48	62
NT 2	150	68	27	58	72
NT 3	150	68	33	67	84,5
NT00C	78	40	15	21	56,5
NT1C	135	68	21	29	62
NT2C	150	68	33	48	84,5

Type	In (A)	Un (V)	Packing / Box (pcs)	Product category	Catalogue number
NT00	16	500,600	3 / 90	B	10001
NT00	25	500,600	3 / 90	B	10002
NT00	32	500,600	3 / 90	B	10003
NT00	40	500,600	3 / 90	B	10004
NT00	50	500,600	3 / 90	B	10005
NT00	63	500,600	3 / 90	B	10006
NT00	80	500,600	3 / 90	B	10008
NT00	100	500,600	3 / 90	B	10009
NT00	125	500,600	3 / 90	B	10012
NT00	160	500,600	3 / 90	B	10016



Type	In (A)	Un (V)	Packing / Box (pcs)	Product category	Catalogue number
NT0	16	500,600	3 / 90	B	10015
NT0	25	500,600	3 / 90	B	10025
NT0	32	500,600	3 / 90	B	10032
NT0	40	500,600	3 / 90	B	10040
NT0	50	500,600	3 / 90	B	10050
NT0	63	500,600	3 / 90	B	10063
NT0	80	500,600	3 / 90	B	10080
NT0	100	500,600	3 / 90	B	10090
NT0	125	500,600	3 / 90	B	10092
NT0	160	500,600	3 / 90	B	10096

In case of insufficient quantity in stock of any item listed on this page, the delivery time after order confirmation will be 90 days.



Type	In (A)	Un (V)	Packing / Box (pcs)	Product category	Catalogue number
NT1	80	500,600	3 / 36	B	10108
NT1	100	500,600	3 / 36	B	10110
NT1	125	500,600	3 / 36	B	10112
NT1	160	500,600	3 / 36	B	10116
NT1	200	500,600	3 / 36	B	10120
NT1	225	500,600	3 / 36	B	10122
NT1	250	500,600	3 / 36	B	10125



Type	In (A)	Un (V)	Packing / Box (pcs)	Product category	Catalogue number
NT2	160	500,600	1 / 24	B	10216
NT2	200	500,600	1 / 24	B	10220
NT2	250	500,600	1 / 24	B	10225
NT2	315	500,600	1 / 24	B	10231
NT2	400	500,600	1 / 24	B	10240



Type	In (A)	Un (V)	Packing / Box (pcs)	Product category	Catalogue number
NT3	500	500,600	1 / 24	B	10350
NT3	630	500,600	1 / 24	B	10363



Type	In (A)	Un (V)	Packing / Box (pcs)	Product category	Catalogue number
NT00C	16	500,600	3/120	B	10001C
NT00C	25	500,600	3/120	B	10002C
NT00C	32	500,600	3/120	B	10003C
NT00C	40	500,600	3/120	B	10004C
NT00C	50	500,600	3/120	B	10005C
NT00C	63	500,600	3/120	B	10006C
NT00C	80	500,600	3/120	B	10008C
NT00C	100	500,600	3/120	B	10009C



Type	In (A)	Un (V)	Packing / Box (pcs)	Product category	Catalogue number
NT1C	80	500,600	3/54	B	10108C
NT1C	100	500,600	3/54	B	10110C
NT1C	125	500,600	3/54	B	10112C
NT1C	160	500,600	3/54	B	10116C



In case of insufficient quantity in stock of any item listed on this page, the delivery time after order confirmation will be 90 days.



Type	In (A)	Un (V)	Packing / Box (pcs)	Product category	Catalogue number
NT2C	160	500,600	1/30	B	10216C
NT2C	200	500,600	1/30	B	10220C
NT2C	250	500,600	1/30	B	10225C



Documents corresponding to the product:

Standard EN 60947-1; EN 60947-3



ISOLATING SWITCHES

3+2 standard +extended **5** YEAR TOTAL WARRANTY

Designed in two types – horizontal and vertical. They represent a combination of low voltage isolating switch and high power safety devices mounted in a common plastic corpus. They are used for low voltage distribution boards and complete transformer substations (CTS) where visible circuit distribution is necessary. They provide safety and convenience at fuse links change. The plastic corpus increases the IP code and the plastic lid provides simultaneous circuits switching on/off. The lid allows easy removing which is additional measure at repairs. The vertical isolating switches are mounted directly to the power supply rails which enables the exploitation and improves the safety of the staff.

TECHNICAL DATA:

- Rated voltage: 500V
- Rated short circuit current: according to the mounted fuse links
- Number of poles: 3
- Impulse voltage wear resistance: 8kV
- Mechanical wear resistance: 3000 cycles
- IP code: IP 40
- Plastic: UV rays wear resistance
- Ambient temperature: -5 to +65°C
- Altitude: up to 2000m

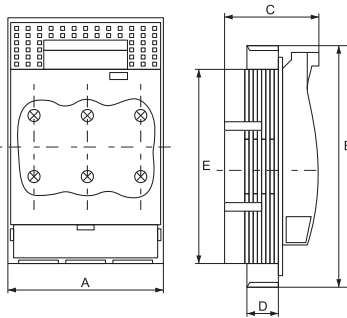

Base type	Overall dimensions (mm)				
	A	B	C	D	E
THB - 160	105	160	85	45	100
THB - 250	185	220	111	66	180
THB - 400	210	260	130	88	205
THB - 630	256	270	140	94.5	245

Type	In (A)	Un (V)	Fuse link size	Packing / Box (pcs)	Product category	Catalogue number
THB	160	500,660	NT00	1 / 18	B	44801
THB	250	500,660	NT1	1 / 6	B	44802
THB	400	500,660	NT2	1 / 4	B	44803
THB	630	500,660	NT3	1/4	B	44804

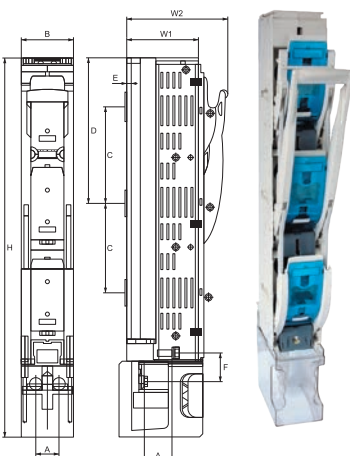

Overall dimensions (mm)										
A	B	C	D	E	F	G	H	W1	W2	
50	99	185	290	2	57	58	746	146	195	

Type	In (A)	Un (V)	Fuse link size	Packing / Box (pcs)	Product category	Catalogue number
HG2B	160	500,660	NT00	1 / 4	B	44805
HG2B	250	500,660	NT1	1 / 4	B	44806
HG2B	400	500,660	NT2	1 / 4	B	44807
HG2B	630	500,660	NT3	1 / 4	B	44808



In case of insufficient quantity in stock of any item listed on this page, the delivery time after order confirmation will be 90 days.

Documents corresponding to the product:

Standard EN 60269-2;
IEC269-2

SWITCH DISCONNECTORS RT18



The series of switch disconnectors are developed for short-circuit protection. They have a high speed of start and high reliability. They have a plastic body of non-flammable plastics adapted for mounting on a DIN rail, where a porcelain round plug, which is filled with fine quartz sand for extinguishing the electric arc. LED indicator is mounted on the front panel to show fuse link condition. In this ceramic body is mounted melting, specifically profiled plate, which connects the input power terminals. These terminals are produced from copper alloy with especially laid nickel layer and contact with the projecting bolts from the plastic body. There are offered two types of insertions according to the degree of quick operation: normally quickly operating ones – class "gG". Suitable for DC system.

TECHNICAL DATA:

- Rated voltage: 500V
- Insulation voltage: >2500V
- Rated current on short-circuit: 100 kA
- Direct mounting to the load
- Two insulated points to the load
- IP code: IP 44
- Cross-section of the supply conductors: up to 35mm²
- Environmental temperature: -5° to +65°C
- Utilization category: AC - 20B; DC - 20B
- Altitude: up to 2000m

Overall dimensions

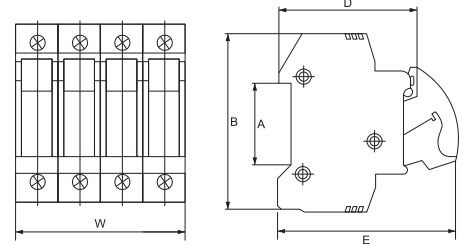

Base type	Number of poles	Rated current (A)	Type of the fuse	Base dimensions (mm)				Packing / Box (pcs)	Product category	Catalogue number
				A	B	W	E			
1PRT18 - 32x	1P	32	xxG1038	37	82	18	78	12 / 240	B	10RT1831
1NRT18 - 32x	1P+N	32	xxG1038	37	82	36	78	6 / 120	B	10RT18311
2PRT18 - 32x	2P	32	xxG1038	37	82	36	78	6 / 120	B	10RT1832
3PRT18 - 32x	3P	32	xxG1038	37	82	54	78	4 / 80	B	10RT1833
3NRT18 - 32x	3P+N	32	xxG1038	37	82	72	78	3 / 60	B	10RT18331
1PRT18 - 63x	1P	63	xxG1451	37	105	27	110	6 / 108	B	10RT1861
1NRT18 - 63x	1P+N	63	xxG1451	37	105	54	110	6 / 108	B	10RT18611
2PRT18 - 63x	2P	63	xxG1451	37	105	54	110	6 / 108	B	10RT1862
3PRT18 - 63x	3P	63	xxG1451	37	105	81	110	6 / 108	B	10RT1863
3NRT18 - 63x	3P+N	63	xxG1451	37	105	108	110	6 / 108	B	10RT18631



FUSE FOR SWITCH DISCONNECTORS RT18



RT18 Type

Type of the fuse class gG	Voltage (V)	Rated current (A)	Size of the fuse A x ØB x C	Packing / Box (pcs)	Product category	Catalogue number
01G1038	500	1	38xØ10.3x10mm	10 / 2000	B	10G10381
02G1038	500	2	38xØ10.3x10mm	10 / 2000	B	10G10382
04G1038	500	4	38xØ10.3x10mm	10 / 2000	B	10G10384
06G1038	500	6	38xØ10.3x10mm	10 / 2000	B	10G10386
10G1038	500	10	38xØ10.3x10mm	10 / 2000	B	10G103810
16G1038	500	16	38xØ10.3x10mm	10 / 2000	B	10G103816
20G1038	500	20	38xØ10.3x10mm	10 / 2000	B	10G103820
25G1038	500	25	38xØ10.3x10mm	10 / 2000	B	10G103825
32G1038	500	32	38xØ10.3x10mm	10 / 2000	B	10G103832
40G1451	500	40	51xØ14.3x12mm	10 / 500	B	10G145140
50G1451	500	50	51xØ14.3x12mm	10 / 500	B	10G145150
63G1451	500	63	51xØ14.3x12mm	10 / 500	B	10G145163



FUSE FOR SWITCH DISCONNECTORS EL-D02



EL-D02 Type

UNTIL SUPPLY
LAST

Type of the fuse class gG	Voltage (V)	Rated current (A)	Size of the fuse A x ØB x C	Product category	Catalogue number
RO 26/32 2A	500	2	Ø11x 36mm	F	10R0232
RO 26/32 4A	500	4	Ø11x 36mm	F	10R0234
RO 26/32 6A	500	6	Ø11x 36mm	F	10R0236
RO 26/32 10A	500	10	Ø11x 36mm	F	10R0240
RO 26/32 16A	500	16	Ø11x 36mm	F	10R0246
RO 26/32 20A	500	20	Ø15x 36mm	F	10R0248
RO 26/63 40A	500	40	Ø15x 36mm	F	10R0640
RO 26/63 50A	500	50	Ø15x 36mm	F	10R0650



Documents corresponding to the product:
Standard EN 60947-3 and IEC947-3

SWITCH DISCONNECTORS ISS FROM 20A TO 125A SERIES

5+2 standard +extended **7** YEAR TOTAL WARRANTY *for industrial usage 3 years warranty



Dimensions (mm)

H1	H2	D1	D2	D3
81	45	50	65	76
W1	W2	W3	W3	
17,5	35	52,5	70	

FUNCTIONS:

- switching on/off heavy loaded electrical circuits
- breaking of electrical circuits
- can be used as a main breaker
- it has no protective function
-

TECHNICAL DATA:

- Rated voltage: 230/400V; 50/60Hz
- Joining terminal: flat (tunnel) screw terminal
- Connecting: power supply busbar, rigid or flexible conductors
- Tightening moment: 1.33Nm
- Isolating voltage: $\geq 500V$

- Electrical wear resistance (number of cycles): ≥ 10000
- Mechanical wear resistance (number of cycles): ≥ 20000
- IP code: IP>20
- Mounting: DIN-rail
- Plastic material of UV rays
- Ambient temperature: $-20^{\circ}C + 65^{\circ}C$

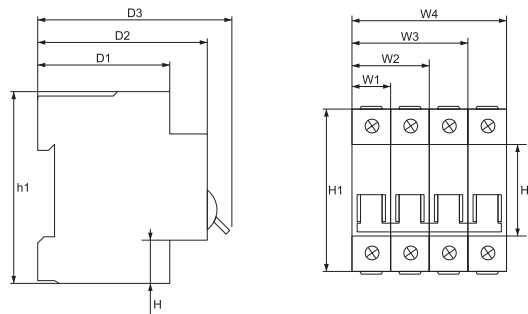

Type	Number of poles	Rated current In (A)	Recommended conductor (mm ²)	Packing/Box (pcs)	Product category	Catalogue number
ISS	1P	40	10	12 / 240	B	41914
ISS	1P	63	16	12 / 240	B	41911
ISS	1P	80	25	12 / 240	B	41912
ISS	1P	100	35	12 / 240	B	41913
ISS	1p	125	50	12 / 240	B	41916



Type	Number of poles	Rated current In (A)	Recommended conductor (mm ²)	Packing/Box (pcs)	Product category	Catalogue number
ISS	2P	40	10	6 / 120	B	41924
ISS	2P	63	16	6 / 120	B	41921
ISS	2P	80	25	6 / 120	B	41922
ISS	2P	100	35	6 / 120	B	41923
ISS	2p	125	50	6 / 120	B	41925

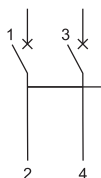

In case of insufficient quantity in stock of any item listed on this page, the delivery time after order confirmation will be 90 days.

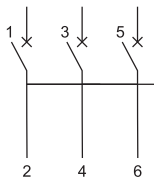

Type	Number of poles	Rated current In (A)	Recommended conductor (mm ²)	Packing/Box (pcs)	Product category	Catalogue number
ISS	3P	20	2.5	4/80	B	41935
ISS	3P	32	6.0	4/80	B	41936
ISS	3P	40	10	4 / 80	B	41934
ISS	3P	63	16	4 / 80	B	41931
ISS	3P	80	25	4 / 80	B	41932
ISS	3P	100	35	4 / 80	B	41933
ISS	3p	125	50	4 / 80	B	41937

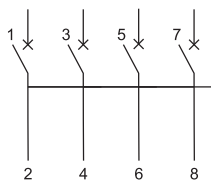

Type	Number of poles	Rated current In (A)	Recommended conductor (mm ²)	Packing/Box (pcs)	Product category	Catalogue number
ISS	4P	40	10	3 / 60	B	41944
ISS	4P	63	16	3 / 60	B	41941
ISS	4P	80	25	3 / 60	B	41942
ISS	4P	100	35	3 / 60	B	41943
ISS	4p	125	50	3 / 60	B	41945



PADLOCK ADAPTOR FOR MCB

An adaptor makes it possible to block the operating lever whether switched ON or OFF



Type	Product category	Catalogue number
Padlock adaptor for MCB	B	41904



In case of insufficient quantity in stock of any item listed on this page, the delivery time after order confirmation will be 90 days.

DOCUMENTS CORRESPONDING TO THE PRODUCT:

Standard EN 60947-1
EN 60947-3 and IEC 60947-6

SWITCH DISCONNECTORS ISS2 FROM 125A TO 800A

5+2 standard +extended **7** YEAR TOTAL WARRANTY *for industrial usage, 3 years warranty



The series three- and four-pole load switch disconnectors ISS2 xxx are produced for mounting in main electrical boards for disconnection of the circuits, switching on of generators because of the fact they are not affected by the frequency variations. High mechanical strength and resistance to circulation. Simple and secure management.

FUNCTIONS:

- switching on and off of electrical circuits under load
- disconnection of electrical circuits
- used as main circuit-breaker
- resistant to high voltages, to short circuits in the protected circuit
- it has no protective function

TECHNICAL FEATURES:

- Rated voltage: not higher than 660V; 50/60Hz
- Double connector: screw connection
- Connection: solid or flexible conductors
- Insulation voltage: $\geq 1000V$
- Resistance to impulse voltage: 8000V
- Electrical endurance (number of cycles): $\geq 5\ 000$
- Mechanical endurance (number of cycles): $\geq 10\ 000$
- IP code: IP>20
- Mounting method: to a surface by means of bolts
- Plastic resistant to UV rays
- Ambient temperature: $-20^{\circ}\div 65^{\circ}C$

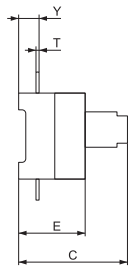
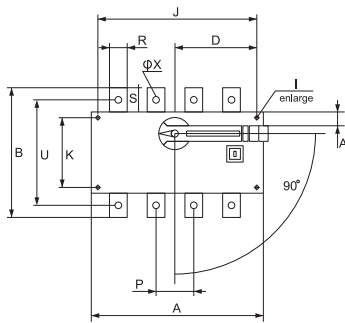

Type	Dimensions (mm)											
	A	B	C	D	E	J	J1	K	R	S	T	Y
ISS2-125/3	140	135	125	27	73	120	120	65	20	25	3.5	25
ISS2-125/4	170	135	125	27	73	150	150	65	20	25	3.5	25
ISS2-160/3	140	135	125	27	73	120	120	65	20	25	3.5	25
ISS2-160/4	170	135	125	27	73	150	150	65	20	25	3.5	25
ISS2-250/3	180	170	138	35	86	160	160	90	25	30	3.5	25
ISS2-250/4	230	170	138	35	86	210	210	90	25	30	3.5	25
ISS2-400/3	230	240	165	50	110	210	210	140	32	40	5	37
ISS2-400/4	295	240	165	50	110	275	275	140	32	40	5	37
ISS2-630/3	230	260	165	50	110	210	210	140	40	50	6	37
ISS2-630/4	295	260	165	50	110	275	275	140	40	50	6	37
ISS2-800/3	378	312	240	50	140	353	353	175	60	56	8	48
ISS2-800/4	498	312	240	50	140	473	473	175	60	56	8	48

Type	Rated current In (A)	Maximum breaking capacity Icu (A)	Tightening moment (Nm)	Packing/Box (pcs)	Product category	Catalogue number three-pole	Catalogue number four-pole
ISS2-125in	125	1250	6.5	1 / 12	B	41951	41961
ISS2-125out	125	1250	6.5	1 / 12	B	41952	41962
ISS2-160in	160	1250	6.5	1 / 12	B	41953	41963
ISS2-160out	160	1250	6.5	1 / 12	B	41954	41964
ISS2-250in	250	2000	10	1 / 6	B	41955	41965
ISS2-250out	250	2000	10	1 / 6	B	41956	41966
ISS2-400in	400	3200	14.5	1 / 2	B	41957	41967
ISS2-630in	630	4000	14.5	1 / 2	B	41958	41968
ISS2-800in	800	1000	27	1 / 2	B	41959	41969



Note: ISS2-xxx in – load circuit-breaker for mounting in the interior of a board
ISS2-xxx out – load circuit-breaker with an extended lever for mounting on the front panel of the board

In case of insufficient quantity in stock of any item listed on this page, the delivery time after order confirmation will be 90 days.

DOCUMENTS CORRESPONDING TO THE PRODUCT:

Standard EN 60947-1
EN 60947-3 and IEC 60947-6

MANUAL SWITCHING TO RESERVE SERIES EQ 2M FROM FROM 160A TO 800A

5+2 standard +extended **7** YEAR TOTAL WARRANTY *for industrial usage 3 years warranty

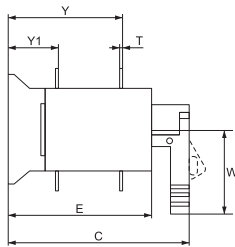
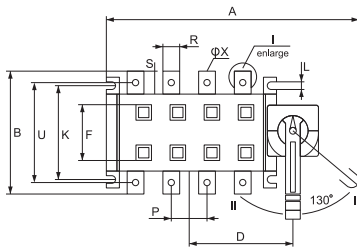

The series three- and four-pole load isolating switch EQ 2 M xxx are produced for mounting in main electrical boards for disconnection of the circuits, manual switching between two power supplies or switching ON of generators because of the fact they are not affected by the frequency variations. High mechanical strength and resistance to circulation. Simple and secure management.

FUNCTIONS:

- switching on and off of low voltage electrical circuits under load
- disconnection of the electrical circuit from one of the power supplies, while providing immediately switching to the other
- used as main switch
- resistant to high voltages, to short circuits in the protected circuit
- it has no protective function

TECHNICAL CHARACTERISTICS:

- Rated voltage: not higher than 690V; 50/60Hz
- Double connector: screw connection
- Connection: hard or flexible conductors
- Insulation voltage: $\geq 1000V$
- Resistance to impulse voltage: 8000V
- Electrical endurance (number of cycles): $\geq 5\ 000$
- Mechanical endurance (number of cycles): $\geq 10\ 000$
- IP code: IP>20
- Mounting method: to a surface by means of bolts
- Plastic resistant to UV rays
- Ambient temperature: $-20^{\circ}\div 65^{\circ}C$
- Small size
- Indication which of the two supplies is operating

Type	Dimensions (mm)												
	A	B	C	D	E	J	J1	K	R	S	T	Y	Y1
EQ2M-160/3	270	135	212	89	150	120	65	95	20	25	3.5	55	25
EQ2M-160/4	300	135	212	104	150	150	65	95	20	25	3.5	55	25
EQ2M-250/3	307	170	260	110	180	160	65	115	25	30	3.5	70	25
EQ2M-250/4	357	170	260	135	180	210	65	115	25	30	3.5	70	25
EQ2M-400/3	372	240	297	150	236	210	77	180	32	40	5	83	37
EQ2M-400/4	432	240	297	180	236	275	77	180	32	40	5	83	37
EQ2M-630/3	372	240	297	150	236	210	77	180	40	50	6	83	37
EQ2M-630/4	432	240	297	180	236	275	77	180	40	50	6	83	37
EQ2M-800/3	372	240	297	150	236	210	77	180	60	56	8	83	48
EQ2M-800/4	432	240	297	180	236	275	77	180	60	56	8	83	48

Type	Rated current In (A)	Maximum breaking capacity Icu (A)	Tightening moment (Nm)	Packing/Box (pcs)	Product category	Catalogue number three-pole	Catalogue number four-pole
EQ2M-160	160	1250	6.5	1 / 4	B	44641	44641P
EQ2M-250	250	2000	10	1 / 2	B	44642	44642P
EQ2M-400	400	3200	14.5	1 / 2	B	44643	44643P
EQ2M-630	630	4000	14.5	1 / 2	B	44644	44644P
EQ2M-800	800	1000	27	1 / 2	B	44645	44645P



In case of insufficient quantity in stock of any item listed on this page, the delivery time after order confirmation will be 90 days.

Documents corresponding to the product:

Standard EN 60947-1
EN 60947-2

**HIGH BREAKING CAPACITY LEVEL
MOULDED CASE CIRCUIT BREAKERS
(MCCB) DS1 MAX FROM 63A... 800A**

7+0 standard +extended **7** YEAR TOTAL WARRANTY *for industrial usage 3 years warranty

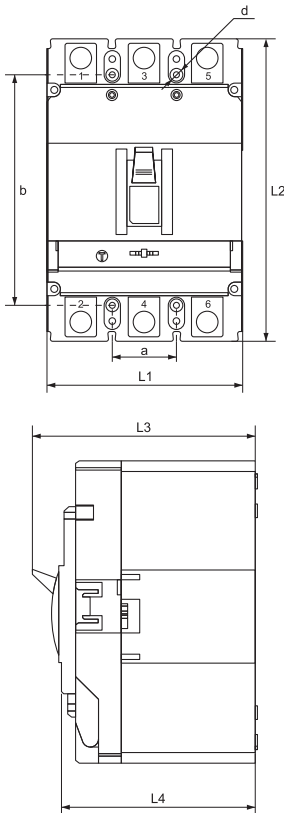

FUNCTIONS:

- high breaking capacity level
- switching on/off heavy loaded electrical circuits
- breaking of electrical circuits and control of powerful consumers
- can be used as a main breaker in housing or industrial distributing installations
- endures high currents of short circuit in the protected circuit
- remarkable with high reliability of current characteristics control: manual
- possibility for auxiliary devices mounting for automation

TECHNICAL DATA:

- Rated operating voltage: 415/690V; 50/60Hz
- Isolating voltage: 2000V
- Surge voltage wear resistance: ≥8000V
- Connecting:
 - rigid or flexible conductors
 - front conductors joining

- possibility for mounting to lengthening terminal
- Plastic elements
 - not keeping the burning material nylon PA66
 - box permittivity strength: >16MV/m
- Abnormal heating wear resistance and fire of the outer parts: 960°C
- Static contacts – alloy: pure copper T2Y2
 - acontact head: silver graphite CAg(5)
 - athickness: depends on the current
- Tightening moment: 1.33Nm
- Electrical wear resistance (number of cycles): ≥10000
- Mechanical wear resistance (number of cycles): ≥20000
- IP code: IP>20
- Mounting:
 - joining with bolts
 - mounting position: vertical
- Plastic material of UV rays and non-flammable
- Test button
- Ambient temperature: -20°/65°C.

Type	Overall dimensions (mm)						
	L1	L2	L3	L4	a	b	d
DS1 MAX 125/63 3P M	92	150	110	92	30	129	4.5
DS1 MAX 125/80 3PM	92	150	110	92	30	129	4.5
DS1 MAX 125/100 3P M	92	150	110	92	30	129	4.5
DS1 MAX 125/125 3P M	92	150	110	92	30	129	4.5
DS1 MAX 250/160 3P M	92	165	110	90	35	126	4.5
DS1 MAX 250/200 3P M	107	165	110	90	35	126	4.5
DS1 MAX 250/250 3P H	107	165	110	90	35	126	4.5
DS1 MAX 400/400 3P H	150	257	146	106	44	194	7
DS1 MAX 630/630 3P H	182	270	155	116	116	200	7
DS1 MAX 800/800 3P H	210	28	155	116	70	243	7
DS1 MAX 125/63 4P M	122	150	110	92	60	129	4.5
DS1 MAX 125/80 4PM	122	150	110	92	60	129	4.5
DS1 MAX 125/100 4P M	122	150	110	92	60	129	4.5
DS1 MAX 125/125 4P M	122	150	110	92	60	129	4.5
DS1 MAX 250/160 4P M	142	165	110	90	70	126	4.5
DS1 MAX 250/200 4P M	142	165	110	90	70	126	4.5
DS1 MAX 250/250 4P H	142	165	110	90	70	126	4.5
DS1 MAX 400/400 4P H	198	257	146	106	44	194	7
DS1 MAX 630/630 4P H	240	270	155	116	116	200	7
DS1 MAX 800/800 4P H	280	280	155	116	70	243	7

Type	Rated current In (A)	Operating breaking capacity (kA) Ics	Maximum breaking capacity (kA) Icu		Thermal current adjustment (A)	Packing/ box	Product category	Catalogue number three-poles	Catalogue number four-poles
			415V	690V					
DS1 MAX - 125 63	63	36	50	20	50,4-63	1/16	B	44163MM	444163MM
DS1 MAX - 125 80	80	36	50	20	64-80	1/16	B	44164MM	444164MM
DS1 MAX - 125 100	100	36	50	20	80-100	1/16	B	44165MM	444165MM
DS1 MAX - 125 125	125	36	50	20	100-125	1/16	B	44166MM	444166MM
DS1 MAX - 250 160	160	36	50	20	128-160	1/6	B	44160MM	444160MM
DS1 MAX - 250 200	200	36	50	20	160-200	1/6	B	44200MM	444200MM
DS1 MAX - 250 250	250	42	65	25	200-250	1/6	B	44250MH	444250MH
DS1 MAX - 400 400	400	50	85	30	320-400	1/3	B	44401MH	444401MH
DS1 MAX - 630 630	630	50	85	30	504-630	1/2	B	44630MH	444630MH
DS1 MAX - 800 800	800	65	100	50	640-800	1/2	B	44800MH	444800MH



Documents corresponding to the product:

Standard EN 60947-1
EN 60947-2

**HIGH BREAKING CAPACITY LEVEL
MOULDED CASE CIRCUIT BREAKERS
(MCCB) DS1 MAX TO 800A-ELECTRONIC TYPE**

7+0 standard +extended **7** YEAR TOTAL WARRANTY *for industrial usage 3 years warranty

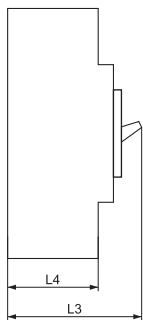
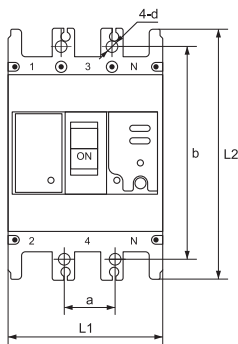

FUNCTIONS:

- high breaking capacity level
- switching on/off heavy loaded electrical circuits
- breaking of electrical circuits and control of powerful consumers
- can be used as a main breaker in housing or industrial distributing installations
- endures high currents of short circuit in the protected circuit
- remarkable with high reliability of current characteristics
- control: manual
- possibilities for electrical module parameters adjustment through direct modules (combination of keys) thus providing accurate protection from overload and short circuit
- simultaneous protection of the three phases
- possibility for auxiliary devices mounting for automation
- contactor for TT test 15V DC

TECHNICAL DATA:

- Rated operating voltage: 415/690V; 50/60Hz
- Isolating voltage: 2000V
- Surge voltage wear resistance: ≥8000V
- Joining terminal: flat (tunnel) screw terminal
- Connecting:
 - rigid or flexible conductors
 - front conductors joining
 - possibility for mounting to lengthening terminal
- Electrical wear resistance (number of cycles): ≥ 10000
- Mechanical wear resistance (number of cycles): ≥ 20000
- IP code: IP>20
- Abnormal heating wear resistance and fire of the outer parts: 960°C
- Mounting:
 - joining with bolts
 - mounting position: vertical
- Plastic material of UV rays and non-flammable
- Test button
- Ambient temperature: -20°÷65°C

Type	Rated current In (A)	Operating breaking capacity (kA) Ics	Maximum breaking capacity (kA) Icu		Thermal current adjustment (A)	Packing/box	Product category	Catalogue number three-poles	Catalogue number four-poles
			415V	690V					
DS1 MAX - 400E	400	50	85	30	200-400	1/3	B	44940MH	444940MH
DS1 MAX - 630E	630	50	85	30	400-630	1/2	B	44963MH	444963MH
DS1 MAX - 800E	800	65	100	50	630-800	1/2	B	44980MH	444980MH

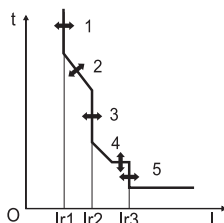

Tripping characteristic:

Ir1 (A) Over-load long time delay tripping current
Ir1 adjustment, according to the different rated current of MCCB.
t1 (s) Long time delay tripping time t1 adjustment.
Ir2(XIr1) Short circuit short time delay tripping time Ir2 adjustment.
t2 (s) Short time delay tripping time t2 adjustment.
Ir3(XIr1) Short circuit instantaneous tripping current Ir3 adjustment.
Ir0(XIr1) Pre-alarm tripping current
Ir0 adjustment.

TEST

DS1 MAX - 400E

DS1 MAX - 630E

DS1 MAX - 800E

In case of insufficient quantity in stock of any item listed on this page, the delivery time after order confirmation will be 90 days.

Documents corresponding to the product:

Standard EN 60947-1
EN 60947-2



**MOULDED CASE CIRCUIT BREAKERS (MCCB)
DS1 SERIES FROM 40A TO 1250A**

3+0 standard +extended **3** YEAR TOTAL WARRANTY

FUNCTIONS:

- switching on/off heavy loaded electrical circuits
- breaking of electrical circuits and control of powerful consumers
- can be used as a main breaker in housing or industrial distributing installations
- endures high currents of short circuit in the protected circuit
- remarkable with high reliability of current characteristics
- control: manual
- possibility for auxiliary devices mounting for automation

- Connecting:
 - rigid or flexible conductors
 - front conductors joining
 - possibility for mounting to lengthening terminal
- Plastic elements
 - not keeping the burning material nylon PA66
 - box permittivity strength: >16MV/m
- Abnormal heating wear resistance and fire of the outer parts: 960°C
- Static contacts – alloy: pure copper T2Y2
 - contact head: silver graphite CAg(5)
 - thickness: depends on the current
- Tightening moment: 1.33Nm
- Electrical wear resistance (number of cycles): ≥10000
- Mechanical wear resistance (number of cycles): ≥20000
- IP code: IP>20
- Mounting:
 - joining with bolts
 - mounting position: vertical
- Plastic material of UV rays and non-flammable
- Test button
- Ambient temperature: -20°÷65°C

TECHNICAL DATA:

- Rated operating voltage: 415/690V; 50/60Hz
- Isolating voltage: 2000V
- Surge voltage wear resistance: ≥8000V
- Joining terminal: flat (tunnel) screw terminal for the breakers up to 160A and a bolt connection for the breakers from 250A to 1600A

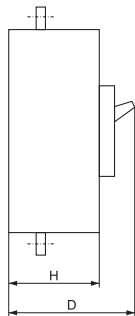
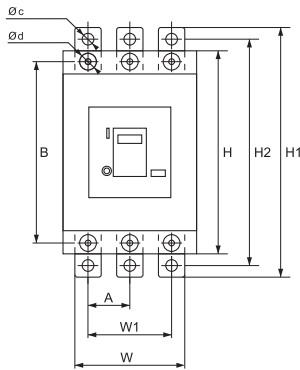

Type	Overall dimensions (mm)					Installation dimensions (mm)					
	W	H	D	H1	D1	A	B	W1	H2	Ø d	Ø e
DS1-125/3P	76.2	120	70		90	25	100	50		4	
DS1-160/3P	90	120	70		93	30	100	60		5	
DS1-250/3P	105	170	104	238	143.5	35	139	70	210	6	8.5
DS1-400/3P	140	257	104	316	144	44	214	87.5	285	6	11
DS1-630/3P	210	275	104	310	172	70	230	140	280	6	11
DS1-800/3P	210	275	104	347	172	70	230	140	307	6	16
DS1-1600/3P	210	410	140	410	210	70	300	140	350	10	12
DS1-125/4P	110	120	70		90	25	100	50		4	
DS1-160/4P	120	120	70		93	30	100	60		5	
DS1-250/4P	140	170	104	238	143.5	35	139	70	210	6	8.5
DS1-400/4P	184	257	104	316	144	44	214	87.5	285	6	11
DS1-630/4P	280	275	104	310	172	70	230	140	280	6	11
DS1-800/4P	280	275	104	347	172	70	230	140	307	6	16
DS1-1600/4P	280	410	140	410	210	70	300	140	350	10	12

Type	Rated current In (A)	Operating breaking capacity (kA) Ics	Maximum breaking capacity (kA) Icu		Thermal current adjustment (A)	Section of the conductor (mm²)	Packing/Box (pcs)	Product category	Catalogue number tree-poles
			415V	690V					
DS1-125	40	16	35	10	fixed	16	1 / 20	F	44040
DS1-125	50	16	35	10	fixed	16	1 / 20	F	44050

UNTIL SUPPLY LAST





UNTIL SUPPLY
LAST

Type	Rated current In (A)	Operating breaking capacity (kA) Ics	Maximum breaking capacity (kA) Icu		Thermal current adjustment (A)	Section of the conductor (mm ²)	Packing/Box (pcs)	Product category	Catalogue number tree-poles
			415V	690V					
DS1 - 160	100	22	35	15	70 - 100	50	1 / 20	F	44165



UNTIL SUPPLY
LAST

Type	Rated current In (A)	Operating breaking capacity (kA) Ics	Maximum breaking capacity (kA) Icu		Thermal current adjustment (A)	Section of the conductor (mm ²)	Packing/Box (pcs)	Product category	Catalogue number tree-poles
			415V	690V					
DS1 - 630	500	65	75	25	fixed	185	1 / 2	F	44500



UNTIL SUPPLY
LAST

Type	Rated current In (A)	Max. breaking capacity (kA) Icu	Operating breaking capacity (kA) Ics	Section of the power supply conductor (mm ²)	Protection from overload	Packing/Box (pcs)	Product category	Catalogue number
DS1 - 1250	1250	85	65	240	fixed	1 / 1	F	44502



3+0
standard
+extended **3** YEAR TOTAL
WARRANTY

Documents corresponding to the product:

Standard EN 60947-1
EN 60947-2



**MOULDED CASE CIRCUIT BREAKER (MCCB)
DS2 SERIES**

FUNCTIONS:

- no auxiliaries available for this type of MCCB
- switching on/off heavy loaded electrical circuits
- breaking of electrical circuits and control of powerful consumers
- can be used as a main breaker in housing or industrial distributing installations
- endures high currents of short circuit in the protected circuit
- remarkable with high reliability of current characteristics
- control: manual

TECHNICAL DATA:

- Rated operating voltage: 400V; 50/60Hz
- Isolating voltage: 690V

- Surge voltage wear resistance: $\geq 6000V$
- Joining terminal: flat (tunnel) screw terminal
- Connecting:
 - rigid or flexible conductors
 - front conductors joining
 - possibility for mounting to lengthening terminal
- Electrical wear resistance (number of cycles): ≥ 6000
- Mechanical wear resistance (number of cycles): ≥ 10000
- IP code: IP>20
- Mounting:
 - joining with bolts
 - mounting position: vertical
- Plastic material of UV rays and non-flammable
- Test button
- Ambient temperature: $-20^{\circ} \div 55^{\circ}C$

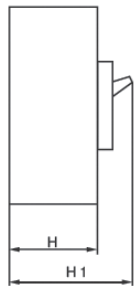
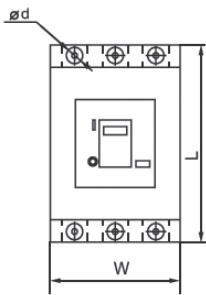

UNTIL SUPPLY
LAST

Type	Overall dimensions (mm)			
	W	L	H	H1
DS2-63	76	135	73,5	90,5
DS2-500	180	270	111,5	160
DS2-630	180	270	111,5	160
DS2-800	210	274,3	109	145,8

Type	Rated current In (A)	Max. breaking capacity (kA) Icu	Operating breaking capacity (kA) Ics	Recommended conductor (mm ²)	Protection from overload	Packing/Box (pcs)	Product category	Catalogue number tree-poles
DS2-63	63	18	12	16	fixed	1/12	F	44006
DS2-800	800	65	48	240	fixed	1/1	F	44008



3+0
standard
+extended **3** YEAR TOTAL
WARRANTY

Documents corresponding to the product:

Standard EN 60947-1
EN 60947-2



MOULDED CASE CIRCUIT BREAKERS (MCCB) DS1 TO 1600A-ELECTRONIC TYPE

FUNCTIONS:

- switching on/off heavy loaded electrical circuits
- breaking of electrical circuits and control of powerful consumers
- can be used as a main breaker in housing or industrial distributing installations
- endures high currents of short circuit in the protected circuit
- remarkable with high reliability of current characteristics
- control: manual
- possibilities for electrical module parameters adjustment through direct modules (combination of keys) thus providing accurate protection from overload and short circuit
- simultaneous protection of the three phases
- possibility for auxiliary devices mounting for automation
- contactor for TT test 15V DC

TECHNICAL DATA:

- Rated operating voltage: 415/690V; 50/60Hz
- Isolating voltage: 2000V
- Surge voltage wear resistance: $\geq 8000V$
- Joining terminal: flat (tunnel) screw terminal
- Connecting:
 - rigid or flexible conductors
 - front conductors joining
 - possibility for mounting to lengthening terminal
- Electrical wear resistance (number of cycles): ≥ 10000
- Mechanical wear resistance (number of cycles): ≥ 20000
- IP code: IP>20
- Abnormal heating wear resistance and fire of the outer parts: 960°C
- Mounting:
 - joining with bolts
 - mounting position: vertical
- Plastic material of UV rays and non-flammable
- Test button
- Ambient temperature: $-20^{\circ} \div 65^{\circ}C$

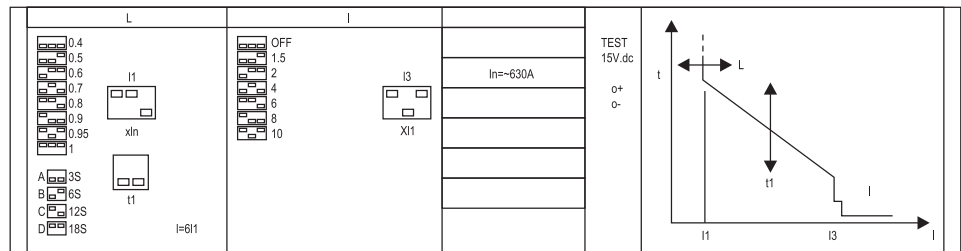

PROTECTING FUNCTIONS:

Function L – step adjustment for protection against overload. Adjustment of the operating current $I1=0.4 \times I_n$ with discrete coefficients as the value can be 0.4; 0.5; 0.6; 0.7; 0.8; 0.9; 0.95 and 1

Time delay adjustment $t1$ of the protection against overload – step adjustment with four values A-3s; B-6s; C-12s; D-18s when current is $I=6I1$. The diagram of the current curves is presented on fig.1

Adjustment of the transitory protection current against short circuit $I3=X \times I1$ where X can take discrete value OFF; 1.5; 2; 4; 6; 8; 10

Type	Rated current I_n (A)	Operating breaking capacity I_{cs} (kA)	Maximum breaking capacity (kA) I_{cu}		Thermal current adjustment (A)	Section of the Packing/Box conductor (mm ²)	Product category	Catalogue number tree-poles
			415V	690V				
DS1 - 630E	630	65	75	25	252 - 630	240	1 / 2	F 44963
DS1 - 1250E	1000	85	100	65	400 - 1000	240	1 / 1	F 44999
DS1 - 1250E	1250	85	100	65	500 - 1250	240	1 / 1	F 44925
DS1 - 1600E	1600	85	100	65	640 - 1600	240	1 / 1	F 44960

UNTIL SUPPLY
LAST



7+0 standard+extended **7** YEAR TOTAL WARRANTY *for industrial usage 3 years warranty

SHUNT RELEASE (MX)



The device is used for remote control of breakers as at voltage signal it starts operating and switches off the breaker to which it is mounted

TECHNICAL DATA:

- rated operating voltage: 230/400V 50/60Hz
- electromagnetic coil 100VA for breakers up to 400A
- electromagnetic coil 150VA for breakers 630-800A
- available joining conductors

MOUNTING:

Mounted in a special jack after cover dismounting

CONNECTING:

Connected with the operative system through the provided conductors

UNTIL SUPPLY
LAST

*Until Supply Last- 3 year standard+0 year extended warranty

DS1-ELECTRONIC TYPE WITH MOUNTED MX

Type	Product category	Catalogue number	
		400V	230V
DS1 630/3300*	F	44455	



DS1 MAX-ELECTRONIC TYPE WITH MOUNTED MX

Type	Product category	Catalogue number	
		400V	230V
DS1 MAX 400/3300 B	B	44451M	44452M
DS1 MAX 630/3300 B	B	44455M	44456M
DS1 MAX 800/3300 B	B	44459M	44460M



DS1-THERMOMAGNETIC TYPE WITH MOUNTED MX

Type	Product category	Catalogue number	
		400V	230V
DS1 125/40*	F	44317	44318
DS1 125/50*	F	44321	44322
DS1 160/100*	F	44463	44464
DS1 630/500*	F	44359	44360



DS1 MAX-THERMOMAGNETIC TYPE WITH MOUNTED MX

Type	Product category	Catalogue number	
		400V	230V
DS1 MAX 125/63	B	44326M	44327M
DS1 MAX 125/80	B	44331M	44332M
DS1 MAX 125/100	B	44336M	44337M
DS1 MAX 125/125	B	44340M	44341M
DS1 MAX 250/160	B	44333M	44344M
DS1 MAX 250/200	B	44347M	44348M
DS1 MAX 250/250	B	44351M	44352M
DS1 MAX 400/400	B	44355M	44356M
DS1 MAX 630/630	B	44363M	44364M
DS1 MAX 800/800	B	44367M	44368M



7+0 standard +extended **7** YEAR TOTAL WARRANTY *for industrial usage 3 years warranty

UNDER VOLTAGE RELEASE (MN)



MN for DS1 - 125-160



MN for DS1 - 250-800



The device switches off and/or does not allow the switching on of the breaker to which it is mounted at power breakdown or voltage decrease under certain limits

TECHNICAL DATA:

- operating voltage: 230/400V 50Hz
- electromagnetic coil 6VA for breakers up to 400A
- electromagnetic coil 10VA for breakers 630-800A
- available joining conductors
- switches off at voltage decrease under 75% of the operating

UNTIL SUPPLY LAST

*Until Supply Last - 3 year standard+0 year extended warranty

MOUNTING:

Mounted in a special jack after cover dismounting
Note: The breakers are offered with mounted accessory

CONNECTING:

Connected with the operative system through the provided conductors

DS1-ELECTRONIC TYPE WITH MOUNTED MN

Type	Product category	Catalogue number	
		400V	230V
DS1 630/3300*	F	44487	44488



DS1 MAX-ELECTRONIC TYPE WITH MOUNTED MN

Type	Product category	Catalogue number	
		400V	230V
DS1 MAX 400/3300 B	B	44483M	44484M
DS1 MAX 630/3300 B	B	44487M	44488M
DS1 MAX 800/3300 B	B	44491M	44492M



DS1-THERMOMAGNETIC TYPE WITH MOUNTED MN

Type	Product category	Catalogue number	
		400V	230V
DS1 125/40*	F	44383	44384
DS1 125/50*	F	44387	44388
DS1 160/100*	F	44475	44476
DS1 630/500*	F	44427	44428



DS1 MAX-THERMOMAGNETIC TYPE WITH MOUNTED MN

Type	Product category	Catalogue number	
		400V	230V
DS1 MAX 125/63	B	44391M	44392M
DS1 MAX 125/80	B	44395M	44396M
DS1 MAX 125/100	B	44399M	44402M
DS1 MAX 125/125	B	44407M	44408M
DS1 MAX 250/160	B	44411M	44412M
DS1 MAX 250/200	B	44415M	44416M
DS1 MAX 250/250	B	44419M	44420M
DS1 MAX 400/400	B	44423M	44424M
DS1 MAX 630/630	B	44431M	44432M
DS1 MAX 800/800	B	44435M	44436M



In case of insufficient quantity in stock of any item listed on this page, the delivery time after order confirmation will be 90 days.

Documents corresponding to the product:

Standard EN 60947-1
EN 60947-2

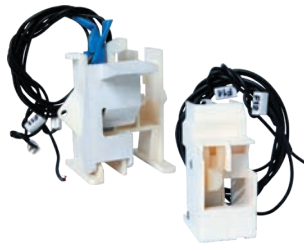

AUXILIARY CONTACT (OF)

7+0 standard +extended **7** YEAR TOTAL WARRANTY *for industrial usage, 3 years warranty

According to the way of mounting the auxiliary devices can be divided into two groups:

- internal devices – accessories for whose mounting it is necessary to dismount the cover of the breakers and fix them in specially designed jacks
- external devices – they are mounted right on the top cover of the breaker

INTERNAL DEVICES

AUXILIARY CONTACT (OF)

The device changes its condition conformably to the breaker's condition; it has a NO and a NC contactor.

UNTIL SUPPLY LAST

*Until Supply Last - 3 year standard+0 year extended warranty

TECHNICAL DATA:

- for breakers up to 160A operating current through the auxiliary contact: 3A
- for breakers from 250 to 800A operating current through the auxiliary contact: 6A
- available joining conductors
- labeling of the cables

MOUNTING:

Mounted in a special jack after cover dismounting

NOTE:

The breakers are offered with mounted accessory

CONNECTING:

Connected with the operative system through the provided conductors

DS1-THERMOMAGNETIC TYPE WITH MOUNTED OF

Type	Product category	Catalogue number
DS1 125/40*	F	44301
DS1 125/50*	F	44302
DS1 630/500*	F	44311



DS1 MAX-THERMOMAGNETIC TYPE WITH MOUNTED OF

Type	Product category	Catalogue number
DS1 MAX 125/63	B	44303M
DS1 MAX 125/80	B	44304M
DS1 MAX 125/100	B	44305M
DS1 MAX 125/125	B	44306M
DS1 MAX 250/160	B	44307M
DS1 MAX 250/200	B	44308M
DS1 MAX 250/250	B	44309M
DS1 MAX 400/400	B	44310M
DS1 MAX 630/630	B	44312M
DS1 MAX 800/800	B	44313M



DS1 - ELECTRONIC TYPE WITH MOUNTED MX+OF

	Product category	Catalogue number 400V
DS1 630/3300*	F	44457





MCCB WITH AUXILIARY DEVICES MOUNTED (MX+OF) AND (MN+OF)

7+0 standard +extended **7** YEAR TOTAL WARRANTY *for industrial usage 3 years warranty

UNTIL SUPPLY LAST

*Until Supply Last- 3 year standard+0 year extended warranty

DS1-THERMOMAGNETIC TYPE WITH MOUNTED MX+OF

	Product category	Catalogue number 400V	Catalogue number 230V
DS1 125/40*	F	44319	44320
DS1 125/50*	F	44323	44324
DS1 160/100*	F	44465	44466
DS1 630/500*	F	44361	



DS1 MAX-THERMOMAGNETIC TYPE WITH MOUNTED MN+OF

	Product category	Catalogue number 400V	Catalogue number 230V
DS1 MAX 125/63	B	44393M	44394M
DS1 MAX 125/80	B	44397M	44398M
DS1 MAX 125/100	B	44405M	44406M
DS1 MAX 125/125	B	44409M	44410M
DS1 MAX 250/160	B	44413M	44414M
DS1 MAX 250/200	B	44417M	44418M
DS1 MAX 250/250	B	44421M	44422M
DS1 MAX 400/400	B	44425M	44426M
DS1 MAX 630/630	B	44433M	44434M
DS1 MAX 800/800	B	44437M	44438M



DS1 MAX-ELECTRONIC TYPE WITH MOUNTED MN+OF

	Product category	Catalogue number 400V	Catalogue number 230V
DS1 MAX 400/3300	B	44485M	44486M
DS1 MAX 630/3300	B	44489M	44490M
DS1 MAX 800/3300	B	44493M	44494M



In case of insufficient quantity in stock of any item listed on this page, the delivery time after order confirmation will be 90 days.



DS1 MAX-ELECTRONIC TYPE WITH MOUNTED MX+OF

	Product category	Catalogue number 400V	Catalogue number 230V
DS1 MAX 400/3300	B	44453M	44454M
DS1 MAX 630/3300	B	44457M	44458M
DS1 MAX 800/3300	B	44461M	44462M



DS1 MAX- THERMOMAGNETIC TYPE WITH MOUNTED MX+OF

	Product category	Catalogue number 400V	Catalogue number 230V
DS1 MAX 125/63	B	44328M	44330M
DS1 MAX 125/80	B	44334M	44335M
DS1 MAX 125/100	B	44338M	44339M
DS1 MAX 125/125	B	44342M	44343M
DS1 MAX 250/160	B	44345M	44346M
DS1 MAX 250/200	B	44349M	44350M
DS1 MAX 250/250	B	44353M	44354M
DS1 MAX 400/400	B	44357M	44358M
DS1 MAX 630/630	B	44365M	44366M
DS1 MAX 800/800	B	44369M	44370M



DS1-THERMOMAGNETIC TYPE WITH MOUNTED MN+OF

	Product category	Catalogue number 400V	Catalogue number 230V
DS1 125/40	F	44385	44386
DS1 125/50	F	44389	44390
DS1 125/125	F	44409	44410
DS1 160/100	F	44477	44478
DS1 630/500	F	44429	44430

UNTIL SUPPLY
LAST



DS1-ELECTRONIC TYPE WITH MOUNTED MN+OF

	Product category	Catalogue number 400V	Catalogue number 230V
DS1 630/3300	F	44489	44490

UNTIL SUPPLY
LAST





REMOTE CONTROL (MANUAL)

5+2 standard +extended **7** YEAR TOTAL WARRANTY *for industrial usage 3 years warranty

Description:

The device switches off/on the breaker to which manual operative rotary mechanism is mounted

- two operating positions of the executive mechanism fixed at 90°C

Mounting:

The base is mounted with bolts right on the cover (scheme 1 mounting), and the handle is mounted at the door of the distribution box, using an extension axis it is joined to the base

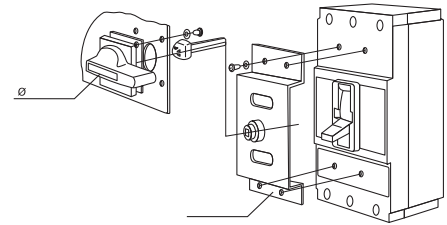
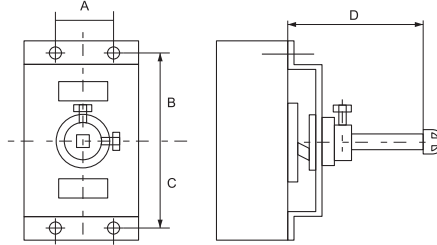

REMOTE CONTROL FOR MCCB, DS1

Type of the breaker	Dimensions (mm)			Dmin	Dmax	Packing/Box (pcs)	Product category	Catalogue number
	A	B	C					
DS1 125A*	25	50	50	65	115	1	F	44967
DS1 160A*	30	50	50	65	115	1	F	44968
DS1 250A*	35	70	70	80	130	1	F	44969
DS1 400A*	45	107	107	85	105	1	F	44970
DS1 630A*	70	119	119	110	110	1	F	44971
DS1 800A*	70	119	119	110	110	1	F	44972

*3 year standard+0 year extended warranty

UNTIL SUPPLY
LAST



REMOTE CONTROL FOR MCCB, DS1 MAX

Type of the breaker	Dimensions (mm)			Dmin	Dmax	Packing/Box (pcs)	Product category	Catalogue number
	A	B	C					
DS1 MAX 63A	25	50	50	65	115	1	B	44966M
DS1 MAX 125A	25	50	50	65	115	1	B	44967M
DS1 MAX 250A	35	70	70	80	130	1	B	44969M
DS1 MAX 400A	45	107	107	85	105	1	B	44970M
DS1 MAX 630/800A	70	119	119	110	110	1	B	44972M





DS1 - 125-160

REMOTE CONTROL (ELECTRICAL)

5+2 standard+extended 7 YEAR TOTAL WARRANTY *for industrial usage 3 years warranty

Description:

The device switches off/on the breaker to which manual operative rotary mechanism is mounted
 • two operating positions of the executive mechanism fixed at 90°C

Mounting:

The base is mounted with bolts right on the cover (scheme 1 mounting), and the handle is mounted at the door of the distribution box, using an extension axis it is joined to the base



DS1 - 250-800

ELECTRICAL REMOTE CONTROL FOR MCCB DS1

Type of the breaker	Dimensions (mm)					Packing/Box (pcs)	Product category	Catalogue number	
	A	A1	B	B1	H			Operating voltage (V) 230V	Operating voltage (V) 400V
DS1 125	103.5	110	30	90	92	1	F	44912	44907
DS1 160	103.5	110	35	90	92	1	F	44913	44908
DS1 250	139	-	132	-	105	1	F	44914	44909
DS1 400	226	-	132	-	132	1	F	44915	44910
DS1 630	226	-	132	-	132	1	F		44911
DS1 800	226	-	132	-	132	1	F		44911

*3 year standard+0 year extended warranty

UNTIL SUPPLY LAST



DS1 MAX - 63-250

ELECTRICAL REMOTE CONTROL FOR MCCB DS1 MAX

Type of the breaker	Dimensions (mm)					Packing/Box (pcs)	Product category	Catalogue number	
	L1	B	B	H	H1			Operating voltage (V) 230V	Operating voltage (V) 400V
DS1 MAX 63A	116	90	50	77	12,5	1	B	44917M	44906M
DS1 MAX 125A	116	90	50	77	12,5	1	B	44912M	44907M
DS1 MAX 250A	116	90	70	77	15	1	B	44914M	44909M
DS1 MAX 400A	176	130	107	115	27	1	B	44915M	44910M
DS1 MAX 630A	176	130	119	115	31	1	B	44916M	44911M
DS1 MAX 630A	176	130	119	115	31	1	B	44916M	44911M

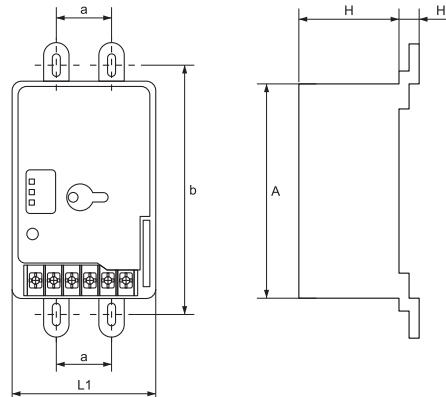

In case of insufficient quantity in stock of any item listed on this page, the delivery time after order confirmation will be 90 days.

TERMINAL PLATES FOR MCCB - DS1 AND DS1 MAX TYPE

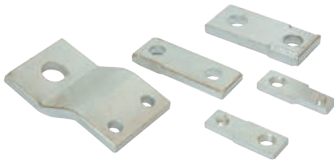

Straight copper electro-tinned extensions enabling cable connection outside the switch terminals and providing excellent contact with the switch terminal base. Terminal extensions with different cross section are available depending on the switch rated power.

MOUNTING:

Extensions are directly bolt mounted to the switch terminal base.

TERMINAL PLATES FOR MCCB - DS1

Type	Product category	Rated current (A)	Catalogue number 3pcs/set
TP 125	F	125	31125
TP 160	F	160	31160
TP 250	F	250	31250
TP 400	F	400	31400
TP 630	F	630	31630
TP 800	F	800	31850

UNTIL SUPPLY
LAST



TERMINAL PLATES FOR MCCB - DS1 MAX

Type	Product category	Rated current (A)	Catalogue number 3pcs/set	Catalogue number 4pcs/set
TP 125 MAX	B	125	31125M	-
TP 250 MAX	B	250	31250M	-
TP 400 MAX	B	400	31400M	314400M
TP 630 MAX	B	630	31630M	314630M
TP 800 MAX	B	800	31850M	314850M



Documents corresponding to the product:

Standard EN 60947-1; EN 60947-2; IEC 947-2

MOULDED CASE CIRCUIT BREAKER(MCCB) DW1 SERIES

5+2 standard +extended **7** YEAR TOTAL WARRANTY *for industrial usage, 3 years warranty

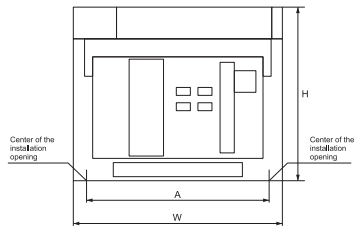

The DW1 series is an intelligent type circuit breaker used to control and protect low voltage electrical distribution network. Possibility to set the parameters of the circuit protection, built in under voltage release, remote control, earth protection and load monitoring.

FUNCTIONS:

- switching on/off heavy loaded electrical circuits
- breaking of electrical circuits and control of powerful consumers
- used as a main breaker in housing or industrial distributing installations
- endures high currents of short circuit in the protected circuit
- remarkable with high reliability of current characteristics
- motor control
- mounted auxiliary devices for automation - under voltage release, earth protection, intelligent controlling block with a possibility for a choice of the protected function

TECHNICAL DATA:

- Rated operating voltage: 690V; 50/60Hz
- Isolating voltage: 690V
- Surge voltage wear resistance: 2kV

- Joining terminal: bolt connection with 4 bolts to the power supply railConnecting:
 - copper rails
 - busway connection – at the back
- Electrical wear resistance (number of cycles): ≥2000
- Mechanical wear resistance (number of cycles): ≥9000
- IP code: IP54
- Mounting:
 - clamping with bolts
 - mounting position: vertical gradient – maximum 5°
- Plastic material of UV rays and non-flammable
- Test button
- Ambient temperature: -10°C + 65°C
- Installation altitude: up to 2000m
- BASIC PROTECTIVE FUNCTIONS:**
 - Overload protection with long time delay
 - Short circuit protection with short time delay, time inversion limit
 - Short circuit protection with short time delay, time fixed limit
 - Instantaneous short circuit protection
 - Earth protection function
 - Full stability function
 - "Overload alarm" function
 - Test function
 - Auto diagnostics function

A commutation type of breakers with RS 485 connection for duplex transmission of all function parameters, adjustment and data can also be produced at client's order and delivery terms agreement.

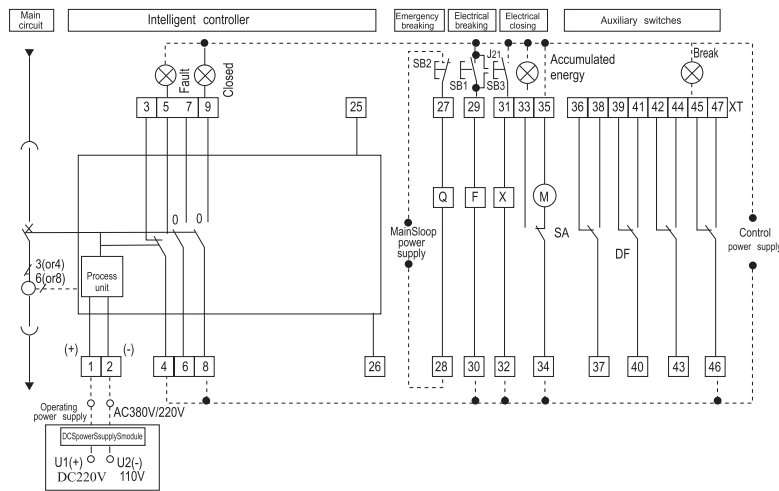

Type	Dimensions		
	A	H	W
DW1-2000 FIXED	362	402	373
DW1-3200 FIXED	422	402	363
DW1-2000 DRAW-OUT	375	432	461
DW1-3200 DRAW-OUT	435	432	494
DW1-4000 DRAW-OUT	550	432	494
DW1-6300 DRAW-OUT	813	452	504

Type	Rated current In (A)	Rated voltage Un (V)	Breaking capacity (kA)		Electrical wear resistance (number of cycles)	Mechanical wear resistance (number of cycles)	Packing/Box (pcs)	Product category	Catalogue number
			400 V	690 V					
DW1-2000 FIXED	1600	AC400V	80	50	2000	9000	1/1	B	44208
DW1-2000 FIXED	2000	AC400V	80	50	2000	9000	1/1	B	44209
DW1-3200 FIXED	2500	AC400V	100	65	2000	9000	1/1	B	44255
DW1-3200 FIXED	3200	AC400V	100	65	2000	9000	1/1	B	44329
DW1-2000 DRAW-OUT	1600	AC400V	80	50	2000	9000	1/1	B	44208DO
DW1-2000 DRAW-OUT	2000	AC400V	80	50	2000	9000	1/1	B	44209DO
DW1-3200 DRAW-OUT	2500	AC400V	100	65	2000	9000	1/1	B	44255DO
DW1-3200 DRAW-OUT	3200	AC400V	100	70	2000	9000	1/1	B	44329DO
DW1-4000 DRAW-OUT	3600	AC400V	100	75	2000	9000	1/1	B	44436DO
DW1-4000 DRAW-OUT	4000	AC400V	100	75	2000	9000	1/1	B	44440DO
DW1-6300 DRAW-OUT	5000	AC400V	120	75	2000	9000	1/1	B	44650DO
DW1-6300 DRAW-OUT	6300	AC400V	120	75	2000	9000	1/1	B	44663DO



In case of insufficient quantity in stock of any item listed on this page, the delivery time after order confirmation will be 90 days.

Documents corresponding to the product:

EN 60947-1
EN 60947-2; EN 60947-6-1

**DUAL POWER CHANGE-OVER SWITCH
EQ1 SERIES (ATS)**

5+2 standard +extended
7 YEAR TOTAL WARRANTY
*for industrial usage 3 years warranty

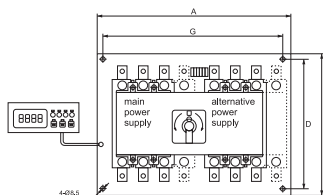
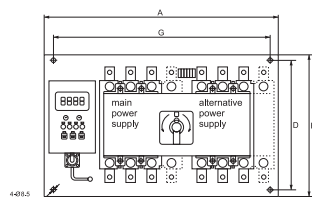

The system for dual power change-over switch EQ1 is designed to provide continuous power supply and two electrical sources automatic switch in case of failure or deviation from the set parameters. It switches only when the three phases of the second power supply source are available. The system for dual power change-over switch consists of two molded case circuit breakers mounted on a metal frame connected with common operating mechanism and controlled by a command device that controls the system parameters' correspondence.

FUNCTIONS:

- Switching on/off heavy loaded electrical circuits at main power supply discrepancy
- Switching to dual power change-over at power supply phase lack
- with option to connect to fire alarm controller. In case of fire, the ATS switches off both power supply sources
- Breaking of electrical circuits and control of powerful consumers
- Used as a main breaker in housing or industrial distributing installations supplied with a generator or a second power supply source (hospitals, post offices, military sites, control rooms)
- Remarkable with high reliability of current characteristics
- Control: motor
- Controls the following circuit parameters:
 - presence of the three phases
 - the phase voltage to be in the set limits
 - overload
 - short circuit at the outlet

TECHNICAL DATA:

- Rated operating voltage: 690V; 50/60Hz
- Surge voltage wear resistance: ≥6000V
- Joining terminal: bolt connection with 4 bolts to the power supply rail
- Connecting:
 - copper rails
 - flexible or rigid conductors
- Electrical wear resistance (number of cycles): ≥2000
- Mechanical wear resistance (number of cycles): ≥6000
- IP code: IP21
- Mounting:
 - clamping with bolts
 - mounting position: vertical gradient, maximum 5°
- Plastic material of the breakers of UV rays and non-flammable
- Ambient temperature: -10°C + 65°C
- Installation altitude: up to 2000m

BASIC FUNCTIONS OF THE CONTROL DEVICE:

- Overload protection
 - Instantaneous short circuit protection
 - Under phase protection
 - Undervoltage protection
 - Possibility for setting the change-over time between the two sources – min 3s
 - Possibility for automatic switch-over to the main power supply source after restoring its parameters
- The system for dual power change-over switch is offered in two types:
- with display (control device) mounted on the mounting plate (integrated type)
 - with separated control display

Type of the breaker	Overall dimensions (mm)				
	A	B	C	D	H
EQ1 - 100	405	365	230	250	<170
EQ1 - 225	450	410	230	250	<190
EQ1 - 400	570	510	300	330	<200
EQ1 - 630	680	620	300	330	<250
EQ1 - 800	750	690	300	330	<250

Type	Rated current In (A)	Max. breaking capacity (kA) Icu	Operating breaking capacity (kA) Ics	Section of the power supply conductor (mm²)	Electrical wear resistance (number of cycles)	Mechanical wear resistance (number of cycles)	Packing / Box (pcs)	Product category	Catalogue number
EQ1 - 100	100	50	35	35	2000	6000	1 / 1	B	44100
EQ1 - 225	225	50	35	70	2000	6000	1 / 1	B	44225
EQ1 - 400	400	100	65	180	2000	6000	1 / 1	B	44403
EQ1 - 630	630	100	65	240	1000	3000	1 / 1	B	44633
EQ1 - 800	800	100	65	240	1000	3000	1 / 1	B	44833
EQ1 - 100*	100	50	35	35	2000	6000	1 / 1	B	44101
EQ1 - 225*	225	50	35	70	2000	6000	1 / 1	B	44226
EQ1 - 400*	400	100	65	180	2000	6000	1 / 1	B	44404
EQ1 - 630*	630	100	65	240	1000	3000	1 / 1	B	44634
EQ1 - 800*	800	100	65	240	1000	3000	1 / 1	B	44834



Note: *Dual power change-over switch with separated control display

Documents corresponding to the product:

EN 61008-1
EN 61008-2; EN 60947-1



TYPE AC FOR AC CURRENT

ELECTRO-MAGNETIC RESIDUAL CURRENT DEVICES (RCD) JEL1

7+0 standard +extended
7 YEAR TOTAL WARRANTY
*for industrial usage 3 years warranty

The residual current device works with no extra power supply to the operating mechanism. It compares the magnitude of the currents through the neutral and phase conductors. The conductors are coiled on toroid and together with the secondary winding form a measurement transformer. The power conductors are coiled in such a way that the magnetic fields generated at electrical current flow through them are mutually neutralized. At failure in the insulation of some of the conductors or at presence of a person under voltage, the system is misbalanced and the magnetic fields can not be neutralized. This residual field generates in the secondary current winding, called current leakage. The device breaks when the value of this current exceeds the limit value of the residual current breaker.

- Joining terminal: flat (tunnel) screw terminal made of 1.5 coldly draw-plated plane Q235A
- Type of the plastic:
 - material: self-extinguishing nylon PA66
 - permittivity strength: > 18MV/m
- Contact head: silver graphite CAg(5)
- Static contact: pure copper T2Y2 type
- Electrical wear resistance (number of cycles): ≥5000
- Mechanical wear resistance (number of cycles): ≥10000
- IP code: IP>20
- Indication for operating (switched on) position
- Plastic material of the breakers of UV rays and non-flammable
- Ambient temperature: -10°C + 65°C
- Installation altitude: up to 2000m

FUNCTIONS:

- switching off heavy-loaded electrical circuits at insulation damage of the conductors to the consumers
- switching off heavy-loaded electrical circuits at presence of a person under voltage
- used to protect not only particular consumers/ circuits, but also the whole panel
- remarkable with high reliability of current characteristics
- control: manual switching on and automatic switching off at exit failure

CONNECTING:

- power supply busbar (only for bipolar)
- flexible or rigid conductors with corresponding section

MOUNTING:

- on DIN-rail
- mounting position: vertical

The residual current device is mounted in the distribution box, and after the device the neutral conductor and the earthing conductor must not be connected together. In order to work accurately, the device must have three- or five-conductor grid with separate protective conductor (PE) (e.g. earthing system TN-S or TT with three or five conductors). The corpus of the consumer depending on the grid type must be connected either to the protective conductor or be earthed. (Fig.1)

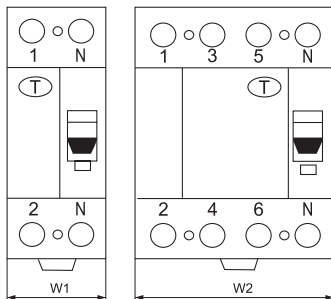

TECHNICAL DATA:

- Rated operating voltage: 230/400V; 50/60 Hz
- Rated current: according to the table
- Responsiveness: 30; 100; 300; 500mA
- Time delay until break: <0.1s at I Δ n and <0.04s at 2I Δ n
- Surge voltage wear resistance: ≥2000V
- Short circuit current wear resistance: 4500A, 6000A

Dimensions (mm)

W1	W2	H	H1	H2	D1	D2
35	70	81	35	45	50	72

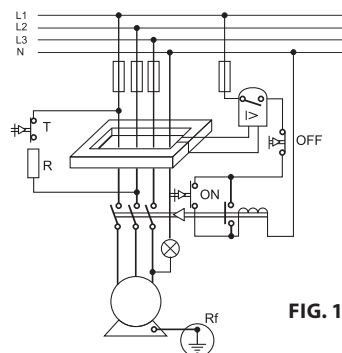
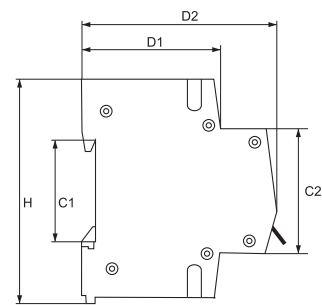
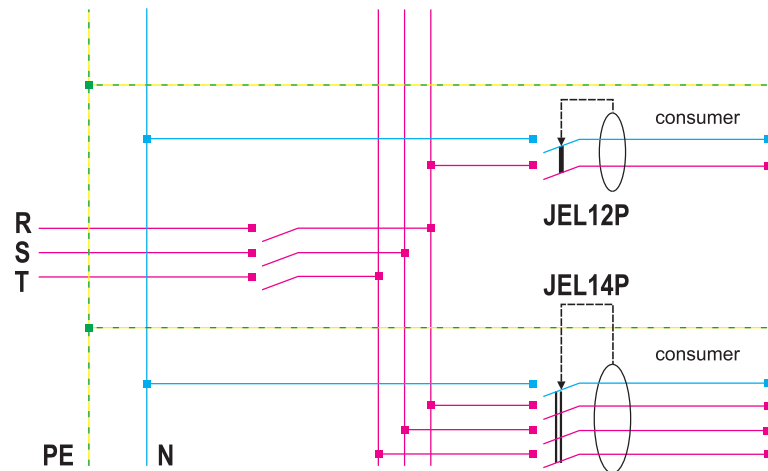

FIG. 1

CONNECTING SCHEME



In case of insufficient quantity in stock of any item listed on this page, the delivery time after order confirmation will be 90 days.

ELECTRO-MAGNETIC RESIDUAL CURRENT DEVICES (RCD) JEL1 AND JEF

7+0 standard +extended **7** YEAR TOTAL WARRANTY *for industrial usage 3 years warranty

Residual current devices JEL 1, 6kA - Type AC - alternating fault currents sensible. Impulse withstand voltage 2000VAC



TYPE AC FOR AC CURRENT

Type	Number of poles	Breaking capacity (kA)	Rated current In (A)	Packing/Box (pcs)	Product category	Catalogue number			
						Leakage current I Δ n (mA)			
						30	100	300	500
JEL 1	2P	6	10.0	1 / 60	B	40210	40212	40213	40214
JEL 1	2P	6	16.0	1 / 60	B	40216	40217	40218	40219
JEL 1	2P	6	20.0	1 / 60	B	40292	40293	40294	40295
JEL 1	2P	6	25.0	1 / 60	B	40221	40222	40223	40224
JEL 1	2P	6	32.0	1 / 60	B	40231	40232	40233	40234
JEL 1	2P	6	40.0	1 / 60	B	40241	40242	40243	40244
JEL 1	2P	6	63.0	1 / 60	B	40261	40262	40263	40264
JEL 1	2P	6	80.0	1 / 60	B	40281	40282	40283	40284
JEL 1	2P	6	100.0	1 / 60	B	40291	40296	40297	40298



TYPE AC FOR AC CURRENT

Type	Number of poles	Breaking capacity (kA)	Rated current In (A)	Packing/Box (pcs)	Product category	Catalogue number			
						Leakage current I Δ n (mA)			
						30	100	300	500
JEL 1	4P	6	10.0	1 / 30	B	40410	40412	40413	40414
JEL 1	4P	6	16.0	1 / 30	B	40416	40417	40418	40419
JEL 1	4P	6	20.0	1 / 30	B	40492	40493	40494	40495
JEL 1	4P	6	25.0	1 / 30	B	40421	40422	40423	40424
JEL 1	4P	6	32.0	1 / 30	B	40431	40432	40433	40434
JEL 1	4P	6	40.0	1 / 30	B	40441	40442	40443	40444
JEL 1	4P	6	63.0	1 / 30	B	40461	40462	40463	40464
JEL 1	4P	6	80.0	1 / 30	B	40481	40482	40483	40484
JEL 1	4P	6	100.0	1 / 30	B	40491	40496	40497	40498



TYPE AC FOR AC CURRENT

Type	Number of poles	Breaking capacity (kA)	Rated current In (A)	Packing/Box (pcs)	Product category	Leakage current I Δ n (mA)	Catalogue number
JEF*	2P	4.5	10	1/60	F	300	40713JEF
JEF*	2P	4.5	10	1/60	F	30	40710JEF
JEF*	2P	4.5	16	1/60	F	300	40718JEF
JEF*	2P	4.5	20	1/60	F	300	40794JEF
JEF*	2P	4.5	25	1/60	F	300	40723JEF
JEF*	2P	4.5	32	1/60	F	300	40733JEF
JEF*	2P	4.5	63	1/60	F	300	40763JEF

*3 year standard+0 year extended warranty



UNTIL SUPPLY
LAST

In case of insufficient quantity in stock of any item listed on this page, the delivery time after order confirmation will be 90 days.

Documents corresponding to the product:

EN 61008-1
EN 61008-2; EN 60947-1



TYPE A FOR AC/DC CURRENT



TYPE A FOR AC/DC CURRENT



TYPE A FOR AC/DC CURRENT

ELECTRO-MAGNETIC RESIDUAL CURRENT DEVICES (RCD) JEL1A

7+0 standard +extended **7** YEAR TOTAL WARRANTY *for industrial usage 3 years warranty

These are Residual Current Devices (RCDs) JEL 1A with enhanced sensibility and fast - operating protection devices applicable in circuits with harmonic or direct pulsating current component presence.

FUNCTIONS:

- switching off electrical circuits on load at conductor insulation breaking to the consumer
- switching off electrical circuits on load at direct and indirect contact
- switching off electrical circuits on load at alternating earth fault currents during consequent light impact
- switching off consumers at harmonic presence due to luminescent lights
- switching off consumers in DC circuits at fault currents presence
- mechanical indicator for ON position

TECHNICAL DATA:

- Rated operating voltage: 230/400V; 50 Hz
- Rated current: according to the table
- Responsiveness: 30; 100; 300; 500mA
- Time delay until break: <0.1s at I Δ n and <0.04s at 2I Δ n
- Short circuit current wear resistance: 6000A
- Electrical wear resistance (number of cycles): ≥10000
- Mechanical wear resistance (number of cycles): ≥10000
- IP code: IP>20

CONNECTING:

- power supply busbar (only for bipolar)
- flexible or rigid conductors with corresponding section

MOUNTING:

- on DIN-rail
- mounting position: vertical

Residual current devices JEL 1A, 6kA - Type A - alternating and pulsating direct fault currents sensible Impulse withstand voltage 2000VAC/ 400VDC

Type	Number of poles	Breaking capacity (kA)	Rated current In (A)	Packing/Box (pcs)	Product category	Catalogue number			
						Leakage current I Δ n (mA)			
						30	100	300	500
JEL 1A	2P	6	10.0	1 / 60	B	40510	40512	40513	40514
JEL 1A	2P	6	16.0	1 / 60	B	40516	40517	40518	40519
JEL 1A	2P	6	20.0	1 / 60	B	40592	40593	40594	40595
JEL 1A	2P	6	25.0	1 / 60	B	40521	40522	40523	40524
JEL 1A	2P	6	32.0	1 / 60	B	40531	40532	40533	40534
JEL 1A	2P	6	40.0	1 / 60	B	40541	40542	40543	40544
JEL 1A	2P	6	63.0	1 / 60	B	40561	40562	40563	40564
JEL 1A	2P	6	80.0	1 / 60	B	40581	40582	40583	40584
JEL 1A	2P	6	100.0	1 / 60	B	40591	40596	40597	40598



Type	Number of poles	Breaking capacity (kA)	Rated current In (A)	Packing/Box (pcs)	Product category	Catalogue number			
						Leakage current I Δ n (mA)			
						30	100	300	500
JEL 1A	4P	6	10.0	1 / 30	B	40610	40612	40613	40614
JEL 1A	4P	6	16.0	1 / 30	B	40616	40617	40618	40619
JEL 1A	4P	6	20.0	1 / 30	B	40692	40693	40694	40695
JEL 1A	4P	6	25.0	1 / 30	B	40621	40622	40623	40624
JEL 1A	4P	6	32.0	1 / 30	B	40631	40632	40633	40634
JEL 1A	4P	6	40.0	1 / 30	B	40641	40642	40643	40644
JEL 1A	4P	6	63.0	1 / 30	B	40661	40662	40663	40664
JEL 1A	4P	6	80.0	1 / 30	B	40681	40682	40683	40684
JEL 1A	4P	6	100.0	1 / 30	B	40691	40696	40697	40698



In case of insufficient quantity in stock of any item listed on this page, the delivery time after order confirmation will be 90 days.

ELECTRO-MAGNETIC RESIDUAL CURRENT DEVICES (RCD) JEL2

3+0 standard +extended **3** YEAR TOTAL WARRANTY



TYPE AC FOR AC CURRENT

UNTIL SUPPLY LAST

Residual current devices JEL2, 4,5kA - Type AC - alternating fault currents sensible. Impulse withstand voltage 2000VAC

Type	Number of poles	Breaking capacity (kA)	Rated current In (A)	Packing/Box (pcs)	Product category	Catalogue number			
						Leakage current I Δ n (mA)			
						30	100	300	500
JEL 2	2P	4,5	10.0	1 / 60	F				
JEL 2	2P	4,5	16.0	1 / 60	F	40716		40718	
JEL 2	2P	4,5	32.0	1 / 60	F				
JEL 2	2P	4,5	40.0	1 / 60	F				40743 40744
JEL 2	2P	4,5	63.0	1 / 60	F				40763



TYPE AC FOR AC CURRENT

UNTIL SUPPLY LAST

Type	Number of poles	Breaking capacity (kA)	Rated current In (A)	Packing/Box (pcs)	Product category	Catalogue number			
						Leakage current I Δ n (mA)			
						30	100	300	500
JEL 2	4P	4,5	16.0	1 / 30	F				
JEL 2	4P	4,5	40.0	1 / 30	F				40844
JEL 2	4P	4,5	63.0	1 / 30	F			40863	40864



ELECTRO-MAGNETIC RESIDUAL CURRENT DEVICES (RCD) JEL2 SIGMA

3+0 standard +extended **3** YEAR TOTAL WARRANTY



TYPE AC FOR AC CURRENT

UNTIL SUPPLY LAST

Type	Number of poles	Breaking capacity (kA)	Rated current In (A)	Packing/Box (pcs)	Product category	Catalogue number			
						Leakage current I Δ n (mA)			
						30	100	300	500
JEL 2 SIGMA	2P	6	10.0	1 / 30	F			40213S	
JEL 2 SIGMA	2P	6	16.0	1 / 30	F				
JEL 2 SIGMA	2P	6	20.0	1 / 30	F			40294S 40295S	
JEL 2 SIGMA	2P	6	25.0	1 / 30	F			40223S	
JEL 2 SIGMA	2P	6	40.0	1 / 30	F			40242S	
JEL 2 SIGMA	2P	6	63.0	1 / 30	F			40262S 40263S	
JEL 2 SIGMA	4P	6	20.0	1 / 30	F	40492S		40494S	
JEL 2 SIGMA	4P	6	25.0	1 / 30	F			40423S	
JEL 2 SIGMA	4P	6	32.0	1 / 30	F			40432S	
JEL 2 SIGMA	4P	6	40.0	1 / 30	F				
JEL 2 SIGMA	4P	6	63.0	1 / 30	F				40464S



Documents corresponding to the product:

EN 61 009-1; EN 61009-2;

ELECTRO-MAGNETIC RESIDUAL CURRENT OPERATED CIRCUIT BREAKER (RCBO)- JEL5

7+0 standard +extended **7** YEAR TOTAL WARRANTY *for industrial usage 3 years warranty



TYPE AC FOR AC CURRENT

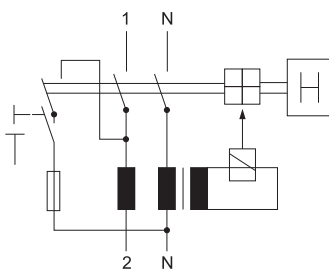
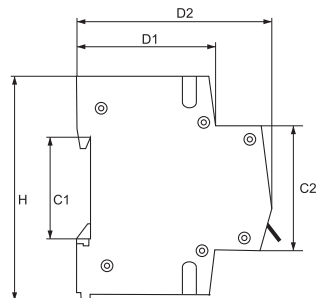
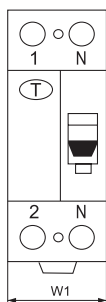

TYPE AC FOR AC CURRENT

DESCRIPTION OF THE OPERATING SYSTEM:

It is a combination of automatic circuit breaker and residual current electromagnetic device. It combines the properties of the two elements. The circuit breaker reacts at short circuit or overload in the protected circuit, and the electromagnetic residual current device - at failure in the conductors' insulation. It compares the magnitude of the currents through the neutral and phase conductors. The conductors are coiled on toroid and together with the secondary winding form a measurement transformer. The power conductors are coiled in such a way that the magnetic fields generated at electrical current flow through them are mutually neutralized. At failure in the insulation of some of the conductors or at presence of a person under voltage, the system is misbalanced and the magnetic fields can not be neutralized. This residual magnetic field generates in the secondary current winding, called current leakage. When the value of this current exceeds the limit value of the residual current breaker the device breaks and the residual current device switches off from the power supply grid. The device operates without any extra power supply to the electromagnetic residual current and is not influenced by voltage varying or decreasing.

FUNCTIONS:

- switching off heavy-loaded electrical circuits at short circuit or overload
- switching off heavy-loaded electrical circuits at insulation damage of the conductors to the consumers
- switching off heavy-loaded electrical circuits at presence of a person and animals under voltage
- used to protect not only particular consumers/circuits, but also the whole panel
- remarkable with high reliability of current characteristics
- control: manual switching on and automatic switching off at failure in the insulation after the breaker

TECHNICAL DATA:

- Rated operating voltage: 230V 50 Hz
- Circuit breaker rated current: according to the table
- Residual current responsiveness: 30; 100; 300; 500mA

- Time delay until break:
 - of the residual current device: <0.1s at I Δ n and <0.04s at 2I Δ n
 - of the circuit breaker: <0.1s
- Circuit breaker tripping curve: C
- Surge voltage wear resistance: ≥2000V
- Breaking capacity: 10000
- Joining terminal: flat (tunnel) screw terminal made of 1.5 coldly draw-plated plane Q235A
- Type of the plastic:
 - material: self-extinguishing nylon PA66
 - dielectrical strength: >18MV/m
- Contact head: silver graphite CAg(5)
- Static contact: pure copper T2Y2 type
- Electrical wear resistance (number of cycles): ≥5000
- Mechanical wear resistance (number of cycles): ≥10000
- IP code: IP>20
- Indication for operating (switched on) position
- Breakers plastic material of UV rays and non-flammable
- Ambient temperature: -10°C + 65°C
- Installation altitude: up to 2000m

CONNECTING:

- flexible or rigid conductors with corresponding section

MOUNTING:

- on DIN-rail
- mounting position: vertical

The residual current device is mounted in the distribution box, and after the device the neutral conductor and the earthing conductor must not be connected together. In order to work accurately, the device must have three- or five-conductor grid with separate operating neutral conductor (N) and separate protecting conductor (PE) (e.g. earthing system TN-S or TT with three or five conductors).

Dimensions (mm)

W1	H	C1	C2	D1	D2
35	81	35	45	50	72

Combined electromagnetic residual current device and circuit breaker 2P 6kA

Type designation	Number of poles	Breaking capacity (kA)	Rated current (A)	Packing / Box (pcs)	Product category	Catalogue number			
						Leakage current I Δ n (mA)			
						30	100	300	500
JEL5	2p	6	10	1 / 60	B	40010	40011	40013	40015
JEL5	2p	6	16	1 / 60	B	40016	40017	40018	40019
JEL5	2p	6	25	1 / 60	B	40025	40021	40023	40026
JEL5	2p	6	32	1 / 60	B	40032	40031	40033	40035
JEL5	2p	6	40	1 / 60	B	40040	40041	40043	40045



In case of insufficient quantity in stock of any item listed on this page, the delivery time after order confirmation will be 90 days.

Documents corresponding to the product:

EN 61 009-1; EN 61009-2;

ELECTRONIC RESIDUAL CURRENT OPERATED CIRCUIT BREAKER (RCBO)

7+0 standard +extended **7** YEAR TOTAL WARRANTY *for industrial usage, 3 years warranty



TYPE AC FOR AC CURRENT

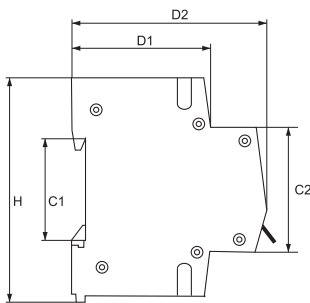
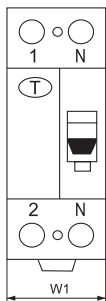

DESCRIPTION OF THE OPERATING SYSTEM:

It is a combination of automatic circuit breaker and residual current electromagnetic device. It combines part of the properties of the two elements. The circuit breaker reacts at short circuit in the protected circuit, and the electromagnetic residual current device - at failure in the conductors' insulation. It compares the rate of the currents through the conductors in an electronic comparator. The residual current device operates normally at voltage feed. The voltage is needed for the comparator's energizing – a semi-conductor element with constantly set leakage current rate. This rate is compared with the actual rate. When the margin of the comparison is neutral, the residual current device does not operate, but at failure in the protected circuit insulation when it exceeds the set margin it operates and switches off the protection. For the normal operation of the residual current device, the power supplying circuit voltage must be over 170V and there must be no time variation.

FUNCTIONS:

- switching off heavy-loaded electrical circuits at short circuit or overload
- switching off heavy-loaded electrical circuits at insulation damage of the conductors to the consumers
- switching off heavy-loaded electrical circuits at presence of a person under voltage
- used to protect not only particular consumers/ circuits, but also the whole panel
- remarkable with high reliability of current characteristics
- control: manual switching on and automatic switching off at exit failure

TECHNICAL DATA:

- Rated operating voltage: 230/400V 50 Hz
- Circuit breaker rated current: according to the table
- Residual current responsiveness: 30; 100; 300; 500mA
- Time delay until break:
 - of the residual current device: <0.1s at I Δ n and <0.04s at 2I Δ n
 - of the circuit breaker: <0.1s
- Circuit breaker tripping curve: C
- Surge voltage wear resistance: ≥2000V
- Breaking capacity: 4500A; 6000A; 10000A
- Joining terminal: flat (tunnel) screw terminal
- Electrical wear resistance (number of cycles): ≥500
- Mechanical wear resistance (number of cycles): ≥2000
- IP code: IP>20
- Indication for operating (switched on) position

CONNECTING:

- power supply busbar (for two- or three polar)
- flexible or rigid conductors with corresponding section

MOUNTING:

- on DIN-rail
- mounting position: vertical
- Breakers plastic material of UV rays and non-flammable
- Ambient temperature: -10°C + 65°C
- Installation altitude: up to 2000m

The residual current device is mounted in the distribution box, and after the device the neutral conductor and the earthing conductor must not be connected together. In order to work accurately, the device must have separate conductors for operational neutral conductor (N) and protective conductor (e.g. earthing system TN-S or TT with three or five conductors).

Dimensions (mm)

W1	H	C1	C2	D1	D2
35	81	35	45	50	72



TYPE AC FOR AC CURRENT

Combined electronic residual current device with circuit breaker 2P, 6kA

Type designation	Number of poles	Breaking capacity (kA)	Rated current (A)	Packing / Box (pcs)	Product category	Catalogue number	
						Leakage current I _{Δn} (mA)	
JEL 4 C10	2p	6	10	1 / 60	B	30	40211CE
JEL 4 C16	2p	6	16	1 / 60	B		40215CE
JEL 4 C20	2p	6	20	1 / 60	B		40225CE
JEL 4 C25	2p	6	25	1 / 60	B		40240CE
JEL 4 C32	2p	6	32	1 / 60	B		40265CE
JEL 4 C40	2p	6	40	1 / 60	B		40274CE



ELECTRONIC RESIDUAL CURRENT OPERATED CIRCUIT BREAKER (RCBO) JEL3

7+0 standard +extended **7** YEAR TOTAL WARRANTY *for industrial usage, 3 years warranty



TYPE AC FOR AC CURRENT

Combined electronic residual current device with circuit breaker 2P, 10kA

Type designation	Number of poles	Breaking capacity (kA)	Rated current (A)	Packing/Box (pcs)	Leakage current I _{Δn} (mA)	Product category	Catalogue number curve B	Catalogue number curve C
JEL 3 C6	1p+N	10	6	5/100	30	B	40906B	40906
JEL 3 C10	1p+N	10	10	5/100	30	B	40910B	40910
JEL 3 C16	1p+N	10	16	5/100	30	B	40916B	40916
JEL 3 C20	1p+N	10	20	5/100	30	B	40920B	40920
JEL 3 C25	1p+N	10	25	5/100	30	B	40925B	40925
JEL 3 C32	1p+N	10	32	5/100	30	B	40932B	40932
JEL 3 C40	1p+N	10	40	5/100	30	B	40940B	40940



Combined electronic residual current device with circuit breaker 2P, 6kA

Type designation	Number of poles	Breaking capacity (kA)	Rated current (A)	Packing/Box (pcs)	Leakage current I _{Δn} (mA)	Product category	Catalogue number curve B	Catalogue number curve C
JEL 3 B6	1p+N	6	6	5/100	30	B	40956B	40956C
JEL 3 B10	1p+N	6	10	5/100	30	B	40960B	40960C
JEL 3 B16	1p+N	6	16	5/100	30	B	40966B	40966C
JEL 3 B20	1p+N	6	20	5/100	30	B	40970B	40970C
JEL 3 B25	1p+N	6	25	5/100	30	B	40975B	40975C
JEL 3 B32	1p+N	6	32	5/100	30	B	40982B	40982C
JEL 3 B40	1p+N	6	40	5/100	30	B	40990B	40990C



TYPE AC FOR AC CURRENT



In case of insufficient quantity in stock of any item listed on this page, the delivery time after order confirmation will be 90 days.

3+0 standard +extended **3** YEAR TOTAL WARRANTY

ELECTRONIC RESIDUAL CURRENT OPERATED CIRCUIT BREAKER (RCBO) JEL6



UNTIL SUPPLY LAST

Combined electronic residual current device 2P

Compares the leakage current between the phase and neutral conductors or between two phases.

Type designation	Number of poles	Breaking capacity (kA)	Rated current (A)	Packing / Box (pcs)	Product category	Catalogue number
						Leakage current I _{Δn} (mA)
						30
JEL 6 C50	2P	6	50	6 / 120	F	40265



UNTIL SUPPLY LAST

Combined electronic residual current device 3P

Compares the leakage current between the phases

Type designation	Number of poles	Breaking capacity (kA)	Rated current (A)	Packing / Box (pcs)	Product category	Catalogue number
						Leakage current I _{Δn} (mA)
						30 300
JEL 6 C16	3P	6	16	3 / 60	F	40318
JEL 6 C25	3P	6	25	3 / 60	F	40325 40323
JEL 6 C40	3P	6	40	3 / 60	F	40340 40343



UNTIL SUPPLY LAST

Combined electronic residual current device 3P+N

Compares the leakage current between the three phases and neutral conductors.

Type designation	Number of poles	Breaking capacity (kA)	Rated current (A)	Packing / Box (pcs)	Product category	Catalogue number
						Leakage current I _{Δn} (mA)
						300
JEL 6 C40	3P+N	6	40	2 / 40	F	40447
JEL 6 C50	3P+N	6	50	2 / 40	F	40436





COMBINED SURGE ARRESTERS TYPE 1 + 2

7+0 standard +extended
7 YEAR TOTAL WARRANTY
*for industrial usage, 3 years warranty

Combined surge arresters Type 1 + 2 are coordinated in advance. They can manage and prevent the high energy during a thunderbolt and to assure the better level of security of electricity of the electrical equipment

Surge arresters Type 1 is used to catch the energy caused by higher electricity compared to the capacity of direct thunderbolt. The security device has passed a successful test according to the standards with electric wave 10/350 (class 1 test).

Surge arresters Type 2 is used to catch the energy caused by higher electricity, compared to the capacity of indirect strike or commutative overvoltage. The security device has passed a successful test according to the standards with electric wave 8/20 (class 2 test).

Response time: <25 nS
Voltage protection level: 1,5kV

Type of arrester	Max inpluse current limp (10/350µS)	Max discharge current I _{max} (8/20 µS)	Nominal line voltage Un (V)	Earthing system	Product category	Catalogue number
SPD-X/1P+N	12.5kA	50kA	230	TT,TN-S	B	64502
SPD-X/3P	12.5kA	50kA	230/400	TN-C	B	64503
SPD-X/3P+N	12.5kA	50kA	230/400	TT,TN-S	B	64504



Three phase protection TN-C system

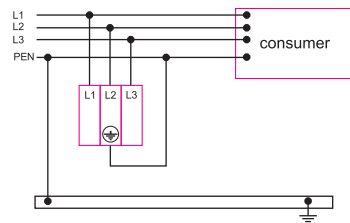

Three phase protection TN-S system

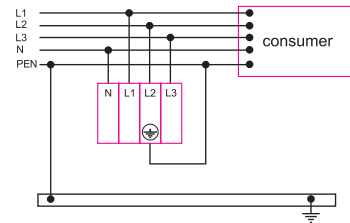

Monophase protection TT system

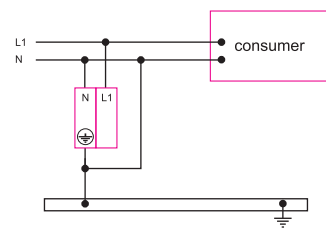

Documents corresponding to the product:

Standard EN61 643-1



TYPE AC FOR AC CURRENT

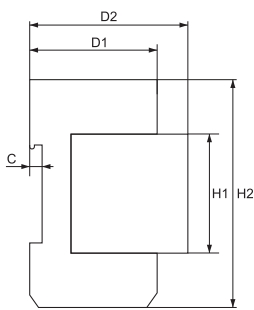

Dimensions (mm)

C	H1	H2	D1	D2
5	90	45	43,5	58

SURGE ARRESTERS SPD TYPE

7+0 standard +extended **7** YEAR TOTAL WARRANTY *for industrial usage 3 years warranty

The surge arrester consists of a semi-conductor valve element that opens at certain conditions. At normal conditions of the system, the surge arrester has infinitely high resistance between the protected conductors and earthing circuit. At voltage increase due to atmospheric nature or system failure, the valve element opens and leads the excessive voltage to the grounded circuit.

After reversion of the normal voltage the valve element closes. The arrester can endure high momentary overloading.

FUNCTIONS:

- protection of heavy-loaded electrical circuits from overload
- used to protect not only particular consumers/ circuits, but also the whole panel
- remarkable with high reliability of current characteristics
- control: automatic switching off at exit failure and recovery after eliminating the danger

TECHNICAL DATA:

- Rated operating voltage U_c : - the operating voltage of the surge arrester 275/440V; 50Hz
- Surge voltage U_p : the voltage created in surge arrester terminals at rated discharge current running:

according to the tables

- Rated discharge current I_n – the rated value of discharge current with a sinusoid 8/20 μ s, which can be repeatedly led to the ground: according to the tables
- Full discharge current I_{max} – the peak value of the discharge current with a sinusoid 8/20 μ s, which the surge arrester can bear once: according to the table
- Constant operating current: up to 800 μ A for 1P, 2P and 3P; up to 600 μ A for 1P + N, 3P + N
- Indication for damaged surge arrester
- Offered in types: 1P; 1P + N; 3P; 3P + N

CONNECTING:

- flexible or rigid conductors with corresponding section

MOUNTING:

- on DIN-rail
- mounting position: vertical
- mounting in the distribution box on the front or right before the breaker according to the attached schemes
- Breakers plastic material of UV rays and non-flammable
- Ambient temperature: -10°C + 65°C
- Installation altitude: up to 2000m

COLOUR CODE for all types 5kA - yellow; white – 10kA; green – 20 kA and red 40kA

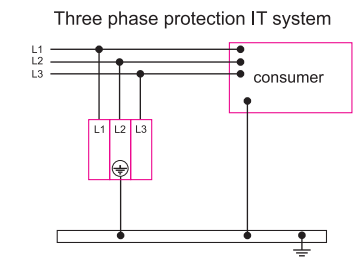
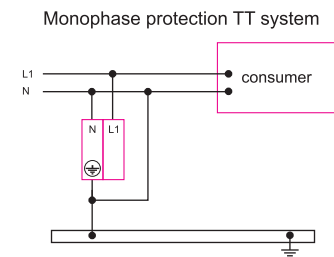
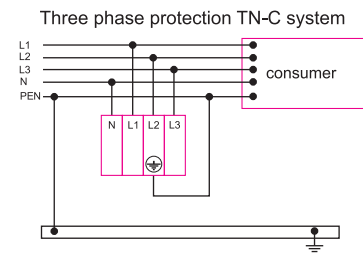
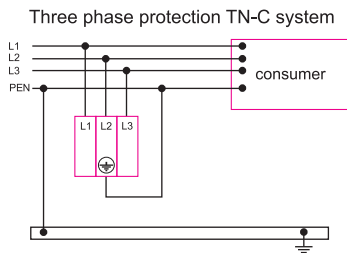

The surge arrester selection is made according to the overload risk level or atmosphere activity, named B, C or D (from high to low risk level).

THE COMPANY OFFERS THE FOLLOWING MODELS OF ARRESTERS:

- Model SPD – Bxxxx – for systems with exceptionally high risk level. Mounted mainly in the beginning of the installation or in the main panel.
- Model SPD – Cxxxx – for systems with high or average risk level. Mounted in the beginning of the installation or before the breaker.
- Model SPD – Dxxxx – for systems with low risk level. Suitable for secondary protection of consumers in combination with SPD – Bxxxx/SPD – Cxxxx

In case of insufficient quantity in stock of any item listed on this page, the delivery time after order confirmation will be 90 days.



Type of the arrester	In (kA)	I _{max} (kA)	U _c (V)	U _p (kV)	Packing/Box (pcs)	Product category	Catalogue number
SPD-D5/1p	5	10	275	1.2	17 / 170	B	64101
SPD-C10/1p	10	20	275	1.2	17 / 170	B	64102
SPD-C20/1p	20	40	275	1.8	17 / 170	B	64103
SPD-B40/1p	40	60	275	2	17 / 170	B	64104



Type of the arrester	In (kA)	I _{max} (kA)	U _c (V)	U _p (kV)	Packing/Box (pcs)	Product category	Catalogue number
SPD-D5/1pN	5	10	275	1.2	8 / 80	B	64201
SPD-C10/1pN	10	20	275	1.2	8 / 80	B	64202
SPD-C20/1pN	20	40	275	1.8	8 / 80	B	64203
SPD-B40/1pN	40	60	275	2	8 / 80	B	64204



Type of the arrester	In (kA)	I _{max} (kA)	U _c (V)	U _p (kV)	Packing/Box (pcs)	Product category	Catalogue number
SPD-D5/3p	5	10	440	1.2	5 / 50	B	64301
SPD-C10/3p	10	20	440	1.2	5 / 50	B	64302
SPD-C20/3p	20	40	440	1.8	5 / 50	B	64303
SPD-B40/3p	40	60	440	2	5 / 50	B	64304



Type of the arrester	In (kA)	I _{max} (kA)	U _c (V)	U _p (kV)	Packing/Box (pcs)	Product category	Catalogue number
SPD-D5/3pN	5	10	440	1.2	4 / 40	B	64401
SPD-C10/3pN	10	20	440	1.2	4 / 40	B	64402
SPD-C20/3pN	20	40	440	1.8	4 / 40	B	64403
SPD-B40/3pN	40	60	440	2	4 / 40	B	64404

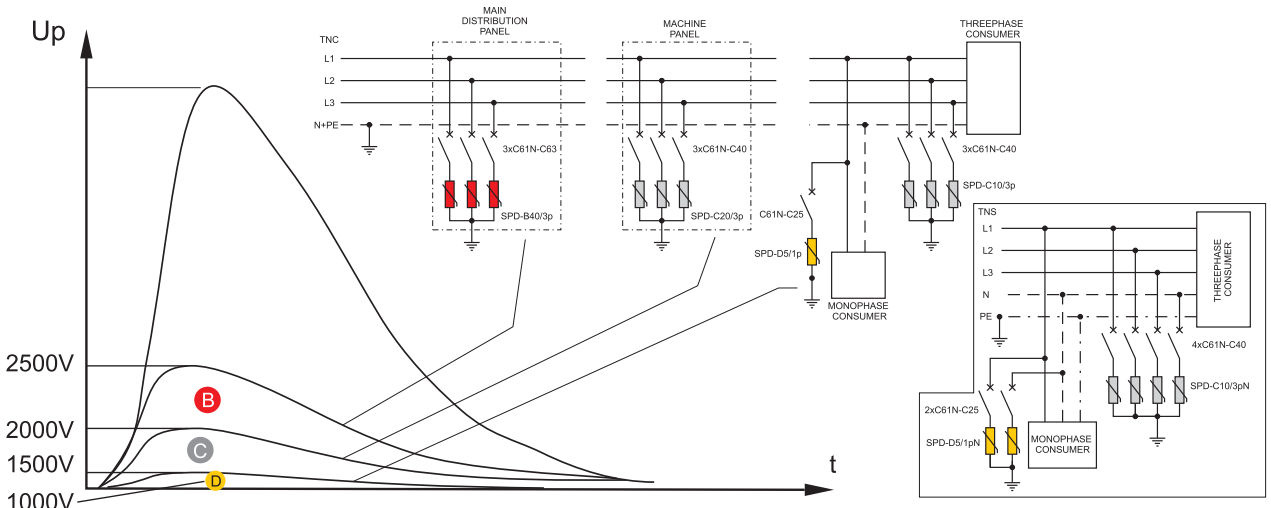

In case of insufficient quantity in stock of any item listed on this page, the delivery time after order confirmation will be 90 days.

COMBINED SURGE ARRESTERS AC – DC

7+0 standard +extended **7** YEAR TOTAL WARRANTY *for industrial usage, 3 years warranty

Specially designed surge arresters providing protection of solar and photo - voltaic systems; designed to protect system against overvoltages resulting from indirect light impact. They could be installed in earthed and non - earthed systems. They break photo - voltaic generator electric circuit when voltage reaches or over passes limit threshold value, providing photo - voltaic protection against destroying.

COLOUR CODE for all types 5kA - yellow; white – 10kA; green – 20 kA and red 30kA



TYPE AC FOR AC/DC CURRENT

Type of the arrester	In (kA)	I _{max} (kA)	U _c (V)	U _p (kV)	Packing/Box (pcs)	Product category	Catalogue number
SPD-DC-D5/1p	5	10	275 AC/440 DC	≤ 1.2	17 / 170	B	64105
SPD-DC-C10/1p	10	20	275 AC/440 DC	≤ 1.5	17 / 170	B	64106
SPD-DC-C20/1p	20	40	275 AC/440 DC	≤ 1.8	17 / 170	B	64107
SPD-DC-B40/1p	30	60	275 AC/440 DC	≤ 2.2	17 / 170	B	64108



TYPE AC FOR AC/DC CURRENT

Type of the arrester	In (kA)	I _{max} (kA)	U _c (V)	U _p (kV)	Packing/Box (pcs)	Product category	Catalogue number
SPD-DC-D5/1pN	5	10	275 AC/440 DC	≤ 1.2	8 / 80	B	64205
SPD-DC-C10/1pN	10	20	275 AC/440 DC	≤ 1.5	8 / 80	B	64206
SPD-DC-C20/1pN	20	40	275 AC/440 DC	≤ 1.8	8 / 80	B	64207
SPD-DC-B40/1pN	30	60	275 AC/440 DC	≤ 2.2	8 / 80	B	64208



TYPE AC FOR AC/DC CURRENT

Type of the arrester	In (kA)	I _{max} (kA)	U _c (V)	U _p (kV)	Packing/Box (pcs)	Product category	Catalogue number
SPD-DC-D5/3p	5	10	385 AC/500 DC	≤ 1.2	5 / 50	B	64305
SPD-DC-C10/3p	10	20	385 AC/500 DC	≤ 1.5	5 / 50	B	64306
SPD-DC-C20/3p	20	40	385 AC/500 DC	≤ 1.8	5 / 50	B	64307
SPD-DC-B40/3p	30	60	385 AC/500 DC	≤ 2.2	5 / 50	B	64308





Documents corresponding to the product:

Standard EN 60947-1; EN 60 947-4-1
 The products are in accordance with the directives of EC "Low voltage directives (LVD) no. 2006/95/EC" and "Electromagnetic Compatibility Directives (EMC) no. 2004/108/EC".

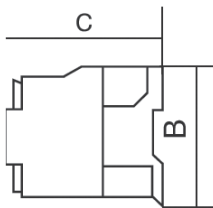

LH1-D09-32

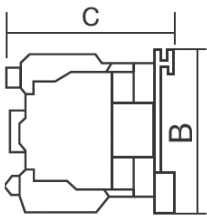
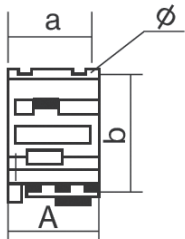

LH1-D40

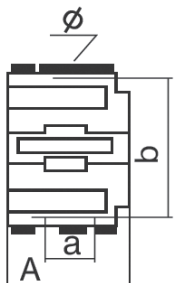

UNTIL SUPPLY
LAST

LOW VOLTAGE CONTACTORS LH1 - D

LH1 D contactors are alternating current contactors for control of circuits and consumers operating in class AC3.

It is suitable for consumers with rated current up to 95A. The contactors are offered in a type with 1 NO contact for operating circuit making and the models over 40A also have 1NC operating contactor.

FUNCTIONS:

- switching on/off heavy-loaded electrical circuits at controlling signal to the coil
- making of control systems
- used as an operating element in process control panels
- remarkable with high reliability of current characteristics
- reliable separation of power contactors
- secured cover of the movable part of the contactor

TECHNICAL DATA:

- Operation class: AC 3
- Rated operating voltage of power contactors: up to 690V; 50/60Hz

- Composition of the power contact surfaces: unalloyed copper with coating 80% AgSnO
- Surge voltage wear resistance: >6000V
- Rated voltage of the coil: from 12 to 400V AC
- Limits of the controlling coil voltage: from 0.8 to 1.15 U_c
- Joining terminal: screw terminal
- Connecting:
 - flexible conductors with or without cable terminal
 - rigid conductors
- Electrical wear resistance (number of cycles): ≥500000
- Mechanical wear resistance (number of cycles): ≥500000
- Number of cycles per hour: 500 UP TO 32A; 600 for 40-95A
- Pole leaking power: up to 10W

MOUNTING:

- on DIN-rail or
- -ith bolts to the surface
- mounting position: vertical gradient – maximum ± 5°
- Ambient temperature: -10°C + 60°C
- Altitude: up to 2000m

Type	Overall dimensions (mm)					
	a	b	∅	A	B	C
LH1 - D09-12	34/35	50/60	4.5	47	70	82
LH1 - D2510	40	48	4.5	57	80	95
LH1 - D3210	40	48	4.5	57	80	100
LH1 - D4011	40	100	6.5	77	126	116

Type number	Motor rated capacity (kW)					Coil capacity (VA)		Rated current in AC-3 440Vtp up	Tightening moment (N.m)	Coil voltage	Packing/ Box (pcs)	Product category	Catalogue number
	220V	380V	415V	440V	660V	closed	open						
LH1 - D3210 1NO	7.5	15	15	15	18.5	7.5	90	32A	2.5	230	1/50	F	73321
										400			73322



Documents corresponding to the product:

Standard EN 60947-1; EN 60 947-4-1



LOW VOLTAGE CONTACTORS LT1-D/HK

5+2 standard +extended **7** YEAR TOTAL WARRANTY *for industrial usage 3 years warranty

LT 1 D contactors are alternating current contactors for control of circuits and consumers operating in class AC3. It is suitable for consumers with rated current up to 95A. The contactors are offered in a type with 1 NO contact for operating circuit making and the models over 40A also have 1NC operating contactor.

FUNCTIONS:

- switching on/off heavy-loaded electrical circuits at controlling signal to the coil
- making of control systems
- used as an operating element in process control panels
- remarkable with high reliability of current characteristics
- reliable separation of power contactors
- secured cover of the movable part of the contactor

TECHNICAL DATA:

- Operation class: utilization category AC-3
- Rated operating voltage of power contactors: up to 690V; 50/60Hz
- Composition of the power contact surfaces: unalloyed copper with coating 80% AgSnO
- Surge voltage wear resistance: >8000V
- Rated voltage of the coil: from 12 to 400V AC

- Coil material: pure copper type QA-1
- Magnetic core material: alloy steel type 360
- Moveable part material: Bakelite
- Limits of the controlling coil voltage: operating range of coil
- Joining terminal: screw terminal
- Connecting:
 - flexible conductors with or without cable terminal
 - rigid conductors
- Electrical wear resistance (number of cycles): ≥1000000
- Mechanical wear resistance (number of cycles): ≥10000000
- Number of cycles per hour: 1200 UP TO 32A; 600 for 40-95A
- Pole leaking power: up to 13W

MOUNTING:

- on DIN-rail
- with bolts to the surface
- mounting position: vertical gradient – maximum ± 5°
- Plastic: wear resistance of UV rays and non-flammable (self-extinguishing material)
- Ambient temperature: -10°C + 65°C
- Altitude: up to 2000m



Type	Overall dimensions (mm)					
	a	b	∅	A	B	C
LT1-HK 06~12/LT-1K	34/35	45	4.5	45	50	50
LT-D 09~12	34/35	50/60	4.5	47	70	82
LT1 D18	34/35	50/60	4.5	47	70	87
LT1 D25	40	48	4.5	57	80	95
LT1 D32	40	48	4.5	57	80	100
LT-D 40~65	40	100/110	6.5	77	126	116
LT-D 80~95	40	100/110	6.5	87	126	127

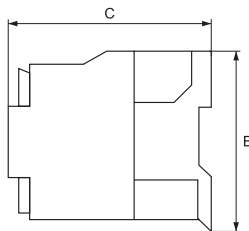

LT1-D 09~32
LT1 - K

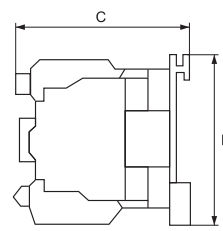
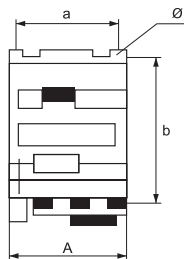

LT-D 95~40

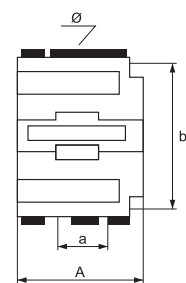

Type number	Rated capacity (kW)					Power consumption of coil (VA)		Rated current in AC-3 440V to up	Tightening moment (N.m)	Section of the power supply conductor	Packing/ Box (pcs)	Product category	Catalogue number according to the coil voltage (V)						
	220V 230V	380V 400V	415V	440V	660V 690V	closed inrush	open hold						230V	400V	12V	24V	36V	48V	110V
LT 1 - HK 0610 1NO	1.5	2.2	2.2	2.2	3	7	60	6A	1.7	0.75-2.5	1 / 100	B	23061E	23062E	23063E	23064E	23065E	23066E	23067E
LT 1 - HK 0910 1NO*	2.2	3.7	3.7	3.7	4	7	60	9A	1.7	0.75-2.5	1 / 100	F	23091E	23092E		23094E	23095E	23096E	23097E
LT 1 - HK 1210 1NO*	3	4	4	4	5	7	60	12A	1.7	0.75-2.5	1 / 100	F	23121E	23122E			23125E	23126E	23127E
LT 1 - HK 0610 1NO*	1.5	2.2	2.2	2.2	3	7	60	6A	1.7	0.75-2.5	1 / 100	F		23062	23063		23065	23066	23067
LT1 - D0910 1NO	2.2	4	4	4	5.5	7	60	9A	1.7	1-4	1 / 50	B	23091	23092	23093	23094	23095	23096	23097
LT1 - D0901 1NC	2.2	4	4	4	5.5	7	60	9A	1.7	1-4	1 / 50	B	23273	23270	23271	23272	23277	23278	23279
LT1 - D1210 1NO	3	5.5	5.5	5.5	7.5	7	60	12A	1.7	1-4	1 / 50	B	23121	23122	23123	23124	23125	23126	23127
LT1 - D1201 1NC	3	5.5	5.5	5.5	7.5	7	60	12A	1.7	1-4	1 / 50	B	23274	23280	23281	23282	23283	23284	23285
LT1 - D1810 1NO	4	7.5	9	9	10	7	60	18A	1.7	1-4	1 / 50	B	23181	23182	23183	23184	23185	23186	23187
LT1 - D1801 1NC	4	7.5	9	9	10	7	60	18A	1.7	1-4	1 / 50	B	23275	23286	23287	23288	23289	23290	23291
LT1 - D2510 1NO	5.5	11	11	11	15	7.5	90	25A	2.5	2.5-10	1 / 50	B	23251	23252	23253	23254	23255	23256	23257
LT1 - D2501 1NC	5.5	11	11	11	15	7.5	90	25A	2.5	2.5-10	1 / 50	B	23276	23292	23293	23294	23295	23296	23297
LT1 - D3210 1NO	7.5	15	15	15	18.5	7.5	90	32A	2.5	2.5-10	1 / 50	B	23321	23322	23323	23324	23325	23326	23327
LT1 - D4011 1NO+1NC	11	18.5	22	22	30	20	200	40A	5	2.5-16	1 / 20	B	23401	23402	23403	23404	23405	23406	23407
LT1 - D5011 1NO+1NC	15	22	25	25	33	20	200	50A	5	6-25	1 / 20	B	23501	23502	23503	23504	23505	23506	23507
LT1 - D6511 1NO+1NC	18.5	30	37	37	37	20	200	65A	5	6-25	1 / 20	B	23651	23652	23653	23654	23655	23656	23657
LT1 - D8011 1NO+1NC	22	37	45	45	45	20	200	80A	9	10-50	1 / 15	B	23801	23802	23803	23804	23805	23806	23807
LT1 - D9511 1NO+1NC	25	45	45	45	45	20	200	95A	9	10-50	1 / 15	B	23951	23952	23953	23954	23955	23956	23957



Note: *Until supply last - 3 year standard+0 year extended warranty

Documents corresponding to the product:

Standard EN 60947-1; EN 60 947-4-1

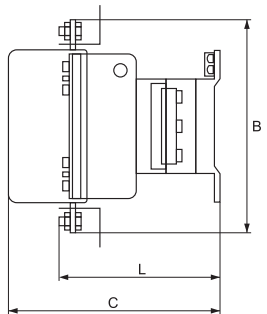
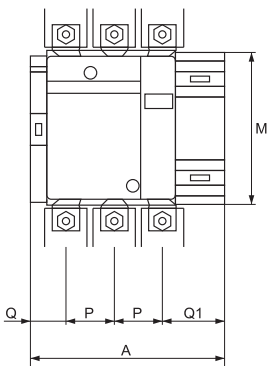

LOW VOLTAGE CONTACTORS LT1-F

5+2 standard +extended **7** YEAR TOTAL WARRANTY *for industrial usage 3 years warranty

The contactors LT 1- F are alternating current contactors used to control circuits and consumers operating in normal working conditions with switching on /off the consumer and dirty working environment. They are suitable for consumers with electrical power consumption from 115A to 800A.

FUNCTIONS:

- frequently switching on/off heavy-loaded electrical circuits at controlling signal to the coil
- making of systems for consumers' control
- used as an operating element in process control panels
- remarkable with high reliability of current characteristics
- reliable separation of power contactors
- secured cover of the movable part of the contactor

TECHNICAL DATA:

- Operation class: utilization category AC-3
- Rated operating voltage of power contactors: up to 1000V; 50/60Hz
- Composition of the power contact surfaces: unalloyed copper with coating 80% AgSnO
- Surge voltage wear resistance: >8000V
- Coil composition: pure coil copper QA-1 type
- Magnetic core composition: steel alloy 360

- Movable part composition: bakelite
- Limits of the controlling coil voltage: operating range of coil
- Joining terminal: screw terminal
- Connecting:
 - flexible conductors with or without cable terminal
 - rigid conductors
 - rail
- Electrical wear resistance (number of cycles): ≥10000000
- Mechanical wear resistance (number of cycles): ≥10000000
- Number of cycles (switching on) per hour: 200
- Pole leaking power: from 16 to 80W
- Mounting:
 - with bolts to the surface
 - mounting position: vertical gradient – maximum ± 10°C
- Plastic: wear resistance of UV rays and non-flammable (self-extinguishing material)
- Ambient temperature: -10°C + 65°C
- Altitude: up to 2000m

Type	Overall dimensions (mm)							
	A	B	C	L	M	Q	Q1	P
LT 1 F150	163.5	170	171	107	150	26	57.5	40
LT 1 F225	168.5	197	181	113.5	172	21	51.5	48
LT 1 F265	201.5	203	181	141	178	39	66.5	48
LT 1 F400	213	206	219	145	182	43	74	48
LT 1 F630	309	304	255	155	264	60	89	80
LT 1 F800	309	304	255	155	264	60	89	80

Type number	Motor rated capacity (kW)								Power consumption of coil (VA)	Rated current in AC-3 440V (N.m) to up	Tightening moment	Packing/ Box (pcs)	Product category	Catalogue number according to the coil voltage (V)					
	220V 230V	380V 400V	415V	440V	500V	660V 690V	1000V	closed						open	230V	400V	24V*	36V	48V
LT1 - F115	30	55	59	59	59	80	60	45	550	115 A	18	1 / 4	B	23111	23112	23114	23115	23116	23117
LT1 - F150	40	75	80	80	90	100	65	45	550	150 A	25	1 / 4	B	23151	23152		23155	23156	23157
LT1 - F225	63	110	110	110	129	129	100	55	805	225 A	35	1 / 2	B	23861	23862		23865	23866	23867
LT1 - F265	75	132	140	140	160	160	147	10	700	265 A	35	1 / 2	B	23261	23262		23265	23266	23267
LT1 - F400	110	200	220	250	257	280	185	18	1000	400 A	50	1 / 1	B	23751	23752				
LT1 - F630	200	335	375	400	400	450	450	25	1500	630 A	50	1 / 1	B	23771	23772				
LT1 - F800	250	450	450	450	450	475	450	15	1300	800 A	50	1 / 1	B	23881	23882				



Note: At mounting the containers from the series in control schemes a distance must be provided at the side of the contactor in case of eventual coil change.

*Until Supply Last- Product category F

In case of insufficient quantity in stock of any item listed on this page, the delivery time after order confirmation will be 90 days.

Documents corresponding to the product:

Standard EN60947-1; EN 60947-4-1

LOW VOLTAGE CONTACTORS WITH DIRECT CURRENT COIL LP1-D

5+2 standard +extended **7** YEAR TOTAL WARRANTY *for industrial usage 3 years warranty

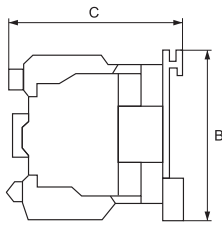
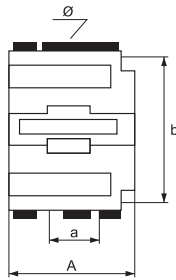

LP1-D 09~95

The contactors LP1 D are alternating current contactors with DC operating of coil for control. The power plugs of the contactor are designed for control of alternating current circuits and consumers operating in normal operating class AC-3 with frequently switching on/off the consumer and dirty working environment. The contactors are suitable for consumers with electrical power consumption from 9A to 225A.

FUNCTIONS:

- switching on/off alternating current consumers in direct current controlling schemes at controlling signal to the coil
- making of systems for consumers' control
- used as an operating element in process control panels
- remarkable with high reliability of current characteristics
- reliable separation of power contacts
- secured cover of the movable part of the contactor

TECHNICAL DATA:

- Rated operating voltage of the coil: from 12V DC to 220V DC
- Rated operating voltage of the power circuit: up to 690V DC
- insulation voltage: 690V

- Surge voltage wear resistance: >8000V
- Limits of the controlling coil voltage: operating range of coil
- Joining terminal: screw terminal
- Connecting:
 - flexible conductors with or without cable terminal
 - rigid conductors
- Electrical wear resistance (number of cycles): ≥10000000
- Mechanical wear resistance (number of cycles): ≥10000000
- Number of cycles per hour: 1200 up to 32A; 600 for 40-95A
- Pole leaking power: up to 13W

MOUNTING:

- on DIN-rail
- with bolts to the surface
- mounting position: vertical gradient – maximum ± 5°
- Plastic: wear resistance of UV rays and non-flammable (self-extinguishing material)
- Ambient temperature: -10°C + 65°C
- Altitude: up to 2000m

Type	Overall dimensions (mm)				
	A	B	C	a	b
LP 1 D0910	47	76	95	34/35	50/60
LP 1 D1210	47	76	95	34/35	50/60
LP 1 D1810	47	76	95	34/35	50
LP 1 D2510	57	86	101	40	50
LP 1 D3210	57	86	101	40	50
LP 1 D4011	77	129	176	40	100
LP 1 D5011	77	129	176	40	100
LP 1 D6511	77	129	176	40	100
LP 1 D9511	87	129	182	40	100
LP 1 F115	163.5	170	171	40	150
LP 1 F150	163.5	170	171	40	150
LP 1 F225	168.5	197	181	48	172

Type	Rated current (A)	Auxiliary contact (pcs.)	Rated capacity of the consumer (kW)					Packing/Box (pcs)	Product category	Catalogue number according to the coil voltage (V DC)					
			230V	400V	415V	440V	690V			12V	24V	36V	48V	110V	230V
LP 1 D0910	9	1NO	2.20	4.00	4.00	4.00	5.50	1/40	B	23962	23098	23130	23971	23980	23139
LP 1 D1210	12	1NO	3.00	5.50	5.50	5.50	7.50	1/40	B	23963	23128	23131	23972	23981	23140
LP 1 D1810	18	1NO	4.00	7.50	7.50	7.50	10.0	1/30	B	23964	23188	23132	23973	23982	23141
LP 1 D2510	25	1NO	5.50	11.0	11.0	11.0	15.0	1/20	B	23925	23258	23133	23974	23983	23142
LP 1 D3210	32	1NO	7.50	15.0	15.0	15.0	18.5	1/30	B	23966	23328	23134	23975	23984	23143
LP 1 D4011	40	1NO+1NC	11.0	18.5	18.5	18.5	30.0	1/10	B	23967	23408	23135	23976	23985	23144
LP 1 D5011	50	1NO+1NC	15.0	22.0	22.0	22.0	33.0	1/10	B	23968	23508	23136	23977	23986	23145
LP 1 D6511	65	1NO+1NC	18.5	30.0	30.0	30.0	37.0	1/10	B	23969	23658	23137	23978	23987	23146
LP 1 D9511	95	1NO+1NC	25.0	45.0	45.0	45.0	45.0	1/10	B	23970	23958	23138	23979	23988	23147
LP 1 F115	115	1NO	30.0	55.0	59.0	59.0	80.0	1/4	B		23118*	23914	23917	23989	23148
LP 1 F150	150	1NO	40.0	75.0	80.0	80.0	100	1/4	B		23158*	23915	23918	23990	23149
LP 1 F225	225	1NO	63.0	110	110	110	129	1/2	B			23916	23919	23994	23201



In case of insufficient quantity in stock of any item listed on this page, the delivery time after order confirmation will be 90 days.

Documents corresponding to the product:

Standard EN60947-1; EN 60947-4-1

LOW VOLTAGE CONTACTORS FOR SWITCHING ON OF CAPACITOR BANKS CJ19-43

5+2 standard +extended
7 YEAR TOTAL WARRANTY
 *for industrial usage 3 years warranty

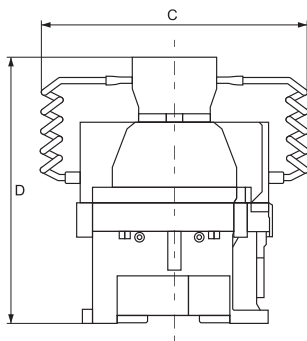
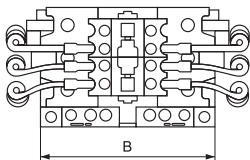
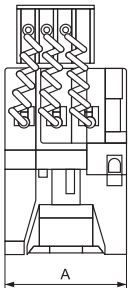

The AC contactors CJ19-43 are specially designed electrical devices for commutation of three phase capacitors used for power correction. They are alternating current contactor LT1 Dxx with mounted a group for peak current lowering from the transitional process of the capacitor's switching on/off. This group is a combination of current limiting resistors, switched on in the beginning of the transitional process (switching on/off of the capacitor group). The contactors are suitable for capacitors with rate up to 50 kVAr.

FUNCTIONS:

- switching on/off of capacitor banks for reactive power compensation
- making of systems for compensation of the energy reactive component
- lowering of the peak transitional currents at switching on/off of the capacitor
- remarkable with high reliability of current characteristics
- reliable separation of power contacts
- secured part of the contactor against consumer contact
- do not allow manual operation

TECHNICAL DATA:

- Operation class: utilization category AC6b
- Rated operating voltage of the controlling coil: 230V

AC; 50/60Hz

- Rated operating voltage of the power circuit: up to 690V AC
- insulation voltage: 690V
- Surge voltage wear resistance: >8000V
- Limits of the controlling coil voltage: from 0.8 to 1.15 U_c
- Number of the contacts: 3 NO power contacts +1NO operative
- Joining terminal: screw terminal
- Connecting:
 - flexible conductors with or without cable terminal
 - rigid conductors
- Electrical wear resistance (number of cycles): ≥300000
- Mechanical wear resistance (number of cycles): ≥1000000
- Number of cycles (switching on) per hour: up to 600
- Pole leaking power: up to 13W

MOUNTING:

- on DIN-rail or
- with bolts to the surface
- mounting position: vertical gradient – maximum ± 5°
- Plastic: wear resistance of UV rays and non-flammable (self-extinguishing material)
- Ambient temperature: -10°C + 65°C
- Altitude: up to 2000m

Type	Overall dimensions (mm)			
	A	B	C	D
CJ19-32 DPK	56	74	130	150
CJ19-40 DPK	75	127	180	150
CJ19-65 DPK	85	127	200	157
CJ19-95 DPK	85	127	200	157
CJ19-115DPK	122	165	230	157
CJ19-150DPK	122	165	230	157
CJ19-170DPK	122	165	230	157

Type	Rated current (A)	Rated capacity of the consumer (kVAr)		Coil voltage (V)	Packing/Box (pcs)	Product category	Catalogue number
		400/440V	690V				
CJ19-32 DPK	32	8	12.5	230	1/20	B	23932
CJ19-32 DPK	32	8	12.5	400	1/20	B	23910
CJ19-40 DPK	40	12.5	15	230	1/16	B	23900
CJ19-40 DPK	40	12.5	15	400	1/16	B	23940
CJ19-65 DPK	65	25	30	230	1/16	B	23961
CJ19-65 DPK	65	25	30	400	1/16	B	23965
CJ19-95 DPK	95	30	36	230	1/16	B	23909
CJ19-95 DPK	95	30	36	400	1/16	B	23995
CJ19-115 DPK	115	35	40	230	1/4	B	23991
CJ19-150 DPK	150	40	50	230	1/4	B	23992
CJ19-170 DPK	170	50	60	230	1/4	B	23993



In case of insufficient quantity in stock of any item listed on this page, the delivery time after order confirmation will be 90 days.

Documents corresponding to the product:

Standard EN60947-1; EN 60947-4-1

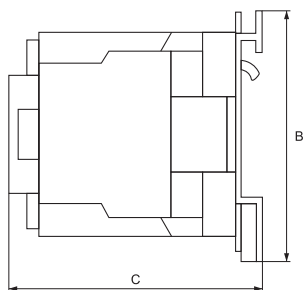
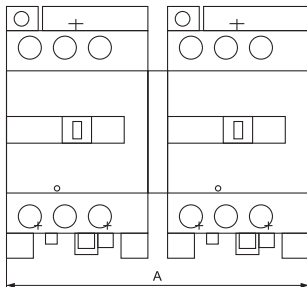

Type	Overall dimensions (mm)		
	A	B	C
LT 4 - D1810	100	70	83
LT 4 - D2510	130	80	98
LT 4 - D3210	130	80	105
LT 4 - D4011	167	126	116
LT 4 - D6511	167	126	116
LT 4 - D9511	182	127	127

REVERSE CONTACTORS LT4-DXX

5+2 standard +extended **7** YEAR TOTAL WARRANTY *for industrial usage, 3 years warranty

LT 4-Dxx series contactors is suitable for across- the line starting and reversing of-3 phase squirrel cage and slip ring motors. It consist of two magnetic contactors LT1D. The contactor is provided whit a built-in interlock safety mechanism. The contactor is used for reverse control of induction motors with shortly rotor. The contactors from the series are offered for consumers up to 95A.

FUNCTIONS:

- switching on of electrical motors in one direction of rotation and reversing of the rotation direction at outside command
- making of control systems
- remarkable with high reliability of current characteristics
- reliable switching on or separation of power contacts
- secured part of the contactors against consumer contact
- secured cover of the movable part of the contactor
- impossibility for simultaneous switching on of the two contactors from the group due to mechanical locking

TECHNICAL DATA:

- Operation class: AC 3
- Rated operating voltage of the controlling coil: 230V AC; 50/60 Hz
- Rated operating voltage of the power circuit: up to 690V AC

- insulation voltage: 690V
- Surge voltage wear resistance: >8000V
- Limits of the controlling coil voltage: from 0.8 to 1.15 U_c
- Number of plugs: 3 NO power contacts +1NO operative (for contactors over 40A there is also additional 1NC contact)
- Joining terminal: screw terminal
- Connecting:
 - flexible conductors with or without cable terminal
 - rigid conductors

NOTE: The contactors are offered without factory cabling

- Electrical wear resistance (number of cycles):≥1 000 000
- Mechanical wear resistance (number of cycles):≥10 000 000
- Number of cycles (switching on) per hour: up to 600
- Pole leaking power: up to 13W

MOUNTING:

- on DIN-rail or
- with bolts to the surface
- mounting position: vertical gradient – maximum± 5°
- Plastic: wear resistance of UV rays and non-flammable (self-extinguishing material)
- Ambient temperature: -10°C + 65°C
- Altitude: up to 2000m

Type	Rated current (A)	Rated capacity of the consumer (kW)					Packing/Box (pcs)	Product category	Catalogue number
		230V	400V	415V	440V	690V			
LT 4 D1810	18	4	7.5	7.5	7.5	10	1 / 20	B	23301
LT 4 D2510	25	5.5	11	11	11	15	1 / 20	B	23302
LT 4 D3210	32	7.5	15	15	15	18.5	1 / 20	B	23303
LT 4 D4011	40	11	18.5	18.5	18.5	30	1 / 8	B	23304
LT 4 D6511	65	18.5	30	30	30	37	1 / 8	B	23305
LT 4 D9511	95	25	45	45	45	45	1 / 6	B	23306



TIME DELAY CONTACT BLOCK LT02-DXX

5+2 standard +extended **7** YEAR TOTAL WARRANTY *for industrial usage, 3 years warranty

LT02-Dxx is designed to set time intervals from 0.1 to 180s in different control schemes. It is used most frequently in combination with contactors from LT1-Dxx series to form "star/delta" starters for electrical motor control, as it provides the necessary time for motor winding.

Type	Number of contacts	Time delay	Delay	Product category	Catalogue number
LT02-DT0	NO+NC	0.1~3s	ON	B	23901
LT02-DT2	NO+NC	0.1~30s	ON	B	23902
LT02-DT4	NO+NC	10~180s	ON	B	23903
LT02-DT22	NO+NC	0.1~30s	OFF	B	239022



Dimensions (mm)					
W	W2	L1	h1	h2	H
33	45	48	22	14	59

In case of insufficient quantity in stock of any item listed on this page, the delivery time after order confirmation will be 90 days.

Documents corresponding to the product:

Standard EN 60947-4-1

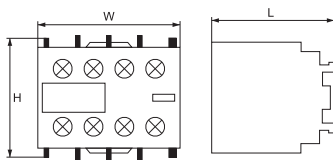

Dimensions (mm)

H	W	L	W1	W2
32	40	35	26	45
H2	L1	L2		
48	6,5	37		

AUXILIARY CONTACTS

5+2 standard +extended **7** YEAR TOTAL WARRANTY *for industrial usage, 3 years warranty

AUXILIARY CONTACTS

At necessity the element provide auxiliary number of contacts. They are specially designed for mounting on the movable part of the magnetic core of the contactors LT 1K/D series.

FUNCTIONS:

- extending the number of the operative contactors up to 4 in different
- Combinations
 - switches on simultaneously with the other contact system of the contactor
- Operation class: AC 3

- insulation voltage: 690V
- Joining terminal: screw terminal
- Connecting:
 - flexible conductors with or without cable terminal
 - rigid conductors

MOUNTING:

- on the movable cover of the contactor through pinching
- mounting position: vertical gradient – maximum ± 5°
- Plastic: wear resistance of UV rays and non-flammable (self-extinguishing material)

Type	For Contactor Series	Number of contacts	Rated current	Section of the conductor (mm ²)	Product category	Catalogue number
LT01-DN02	LT1-D & LT1-F	2NC	6A	0,5-1	B	23002
LT01-DN11	LT1-D & LT1-F	NO+NC	6A	0,5-1	B	23011
LT01-DN20	LT1-D & LT1-F	2NO	6A	0,5-1	B	23020
LT01-DN22	LT1-D & LT1-F	2NO+2NC	6A	0,5-1	B	23022
LT01-DN40	LT1-D & LT1-F	4NO	6A	0,5-1	B	23040
LT01-DN04	LT1-D & LT1-F	4NC	6A	0,5-1	B	23004
LT01-KN11	LT1-HK	NO+NC	6A	0,5-1	B	23001
LT01-KN22	LT1-HK	2NO+2NC	6A	0,5-1	B	23003



AUXILIARY CONTACTS LT03-DN11

5+2 standard +extended **7** YEAR TOTAL WARRANTY *for industrial usage, 3 years warranty



Dimensions (mm)

W1	W2	H	L	A
73	48	22	12,5	72

Providing on necessity additional number of plug points and are mounted sideward to the movable part of the magnetic cores of contactors of the series LT1D till 65A. Variants with two additional plug points NO and NC are offered.

FUNCTIONS:

- expanding the number of the operational plug points
- switching on simultaneously with the rest of the contact system
- of the contactor

- flexible conductors with or without cable end
- solid conductors
- Mounting method:
 - mounting position – sideward to the contactor
- Plastic: resistant to UV and non-burning (self-extinguishing material)

TECHNICAL CHARACTERISTICS:

- Environment operational regime: AC 3
- Insulation voltage: 690V
- Double connector: screw connector
- Connection:

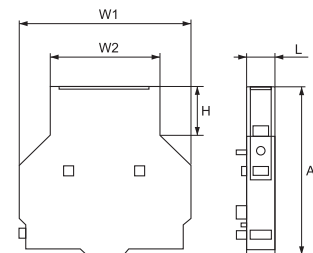

Type	Rated current	Section of the conductor (mm ²)	Product category	Catalogue number
LT03-DN11	6A	0,5-1	B	23311



In case of insufficient quantity in stock of any item listed on this page, the delivery time after order confirmation will be 90 days.

Documents corresponding to the product:

Standard EN 61095

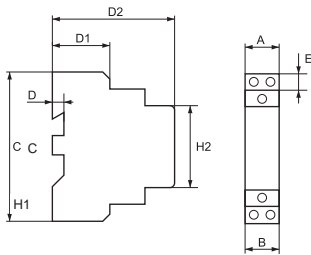

Dimensions (mm)

H1	C	D1	D2	A	E
81	5	31	66	18	9

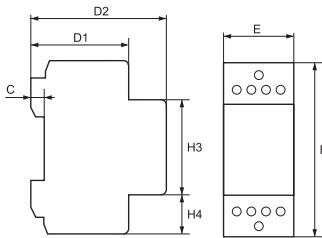

Dimensions (mm)

C	D1	D2	H3	H4
5	66	48	45	20

E	F
35	85

MODULE CONTACTORS K SERIES

5+2 standard +extended **7** YEAR TOTAL WARRANTY *for industrial usage 3 years warranty

Modular contactors K series are used for commutation of mono-phase and three-phase low power electrical consumers. They provide connection between the consumers in small overall dimensions, silent work, mounting only at DIN-rails.

FUNCTIONS:

- switching on of consumers
- making of control systems
- remarkable with high reliability of current characteristics
- reliable switching on or separation of power contacts

TECHNICAL DATA:

- Operation class: AC 7a
- Rated operating voltage of the controlling coil: 230V

AC; 50/60 Hz

- Rated operating voltage of the power circuit: up to 690V AC
- insulation voltage: 690V
- Surge voltage wear resistance: >8000V
- Joining terminal: screw terminal
- Connecting:
 - flexible conductors with or without cable terminal
 - rigid conductors

MOUNTING:

- on DIN-rail or
- mounting position: vertical gradient – maximum ± 5°
- Plastic: wear resistance of UV rays and non-flammable (self-extinguishing material)
- Ambient temperature: -10°C + 65°C
- Altitude: up to 2000m

Type	In	Coil voltage (V)	Contacts	Packing/Box (pcs)	Product category	Catalogue number
K20	20A	230V	2NO	1/12/120	B	23008
K20	20A	230V	NO+NC	1/12/120	B	23007
K20	20A	230V	2NC	1/12/120	B	23009
K20	25A	230V	NO+NC	1/12/100	B	23012
K20	25A	230V	2NO	1/12/100	B	23013
K20	25A	230V	2NC	1/10/100	B	23014
K20	40A	230V	NO+NC	1/6/60	B	23015
K20	40A	230V	2NO	1/6/60	B	23016
K20	40A	230V	2NC	1/6/60	B	23017
K20	100A	230V	2NO	1/4/40	B	23080
K20	100A	230V	1NO+1NC	1/4/40	B	23083
K20	100A	230V	2NC	1/4/40	B	23084
K40	25A	230V	2NO+2NC	1/6/60	B	23410
K40	25A	230V	3NO+1NC	1/6/60	B	23411
K40	25A	230V	4NO	1/6/60	B	23412
K40	25A	230V	4NC	1/6/60	B	23413
K40	40A	230V	2NO+2NC	1/4/40	B	23422
K40	40A	230V	3NO+1NC	1/4/40	B	23423
K40	40A	230V	4NO	1/4/40	B	23409
K40	40A	230V	4NC	1/4/40	B	23424
K40	63A	230V	2NO+2NC	1/4/40	B	23425
K40	63A	230V	3NO+1NC	1/4/40	B	23426
K40	63A	230V	4NO	1/4/40	B	23427
K40	63A	230V	4NC	1/4/40	B	23428
K40	80A	230V	4NO	1/2/20	B	23480
K40	80A	230V	2NO+2NC	1/2/20	B	23483
K40	80A	230V	4NC	1/2/20	B	23484
K40	80A	230V	3NO+1NC	1/2/20	B	23485

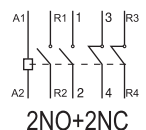
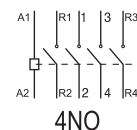
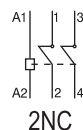
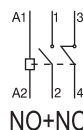
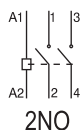

In case of insufficient quantity in stock of any item listed on this page, the delivery time after order confirmation will be 90 days.

AUTOMATION
100
MODULE CONTACTORS

Documents corresponding to the product:

Standard EN 60947-1
EN 60947-4-1

THERMAL OVERLOAD RELAYS

5+2 standard +extended **7** YEAR TOTAL WARRANTY *for industrial usage 3 years warranty

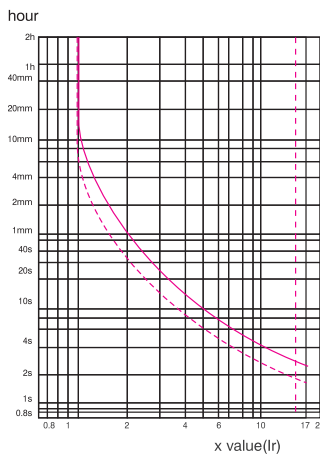
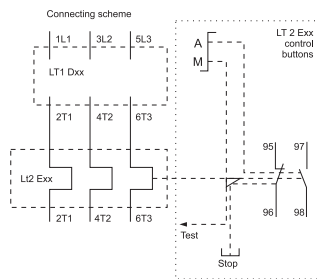
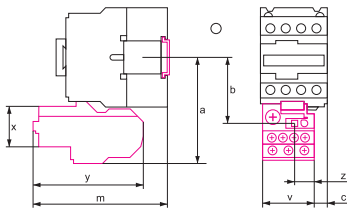

The thermal relays LT 2- K/Exx series are three pole relays designed for protection of induction motors from overload or overheat. They are mounted to contactors LT 1 K/Dxx series and an operating circuit for motor control is passed through their NC contacts. They have bimetallic releases /1 per phase/ through them the motors current flows and indirectly mated. The bimetallic releases bend subject to the influence of mating and this results in tripping of the relay. The contacts change switch position. The choice of a suitable protection prevents motor's operation at unusual temperature conditions and guarantees maximum constant operation, increases the effectiveness and prolongs the term of exploitation.

FUNCTIONS:

- switching off alternating current consumers at current overload
- making of control systems for consumers
- used as a protective operating element in control panels of induction motors
- remarkable with high reliability of current characteristics

TECHNICAL DATA:

- Rated operating voltage: up to 690V AC; 50/60 Hz
- Rated operating current range: up to 690V AC
- insulation voltage: >690V
- Surge voltage wear resistance: ≥6000V
- Joining terminal: screw terminal
- temperature compensation: -25 +55
- tripping category: class 10A

- Connecting:
 - flexible or rigid conductors with or without cable terminal for joining to the consumer
 - to the contactor through the relay terminals
 - the connecting terminals with the consumer can be adjusted according to the type of the contactor
- Electrical wear resistance (number of cycles): ≥1000000
- Mechanical wear resistance (number of cycles): ≥10000000
- Indication for protection activating
- Possibility for choice of the protection restoring (through the blue button)
- Possibility for range adjustment of the protection activating
- Possibility for operation at higher frequency

MOUNTING:

- mounting to the contactor: to the terminals of the contactor as it is additionally clamped to its frame through a pin
- mounting position: vertical gradient – maximum ± 5°
- Plastic: wear resistance of UV rays and non-flammable (self-extinguishing material)
- Ambient temperature: -10°C + 65°C
- Installation altitude: up to 2000m

NOTE: To protect the consumer from short circuit, before the combination contactor- thermal relay, a suitably measured breaker or safety device should be mounted.

Type	Dimensions (mm)							
	a	b	c	m	x	y	v	z
LT 2 - Kxx	81	50	0	98	47	92	44	17
LT 2 - E13xx	86	55	10.7	108	47	92	44	17
LT 2 - E23xx	86	55	9	109	47	92	44	17
LT 2 - E33xx	115	76	9.5	124	54	109	70	30



For contactor LT1-K06 type	Motor capacity (kW)			Rated current (A)	Protection adjustment range	Packing/Box (pcs)	Product category	Catalogue number
	220V 230V	380V 400V	660V 690V					
LT2-K0303	-	-	-	0.30	0.25 - 0.30	1 / 100	B	13403
LT2-K0306	-	0.37	1.10	1.20	0.80 - 1.20	1 / 100	B	13406
LT2-K0307	0.37	0.75	1.50	1.80	1.20 - 1.80	1 / 100	B	13407
LT2-K0308	0.75	1.10	2.20	2.60	1.80 - 2.60	1 / 100	B	13408
LT2-K0312	1.10	2.20	4.00	5.50	3.70 - 5.50	1 / 100	B	13411
LT2-K0314	2.20	4.00	5.50	8.00	5.50 - 8.00	1 / 100	B	13412
LT2-K0316	3.00	5.00	7.50	11.5	8.00 - 11.5	1 / 100	B	13413



For contactor LT1-K06 type	Rated current (A)	Protection adjustment range	Packing/Box (pcs)	Product category	Catalogue number
LT2-K0301*	0.16	0.10 - 0.16	1 / 100	F	13401
LT2-K0302*	0.25	0.16 - 0.25	1 / 100	F	13402
LT2-K0304*	0.54	0.30 - 0.54	1 / 100	F	13404
LT2-K0305*	0.80	0.54 - 0.80	1 / 100	F	13405

*3 year standard+0 year extended warranty



UNTIL SUPPLY
LAST



For contactor LT1-D9 to LT1-D25 type	Motor capacity (kW)			Rated current (A)	Protection adjustment range	Packing/Box (pcs)	Product category	Catalogue number
	220V 230V	380V 400V	660V 690V					
LT2-E1301	-	-	-	0.16	0.10 - 0.16	1 / 100	B	13001
LT2-E1302	-	-	-	0.25	0.16 - 0.25	1 / 100	B	13002
LT2-E1303	-	-	-	0.40	0.25 - 0.40	1 / 100	B	13003
LT2-E1304	-	-	0.37	0.63	0.40 - 0.63	1 / 100	B	13004
LT2-E1305	-	-	0.55	1.00	0.63 - 1.00	1 / 100	B	13005
LT2-E1306	-	0.37	1.10	1.60	1.0 - 1.60	1 / 100	B	13006
LT2-E1307	0.37	0.75	1.50	2.50	1.6 - 2.50	1 / 100	B	13007
LT2-E1308	0.75	1.50	3.00	4.00	2.5 - 4.00	1 / 100	B	13008
LT2-E1310	1.10	2.20	4.00	6.00	4.0 - 6.00	1 / 100	B	13010
LT2-E1312	2.00	3.70	5.50	8.00	5.5 - 8.00	1 / 100	B	13012
LT2-E1314	2.20	4.00	7.50	10.0	7.0 - 10.0	1 / 100	B	13014
LT2-E1316	3.70	5.50	11.0	13.0	9.0 - 13.0	1 / 100	B	13016
LT2-E1321	4.00	7.50	15.0	18.0	12.0 - 18.0	1 / 100	B	13021
LT2-E1322	5.50	9.00	18.5	25.0	17.0 - 25.0	1 / 100	B	13022
LT2-E1353	9.00	11.0	18.5	33.0	23.0 - 32.0	1 / 100	B	13053





For contactor
LT1-D32 type

Motor capacity (kW)		
220V	380V	660V
230V	400V	690V

Rated current
(A)

Protection
adjustment range

Packing/Box
(pcs)

Product
category

Catalogue
number

LT2-E2353	11	11	18.5	32	23.0 - 32.0	1 / 100	B	13253
LT2-E2355	15	15	22.0	36	28.0 - 36.0	1 / 100	B	13255



For contactor
LT1-D40 to
LT1-D95 type

Motor capacity (kW)		
220V	380V	660V
230V	400V	690V

Rated current
(A)

Protection
adjustment range

Packing/Box
(pcs)

Product
category

Catalogue
number

LT2-E3355	18.5	18.5	30	40	30.0 - 40.0	1 / 50	B	13355
LT2-E3357	22	22	30	50	37.0 - 50.0	1 / 50	B	13357
LT2-E3359	30	30	37	65	48.0 - 65.0	1 / 50	B	13359
LT2-E3363	45	45	55	80	63.0 - 80.0	1 / 50	B	13363
LT2-E3365	55	55	75	93	80.0 - 93.0	1 / 50	B	13365



For contactor LT1-F115
to LT1-F150

Motor capacity (kW)		
220V	380V	660V
230V	400V	690V

Rated current
(A)

Protection
adjustment range

Packing/Box
(pcs)

Product
category

Catalogue
number

LT2-F4367	40	75	100	150	90-150	1/30	B	13367
-----------	----	----	-----	-----	--------	------	---	--------------



For contactor LT1-F225
to LT1-F400

Motor capacity (kW)		
220V	380V	660V
230V	400V	690V

Rated current
(A)

Protection
adjustment range

Packing/Box
(pcs)

Product
category

Catalogue
number

LT2-F4368	63	110	129	220	132-220	1/30	B	13368
LT2-F4369	100	160	220	330	200-330	1/18	B	13369
LT2-F4370	147	250	335	500	300-500	1/18	B	13370



For contactor LT1-F630

Motor capacity (kW)		
220V	380V	660V
230V	400V	690V

Rated current
(A)

Protection
adjustment range

Packing/Box
(pcs)

Product
category

Catalogue
number

LT2-F4371	200	335	450	630	380-630	1/18	B	13371
-----------	-----	-----	-----	-----	---------	------	---	--------------



THERMOMAGNETIC AUTOMATIC BREAKER TM2/TM3

5+2 standard +extended
7 YEAR TOTAL WARRANTY
*for industrial usage 3 years warranty



Dimensions

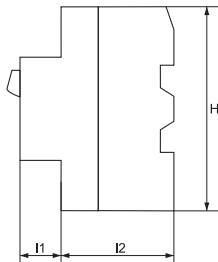

Auxiliary contact

UVR

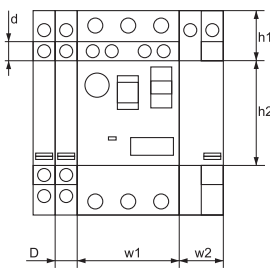

Dimensions (mm)

H	I1	I2	d	D
89	16	50	10	9,2
w1	w2	h1	h2	
44,5	18	22	45	

The thermomagnetic automatic breakers TM 2-Exx series are devices designed for control and protection of induction motors from overload, overheat or short circuit. The overload motor protection is carried out by the built in the breaker thermal elements, and the short circuit protection is carried out by the magnetic elements. These magnetic elements allow the adjustment of the current leakage which is 13 times the maximum current of the thermal protection. The overload protection elements include automatic compensation for the ambient temperature changes. In combination with under voltage release the thermomagnetic breaker TM 2-Exx also provides protection of the motors from fall out of a phase from the power supply. The choice of a suitable protection prevents motor's operation at unusual temperature conditions and guarantees maximum constant operation, increases the effectiveness and prolongs the term of exploitation.

FUNCTIONS:

- switching off alternating current consumers at current overload
- switching off the electrical circuit to the consumer at inlet short circuit
- protects the motor at lack/lowering of the phase voltage (if there is under voltage release)
- used as a protective operating element in control panels of induction motors
- remarkable with high reliability of current characteristics
- possibility for change/choice of the protection current (according to the operating current of the motor)
- automatic compensation of the ambient temperature

TECHNICAL DATA:

- Rated operating voltage: up to 690V AC; 50/60 Hz
- Rated operating current range: from 0.1 to 80A according to the type in table 1
- insulation voltage: 690V
- Surge voltage wear resistance: ≥6000V
- Joining terminal: screw terminal
- Connecting:
 - flexible or rigid conductors with or without cable terminal for joining to the consumer
 - to the contactor through the relay terminals
 - the connecting terminals with the consumer can be adjusted according to the type of the contactor
- Electrical wear resistance (number of cycles): ≥1000000
- Mechanical wear resistance (number of cycles): ≥10000000
- Indication for protection activating
- Switching on of the breaker manually with button "I" and switching off with button "O" manually or automatically at failure or after activating of the protection
- Possibility for range adjustment of the protection activating
- Possibility for operation at higher frequency
- Possibility for independent operation or as an element of an automation system
- tripping category: class 10A

MOUNTING:

- mounting to DIN-rail
- mounting position: vertical gradient – maximum ± 5°
- Plastic: wear resistance of UV rays and non-flammable (self-extinguishing material)
- Ambient temperature: -10°C + 65°C
- Altitude: up to 2000m



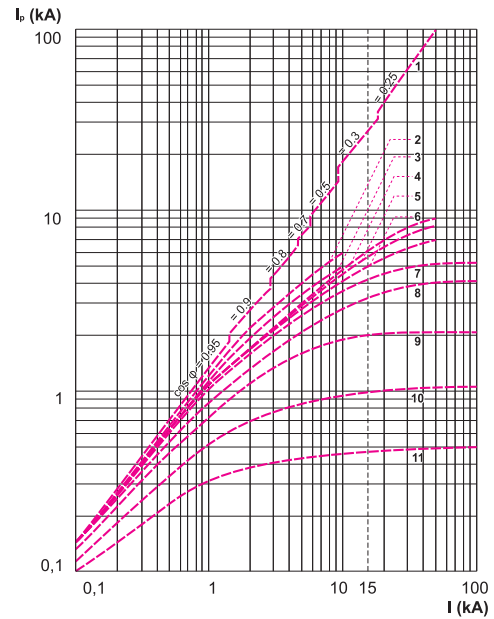
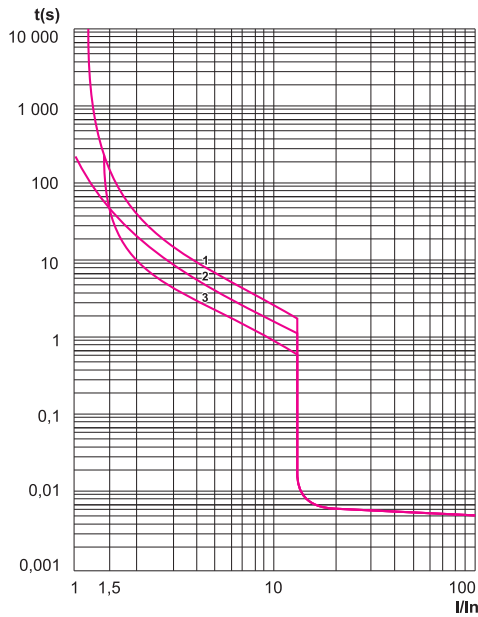

Type	Rated capacity of three-phase motor in AC-3 category					instantaneous short-circuit release (A)	Current setting range (A)	Thermal current I _{the} TM2-E (A)	Packing/Box (pcs)	Product category	Catalogue number
	220V 230V	400V 410V	440V	500V	690V						
TM2-E01	-	-	-	-	-	1.5	0.1 - 0.16	0.16	1 / 50	B	48001
TM2-E02	-	0.06	0.06	-	-	2.4	0.16 - 0.25	0.25	1 / 50	B	48002
TM2-E03	0.06	0.09	0.09	-	-	5.0	0.25 - 0.40	0.40	1 / 50	B	48003
TM2-E04	-	0.12	0.18	-	0.37	8.0	0.40 - 0.63	0.63	1 / 50	B	48004
TM2-E05	0.09	0.25	0.25	0.37	0.55	13.0	0.63 - 1.00	1	1 / 50	B	48005
TM2-E06	0.18	0.37	0.37	0.37	0.75	22.5	1 - 1.60	1.6	1 / 50	B	48006
TM2-E07	0.37	0.75	0.75	1.10	1.50	33.5	1.6 - 2.50	2.5	1 / 50	B	48007
TM2-E08	0.55	1.10	1.50	1.50	2.20	51.0	2.5 - 4.00	4	1 / 50	B	48008
TM2-E10	1.10	2.20	2.20	3.00	4.00	78.0	4 - 6.30	6.3	1 / 50	B	48010
TM2-E14	1.50	3.00	4.00	4.00	5.50	138	6 - 10.0	9	1 / 50	B	48014
TM2-E16	2.20	5.50	5.50	7.50	9.00	170	9 - 14.0	13	1 / 50	B	48016
TM2-E20	4.00	7.50	7.50	9.00	15.0	223	13 - 18.0	17	1 / 50	B	48020
TM2-E21	5.50	9.00	11.0	11.0	18.5	327	17 - 23.0	21	1 / 50	B	48021
TM2-E22	5.50	11.0	11.0	15.0	22.0	327	20 - 25.0	23	1 / 50	B	48022
TM2-E32	7.50	15.0	15.0	18.5	22.0	416	24 - 32.0	24	1 / 50	B	48032
TM3-E40	11.0	18.5	22.0	25.0	33.0	480	25 - 40.0	32	1 / 15	B	48040
TM3-E63	15.0	30.0	33.0	40.0	55.0	550	40 - 63.0	50	1 / 15	B	48063
TM3-E80	22.0	40.0	45.0	55.0	63.0	665.5	56 - 80.0	64	1 / 15	B	48080



Documents corresponding to the product:

Standard EN 60947-1
EN 60 947-2; EN 60947-4-1



Type	Voltage (V)	Product category	Catalogue number
TM2 AU225	230	B	48099
TM3 AU385	400	B	48098



VOLTAGE RELEASE (VR) FOR TM2

For increasing the effectiveness of the thermomagnetic breakers TM 2-Exx operation, they can be supplied with auxiliary devices, designed for widening the practice range and improving the technical characteristics of the breakers. The release is designed to switch off the thermomagnetic breaker when the controlling voltage falls under breaking level 0.55 to 0.7 UN and does not allow switching on of the breaker unless the voltage is over 0.85 Un.

FUNCTIONS:

- switching off the breaker at power supply voltage fall under 0.55 – 0.7 Un
- does not allow switching on of the breaker when the power supply voltage is under 0.85 Un
- prevents unwarranted secondary start of the breaker at falling off and restoring of the power supply voltage
- protects the motor at lack/lowering of the phase voltage
- used as a protective operating element in control panels of induction motors
- remarkable with high reliability of current characteristics

MOUNTING:

- laterally to a breaker
- At the side of the breaker through special openings

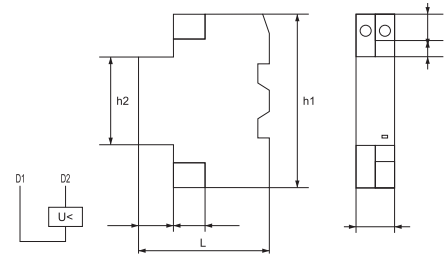

5+2 standard +extended **7** YEAR TOTAL WARRANTY *for industrial usage 3 years warranty

Documents corresponding to the product:

Standard EN 60529



Type	Product category	Catalogue number
TM2 E	B	8083



WATERTIGHT BOX FOR TM2-E

Specially designed plastic box with silicon screen for increasing the IP code from dust and moisture to IP 65. Designed for thermal-magnetic circuit breakers of up to 32A

- Mounting:
 - mounting position: vertical gradient, maximum ± 5°
 - mounted to horizontal surfaces (walls) with bolts
 - the breaker TM2 Exx is fixed inside of it on rail
- Plastic: wear resistance of UV rays and non-flammable (self-extinguishing material)

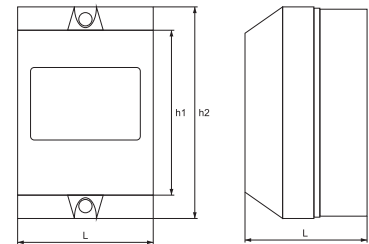



Type	Product category	Catalogue number
TM2 AE11	B	48912



AUXILIARY CONTACT BLOCK TM2 AE11-FRONT MOUNTING

5+2 standard +extended **7** YEAR TOTAL WARRANTY *for industrial usage, 3 years warranty

It is designed to switch on operational systems or signalization. Designed with one NO and one NC contact. It changes the position of its contacts according to the position of the breaker (switched on/off) to which it is mounted.

- Mounting:
 - laterally to a breaker TM2-Exx
- Plastic: wear resistance of UV rays and non-flammable (self-extinguishing material)
- Ambient temperature: -10°C + 65°C
- Altitude: up to 2000m

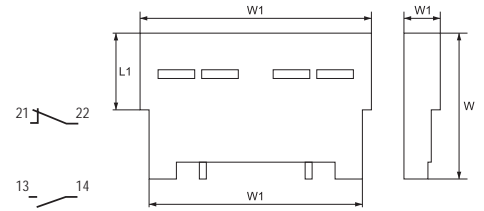

AUXILIARY CONTACT BLOCK TM2 AE11-SIDE MOUNTING

5+2 standard +extended **7** YEAR TOTAL WARRANTY *for industrial usage, 3 years warranty



Type	Product category	Catalogue number
TM2 AN11	B	48911
TM3 AN11	B	48913



It is designed to switch on operational systems or signalization. Designed with one NO and one NC contact. It changes the position of its contacts according to the position of the breaker (switched on/off) to which it is mounted.

- Mounting:
 - laterally to a breaker TM2-Exx
- Plastic: wear resistance of UV rays and non-flammable (self-extinguishing material)
- Ambient temperature: -10°C + 65°C
- Altitude: up to 2000m

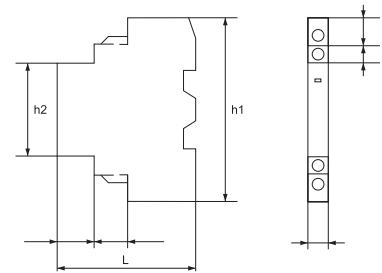

Documents corresponding to the product:

Standard EN 60947-1
EN 60947-4-1



with thermal overload relays

STARTERS FOR DIRECT START

5+2 standard +extended **7** YEAR TOTAL WARRANTY *for industrial usage, 3 years warranty

The electromagnetic starters LT 5 Dxx series are devices designed for remote control, direct control and protection of induction motors or other electrical consumers. They are a combination of contactors LT 1 Dxx series and thermal protection LT 2 Exx factory cabled. The starters are offered on the market in metal or plastic boxes with the corresponding IP code from dust and moisture. At mounting there should be provided protection of the device from short circuit through breakers or disconnectors. If necessary, at client's order the factory mounted thermal protection in the pneumatic starter can be substituted. The choice of a suitable protection prevents motor's operation at unusual temperature conditions and guarantees maximum constant operation, increases the effectiveness and prolongs the term of exploitation.

FUNCTIONS:

- switching on/off alternating current consumers
- does not allow secondary unwarranted switching on of the starter at transitory lowering of the voltage
- protects the motor from overload in the range of the corresponding thermal protection
- remarkable with high reliability of current characteristics

TECHNICAL DATA:

- Rated voltage of the controlling voltage: 230/400V AC; 50/60 Hz

NOTE: In case you need different controlling coils voltage of the starters you can turn to our regional representatives.

- Rated operating voltage: 690V
- Rated operating current range: from 7 to 93 A AC
- insulation voltage: 690V
- Surge voltage wear resistance: ≥6000V
- Joining terminal: screw terminal
- Little power consumption and small dimensions
- Connecting:
 - flexible or rigid conductors with or without cable terminal for joining to the consumer and section according to the motor power
 - two by two inlets/outlets supplied with orifices for the cables
- Possibility for range adjustment of the protection activating
- IP code: IP 44
- Possibility for operation at higher frequency
- Mounting:
 - mounting to a flat surface (wall) with bolts/screws
 - mounting position: vertical gradient, maximum ± 5°
- Plastic: wear resistance of UV rays and non-flammable (self-extinguishing material)
- Metal corpus: corrosion-proof coating
- Ambient temperature: -10°C + 65°C
- Altitude: up to 2000m

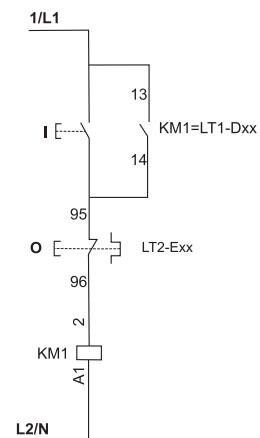
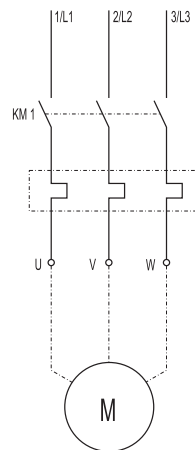

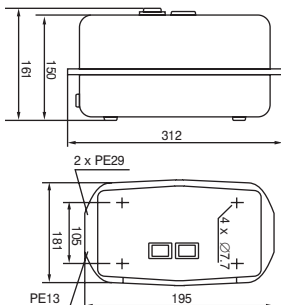
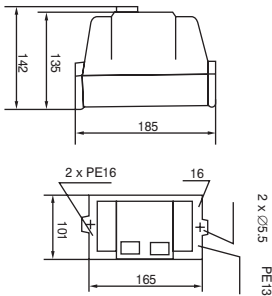
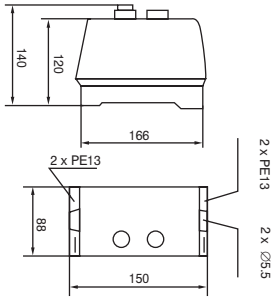

Type	Rated capacity of motors 50/60Hz AC-3 category			Rated current (A)	Thermal relay adjustment range	Coil voltage (V)	Packing/Box (pcs)	Product category	Catalogue number
	220V 230V	380V 400V	415V 440V						
LT5 D093	2.2	4.0	4.0	9	7 .. 10A	230 400	1 / 16	B	43091 43092
LT5 D123	3.0	5.5	5.5	12	9 .. 13A	230 400	1 / 16	B	43121 43122
LT5 D185	4.0	7.5	9.0	18	12 .. 18A	230 400	1 / 16	B	43181 43182



Note: Upon request the thermal relay will be replaced

Type	Rated capacity of motors 50/60Hz AC-3 category			Rated current (A)	Thermal relay adjustment range	Coil voltage (V)	Packing/Box (pcs)	Product category	Catalogue number
	220V 230V	380V 400V	415V 440V						
LT5 D255	5.5	11	11	25	17 .. 25A	230 400	1 / 16	B	43251 43252
LT5 D325	7.5	15	15	32	23 .. 32A	230 400	1 / 16	B	43321 43322



Note: Upon request the thermal relay will be replaced

Type	Rated capacity of motors 50/60Hz AC-3 category			Rated current (A)	Thermal relay adjustment range	Coil voltage (V)	Packing/Box (pcs)	Product category	Catalogue number
	220V 230V	380V 400V	415V 440V						
LT5 D405	11.0	18.5	22	40	30 .. 40A	230 400	1/6	B	43401 43402
LT5 D655	18.5	30.0	37	65	48 .. 65A	230 400	1/6	B	43651 43652
LT5 D955	25.0	45.0	45	95	80 .. 93A	230 400	1/6	B	43951 43952



Note: Upon request the thermal relay will be replaced

In case of insufficient quantity in stock of any item listed on this page, the delivery time after order confirmation will be 90 days.

Documents corresponding to the product:

Standard EN 60947-1
EN 60947-4-1



“STAR/DELTA”STARTER

5+2 standard +extended **7** YEAR TOTAL WARRANTY *for industrial usage 3 years warranty

The electromagnetic starters LT 3 Dxx series are devices designed for remote control, direct control and protection of induction motors coiled and operating according to a starter scheme “star/delta”. They are a combination of three contactors LT 1 Dxx series, time relay and a set of buttons “start” and “stop” factory cabled. They provide the easy motor unwinding giving possibility for setting the time for unwinding in “star” as the time for switching between “star” and “delta” is fixed to 0.5 seconds.

- The starters are offered on the market in two types:
- closed type – metal boxes providing the corresponding IP code from dust and moisture (IP 54) as at mounting there should be provided protection of the device from short circuit through breakers or disconnectors
 - open type – for mounting in distribution boxes as at mounting there should be provided protection of the device from short circuit through breakers or disconnectors

The starters are offered on the market without mounted thermal protection which is purchased separately according to the motor capacity. The choice of a suitable protection prevents motor’s operation at unusual temperature conditions and guarantees maximum constant operation, increases the effectiveness and prolongs the term of exploitation. If necessary, at client’s order the power supply operating voltage of the pneumatic starter can be changed.

FUNCTIONS:

- switching on/off alternating current three phase motors operating according to a scheme “star - delta”
- does not allow secondary unwarranted switching on of the starter at transitory lowering of the voltage

- protects the motor from overload in the range of the corresponding thermal protection
- indication of the operating condition through a valve indicator
- possibility for mounting of additional contacts (for the open type)
- remarkable with high reliability of current characteristics

TECHNICAL DATA:

- Rated voltage of the controlling voltage: 400V AC; 50/60 Hz

NOTE: In case you need different controlling coils voltage of the starters you can turn to our regional representatives.

- Rated operating voltage: 690V
- Rated operating current range: from 7 to 93A AC
- insulation voltage: >690V
- Surge voltage wear resistance: ≥6000V
- Joining terminal: screw terminal
- Little power consumption and small dimensions
- Connecting:
 - flexible or rigid conductors with or without cable terminal for joining to the consumer and section according to the motor power
 - three by three inlets/outlets supplied with orifices for the cables
- Possibility for operation at higher frequency
- IP code: IP54
- Mounting:
 - mounting to a flat surface (wall) with bolts/screws
 - mounting position: vertical gradient, maximum ± 5°
- The metal body is covered with corrosion-proof paint
- Ambient temperature: -10°C + 65°C
- Altitude: up to 2000m

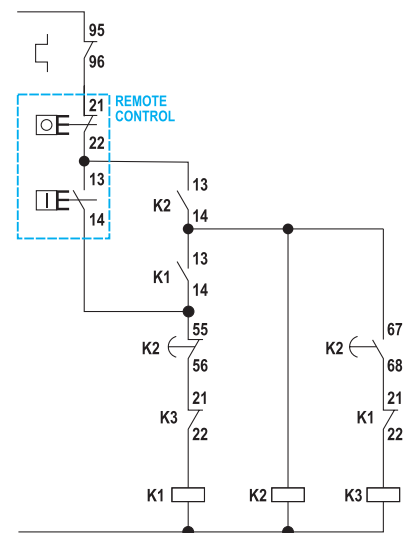
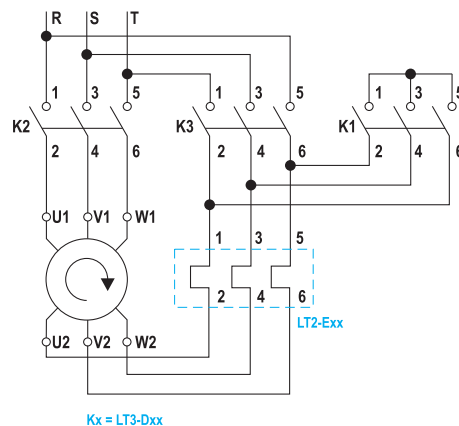



Type designation (without a box)	Overall dimensions (mm)		
	height	width	depth
LT3-D25A	135	170	160
LT3-D32A	135	170	160
LT3-D40A	150	285	190
LT3-D65A	150	285	190
LT3-D95A	150	310	190

Type designation (without a box)	Rated capacity (kW)				Rated current (A)	Coil voltage (V AC)	Packing/Box (pcs)	Product category	Catalogue number
	220V 230V	380V 400V	415V	440V					
LT3-D25A	11	15	15	15	25	400	1 / 6	B	43253
LT3-D32A	15	18.5	18.5	18.5	32	400	1 / 6	B	43323
LT3-D40A	18.5	22	22	22	40	400	1 / 4	B	43403
LT3-D65A	30	55	55	55	65	400	1 / 4	B	43653
LT3-D95A	37	75	75	75	95	400	1 / 4	B	43953



Note: It is necessary that thermal protection with suitable range is mounted to protect the controlled motor. The shown values of magnetic starters are for normal regimes for motor control, for hard operation regimes are chosen starters which correspond to the current rating of the motor.



Type designation (with box)	Overall dimensions (mm)		
	height	width	depth
LT 3 - B - D25A	370	240	160
LT 3 - B - D32A	370	240	160
LT 3 - B - D40A	470	265	160
LT 3 - B - D65A	470	265	160
LT 3 - B - D95A	470	265	160

Type designation (with box)	Rated capacity (kW)				Rated current (A)	Coil voltage (V AC)	Packing/Box (pcs)	Product category	Catalogue number
	220V 230V	380V 400V	415V	440V					
LT 3 - B - D25A	11	15	15	15	25	400	1 / 4	B	43254



Note: It is necessary that thermal protection with suitable range is mounted to protect the controlled motor. The shown values of magnetic starters are for normal regimes for motor control, for hard operation regimes are chosen starters which correspond to the current rating of the motor.

Documents corresponding to the product:

Standard EN 60947-1
EN 60947-4-1



with thermal overload relays

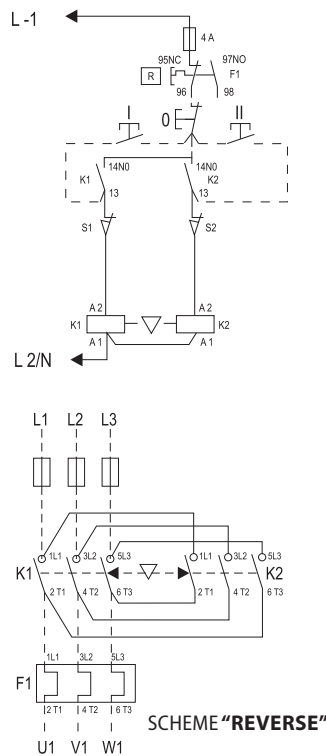

REVERSE STARTER

The electromagnetic starters LT4 Dxx series are devices used for direct start, reverse start and protection of induction motors with short connected rotor. They provide the unwinding of the motor in one of the directions with possibility for pushing the button “stop” and giving command from the other “start” for changing the motor winding direction. The two contactors are mechanically blocked and do not allow simultaneous start in both winding directions. The starters are offered – closed type in metal boxes providing the corresponding IP code from dust and moisture (IP54) as at mounting there should be provided protection of the device from short circuit through breakers or disconnectors. The starters are offered with mounted thermal protection which can be substituted according to the motor power. The choice of a suitable protection prevents motor’s operation at unusual temperature conditions and guarantees maximum constant operation, increases the effectiveness and prolongs the term of exploitation.

If necessary, at order the power supply operating voltage of the pneumatic starter can be changed.

FUNCTIONS:

- switching on alternating current three phase motors in one winding direction, switching off and change of the winding direction at giving a signal
- does not allow secondary unwarranted switching on of the starter at transitory lowering of the voltage
- protects the motor from overload in the range of the corresponding thermal protection
- remarkable with high reliability of current characteristics

TECHNICAL DATA:

- Rated voltage of the controlling voltage: 400V AC; 50/60 Hz

NOTE: In case you need different controlling coils voltage of the starters you can turn to our regional representatives.

- Rated operating voltage: 690V
- Rated operating current range: from 7 to 93 A AC
- insulation voltage: 690V
- Surge voltage wear resistance: ≥6000V
- Joining terminal: screw terminal
- Little power consumption and small dimensions
- Connecting:
 - flexible or rigid conductors with or without cable terminal for joining to the consumer and section according to the motor power
 - three by three inlets/outlets supplied with orifices for the cables
- Possibility for operation at higher frequency
- IP code: IP 44
- Mounting:
 - mounting to a flat surface (wall) with bolts/screws
 - mounting position: vertical gradient, maximum ± 5°
- The metal body is covered with corrosion-proof paint
- Ambient temperature: -10°C + 65°C
- Altitude: up to 2000m

Type designation (with a box)	Rated capacity (kW)				Overall dimensions (mm)			Rated current (A)	Coil voltage (V AC)	Packing/ Box (pcs)	Product category	Catalogue number
	220V	380V	415V	440V	height	width	depth					
LT 4 - B - D25A	11.0	15.0	15.0	15.0	240	240	160	25	400	1 / 8	B	43001
LT 4 - B - D40A	18.5	22.0	22.0	22.0	270	265	160	40	400	1 / 2	B	43003
LT 4 - B - D95A	37.0	75.0	75.0	75.0	270	265	160	95	400	1 / 4	B	43005
LT 4 - B - D25A	11.0	15.0	15.0	15.0	240	240	160	25	230	1 / 4	B	43006
LT 4 - B - D32A	15.0	18.5	18.5	18.5	240	240	160	32	230	1 / 4	B	43007
LT 4 - B - D40A	18.5	22.0	22.0	22.0	270	265	160	40	230	1 / 4	B	43008
LT 4 - B - D65A	30.0	55.0	55.0	55.0	270	265	160	65	230	1 / 4	B	43009
LT 4 - B - D95A	37.0	75.0	75.0	75.0	270	265	160	95	230	1 / 4	B	43010



Documents corresponding to the product:

Standard EN61800-3
EN61800-5-1

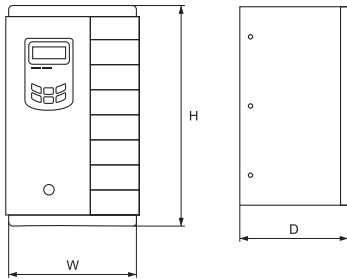

ELM 2000+ FREQUENCY INVERTERS

3+2 standard +extended **5** YEAR TOTAL WARRANTY

High-tech motor control concept, based on advanced DSP-technology - ready for V/Hz, SENSORLESS VECTOR, CLV and PMM motor control - intelligent AUTOTUNING functions for easy setup

Flexible inverter control, dual high resolution analogue inputs, free mappable digital I/O channels

Ready for all commonly used fieldbus systems

Universal function-set for all kind of industrial and residential applications, including integrated PID/pump controller routines

Smart PC-tools, for inverter control, parametrization and troubleshooting. Parameter-duplication stick

Brake chopper integrated

TECHNICAL FEATURES:

- Power range:
 - 0,4.....400 kW
- Power input:
 - Rated input voltage- 1-Phase 220V~240V~±15%); 3-Phase 380V-460V (+/-)15%
 - Input frequency- 44....67 Hz
- Motor output:
 - Output frequency- 0-650 Hz
 - Frequency resolution- 0,01 Hz
 - Overload capability- 150% - 60 sec. / 10 min
- Control mode:
 - Motor control algorithm- V/Hz-SpaceVector, SLV-SENSORLESS VECTOR,Torque/Speed control
 - mode CLV-Closed loop vector,Permanent Magnet Synchronous Motor
 - Chopper frequency- 0.8...16 kHz (fixed / random)
 - V/Hz curve- Linear, exponential, and user-programmable curve
 - Starting torque- 150% rated torque at 0,5 Hz (in SLV Mode)
 - Torque compensation- Automatic / Manual
 - Motor data input- Manual, from nameplate / AUTOTUNING
 - Control range- 1:100 in SLV mode,1:1000 in CLV mode,1:20 in PMSM mode
 - Speed precision +/- 0,5% (SLV),+/- 0.02% (CLV)
 - Torque precision +/- 5% (SLV)
 - DC-Brake- User programmable functions
 - Brake chopper- Chopper transistor integrated (up to 90 kW)

- Display:
 - 7 segment, 4 characters
 - Config-Parameters and -value, programmable to display various working parameters
- I/O Channels and control functions:
 - Inverter control- Via terminals / Keypad / Serial link (or combination of all)
 - Digital inputs- 6 (8) Dig. inputs (NPN-PNP selectable) pulstrain-input
 - Speed reference input- Potentiometer (on keypad unit, external), analogue signal (terminals), keypad, internal programmable value, pulstrain, serial link
 - Analogue channels- analogue channels - 12 BIT: 0...10V, 0...5V, -10V...0...10V, 0..(4)20 mA,
 - all free scalable in gain and offset, and mathematically concatenable
 - Analogue outputs- 2 analogue outputs, programmable in gain and function (0...10V, 0(4)..20 mA)
 - Digital outputs- 2 digital outputs (free mapping to different functions)
 - Relais output- 1 switchover contact 3A 250VAC/30VDC (programmable assignment)
 - Data link- Serial link RS 485 (MODBUS)
 - Special functions- 24V / 50 mA auxiliary power supply on terminals, 10V potentiometer power supply, 5V/100 mA power supply on modbus connector Simple PTC / KLIXON motor protection
- Protection:
 - Electrical- Overvoltage, undervoltage
 - Overcurrent, overload, motor-overload, output short-circuit
 - Thermal- Heatsink overtemperature, I²t motorprotection
- Operating conditions:
 - Protection class IP20
 - Working temperature -10+50 °C
 - Humidity- 0 to 95% RH, non-condensing, non-corrosive
 - Altitude- 1000 m, above 1% derating / 100m
 - Vibration- Max. 0,5 g

Type of sign

ELM2000+ 0015 T3

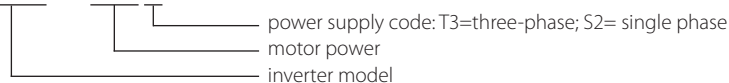



LCD REMOTE FRAME SIZE
KEYPAD FOR CABINET IP66
423432P



CABLE FOR REMOTE KEYPAD
IP66 - 1.5meter
423433P



PARAMETER
COPY STICK
423434P

Type	Input voltage (V)	Maximum output power (kW)	Maximum current output (A)	Dimensions (WxDxH-mm)	Weights (kg)	Product category	Catalogue number
E2000-0004 S2B	230	0.4	2.5A	80x140x135	1.40	B	423400P
E2000-0007 S2B	230	0.7	4.5A	80x140x135	1.50	B	423401P
E2000-0015 S2B	230	1.5	7A	106x180x150	2.00	B	423402P
E2000-0022 S2B	230	2.2	10A	106x180x150	2.10	B	423403P
E2000-0007 T3	400	0.7	2A	106x180x150	2.00	B	423404P
E2000-0015 T3	400	1.5	4.6A	106x180x150	2.10	B	423405P
E2000-0022 T3	400	2.2	6.5A	106x180x170	2.20	B	423406P
E2000-0030 T3	400	3.0	7A	138x235x152	2.50	B	423407P
E2000-0040 T3	400	4.0	9A	138x235x152	3.00	B	423408P
E2000-0055 T3	400	5.5	12A	156x265x170	3.50	B	423409P
E2000-0075 T3	400	7.5	17A	156x265x170	4.50	B	423410P
E2000-0110 T3	400	11.0	23A	205x340x196	4.80	B	423411P
E2000-0150 T3	400	15.0	32A	205x340x196	8.00	B	423412P
E2000-0185 T3	400	18.5	38A	205x340x196	8.50	B	423413P
E2000-0220 T3	400	22.0	44A	270x435x235	9.00	B	423414P
E2000-0300 T3	400	30.0	60A	315x480x235	22.50	B	423415P
E2000-0370 T3	400	37.0	75A	315x480x235	24.00	B	423416P
E2000-0450 T3	400	45.0	90A	360x555x265	24.50	B	423417P
E2000-0550 T3	400	55.0	110A	360x555x265	41.50	B	423418P
E2000-0750 T3	400	75.0	150A	410x650x300	42.00	B	423419P
E2000-0900 T3	400	90.0	180A	410x650x300	56.00	B	423420P
E2000-1100 T3	400	110.0	220A	516x765x326	56.50	B	423421P
E2000-1320 T3	400	132.0	265A	560x910x342	87.00	B	423422P
E2000-1600 T3	400	160.0	320A	560x910x342	123.00	B	423423P
E2000-1800 T3	400	180.0	360A	400x1310x385	124.00	B	423424P
E2000-2000 T3	400	200.0	400A	535x1340x380	125.00	B	423425P
E2000-2200 T3	400	220.0	440A	535x1340x380	185.00	B	423426P
E2000-2500 T3	400	250.0	480A	600x1465x380	186.00	B	423427P
E2000-2800 T3	400	280.0	530A	600x1465x380	225.00	B	423428P
E2000-3150 T3	400	315.0	580A	600x1465x380	230.00	B	423429P
E2000-3550 T3	400	355.0	640A	600x1600x388	233.00	B	423430P
E2000-4000 T3	400	400.0	690A	600x1600x388	234.00	B	423431P



Documents corresponding to the product:

Standard EN60898-1
EN 60947-2

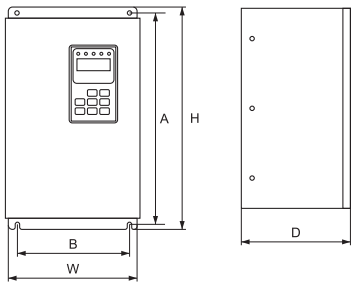

Type	Overall dimensions (mm)					
	H	W	A	B	D	d
G0007S2B	150	105	139	94	120	Ø4
G0015S2B	170	125	160	114	140	Ø5
G0022S2B	170	125	160	114	140	Ø5
G0007T3B	170	125	160	114	140	Ø5
G0015T3B	170	125	160	114	140	Ø5
G0022T3B	170	125	160	114	140	Ø5
G0037T3B	250	162	233	145	150	Ø6
G0040T3B	250	162	233	145	150	Ø6
G0055T3B	300	200	282	182	160	Ø6
G0075T3B	300	200	282	182	160	Ø6
G0110T3C	340	225	322	160	220	Ø6
G0150T3C	380	230	362	186	225	Ø6

UNTIL SUPPLY
LAST

ELM 1000 FREQUENCY INVERTERS

3+0 standard +extended **3** YEAR TOTAL WARRANTY

Frequency inverters are designed to control three-phase induction motors with short-circuited rotor. They provide for the implementation of some control laws, thus becoming an indispensable part of the control systems for conveyors and packaging machines, pumps, air conditioning systems, etc. The ELM 1000 inverter provides the so-called no-sensor control, V/f control and impulse control while the output load can reach up to 150% within 60 seconds. It features easy definition of curves and easy parameters setting of inverter through the use of control panel buttons. The inverter can auto calibrate according to the motor power, i.e. if the inverter is connected to a motor with power different from that set by the inverter manufacturer, it automatically adjusts its programmable parameters to suit the motor parameters.

FUNCTIONS:

- rotation speed increase – automatic and manual
- sliding compensation: from 0 to 20%
- no-sensor control of the motor
- adjustment of the V/F control curve – linear or quadratic
- energy saving through automatic optimization of the V/F curve
- PID control law implementation option
- omission of resonance frequencies
- JOG function
- 'counter' function
- automatic restart option in case of power supply failure
- fifteen speed degrees control option
- control choice from the control panel; external or COM terminal
- frequency control from the control panel, external potentiometer by current or by voltage
- auto-calibration in accordance with the switched motor
- incoming signals on clockwise or counter-clockwise rotation, multi-step control, restart, etc.
- outgoing discrete control signal 24V
- outgoing analogue control signal 0 – 10V
- DC brake in static mode
- dynamic braking with external braking resistor – used in inert electric motor load
- output voltage adjustment option
- activation of output safety functions option
- electronic motor protection

TECHNICAL FEATURES:

- Rated working voltage: 230/400V AC; 50 Hz
- Permissible working voltage deviation: ±10%
- Unbalance of phases: < 3%
- Frequency fluctuation: < 5%
- Output frequency: 0 – 400 Hz
- Output voltage: from 0 to U_{bx} max
- Overload capacity:
 - constant: up to 110%
 - momentary: up to 150%
- Precision of output frequency adjustment: 0.1%
- Type of connection:
 - the connection of the inverter to the power supply should always be done through a circuit breaker of the MCB or MCCB type
 - connection of consumer to power terminals: through conductors suitable for the power
 - connection of control circuits: flexible conductor up to 1.5 mm²

NOTE: It is not recommendable to mount contactors or other commutation devices between the frequency inverter and the motor, except as described in the product passport.

Mounting:

- mounting to a flat surface by means of bolts
- mounting position – vertical gradient maximum ± 5°

NOTE: When more than one inverter is mounted in a board, it is recommendable to mount them side by side and when this is not possible, the appropriate cooling conditions should be provided.

- Plastic: UV-rays resistant and fire resistant (self-extinguishing material)
- Ambient temperature: -10° to 65° C
- Altitude : up to 2000 m
- Function enhancement option: through the inclusion of additional modules

Type	Input voltage (V)	Maximum output power (kW)	Maximum current output (A)	Packing/Box (pcs)	Product category	Catalogue number
ELM1000-G0007T3B	400	0.75	2	1 / 4	F	423307M



Type of sign

ELM1000- G -0150 T3 C

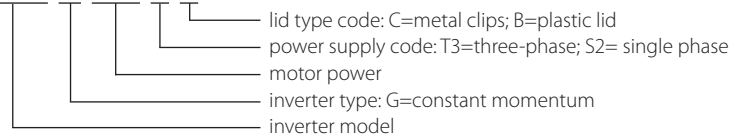

Documents corresponding to the product:

Standard EN60947-4-2
EN 60947-1



SOFT STARTER ELM 2500



Soft starters are designed to control the start of three-phase induction motors with short-circuited rotor. A number of motor control issues are avoided through them, and namely: prolonged start moments, auto-ignition of motor, there is no need of stardelta switching, auto-transformer switching, resistant switching, etc. The ELM 2500 soft starter pertains to the AC53b type of starters as per the standard requirements and it provides rotation of motor and once the operation mode is set, a shunt contactor of the LT 1 D/F series is switched to control motor operation as the soft starter is not designed to control motors in a set mode. Under a stop command in accordance with the selected control scheme, the soft starter can or can not be included in shutting the motor down.

- Control functions
 - output faults
 - motor faults diagnostics
 - keyboard or outward control
 - delayed start option
 - faults memory

TECHNICAL FEATURES:

- Rated working voltage: 230/400V AC; 50 Hz
- Permissible working voltage deviation: ±10%
- Unbalance of phases: < 3%
- Frequency fluctuation: < 5%
- Obligatory bypass contactor installation
- Mounting :
 - mounting to a flat surface through bolts
 - mounting position – vertical gradient maximum ± 5°

FUNCTIONS:

- System functions
 - over-voltage protection – motor will switch off when power supply exceeds the preset limits
 - overload protection – protects the motor from overloading
 - phase loss protection
 - temperature overload protection

NOTE: When more than one soft starter is mounted in a board, it is recommendable to mount them side by side and when this is not possible, the appropriate cooling conditions should be provided.

- Plastic: UV-rays resistant and fire resistant (self-extinguishing material)
- Altitude : up to 2000 m

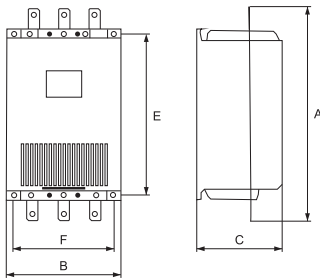

Type	Overall dimensions (mm)					
	A	B	C	E	F	d
EL M25015	250	153	162	219	140	Ø6
EL M25022	250	153	162	219	140	Ø6
EL M25037	250	153	162	219	140	Ø6
EL M25045	250	153	162	219	140	Ø6
EL M25055	250	153	162	219	140	Ø6
EL M25075	510	260	194	389	232	Ø8

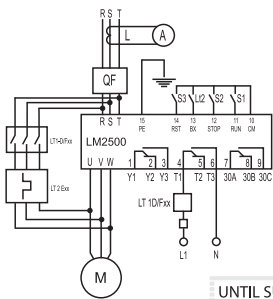

UNTIL SUPPLY
LAST

Type	Power of motor (kW)	Rated current (A)	Type of bypass contactor	Section of power supply conductors	Packing/Box (pcs)	Product category	Catalogue number
EL M25055	55	110	LT 1-F 115	25	1 / 1	F	42225055
EL M25075	75	150	LT 1-F 150	35	1 / 1	F	42225075





COMPLEX COMPENSATING DEVICES

3+2
standard
+extended **5** YEAR TOTAL
WARRANTY

The use of electrical energy in industry is invariably connected with its transformation. The development of semiconductor elements and the broader coming of semi-conductor transformers, frequency control, welding machines and electrical arc furnaces in industrial projects have a negative impact over the electrical power quality in the electro distributing systems. Induction machines need reactive energy to create electromagnetic field. The reactive component of current is taken from the electro distributing systems but it leads to additional losses in the power supply system and makes shorter the exploitation term of electrical devices. This leads to curving of the sinusoid form of current and voltage and interferences with harmonic character. Compensating the reactive power means to fill up the system in such a way that the needed reactive power to be created from the compensating device instead of being taken from the electro transportation system. This leads to killing the voltage fall and cable losses and increasing the outlet power of the power transporters and cutting down the bills for overconsumption of reactive energy paid by consumers to the electricity supply company. In practice compensating the reactive energy and high harmonics through LC filters combined in compensating installations has the broadest spreading.

THERE ARE SEVERAL TYPES OF COMPENSATION ACCORDING TO THEIR LOCATION:

- individual compensation – when to every single motor or consumer is mounted a compensating system. It is applied to powerful motors and transformers with fixed capacity.
- installation compensation – when the consumers from the whole section (workshop) are grouped and compensation is accomplished for the whole section.
- overall compensation – accomplished at full compensation in the inlet of the installation.

ACCORDING TO THE TYPE OF THE COMPENSATING DEVICES COMPENSATION CAN BE:

- passive – when the system supplies constant reactive power. In this case the system does not react to changes in the size and nature of the harmonic components and also to the per cent increase of the reactive energy in time.

- active – broader spread. The system controls the form of the consumed current and generates different capacity depending on the load changes. When designing the electro distributing system of industrial projects the following tasks are taken into consideration:
 - defining the factor of non-sinusoid of the consumers and the voltage harmonic components
 - defining the additional loading of the capacitor batteries from the harmonic components and calculating the filtering elements if needed
 The calculation of the compensating device capacity is done by reading the reactive energy of the system and the working time of the system. Compensating devices represent a device of one or several metal boxes with common rail system, automatic regulator for cosφ control RPSF-xx series, different number of capacitor batteries (according to the capacity of the device) with different capacity HY 111 series, contactors for capacitor batteries control CJ 19-43 series, protective elements, etc.

The broadest spreading of compensation has acquired the compensation of harmonics and reactive energy with capacitors for high voltage. Capacitors HY 111 series are voltage remeasured and are able to endure overload from harmonic components up to 7% from the basic harmonics. They are used in systems with high harmonics foul up to 25%.

The high harmonics composition is defined after measuring the influence rate of each separate harmonics compared to the first one. In Bulgaria mostly spread are 5, 7, 9, 11 and 13 harmonics. The capacitors are remeasured for voltage 415V and are normally mounted right in the compensation systems.

When the high harmonics are over 25% the system is taken to be foul and in this case except using capacitors, filters for leveling the harmonics are to be used as well. These filters are calculated on the basis of the corresponding voltage harmonics and differ for the different harmonics. They are calculated using complex mathematical programme which reads the foul rate, the significance per cent of the voltage harmonic component, etc.

Documents corresponding to the product:

Standard EN 60831-1
EN 60831-2



CAPACITOR BATTERIES FOR REACTIVE ENERGY COMPENSATION

2+0 standard +extended **2** YEAR TOTAL WARRANTY

Capacitor batteries HY 111 series are specially designed three phase dry capacitors for compensation of reactive energy and correction of the capacity factor. It represents an aluminum cylindrical body in which a metal polypropylene folio is mounted which does not require special impregnation. The permittivity characteristics are acquired through filling with a special mixture on a vegetable base (resins). The capacitor battery is constructed in such a way that at failure (overload from voltage, current or temperature) breaks the connection to the upper cover where are the connections to the power supply. This is done by a specially constructed valve for overpressure mounted right above the capacitor element. The breaking of the inner couplings provides protection to the staff and environment from damage due to capacitor element failure. There is a three phase capacitor in the cylindrical body with built in resistor for rarefying the

capacitors. The capacitor battery can be used both for passive and active compensation.

TECHNICAL DATA:

- Rated operating voltage: 450V; 50Hz
- insulation voltage: 690V
- Surge voltage wear resistance: 6kV per minute
- Capacity: from 5,0 to 100,0 kVAr at 450V
- Tolerance: ±5%
- Operating temperature: -40°C - +65°C
- Capacity losses: 0,5W/kVAr
- Built in discharging resistance
- Admissible current overload: twice as much the peak current
- Discharge time: <50V per minute
- Altitude: 2000m

MOUNTING:

- With bolt M12 or M16 to a flat horizontal base

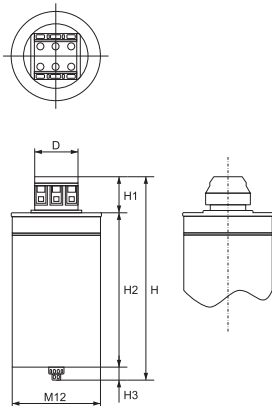

Dimensions (mm)

D	H1	H3
30	35	16

Type of the battery	Dimensions H / Ø (mm)	Operating voltage (V)	Battery capacity (kVAr)	Capacity (µF)	Packing/Box (pcs)	Product category	Catalogue number
HY 11A5	210/76	450	5.0	3X26.2	6	B	49005
HY 11A7	210/76	450	7.5	3X39	6	B	49007
HY 11A8*	230/80	450	8.0	3X39	6	F	49008
HY 11A10	240/76	450	10.0	3X52.4	6	B	49010
HY 11A15	240/86	450	15.0	3X78.9	6	B	49015
HY 11A20	240/116	450	20.0	3X105	6	B	49020
HY 11A30	280/160	450	30.0	3X157	6	B	49030
HY 11A50	345/180	450	50.0	3X262	6	B	49050
HY 11A100	300/300	450	100.0	3X524	6	B	49100
HY 11A12**	230 / 85	690	12.5	3X27.9	6	B	49031
HY 11A25**	280 / 115	690	25	3X55.7	6	B	49032



Note: *Until supply last, **Suitable for wind generators

CONTROLLER FOR AUTOMATIC REGULATION OF THE CAPACITY FACTOR (COSΦ REGULATOR)

3+2 standard +extended **5** YEAR TOTAL WARRANTY

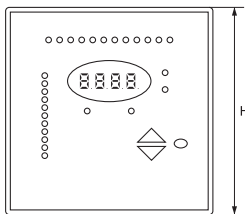

The automatic regulators of the capacity factor RPCF-xx series are devices for monitoring of low voltage systems and control of switching on of capacitor batteries for the capacity factor compensation. There is possibility for adjustment of the system parameters and control. Manufactured by the latest CMOS technology, they are distinguished with high degree of data security, easy programming and secure control of the outlets. There is possibility for indication and setting the parameters of the power supply system as: capacity coefficient, display of the system parameters such as voltage, current and capacity, losses, protection against overload, overload indication or lack of voltage, etc.

The change of parameters is performed through a combination of buttons on the front panel. There is light diode to indicate which parameter is being displayed on the screen and which outlets are in operation. The display is four digital. There is possibility for choice of the working conditions: manual or automatic.

TECHNICAL DATA:

- Rated operating voltage: 230/400V
- Operating frequency: 45 – 65Hz
- insulation voltage: 690V
- Surge voltage wear resistance: 6kV per minute
- Measurement range: from 0 to 9999kVAr
- Measurement accurateness:
 - voltage: ±1.0%
 - current: ±1.0%
 - capacity coefficient: ±1.0%
 - reactive energy: ±2.0%
- Operating temperature: -10+65°C
- Humidity: 30 – 60%
- Display: 4 digital
- Responsiveness: 20mA
- Outlet: 7A
- Number of outlets: 12 and 16
- Altitude: up to 2500m

MOUNTING:

On the front panel of the box through cutting an opening

Type	Number of steps	Dimensions H (mm)	Packing/Box (pcs)	Product category	Catalogue number
HY-RPCF12	12	122x122	8	B	49120
HY-RPCF16	16	144x144	8	B	49160



USE OF THE SOLAR ENERGY - A PERSPECTIVE CHOICE

During the last years, the use of solar energy is more popular and it gets into our every day life more and more tangible, we can find it in different products of different mode and type - charging stations and batteries for cell phones, outdoor lighting bodies, street lamps, video surveillance cameras and etc.

The continuous improvement of the technology and the reduce of the prices of the solar products worldwide, makes the idea for autonomic production of energy for our homes more and more attractive, and even more profitable within the last years. The reasons to use this type of energy and products become numerous and more convincible.





REDUCE YOUR BILLS FOR ELECTRICITY DRASTICALLY



Regardless of it, if you are an owner of a small home or business, the electricity bill is a great part of all expenses each month. The use of the solar energy for energy production can reduce this expense partially or even to exclude it entirely. Having in mind the long life of the modern solar system, which is approximately around 25 years, the perspective of this type of system for powering your home or business, despite the low electricity bills, and in its longevity. And meaning the unstable and constantly rising prices of the electricity, this will give you security and predictability of the expenses for years ahead.

USE OF 100% CLEAN ENERGY



The solar energy is 100% clean and restorable energetic source. Thanks to it, the need of, and the dependence on the exhaustive sources like petrol, gas and solid fuels for production of electricity is reduced. These solid fuels produce harmful emissions which affect the air quality, the water and soil and are responsible for the global warming. On the other hand, the sun offers an unlimited source of energy which doesn't pollute the environment at all. The living systems of solar energy represent an investment in the future of the planet, keeping the non-renewable energetic sources and protecting the environment.

ADD SOME COST TO YOUR HOME

Building of the solar system for electricity consumption will add inevitably value to your estate, in case you decide to sell it one day. This will be a solid argument for each of the buyers to choose your estate in front of such, without a build in solar system.



SOLAR POWER OFF-GRID SYSTEMS



The Solar Home Power system is a fixed installation designed for domestic application. It is powered by solar energy using solar cells that convert solar energy (sunlight) directly to electricity. The Solar Home Power system are the perfect compact solution for an independent power supply in remote locations where electricity is unavailable, unreliable or expensive. Can be used in houses, Huts & Cottages, holiday areas, offices and etc. The Solar Home Power system can achieve energy independence - no accession contracts, monthly charges and the need to build an energy grid to your home. The Solar Home Power Systems are compact, portable and easily mountable. They are an economical solution to all your power problems.



HOME SOLAR POWER OFF-GRID SYSTEM 500W SET

3+2 standard +extended **5** YEAR TOTAL WARRANTY

FUNCTION:

- Solar power supply

SOLAR PANEL:

- Type: Polycrystalline 18V 150W
- Optimum Operating Voltage: 18V
- Optimum Operating Current: 8.33A
- Open- Circuit Voltage: 20.88V
- Short- Circuit Current: 9.57A
- Power: 150W
- Sizes LxWxH(mm): 1490x680x5

INVERTER:

- 500W
- Output
 - USB 5V
 - 12V DC
 - 220V AC: Universal socket
- Size LxWxH (mm): 200x94x228

SET INCLUDED:

- Solar panel 18V 150W: 1 pc
- Inverter 500W: 1 pc

Type	Solar panel	Inverter	Battery	Packing/Box (pcs)	Product category	Catalogue number
ELM- 500SOL	18V 150W	500W	100Ah Not included	1	E	98SOL500

Recommended with a battery 100Ah with a catalog number: 98BAT100

Discharging time at 75% consumption from total Inverter power (about 375W) by using 100Ah battery: 3.2h

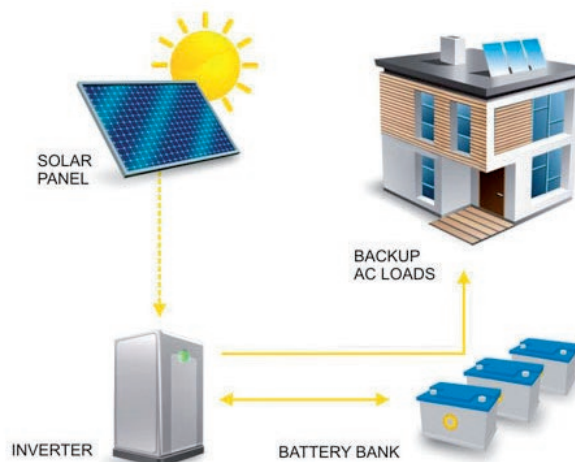

In case of insufficient quantity in stock of any item listed on this page, the delivery time after order confirmation will be 90 days.

HOME SOLAR POWER OFF-GRID SYSTEM 800W SET

3+2
standard
+extended
5 YEAR TOTAL
WARRANTY



FUNCTION:

- Solar power supply

SOLAR PANEL:

- Type: Polycrystalline 18V 150W
- Optimum Operating Voltage: 18V
- Optimum Operating Current: 8.33A
- Open- Circuit Voltage: 20.88V
- Short- Circuit Current: 9.57A
- Power: 150W
- Sizes LxWxH(mm): 1490x680x5

INVERTER:

- 800W
- Output
 - USB 5V
 - 12V DC
 - 220V AC: Universal socket
- Size LxWxH (mm): 300x100x220

SET INCLUDED:

- Solar panel 18V 150W: 1 pc
- Inverter 800W: 1 pc



Type	Solar panel	Inverter	Battery	Packing/Box (pcs)	Product category	Catalogue number
ELM- 800SOL	18V 150W	800W	100Ah Not included	1	E	98SOL800

Recommended with a battery 100Ah with a catalog number: 98BAT100

Discharging time at 75% consumption from total Inverter power (about 600W) by using 100Ah battery: 2h



In case of insufficient quantity in stock of any item listed on this page, the delivery time after order confirmation will be 90 days.

HOME SOLAR POWER OFF-GRID SYSTEM 2000W SET

3+2
standard
+extended
5 YEAR TOTAL
WARRANTY



FUNCTION:

- Solar power supply

SOLAR PANEL:

- Type: Polycrystalline 36V 250W
- Optimum Operating Voltage: 36V
- Optimum Operating Current: 13.89A
- Short- Circuit Current: 15.97A
- Power: 2x250W

INVERTER:

- 2000W
- Output
 - USB 5V
 - 12V DC
 - 220V AC: Universal socket
- Size LxWxH (mm): 300x100x220

SET INCLUDED:

- Solar panel 36V 250W: 2 pc
- Inverter 2000W: 1 pc

Type	Solar panel	Inverter	Battery	Packing/Box (pcs)	Product category	Catalogue number
ELM- 2000SOL	36V 250Wx2	2000W	2x250Ah	Not included	1	E 98SOL2000

Recommended with two battery 250Ah with a catalog number: 98BAT250

Discharging time at 75% consumption from total Inverter power (about 1500W) by using 2 battery 250Ah: 4h



2+0 standard+extended **2** YEAR TOTAL WARRANTY



98BAT100

VRLA BATTERY ULTRACELL 100AH

APPLICATION:

- Golf Trolleys
- Garden Equipment
- Portable Equipment
- Solar/Wind Mill Units
- Medical Equipment
- Traffic Lights

TECHNICAL DATA:

- Nominal Voltage: 12V
- Nominal Capacity (10HR): 100Ah
- Cycle Life in Relation to Depth of Discharge:
Extracted Capacity 50%: 1200 Cycles
Extracted Capacity 20%: 3600 Cycles
- Rated Capacity:
20HR 1.80V/cell, 25°C- 103 Ah/5.15A
10HR 1.80V/cell, 25°C- 100 Ah/10.0A

- 5HR 1.75V/cell, 25°C- 85 Ah/17.0A
- 3HR 1.75V/cell, 25°C- 73.8 Ah/24.6A
- 1HR 1.60V/cell, 25°C- 59.7 Ah/59.7A
- Max Discharge Current: 1200A (5s)
- Internal resistance: Approx 5mΩ
- Operating Temp Range:
Discharge: -15 ~ 50°C
Charge: 0 ~ 40°C
Storage: -15 ~ 40°C
- Nominal Operating Temp Range: 25 ± 3°C
- Container Material: ABS
- Indoor use
- Dimension LxWxH (mm):
330±3MMx173±3MMx232±3MM
- Weight: 30.4 kg
- Catalogue number: 98BAT100
- Product category: E

Discharge Characteristics

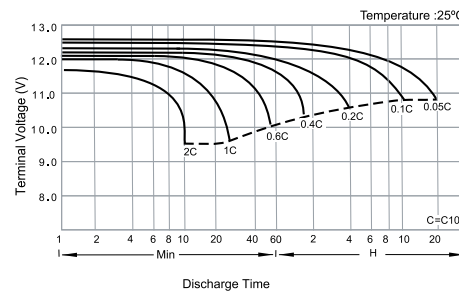

Cycle Life in Relation to Depth of Discharge

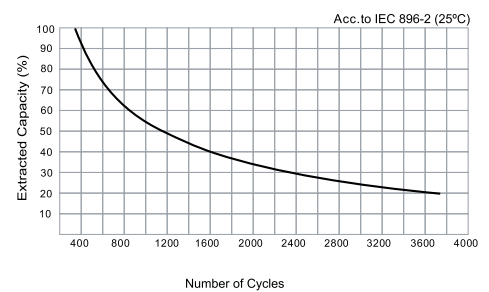

Float Charging Characteristics

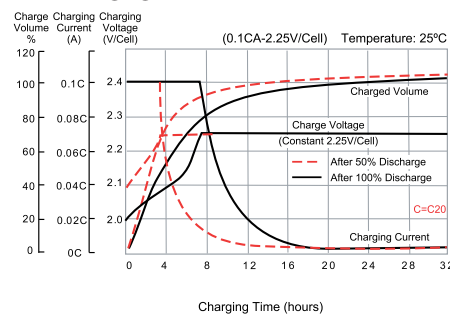

General Relation of Capacity vs. Storage Time

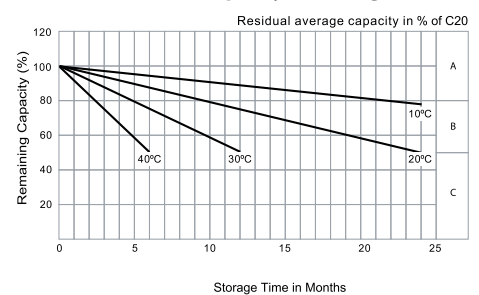

2+0 standard +extended YEAR TOTAL WARRANTY



98BAT250

VRLA BATTERY ULTRACELL 250AH

APPLICATION:

- UCG Series VRLA batteries can be used for:
- Golf Trolleys
- Garden Equipment
- Portable Equipment
- Solar/Wind Mill Units
- Medical Equipment
- Traffic Lights

TECHNICAL DATA:

- Nominal Voltage: 12V
- Nominal Capacity (10HR): 250Ah
- Cycle Life in Relation to Depth of Discharge:
 - Extracted Capacity 50%: 1200 Cycles
 - Extracted Capacity 20%: 3600 Cycles
- Rated Capacity:
 - 20HR 1.80V/cell, 25°C- 258 Ah/12.9A
 - 10HR 1.80V/cell, 25°C- 250 Ah/25A

- 5HR 1.75V/cell, 25°C- 212.5 Ah/42.5A
- 3HR 1.75V/cell, 25°C- 184.5 Ah/61.5A
- 1HR 1.60V/cell, 25°C- 149.3 Ah/149.3A
- Max Discharge Current: 2500A (5s)
- Internal resistance: Approx 2.5mΩ
- Operating Temp Range:
 - Discharge: -15 ~ 50°C
 - Charge: 0 ~ 40°C
 - Storage: -15 ~ 40°C
- Nominal Operating Temp Range: 25 ± 3°C
- Container Material: ABS
- Indoor use
- Dimension LxWxH (mm): 522±3MMx268±3MMx226±3MM
- Weight: 70 kg
- Catalogue number: 98BAT250
- Product category: E

Discharge Characteristics

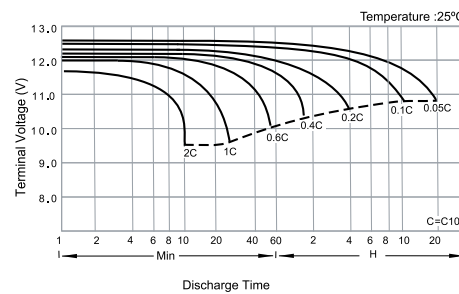

Cycle Life in Relation to Depth of Discharge

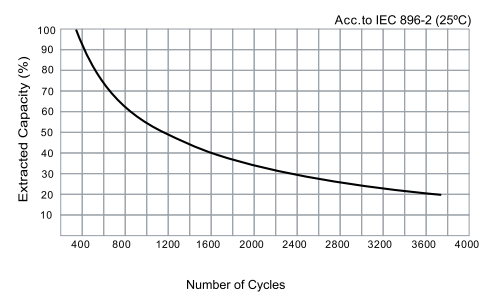

Float Charging Characteristics

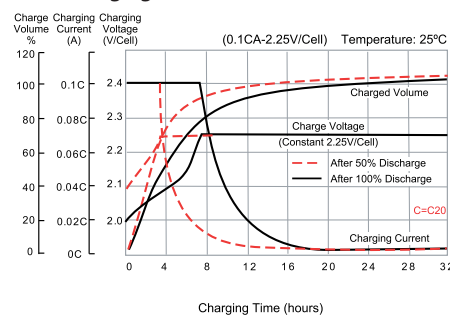

General Relation of Capacity vs. Storage Time

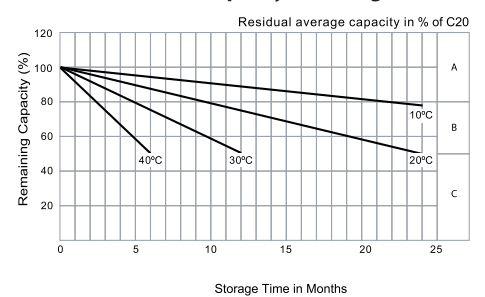

SOLAR POWER SYSTEMS

BATTERIES

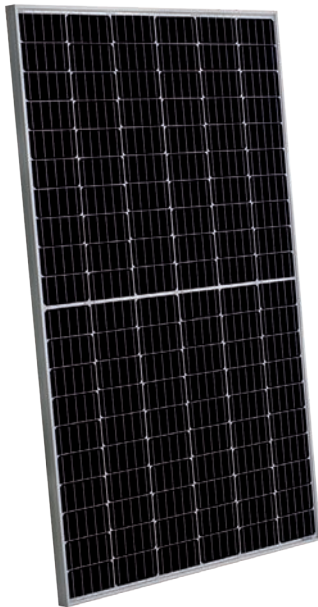

**MONOCRYSTALLINE HALF CUT CELL
SOLAR PANEL 410W**

10+0 standard +extended **10** YEAR TOTAL WARRANTY

Mono half cut cells Solar Panel that are cut in half. That improves the module's performance and durability. When solar cells are halved, their current is also halved, so resistive losses are lowered and the cells can produce a little more power. Smaller cells experience reduced mechanical stresses, so there is a decreased opportunity for cracking. Half-cell modules have higher output ratings and are more reliable than traditional panels.

Catalogue number: 98SOL340M

SPECIFICATION 410W

- Irradiance 1000 W/m², AM 1.5, gand cell temperature of 25°C
- Peack power (Pmax): 410
- Maximum power voltage (Vmp): 34.89
- Maximum power current (Imp): 11.76
- Open circuit voltage (Voc): 41.90
- Short circuit current (Isc): 12.47
- Module efficiency (%): 21.3
- Maximum system voltage (V): 1500
- Number of cells: 120 (5x12+5x12)
- Dimensions HxWxD (mm): 1754x1096x30
- Weight (kg): 21
- Max. load (Pa): 5400
- EC Declaration of conformity

*Note: the specifications are obtained under the Standard Test Conditions (STCs): 1000W/m² solar irradiance, 1.5 Air Mass, and cell temperature of 25°C.

CHARACTERISTICS AT DIFFERENT IRRADIATIONS

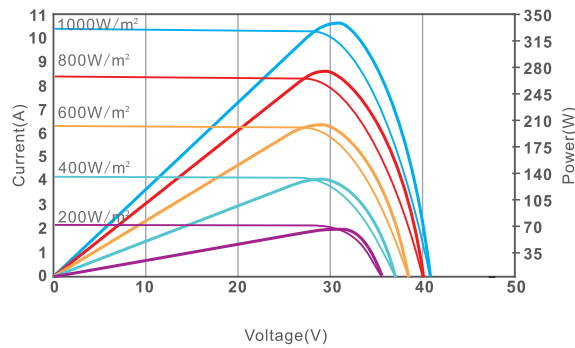

CHARACTERISTICS AT DIFFERENT TEMPERATURES

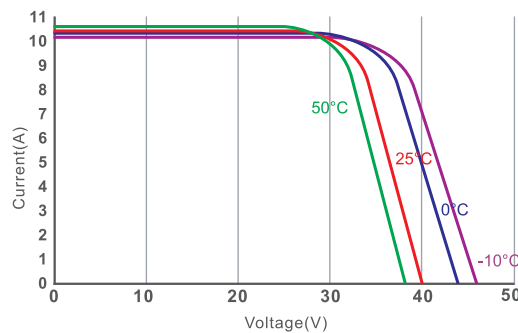

In case of insufficient quantity in stock of any item listed on this page, the delivery time after order confirmation will be 90 days.

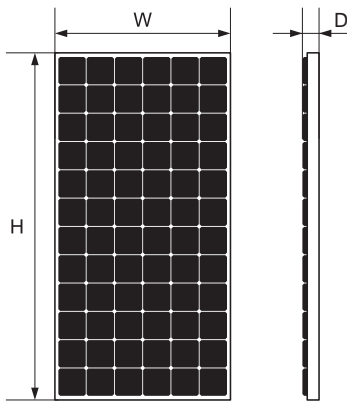

MECHANICAL DATA 410W

Number of Cells: 120 cells (5x12+5x12)
 Weight: 21kg
 Dimension: 1754x1096x30mm
 Max Load: 5400 Pascals
 Junction Box: IP68 rated
 Connector: MC4 Compatible
 Wire Type: PV Wire
 Frame: Anodized aluminium alloy type

TEMPERATURE CHARACTERISTICS 410W

Nominal module operating temperature (NMOT): 44° C±2° C
 Temp. Coeff. of Voc (TK Voc): -0.25% /°C
 Temp. Coeff. of Isc (TK Isc): 0.04% /°C
 Temp. Coeff. of Pmax (TK Pmax): -0.34% /°C
 Operating temperature: -40°C+85°C

FEATURES:

- High conversion efficiency: High module efficiency to guarantee power output.
- Self-cleaning glass: Coating glass for self-cleaning, reduce surface dust.
- Outstanding low irradiation performance: Excellent module efficiency even in the weak light conditions, such as morning or cloudy.
- Excellent loading capability: 2400Pa wind loads, 5400Pa snow loads.

TECHNOLOGY ADVANTAGES OF HALF CUT CELLS SOLAR PANELS:

- It is superior in low sunlight performance.
- It is not affected by shade as much as standard panels.
- It is more durable for long life performance
- It is less susceptible to micro cracking. (cracks that develop in cells over time)
- They perform better under high heat conditions than standard solar panels.
- They are less susceptible to hot spots, a major cause of panel failure.
- They are much higher efficiency than standard panels.

Dimensions 410W (mm)

H	W	D
1754	1096	30

HALF CELL MODULE

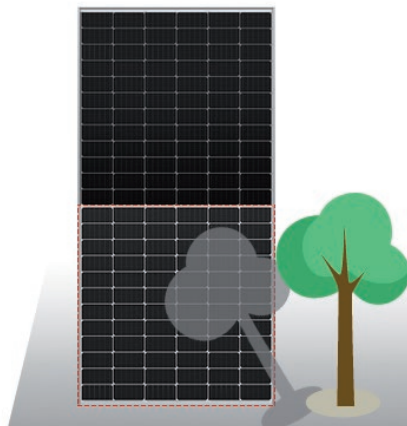

STANDART MODULE

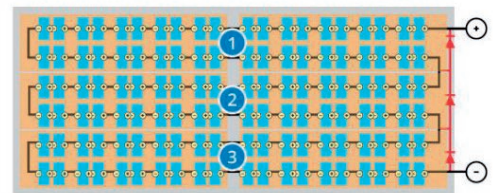
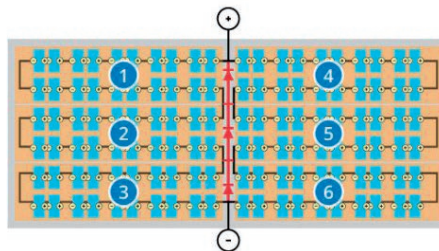
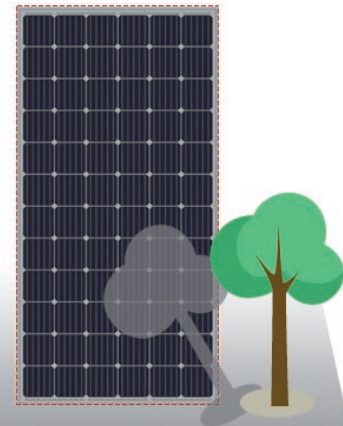



SOLAR MOUNTING STRUCTURE

Since solar panels are designed for outdoor installation and are subject to continuous weather conditions, the type of material that makes the structure is important for the reliability of the entire system. Due to the envisaged long service life of more than 25 years, the construction and attachment of the panels to it must be secure. The mounting structure are available for grround and in different variants according to the type of the roof - metal, bitumen or tile, flat or pitched.

1 | TILE ROOF MOUNTING STRUCTURE FOR PITCHED ROOF, SET

TECHNICAL DATA:

- Installation Site: tile roof
- Panel type: framed
- Roof Slope: Up to 60 degree
- Wind Speed: Up to 60 m/s
- Snow load: 1.4 KN/m2

FEATURES:

- You can choose your own configuration of elements or the proposed ready-made variants of kits for different power
- Variuos roof hooks for different tile roofs
- Suitable for all framed PV modules
- Easy and fast installation
- Pre-assembled components save the installation time and cost

SUITABLE COMPONENTS FOR PITCHED TILE ROOF



Description	Material	Product category	Catalogue number
Rails- 2300mm	Aluminium 6005-T5	E	423199



Description	Material	Product category	Catalogue number
Rail connector- 140mm	Aluminium 6005-T5	E	423201



Description	Material	Product category	Catalogue number
Mid clamp for framed panel 30-50mm	Aluminium 6005-T5	E	423202



Description	Material	Product category	Catalogue number
End clamp for framed panel 30-50mm	Aluminium 6005-T5	E	423203



Description	Material	Product category	Catalogue number
Tile Roof Hook 1	stainless steel	E	423204



In case of insufficient quantity in stock of any item listed on this page, the delivery time after order confirmation will be 90 days.



Description	Material	Product category	Catalogue number
Tile Roof Hook 2	stainless steel	E	423205



Description	Material	Product category	Catalogue number
Tile Roof Hook 13	stainless steel	E	423206



Description	Material	Product category	Catalogue number
Tile Roof Hook 14	stainless steel	E	423207



Description	Material	Product category	Catalogue number
Grounding Clip	stainless steel	E	423208



Description	Material	Product category	Catalogue number
Earth lug	Aluminium	E	423209



Description	Material	Product category	Catalogue number
Cable clip 1- 2x4/6mm ²	stainless steel	E	423210

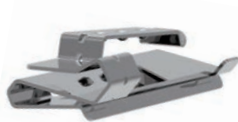

Description	Material	Product category	Catalogue number
Cable clip 2- 4x90°4/6mm ² /3x90°10mm ²	stainless steel	E	423211



In case of insufficient quantity in stock of any item listed on this page, the delivery time after order confirmation will be 90 days.

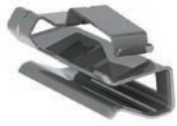

Description	Material	Product category	Catalogue number
Cable clip 8- 2x90°4/6mm²	stainless steel	E	423212



Description	Material	Product category	Catalogue number
Cable clip 9- 2x90°4/6mm²	stainless steel	E	423213

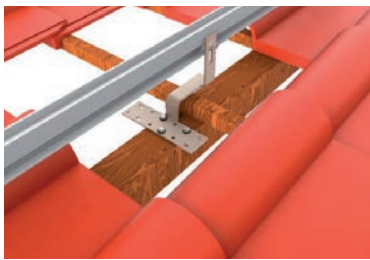

BASIC ELEMENTS QUANTITY CALCULATION FOR EACH SOLAR POWER SYSTEMS STRUCTURE SETS FROM 3.6 TO 30KW:

Quantity from each elements are calculated for solar panel with dimensions 1754x1096x30mm and peak power 410 W with catalogue number 98SOL340M.

ELEMENT		ELEMENT QTY					
Description	Catalogue number	at 3.6 kW	at 5 kW	at 10 kW	at 15 kW	at 20 kW	at 30 kW
Rails- 2300mm	423199	10	14	26	38	50	74
Rail connector- 140mm	423201	8	12	22	34	45	67
Mid clamp for framed panel 30-50mm	423202	18	26	66	78	102	154
End clamp for framed panel 30-50mm	423203	20	28	60	76	100	148
Tile Roof Hook 1	423204	26	34	64	98	126	190
Grounding Clip	423208	18	26	66	78	102	154
Earth lug	423209	10	14	26	38	50	74



SETS CATALOGUE NUMBERS:

The quantity elements for each structure set is to described in the table upper.

Solar power systems (kW)	Product category	Catalogue number
3.6	E	423270P/TR
5	E	423271P/TR
10	E	423272P/TR
15	E	423273P/TR
20	E	423274P/TR
30	E	423275P/TR



TILE ROOF MOUNTING STRUCTURE FOR PITCHED ROOF

In case of insufficient quantity in stock of any item listed on this page, the delivery time after order confirmation will be 90 days.



2 | SANDWICH ROOF MOUNTING STRUCTURE FOR PITCHED ROOF, SET

TECHNICAL DATA:

- Installation: tin roof mounting brackets
- Panel type: framed
- Panel orientation: landscape or portrait
- Roof slope: up to 60 degree
- Max wind speed: up to 60 m/s
- Snow load: 1.4 KN/m2

FEATURES:

- Universal roof brackets for different tin roofs
- Suitable for all framed PV modules
- Easy and fast installation
- Pre-assembled components save the installation time and cost

SUITABLE COMPONENTS FOR PITCHED SANDWICH ROOF:



Description	Material	Product category	Catalogue number
Rails- 2300mm	Aluminium 6005-T5	E	423199



Description	Material	Product category	Catalogue number
Rail connector- 140mm	Aluminium 6005-T5	E	423201



Description	Material	Product category	Catalogue number
Middle clamp for framed panel 30-50mm	Aluminium 6005-T5	E	423202



Description	Material	Product category	Catalogue number
End clamp for framed panel 30-50mm	Aluminium 6005-T5	E	423203



Description	Material	Product category	Catalogue number
L-feet for tin roof	stainless steel	E	423216



Description	Material	Product category	Catalogue number
Tin Roof Hook 2	stainless steel	E	423217



In case of insufficient quantity in stock of any item listed on this page, the delivery time after order confirmation will be 90 days.



Description	Material	Product category	Catalogue number
Tin Roof Hook 3	stainless steel	E	423218



Description	Material	Product category	Catalogue number
Grounding Clip	stainless steel	E	423208



Description	Material	Product category	Catalogue number
Earth lug	Aluminium	E	423209



Description	Material	Product category	Catalogue number
Cable clip 1- 2x4/6mm ²	stainless steel	E	423210

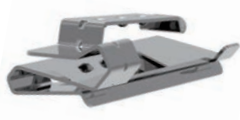

Description	Material	Product category	Catalogue number
Cable clip 2- 4x90°4/6mm ² /3x90°10mm ²	stainless steel	E	423211

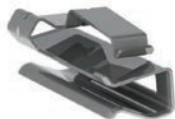

Description	Material	Product category	Catalogue number
Cable clip 8- 2x90°4/6mm ²	stainless steel	E	423212



Description	Material	Product category	Catalogue number
Cable clip 9- 2x90°4/6mm ²	stainless steel	E	423213



BASIC ELEMENTS QUANTITY CALCULATION FOR EACH SOLAR POWER SYSTEMS STRUCTURE SETS FROM 3.6 TO 30KW:

Quantity from each elements are calculated for solar panel with dimensions 1754x1096x30mm and peak power 410 W with catalogue number 98SOL340M.



ELEMENT		ELEMENT QTY					
Description	Catalogue number	at 3.6 kW	at 5 kW	at 10 kW	at 15 kW	at 20 kW	at 30 kW
Rails- 2300mm	423199	10	14	26	38	50	74
Rail connector- 140mm	423201	8	12	22	34	45	67
Middle clamp for framed panel 30-50mm	423202	18	26	66	78	102	154
End clamp for framed panel 30-50mm	423203	20	28	60	76	100	148
L-feet for tin roof	423216	26	34	64	98	126	190
Grounding Clip	423208	18	26	66	78	102	154
Earth lug	423209	10	14	26	38	50	74

SETS CATALOGUE NUMBERS:

The quantity elements for each structure set is to described in the table upper.

Solar power systems (kW)	Product category	Catalogue number
3.6	E	423270P/DR
5	E	423271P/DR
10	E	423272P/DR
15	E	423273P/DR
20	E	423274P/DR
30	E	423275P/DR

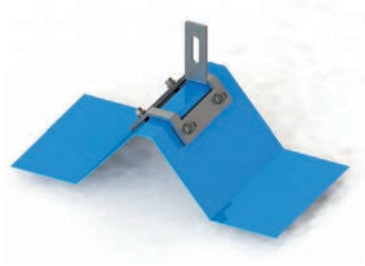

SANDWICH ROOF MOUNTING OPTION 1

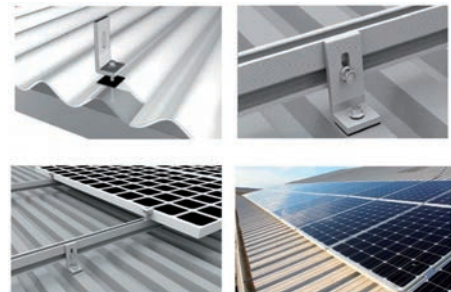

SANDWICH ROOF MOUNTING OPTION 2

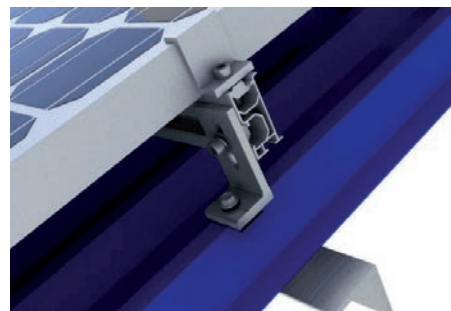

SANDWICH ROOF MOUNTING STRUCTURE FOR PITCHED ROOF



In case of insufficient quantity in stock of any item listed on this page, the delivery time after order confirmation will be 90 days.



3 | SHINGLE ROOF MOUNTING STRUCTURE FOR PITCHED ROOF, SET

TECHNICAL DATA:

- Installation Site: shingle roof
- Panel type: framed
- Roof Slope: Up to 60 degree
- Wind Speed: Up to 60 m/s
- Snow load: 1.4 KN/m2

FEATURES:

- Suitable for all framed PV modules
- Easy and fast installation
- Pre-assembled components save the installation time and cost

SUITABLE COMPONENTS FOR PITCHED SHINGLE ROOF:



Description	Material	Product category	Catalogue number
Rails- 2300mm	Aluminium 6005-T5	E	423199



Description	Material	Product category	Catalogue number
Rail connector- 140mm	Aluminium 6005-T5	E	423201



Description	Material	Product category	Catalogue number
Middle clamp for framed panel 30-50mm	Aluminium 6005-T5	E	423202



Description	Material	Product category	Catalogue number
End clamp for framed panel 30-50mm	Aluminium 6005-T5	E	423203



Description	Material	Product category	Catalogue number
L-feet with cone hole	stainless steel	E	423214



Description	Material	Product category	Catalogue number
Flashing plate 280x280	stainless steel	E	423215



In case of insufficient quantity in stock of any item listed on this page, the delivery time after order confirmation will be 90 days.



Description	Material	Product category	Catalogue number
Grounding Clip	stainless steel	E	423208



Description	Material	Product category	Catalogue number
Earth lug	Aluminium	E	423209



Description	Material	Product category	Catalogue number
Cable clip 1- 2x4/6mm ²	stainless steel	E	423210



Description	Material	Product category	Catalogue number
Cable clip 2- 4x90°4/6mm ² /3x90°10mm ²	stainless steel	E	423211

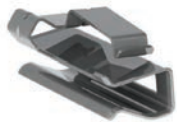

Description	Material	Product category	Catalogue number
Cable clip 8- 2x90°4/6mm ²	stainless steel	E	423212



Description	Material	Product category	Catalogue number
Cable clip 9- 2x90°4/6mm ²	stainless steel	E	423213





BASIC ELEMENTS QUANTITY CALCULATION FOR EACH SOLAR POWER SYSTEMS STRUCTURE SETS FROM 3.6 TO 30KW:

Quantity from each elements are calculated for solar panel with dimensions 1754x1096x30mm and peak power 410 W with catalogue number 98SOL340M.

ELEMENT		ELEMENT QTY					
Description	Catalogue number	at 3.6 kW	at 5 kW	at 10 kW	at 15 kW	at 20 kW	at 30 kW
Rails- 2300mm	423199	10	14	26	38	50	74
Rail connector- 140mm	423201	8	12	22	34	45	67
Middle clamp for framed panel 30-50mm	423202	18	26	66	78	102	154
End clamp for framed panel 30-50mm	423203	20	28	60	76	100	148
L-feet with cone hole	423214	26	34	64	98	126	190
Flashing plate 280x280	423215	26	34	64	98	126	190
Grounding Clip	423208	18	26	66	78	102	154
Earth lug	423209	10	14	26	38	50	74

SETS CATALOGUE NUMBERS:

The quantity elements for each structure set is to described in the table upper.

Solar power systems (kW)	Product category	Catalogue number
3.6	E	423270P/SR
5	E	423271P/SR
10	E	423272P/SR
15	E	423273P/SR
20	E	423274P/SR
30	E	423275P/SR

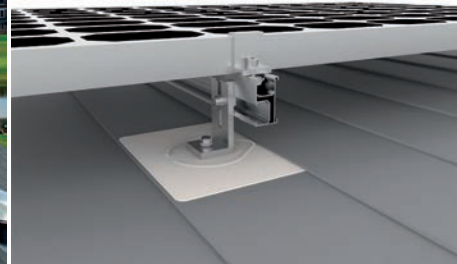

SHINGLE ROOF MOUNTING STRUCTURE FOR PITCHED ROOF





4 | TRIANGULAR MOUNTING STRUCTURE FOR GROUND AND FLAT ROOF, SET

TECHNICAL DATA:

- Installation Site: flat roof
- Panel type: framed
- Wind Speed: Up to 60 m/s
- Snow load: 1.4 KN/m2

FEATURES:

- Triangular mounting brackets with stable structure, it can be installed directly on rooftop, ground or pre-made cement blocks as your option
- Suitable for all framed PV modules
- Easy and fast installation
- Pre-assembled components save the installation time and cost

SUITABLE COMPONENTS FOR TRIANGULAR MOUNTING STRUCTURE FOR GROUND AND FLAT ROOF:



Description	Material	Product category	Catalogue number
Rails- 2300mm	Aluminium 6005-T5	E	423199



Description	Material	Product category	Catalogue number
Rail connector- 140mm	Aluminium 6005-T5	E	423201



Description	Material	Product category	Catalogue number
Middle clamp for framed panel 30-50mm	Aluminium 6005-T5	E	423202



Description	Material	Product category	Catalogue number
End clamp for framed panel 30-50mm	Aluminium 6005-T5	E	423203



Description	Material	Product category	Catalogue number
15° Triangular mounts	Aluminium 6005-T5	E	423223



Description	Material	Product category	Catalogue number
30° Triangular mounts	Aluminium 6005-T5	E	423227



In case of insufficient quantity in stock of any item listed on this page, the delivery time after order confirmation will be 90 days.



Description	Material	Product category	Catalogue number
L-connector for rail	stainless steel	E	423224



Description	Material	Product category	Catalogue number
Hex nut anchor	Galvanized steel	C	M517215



Description	Material	Product category	Catalogue number
Grounding Clip	stainless steel	E	423208



Description	Material	Product category	Catalogue number
Earth lug	Aluminium	E	423209



Description	Material	Product category	Catalogue number
Cable clip 1- 2x4/6mm ²	stainless steel	E	423210



Description	Material	Product category	Catalogue number
Cable clip 2- 4x90°4/6mm ² /3x90°10mm ²	stainless steel	E	423211

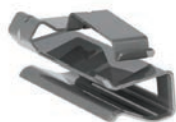

Description	Material	Product category	Catalogue number
Cable clip 8- 2x90°4/6mm ²	stainless steel	E	423212



In case of insufficient quantity in stock of any item listed on this page, the delivery time after order confirmation will be 90 days.



Description	Material	Product category	Catalogue number
Cable clip 9- 2x90°4/6mm ²	stainless steel	E	423213



BASIC ELEMENTS QUANTITY CALCULATION FOR EACH SOLAR POWER SYSTEMS STRUCTURE SETS FROM 3.6 TO 30KW:

Quantity from each elements are calculated for solar panel with dimensions 1754x1096x30mm and peak power 410 W with catalogue number 98SOL340M.

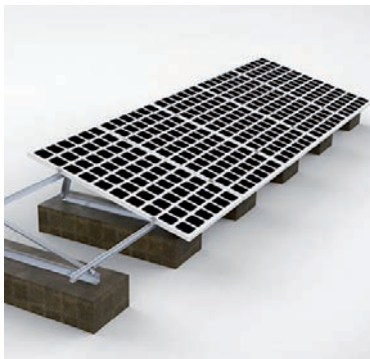

ELEMENT	Description	Catalogue number	ELEMENT QTY					
			at 3.6 kW	at 5 kW	at 10 kW	at 15 kW	at 20 kW	at 30 kW
Rails- 2300mm		423199	10	14	26	38	50	74
Rail connector- 140mm		423201	8	12	22	34	45	67
Middle clamp for framed panel 30-50mm		423202	18	26	66	78	102	154
End clamp for framed panel 30-50mm		423203	20	28	60	76	100	148
30° Triangular mounts		423227	10	14	26	38	50	74
L-connector for rail		423224	20	28	52	76	100	148
Hex nut anchor		M517215	26	34	64	98	126	190
Grounding Clip		423208	18	26	66	78	102	154
Earth lug		423209	10	14	26	38	50	74

SETS CATALOGUE NUMBERS:

The quantity elements for each structure set is to described in the table upper.

Solar power systems (kW)	Product category	Catalogue number
3.6	E	423270F/TR
5	E	423271F/TR
10	E	423272F/TR
15	E	423273F/TR
20	E	423274F/TR
30	E	423275F/TR



TRIANGULAR MOUNTING STRUCTURE FOR GROUND AND FLAT ROOF



5 | BALLASTED TRIANGULAR MOUNTING STRUCTURE FOR FLAT ROOF, SET

TECHNICAL DATA:

- Installation Site: flat roof
- Panel type: framed
- Wind Speed: Up to 60 m/s
- Snow load: 1.4 KN/m²

FEATURES:

- Triangular mounting brackets with stable structure, it can be installed directly on rooftop, ground or pre-made cement blocks as your option
- Suitable for all framed PV modules
- Easy and fast installation
- Pre-assembled components save the installation time and cost

SUITABLE COMPONENTS FOR BALLASTED TRIANGULAR MOUNTING STRUCTURE FOR FLAT ROOF:



Description	Material	Product category	Catalogue number
Rails- 2300mm	Aluminium 6005-T5	E	423199



Description	Material	Product category	Catalogue number
Rail connector- 140mm	Aluminium 6005-T5	E	423201



Description	Material	Product category	Catalogue number
Middle clamp for framed panel 30-50mm	Aluminium 6005-T5	E	423202



Description	Material	Product category	Catalogue number
End clamp for framed panel 30-50mm	Aluminium 6005-T5	E	423203



Description	Material	Product category	Catalogue number
15° Triangular mounts	Aluminium 6005-T5	E	423223



Description	Material	Product category	Catalogue number
30° Triangular mounts	Aluminium 6005-T5	E	423227



In case of insufficient quantity in stock of any item listed on this page, the delivery time after order confirmation will be 90 days.



Description	Material	Product category	Catalogue number
L-connector for rail	stainless steel	E	423224



Description	Material	Product category	Catalogue number
Angle Plate	stainless steel	E	423225



Description	Material	Product category	Catalogue number
Grounding Clip	stainless steel	E	423208



Description	Material	Product category	Catalogue number
Earth lug	Aluminium	E	423209



Description	Material	Product category	Catalogue number
Cable clip 1- 2x4/6mm ²	stainless steel	E	423210



Description	Material	Product category	Catalogue number
Cable clip 2- 4x90°4/6mm ² /3x90°10mm ²	stainless steel	E	423211

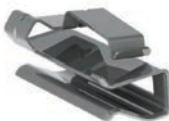

Description	Material	Product category	Catalogue number
Cable clip 8- 2x90°4/6mm ²	stainless steel	E	423212



In case of insufficient quantity in stock of any item listed on this page, the delivery time after order confirmation will be 90 days.



Description	Material	Product category	Catalogue number
Cable clip 9- 2x90°4/6mm ²	stainless steel	E	423213



BASIC ELEMENTS QUANTITY CALCULATION FOR EACH SOLAR POWER SYSTEMS STRUCTURE SETS FROM 3.6 TO 30KW:

Quantity from each elements are calculated for solar panel with dimensions 1754x1096x30mm and peak power 410 W with catalogue number 98SOL340M.

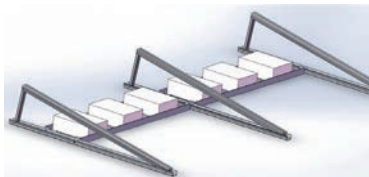

BALLASTED TRIANGULAR MOUNTING STRUCTURE FOR FLAT ROOF

ELEMENT		ELEMENT QTY					
Description	Catalogue number	at 3.6 kW	at 5 kW	at 10 kW	at 15 kW	at 20 kW	at 30 kW
Rails- 2300mm	423199	10	14	26	38	50	74
Rail connector- 140mm	423201	8	12	22	34	45	67
Middle clamp for framed panel 30-50mm	423202	18	26	66	78	102	154
End clamp for framed panel 30-50mm	423203	20	28	60	76	100	148
30° Triangular mounts	423227	10	14	26	38	50	74
L-connector for rail	423224	20	28	52	76	100	148
Angle Plate	423225	12	16	30	46	60	90
Grounding Clip	423208	18	26	66	78	102	154
Earth lug	423209	10	14	26	38	50	74

SETS CATALOGUE NUMBERS:

The quantity elements for each structure set is to described in the table upper.

Solar power systems (kW)	Product category	Catalogue number
3.6	E	423270F/BTR
5	E	423271F/BTR
10	E	423272F/BTR
15	E	423273F/BTR
20	E	423274F/BTR
30	E	423275F/BTR





H1Z2Z2-K UNIPOLAR CABLE FOR PHOTOVOLTAIC AND SOLAR PLANTS WITH UV RESISTANT SHEATH

TECHNICAL CHARACTERISTICS:

- Operating voltage: AC- 1.0KV; DC- 1.5KV
- Max. operating voltage: AC- 1.2KV; DC- 1.8KV
- Test voltage: AC- 6.5KV for 5 min; DC- 15KV for 5 min
- Ambient work temperature: from -40 to + 90 °C
- Max. short circuit temperature: +250 °C for 5s
- Maximum pulling stress: 15 N/mm² in operation, 50 N/mm² during installation

TECHNICAL DATA:

- Conductor: Tinned copper multi-wires class 5
- Insulation: LSZH reticulated elastomeric compound with neutral colour
- Outer sheath: LSZH reticulated elastomeric compound
- UV resistant
- Colour: Black and red
- Reaction to fire - Performance: EN 50575:2016 Eca

Cross section (n x mm ²)	Colour	Outer diameter (mm)	Total weight (kg/km)	Packing (m)	Product category	Catalogue number
4	black	5,6	58	100	E	M411079/BL
4	red	5,6	58	100	E	M411079/R
6	black	6,2	78	100	E	M411080/BL
6	red	6,2	78	100	E	M411080/R



SOLAR CABLE LENGTH, INCLUDED TO EACH SET

3.6kW	5kW	10kW	15kW	20kW	30kW	Catalogue number
x50m	x50m	x50m	x75m	x100m	x100m	M411079/BL
x50m	x50m	x50m	x75m	x100m	x100m	M411079/R

SINGLE MALE/FEMALE CABLE COUPLER IP67 SET, MC4 COMPATIBLE



TECHNICAL DATA:

- Rated voltage: 1000V
- Rated current: 30A
- Test voltage: 6KV(50Hz)
- Contact material: Copper, silver plated
- Operating temperature: -40 to +125°C
- Suitable cable cross section: 2.5mm²; 4mm² and 6mm²

Type	Range of cable glands (mm)	Conductor cross section (mm ²)	Packing (m)	Product category	Catalogue number
Single male/female couplers, SET	3-6	4/6	1/5	E	411078/MF

EC Declaration of conformity





DOUBLE MALE SINGLE FEMALE CABLE COUPLER IP67, MC4 COMPATIBLE

Type	Range of cable glands (mm)	Conductor cross section (mm ²)	Packing (m)	Product category	Catalogue number
2 male/ 1 female coupler	3-6	4/6	E	1	411080/M

EC Declaration of conformity



DOUBLE FEMALE SINGLE MALE CABLE COUPLER IP67, MC4 COMPATIBLE

Type	Range of cable glands (mm)	Conductor cross section (mm ²)	Packing (m)	Product category	Catalogue number
2 female/ 1 male coupler	3-6	4/6	E	1	411080/F

EC Declaration of conformity



DC PHOTOVOLTAIC ISOLATOR FOUR POLES SWITCH 1200V, IP66

3+2 standard +extended **5** YEAR TOTAL WARRANTY

DC switches shall be installed between the solar arrays and solar inverter for isolation the PV array during system installation or any maintenance.

TECHNICAL DATA:

- Rated insulation voltage (Ui): 1200V
- Rated heating current (Ith): 32A
- Poles: 4P
- Mechanical life: 10 000 cycles
- Operating temperature: -25 to +70°C
- Storage temperature: -40 to +70°C
- IP code: IP66
- Handle colour: Black

FEATURES:

- Vertical and horizontal installation
- UV resistance
- Flame retardant material
- Breatle valve
- Lockable at off position

Model	Poles	Rated insulation voltage (V)	Rated heating current (A)	IP code	Packing/Box (pcs)	Product category	Catalogue number
EL-DC4P	4	1200	32	66	1/20	E	98SOL4P/DC



DC SWITCH QUANTITY, INCLUDED TO EACH SET

3.6kW	5kW	10kW	15kW	20kW	30kW	Catalogue number
1	2	2	2	2	3	98SOL4P/DC

In case of insufficient quantity in stock of any item listed on this page, the delivery time after order confirmation will be 90 days.

PV ON-GRID TIE INVERTERS, SOLIS

5+0
standard
+extended
5 YEAR TOTAL
WARRANTY



Converts the variable direct current (DC) output of a photovoltaic (PV) solar panel into a utility frequency alternating current (AC) that can be fed into a commercial electrical grid. The output current has a standard output of 220/230V for single phase and 220/380V, 230/400V for three phase. Inverters (3.6-30)kW are reliable preferred equipment for residential, industrial and commercial pv power stations. Smaller size, higher efficiency, huge large color display for visual inspection of product operation.

FEATURES

- Super high frequency switching technology
- Wide voltage range and low startup voltage
- Precise MPPT algorithm
- Intergrated Export Power Manager (EPM)
- Friendly and adaptable connection to the grid
- IP protection: IP65

COMMUNICATION

- RS485
- Wi-Fi- optional with WI-FI stick with cat. number 423050

CERTIFICATION

- TÜV Rheinland CERTIFICATED
- Compliance Document
- Certificate of Conformity

PROTECTION:

- DC reverse-polarity protection
- Short circuit protection
- Output over current protection
- Surge protection
- Grid monitoring
- Anti-islanding protection
- Temperature protection

Model	Recommended max. PV power	Rated output power	Operation phase	MPPT number	Width (mm)	Height (mm)	Depth (mm)	Product category	Catalogue number
Solis-mini-3600-4G	4kW	3.6kW	Single	1	310	373	160	E	423001
Solis-1P5K-4G	5.8kW	5kW	Single	2	310	543	160	E	423002
Solis-3P10K-4G	12kW	10kW	Three	2	310	563	219	E	423020
Solis-3P15K-4G	18kW	15kW	Three	2	310	563	219	E	423021
Solis-3P20K-4G	24kW	20kW	Three	2	310	563	219	E	423022
Solis-3P30K-5G	36kW	30kW	Three	3	530	700	356.5	E	423023



SOLAR POWER SYSTEMS

INVERTERS

In case of insufficient quantity in stock of any item listed on this page, the delivery time after order confirmation will be 90 days.



ENERGY STORAGE INVERTER, SOLIS

5+0 standard +extended **5** YEAR TOTAL WARRANTY

The AC-Coupled inverter is used for upgrade the existing SOLIS single phase on-grid power generation system to a hybrid system which can work with batteries to optimize self-consumption. Energy storage inverter is a good choice for ON- GRID and OFF-GRID integrated storage solutions.

FEATURES

- Compatible with any existing SOLIS single phase grid-tied PV system, option to upgrade
- Compatible with both lead-acid battery and li-ion battery
- Off-grid backup function
- Emergency Power Supply function (EPS)
- Intelligent Energy Management System (EMS)
- Natural cooling without external fan
- Intelligent debugging APP which support one-click inverter configuration
- Various work mode for different application scenario
- IP protection: IP65

PROTECTION:

- Battery reverse protection
- Battery over and under voltage protection
- Short circuit protection
- Output over current protection
- Temperature protection

COMMUNICATION

- RS485
- CAN
- Wi-Fi- optional with WI-FI stick with cat. number 423050

CERTIFICATION

- TÜV SÜD CERTIFICATED
- Attestation of Conformity
- Certificate

Model	Max. charging power (W)	Operation phase	Battery type	Battery voltage range (V)	Battery capacity (Ah)	Width (mm)	Height (mm)	Depth (mm)	Product category	Catalogue number
SOLIS-RAI-3K-48ES-5G	3000W	Single	Li-ion/Lead-acid*	40-60V	50-2000Ah	403	525	170	E	423040

*Battery voltage range: 42-58V | Battery type: Li-ion/Lead-acid | Battery capacity: 50 - 2000Ah | Battery not included | Compatible with Pylontech US2000



5+0 standard +extended **5** YEAR TOTAL WARRANTY

SINGLE PHASE HYBRID INVERTER SOLIS, 5KW



This inverter is used for residential hybrid system, witch can work with batteries to optimize self consumption. This unit is a good choice for ON- GRID and for OFF-GRID integrated storage solutions. Can operate in both ON- GRID and in OFF-GRID mode.

FEATURES

- Uninterrupted power supply, 20ms reaction
- With shifting and peak shaving capabilities friendly to grid
- Multiple working modes to make maximize self-consumption, increase benefit
- Higher charge-discharge efficiency, improving the economic benefits
- Compatible with lithium & lead-acid batteries, increased more choice in different markets
- Fanless design, long lifespan
- Intelligent BMS function, improving battery's reliability
- With high-frequency isolation technology, making system safer and long lifespan
- 24-hour fully intelligent energy management, Real-time grasp of PV plant status
- Remotely control & upgrade function, making digital power plant maintenance at your fingertips

PROTECTION:

- Ground fault monitoring
- Battery over and under voltage protection
- Short circuit protection
- Output over current protection
- Temperature protection
- DC reverse-polarity protection

COMMUNICATION

- RS485
- Wi-Fi- optional with WI-FI stick with cat. number 423050

CERTIFICATION

- TÜV SÜD CERTIFICATED
- Attestation of Conformity
- Certificate
- Compliance Document
- Bestätigung

Model	Recommended max. PV power	Rated output power (Grid side)	Rated output power (Back-up)	Operation phase	MPPT number	Width (mm)	Height (mm)	Depth (mm)	Product category	Catalogue number
SOLIS-RHI-5K-48ES	6.5kW	5kW	3kW	Single	2	333	505	249	E	423041

*Battery voltage range: 42-58V | Battery type: Li-ion/Lead-acid | Battery capacity: 50 - 2000Ah | Battery not included | Compatible with Pylontech US2000



3+0 standard +extended **3** YEAR TOTAL WARRANTY

WIFI STICK FOR INVERTERS



Solar power system can be monitored remotely via WIFI to provide you accurate and comprehensive data analysis and fault alarm at any time and place, make product operation more stable and reliable, and realize stable and intelligent operation and maintenance management services. This is possible with WIFI stick, which you need to connect to your inverter.

FEATURES

- Quick installation and easy operation
- Easy visualization of data and other information via Internet
- Enabling local and remote monitoring
- WiFi communication supporting remote monitoring

Model	Max.number of inverters	Remote communication	Firmware updates	Data storage	Preferences setting	Protection class	Product category	Catalogue number
EL-WIFI 1		WiFi(802.11/b/g/n)	Wireless	8MBYTE FLASH	Web Sever	IP65	E	423050

* WiFi communication range: 100m in outdoor open area without obstruction.



SINGLE AND THREE PHASE MULTIFUNCTION SMART DIN KWH METERS

3+0 standard +extended **3** YEAR TOTAL WARRANTY



DTSD1352 is a smart meter designed for power supply system, industrial and mining enterprises and utilities to calculate the electricity consumption and manage the electric demand. It features the high precision, small size and simple installation. It integrates the measurement of all electrical parameters with the comprehensive electricity metering and management provides various data on previous 12 months, checks the 31st harmonic content and the total harmonic content, realizes the remote communication and the remote control with switching input and relay output and boasts the alarm output. It is fitted with RS485 communication port and adapted to MODBUS-RTU. DTSD1352 can be used in all kinds of control systems, SCADA systems and energy management systems

FEATURES

- 8 bits lcd display
- Measure parameters: Voltage, current, active power, reactive power, apparent power, power factor and frequency (U,I ,P,Q,S,PF,F)
- Optional communication protocol and functions: Modbus RTU RS485
- Multi-tariff :frozen KWH historical, KWH in 3 months, adapt 4 time zones, 2 time interval lists, 14 time interval by day and 4 tariff rates



Model	Type	Measuring range	Overall dimensions (mm)	Product category	Catalogue number
DDSD1352	Single phase	10 (60A)	88x36x70	E	423060
DTSD1352	Three phase	10 (80A)	80x126x70	E	423061



In case of insufficient quantity in stock of any item listed on this page, the delivery time after order confirmation will be 90 days.



SOLIS EXPORT MANAGER EPM3-5G

5+0 standard +extended **5** YEAR TOTAL WARRANTY

The Solis export power manager is the ideal solution for smart energy management for both residential and commercial systems. The unit allows you to adjust export values to satisfy local network regulatory requirements. Energy management with the Solis export power manager allows for higher self-consumption and efficient use of the locally generated PV power.

FEATURES

- Smart & strong: Simultaneous control of 80 X Solis inverters
- Saving & high precision: Simultaneously monitor the operating data of the 80 X Solis inverter, saving the cost of the monitoring system
- Friendly & compatible: Saving & high precision: Support "Δ" and "Y" grid systems
- Realizing reactive compensation of the system, which ensure the power factor of the system is up to standard
- The control accuracy is up to 3%, which improves the system's spontaneous use rate
- Supports simultaneous access of Solis inverters with different power

COMMUNICATION:

- With inverter: Modbus RS485
- Maximum communication inverter numbers: 10
- Maximum communication distance: 1000m
- Monitoring: Wi-Fi stick or GPRS stick for single inverter connection Wi-Fi box or GPRS box for 2-10 inverters connection

TECHNICAL DATA

- Input frequency range: 45-65 Hz
- Input voltage range: L to N: 100-277 V
- Ambient temperature: -25°C to +60°C
- Ingress protection: IP65
- Relative humidity: 5%-95%
- CT connection: Plug terminal
- Weight: 2.1 kg

Model	Rated voltage (V)	Input current (A)	Maximum communication inverter numbers	Length (mm)	Width (mm)	Height (mm)	Product category	Catalogue number
Solis-EPM3-5G	400V, 3/N/PE or 3/PE	5	10	364	276	114	E	423051



SOLIS EXPORT MANAGER EPM3-5G-PLUS

5+0 standard +extended **5** YEAR TOTAL WARRANTY



The Solis export power manager is the ideal solution for smart energy management for both residential and commercial systems. The unit allows you to adjust export values to satisfy local network regulatory requirements. Energy management with the Solis export power manager allows for higher self-consumption and efficient use of the locally generated PV power.

FEATURES

- Smart & strong: Simultaneous control of 80 X Solis inverters
- Saving & high precision: Simultaneously monitor the operating data of the 80 X Solis inverter, saving the cost of the monitoring system
- Friendly & compatible: Saving & high precision: Support "Δ" and "Y" grid systems
- Realizing reactive compensation of the system, which ensure the power factor of the system is up to standard
- The control accuracy is up to 3%, which improves the system's spontaneous use rate
- Supports simultaneous access of Solis inverters with different power

COMMUNICATION:

- With inverter: Modbus RS485
- Maximum communication inverter numbers: 80
- Maximum communication distance: 1000m
- Monitoring: Wi-Fi box (Built in)

TECHNICAL DATA

- Input frequency range: 45-65 Hz
- Input voltage range: L to N: 320-480V
- Display: LCD
- Ambient temperature: -25°C to +60°C
- Ingress protection: IP65
- Relative humidity: 5%-95%
- CT connection: Plug terminal
- Weight: 5.4 kg

Model	Rated voltage (V)	Input current (A)	Maximum communication inverter numbers	Length (mm)	Width (mm)	Height (mm)	Product category	Catalogue number
Solis-EPM3-5G-PLUS	400V, 3/N/PE	5	80	488	446	149	E	423052



PYLONTECH LITHIUM BATTERY, US2000 SERIES

7+3
standard
+extended
10 YEAR TOTAL
WARRANTY



Lithium battery US2000 series is the latest generation lithium iron phosphate battery module and is a perfect solution for residential storage facilities. The easy in modulating makes it possible to create storage systems of small or large capacities. The first installation can be expanded depending on the change in energy requirements in time latter.

FEATURES

- The whole module is non-toxic, non-polluting and environmentally friendly.
- Cathode material is made from LiFePO4 with safety performance and long cycle life.
- Battery management system (BMS) has protection functions including over-discharge, over-charge, over-current and high/low temperature.
- Vertical industry integration ensures more than 6000 cycles with 90% DoD.
- The system can automatically manage charge and discharge state and balance current and voltage of each cell.
- Flexible configuration, multiple battery modules can be in parallel for expanding capacity and power.
- Adopted self-cooling mode rapidly reduced system entire noise.
- The module has less self-discharge, up to 6 months without charging on shelf.
- No memory effect, excellent performance of shallow charge and discharge.
- Working temperature range is from -10° to 50°C, (Charging 0~50°C; discharging -10~50°C) with

excellent discharge performance and cycle life.

- Compact and fashionable design fits in your home environment.
- Compatible with most of the available Hybrid inverters.

TECHNICAL DATA:

- Nominal voltage: 48V
- Nominal capacity: 2400Wh
- Usable capacity: 2200Wh
- Dimension: 442x410x89mm
- Charge voltage: 52.5- 53.5V
- Discharge voltage: 45- 53.5V
- Communication port: RS485, CAN
- Configuration (max. in 1 battery group): 8pcs
- IP code: IP20
- Cooling type: Natural cooling
- Working temperature: Charge: from 0 to 50°C, Discharge: from -10 to 50°C
- Humidity: 5-85%
- Weight: 24Kg
- Altitude: up to 2000m
- Cycle life: > 4500, 25°C

Model	Nominal voltage (V)	Nominal capacity (Wh)	Usable capacity (Wh)	Product category	Catalogue number
US2000	48	2400	2200	E	98BAT2000US

Up to 6 months without charging.



MOUNTING BRACKETS FOR PYLONTECH LITHIUM BATTERY, US2000 SERIES



Mounting brackets keep a few batteries in one pile. It is an essential accessorie because it improves the cooling of the batteries and allows easy circulation of air around the batteries.

Set of 2 mounting brackets.

INSTALLATION REQUIREMENT:

- We do not recommend to stack batteries one on top of the other without the brackets.
- Maximum 4 batteries can be athwart stacked
- One or two batteries can be sidelong stacked

SET: 2 mounting brackets

SET catalogue number: 98BAT2000BR



In case of insufficient quantity in stock of any item listed on this page, the delivery time after order confirmation will be 90 days.

ON GRID SOLAR SYSTEMS - SET WITH MONOCRYSTALLINE HALF CELLS SOLAR PANEL

10+0 standard +extended **10** YEAR TOTAL WARRANTY

Solar power systems (kW)	Phase	Panel QTY	Product category	Catalogue number
3.6	1	9	E	98SOL3600M
5	1	13	E	98SOL5000M/TB
10	3	26	E	98SOL10000M
15	3	38	E	98SOL15000M
20	3	50	E	98SOL20000M
30	3	74	E	98SOL30000M

*SET Included: Solar panels, inverter, DC power cables and DC 4P Switch 32A | Warranty: 10+0, Inverter: 5+0



HYBRID SOLAR SYSTEMS - SET WITH MONOCRYSTALLINE HALF CELLS SOLAR PANEL

10+0 standard +extended **10** YEAR TOTAL WARRANTY

Solar power systems (kW)	Phase	Panel QTY	Product category	Catalogue number
5	1	13	E	98SOL5000HM

*SET Included: Solar panels, inverter, DC power cables, 1x2.4kW battery US2000 and DC 4P Switch 32A | Warranty: 10+0, Inverter: 5+0



**ENERGY STORAGE INVERTER SOLIS
SOLIS-RAI-3K-48ES-5G WITH BATTERY
PYLONTECH US2000**

10+0
standard
+extended **10** YEAR TOTAL
WARRANTY

Solar power systems (kW)	Phase	Panel QTY	Product category	Catalogue number
3	1	Not included	E	98SOL3000EM

*SET Included: Inverter and 1x2.4kW battery US2000 | Warranty: 10+0, Inverter: 5+0
Compatible with any existing SOLIS single phase ON-grid-tied PV system, option to upgrade



3+0
standard
+extended
3 YEAR TOTAL
WARRANTY

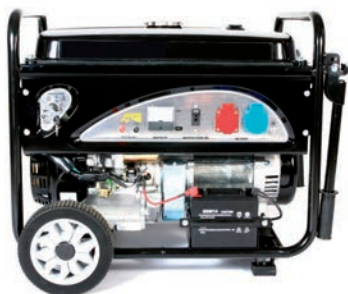

ELECTRICAL GASOLINE GENERATORS EL-GF SERIES

Generators are machines that provide electricity when power from the local grid is unavailable. Electrical generators are used as a primary power source in areas where a local electrical grid is unavailable or difficult to access such as mining and farming operations or even new developments and construction and to supply backup power to facilities, businesses, or homes during power outages. Electrical generators don't create electricity. They convert mechanical energy into electrical power. Capturing the power of motion and turning it into electrical energy by forcing electrons from the external source through an electrical circuit. A generator is an electrical motor working in reverse. Once an electrical current has been established, it is directed through copper wires to power machines, devices, or electrical systems

FEATURES:

Automatic voltage regulator (AVR): An automatic voltage regulator (AVR) is an electronic device for automatically maintaining generator output terminal voltage at a set value under varying load and operating temperature. It controls output by sensing the voltage V_{out} at a power-generating coil and comparing it to a stable reference. The error signal is then used to adjust an average value of the field current.

Switch for electric start: no included by EL-3GF-6

Two power supply voltage: 220 and 380V AC (all models without EL-3GF-6)

Four stroke engine: more fuel efficient as compared to 2-stroke generators. They consume the fuel on every 4th cycle. Moreover 4 stroke engine is and more durability A 2-stroke engine works more as compared to a 4 stroke engine for a specific time. It is evident from the fact that a 2-stroke engine produces more heat and more exhaust in one hour as compared to a 4-stroke engine

Less sound: A 4-stroke engine produces less sound and makes less pollution. It is safe for the environment. This is due to the fact that you do not have to add oil in the gas and hence no oil is burned during the combustion process

No Extra Oil in Fuel: There is no need to add extra oil along with the fuel in the fuel tank. Separate engine oil is used which needs to be replaced after every 500 hours of activity

Compact design. User-friendly in operations

Model	Rated power (kW)	Max. power (kW)	Fuel tank capacity (L)	Fuel consumption (g/(kW-h))	Running time (h)	Product category	Catalogue number
EL-2.8GF-6	2.8	3	15	≤530	10	E	45GF36
EL-5GF-2-4	5	5.5	25	≤480	9.5	E	45GF524
EL-7GF-2-4	7	7.5	25	≤515	5.8	E	45GF724



In case of insufficient quantity in stock of any item listed on this page, the delivery time after order confirmation will be 90 days.

ELECTRICAL DIESEL GENERATORS EL-DF SERIES



A diesel generator is machinery that converts the chemical energy in diesel to electrical energy and is used to power electrical equipment. They can be used to supply a range of applications such as homes, schools, factories, hospitals and other.

Diesel generators are available with and without canopy. Canopies are made of galvanized 3 mm metal sheets. The painting is done by nano technologic electronic powder coating technic. Galvanized metal sheets are durable against rust. On the doors of canopies are used stainless steel hinges and locks.

In canopies, high levels of sound muting type of silence are located in an isolated area to insulate heat which included exhaust pipes and exhaust itself.

ELECTRICAL DIESEL GENERATORS EL-DF SERIES WITH CANOPY



Model	Power stand by (kVA/kW)	Power prime (kVA/kW)	Output voltage (V)	Length (mm)	Width (mm)	Height (mm)	Product category	Catalogue number
EL-DF15C	12/10	11/9	400/230	1350	850	1080	E	45DG15/12C
EL-DF25C	25/20	23/18	400/230	2000	950	1450	E	45DG25/20C
EL-DF55C	55/44	50/40	400/230	2400	1000	1800	E	45DG55/44C
EL-DF75C	75/60	68/55	400/230	2400	1000	1800	E	45DG75/60C
EL-DF94C	94/75	85/68	400/230	2700	1100	1800	E	45DG94/75C
EL-DF110C	110/88	100/80	400/230	3100	1100	1880	E	45DG110/88C
EL-DF150C	150/120	136/109	400/230	3100	1100	1880	E	45DG150/120C
EL-DF175C	175/140	159/127	400/230	3100	1100	1880	E	45DG175/140C



ELECTRICAL DIESEL GENERATORS EL-DF SERIES WITHOUT CANOPY



Model	Power stand by (kVA/kW)	Power prime (kVA/kW)	Output voltage (V)	Length (mm)	Width (mm)	Height (mm)	Product category	Catalogue number
EL-DF15	12/10	11/9	400/230	1350	850	1050	E	45DG15/12
EL-DF25	25/20	23/18	400/230	1650	950	1400	E	45DG25/20
EL-DF55	55/44	50/40	400/230	2000	1000	1700	E	45DG55/44
EL-DF75	75/60	68/55	400/230	2000	1000	1800	E	45DG75/60
EL-DF94	94/75	85/68	400/230	2150	1100	1800	E	45DG94/75
EL-DF110	110/88	100/80	400/230	2500	1100	1780	E	45DG110/88
EL-DF150	150/120	136/109	400/230	2500	1100	1780	E	45DG150/120
EL-DF175	175/140	159/127	400/230	2500	1100	1780	E	45DG175/140





QUARZ TIME SWITCH WITH POWER RESERVE TM 180 MINI

3+2
standard
+extended **5** YEAR TOTAL
WARRANTY

The mechanic relay for time is supposed to be used for managing chains with maximum capacity of 3500W. After the setting, the timer executes the functions we required in 24 hours regime. The minimum period for setting is 15 minutes as it is executed within 96 pcs segments which the timing of the work and rest of the consummator is being set. The timer is accomplished with a battery which assures the work by 70 hours after power failure.

TECHNICAL DATA:

- Rated voltage: 230-240V AC 50/60Hz
- Time range: 24 hours
- Min. programmable interval: 15 minutes
- Time adjustment: manual
- Battery power reserve: 70 hours
- Time deviation: ± 1s (at 20°C)
- Consumption: 2.5VA
- Contact: 1NO
- Contact capacity:
- 16A/250V (COSΦ=1)
- 4A/250V (COSΦ=0.6)
- Electrical endurance: 10⁵ times
- Mechanical endurance: 10⁷ times
- Section of the conductor: rigid conductors up to 6mm²

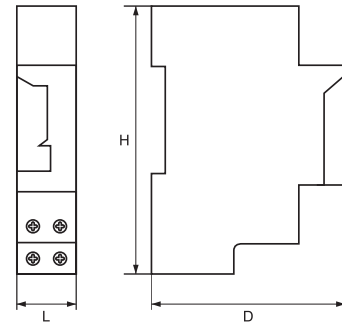

Type	Packing/Box (pcs)	Product category	Catalogue number
TM 180	1 / 200	B	50137



Dimensions (mm)

H	L	D
90	18	60

MOUNTING:

- DIN-rail



QUARZ TIME SWITCH WITH POWER RESERVE TM 181

3+2
standard
+extended **5** YEAR TOTAL
WARRANTY

The mechanic relay for time is supposed to be used for managing chains with maximum capacity of 3500W. After the setting, the timer executes the functions we required in 24 hours regime. The minimum period for setting is 30 minutes as it is executed within 48 pcs segments which the timing of the work and rest of the consummator is being set. The timer is accomplished with a battery which assures the work by 150 hours after power failure.

TECHNICAL DATA:

- Rated voltage: 110-240V AC 50/60Hz
- Time range: 24 hours
- Min. programmable interval: 30 minutes
- Time adjustment: manual
- Battery power reserve: 150 hours
- Time deviation: ± 1s (at 20°C)
- Consumption: 2.5VA
- Contact: 1NO
- Contact capacity: 16A
- Electrical endurance: 10⁵ times
- Mechanical endurance: 10⁷ times
- Section of the conductor: rigid conductors up to 6mm²

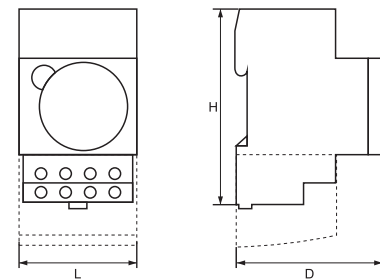

Type	Packing/Box (pcs)	Product category	Catalogue number
TM 181	1 / 100	B	50138



Dimensions (mm)

H	L	D
90	53.5	65.5

MOUNTING:

- DIN-rail



24 HOURS PLUG-IN MECHANICAL TIMER

2+0
standard
+extended **2** YEAR TOTAL
WARRANTY

Mechanical german plug-in timer with children protector. Two position switch for permanent and time control.

TECHNICAL DATA:

- Power supply voltage: 230V; 50Hz
- Min. setting time: 15 mins
- Max. setting time: 24 hours
- active load: up to 16A
- IP20
- Size (mm): 82x84x56

Type	Packing/Box (pcs)	Product category	Catalogue number
EL-PMT-1	1/24/48	B	50140



PROGRAMMABLE WEEKLY TIMER

3+2
standard
+extended **5** YEAR TOTAL
WARRANTY

The product according to the time set by the user, automatically turn On/Off the variety of electrical equipment. Included LI-ion battery

TECHNICAL DATA:

- Power supply voltage: 220-250V; 50/60Hz
- Adjustment range: 1 min
- Commutating capacity:
- active load: up to 30A
- Operations: 17 switching ON/OFF per day, up to 119 ON/OFF per week
- Operating temperature: 0 ÷ +55°C
- Size (LxWxH)mm: 60x32.5x60

MOUNTING:

- With bolts to the surface

Type	Packing/Box (pcs)	Product category	Catalogue number
EL-PWT-1	1/200	B	50139





WEEKLY PLUG-IN DIGITAL TIMER

3+2
standard
+extended **5** YEAR TOTAL
WARRANTY

Digital german plug-in timer with countdown function and rechargeable NI-MH battery. Two outlets for permanent and time control.

TECHNICAL DATA:

- Power supply voltage: 230V; 50Hz
- Min. setting time: 1 min
- Max. setting time: 7 days
- Program per day: 16 ON/OFF
- active load: up to 16A
- IP20
- Size (mm): 68.4x73x77.2

Type	Packing/Box (pcs)	Product category	Catalogue number
EL-WDT-2	1/24/48 B		50141



WEEKLY PLUG-IN DIGITAL TIMER

3+2
standard
+extended **5** YEAR TOTAL
WARRANTY

Digital german plug-in timer with children protector and rechargeable NI-MH battery. Two outlets for permanent and time control.

TECHNICAL DATA:

- Power supply voltage: 230V; 50Hz
- Min. setting time: 1 min or 1 sec
- Max. setting time: 7 days
- Program per day: 8 or 20 ON/OFF
- active load: up to 16A
- IP20
- Size (mm): 130x75x70

Type	Packing/Box (pcs)	Product category	Catalogue number
EL-WDT-3	1/24/48 B		50142





**PROGRAMMABLE DIGITAL ONE-CHANNEL TIMER
TE 15A**

3+2 standard +extended **5** YEAR TOTAL WARRANTY

The timer is manufactured under the CMOS technology with a quartz minicontroller which makes it reliable for operation. The timer is adjusted for DIN-rail mounting. It can memorize up to eight ON/OFF programs (ON/OFF cycles). Each program setting is done through the push buttons. Programming starts with selection of the days of the week (you can choose among a whole week cycle, work days cycle, weekend cycle, or a specific day of the week); then the cycle start time and end time are set. If you have selected work days cycle, then the program will start and stop at the set times each work day of the week. This is one ON/OFF program. Where necessary, other programs can be memorized up to the limit of eight possible programs. If you continue setting new programs the first memorized program will be deleted. The minimal interval for cycle programming is 1 minute.

Type	Packing/Box (pcs)	Product category	Catalogue number
TE 15A	1 / 100	B	50036



Dimensions (mm)

H	L	D
85	36	64

TECHNICAL DATA:

- Display: LCD
- Power supply voltage: 230V; 50Hz
- Operations: 16 switching ON/OFF
- Minimum setting unit: 1 min
- Time setting range: 1 min- 168 hours
- Time deviation: <2s (at 25°C)
- Battery for programme storing: up to 15 days
- Power consumption: <4.5VA
- Switched on indicator
- Electrical wear resistance: 105 cycles

- Mechanical wear resistance: 107 cycles
- Operating temperature: -10°C ÷ +65°C
- Humidity: 35 – 85%RH
- Number of contacts: 1NO + 1NC
- Commutating capacity:
 - active load: up to 16A
- Weight: 125g

MOUNTING:

- DIN-rail



**PROGRAMMABLE DIGITAL ONE-CHANNEL
TIMER TE 15B**

UNTIL SUPPLY
LAST

3+2 standard +extended **5** YEAR TOTAL WARRANTY

The timer is manufactured under the CMOS technology with a quartz minicontroller which makes it reliable for operation. The timer is adjusted for DIN-rail mounting. It can memorize up to six ON/OFF programs (ON/OFF cycles). Each program setting is done through the push buttons. Programming starts with selection of the days of the week (you can choose among a whole week cycle, work days cycle, weekend cycle, or a specific day of the week); then the cycle start time and end time are set. If you have selected work days cycle, then the program will start and stop at the set times each work day of the week. This is one ON/OFF program. Where necessary, other programs can be memorized up to the limit of eight possible programs. If you continue setting new programs the first memorized program will be deleted. The minimal interval for cycle programming is 1 minute. There is possibility for automatic correction of the time according to the seasonal sun variations.

Type	Packing/Box (pcs)	Product category	Catalogue number
TE 15 B	1 / 100	F	50101



Dimensions (mm)

H	W	L
85	36	64

TECHNICAL DATA:

- Display: LCD
- Automatic adjustment of the current time (time correction winter/summer)
- Power supply voltage: 230V; 50Hz
- Operations: 6 switching ON/OFF
- Time deviation: <2s (at 25°C)
- Battery for programme storing: up to 15 days
- Power consumption: <5VA
- Switched on indicator
- Electrical wear resistance: 10⁵ cycles
- Mechanical wear resistance: 10⁷ cycles
- Operating temperature: -10 ÷ +65°C
- Humidity: 35 – 85%RH
- Number of contacts: 1NO + 1NC
- Commutating capacity:
 - active load: up to 6A
 - inductive load: up to 2.5
- Weight: 120g

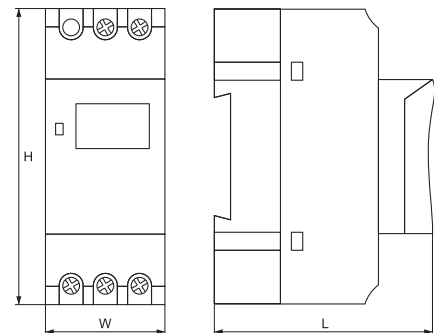

MOUNTING:

- DIN-rail

In case of insufficient quantity in stock of any item listed on this page, the delivery time after order confirmation will be 90 days.



STARCASE DELAY TIMER

3+2 standard +extended **5** YEAR TOTAL WARRANTY

The timer is adjusted for DIN-rail mounting. Provide control of lighting circuits with automatic switch Off after pre-set time. Two position switch for permanent and time lighting control and choice for time delay setting from 30 sec to 10 minutes. Compact 1-mode design- 17.5mm

TECHNICAL DATA:

- Power supply voltage: 230V; 50Hz
- Adjustment range: 0.5 to 10 min
- Power consumption: <2.5VA
- Operating temperature: -10 ÷ +60°C
- Humidity: 45 – 95%RH
- Number of contacts: 1NO
- Commutating capacity:
- active load: up to 16A
- inductive load: up to 10 A

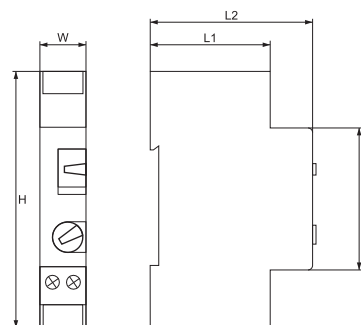

Type	Packing/Box (pcs)	Product category	Catalogue number
TE 17	1/240	B	35007



Dimensions (mm)

H	W	L1	L2	D
82	17.5	40	65	45

MOUNTING:

- DIN-rail



TIME RELAY "STAR/DELTA" TE 19

3+2 standard +extended **5** YEAR TOTAL WARRANTY

The time relay is manufactured under the most modern methods of qualitative and reliable materials. The timer is adjusted for DIN-rail mounting. It is used to provide reliable and safe time hold at "star/delta" starters and it is used for setting fixed time intervals. Programming is done through selection of the time unit (seconds or minutes) and rate (x 0.1 or x1) by the slide switches, and then selection of a value from the timer knob (from 0 to 10). Whenever timer circuit receives a signal, it executes the set cycle and then stops until a new signal is available. It gives possibility for time adjustment for motor unwinding in star up to 600s and time change to delta according to the consumer's need.

TECHNICAL DATA:

- Power supply voltage: 230V; 50Hz
- Adjustment range for operation in star: 1 to 600 seconds
- Repetition accuracy: ±5% from the whole scale
- Adjustment accuracy: ±5% from the whole scale
- Zeroing time: <0.5s
- Power consumption: <5VA
- Electrical wear resistance: 100 000 cycles
- Mechanical wear resistance: 1 000 000 cycles
- Operating temperature: -10 ÷ +65°C
- Humidity: 45 – 85%RH
- Commutating capacity: up to 5A
- Indication:
 - at operation in "star": red indication
 - at operation in "delta": green indication
- Weight: 150g

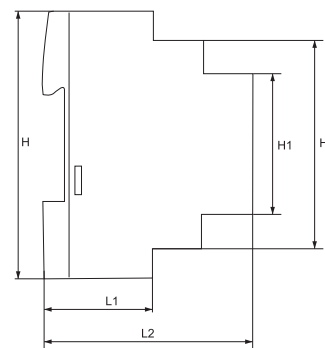
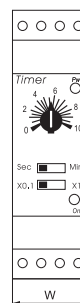

Type	Packing/Box (pcs)	Product category	Catalogue number
TE19	1 / 200	B	50102



Dimensions (mm)

H	W	L1	L2	H1	H2
85	24	34	66	45	60

MOUNTING:

- DIN-rail

3+2
standard
+extended **5** YEAR TOTAL
WARRANTY

TIMER TE8A – 1A, TE8A – 2A



The timer is manufactured under the most modern technology CMOS with a quartz minicontroller which makes it precise, qualitative and reliable. It has a built in battery which allows operation of the timers without charging up to 150 hours. The timer is adjusted for DIN-rail mounting. Timer programming is done through selection of the operational day(s) of the week, followed by selection of the start time and end time. You may choose out of ten modes (one for each day of the week, one for the work days, one for the weekends and one for the whole week). When setting the time, you should start first with the hours and then continue with the minutes.
 TE8A - 1a - Up to eight programs can be memorized. The on/off time resolution is 1 minute.
 TE8A - 2a - It has two operating channels, each of which can adjust four programmes for a day or a week with minimal interval of 1 minute for switching on and off.
 Indication on LCD display with high resolution and showing the time in hours, minutes and seconds.

Type	Packing/Box (pcs)	Product category	Catalogue number
------	-------------------	------------------	------------------

TE8A - 1a	1 / 75	B	50113
TE8A - 2a	1 / 75	B	50114



Dimensions (mm)

H	H1	H2	W
100	50	68	50
E	L1	L2	F
36	60	74	90

Technical data:

- Power supply voltage: 230V; 50Hz
- Power consumption: <5VA
- Electrical wear resistance: 10⁷ cycles
- Mechanical wear resistance: 10⁵ cycles
- Operating temperature: -10°C ÷ +65°C
- Temperature of storage: up to 70C
- Humidity: 45 – 85%RH
- Commutating capacity: up to 16A
- Two outlet relays
- Li-Ion battery: 150h
- Weight: 150g
-

Mounting:

- DIN-rail

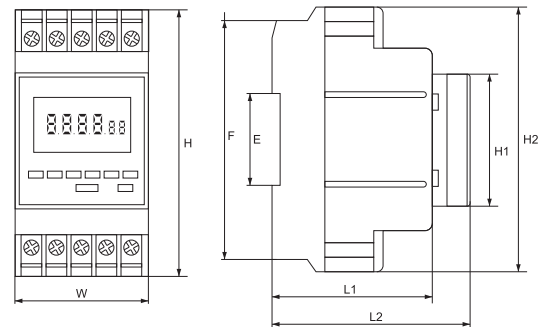

IMPULSE RELAY

3+2
standard
+extended **5** YEAR TOTAL
WARRANTY



Impulse relays allow circuit remote control. They can be operated manually, remotely, from several control points, or by impulses. Impulse relays are most frequently used for the control of lighting circuits in various public places with multiple control points.

TECHNICAL DATA:

- Control voltage: 230V
- Rated current of the power circuit: 16A
- Electrical endurance: 200000 cycles
- Maximum switching frequency: 5 operations/minute
- Impulse duration: 50ms

CONNECTION:

- tunnel terminals

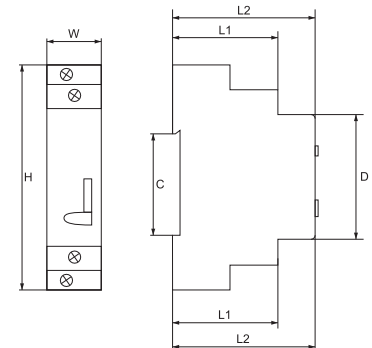

Type	Packing/Box (pcs)	Product category	Catalogue number
------	-------------------	------------------	------------------

EPN510	8 / 160	B	50300
--------	---------	---	--------------



Dimensions (mm)

H	W	C	D	L1	L2
85	24	36	45	34	66

In case of insufficient quantity in stock of any item listed on this page, the delivery time after order confirmation will be 90 days.



TIMER TE6B

3+2
standard
+extended **5** YEAR TOTAL
WARRANTY

The timer is manufactured under the most modern technology CMOS with a quartz minicontroller which makes it precise, qualitative and reliable. The timer is modulated to be mounted on the front panel of boards. The direction of operation is adjusted – direct or reverse. There is possibility to adjust the time range from 0.01 second to 99 hours 59 minutes, possibility for correction of the set values during operation. Indication on LCD display with high resolution and showing the time in hours, minutes and seconds.

TECHNICAL DATA:

- Power supply voltage: 230V; 50Hz
- Possibility for choice of operating range:
 - from 0.01 second to 99.99 seconds
 - from 1 second to 99.59 minutes
 - from 1 minute to 99.59 hours
- Error: <0.01% ±0.05s
- Minimal duration of the input pulse: 20ms
- Power consumption: <5VA
- Electrical wear resistance: 10⁷ cycles
- Mechanical wear resistance: 10⁵ cycles
- Operating temperature: -10 ÷ +65°C
- Temperature of storage: up to 70°C
- Humidity: 45 – 85%RH
- Commutating capacity at active load: 3A
- Weight: 300g

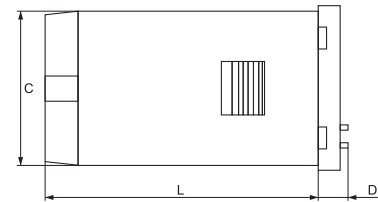

Type	Packing/Box (pcs)	Product category	Catalogue number
TE6B	1 / 100	B	50104



Dimensions (mm)

D	W	L
8.5	45	80

MOUNTING:

- on the front panel of the board



TIMER TE48S-S

3+2
standard
+extended **5** YEAR TOTAL
WARRANTY

The timer is manufactured under the most modern technology CMOS with a quartz minicontroller which makes it precise, qualitative and reliable. The timer is modulated to be mounted on the front panel of boards. The direction of operation is adjusted – direct or reverse. It represents two separate operating channels, each of which can operate independently with time range adjustment from 1 second to 99 minutes. Possibility for correction of the set values during operation. First, select the time unit (seconds or minutes) and then set the time. Depending on the timer coupling, it can be used as a cyclic timer relay, i.e. it initially counts the first time set, then counts the second time set, then starts counting over the first time again, etc. until a stop signal is received. In another mode, the timer can count the set time and stop until a new signal is received to count the next cycle. Indication on LCD display with high resolution and showing the time in hours, minutes and seconds.

TECHNICAL DATA:

- Power supply voltage: 230V; 50Hz
- Admissible variation of the input voltage: 85-110%U
- Possibility for choice of operating range:
 - from 1 to 99 seconds
 - from 1 minute to 99 minutes
- Error: <0.01% ±0.05s
- Minimal duration of the input pulse: 20ms
- Power consumption: <5VA
- Electrical wear resistance: 10⁷ cycles
- Mechanical wear resistance: 10⁵ cycles
- Operating temperature: -10 ÷ +65°C
- Temperature of storage: up to 70°C
- Humidity: 45 – 85%RH
- Commutating capacity at load: 3A
- Weight: 300g

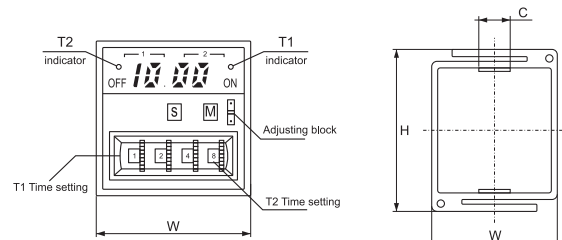
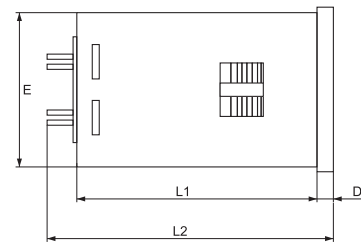

Type	Packing/Box (pcs)	Product category	Catalogue number
TE48S-S	84	B	50105



Dimensions (mm)

D	E	L1	L2
5	44.8	74	95
C	H	W	
15	58	48	

MOUNTING:

- on the front panel of the board

3+2 standard +extended **5** YEAR TOTAL WARRANTY

TIMER TE 19M



Timer is developed using modern technologies from quality and reliable materials and is adapted for mounting on DIN rail. It is used for providing time intervals in eight time programs, which are assigned by combinations of the keys. There is an option for it to operate in time ranges (assigned by the keys K4, K5, K6): seconds, minutes or hours depending on the necessity of the user. Power contact up to 3A.

TECHNICAL CHARACTERISTICS:

- Input voltage: 230V; 50Hz
- Range of setting: from 0.6 sec to 100 hours
- Accuracy of setting: ± 5% from the whole scale
- Time for nullifying: <0.5 seconds
- Consumed capacity: < 5VA
- Electrical endurance (number of cycles): 100 000 cycles
- Mechanical endurance (number of cycles): 1 000 000 cycles
- Operation temperature: -10 ÷ +65°C
- Humidity: 45 - 85%RH
- Computing option: up to 5A
- Indication:
 - ▶ on power supply: red indication
 - ▶ on operational output relay: green indication
- Weight: 150 gr.
- Time functions: according to the programming guide

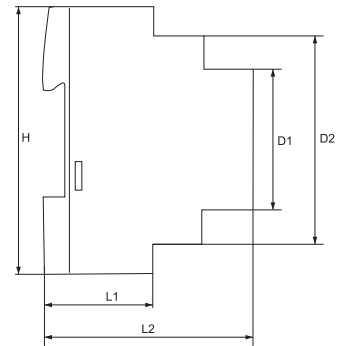
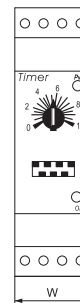

Type	Packing/Box (pcs)	Product category	Catalogue number
TE 19M	1 / 200	B	50102M



Dimensions (mm)

H	W	H1	H2	L1	L2
85	24	45	60	34	66

MOUNTING METHOD:

- DIN rail

UNIVERSAL DIGITAL COUNTER CE2J

3+2 standard +extended **5** YEAR TOTAL WARRANTY



The device is manufactured under the modern technology CMOS which allows high speed of counting and high counting reliability. It has a built in battery which allows data storing for more than 10 years. It is supplied with a digital display with black lighting digits, providing excellent visibility at different lighting. The counter is to be mounted on the front panel of the boards. It is used for impulse sequence counting with accumulation or deduction. There is possibility for relay outlet operation at reaching beforehand set value, and also a possibility for changing the position of the decimal point.

TECHNICAL DATA:

- Display: LCD
- Power supply voltage: 230V; 50Hz
- Counting range: 0 - 99999
- Counting speed: 30/3k cps
- Zeroing: outside impulse
- Battery for programme storing: up to 10 years
- Power consumption: <5VA
- Operating temperature: -10 ÷ +65°C
- Humidity: 35 - 85%RH
- Commutating capacity: relay outlet with active load: up to 3A
- Weight: 250g

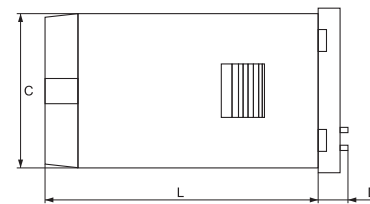

Documents corresponding to the product:

Standard EN 61010-1

Type	Packing/Box (pcs)	Product category	Catalogue number
CE2J	1 / 45	B	50111



Dimensions (mm)

H	W	C	D	L
68	68	65	8.5	90

MOUNTING:

- on the front panel
- opening with dimensions: 45x45

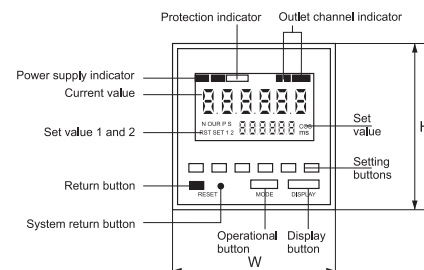

In case of insufficient quantity in stock of any item listed on this page, the delivery time after order confirmation will be 90 days.



COMBINED DIGITAL COUNTER/TIMER CE10J

3+2
standard
+extended **5** YEAR TOTAL
WARRANTY

The device is for front mounting in the board. It can be used as a counter or timer choosing a definite combination from keys. It is manufactured under the modern technology CMOS which allows high speed of counting, precision at operation as a timer and high reliability. It has a built in battery which allows data storing for more than 10 years. It is supplied with a digital display providing excellent visibility at different lighting. It is used for impulse sequence counting with accumulation or deduction. There is possibility for relay outlet operation at reaching beforehand set value, and also a possibility for changing the position of the decimal point.

Documents corresponding to the product:

Standard EN 61010-1

Type	Packing/Box (pcs)	Product category	Catalogue number
------	-------------------	------------------	------------------

CE10J 1 / 45 B 50120



Dimensions (mm)

H	W	C	D	L
68	68	65	6	90

TECHNICAL DATA:

- Display: LCD
- Power supply voltage: 230V; 50Hz
- Counting range: 0 – 999
- Timer range: 0.01 – 99h99min
- Counting speed: 30/500 cps
- Zeroing: outside impulse
- Battery for programme storing: up to 10 years
- Power consumption: <3VA
- Mechanical wear resistance: 107 cycles
- Operating temperature: -5 ÷ +65°C
- Humidity: 35 – 85%RH
- Commutating capacity: relay outlet with active load: up to 3A
- Weight: 120g

MOUNTING:

- on the front panel
- opening with dimensions: 45x45

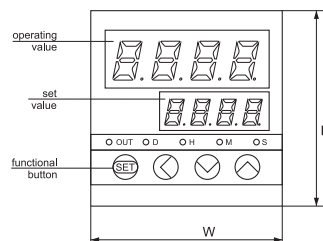
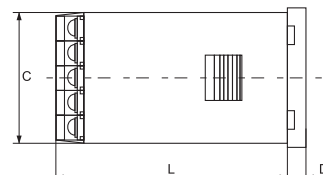

TOTAL DIGITAL COUNTER CE15J

3+2
standard
+extended **5** YEAR TOTAL
WARRANTY

The device is to be mounted on DIN-rail. It is used as an impulse counter with no outside power supply. For that purpose there is a Li battery built in the device which provides data storing and operation of the device for 5 years. It has eight digital lighting display providing excellent visibility at different lighting. It is used for impulse sequence counting with accumulation.

TECHNICAL DATA:

- Display: LCD
- Power supply voltage: built in battery
- Inlet signal: 100-230V AC/DC
- Counting accuracy: <0.002%
- Data storing battery: up to 5 years
- Operating temperature: -5 ÷ +65°C
- Humidity: 35 – 85%RH
- Weight: 120g

Dimensions (mm)

H	W	D	L
86	36	45	64

MOUNTING:

- DIN-rail

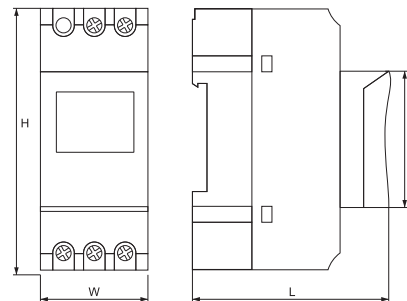



TOTAL DIGITAL COUNTER CE15L

3+2 standard +extended **5** YEAR TOTAL WARRANTY

The device is to be mounted on DIN-rail. It is used as a time impulse counter with no outside power supply. For that purpose there is a Li battery built in the device which provides data storing and operation of the device for 5 years. It has eight digital lighting display providing excellent visibility at different lighting. It is used for time impulse sequence counting with accumulation. It displays the operated time.

Documents corresponding to the product: EN 61010-1

Type	Packing/Box (pcs)	Product category	Catalogue number
------	-------------------	------------------	------------------

CE15L 1 / 100 B 50115



TECHNICAL DATA:

- Display: LCD
- Power supply voltage: built in battery
- Inlet signal: 100-230V AC/DC
- Counting accuracy: <0.002%
- Battery for data storing: up to 5 years
- Operating temperature: -5 ÷ +65°C
- Humidity: 35 – 85%RH
- Weight: 120g

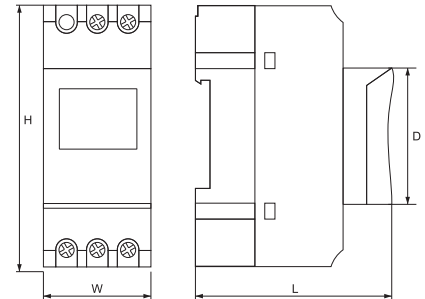

Dimensions (mm)			
H	W	D	L
86	36	45	64

MOUNTING:

- DIN-rail



PHASE SEQUENCE INDICATOR EK - RSTB

3+2 standard +extended **5** YEAR TOTAL WARRANTY

The device is to be mounted on DIN-rail. It is used for control and indication of the presence, sequence and quality of the phases. The device indicates the following fault: lack of one or several phases; change in the sequence of the phases; lowering of the power supplying voltage: under 10%; increasing of the power supplying voltage: over 10%; phase asymmetry of the power supplying voltage: ±10%. In the presence of one of the conditions above a relay starts operating in the device which breaks the controlling circuit. The time between fault indication and outlet relay switching on can be adjusted in order to prevent unwilling stops at very short breaks. When the voltage is back to normal limits, the device receives energy (indication lights) according to the hysteresic values. At phase sequence fault the device operates immediately.

Documents corresponding to the product: EN 61010-1

Type	Packing/Box (pcs)	Product category	Catalogue number
------	-------------------	------------------	------------------

EK - RSTB 1 / 200 B 50103



TECHNICAL DATA:

- Power supply voltage: 400V; 50Hz
- Possibility for operation range adjustment: 0.1 – 10 seconds
- Possibility for working range adjustment: from 300 to 480 V
- Electrical wear resistance: 1 000 000 cycles
- Mechanical wear resistance: 10 000 000 cycles
- Indication: green LED – indication for a change in the condition; red LED - failure
- Operating temperature: -5 ÷ +65°C
- Humidity: 35 – 85%RH
- Weight: 120g
-

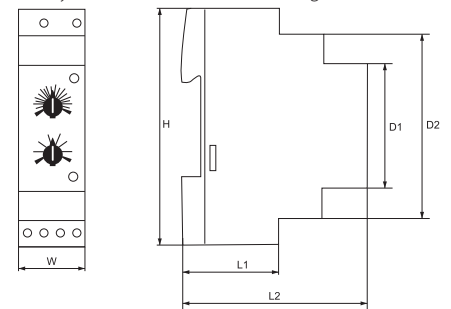

Dimensions (mm)					
H	W	D1	D2	L1	L2
85	24	45	60	34	66

MOUNTING:

- DIN-rail

3+0
standard
+extended
3 YEAR TOTAL
WARRANTY

EVT5 - CONTROL VOLTAGE TRANSFORMER



Documents corresponding to the product: Standard EN 60051-1

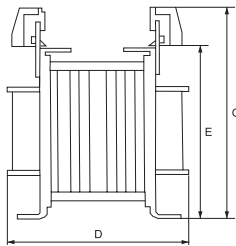
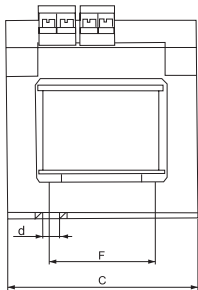

UNTIL SUPPLY
LAST

FUNCTIONS:

Reduction of main voltage within standard range

- Galvanic separation of the power supply circuit from the operation circuit

TECHNICAL FEATURES:

- Input voltage: 400 or 230 V
- Frequency : 50/60Hz
- Short circuit resistance: unstable
- Temperature class: B (130°C)
- Construction: open (for installation in other products)
- Magnetic circuit: cold rolled electric furnace steel
- Coils: pure electrotechnical copper
- IP code: IP20

CONNECTION:

- flexible or hard conductors of relevant section to terminals

MOUNTING:

- Mounting in distribution boards or products
- fastening: by means of screws/bolts to the surface
- position: vertical
- ambient temperature: -20 ÷ +65°C

Type	Initial voltage (V)	Secondary voltage (V)	Power VA	Dimensions						Packing / Box (pcs.)	Product category	Catalogue number
				C	D	E	F	G	d			
EVT5 - 250VA	400	24-12	250	130	100	120	53	130	20	12	F	45444
EVT5 - 500VA	400	48-24-12	500	150	113	133	53	140	20	4	F	45445
EVT5 - 1000VA	400	48-24-12	1000	170	125	150	65	155	20	2	F	45441
EVT5 - 1600VA	400	48-24-12	1600	190	125	150	65	170	20	2	F	454416





Documents corresponding to the product: Standard EN 61010-1; EN 60044-1; EN 60044-6

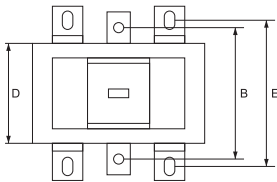
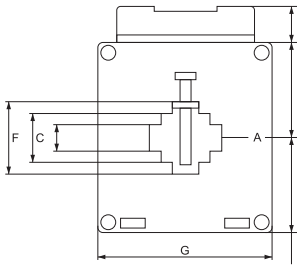

CURRENT MEASUREMENT TRANSFORMERS MES - XX/X5 TYPE

3+2 standard +extended **5** YEAR TOTAL WARRANTY

The measurement transformers find application at current measuring, current regulation, systems for current characteristics watching, systems for reactive energy compensation, signaling, etc. They are with x/5 gear ratio as X is the inlet range of the transformer.

TECHNICAL DATA:

- Maximum operating voltage: 720V; 50Hz
- Admissible deviation of the operating current: 1.2 x In
- Inlet current: 50 – 1200A
- Outlet current: 5A
- Impulse voltage wear resistance: 4000V; 50Hz (1min)
- Operating temperature: -5 ÷ +65°C

- Humidity: 35 – 85%RH
- Precision class: 0.5

MOUNTING:

- Current transformers can be DIN rail mounted;
- vertically or horizontally to the power supplying rails according to the opening of the transformer
- Current transformers can be mounted on flat surfaces by use of fixing clamps.

Type	Overall dimensions (mm)						
	A	B	C	D	E	F	G
MES - 75/30	88	52	52	41	77	31	31
MES - 75/40	88	52	52	41	77	41	41
MES - 86/60	117	57	57	184	77	61	61

Type	Range	Precision class	Capacity VA	Weight kg	Packing/Box (pcs)	Product category	Catalogue number
MES - 75/30	50/5	0.5	1	0.60	1 / 40	B	45050A
MES - 75/30	75/5	0.5	1.5	0.60	1 / 40	B	45075A
MES - 75/30	100/5	0.5	1.5	0.60	1 / 40	B	45103A
MES - 75/30	150/5	0.5	2.5	0.60	1 / 40	B	45153A



Type	Range	Precision class	Capacity VA	Weight kg	Packing/Box (pcs)	Product category	Catalogue number
MES - 75/40	200/5	0.5	3.75	0.60	1 / 40	B	45204A
MES - 75/40	250/5	0.5	3.75	0.60	1 / 40	B	45254A
MES - 75/40	300/5	0.5	5	0.60	1 / 40	B	45304A
MES - 75/40	400/5	0.5	5	0.60	1 / 40	B	45404A
MES - 75/40	500/5	0.5	5	0.60	1 / 40	B	45504A
MES - 75/40	600/5	0.5	5	0.60	1 / 40	B	45604A



Type	Range	Precision class	Capacity VA	Weight kg	Packing/Box (pcs)	Product category	Catalogue number
MES - 86/60	400/5	0.5	3.75	0.60	1 / 40	B	45406A
MES - 86/60	500/5	0.5	5	0.60	1 / 40	B	45506A
MES - 86/60	600/5	0.5	10	0.60	1 / 40	B	45606A
MES - 86/60	800/5	0.5	10	0.60	1 / 40	B	45806A
MES - 86/60	1000/5	0.5	10	0.60	1 / 32	B	45906A
MES - 86/60	1200/5	0.5	10	0.60	1 / 32	B	45916A



In case of insufficient quantity in stock of any item listed on this page, the delivery time after order confirmation will be 90 days.



Documents corresponding to the product: Standard EN 60044-1

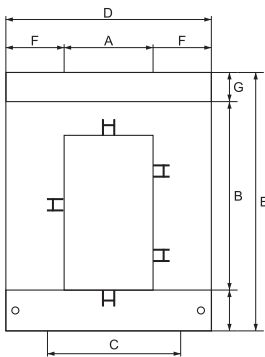

CURRENT TRANSFORMERS, TYPE CP



Current measuring transformers of duct type. Specially designed to be installed in measuring circuits without removing cables in current measuring circuit. CP Transformers save installation time and decrease installation costs

TECHNICAL SPECIFICATION:

- small size table:
- secondary coil rated current 5A
- rated voltage 720V
- frequency 50Hz
- rated load: up to 30VA
- safety coefficient: $f_s \leq 5$
- accuracy class :0.5; 1
- secondary coil connection: cable shoe terminal

Type	Overall dimensions (mm)						
	A	B	C	D	E	F	G
CP 23	20	30	51	89	111	34	47
CP 58	50	80	78	114	145	32	32
CP 88	80	80	108	144	145	32	32

Type	Range	Precision class	Capacity VA	Weight kg	Packing/Box (pcs)	Product category	Catalogue number
CP 23	200/5	1	1.5	0,74	1 / 45	B	452320
CP 23	250/5	1	2.5	0,74	1 / 45	B	452325
CP 23	300/5	0,5	2.5	0,74	1 / 45	B	452330



Type	Range	Precision class	Capacity VA	Weight kg	Packing/Box (pcs)	Product category	Catalogue number
CP 58	250/5	0,5	1,5	0,87	1 / 36	B	455825
CP 58	300/5	0,5	2,5	0,87	1 / 36	B	455830
CP 58	400/5	0,5	2,5	0,87	1 / 36	B	455840
CP 58	500/5	0,5	5	0,87	1 / 36	B	455850
CP 58	600/5	0,5	5	0,87	1 / 36	B	455860



Type	Range	Precision class	Capacity VA	Weight kg	Packing/Box (pcs)	Product category	Catalogue number
CP 88	500/5	0,5	2,5	1	1 / 20	B	458850
CP 88	600/5	0,5	5	1	1 / 20	B	458860
CP 88	750/5	0,5	2,5	1	1 / 20	B	458875
CP 88	800/5	0,5	3.75	1	1 / 20	B	458880
CP 88	1000/5	0,5	5	1	1 / 20	B	458890



In case of insufficient quantity in stock of any item listed on this page, the delivery time after order confirmation will be 90 days.

INDUSTRIAL RELAYS AND BASES

3+2 standard +extended **5** YEAR TOTAL WARRANTY



Documents corresponding to the product: EN 60947-5-1; EN 61810

Devices intended for construction of automation and signalling boards. They are mainly used for command transfer towards the executive mechanisms. Currents of comparatively heavy values enabling the direct control of industrial executive mechanisms are commuted in comparatively small sizes. The contact surfaces are made from silver-coated electrolytic copper. The entire contact system is closed within a lid of colourless fire-proof plastic with a test-button installed to it. The base provides a safe electric connection of the conductors of the electric installation and the relays and is used to install the relay to the DIN busbar.

TECHNICAL CHARACTERISTICS:

- Supply voltage: from 12 to 230V AC, 50 Hz and from 12 to 110V DC
- Acceptable deviation of the supply voltage: 85 -110% Un
- Rated current of the sockets: 10A AC
- Electrical endurance: 1 000 000 cycles
- Isolation resistance: 500 mΩ /min (500V)
- Impulse tension resistance: 2000V, 50Hz
- Dielectric strength: 1000V AC/1 min
- Turn-out time: 25ms
- Working temperature: -5 ÷ + 65°C
- Humidity: 35 - 85% RH

METHOD OF INSTALLATION:

- on a DIN rail by means of a socket



Relay type	Voltage of the coil (V)	Socket type	Resistance of the coil (Ω)	Number of contacts	Packing/Box (pcs)	Product category	Catalogue number
ELM - 14FC	12 VDC	ELM-RT624-B	260	NO+NC	100 / 1000	B	57141
ELM - 14FC	24 VDC	ELM-RT624-B	1080	NO+NC	100 / 1000	B	57142
ELM - 14FC	48 VDC	ELM-RT624-B	4260	NO+NC	100 / 1000	B	57143



Relay type	Voltage of the coil (V)	Socket type	Resistance of the coil (Ω)	Number of contacts	Packing/Box (pcs)	Product category	Catalogue number
ELM - 60.2*	12 VDC	ELM - 90.22	96	2NO+2NC	20 / 300	F	57601
ELM-90.2	12VDC	ELM-90.22	96	2NO+2NC	20/300	B	57601N
ELM - 60.2	24 VDC	ELM - 90.22	384	2NO+2NC	20 / 300	B	57602
ELM - 60.2	48 VDC	ELM - 90.22	1540	2NO+2NC	20 / 300	B	57603
ELM - 60.2	230 VAC	ELM - 90.22	7400	2NO+2NC	20 / 300	B	57605
ELM-60.2	24VAC	ELM-90.22		2NO+2NC	20 / 300	B	57606
ELM - 60.2*	12 VDC	ELM - 90.23	96	3NO+3NC	20 / 300	F	57611
ELM-90.3	12VDC	ELM-90.23	96	3NO+3NC	20/300	B	57611N
ELM - 60.13	24 VDC	ELM - 90.23	384	3NO+3NC	20 / 300	B	57612
ELM - 60.13	48 VDC	ELM - 90.23	1540	3NO+3NC	20 / 300	B	57613
ELM - 60.13	110 VAC	ELM - 90.23	1700	3NO+3NC	20 / 300	B	57614
ELM - 60.13	230 VAC	ELM - 90.23	7400	3NO+3NC	20 / 300	B	57615
ELM-60.13	24VAC	ELM90.23		3NO-3NC	20/300	B	57616

* Until supply last



In case of insufficient quantity in stock of any item listed on this page, the delivery time after order confirmation will be 90 days.

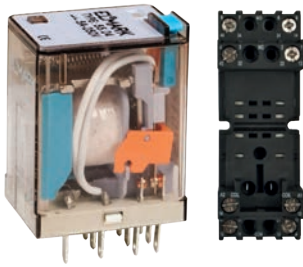

Relay type	Voltage of the coil (V)	Socket type	Resistance of the coil (Ω)	Number of contacts	Packing/Box (pcs)	Product category	Catalogue number
ELM - 55.02*	12 VDC	ELM - RT702-B	42	2NO+2NC	50 / 500	F	57521
ELM-36.02	12VDC	ELM-RT702-B	42	2NO+2NC	50/500	B	57521N
ELM - 55.02*	24 VDC	ELM - RT702-B	168	2NO+2NC	50 / 500	F	57522
ELM - 55.02	48 VDC	ELM - RT702-B	675	2NO+2NC	50 / 500	B	57523
ELM - 36.02	24VDC	ELM-RT702-B	168	2NO+2NC	50/500	B	57522N
ELM - 55.02*	230 VAC	ELM - RT702-B	14000	2NO+2NC	50 / 500	F	57525
ELM-36.02	230VAC	ELM-RT702-B	14000	2NO+2NC	50/500	B	57525N
ELM - 55.02	24VAC	ELM - RT702-B	-	2NO+2NC	50 / 500	F	57526
ELM-36.02	24VAC	ELM-RT702-B	-	2NO+2NC	50/500	B	57526N
ELM - 55.04*	12 VDC	ELM-RT704-B	42	4NO+4NC	50 / 500	F	57541
ELM-36.04	12VDC	ELM-RT704-B	42	4NO+4NC	50/500	B	57541N
ELM - 55.04*	24 VDC	ELM-RT704-B	168	4NO+4NC	50 / 500	F	57542
ELM-36.04	24VDC	ELM-RT704-B	168	4NO+4NC	50/500	B	57542N
ELM - 55.04	48 VDC	ELM-RT704-B	675	4NO+4NC	50 / 500	B	57543
ELM - 55.04	110 VAC	ELM-RT704-B	3500	4NO+4NC	50 / 500	B	57544
ELM - 55.04	230 VAC	ELM-RT704-B	14000	4NO+4NC	50 / 500	B	57545
ELM-55.04	24VAC	ELM-RT704-B	-	4NO+4NC	50 / 500	B	57546

* Until supply last



57901 57902, 57912

Socket type	Dimensions (mm)	Number of terminals (pcs)	Packing/Box (pcs)	Product category	Catalogue number
ELM - RT624-B	76 x 15	5	20 / 600	B	57901
ELM - RT702-B	76 x 27	11	10 / 240	B	57902
ELM - RT704-B	76 x 27	14	10 / 240	B	57912
ELM - 90.22	68 x 38	8	10 / 400	B	57904
ELM - 90.23	68 x 38	11	10 / 400	B	57905



57904, 57905

INDUSTRIAL SOLID STATE RELAYS (SSR)

3+2 standard +extended **5** YEAR TOTAL WARRANTY



Documents corresponding to the product: EN 60947-5-1; EN 61810

Industrial SSR are intended for mounting in power and control cabinets as an output switch devices with reliable ON/OFF performance. The SSR are based on the CMOS technology. The non-contact electronic switch is optically separated from the input signal by a photoelectric coupler. This allows use of switch currents of up to 50A despite of the devices small overall size. Another important feature of the relay is that output load can be regulated depending on the input signal value. The relay is mainly used to transmit control signals to actuating mechanisms since it can work at comparatively high currents making it possible to directly control actuators. SSR have transparent plastic covers to additionally improve their safety level. The SSR use is connected with considerable heat emissions, so measures must be taken to dispense the excessive thermal energy in the atmosphere. This is achieved through application of specially deigned radiators. The correct definition of radiator parameters is of critical importance. It is made by calculating the heat generation capacity with the formula: Heat generation = active load current x 3.0 W/A. The heat removal surface is estimated with the help of the following graphic:

TECHNICAL SPECIFICATIONS:

- Load/output voltage: 30/400V 50 Hz or the solid state voltage regulators
- Rated output current: from 10A to 60A
- Insulating voltage: 1000 MΩ /min (500V)
- Impulse voltage stability: 2000V, 50Hz
- Dielectric Strength: < 2500VAC / 1 min
- Leakage current: <2mA
- Turn-on time: <10ms
- Operating temperature: -5°C + 65°C
- Relative Humidity: 35 - 85%RH



Type	Relay Type	Control Voltage (V)	Output Voltage (V)	Number of phases	Output Current (A)	Packing/Box (pcs)	Product category	Catalogue number
ZG3NC - 2 - 10B	SSR	3-32VDC	230VAC	1	10	10 / 100	B	57710
ZG3NC - 2 - 20B	SSR	3-32VDC	230VAC	1	20	10 / 100	B	57720
ZG3NC - 2 - 25B	SSR	3-32VDC	230VAC	1	25	10 / 100	B	57725
ZG3NC - 2 - 40B	SSR	3-32VDC	230VAC	1	40	10 / 100	B	57740
ZG3NC - 2 - 60B	SSR	3-32VDC	230VAC	1	60	10 / 100	B	57760
ZG3NC - 3 - 10B	SSR	3-32VDC	400VAC	2	10	10 / 100	B	57713
ZG3NC - 3 - 20B	SSR	3-32VDC	400VAC	2	20	10 / 100	B	57723
ZG3NC - 3 - 25B	SSR	3-32VDC	400VAC	2	25	10 / 100	B	57735
ZG3NC - 3 - 40B	SSR	3-32VDC	400VAC	2	40	10 / 100	B	57743
ZG3NC - 3 - 60B	SSR	3-32VDC	400VAC	2	60	10 / 100	B	57763



UNTIL SUPPLY LAST

Type	Relay Type	Control Voltage (V)	Output Voltage (V)	Number of phases	Output Current (A)	Packing/Box (pcs)	Product category	Catalogue number
ZG1NC - 2 - 10D	SS voltage regulator	1-10VDC	0-230VAC	1	10	10 / 100	F	57810
ZG1NC - 3 - 10D	SS voltage regulator	1-10VDC	0-400VAC	2	10	10 / 100	F	57813



Type	Relay Type	Control Voltage (V)	Output Voltage (V)	Number of phases	Output Current (A)	Packing/Box (pcs)	Product category	Catalogue number
ZG33 - 3 - 10B	SSR	3-32VDC	400VAC	3	10	1 / 30	B	57831
ZG33 - 3 - 20B	SSR	3-32VDC	400VAC	3	20	1 / 30	B	57832
ZG33 - 3 - 25B	SSR	3-32VDC	400VAC	3	25	1 / 30	B	57833
ZG 33 - 3 - 40B	SSR	3-32VDC	400VAC	3	40	1 / 30	B	57834



Note: The relay output must be supplied with a varistor to ensure its over-voltage protection, whenever RRS is used to control inductive loads.

In case of insufficient quantity in stock of any item listed on this page, the delivery time after order confirmation will be 90 days.



DIGITAL VOLTMETER/AMPEREMETER EKDP 15 A/V

3+2 standard +extended **5** YEAR TOTAL WARRANTY

Digital device adjusted for DIN-rail mounting and offered in two types:

- amperemeter
- voltmeter

It is supplied with LCD display where the measurement quantity is displayed with numbers with 31/2 size. It has high accuracy of analogue-digital transfer, measurement precision and electromagnetic interference stability.

There is possibility for adjustment of the measurement range through built in micro switches. Adjusted to measure constant current (AD,DV) and alternating current (AA,VA) quantities.

Documents corresponding to the product: Standard EN 61010-1

Type	Packing/ Box (pcs)	Product category	Catalogue number
EKDP-15AA	1 / 100	B	50117A
EKDP-15DA	1 / 100	B	50117D
EKDP-15AV	1 / 100	B	50116A
EKDP-15DV	1 / 100	B	50116D



Dimensions (mm)

H	W	L	D
88	36	64	45

TECHNICAL DATA:

- Power supply voltage: 100 - 240V; 50Hz
- Inlet signal:
 - operating as voltmeter: 2 – 700V (the range is adjusted from inside)
 - operating as amperemeter: 5 – 2000A (the range is adjusted from inside)

NOTE: At current range over 5A a current measurement transformer should be used

- Consumption: <4VA
- Impulse voltage wear resistance: 4000V; 50Hz (1 min)
- Operating temperature: -5 ÷ +65°C
- Humidity: 35 – 85%RH
- Precision: 0.5% from the whole scale
- Display: LCD
- Weight: 150gr

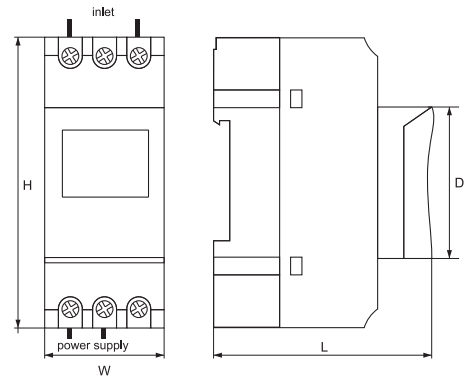

MOUNTING:

- DIN-rail

DIGITAL VOLTMETER/AMPEREMETER AND FREQUENCY METER EKDP7

3+2 standard +extended **5** YEAR TOTAL WARRANTY



Digital device adjusted for mounting on the front panel of electrical boards and offered in the following types:

- amperemeter:
 - EKDP7 – AA – amperemeter for alternating current
 - EKDP7 – DA – amperemeter for direct current
- voltmeter:
 - EKDP7 – AV – voltmeter for alternating current
 - EKDP7 – DV – voltmeter for direct current
- EKDP7 – Hz – frequency meter

It is supplied with LCD display where the measurement quantity is displayed with numbers with 31/2 size. It has high accuracy of analogue-digital transfer, measurement precision and electromagnetic interference stability.

There is possibility for adjustment of the measurement range through built in micro switches. Adjusted to measure direct current and alternating current quantities.

Documents corresponding to the product: Standard EN 61010-1

Type	Packing/ Box (pcs)	Product category	Catalogue number
EKDP7-AV	1 / 84	B	50106
EKDP7-AA	1 / 84	B	50107
EKDP7-DV	1 / 84	B	50108
EKDP7-DA	1 / 84	B	50109
EKDP7-HZ	1 / 84	B	50110



Dimensions (mm)

H	W	H1	D	L
72	72	68	6	42

TECHNICAL DATA:

- Power supply voltage: 100 - 240V; 50Hz
- Inlet signal:
 - operating as voltmeter: 2 – 700V (the range is adjusted from inside)
 - operating as amperemeter: 5 – 2000A (the range is adjusted from inside)

NOTE: For high current range a current measurement transformer should be used for alternating current device and a measurement shunt for direct current.

- Consumption: <5A
- Impulse voltage wear resistance: 4000V; 50Hz (1 min)
- Operating temperature: -5 ÷ +65°C
- Humidity: 35 – 85%RH
- Precision: 0.5% from the whole scale
- Display: LCD
- Weight: 130gr

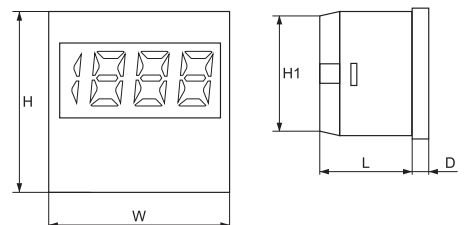

MOUNTING:

- on the front panel

In case of insufficient quantity in stock of any item listed on this page, the delivery time after order confirmation will be 90 days.



DIGITAL ROUND VOLTMETER/ AMPEREMETER AND FREQUENCY METER EL-ED16R

3+2 standard +extended **5** YEAR TOTAL WARRANTY

Type	Range	Diameter (mm)	Packing / Box (pcs)	Product category	Catalogue number
Voltmeter	AC 12-500V	22	10/500	B	401553
Amperemeter	AC 0-100A	22	10/500	B	401554
Frequency meter	AC 35-99 HZ	22	10/500	B	401555



DIGITAL SQUARE VOLTMETER/ AMPEREMETER AND FREQUENCY METER EL-ED16S

3+2 standard +extended **5** YEAR TOTAL WARRANTY

Type	Range	Diameter (mm)	Packing / Box (pcs)	Product category	Catalogue number
Voltmeter	AC 12-500V	22	10/500	B	401556
Amperemeter	AC 0-100A	22	10/500	B	401557
Frequency meter	AC 35-99 HZ	22	10/500	B	401558

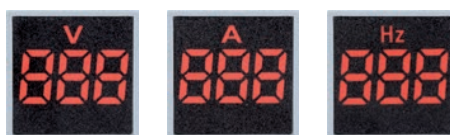

Documents corresponding to the product: Standard IEC 62052-11; IEC 62053-21; IEC 62056-21

DIN RAIL MOUNTED KWH METERS

3+2 standard +extended **5** YEAR TOTAL WARRANTY

Electronic single and three phase kWh meters intended for DIN rail mounting and active energy measurement. Meters are suitable for home and commercial applications. They perform direct measurement of the real consumption of electric power and the results are shown on the LCD display. The system doesn't need any additional adjustment or calibration. The range includes single and multi-tariff models.

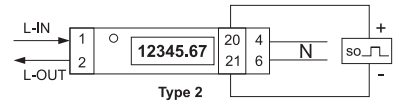
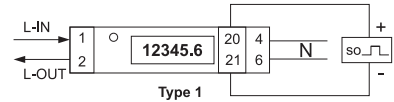
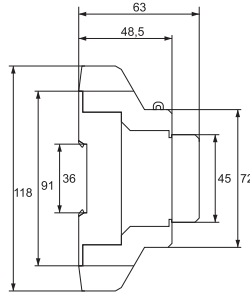

Type	Measuring range	Number of Tariffs	Meter constant (imp/kWh)	Voltage (V)	Overall dimensions (mm) height / width / depth	Packing/Box (pcs)	Product category	Catalogue number
DDS - 1Y - 45	5A (45A)	1	1000	230	63 / 18 / 118	1 / 120	F	50214

UNTIL SUPPLY LAST

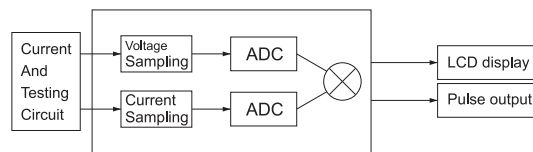
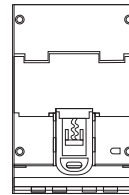
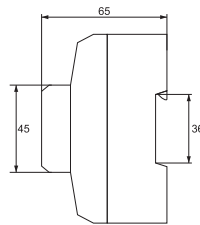
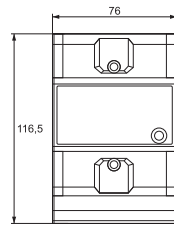

Type	Measuring range	Number of Tariffs	Meter constant (imp/kWh)	Voltage (V)	Overall dimensions (mm) height / width / depth	Packing/Box (pcs)	Product category	Catalogue number
DD4F-S01-1Y-60	5A (60A)	4	1600	230	116.5 / 76 / 65	1 / 48	F	50220

UNTIL SUPPLY LAST



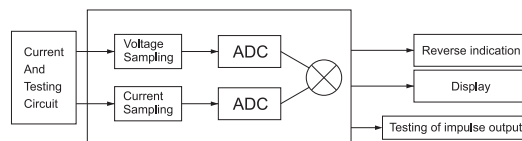
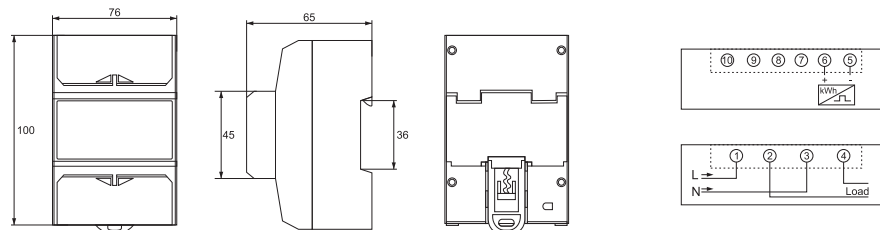

Type	Measuring range	Number of Tariffs	Meter constant (imp/kWh)	Voltage (V)	Overall dimensions (mm) height / width / depth	Packing/Box (pcs)	Product category	Catalogue number
DDS - 1Y - 100	10A (100A)	1	1600	230	65 / 76 / 100	1 / 45	F	50260

UNTIL SUPPLY
LAST

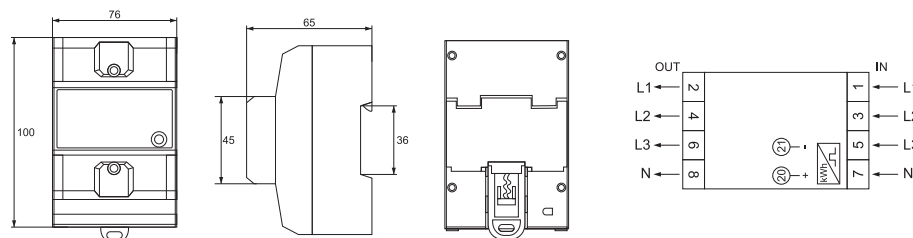

Type	Measuring range	Number of Tariffs	Meter constant (imp/kWh)	Voltage (V)	Overall dimensions (mm) height / width / depth	Packing/Box (pcs)	Product category	Catalogue number
DDS - 3Y 80	20A (80A)	1	800	3x230/400	65 / 76 / 100	1 / 45	F	50380

UNTIL SUPPLY
LAST

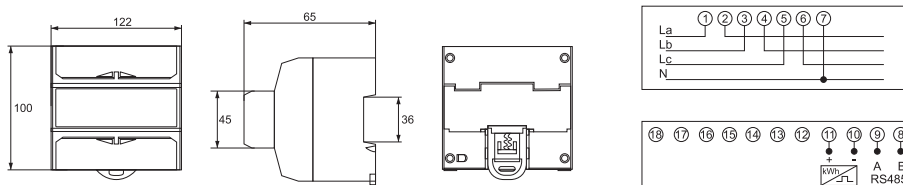

Type	Measuring range	Number of Tariffs	Meter constant (imp/kWh)	Voltage (V)	Overall dimensions (mm) height / width / depth	Packing/Box (pcs)	Product category	Catalogue number
DTGS-S01-3Y100	10A (100A)	4	800	3X230/400	122 / 100 / 65	1 / 30	F	50400

UNTIL SUPPLY
LAST



In case of insufficient quantity in stock of any item listed on this page, the delivery time after order confirmation will be 90 days.



Type	Measuring range	Number of Tariffs	Meter constant (imp/kWh)	Voltage (V)	Overall dimensions (mm) height / width / depth	Packing/Box (pcs)	Product category	Catalogue number
EL-45SA	5A(40A)	1	2000	230	116 / 18 / 59	1/10	B	50213



Type	Measuring range	Number of Tariffs	Meter constant (imp/kWh)	Voltage (V)	Overall dimensions (mm) height / width / depth	Packing/Box (pcs)	Product category	Catalogue number
EL-100SA-U	10A(100A)	1	1600	230	100 / 76 / 65	1/60	B	50216



Type	Measuring range	Number of Tariffs	Meter constant (imp/kWh)	Voltage (V)	Overall dimensions (mm) height / width / depth	Packing/Box (pcs)	Product category	Catalogue number
EL-024	3x20A(100A)	1	400	3x220/380	100 / 76 / 65	1/60	B	50217





Documents corresponding to the product:

Standard EN 60051-1



ANALOGUE (POINTER) PANEL METERS SD72 TYPE FOR BUILD-IN

3+2 standard +extended **5** YEAR TOTAL WARRANTY

Analogue devices adjusted for mounting on the front panel of electrical boards. Designed for frequency measurement, capacity, alternating or direct voltage and current of the power supply grid, with overall dimensions 72x72mm. They are manufactured on the basis of bridge measurement schemes. There is possibility for display change for the higher scopes of measuring.

Type	Type of the measurement system	Precision class	Range	Note	Packing/Box (pcs)	Product category	Catalogue number
amperemeter AC	MEMSI	1.5	0-100A	current transfer 100/5	1 / 100	B	654010
amperemeter AC	MEMSI	1.5	0-200A	current transfer 200/5	1 / 100	B	654020
amperemeter AC	MEMSI	1.5	0-400A	current transfer 400/5	1 / 50	B	654040
amperemeter AC	MEMSI	1.5	0-600A	current transfer 600/5	1 / 50	B	654060
amperemeter AC	MEMSI	1.5	0-1000A	current transfer 1000/5	1 / 50	B	654100
amperemeter AC	MEMSI	1.5	0-1500A	current transfer 1500/5	1 / 50	B	654150
voltmeter AC*	MEMSI	1.5	0-500V	-	1 / 50	B	50125
frequency meter**	ME	0.5	45-65Hz	-	1 / 50	B	50126
cosφ meter	MEMSI	1.5	3P 400V	-	1 / 50	B	50127
amperemeter DC	MEMC	1.5	0-5A	-	1 / 50	B	50128
amperemeter DC	MEMC	1.5	0-50A	outer resistor 60mV	1 / 50	B	50129
voltmeter DC	MEMC	1.5	0-50V	-	1 / 50	B	50130
voltmeter DC	MEMC	1.5	0-100V	-	1 / 20	B	50131
wattmeter	MEMSI	1.5	0-3000W 1P240V	-	1 / 25	B	50132
wattmeter	MEMSI	1.5	0-3000W 3P 3 line	-	1 / 25	B	50133
wattmeter	MEMSI	1.5	0-3000W 3P 4 line	-	1 / 25	B	50134



Note: MEMSI - magnetic-electrical movable steel instrument; MEMC – magnetic-electrical movable coil

* Possibility for supplying with voltage transformer X/100V for range expanding

** Possibility for voltage 110V, 230V , 400V

ALL-PURPOSE LIMIT SWITCH – SERIES CSA-XXX

3+0 standard +extended **3** YEAR TOTAL WARRANTY

The all-purpose limit switches are devices used in automatic systems as a control element. They are used for setting of gearing limits. They are mounted on transport lines, conveyors and other linear progressive motion machines. They feature a vibration-resistant metal shell.

PRODUCT CONFORMITY DOCUMENTATION:

- Standard: EN 60947-1; EN 60947-5-1
- Dielectric strength: 1000V AC
- Rated current: 10A active; 4A inductive
- Insulating resistance: 100mΩ
- Electrical endurance (number of cycles): 500 000 with active load
- Mechanical endurance (number of cycles): 1 000 000
- Gearing speed: 5mm/s to 0.5 m/s
- Rated voltage: 230V
- Rated current: up to 10A
- IP code: IP66
- Cable input: cable gland PG11
- Section of power supply conductor: up to 2mm²
- Fastening strength of terminals: 6-8kgf/cm

Type of contact system	Type	Type of the head	Power of starting (g)	Power of release (g)	Switching position	General movement	Packing/ Box (pcs)	Product category	Catalogue number
------------------------	------	------------------	-----------------------	----------------------	--------------------	------------------	--------------------	------------------	------------------

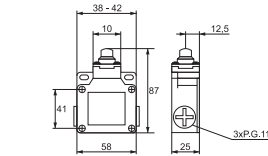
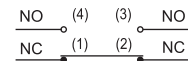

CSA - 001 metal cylinder 800 400 2.0mm 5.8mm 10 / 90 B **46A001**

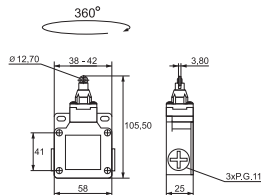

CSA - 003 cylinder with metal roll 800 400 2.0mm 5.8mm 10 / 90 B **46A003**

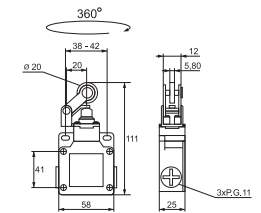

CSA - 012 horizontal lever with metal roll 800 400 2.0mm 5.8mm 10 / 90 B **46A012**

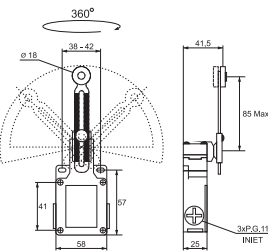

CSA - 031 adjustable lever with metal roll 400 100 22.5° 95° 10 / 80 B **46A031**

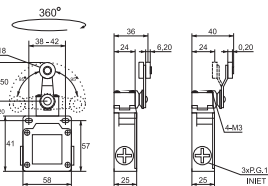

CSA - 021 lever with metal roll 400 100 22.5° 95° 10 / 80 B **46A021**

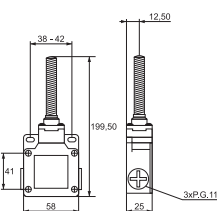

CSA - 081 spring lever 150 50 22.5° 50mm 10 / 80 B **46A081**



In case of insufficient quantity in stock of any item listed on this page, the delivery time after order confirmation will be 90 days.

AUTOMATION
LIMIT SWITCHES

ALL-PURPOSE LIMIT SWITCH – SERIES TZ-6XXX

3+0 standard +extended **3** YEAR TOTAL WARRANTY

The all-purpose limit switches are installed on transport lines, conveyors and other linear progressive motion machines. The miniature limit switch is mounted in an aluminum shell, resistant to vibrations, lubricants and water.

PRODUCT CONFORMITY DOCUMENTATION:

- Standard: EN 60947-1; EN 60947-5-1
- Dielectric strength: 1000V AC
- Rated current: 15A active; 5A inductive
- Insulating resistance: 100mΩ
- Contact resistance: 15mΩ
- Electrical endurance (number of cycles): 500 000 with active load
- Mechanical endurance (number of cycles): 10 000 000
- Gearing speed: 0.1mm/s to 0.5 m/s
- Rated voltage: 230V
- IP code: IP65
- Cable input: cable gland PG11
- Section of power supply conductor: up to 1.5mm²

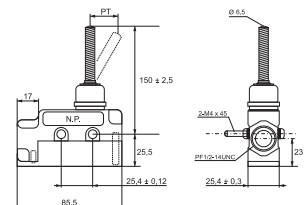
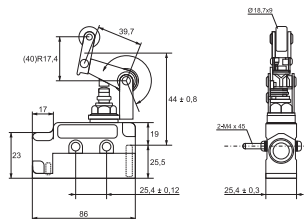
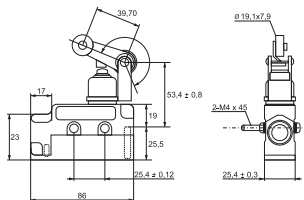
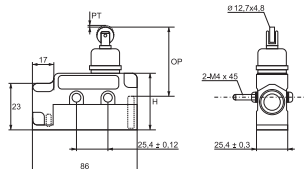
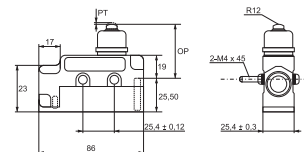
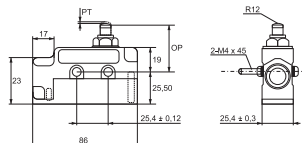
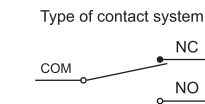

Type	Type of the head	Power of starting (g)	Power of release (g)	Switching position	General movement	Packing/ Box (pcs)	Product category	Catalogue number
------	------------------	-----------------------	----------------------	--------------------	------------------	--------------------	------------------	------------------

TZ-6001	metal cylinder	350	115	0.5mm	5.5mm	1 / 50	B	466001
TZ-6101	oil-resistant metal cylinder	800	240	2mm	5mm	1 / 50	B	466101
TZ-6102	oil-resistant cylinder with metal roll	500	100	1mm	3.5mm	1 / 50	B	466102
TZ-6104	oil-resistant horizontal lever with metal roll	640	230	5mm	6mm	1 / 50	B	466104
TZ-6143	oil-resistant vertical lever with metal roll	640	230	5mm	6mm	1 / 50	B	466143
TZ-6106	spring lever	150	-	20°	-	1 / 50	B	466106



In case of insufficient quantity in stock of any item listed on this page, the delivery time after order confirmation will be 90 days.

UNIVERSAL LIMIT SWITCH – SERIES CM-1XXX

3+0 standard +extended **3** YEAR TOTAL WARRANTY

Limit switches of the CM series are used mainly as replacement of the limit switches of the TZ series or for setting the movement limits of some types of equipment. The switches are supplied with screw cable terminals. They can work at resistance loads as high as 15A, and are of single circuit type. Limit switches have high accuracy and can operate at wide variety of speeds.

ITEMS ARE COMPLIANT WITH THE FOLLOWING STANDARDS:

- EN 60947-1; EN 60947-5-1
- Dielectric Strength: 1000V AC
- Rated current: 15A active; 5A inductive
- Insulation Resistance: 100mΩ min. (at 500VDC)
- Contact Resistance: 5mΩ
- Electrical Life (No. of cycles): 500 000 with non-inductive load

- Mechanical Life (No. of cycles): 5 000 000
- Operating frequency: 20 electrical operations/minute
- Operating speed: 0.1mm/s to 1.0m/s
- Rated voltage: 230V
- IP code: IP40
- Fastening strength of terminals: 6-8kgf/cm



Type of contact system

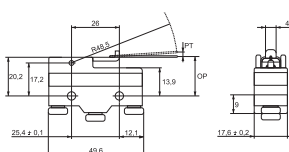
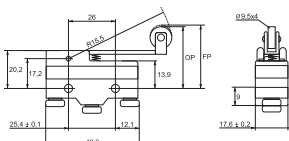
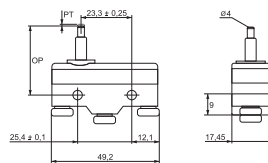
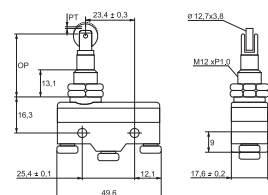
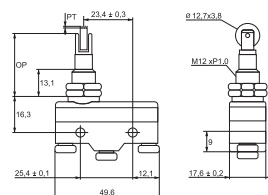
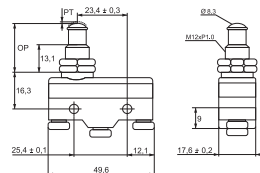

Type	Type of the head	Power of starting (g)	Power of release (g)	Switching position	General movement	Packing/ Box (pcs)	Product category	Catalogue number
------	------------------	-----------------------	----------------------	--------------------	------------------	--------------------	------------------	------------------

CM -1307	Metal cylinder	350	114	0.4mm	5.5mm	1 / 480 B		468105
----------	----------------	-----	-----	-------	-------	-----------	--	---------------

CM -1309	Cylinder and transverse metal roll	350	114	0.4mm	5.5mm	1 / 480 B		468106
----------	------------------------------------	-----	-----	-------	-------	-----------	--	---------------

CM -1308	Cylinder longitudinal metal roll	350	114	0.4mm	5.5mm	1 / 480 B		468109
----------	----------------------------------	-----	-----	-------	-------	-----------	--	---------------

CM -1305	Metal cylinder	350	114	0.4mm	1.6mm	1 / 480 B		468110
----------	----------------	-----	-----	-------	-------	-----------	--	---------------

CM -1703	Extended metal roll	160	22	7.1mm	1.02mm	1 / 480 B		468113
----------	---------------------	-----	----	-------	--------	-----------	--	---------------

CM -1705	Spring lever	10	3	20mm	5.6mm	1 / 480 B		468117
----------	--------------	----	---	------	-------	-----------	--	---------------



In case of insufficient quantity in stock of any item listed on this page, the delivery time after order confirmation will be 90 days.

ALL-PURPOSE LIMIT SWITCH – SERIES TZ-8XXX

3+0 standard + extended **3** YEAR TOTAL WARRANTY

The all-purpose limit switches are devices used for setting gearing limits. They are mounted on transport lines, conveyors and other linear progressive motion machines. They have small dimensions and a vibration-resistant metal shell with plastic lid, resistant to oil and water.

PRODUCT CONFORMITY DOCUMENTATION:

- Standard: EN 60947-1; EN 60947-5-1
- Dielectric strength: 1000V AC
- Rated current: 5A active; 3A inductive
- Insulating resistance: 100MΩ
- Contact Resistance: 25mΩ
- Electrical endurance (number of cycles): 500 000 with active load
- Mechanical endurance (number of cycles): 5 000 000
- Gearing speed: 5mm/s to 0.5 m/s
- Rated voltage: 230V
- IP code: IP65
- Cable input: cable gland PG11
- Section of power supply conductor: up to 2mm
- Fastening strength of terminals: 6-8kgf/cm

Type of contact system

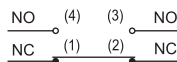

Type	Type of the head	Power of starting (g)	Power of release (g)	Switching position	General movement	Packing/Box (pcs)	Product category	Catalogue number
------	------------------	-----------------------	----------------------	--------------------	------------------	-------------------	------------------	------------------

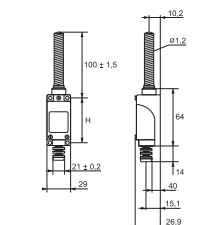
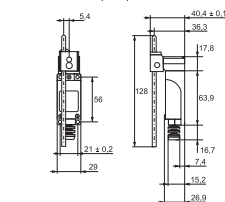
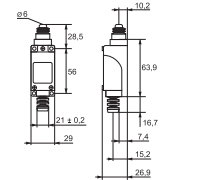
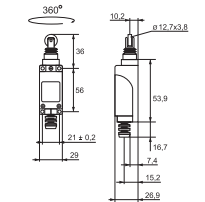
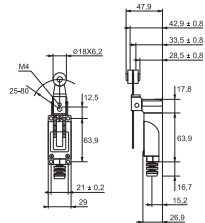
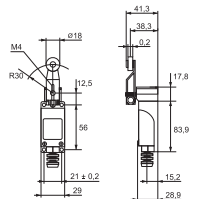

TZ-8104	lever with metal roll	750	100	20°	50°	10 / 100	B	468104
---------	-----------------------	-----	-----	-----	-----	----------	---	---------------

TZ-8108	adjustable lever with metal roll	750	100	20°	50°	10 / 100	B	468108
---------	----------------------------------	-----	-----	-----	-----	----------	---	---------------

TZ-8112	cylinder with metal roll	900	150	1.5mm	4.0mm	10 / 100	B	468112
---------	--------------------------	-----	-----	-------	-------	----------	---	---------------

TZ-8111	metal cylinder	900	150	1.5mm	4.0mm	10 / 100	B	468111
---------	----------------	-----	-----	-------	-------	----------	---	---------------

TZ-8107	metal rod	750	100	20°	50°	10 / 100	B	468107
---------	-----------	-----	-----	-----	-----	----------	---	---------------

TZ-8167	spring lever	150	-	30mm	-	10 / 100	B	468167
---------	--------------	-----	---	------	---	----------	---	---------------



ALL-PURPOSE LIMIT SWITCH – SERIES CWL-XXX

3+0 standard +extended **3** YEAR TOTAL WARRANTY

The all-purpose limit switches are devices used for setting gearing limits. They are mounted on transport lines, conveyors and other linear progressive motion machines. They have aluminium shell of high mechanic strength and resistance to oil, water and pressure.

PRODUCT CONFORMITY DOCUMENTATION:

- Standard: EN 60947-1; EN 60947-5-1
- Dielectric strength: 1000V AC
- Rated current: 10A active; 3A inductive
- Insulating resistance: 100mΩ
- Contact resistance: 15mΩ
- Electrical endurance (number of cycles): 500 000 with active load
- Mechanical endurance (number of cycles): 10 000 000
- Gearing speed: 1mm/s to 2 m/s
- Rated voltage: 230V
- IP code: IP66
- Cable input: cable gland
- Metal shell
- Vibration-resistant

Type of contact system

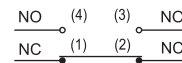

Type	Type of the head	Power of starting (g)	Power of release (g)	Switching position	General movement	Packing/ Box (pcs)	Product category	Catalogue number
------	------------------	-----------------------	----------------------	--------------------	------------------	--------------------	------------------	------------------

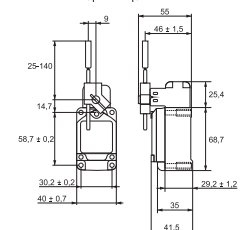
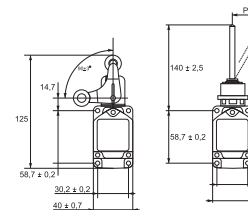
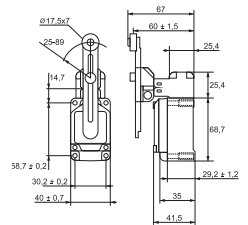
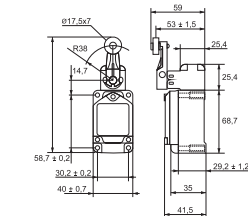
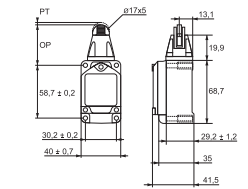
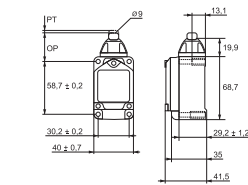

CWLD	metal cylinder	2720	910	2.0mm	6.4mm	1 / 50	B	46LD
CWLD2	cylinder with metal roll	2720	910	2.0mm	5.6mm	1 / 50	B	46LD2
CWLCA2-2	lever with metal roll	1360	227	20°	50°	1 / 50	B	46LCA2-2
CWLCA12-2-Q	adjustable lever with metal roll	2720	910	20°	50°	1 / 50	B	46LCA12-2Q
CWCA32-41	fork	1200	-	55°	90±10°	1 / 50	B	46LCA32-41
CWLNJ	oil-resistant spring lever	150	-	28mm	90±10°	1 / 50	B	46LNJ
	metal rod	142	28	20°	50°	1 / 50	B	46LCL



In case of insufficient quantity in stock of any item listed on this page, the delivery time after order confirmation will be 90 days.

UNIVERSAL LIMIT SWITCH – SERIES CZ93-XX

3+0 standard +extended **3** YEAR TOTAL WARRANTY

Limit switches of the CZ 93 series are Safety Key Interlock Switches. They are used in object control systems with high safety requirements. The limit switch body is mounted to the fixed system component, while the safety key is mounted to the movable system component. System operation cannot start, unless a full interlocking is achieved. Safety key interlock switches can operate at up to 10A non-inductive resistance load, 3A lamp load and 5A inductive load. They have high operating accuracy at wide variety of speeds. These limit switches are available in two versions depending on the operating contacts number: 2NC and NO+NC

COMPLIANT WITH THE FOLLOWING STANDARDS:

- EN 60947-1; EN 60947-5-1
- Dielectric Strength: 2500V AC
- Rated current: 10A active; 3A inductive
- Insulation Resistance: 100mΩ min. (at 500VDC)
- Contact Resistance: 25mΩ
- Electrical Life (No. of cycles): 50 000 with non-

- inductive load
- Mechanical Life (No. of cycles): 2 000 000
- Operating frequency: 30 electrical operations/minute
- Operating speed: 0.1 mm/s to 0.5m/s
- Rated voltage: 230V
- IP code: IP65

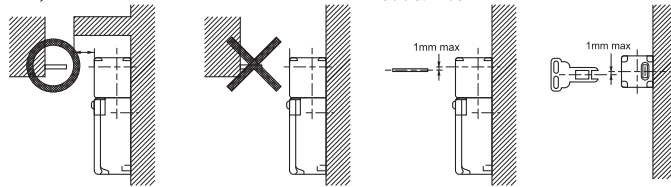

Type of the contact system

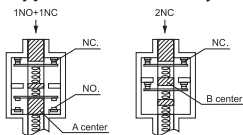

Type	Key type	Power of starting (g)	Power of release (g)	Switching position	General movement	Packing/ Box (pcs)	Product category	Catalogue number
------	----------	-----------------------	----------------------	--------------------	------------------	--------------------	------------------	------------------

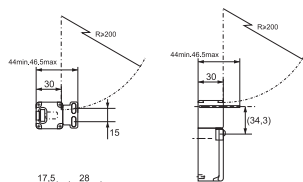

CZ-93BPG01	CZ93-K1	147N	29.4N	6 mm	28mm	10 / 100	B	46CZ08
------------	---------	------	-------	------	------	----------	---	---------------

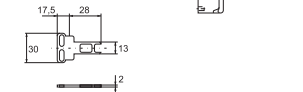

CZ-93CPG01	CZ93-K1	147N	29.4N	6 mm	28mm	10 / 100	B	46CZ09
------------	---------	------	-------	------	------	----------	---	---------------

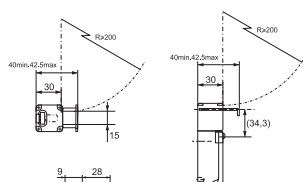

CZ-93BPG02	CZ93-K2	147N	29.4N	6 mm	28mm	10 / 100	B	46CZ10
------------	---------	------	-------	------	------	----------	---	---------------

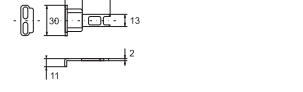

CZ-93CPG02	CZ93-K2	147N	29.4N	6 mm	28mm	10 / 100	B	46CZ11
------------	---------	------	-------	------	------	----------	---	---------------

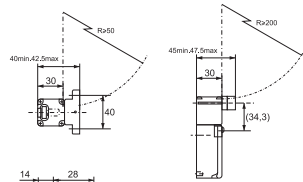

CZ-93BPG03	CZ93-K3	147N	29.4N	6 mm	28mm	10 / 100	B	46CZ12
------------	---------	------	-------	------	------	----------	---	---------------

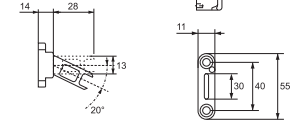

Type	Key Actuating	Packing / Box (pcs)	Product category	Catalogue number
CZ 93 - K 1	Horizontal	1 / 100	B	46CZ931
CZ 93 - K 2	Vertical	1 / 100	B	46CZ932
CZ 93 - K 3	Adjustable	1 / 100	B	46CZ933



In case of insufficient quantity in stock of any item listed on this page, the delivery time after order confirmation will be 90 days.

ALL-PURPOSE PROXIMITY SWITCH – SERIES LM XX

3+0 standard + extended **3** YEAR TOTAL WARRANTY

Proximity induction sensors are all-purpose switches used in machine systems and equipment for no contact surveillance of metal elements motion. They can also be used in other machine systems applications as no contact control sensors for level of liquids, control sensors for the speed and position of rotating chains, etc. They are developed on the base of PNP and NPN transition. They have small dimensions and feature a metal cylindrical shell resistant to vibrations and a plastic lid which is oil and water resistant.

- Insulating resistance: $\geq 50\text{ M}\Omega$
- Gearing distance: from 2 mm to 7 mm
- Precision of repetition: 0.01
- Ambient temperature: -25°C to $+65^{\circ}\text{C}$
- Gearing speed: 5mm/s
- Rated voltage: 6~36VDC; 90~230VAC
- IP code: IP 67

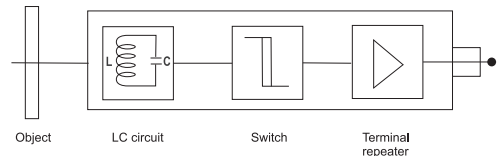

EL-LM8



EL-LM12



EL-LM18



EL-LM22

Type	Start distance (mm)	Power supply voltage	Type of transition	Type of contact	Output load	Packing / Box (pcs)	Product category	Catalogue number
EL-LM8-3002NA	2	15~30 VDC	NPN	NO	130 mA	2 / 200 B	46LM 8-32NA	
EL-LM8-3002NB	2	15~30 VDC	NPN	NC	130 mA	2 / 200 B	46LM 8-32NB	
EL-LM8-3002PA	2	15~30 VDC	PNP	NO	130 mA	2 / 200 B	46LM 8-32PA	
EL-LM8-3002PB	2	15~30 VDC	PNP	NC	130 mA	2 / 200 B	46LM 8-32PB	
EL-LM8-2002A	2	90~230VAC	SCR	NO	150 mA	2 / 200 B	46LM 8-22A	
EL-LM12-3004NA	4	15~30 VDC	NPN	NO	200 mA	2 / 200 B	46LM 12-34NA	
EL-LM12-3004NB	4	15~30 VDC	NPN	NC	200 mA	2 / 200 B	46LM 12-34NB	
EL-LM12-3004PA	4	15~30 VDC	PNP	NO	200 mA	2 / 200 B	46LM 12-34PA	
EL-LM12-3004PB	4	15~30 VDC	PNP	NC	200 mA	2 / 200 B	46LM 12-34PB	
EL-LM12-2004A	4	90~230VAC	SCR	NO	300 mA	2 / 200 B	46LM 12-24A	
EL-LM18-3008NA	8	15~30 VDC	NPN	NO	200 mA	1 / 100 B	46LM 18-38NA	
EL-LM18-3008NB	8	15~30 VDC	NPN	NC	200 mA	1 / 100 B	46LM 18-38NB	
EL-LM18-3008PA	8	15~30 VDC	PNP	NO	200 mA	1 / 100 B	46LM 18-38PA	
EL-LM18-3008PB	8	15~30 VDC	PNP	NC	200 mA	1 / 100 B	46LM 18-38PB	
EL-LM18-2008A	8	90~230VAC	SCR	NO	300 mA	1 / 100 B	46LM 18-28A	
EL-LM22-3010NA	10	15~30 VDC	NPN	NO	200 mA	1 / 100 B	46LM 22-30NA	
EL-LM22-3010NB	10	15~30 VDC	NPN	NC	200 mA	1 / 100 B	46LM 22-30NB	
EL-LM22-3010PA	10	15~30 VDC	PNP	NO	200 mA	1 / 100 B	46LM 22-30PA	
EL-LM22-3010PB	10	15~30 VDC	PNP	NC	200 mA	1 / 100 B	46LM 22-30PB	
EL-LM22-2010A	10	90~230VAC	SCR	NO	300 mA	1 / 100 B	46LM 22-20A	
EL-LM12-4002A	2	230VAC	inductive	NO	100 mA	2 / 200 B	46LM 12-44A	
EL-LM12-4004A	4	230VAC	inductive	NO	300 mA	2 / 200 B	46LM 12-46A	
EL-LM18-4006A	5	230VAC	inductive	NO	100 mA	1 / 100 B	46LM 18-44A	
EL-LM18-4008A	8	230VAC	inductive	NO	300 mA	1 / 100 B	46LM 18-48A	



In case of insufficient quantity in stock of any item listed on this page, the delivery time after order confirmation will be 90 days.









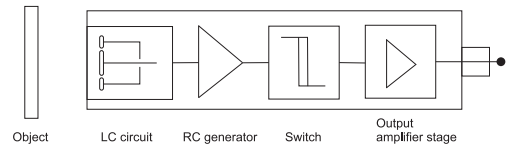



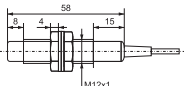
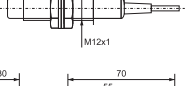

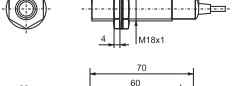
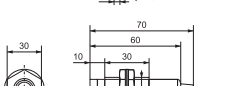
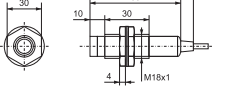
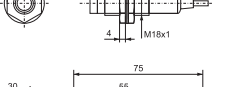
CAPACITIVE SENSORS – SERIES CM XX

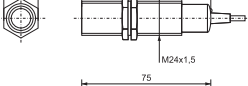
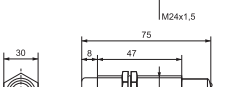
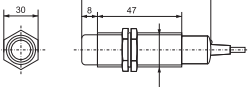
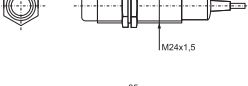
3+0 standard + extended **3** YEAR TOTAL WARRANTY

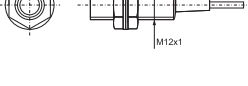
Capacitive sensors are used in machine systems and equipment for no-contact motion surveillance. They consist of two coaxial electrodes, a condenser and RC generator. This type of sensors reacts to both metal and non-metal objects, as the gearing distance for non-metal objects depends on their dielectric constants. They allow gearing distance adjustment for non-magnetic conductive materials. They are developed on the base of PNP and NPN transition. They have small dimensions and feature a metal cylindrical shell resistant to vibrations and a plastic lid which is oil and water resistant.

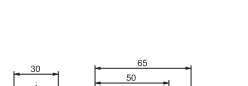
- Insulating resistance: $\geq 50 \text{ M}\Omega$
- Gearing distance: from 2 mm to 15 mm
- Precision of repetition: 0.01
- Ambient temperature: -25°C to $+65^\circ\text{C}$
- Gearing speed: 5mm/s
- Rated voltage: 6~36VDC; 90~230VAC
- IP code: IP 54

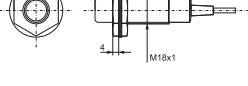

Type	Start distance (mm)	Power supply voltage	Type of transition	Type of contact	Output load	Packing / Box (pcs)	Product category	Catalogue number
 EL-CM12-3004NA	0~4	15~30 VDC	NPN	NO	200 mA	1/100 B	46CM 12-32NA	
 EL-CM12-3004NB	0~4	15~30 VDC	NPN	NC	200 mA	1/100 B	46CM 12-32NB	
 EL-CM12-3004PA	0~4	15~30 VDC	PNP	NO	200 mA	1/100 B	46CM 12-32PA	
 EL-CM12-3004PB	0~4	15~30 VDC	PNP	NC	200 mA	1/100 B	46CM 12-32PB	
 EL-CM18-3008NA	0~8	15~30 VDC	NPN	NO	200 mA	1/100 B	46CM 18-38NA	
 EL-CM18-3008NB	0~8	15~30 VDC	NPN	NC	200 mA	1/100 B	46CM 18-38NB	
 EL-CM18-3008PA	0~8	15~30 VDC	PNP	NO	200 mA	1/100 B	46CM 18-38PA	
 EL-CM18-3008PB	0~8	15~30 VDC	PNP	NC	200 mA	1/100 B	46CM 18-38PB	
 EL-CM18-2008A	0~8	90~230VAC	SCR	NO	300 mA	1/100 B	46CM 18-28A	
 EL-CM24-3012NA	8	15~30 VDC	NPN	NO	200 mA	1/100 B	46CM 24-12NA	
 EL-CM24-3012NB	8	15~30 VDC	NPN	NC	200 mA	1/100 B	46CM 24-12NB	
 EL-CM24-3012PA	8	15~30 VDC	PNP	NO	200 mA	1/100 B	46CM 24-12PA	
 EL-CM24-3012PB	8	15~30 VDC	PNP	NC	200 mA	1/100 B	46CM 24-12PB	
 EL-CM24-2012A	8	90~230VAC	SCR	NO	300 mA	1/100 B	46CM 24-12A	
 EL-SM12-3110NA	10	15~30 VDC	NPN	NO	200 mA	2/200 B	46SM 12-31NA	
 EL-SM12-3110NB	10	15~30 VDC	NPN	NC	200 mA	2/200 B	46SM 12-31NB	
 EL-SM18-3110PA	10	15~30 VDC	PNP	NO	200 mA	1/100 B	46SM 18-31PA	
 EL-SM18-3110PB	10	15~30 VDC	PNP	NC	200 mA	1/100 B	46SM 18-31PB	
 EL-XM18-305PMI	5	15~30 VDC	inductive	NO	100 mA	1/100 B	46XM 18-35A	
 EL-XM18-305PMU	5	15~30 VDC	inductive	NC	100 mA	1/100 B	46XM 18-35B	
Note: Sensor of Hall								
 EL-XM24-308PMI	8	15~30 VDC	inductive	NO	300 mA	1/100 B	46XM 24-38A	
 EL-XM24-308PMU	8	15~30 VDC	inductive	NC	300 mA	1/100 B	46XM 24-38B	

Note: MI - current type; MU - voltage type



In case of insufficient quantity in stock of any item listed on this page, the delivery time after order confirmation will be 90 days.

PHOTOELECTRICAL SENSOR

3+0 standard + extended **3** YEAR TOTAL WARRANTY

Photoelectrical sensors of the Gxx series are all-purpose switches used in machine systems and equipment for no contact surveillance of motion of elements. They are based on the photoelectric principle of operation – inside the sensor there is a photo signal emitter and receiver of the returned signal. There are three types of sensors: diffuse sensors, reflector sensors and emitter-receiver sensors. These types of sensors differ in the way of returning the signal. They allow for gearing distance adjustment. They are developed on the base of PNP and NPN transition. They have small dimensions and feature a metal cylindrical shell resistant to vibrations and a plastic lid which is oil and water resistant.

TECHNICAL FEATURES:

- Power supply voltage: 15~30 VDC
- Insulating resistance: $\geq 50 \text{ M}\Omega$
- Gearing distance: from 2 mm to 7 mm
- Precision of repetition: 0.01
- Ambient temperature: -25°C to +65°C
- Gearing speed: 5mm/s
- Rated voltage: 6~36VDC; 90~230VAC
- IP code: IP 67

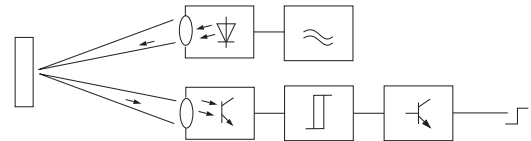

EL-G12



EL-G18



EL-G30



EL-G35



EL-G50



EL-BZJ

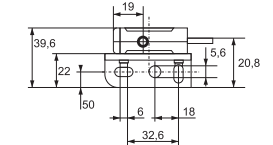
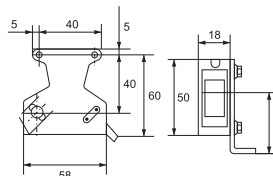
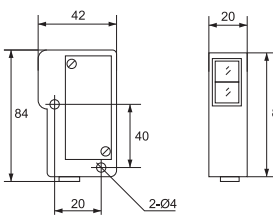
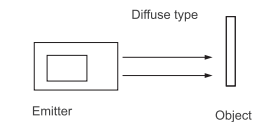
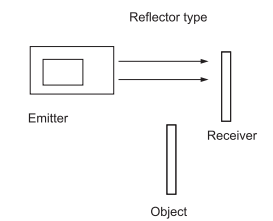
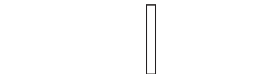
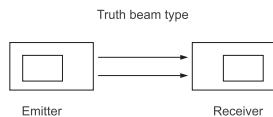

Type	Start distance	Type of transition	Type of contact	Type of sensor	Packing / Box (pcs)	Product category	Catalogue number
EL-G12-3A07NA	70 mm	NPN	Ø12; l=50	Diffuse	1 / 100	B	46G12A071
EL-G12-3A07PA	70 mm	PNP	Ø12; l=50	Diffuse	1 / 100	B	46G12A072
EL-G18-3A10NA	100 mm	NPN	Ø18; l=70	Diffuse	1 / 100	B	46G18A101
EL-G18-3A10PA	100 mm	PNP	Ø18; l=70	Diffuse	1 / 100	B	46G18A102
EL-G18-3B2NA	2 m	NPN	Ø18; l=70	Reflector	1 / 100	B	46G183B11
EL-G18-3B2PA	2 m	PNP	Ø18; l=70	Reflector	1 / 100	B	46G183B12
EL-G18-3C5NA	5 m	NPN	Ø18; l=70	Truth beam	1 / 100	B	46G185C11
EL-G18-3C5PA	5 m	PNP	Ø18; l=70	Truth beam	1 / 100	B	46G185C12
EL-G30-3A70NA	500 mm	NPN	Ø22; l=70	Diffuse	1 / 100	B	46G30A101
EL-G30-3A70PA	500 mm	PNP	Ø22; l=70	Diffuse	1 / 100	B	46G30A102
EL-G30-3C101NA	10 m	NPN	Ø22; l=70	Truth beam	1 / 52	B	46G305C11
EL-G30-3C101PA	10 m	PNP	Ø22; l=70	Truth beam	1 / 52	B	46G305C12
EL-G35-3A50PA	500 mm	PNP	NO	Diffuse	1 / 100	B	46G35A102
EL-G35-3B3NA	3 m	NPN	NO	Reflector	1 / 100	B	46G353B11
EL-G35-3B3PA	3 m	PNP	NO	Reflector	1 / 100	B	46G353B12
EL-G50-3A30NA	500 mm	NPN	NO	Diffuse	1 / 100	B	46G50A101
EL-G50-3A30PA	500 mm	PNP	NO	Diffuse	1 / 100	B	46G50A102
EL-G50-3B4NA	4 m	NPN	NO	Reflector	1 / 100	B	46G503B11
EL-G50-3B4PA	4 m	PNP	NO	Reflector	1 / 100	B	46G503B12
EL-G50-3C5NA	5 m	NPN	NO	Truth beam	1 / 50	B	46G505C11
EL-G50-3C5PA	5 m	PNP	NO	Truth beam	1 / 50	B	46G505C12
EL-BZJ-211	10 mm	Reflector	NO	Colour detector	1 / 50	B	46BZJ211
EL-BZJ-311	9mm	Reflector	NO	Colour detector	1 / 50	B	46BZJ311
EL-BZJ-411	9mm	Reflector	NO	Colour detector	1 / 50	B	46BZJ411



In case of insufficient quantity in stock of any item listed on this page, the delivery time after order confirmation will be 90 days.

AUTOMATION

188

PHOTOELECTRICAL SENSOR

POWER SUPPLIES

3+2
standard
+extended **5** YEAR TOTAL
WARRANTY

The DRP-xx-xx series of power supplies are voltage reduction and rectification units ideally suited to provide stable power supply of systems and equipment for contact-free movement monitoring elements (such as inductive, capacity and photo sensors, logic elements and systems, etc.). They have small overall dimensions and can be installed on a DIN rail. The power units have metal or plastic cases resistant to vibrations and plastic oil- and waterproof covers. They are able to provide stable output voltage at comparatively fluctuating input voltage. Devices have built-in overload and short circuit protection, allowing short time overload of up to 130%. Power supplies are available with various output voltages (5, 12, 15 and 24 V DC) and different output power rates.



TECHNICAL SPECIFICATIONS:

- Input voltage: 80 ~ 230V AC
- Over-voltage: 115 ~ 135% of the rated output voltage
- Overload: 120 ~ 120% of the rated output power
- Terminals: Input – 2 screw terminals; Output: 4 screw terminals;
- IP code: IP44
- Power indicator
- Installation: DIN rail
- Cooling: Free air cooling convection



Type	Output Voltage (V)	Output Load (A)	Tolerance	Power (W)	Dimensions W/H/L (mm)	Packing / Box (pcs)	Product category	Catalogue number
DR - 45 - 5	5	5	±2%	25	78 / 93 / 56	1 / 50	C	46DR455
DR - 45 - 12	12	3.5	±1%	42	78 / 93 / 56	1 / 50	C	46DR4512
DR - 45 - 15	15	2.8	±1%	42	78 / 93 / 56	1 / 45	C	46DR4515
DR - 45 - 24	24	2	±1%	48	78 / 93 / 56	1 / 16	C	46DR4524

Type	Output Voltage (V)	Output Load (A)	Tolerance	Power (W)	Dimensions W/H/L (mm)	Packing / Box (pcs)	Packing / Box (pcs)	Catalogue number
DR - 75 - 12	12	6.3	±2%	75	55.5 / 125.3 / 100	1 / 18	C	46DR7512
DR - 75 - 24	24	3.2	±1%	75	55.5 / 125.3 / 100	1 / 18	C	46DR7524
DRP - 240 - 24	24	10	±1%	240	125.5 / 125.3 / 100	1 / 12	C	46DR2424



In case of insufficient quantity in stock of any item listed on this page, the delivery time after order confirmation will be 90 days.

FLOAT SWITCHES

3+0
standard
+extended **3** YEAR TOTAL
WARRANTY



Float switches of the type QW-xx-xx are sealed units for direct pump control. They are intended for continuous liquid level maintenance in pools, tanks or ponds exercised through direct control of the pumping in or out process in the respective reservoir. They are pre-wired and depending on the chosen configuration can control either the pumping in, or pumping out of the reservoir. They allow direct control of single phase pumps with mounted power of 1 kW. Float switches are waterproof.

The automatic level control units of the DHC1Y-xx series are intended for mounting on pumping control panels. They do not use any additional sensors, but conductive probes to contact the liquid. The unit sends low (harmless) voltage signals to the probes and once a contact between a probe and liquid is established, the unit changes its contactors' state. Units are available in three variants with different number of control contacts suitable for different applications. Each contact can transfer current of up to 5A, which is enough to ensure control over the powerful pumps' contactors or to directly control pumps with mounted power of 1 kW. The automatic level control units can be installed on a DIN rail.

Type	Number of probes (No. of levels)	Output Load (A)	Accuracy	Operating Voltage (V)	Note	Packing / Box (pcs)	Product category	Catalogue number
DHC1Y - S	1	5	±1%	230	-	100	B	46DW001
DHC1Y - SD	3	5	±1%	230	-	100	B	46DW002
DHC1Y - T	1	5	±1%	230	2 pumps control	100	B	46DW003

Type	Number of probes (No. of levels)	Output Load (A)	Accuracy	Operating Voltage (V)	Note	Packing / Box (pcs)	Product category	Catalogue number
QW - M 15 - 3	2	6	±1%	230	-	1 / 30	B	46DW004
QW - 70AB	2	4	±1%	230	-	1 / 20	B	46DW005



Documents corresponding to the product: Standard: EN 60947-1; EN 60947-3-1

ROTARY SWITCHES LW26 SERIES

3+2 standard +extended **5** YEAR TOTAL WARRANTY



The rotary switches LW26 series are produced for switching on/off electrical circuits with commutated current from 20 to 160A. They are designed on the bases of the rotor-eccentric switching on which is realized through turning of the handle to 60 or 90 degrees. The normal operation is used for commutation of two, three or four conductor systems. There are special rotary switches that switch on under given connection schemes and are used to control motors, electric welding machines and other consumers.

TECHNICAL DATA:

- Power supply voltage: 230/400V; 50Hz
- Insulation voltage: 690V
- Impulse voltage wear resistance: 6000V
- Mechanical wear resistance: 3x10⁵ commutation cycles
- Operating temperature: -10 ÷ +65°C
- Humidity: 35 – 85% RH
- Commuting capacity: up to 160A according to the tables
- Plastic: UV rays wear resistance
- IP code:

- IP42 for the ordinary breakers mounted in a panel
- IP65 for the breakers offered in a box
- Cable connection: screw joining
- Tightening moment of the bolt: 1.33N
- Maximum section of the power supply conductors: according to the dimensions table
- Weight: according to the number of the contacts

MOUNTING:

- directly to the control panel
- thickness of the surface to which it is mounted: max 5mm

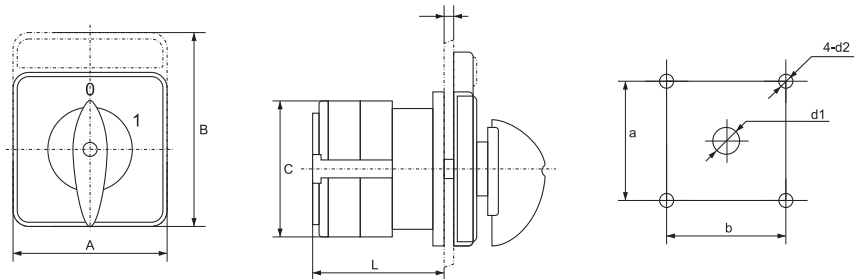

Type	Front panel	Joining conductor (mm ²)	Overall dimensions (mm)				Mounting dimensions (mm)			
			A	B	C	L	a	b	d1	d2
LW26-20	M1 panel	1x2.5	48	48	43	22 + 9.6n	36	36	Ø8.5	Ø4.5
	M1 panel with inscription field		48	60	43	22 + 9.6n	36	36	Ø8.5	Ø4.5
LW26-25	M1 panel	1x4.0	48	48	45.2	23+12.8n	36	36	Ø8.5	Ø4.5
LW26-32	M2 panel	1x6.0	64	64	58	29.2 + 12.8n	48	48	Ø10	Ø4.5
LW26-63	M2 panel	1x16	64	64	66	29.2 + 21.5n	48	48	Ø10	Ø4.5
LW26-125	M3 panel	1x35	88	88	84	35 + 26.5n	68	68	Ø13	Ø6
LW26-160	M3 panel	1x50	88	88	88	35 + 32.5n	68	68	Ø13	Ø6

* n - number of modules



Type	Scheme	In (A)	Levels	Packing / Box (pcs)	Product category	Catalogue number
LW26 - 10Q	Q10 three-poles switching on; motor starting and stopping; voltage turning on/off to the consumers	10	2	1 / 100	B	492101
LW26 - 16Q		16	2	1 / 100	B	492161
LW26 - 20Q		20	2	1 / 100	B	492201
LW26 - 25Q		25	2	1 / 100	B	492251
LW26 - 32Q		32	2	1 / 72	B	492321
LW26 - 63Q		63	2	1 / 30	B	492631
LW26 - 125Q		125	2	1 / 24	B	492951
LW26 - 160Q		160	2	1 / 27	B	492961



In case of insufficient quantity in stock of any item listed on this page, the delivery time after order confirmation will be 90 days.



Type	Scheme	In (A)	Levels	Packing / Box (pcs)	Product category	Catalogue number
LW26GS - 20/04	Q11	20	2	1 / 100	B	492207
LW26GS - 25/04	three-poles switching over; motor starting and stopping; voltage turning on/off to the consumers; possibility for access control	25	2	1 / 100	B	492257
LW26GS - 32/04		32	2	1 / 72	B	492327
LW26GS - 63/04		63	2	1 / 30	B	492637

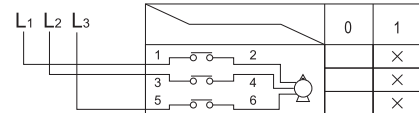
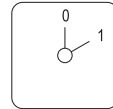

Type	Scheme	In (A)	Levels	Packing / Box (pcs)	Product category	Catalogue number
LW26 - 20N	N11 3-position – 2 start positions and 1 stop; for motor reversing	20	3	1 / 100	B	492202
LW26 - 25N		25	3	1 / 100	B	492252
LW26 - 32N		32	3	1 / 64	B	492322
LW26 - 63N		63	3	1 / 48	B	492632
LW26 - 125N		125	3	1 / 24	B	492952
LW26 - 160N		160	3	1 / 18	B	492962

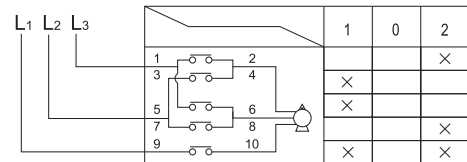
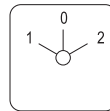

Type	Scheme	In (A)	Levels	Packing / Box (pcs)	Product category	Catalogue number
LW26 - 25S	S19 3-position – 2 start positions and 1 stop; for two speed motor control; switching over between charging*	25	4	1 / 100	B	492253
LW26 - 63S		63	4	1 / 30	B	492633
LW26 - 125S		125	4	1 / 24	B	492953
LW26 - 160S		160	4	1 / 18	B	492963

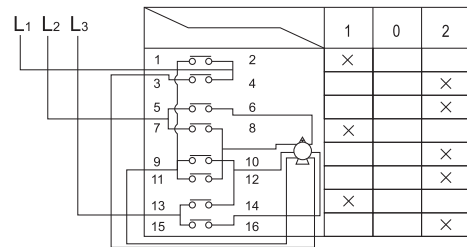
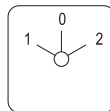

Note: It is necessary that additional bridges be placed at switching over between charging



Type	Scheme	In (A)	Levels	Packing / Box (pcs)	Product category	Catalogue number
LW26 - 25 SD	S21	25	4	1 / 100	B	492025
LW26 - 63 SD	3-position switching on star/delta	63	4	1 / 30	B	492063

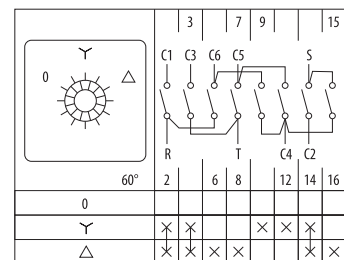



Type	Scheme	In (A)	Levels	Packing / Box (pcs)	Product category	Catalogue number
LW26 - 32H 5881/3	H5881/3 – 85	32	3	1 / 64	B	492324
LW26 - 63H 5881/3	for welding transformer windings switching over	63	3	1 / 48	B	492634

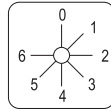

	0	1	2	3	4	5	6
1		X					
2			X				
3				X			
4					X		
5						X	
6							X



Type	Scheme	In (A)	Levels	Packing / Box (pcs)	Product category	Catalogue number
LW26 - 20 YH5/3	YH5/3 - 66 for voltage switching over	20	3	1 / 72	B	492205

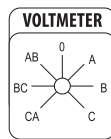

	CA	BC	AB	0	A	B	C
1		X					X
2			X				
3				X			
4					X		
5	X						
6		X					
7			X				



Type	Scheme	In (A)	Levels	Packing / Box (pcs)	Product category	Catalogue number
LW26 - 20 LH3/3	LH3/3 - 58 for amperemeter switching on to current transformers	20	3	1 / 100	B	492206

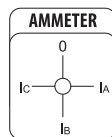

	0	I _a	I _b	I _c
1	X	X	X	X
2	X	X	X	X
3	X	X	X	X
4	X	X	X	X



Type	Scheme	IP code:	Packing / Box (pcs)	Product category	Catalogue number
LW26 - 20-25-Q	Box for LW26-20/25	IP 42	1 / 68	B	492037
LW26 - 32-Q	Box for LW26-32	IP 42	1 / 30	B	492038
LW26 - 20-25-DIN	Adaptor for DIN-rail for LW26-20/25		15 / 1500	B	492039



In case of insufficient quantity in stock of any item listed on this page, the delivery time after order confirmation will be 90 days.



Type	Scheme	In (A)	Levels	Packing / Box (pcs)	Product category	Catalogue number
LW26 4.I7168/7	4.I7168/7	20	7	1 / 100	B	492028

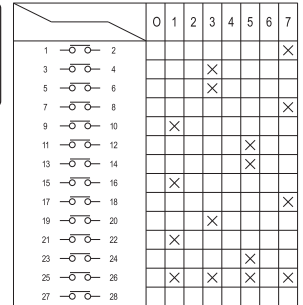

Type	Scheme	In (A)	Levels	Packing / Box (pcs)	Product category	Catalogue number
LW26 4.H6518/5	4.H6518/5	25	5	1 / 100	B	492029

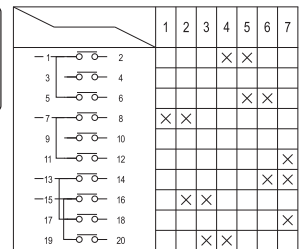
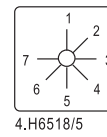

Type	Scheme	In (A)	Levels	Packing / Box (pcs)	Product category	Catalogue number
LW30-20	LW30-20	20	3	1 / 32	B	492030
LW30-32	LW30-32	32	3	1 / 32	B	492031
LW30-40	LW30-40	40	3	1 / 32	B	492033
LW30-63	LW30-63	63	3	1 / 32	B	492034



LW30-20-100A
ON/OFF switch 3 poles

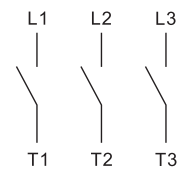

* Possibility for access control



Type	Scheme	IP code:	In (A)	Levels	Packing / Box (pcs)	Product category	Catalogue number
LW30-32	LW30-32	IP54	32	3	1 / 30	B	492032



LW30-20-100A
ON/OFF switch 3 poles

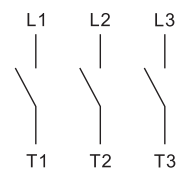

* Possibility for access control

In case of insufficient quantity in stock of any item listed on this page, the delivery time after order confirmation will be 90 days.

Documents corresponding to the product: Standard: EN 60947-1; EN 60947-5-1

BUTTONS AND LED INDICATORS

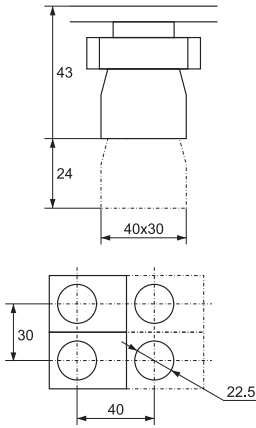

Overall dimensions
Diagram for drill the openings

These are devices used in control and indication systems, command boards and panels in industrial automation systems. They are manufactured to commute controlling circuits and to control the switching on or off executive mechanisms such as relays, contactors, etc. The signal lamps and indicators find broad application in all industrial fields. The devices endure short time current overload up to 10A, and normally they can commute thermal current up to 6A in their contact system. The connection to the contact terminals is through screw terminals to which operational conductors with section up to 2.5mm² can be joined.

DOCUMENTATION CORRESPONDING TO THE PRODUCT:

- Standard: EN 60947-1; EN 60947-5-1

TECHNICAL DATA:

- Insulation voltage: 660V; 50/60Hz
- Impulse voltage wear resistance: 6000V;
- Rated current: 6A (230V AC); 0.3A (230V DC)
- Short circuit protection: safety device 10A gG outside in the circuit
- Mechanical wear resistance: 1x10⁶ commutation cycles
- Power of mechanical compression:

- ▶ at closing: 20N
- ▶ at opening: 8N
- Operating temperature: -20 - +65°C
- Humidity: 35 – 85%RH
- Tightening moment of the joining conductors: 0.15Nm
- Section of the conductor: 1x0.5; 1x0.75; 1x1; 1x1.5; 1x2.5mm²

MOUNTING:

- to a flat metal or plastic surface with thickness: max 4mm
- opening with size: Ø 22.5mm



Type	Description	Type of contacts	Rated current (A) at 400V	Colour	Packing / Box (pcs)	Product category	Catalogue number
EL-EA25	Button round with spring reverse	NO+NC	6	black	10/500	B	401025
EL-EA31		NO	6	green	10/500	B	401030
EL-EA42		NC	6	red	10/500	B	401040

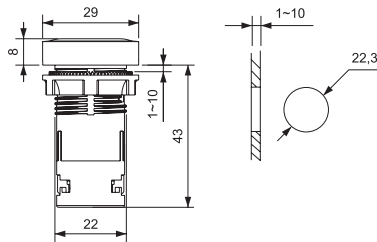

Type	Description	Type of contacts	Rated current (A) at 400V	Colour	Packing / Box (pcs)	Product category	Catalogue number
EL-EA25	Button round with spring reverse and silicon lid- IP44	NO+NC	6	black	10/500	B	401026
EL-EA31		NO	6	green	10/500	B	401033
EL-EA42		NC	6	red	10/500	B	401041



Type	Description	Type of contacts	Rated current (A) at 400V	Colour	Packing / Box (pcs)	Product category	Catalogue number
EL-ED25	Switch with arrest	NO+NC	6	black	10/500	B	401425

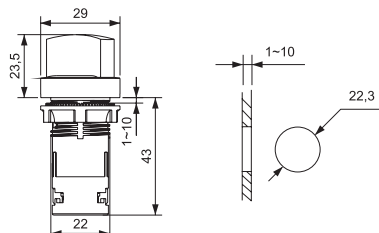

In case of insufficient quantity in stock of any item listed on this page, the delivery time after order confirmation will be 90 days.



Type	Description	Type of contacts	Rated current (A) at 230V	Colour	Diameter (mm)	Note	Packing / Box (pcs)	Product category	Catalogue number
EL-2211T	Button with head "mushroom" type	1NO+1NC	5	red	22	release with spinning	20/800	B	401546

Material: Stainless steel | Chromium plated brass | IP65

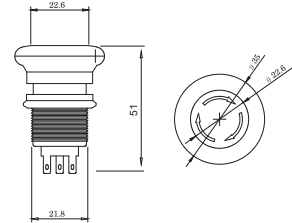

Type	Description	Type of contacts	Rated current (A) at 230V	Colour	Diameter (mm)	Packing / Box (pcs)	Product category	Catalogue number
EL-2211DZR	Button round with LED indicator-latching	1NO+1NC	5	red	22	20/800	B	401547
EL-2211DZG	Button round with LED indicator-latching	1NO+1NC	5	green	22	20/800	B	401548

Material: Stainless steel | Chromium plated brass | IP65

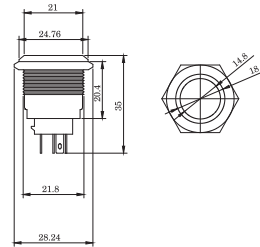

Type	Description	Type of contacts	Rated current (A) at 230V	Diameter (mm)	Packing / Box (pcs)	Product category	Catalogue number
EL-2211F	Button round momentary	1NO+1NC	5	22	20/800	B	401549

Material: Stainless steel | Chromium plated brass | IP65

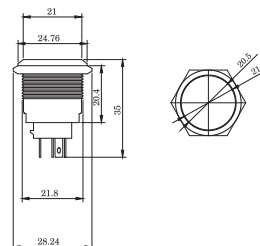



Type	Description	Type of contacts	Rated current (A) at 230V	Colour	Diameter (mm)	release with spinning	Packing/ Box (pcs)	Product category	Catalogue number
EL-22X2	Two position Switch with arrest	1NO+1NC	5	red	22		20/800	B	401550

Material: Stainless steel | Chromium plated brass | IP65

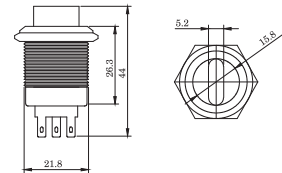

Type	Description	Type of contacts	Rated current (A) at 230V	Colour	Diameter (mm)	Packing/ Box (pcs)	Product category	Catalogue number
EL-22Y2	Two position Key Switch with arrest	1NO+1NC	5	red	22	20/800	B	401551
EL-22Y3	Three position Key Switch with arrest	2NO+2NC	5	green	22	20/800	B	401552

Material: Stainless steel | Chromium plated brass | IP65

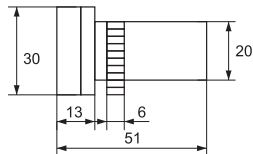
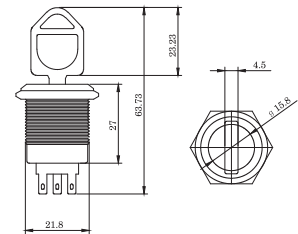

Type	Description	Voltage (V)	Colour	Packing / Box (pcs)	Product category	Catalogue number
AD56-22-W-230		230V AC	white	10 / 500	B	401123
AD56-22-W-110		110V AC	white	10 / 500	B	401111
AD56-22-W-24		24V AC/DC	white	10 / 500	B	401124
AD56-22-A-110		110V AC	amber	10 / 500	B	401211
AD56-22-A-24		24V AC/DC	amber	10 / 500	B	401224
AD56-22-A-230		230V AC	amber	10 / 500	B	401223
AD56-22-PG-230		230V AC	green	10 / 500	B	401323
AD56-22-PG-110		110V AC	green	10 / 500	B	401311
AD56-22-PG-24	LED indicators	24V AC/DC	green	10 / 500	B	401324
AD56-22-B-230		230V AC	blue	10 / 500	B	401523
AD56-22-B-110		110V AC	blue	10 / 500	B	401511
AD56-22-B-24		24V AC/DC	blue	10 / 500	B	401524
AD56-22-Y-230		230V AC	yellow	10 / 500	B	401723
AD56-22-Y-110		110V AC	yellow	10 / 500	B	401711
AD56-22-Y-24		24V AC/DC	yellow	10 / 500	B	401724
AD56-22-R-230		230V AC	red	10 / 500	B	401423
AD56-22-R-110		110V AC	red	10 / 500	B	401411
AD56-22-R-24		24V AC/DC	red	10 / 500	B	401424



In case of insufficient quantity in stock of any item listed on this page, the delivery time after order confirmation will be 90 days.

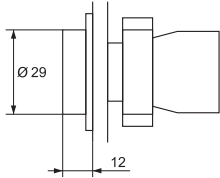

Type	Description	Type of contacts	Rated current (A) at 400V	Colour	Packing / Box (pcs)	Product category	Catalogue number
EL 2- BA 21	Button round with spring reverse	NO	6	black	20 / 300	B	401021
EL 2- BA 31		NO	6	green	20 / 300	B	401031
EL 2- BA 51		NO	6	yellow	20 / 300	B	401051
EL 2- BA 61		NO	6	blue	20 / 300	B	401061
EL 2- BA 42		NC	6	red	20 / 300	B	401042

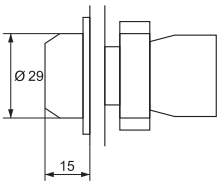

Type	Description	Type of contacts	Rated current (A) at 400V	Colour	Note	Packing / Box (pcs)	Product category	Catalogue number
EL 2- BP 31	Button round with spring reverse	NO	6	green	IP=65 Provided from silicon lid	20 / 300	B	401032
EL 2- BP 42	Button round with spring reverse	NC	6	red	IP=65 Provided from silicon lid	20 / 300	B	401043



Type	Description	Voltage (V)	Rated current (A) at 400V	Colour	Packing / Box (pcs)	Product category	Catalogue number
EL 2- BW3471	Button round with spring reverse and LED indicator	24V	6	red	20 / 200	B	401474
EL 2- BW3371		24V	6	green	20 / 200	B	401374
EL 2- BW3571		24V	6	yellow	20 / 200	B	401574
EL 2- BW3671		24V	6	blue	20 / 200	B	401674
EL 2- BW3471		110V	6	red	20 / 200	B	401473
EL 2- BW3371		110V	6	green	20 / 200	B	401373
EL 2- BW3571		110V	6	yellow	20 / 200	B	401573
EL 2- BW3671		110V	6	blue	20 / 200	B	401673
EL 2- BW3471		230V	6	red	20 / 200	B	401471
EL 2- BW3371		230V	6	green	20 / 200	B	401371
EL 2- BW3571		230V	6	yellow	20 / 200	B	401571
EL 2- BW3671		230V	6	blue	20 / 200	B	401671

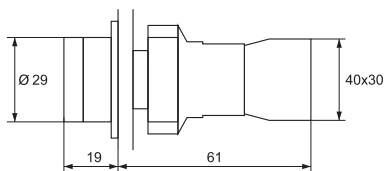

In case of insufficient quantity in stock of any item listed on this page, the delivery time after order confirmation will be 90 days.



Type	Description	Type of contacts	Rated current (A) at 400V	Colour	Note	Packing / Box (pcs)	Product category	Catalogue number
EL 2- BD 21	Switch with arrest	1NO	6	black	two-position	20 / 200	B	401421
EL 2- BD 33		2NO	6	black	three-position	20 / 200	B	401433

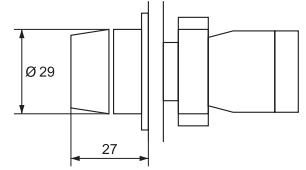

Type	Description	Type of contacts	Rated current (A) at 400V	Colour	Note	Packing / Box (pcs)	Product category	Catalogue number
EL2-BS 142	Button with head "mushroom" type and with key	NC	6	red	release with spinning	15/150	B	401142

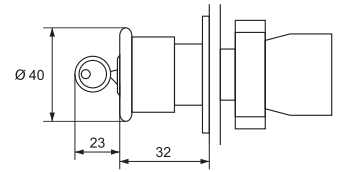

Type	Description	Type of contacts	Rated current (A) at 400V	Colour	Note	Packing / Box (pcs)	Product category	Catalogue number
EL 2- BC 42	Button with head "mushroom" type	1NC	6	red	spring reverse	15 / 150	B	401642

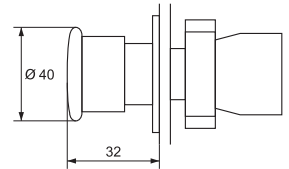

Type	Description	Type of contacts	Rated current (A) at 400V	Colour	Note	Packing / Box (pcs)	Product category	Catalogue number
EL 2- BS 545	Button with head "mushroom" type	1NC + 1NO	6	red	release with spinning	15 / 150	B	401545



Type	Description	Type of contacts	Rated current (A) at 400V	Note	Packing / Box (pcs)	Product category	Catalogue number
EL 2- BG 21	Change-over switch with switch	1NO	6	two-position with switch	20 / 200	B	401121

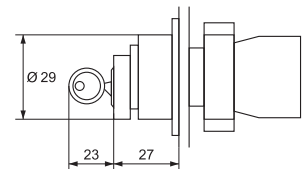

In case of insufficient quantity in stock of any item listed on this page, the delivery time after order confirmation will be 90 days.



Type	Description	Type of contacts	Rated current (A) (V) at 400V	Voltage	Note	Packing / Box (pcs)	Product category	Catalogue number
EL 2- BW8475	Button double	1NO+1NC	6	24 AC	Green and red button + LED indicator	20 / 200	B	401844
EL 2-BW8475	Button double	1NO+1NC	6	230 AC	Green and red button+LED indicator	20/200	B	401845

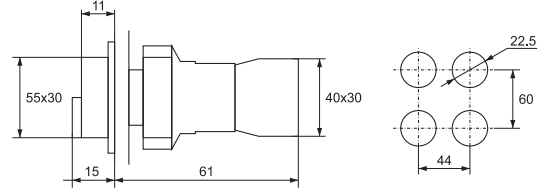

Type	Description	Type of contacts	Colour	Packing / Box (pcs)	Product category	Catalogue number
EL02 - BE101	1	1 NO	green	100 / 1000	B	401001
EL02 - BE102	2	1 NC	red	100 / 1000	B	401002



Type	Description	Voltage (V)	Colour	Packing / Box (pcs)	Product category	Catalogue number
XB2-BV75	Signal lamp	230V AC	yellow	20 / 200	F	401975
XB2-BV76	Signal lamp	230V AC	blue	20 / 200	F	401976
XB2-BV77	Signal lamp	230V AC	colourless	20 / 200	F	401977



UNTIL SUPPLY
LAST



Type	Description	Voltage (V)	Colour	Packing / Box (pcs)	Product category	Catalogue number
XB7-EV45	Button	230V AC	yellow	20 / 200	F	401004



UNTIL SUPPLY
LAST



Type	Description	Voltage (V)	Colour	Packing / Box (pcs)	Product category	Catalogue number
XB - BW - 3561	Button + LED indicator	230V AC	yellow	20 / 200	F	401561



UNTIL SUPPLY
LAST

In case of insufficient quantity in stock of any item listed on this page, the delivery time after order confirmation will be 90 days.



Type	Description	Voltage (V)	Packing / Box (pcs)	Product category	Catalogue number
EL-1035	Glim indicator lamp	220 VAC	1	C	M030015

Shape and color of the indicator - oval, red | Dimensions - 10 mm x 30 mm | Base diameter: 10mm | Case colour: red | Conductor length: 20mm



BUTTONS

2+0 standard +extended **2** YEAR TOTAL WARRANTY

Type	Description	Voltage (V)	Rated current (A)	LED colour	Packing / Box (pcs)	Product category	Catalogue number
ASW-13	Toggle Switch ON-OFF SPST	12 VDC	20	red	1	C	M519114

Function: ON/OFF | Leads: 3 | Body dimensions: 30.5 x 13.5 x 22mm | Mounting hole diameter - 12 mm | Toggle height - 27 mm | Operating temperature -from - 25 °C to + 85 °C



Type	Description	Voltage (V)	Rated current (A)	Colour	Packing / Box (pcs)	Product category	Catalogue number
V 144/B	Switch ON-OFF	250 VAC	5	white	1	C	M300001

Function: ON/OFF | Leads: 3 | Body dimensions: 26.2 x 12 x 14.5 mm | Mounting hole - 29 x 11 mm | Operating temperature - up to 105°C

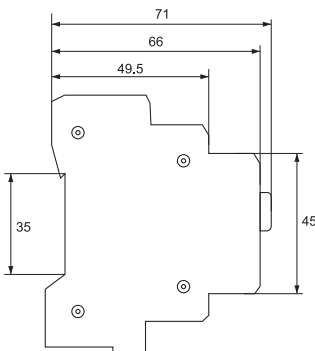

Documents corresponding to the product: Standard EN 60947-1
EN 60 947-5-1 t

DIN-RAIL BUTTONS AND LED INDICATORS

3+2 standard +extended **5** YEAR TOTAL WARRANTY

These are devices used in control and indication systems adjusted for mounting in command boards and panels directly on DIN-rail. They are manufactured to commute controlling circuits and to control the switching on or off executive mechanisms such as relays, contactors, etc. The signal lamps and indicators find broad application in all industrial fields. The devices endure short time current overload up to 20A, and normally they can commute current up to 10A with their contact system. The connection to the contact terminals is through screw terminals to which operational conductors with section up to 2.5mm² can be joined. There are also designed buttons combined with lamps.

TECHNICAL DATA:

- Insulation voltage: 660V; 50/60Hz
- Impulse voltage wear resistance: 6000V;
- Rated current: up to 10A (230V AC)
- Short circuit protection: safety device 10A gG outside in the circuit
- Rated consumed current (for indicators and buttons combined with indicators): <20mA
- wear resistance (indicators): >2000h
- Mechanical wear resistance (buttons): 1x106 commutation cycles
- Power of mechanical compression:

- at closing: 20N
- at opening: 8N
- Operating temperature: -20 - +65°C
- Humidity: 35 – 85%RH
- Tightening moment of the joining conductors: 0.15Nm
- Section of the conductor: 1x0.5; 1x0.75; 1x1; 1x1.5; 1x2.5mm²
- Plastic: UV rays wear resistance

MOUNTING:

- to a DIN-rail
- Altitude: up to 2000m



Type	Description	Voltage (V)	Rated current (A) at 400V	Colour	Packing / Box (pcs)	Product category	Catalogue number
ELD-RG-DIN	lamp	230V	<20	red/green	12 / 240	B	401559



Type	Description	Voltage (V)	Rated current (A) at 400V	Colour	Packing / Box (pcs)	Product category	Catalogue number
ELD-RGB-DIN	lamp	230V	<20	red/green/blue	12 / 240	B	401560



Type	Description	Voltage (V)	Rated current (A) at 400V	Colour	Packing / Box (pcs)	Product category	Catalogue number
ELD - G - DIN	lamp	230V	<20	green	12 / 240	B	401500
ELD - R - DIN	lamp	230V	<20	red	12 / 240	B	401501
ELD - Y - DIN	lamp	230V	<20	yellow	12 / 240	B	401502
ELD - B - DIN	lamp	230V	<20	blue	12 / 240	B	401503
ELD - W - DIN	lamp	230V	<20	white	12 / 240	B	401504



Type	Description	Rated current (A) at 400V	Type of the contact	Colour	Packing / Box (pcs)	Product category	Catalogue number
ELB - BL - DIN	button	<10	1NO+ 2 NC	black	12 / 240	F	401506
ELB - G - DIN	button	<10	1NO+ 2 NC	green	12 / 240	F	401508
ELB - Y - DIN	button	<10	2NO+ 1 NC	yellow	12 / 240	F	401509
ELB - Y - DIN	button	<10	1NO+ 2 NC	yellow	12 / 240	F	401510



UNTIL SUPPLY
LAST



Type	Description	Voltage (V)	Rated current (A) at 400V	Type of the contact	Colour	Packing / Box (pcs)	Product category	Catalogue number
ELBD - G - DIN	button + lamp	230V	<20	1NO+ 2 NC	green	12 / 240	F	401515
ELBD - R - DIN	button + lamp	230V	<20	1NO+ 2 NC	red	12 / 240	F	401517
ELBD - Y - DIN	button + lamp	230V	<20	1NO+ 2 NC	yellow	12 / 240	F	401519



UNTIL SUPPLY
LAST

BUTTONS AND SWITCHES WITH BOX

3+2
standard
+extended **5** YEAR TOTAL
WARRANTY



Type	Description	IP code:	Overall dimensions (mm)			Type of the contact	Colour	Packing / Box (pcs)	Product category	Catalogue number
			L	H	W					
EL1-B134	switching on 0-1	IP44	68	68	50	1 NO	black	1 / 100	B	401134



Type	Description	IP code:	Overall dimensions (mm)			Type of the contact	Colour	Packing / Box (pcs)	Product category	Catalogue number
			L	H	W					
EL1-B102	1 button with spring return	IP44	68	68	50	1 NO	green	1 / 100	B	401102
EL1-BP102	1 button with spring return	IP65	68	68	50	1 NO	green	1 / 100	B	401132



Type	Description	IP code:	Overall dimensions (mm)			Type of the contact	Colour	Packing / Box (pcs)	Product category	Catalogue number
			L	H	W					
EL1-B213	2 buttons with spring return	IP44	104	68	50	1 NC 1 NO	1 - red 1 - green	1 / 100	B	401213
EL1-BP213	2 buttons with spring return	IP65	104	68	50	1 NC 1 NO	1 - red 1 - green	1 / 100	B	401233



Type	Description	IP code:	Overall dimensions (mm)			Type of the contact	Colour	Packing / Box (pcs)	Product category	Catalogue number
			L	H	W					
EL1-B339	3 buttons with spring return	IP44	134	68	50	1 NO 1 NC 1 NO	1 - green 1 - red 1 - green	1 / 50	B	401339
EL1-BP339	3 buttons with spring return	IP65	134	68	50	1 NO 1 NC 1 NO	1 - green 1 - red 1 - green	1 / 50	B	401349



Type	Description	IP code:	Overall dimensions (mm)			Type of the contact	Colour	Packing / Box (pcs)	Product category	Catalogue number
			L	H	W					
EL1-B174	Emergency button with head "mushroom" type Ø40.Release through turning	IP44	68	68	50	1 NC	red	1 / 100	B	401174



In case of insufficient quantity in stock of any item listed on this page, the delivery time after order confirmation will be 90 days.

DEVICES FOR TELPHER CONTROL MBP TYPE





















They represent different combinations of START and STOP buttons mounted in plastic boxes in different sizes. They are connected to the operating circuits of cranes or telfers and serve as a remote control of their movement. They are connected directly to the operating cable of the telfer and send commands directly to the executive mechanisms. They are designed to provide protection from dust and moisture IP65.

TECHNICAL DATA:

- Supplying voltage: 230V; 50/60Hz
- Electrical wear resistance: 1x10⁵ cycles
- Operating temperature: -10 +65°C
- Humidity: 35 – 85% RH
- Number of contacts: according to the number of the buttons
- Commuting capacity: up to 6A
- Plastic: UV rays wear resistance
- IP code: IP65
- Weight: according to the number of the contacts

MOUNTING:

- directly to the control cable of the telfer (crane)

Type	Number of buttons	Contact block and scheme Emergency	For the directions	Packing / Box (pcs)	Product category	Catalogue number
 MBP-A281	2	-	NO+NC	1/20	B	46281
 MBP-A291 two speed	2	-	NO+NC	1/20	B	46291
 MBP-A2813	2+1	emergency button	NO+NC	1/20	B	46283
 MBP-A2813K	2+1	emergency button with switch	NO+NC	1/20	B	46283K
 MBP-A2913 two speed	2+1	emergency button	NO+NC	1/20	B	46294
 MBP-A2913K two speed	2+1	emergency button with switch	NO+NC	1/20	B	46294K
 MBP-A481	4	-	NO+NC	1/20	B	46481
 MBP-A491 two speed	4	-	NO+NC	1/20	B	46491
 MBP-A4813	4+1	emergency button	NO+NC	1/20	B	46483
 MBP-A4813K	4+1	emergency button with switch	NO+NC	1/20	B	46483K
 MBP-A4913 two speed	4+1	emergency button	NO+NC	1/20	B	46493
 MBP-A4913K two speed	4+1	emergency button with switch	NO+NC	1/20	B	46493K
 MBP-A681	6	-	NO+NC	1/20	B	46681
 MBP-A691 two speed	6	-	NO+NC	1/20	B	46691
 MBP-A6813	6+1	emergency button	NO+NC	1/20	B	46683
 MBP-A6813K	6+1	emergency button with switch	NO+NC	1/20	B	46683K
 MBP-A6913 two speed	6+1	emergency button	NO+NC	1/20	B	46693
 MBP-A6913K two speed	6+1	emergency button with switch	NO+NC	1/20	B	46693K
MBP-A881	8	-	NO+NC	1/20	B	46881
MBP-A891 two speed	8	-	NO+NC	1/20	B	46891
MBP-A8813	8+1	emergency button	NO+NC	1/20	B	46883
MBP-A8813K	8+1	emergency button with switch	NO+NC	1/20	B	46883K
MBP-A8913 two speed	8+1	emergency button	NO+NC	1/20	B	46893
MBP-8913K two speed	8+1	emergency button with switch	NO+NC	1/20	B	46893K



MBP-Axxxx — stop button type
 — button type – one-speed (x81) or two-speed (x91)
 — number of buttons

In case of insufficient quantity in stock of any item listed on this page, the delivery time after order confirmation will be 90 days.

AUTOMATION

204

DEVICES FOR TELPHER CONTROL

WARNING LIGHTS AND TOWERS



The revolving warning lights and towers are devices intended for use as status indicators in the human-machine control systems. They are suitable for installation on control cabinets and panels or directly on machines. They are manufactured in different colour combinations to attract attention of operators working in a given production sector. Warning lights and towers are widely used in almost any industrial branch. They can be mounted on movable components or such, creating potential danger and can warn all workers for a critical situation with their blinking light and siren. These devices are electrically connected through cables, protruding out of the lamp casing.



TECHNICAL SPECIFICATION:

- Rated voltage: 12 VAC/230VAC; 50/60 Hz;
- Isolation voltage: 660V; 50/60 Hz;
- Impulse voltage stability: 6000V
- Rated power: see the tables below
- Short circuit protection: 1A gG external fuse
- Operating Temperature: - 20°C + 65°C

- Humidity: 35 – 85% RH
- Plastic cover: UV resistant polycarbonate not considered as being harmful to human health

INSTALLATION:

- Warning lights are fixed to the respective machine body with the studs protruding from the light plastic casing.



Type	Description	Voltage (VAC)	Rated Power (W)	Colour	Packing / Box (pcs)	Product category	Catalogue number
LTE1101 - R	Warning light	12	10	Red	1 / 30	B	401525R
LTE1101 - G	Warning light	12	10	Green	1 / 30	B	401525G
LTE1101 - Y	Warning light	12	10	Yellow	1 / 30	B	401525Y
LTE1101J - R	Warning light + siren	12	11	Red	1 / 30	B	401526R
LTE1101J - G	Warning light + siren	12	11	Green	1 / 30	B	401526G
LTE1101J - Y	Warning light + siren	12	11	Yellow	1 / 30	B	401526Y
LTE1101 - R	Warning light	230	8	Red	1 / 30	B	402525R
LTE1101 - G	Warning light	230	8	Green	1 / 30	B	402525G
LTE1101 - Y	Warning light	230	8	Yellow	1 / 30	B	402525Y
LTE1101J - R	Warning light + siren	230	9	Red	1 / 30	B	402526R
LTE1101J - G	Warning light + siren	230	9	Green	1 / 30	B	402526G
LTE1101J - Y	Warning light + siren	230	9	Yellow	1 / 30	B	402526Y
LTE1161 - R	Warning light	12	35	Red	1 / 8	B	401527R
LTE1161 - G	Warning light	12	35	Green	1 / 8	B	401527G
LTE1161 - Y	Warning light	12	35	Yellow	1 / 8	B	401527Y
LTE1161 - R	Warning light	230	28	Red	1 / 8	B	402527R
LTE1161 - G	Warning light	230	28	Green	1 / 8	B	402527G
LTE1161 - Y	Warning light	230	28	Yellow	1 / 8	B	402527Y
LTA205 - 1	Tower / flashing	12	4	1 - Red	1 / 20	B	401528
LTA205 - 2	Tower / flashing	12	8	2 - Red/Green	1 / 20	B	401529
LTA205 - 3	Tower / flashing	12	12	3 - Red/Yellow/Green	1 / 20	B	401530
LTA205 - 3J	Tower / flashing + siren	12	12	3 - Red/Yellow/Green	1 / 20	B	401531
LTA205 - 5	Tower / flashing	12	18	5 - Red/Yellow/Green/Blue/Transparent	1 / 20	B	401532
LTA205 - 1	Tower / flashing	230	6	1 - Red	1 / 20	B	402528
LTA205 - 2	Tower / flashing	230	8	2 - Red/Green	1 / 20	B	402529
LTA205 - 3	Tower / flashing	230	10	3 - Red/Yellow/Green	1 / 20	B	402530
LTA205 - 3J	Tower / flashing + siren	230	11	3 - Red/Yellow/Green	1 / 20	B	402531
LTA205 - 5	Tower / flashing	230	14	5 - Red/Yellow/Green/Blue/Transparent	1 / 20	B	402532



In case of insufficient quantity in stock of any item listed on this page, the delivery time after order confirmation will be 90 days.



Type	Description	Voltage (V)	Rated Power (W)	Sound level (dB)	Packing / Box (pcs)	Product category	Catalogue number
MS-290A	metal siren	230	60	100	1 / 24	B	401533
MS-290B	plastic siren	230	60	100	1 / 24	B	401541



Type	Description	Voltage (V)	Rated Power (W)	Sound level (dB)	Packing / Box (pcs)	Product category	Catalogue number
MS-390	siren	230	160	120	1 / 10	B	401534



Type	Description	Voltage (V)	Rated Power (W)	Sound level (dB)	Packing / Box (pcs)	Product category	Catalogue number
CB-4	alarm bell	12	-	85	1 / 50	B	401535
CB-4	alarm bell	24	-	85	1 / 50	B	401536
CB-4	alarm bell	110	-	85	1 / 50	B	401537
CB-4	alarm bell	230	-	85	1 / 50	B	401538



Type	Description	Voltage (V)	Rated Power (W)	Sound level (dB)	Packing / Box (pcs)	Product category	Catalogue number
FA-01	fire alarm	230	-	120	1 / 100	B	401540

