

# 1940-96

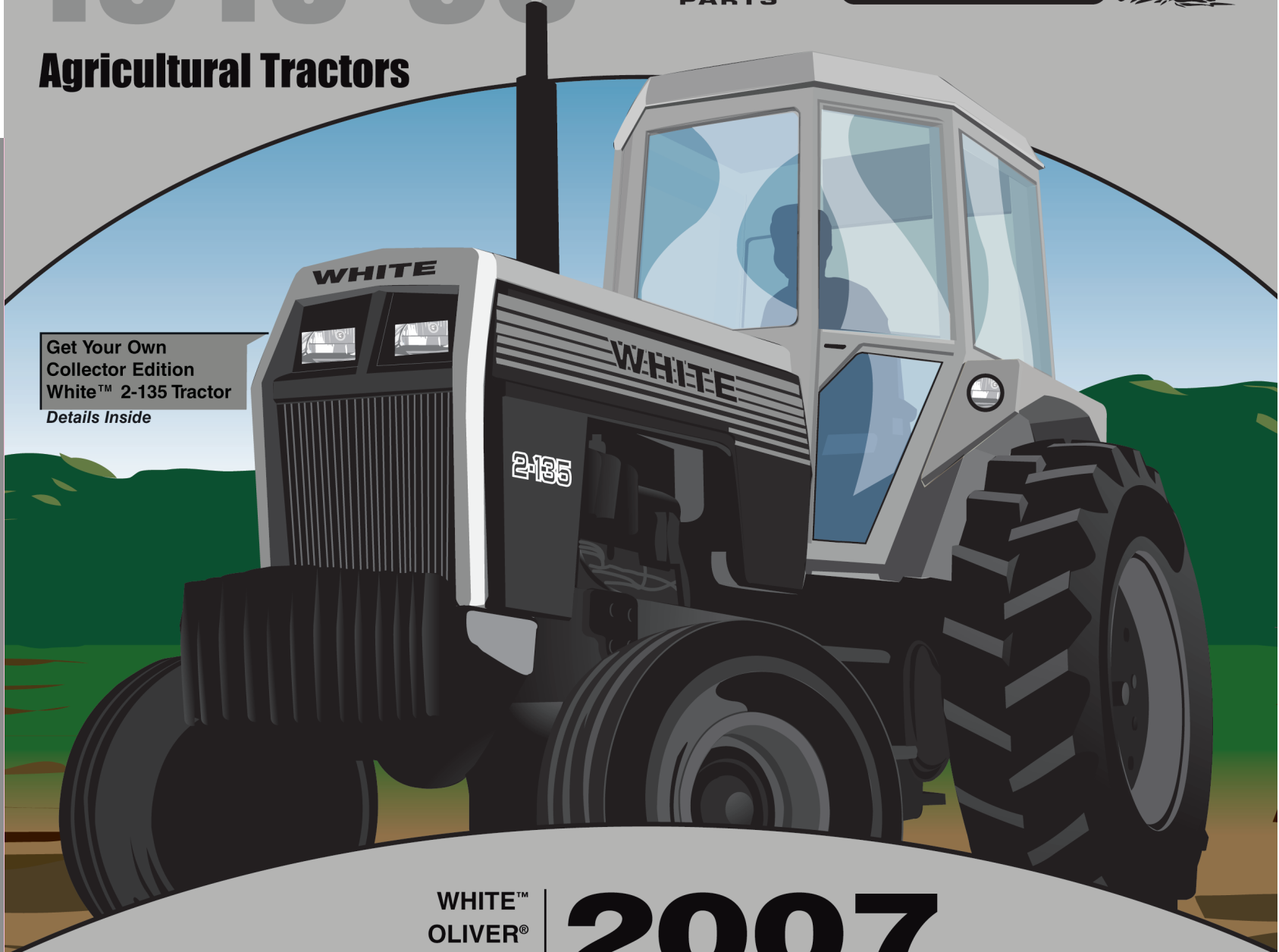

# HERITAGE LINE

## Agricultural Tractors



Get Your Own  
Collector Edition  
White™ 2-135 Tractor  
*Details Inside*

WHITE™  
OLIVER®  
OLIVER® HART-PARR®  
MINNEAPOLIS-MOLINE®  
COCKSHUTT®

# 2007

PARTS & MERCHANDISE CATALOG

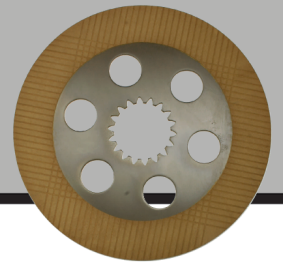

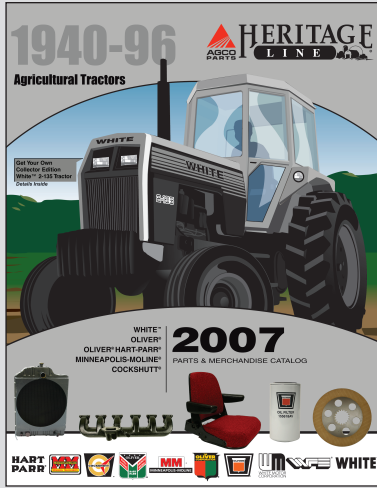

### Cover Illustration

The White™ 2-135 tractor, featuring 135 PTO hp, was one of the most popular White™ tractors ever produced by White Farm Equipment. The tractor was manufactured at the company's Charles City, Iowa facility from 1976 through 1987.

Today, you can still find thousands of White™ tractors hard at work across North America as well as Oliver®, Minneapolis-Moline® and Cockshutt® tractors. Whether you're a collector, a farmer or both, you'll find that an AGCO® Heritage® part maintains the original equipment's performance. You'll also appreciate a Heritage® part's attractive price and full 12-month warranty.

- Illustration by Elmer C. Meider III



**White™ 2-135  
Tractor**  
1/16 Scale  
Part No. FU-0650

This White™ 2-135 toy tractor, die-cast in 1/16 scale, was first released in 1978 with the tractor series' introduction. This model was also the first die-cast piece produced by Joe Ertl for his then fledgling company, Scale Models in Dyersville, Iowa, today one of the premier agricultural die-cast companies in North America. (For more information, check out their web site at [www.scalemodeltoys.com](http://www.scalemodeltoys.com).)

Copyright © 2007 AGCO Corporation.



## 2007 AGCO® HERITAGE® PARTS AND MERCHANDISE CATALOG

WHITE™, OLIVER®, OLIVER® HART-PARR®, MINNEAPOLIS-MOLINE®, COCKSHUTT® TRACTORS

**Dealers:** Look for the latest version of this catalog on the Epsilon® Electronic Parts and Service Information System, the worldwide publishing and distribution network for technical and parts documents for AGCO® Corporation dealers and distributors. AGCO® Parts > Parts Documents > Catalogs > Promotional

### NEWLY EXPANDED CONTENT!

Fully half of the products in this catalog have been added back to the AGCO® parts offering for 2007. In particular, check out the aesthetics section (decals, emblems and sheet metal), radiators, exhaust manifolds, front-end parts, and starters and alternators.

White™ is a trademark, and AGCO®, Cockshutt®, Epsilon®, Hart-Parr®, Heritage®, Hesston®, Massey Ferguson®, Minneapolis-Moline®, Multiguard®, Oliver®, Permatran®, Preferred 55®, Solutions® and WFE® are registered trademarks of AGCO Corporation, Duluth, GA., USA. Challenger® is used worldwide under license from Caterpillar Inc., Peoria, IL, USA.

For additional intellectual property acknowledgements, see the last page of this catalog.

While AGCO® has made every effort to catalog this information correctly, the possibility for error exists. Please verify each listing with your parts book or service manual.

Today, the 2-135 tractor tooling has been updated to create a Collector Edition model commemorating the release of this Heritage® parts catalog. The model, which includes a cab imprint and special packaging, is available while supplies last. To reserve your model, contact a participating AGCO® dealer.

**Dealer:** Go to OneAGCO Dealer Info Net, Parts Documents, Licensed Products, for order details.

No part of this catalog can be reprinted w/o permission.

# CONTENTS

<b>INTRODUCTION</b> .....	<b>2-3</b>
<b>RESTORE YOUR WORK HORSE TO LIKE-NEW CONDITION</b> .....	<b>4-5</b>
<b>OFFICIALLY LICENSED PRODUCT</b> .....	<b>6-13</b>
Die Cast Pedal Tractors, Tractors, Trucks and Crawlers, Replicas and Collector Series; Resin and Pewter Collectibles, Clothing and Caps, Puzzles, Key Chains, Watch Fobs, Specialty and Metal Items	
<b>INDEX</b> .....	<b>14-15</b>
<b>MACHINE INFORMATION</b> .....	<b>16-47</b>
Engine Information, Tractor Information, White Tractor Serial Number Location Guide, Machine Photo Reference, Operators and Service Manuals, Parts Books	
<b>UNIVERSAL ACCESSORIES</b> .....	<b>48</b>
Quick Hitches, Toolbox, Magnetic Heater, High-Lift Jack, SMV Signs, Brackets	
<b>AESTHETICS</b> .....	<b>49-69</b>
Decals, Decal Kits, Emblems, Paint Application Guide, Sheet Metal, Cab Interior, Knobs, Levers, Seats, Gauges, Meters	
<b>AGCO® LUBRICANTS &amp; OILS</b> .....	<b>70-78</b>
Hydraulic Oil, Motor and Engine Oil, Transmission and Hydraulic (T&H) Oil, Automatic Transmission Fluid, Synthetic Transmission Fluid, Grease, Antifreeze and Coolant	
<b>FILTERS</b> .....	<b>79-82</b>
Oliver® Brand, Heritage® Brand Filters	
<b>ENGINE</b> .....	<b>83-120</b>
Pistons, Liners, Engine Components: White, Oliver, Minneapolis-Moline, Complete Overhaul Kits, Block Kits, Engine Belts, Lubrication Components	
<b>COOLING</b> .....	<b>121-125</b>
Water Pump Repair Kits, Thermostats, Radiators, Caps, Clamps, Hose, Block Heaters	
<b>FUEL</b> .....	<b>126-133</b>
Fuel Caps, Fuel Lines, Carburetors and Repair Kits, Floats, Fuel Bowls, Mechanical Fuel Pumps, Injection Pumps and Lines	
<b>ELECTRICAL</b> .....	<b>134-154</b>
Spark Plugs and Wire Sets, Tune-Up Kits, Electronic Conversion Kits and Universal Electrical Products, Distributor Ignition Components, Starters and Alternators, Cross Reference Chart, Switches, Keys, Regulators, Relays, Battery Boxes, Lighting	
<b>INTAKE &amp; EXHAUST</b> .....	<b>155-162</b>
Hose, Pre-Cleaners, Air Cleaner Caps, Elbows, Manifolds, Gaskets, Hardware, Glow Plugs, Heat Shields, Mufflers, Universal Exhaust Accessories	
<b>STEERING, FRONT AXLE</b> .....	<b>163-169</b>
Steering Wheels, Steering Caps, Repair Kits, Tie-Rod Boots, Tie-Rod Assemblies, Hubs, Steering Arms, Bearings, Steering Pumps	
<b>CLUTCH</b> .....	<b>170-184</b>
Troubleshooting Guide, Clutch Sets, Bearings and Components	
<b>HYDRAULICS</b> .....	<b>184-185</b>
Universal Directional Hydraulic Control Valves, Repair Parts, Pumps, Lift Pumps	
<b>DIFFERENTIAL, 3-PT. HITCH, PTO</b> .....	<b>186</b>
Bearings, PTO Couplers, Shafts, Shields, Cranks, Lift Arms	
<b>BRAKES</b> .....	<b>187-188</b>
Hand Brakes, Actuating Brake Assemblies, PTO Brakes, Shoes, Discs	
<b>TIRES, RIMS, WEIGHTS</b> .....	<b>189-190</b>
Tires, Tubes, Rims, Disc/Dish, Wheel Weights	
<b>TRADEMARK ACKNOWLEDGEMENT</b> .....	<b>191</b>

This is the second in a series of catalogs for Heritage® parts. For more information on Heritage® parts, go to [www.agcoparts.com](http://www.agcoparts.com) and click on the Heritage® icon. For a list of dealers eligible to sell AGCO® Heritage® parts, go to [www.agcoparts.com](http://www.agcoparts.com) and type in your Zip or Postal Code where indicated in Find a Dealer.

## INTRODUCTION



### **Heritage® Parts carry distinctive packaging and labels. Heritage® Parts are backed by a 12-month warranty for quality, performance.**

Heritage® parts are original-equipment-quality parts for older equipment now part of the AGCO® family of equipment brands. An AGCO Heritage® part carries its own packaging and can be sold by any U.S. or Canadian AGCO dealer, including Massey Ferguson®, AGCO® Tractor and Challenger® dealers.

AGCO® Heritage® parts offer the following benefits:

- O.E. approved for the original equipment
- Attractively priced
- Backed by a full 12-month warranty
- Stocked in AGCO parts distribution centers across the U.S. and Canada
- Available for sale from all AGCO® dealers

In addition, dealers actively promoting Heritage® parts will have signage highlighting the line.





Dealers carrying Heritage® parts may promote this fact with indoor and outdoor signage.



This catalog overviews O.E.-quality replacement parts available for the White™ tractor family, including the vintage tractor lines of Oliver®, Oliver® Hart-Parr®, Minneapolis-Moline® and Cockshutt®. (A handful of parts are also included for combine and industrial applications.) This catalog is intended to help dealers and customers alike identify Heritage® O.E.-approved parts currently available from AGCO Parts.

If you do not find the part you need, it may still be available:

- This catalog references the most popular Heritage® parts only. Not included are thousands of additional parts also available from AGCO Parts for these applications.
- The Heritage® parts line grows daily. In fact, in just the past year, this catalog more than doubled in size thanks to focused management of the Heritage® line.
- The part you're looking for could still be available from AGCO under an O.E.M. part number.

## HOW TO ORDER

Any AGCO® dealer can order a Heritage® part from AGCO Parts. Heritage® parts are stocked in U.S. and Canadian parts distribution centers for fast, convenient availability. Most Heritage® part numbers end with, or include, the letter "V", although there are exceptions.

A customer looking for a Heritage® part should order the part directly from a participating AGCO dealer.

## HOW TO USE THIS CATALOG

The catalog is divided into major sections based on the tractor component area (for example, engine, cooling and hydraulics).

Within the body of this catalog, individual sections are usually organized by MUO (Machine Used On) information, from late to early models. Photos and illustrations are added throughout. This information is clearly identified by brand (White™, Oliver®, Minneapolis-Moline®, Cockshutt®). Much of the product included in this catalog was added to the Heritage® line in just the past year, so be sure to review it carefully.

You'll appreciate the Engine and Tractor Information sections that help you pinpoint a tractor's year of manufacture along with its engine brand. Extensive information is included for White™ and Oliver® tractors along with the most popular Minneapolis-Moline® tractors. Also included is a helpful Serial Number Location Reference section for White™ tractors.

The AGCO® Heritage® parts line was introduced 10 years ago to make O.E.-quality parts available for sale by all AGCO dealers, U.S. and Canada.

Ultimately, by expanding the Heritage® parts line, farmers and collectors who want O.E. parts quality should be able to more easily find a dealer who can support their older equipment.

# RESTORE YOUR WORK HORSE TO LIKE-NEW CONDITION



*Photo courtesy of Jerry Oxborough*

Keeping an older tractor, including a White™ 170 Work Horse, in top condition isn't simply a matter of pride. Improve its performance with an update using Heritage® parts. Here are just a few of the ways you can keep your own Work Horse tractor performing like new.



**1550 OLIVER**

## Manuals

Pg 45-47

## Decals & Emblems

Pg 49-54

## Paint

Pg 55-56

## Interior Cab

Pg 58-59

## Lubricants & Oils

Pg 70-78

## Filters

Pg 79-82

## Engine

Overhaul Kits

Pg 107-109

## Cooling

Pg 121-125

## Electrical

Starters & Alternators

Pg 138-150

## Steering

Pg 163-164

## Front Axle

Pg 165-169

## Clutch

Pg 172-189

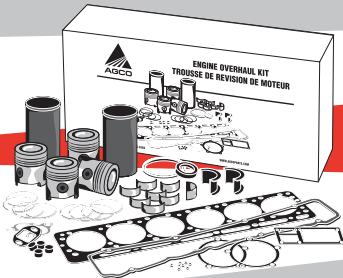

# AGCO® Licensed Products

## Die Cast Pedal Tractors

Scale Models

### Oliver 1755

FU-1334



### AGCO RT150

FT-0703



### Challenger

FT-0709



- Sized for children 3-10 years old
- Rubber tires, pedals, plastic seat and throttle
- Some assembly required

## 1:64 Die Cast



Oliver "Finest in Farm Machinery" Peterbilt truck  
Spec Cast  
SC32921



M-M "Finest in Farm Machinery" Freightliner Classic XL truck  
Spec Cast  
SC36576



AGCO Parts Friendly Service Peterbilt truck  
Spec Cast  
SC33571



AGCO Heritage Parts Freightliner truck  
Spec Cast  
SC35512



AGCO Flatbed Freightliner truck  
Spec Cast  
SC35513

## Mailbox



**Oliver 88 Row Crop**  
Distel Grain Systems  
RMB-OL

## Pewter Frame



**Oliver**  
S&D Inc.  
44477





# AGCO® Licensed Products

1:16 Die Cast

## Special Edition White 2-135



**White 2-135 Field Boss**  
Spec Cast  
FU-0650

The 2-135 tractor tooling has been updated this year to create a Collector Edition model commemorating the release of this Heritage® parts catalog. The model, which includes a cab imprint and special packaging, is available while supplies last. To order, contact a participating AGCO® dealer for details.



**Oliver 770 Gas**  
Spec Cast  
SCT239



**Oliver Super 77 Diesel**  
Spec Cast  
SCT241



**Oliver 77 Row Crop**  
Spec Cast  
SCT282



**Oliver 770 Gas w/ Checked Grille**  
Spec Cast  
SCT259



**Mark Twain Oliver Super 99 GM Diesel**  
Spec Cast  
SCT267



**Oliver 77 LP Gas**  
Spec Cast  
SCT285



**Oliver 880 Diesel Wide Front**  
Spec Cast  
SCT281



**Oliver 880 Diesel**  
Spec Cast  
SCT286

# AGCO® Licensed Products

## 1:16 Die Cast



**Oliver 770 Diesel**

Spec Cast  
SCT220



**Oliver OC-12 Crawler**

Spec Cast  
SCT288



**Oliver Super 77 Gas**

Spec Cast  
SCT222



**M-M 445 Gas**

Spec Cast  
SCT230



**M-M 2 Star Crawler**

Spec Cast  
SCT244



**M-M 2 Star Crawler**

Spec Cast  
SCT233



**M-M 4 Star Super Gas**

Spec Cast  
SCT232



**M-M U Diesel**

Spec Cast  
SCT234



**M-M 4 Star Super Gas**

Spec Cast  
SCT245



**Cockshutt 770**

Spec Cast  
SCT249



**Oliver 880 Twin-Engine Industrial**

Spec Cast  
SCT264



**M-M 4 Star Gas**

Spec Cast  
SCT258



# AGCO® Licensed Products

## 1:12 Die Cast



**Oliver Super 99 Diesel**  
Franklin Mint  
FM-0002



**Oliver Super 99 Diesel w/ Hiniker Cab**  
Franklin Mint  
FM-0005

## 1:16 Resin



**Oliver 70 Flag Tractor**  
Spec Cast  
SCT276

## 1:25 Die Cast



**Oliver 47 International Pickup**  
Spec Cast  
SC89200



**Oliver 57 Chevy Panel Truck**  
Spec Cast  
SC78147



**M-M 57 Chevy Stake Bed**  
Spec Cast  
SC78153



**Cockshutt 57 Chevy Stake Bed**  
Spec Cast  
SC78168

## Collectible Jigsaw Puzzles



**Oliver Montage**  
Putt-Putt Puzzles, 513 pieces, 15"x12"  
0-06-2



**Oliver Montage**  
Putt-Putt Puzzles, 513 pieces, 15"x12"  
0-04-1



**Minneapolis-Moline Montage**  
Putt-Putt Puzzles, 513 pieces, 15"x12"  
MM-05-1



# AGCO® Licensed Products

## Tire Gauges



### Complete Display

Key Enterprises  
06029

Only available as  
complete display for  
point of sale

## Windchimes



### Oliver RC 77

S&D Inc.  
6 1/2"W X 36" H  
55512

#### Also Available:

M-M: U 55575  
White: 55544  
AGCO Allis: 55543  
AGCO RT: 55579

### Oliver Resin Farm Scene

34" Tall (Approx.)  
S&D Inc.  
55585

## Pewter Key Chains

Lone Tree Creek LLC.

Display case available for entire 14 AGCO family key chain set.



**Hart-Parr**  
LAAW0013

**WFE**  
LAAW0014



**Cockshutt**  
LAAW0010

**Cletrac**  
LAAW0008



**M-M**  
LAAW0003

**M-M Shield**  
LAAW0006



**Oliver**  
LAAW0002



# AGCO® Licensed Products

## Limited Edition Print



### Historic Horsepower

14.5" x 21.25"  
by Dorothea Paul  
124516

### Adjustable Caps

Available in a variety of colors, brands and styles.

- American Identity
- Antonio Moreau (Canada)
- Cary Francis
- The Jym Bag Co.



## Time Piece



### Oliver

Walnut w/ Laser-engraved logo, sliding lid  
1-7/16" x 1-7/16" x 11/16"  
88860

### Also Available:

M-M: 88865

## Vintage Brand Hats Available



The emblems shown above are available on red twill, black twill or denim/mesh caps. To order, please call American Identity at: 800.369.4268. Minimum: 24 pieces.

## Pewter Watch Fobs

Lone Tree Creek LLC.

Display case available for entire 14 AGCO family fob set.

Watch fob comes with leather strap.



**Hart-Parr**  
LAAW0027



**WFE**  
LAAW0028



**Cockshutt**  
LAAW0024



**Cletrac**  
LAAW0022



**M-M**  
LAAW0017



**M-M Shield**  
LAAW0020



**Oliver**  
LAAW0016

# AGCO® Licensed Products

## Adult T-Shirts



**Oliver**  
The Jym Bag Co.  
S03149



**Oliver**  
The Jym Bag Co.  
S06438



**Oliver**  
The Jym Bag Co.  
S03149

Many other styles available.

## License Plates

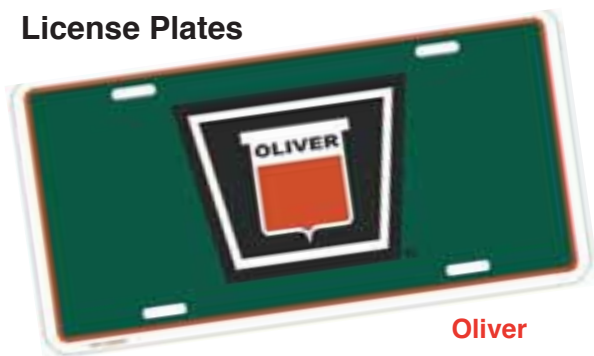

**Oliver**  
Key Enterprises  
6" x 12"  
06008



**M-M**  
Key Enterprises  
6" x 12"  
06009

## Street Signs



**M-M Street**  
Key Enterprises  
24" x 5"  
06022



**Oliver Avenue**  
Key Enterprises  
24" x 5"  
06006

## Parking Signs



**Oliver Collector**  
Key Enterprises  
12"x18"  
06007

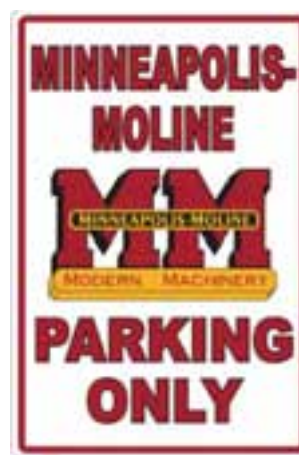

**M-M Parking**  
Key Enterprises  
12"x18"  
06021



# AGCO® Licensed Products

## Thermometer

Rust resistant metal  
S&D  
27" x 8"  
33353



## Adult Folding Camp Chair



S&D Inc.  
w/ carrying bag  
33362

## Match Box Holder

S&D Inc.  
Metal  
6"H x 3-3/4"D x 3"W  
88814  
**Also Available:**  
M-M: 88815



## Windmill

S&D Inc.  
8' Tall  
22" Fan Blades  
26" Base  
99909

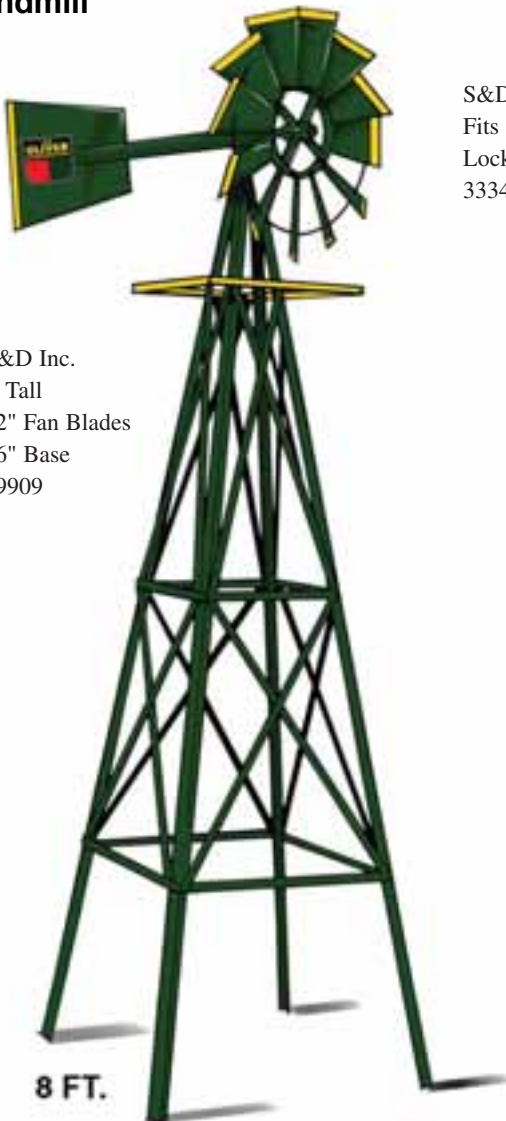

## Hitch Cover

S&D Inc.  
Fits 2" hitch  
Locking pin included  
33343



## Oil Lamp

S&D Inc.  
Functional; w/ Kerosene,  
Citronella or Lamp Oil  
12" H  
33348



When looking for brand merchandise, look for the AGCO Licensed Product mark... your assurance you have a genuine licensed item.

**OFFICIALLY  
LICENSED PRODUCT**

To purchase merchandise featured in this catalog, see a participating AGCO dealer.

### Dealer Websites

American Identity  
Antonio Moreau (Canada)  
Cary Francis  
CTH Collectibles  
Distel Grain Systems  
Lone Tree Creek LLC  
Protexall  
Putt Putt Puzzles  
Rainbow Marketing (Canada)  
S&D Inc.

[www.americanidentity.com](http://www.americanidentity.com)  
[www.antoniomoreau.com](http://www.antoniomoreau.com)  
[www.thecfg.com](http://www.thecfg.com)  
[www.cthcollectibles.com](http://www.cthcollectibles.com)  
[www.distelgrain.com](http://www.distelgrain.com)  
[www.lonetreecreek.com](http://www.lonetreecreek.com)  
[www.protexallinc.com](http://www.protexallinc.com)  
[www.putt-puttpuzzles.com](http://www.putt-puttpuzzles.com)  
[www.rainbowmarketing.ca](http://www.rainbowmarketing.ca)  
[www.harvest-farms.com](http://www.harvest-farms.com)

### Retail Websites

Franklin Mint  
Scale Models  
Spec Cast

[www.franklinmint.com](http://www.franklinmint.com)  
[www.scalemodeltoys.com](http://www.scalemodeltoys.com)  
[www.toycollectorclub.com](http://www.toycollectorclub.com)

For licensing information, including having a collectible personalized for an event, or for information regarding participating dealers, contact Jacques Baillargeon, AGCO Licensed Merchandise Manager: [jacques.baillargeon@agcocorp.com](mailto:jacques.baillargeon@agcocorp.com)



# Index

## MACHINE INFORMATION

Manuals, Operators .....	45-47
Manuals, Service .....	45-47
Parts Books .....	45-47

## ACCESSORIES, UNIVERSAL

Handi-Heat Magnetic Heater .....	48
High-Lift Jack .....	48
Quick Hitch, Cat. 1, 2, 3 .....	48
Quick Hitch Replacement Parts .....	48
SMV Brackets, Signs .....	48
Tractor Toolbox, Black .....	48

## AESTHETICS

Adhesive, Spray .....	59
Air Conditioning Systems .....	60
Cab Kits, Interior .....	58
Compressor Conversion Kit .....	61

## Decals, Decal Kits, Emblems

Cockshutt .....	49
M-M .....	53-54
Oliver .....	49-52
White .....	54
Floor Mats, Pre-Cut .....	59

## Gauges

(Fuel, Tachometer, Hour, Oil Pressure, Ammeter, MultiMeter, Water Temperature)

Cockshutt .....	69
M-M .....	68-69
Oliver (includes Oliver® Brand gauges) .....	67
White .....	66
Headliners .....	58
Insulation Tape .....	61
Knobs, Levers .....	62
Paint Part Number Listing .....	56
Refrigerant, Refrigerant Oil .....	61
Sheet Metal .....	57
Seats, Seat Components .....	63-65
Tachometer Cable, Components .....	68-69
Windshield Wiper Motor .....	61

## AGCO® LUBRICANTS & OILS

Antifreeze & Coolant, AGCO .....	76, 78
Automatic Transmission Fluid, AGCO Powerfluid .....	71, 73
Hydraulic Oil, AGCO Preferred 55® .....	70, 76
Engine Oil, Multi-Viscosity, AGCO Powerlube Multiguard® .....	77-78
Engine Oil, Straight Weight, AGCO Powerlube Multiguard® .....	71, 78
Gear Lubricant, AGCO High-Pressure Worm Gear .....	72, 76
Grease, AGCO .....	74-75, 78
Grease, AGCO Wheel Bearing .....	76, 78
Hydraulic Oil, AGCO Anti-Wear .....	73
Motor Oil, AGCO Powerlube Multiguard® .....	70, 77
Synthetic Transmission Fluid, AGCO .....	73, 77
Transmission Oil, AGCO Gearlube .....	71
Transmission & Hydraulic Oil, AGCO Permatran® 821XL .....	74, 77

## FILTERS

M-M Tractor Applications .....	81-82
Oliver Tractor Applications (includes Oliver® Brand versions) .....	80-81
White Tractor Applications .....	79-80

## ENGINE

Belts, Engine / by M-M Model .....	118-119
Belts, Engine / by Oliver Model .....	115-117
Belts, Engine / by White Model .....	114
Block Kits, Engine / by M-M Model .....	113
Block Kits, Engine / by Oliver Model .....	110-113
Block Kits, Engine / by White Model .....	109-110

### Components, M-M

Connecting Rod Bearings .....	102
Connecting Rod Bushings .....	102
Crankshaft Bearings .....	106
Exhaust Valves, Cylinder Head .....	102-103
Flywheels .....	106
Gaskets, Gasket Sets .....	104-105
Intake Valves, Cylinder Head .....	103
Piston Kits .....	100-101
Ring Kits .....	100-101
Rocker Arms, Cylinder Head .....	101
Valve Guides & Seals, Cylinder Head .....	103
Valve Insert, Exhaust "Stellite" .....	106

### Components, Oliver

Camshaft .....	99
Connecting Rods .....	91
Connecting Rod Bearings .....	91
Connecting Rod Bushings .....	91
Crankshaft Bearings .....	98
Crankshaft Assemblies, Dampener, Main Seal .....	99
Cylinder Head .....	92-95
Flywheels .....	99
Gaskets, Gasket Sets .....	96-99
Piston Ring Kits .....	90
Pistons, Sleeves & Rings .....	89, 90
Rocker Arms .....	94
Valve Seals .....	95

### Components, White

Camshaft .....	88
Connecting Rods & Bearings .....	84-85
Crankshaft Bearings .....	87
Crankshaft Assemblies, Dampener, Main Seal .....	88
Cylinder Head .....	85-86
Cylinder Head Assembly .....	86
Flywheels .....	88
Gaskets, Gasket Sets .....	86
Pistons, Sleeves & Rings .....	83

Lubrication Components .....	119-120
Overhaul Kits, Complete Engine / by Oliver Model .....	108-109
Overhaul Kits, Complete Engine / by White Model .....	107-108

## COOLING

Block Heaters .....	125
Heat Shield .....	125
Hose, Radiator .....	124-125
Hose Clamps, Stainless Steel .....	124
Radiators, Radiator Caps .....	123
Thermostats .....	122-123
Water Pumps, Repair Kits .....	121-122

## FUEL

Carburetor Floats .....	128
Carburetors, Carburetor Repair Kits .....	127-128
Fuel Line .....	126
Fuel Caps, Non-Vented & Vented .....	126
Fuel Bowls & Components .....	129-131
Fuel Pumps, Mechanical .....	131
Hand Primer .....	132
Lines, Fuel Injection .....	132-133
Pumps, Fuel Injection .....	132



## ELECTRICAL

### Alternators

M-M .....	145
Oliver .....	143
White.....	139-140
Battery Boxes.....	152
Conversion Kits, Electronic .....	135

Cross-Reference, OEM to Heritage Part No.,

Alternators & Starters .....	146-150
------------------------------	---------

### Distributor Ignition Components

M-M.....	137
Oliver .....	136-137
White.....	136

Ignition Switches, Keys .....	151
-------------------------------	-----

Lighting.....	153-154
---------------	---------

Regulators, Voltage .....	151
---------------------------	-----

Solenoid, Replacement .....	144
-----------------------------	-----

Spark Plugs .....	134
-------------------	-----

Spark Plugs, Autolite .....	134
-----------------------------	-----

### Starters

M-M.....	145
Oliver .....	143-144
White.....	140-142

Switches & Relays .....	152
-------------------------	-----

Tune-Up Kits.....	134
-------------------	-----

Universal Alternators, Starters .....	138
---------------------------------------	-----

Universal Electrical Products.....	135
------------------------------------	-----

Wire Sets, Spark Plug .....	134
-----------------------------	-----

## INTAKE & EXHAUST

Caps, Air Cleaner.....	155
------------------------	-----

Gaskets, Exhaust .....	158-159
------------------------	---------

Glow Plugs.....	157
-----------------	-----

Hardware, Manifold.....	157
-------------------------	-----

Heat Shield.....	160
------------------	-----

Hose .....	155
------------	-----

### Manifold & Gaskets

Cockshutt .....	157
M-M .....	157
Oliver .....	156-157
White.....	156

White.....	156
------------	-----

### Mufflers

Cockshutt .....	161
-----------------	-----

M-M .....	161
-----------	-----

Oliver .....	161
--------------	-----

White.....	160
------------	-----

Pre-Cleaner Body.....	155
-----------------------	-----

Universal Exhaust Accessories .....	162
-------------------------------------	-----

## STEERING & FRONT AXLE

Bearings, Steering Arms .....	169
-------------------------------	-----

Caps, Steering Wheel (includes Oliver Brand versions) .....	163-164
---	---------

Hubs, Front Wheel .....	168
-------------------------	-----

Power Steering .....	164
----------------------	-----

Pumps, Power Steering .....	169
-----------------------------	-----

Spindles.....	167
---------------	-----

Steering Arms.....	168-169
--------------------	---------

Steering Joint Repair Kit, Universal .....	164
--	-----

Tie-Rod Boots .....	164
---------------------	-----

Tie-Rod Assemblies and Components	
-----------------------------------	--

M-M .....	167
-----------	-----

Oliver .....	166
--------------	-----

White .....	165
-------------	-----

Wheels, Steering .....	163
------------------------	-----

## CLUTCH

Clutch Sets, Bearings and Components	
--------------------------------------	--

M-M.....	180-185
----------	---------

Oliver .....	176-181
--------------	---------

White.....	172-177
------------	---------

Troubleshooting Clutch Problems .....	170-171
---------------------------------------	---------

## HYDRAULICS

Accessories .....	185
-------------------	-----

Control Valves, Hydraulic Directional.....	185
--	-----

Lift Pump Kit .....	185
---------------------	-----

Pump, Hydraulic .....	185
-----------------------	-----

Repair Parts, Hydraulic Directional Control Valves .....	185
--	-----

## DIFFERENTIAL, PTO, 3-PT. HITCH

Bearings, Differential.....	186
-----------------------------	-----

Coupler, PTO .....	186
--------------------	-----

Leveling Crank, 3-pt. Hitch .....	186
-----------------------------------	-----

Lift Arms.....	186
----------------	-----

Shaft .....	186
-------------	-----

Shields, PTO .....	186
--------------------	-----

## BRAKES

Cable Assembly .....	187
----------------------	-----

Hand Brake .....	187
------------------	-----

Assemblies, Actuating Brake .....	187
-----------------------------------	-----

PTO .....	188
-----------	-----

Band Shoes, Brake Discs .....	188
-------------------------------	-----

## TIRES, RIMS & WEIGHTS

Disc .....	190
------------	-----

### Rims

Cockshutt .....	189
-----------------	-----

M-M .....	189-190
-----------	---------

Oliver .....	190
--------------	-----

White.....	190
------------	-----

Tires and Tubes .....	189
-----------------------	-----

Weights, Wheel .....	190
----------------------	-----

## TRADEMARKS

AGCO Intellectual Property.....	Inside Front Cover
---------------------------------	--------------------

Outside AGCO Intellectual Property .....	191
--	-----

# SPECIALS

## Color Sections, Helpful Information and Interesting Facts

Cross Reference, White/Oliver to Fiat Tractor Model.....	16
Engine Information by Tractor Model (White, Oliver, M-M) .....	16-17
Machine Manufacture & Serial No. by Model and Year.....	18-30
White Fact: Origin of the Boss Series.....	20
Serial No. Location & Machine Photo Reference: White.....	30-34
Machine Photo Reference: Oliver, M-M, Cockshutt, Hart-Parr .....	35-44
Decal Application Instructions.....	49
Oliver Fact: Red, Yellow Model # Change Timeframe .....	50
Color Photos: Decals, Decal Kits, Emblems .....	51-54
Special Color Feature: Vintage Paint .....	56
Color Photo: Complete Cab Kit for White tractor.....	58
Color Photos: White 2-180 Field Boss Tractor Cab, Before and After.....	59
Color Photos: Oliver Brand Meters .....	67
Color Photos: AGCO Lubricants & Oils.....	70-76
Color Photos: Oliver, AGCO Parts Brand Filters.....	79
Engine Overhaul Kit Selection and Ordering Guide (Dealer) .....	107
Engine Block Kit Selection and Ordering Guide (Dealer) .....	109
Engine Belt Gauge Tool.....	114
Engine Belt Alignment Notes .....	114, 117
Rules of Engine V-Belt Tensioning, Maintenance .....	115
Electronic Conversion Kits: Important Points .....	135
Part No. Cross Reference, OEM to Heritage Part No.	
Starters .....	146-148
Alternators.....	148-150
Oliver Fact: Oliver Brand Steering Wheel Caps.....	164
Oliver Brand Steering Wheel Caps .....	164
Clutch Troubleshooting Guide.....	170-171
Oliver Brand Filter Ad .....	Inside Back Cover

# Engine Information

This information will help you identify engines associated with the tractors included in this catalog. The tractor model cross-reference information (below) should be particularly useful for Canadian farmers and dealers.

## CROSS REFERENCE

### White/Olivers to Fiat Tractor Model

White/Olivers Model	Fiat Model
1250 G	411
1250 G 4wd	411DT
1250 D	415
1250 D 4wd	415
1255 D	450
1255 D 4wd	450 DT
1265 D	450
1265 D 4wd	450 DT
1265 - 1270	480
1265 - 1270 D 4wd	480 DT
1355 D	550
1355 D 4wd	550 DT
1365 D	600
1365 D 4wd	600 DT3
1365 - 1370 D	640
1365 - 1370 D	640
1365 - 1370 D 4wd	640 DT3
1365 - 1370 D 4wd	640 DT
1450 D	615
1450 D 4wd	615 DT
1465 D	750 Spec.
1465 D 4wd	750 DT Spec.
2-50 D	500 Spec.
2-50 D 4wd	500 DT Spec.
2-60 D	640
2-60 D	640 DT
700 D 1*	780
700 D 4wd*	780 DT

\*Canada Only

## WHITE

MODEL	ENG.	FUEL
2-44	155 Waukesha	G & D
2-50	8035.02, 159 Fiat	D
2-63	232 Waukesha	G & D
2-70	283 Waukesha	D
2-78	283 Waukesha	D
2-85	6.354 Perkins	D
2-88	6.354 Perkins	D
2-105	T6.354 Perkins	D
2-110	T6.354 Perkins	D
2-115	4-53 Detroit	D
2-135	478 Hercules	D
2-144	478 Hercules	D
2-150	585 Moline	D, 4.75" Bore
2-155	478 Hercules	D
2-180	3208 Caterpillar	D
4-115	4-53 Detroit	D
4-144	478 Hercules	D
4-150	3208 Caterpillar	D
4-175	3208 Caterpillar	D
4-180	3208 Caterpillar	D
4-210	3208 Caterpillar	D
4-225	3208T Caterpillar	D
4-270	3208T Caterpillar	D
60 American	4390 Cummins	D
80 American	4T390 Cummins	D
100	6590 Cummins	D
120	6T590 Cummins	D
125	6T590 Cummins	D
140	6TA590 Cummins	D
145	6TA590 Cummins	D
160	6TA830 Cummins	D
170	6TA830 Cummins	D
185	6TA830 Cummins	D
195	6TA830 Cummins	D
6124	6T590 Cummins	D
6125	6T590 Cummins	D
6140	6TA590 Cummins	D
6145	6TA590 Cummins	D
6175	6TA830 Cummins	D
6195	6TA830 Cummins	D

## OLIVER

Super 44	F140 Continental	G
44	F140 Continental	G
Super 55	155 Waukesha	G & D
55	155 Waukesha	G & D
60	121 Waukesha	G
Super 66	155 Waukesha	G & D

## OLIVER

MODEL	ENG.	FUEL
66	155 Waukesha	G & D
70	DS202 Continental	G
Super 77	216 Waukesha	G & D
77	216 Waukesha	G & D
Super 88	231 Waukesha	G & D
88	231 Waukesha	G & D
440	F140 Continental	G
550	155 Waukesha	G & D
660	155 Waukesha	G & D
770	216 Waukesha	G & D
880	231 Waukesha	G & D
1250	615.00, 138 Fiat	D
1255	8035.01, 143 Fiat	D
1265	8035.02, 159 Fiat	D
1270	8035.02, 159 Fiat	D
1355	8045.01, 190 Fiat	D
1365	8045.02, 211 Fiat	D
1370	8045.02, 211 Fiat	D
1550	232 Waukesha	G & D
1555	232 Waukesha	G & D
1600	265 Waukesha	G & D
1650	265 Waukesha	G & D
	283 Waukesha	D
1655	265 Waukesha	G & D
	283 Waukesha	D
1750	283 Waukesha	G
	310 Waukesha	D
1755	283 Waukesha	G
	310 Waukesha	D
1800	283 Waukesha	G & D
1850	310 Waukesha	G
	6.354 Perkins	D
1855	310 Waukesha	G
	310T Waukesha	D
1900	310T Waukesha	D
1950T	310T Waukesha	D
1950	310 Waukesha	G
	310T Waukesha	D
1955	310T Waukesha	D
2050	478 Hercules	D
2150	478 Hercules	D
2055	504 Moline	G
2155	585 Moline	G
2255	3150 Caterpillar	D
2270	585 Moline	D
2455	504 Moline	G
2655	585 Moline	D

G = gas

D = diesel

# Engine Information

## OLIVER CONTINUED

MODEL	ENG.	FUEL
A4T1400	D504 Moline	D, 4.625" Bore
A4T1600	D504 Moline	D, 4.625" Bore

## M-M

BF	IXB3 Hercules	G, 3.25" Bore
BFH	IXB3 Hercules	G, 3.25" Bore
BG	IXB3 Hercules	G, 3.25" Bore
G	403 Moline	G
GB	403 Moline	G
GTB	403 Moline	G
GTC	403 Moline	G
G450	8045.02, 211 Fiat	D
G704	D504 Moline	D, 4.265" Bore
	504 Moline	G
G705	D504 Moline	D, 4.265" Bore
	504 Moline	G
G706	D504 Moline	D, 4.265" Bore
	504 Moline	G
G707	D504 Moline	D, 4.265" Bore
G708	D504 Moline	D, 4.265" Bore
G750	283 Waukesha	D
	265 Waukesha	G
G850	310 Waukesha	D
	283 Waukesha	D
G900	D451 Moline	D, 4.375" Bore
	425 Moline	G, 4.25" Bore
G940	310 Waukesha	G
	310T Waukesha	D
G950	D451 Moline	D, 4.375" Bore
G955	425 Moline	G, 4.25" Bore
	D451 Moline	D, 4.375" Bore
G1000	D504 Moline	D, 4.625" Bore
	504 Moline	G
G1050	D504 Moline	D, 4.625" Bore
	504 Moline	G
G1350	D504 Moline	D, 4.625" Bore
	504 Moline	G
Jet Star	206 Moline	G, D, 3.625" Bore
Jet Star 3	206 Moline	G, D, 3.625" Bore
Jet Star 3 Super	206 Moline	G, D, 3.625" Bore
M5	D336 Moline	D, 4.625" Bore, G
M504	D336 Moline	D, 4.625" Bore, G

## M-M

MODEL	ENG.	FUEL
M602	D336 Moline	D, 4.625" Bore, G
M604	D336 Moline	D, 4.625" Bore, G
M670	D336 Moline	D, 4.625" Bore, G
M670 Super	D336 Moline	D, 4.625" Bore, G
R	165 Moline	G, 3.625" Bore
RT	165 Moline	G, 3.625" Bore
U	283 Moline	G, 4.25" Bore
UBE	283 Moline	G, 4.25" Bore
UBED	283 Moline	G, 4.25" Bore
UBN	283 Moline	G, 4.25" Bore
UBND	283 Moline	G, 4.25" Bore
UTC	283 Moline	G, 4.25" Bore
UTID	283 Moline	G, 4.25" Bore
UTIL	283 Moline	G, 4.25" Bore
UTS	283 Moline	G, 4.25" Bore
UTSD	283 Moline	G, 4.25" Bore
Z	165 Moline	G, 3.625" Bore
ZA	165 Moline	G, 3.625" Bore
ZAE	165 Moline	G, 3.625" Bore
ZAS	165 Moline	G, 3.625" Bore
ZAU	165 Moline	G, 3.625" Bore
4 Star	206 Moline	G, D, 3.625" Bore
5 Star	283 Moline D336 Moline	G, 3.625" Bore D, 4.625" Bore
335	165 Moline	G, 3.625" Bore
445	206 Moline	G, D, 3.625" Bore

G = Gas

D = Diesel

# Tractor Production Information - White

Use this Serial Number Guide to accurately determine when your tractor was manufactured.

## WHITE TRACTOR

### MODEL AND YEAR SERIAL NO.

#### 2-30 FIELD BOSS

1979 - 1984	001 418 - 101 461
-------------	-------------------

#### 2-32 FIELD BOSS

1985 - 1986	000 0007 - 000 315
-------------	--------------------

#### 2-35 FIELD BOSS

1979 - 1984	005 822 - 004 001
-------------	-------------------

#### 2-45 FIELD BOSS

1979 - 1981	000 001 - 000 548
-------------	-------------------

#### 2-50 FIELD BOSS

1976 (2WD)	516 625 - 518 781
------------	-------------------

1976 (4WD)	516 898 - 518 993
------------	-------------------

1977 (2WD)	518 782 - 520 783
------------	-------------------

1977 (4WD)	518 994 - 521 634
------------	-------------------

1978 (2WD)	520 784 - 525 267
------------	-------------------

1978 (4WD)	521 635 - 525 289
------------	-------------------

1979 (2WD)	525 268 - 525 725
------------	-------------------

1979 (4WD)	525 290 - 527 580
------------	-------------------

1980 (2WD)	525 726 - 527 626
------------	-------------------

1980 (4WD)	527 581 - 527 687
------------	-------------------

#### 2-55 FIELD BOSS

1982 - 1987	000 097 - 000 807
-------------	-------------------

#### 2-60 FIELD BOSS

1976 (2WD)	780 725 - 790 272
------------	-------------------

1976 (4WD)	782 037 - 790 272
------------	-------------------

1977 (2WD)	790 273 - 944 701
------------	-------------------

1977 (4WD)	790 273 - 946 284
------------	-------------------

1978 (2WD)	944 702 - 959 279
------------	-------------------

1978 (4WD)	946 285 - 959 302
------------	-------------------

1979 (2WD)	959 280 - 959 999
------------	-------------------

	480 187 - 490 334
--	-------------------

1979 (4WD)	959 303 - 959 999
------------	-------------------

	480 307 - 486 531
--	-------------------

#### 2-62 FIELD BOSS

1979 - 1981	000 001 - 001 143
-------------	-------------------

#### 2-65 FIELD BOSS

1982 - 1987	000 099 - 001 202
-------------	-------------------

#### 2-70 FIELD BOSS

1976	266 173 - 273 088
------	-------------------

1977	274 543 - 281 876
------	-------------------

1978	283 917 - 284 276
------	-------------------

1979	287 528 - 292 563
------	-------------------

1980	293 819 - 294 062
------	-------------------

1981	296 246 - 298 946
------	-------------------

1982	299 887 - 300 091
------	-------------------



WHITE 2-45 FIELD BOSS

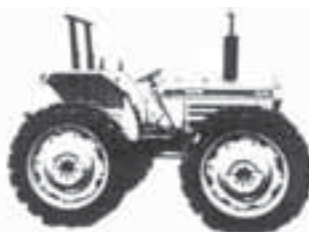

WHITE 2-62 FIELD BOSS  
"MUDDER"



WHITE 2-85 FIELD BOSS

The complete tractor photo reference begins on page 30.

## WHITE TRACTOR

### MODEL AND YEAR SERIAL NO.

#### 2-75 FIELD BOSS

1982 - 1987	000 177 - 000 955
-------------	-------------------

#### 2-85 FIELD BOSS

1975	263 341 - 265 402
------	-------------------

1976	268 142 - 273 315
------	-------------------

1977	274 287 - 281 504
------	-------------------

1978	282 339 - 287 196
------	-------------------

1979	287 469 - 293 408
------	-------------------

1980	294 063 - 295 791
------	-------------------

1981	297 751 - 299 123
------	-------------------

1982	300 092 - 300 158
------	-------------------

#### 2-88 FIELD BOSS

1982	301 457 - 301 717
------	-------------------

1984	302 464 - 302 599
------	-------------------

1986	400 001 - 400 599
------	-------------------

1987	400 7341 - 400 762
------	--------------------

#### 2-105 FIELD BOSS

1974	255 216 - 255 537
------	-------------------

1975	255 538 - 265 927
------	-------------------

1976	265 928 - 273 619
------	-------------------

1977	273 760 - 280 588
------	-------------------

1978	282 102 - 287 189
------	-------------------

1979	287 197 - 293 357
------	-------------------

1980	294 109 - 295 781
------	-------------------

1981	296 878 - 299 731
------	-------------------

1982	300 779 - 300 782
------	-------------------

#### 2-110 FIELD BOSS

1982	300 783 - 301 965
------	-------------------

1983	301 998 - 302 158
------	-------------------

1984	302 334 - 303 551
------	-------------------

1985	303 552 - 303 614
------	-------------------

1986	400 231 - 400 609
------	-------------------

1987	400 764 - 401 005
------	-------------------

#### 2-135 FIELD BOSS

1976	272 663 - 273 628
------	-------------------

1977	273 629 - 282 078
------	-------------------

1978	282 825 - 286 928
------	-------------------

1979	288 201 - 293 818
------	-------------------

1980	294 330 - 296 128
------	-------------------

1981	296 611 - 299 632
------	-------------------

1982	300 380 - 300 693
------	-------------------



# Tractor Production Information - White

## WHITE TRACTOR

MODEL AND YEAR	SERIAL NO.
<b>2-135 SERIES III</b>	
1982	301 116 - 301 811
1983	302 159 - 302 233
1984	302 715 - 303 289
1986	400 167 - 400 733
1987	400 831 - 400 880
<b>2-150 FIELD BOSS</b>	
1975	257 899 - 265 201
1976	266 783 - 271 312
<b>700 (CANADA ONLY)</b>	
1976	854438
1977	854673
1978	862561
1979	870824
1980	876188
<b>2-155 FIELD BOSS</b>	
1976	272 595 - 272 812
1977	276 055 - 281 209
1978	282 280 - 286 929
1979	287 812 - 293 708
1980	296 160 - 296 244
1981	297 134 - 299 365
1982	300 259 - 300 429
<b>2-155 SERIES III</b>	
1982	300 928 - 301 921
1984	302 791 - 303 344
1986	400 107 - 400 718
<b>2-180 FIELD BOSS</b>	
1977	281 993 - 282 087
1978	282 088 - 286 004
1979	289 447 - 292 891
1980	294 655 - 294 821
1981	296 571 - 299 002
1982	300 159 - 300 258
<b>2-180 SERIES III</b>	
1982	301 922 - 310 963
1983	301 966 - 301 997
1984	302 951 - 302 990
1986	400 082 - 400 230
<b>4-150 FIELD BOSS</b>	
1974	246 001 - 246 849
1975	246 871 - 262 243
1976	262 244 - 267 958
1977	275 051 - 275 405
1978	275 406 - 275 571
<b>4-175 FIELD BOSS</b>	
1979	292 187 - 292 334
1980	295 808 - 295 900
1981	297 293 - 299 848
1982	299 849 - 299 886



WHITE 2-150 FIELD BOSS



WHITE 4-150 FIELD BOSS



WHITE 4-175 FIELD BOSS



WHITE 4-210 FIELD BOSS

## WHITE TRACTOR

MODEL AND YEAR	SERIAL NO.
<b>4-180 FIELD BOSS</b>	
1975	256 587 - 262 099
1976	262 524 - 268 111
1977	268 112 - 275 396
1978	275 450 - 275 502
<b>4-210 FIELD BOSS</b>	
1978	275 572 - 275 943
1979	275 944 - 292 368
1980	295 391 - 296 205
1981	296 471 - 299 826
1982	300 694 - 300 778
<b>4-225 FIELD BOSS</b>	
1983	302 234 - 302 273
1984	302 620 - 303 468
1986	400 344
1987	400 901 - 400 921
<b>4-270 FIELD BOSS</b>	
1983	302 274 - 302 333
1984	302 655 - 303 423
1986	400 639 - 400 658
1987	400 922 - 400 941
1988	401 411 - 401 435
<b>16 FIELD BOSS</b>	
1986 - 1989	(2WD) 02 314 - 02 811
1986 - 1989	(4WD) 14 422 - 16 865
<b>21 FIELD BOSS</b>	
1986 - 1989	(2WD) 00 595 - 01 181
1986 - 1989	(4WD) 02 879 - 04 844
<b>31 FIELD BOSS</b>	
1986 - 1989	(2WD) 00 126 - 01 981
1986 - 1989	(4WD) 00 028 - 01 061
<b>37 FIELD BOSS</b>	
1986 - 1989	(2WD) 00 083 - 00 315
1986 - 1989	(4WD) 00 679 - 01 339
<b>43 FIELD BOSS</b>	
1986 - 1989	(2WD) 00 060 - 00 156
1986 - 1989	(4WD) 00 322 - 00 499
<b>60 AMERICAN SERIES</b>	
1989	402 965 - 403 164
1990	404 299 - 404 454
1991	405 028 - 405 047
<b>80 AMERICAN SERIES</b>	
1989	402 590 - 403 464
1990	404 266 - 404 541
1991	405 048 - 405 052
<b>100 FIELD BOSS</b>	
1987	401 236 - 401 260
1988	401 361 - 401 970
1989	402 661 - 403 764

# Tractor Production Information - White

## WHITE TRACTOR

### MODEL AND YEAR SERIAL NO.

#### 120 FIELD BOSS

1987	401 121 - 401 235
1988	401 296 - 402 520
1989	402 521 - 403 839

#### 125 WORK HORSE

1990	404 066 - 404 165
1991	404 601 - 404 969

#### 140 FIELD BOSS

1987	401 151 - 401 200
1988	401 326 - 402 440
1989	402 736 - 404 064

#### 145 WORK HORSE

1991	404 671 - 404 923
------	-------------------

#### 160 FIELD BOSS

1987	401 096 - 401 120
1988	401 261 - 402 220
1989	403 640 - 404 024

#### 170 WORK HORSE

1990	404 228 - 404 265
1991	404 766 - 405 207

#### 185 FIELD BOSS

1986 (FB 185)	400 659 - 400 708
1987	400 881 - 401 095
1988	401 579 - 402 050
1989	402 761 - 404 014

#### 195 WORK HORSE

1990	404 166 - 404 227
1991	404 826 - 404 995

#### 6105

1992	1001
1993	1161
1994	1252
1995	1343

#### 6124

1994	625001
1995	625501
1996	626301
1997	626357

#### 6125

1993	620001
1994	621001
1995	622001
1996	622301
1997	622338

#### 6144

1994	645001
1995	645501
1996	646301
1997	646411

### White Fact

The Field Boss name came from the White Motor Corporation truck division and was a line extension of the WMC Road Boss over-the-road semi-tractor. Other names included Seed Boss for the White planter, as well as several products in the company's lawn and garden offering from the time, including Lawn Boss and Snow Boss.



WHITE 140 FIELD BOSS

## WHITE TRACTOR

### MODEL AND YEAR SERIAL NO.

#### 6145

1993	640001
1994	641001
1995	642001
1996	642301
1997	642350

#### 6175

1993	660001
1994	661001
1995	662001
1996	662301
1997	662393

#### 6195

1993	680001
1994	681001
1995	682001
1996	682301
1997	682380

#### 6010 SERIES

*Includes 6045, 6065, 6085, 6090*

1998	G001001
1999	H001001

#### 6410, 6510

1998	G01001
1999	H01001
2000	J01001
2001	K01001

#### 6710, 6810

1998	G001001
1999	H001001
2000	J001001
2001	K001001

#### 8310, 8410

1998	G001001
1999	H001001
2000	J001001
2001	K001001

#### 8610, 8710, 8810

1998	CG001001
1999	CH001001
2000	J001001
2001	K001001

# Tractor Production Information - Oliver

## OLIVER TRACTOR

**MODEL AND YEAR SERIAL NO.**

<b>ROW CROP 60</b>	
1940	600 001 - 600 070
1941	600 071 - 606 303
1942	606 304 - 607 394
1943	607 395 - 608 525
1944	608 526 - 609 930
1944	609 931 - 612 046
1945	612 047 - 615 627
1946	615 628 - 616 706
1947	616 707 - 620 256
1948	620 257 - 325 131
<b>STANDARD 60 (4 SPEED)</b>	
1942	410 001 - 410 500
1943	410 501 - 410 510
<b>STANDARD 60 (5 SPEED)</b>	
1944	410 511 - 410 616
1945	410 617 - 410 910
1946	410 911 - 411 310
1947	411 311 - 411 960
1948	411 961 - 413 605
<b>ROW CROP 70 (4 SPEED)</b>	
1937	216 926 - 219 644
1937	220 426 - 220 694
1938	219 645 - 220 425
1938	220 695 - 223 254
1939	223 255 - 231 115
1940	231 116 - 236 355
1941	236 356 - 241 390
1942	241 391 - 243 639
1943	243 640 - 244 710
1944	244 711 - 245 040
<b>ROW CROP 70 (6 SPEED)</b>	
1944	245 041 - 250 179
1945	520 180 - 252 779
1946	252 780 - 258 139
1947	258 140 - 262 839
1948	262 840 - 267 866
<b>STANDARD 70 (4 SPEED)</b>	
1937	301 803 - 302 083
1938	302 084 - 303 464
1939	303 465 - 305 361
1940	305 362 - 306 593
1941	306 594 - 307 579
1942	307 580 - 308 187
1943	308 188 - 308 483



**OLIVER 60**



**OLIVER  
70 ROW CROP**



**OLIVER  
80 ROW CROP**

## OLIVER TRACTOR

**MODEL AND YEAR SERIAL NO.**

<b>STANDARD 70 (6 SPEED)</b>	
1944	308 484 - 310 217
1945	310 218 - 311 115
1946	311 116 - 312 689
1947	312 690 - 314 220
1948	314 221 - 315 420
<b>80 ROW CROP (3 SPEED)</b>	
1937	109 152 - 109 166
1938	109 167 - 109 782
1939	109 783 - 109 852
<b>80 ROW CROP (4 SPEED)</b>	
1939	109 853 - 110 220
1940	110 221 - 110 614
1941	110 615 - 110944
1942	110 945 - 111 218
1943	111 219 - 111 390
1944	111 391 - 111 928
1945	111 929 - 112 878
1946	112 879 - 114 143
1947	114 144 - 114 943
1948	114 944 - 115 373
<b>STANDARD 80 (3 SPEED)</b>	
1937	803 929 - 803 990
1938	803 991 - 805 319
<b>STANDARD 80</b>	
1938	805 320 - 805 376
1939	805 377 - 806 879
1940	806 880 - 808 124
1941	808 125 - 809 050
1942	809 051 - 809 990
1943	809 991 - 810 469
1944	810 470 - 811 990
1945	811 911 - 813 066
1946	813 067 - 814 563
1947	814 564 - 815 215
1948	815 216 - 816 241
<b>90 &amp; 99 (4 CYLINDER)</b>	
1937	508 918 - 508 934
1938	508 935 - 509 611
1939	509 612 - 510 067
1940	510 068 - 510 563
1941	510 564 - 510 976
1942	510 977 - 511 295
1943	511 296 - 511 473
1944	511 474 - 512 043
1945	512 - 044 - 512 820
1946	512 821 - 513 105
1947	513 106 - 513 855
1948	513 856 - 514 855

# Tractor Production Information - Oliver

## OLIVER TRACTOR

**MODEL AND YEAR SERIAL NO.**

**90 & 99 (4 CYLINDER) CONTINUED**

1949	514 856 - 516 275
1950	516 276 - 516 887
1951	516 888 - 517 873
1952	517 874 - 518 212

**HG CRAWLER**

1945	13GA422 - 19GA992
1946	19GA994 - 25GA238
1947	25GA240 - 33GA144
1948	33GA146 - 41GA894
1949	41GA895 - 48GA426
1950	48GA427 - 55GA429
1951	55GA430 - 59GA000

**ROW CROP 66**

1949	420 001 - 423 100
1950	423 101 - 426 010
1951	426 011 - 429 770
1952	429 771 - 431 472
1953	3 503 990 - 3 510 962
1954	4 500 309 - 4 503 563

**STANDARD 66**

1949	470 001 - 471 050
1950	471 051 - 472 390
1951	472 391 - 474 232
1952	474 233 - 476 408
1953	3 504 001 - 3 511 337
1954	4 501 624 - 4 504 476

**ROW CROP 77**

1948	320 001 - 320 240
1949	320 241 - 327 900
1950	327 901 - 337 242
1951	337 243 - 347 903
1952	347 904 - 354 447
1953	3 500 001 - 3 510 830
1954	4 501 301 - 4 504 470

**STANDARD 77**

1948	269 001 - 269 940
1949	269 941 - 271 266
1950	271 267 - 272 465
1951	272 466 - 273 375
1952	273 376 - 274 051

**ROW CROP 88 (STREAMLINE)**

1947	120 001 - 120 352
1948	120 353 - 121 300



**OLIVER SUPER 88**



**OLIVER SUPER 77**



**OLIVER 99**

## OLIVER TRACTOR

**MODEL AND YEAR SERIAL NO.**

**ROW CROP 88 (FLEETLINE)**

1948	121 301 - 123 300
1949	123 301 - 128 652
1950	128 653 - 132 862
1951	132 863 - 138 183
1952	138 184 - 143 232
1953	3 500 977 - 3 511 566
1954	4 500 076 - 4 505 123

**STANDARD 88 (STREAMLINE)**

1947	820 001 - 820 135
1948	820 136 - 820 485

**STANDARD 88 (FLEETLINE)**

1948	820 486 - 821 085
1949	821 086 - 824 240
1950	824 241 - 825 810
1951	825 811 - 826 916
1952	826 917 - 827 966
1953	3 501 813 - 3 511 484
1954	4 500 080 - 4 505 081

**99 (STYLED & 6 CYLINDER)**

1952	518 300 - 518 313
1953	518 314 - 519 292

**SUPER 44**

1957	1 001 - 1 550
1958	1 551 - 1 775

**SUPER 55**

1954	6 001 - 8 290
1955	11 837 - 31 370
1956	35 001 - 43 647
1957	43 916 - 56 036
1958	56 501 - 59 033

**SUPER 66**

1954	7 085 - 7 284
1955	14 099 - 27 842
1956	39 371 - 42 430
1957	45 846 - 55 800
1958	57 858 - 72 824

**SUPER 77**

1954	8 303 - 8 988
1955	10 001 - 29 842
1956	38 500 - 43 637
1957	44 167 - 55 955
1958	56 917 - 59 008

**SUPER 88**

1954	6 503 - 8 302
1955	10 075 - 29 347
1956	36 774 - 43 715
1957	43 901 - 55 607
1958	56 580 - 59 001

# Tractor Production Information - Oliver

## OLIVER TRACTOR

### MODEL AND YEAR SERIAL NO.

#### SUPER 99 & SUPER 99 GM

1954	519 300 - 519 675
1955	519 676 - 520 455
1956	520 456 - 520 943
1957	520 944 - 521 612
1958	521 613 - 521 635

#### 440

1960	85 725 87 817
1962	121 833 - 122 542

#### 500

1960	100 001 - 100 500
1961	100 501 - 101 200
1962	101 201 - 101 700
1963	101 701 - 102 000

#### 550

1958	60 501 - 74 745
1959	72 632 - 84 415
1960	84 416 - 110 966
1961	111 868 - 117 540
1962	117 541 - 123 699
1963	127 365 - 140 619
1964	140 620 - 149 764
1965	162 265 - 163 114
1966	171 923 - 176 454
1967	186 165 - 193 085
1968	206 095 - 207 856
1969	213 340 - 217 921
1970	222 833 - 223 056
1971	226 965 - 227 120
1972	232 918 - 235 123
1973	238 237 - 242 700
1974	248 375 - 254 410
1975	259 255 - 259 491

#### 600

1962	449 800 - 452 300
1963	452 301 - 453 700

#### 660

1959	73 132 - 84 553
1960	86 166 - 110 955
1961	111 213 - 117 266
1962	117 873 - 126 294
1963	127 356 - 136 486
1964	141 160 - 144 039

#### 770

1958	60504
1959	71011
1960	84554
1961	111472
1962	117600
1963	127319



OLIVER 500



OLIVER 440



OLIVER 660



OLIVER 880



OLIVER 550

## OLIVER TRACTOR

### MODEL AND YEAR SERIAL NO.

#### 770 CONTINUED

1964	141901
1965	153255
1966	171515
1967	183649

#### 880

1958	60 505 - 71 317
1959	71 640 - 84 335
1960	84 555 - 110 954
1961	111 262 - 117 504
1962	117 640 - 126 354
1963	128 911 - 135 054

#### 950, 990 GM & 995 GM

1958	530 001 - 530 387
1958	67 828 - 71 112
1959	71 245 - 84 376
1960	84 487 - 95 350
1961	110 064 - 115 469

#### 1600

1962	124 420 - 127 043
1963	127 044 - 140 262
1964	140 723 - 147 568

#### 1800 A, B & C

1960 A	90 525 - 111 024
1961 A	111 025 - 117 375
1962 A	118 344 - 124 395
1962 B	124 397 - 126 352
1963 B	129 286 - 134 683
1963 C	136 501 - 140 085
1964 C	140 893 - 149 818

#### 1900 A, B & C

1960 A	90 532 - 111 022
1961 A	111 028 - 117 374
1962 A	118 356 - 124 372
1962 B	124 396 - 126 355
1963 B	128 422 - 712 832
1963 C	138 440 - 140 066
1964 C	141 168 - 148 651

#### 1250

1965	705 376 - 712 832
1966	712 833 - 725 780
1967	728 661 - 739 518
1968	739 527 - 742 520
1969	742 526 - 743 152

#### 1450

1967	132 382 - 147 473
1968	147 482 - 155 196
1969	155 479 - 159 945



# Tractor Production Information - Oliver

## OLIVER TRACTOR

### MODEL AND YEAR SERIAL NO.

#### 1550

1965	157 841 - 166 406
1966	168 919 - 181 061
1967	184 488 - 196 205
1968	196 301 - 208 959
1969	213 243 - 218 186

#### 1650

1964	149 836 - 152 569
1965	153 855 - 167 667
1966	167 668 - 183 194
1967	183 923 - 195 765
1968	201 091 - 209 251
1969	212 733 - 218 193

#### 770 INDUSTRIAL

1965	153255
1966	171515
1967	183649

#### 1750

1966	181 062 - 182 126
1967	185 301 - 200 216
1968	200 217 - 211 777
1969	214 936 - 218 850

#### 1850

1964	150 421 - 153 013
1965	153 014 - 167 285
1966	168 127 - 183 381
1967	183 382 - 199 964
1968	200 360 - 212 448
1969	212 673 - 218 852

#### 1950

1964	150 492 - 153 011
1965	153 016 - 167 298
1966	168 190 - 177 661
1967	189 008 - 199 186

#### 1950T

1967	188 974 - 199 339
1968	201 931 - 211 117
1969	213 376 - 218 449

#### 2050

1968	204 444 - 212 527
1969	212 560 - 213 932

#### 2150

1968	204 480 - 212 553
1969	212 554 - 216 595

#### 1250A & 1255

1969 (1250A)	305 985 - 309 380
1969 (1255)	309 381 - 360 743
1970 (1255)	312 957 - 318 393



OLIVER 1950 SERIES



OLIVER 1950 SERIES



OLIVER 1850 SERIES



OLIVER 1850 SERIES



OLIVER 1750 SERIES

## OLIVER TRACTOR

### MODEL AND YEAR SERIAL NO.

#### 1250A & 1255 CONTINUED

1971 (1255)	317 328 - 318 385
-------------	-------------------

#### 1265

1971	302 402 - 303 466
1972	304 497 - 307 220
1973	307 221 - 314 368
1974	314 369 - 319 893
1975	317 000 - 321 497

#### 1355

1969	503 287 - 512 149
1970	512 698 - 525 078
1971	523 254 - 526 640

#### 1365

1971	706 251 - 712 386
1972	706 277 - 716 975
1973	714 614 - 730 076
1974	725 451 - 764 138
1975	729 125 - 766 614

#### 1465

1973	827 183 - 831 562
1974	827 580 - 839 423
1975	287 287 - 839 487

#### 1555

1969	218 128 - 220 639
1970	221 295 - 223 072
1971	225 914 - 230 893
1972	232 089 - 235 984
1973	236 883 - 242 906
1974	244 937 - 250 430
1975	256 165 - 262 877

#### 1655

1969	218 025 - 220 399
1970	222 600 - 222 761
1971	225 997 - 230 735
1972	231 772 - 235 188
1973	236 - 586 - 244 447
1974	244 735 - 255 515
1975	257 700 - 263 340

#### 1755

1970	221 603 - 223 322
1971	226 445 - 229 636
1972	231 415 - 236 163
1973	238 136 - 244 369
1974	245 667 - 253 668
1975	257 515 - 260 346

#### 1855

1969	220 640 221 098
1970	221 099 - 223 507
1971	225 508 - 231 365

# Tractor Production Information - Oliver, M-M

## OLIVER TRACTOR

MODEL AND YEAR	SERIAL NO.
<b>1855 CONTINUED</b>	
1972	231 366 - 236 584
1973	236 585 - 244 489
1974	247 436 - 254 772
1975	255 727 - 255 785
<b>1865 (M-M G950)</b>	
1971	43 600 416 - 43 600 829
<b>1955</b>	
1970	222 304 - 223 439
1971	226 858 - 230 456
1972	232 958 - 236 326
1973	239 032 - 244 558
1974	247 871 - 253 050
<b>2055 (M-M G1050)</b>	
1971	43 100 416 - 43 100 544
<b>2155 (M-M G1350)</b>	
1971	43 300 043 - 43 300 253
<b>2255</b>	
1972	235 598 - 235 999
1973	237 210 - 244 214
1974	244 825 - 252 714
1975	258 472 - 258 571
1976	266 683 - 266 782
<b>2455 (M-M A4T-1600)</b>	
1969	43 900 001 - 43 900 102
1970	43 900 103 - 43 900 247
<b>2655 (M-M A4T-1600)</b>	
1971	45 600 188 - 45 600 700
1972	45 600 701 - 45 601 190

## M-M TRACTOR

MODEL AND YEAR	SERIAL NO.
<b>GTB</b>	
1947	164001
1948	164800001
1949	164900001
1950	16500001
1951	1601864
1952	1603397
1953	1604890
1954	1605973
<b>GTC</b>	
1951	4700001
1952	4700019
1953	4700677
<b>GTBD</b>	
1953	6800001
1954	6800002



OLIVER 1655  
WHITE-M-M G750



WHITE-OLIVER 1755  
M-M G850



OLIVER 1855  
M-M G940



OLIVER 1955

## M-M TRACTOR

MODEL AND YEAR	SERIAL NO.
<b>GTBD</b>	
1955	8900001
1956	8901501
1957	8902602
1958	8903402
1959	8904252
<b>GBD</b>	
1955	9000001
1956	9000851
1957	9001526
1958	9002146
1959	9002656
<b>GVI</b>	
1959	1600002
1960	16000877
1961	16001676
1962	16002033
<b>GVI DIESEL</b>	
1959	16200001
1960	16200806
1961	16201891
1962	16202961
<b>RT</b>	
1940	402201
1941	405576
1942	407951
1943	408826
1944	419358
1945	410748
1946	413755
1947	416545
1948	14800001
1948	34800001
1948	44800001
1948	14900001
1948	24900001
1948	34900001
1949	44900001
<b>RTU</b>	
1950	15000001
1951	102156
1952	103973
1953	None
1954	104824
Last Number	104831
<b>RTN</b>	
1950	35000001
1951	300094
Last Number	300173

# Tractor Production Information - M-M

## M-M TRACTOR

### MODEL AND YEAR SERIAL NO.

#### RTE

1951	45000001
1951	400285
1952	400285
1953	400283
Last Number	400287

#### RTS

1950	25000001
1951	200301
1952	200402
1953	200552
Last Number	200701

#### U & UT

1940	312451
1941	314893
1942	316501
1943	317702
1944	318163
1945	321102
1946	325231
1947	329752
1948	337418
Last Number	339682

#### UTC

1948	154800001
1949	154900001
1950	None
1951	15000101
1952	15000181
1953	None
1954	10500266
1954	8800001
1955	8800061
Last Number	8800110

#### UTE

1951	4300001
1952	4300112
1953	4300262
Last Number	4300265

#### UTN

1950	385000001
1951	3800102
1952	3800205
Last Number	3800354

#### UTS

1948	1248000001
1949	1249000001
1950	125000001
1951	1203851



**M-M G1355  
WHITE 2270**



**OLIVER 1365  
WHITE 1370  
M-M G450**



**OLIVER 1265  
WHITE 1270  
M-M G350**



**OLIVER 2655  
M-M A4T  
WHITE PLAINSMAN**

## M-M TRACTOR

### MODEL AND YEAR SERIAL NO.

#### UTS CONTINUED

1952	1207139
1953	1210571
1954	1213220
1955	1213326
Last Number	1214125

#### UTU

1948	114800001
1949	114900001
1950	115000001
1951	1105384
1952	1110118

#### UDU

1952	4900001
1953	4900002
Last Number	4900030

#### UDS & UTSD

1952	5000001
1953	None
1954	5000019
1955	5000955
1956	5002105

#### UTSD-M

1955	5001155
1956	10800001
1957	10800246
1958	10800391

#### UBE

1953	5900001
1954	5900897
1955	5901069
Last Number	5901421

#### UBED

1954	7000001
1955	7000232
Last Number	7000362

#### UBU

1953	5800001
1954	5802913
1955	5804003
Last Number	5805077

#### UBUD

1954	7800001
1955	7800747
Last Number	7801041

#### UBN

1953	6000001
1954	6000203
1955	6000208
Last Number	6000241

# Tractor Production Information - M-M

## M-M TRACTOR

**MODEL AND YEAR SERIAL NO.**

**UBND**

1954	6900001
Last Number	6900048

**UBG**

1953	5900001
------	---------

**UB SPECIAL**

1955	9700001
Last Number	9701475

**UBD SPECIAL**

1955	9800001
1956	9800301
1957	9800465
Last Number	9800521

**BF**

1950	R500
1951	R1839
1952	R4460
Last Number	R6537

**BF**

1953	6538
Last Number	R7571

**BFD**

1953	57700001
Last Number	57700358

**BFS**

1953	57600001
Last Number	57600047

**BFH**

1953	58000001
Last Number	58000150

**V**

1947	1V144
1948	2V577
1949	4V490
1950	5V501
1951	6C207
1952	6V422
Last Number	7V271

**ZAE**

1949	949000001
1950	95000001
1951	9000374
1952	900577
1953	900998
Last Number	91122

**ZAN**

1949	84900001
1950	85000001
1951	800239
1952	800443

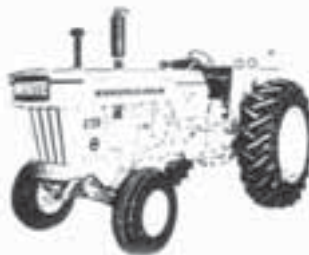

**OLIVER 2155  
M-M G1350**



**OLIVER 2055  
M-M G1050**



**OLIVER 1865  
M-M G950**



**WHITE-OLIVER 1655  
WHITE-M-M G750**



**WHITE OLIVER 1555  
WHITE-M-M G-550**

## M-M TRACTOR

**MODEL AND YEAR SERIAL NO.**

**ZAN CONTINUED**

1953	800619
Last Number	800620

**ZAS**

1949	74900001
1950	75000001
1951	700481
1952	701286
1953	701911
Last Number	702610

**ZAU**

1949	64900001
1950	65000001
1951	65436
1952	609940
Last Number	614658

**ZTN & ZTU**

1947	578014
1948	581815
Last Number	585817

**ZTS**

1947	613086
Last Number	613490

**ZBN**

1954	6400001
1955	6400073
Last Number	6400106

**ZM**

1953	7600001
1954	7600018

**ZBE**

1953	6300001
1954	6300076
1955	6300307
Last Number	6300501

**ZBU**

1953	6300001
1954	6200958
1955	6202480
Last Number	6203059

**335 INDUSTRIAL**

1957	11300001
1958	11300441
1959	11300522
1960	11300597

**335 UTILITY**

1956	10400001
1957	10400102
1958	10402088



# Tractor Production Information - M-M

## M-M TRACTOR

**MODEL AND YEAR SERIAL NO.**

**335 UTILITY CONTINUED**

1959	10402337
1960	10402440
1961	10402490

**335 UNIVERSAL**

1957	11600001
1958	11600302
1959	11600307

**445 UTILITY**

1956	10200001
1957	10201446
1958	10202102
1959	10202243

**445 UNIVERSAL**

1956	10100001
1957	10102855
1958	10104126
1959	10104805

**445 DIESEL UTILITY**

1959	15400001
------	----------

**445 DIESEL UNIVERSAL**

1959	15200001
------	----------

**5 STAR UNIVERSAL**

1957	11000001
1958	11001066
1959	11002914
Last Number	11002917

**5 STAR DIESEL UNIVERSAL**

1957	14400001
1958	14400211
1959 (Last No.)	14401295

**5 STAR STANDARD**

1958	11200001
1959 (Last No.)	11200380

**5 STAR DIESEL STANDARD**

1958	14500001
1959 (Last No.)	14500188

**JET STAR**

1959	16500001
1960	16500285
1961	16500835
1962	16501702

**JET STAR DIESEL**

1960	17500011
1961	17500061
1962	17500136

**JET STAR 2**

1963	25800001
------	----------



M-M G-550



M-M G450



M-M G350



M-M G950

## M-M TRACTOR

**MODEL AND YEAR SERIAL NO.**

**JET STAR 2 DIESEL**

1963	25700001
------	----------

**JET STAR 3**

1964	28300001
1965	28301001
1966	28302056
1967	28302895
1968	28304158
1969	28304801
1970	36000001

**JET STAR 3 DIESEL**

1964	28400001
1965	28400051
1966	28302056
1967	28302895
1968	28400464
1969	28400527
1970	28400602

**M5**

1960	17100001
1961	17101536
1962	17103496
1963	171047108

**M5 DIESEL**

1960	17200001
1961	17201041
1962	17202000
1963	17202507

**M504**

1962	24300001
------	----------

**M504**

1962	24200001
1963	24200021

**M602**

1963	26600001
1964	26601276

**M602 DIESEL**

1963	26700001
1964	26700743

**M604**

1963	26800001
1964	26800051

**M604**

1963	26900001
1964	26900051

**M670**

1964	29900001
1965	29900007
1966	29901892
1967	29903580

# Tractor Production Information - M-M

## M-M TRACTOR

MODEL AND YEAR SERIAL NO.

### M670 CONTINUED

1968	29904455
1969	29904595
1970	29905005

### M670 DIESEL

1964	30000001
1965	30000005
1966	30000820
1967	30001635
1968	30002310
1969	30002570
1970	30002681

### U302

1964	27600001
1965	27601001
1966	27601301
1967	27602301
1968	27602360
1969	27602760
1970	27602860

### G704

1962	23400001
------	----------

### G704

1962	23500001
------	----------

### G705

1962	23800001
1963	23800079
1964	23800591
1965	23801093

### G705 DIESEL

1962	29300001
1963	23900051
1964	23900899
1965	23901869

### G706

1962	24000001
1963	24000073
1964	24000306
1965	24000351

### G706 DIESEL

1962	24100001
1963	24100107
1964	24100550
1965	24100796

### G707

1965	31200001
------	----------

### G707 DIESEL

1965	31300001
------	----------

### G708

1965	31400001
------	----------



M-M G1355

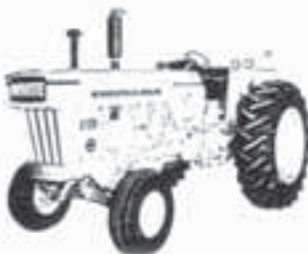

M-M G1350



M-M G1050



M-M G940



M-M A4T

## M-M TRACTOR

MODEL AND YEAR SERIAL NO.

### G708 DIESEL

1965	31500001
------	----------

### G900

1967	33000001
1968	33000111
1969	33000548

### G900

1969	36300001
------	----------

### G900 DIESEL

1967	33100001
1968	33100317
1969	33101377

### G950 LP

1969	43500001
1970	43500061
1971	43500086

### G950 DIESEL

1969	43600001
1970	43600211
1971	43600416
1972	43600830

### G955

1973	239825
1974	244559

### G1000 ROW CROP

1965	30500001
1966	30500451
1967	30500297

### G1000 DIESEL ROW CROP

1965	30600001
1966	30600501
1967	30601126

### G1000 VISTA

1967	34500011
------	----------

### G1000 VISTA LP

1969	34500291
1970	34500391

### G1000 VISTA D

1968	34600016
1969	34600736
1970	34601186

### G1000 WHEATLAND

1966	32600001
1967	32600516
1968	32600651
1969	None
1970	32600653

# Serial Number Location & Machine Reference - White

'Right' and 'Left' are made from the perspective of a seated operator.

## M-M TRACTOR

MODEL AND YEAR SERIAL NO.

### G1000 WHEATLAND D

1966	32700001
1967	32700734
1968	32701451
1969	None
1970	32701775

### 1050 LP

1969	43000001
1970	43000041
1971	43000061
1972	43000106

### G1050 DIESEL

1969	43100001
1970	43100286
1971	43100416

### G1350 ROW CROP LP

1969	43200001
1970	43200023

### G1350 WHEATLAND LP

1969	45300001
------	----------

### G1350 LP

1971	43200045
1972	43200098

### G1350 DIESEL

1970	43300001
1971	43300043
1972	43300254

### G1355

1972	236442
1973	237875
1974	245258

### A4T-1400

1969	43900001
1970	43900103

### A4T-1600 LP

1970	45700001
1971	45700127
1972	45700198

### A4T-1600 DIESEL

1970	45600001
1971	45600188
1972	45600701



### 125 & 145 WORK HORSE

1990-1991

Tractor model and serial numbers are stamped on a metal plate attached to the left rear side of main frame. Engine serial number is stamped on metal plate attached to gear housing in front of fuel injection pump.



### WHITE 120 FIELD BOSS

1986-1989

Tractor serial number and model number are stamped on metal plate attached to left rear side of main frame. Engine serial number is stamped on metal plate attached to gear housing in front of fuel injection pump.



### 170 & 195 WORK HORSE

1990-1991

Tractor serial number and model number are stamped on metal plate attached to left rear side of main frame. Engine serial number is stamped on metal plate attached to gear housing in front of fuel injection pump.



### WHITE 160 FIELD BOSS

1986 -1989

Tractor serial number and model number are stamped on metal plate attached to left rear side of main frame. Engine serial number is stamped on metal plate attached to gear housing in front of fuel injection pump.



### WHITE 140 FIELD BOSS

1986-1989

Tractor serial number and model number are stamped on metal plate attached to left rear side of main frame. Engine serial number is stamped on metal plate attached to gear housing in front of fuel injection pump.



### WHITE 100 FIELD BOSS

1986-1989

Tractor serial number and model number are stamped on metal plate attached to left rear side of main frame. Engine serial number is stamped on metal plate attached to gear housing in front of fuel injection pump.

## Serial Number Location &amp; Machine Reference - White

**WHITE 185 FIELD BOSS**

1986-1989

Tractor serial number and model number are stamped on metal plate attached to left rear side of main frame. Engine serial number is stamped on metal plate attached to gear housing in front of fuel injection pump.

**WHITE 37 FIELD BOSS**

1986-1989

Tractor serial number is located on metal plate attached to the left side on the tractor frame. Engine serial number is stamped on the lower side of the engine directly behind engine oil dipstick and filler tube.

**WHITE 16 FIELD BOSS**

1986-1989

Tractor serial number is stamped on the left hand front corner of the frame and on the serial number plate on the transmission. Engine serial number is printed on a decal located on the engine valve cover.

**WHITE 2-65 FIELD BOSS  
HIGH CLEARANCE**

1987-1988

Tractor serial number is located on a metal plate attached to the left side on the tractor frame. It is also stamped on the front frame at the lower left corner of the radiator grille. Engine serial number is stamped on the left side of the engine behind the alternator.

**WHITE 31 FIELD BOSS**

1986-1989

Tractor model and chassis number can be found on a metal plate attached to the left side of the tractor frame. Serial number is stamped into right side of the transmission case. Engine model and serial number is stamped or cast into right side of engine cylinder block.

**WHITE 2-32 FIELD BOSS**

1984-1986

Tractor serial number is located on a metal plate attached to the left side on the tractor frame. Engine serial number is stamped on the lower left side of the engine directly behind engine oil dipstick and filler tube.

**WHITE 43 FIELD BOSS**

1986-1989

Tractor serial number and model number is located on metal plate attached to the left side of tractor frame. Serial number is also stamped into right side of transmission case. Engine serial number and model number is stamped into left side of cylinder block.

**WHITE 21 FIELD BOSS**

1986-1989

Tractor model and chassis number can be found on a metal plate attached to the left side of the tractor frame. Serial number is stamped into right side of the transmission case. Engine model and serial number is stamped or cast into right side of engine cylinder block.

**WHITE 4-270 FIELD BOSS**

1983-1988

Tractor model and serial numbers are stamped on metal plate attached to center frame on left side of tractor. Engine serial number is also stamped on this plate. Engine serial number is stamped on metal plate attached to rear of engine block on left side of tractor.



## Serial Number Location &amp; Machine Reference - White

**WHITE 4-225 FIELD BOSS**

1983-1987

Tractor serial and model numbers are stamped on metal plate attached to center frame on left hand side of tractor. Engine serial number is stamped on metal plate attached to top of left valve cover. Engine serial number is also stamped on model and serial number plate.

**WHITE 2-75 FIELD BOSS**

1982-1988

Tractor serial and specification numbers are stamped on a metal plate attached to left side on tractor frame. It is also stamped on front frame at lower left corner of radiator grille. Engine serial number is stamped on left side of engine adjacent to front mounting pad.

**WHITE 2-55 FIELD BOSS**

1982-1988

Tractor serial number is located on metal plate attached to left side on tractor frame. It is also stamped on the front frame at lower left corner of radiator grille. Engine serial number is stamped on left side of engine behind alternator.

**WHITE 2-110 FIELD BOSS**

1982-1987

Tractor serial and specification numbers are stamped on a metal plate attached to the left rear side of main frame. Engine serial number is stamped on engine block directly below injection pump.

**WHITE 2-65 FIELD BOSS**

1982-1988

Tractor serial number is located on a metal plate attached to the left side on the tractor frame. Engine serial number is located on the left side of the engine behind the alternator.

**WHITE 2-62 FIELD BOSS**

1980-1982

Tractor serial number is located on a metal plate attached to the left side on the tractor frame. Engine serial number is located on the left side of the engine behind the alternator.

**WHITE 2-88 FIELD BOSS**

1982-1987

Tractor serial and specification numbers are stamped on a metal plate attached to the left rear side of main frame. Engine serial number is stamped on engine block directly below injection pump.

**WHITE 2-62 FIELD BOSS****"MUDDER"** 1982-1986

Tractor serial number is located on a metal plate attached to the left side on the tractor frame. Engine serial number is located on the left side of the engine behind the alternator.

**WHITE 2-45 FIELD BOSS**

1980-1982

Tractor serial number is located on a metal plate attached to the left side on tractor frame. Engine serial number is stamped on the left side of the engine behind alternator.

## Serial Number Location &amp; Machine Reference - White

**WHITE 2-35 FIELD BOSS**

1979-1984

Tractor serial number is located on metal plate attached to left side of tractor frame. Engine serial number is stamped on right side of engine below front fuel injector.

**WHITE 2-30 FIELD BOSS**

1979-1984

Tractor serial number is located on metal plate attached to left side of tractor frame. Engine serial number is stamped on right side of engine below front fuel injector.

**WHITE 4-210 FIELD BOSS**

1978-1982

Tractor serial and specification numbers are stamped on a metal plate attached to center frame on left hand side of tractor. Engine serial number plate is located on top of front housing cover.

**WHITE 2-155 FIELD BOSS SERIES III**

1976-1987

Tractor serial number and model are stamped on metal plate attached to left rear side of main frame. Engine serial number is also stamped on this plate. Engine serial number is stamped on metal plate attached to right side of engine.

**WHITE 2-180 FIELD BOSS**

1977-1986

Tractor model and serial numbers are stamped on metal plate attached to front frame above step and battery box. Engine serial number is stamped on metal plate attached to top left valve cover.

**WHITE 2-155 FIELD BOSS**

1976-1987

Tractor serial and specification numbers are stamped on a metal plate attached to left side of front frame. Engine serial number is stamped on a metal plate attached to right side of engine.

**WHITE 2-135 FIELD BOSS**

1976-1987

Tractor serial and specification numbers are stamped on a metal plate attached to the left side of front frame. Engine serial number is stamped on a metal plate attached to right side of engine.

**WHITE 2-135 FIELD BOSS SERIES III**

1976-1987

Tractor serial number and model are stamped on metal plate attached to left rear side of main frame. Engine serial number is also stamped on this plate. Engine serial number is stamped on metal plate attached to right side of engine.

## Serial Number Location &amp; Machine Reference - White

**WHITE 2-70 FIELD BOSS**

1976-1982

Tractor serial and specification numbers are stamped on a metal plate attached to rear panel support. Engine serial number is stamped directly below alternator along outer edge of timing gear cover mounting flange.

**WHITE 2-85 FIELD BOSS**

1975-1982

Tractor serial and specification numbers are stamped on a metal plate attached to the left rear side of the main frame. Engine serial number is stamped on the engine block directly below the injection pump.

**WHITE 4-175 FIELD BOSS**

1979-1982

Tractor serial and specification numbers are stamped on a metal plate attached to center frame on left hand side of tractor. Engine serial number plate is located on top of the left valve cover.

**WHITE 2-60 FIELD BOSS**

1976-1980

Tractor serial and specification numbers are stamped on a metal plate attached to instrument panel. Engine serial number is stamped near front of cylinder block on left side of engine.

**WHITE 2-150 FIELD BOSS**

1975-1976

Tractor serial number and specification numbers are stamped on a metal plate attached to rear panel support. Engine serial number is stamped on a metal plate attached to right side of engine.

**WHITE 4-180 FIELD BOSS**

1975-1978

Tractor serial and specification numbers are stamped on a metal plate attached to center frame on left hand side of tractor. Engine serial number plates are located on rear of right back of cylinder block and on top of front housing cover.

**WHITE 2-50 FIELD BOSS**

1976-1980

Tractor serial number is located on a metal plate attached to the instrument panel. Engine serial number is stamped near front of cylinder block on left side of engine.

**WHITE 2-105 FIELD BOSS**

1975-1982

Tractor serial and specification numbers are stamped on a metal plate attached to the left rear side of main frame. Engine serial number is stamped on engine block directly below injection pump.

**WHITE 4-150 FIELD BOSS**

1974-1978

Tractor serial and specification numbers are stamped on a metal plate attached to center frame on left side of tractor. Engine serial number plates are located on right side of block and on top of front housing cover.



# Machine Reference



**M-M POWER UNITS**  
 HD220, HD605 1973  
 HD800 1973, 1975-76, 1979



**M-M G1355** 1973-1974  
**WHITE 2270** 1973-1974



**WHITE 1870** 1973-1974  
**M-M G955** 1973-1974



**OLIVER 2255** 1973-1976  
**WHITE 2255** 1973-1976



**OLIVER 1465** 1971-1975  
**WHITE 1470** 1973-1975



**OLIVER 1365** 1971-1975  
**WHITE 1370** 1973-1975  
**M-M G450** 1971



**OLIVER 1265** 1971-1975  
**WHITE 1270** 1973-1975  
**M-M G350** 1971



**OLIVER 2655** 1971  
**M-M A4T** 1969-1971  
**WHITE PLAINSMAN** 1970  
**HERITAGE** 1970

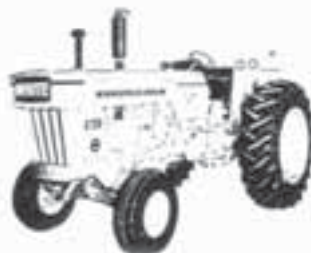

**OLIVER 2155** 1971  
**M-M G1350** 1969-1971



**OLIVER 2055** 1971  
**M-M G1050** 1969-1971



**OLIVER 1865** 1971  
**M-M G950** 1971



**WHITE-OLIVER 1955** 1969-1975  
**\*HERITAGE** 1970



**WHITE-OLIVER 1755** 1969-1975  
**WHITE-M-M G850** 1971  
**\*HERITAGE** 1970



**WHITE-OLIVER 1855** 1969-1975  
**WHITE-M-M G940** 1971  
**\*HERITAGE** 1969-1970

\* Heritage Special featured optional red, white and blue stars.



# Machine Reference



**WHITE-OLIVER 1655** 1969-1975  
**WHITE-M-M G750** 1971  
**HERITAGE** 1969-1970



**WHITE OLIVER 1555** 1969-1975  
**WHITE-M-M G-550** 1971  
**\*HERITAGE** 1969-1970



**WHITE OLIVER 1355**  
1969-1971



**WHITE OLIVER 1255**  
1969-1971



**OLIVER 1250-A**  
1969



**OLIVER 2150**  
1968-1969



**OLIVER 2050**  
1968-1969



**OLIVER 1950T**  
1967-1969



**OLIVER 1450**  
1967-1969



**WHITE IND**  
**4-80-L LOADER**  
1973-1975



**WHITE IND**  
**2-80-17, 4-80-17 MIGHTY HOE**  
1973-1975



**WHITE IND**  
**2-44 MOBILE HOME SPECIAL**  
1972-1975



**WHITE IND**  
**2-44-12 MIGHTY HOE**  
1972-1975



**WHITE IND**  
**2-63-FL MIGHTY LIFT**  
1971-1975



**WHITE IND**  
**2-63-L LOADER**  
1966-1975



**WHITE IND**  
**2-44-FL MIGHTY LIFT**  
1966-1975

# Machine Reference



**WHITE IND**  
2-44-13L MIGHTY HOE  
1966-1975



**WHITE IND**  
2-78-FL, 4-78-FL MIGHTY LIFT  
1966-1975



**WHITE IND**  
2-105, 4-105 MIGHTY TOW  
1966-1975



**WHITE IND**  
2-44-L, 2-44-LL LOADERS  
1966-1975



**WHITE IND**  
2-63-15 MIGHTY HOE  
1966-1975



**WHITE IND**  
2-62-FL MIGHTY LIFT  
1966-1975



**WHITE IND**  
2-78-15, 4-78-15 MIGHTY HOE  
1966-1975



**WHITE IND**  
2-62-15 MIGHTY HOE  
1966-1975



**WHITE IND**  
2-78-L 4-78-L LOADER  
1966-1975



**WHITE IND**  
2-44-LS LANDSCAPER  
1966-1975



**WHITE IND**  
2-62-L LOADER  
1966-1975



**WHITE IND**  
2-115 4-115 MIGHTY TOW  
1966-1975



**WHITE IND**  
2-44-13 MIGHTY HOE  
1966-1975



**WHITE IND**  
2-78-17, 4-78-17 MIGHTY HOE  
1966-1975



**WHITE IND**  
2-78, 4-78 MIGHTY TOW  
1966-1975

# Machine Reference



**OLIVER 1250**  
1965-1969



**OLIVER 1550**  
1965-1969



**OLIVER OC-4, OC-46,  
OC-9, OC-96**  
1962-1965



**OLIVER 1950 SERIES**  
1964-1969



**OLIVER 1850 SERIES**  
1964-1969



**OLIVER 1650 SERIES**  
1964-1969



**OLIVER 1750 SERIES**  
1966-1969



**OLIVER 1750 (1800 "C")**  
1964-1965



**OLIVER 1600 SERIES**  
1962-1964



**OLIVER 600**  
1962-1963



**OLIVER 1900 SERIES**  
1960-1964



# Machine Reference



**OLIVER 1800 SERIES**  
1960-1964



**OLIVER 500**  
1960-1963



**OLIVER 440**  
1960



**OLIVER 660**  
1959-1964



**OLIVER 995 SCRAPER**  
1958



**OLIVER 950, 990, 995**  
1958-1961



**OLIVER 880**  
1958-1963



**OLIVER 770 ORCHARD**  
1958-1967



**OLIVER 770**  
1958-1967



**OLIVER 552 FORK LIFT**  
1965-1967



**OLIVER 551 FORK LIFT**  
1960-1964



**OLIVER 550 FORK LIFT**  
1958-1960



# Machine Reference



**OLIVER SUPER 99**  
1957-1958

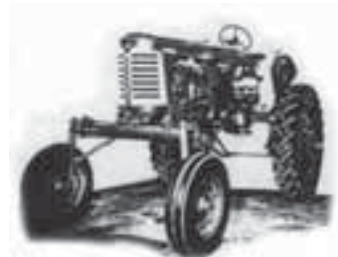

**OLIVER 990 SCRAPER**  
1955-1957

**OLIVER SUPER 77**  
1954-1958

**OLIVER 550**  
1958-1975



**OLIVER OL-175 LOADER**  
1957

**OLIVER SUPER 66**  
1954-1958



**OLIVER 225 POWER UNIT**  
1957-1960

**OLIVER SUPER 88**  
1954-1958

**OLIVER SUPER 55 FORKLIFT**  
1954-1958



**OLIVER SUPER 44 UTILITY**  
1957-1958

**OLIVER SUPER 77**  
1954-1958

**OLIVER SUPER 55**  
1954-1958

# Machine Reference

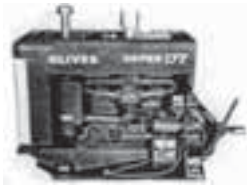
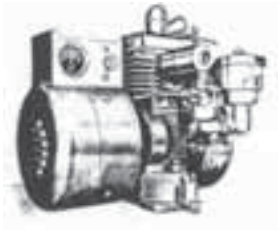

**OLIVER POWER UNITS**  
1950-1960



**OLIVER 66**  
1949-1954



**OLIVER 77**  
1948-1954



**OLIVER 88**  
1948-1954



**OLIVER 900 INDUSTRIAL**  
1945-1951



**OLIVER 60 STANDARD**  
1940-1948



**OLIVER 60**  
1940-1948



**OLIVER ENGINE-OVER-AXLE UNITS**  
1938-1967



**OLIVER 99**  
1937-1957



**OLIVER 90**  
1937-1953



**OLIVER 80 ROW CROP**  
1937-1948

# Machine Reference

MACHINE INFORMATION



**OLIVER  
50 INDUSTRIAL**  
1937-1948



**OLIVER HART-PARR  
70 STANDARD**  
1935-1937

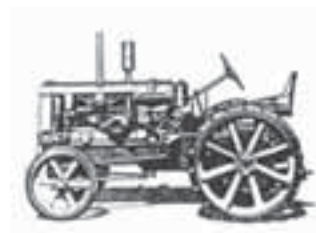

**OLIVER HART-PARR  
"18" IND**  
1931-1937



**OLIVER  
35 INDUSTRIAL**  
1937-1938

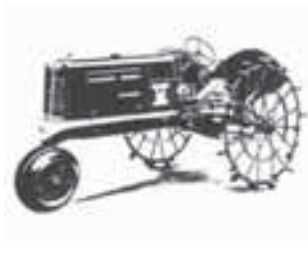

**OLIVER HART-PARR  
70 ROW CROP**  
1935-1937

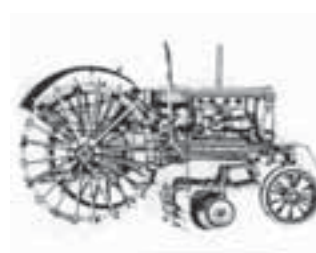

**OLIVER HART-PARR  
ROW CROP 18-27 DUAL**  
1931-1937



**OLIVER  
25 AIRPORT**  
1937-1948



**OLIVER HART-PARR  
"99" IND**  
1932-1947



**OLIVER HART-PARR  
ROW CROP 18-27 SINGLE**  
1930-1931



**OLIVER  
70 ORCHARD**  
1937-1948



**OLIVER HART-PARR  
"80" IND**  
1932-1947



**OLIVER HART-PARR  
44 POWER UNIT**  
1930-1937



**OLIVER  
70 ROW CROP**  
1937-1948



**OLIVER HART-PARR  
"28" IND**  
1931-1937

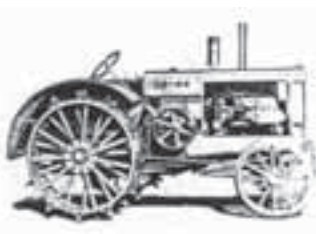

**OLIVER HART-PARR  
28-44**  
1930-1937



# Machine Reference

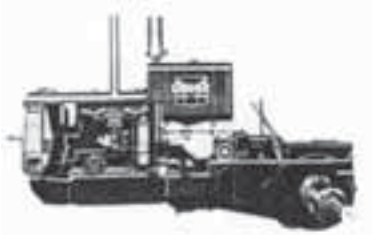

**OLIVER HART-PARR  
28 POWER UNIT**  
1930-1937

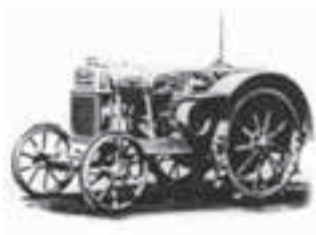

**HART-PARR 12-24 "H"**  
1928-1930

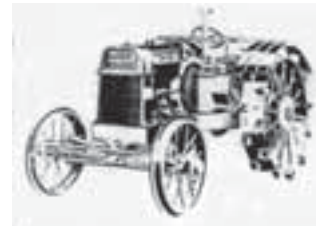

**HART-PARR  
10-20 "B" 1921-1922  
10-20 "C" 1922-1924**



**OLIVER HART-PARR 18-28**  
1930-1937



**HART-PARR 12-24 "E"**  
1924-1928

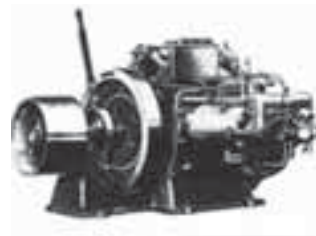
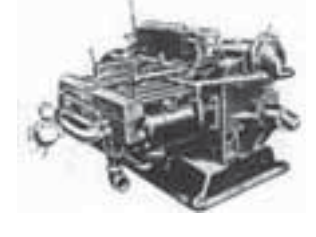

**HART-PARR  
STATIONARY ENGINES**  
1921-1929



**HART-PARR 28-50**  
1927-1930



**HART-PARR  
WASHING MACHINE**  
1924-1927



**HART-PARR 35  
ROAD KING**  
1919



**HART-PARR  
18-36 "G" 1923-1927  
18-36 "H" 1927-1930**



**HART-PARR 22-40**  
1923-1927



**HART-PARR 16-30 "E"**  
1924-1926



**HART-PARR 15-30 "C"**  
1922-1924



**HART-PARR 15-30 "A"**  
1918-1922



# Machine Reference



**HART-PARR 12-25**  
1918

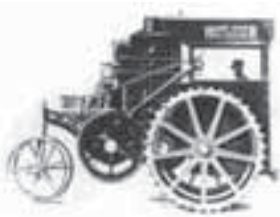

**HART-PARR 18-35**  
1915-1918



**HART-PARR**  
"LITTLE RED DEVIL"  
1914-1916



**HART-PARR 12-27**  
1914-1915



**HART-PARR 20-40**  
1912-1914



**HART-PARR 60-100**  
1911-1912

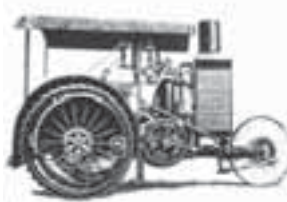

**HART-PARR 15-30**  
1909-1912



**HART-PARR 40-80**  
1908-1914



**HART-PARR 30-36**  
1907-1918



**HART-PARR 22-45**  
1903-1906

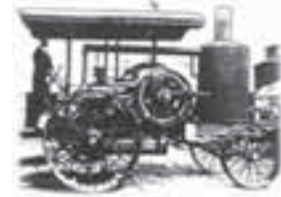

**HART-PARR 17-30**  
1903-1906



**HART-PARR 18-30 (NO.3)**  
1903

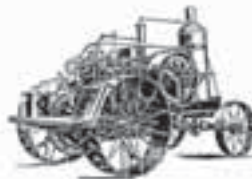

**HART-PARR 22-45 (NO.2)**  
1902-1903



**HART-PARR 17-30 (NO.1)**  
1901-1902



**HART-PARR**  
STATIONARY ENGINES  
1898-1906

Illustrations taken from "A Rich Heritage; A Solid Future," a brochure printed in early 1989 by White New Idea Farm Equipment Company

# Operators Manuals, Parts Books, Service Manuals

MUO	Serial No.	Operators Manual	Service Manual	Parts Book
<b>WHITE</b>				
FB 16		432471	432891	433383A
FB 16H		432482	na	433383A
FB 21		432472A	432892	433384
FB 31		432473	432893	433385
FB 37		432474B	432894	433386
FB 43		432475	432895	433387
60 American		432483B	79016442	79015674
80 American		432483B	79016442	79015674
FB 2-30		432452A	432769	433317A
FB 2-32		432468	432894	433380
FB 2-35		432452A	432769	433317A
FB 2-45		432454	432854	433338
FB 2-50		432440	432586	433260A
FB 2-55		432456	432884	433365A
FB 2-60		432439A	432586	433261A
FB 2-62		432455	432854	433339A
FB 2-65		432457	432884	433365A
FB 2-70		432438C	na	433259
FB 2-75		432458	432884	433369
FB 2-85		432431D	432860	433243B
FB 2-88		432459	na	X433367
FB 2-105		432412E	432860	433220C
FB 2-110	Prior to SN 302445	432460	na	433368
FB 2-110	Eff. SN 302446	432467	na	433368
FB 2-135		432443D	432698A	433282B
FB 2-135 Series III		432461	432927	433370A
FB 2-150		432416A	432691	433222A
FB 2-155		432444B	432698A	433282B
FB 2-155 Series III		432461	432927	433370A
FB 2-180		432446A	432665	433292
FB 2-180 Series III		432463	432927	433372
FB 4-150		432408B	na	433249A
FB 4-175		432453	na	433329
FB 4-180		432414B	na	433219B
FB 4-210		432448	432665	79017301
FB 4-225		432465	na	X433375
FB 4-270		432464	432885	433374
FB 100		432481	432929	79014431
FB 120		432481	432929	79014431
WH 125		432486	432929	79014463
FB 140		432480	432929	79014435
WH 145		432486	432929	79014459
FB 160		432479	432929	79014433
WH 170		432487	432929	79014461
FB 185		432479	432929	79014433
WH 195		432487	432929	79014461
700	Canada only	na	na	433273A
6045	95	72201178	79017258	79017011
6065	93	72200690	79018268	na
6065 Cab		72200690	79018268	79014894



432443D



432460



432412E

# Operators Manuals, Parts Books, Service Manuals

MACHINE INFORMATION



432475



5016772M2



3378091M3

MUO	Serial No.	Operators Manual	Service Manual	Parts Book
<b>WHITE CONTINUED</b>				
6065 ROPS	Prior to SN 1500	72201406	79018268	79016722
6065 ROPS	Eff. SN 1501	72201406	79018268	79016624
6085		72200690	79018268	79017959
6085 Cab		72200690	79018268	79017959
6090	94	72200851	79018268	79016484
6105 Tractor		72200691	79017738B	79017006
6124	94	72505899	79016321	79019068
6125	95	72509648	79015815	79018762
6125	93	72503725	79015815	79018762
6125	94	72506795	na	79018762
6144	94	72505899	79016321	79019068
6145	95	72509648	79015815	79017151
6145	93	72503725	79015815	79017151
6145	94	72506795	79015815	79017151
6175	93	72503724	79015815	79017104
6175	94	72506795	79015815	79017104
6175	95	72509649	79015815	79017104
6195	93	72503724	79015815	79017104
6195	94	72506796	79015815	79017104
6195	95	72509649	79015815	79017104
6210E Tractor		na	79015815	79016908
6215	95	72509650	79015815	79018730
6410 Cab		1857083M1	1857089M91	79019864
6410 Footstep		1857119M1	1857089M91	79019864
6510 Cab		1857083M1	1857089M91	79019865
6510 Footstep		1857119M1	1857089M91	79019865
6710	J001001	3378091M1	79017540	79017787
6710	J117019	3378091M3	na	79019160
6810	J001001	3378091M1	79017540	79017786
6810	J117019	3378091M3	na	79019160
8310		3378093M1	79017545	79019860
8310	Cummins Supplement	na	na	79021593
8410		3378093M1	79017545	79019861
8410	Cummins Supplement	na	na	79021595
8510	2/98	5016772M2	79018655	79019131
8510	Eff. 2001	na	na	79019250
8510	Cummins Supplement	na	na	79021597
8610	2/98	5016772M2	79018655	79019132
8610	Eff. 2001	na	na	79019250
8610	Cummins Supplement	na	na	79021599
8710	2/98	5016772M2	79018655	79019139
8710	EFF. 2001	na	na	79019272
8710	Cummins Supplement	na	na	79021601
8810	2/98	5016772M2	79018655	79019139
8810	Cummins Supplement	na	na	79021603

# Operators Manuals, Parts Books, Service Manuals



3378091M1



702201411



4324748



337809M2



432416A



432448



432408B



432463



432465



1857083M1



432414B



432461

MUO	Notes	Operators Manual	Service Manual	Parts Book
<b>MINNEAPOLIS-MOLINE</b>				
G450	Can use for 2-50 except for engine	na	432586	na
<b>OLIVER</b>				
1355 Oliver		na	432586	na
1365 Oliver		na	432586	na
<b>ENGINES - TRACTORS</b>				
2-150 D585: also includes 425 LP, D451 & 504 LP		na	432691	na
2-85 6.354		na	432667B	na
2-105 6.354		na	432667B	na
3208 Caterpillar		na	432665	na
2500 Engine		na	na	79015473
2600 Engine		na	na	79015473



# Machine Accessories

Category 2 Quick Hitch



79023043V

UNIVERSAL ACCESSORIES

## Universal Quick Hitches

Part No.	Description	Weight (lb/kg)	Dimensions (in/cm)
<b>QUICK HITCHES</b>			
79023042V	Category 1	76 lbs.	30" x 10" x 24"
79023043V	Category 2	134 lbs.	38" x 9" x 23"
79023044V	Category 2 Heavy Duty	160 lbs.	38" x 9" x 25"
79023962V	Category 2/3	192 lbs.	43.5" x 9.5" x 28"
79023046V	Category 3 Narrow	176 lbs.	39" x 9" x 29"
79023045V	Category 3	182 lbs.	43.5" x 9" x 29"
<b>BUSHINGS</b>			
79023086V	Category 1 Bushing - Quick Hitch to Implement		1 pair
79023087V	Category 2 Bushing - Quick Hitch to Implement		1 pair
79023871V	Category 1, Upper Hook Only		1
79024009V*	Category 1, Lower Link Pin		1
79024010V*	Category 2, Lower Link Pin		1
79024012V*	Category 2/3, Lower Link Pin		1
79024011V*	Category 3, Lower Link Pin		1

\*Tractor to Quick Hitch

Quick Hitch includes one set of bushings

Quick Hitch Part No.	Handle Grip Part No.	Inner Spring Part No.	Bushing Kit Part No.	Handle Part No.	Lock Part No.	Inner Rod Part No.	Locking Pin Part No.
<b>QUICK HITCH REPLACEMENT COMPONENTS</b>							
79023042V	79026347V	79026348V	79023086V	79026350V	79026352V	79026355V	79024009V
79023043V	79026347V	79026348V	79026349V	79026350V	79026351V	79026353V	79024010V
79023044V	79026347V	79026348V	79026349V	79026350V	79026351V	79026356V	79026358V
79023962V	79026347V	79026348V	79026349V	79026350V	79026351V	79026356V	79026358V
79023045V	79026347V	79026348V	na	79026350V	79026351V	79026354V	79026357V
79023046V	79026347V	79026348V	na	79026350V	79026351V	79026354V	79026357V

## Universal Tractor Toolbox

Black Frame-Mount Toolbox  
Heavy-Duty



72160035V

Also order Bracket for attaching toolbox to tractor.  
Part No. 72509278



**Handi-Heat  
Magnetic Heater**  
- 110 Volts, 180 Watts  
79015643



**High-Lift Jack**  
- 7,000 lb. Capacity 48"  
19988A91



Part No.	Description
<b>SMV SIGNS</b>	
71379434	Galvanized
71379433	Decal Only

Part No.	Description
<b>SMV BRACKETS</b>	
19516A91	Support
79001235	Socket

# Decals, Decal Kits and Emblems

## Decal Application Instructions

Have the pitted area filled, sanded smooth, and painted. Wash newly painted area on which the decals are to be placed with soap and water. Allow to dry before proceeding.

**For Mylar Cut:** Trim to border of design where possible prior to removing white paper backing. Lightly spray the area with non-aerosol glass cleaner. Peel the white backing paper from decal and place in position. Squeegee window cleaner from under decal beginning in center and working outward. If air bubbles occur, puncture with a pin and smooth out air bubbles. Note: Decals have been printed on a tough mylar film using mylar ink. A pressure-sensitive adhesive on the back of the mylar helps ensure good adhesion to any clean, hard surface.

**For Vinyl-Cut Decals (where noted):** Peel backing paper from decal. The decal will be stuck to the application paper. Align the decal using the design, not the application paper, and firmly press decal into place. Slowly remove the application paper starting at one corner. Note: The colors are fused into the vinyl to eliminate stacking.

Store decals in cool, dry place. Do not soak in water.

Part No.	MUO	Description
<b>COCKSHUTT DECAL SETS</b>		
79024556V	20	Vinyl cut
79024548V	30	Vinyl cut
79024555V	40	Vinyl cut

Part No.	Description	MUO
<b>COCKSHUTT EMBLEMS</b>		
T11322V	Front nose	20
T8707V	Front nose, painted	30
TG8707V	Front nose	35, 40, 50
T11443V	Front nose	Co-op E2
T9736V	Front nose	Co-op E3
TG8736V	Front nose	Co-op E4

Part No.	MUO	Description
<b>OLIVER DECAL SETS</b>		
79024456V	60 Row Crop	
79024520V	66 Row Crop	Red Numbers
79024463V	66 Row Crop	Yellow Numbers
79024521V	66 Row Crop Diesel	Red Numbers
79024464V	66 Row Crop Diesel	Yellow Numbers
79024522V	66 Standard	Red Numbers
79024543V	66 Standard	Yellow Numbers



TG8736V



T11322V



T11443V



TG8707V



T8707V

# Decals, Decal Kits and Emblems

## Oliver Fact:

Prior to 1951, Oliver used red model numbers. In 1951, this changed to yellow decals and model numbers.

AESTHETICS

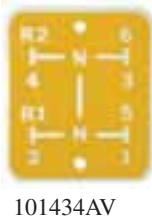

161109ASV



155948ASV



Part No.	MUO	Description
<b>OLIVER CONTINUED</b>		
79024523V	66 Standard Diesel	Red Numbers
79024459V	70 Industrial	
79024457V	70 Row Crop	
79024865V	Hart Parr 70 Row Crop	
79024524V	77 Row Crop	Red Numbers
79024465V	77 Row Crop	Yellow Numbers
79024525V	77 Row Crop Diesel	
79024466V	77 Row Crop Diesel	Yellow Numbers
79024526V	77 Standard	Red Numbers
79024545V	77 Standard	Yellow Numbers
79024527V	77 Standard Diesel	Red Numbers
79024546V	77 Standard Diesel	Yellow Numbers
79024460V	80 Row Crop	
79024461V	80 Standard	
79024469V	88 Industrial	
79024528V	88 Row Crop	Red Numbers
79024467V	88 Row Crop	Yellow Numbers
79024535V	88 Row Crop	Yellow Numbers
79024529V	88 Row Crop Diesel	Red Numbers
79024530V	88 Standard	Red Numbers
79024547V	88 Standard	Yellow Numbers
79024531V	88 Standard Diesel	Red Numbers
79024468V	88 Standard Diesel	Yellow Numbers
79024470V	99	
79024471V	99 Diesel	
79024481V	Early 550 Diesel	
79024480V	Early 550 Gas	
79024557V	Late 550	
79024483V	Early 660 Diesel	
79024482V	Early 660 Gas	
79024485V	Early 770 Diesel	
79024484V	Early 770 Gas	
79024487V	Early 880 Diesel	
79024486V	Early 880 Gas	
79024488V	Early 950 Diesel	
79024490V	Early 995 Diesel	
79024472V	Super 55 Diesel	
79024473V	Super 55 Diesel	
79024474V	Super 66	
79024475V	Super 66 Diesel	
79024477V	Super 77 Diesel	
79024478V	Super 88	
79024479V	Super 88 Diesel	
79024476V	Super 77	
79024536V	1550	Vinyl Cut, OEM Kit: 161109ASV
155948ASV	1600	
79024537V	1650	Vinyl Cut
79024538V	1750	Vinyl Cut, OEM Kit: 163401AV
79024539V	1850	Vinyl Cut

# Decals, Decal Kits and Emblems

AESTHETICS

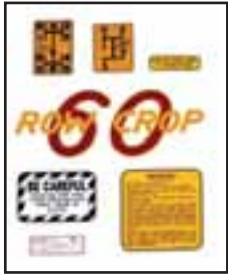

79024456V



79024457V



79024458V



79024459V



79024460V



79024461V



79024462V



79024463V



79024464V



79024465V



79024466V



79024467V



79024468V



79024470V

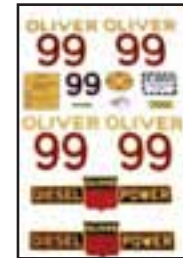

79024471V



79024472V

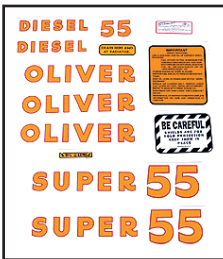

79024473V



79024474V



79024475V



79024476V



79024477V



79024478V

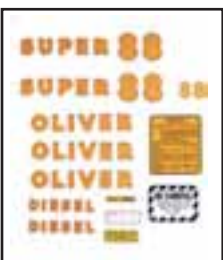

79024479V



79024480V



79024482V



79024483V



79024484V



79024485V



79024486V



79024487V



79024488V



79024490V



79024520V



79024521V



# Decals, Decal Kits and Emblems

AESTHETICS



79024522V



79024524V



79024525V



79024526V



79024527V



79024528V

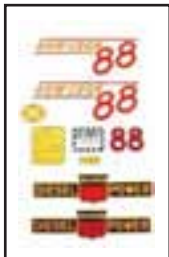

79024529V



79024530V



79024531V



79024535V



79024543V



79024544V



79024545V



79024671V



79024672V



79024546V



79024547V



79024863V



169007AV

Part No.	Description	MUO
<b>OLIVER EMBLEMS</b>		
79024671V	Front Emblem, 3 color	66, 77, 88 (1949 - early 1950)
79024672V	Front Emblem, 2 color	Super 44, Super 55, Super 66, Super 77, Super 88, Super 99 (1950 - 1959)
79024686V	Vertical Name Plate	44, 440
79024687V	Vertical Name Plate	Super 55
79024688V	Vertical Name Plate	66, Super 66, 660
79024689V	Vertical Name Plate	77, Super 77
79024690V	Vertical Name Plate	88, Super 88
79024691V	Vertical Name Plate	Super 99
101434AV	Shift Pattern Plate	66, 77, 88, Super 66, Super 77, Super 88, 660, 770, 880 (Prior to SN 73638)
169007AV	Side Name Plate 16" long x 1.25" wide	1550 & 1555 (Eff. SN 160000), 1650 & 1655 (Eff. SN 147569), 1750, 1755 (Eff. SN 220000), 1855 & 1955 (Eff. SN 220000), 1800 & 1900 (Eff. SN 124396), 1850 & 1950 (Eff. SN 150421), 1950T, 2050 & 2150, 2155, 2255 (Eff. SN 235650), 2655
79024912V	Ignition Switch Plate	66, 77, 88, Super 66, Super 77, Super 88, Super 99

# Decals, Decal Kits and Emblems



79024501V



79024502V



79024507V



79024864V

AESTHETICS

## Serial Number Plates For Restoration (Includes Rivets)



79025129V  
M-M- Z, RTU, and other popular models  
(5" L x 2-3/4"H)  
Blank (4-rivets)



79025130V  
M-M- ZB, 335, 445, etc.  
(5" L x 2-3/4"H)  
Blank (4-rivets)

Part No.	MUO	Description
<b>MINNEAPOLIS-MOLINE DECALS</b>		
10V31053	445, G1000 Row Crop Wheatland & Rice-Special, G1000 Vista, G1050 (PCR2193 & R2193), G707 & G708 2wd and 4wd, G900, G950, Jet Star 3 Super, M670 & M670 Super	Seat Under Ride ( 2-13/16" x 6-3/8")
10V23609	G1000 Row Crop Wheatland & Rice-Special, G1050 (PCR2193 & R2193), G900, G950, GTB, GTBD, GTC, Jet Star 3 Super, Jet Star 5-Star, M670 & M670 Super	Diesel Decal, (13/16" x 6-1/8")
10V23460	G1000 Row Crop Wheatland & Rice-Special, G1000 Vista, G1050 (PCR2193 & R2193), G707 & G708 2wd and 4wd, G900, G950, Jet Star 3 Super, M670 & M670 Super	Long Life Engine (4.75" Dia.) Vinyl Cut
10V23809	G1000 Row Crop Wheatland & Rice-Special, G1000 Vista, G900, M670 & M670 Super	"Minneapolis-Moline" Name Plate (7/8"x16") Vinyl Cut



10V23809



10V23460

- Anodized Aluminum
- Will work for engine or transmission serial numbers

# Decals, Decal Kits and Emblems

AESTHETICS



79024449V



79024450V



79024451V



79024453V



79024455V



79024500V



169007AV

Part No.	Application
<b>MINNEAPOLIS-MOLINE DECAL SETS</b>	
79024449V	U
79024450V	R
79024451V	Z
79024452V	UB
79024453V	ZB
79024454V	G
79024534V	5 Star (Black)
79024455V	M5 (Red)
79024507V	M5 (Black)
79024500V	4 Star (Red)
79024501V	4 Star (Black)
79024502V	4 Star Super (Red)

Part No.	Description	Application
<b>MINNEAPOLIS MOLINE SIDE PLATE</b>		
169007AV	G750, G955, G1350, G1355	Side Name Plate

Part No.	Description
<b>WHITE DECALS</b>	
<b>FB 2-75</b>	Vinyl Cut
33V0061034	Speed Chart
33V0054658	Lubrication Maintenance
33V0057770	Operator Safety
33V0033766	Draft Control
33V0033774	Position Control
33V0033731	Creeper & PTO
33V0033782	Instrument Panel
33V0033790	External Port
33V0054666	Steering Wheel Cap
33V0015865	Warning PTO Shield
33V0057789	Don't be Careless PTO
33V0051373	Ether Warning
33V0054925	Caution Hydraulic Element
33V0054682	PTO Adjustment
33V0054690	Caution PTO Engagement

Part No.	Description	Application
<b>WHITE EMBLEMS</b>		
33V0054607	WFE Side Panel Emblem	FB 2-75

# Paint Application Guide

Use this Machine Locator to identify key paint locations on your tractor: Trim, Sheet Metal, Chassis, Wheels, and Center Wheel Dish/Disc.

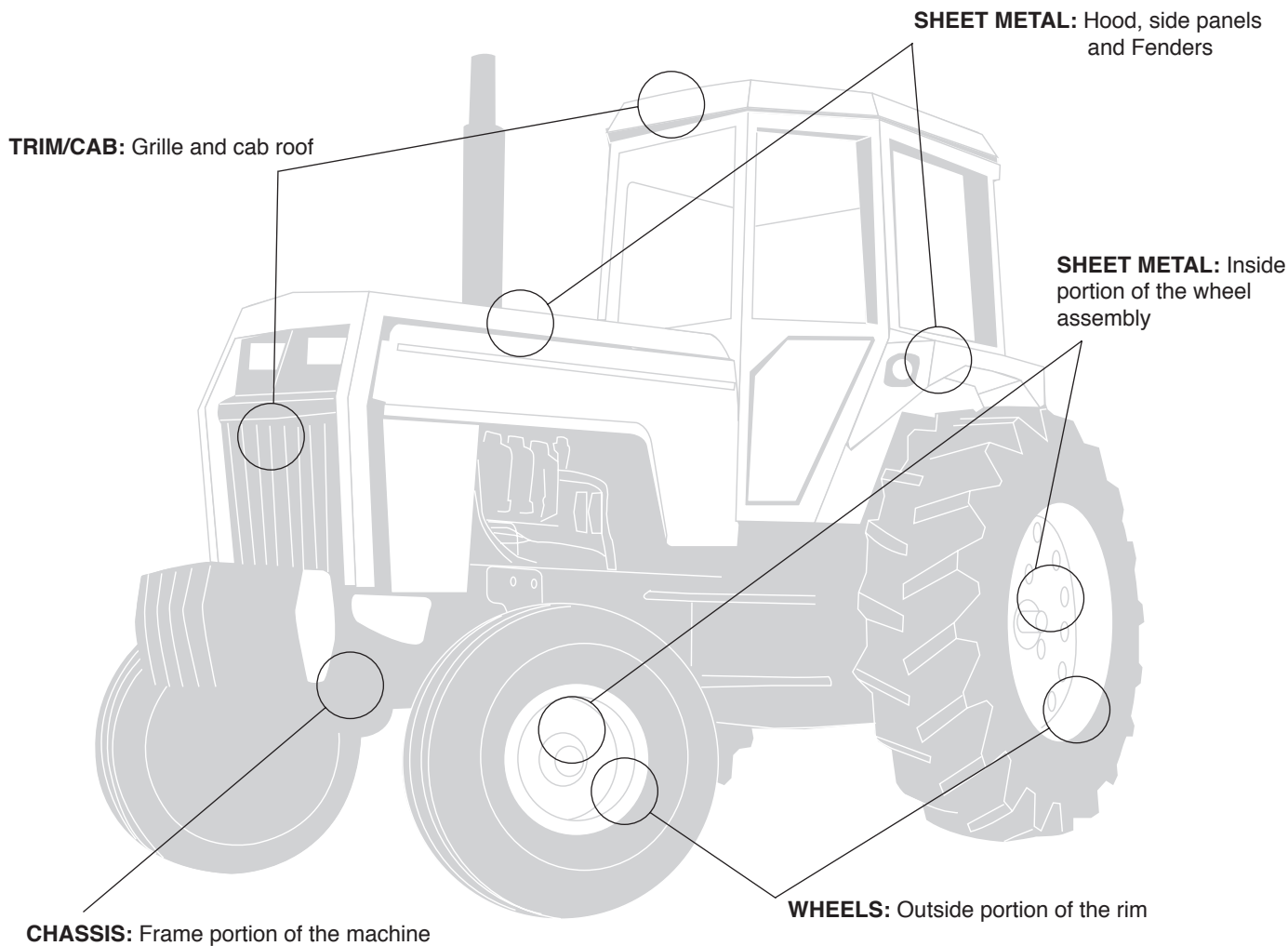

<b>WHITE</b>			
<b>Make &amp; Years</b>	<b>Sheet Metal</b>	<b>Wheels</b>	<b>Trim/Cab</b>
1975-1986	Argent Silver	Charcoal Gray Metallic	-
1982-1986	Argent Silver	Charcoal Gray Metallic	-
1986-1991	Argent Silver	Corporate Wheel Gray	Charcoal Gray Gloss
1992-2002	Corporate Silver	Corporate Wheel Gray	Black Gloss
American 60 & 80 Series	FW III Red	Bossline White	Bossline White
White Combines	Combine Red	Bossline White	Bossline White (Cab Roof)

<b>OLIVER</b>			
<b>Make &amp; Years</b>	<b>Sheet Metal</b>	<b>Wheels</b>	<b>Trim/Cab</b>
1940-1957	Meadow Green	Southbend Red	Industrial Yellow
1957-1974	Meadow Green	Clover White	Clover White



# Paint Application Guide

AESTHETICS



- Original Equipment Colors
- Original Equipment Quality
- Fast-Drying Formula

Most colors are available in quarts, aerosols and gallons

ARGENT SILVER



CLOVER WHITE

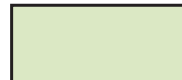

MEADOW GREEN



WFE RED



PRAIRIE GOLD



Description	Aerosol Part No.	Quart Part No.	Gallon Part No.
<b>FAST DRYING FORMULATION PAINTS</b>			
Argent Silver	79014836	79014811	79014810
Corporate Silver	79014803	79014802	79014801
Corporate Wheel Gray	79016947	79016946	na
Charcoal Gray	79014839	79014816	79014814
Charcoal Gray Metallic	79014838	79014815	na
Bossline White	79014833	79014807	na
Clover White	79014832	79014806	na
Meadow Green	79014831	79014805	79014804
Southbend Red	20-7002256	na	na
Combine Red	20-7002255	20-7002850	na
WFE III Red (M-M Red)	79015804	79015803	79015802
Industrial Yellow	79014835	79014809	na
Prairie Gold	79014834	79014808	na

Description	Aerosol Part No.
<b>MUFFLER PAINT</b>	
Hi-Temp Aluminum	79015023
Hi-Temp Black	79014480
Description	Gallon Part No.
<b>THINNER</b>	
Thinner	79015024

Description	Aerosol Part No.	Quart Part No.	Gallon Part No.
<b>PRIMER</b>			
Red Oxided Primer	1904943M1	1904945M1	na
Gray Primer	79014483	79014481	79014482

## Prime First

It's the foundation for a sound paint job.

## Why Prime?

- Primer seals the surface to provide a uniform, even gloss finish.
- Primer penetrates and bonds to allow for best topcoat adhesion.
- Primer provides the maximum rust resistance for maximizing the life of the finish coat.

Dealer: Order Paint, Primer and Thinner on AGCO Paint Direct-Ship Promo 265.

# Sheet Metal



HS1377V



HS1378V



HS861V

AESTHETICS



HS860V



HS1016V

Sheet Metal is shipped with a primer coat only and must be top-coat painted upon receipt to match tractor color.

## COCKSHUTT

Part No.	Description	MUO
<b>FRONT GRILLE</b>		
79024417V	LH & RH Front Grille w/screen (Set)	20, Co-op E2
79024418V	LH & RH Front Grille w/screen (Set)	30, Co-op E3
79024419V	LH & RH Front Grille w/screen (Set)	35, 40, 50, Co-op E4, E5

## OLIVER

Part No.	Description	MUO
<b>FENDERS</b>		
HS861V	LH Fender	60
HS860V	RH Fender	60
<b>SIDE CURTAIN PANELS &amp; COMPLETE SETS</b>		
79024656V	<b>SET</b> Front & Rear 4-piece side curtain set with correct handle position	60 Row Crop
79024657V	Front RH & LH, 2-piece side curtain set	60 Row Crop
HS1377V	Front RH Side Curtain	60 Row Crop
HS1378V	Front LH Side Curtain	60 Row Crop
79024658V	Rear RH & LH, 2-piece side curtain set	60 Row Crop
HS1015V	Rear RH Side Curtain	60 Row Crop
HS1016V	Rear LH Side Curtain	60 Row Crop
79024667V	<b>SET</b> Front & Rear 4- piece side curtain set with correct handle position	60 Standard & Industrial
79024657V	Front RH & LH, 2-piece side curtain set	60 Standard & Industrial
HS1377V	Front RH Side Curtain	60 Standard & Industrial
HS1378V	Front LH Side Curtain	60 Standard & Industrial
79024669V	Rear RH & LH, 2-piece side curtain set	60 Standard & Industrial
HS1015V	Rear RH Side Curtain	60 Standard & Industrial
HS1016V	Rear LH Side Curtain	60 Standard & Industrial
79024659V	<b>SET</b> Front & Rear 4- piece side curtain set with correct handle position	70 Row Crop
79024661V	Front RH & LH, 2-piece side curtain set	70 Row Crop
79024660V	Front RH Side Curtain	70 Row Crop
79024662V	Front LH Side Curtain	70 Row Crop
79024664V	Rear RH & LH, 2-piece side curtain set	70 Row Crop
79024663V	Rear RH Side Curtain	70 Row Crop
79024665V	Rear LH Side Curtain	70 Row Crop

## OLIVER

Part No.	Description	MUO
<b>FRONT ENGINE PANEL SETS</b>		
79024676V	Louvered	66, 77. Gas
79024692V	Louvered	88 Gas or Diesel
79024674V		Super 77

# Cab Interior

AESTHETICS



## Benefits of Refurbishing a Cab

- Cleaner, more comfortable work environment
- Insulates cab from noise
- Reduces vibration
- Increases resale value of used machinery

A complete cab interior kit consists of a headliner and cab upholstery.

A lower upholstery kit does not include a headliner.

*Floor mats and Spray adhesive not included in kit but are available seperately. (See next page)*

### HEADLINERS

Kit No.	MUO	No. of Pieces	Color
79022936V	FB 100, 120, 140, 160, 185, WH 125, 145, 170, 195 (Series III) American Series 60, 80 (Prior to SN 405028)	1	Gray
79022962V	FB 2-88, FB 2-110, FB 2-135, FB 2-155, FB 2-180 (Series III)	1	Red
79022966V	FB 4-225, FB 4-270	2	Gray
79022967V	FB 4-225, FB 4-270	2	Red

### CAB KITS

#### WHITE

Kit No.	MUO	No. of Pieces	Color
79022973V	Complete Kit Fits: FB 2-135, FB 2-155 (1976 -1979), (EM) (With 1" Headliner)	4	Red
79022974V	Complete Kit Fits: FB 2-85, FB 2-105, FB 2-150 (1976 -1979), (EM) (With 1" Headliner)	4	Red
79022975V	Complete Kit Fits: FB 2-135, FB 2-155, FB 2-180 (1979 - 1982), (LM) (2" Headliner, Padded Cowel)	9	Red
79022976V	Complete Kit Fits: FB 2-85, FB 2-105 (1979 -1982), (LM) (With 2" Headliner)	6	Red
79022937V	Lower Kit Fits: FB 100, 120, 140, 160, 185, WH 125, 145, 170, 195 (With Manual Seat)	19	Gray
79023033V	Lower Kit Fits: FB 100, 120, 140, 160, 185, WH 125, 145, 170, 195 (With Air Ride Seat )	19	Gray
79023034V	Lower Kit Fits: FB 100, 120, 140, 160, 185, WH 125, 145, 170, 195 (Series III)	19	Gray
79022963V	Lower Kit Fits: FB 2-88, FB 2-110, FB 2-135, FB 2-155, FB 2-180 (Series III)	21	Red
79022964V	Complete Kit Fits: FB 4-150, FB 4-180	8	Red
79022965V	Complete Kit Fits: FB 4-175, FB 4-210	7	Red
79022968V	Lower Kit Fits: FB 4-225, FB 4-270 (Gray Update)	23	Gray
79022969V	Lower Kit Fits: FB 4-225, FB 4-270	23	Red
79022970V	Complete Kit Fits: 8600, 8800 Combine (EM)	10	Black
79022971V	Complete Kit Fits: 8600, 8800 Combine (LM) (With Padded Right Hand Console)	14	Black
79022972V	Complete Kit Fits: 8700, 8900, 8920 Combine	9	Black
79022955V	Complete Kit Fits: 9700, 9320, 9720 Combine	7	Black
<b>OLIVER</b>			
79022977V	Complete Kit Fits: 1755, 1855, 1955, 2255 Category II Hitch	5	Black
79022978V	Complete Kit Fits: 1755, 1855, 1955, 2255 Category III Hitch	5	Black
<b>MINNEAPOLIS-MOLINE</b>			
79022977V	Complete Kit Fits: 955 -1355 (With Category II Hitch)	5	Black
79022978V	Complete Kit Fits: 955-1355 (With Category II Hitch)	5	Black
<b>AFTERMARKET</b>			
79022981V	Year A Round (Add-on Cab) Various AGCO Models	7	Black
79022982V	Hiniker Cab (Add-on Cab) Various AGCO Models	7	Black

FB = Field Boss WH = Work Horse

# Cab Interior



AESTHETICS

These before-and-after pictures were taken of a 1979 White 2-180 Field Boss tractor as it was readied for sale. By using a complete cab kit (Part No. 79022975V) and a pre-cut floor mat (Part No. 79022999V), the tractor owner was able to restore his 2-180 to its former beauty. The most critical part of the whole job was ensur-

ing the old material was completely cleaned off before adhesive was applied and the new pieces added.

*The tractor sold quickly and now lives and works in central Illinois.*

*- Photos courtesy of Jim Kaus*

## FLOOR MATS, PRE-CUT

### WHITE

Kit No.	MUO	Description	Color
79022998V	FB 2-85, FB 2-105, FB 2-150	One Piece	Black
79022999V	FB2-135, FB 2-155, FB 2-180	One Piece	Black
79023000V	FB 4-150, FB 4-180	One Piece	Black
79023001V	FB 4-175, FB 4-210	One Piece	Black

### OLIVER

79023002V	1755, 1855, 1955, 2255	One Piece	Black
-----------	------------------------	-----------	-------

### MINNEAPOLIS-MOLINE

79023002V	1955, 1355		Black
-----------	------------	--	-------

## ADHESIVE

Part No.	Description	Pack Quantity
79023003V	3M 74 Foam Fast Orange Adhesive - When sprayed on upholstery and the piece is placed into position, this adhesive allows for a little movement and dries almost immediately on contact.	12 Cans per Case
79023004V	Pro Bond Adhesive - When sprayed on upholstery and the piece is placed into position, this adhesive is more forgiving and allows for some movement before drying.	12 Cans per Case



# Air Conditioning

AESTHETICS



MUO

Part No.

## BLOWER MOTORS

### WHITE

FB 2-85	72162089V
FB 2-88	72162089V
FB 2-105	30V3156508
FB 2-110	72162089V
FB 2-135, FB 2-155	72162089V
FB 2-135 Series III, FB 2-155 Series III	72162089V
FB 2-150	30V3156508
FB 2-155	72162089V
FB 2-180	72162089V
FB 2-180 Series III	72162089V
FB 4-180	30V3378543 - CW 20V7002066 - CCW
FB 4-210 (Eff. SN 295391)	30V3378543
FB 4-225	30V3378543
FB 4-270	30V3378543
FB 100, FB 120	72162089V
FB 140	72162089V
FB 160, FB 185	72162089V
WH 125, WH 145, WH 170, WH 195	72162089V
<b>OLIVER, MINNEAPOLIS-MOLINE</b>	
1755, 1855, 1955, 2255, 2655	30V3156508
G955, G1050, G1350, G1355	30V3156508

MUO

Serial No.

Receiver Dryer  
Part No.

Condenser  
Part No.

Expansion Valve  
Part No.

Evaporator  
Part No.

Compressor  
Part No.

## AIR CONDITIONING SYSTEMS

### WHITE

FB 2-105		30V3224724	30V3175227	30V3178706	30V3174247	30V3075699
FB 2-110		72161835V	72503630V	30V3178706	30V3174247	72162168V
FB 2-135, 2-155		72161835V, 30V3224724	72503630V	30V3178706	30V3174247	30V3075699
FB 2-135 Series III	SN 300928-400417	72161835V	72503630V	30V3178706	30V3174247	72162168V
FB 2-155 Series III						
FB 2-135 Series III, FB 2-155 Series III	Eff. SN 400418	72161835V	72503630V	72506807V	72162194V	72162168V
FB 2-150		30V3224724	30V3175227	30V3178706	30V3174247	30V3075699
FB 2-155		30V3224724	72503630V	30V3178706	30V3174247	30V3075699
FB 2-180		30V3224724	72503630V	30V3178706	30V3174247	30V3075699
FB 2-180 Series III		72161835V	72503630V	30V3178706	30V3174247	30V3075699
FB 2-85	SN 263341-277181	30V3224724	30V3175227	30V3178706	30V3174247	30V3075699 Tecumseh, 30V3075699 York

FB = Field Boss

WH = Work Horse

# Air Conditioning

MUO	Serial No.	Receiver Dryer Part No.	Condenser Part No.	Expansion Valve Part No.	Evaporator Part No.	Compressor Part No.
<b>AIR CONDITIONING SYSTEMS CONTINUED</b>						
<b>WHITE CONTINUED</b>						
FB 2-85	Eff. SN 277181	72161835V	72503630V	30V3178706	30V3174247	30V3075699 Tecumseh, 30V3075699 York
FB 2-88		72161835V	72503630V	30V3178706	30V3174247	72162168V
FB 4-150		30V3224724	30V3114643	20V7000453	na	30V3075699
FB 4-175		30V3224724	72503630V	30V3178706	30V3377180	30V3075699
FB 4-180		30V3224724	30V3114643	20V7000453	na	30V3075699
FB 4-210	SN 275572-295390	30V3224724	72503630V	30V3178706	30V3377180	30V3075699
	Eff. SN 295391	72161835V		30V3178706	30V3377180	30V3075699
FB 4-225		72161835V	72503630V	30V3178706	30V3377180	72162168V
FB 4-270		72161835V	72503630V	30V3178706	30V3377180	72162168V
FB 100, FB 120, FB 140, FB 160, FB 185		72161835V	72503630V	72506807V	72162194V	72162168V
WH 125, WH 145, WH 170, WH 195		72161835V	72503630V	72506807V	72162194V	72162168V
<b>OLIVER, MINNEAPOLIS-MOLINE</b>						
1755, 1855, 1955, 2255, 2655		731157V	10V3948	20V7000453	na	30V3075699
G955, G1050, G1350, G1355	SN PCR2192 & R2193	731157V	10V3948	20V7000453	na	30V3075699

AESTHETICS

**MUO Part No.**  
**COMPRESSOR CONVERSION KIT TO SANKYO**

Description	Part No.
FB 2-135, FB 2-155	20V7101165

**Description Part No.**  
**REFRIGERANT**

Description	Part No.
R134A - 12 oz./1lb. Can	71369762
R134A - 30lb. Cylinder	79018664

**Description Part No.**  
**REFRIGERANT OIL**

Description	Part No.
1 Quart	70256635

**Description Part No.**  
**INSULATION TAPE**

Description	Part No.
2" W x 30' L	20-7001443



72161835V



20V7101165



79016405V

**Part No. MUO**  
**WINDSHIELD WIPER MOTOR**

79016405V	<b>White</b> - FB 2-150, FB 2-105, FB 2-180, FB 2-85, 2-155 , FB 4-175, FB 4-210, FB 100, FB 120, FB 140, FB 160, FB 185, WH 125, WH 145 <b>Oliver</b> - 1550, 1555 <b>M-M</b> - G750
-----------	---

# Knobs, Levers and Boots

AESTHETICS



BA916AV



700349V



70242338V



72094054V



70202862V



70206456V

Part No.	Description	Application/Notes
<b>KNOBS AND LEVERS</b>		
<b>COCKSHUTT</b>		
70206456V	Gear Shift, Ball Type	3/8" I.D., 3/4" deep
70202862V	Gear Shift Lever	20, Co-op E2
79024781V	Gear shift boot	2-1/4" bottom I.D., 7/16" hole diameter
BA916AV	30, 35, 40, 50, Blackhawk 50	1-7/8" bottom I.D., 1/2" hole diameter
<b>MINNEAPOLIS-MOLINE</b>		
70206456V	Gear Shift Knob, Ball Type	3/8" I.D., 3/4" deep
70202862V	Gear Shift Knob	G955, G1355
79024781V	Gear Shift Boot	2-1/4" bottom I.D., 7/16" hole diameter
BA916AV	Gear Shift Boot	G750, G950, G955, G1355 1-7/8" bottom I.D., 1/2" hole diameter
700349V	Handle, Transfer Case Shifting Lever	G VI, G705 G706 G707 G708 -2 & 4 Wheel Drive 2-1/4" bottom I.D., 7/16" hole diameter
<b>OLIVER &amp; WHITE</b>		
70206456V	Gear Shift Knob, Ball Type	<b>Oliver</b> - 66 through 2-70
70202862V	Gear Shift Knob	55, 550, 60, 66, 70, 77, Super 77, 770, 88, Super 88, 880, 1550, 1600, 1650, 1655, 1750, 1755, 1800, 1850, 1855, 1950, 1955, 2050, 2150, 2255 <b>White</b> - 2-70, 2-85, 2-88, 2-105, 2- 110, 2-135, 2-150, 2-180, 4-150, 4-180, 4-270
72094054V	Knob, Final Drive	<b>Oliver</b> - 1250, 1250-A, 1255 (Eff. SN 303397), 1265, 1270, 1355 (Eff. SN 503289), 1365, 1370, 1450 (Eff. SN 132382), 1465 & 1470 <b>White</b> - FB 2-50, FB 2-60, 700
70242338V	Control Knob, Threaded	<b>Oliver</b> - 1550 & 1555 (Eff. SN 160000), 1650 & 1655 (Eff. SN 147569), 1750, 1800 & 1900 (Eff. SN 90525), 1850, 1950, 1950T (Eff. SN 194080), 2050, 2150 (Eff. SN 204001), 66, Super 66, 77, Super 77, 770, 880 (Eff. SN 66271), 950, 990, 995 (Eff. SN 80826) <b>M-M</b> - G750 (Eff. SN 147569) <b>White</b> - 2-70 FB
BA916AV	Gear Shift Boot	<b>Oliver</b> - 55, 60, 66, 70, 77, 80, 88, Supers, 550, 660, 770, 880, 1550, 1555, 1600, 1650, 1655, 1750, 1755, 1850, 1855, 1950, 1955, 2050, 2150, 2255 <b>White</b> - 2-70, 2-85, 2-105, 2-150, 4-150, 4-180 1-7/8" bottom I.D., 1/2" hole diameter

# Seats and Components



20V7002123



3705112V91



72161852V

AESTHETICS

MUO	Description	Color	OEM Part No.	Heritage Part No.
<b>WHITE</b>				
FB 2-62, FB 2-78, FB 4-78	Seat Bottom, Wood Based	Black	105812ASB, 20-7002120	20V7002120
	Vinyl Seat Bottom Cover		105808A	20V7002133
	Backrest, Wood Based		20-7002122	20V7002122
	Vinyl Backrest Cover		156255A	156255AV
FB 2-62, FB 2-78, FB 4-78	Shock Absorber, Oil Filled		159836A	159836AV
	Vinyl Cushion, Wood Based	White	159859A, 20-7002123	20V7002123
	Vinyl Cover w/ Drawstring		164360A, 20-7002127	20V7002127
	Vinyl Backrest, Wood Based		159860A, 20-7002124	20V7002124
	Vinyl Backrest Cover w/ Zipper Closure		164361A, 20-7002128	20V7002128
	Vinyl Upper Backrest, Wood Based		159992A, 20-7002125	20V7002125
FB 21, FB 2-32, FB 37	Seat Cushion		33-0073075	3607775V91
	Seat Backrest		33-0071676	72165294V
FB 43	Seat Assembly		33-0140384	3705112V91
FB 2-70, FB 2-85, FB 2-105, FB 2-150	Shock Absorber, Oil Filled		159836A	159836AV
	Seat Bottom, Wood Based, Vinyl	Red	30-3139611	20V7002129
	Backrest, Wood Based, Vinyl		30-3139603	20V7002131
FB 4-150, FB 4-180	Upper Backrest, Wood Based, Vinyl		30-3169766	20V7002130
	Oil Filled Shock Absorber		159836A	159836AV
	Seat Bottom, Wood Based, Vinyl	Black	30-3171906, 30-3171930	30V3171930
	Backrest, Steel Based, Vinyl		30-3171914, 30-3171949	30V3171949
<b>Deluxe Seat</b>				
FB 2-85, FB 2-105, FB 2-135, FB 2-155, FB 2-180 Combines: 8700, 8900, 8920	Shock Absorber, Oil Filled		159836A	159836AV
	Vinyl Cushion, Bracket Style, Steel Based	Black	30-3225275	30V3225275
	Backrest, Steel Based, Vinyl		30-3225283	30V3225283
	Armrest, Left		30-3225348	72161821V
	Armrest, Right		30-3225356	72161822V
<b>Standard Seat</b>				
WH 125, WH 145, WH 170, WH 195, FB 100, FB 120, FB 140, FB 160, FB 185 FB 2-85, FB 2-88, FB 2-105, FB 2-110, FB 2-135 & 2-155, FB 2-180, FB 2-135 Series III, FB 2-155 Series III, FB 2-180 Series III	Cavalry Red Fabric Seat Assembly		30-3382354, 72161852	72161852V
	Cushion, Steel Based, Fabric	Red	30-3342662, 30-3374238	30V3374238
	Backrest, Steel Based, Fabric		30-3342638, 30-3374254	30V3374254
	Cushion, Steel Based, Vinyl	Black	30-3374211, 30-3343030	30V3343030
	Backrest, Steel Based, Vinyl		30-3225283, 30-3343022	30V3225283
	Armrest, Left		30-3225348	72161821V
	Armrest, Right		30-3225356	72161822V
	Shock Absorber, Standard Seat		72162151	72162151V
	Bracket, Seat Mounting		30-3342689	72162681V



# Seats and Components



K945V



70204229V



K1854AV



K1854V



ES1854V



30V3325075

AESTHETICS

MUO

Part No.

**OLIVER**

**Rubber Seat Bushings**

66, 77, 88	K1854V
Super 55 (Eff. SN 18135), 550	ES1854V
Super 66, Super 77, Super 88, Super 99, 660, 770, 880, 950, 990 (Eff. Mid 1951)	K1854AV

MUO

Description

Color

OEM Part No.

Heritage Part No.

**WHITE CONTINUED**

**Air Ride Seat**

FB 100, FB 120, FB 140, FB 160, FB 185, WH 125, WH 145, WH 170, WH 195, American Series 60, 80

Seat Assembly	Gray	72502480	72502480V
Seat Headrest		30-3450538	72162446V
Seat Backrest		30-3450511	72162445V
Seat Cushion		30-3450333	72162429V
Arm Rests, Left and Right Sides		30-3450546	72162447V
Air Suspension Spring		30-3449793	71365277V
Air Suspension Compressor		30-3449823	72271386V

**Bostrom Seat**

FB 4-175, FB 4-210, FB 4-225, FB 4-270

Seat Cushion, Vinyl	Black	30-3325830, 30-3386279	30V3386279
Seat Backrest, Vinyl		30-3325849, 30-3386260	30V3386260
Shock Absorber Kit		30-3325075	30V3325075

MUO

Description

Color

OEM Part No.

Heritage Part No.

**OLIVER**

Super 44, 55, 550, 66, 660, 77, 88, 880, 950, 990, 995	Pan Seat: Tie-on Cover w/Foam, Deluxe Foam 21"	White/ Green	K945	K945V
770, 880, 1550, 1555, 1650, 1655, 1800, 1900	Seat Bottom, Wood Based	Black	105812ASB, 20-7002120	20V7002120
	Vinyl Seat Bottom Cover		105808A	20V7002133
	Backrest, Wood Based		20-7002122	20V7002122
	Vinyl Backrest Cover		156255A	156255AV
1550, 1650, 1750, 1850, 1950, 1950T, 2150, 2270, 1555, 1655, 1755, 1855, 1955, 2255	Oil Filled Shock Absorber		159836A	159836AV
	Vinyl Cushion, Wood Based	White	159859A, 20-7002123	20V7002123
	Vinyl Cover with Drawstring		164360A, 20-7002127	20V7002127
	Vinyl Backrest, Wood Based		159860A, 20-7002124	20V7002124
	Vinyl Backrest Cover w/ Zipper Closure		164361A, 20-7002128	20V7002128
	Vinyl Upper Backrest, Wood Based		159992A, 20-7002125	20V7002125
2155, 2655	Seat Bottom, Wood Based, Vinyl	Black	10P3477	10V3477
	Backrest, Wood Based, Vinyl		10P3029	10V3029
	Upper Backrest, Wood Based, Vinyl		10P3479	10V3479

FB = Field Boss WH = Work Horse

# Seats and Components



10V3479



10V3477



10V3029

MUO	Description	Color	OEM Part No.	Heritage Part No.
<b>MINNEAPOLIS-MOLINE</b>				
GTB, 335, U, GB	Pan Seat: Seat Pad, 1" Poly Foam, 21"	Orange/White	70204229	70204229V Economy
	Pan Seat: Seat Pad, 1" Heavy Duty Foam, 21"	Orange/White	70231536	70231536V Deluxe
ZB, ZAS, ZAU, ZAS, ZAN, AZE, R, GTB, GTBD, GTC, U	Pan Seat: Seat Pad, 1" Heavy Duty Foam, 21"	Yellow	10R80A	10R80AV Deluxe
G-VI, JetStar 3, JetStar 4, M5, M504, M602, M604, M705, M706, U302, BIG MO 400, 500, 600	Seat Bottom, Wood Based, Vinyl	Must. Gold	10P2720	10V2720
	Backrest, Wood Based, Vinyl		10P1632	10V1632
ZAU, ZAS, ZAN, AZE, R, RTI, UTI & UTIL Industrial Wheelers	Seat Bottom, Wood Based, Vinyl	Must. Gold	10A489	10V489
	Backrest, Wood Based, Vinyl		10A490	10V490
G750, G955, G1355	Oil Filled Shock Absorber		159836A	159836AV
	Vinyl Cushion, Wood Based	White	159859A, 20-7002123	20V7002123
	Vinyl Cover with Drawstring		164360A, 20-7002127	20V7002127
	Vinyl Backrest, Wood Based		159860A, 20-7002124	20V7002124
	Vinyl Backrest Cover w/ Zipper Closure		164361A, 20-7002128	20V7002128
	Vinyl Upper Backrest, Wood Based		159992A, 20-7002125	20V7002125
	G750	Seat Bottom, Wood Based	Black	105812ASB, 20-7002120
Vinyl Seat Bottom Cover			20-7002133, 105808A	20V7002133
Backrest, Wood Based			105809A, 105811A, 156231AS	20V7002122
Vinyl Backrest Cover			156255A	156255AV
A4T1440, A4T1600, G705, G706, G707, G708, G900, G950, G1000, G1000 Vista, G1050, G1350, Jet Star 3, M602, M670, M670 Super, U302	Seat Bottom, Wood Based, Vinyl	Black	10P3477	10V3477
	Backrest, Wood Based, Vinyl		10P3029	10V3029
	Upper Backrest, Wood Based, Vinyl		10P3479	10V3479

# Gauges, Meters

AESTHETICS



10V23140



72161801V



43349165V



30V3485587

MUO	Serial No.	Fuel Gauge Part No.	Tachometer & Hour Meter Part No.	Oil Pressure Part No.	Ammeter Part No.	MultiMeter Part No.	Water Temp Part No.
<b>WHITE</b>							
FB 2-50		na	na	na	na	4334916V	na
FB 2-60		na	na	na	na	4334916V	na
FB 2-70		72161800V	3609808V91	530558V1	na	na	na
FB 2-85		72161800V	10V23140	72161799V	72161801V	na	70277471V
FB 2-88		72161800V	30V3385787	72161799V	72161801V	na	70277471V
FB 2-105	SN 255216 - 297446	72161800V	30V3485420 (SN 255216- SN 255615), 10V23140 (Eff. SN 255616)	72161799V	530562V1	na	na
FB 2-110		72161800V	30V3385787	72161799V	72161801V	na	70277471V
FB 2-135		72161800V	30V3385787	72161799V	72161801V	na	70277471V
FB 2-135 Series III		72161800V	na	72161799V	72161801V	na	70277471V
FB 2-150		72161800V	10V23140	72161799V	72161801V	na	70277471V
FB 2-155		na	30V3485439	72161799V	na	na	na
FB 2-155		72161800V	30V3485439	72161799V	72161801V	na	70277471V
FB 2-155 Series III		72161800V	na	72161799V	72161801V	na	70277471V
FB 2-180		72161800V	na	72161799V	72161801V	na	70277471V
FB 4-150		72161800V	na	na	530562V1	na	na
FB 4-180		72161800V	30V3485439 (SN 24600 - SN 275351)	79017409V	530562V1	na	na
FB 100		72161800V	72512513	72161799V	72161801V	na	70277471V
FB 120		72161800V	72512513	72161799V	72161801V	na	70277471V
WH 125		72161800V	72512513	72161799V	72161801V	na	70277471V
FB 140		72161800V	72512513	72161799V	72161801V	na	70277471V
WH 145		72161800V	72512513	72161799V	72161801V	na	70277471V
FB 160, 185	SN 400659 - 401045	72161800V	na	72161799V	72161801V	na	70277471V
FB 160, 185	Eff. SN 401046	72161800V	72512513	72161799V	72161801V	na	70277471V
WH 170, 195		72161800V	72512513	72161799V	72161801V	na	70277471V

FB = Field Boss  
WH = Work Horse

# Gauges, Meters



IK528EV



IHA7353V



IHA344AV

MUO	Serial No.	Fuel Gauge Part No.	Tachometer & Hour Meter Part No.	Oil Pressure Part No.	Ammeter Part No.	MultiMeter Part No.	Water Temp Part No.
<b>OLIVER</b>							
Super 44, Super 55, 66, Super 66, 77, Super 77, 88, Super 88, 440, 660				IHA344AV*	IHA7353V* (20-20)		IK528EV* (Cold-Work-Hot) 79024380V 100 °-200° Range
Super 44	Eff. SN 1001	na	na	na	528418V92	na	na
Super 55		na	3609808V91	na	na	na	na
	Eff. SN 51377	na	30V3485587	na	na	na	na
66, Super 66		na	3609808V91	528415V91	528418V92	na	K528AV
77, Super 77		na	3609808V91	528405V91	na	na	na
88, Super 88	RC Diesel Prior to Eng. SN 6502 RC 120001 - 41802 STD. 820001 - 6502	na	na	528415V91	na	na	K528AV
88, Super 88	RC & STD. Eff. SN 6503 RC-Eff. SN 41803	na	3609808V91	na	na	na	30V3485587
440	Eff. SN 1001	na	na	na	528418V92	na	na
660		na	3609808V91	528415V91	528418V92	na	K528AV
770		na	3609808V91	na	na	na	na
880		na	3609808V91	na	na	na	na
1250A	Eff. 3SN. 60745	na	na	na	na	4334916V	na
1255	Eff. SN 303397	na	na	na	na	4334916V	na
1270	Eff. SN 000001	na	na	na	na	4334916V	na
1355	Eff. SN 503289	na	na	na	na	4334916V	na
1365	Eff. SN 000001	na	na	na	na	4334916V	na
1370	Eff. SN 000001	na	na	na	na	4334916V	na
1550		72503551V (- Grid), 72503552V (+ Grid) (Eff. SN 160000)	3609808V91 (Eff. SN 160000)	528415V91 (Eff. SN 168919)	528418V92 (Eff. SN 168919)	na	70277467V (- Grid) (Eff. SN 160000)
1555		72503551V (- Grid), 72503552V (+ Grid) (Eff. SN 160000)	3609808V91 (Eff. SN 160000)	528415V91 (Eff. SN 168919)	528418V92 (Eff. SN 168919)	na	70277467V (- Grid) (Eff. SN 160000)
1650	Eff. SN 147569 w/o over/under	72503551V (- Grid), 72503552V (+ Grid)	3609808V91	528415V91	528418V92	na	72163352V (+ Grid)

\*Oliver Brand - Yellow Faced



# Gauges, Meters

**AESTHETICS**

MUO	Serial No.	Fuel Gauge Part No.	Tachometer & Hour Meter Part No.	Oil Pressure Part No.	Ammeter Part No.	MultiMeter Part No.	Water Temp Part No.
<b>OLIVER CONTINUED</b>							
1655	(Eff. SN 147569)	72503551V (- Grid), 72503552V (+ Grid)	3609808V91	528415V91	528418V92	na	72163352V (+ Grid)
1750	(Eff. SN 180537)	72503551V (- Grid), 72503552V (+ Grid)	30V3485439	528415V91	528418V92	na	70277467V (- Grid), 72163352V (+ Grid)
1755	(Eff. SN 220000)	na	30V3485439 Tach, 25V1000870 Hour meter, 72500500 Speed-O-Tach	na	528418V92	na	70277467V (- Grid)
1800	(SN 90525 - 112570)	72503552V	3609808V91	na	na	na	na
1850	(Eff. SN 150421)	na	30V3485439 Tach, 25V1000870 Hour meter	na	528418V92	na	na
1855	(Eff. SN 220000)	na	30V3485439 Tach, 25V1000870 Hour meter (Eff. SN 220000)	na	528418V92	na	na
1870		na	na	na	530562V1	na	na
1900	(SN 90525 - 112570)	72503552V	3609808V91	na	na	na	na
1950	(Eff. SN 150421)	na	30V3485439 Tach, 25V1000870 Hour meter	na	528418V92	na	na
1950T	(Eff. SN 194080)	na	30V3485439	na	528418V92	na	na
1955	(Eff. SN 220000)	na	30V3485439	na	528418V92	na	na
2050	(Eff. SN 204001)	na	30V3485439	na	528418V92	na	na
2150	(Eff. SN 204001)	na	30V3485439	na	na	na	na
2255	(Eff. SN 235650)	72161800V	30V3485439	79017409V	530562V1	na	na
2265		na	10V23140	na	na	na	na

MUO	Serial No.	Fuel Gauge Part No.	Tachometer & Hour Meter Part No.	Oil Pressure Part No.	Ammeter Part No.	MultiMeter Part No.	Water Temp Part No.
<b>MINNEAPOLIS-MOLINE</b>							
G705		528415V91	na	528415V91	528418V92	na	30V3485587
G706		na	na	528415V91	528418V92	na	30V3485587
G707		na	na	na	528418V92	na	30V3485587
G708		na	na	na	528418V92	na	30V3485587
G750	Row Crop (Eff. SN 147569) Tractors w/o Over/Under	na	3609808V91	na	528418V92	na	na
G900		72503552V	10V23140	30V3284484	530562V1	na	na
G950		na	10V23140	na	na	na	na
G955		72161800V	na	na	530562V1	na	na
G1000	Wheatland, Rice Special, Vista	72503552V1	10V23140	30V3284484	530562V1	na	na

<b>TACHOMETER CABLE</b>		
<b>WHITE</b>		
MUO	Description	Part No.
FB 2-88, FB 2-150	Tachometer Cable - Length - 95"	30V3493873
FB 2-88, FB 2-150	Tachometer Cable Length - 79"	30V3186466

FB = Field Boss  
WH = Work Horse

# Gauges, Meters

MUO	Serial No.	Fuel Gauge Part No.	Tachometer & Hour Meter Part No.	Oil Pressure Part No.	Ammeter Part No.	MultiMeter Part No.	Water Temp Part No.
<b>MINNEAPOLIS-MOLINE CONTINUED</b>							
G1050	PCR2193 & R2193	na	10V23140	na	na	na	na
G1355		72161800V	na	na	530562V1	na	na
AZE		na	na	na	528418V92	na	na
GRB		na	na	na	528418V92	na	30V3485587
GTB		na	na	528415V91	na	na	30V3485587
GTBD		na	na	na	528418V92	na	30V3485587
GTC		na	na	na	528418V92	na	30V3485587
GVI		na	na	528415V91	528418V92	na	30V3485587
Jet Star	Orchard	na	na	528415V91	528418V92	na	na
Jet Star		na	na	528415V91	na	na	30V3485587
Jet Star 3		na	na	na	528418V92	na	30V3485587
Jet Star 3 Super		72503552V	na	30V3284484	530562V1/ 528418V92	na	30V3485587
Jet Star 4 Super		na	na	na	528418V92	na	na
M5		na	na	528415V91	528418V92	na	30V3485587
M504		na	na	na	528418V92	na	30V3485587
M602		na	na	na	528418V92	na	30V3485587
M604		na	na	na	528418V92	na	30V3485587
M670, 670 Super		72503552V	10V23140	30V3284484	530562V1/ 528418V92	na	30V3485587
R		na	na	528415V91	528418V92	na	30V3485587
U		na	na	na	528418V92	na	30V3485587
UTI		na	na	528415V91	528418V92	na	30V3485587
UTIL		na	na	na	528418V92	na	30V3485587
ZA		na	na	528415V91	528418V92	na	30V3485587
ZAN		na	na	na	528418V92	na	30V3485587
ZAS		na	na	na	528418V92	na	30V3485587
ZAU		na	na	na	528418V92	na	30V3485587
ZB		na	na	528415V91	528418V92	na	30V3485587

AESTHETICS

MUO	Description	Part No.
<b>WATER TEMP GAUGE COCKSHUTT</b>		
Co-op - E2, E3, E4, E5, Cockshutt - 20, 30, 40, 50 Golden Eagle 550, 560, 570	100°-200° Temp Range, 90° Pointer Sweep, 6' Capillary Tube	79024380V

MUO	Description	Part No.
<b>TACHOMETER COMPONENTS</b>		
<b>WHITE</b>		
FB 4-150	Adapter, Tachometer	30V3318613
FB 2-135 & 2-155,	Sleeve, Tachometer Drive	40V1096801
FB 2-135 Series III, 2-155 Series III, 2-155	Drive Assembly, Tachometer Right Angle	40V3892303
<b>OLIVER</b>		
2255	Adapter, Tachometer	30V3318613
1850	Tachometer Adapter, Diesel	158761AV
2050, 2150 (Eff. SN 204001), 2255 (Eff. SN 235650)	Shaft, w/ Core, Tachometer	166318ASV

# AGCO® Lubricants and Oils

LUBRICANTS



## Maintain Original Performance w/ AGCO® Lubricants and Oils!

AGCO® Lubricants and Oils are formulated for the exacting requirements set by AGCO engineers for our wholegoods equipment brands. We use only those additive packages, fortifiers and specifications our engineers demand. That is your assurance of quality.

Unless otherwise noted, AGCO Lubricants and Oils are available direct-ship or via PDC Stock Order. Some product formulations are also available as Massey Ferguson® brand.



2.5 gal. jug  
20-7003003



5 gal. pail  
20-7003004

### AGCO® Preferred 55® SAE 5W-20 Hydraulic Oil

AGCO Preferred 55® Hydraulic Oil is specially formulated as a fluid for White™ UHTF and Oliver® Type 55 fluids.



1 qt. bottle  
79015705



2.5 gal. jug  
79015703

### AGCO® Powerlube Multiguard® SAE 5W-30 Motor Oil

This fuel-efficient motor oil is designed for easier starts and outstanding performance in today's modern gasoline engines. The superior additive system provides excellent engine durability.

Meets or exceeds all requirements for API Service ILSAC GF-4, SM, SL, SJ, SH and SG for gasoline engines.

# AGCO® Lubricants and Oils

## AGCO® Powerlube Multiguard® SAE 10W-30, SAE 15W-40 Engine Oil

A super-premium heavy-duty engine oil blended with high-quality Group II base stocks meeting global performance specifications for new cleaner-burning EGR (Exhaust Gas Recirculation) engines. Formulated to give outstanding soot control and improved protection against oxidation. Superior performance for today's high-performance, fuel efficient, low-emission diesel and gasoline engines operating in severe conditions.

### Meets or exceeds all requirements for:

- ACEA 02-E2/B3/A2
- MIL-L-2104E
- Mack EO-M Plus
- Caterpillar TO-2
- Volvo VDS, VDS-2
- Mercedes-Benz 228, 229.1
- Meets performance requirements of Cummins CES 20078 and 20076
- Detroit Diesel 7SE 270
- Caterpillar ECF-1
- MIL-L-46152D
- MAN 271
- Detroit Diesel Allison C-4



1 qt. bottle	2.5 gal. jug	5 gal. pail
10W-30: 841787M1	10W-30: 1079943M2	10W-30: 79014681
15W-40: 841789M1	15W-40: 841734M2	15W-40: 841815M2

Also available in 30- and 50-gal. drums and 110- and 350-gal. liquid packs.

LUBRICANTS

## AGCO® Powerlube Multiguard® SAE 10W, SAE 30, SAE 40 Straight-Weight Engine Oil

Formulated to protect gasoline and diesel engines. Excellent detergent, dispersant, anti-wear and anti-oxidant additives provide superior engine durability.

### Meets or exceeds all requirements for:

- Caterpillar Superior Lubricants Series 3
- Caterpillar TO-2 (SAE 10W and SAE 30 only)
- Detroit Diesel Allison C-4 (SAE 10W and SAE 30 only)
- Detroit Diesel 7SE270 (SAE 30 and SAE 40 only)
- MAN 270
- Mercedes-Benz 228.1
- MIL-L-2104E
- MIL-L-46152D
- MTU Type 1



1 qt. bottle	2.5 gal. jug	5 gal. pail
SAE 30: 841788M1	SAE 40: 79014700	SAE 30: 79014696
	SAE 30: 79014695	
	SAE 10W: 841725M2	

SAE 30 also available in 30- and 50-gal. drums and 110- and 350-gal. liquid packs.

## AGCO Gearlube 710 M1103 Transmission Oil SAE 90

This single-grade straight mineral oil gear lubricant is designed for manual transmissions and various other gearboxes with straight-cut gears. This economical gear oil offers excellent lubricity and flow characteristics, making it suitable for cold-weather service.

Use where API Service designation GL-1 is recommended; not recommended for extreme pressure or hypoid gear applications.



2.5 gal. jug  
841577M2

Also available in a 55-gal. drum.





1 qt. bottle  
79022402



2.5 gal. jug  
79014722

Also available in 55- and 110-gal. liquid packs

## AGCO Gearlube Gear/Axle Oil 715 M1134 SAE 80W-90

Designed to meet the demands of heavy-duty axles and manual transmissions. Meets or exceeds the requirements of many gear, transmission and automobile manufacturers. Suited for use in passenger cars as well as heavy-duty equipment for both on- and off-highway applications. Recommended for limited slip, conventional differentials with hypoid, spiral, beveled gears; manual transmissions; manual steering gears; universal joints; and all other units for which a multi-purpose gear lubricant is recommended.

### Meets or exceeds all requirements for:

- Eaton Axle
- Ford M2C83-C, M2C108C, M2C154A
- Mack G0-J, GO-H
- Rockwell International 0-76-D, 0-78-D
- SAE J2360 (MIL-L-2105E, 2105D)

## AGCO Gearlube Gear/Axle Oil 775 SAE 85W-140

Meets or exceeds the requirements of many gear, transmission and automobile manufacturers. Suited for use in passenger cars, and heavy-duty equipment for both on- and off-highway applications. Recommended for limited slip, conventional differentials with hypoid, spiral, beveled gears; manual transmissions; manual steering gears; universal joints; and all other units for which a multi-purpose gear lubricant is recommended.



2.5 gal. jug  
79014724

Also available in a 55-gal. liquid pack

### Meets or exceeds all requirements for:

- API GL-5, MT-1
- Eaton Axle
- Mack G0-J, GO-H
- Rockwell International 0-76-A
- SAE J2360 (MIL-L-2105E, 2105D)

## AGCO Special High-Pressure Worm Gear Lubricant

Prevents gearbox overheating and component wear. This economical gear oil offers excellent lubricity and flow characteristics, making it suitable for cold-weather service. Not recommended for extreme pressure or hypoid gear applications.



1 gal. jug  
213028

# AGCO® Lubricants and Oils

## AGCO Hydraulic Oils, Anti-Wear: ISO 32, ISO 46, ISO 68, ISO 100

AGCO Anti-Wear Hydraulic Oils are formulated to protect against wear, rust and oxidation and are available in a variety of viscosity grades use in every temperature.

Anti-Wear ISO Viscosity Grades 32 ("light"), 46 ("medium") and 68 ("heavy") are general-purpose formulas that are recommended for most farm equipment hydraulic systems and general industrial applications.

Anti-Wear ISO Viscosity Grade 100 ("heavy") is a premium quality formula intended for high-speed, high-pressure vane and gear pump, and axial piston pump applications.



5 gal. pail  
ISO 32: 79018543  
ISO 46: 79022604  
ISO 100: 79022781



Liquid Pack  
Heavy (ISO 100)  
available in 100-gal. and  
330-gal. size.

### Meet or exceed the following OEM pump specifications:

- AFNOR E 48-603
- B.F. Goodrich 0152
- Cincinnati Milacron P-68, P-69, P-70
- Denison HF-1, HF-2, HF0
- DIN 51524, Part 2
- Ford M-6C32
- General Motors LH-04-1, LH-06-1, LH-15
- Jeffrey No. 87
- Lee-Norse 100-1
- Racine variable volume vane pumps
- U.S. Steel 136, 127
- Vickers 1-286-S, M-2950-S

Also available in a 55-gal. drum (ISO 32, 68, 100) and 110- and 330-gal. (ISO 100) liquid packs.

LUBRICANTS

## AGCO Powerfluid 411 Automatic Transmission Fluid (ATF) SAE 5W-20

Recommended for use in transmissions where Dexron III, Dexron IID, Dexron IIE, Dexron, Ford Mercon, Ford M2C166-H or Ford M2C138CJ fluids are required. Meets General Motors "H" specification. Also may be used in Mercedes-Benz, Chrysler, Toyota, Nissan, Honda, VW, Mazda and other domestic and import vehicles requiring Dexron III.



1 qt. bottle  
79014716



2.5 gal. jug  
79014717



5 gal. pail  
79014718

Also available in a 55-gal. drum as well as 110- and 330-gal. liquid packs.

## AGCO Synthetic Transmission Fluid SAE 50

AGCO Synthetic Transmission Fluid SAE 50 is specifically designed to optimize the performance of modern off-highway transmissions and gear sets. Manufactured from polyalphaolefin base oils, this is the highest quality product available capable of handling extreme heat and oxidation, providing maximum heat stability. This is a Group IV full synthetic product.

AGCO Synthetic Transmission Fluid SAE 50 is specifically recommended for use in the reaction arm bearings (drive wheel hubs), mid-roller wheel hubs and idler wheel hubs of Challenger® MT700, MT700B, MT800 and MT800B Series tractors.

Meets or exceeds all requirements for Caterpillar TO-4 and Allison C-4 transmission requirements.

**NEW**



1 gal. jug  
79023764

# AGCO® Lubricants and Oils

## AGCO Permatran® 821XL T&H Oil, SAE 10W-30

AGCO Permatran® 821XL Transmission & Hydraulic Oil is specially formulated with the finest quality, hydrotreated, high-viscosity index, paraffinic base oils and the most advanced and rigorously-tested additive system to deliver 'above and beyond' protection and performance. Group II base stocks provide the added benefits of improved thermal and oxidation performance and low temperature properties.

### Meets or exceeds oil requirements for:

- AGCO:** AGCO Permatran® 821XL  
Allis-Chalmers 626371, Powerfluid 821XL  
Massey Ferguson® Permatran® M-1143, M-1141, M-1135, M-1129A, M-1127A/B, M-1110, M-2235  
White Farm Equipment® UHTF,  
Oliver® Type 55 fluids, Q-1826, Q-1766, Q-1722, Q-1766B
- ABEX/Denison** Hydraulic Fluid HF-0 (all pumps), HF-2, HF-1
- CNH:** Case IH Hy-Tran Plus, Hy-Tran Ultra, 1208, MS-1209, MS-1210 (TCH Fluid), MS-1230  
Ford New Holland M2C134 A/B/C/D, M2C86 A/B, M2C53 A/B, M2C41 A/B  
Hesston® Fiat Oilofiat Tutela Multi-F, AF-87  
International Harvester Hy-Tran B6JI Case TFD Fluid (MS-1024, JIC-185), TFDII Fluid (MS-1205, JIC-145), Powergard PTF Fluid (MS-1206, MS-1210)  
Poclain Equipment for High Pressure  
Steiger HTF SEMS 17001  
Versatile Gear and Hydraulic Transmission Fluid ESN-M2C134D
- Caterpillar:** TO-2, MTO
- Clark:** Lift Truck Transmission Fluid TA12, TA18, HR 500, HR 600
- Deutz:** Hydraulic Transmission Fluid
- Grove Manufacturing:** Hydraulic Fluid
- John Deere:** Hy-Gard, J-20C (J-20A), J-14B/C, Hydrostatic Fluid (J-21A), Type 303 Fluid
- Komatsu Dresser:** Transmission/Hydraulic Fluid
- Kubota:** UDT Hydraulic Fluid, Universal Transdraulic Fluid
- Renk:** Bus ATF
- Sauer-Danfoss (Sundstrand):** Hydrostatic Transmission Fluid
- Sperry Vickers:** M-2950-S Mobil Hydraulics, I-286-S Industrial Hydraulics
- ZF:** TE-ML-03E (Torque Converter Transmission Off-Highway and Industrial)  
TE-ML-05F (Off-Road Axles, exception of hypoid gears)



Also available in a 30- and 55-gal. drums and 110-gal. and 330-gal. liquid packs.



## AGCO HI-TEMP Grease EP-2 (Extreme Pressure)

AGCO HI-TEMP Grease is an Extreme Pressure non-soap-thickened polyurea lubricating grease formulated with high quality raw materials. It is also fortified with rust and oxidation inhibitors and extreme-pressure additives. AGCO HI-TEMP offers a dropping point of more than 500° F / 260° C. It performs well in areas where water washout is a major concern. The chemical and physical properties of AGCO HI-TEMP grease make it superb as an all-purpose lubricating grease.

# AGCO® Lubricants and Oils

## AGCO Cornhead EP-0 (Extreme Pressure) Grease

AGCO Cornhead Grease is a non-soap polyurea lubricating grease formulated with high-quality raw materials. It is fortified with rust and oxidation inhibitors as well as extreme pressure additives. AGCO Cornhead Grease meets John Deere material specification JDM J13E6.



14 oz. tube  
79014732

## AGCO Moly EP-2 (Extreme Pressure) Lithium II Grease

AGCO Moly Extreme-Pressure (EP-2) Grease is a high-quality, multi-purpose Lithium II grease, designed for lubricating heavy-duty automotive and industrial equipment, where heavy loads and wet conditions require high film strength and resistance to water washing.

Formulated with the highest quality base oils available, AGCO Moly EP-2 Grease is fortified with rust and oxidation inhibitors as well as extreme pressure additives. In addition, it is fortified with Molybdenum Disulfide to protect against seizure under high loads and severe shock load conditions. AGCO Moly EP-2 grease retains its lubricating ability over long periods of heavy use, and will not harden in bearings.



14 oz. tube  
79017915

## AGCO Gear Box EP-0 (Extreme Pressure) Grease

AGCO Gear Box Extreme-Pressure EP-0 Grease is a lithium 12 hydroxy lubricating grease formulated with the highest quality base oils available, and fortified with rust and oxidation inhibitors as well as extreme-pressure additives.

This product has been formulated with a special additive package, which ensures high film strength along with extreme pressure and anti-wear properties.



14 oz. tube  
747003

## AGCO Super HI-TEMP Grease

AGCO Super HI-TEMP is a non-soap lubricating grease formulated with quality base oils. Because this grease has no dropping point, it has excellent resistance to high temperatures with a working temperature range of -40° F to +350° F / -40° C to 176° C. This product is perfect for various drive shaft and hub splines, wheel bearings and engine accessories. It features high load-carrying ability at high speeds, and is water-, corrosion- and oxidation-resistant.

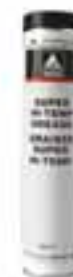

14 oz. tube  
732170

## AGCO Lithium II Multi-Purpose EP-2 (Extreme Pressure) Grease

This lithium-based lubricating grease is formulated with the highest-quality virgin base oils available. AGCO Lithium II Multi-Purpose Grease is also formulated with a special additive package, which ensures anti-wear and extreme pressure properties. This product is fortified with rust and corrosion inhibitors as well as oxidation inhibitors to make this a truly versatile multi-purpose lubricant.



14 oz. tube  
79014728

Also available in a 35-lb. pail

LUBRICANTS



# AGCO® Lubricants and Oils



16 oz. tub  
79014730

## AGCO Heavy-Duty Wheel Bearing Grease

AGCO Heavy-Duty Wheel Bearing Grease is a premium, state-of-the-art lithium complex grease. This multi-purpose product has a high dropping point (in excess of 500° F / 260° C), which ensures retention where high temperatures are encountered. This product is formulated with a special additive package that insures high film strength as well as extreme pressure and anti-wear properties. High-quality virgin base fluids provide excellent natural oxidation inhibition and, combined with effective antioxidants as well as corrosion inhibitors, provide extra stability under storage and extreme service conditions.

- Recommended for Disc Brake Wheel Bearings, including those found on a variety of AGCO equipment brands and models.
- Meets NLGI (National Lubricating Grease Institute) Certification GC-LB

LUBRICANTS



1 gal. jug  
U.S. Only  
79022729

## AGCO Antifreeze and Summer Coolant

Dual-purpose AGCO Antifreeze is a universal formula that meets or exceeds the exacting performance requirements for both diesel and gasoline engine cooling systems. AGCO Antifreeze protects all cooling system parts, including aluminum and high lead solders and meets heavy-duty standards for low silicate antifreeze.

### Meets or exceeds requirements for:

#### AUTOMOBILE

- ASTM D-3306, ASTM D-4340
- Chrysler MS 7170
- Ford ESE-M97B44-A
- GM 1825M (Aluminum)
- SAE J1034



1 gal. jug  
Canada Only  
79022730

### Meets or exceeds requirements for:

#### HEAVY-DUTY

- ASTM D-4985
- Mack Truck
- Caterpillar
- RP-302B Maintenance Council
- Cummins 90T8-4
- American Trucking
- GM 1899M (Non-Aluminum)
- SAE J1941
- John Deere H24B1/C1
- Volvo/GM

## Product Listing

Description	Type	Sizes	Part No.
<b>TRANSMISSION AND HYDRAULIC LUBRICANTS &amp; OILS</b>			
AGCO Preferred 55® Hydraulic Oil	SAE 5W-20	2.5 gal (9.46L)	20-7003003
		5 gal (18.9L)	20-7003004
		55 gal (208L)	20-7003005
AGCO Gearlube 710 / M1103	SAE 90	2.5 gal (9.46L)	841718M2
		55 gal (208L)	841577M2
AGCO Gearlube 715 / M1134	SAE 80W-90	1 qt (0.946L)	79022402
		2.5 gal (9.46L)	79014722
		55 gal (208L)	79014723
		110 gal (416L)	79016501
AGCO Gearlube 775	SAE 85W-140	2.5 gal (9.46L)	79014724
		55 gal (208L)	79022322
AGCO Special High-Pressure Worm Gearlube	ISO 220	1 gal (3.78L)	213028

Dealer:

+ Available direct-ship Only on Promo 105.

# AGCO® Lubricants and Oils

## Product Listing

**LUBRICANTS**

Description	Type	Sizes	Part No.
<b>TRANSMISSION AND HYDRAULIC LUBRICANTS &amp; OILS CONTINUED</b>			
AGCO Hydraulic Oil	AW ISO 32 (Light)	5 gal (18.9L)	79018543
		55 gal (208L)	79018544
	AW ISO 46 (Medium)	5 gal (18.9)	79022604
	AW ISO 68 (Heavy)	55 gal (208L)	79021753
	AW ISO 100 (Heavy)	5 gal (18.9L)	79022781
		55 gal (208L)	79022782
		110 gal (416L)	+79023346
330 gal (1,249L)		+79023347	
AGCO Permatran® 821XL T&H Oil	SAE 10W-30	1 qt (0.946L)	841824M1
		1 gal (3.78L)	841867M1
		2.5 gal (9.46L)	841743M1
		5 gal (18.9L)	841813M1
		30 gal (113.5L)	79014714
		55 gal (208L)	79014715
		110 gal (416L)	+79016502
		330 gal (1,249L)	+79015650
AGCO Powerfluid 411 Automatic Transmission Fluid	SAE 5W-20	1 qt (0.946L)	79014716
		2.5 gal (9.46L)	79014717
		5 gal (18.9L)	79014718
		55 gal (208L)	79014720
		110 gal (416L)	+79016503
		330 gal (1,249L)	+79015671
AGCO Synthetic Transmission Fluid	SAE 50	1 gal (3.78L)	*79023764

Dealers:  
 + Available direct-ship only on Promo 105  
 \* Available from PDC inventory on a Stock Order only

Description	Type	Sizes	Part No.
<b>MULTI-VISCOSITY MOTOR &amp; ENGINE OIL</b>			
AGCO Powerlube Multiguard®	SAE 5W-30 Motor	1 qt (0.946L)	79015705
		2.5 gal (9.46L)	79015703
		55 gal (208L)	79015702
		330 gal (1,249L)	+79015706
AGCO Powerlube Multiguard®	SAE 10W-30 Engine	1 qt (0.946L)	841787M1
		1 gal (3.78L)	841865M1
		2.5 gal (9.46L)	1079943M2
		5 gal (18.9L)	79014681
		30 gal (113.5L)	79014682
		55 gal (208L)	79014683
		110 gal (416L)	+79016498
		330 gal (1,249L)	+79015673

Dealers:  
 + Available direct-ship only on Promo 105

# AGCO® Lubricants and Oils

## Product Listing

Description	Type	Sizes	Part No.
<b>MULTI-VISCOSITY MOTOR &amp; ENGINE OIL CONTINUED</b>			
AGCO Powerlube Multiguard®	SAE 15W-40 Engine	1 qt (0.946L)	841789M1
		1 gal (3.78L)	841866M1
		2.5 gal (9.46L)	841734M2
		5 gal (18.9L)	841815M2
		30 gal (113.5L)	79014676
		55 gal (208L)	79014677
		110 gal (416L)	+79016499
		330 gal (1,249L)	+79015648

Dealers:  
+ Available direct-ship only on Promo 105

Description	Type	Sizes	Part No.
<b>STRAIGHT-WEIGHT ENGINE OIL</b>			
AGCO Powerlube Multiguard®	SAE 10W Engine	2.5 gal (9.46L)	841725M2
AGCO Powerlube Multiguard®	SAE 30 Engine	1 qt (0.946L)	841788M1
		2.5 gal (9.46L)	79014695
		5 gal (18.9L)	79014696
		30 gal (113.5L)	79014697
		55 gal (208L)	79014698
		110 gal (416L)	+79016500
		330 gal (1,249L)	+79015649
AGCO Powerlube Multiguard®	SAE 40 Engine	2.5 gal (9.46L)	79014700

Dealers:  
+ Available direct-ship only on Promo 105

Description	Type	Sizes	Part No.
<b>GREASE</b>			
AGCO HI-TEMP EP-2	Polyurea	14 oz (414ml) tube	79014733
AGCO Cornhead EP-O	Polyurea	14 oz (414ml) tube	79014732
AGCO Moly EP-2 Lithium II	Lithium II	14 oz (414 ml) tube	79017915
AGCO Gear Box EP-O	Lithium	3.5 oz (103.5ml) tube	526204
		14 oz (414ml) tube	747003
		16 oz (473ml) bottle	745212
AGCO Super HI-TEMP	Inorganic	14 oz (414ml) tube	*732170
AGCO Multi-Purpose EP-2	Lithium II	14 oz (414ml) tube	79014728
		35 lb (15.87kg) pail	79014726
AGCO Heavy-Duty Wheel Bearing	Lithium Complex	16 oz (473ml) tub	79014730

Dealers:  
\* Available from PDC inventory on a Stock Order only

Description	Type	Sizes	Part No.
<b>ANTIFREEZE AND COOLANT</b>			
AGCO Antifreeze and Coolant	US only	1 gal (3.78L)	79022729
		55 gal (208L)	79023022
AGCO Antifreeze and Coolant	Canada only	1 gal (3.78L)	79022730
		55 gal (208L)	79022731

# Filters

## OLIVER BRAND FILTERS

Put the final touches on your restoration project

ENGINE OIL FILTERS, SPIN-ON	
MUO	Part No.
Super 55, 66, Super 66, 77, Super 77, 88, Super 88, 550, 660, 770, 880, 950	100126ASAV
Super 55, 66, Super 66, 77, Super 77, 88, Super 88, 550, 660	100125ASAV
Super 55, 550, 66, Super 66, 660, 77, Super 77, 770, 88, Super 88, 880, Super 99	104397AV
1650, 1655, 1800	155618AV



155618AV

100126ASAV



MUO	Type	Part No.	
<b>WHITE</b>			
FB 16	Fuel	3755746M1	
FB 2-50	Oil	70237000V	
	Fuel	70251397V	
	Air	676920A	
	Lift System	72093722	
	Power Steering	72093701V	
FB 2-55	Air Outer	33V0032042	
FB 2-60	Oil	70237000V	
	Fuel	70251397V	
	Air	676920A	
	Lift System	72093722	
	Power Steering	72093701V	
60, 80 American Series	Oil	72501532	
	Fuel	72501530	
	Over/Under - Spin-On	72161316	
FB 2-70	Oil - Diesel	30V3068145	
	Sediment Bowl	WJAS841V	
	Over/Under - Spin-On	72161316	
FB 2-75	Oil	72165040	
FB 2-85, FB 2-105	Oil	31V2752257	
	Fuel	70251397V	
	Over/Under - Spin-On	72161316	
	Air Inner	72163296	
FB 2-88, FB 2-110	Oil	31V2752257	
	Fuel	70251397V	
	Water Separator	71367686V	
	Over/Under - Spin-On	72161316	
	Hyd. Element	30V3024725	
	Air Inner	72163296	
	FB 100, FB 120	Oil	72501532
		Fuel	72501530
Water Separator		72501531	
Air Filter Inner		72163296	
Over/Under - Spin-On		72161316	

MUO	Type	Part No.
<b>WHITE</b>		
WH 125	Oil	72501532
	Fuel	72501530
	Water Separator	72501531
	Air Filter Inner	72163296
FB 2-135	Oil Filter	30V3068145
	Fuel	20V0006803
	Water Separator	71367686V
FB 140	Over/Under - Spin-On	72161316
	Oil	72501532
	Fuel	72501530
	Water Separator	72501531
WH 145	Over/Under - Spin-On	72161316
	Air Filter Inner	72163296
	Oil	72501532
	Fuel	72501530
FB 2-150	Water Separator	72501531
	Air Filter Inner	72163296
	Oil Filter	30V3119475
	Fuel	20V0006803
FB 2-155	Over/Under - Spin-On	72161316
	Hyd. Element	30V3024725
	Inner Air Filter	20V7000316
	Oil Filter	30V3119475
	Fuel	20V0006803
	Water Separator	71367686V
FB 160, WH 170	Over/Under - Spin-On	72161316
	SN 272595 - 287811	
	Over/Under - Spin-On	30V3119475
	Eff. SN 287812	
	Fuel	72501530



# Filters

MUO	Type	Part No.
<b>WHITE CONTINUED</b>		

FB 2-180	Oil Filter	30V3119475
	Eff. Eng. SN 90N39454	
	Water Separator	71367686V
	Over/Under - Spin-On	30V3119475
FB 185, WH 195	Fuel	72501530
	Water Separator	72501531
	Over/Under - Spin-On	30V3119475
FB 4-150	Oil Filter	30V3119475
	Eff. Eng. SN 90N39454	
	Water Separator	71367686V
	Over/Under - Spin-On	72161316
	Hyd. Element	30V3024725
FB 4-175	Oil Filter	30V3119475
	Water Separator	71367686V
	Over/Under - Spin-On	30V3119475
	Trans. Spin-On Filter	72161316
	Hyd. Element	30V3024725
FB 4-180	Oil Filter	30V3119475
	Eng. SN 90N38769 - SN 90N39379	
	Water Separator	71367686V
	Trans. Spin-On Filter	72161316
	Hyd. Element	30V3024725
FB 4-210	Oil Filter	30V3119475
	Eng. SN 90N38769 - SN 90N39379	
	Water Separator	71367686V
	Over/Under - Spin-On	30V3119475
FB 4-225, FB 4-270	Water Separator	71367686V

MUO	Type	Part No.
<b>OLIVER</b>		

Super 55 Gas, 66 Gas, Super 66 Gas, 77, Super 77, 88, Super 88	Oil Filter	100126ASAV*
	Bosch - Secondary	90910V
	Roosa - Secondary	609689ASV
99 Gas, Super 99 Gas	Oil Filter	100125ASAV*
	Fuel	740104ASV
550, 660	Oil Filter	100126ASAV*
	Bosch - Secondary	90910V
	Roosa - Secondary	609689ASV
770, 880	Oil Filter	100125ASAV*
	Bosch - Secondary	90910V
	Roosa - Secondary	609689ASV
950	Oil Filter - Gas	100125ASAV*
	Oil Filter - Diesel	7A5507A
	Fuel - Diesel Final	90910V
	Sediment Bowl - Diesel	WJAS841V

MUO	Type	Part No.
<b>OLIVER</b>		

990, 995	Oil Filter - Diesel	7A5507A
	Fuel - Diesel Secondary	740104ASV
	Sediment Bowl - Diesel	WJAS841V
1250	Oil Filter - Gas	70237000
	Oil Filter - Diesel	674124AS
1250A	Oil Filter	70237000
	Fuel	70251397V
	Hyd. Lift System - Element	72093722
1255, 1265, 1270, 1355, 1365, 1370	Oil Filter	70237000
	Fuel	70251397V
	Air	676920A
	Hyd. Lift System - Element	72093722
	Power Steering	72093701V
1465, 1470	Oil Filter	70237000
	Fuel	1909103V
	Power Steering	72093701V
1550, 1555 Gas	Oil Filter	104397AV*
	Sediment Bowl	WJAS841V
	Over/Under-Spin-On	72161316
1555 Diesel, 1600	Oil Filter	104397AV*
	Fuel Secondary	609689ASV
	Over/Under-Spin-On	72161316
1650 Gas, 1655 Gas	Oil Filter	155618AV*
	Sediment Bowl	WJAS841V
	Over/Under-Spin-On	72161316
1750	Oil Filter - Gas	156202AS
	Sediment Bowl	WJAS841V
	Fuel Filter - Diesel	70251397V
	Over/Under-Spin-On	72161316
	Oil Filter - Gas	155618AV*
	Sediment Bowl	WJAS841V
1755	Fuel Filter - Diesel	70251397V
	Over/Under-Spin-On	72161316
	Hyd. Element	30V3024725
	Oil Filter - Gas	155618AV*
1800-A	Sediment Bowl	WJAS841V
	Fuel Filter - Diesel	70251397V
	Over/Under-Spin-On	72161316
	Hyd. Element	30V3024725
	Oil Filter - Gas	104397AV*
1800 B & C	Oil Filter - Diesel	155618AV*
	Sediment Bowl - Gas	WJAS841V
	Fuel Secondary - Diesel	609689ASV
	Air Filter	74009078V
	Hyd. Spin-on	72161316
	Air Filter	74009078V
	Fuel Secondary - Diesel	609689ASV
	Hyd. Spin-On	72161316

\* Oliver Brand

FB = Field Boss WH = Work Horse

# Filters

MUO	Type	Part No.
<b>OLIVER CONTINUED</b>		
1850	Oil Filter - Diesel	70237000V
	Fuel - Secondary	70251397V
	Sediment Bowl - Gas	WJAS841V
	Hyd. Spin-On	72161316
1855	Oil Filter - Gas	155618AV
	Sediment Bowl - Gas	WJAS841V
	Hyd. Spin-On	72161316
	Hyd. Element	30V3024725
1855 Diesel	Oil Filter Eff. SN 233684	30V3068145
	Fuel Prior to SN 233684	70251397V
	Hyd. Spin-On	72161316
	Hyd. Element	30V3024725
1900, 1950	Oil Filter - Spin-On	70237000V
	Hyd. Spin-On	72161316
2050, 2150	Oil Filter	30V3068145
	Adapter	40V0003702
	By-Pass - Element	166975AV
	Hyd. Spin-On	72161316
2155	Inner Air Filter	20V7000316
	Outer Air Filter	20V7000317
2255	Oil Filter	30V3119475
	Fuel - 3150 Engine	7722358
	Hyd. Spin-On	72161316
2655	Inner Air Filter	20V7000316
	Outer Air Filter	20V7000317

\* Oliver Brand



155618AV



30V3119475

MUO	Type	Part No.
<b>MINNEAPOLIS-MOLINE</b>		
Jet Star 3, Jet Star 3 Super	Oil Filter	70237000
	Hyd. Element	10V23992
	Fuel Prior to SN 28400467	609689ASV
	Fuel Eff. SN 28400467	70251397V
4 Star	Oil Filter - Spin-On	1015511V92
	Hyd. Element	10V23992
5 Star	Oil Filter - Element	10V10423
	Hyd. Element	10V23992
335, 445	Oil Filter - Element	10V732
G705, 706	Oil Filter - Spin-On	1015511V92
	Fuel - Secondary	609689ASV
G707, G708 (2WD & 4WD)	Oil Filter - Spin-On	1015511V92
	Fuel	70251397V
G750	Air Filter	74009078V
	Oil Filter - Spin-On	155618AV
	Sediment Bowl	WJAS841V
	Fuel - Secondary SN 147569 - 187585	609689ASV
	Fuel Eff. SN 187586	70251397V



10V10423

FILTERS

# Filters



10V23992

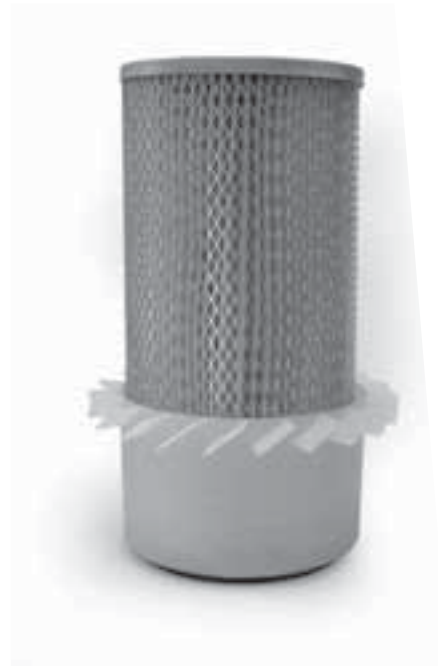

74009078V

FILTERS

MUO	Type	Part No.
<b>MINNEAPOLIS-MOLINE CONTINUED</b>		
G900	Oil Filter - Element	10V10423
	Fuel	70251397V
	Air Filter	74009078V
	Hyd. Element	30V3024725
G955	Oil Filter - Element	10V10423
	Oil Filter - Spin-On	30V3119475
	Fuel - Square Element	20V0006803
	Hyd. Spin-On	72161316
	Hyd. Element	30V3024725
G1000 Wheatland, Riceland Special, & Vista	Oil Filter - Element	10V10423
	Fuel	70251397V
	Air Filter	74009078V
G1050, G1350	Oil Filter - Spin-On	30V3119475
	Oil Filter - Element	10V10423
	Fuel	70251397V
	Fuel - Square Element	20V0006803
	Hyd. Element	30V3024725
	Inner Air Filter	20V7000316
	Outer Air Filter	20V7000317
G1355	Oil Filter - Spin-on - Diesel	30V3119475
	Oil Filter - Element - Gas	10V10423
	Fuel	20V0006803
	Hyd. Spin-On	72161316
	Inner Air Filter	20V7000316
M5, M504, M602, M604	Oil Filter - Element	10V10423
	Fuel - Secondary	609689ASV
	Hyd. Element	10V23992
M670	Oil Filter - Element	10V10423
	Fuel	70251397V
	Hyd. Element	30V3024725

MUO	Type	Part No.
<b>MINNEAPOLIS-MOLINE</b>		
U302	Oil Filter - Spin-On	70237000
	Fuel	609689ASV
	Prior to SN 27700100	
	Fuel	7251397V
	Eff. SN 27700101	
	Air	70243163V
A4T1400	Hyd. Element	30V3024725
	Hyd. Element	10V23992
	Oil Filter - Element	10V10423
	Fuel Filter	70251397V
	Prior to SN 45600654	
A4T1600 Diesel	Fuel Filter	71367687V
	Eff. SN 45600654	
	Hyd. Element	30V3024725
	Inner Air Filter	20V7000316
	Outer Air Filter	20V7000317
A4T2655	Oil Filter - Element	10V10423
	Oil Filter - Spin-On	30V3119475
	Fuel	70251397V
	Fuel Filter - Square	20V0006803
	Hyd. Element	30V3024725
	Inner Air Filter	20V7000316
A4T2655	Outer Air Filter	20V7000317
	Oil Filter - Element	10V10423
	Oil Filter - Spin-On	30V3119475
	Fuel - Primary	70251397V
	Fuel - Secondary	20V0006803
Hyd. Element	30V3024725	

# Engine Components - White



79023107V



30V3090264

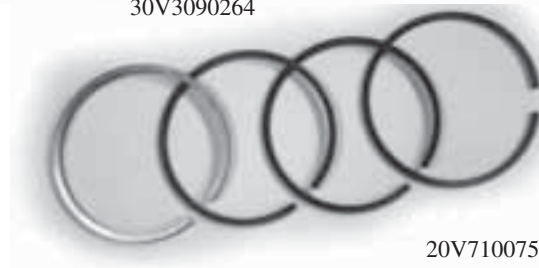

20V7100758

MUO	Notes	Piston Part No.	Piston Kit Part No.	Piston & Sleeve Kit Part No.	Sleeve Part No.	Ring Set Part No.	Size
<b>PISTONS, SLEEVES &amp; RINGS</b>							
FB 2-30		72165295V	na	na	na	33V0016519	0.55 Oversized
		72165240V	na	na	na	72165239V	1.00 Oversized
FB 2-35		72165115V	na	na	na	33V0016519	0.55 Oversized
FB 2-50		31V2906447	na	na	72090603V	1908737V	Standard
		na	na	na	72090604V	na	0.2 Oversized
FB 2-60		31V2906447	na	na	72090603V	1908737V	Standard
		na	na	na	72090604V	na	0.2 Oversized
FB 2-70	Gas 3-3/4" Bore	na	na	159482ASV	na	159480ASV	Standard
	Diesel 3-7/8" Bore	na	na	30V3340600	na	30V3046222	Standard
FB 2-75		72165335V	na	na	na	33V0034843	Standard
FB 2-85	SN 263341 - SN 297446	na	3637280V91	30V3180689	744948V1	31V2751057	Standard
FB 2-85	Eff. 297447	na	747541V91	na	744948V1 Slip Fit	745738V91	Standard
FB 2-88		na	747541V91	na	744948V1 Slip Fit	745738V91	Standard
FB 2-105	SN 255216 - SN 297446	na	738368V91	30V3158527	744948V1 Slip Fit	745751V91	Standard
	Eff. SN 297447	na	745379V91	na	744948V1 Slip Fit	745277V91	Standard
						1 piston	
FB 2-110		na	745379V91	na	744948V1 Slip Fit	745277V91	Standard
FB 2-135, Eff. SN 300928		na	40V3810356	na	166631AV	40V3810455	Standard
FB 2-155 Series III		na	na	na	79017590V	na	0.05 Oversized
FB 2-150		na	11V23860	na	na	20V7100791	Standard
						1 piston	
		na	20V2006610	na	na	20V7100792	0.02 Oversized
						1 piston	
		na	20V2006611	na	na	20V7100793	0.04 Oversized
						1 piston	
		na	20V2006612	na	na	na	0.05 Oversized
FB 2-135, FB 2-155		na	40V3810356	na	166631AV	40V3810455	Standard
		na	na	na	79017590V	na	0.005 Oversized
FB 2-155		na	79023107V	na	166631AV	40V3810455	Standard

FB = Field Boss  
WH = Work Horse



# Engine Components - White



40V3807851

MUO	Notes	Con. Rod Part No.	Con. Rod Bushing Part No.	Con. Rod Bolt Part No.	Con. Rod Nut Part No.	Con. Rod Bearing Part No.	Size
<b>CONNECTING RODS AND BEARINGS</b>							
700		72094293V na	72093818V	na	72094308V	72094399V 72094304V	Standard 0.508 Undersized
FB 2-30		na	na	na	na	72165056V	Standard
FB 2-35		na	na	na	na	72165056V	Standard
FB 2-50		72094161V	72093818V	na	72089460V	72094399V na 72094304V	Standard 0.2 Oversized 0.508 Undersized
FB 2-60		72094161V	72093818V	na	72089460V	72094399V 72094304V	Standard 0.508 Undersized
FB 2-70	Gas 3-3/4" Bore Gas Gas	na	K219V	H220V	K219V	K217AV KXS217AV 103972AV	Standard 0.02 Undersized 0.03 Undersized
FB 2-70	Diesel 3-7/8" Bore Diesel Diesel Diesel	30V3052141	20V7002212	na	102633AV	30V3137589 30V3137600 30V3137589 30V3137619	Standard 0.002 Undersized 0.10 Undersized 0.02 Undersized
FB 2-75		33V0145505	33V0034886	na	na	33V0037362 72165136V	Standard 0.50 Oversized
FB 2-85	SN 263341 - SN 297446	3637034V91	4222485V1	159369AV	733767V1	3638572V91	Standard
FB 2-85	Eff. 297447	3637034V91	70927726V	159369AV	733767V1	159988AV 736935V91 3637026V91 736937V91	Standard 0.10 Undersized 0.02 Undersized 0.03 Undersized
FB 2-88		3637034V91	4222485V1	733767V1	733767V1	159988AV 736935V91 736936V91	Standard 0.02 Undersized 0.03 Undersized
FB 2-105	SN 255216 - SN 297446 Eff. SN 297447	3638749V91 4225381V91	4222485V1 70927726V	159369AV 159369AV	735490V1 744971V1	3638572V91 159988AV	Standard Standard
FB 2-110		4225381V91	70927726V	159369AV	744971V1	3638572V91 (Individual) 3637025V91	Standard 0.10 Undersized
FB 2-135 & 2-155		40V3807851 w/bushing & hardware	40V1091706 na na	na na na	166693AV na na	166696AV 167535AV 167536AV	Standard 0.01 Undersized 0.02 Undersized
FB 2-150		na	907687V	na	10V24055	10V1326 20V7100278 20V7100279 20V7100280 20V7100281	Standard 0.01 Undersized 0.02 Undersized 0.03 Undersized 0.04 Undersized

ENGINE

# Engine Components - White

MUO	Notes	Con. Rod Part No.	Con. Rod Bushing Part No.	Con. Rod Bolt Part No.	Con. Rod Nut Part No.	Con. Rod Bearing Part No.	Size
<b>CONNECTING RODS AND BEARINGS-CONTINUED</b>							
FB 2-135, Eff. SN 300928		40V3807851	40V1091706	na	166693AV	166696AV	Standard
FB 2-155 Series III		w/bushing & hardware				167535AV	0.01 Undersized
						167536AV	0.02 Undersized
						30V3443337	0.03 Undersized



MUO	Notes	Intake Valve Part No.	Exhaust Valve Part No.	Valve Guide Part No.	Inner Valve Springs Part No.	Outer Valve Springs Part No.	Push Rods Part No.	Tappet Part No.
<b>CYLINDER HEAD</b>								
FB 2-50		72094310V	72089669V	72094309V	72091160V	72091160V	72094487V	72094013V
FB 2-60		72094310V	72089669V	72094309V	72091160V	72091160V	72094487V	72094013V
FB 2-70	Gas	155888AV	155887AV	Intake: 158785AV Exhaust: 106620AV	106573AV	159026AV	155895AV	M201V
FB 2-70	Diesel	165375AV	169447AV	164904AV	106573AV	106573AV	30V3055361	M201V
FB 2-75		33V0061301	na	33V0034770	na	na	33V0037451	72165329V
FB 2-85	Prior to SN 297446	735820V1	30V3158640	Intake: 4223073V1 Exhaust: 4223074V1	735525V1*	735521V1*	733817V1	4222069V1
FB 2-85	Eff. SN 297447	735820V1	748309V1	Intake: 4223073V1 Exhaust: 4223074V1	735525V1*	735521V1*	733817V1	4222069V1
FB 2-88		735820V1	748309V1	Intake: 4223073V1 Exhaust: 4223074V1	735525V1*	735521V1*	733817V1	4222069V1
FB 2-105	Prior to SN 297446	735820V1	30V3158640	Intake: 4223073V1 Exhaust: 4223074V1	735525V1*	735521V1*	733817V1	4222069V1

\* Intake and Exhaust

ENGINE

# Engine Components - White

MUO	Notes	Intake Valve Part No.	Exhaust Valve Part No.	Valve Guide Part No.	Inner Valve Springs Part No.	Outer Valve Springs Part No.	Push Rods Part No.	Tappet Part No.
<b>CYLINDER HEAD CONTINUED</b>								
FB 2-105	Eff. SN 297447	735820V1	748309V1	Intake: 4223073V1 Exhaust: 4223074V1	735525V1*	735521V1*	733817V1	4222069V1
FB 2-110		735820V1	748309V1	Intake: 4223073V1 Exhaust: 4223074V1	735525V1*	735521V1*	733817V1	4222069V1
FB 2-135, FB 2-155		40V1022502	40V3822701	40V3891403	40V3822651	40V3822651	166830AV	166831AV
FB 2-135 Series III, FB 2-155 Series III		40V1022502	40V3822701	40V3891403	40V3822651	40V3822651	166830AV	166831AV
FB 2-150		30V3203905	30V3136515	30V3099210	20V0007808	20V0007808	10V26274	30V3169464

\* Intake and Exhaust



40V3820475

MUO Part No.	Cylinder Head Assembly Part No.	Front Valve Cover Part No.	Rear Valve Cover
<b>CYLINDER HEAD ASSEMBLY</b>			
FB 2-135 , FB 2-155, FB 2-135, 2-155 Series III, FB 2-155	40V3820475	166832ASV	166833ASV

FB = Field Boss  
WH = Work Horse

ENGINE

MUO	Notes	Overhaul Gasket Set Part No.	Upper Gasket Set Part No.	Bottom Gasket Set Part No.	Valve Grinding Gasket Set Part No.
-----	-------	------------------------------	---------------------------	----------------------------	------------------------------------

## GASKETS AND GASKET SETS

FB 2-50		1940063V	na	na	na
FB 2-60		1940023V	na	1940023V	1940031V
FB 2-70	Gas	156163ASV	na	na	156161ASV
	Diesel	163690ASV	na	na	163692AS
FB 2-85	Prior to SN 297446	na	743684V91	4224120V91	743684V91
	Eff. SN 297447	na	4224053V91	4224120V91	4224053V91
FB 2-88		na	4224053V91	4224120V91	4224053V91
FB 2-105	Prior to SN 297446	na	743684V91	4224120V91	743684V91
	Eff. SN 297447	na	4224053V91	4224120V91	4224053V91
FB 2-110		na	4224053V91	4224120V91	4224053V91
FB 2-135 & 2-155		79018171V	79018172V	na	79018172V
FB 2-135 & 2-155 Series III		79018171V	79018172V	na	79018172V
FB 2-150		20V7100837	20V7100263	na	20V7100263
FB 2-155		79018171V	79018172V	na	79018172V

FB = Field Boss  
WH = Work Horse

# Engine Components - White



40V1091455

MUO	Notes	Main Bearings Part No.	Thrust Bearings Part No.	Bearing Size Part No.
<b>CRANKSHAFT BEARINGS</b>				
FB 2-50, FB 2-60		72094305V	72094146V	Standard
		72094306V	na	0.254 Undersized
		72094355V	na	0.508 Undersized
		na	72094147V	0.127 Undersized
FB 2-70	Gas	K101AV	157941AV	Standard
		103972AV	na	0.003 Undersized
	Diesel	30V3109887	30V3109925	Standard
		30V3109895	na	0.002 Undersized
FB 2-85	Prior to SN 297446	30V3176193	4223140V91	Standard
FB 2-85, FB 2-88, FB 2-105, FB 2-110	FB 2-105: Eff. SN 297447	na	747129V1	Upper Standard
		na	735743V1	0.007
		na	747128V1	Lower Standard
		na	735742V1	0.007
		744921V91*	na	Standard
		744922V91*	na	0.010 Undersized
		31V2765307*	na	0.020 Undersized
FB 2-105	Prior to SN 297446	4223140V91*	na	na
FB 2-135, 2-155, FB 2-135 Series III, FB 2-155 Series III,		40V1091455	40V1091457	Standard
		40V1091463	40V1091463	0.010 Undersized
		na	na	0.020 Undersized
		40V1091485	40V1091487	0.030 Undersized
FB 2-150		na	20V7100265	Standard
		na	20V7100267	0.010 Undersized
		na	20V7100268	0.020 Undersized

\* Complete Bearing Set

Cylinder Head Gasket Part No.	Valve Cover Gasket Part No.	Oil Pan Gasket Part No.	Timing Cover Gasket Part No.
98472006V	676732V	1940006V	4849994V
98472008V	31V2902203	1940004V	4849994V
155886AV	167695AV	30V3071782	30V3038882
30V3072886	164044AV	30V3071782	101232AV
740376V1	4222942V1	4224291V1	4223127V1
3638305V1	4223925V1	4224291V1	4223127V1
3638305V1	4223925V1	4224291V1	4223127V1
740376V1	745462V1	4224291V1	4223127V1
3638305V1	739791V1	4224291V1	4223127V1
3638305V1	745462V1	3638772V1	4223127V1
(2) 40V3891123	(2) 166836AV	40V1093436	166774AV
(2) 40V3891123	(2) 166836AV	40V1093436	166774AV
(3) 20V0000440	(3) 20V0006319	20V0008252	10V30449
(2) 40V3891123	(2) 166836AV	40V1093436	166774AV



# Engine Components - White



40V1093705



166680AV

MUO

Front Seal  
Part No.

Rear Seal  
Part No.



3637404V91

### CRANKSHAFT MAIN SEAL

MUO	Front Seal Part No.	Rear Seal Part No.
FB 2-50	40101333V	72091451V
FB 2-60	40101333V	72091451V
FB 2-70	156172AV	30V3072959
FB 2-85	1447690V1	1447691V1
FB 2-88	1447690V1	1447691V1
FB 2-105	1447690V1	1447691V1
FB 2-110	1447690V1	1447691V1
FB 2-135, FB 2-155	40V1093705	166680AV
FB 2-135, FB 2-155 Series III	40V1093705	166680AV
FB 2-150	103682AV	30V3134008
FB 2-155	40V1093705	166680AV



40V3882001

MUO

Part No.

### CRANKSHAFT ASSEMBLIES

MUO	Part No.
FB 2-50	72094402V
FB 2-105, FB 2-110	3637404V91
Includes: six Rod Bearings, two lower thrust washers standard, two upper thrust washers standard, main bearings	
FB 2-135, FB 2-155 Series III, FB 2-135, FB 2-155	40V3803054



40V3876252

MUO

Part No.

### CRANKSHAFT DAMPENER AND PULLEY ASSEMBLY

FB 2-135, FB 2-155, FB 2-155 (Eff. SN 298626)	40V3882001
FB 2-135, FB 2-155 Series III (Eff. SN 300928)	

MUO

Flywheel  
Part No.

Ring Gear  
Part No.

### FLYWHEELS

FB 2-88	na	731988V1
FB 2-105	na	731988V1
FB 2-110	na	731988V1
FB 2-135, FB 2-155	166687ASV*	166688AV
FB 2-135 Series III, FB 2-155 Series III	166687ASV*	166688AV

\* Includes Ring Gear

MUO

Camshaft  
Part No.

Gear  
Part No.

### CAMSHAFT AND COMPONENTS

FB 2-50	72089521V	na
FB 2-105	739945V1	na
FB 2-135, FB 2-155	40V1003655*	40V3876252
FB 2-135 Series III, FB 2-155 Series III	40V1003655*	40V3876252

\* Includes Sleeve

ENGINE

40V1003655

# Engine Components - Oliver



20V7002940

MUO	Size	Kit Part No.
<b>PISTON, SLEEVES AND RINGS</b>		
Super 55, 550, 66, Super 66, Gas; 77, Super 77, 770 Gas & LP	3-1/2" Bore	163108ASV
Super 55, 550, 66, Super 66, 77, Super 77, 770 Diesel	3-1/2" Bore	163109ASV
550, 660 Gas	3-5/8" Bore	30V3034070
550, 660 Diesel	3-5/8" Bore	161345ASV
1550 Gas & LP, 1555 Gas	3-5/8" Bore	30V3034070
1550 & 1555 Diesel	3-5/8" Bore	161345ASV
1600 Gas & LP	3-5/8" Bore	157705ASV
1650 Gas & LP, 1655 Gas	3-3/4" Bore	159482ASV
1650 Diesel, Lanova Injection (Prior to SN 187585)	3-7/8" Bore	163117ASV
1750 Gas (Eff. SN 147260), 1755 Gas	3-7/8" Bore	164660ASV
1750 & 1755 Diesel	3-7/8" Bore	30V3043932
1800 Gas & LP	3-7/8" Bore	156409ASV
1800 Diesel (Prior to SN 124395)	3-7/8" Bore	163117ASV
1800 Diesel (Eff. SN 124396)	3-7/8" Bore	163116ASV
1850 Gas (Eff. SN 147254), 1850 LP (Eff. SN 161492), 1855 Gas	3-7/8" Bore	169083ASV
1850 Diesel	3-7/8" Bore	3638885V91
1855 Diesel	3-7/8" Bore	20V7002940
1950 T, 1955	3-7/8" Bore	20V7002940

Each kit includes one piston, one sleeve, one piston ring and packing for one piston, and hardware for one cylinder.

MUO	Note	Part No.
<b>PISTONS</b>		
1250-A (Eff. SN 360745), 1255 (Eff. SN 303397), 1355 (Eff. SN 503289), 1365, 1370	Standard	72094302V
1850 (Eff. SN 150421)	Standard	738871V91
2050, 2150		40V3810356 40V3810455
2155, 2655 (504B-6 LP & Gas)	Standard	20V2009028*
	0.020 Oversized	20V2009029*
	0.040 Oversized	20V2009030*
	0.060 Oversized	20V2009031*
2155, 2655 (D586-6 Diesel)	Standard	11V23860*
	0.020 Oversized	20V2006610*
	0.040 Oversized	20V2006611*
	0.060 Oversized	20V2006612*

\* Piston includes pin and retainer.



72094302V

# Engine Components - Oliver

MUO	Notes	Part No.
<b>SLEEVES</b>		
1265 & 1270 (Eff. SN 000001), 1365, 1370	Standard	72090603V
	0.20 Oversized	72090604V
2050, 2150, 2155		166631AV

MUO	Notes	Part No.
<b>PISTON RING KITS</b>		
Super 55, Super 66, Super 77, 88	3-1/2" Bore, 1/4" oil ring	106565ASV
Super 55, 550, Super 66, Super 77, 770 550, 660	3-1/2" Bore, 3/16" oil ring	106566ASV
66, 77	3-5/8" Bore	106569ASV
	3-3/16" Bore	106564ASV
<b>Use With Cast Sleeves</b>		
Super 88	3-3/4" Bore, 1/4" oil Ring	106567ASV
1250 Diesel	Standard	674053ASV
1255, 1355	Standard	72094303V
1550 Gas & LP, 1555 Gas	3-5/8" Bore	30V3034089
1550 & 1555 Diesel	3-5/8" Bore	161344ASV
1600 Diesel	3-3/4" Bore	161825ASV
1600 Gas & LP	3-5/8" Bore	157757ASV
1650 Gas & LP, 1655 Gas	3-3/4" Bore	159480ASV
1650 Diesel, 1655 Diesel (Eff. SN 187586)	3-7/8" Bore	30V3046222
1750, 1850 Gas & LP, 1755, 1855 Gas	3-7/8" Bore	162813ASV
1755 Diesel	3-7/8" Bore	30V3046222
1800 Diesel, 1650 Diesel (Prior to Eng. SN 187585)	3-7/8" Bore	106571ASV
1800 Gas & LP	3-7/8" Bore	156408ASV
1850 Diesel	3-7/8" Bore	745760V91
1855 Diesel	3-7/8" Bore	30V3090264
1950-T, 1955	Standard	30V3090264
2050, 2150	Standard (With Keystone Compression Rings)	40V3810455
<b>Use With Chrome Sleeves</b>		
1655 Diesel (Eff. SN 187586)	3-7/8" Bore	30V3046222

*Each ring kit is designed for a single piston.*

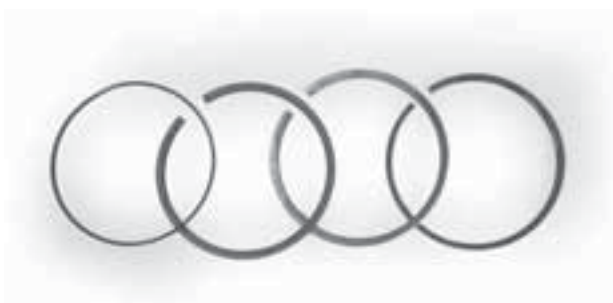

30V3090264



20V7100758

# Engine Components - Oliver

<b>CONNECTING ROD BEARINGS</b>		
<b>MUO</b>	<b>Part No.</b>	<b>Size</b>
Super 55 Gas, 88 Gas & LP, Super 99 6 Cylinder Gas (Prior to SN 964431)	KAS217V	Standard
Super 55, 88 Diesel, 550, Super 66, 660, Super 77, 770, 1550, 1555, 1600 Gas & LP, 1655 Gas	K217AV KRS217AV	Standard 0.003 Undersized
66 Gas, 77 Gas & LP	HAS217V	Standard
Super 88, 880 1650 Diesel (Prior to SN 187585), 1750, 1800	102700AV 102702AV 102704AV	Standard 0.003 Undersized 0.020 Undersized
1650 Diesel (Eff. SN 187586), 1655, 1850 Gas, 1950T, 1755, 1855, 1955	30V3137589 30V3137600	Standard 0.002 Undersized
1850 Diesel	159988AV	Standard
1755, 1855, 1955	30V3137589 30V3137600 30V3137597 30V3137619	Standard 0.002 Undersized 0.010 Undersized 0.020 Undersized
2050, 2150	166696AV 167535V	Standard 0.010 Undersized

<b>MUO</b>	<b>Part No.</b>
<b>CONNECTING RODS</b>	
Super 88, 88, 880 (Eff. SN 6503)	KS216BV
1250A, 1255, 1265, 1355, 1365	72094161V
1600 Diesel	KS216BV
1650, 1655 (Eff. SN 187586), 1750, 1755, 1800 (Eff. SN 124396), 1855, 1950T, 1955 Diesel, 1850 Gas	30V3052141
1850 Diesel	3637034V91
2050, 2150	40V3807851

<b>MUO</b>	<b>Part No.</b>
<b>CONNECTING ROD BUSHINGS</b>	
Super 55, 550, Super 66, 66, 660, Super 77, 77, 770, Super 88, 88, 880, 99 Gas (Eff. SN 51833), Super 99, (Prior to Eng. SN 964431)	30V3443353
1550, 1555, 1600, 1650, 1655, 1750, 1755, 1800, 1850 Gas, 1855, 1950T, 1955 1250A, 1255, 1265, 1355, 1365	72089460V

ENGINE



# Engine Components - Oliver



10V26358

<b>MUO</b>	<b>Intake Valves Part No.</b>	<b>Exhaust Valves Part No.</b>	<b>Intake Valve Guides Part No.</b>	<b>Exhaust Valve Guide Part No.</b>
------------	-----------------------------------	------------------------------------	---	---

## CYLINDER HEAD

Super 55 Gas	106096AV	106097AV	KR195V*	KR195AV*
Super 55 Diesel	107299AV Prior to SN 72831	107300AV	KR195BV*	KR195CV*
550 Gas	106096AV Prior to SN 72831	106097AV Prior to SN 72831	106608AV Prior to Eng. SN 93521	106614AV SN 60501- SN 72831
	106094AV Eff. Sn 72832)	106095AV Eff. Sn 72832	158786AV Eff. Eng. SN 93521	106609AV Eff. SN 72832
550 Diesel	107299AV Prior to SN 72831	107300AV Prior to SN 72831	106612AV	106609AV
	107297AV Eff. SN 72832	na	na	na
66 Gas	M196V	M197V	na	na
66 Diesel	M196AV	M197AV	na	na
Super 66 Gas	106096AV	106097AV	na	na
Super 66 Gas & LP	M196V	na	na	na
Super 66 Diesel	107299AV	107300AV	na	na
660 Gas	106094AV	106095AV	na	na
660 Diesel	107297AV	na	na	na
77 Gas	na	M197V	na	na
77 Diesel	M196AV	M197AV	na	na
Super 77 Gas & LP	106096AV	106097AV	na	na
Super 77 Diesel	107299AV	107300AV	na	na
770 Gas & LP	106096AV	106097AV	na	na
770 Diesel	107299AV	107300AV	na	na
88 Gas & LP	106096AV	106097AV	na	na
88 Diesel	K196AV	107302AV	na	na
Super 88 Gas & LP	106098AV	106099AV	na	na
Super 88 Diesel	107301AV	7A197AV Prior to SN 1000110, 107302AV	na	na
880 Gas & LP	106098AV	106099A	na	na
880 Diesel	107301AV	107302AV Eff. SN 1000110	na	na
Super 99 (6-Cyl.) Diesel	107301AV	7A197AV	na	na
950 Diesel	107301AV	7A197AV	na	na
1255	72094310V	72089669V	72094309V	72094309V
1355	72094310V	72089669V	72094309V	72094309V
1550 Gas & LP	106096AV	162802AV LP	158786AV	106614AV
1550 Diesel	107297AV	107300AV	106612AV	106609AV
1555 Gas	106096AV	na	na	106614AV
1555 Diesel	107297AV	107300AV	106612AV	106609AV
1600 Gas & LP	155888AV	155887AV Gas, 155889A LP	na	na
1600 Diesel	107301AV	107302AV	na	na
1650 Gas & LP	155888AV	155887AV Gas, 155889AV LP	158785AV, 156159AV	106620AV
1650 Diesel	158797AV Prior to SN 187585	107158AV Prior to 187585	164904AV	164904AV
	165375AV Eff. SN 187585		106623AV	106624AV

\*Includes Guide and Seat

# Engine Components - Oliver

40V1022502



Intake Valve Spring Part No.	Exhaust Valve Spring Part No.	Push Rods Part No.	Tappet Part No.
K198V	K198AV	106505AV	na
K198V	K198V	101192AAV	na
K198V	K198AV	106505AV	M201V
K198V	K198AV	106505AV	M201V
K198V Prior to SN19635	K198V Prior to SN19635	101192AAV	M201V
159026AV	106573AV	101192AAV	M201V
K198V	K198V	106505AV, 101192AAV	na
na	na	106505AV, 101192AAV	na
K198V	K198AV	106505AV, 101192AAV	na
na	na	106505AV, 101192AAV	na
K198V Prior to SN 19635	K198V Prior to SN 19635	106505AV, 101192AAV	na
K198V	K198AV	106505AV, 101192AAV	na
K198V Prior to SN 19635	K198V Prior to SN 19635	106505AV, 101192AAV	na
159026AV Eff. Eng. SN 19636	106573AV Eff. Eng. SN 19636	106505AV, 101192AAV	na
K198V	K198V	106505AV, 101192AAV	na
K198V	K198V	106505AV, 101192AAV	na
K198V, 106573AV	K198AV, 159026AV	106505AV, 101192AAV	na
K198V Prior to Eng. SN 13682	K198V Prior to Eng. SN 13682	106505AV, 101192AAV	na
106573AV Prior to Eng. SN 13682	106573AV Prior to Eng. SN 13682	106505AV, 101192AAV	na
K198V, 106573AV	K198AV, 159026AV	106505AV	na
K198V Prior to Eng. SN 13682,	K198V Prior to Eng. SN 13682,	101192AAV	na
159026AV Eff. Eng. SN 16683	106573AV Eff. Eng. SN 16683		
K198V	K198V	106506AV	na
K198V	K198V	106506AV	na
K198V	K198AV	106506AV	na
K198V Prior to Eng. SN 13682	K198V Prior to Eng. SN 13682	106506AV	na
K198V	K198AV	106506AV	na
K198V Prior to Eng. SN 13682,	K198V Prior to Eng. SN 13682,	106505AV	na
159026AV Eff. Eng. SN 16683	106573AV Eff. Eng. SN 16683		
K198V	K198V	106506AV	na
K198V	K198V	106506AV	na
72091160V - Outer,	72091160V Outer,	72094487V	na
72090613V - Inner	72090613V Inner	na	
72091160V - Outer,	72091160V Outer,	72094487V	na
72090613V - Inner	72090613V Inner		
106573AV	159026AV	106505AV	na
159026AV	106573AV	101192AAV	na
106573AV	159026AV	106505AV	M201V
159026AV	106573AV	101192AAV	M201V
106573AV	159026AV Eff. SN 124420	155895AV	M201V
159026AV (Eff. SN 124420)	106573AV	106505AV	M201V
106573AV	159026AV	155895AV	M201V
na	na	106506AV Prior to SN 187595	M201V
159026AV	106573AV, 159026AV	30V3055361 Eff. SN 187585	M201V

# Engine Components - Oliver

MUO	Intake Valves Part No.	Exhaust Valves Part No.	Intake Valve Guides Part No.	Exhaust Valve Guide Part No.
<b>CYLINDER HEAD CONTINUED</b>				
1655 Gas & LP	155888AV	155887AV	158785AV, 156159AV	106620AV
1655 Diesel	165375AV Eff. SN 187586, 158797AV Prior to SN 187585		164904AV Eff. SN 18786, 106623AV Prior to SN 187585	164904AV Eff. SN 18786, 106624AV Prior to SN 187585
1750 Gas	169430AV	169431AV	158786AV	106620AV
1750 Diesel	163648AV	169447AV	164904AV	164904AV
1755 Gas	169430AV	169431AV	158786AV	106620AV
1755 Diesel	163648AV	169447AV	164904AV	164904AV
1800 Gas	169430AV	169431AV Gas, 155732AV LP	na	na
1800 Diesel	158797AV Prior to SN 187585	107158AV	na	na
1850 Gas	169430AV	169431AV Gas, 155732AV LP	158786AV	106620AV
1850 Diesel	739027V1	169447AV, 747552V1	4223073V1	4223074V1
1855 Gas	169430AV	169431AV	158786AV	106620AV
1855 Diesel	163648AV	169447AV, 30V3113019	164904AV	164904AV
1950T Diesel	163648AV	169447AV, 30V3113019	164904AV	164904AV
1955 Diesel	163648AV	169447AV	164904AV	164904AV
2050	40V1022502	na	40V3891403	40V3891403
2150	40V1022502	na	40V3891403	40V3891403



KS206EV

MUO Serial No. Part No.

### ROCKER ARMS

Super 55, 550, 770, 880, 1550, 1555, 1600 Diesel, 1800 Diesel, 166, Super 166, 177, Super 177, 199, Super 199		Left - KS206DV Right - KS206EV
66, Super 66, 660	Eff. Eng. SN 861958	
77, Super 77	Eff. Eng. SN 868206	
88, Super 88, 188, Super 188	Eff. Eng. SN 875527	
99, Super 99	99: Eff. SN 518300	
1650, 1655 Diesel	Eff. SN 187586	
1850 Diesel		Left - 4223076V91 Right - 31V2751247
2050, 2150 Intake & Exhaust		166828ASV

# Engine Components - Oliver

Intake Valve Spring Part No.	Exhaust Valve Spring Part No.	Push Rods Part No.	Tappet Part No.
106573AV	159026AV	155895AV	M201V
106573AV	na	106506AV Prior to SN 187595 30V3055361 Eff. SN 187586	M201V M201V
106573AV	159026AV	105534AV	M201V
106573AV	106573AV	30V3055361	M201V
106573AV	159026AV	105534AV 30V3055361	M201V M201V
K198V Prior to SN 124395, 106573AV Eff. SN 124396	K198AV Prior to SN 124395, 159026AV Eff. SN 124396	105534AV	na
106573AV Prior to SN 6840, 159026AV Eff. Eng. SN 29467	106573AV Prior to SN 6840, 159026AV Eff. Eng. SN 29467	106506AV	na
106573AV	159026AV	105534AV	4222069V91
106573AV Prior to SN 6840, K198AV Eng. SN 6841-29466, 159026AV Eff. Eng. SN 29467, 735521V1 Outer, 735525V1 Inner	106573AV Prior to SN 6840, K198V Eng. SN 6841-29466, 159026AV Eff. Eng. SN 29467, 735521V1 Outer, 735525V1 Inner	733817V1	4222069V91
	159026AV	105534AV 30V3055361 30V3055361	M201V M201V M201V
106573AV	106573AV	30V3055361	M201V
40V3822651	40V3822651	166830AV	166831AV
40V3822651	40V3822651	166830AV	166831AV

## MUO

### VALVE SEALS

MUO	Part No.
550 Gas (Eff. SN 93521), 770 Gas , 1600 Gas, 1800 Gas, 1650 & 1655 Gas & LP, 1750 & 1755 Gas, 1850 Gas & LP, 1850 Diesel, 1855 Gas	30V3043096 (Pkg. 1)
770 Diesel (O-Ring Type), 1800 Diesel, 550 Diesel, 770 Diesel, 1600 LP & Diesel, 1800 Gas & LP, 1650, 1655 Diesel, 1750 & 1755 Diesel, 1855 Diesel, 1950T, 1955	107160AV (Pkg. 24)
1850 Diesel (Prior to Eng. SN 8512096)	30V3043096 (Pkg. 1)
2050, 2150	40V3903852 (Pkg. 1)



# Engine Components - Oliver

MUO	Fuel Type	Overhaul Gasket Set Part No.	Valve Grinding Gasket Set Part No.
<b>GASKETS AND GASKET SETS</b>			
Super 55	Gas	ES499V	102071ASV
	Diesel	ES499AV	102073ASV
550	Gas	ES499V Prior to SN 61123, 103456ASV	103454ASV Eff. SN 72832, 102071ASV Prior to SN 72831
	Diesel	ES499AV Prior to SN 61123	102073ASV
	Diesel	103457ASV Eff. SN 72832	103455ASV
66	Gas	106114ASV	102071ASV
	Diesel	106114ASV	102071ASV
Super 66	Gas	106114ASV	102071ASV
	Diesel	na	102073ASV
660	Gas	103456ASV	na
	Diesel	na	103455ASV
77	Gas & LP	102132ASV	102131ASV
	Diesel	na	na
Super 77	Gas & LP	na	102131ASV
	Diesel	na	102133ASV
770	Gas		102131ASV
	Diesel	106532ASV	102133ASV
88	Gas & LP	106116ASV	102135ASV
	Diesel	KS499BV	na
Super 88	Gas & LP	106116ASV	102135ASV
	Diesel	KS499DV	102137ASV
880	Gas & LP	102136ASV	102135ASV
	Diesel	106533ASV	102137ASV
1355		na	30V3001776
1365		na	1940031V
1550	Gas & LP	161130ASV	161131ASV
	Diesel	161239ASV	161237ASV
1555	Gas	161130ASV	161131ASV
	Diesel	161239ASV	161237ASV
1600	Gas & LP	156163ASV	156161ASV
	Diesel	156164ASV	156162ASV
1650	Gas & LP	156163ASV	156161ASV
	Diesel	163690ASV Direct Injection, Eff. SN 187586	30V3099458 Eff. SN 187586
1650	Diesel	156414ASV Lanova, Prior to SN 187585	156412ASV Eff. SN 124396
1655	Gas	156163ASV	156161ASV
	Diesel	30V3099466	30V3099458
1750	Gas & LP	156413ASV	156411ASV
	Diesel	165943ASV Eng. SN 151055 - SN 151374, SN 151452 - SN 151682	165944ASV
	Diesel	30V3099466 SN 150763 - SN 151054, SN 151375 - SN 151451, SN 151683- SN 180536, Eff. SN 180537	30V3099458 SN 150763 - SN 151054, SN 151375 - SN 151451, SN 1516836 - SN180536, Eff. 180537

# Engine Components - Oliver

Cylinder Head Gasket Part No.	Valve Cover Gasket Part No.	Oil Pan Gasket Part No.
L181BV	101761AAV	L166V
L181BV	101761AAV	L166V
L181BV	101761AAV	L166V
L181BV SN 60501 - SN 72831	101761AAV	L166V
L181BV Eff. SN 72832	101761AAV	L166V
na	101761AAV	L166V
L181BV	101761AAV	L166V
na	101761AAV	L166V
L181BV	101761AAV	L166V
L181BV	101761AAV	L166V
L181BV RC SN 6503-73131	101761AAV	L166V
M181CV	101775AV	M166V
MR181AV	101775AV	M166V
M181CV	101775AV	M166V
MR1881AV SN 320001 - SN 6502 160930AV Eff. SN 6503	101775AV	M166V
M181CV	101775AV	M166V
160930AV	101775AV	M166V
K181DV	101796AV	30V3071782
KR181DV Prior to SN 6502 K181CV Eff. SN 6503	101796AV	30V3071782
K181DV	101796AV	30V3071782
KR181DV Prior to SN 6502 K181CV Eff. SN 6503	101796AV	30V3071782
K181DV	101796AV	30V3071782
K181CV	101796AV	30V3071782
na	31V2902203, 30V3010031	30V30140090
98472008V	31V2902203, 30V3010031	30V3010090
M181CV	164043AV	30V30714773
160930AV	164043AV	30V30714773
M181CV	164043AV	30V30714773
160930AV	164043AV	30V30714773
155886AV	167695AV	30V3071782
155886AV	101776AV	30V3071782
155886AV	167695AV	30V3071782
30V3072886 Direct Injection	164044AV	30V3071782
158850AV Lanova Injection	164044AV	30V3071782
155886AV	167695AV	30V3071782
30V3072886	164044AV	30V3071782
159320ASV	167696AV	30V3071782
30V3068269 SN 151055 - SN 151374, SN 151452 - SN151682	164044AV SN 202441 - SN 203482	30V3071782
30V3072886 SN 180537 - SN 202440, Eff. 203483	164044AV	30V3071782

ENGINE

# Engine Components - Oliver

<b>MUO</b>	<b>Fuel Type</b>	<b>Overhaul Gasket Set Part No.</b>	<b>Valve Grinding Gasket Set Part No.</b>
------------	------------------	---	---

## GASKETS AND GASKET SETS CONTINUED

1755	Gas	156413ASV	156411ASV
	Diesel	30V3099466	30V3099458
1800	Gas & LP	156413ASV Eff. SN 124396	156411ASV Eff. SN 124395
	Gas & LP	105815ASV Prior to SN 124395	105816ASV Prior to SN 124395
	Diesel	105817ASV Prior to SN 124395	105818ASV Prior to SN 124394
	Diesel	156414ASV Eff. SN 124396	156412ASV Eff. SN 124396
1850	Gas & LP	156413ASV	156411ASV
	Diesel	159046ASV	160177ASV
1855	Gas	156413ASV	156411ASV
	Diesel	30V3099466	30V3099458
1950T	Diesel	165943ASV	165944ASV
1955	Diesel	165943ASV	165944ASV
2050	Diesel	79018171V	79018172V
2150	Diesel	79018171V	79018172V

<b>MUO</b>	<b>Main Bearings Part No.</b>	<b>Thrust Bearings Part No.</b>	<b>Size</b>
------------	-----------------------------------	-------------------------------------	-------------

## CRANKSHAFT BEARINGS

Super 55, 66, Super 66 Gas, Super 77 Gas & LP	MAS101V na	MBSA105V 103971AV	Standard 0.020 Undersized
Super 55, 66, Super 66, 77, Super 77 Diesel, 660, 770, 1550, 1555	103653AV	MASA105AV	Standard
88, Super 88 Gas & LP, Super 99 6-cyl. Gas Prior to Eng. SN 964431	na	KBSA105V	Standard
88, Super 88 Diesel, 880, 1600, 1650 Gas & LP Prior to SN 147568	K101AV 103972AV	157941AV na	Standard 0.003 Undersized
Super 99 6-cylinder Gas, 950 Gas (Eff. Eng. SN 964432), Super 99, 950 Diesel	na	7001485ASV	Standard
1650 Gas & LP Eff. Eng. SN 147569, 1650 Diesel, 1750, 1850 Gas, 1950T, 1655, 1755, 1855, 1955	30V3109887 30V3109895 30V3109909 30V3109917	30V3109925 na 30V3109941 30V3109984	Standard 0.002 Undersized 0.010 Undersized 0.020 Undersized
1850 Diesel	159614AV na	736930V91 736932V91	Standard 0.020 Undersized
2050 - 2150	40V1091455 40V1091463* na 40V1091485	40V1091457 40V1091463* na 40V1091487	Standard 0.010 Undersized 0.020 Undersized 0.030 Undersized

\*Complete Kit; includes main and thrust bearings.

# Engine Components - Oliver

**Cylinder Head Gasket**  
Part No.

**Valve Cover Gasket**  
Part No.

**Oil Pan Gasket**  
Part No.

159320ASV	167696AV	30V3071782
30V3072886	164044AV	30V3071782
na	167696AV	30V3071782
159319ASV w/ Firing Rings	167696AV	30V3071782
159319ASV Prior to SN 124395, w/ Firing Rings	101796AV	30V3071782
159320ASV Eff. SN 124396, w/ Firing Rings	101796AV	30V3071782
159320ASV	167696AV	30V3071782
740337V1, Rear 4222004V1	165990AV Cast Valve Covers, 164890AV Pressed Steel Cover	4224291V1
159320ASV	167696AV	30V3071782
30V3072886	164044AV	30V3071782
30V3068269	164044AV	30V3071782
30V3068269	164044AV	30V3071782
40V3891123	166836AV	40V1093436
40V3891123	166836AV	40V1093436

**MUO**      **Notes**      **Front Seal**  
**Part No.**      **Rear Seal**  
**Part No.**

## CRANKSHAFT MAIN SEAL

1600		K126V	30V3072959
2050, 2150	Eff. SN 204001	40V1093705	166680AV
2155		103682AV	30V3134008
2655		103682AV	30V3134008

**MUO**      **Part No.**

## CRANKSHAFT ASSEMBLIES

1255 Eff. SN 303397, 1265, 1275 Eff. SN 000001, 1250A Eff. SN 360745	72094402V
1750 Diesel, 1755 Diesel, 1800 Diesel, 1850 Gas and Diesel Turbo, 1950T Turbo, 1955 Turbo, 310 Waukesha engine (machined for 1-1/2" thrust)	30V3078663
2050, 2150	40V3803054

**MUO**      **Part No.**

## CRANKSHAFT DAMPENER AND ASSEMBLY

2050, 2150	40V3882001
------------	------------

**MUO**      **Flywheel**      **Ring Gear**  
**Part No.**      **Part No.**

## FLYWHEELS

2050, 2150 Eff. SN 204001	166687ASV*	166688AV
---------------------------	------------	----------

\*Includes Ring Gear

**MUO**      **Kit**      **Camshaft**      **Gear**  
**Part No.**      **Part No.**      **Part No.**

## CAMSHAFT AND COMPONENTS

1600	na	na	K153V
1750	30V3052206*	30V3133435	30V3133443
1955 Eff. SN 220000	30V3052206*	30V3133435	30V3133443

\*Includes: Camshaft, Gear and Keyway



166680AV

40V1093705



166688AV

ENGINE

# Engine Components - Minneapolis-Moline

MUO	Piston Kit Part No.	Ring Set Part No.	Size
<b>PISTON KITS &amp; RING SETS</b>			
G1000, G1050, 605-6A: LP	20V2009028	20V7100751	Standard
G1000, G1050: Diesel	11V18860	20V7100751	Standard
A4T 1400, DHD504-6A, D504A-6: Diesel	20V2009029	20V7100752	Standard
A4T 1600, G1350, G1355LP, 504B6: LP	20V2009030	20V7100753	Standard
	20V2009031	20V7100753	.060 Oversized
A4T 1600, G1350, G1355, 585-6: Diesel	11V23860	20V7100791	Standard 4-3/4"
	20V2006610	20V7100792	.020 Oversized
	20V2006611	20V7100793	.040 Oversized
	20V2006612	20V7100794	.060 Oversized
A4T 1600, 800-6, HD800-6A, HD800A-6A: LP	20V2009024	20V7100770	Standard 5-5/16"
	20V2009025	20V7100771	.020 Oversized
	20V2009026	20V7100772	.040 Oversized
	20V2009026	20V7100773	.060 Oversized
GTC, GVI, U, UB, UT, 5 Star, 283-4A, 425A-6A: Gas & LP	20V7100931	20V7100758	Standard 4-1/4"
	20V7100932	20V7100759	.020 Oversized
G705, G706, G707, G708, 336-4A, 336A-4A	20V2009028	20V7100741	Standard 4-5/8"
	20V2009029	20V7100742	.020 Oversized
	20V2009030	20V7100743	.040 Oversized
	20V2009031	20V7100744	.060 Oversized
D336A-4A, HD504-6A Eff. SN 26500050, HD504A-6A	na	20V7100751	Standard 4-5/8"
	na	20V7100752	.020 Oversized
	na	20V7100753	.040 Oversized
	na	20V7100754	.060 Oversized
GB, M5, M504: Gas & LP	na	20V7100719	Standard 4-5/8"
	na	na	.020 Oversized
	na	20V7100720	.030 Oversized
	na	na	.063 Oversized
G900, G950, G955, HD425-6A: Gas & LP	na	20V7100782	Standard 4-1/4"
	20V2009021	20V7100783	.020 Oversized
	20V2009022	20V7100784	.040 Oversized
	na	20V7100785	.060 Oversized
G900, G950, G955: Diesel	20V2009036	20V7100774	Standard 4-3/8"
	20V2009037	20V7100775	.020 Oversized
	20V2009038	20V7100776	.040 Oversized
Jet Star, Jet Star 2, Jet Star 3, 4 Star, 4 Star Super, 400, 500, 600: Gas & LP. Jet Star and Jet Star 3: Diesel	11V22886	20V7100735**	Standard 3-5/8"
	11V22887	20V7100746	.020 Oversized
	11V22888	20V7100747	.040 Oversized
Jet Star, Jet Star 2, 4 Star Super, 500 Eff. Eng. SN 10700578: Diesel	na	20V7100735**	Standard 3-5/8"
M-5, M504: Gas & LP	na	20V7100741	Standard 4-5/8"
	na	20V7100752	.020 Oversized
	na	20V7100720	.030 Oversized
	na	20V7100743	.040 Oversized
	na	20V7100754	.060 Oversized

\* Piston Kit includes pin and retaining rings

\*\* Two in One Chrome



# Engine Components - Minneapolis-Moline

MUO	Piston Kit * Part No.	Ring Set Part No.	Size
<b>PISTON KITS &amp; RING SETS</b>			
M602, M604, M670, M670 Super: Gas, LP, & Diesel	na	20V7100741,	Standard 4-5/8"
M-5, M-504: Diesel, D336A Use with 4-Ring piston	na	20V7100751	
	11V18861	20V7100752	.020 Oversized
	11V18862	20V7100743, 20V7100753	.040 Oversized
	11V18863	20V7100754	.060 Oversized
M-5, M-504, D336-4A; Diesel	11V18860	20V7100795	Standard 4-5/8"
R, RT1, ZA, ZB, 165-4A, 206A-4A: Gas	na	20V7100724**	Standard 3-5/8"
U-302, U302 Super, HD220-4A: Gas & LP	11V4860	20V7100748	Standard 3-3/4"
	11V17475	20V7100749	.020 Oversized
	11V17476	20V7100750	.040 Oversized
5 Star: Diesel	11V18860	20V7100795	Standard 4-5/8"
	na	20V7100723	.030 Oversized
335, 445, 206H-4A: Gas & LP	11V22886	20V7100717** 20V7100735**	Standard 3-5/8"
	11V22887	na	.020 Oversized
	11V22888	na	.040 Oversized
445: Diesel	na	20V7100735**	Standard 3-5/8"
	na	20V7100746**	.020 Oversized
605-6A, 605A-6A, 1210-12A, 403-4A (w/ aluminum flat top pistons)	na	20V7100720	.030 Oversized
605A-6A (w/ aluminum dished top pistons)	20V2009028	20V7100741	Standard 4-5/8"
	20V2009029	20V7100752	.020 Oversized
	20V2009030	20V7100743	.040 Oversized
	20V2009031	20V7100754	.060 Oversized
HD605-6A	20V2009028	20V7100751	Standard 4-5/8"
	20V2009029	na	.020 Oversized
	20V2009030	20V7100753**	.040 Oversized
	20V2009031	na	.060 Oversized

\* Piston Kit includes pin and retaining rings.

\*\* Two-in-One Chrome.

MUO	Part No.
<b>CYLINDER HEAD ROCKER ARMS</b>	
445, Big Mo-44M, Big Mo-400 Ind., Big Mo 500 & 600, Jet Star 3, Jet Star 3 Super, Jet Star, 4 Star, 4 Star Super, 206H-4A, 220-4A, HD220-4A	10V6479
U302 Gas	10V6479
G900, G950, G955 Diesel	10V25032
G1000 Diesel 17-3/16"	10V25032
G1050 Diesel Eff. SN 32700926	10V25032
A4T 1400	10V25032
DHD504-6A All Models 17-3/16"	10V25032

# Engine Components - Minneapolis-Moline



10V406



10V29704

ENGINE

MUO	Part No.	Size
<b>CONNECTING ROD BEARINGS</b>		
ZB, 445, Jet Star, 4 Star, 206A, 106A	10V420	Standard
	10V1257	.002 Undersized
	10V1147	.010 Undersized
	10V422	.020 Undersized
	10V423	.040 Undersized
UT, UB, 5 Star, GBI, 283, 425	11V9210	Standard
G705, G705D, G707D, M602D, M604D, 504-6A, G900, G1000 Vista, G950, G1050, G1350 LP, A4T1600 LP, A4T 1400 Diesel	10V406	Standard
G1355 LP, G955	10V1159	.010 Undersized
	10V409	.020 Undersized
A4T 1600 Diesel, G1355 Diesel	10V1326	Standard
	20V7100278	.010 Undersized
	20V7100279	.020 Undersized
	20V7100280	.030 Undersized
	20V7100281	.040 Undersized
HD 800-6A	10V1038	Standard
605-6A	10V11339	Standard

MUO	Part No.
<b>CONNECTING ROD BUSHINGS</b>	
GTB, GTBD, GTC, GB Gas	10V1908
GTB, GTBD, GTC, GB Diesel	10V29275
RTI Industrial	10V6536
U, UTU, UTS, UTC, UTN, UTE, UTI, UTIL	10V1908
445 Gas, Jet Star 3, Jet Star 3 Super, Jet Star 4 Star, 4 Star Super Gas	10V6536
445 Diesel, Jet Star-3, Jet Star 3 Super, Jet Star, 4 Star, 4 Star Super Diesel	10V6017
U302	10V4865
M5, M504, M602, M670, M670 Super, G707, G708 Gas, G1000, G1000 Vista, G1050, G1350 Gas	10V9105
M5, M504, M602, M670, M670 Super, G707, G708, G900, G950, G1000, G1000 Vista, G1050 Diesel	10V29275
G900, G950 Gas, G955 LP	10V1908
G1350, G1355 Diesel	10V24055
G955 Diesel	20V0006412

MUO	Part No.
<b>CYLINDER HEAD EXHAUST VALVES</b>	
GTB, GB, 403, 605	GE32V
G705, & G706 LP Gas, 336-4A, M602, M604, 504-6A	10V17914
M670, G707, G708, G1000, G1000 Vista, G900, G950 LP, G1050 LP, A4T1600 LP	20V0006864
M670, G707, G708, G1000, G1000 Vista, G950 LP, G1050 LP, A4T1600 LP	10V29701
R, Z, ZA, ZB, 165, 206A	RE103BV
UB, GTB, GB, 800	10V2272
UBD, GTB, GBD, GVID, D425, G950, G955 Diesel	10V29704
UT, UB, 5 Star, M5, GTB, GB, GVI, 283, 403, 425, 605	10V10073
U302, Jet Star 3	10V29728

# Engine Components - Minneapolis-Moline

MUO

Part No.

## CYLINDER HEAD EXHAUST VALVES-CONTINUED

5 Star, M5D, G705, G706, M602, M604, G670, G1000D, G707, G708, G1050, A4T 1400 Diesel	10V26359
335, 445, Jet Star, 4 Star, 206H, 400, 500, 600, Jet Star 3	10V29833
800A-6A, HD800-6A (45 Degree)	10V19206
800A-6A, HD800-6A (45 Degree)	10V26125
G1355 LP	20V0006864
G1355 Diesel	30V3136515*

\*Requires Key 166799A & Retainer 30-3136507

MUO

Part No.

## CYLINDER HEAD INTAKE VALVES

GTB, GB, 403, 605, 800	GE31V
G705 & G706 LP, 336-4A, M602, M604, G707, G708, 504-6A, M670, G1000, G1000 Vista	10V29696
M670, G1000, G707, G708, G1000 Vista, G900, G950 LP, G1050 LP, A4T-1600 LP, A4T-1400 Diesel, G955 LP	10V29699
UT, UB, GTB, GB, 5 Star, M5, GVI, 283, 403, 425, 605, 800	10V9108
UBD, GTBD, D425, 5 Star Diesel, M5D, GBD, G1000 Diesel, GVID, G705 & G706 Diesel, M602, M604, M670 Diesel, G950 Diesel, G1050 Diesel, G955 Diesel	10V26358
U302, Jet Star 3	10V29697
U302 Diesel	10V29698
335, 445, 4 Star, Jet Star, R, Z, 165, 206A, 206H, 400, 500, 600	10V6429
445D, Jet Star Diesel, 4 Star Diesel, Jet Star 3 Diesel	10V9275
800A-6A, HD800-6A	10V20408
G1355 Diesel	30V3203905
G1355 LP	20V0006863

MUO

Part No.

## CYLINDER HEAD VALVE GUIDES

335, 445, Jet Star, 4 Star, 206H, U302, Jet Star 3 Gas	10V27221 (Int. & Ext.)
335, 445, Jet Star, 4 Star, 206H, U302, Jet Star 3 Diesel	10V27220 I (Int.), 10V27221 (Ext.)
G900, G955, G1000, G1050, G1350, G1355, A4T-1600, 425-6A Gas	10V26421 (Int. & Ext.)
G900, G955, G1000, G1050, A4T-400, HD425-6A Diesel	na (Int.), 10V29501 (Ext.)
G1350, G1355, A4T-1600, 2655 Diesel	30V3099210 (Int. & Ext.)
HD800A-6A, 800A-6A	10V26467 (Int. & Ext.)

Int. = Intake Ext. = Exhaust

MUO

Part No.

## CYLINDER HEAD VALVE SEALS

G950, G1050, G1350, A4T, G1355, G955	10V27215 (Pkg. 16)
All 3-5/8" & 3-3/4" Bore Spark Ignition & Diesel	10V21650 (Pkg. 16)
All 4-1/4" & 4-5/8" Bore Spark Ignition	40V3903601 (Pkg. 16)
All 5.319 Spark Ignition Engines	10V20420 (Pkg. 16)

# Engine Components - Minneapolis-Moline

MUO	Overhaul Gasket Set Part No.	Valve Grinding Upper Gasket Set Part No.
<b>GASKETS AND GASKET SETS</b>		
R, ZA, ZB, 206A	10V1A	10V25
U, UB, 5-Star, 283, 283A	10V246	10R251V
5-Star, GVI, U, UB, 283E-4	na	na
GB, GTB, 340-4, 340A-4 Gas & LP	10V246	na
GB, GTB, 403A-4, 403C-4, M5 Gas & LP	na	10V1045
GTBD, GBD, GVID, D425 Diesel	na	10V944
G705, G706, 504-6 LP	10V1044	10V1043
G705, G706, D504-6 Diesel	na	10V1022
G707, G708, G900LP, G1000, G1050LP, G1000 Vista, G1350LP	10V1289	10V1104
G707, G708D, G900 Diesel, G1000 Vista, G1050 Diesel, G1000D, D451-6	10V1290	10V1106
U302, 204-A Gas	10V1060	10V1059
Jet Star, 4 Star, 500, 600, D206-4 Diesel	10V1016	na
400, 500, 600, 206H	10V884	na
4 Star, 445	10V884	10V823A
G1350, A4T 1600 Diesel Prior to SN 45200220	20V7100264	na
G1350, A4T 1600 Diesel Eff. SN 45200221	20V7100798	na
G1355, D585-6 Diesel	20V7100798	20V7100263
A4T 1600 Gas & LP Prior to SN 45100260	10V1289	na
M5, M504 Diesel D336-4	10V989	na
Jet Star 3, 206-4 Gas & LP	10V1074	na
Jet Star 3, D206L-4 Diesel	10V1075	na
M670, M670 Super, 336A-4A Gas	10V1095	10V1094
M670, D336A-4A Diesel	10V1097	10V1096
M602, M604, 336-4 Gas	na	10V1045
M602, 604 Diesel	10V989	10V1045
425A	10V61	10V62
800-6A, HD900A-6A Prior to SN 34902062	10V1053	na
HD800A-6A Eff. SN 34902063	20V7100809	10V1052
<b>MUO</b>	<b>Part No.</b>	
<b>CYLINDER SIDE COVER GASKET</b>		
R, ZA, ZB, V206, 165, 206A	RE114V	
<b>MUO</b>	<b>Part No.</b>	
<b>BREATHER GASKET</b>		
U, UB, 5 Star, M5, GTB, GB, GVI	10V29871	

# Engine Components - Minneapolis-Moline

Block to Crank Case Part No.	Head to Block Part No.	Adapter to Head Part No.	Valve Cover Part No.	Oil Pan Part No.	Timing Cover Part No.
RE115V	RE227AV	na	na	na	na
10V22209	na	na	KE265CV	10V9130	20V0000274
10V16979	10V9021	na	10V27663	10V9130	20V0000274
10V16979	10V527	na	KE265CV	20V0008252	20V0000274
10V16979	10V492	na	10V27663	10V9130	20V0000274
10V16979	10V2991	na	na	20V0008252	10V27663
10V16979	10V16981	na	KE265CV	20V0008252	10V30449
10V16979	10V16981	na	KE265CV	20V0008252	10V30449
10V16979	10V22209 Cyl. Bore Side, 10V22239 Push Rod Side	na	10V27663	20V0008252	10V30449
10V22563	10V21916 Cyl. Bore Side, 10V22239 Push Rod Side	na	10V27663	20V0008252	10V30449
10V13667	na	10V6009	10V6005	na	na
na	10V5919	10V6009	10V6005	na	na
na	10V5919	10V6009	10V6005	na	na
na	10V5919	10V6009	10V6005	na	na
10V25220	20V0000440	na	20V0006319	20V0008252	10V30449
10V25220	20V0000440	na	20V0006319	20V0008252	10V30449
10V25220	20V0000440	na	20V0006319	20V0008252	10V30449
10V22209	na	na	10V27663	20V0008252	10V30449
10V16979	10V16981	na	10V27663	10V9130	10V30449
10V20566	10V5919	10V6009	10V6005	na	na
na	10V5919	10V6009	10V6005	na	na
10V16979	10V22209 Cyl. Bore Side 10V22239 Push Rod Side	na	10V27663	10V3044	10V30449
10V13667	10V21916 Cyl. Bore Side 10V22239 Push Rod Side	na	10V27663	10V3044	10V30449
na	10V22660	na	10V27663	10V9130	10V30449
10V16979	10V16981	na	10V27663	10V9130	10V30449
na	na	na	10V27663	na	na
10V19117	na	na	na	na	na
10V19117	na	na	na	na	na

**MUO**

**Part No.**

**CRANKCASE SIDE COVER GASKET**

R, ZA, ZB, 165, 206A	10V1039
335, 445, 4 Star, 206H, 400, Jet Star 3, 500, 600	10V9835

ENGINE



# Engine Components - Minneapolis-Moline

MUO	Part No.
<b>CYLINDER HEAD VALVE INSERT - EXHAUST "STELLITE"</b>	
UB Spec, GTB, GV, GVI, 5 Star, M5, G705, G706, M602, M604, G707, G708, G1050, G1355 LP, A4T 1600 LP, A4T 1400, G950, G955, 283, 403, 425, 605, 800, Jet Star 3, U302	10V5844
800-6A, HD800-6A, HD800A-6A, 800-6 (intake)	10V26836
M670, G900, G1000, 336-4A, 504-6A, HD800-6A, HD800-6A (45 degree exhaust)	10V19404
M670, G900, G1000, 336-4A, 504-6A, HD800-6A, HD800-6A (30 degree exhaust)	10V26591

MUO	Notes	Front Part No.	Center Part No.	Rear Part No.	Size
<b>CRANKSHAFT BEARINGS</b>					
UT, UB, 5-Star, M5, GTB, GB, GVI, 283, 403, 425, 605, G705 LP, G706 LP, 336-4A	Tri-Metal	10V396	10V401	na	Standard
	Tri-Metal	na	10V1157	na	0.005 Undersized
	Tri-Metal	10V399	10V404	10V957	.020 Undersized
UBD, 5 Star D, M5D, GTBD, GBD, GVID, D425, G705D, G706D, M603, M604, 504-6A, G900, G1000 Vista, G950, G1050, G1350 LP, G1355 LP, G955 A4T 1600, G1355 Diesel	Tri-Metal	10V396	10V401	10V954	Standard
	Tri-Metal	10V1155	10V1157	na	.010 Undersized
	Tri-Metal	10V399	10V404	na	.020 Undersized
U302		20V7100271	na	20V7100265	Standard
		20V7100273		20V7100267	.010 Undersized
		na		20V7100268	.020 Undersized
RT, ZA, ZB, 335, 445, 4 Star, Jet Star, 165, 206H, 400, 500	Tri-Metal	10V1182	na	na	Standard
		na		10V11778	.020 Undersized
800-6A, HD800-6A	Tri-Metal	20V7100271		20V7100265	Standard
		20V7100273		20V7100267	0.10 Undersized
		na		20V7100268	0.02 Undersized

MUO	Description	Part No.
<b>FLYWHEEL</b>		
R, RTI, ZA, ZB, ZAS	Ring Gear	10V7878

# Overhaul Kits

**Complete Kit Includes:** Sleeves, pistons, piston rings, gaskets, thrust washers, washers, seals, bushings, valves, springs, guides, valve locks

## KIT ORDERING GUIDE

1. Locate Tractor or Combine Model
2. Verify Engine / Serial Number Information
3. Locate additional options required for rebuild in this Catalog
  - a. Upper Gasket Set
  - b. Main Bearing Set
  - c. Rod Bearing Set
  - d. Thrust Washers
  - e. Oil Pump



MUO	Engine Description	Part No.
<b>WHITE</b>		
<b>FB 2-85</b>	6.354.1	79016609
Prior to SN 297447		
Parts in Kit		Qty
Washer		12
Spring		12
Bushing		6
Nut		12
Spring		12
Guide		6
Olive / Pipe Fuel		12
Olive / Pipe Fuel		12
Liner		6
Lock		24
Seal		1
Guide, Valve		6
Valve		6
Valve		6
Gasket Set		1
Piston		6
Ring Set		6
Seal		1
Fitting		10
Seal		12
Gasket		1
Gasket		1
Gasket		1

MUO	Engine Description	Part No.
<b>FB 2-85,</b>	6.354.4	79016613
<b>FB 2-88</b>	Eff. SN 297447	
Parts in Kit		Qty
Washer, (Fuel Flow Meter)		12
Outer Valve Spring		12
Connecting Rod Bushing		6
Nut, Connecting Rod		12
Inner Valve Spring		12
Thrust Washer		2
Thrust Washer		2
Valve Guide		6
Olive / Pipe Fuel		12
Olive / Pipe Fuel		12
Sleeve Kit		6
Lock, Spring Retainer		24
Front Oil Seal		1
Valve Guide		6
Intake Valve		6
Rear Oil Seal		1
Fitting		10
Piston Assembly		6
Ring Set		6
Exhaust Valve		6
Gasket Set, Upper Overhaul		1
Gasket Set, Lower Overhaul		1
Valve Seal		12

ENGINE

# Overhaul Kits

MUO	Engine Description	Part No.
<b>WHITE CONTINUED</b>		
<b>FB 2-105</b>	T6.354.1	79016615
Prior to SN 297447		
Parts in Kit		Qty
Olive / Pipe Fuel		12
Washer, (Fuel Flow Meter)		1
Gasket, Fuel Injection Pump		1
Outer Valve Spring		12
Nut, Connecting Rod		12
O-Ring, Oil Pump		2
Inner Valve Spring		12
Thrust Washer		2
Thrust Washer		2
Seal, Cover		2
Gasket, Cover		1
Valve Guide		6
Olive / Pipe Fuel		12
Olive / Pipe Fuel		12
Sleeve Kit		6
Lock, Spring Retainer		24
Gasket, Fuel Injection Pump		1
Rear Oil Seal		1
Piston Assembly		6
Connecting Rod Bushing		6
Valve Guide		6
Intake Valve		6
Exhaust Valve		6
Gasket		1
Gasket Set, Bottom Overhaul		1
Ring Set		6
Front Oil Seal		1
Gasket, Exhaust Manifold (Center)		2
Gasket, Exhaust Manifold (Center)		1
Fitting		12
Gasket Set, Upper Overhaul		1
Gasket		1

MUO	Engine Description	Part No.
<b>FB 2-105, FB 2-110</b>	T6.354.4	79016617
Eff. SN 397447		
Parts in Kit		Qty
Olive / Pipe Fuel		12
Outer Valve Spring		12
Nut, Connecting Rod		12
Inner Valve Spring		12
Valve Guide		1
Olive / Pipe Fuel		12
Olive / Pipe Fuel		12
Sleeve Kit		6
Lock, Spring Retainer		24
Rear Oil Seal		1
Valve Guide		6
Intake Valve		6
Exhaust Valve		6
Gasket Set, Lower Overhaul		1
Oil Seal		1
Connecting Rod Bushing		6
Fitting		10
Gasket Set, Upper Overhaul		1
Piston Assembly		6
Ring Set		6
Valve Seal		12

MUO	Engine Description	Part No.
<b>WHITE/OLIVER</b>		
<b>White: FB 2-135,</b>	D5000 Hercules	79018170
<b>FB 2-155</b>		
<b>Oliver: 2050</b>	.005 Oversize Sleeves	
Parts in Kit		Qty
Piston Assembly		6
Ring Set		6
Gasket Set, Complete Gasket Set		1
Sleeve Kit, Oversized		6
<b>White: FB 2-135,</b>	D5000 Hercules Standard	79018169
<b>FB 2-155</b>		
<b>Oliver: 2050</b>		
Parts in Kit		Qty
Sleeve Kit		6
Piston Assembly		6
Ring Set		6
Gasket Set, Complete Gasket Set		1
Bulleting		1

ENGINE

# Overhaul Kits, Block Kits

MUO	Engine Description	Part No.
<b>OLIVER</b>		
1850 Diesel	6.354	79016607
	Cast Iron Valve Cover use Gasket	165990AV
	Pressed Steel Valve Cover use Gasket	164890AV
	<b>Parts in Kit</b>	<b>Qty</b>
	Complete Gasket Set, Overhaul	1
	1/4" Compression Sleeve (Fuel Tank Line)	10
	Outer Valve Spring	12
	Connecting Rod Bushing	6
	Nut, Connecting Rod	12
	Inner Valve Spring	12
	Thrust Washer	2
	Thrust Washer	2
	Seal, Housing	2

MUO	Engine Description	Part No.
<b>OLIVER</b>		
<b>1850 Diesel Continued</b>		
	Valve Guide	6
	Olive / Pipe Fuel	12
	Olive / Pipe Fuel	12
	Lock, Spring Retainer	24
	Intake Valve	6
	Exhaust Valve	6
	Piston Assembly	6
	Front Oil Seal	12
	Rear Oil Seal	1
	Valve Guide	6
	Ring Set	6
	Piston Liner	6

## Block Kits

**Kit Includes:** Sleeves, pistons, piston rings, gaskets, thrust washers, olives/washers, seals, bushings

### Kit Ordering Guide

1. Locate Tractor or Combine Model
  2. Verify Engine / Serial Number Information
  3. Locate additional options required for rebuild in the engine component section of Heritage Catalog
- a. Upper Gasket Set
  - b. Main Bearing Set
  - c. Rod Bearing Set
  - d. Thrust Washers
  - e. Oil Pump

MUO	Engine Description	Part No.
<b>WHITE</b>		
FB 2-70 Gas	F283GLA	79016789
	<b>Parts in Kit</b>	<b>Qty</b>
	Sleeve Set	6
	Connecting Rod Bushing	12
	Gasket Set, Complete Overhaul	1
	Connecting Rod Bushing	6
FB 2-70	F283DLA	79016791
	<b>Parts in Kit</b>	<b>Qty</b>
	Sleeve Set	6
	Connecting Rod Bushing	12
	Gasket Set, Complete Overhaul	1
	Connecting Rod Bushing	6

MUO	Engine Description	Part No.
FB 2-85	6.354.1	79016612
	Prior to SN 297447	
	<b>Parts in Kit</b>	<b>Qty</b>
	Inj. Olive	12
	Connecting Rod Bushing	6
	Nut, Connecting Rod	12
	Inj. Olive 3/16	12
	Inj. Olive 5/16	12
	Sleeve Kit	6
	Rear Oil Seal	1
	Gasket Kit, Lower Overhaul	1
	Piston Assembly	6
	Ring Set	6
	Front Oil Seal	1
	Fitting	10
	Gasket, Cylinder Head	1
	Gasket Kit, Upper Overhaul	1
	Gasket Kit, Upper Overhaul	1

ENGINE

# Block Kits

MUO	Engine Description	Part No.
<b>WHITE CONTINUED</b>		
<b>FB 2-85, FB 2-88</b>	6.354.4	79016614
Eff. SN 297447		

Parts in Kit	Qty
Connecting Rod Bushing	6
Thrust Washer	2
Thrust Washer	2
Thrust Washer	1
Inj. Olive	12
Inj. Olive	12
Sleeve Kit	6
Lock, Spring Retainer	24
Inj. Olive	12
Front Oil Seal	1
Gasket Set, Lower Overhaul	1
Rear Oil Seal	1
Fitting	10
Piston (Less Rings)	6
Ring Set	6
Gasket Set, Upper Overhaul	1

MUO	Engine Description	Part No.
<b>FB 2-105</b>	T6.354.1	79016616
Prior to SN 297447		

Parts in Kit	Qty
Gasket, Fuel Lift Pump	1
Washer, (Fuel Flow Meter)	12
Gasket, Injection Pump	1
Nut, Connecting Rod	12
O-Ring - Oil Pump	2
Thrust Washer	2
Thrust Washer	2
Front Oil Seal	2
Gasket, Cover	1
Inj. Olive	12
Sleeve Kit	6
Gasket	1
Rear Oil Seal	1
Piston Assembly	6
Connecting Rod Bushing	6
Gasket - Water Pump	1
Gasket Kit, Lower Overhaul	1
Ring Set	6
Oil Seal	1
Gasket, Exhaust Manifold (Center)	2
Joint	1
Fitting	12
Gasket Set, Upper Overhaul	1
Gasket Set, Upper Overhaul	1

MUO	Engine Description	Part No.
<b>FB 2-105, FB 2-110</b>	T6.354.4	79016618
Eff. SN 397447		

Parts in Kit	Qty
Washer, (Fuel Flow Meter)	12
Nut, Connecting Rod	12
Inj. Olive	12
Inj. Olive	12
Sleeve Kit	6
Rear Oil Seal	1
Gasket Kit, Lower Overhaul	1
Front Oil Seal	1
Connecting Rod Bushing	6
Fitting	10
Gasket Set, Upper Overhaul	1
Piston Assembly	6
Ring Set	6

MUO	Engine Description	Part No.
<b>FB 2-135, FB 2-155</b>	D5000 Hercules Standard	79018169

Parts in Kit	Qty
Sleeve Set	6
Piston Assembly	6
Ring Set	6
Gasket Set, Complete Overhaul	1
Bulletin	1

MUO	Engine Description	Part No.
<b>OLIVER</b>		
<b>550</b>	180GKB	79016775
Prior to SN 72831,		
<b>660</b>	Gas	

Parts in Kit	Qty
Sleeve Set	4
Connecting Rod Bushing	8
Gasket Set, Complete Overhaul	1
Connecting Rod Bushing	4

MUO	Engine Description	Part No.
<b>550</b>	180GKB	79016777
Eff. SN 72832,		
<b>660</b>	Gas	

Parts in Kit	Qty
Sleeve Set	4
Connecting Rod Bushing	8
Gasket Set, Complete Overhaul	1
Connecting Rod Bushing	4



# Block Kits

MUO	Engine Description	Part No.
<b>OLIVER</b>		
550 Diesel Prior to SN 72831	180GKB	79016778
<b>Parts in Kit</b>		<b>Qty</b>
Sleeve Set		4
Connecting Rod Bushing		8
Gasket Set, Complete Overhaul		1
Connecting Rod Bushing		4
550 Eff. SN 72832, 660 Diesel	180GKB	79016780
<b>Parts in Kit</b>		<b>Qty</b>
Sleeve Set		4
Connecting Rod Bushing		8
Gasket Set, Complete Overhaul		1
Connecting Rod Bushing		4
770 Gas	185GLB	79016781
<b>Parts in Kit</b>		<b>Qty</b>
Sleeve Set		6
Connecting Rod Bushing		12
Gasket Set, Complete Overhaul		1
Connecting Rod Bushing		6
770 Diesel	185DLB 3-1/2" Bore	79016782
<b>Parts in Kit</b>		<b>Qty</b>
Sleeve Set		6
Connecting Rod Bushing		12
Gasket Set, Complete Overhaul		1
Connecting Rod Bushing		6
880 Gas	190GLB	79016783
<b>Parts in Kit</b>		<b>Qty</b>
Sleeve Set		6
Connecting Rod Bushing		12
Gasket Set, Complete Overhaul		1
Connecting Rod Bushing		6
880 Diesel	190GLB 3-3/4" Bore	79016784
<b>Parts in Kit</b>		<b>Qty</b>
Sleeve Set		6
Connecting Rod Bushing		12
Gasket Set, Complete Overhaul		1
Connecting Rod Bushing		6
1550, 1555 Gas	F232G	79016785
<b>Parts in Kit</b>		<b>Qty</b>
Sleeve Set		6
Connecting Rod Bushing		12
Gasket Set, Complete Overhaul		1
Connecting Rod Bushing		6

MUO	Engine Description	Part No.
1550, 1555 Diesel	F232DL	79016786
<b>Parts in Kit</b>		<b>Qty</b>
Sleeve Set		6
Connecting Rod Bushing		12
Gasket Set, Complete Overhaul		1
Connecting Rod Bushing		6
1600 Gas	F248G 3-5/8" Bore	79016787
<b>Parts in Kit</b>		<b>Qty</b>
Piston Assembly		6
Connecting Rod Bushing		12
Gasket Set, Complete Overhaul		1
Connecting Rod Bushing		6
1600 Diesel	F265DL 3-3/4" Bore	79016788
<b>Parts in Kit</b>		<b>Qty</b>
Sleeve Set		6
Connecting Rod Bushing		12
Gasket Set, Complete Overhaul		1
Connecting Rod Bushing		6
1650, 1655 Gas	F265GA	79016789
<b>Parts in Kit</b>		<b>Qty</b>
Sleeve Set		6
Connecting Rod Bushing		12
Gasket Set, Complete Overhaul		1
Connecting Rod Bushing		6
1650 Prior to SN 187585	F283DB Lanova Injection, Horizontal Injector	79016790
1800 Prior to SN 124395	F283DL	
<b>Parts in Kit</b>		<b>Qty</b>
Sleeve Set		6
Connecting Rod Bushing		12
Gasket Set, Complete Overhaul		1
Connecting Rod Bushing		6
1650 Eff. SN 187586	F283DB Direct Injection Injector 20 Degrees from Vertical	79016791
1655 Diesel	F283DLA	
<b>Parts in Kit</b>		<b>Qty</b>
Sleeve Set		6
Connecting Rod Bushing		12
Gasket Set, Complete Overhaul		1
Connecting Rod Bushing		6

# Block Kits

MUO	Engine Description	Part No.
<b>OLIVER CONTINUED</b>		
<b>1750</b>	F283GB	79016792
Prior to SN 147260 Gas		
<b>Parts in Kit</b>		<b>Qty</b>
Sleeve Set		6
Connecting Rod Bushing		12
Gasket Set, Complete Overhaul		1
Connecting Rod Bushing		6
<b>1750</b>	F283GB	79016793
Eff. SN 147260		
<b>1755</b>	F283GB	
Gas		
<b>Parts in Kit</b>		<b>Qty</b>
Sleeve Set		6
Connecting Rod Bushing		12
Gasket Set, Complete Overhaul		1
Connecting Rod Bushing		6
<b>1750</b>	F310DB	79016794
Prior to SN 202400, Eff. SN 203483		
<b>1755</b>	F310DB	
Diesel		
<b>Parts in Kit</b>		<b>Qty</b>
Sleeve Set		6
Connecting Rod Bushing		12
Gasket Set, Complete Overhaul		1
Connecting Rod Bushing		6
<b>1750</b>	F310DB	79016795
SN 202401 - 203482 Diesel		
<b>Parts in Kit</b>		<b>Qty</b>
Sleeve Set		6
Connecting Rod Bushing		12
Gasket Set, Complete Overhaul		1
Connecting Rod Bushing		6
<b>1800</b>	F283G	79016797
Eff. SN 124396 Gas		
<b>Parts in Kit</b>		<b>Qty</b>
Sleeve Set		6
Connecting Rod Bushing		12
Gasket Set, Complete Overhaul		1
Connecting Rod Bushing		6
<b>1800</b>	F283DL	79016798
Eff. SN 124396 Diesel		
<b>Parts in Kit</b>		<b>Qty</b>
Sleeve Set		6
Connecting Rod Bushing		12
Gasket Set, Complete Overhaul		1
Connecting Rod Bushing		6

MUO	Engine Description	Part No.
<b>1850</b>		79016799
Gas Prior to SN 147252 F310GA LP Prior to SN 161491 F310LPA		
<b>Parts in Kit</b>		<b>Qty</b>
Sleeve Set		6
Connecting Rod Bushing		12
Gasket Set, Complete Overhaul		1
Connecting Rod Bushing		6
<b>1850</b>		79016800
Gas Eff. SN 147253 F310GA LP Eff. SN 161492 F310LPA		
<b>1855</b>	F310GA	
Gas		
<b>Parts in Kit</b>		<b>Qty</b>
Sleeve Set		6
Connecting Rod Bushing		12
Gasket Set, Complete Overhaul		1
Connecting Rod Bushing		6
<b>1850</b>	6.354	79016608
Diesel		
Cast Iron Valve Cover use Gasket		165990AV
Pressed Steel Valve Cover use Gasket		164890AV
<b>Parts in Kit</b>		<b>Qty</b>
Gasket Set, Complete Engine		1
Inj. Olive		12
Connecting Rod Bushing		6
Nut, Connecting Rod		12
Thrust Washer		2
Thrust Washer		2
Oil Seal		2
Inj. Olive		12
Inj. Olive		12
Lock, Spring Retainer		24
Piston Assembly		6
Oil Seal		1
Fitting (tube)		10
Ring Set		6
Piston Liner		6
<b>1855</b>	F310DBLT	79016801
Prior to SN 244324 Diesel		
Complete Gasket Set		30V3099466
<b>Parts in Kit</b>		<b>Qty</b>
Sleeve Set		6
Connecting Rod Bushing		12
Gasket Set, Complete Overhaul		1
Connecting Rod Bushing		6

ENGINE

# Block Kits

MUO	Engine Description	Part No.
<b>OLIVER CONTINUED</b>		
<b>1855</b>	F310DBLT	79016802
Diesel Eff. SN 244324		
<b>1950T, 1955</b>		
Diesel		
<b>Parts in Kit</b>		<b>Qty</b>
Sleeve Kit		6
Connecting Rod Bushing		12
Gasket Set, Complete Overhaul		1
Connecting Rod Bushing		6
<b>2050, 2150</b>	D5000 Hercules Standard	79018169
<b>Parts in Kit</b>		<b>Qty</b>
Sleeve Kit		6
Piston Assembly		6
Ring Set		6
Gasket Set, Complete Overhaul		1
Bulletin		1
MUO	Engine Description	Part No.
<b>MINNEAPOLIS-MOLINE</b>		
<b>G550</b>	F232G	79016785
Gas		
<b>Parts in Kit</b>		<b>Qty</b>
Sleeve Kit		6
Connecting Rod Bushing		12
Gasket Set, Complete Overhaul		1
Connecting Rod Bushing		6
<b>G550</b>	F232DL	79016786
Diesel		
<b>Parts in Kit</b>		<b>Qty</b>
Sleeve Kit		6
Connecting Rod Bushing		12
Gasket Set, Complete Overhaul		1
Connecting Rod Bushing		6
<b>G750</b>	F265GA	79016789
Gas		
<b>Parts in Kit</b>		<b>Qty</b>
Sleeve Kit		6
Connecting Rod Bushing		12
Gasket Set, Complete Overhaul		1
Connecting Rod Bushing		6
<b>G750</b>	F283DLA	79016791
Diesel		
<b>Parts in Kit</b>		<b>Qty</b>
Sleeve Kit		6
Connecting Rod Bushing		12
Gasket Set, Complete Overhaul		1
Connecting Rod Bushing		6

MUO	Engine Description	Part No.
<b>G850</b>	G283GB	79016793
Gas		
<b>Parts in Kit</b>		<b>Qty</b>
Sleeve Kit		6
Connecting Rod Bushing		12
Gasket Set, Complete Overhaul		1
Connecting Rod Bushing		6
<b>G850</b>	F310DB	79016794
Diesel		
<b>Parts in Kit</b>		<b>Qty</b>
Sleeve Kit		6
Connecting Rod Bushing		12
Gasket Set, Complete Overhaul		1
Connecting Rod Bushing		6
<b>G940</b>	F310GA	79016800
Gas		
<b>Parts in Kit</b>		<b>Qty</b>
Sleeve Kit		6
Connecting Rod Bushing		12
Gasket Set, Complete Overhaul		1
Connecting Rod Bushing		6
<b>G940</b>	F310DBLT	79016801
Prior to SN 244324		
Diesel		
<b>Parts in Kit</b>		<b>Qty</b>
Sleeve Kit		6
Connecting Rod Bushing		12
Gasket Set, Complete Overhaul		1
Connecting Rod Bushing		6
<b>G940</b>	F310DBLT	79016802
Eff. SN 244325		
Diesel		
<b>Parts in Kit</b>		<b>Qty</b>
Sleeve Kit		6
Connecting Rod Bushing		12
Gasket Set, Complete Overhaul		1
Connecting Rod Bushing		6

ENGINE

# Engine Belts

## DO NOT MIX NEW AND USED BELTS

Always replace complete V-belt sets with new V-belts. Reusing V-belts where matched sets are required will substantially reduce the life of the drive.

## INSTALLATION

**WARNING:** Always disconnect power supply to machine before removing or installing sheaves or belts.

Never force the belt into a sheave with a screwdriver or wedge. You will rupture the envelope of fabric and break the cords.

ENGINE

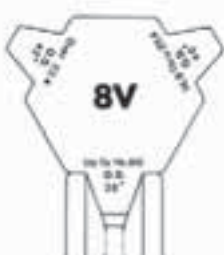

Sheave Groove Gauge

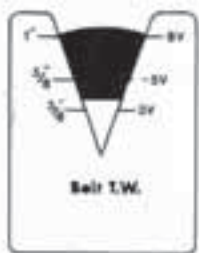

Belt Gauge  
1906302M1

MUO	Description	Part No.
<b>WHITE</b>		
FB 2-32	Fan and Alternator	33V0080489
FB 2-45, FB 2-55, FB 2-62, FB 2-65	Fan and Alternator	33V0037788
FB 2-50, FB 2-60	Fan and Alternator	72090561V
FB 2-70	Fan and Alternator (Gas)	158679AV
	Diesel	162071AV
FB 2-75	Fan and Alternator	72165184V
FB 2-85, FB 2-105	Fan and Alternator (Eff. SN 297446)	30V3417921
	Compressor (Eff. SN 297446)	30V3143589
FB 2-85	Fan and Alternator (Eff. SN 297447)	30V3354288
	Compressor (Eff. SN 297447)	72160495V
	Fan and Alternator (SN 263341 - SN 297446)	30V3417921
FB 2-88	Fan and Alternator	30V3354288
FB 2-105	Fan and Alternator (Eff. SN 297447)	20V0009089
	Fan and Alternator	30V3417921
	Compressor (Eff. SN 297447)	72160795V
FB 100, FB 140	Fan and Alternator	3911559V
	Compressor	72160795V
FB 2-110	Fan and Alternator	30V3387038
FB 2-88, FB 2-110	Compressor	30V3345335
FB 120	Fan and Alternator	3288922V
125 WH	Fan and Alternator	3288966V
	Compressor	72160795V
FB 2-135, FB 2-155	Fan and Alternator	166301AV
	Compressor (SN 1 - SN 272916)	30V3205762
	Compressor (York) (Eff. SN 272917)	30V3372642
FB 2-150	Fan and Alternator	20V0009089
	Compressor	30V3155102
FB 160	Fan and Alternator	3289157V
	Compressor	72160795V
WH 170	Fan and Alternator	3289157V
FB 2-180	Fan and Alternator	30V3287181
	Compressor	30V3287203
FB 185	Fan and Alternator	3289078V
	Compressor	72160795V
FB 4-150, FB 4-175, FB 4-180, FB 4-210	Fan and Alternator	30V3075087
FB 4-150, FB 4-180	Compressor	30V3077276
FB 4-175, FB 4-210	Compressor	72160795V
FB 4-225	Fan	30V3302857
	Alternator and Compressor	30V3397254
FB 4-270	Fan and Alternator	30V3387585
	Compressor	30V3390144
WH 195	Fan and Alternator	3289135V
A4T1400, A4T1600	Fan and Alternator Belt Set	20V0009090
6124, 6144	Fan and Alternator	3289001V
6125, 6145	Fan and Alternator	3289001V
6175, 6195	Fan and Alternator	3288911V

FB = Field Boss, WH = Work Horse

# Engine Belts

## RULES OF V-BELT TENSIONING

- The ideal tension is the lowest tension at which the belt will not slip under peak load conditions.
- Check the belt tension frequently during the first 24-48 hours of run-in operation.
- Do not over-tension belts. This shortens belt and bearing life.
- Keep belts free from foreign material, which may cause slippage.
- Inspect the V-drive periodically. Retension belts if they are slipping.
- Maintain sheave alignment with a strong straight-edge tool while tensioning V-belts.

## V-BELT MAINTENANCE

V-belt drive maintenance is not complicated. Inspecting a V-belt is simply a matter of looking and listening. After belt installation or maintenance, inspect the drive and watch it run.

### What to Look for

Oil and Grease	Liquids will increase the chance a belt will fail prematurely
Dirt	Impairs traction and increases belt wear
Added Loads	Shorten belt life
Belt Guards	Ensure cleanliness and safety
Cracking	Does not reduce tensile strength; larger sheaves and idlers may reduce cracking
Belt Dressing	Do not use any type of belt dressing
Vibration	AKA "Whipping"; Caused by not enough tension
Heat	Causes overcuring, which will shorten belt life
Tension	Proper tension on belts is important
Belt Turnover	Indicates misalignment, worn sheaves or excessive vibration
Change in Rideout	Indicates uneven belt wear or worn sheaves
Lateral Vibration	AKA "Snaking"; Indicates not enough tension
Belt Wear	Wear on belt side-walls indicates constant slippage, excessive dust or rough sheaves
Foreign Matter	Can cause excessive wear or breakage

### What to Listen for

Squeal	Usually indicates insufficient belt tension or overloading
Chirp or Squeak	Usually indicates a dry bearing; realigning the idler may help

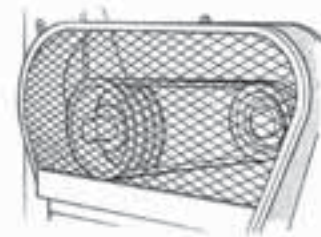

Use Shields

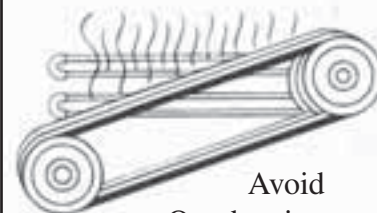

Avoid Overheating

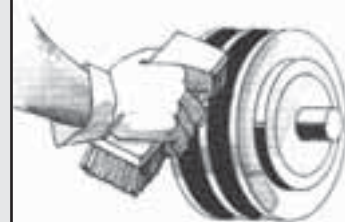

Remove Dirt

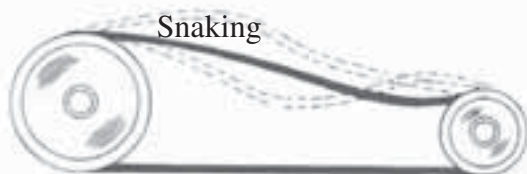

Snaking



Whipping

ENGINE

MUO	Description	Serial No.	Part No.
<b>OLIVER</b>			
Super 55, Super 66, Super 77	Fan Drive		M372V
66, 77	Fan Drive - Regular		M372V
	Fan Drive - Heavy Duty		MR372V
550	Fan Drive - w/ Power Steering	SN 60501 - SN 72831	M372V
		Eff. SN 72832	102752AV
	Fan Drive - w/ Manual Steering	SN 60501 - SN 72831	101635AV
		Eff. SN 72832	102751AV
	Power Steering	Prior to SN 127370	K372BV
770	Fan Drive - w/ Manual Steering	Prior to SN 73638	101635AV
		SN 73639 - SN 156836	101636AV
		Prior to SN 156837	102751AV



# Engine Belts

MUO	Description	Serial No.	Part No.	
<b>OLIVER CONTINUED</b>				
770 Continued	Fan Drive - with Power Steering	Prior to SN 73638	M372BV	
		SN 73639 - 117124	K372BV	
		Prior to SN 117125	102751AV	
		Prior to SN 141901	157538AAV	
88	Fan Drive - Regular		M372BV	
	Fan Drive - Heavy Duty		KR372V	
Super 88	Fan Drive		K372BV	
880	Fan Drive - with Manual Steering		101636AV	
	Fan Drive - with Power Steering	Prior to SN 117124	K372BV	
		Prior to SN 117125	102751AV	
		Prior to SN 141901	157538AAV	
1250	Fan and Alternator (Gas)	Eff. SN 701881	31V2990601	
1250A	Fan and Alternator	Eff. SN 360745	72090561V	
1265, 1365	Fan and Alternator		72090561V	
1355	Fan and Alternator	Eff. SN 503289	72090561V	
1465	Fan and Alternator		31V2990604	
1550, 1555	Fan Drive (Gas)	Prior to SN 169845	160610AV	
		Eff. SN 169846	162123AV	
	Fan Drive (LP)	Prior to SN 169386	160610AV	
		Eff. SN 169387	162123AV	
	Fan Drive (Diesel)	Prior to SN 168920	160610AV	
		Eff. SN 168921	162123AV	
	Power Steering (Gas)		157176AAV	
	Power Steering (Diesel)		157176AAV	
Compressor		167897AV		
1600	Fan Drive (Gas and LP)	Prior to SN 137612	101635AV	
		Eff. SN 137613	101636AV	
	Diesel	Prior to SN 139392	101635AV	
		Eff. SN 139393	101636AV	
1650, 1655	Fan Drive (Gas and LP)		158679AV	
	Fan Drive (Diesel)	Eff. SN 147569	162071AV	
	Power Steering (Gas and LP)		157176AAV	
	Power Steering (Diesel)		157177AAV	
	Compressor (Gas, Diesel, and LP)		167897AV	
1750	Fan Drive		162071AV	
	Compressor		167897AV	
1755	Fan Drive	Eff. SN 220000	162071AV	
	Compressor		167897AV	
	Compressor - ROPS Cab	Prior to SN 234400	30V3080048	
	Coolant Pump R.C. (Diesel):	w/o air conditioning	SN 220000 - SN 235213	168052AV
		w/ air conditioning	SN 220000 - SN 235213	103926AV
		w/ air conditioning	SN 235214 - SN 245666	30V3079473
	Coolant Pump - WHT (Diesel):	w/o air conditioning	SN 220000 - SN 245666	168052AV
		w/ air conditioning	SN 220000 - SN 241903	103926AV
	Coolant Pump - WHT (Diesel):	w/o air conditioning	SN 220000 - SN 245666	157176AAV

# Engine Belts

MUO	Description	Serial No.	Part No.	
<b>OLIVER CONTINUED</b>				
1800	Fan Drive (Gas, LP, and Diesel)	Prior to SN 124395	M372BV	
		Prior to SN 124396	102751AV	
	Power Steering (Gas and LP)	Prior to SN 134684	157176AAV	
	Power Steering (Diesel)	Prior to SN 134683	M372AV	
Prior to SN 134684		157177AAV		
1850	Fan Drive (Gas and LP)	Eff. SN 157680	162071AV	
	Fan Drive (Diesel)	Prior to SN 168642	158599AV	
		Prior to SN 168343	162075AV	
	Power Steering (Gas and LP)		157177AAV	
Power Steering (Diesel)		157177AAV		
1855	Compressor (Gas, LP, and Diesel)		167897AV	
	Fan Drive		162071AV	
	Compressor		167897AV	
	Compressor - ROPS Cab	Prior to SN 232600	30V3080048	
	Coolant Pump R.C. (Diesel):	w/o air conditioning	SN 220000 - SN 235213	168052AV
		w/ air conditioning	SN 220000 - SN 235213	103926AV
		w/ or w/o air conditioning	SN 235214 - SN 247473	30V3079473
	Coolant Pump WHT (Diesel):	w/o air conditioning	SN 220000 - SN 247473	168052AV
		w/ air conditioning	SN 220000 - SN 241903	103926AV
		Coolant Pump (Gas):		
	w/o air conditioning	SN 220000 - SN 247473	157176AAV	
1870	Compressor Drive		20V0009089	
	Fan and Alternator		na	
1900	Fan Drive	Eff. SN 124396	155985AV	
	Generator		M372A	
1950T	Fan Drive		162071AV	
	Compressor		167897AV	
1955	Fan Drive		162071AV	
	Compressor		167897AV	
	Coolant Pump R.C.	w/o air conditioning	SN 220000 - SN 247870	168052AV
		w/ air conditioning	SN 220000 - SN 241903	103926AV
		w/ or w/o air conditioning	SN 235214 - SN 247870	30V3079473
	Coolant Pump WHT	w/o air conditioning	SN 220000 - SN 247870	168052AV
		w/ air conditioning	SN 220000 - SN 241903	103926AV
2050	Fan Drive		166301AV	
2150	Fan Drive		166301AV	
2155	Fan and Alternator		20V0009089	
2255	Fan Drive		30V3075087	
	Compressor	SN 235650 - SN 248720	30V3076253	
	Coolant Pump - Hydraulic		30V3075060	
2655	Fan and Alternator	Engine 504B-6, D585-6	20V0009089	
	Fan and Alternator	Engine D504A-6	20V0009090	

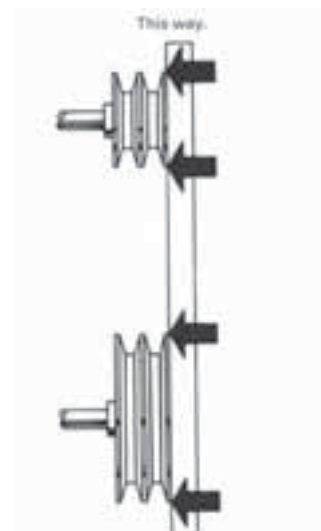

### CHECK ALIGNMENT

Proper alignment is critical to maintain long V-Belt life.

Belt alignment should be checked every time belt maintenance is performed.

Straight edges should touch sheaves at the four points indicated.

Both front and back alignment should be checked.

ENGINE

# Engine Belts

MUO	Description	Serial No.	Part No.
<b>MINNEAPOLIS-MOLINE</b>			
GB, GBD	Fan Drive		KE964EV
GTB, GTC, GTBD, UB,	Fan Drive		KE964EV
UTS, UTI, UTIL	Generator		10A1934V
RTI, ZA	Fan Drive		RE684V
	Generator		10A11202V
U	Fan Drive		KE964EV
	Generator	Prior to SN 01905452	10A11202V
		Prior to SN 01905453	10A1934V
UB, UTS Special	Fan Drive		10A6832V
	Generator		10A1934V
U302	Fan and Generator (Gas & LP)	Prior to SN 27600300	10A7486V
		Prior to SN 27601301	10A22613V
Jet Star 3, Jet Star Orchard	Fan and Generator		10A7486V
Jet Star 3 Super	Fan and Generator		10A22613V
Jet Star 4, 4 Star, 4 Star Super, 335, 445, Big Mo 400, Big Mo 500, Big Mo 600	Fan and Generator		10A7486V
Jet Star 5, M602, M604	Fan Drive		10A29137V
	Generator		10A9733V
M5, M504	Fan Drive		10A29137V
	Generator		10A9733V
M670, M670 Super	Fan Drive (Gas)	Prior to SN 29901589	10A29137V
		Prior to SN 29901892	10A29137V
	Fan Drive (Diesel)	Prior to SN 30000624	10A29137V
		Eff. SN 30000820	10A29137V
	Generator (Gas)	Prior to SN 29901891	10A9733V
		SN 29901892 - SN 29904594	20V0008475
	Generator (Diesel)	Prior to SN 30000819	10A9733V
		SN 30000820 - SN 300002560	20V0008475
Pwr. Steering Pump (Gas)	Prior to SN 29901892	20V0008475	
Pwr. Steering Pump (Diesel)	Prior to SN 30000820	20V0008475	
G705, G706, G707, G708	Fan Drive		KE964EV
	Generator		10A29137V
G750	Fan Drive	Eff. SN 147569	162071AV
G900	Fan Drive (Gas & LP)	Prior to SN 33000550	10A29137V
	Fan Drive (Diesel)	Prior to SN 33101376	10A29137V
	Alt. & Pwr. Steering (Gas & LP)	Prior to SN 33000550	20V0008475
	Alt. & Pwr. Steering (Diesel)	Eff. SN 33101376	20V0008475
G-950, G1050	Fan and Alternator		20V0009090
	Power Steering		20V0009094
G955	Fan and Alternator		20V0009090
	Compressor		20V0009089
G1000 Row Crop	Fan		10A28670V
	Alternator		20V0008475
G1000 Vista	Fan		11V21178
	Alternator		20V0008475

# Engine Belts

MUO	Description	Serial No.	Part No.
<b>MINNEAPOLIS-MOLINE CONTINUED</b>			
G1000 Wheatland	Fan (Gas and LP)	Prior to SN 32600575	10A28670V
	Fan (Gas and LP)	Eff. SN 32600576	11V21178
	Fan (Diesel)		10A28670V
	Alternator (Diesel)		20V0008475
G1050	Fan Belt Set	PCR2193 and R2193	20V0009090
G1350	Fan and Alternator		20V0009089
	Power Steering		20V0009094
G1355	Fan, Alternator, Compressor		20V0009090
A4T1400	Fan and Alternator		20V0009090
A4T1600	Diesel		20V0009089
	Governor		20V0008475
A4T1400, A4T1600	Power Steering (D585 and 504B)		20V0006193

# Lubrication

MUO	Part No.
<b>DIP STICK</b>	
White - FB 2-135, FB 2-155, FB 2-135 Series III, FB 2-155 Series III	168098AV
Oliver - 2050, 2150 (Eff. SN 204001)	

MUO	Height	Part No.
<b>BREATHER CAPS-Copper Filter Element*</b>		
Cockshutt - 30, 40, 50, Co-op - E3, E4, E5 Gas and Diesel	3-1/4"	79024730V**
M-M, Oliver	3-1/4"	70200267V
M-M, Oliver	1-1/2"	71117647V**

*\*Exact Original, "Oil" stamped on top \*\* Includes Clip*

MUO	Part No.
<b>OIL FILL CAP</b>	
White - FB 2-50, FB 2-60, 700	72089449V
Oliver - 1250, 1250-A, 1255 (Eff. SN 303397), 1265, 1270 (Eff. SN 000001), 1355 (Eff. SN 503289), 1365, 1370	
M-M - Z, ZB, R	
	70204827V

MUO	Description	Part No.
<b>DRAIN PRESSURE REGULATOR</b>		
White - FB 2-135, FB 2-155, FB 2-135 Series III, FB 2-155 Series III	Housing, Oil Pressure Regulator	40V3894053
	Housing, Oil Pressure Regulator	40V3894056
	Plug, Oil Pressure Regulator	166787AV
	Valve, Oil Pressure Regulator	168063AV
	Spring, Oil Pressure Regulator (2-19/32")	40V3891201

MUO	Description	Part No.
<b>OIL FEED LINES</b>		
White - FB 2-135, FB 2-155 (SN 272595 - SN 296610)	Hose Assembly, 14-7/16" Length	40V0017651
	Hose Assembly 44" Length	40V0017652



ENGINE

FB = Field Boss

# Lubrication



MUO	Part No.
<b>OIL FILTER HEAD ASSEMBLY</b>	
White - FB 2-85	741614V1

MUO	DESCRIPTION	Part No.
<b>FILTER AND COOLER COMPONENTS</b>		
Oliver - 2050, 2150	Valve	168063AV
	Cover, Oil Cooler	166782AV

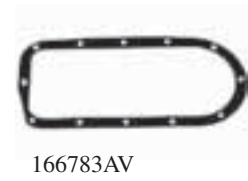

MUO	Oil Pump Part No.	Drive Gear Part No.
-----	-------------------	---------------------

**OIL PUMP/DRIVE GEAR**

WHITE	Oil Pump Part No.	Drive Gear Part No.
700	72091632V	na
FB 2-30, FB 2-35	33V0019410	na
FB 2-32	33V0080241	na
FB 2-50, FB 2-60	72091632V	na
FB 2-70 Diesel	30V3109542	na
FB 2-70 Gas	30V3022803	na
FB 2-85 (Eff. SN 297447)	747292V91	na
FB 2-105 (SN 255216 - SN 297446)	736012V91	na
FB 2-105 (Eff. SN 297447)	747293V91	na
FB 2-110	747293V91	na
FB 2-135, FB 2-155	40V3825264	40V3875901
FB 2-135 Series III, FB 2-155 Series III (Eff. SN 284387, Eff. Eng. SN 4008464)		

MUO	Oil Pump Part No.
<b>OLIVER</b>	
Super 55, 550, Super 66, 66, 660,	100348ASV
Super 77, 77, 770, Super 88, 88, 880, Super 99(Eff. SN 518300), 99, 1550, 1555	MS327V
1250, 1255 (Eff. SN 2303397), 1265 (Eff. SN 000001), 1270 (Eff. SN 000001), 1355 (Eff. SN 503289), 1365, 1370	72091632V
1650, 1655 Diesel,	30V3022803
1750, 1755, 1855, 1950T, 1955, 1800 (Eff. SN 124395), 1850 Gas	
1850 Diesel (Eff. Eng. SN 354U78914)	736012V91

ENGINE



MUO	Part No.
<b>OIL PAN</b>	
White - FB 2-135 Series III, FB 2-155 Series III 4wd, FB 2-135 4wd, FB 2-155 4wd	40V3818659

MUO	Part No.
<b>DRAIN PLUG, OIL PAN</b>	
White - FB 2-135, FB 2-155, FB 2-135 Series III, FB 2-155 Series III	166787AV

FB = Field Boss



# Cooling



20V7101202



72165064V

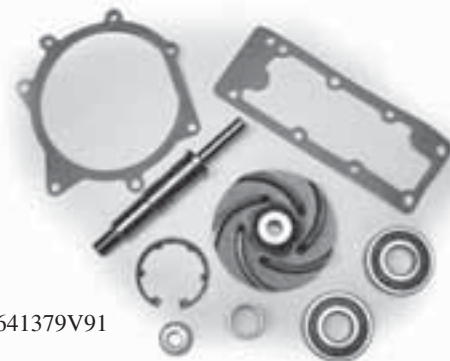

3641379V91

MUO

Serial No.

Water Pump  
Part No.

Repair Kit  
Part No.

## WATER PUMPS, REPAIR KITS

### WHITE

700		1930925V	na
FB 2-30, FB 2-35		72165098V	na
FB 2-32		72165163V	na
FB 2-45		72165064V	33V0035998
FB 2-50, FB 2-60		93191101V	76029352V
FB 2-55		72165064V	na
FB 2-62		72165269V	na
FB 2-65		72165269V	na
FB 2-70	Diesel	164030ASV	20V7100982
	Gas	na	20V7101202
FB 2-75		72165330V	72165061V
FB 2-85	Eff. SN 297447	3641880V91	na
	SN 263341 - SN 297446	4222123V91	20V7101202
FB 2-105	Eff. SN 297447	3641880V91	na
	SN 263341 - SN 297446	4222123V91	20V7101202
FB 2-110		3641880V91	3641379V91
FB 2-135		na	40V3835058
FB 2-110 Series III		3641880V91	3641379V91
FB 2-135 Series III	Eff. SN 300928	na	40V3835058
FB 2-155 Series III	Eff. SN 300928	na	40V3835058
FB 2-155		3641880V91	40V3835058

MUO

Serial No.

Water Pump  
Part No.

Repair Kit  
Part No.

### OLIVER

550	Prior to SN 72831	162900ASV	162902ASV
	SN 72831- SN 127364	162899ASV	162902ASV
	Eff. SN 127365	na	20V7100981
Super 66, 66, 660		162900ASV	162902ASV
Super 77, 77	Prior to Eng. SN 936000	162899ASV	na
Super 77, 77, 770	Super 77, 77: Eff. Eng. SN 936000	162900ASV	162902ASV
Super 88, 88		162899ASV	162902ASV
880		na	162902ASV
1450		675106ASV	na
1465, 1470		31V2904833	na
1550, 1555, 1600, 1650, 1655		na	20V7100981
1600	Diesel Prior to SN 139392	155911ASV	20V7100981
1650, 1655	Diesel Eff. SN 187586	164030ASV	20V7100982
1750		na	20V7100981
1755		na	20V7100982
1800	Eff. SN 124396, 221 560 Cast on Body	157069ASV	20V7100981
1850	Gas	162095ASV	20V7100981
	Diesel	30V3061310	3641378V91
1855, 1950, 1950T		162095ASV	20V7100981

# Cooling



3641880V91

MUO

Water Pump  
Part No.

Repair Kit  
Part No.

## WATER PUMPS, REPAIR KITS CONTINUED

### MINNEAPOLIS-MOLINE

445, 400M, Jet Star 3, Jet Star 4, U302, 400 Industrial, BIG-Mo 500 & 600	10V1076	na
M5, M504, M602, M670, G707, G708, G900, G1000 Gas, G1000 Vista LP & Gas, GTB, GTBD, GTC Diesel, GB Diesel	na	10V1101A

MUO

Notes

Thermostat  
Part No.

Gasket  
Part No.

### THERMOSTATS

#### WHITE

700		98463637V	72089495V
FB 2-30, FB 2-35		3704299V1	33V0126330
FB 2-32		33V0080535	33V0126330
FB 2-45		33V0145645	72165079V
FB 2-50, FB 2-60		98463637V	72089495V
FB 2-55		33V0145645	72165079V
FB 2-62		33V0145645	72165079V
FB 2-65		33V0145645	72165079V
FB 2-70	Diesel Gas	30V3056430 30V3056430	30V3061248 104700AV
FB 2-75		33V0062634	72165096V
FB 2-85	Eff. SN 297447 SN 263341 - SN 297446	4223556V1 4222906V1	1446127V91 1446127V91
FB 2-105	Eff. SN 297447 SN 263341 - 297446	1447384V1 1447384V1	4222906V1 4223556V1
FB 2-110		1447384V1	4222906V1
FB 2-135		166862AV	166859AV
FB 2-110 Series III		1447384V1	4222906V1
FB 2-135 Series III	Eff. SN 300928	166862AV	166859AV
FB 2-155 Series III	Eff. SN 300928	166862AV	166862AV
FB 2-155		166862AV	166862AV

MUO

Notes

Thermostat  
Part No.

Gasket  
Part No.

#### OLIVER

Super 55, 550, Super 66, 66, 660, Super 77, 77, 770, Super 88, 88, 880, 99		101400AV	XK387AV
Super 99, 99	99 Eff. SN 518300	30V3061272	XK387AV
1250, 1255, 1265, 1355, 1365		98463637V	72089465V
1550, 1555, 1600 Gas	1600 Prior to SN 137612	101400AV	XK387AV
1600 Gas	Eff. SN 137613	30V3061272	104700AV
1600 Diesel	Eff. SN 139393	30V3061272	104700AV
1650, 1655: Gas		30V3061272	104700AV
1650, 1655: Diesel	Direct Injection Eff. SN 187586	30V3061272	104700AV
1750, 1755: Gas, 1650, 1655: Diesel Lanova Injection		30V3061272	104700AV
1750, 1755, 1800: Diesel, 1800, 1850, 1855: Gas		30V3061272	104700AV
1850: Diesel		10V19836	159071AV
1855, 1950T, 1955: Diesel		30V3061272	30V3061248
2050, 2150		166862AV	166859AV



1447384V1



10V15861



4222906V1

COOLING

FB = Field Boss  
WH = Work Horse

# Cooling

MUO	Notes	Thermostat Part No.	Gasket Part No.
<b>THERMOSTATS CONTINUED</b>			
<b>MINNEAPOLIS-MOLINE</b>			
5 Star, GVI (Prior to SN 16202960)	Diesel - 170 Degrees	10V12472	10V6829
GTB, GTBD, GTC	Diesel - 175 Degrees	10V9085	10V9082
	LP, Gas - 160 Degrees	10V22156	10V8132
GB	LP, Gas - 160 Degrees	10V22156	10V8132
	Diesel - 175 Degrees	10V9085	10V9082
RTI Industrial, U, UTU, UTS, UTC, UTN, UTE, UTI, UTIL	Gas - 170 Degrees	10V5378	UT609V
	LP, Gas - 160 Degrees	10V22156	UT609V
445, Big-Mo 400M, Big-Mo 400 Industrial, Big-Mo 500 & 600, Jet Star 3, Jet Star 3 Super, Jet Star 4 Super, 4 Star Super	170 Degrees	10V15861	na
U302, M5 Gas, M504, G707, G708	170 Degrees	10V5378	10V6829
M5; Diesel Prior to SN 17201696	170 Degrees	10V19836	159071AV
M5; Diesel Eff. SN 17201697	170 Degrees	10V5378	10V6829
M602, M604, M670, M670 Super	170 Degrees	10V5378	10V6829
	160 Degrees Special	10V22156	10V6829
G900, G950, G955, G1000, G1000 Vista, G1050, A4T 1400, A4T 1600, G1355, G1350	170 Degrees	10V19836	20V0000323



1V507



14628AV

MUO	Part No.
<b>RADIATOR CAP (NON-PRESSURIZED SYSTEMS)</b>	
<b>COCKSHUTT</b>	
20, 30, 40, 50	14628AV
<b>MUO Part No.</b>	
<b>OLIVER</b>	
55, 60, 66, Super 55, Super 66, 70, 77, 88	1V507



31V2903732

MUO	Notes	Radiator Part No.	Radiator Cap Part No.
<b>RADIATORS</b>			
<b>WHITE</b>			
700		na	31V2903732
FB 2-85	Eff. SN 297447, Includes 20" Shroud	30V3369641	30V3225917
FB 2-88	Includes 20" Shroud	30V3348091	30V3225917
FB 2-105	Eff. SN 297447, Includes 20" Shroud	30V3369641	30V3225917
FB 2-110	Includes 20" Shroud	30V3348091	30V3225917
FB 2-155 Series III	Eff. SN 300928	30V3394492	72516498V
FB 2-135 Series III	Eff. SN 300928	30V3394492	72516498V
FB 2-180		30V3352749	72516498V
	3208 Cat Engine	30V3394492	72516498V
FB 2-180 Series III	Eff. SN 301922	30V3352749	72516498V



30V3348091

COOLING

# Cooling



### Heater Hose

PS65005 5/8" x 50 Foot Roll  
PS65009 3/4" x 50 Foot Roll



Part No. Diameter Gauge

### STAINLESS STEEL HOSE CLAMPS\*

70921910	7/16" to 25/32"	#6
70925755	9/16" to 1-1/16"	#8
70921911	11/16" to 1-1/4"	#12
70921912	1-1/16" to 2"	#24
70925881	1-5/16" to 2-1/4"	#28
70922198	1-5/8" to 4-5/8"	#32
70928289	1-7/8" to 2-3/16"	#32
70921913	1-13/16" to 2-3/4"	-
70925758	2" to 3-1/8"	-
70921914	2-5/16" to 3-1/4"	-
70921915	2-3/8" to 3-1/2"	-
70922200	3-5/16" to 4-1/4"	#60
70921916	3-13/16" to 4-3/4"	#68
70925759	5-1/8" to 6"	#88
70921919	4-5/8" to 7-1/4"	#108

\*Worm drive

MUO

Notes

Upper  
Part No.

Lower  
Part No.

### RADIATOR HOSE

#### WHITE

FB 2-85	Eff. SN 297447, Includes 20" Shroud	30V3337456	30V3295877
FB 2-88	Includes 20" Shroud	30V3375943	30V3350037
FB 2-105	SN 255216 - SN 297446	30V3144380	30V3145808
FB 2-105	Eff. SN 297447, Includes 20" Shroud	30V3337456	30V3295877
FB 2-110	Includes 20" Shroud	30V3375943	30V3350037
FB 2-150		30V3154912	10V30898
FB 2-155 Series III	Eff. SN 300928	166288AV	30V3336867
FB 2-135 Series III	Eff. SN 300928	166288AV	30V3336867
FB 2-180		30V3287092	30V3216306
FB 2-180 Series III	Eff. SN 301922	30V3287092	30V3216306
FB 2-180	3208 Cat Engine	30V3287092	30V3216306
FB 100, FB 120		30V3443736	30V3429466
FB 140		30V3443736	30V3448398
FB 160, FB185		30V3424235	30V3424243
WH 125		30V3443736	30V3429466
WH 145		30V3443736	30V3448398
WH 170, WH 195		30V3424235	30V3424243
FB 4-150		30V3146812	30V3076725
FB 4-175, FB 4-210		30V3285073	30V3076725
	Radiator to Engine 1" dia.	30V3285065	30V3076725
FB 4-180		30V3146812	30V3076725
FB 4-225		30V3394999	30V3076725
	Radiator to Engine 1" dia.	30V3395006	na
FB 4-270		30V3390349	na
	Radiator to Engine 1" dia.	30V3376230	na
FB 4-275	2-1/2" I. D.	na	30V3390357



COOLING

# Cooling

MUO	Notes	Upper Part No.	Lower Part No.
<b>RADIATOR HOSE CONTINUED</b>			
<b>OLIVER</b>			
1650, 1655	Eff. SN 147569 (Gas)	157434AV	104979AV (1-3/4" x 4-1/2")
		157434AV	163337AV (3-1/8" x 3-5/8")
	Eff. SN 147569 (Diesel)	158664AV	158625AV ( 1-3/4" x 3-1/4")
1750		158620AV, 158615AV	163337AV
1755	Gas	158615AV	163337AV
	Diesel	168687AV	163337AV
1950	SN 150421-163701	105170AV	105169AV
1870		10V29899	10V30898
2050		166288AV	166290AV
2155		10V30566	10V30898
2255		601624AV	30V3073270
2270		10V30582	10V30898
2655		10V30566	10V30898



30V3186148

MUO	Notes	Upper Part No.	Lower Part No.
<b>MINNEAPOLIS-MOLINE</b>			
G1000	Row Crop & Wheatland LP, All Diesels Prior to SN 30600100	10V20189	10V27664
G900		10V20189	10V27664
G1050	SN PCR2193 - R2193	10V30582 (Diesel)	10V30898
G1350		10V30582 (LP), 10V30566 (Diesel)	10V30898
G1355		10V30582	10V30898
G950		10V29899	10V30898
G955		10V29899	10V30898
M670, Super M670		10V23896	10V27664



30V3141756

MUO	Description	Part No.
<b>HEAT SHIELD</b>		
White - FB 2-135, FB 2-155, FB 2-135 Series III, 2-155 Series III	Manifold, Front to Rear Hose	167537AV
Oliver - 2050 & 2150 (Eff. SN 204001)		

MUO	Notes	Replacement Cord Part No.	Heater Part No.
-----	-------	---------------------------	-----------------

## BLOCK HEATERS

MUO	Notes	Replacement Cord Part No.	Heater Part No.
<b>WHITE</b>			
FB 2-30, FB 2-35		na	71288633V
FB 2-32, FB 2-45, FB 2-55, FB 2-62, FB 2-65		na	71288629V
FB 2-50, FB 2-60, FB 2-70	1000 watt	na	30V3141748
FB 2-75		na	33V0047090
FB 2-85, FB 2-105 (Prior to SN 297446)		30V3287394	30V3287386
FB 2-105 (Eff. SN 297447)		30V3141756	71288631V
FB 2-88, FB 2-110	600 watt	30V3141756	71288631V
FB 2-135, FB 2-155	1000 watt	30V3141756	30V3286363
FB 2-150	1000 watt	30V3141756	30V3286363
FB 2-180, FB 4-150, FB 4-175, FB 4-180, FB 4-210, FB 4-225		30V3141756	30V3186148
FB 4-270		30V3141756	30V3392333
FB 100, FB 120, FB 140		30V3141756	30V3421147
FB 160, FB 185		30V3141756	3918597V

COOLING



# Fuel

FUEL



30V3442616



30V3442470



B824V



70911435V



376526X1

**Description**

**Part No.**

**FUEL LINE**

**OLIVES**

3/16" O.D.	376524X1
5/16" O.D.	376526X1
1/4" O.D.	70911435V

**MUO**

**Part No.**

**FUEL CAPS, VENTED**

<b>White</b> - WH 125, WH 145, FB 140, FB 100, FB 120, FB 160, FB 185	30V3442470
<b>Oliver</b> - 1550, 1555 (Eff. SN 160000), 1650, 1655 (Eff. SN 147569), 1750, 1800, 1850, 1950 (Eff. SN 150421), 1755, 1855, 1955 (Prior to SN 220000), 1800, 1900 (Eff. SN 90525), 1900T (Eff. SN 194080), 2050, 2150 (Eff. SN 204001), 550 (Eff. SN 60501), 66, Super 66, 660 (Eff. SN 47552), 77, Super 77 (Eff. SN 320001), 770, 880 (Eff. SN 60501), 88, Super 88 (Eff. SN 43901), 90, 99 (Prior to SN 508918), 900 (Eff. SN 710001), 950, 990, 995 (Eff. SN 530001), Super 55 (Eff. SN 46001), Super 99 GM Diesel (Prior to SN 519300)	
<b>M-M</b> - G750 (Eff. SN 147569), G905	
<b>White</b> - WH 170, WH 195, FB 2-110, FB 2-70, FB 2-135, 2-155 (SN 272595 - SN 278026), FB 2-135, 2-155 Series III, FB 2-150, FB 2-180, FB 2-180 Series III, FB 4-150, FB 4-175, FB 4-180	30V3049558
<b>Oliver</b> - 1550, 1555 (Eff. SN 160000), 1650, 1655 (Eff. SN 147569), 1750, 1800, 1850, 1870, 1755, 1855, 1955 (Prior to SN 220000), 2155, 2255 (Eff. SN 235650), 60, 80 American Series, Super 55, 66, Super 66, 660, 77, Super 77, 88, Super 88, 950, 990, 995, Super 99 HC, Diesel	
<b>M-M</b> - G1050 (Prior to SN PCR2193 & R2193), G1350, G1355, G750, G955 - Wheel Guard Fuel Tanks	

**MUO**

**Part No.**

**FUEL CAPS, NON-VENTED**

<b>White</b> - 2-105, 2-135, 2-155 FB, 2-150 FB, 2-155, 4-150 FB, 4-175 FB, 4-180 FB, 4-210 FB, 4-225 FB, 2-85 FB	30V3442616
<b>Oliver</b> - 1550, 1555 (Eff. SN 160000), 1650, 1655 (Eff. SN 147569), 1755 & 1855, 1955 (Prior to SN 220000), 1255 (Prior to SN 235650), 1870	
<b>M-M</b> - G750 (Eff. SN 147569), G1355, G955 Wheel Guard Fuel Tanks	
<b>Oliver</b> - 1250 (Eff. SN 701881), 1450 (Eff. SN 132382)	5139618V
<b>Oliver</b> - 1550, 1555 (Eff. SN 160000), 1650, 1655 (Eff. SN 147569), 1750, 1850, 1855, 1950 (Eff. SN 150421), 1950T (Eff. SN 194050), 2050, 2150 (Eff. SN 204001), 2255	72505250V
<b>Oliver</b> - 60, 70, 66, 77, 88, Super 66, Super 77, Super 88	Gas Cap: "Buy Clean Fuel-Keep it Clean" B824V Gasket 79024604V

FB = Field Boss, WH = Work Horse

# Fuel



835924V91



20V7101074

MUO	Description	Part No.
<b>CARBURETORS AND REPAIR KITS</b>		
<b>COCKSHUTT</b>		
20 w/ TSX 480, 520, 531; 30 w/ TSX 264	Repair Kit (Marvel - Schebler)	79024376V
30 w/ 11080, 10432	Repair Kit (Zenith)	79024747V
40 w/ 10946, 11489; 50 w/ 11509	Repair Kit (Zenith)	79024758V
540 w/ 12773, 12262	Repair Kit (Zenith)	79024750V
<b>MUO</b>		
<b>WHITE</b>		
FB 2-70	Carburetor (Facet - Zenith) Repair Kit (Facet - Zenith) Repair Kit (Marvel - Schebler)	20V7002210 835924V91 79017657V
<b>MUO</b>		
<b>OLIVER</b>		
60 w/ TSX 49, 120, 138; 66 w/ TSX 418, 603, 363; 70 w/ TSX 186; 77 w/ TSX 363, 380; 99 w/ TSX 694; Super 44 w/ TSX 665; Super 55 w/ TSX 603; Super 66 w/ TSX 363; Super 77 w/ TSX 63, 380; 660 w/ TSX 418, 603, 363; 550 w/ TSX 603	Repair Kit (Marvel - Schebler)	79024376V
70 w/ Z109	Repair Kit (Zenith)	79024377V
70 w/ 8627, 9725, 10002, 10004	Repair Kit (Zenith)	79024747V
70 w/ 8543, 9739; 770, 880 w/ 12259	Repair Kit (Zenith)	79024758V
550, 66, 660 w/ TSX 775, 811; 77 w/ TSX 374; 88 w/ TSX 181, 221, 374, 610; 880 w/ TSX 755; Super 77 w/ TSX 374; Super 88 w/ TSX 181, 221, 374, 610; 1550, 1555 w/ TSX 903	Repair Kit (Marvel - Schebler)	79024591V
1750, 1800, 1850 w/ USX 29, 31-1, 37, 44	Repair Kit (Marvel - Schebler)	79024588V
550 (Eff. SN 72832), 66, Super 66, 660 (Prior to SN 73132)	Carburetor (Facet - Zenith) Repair Kit (Facet - Zenith) Repair Kit (Marvel - Schebler)	773368V91 835924V91 20V7002190
77, Super 77 (Eff. SN 6503), 770 (Gas), 88, Super 88, 550 (Eff. SN 72832), 1550, 1555, 177, Super 177, 188, Super 188	Carburetor (Facet - Zenith) Repair Kit (Facet - Zenith) Repair Kit (Marvel - Schebler)	20V7101074 835924V91 20V7002190
77, Super 77 (Prior to SN 6501), 70, 60, 66, Super 66, 660 (Prior to SN 6502)	Gasket Set (Facet - Zenith) Carburetor (Facet - Zenith) Repair Kit (Facet - Zenith) Repair Kit (Marvel - Schebler)	70226470V 20V7101076 na 30V3046958
Super 55, 550 (Prior to SN 72831), 66 Super 66, 660 (SN 6503 - SN 73131)	Carburetor (Facet - Zenith) Repair Kit (Facet - Zenith) Repair Kit (Marvel - Schebler)	20V7101078 na 30V3046958
770 (LP), 880, 199	Repair Kit Gasket Set (Zenith PN 181-65)	835749V91 74046624V
1600 (Eff. SN 137613), 950, 999, 995	Carburetor (Facet - Zenith) Repair Kit (Facet - Zenith) Repair Kit (Marvel - Schebler)	na 74062474V 79017657V
1600 (Prior to SN 137612), 1650, 1650, 1800 (Prior to SN 125395)	Carburetor (Facet - Zenith) Repair Kit (Facet - Zenith) Repair Kit (Marvel - Schebler)	20V7002210 835924V91 79017657V
1750, 1755, 1800 (Prior to SN 124396), 1850, 1855	Carburetor (Facet - Zenith) Repair Kit (Facet - Zenith) Repair Kit (Marvel - Schebler)	na 30V3080420 30V3417948

# Fuel

FUEL



70226470V

MUO	Description	Part No.
<b>CARBURETORS AND REPAIR KITS</b>		
<b>MINNEAPOLIS-MOLINE</b>		

4 Star w/TSX 713; 445 w/ TSX 713, 797, 633; Big Mo 400, Big Mo 500, Big Mo 600 w/ TSX 713; Jet Star w/ TSX 713; Jet Star 3 w/ TSX 713; M4 w/ TSX 878; Super 4 Star w/ TSX 713; 302U w/ TSX 878; Z w/ TSX 97; ZA, ZB w/ TSX 97	Repair Kit (Marvel - Schebler)	79024591V
335 w/ TSX 650, 714, 885; R w/ TSX 231, 497; RT with TSX 30, 36; RTI w/ TSX 231, 497, 36	Repair Kit (Marvel - Schebler)	79024376V
Big MO 400, Big MO 400M, 445, Big MO 500 - 600, Jet Star 220-4A Gas, 206H-4A	Carburetor (Facet - Zenith)	20V7101074
	Repair Kit (Facet - Zenith)	835924V91
	Repair Kit (Marvel - Schebler)	20V7002190
	Gasket Set (Facet - Zenith)	70226470V
RTU, RTS, RTN, RTE, RTI (Prior to Eng. SN 01705440)	Carburetor (Facet - Zenith)	20V7101076
	Repair Kit (Facet - Zenith)	na
	Repair Kit (Marvel - Schebler)	30V3046958
RTU, RTS, RTN, RTE, RTI (Eff. Eng. SN 01705441)	Carburetor (Facet - Zenith)	20V7101078
	Repair Kit (Facet - Zenith)	na
	Repair Kit (Marvel - Schebler)	30V3046958
335	Carburetor (Facet - Zenith)	20V7101077
	Repair Kit (Facet - Zenith)	na
	Repair Kit (Marvel - Schebler)	30V3046958
U302, HD220-4A	Carburetor (Facet - Zenith)	773368V91
	Repair Kit (Facet - Zenith)	835924V91
	Repair Kit (Marvel - Schebler)	79017657V
GB, GTB, 5-Star, M670, M670 Super, 336-4A (Eff. SN 30100001), 403-4A	Carburetor (Facet - Zenith)	na
	Repair Kit (Facet - Zenith)	74062474V
	Repair Kit (Marvel - Schebler)	79017657V
U, UB, UTS, UTI, UTUL M5, M504, M602, M604, 283-4A, 336-4A (S/N -30100000), 425A-6A (Tractor Fuel), 425-6A (Distillate), 605-6A (Distillate)	Carburetor (Facet - Zenith)	20V7002210
	Repair Kit (Facet - Zenith)	835924V91
	Repair Kit (Marvel - Schebler)	79017657V*
	Gasket Set (Facet - Zenith)	20V7000120
<i>*If Marvel-Schebler Model No. Is TSX 740, TSX 795, or TSX 901, use Repair Kit</i>		20V7002205
ZA Series ZAU, ZAS, ZAN, AZE, ZB, 445, Jet Star 3 Super, Jet Star 3, Jet Star 4-Star Super, Jet Star Orchard, Big Mo 400M w/M220A-4 Engine, Big MO 500-600 Industrial Wheelers	Gasket Set (Schebler Model TSX 713)	70226470V
<b>White</b> - FB 2-70 <b>Oliver</b> - 1650 & 1655 , 90 Series, 1850, Super 99 HC & Diesel (Prior to SN 519300)	Gasket Set	20V7000120

MUO	Description	Part No.
<b>CARBURETOR FLOATS</b>		

<b>Cockshutt</b> - 30, Co-op E3	Float - Zenith Carburetor	79024375V
<b>Oliver</b> - 99, 900, 1600, 1650, 1655, 1800, OC-12	Float - Marvel-Schebler Carburetor	79024769V
<b>M-M</b> - GB, GTA, GTB, GVI, U, UB, UT, UTS, 5 Star, M5, M504, M602, M604, M670 TSX 67, 68, 624, 625, 693, 740, 795, 901		

# Fuel



1039071V1



1004498V1



WJAS841V

MUO	Description	Assembly Part No.	Glass Fuel Bowl Part No.
-----	-------------	-------------------	--------------------------

**FUEL BOWLS**

<b>OLIVER</b>			
Super 55, 550	Gas	WJAS841V	70237945V
	Diesel	WJAS841V	1004498V1
60, 199	2 1/8" Diameter	WJAS841V	70237947V
	2" Diameter	WJAS841V	70237945V
66, Super 66, 660	Gas	WJAS841V	70237947V
	Diesel (Prior to SN 6502)	na	1004498V1
	Diesel (Eff. SN 6503)	WJAS841V	70237947V
	KD (Eff. SN 710001)	na	70237945V
70, 80	Fuel Pump Bowl	na	1004498V1
	All Models	na	70237947V
77, Super 77	Gas	na	70237947V
	Diesel (Prior to SN 6503)	na	1004498V1
	Diesel (Eff. SN 6503)	na	70237947V
	Fuel Pump Bowl	na	1004498V1
166	Tank - Gas	na	70237945V
	Fuel Pump Bowl - Gas	na	70237947V
	Fuel Pump Bowl - Diesel	na	1004498V1
Super 166, 177, Super 177	Gas	na	70237947V
	Diesel	na	1004498V1
188, Super 188	Fuel Pump & Tank, Gas	na	70237947V
	Tank, Gas	na	70237945V
	Diesel	na	1004498V1
770, 880	Gas, Diesel	na	70237945V
	Fuel Pump Bowl	na	1004498V1
88, Super 88	Gas	na	70237947V
	Diesel (Prior to SN 6502)	na	1004498V1
	Diesel (Eff. SN 6503)	na	70237947V
	KD	na	70237945V
90, 99, 99 IND	Fuel Pump Bowl	na	1004498V1
	All Models	na	70237947V
900	Industrial	WJAS841V	70237945V
99 (Eff. SN 518300)	All Models	WJAS841V	70237947V
	Fuel Pump Bowl	na	1004498V1
Super 99	Gas	na	70237947V
	Diesel, Fuel Pump Bowl	na	1004498V1
1255	Fuel Bowl	na	1039071V1
1265, 1270	Fuel Bowl	na	1039071V1
1355	Fuel Bowl	na	1039071V1
1365, 1370	Fuel Bowl	na	1039071V1
1465, 1470	Primer Pump	672957ASV	772163V
1550, 1555, 1650, 1655, 1750, 1755, 1800, 1850, 1855, 2050, 2150	Fuel Bowl	WJAS841V	70237945V

# Fuel

FUEL



1024386V1

MUO	Assembly Part No.	Glass Fuel Bowl Part No.
-----	-------------------	--------------------------

## FUEL BOWLS

WHITE		
700	na	1039071V1
FB 2-50	na	1039071V1
FB 2-60	na	1039071V1
FB 2-70	WJAS841V	70237945V
FB 2-85	na	1024386V1
FB 2-105	na	1024386V1

MUO	Assembly Part No.	Glass Fuel Bowl Part No.	Description
-----	-------------------	--------------------------	-------------

## FUEL BOWLS

### MINNEAPOLIS-MOLINE

GTB, GTBD, GTC, GB	na	1004498V1	Tank
RTI, U, UTU, UTS, UTC, UTN, UTE, 206H-4A, 283-4A, D283-4A, 336-4A, 403-4A, 425-6A, 425-6A, 605-6A, 605A-6A, 800-6A	na	W2723137V	Tank
UTI, UTIL	na	1004498V1	Tank
Big-Mo 500, 600	WJAS841V	70237945V	Tank
Jet Star 3, Jet Star 3 Super	WJAS841V	70237945V	Tank
M5, M504, M602, M604	WJAS841V	10V1917	Filter
Jet Star 4 Star, 4 Star Super	WJAS841V	70237945V	Tank
	na	10V1917	Filter
Jet Star 5	WJAS841V	70237945V	Tank
U302	na	70237945V	Tank
	na	10V1917	Filter (Prior to SN 27700100)
	na	1039071V1	Filter (Eff. SN 27700101)
M670, M670 Super	WJAS841V	70237945V	Tank
		1039071V1	Filter
G707, G708	na	1004498V1	Tank
	na	1039071V1	Filter
G750	WJAS841V	70237945V	Tank
G900	na	10V1917	Filter (Gas)
	na	1039071V1	Filter (Diesel)
G950	na	1039071V1	Filter
G1000	na	10V1917	Filter (Gas)
	na	1039071V1	Filter (Diesel)
G1000 Vista, G1050 A4T	na	1039071V1	Filter (Diesel)
220-4A, HD2204A	na	W2723137V	Fuel Tank Bowl
	na	W2723137V	Fuel Tank Bowl
D336-4A	na	10V1917	Fuel Filter Bowl
336-4A, D336A-4A	na	W2723137V	Fuel Tank Bowl
	na	1039071V1	Fuel Filter Bowl
D425-A-6A, DHD504A-6A	na	1039071V1	Fuel Tank Bowl



# Fuel



JS5305V



J5307V



J5303V

**MUO**

**Description**

**Part No.**

**FUEL BOWL COMPONENTS**

<p><b>White - FB 2-70</b></p> <p><b>Oliver - 1550, 1555, 1650, 1655, 1750, 1755, 1850, 1855, 60 Series (RC Eff. SN 60001 STD. Eff. SN 410001), 90 Series, Super 44 &amp; 440</b></p> <p><b>M-M - Big MO 500-600 Industrial Wheelers, Big MO 400M w/ M220A-4 Engine, GB, Jet Star 3, Jet Star 3 Super, Jet Star 4-Star 4-Star Super, M5 M504 M602 M604 -2 &amp; 4 Wheel Drive, M670 &amp; M670 Super, G750, Jet Star 5-Star, 445</b></p>	<p>Fuel Strainer</p> <p>Thumb Nut Fuel Strainer</p> <p>Screen, Fuel Strainer</p>	<p>JS5305V</p> <p>J5303V</p> <p>J5307V</p>
<p><b>White - FB 2-70</b></p> <p><b>Oliver - 1550, 1555, 1650, 1655, 1750, 1755, 1855, 60 Series (RC Eff. SN 300001 &amp; Std. Eff. SN 410001), 90 Series (Eff. SN 710001), 1850, Super 44 &amp; 440 Series</b></p> <p><b>M-M - ZB &amp; ZAS, UTI &amp; UTIL Industrial Wheelers, 445, G, G-138 G-149, G-160, G-160 Auxiliary Engine Power, G-226 Power Unit, G707 &amp; G708 -2wd and 4wd, G750, GB, GTB, GTBD, GTC, Jet Star 3 Super, Jet Star 3, Jet Star 4-Star Super, Jet Star 5-Star, Jet Star Orchard, M5, M504, M602, M604 -2wd and 4wd, M670, M670 Super, Big Mo 400 Industrial Wheeler, Big MO 400M w/ M220A-4 engine, Big Mo 500-600 Industrial Wheelers</b></p>	<p>Gasket, Fuel Bowl</p>	<p>70208362V</p>

**MUO**

**Part No.**

**MECHANICAL FUEL PUMPS**

**WHITE**

FB 2-85, FB 2-105 (SN 255216 - 297446)	3637309V91
FB 2-110, FB 2-85 (Eff. SN 297447), FB 2-105 (Eff. SN 297447), FB 2-88	1446951V91
FB 2-50, FB 2-60, 700	72093848V

**MUO**

**Part No.**

**OLIVER**

Super 55, 550, 66, Super 66, 660, 77, Super 77, 770, 88, Super 88, 880	163848AV
1250-A (Eff. SN 360745), 1255 (Eff. SN 303397), 1265, 1355 (Eff. SN 503289), 1365 (requires 4864082 damper)	72093848V
1550, 1555, 1600, 1650, 1655, 1750, 1755, 1800, 1855 Diesel, 1950-T, 1955	79017945V
1750, 1755, 1800, 1850, 1855 Gas	161601AV
1850 Diesel	4222093V91
550 (Eff. SN 110016), 770, 880 (Prior to SN 60501), 1800 (SN 90525 - SN 129285), 2050, 2150 (Eff. SN 204001)	74009409V



4222093V91

72093848V



163848AV

# Fuel

FUEL



74009409V

MUO	Description	Part No.
<b>HAND PRIMER</b>		
White - FB 2-155 , FB 2-135 & 2-155, FB 2-135 Series III, FB 2-155 Series III	Hand Primer Assembly	74009409V
M-M Jet Star 3 Super		
White - FB 2-135, FB 2-155 (Eff. SN 278027)	Bracket, Hand Primer Mounting	40V0019721

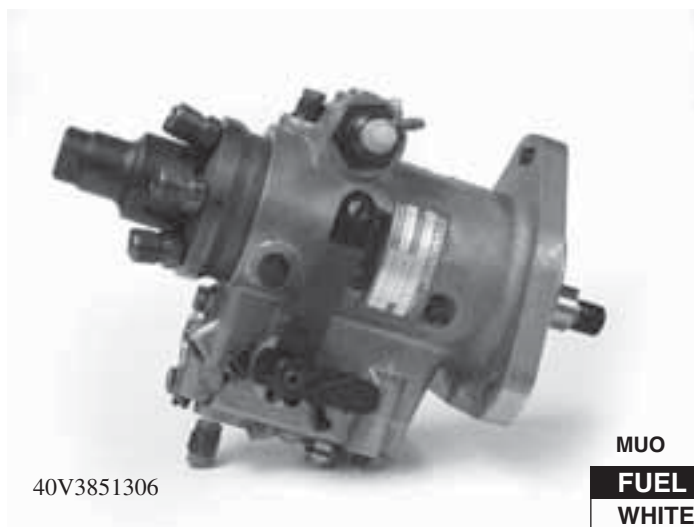

40V3851306



72089400V

MUO	Description	Part No.
<b>FUEL INJECTION PUMPS</b>		
<b>WHITE</b>		
FB 2-135 Series III (Eff. SN 300928)		40V3851307
FB 2-155 Series III (Eff. SN 300928)		40V3851306

MUO	Description	Part No.
<b>FUEL INJECTION LINES</b>		
<b>WHITE</b>		
FB 2-135 Series III,	Fuel Injection line, Injector #1	40V3891325
FB 2-155 Series III	Fuel Injection line, Injector #2	40V3891326
	Fuel Injection line, Injector #3	40V3891327
	Fuel Injection line, Injector #4	40V3891328
	Fuel Injection line, Injector #5	40V3891329
	Fuel Injection line, Injector #6	40V3891330
	Bracket Kit, Fuel Injection Line	40V3895962
	Washer, Injector Lines	376518V1

MUO	Description	Part No.
<b>OLIVER</b>		
2050, 2150	Fuel Injection line, Injector #1	40V3891313
	Fuel Injection line, Injector #2	40V3891320
	Fuel Injection line, Injector #3	40V3891315
	Fuel Injection line, Injector #4	40V3891316
	Fuel Injection line, Injector #6	40V3891318
	Fuel Injection Pump, Tube	40V1055112
	(1 to 2, 2 to 3, 3 to 4, 4 to 5, 5, to 6)	

FB = Field Boss

# Fuel



MUO	Injector Assembly Part No.	Nozzle Part No.	Washer Part No.	Gasket/Dust Shield Part No.
-----	----------------------------	-----------------	-----------------	-----------------------------

## FUEL INJECTION

### WHITE

FB 2-30, FB 2-35	na	20V7000655	na	na
FB 2-32	na	33V0080608	3704434V1	33V0081558
FB 2-32	na	20V7000655	na	na
FB 2-50, FB 2-60	na	72094061V	72093210V	72089405V
FB 2-55, FB 2-75	na	72165326V	na	3706561V1
FB 2-62	na	72165326V	na	3706561V1
FB 2-70	165857ASV Red, Y165393ASV Yellow	na	164355AV	164356AV
FB 2-85 (Prior to SN 297446)	30V3185915	30V3186059	70251926V	732824V1
FB 2-85 (Eff. SN 2974747)	na	1447269V91	70251926V	744171V1
FB 2-105, FB 2-110	30V3159140	30V3211436	376091V1	732824V1
FB 2-135, FB 2-155	na	167109ASV	166903AV - Seal	167546AV
FB 2-150	20V0000085	na	164355AV	164356AV

MUO	Injector Assembly Part No.	Nozzle Part No.	Washer Part No.	Gasket/Dust Shield Part No.
-----	----------------------------	-----------------	-----------------	-----------------------------

### OLIVER

Super 55, 550, 60, 66, Super 66, 660, 77, Super 77, 770, 88, Super 88, 880, 99, 950	na	101971AV	162246AV	na
Super 166, 166, Super 177, 177, Super 188, 188, Super 199, 199	na	101971AV	162246AV	na
1250	na	74050032V	na	671271AV
1250A, 1255, 1355	na	72089400V	72093210V Seal	72089405V
1265	na	72094061V	72093210V Seal	72089405V
1365 (Prior to SN 721487)	na	31V2900003	72093210V Seal	72089405V
1365 (Eff. SN 721488)	na	72094061V	72093210V Seal	72089405V
1550, 1555, 1600, 1650 (Prior to SN187585)	na	101971AV	162246AV	na
1650 (Eff. SN 187586), 1655	165857ASV Red, Y165393ASV Yellow	na	na	na
1750, 1755	30V3043983	na	164355AV	164356AV
1800	na	101971AV	162246AV	na
1850	na	1446703V1	376091V1	na
1855	30V3043983	1446703V1	376091V1	na
1950T, 1955	165857ASV	na	164355AV	164356AV
2050, 2150	na	167109ASV	166903AV Seal	na

# Electrical

ELECTRICAL

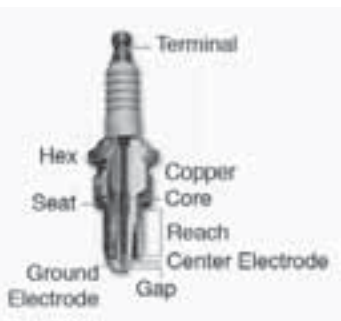

MUO	Description	Part No.
<b>SPARK PLUG WIRE SETS</b>		
<b>COCKSHUTT, OLIVER, MINNEAPOLIS-MOLINE</b>		
All 4-cyl. models	90° boots, copper wires; waterproof neoprene	79024581V
	Straight boots, copper wires; waterproof neoprene	79024410V
All 6-cyl. models	90° boots, stainless steel wires	79024752V*

\* Will not work on Oliver 70, 6-cylinder, which requires longer wires

Part No.	Heat Range	Thread Size & Hex	Reach	Plug Type & Fuel
<b>SPARK PLUGS</b>				
79001655V	General Use (2-Cycle)	14 mm / 3/16"	3/8"	Reg. Gas
20V7000683	Small Engine	18 mm / 7/8"	1/2"	Reg. Gas
79001654V	Hot	14 mm / 3/16"	3/8"	Low Octane
79001653V	Medium	14 mm / 3/16"	3/8"	Reg. Gas
79001652V	Cold	14 mm / 3/16"	3/8"	Reg. Gas
79001651V	Medium	14 mm / 13/16"	3/4"	Reg. Gas
74905799V	Medium	14 mm / 13/16"	3/4"	Reg. Gas
74905798V	Cold	14 mm / 13/16"	3/4"	Thermal Tip / Gas

Part No.	Thread Size & Hex	Champion Cross Reference
<b>AUTOLITE SPARK PLUGS</b>		
79024796V	Autolite #295 - 14mm thread dia., 3/8" reach, 13/16" hex	J8, J8C, UJ8
79024805V	Autolite #306 - 14mm thread dia., 3/8" reach 13/16" hex	RJ8, RJ8C, J11, J11J, RJ11, UJ11G
79024798V	Autolite #386 - 18mm thread dia., 1/2" reach, 7/8" hex	D10, K13, D14, M14, RD14, K15J, D16, D16J, RD16, UD16, D21, D89D
79024799V	Autolite #388 - 18mm thread dia., 1/2" reach, 7/8" hex	D23
79024800V	Autolite #437 - 14mm thread dia., 7/16" reach, 13/16" hex	H14Y, H18Y
79024797V	Autolite #3076 - 7/8" -18 mm thread dia., 5/8" reach, 15/16" hex	W10, W14, C16C, W18, W20

MUO	Description	Part No.
<b>TUNE-UP KITS</b>		
<b>COCKSHUTT</b>		
20, 30, 35; 40, 50 (Eff. 1949); Co-op E3, E4, E5; 550 (Eff. 1946)	Ignition tune-up kit, for Auto-Lite distributor <i>Includes heavy duty point set, vibration resistant condensor and rotor</i>	79024748V
540, 550, 560, 570	Ignition tune-up kit, for Delco-Remy distributor <i>Includes heavy duty point set, vibration resistant condensor and rotor</i>	79024 738V

MUO	Description	Part No.
<b>OLIVER</b>		
44 thru 950 (4 and 6-Cylinder)	Points, Condensor, Gap Gauge (without Rotor)	79024755V
	Points, Condensor, Gap Gauge (with Rotor) <i>Note: For Delco distributor with clip held cap</i>	79024738V
1600, 1800	Heavy-duty points, vibration-resistant condensor and rotor <i>Note: for Delco Remy systems</i>	79024757V

MUO	Description	Part No.
<b>MINNEAPOLIS-MOLINE</b>		
M-M tractors except Jet Star, 302, G900, G1000, M670	Heavy-duty points, vibration-resistant condensor and rotor <i>Note: for Delco-Remy systems</i>	79024738V
Jet Star, 302, G900, G1000, M670	Heavy-duty points, vibration-resistant condensor and rotor <i>Note: for Delco-Remy systems</i>	79024757V

# Electrical

## Electronic Conversion Kits: Important Points to Remember

1. Must use high voltage coils
2. Must use ring terminals only, not spade terminals
3. Must use automotive-style plug wires, not copper core wires
4. Must follow the wiring diagram **exactly**
5. Battery must be correct polarity
6. Do not use a resistor, even though the wiring diagram may show it

## With an Electronic Conversion Kit you'll:

- Never change the points again
- Increase spark plug life
- Increase horse power and fuel economy

**For distributors with clip-type cap**

**Fits entirely inside the distributor**

**Replaces points and condenser with an electronic module**

MUO	Engine	Cyl.	Distributor	Delco Part No.
<b>6-VOLT POSITIVE GROUND SYSTEM ONLY - PART NO. 79024565V</b>				
<b>OLIVER</b>				
44	F-140	4 Cylinder	Delco	1111716, 1112614
55	Oliver	4 Cylinder	Delco	1112555
60	Oliver	4 Cylinder	Delco	1111530
66	Oliver	4 Cylinder	Delco	1111704, 1112555
99	Oliver	4 Cylinder	Delco	1111411, 1885555
550	Oliver	4 Cylinder	Delco	1112555, 1112618

MUO	Engine	Cyl.	Distributor	Delco Part No.
<b>6-VOLT POSITIVE GROUND SYSTEM ONLY - PART NO. 79024566V</b>				
<b>OLIVER</b>				
77, 88	Oliver	6 Cylinder	Delco	1111702, 1111750
77, 88	Waukesha	6 Cylinder	Delco	1112579
99	Oliver	6 Cylinder	Delco	1111731
99	Oliver	6 Cylinder	Delco	1112561, 1112588
770, 880	Oliver	6 Cylinder	Delco	1112587
1800	Oliver	6 Cylinder	Delco	1112603
1600, 1800	Oliver	6 Cylinder	Delco	1112632

MUO	Engine	Cyl.	Distributor	Delco Part No.
<b>12-VOLT NEGATIVE GROUND SYSTEM ONLY - PART NO. 79024567V</b>				
<b>OLIVER</b>				
1650, 1655, 1750	Oliver	6 Cylinder	Holley	7563-1, 2562-1, 69498

Description	Part No.
<b>UNIVERSAL ELECTRICAL PRODUCTS</b>	
Distributor Coil - 6 Volt	79024737V
Distributor Coil - 12 Volt	79024582V
Voltage Resistor - 2 terminal style (reduces voltage from 12V to 6V)	79024773V



# Electrical

ELECTRICAL



30V318664



30V341778



10V2989



70225785V



70225739V

MUO	Dist. Assem. Part No.	Dist. Caps Part No.	Points Part No.	Cond. Sets Part No.	Point & Cond. Kit Part No.	Ignition Coils Part No.	Ignition Rotors Part No.
-----	--------------------------	------------------------	--------------------	---------------------------	----------------------------------	-------------------------------	--------------------------------

## DISTRIBUTOR IGNITION COMPONENTS

### WHITE

FB 2-70	na	30V341778	30V3186806	na	na	189673V92	na
---------	----	-----------	------------	----	----	-----------	----

### OLIVER

Super 55	na	70225733V	70225785V	70225739V	70243507V	na	10V2989
550	na	70225733V	70225785V	70225739V	70243507V	na	10V2989
66	na	70225733V	70225785V	70225739V	70243507V	na	10V2989
Super 66	na	70225733V	70225785V	70225739V	70243507V	na	10V2989
660	na	70225733V	70225785V	70225739V	70243507V	na	10V2989
77	na	74042704V	70225785V	70225739V	70243507V	na	10V2989
Super 77	na	74042704V	70225785V	70225739V	70243507V	na	10V2989
770 Row Crop	na	74042704V	70225785V	70225739V	70243507V	189673V92 Eff. SN 156837	10V2989
88	na	74042704V	70225785V	70225739V	70243507V	na	10V2989
Super 88	na	74042704V	70225785V	70225739V	70243507V	na	10V2989
880	na	74042704V	70225785V	70225739V	70243507V	189673V92 Eff. SN 156837	10V2989
Super 99	na	74042704V	70225785V	70225739V	70243507V	na	10V2989
950	na	74042704V	70225785V	70225739V	70243507V	na	10V2989
770 SN 60501 - SN 156836	na	na	na	na	na	20V3010222	na
770 Eff. SN 156837	na	na	na	na	na	189673V92	na
1250	NA	671777AV	na	70225739V	na	na	671800AV
1550	NA	159746AV	30V3186806	30V3186679 (Mallory)	162817AV	189673V92	161890AV
1555	30V341778	159746AV 30V3186644 (Mallory)	30V3186806	30V3186679 (Mallory)	162817AV	189673V92	161890AV/ 30V3186652
1600	na	10V3023	10V3025	na	na	20V3010222	10V3024
1650	30V341778	159746AV 30V3186644 (Mallory)	30V3186806	30V3186679 (Mallory)	162817AV	189673V92	161890AV
1655	30V341778	159746AV 30V3186644 (Mallory)	30V3186806	30V3186679 (Mallory)	162817AV	189673V92	161890AV/ 30V3186652
1750	30V341778	159746AV 30V3186644 (Mallory)	30V3186806	30V3186679 (Mallory)	162817AV	189673V92	161890AV
1755	30V341778	159746AV 30V3186644 (Mallory)	30V3186806	30V3186679 (Mallory)	162817AV	189673V92	161890AV/ 30V3186652

FB = Field Boss

# Electrical

MUO	Dist. Assem. Part No.	Dist. Caps Part No.	Points Part No.	Cond. Sets Part No.	Point & Cond. Kit Part No.	Ignition Coils Part No.	Ignition Rotors Part No.
-----	--------------------------	------------------------	--------------------	---------------------------	----------------------------------	-------------------------------	--------------------------------

## DISTRIBUTOR IGNITION COMPONENTS

### OLIVER CONTINUED

1800	na	10V3023 Eff. SN 124396 74042704V Prior to SN 124395	10V3025 Eff. SN 124396	na	70243507V Prior to SN 124395	20V3010222	10V2989 Prior to SN 124395 10V3024 Eff. SN 124396
1850	30V3417778	159746AV 30V3186644 (Mallory)	30V3186806	30V3186679 (Mallory)	162817AV	189673V92	161890AV, 30V3186652
1855	30V3417778	159746AV 30V3186644 (Mallory)	30V3186806	30V3186679 (Mallory)	162817AV	189673V92	161890AV, 30V3186652
2155	na	na	na	na	na	189673V92	na
2655	na	na	na	na	na	189673V92	na

MUO	Dist. Assem. Part No.	Dist. Caps Part No.	Points Part No.	Cond. Sets Part No.	Point & Cond. Kit Part No.	Ignition Coils Part No.	Ignition Rotors Part No.
-----	--------------------------	------------------------	--------------------	---------------------------	----------------------------------	-------------------------------	--------------------------------

### MINNEAPOLIS-MOLINE

Jet Star 3	na	70225733V	na	na	70243507V	20V3010222	10V2989
504-6a	na	na	na	na	na	20V3010222	10V2989
800-6A	na	na	na	na	na	na	10V2989
G	na	70225733V	na	na	70243507V	na	10V2989
GVI	na	na	na	na	na	20V3010222	na
GTB	na	na	na	na	na	na	10V2989
UB Regular	na	na	na	na	na	na	10V2989
G1000	na	70225733V 10V3023	10V3025	na	na	20V3010222	10V3024
G900 LP	na	na	na	na	na	189673V92	10V2989
G900	na	10V3023	10V3025	na	na	189673V92	10V3024
G950	na	10V3023	10V3025	na	na	189673V92	10V3024
G955	na	10V3023	156365AV	70225739V	na	189673V92	10V3024
G1050	na	10V3023	10V3025	na	na	189673V92	10V3024
G1350	na	10V3023	10V3025	na	na	189673V92	10V3024
G1355	na	10V3023	10V3025	70225739V	na	189673V92	10V3024
ZB, ZAS	na	na	na	na	na	20V3010222	na
A4T	na	10V3023	156365AV	na	na	189673V92	10V3024
G750	na	30V3417778 Complete Assembly	na	na	162817AV	na	161890AV
G705	na	70225733V 74042704V	na	na	na	20V3010222	10V2989
G706	na	70225733V 74042704V	na	na	na	20V3010222	10V2989
G707	na	70225733V 74042704V	na	na	na	20V3010222	10V2989
G708	na	70225733V 74042704V	na	na	na	20V3010222	10V2989
GVI	na	70225733V 74042704V	na	na	na	na	10V2989
G055	na	70225733V	na	na	na	na	10V2989
M220 P.U.	na	na	na	na	na	20V3010222	10V2989
U302	na	70225733V 74058876V	10V3025	na	na	20V3010222	10V3024
HD800-6A	na	na	na	na	na	20V3010222	10V2989
M670	na	70225733V, 74058876V	10V3025	na	na	20V3010222	10V3024

ELECTRICAL

# Starters and Alternators

ELECTRICAL



89017779V



71370306V



89017780V



89017577V

## Common Abbreviations

CCW - Counterclockwise

CW - Clockwise

(Number) T - (for example, "10T") Teeth

MUO - Machine Used On

OEM - Original Equipment Manufacturer

PDC - Parts Distribution Center

Part No.	Amps/Volts	Description
----------	------------	-------------

### UNIVERSAL APPLICATIONS

#### Alternators

89017779V	42 Amp 1-wire	Used to convert an older, generator-equipped tractor to an alternator-equipped version. Produces more output at lower RPM.
71370306V	130 Amp	Used in any larger application with a J-180 mount (4" between bottom mount). Use when upgrading 100 Amp, or when adding additional lighting equipment.
89017780V	63 Amp 1-wire	Designed to produce high output at high RPM. Not recommended for machines that run at idle for long periods of time.
79026346V	60 Amp	Convert 6-volt system to 12-volt system (includes 2-1/2" diameter pulley)

#### Starters

89017577V	12V, CW, 10T	2.8 gear reduction replacement for direct drive starters ranging from 2kW - 2.5kW. Good for very cold or very hot temperatures.
-----------	--------------	---

## HOW TO READ THE STARTERS AND ALTERNATORS SECTION

Heritage Part No.	AGCO OEM/REMAN Part No. Equivalent	MUO
79023140V	<b>20-3000545</b> 20-7101019 20-7101020 30-3066967 20-7101161 20-3010785 30-3228800 30-3228789 70262153 20-7001446 79005453 79005608 79005610 79004870	Tractors: 1855, 1755, 1955

**Heritage Part Number**

**OEM Part Numbers-Boldface Type**

**MUO (Machine Used On)**

**Additional Product Information**

- 63 Amp
- tach/spade terminal

**Related OEM Number(s) - for other AGCO brands.**

**Remanufactured Part Number(s)- Italic type; sometimes this will be the only number available (prior to the addition of Heritage product). In that case, the remanufactured number will also be boldface type.**

# Starters and Alternators

Heritage Part No.	AGCO OEM/REMAN Part No. Equivalent	MUO
-------------------	------------------------------------	-----

## ALTERNATORS

### WHITE

<b>79004870V</b>	<b>20-3000545</b>	Tractors: FB 2-105, FB 2-85, FB 2-70
	<b>20-7101019</b>	Tractors: FB 2-105, FB 2-85, FB 2-88, FB 2-110
	<b>20-7101020</b>	Tractors: FB 2-105, FB 2-85, FB 2-88, FB 2-110
	<b>30-3066967</b>	Tractors: FB 2-150, FB 4-150, FB 4-180
	20-7101161	
	20-3010785	• 72 Amp
	30-3228800	• Dust screen
	30-3228789	• Spade tach terminal
	70262153	
	20-7001446	
79005453		
79005608		
79005610		
79004870		
<b>79023140V</b>	<b>20-3000545</b>	Tractors: FB 2-105, FB 2-85, FB 2-70
	<b>20-7101019</b>	Tractors: FB 2-105, FB 2-85, FB 2-88, FB 2-110
	<b>20-7101020</b>	Tractors: FB 2-105, FB 2-85, FB 2-88, FB 2-110
	<b>30-3066967</b>	Tractors: FB 2-150, FB 4-150, FB 4-180
	20-7101161	
	20-3010785	• 63 Amp
	30-3228800	• Spade tach terminal
	30-3228789	
	70262153	
	20-7001446	
79005453		
79005608		
79005610		
79004870		
<b>79009642V</b>	<b>79009642</b>	Tractors: 60, 80 American Series, WH 125, WH 145, WH 170
		Combines: 2500 and 2600 w/ 6-374 Cummins
	71340355	
	6673145	
	71339975	• 130 Amp
<b>30V3435717</b>	<b>30-3435717</b>	Tractors: FB 2-180, FB 4-225 (1987-1991), FB 4-270 (1983-1991)
	<b>30R3435717</b>	• 105 Amp

FB = Field Boss  
WH = Work Horse



**79004870V**

ELECTRICAL



**79023140V**



**79009642V**



**30V3435717**

# Starters and Alternators

ELECTRICAL



30V3432467



31V2904907



30V3302873



30V3431517



72501755V

Heritage Part No.	AGCO OEM/REMAN Part No. Equivalent	MUO
-------------------	------------------------------------	-----

## ALTERNATORS

WHITE		
30V3432467	30-3432467 79017361 30R3432467	Tractors: FB 160, FB 185, FB 100, FB 120, FB 160, FB 185, FB 140, 60 & 80 American Series  • 62 Amp
33V0134376	33-0134376 33-0135895	Tractors: FB 21 Tractors: FB 37, FB 43  • 35 Amp
31V2904907	31-2904907	Tractors: FB 2-50, FB 2-60, 700  • 12V, CW, 9T
72091669V	72091669 72091686 72094123 31-2904525 31-2905991 31-2906131 31-2902278 82091669	Tractors: FB 2-50, FB 2-60, 700  • 33 Amp
30V3302873	30-3302873 30-3210413 30-3210421 30-3228274 72088724 30R3302873	Tractors: FB 2-180, FB 4-175, FB 2-180, FB 4-210  • 80 Amp

## STARTERS

WHITE		
30V3431517	30-3431517 30R3431517 737615 82501755	Tractors: FB 100, FB 120, FB 140, 60 & 80 American Series Tractors: FB 2-110, FB 2-120, FB 2-140, FB 2-185  • 12V, CW, 10T
30V3480429	30R3480429 30-3480429 82501755	Tractors: FB 100, FB 120, FB 140, WH 125, WH 145, 60 & 80 American Series  • 12V, CW, 10T
72501755V	72501755 82501756	Tractors: 6125, 6145  • 12V, CW, 10T

FB = Field Boss  
WH = Work Horse



# Starters and Alternators

Heritage Part No.	AGCO OEM/REMAN Part No. Equivalent	MUO
-------------------	------------------------------------	-----

## STARTERS CONTINUED

### WHITE

<b>294165V91</b>	<b>30-3445356</b>	Tractors: FB 2-110, FB 2-105, FB 2-88, FB 2-85,FB 2-70
	294165M91	
	7041973	Replacement Solenoid: 79017977V
	<i>294165R91</i>	• 12V, CW, 10T
<b>102341V91</b>	<b>102341R91</b>	Tractors: FB 2-160
	102341M91	• 12V, CW, 10T
<b>30V3066940</b>	<b>20-7000400</b>	Tractors: FB 2-135, FB 2-155, FB 2-180,FB 4-150, FB 4-175, FB 4-180, FB 4-210, FB 4-225, FB 4-270 Combines: 9700, 9720
	30-3066940	• 12V, CW, 12T
<b>20V7101197</b>	<b>20-7101197</b>	Tractors: FB 4-180, FB 4-175, FB 4-150, FB 2-135, FB 2-150, FB 2-155, FB 2-180, FB 2-175, FB 4-270, FB 4-225, FB 160, FB 185, FB 4-210
	10A18920	
	30-3110486	
	30-3212637	• 12V, CW, 12T
	30-3212645	
	20-7100991	
	20-7101066	
	294183M91	
	1055741M91	
	1446098M91	
	2603003W91	
	521465M91	
	525831M91	
527902M91		
<b>33V0049905</b>	<b>33-0049905</b>	Tractors: FB 2-55, FB 2-65, FB 2-65, FB 2-62
	33-0088153	
	<i>33R0049905</i>	• 12V, CW, 11T
<b>72165254V</b>	<b>33-0135879</b>	Tractors: FB 2-32, FB 37 Tractors: FB 2-45 with 4BA1 (169) Isuzu, FB 2-62 with 4BB1 (219) Isuzu
	33-0080888	
	33-0080888	
	72165254	• 12V, CW, 11T
	<i>33R0080888</i>	
<b>W1227413V</b>	<b>W1227413</b>	Combines: 7300, 8700, 8900, 8920 Harvest Boss
	20-7000390	• 12V, CW, 10T



294165V91



102341V91



30V3066940



20V7101197



33V0049905



72165254V



W1227413V

# Starters and Alternators

Heritage Part No.	AGCO OEM/REMAN Part No. Equivalent	MUO
-------------------	------------------------------------	-----

## STARTERS-CONTINUED

### WHITE

72093256V	82093256	Tractors: FB 2-50, FB 2-60, FB 2-70 (with Lucas)
-----------	----------	--

- 12V, CW, 9T

72272339V	72270794	Tractors: 6105, 6090, 6065 (Eff. SN 1500)
-----------	----------	---

72272339  
72259581  
72259580  
72259587  
82272339

- 12V, CW, 9T

3755718V91	33-0117447	Tractors: FB 16
------------	------------	-----------------

3755718M91  
3755718R91

- 12V, CW, 15T

33V0127507	33R0127507	Tractors: FB 21, FB 31
------------	------------	------------------------

- 12V, CW, 9T

3706495V91	33-0142840	Tractors: FB 43
------------	------------	-----------------

3706495M91

- 12V, CW, 9T

4807375V	31-2906208	Tractors: FB 2-50, FB 2-60, 700
----------	------------	---------------------------------

30-3013448  
30-3043509  
31-2903198  
31-2903227  
31-2903335  
31-2905430  
31-2905992  
31-2905993  
31-2906137  
4807375  
4807373

- 12V, CW, 9T

33V0049425	33-0049425	Tractors: FB 2-55, FB 2-65, FB 2-75 (1982 - 1987), FB 2-45, FB 2-62
------------	------------	--

33-0035963  
33-0045578

FB = Field Boss  
WH = Work Horse



72093256V



72272339V



3755718V91



33V0127507



33V0049425



3706495V91



4807375V

# Starters and Alternators

Heritage Part No.	AGCO OEM/REMAN Part No. Equivalent	MUO
-------------------	------------------------------------	-----

## ALTERNATORS

### OLIVER

<b>79004870V</b>	<b>20-3000545</b>	Tractors: 1855, 1755, 1955
------------------	-------------------	----------------------------

**20-7101019**

20-7101020

30-3066967

20-7101161

20-3010785

30-3228800

30-3228789

70262153

20-7001446

79005453

79005608

79005610

79004870

- 72 Amp
- Dust screen
- Spade tach terminal

<b>79023140V</b>	<b>20-3000545</b>	Tractors: 1855, 1755, 1955
------------------	-------------------	----------------------------

20-7101019

20-7101020

30-3066967

20-7101161

20-3010785

30-3228800

30-3228789

70262153

20-7001446

79005453

79005608

79005610

79004870

- 63 Amp
- Spade tach terminal

<b>72091669V</b>	<b>72091669</b>	Tractors: 1365, 1370
------------------	-----------------	----------------------

72091686

72094123

31-2904525

31-2905991

31-2906131

31-2902278

82091669

- 33 Amp

## STARTERS

### OLIVER

<b>294165V91</b>	<b>30-3445356</b>	Tractors: 2050, 2055, 2150, 2250, 2255
------------------	-------------------	--

294165M91

7041973

294165R91

12V, CW, 10T



79004870V

ELECTRICAL



79023140V



72091669V



294165V91

# Starters and Alternators

ELECTRICAL



30V3066940



20V7101197



72093256V



671434ASV



4807375V

Heritage Part No.	AGCO OEM/REMAN Part No. Equivalent	MUO
-------------------	------------------------------------	-----

## STARTERS CONTINUED

### OLIVER

30V3066940	20-7000400	Tractors: 2050, 2055, 2150, 2250, 2255
	30-3066940	12V, CW, 12T
20V7101197	10A18920	Tractors: 2055, 2155, 2455, 2655 with 585
	30-3110486	12V, CW, 12T
	30-3212645	
	20-7100991	
	20-7101066	
	30-3212637	
	294183M91	
	1055741M91	
	1446098M91	
	2603003W91	
521465M91		
525831M91		
527902M91		
20-7101197		
72093256V	82093256	Tractors: 1270, 1370 12V, CW, 9T
671434ASV	671434AS	Tractors: 1250 with 4-139 Fiat diesel
	R671434AS	24V, CW, 9T
4807375V	31-2906208	Tractors: 1250-A, 1355, 1365, 1370, 1265, 1270, 1255
	4807375	12V, CW, 9T
	4807373	
	30-3013448	
	30-3043509	
	31-2903198	
	31-2903227	
	31-2903335	
	31-2905430	
	31-2905992	
31-2905993		
31-2906137		

## REPLACEMENT SOLENOID

### OLIVER

79017977V	1550 & 1555, 1650 & 1655, 1755, 1800 & 1900, 1855, 1955, 77, Super 77, 770, 880, 88, Super 88, 1850
-----------	---

# Starters and Alternators

<b>Heritage</b>	<b>AGCO</b>	<b>MUO</b>
<b>Part No.</b>	<b>OEM/REMAN</b>	
	<b>Part No. Equivalent</b>	

## ALTERNATORS

### MINNEAPOLIS-MOLINE

<b>79004870V</b>	<b>30-3066967</b>	Tractors: G955, G1355
	20-3000545	
	20-7101019	
	20-7101020	
	20-7101161	• 72 Amp
	20-3010785	• Dust screen
	30-3228800	• Spade tach terminal
	30-3228789	
	70262153	
	20-7001446	
	79005453	
	79005608	
	79005610	
79004870		
<b>79023140V</b>	<b>30-3066967</b>	Tractors: G955, G1355
	20-3000545	
	20-7101019	
	20-7101020	
	20-7101161	• 63 Amp
	20-3010785	• Spade tach terminal
	30-3228800	
	30-3228789	
	70262153	
	20-7001446	
	79005453	
	79005608	
	79005610	
79004870		

## STARTERS

### MINNEAPOLIS-MOLINE

<b>20V7101197</b>	<b>10A18920</b>	Tractors: G705, G706, G707, G708, G1000, G1000 Vista, G900, G1350, G1355, 2270
	30-3110486	
	30-3212645	
	20-7100991	
	20-7101066	
	294183M91	• 12V, CW, 12T
	1055741M91	
	1446098M91	
	2603003W91	
	521465M91	
	525831M91	
	527902M91	
	30-3212637	
	20-7101197	



**79004870V**

ELECTRICAL



**79023140V**



**20V7101197**



# Starters Cross-Reference Chart

ELECTRICAL

Manufacturer	OEM Part No.	Heritage Part No.
Bosch	0 001 359 021	4807375V
Bosch	0 001 359 102	4807375V
Bosch	0 001 367 028	4807375V
Bosch	0 001 359 038	72272339V
Bosch	0 001 359 083	72272339V
Bosch	0 001 359 113	72272339V
Bosch	0 001 367 005	72272339V
Case, Case IH	A-145324	30V3066940
Case, Case IH	A-47464	30V3066940
Case, Case IH	A-75864	30V3066940
Case, Case IH	1273112C91	3755718V91
Case, Case IH	1530289C1	72272339V
Caterpillar	0R-5208	30V3066940
Caterpillar	0R-5216	30V3066940
Caterpillar	2N-3538	30V3066940
Caterpillar	2N-5358	30V3066940
Caterpillar	3T-2655	30V3066940
Caterpillar	3T-2657	30V3066940
Caterpillar	3T-2659	30V3066940
Caterpillar	4N-8252	30V3066940
Caterpillar	4N-8253	30V3066940
Caterpillar	6V-3954	30V3066940
Caterpillar	7N-6503	30V3066940
Caterpillar	7T-1081	30V3066940
Caterpillar	7T-2265	30V3066940
Caterpillar	7T-2267	30V3066940
Caterpillar	7T-9254	30V3066940
Caterpillar	7T-9255	30V3066940
Caterpillar	8C-3596	30V3066940
Caterpillar	8C-3643	30V3066940
Caterpillar	8C-3648	30V3066940
Caterpillar	8L-5881	30V3066940
Caterpillar	9L-3597	30V3066940
Caterpillar	9W-0058	30V3066940
Caterpillar	302071	W1227413V
Caterpillar	343274	W1227413V
Cummins	3604483RX	102341V91
Cummins	3910643	102341V91
Cummins	3928171	102341V91
Cummins	3593752RX	30V3066940
Cummins	3603864RX	30V3066940
Cummins	3604482RX	30V3431517
Cummins	3901386	30V3431517
Cummins	3904445	30V3431517
Cummins	3909913	30V3431517
Cummins	3604648RX	30V3480429
Cummins	3916854	30V3480429
Cummins	St9039	30V3480429
Cummins	3675172RX	89017577V
Delco	10461008	102341V91
Delco	10461012	102341V91
Delco	1990310	102341V91
Delco	1993713	102341V91

Manufacturer	OEM Part No.	Heritage Part No.
Delco	1993794	102341V91
Delco	1993853	102341V91
Delco	1993865	102341V91
Delco	1993874	102341V91
Delco	1993931	102341V91
Delco	1993992	102341V91
Delco	10461003	294165V91
Delco	10461205	294165V91
Delco	10461225	294165V91
Delco	10461273	294165V91
Delco	10478831	294165V91
Delco	1990309	294165V91
Delco	1990315	294165V91
Delco	1993705	294165V91
Delco	1993754	294165V91
Delco	1993762	294165V91
Delco	1993769	294165V91
Delco	1993881	294165V91
Delco	1993886	294165V91
Delco	10461046	30V3066940
Delco	1113158	30V3066940
Delco	1114109	30V3066940
Delco	1114112	30V3066940
Delco	1114114	30V3066940
Delco	1114120	30V3066940
Delco	1114121	30V3066940
Delco	1114127	30V3066940
Delco	1114129	30V3066940
Delco	1114138	30V3066940
Delco	1114141	30V3066940
Delco	1114149	30V3066940
Delco	1114152	30V3066940
Delco	1114156	30V3066940
Delco	1114158	30V3066940
Delco	1114162	30V3066940
Delco	1114166	30V3066940
Delco	1114167	30V3066940
Delco	1114169	30V3066940
Delco	1114171	30V3066940
Delco	1114174	30V3066940
Delco	1114175	30V3066940
Delco	1114190	30V3066940
Delco	1114191	30V3066940
Delco	1114192	30V3066940
Delco	1114198	30V3066940
Delco	1114199	30V3066940
Delco	1114703	30V3066940
Delco	1114705	30V3066940
Delco	1114708	30V3066940
Delco	1114709	30V3066940
Delco	1114724	30V3066940
Delco	1114733	30V3066940
Delco	1114746	30V3066940

## Starters Cross-Reference Chart

Manufacturer	OEM Part No.	Heritage Part No.
Delco	1114748	30V3066940
Delco	1114753	30V3066940
Delco	1114754	30V3066940
Delco	1114780	30V3066940
Delco	1114791	30V3066940
Delco	1114823	30V3066940
Delco	1114824	30V3066940
Delco	1114825	30V3066940
Delco	1114826	30V3066940
Delco	1114827	30V3066940
Delco	1114828	30V3066940
Delco	1114829	30V3066940
Delco	1114830	30V3066940
Delco	1114831	30V3066940
Delco	1114832	30V3066940
Delco	1114833	30V3066940
Delco	1114834	30V3066940
Delco	1114835	30V3066940
Delco	1114881	30V3066940
Delco	1114882	30V3066940
Delco	1114883	30V3066940
Delco	1114885	30V3066940
Delco	1114887	30V3066940
Delco	1114888	30V3066940
Delco	1114911	30V3066940
Delco	1114933	30V3066940
Delco	1114966	30V3066940
Delco	1114967	30V3066940
Delco	1114976	30V3066940
Delco	1114977	30V3066940
Delco	1114986	30V3066940
Delco	1990205	30V3066940
Delco	1990219	30V3066940
Delco	1990220	30V3066940
Delco	1990221	30V3066940
Delco	1990281	30V3066940
Delco	1990290	30V3066940
Delco	1990325	30V3066940
Delco	1993703	30V3066940
Delco	10465026	30V3480429
Delco	10465043	30V3480429
Delco	10479621	30V3480429
Delco	1113276	30V3480429
Delco	10461466	72501755V
Delco	10479617	72501755V
Delco	10461450	89017577V
Delco	10465049	89017577V
Delco	10465050	89017577V
Delco	1113281	89017577V
Delco	1113282	89017577V
Delco	1113402	W1227413V
Delco	1113640	W1227413V
Delco	1113641	W1227413V

Manufacturer	OEM Part No.	Heritage Part No.
Delco	1113656	W1227413V
Delco	1113672	W1227413V
Delco	1113690	W1227413V
Delco	1113692	W1227413V
Denso	028000-4870	33V0049905
Denso	028000-5490	33V0049905
Denso	028000-6561	33V0049905
Denso	128000-7750	33V0049905
Denso	128000-7751	33V0049905
Denso	128000-7752	33V0049905
Denso	128000-7753	33V0049905
Fiat	4169093	31V2904907
Fiat	4172113	4807375V
Fiat	4699705	4807375V
Fiat	4702248	4807375V
Fiat	4703751	4807375V
Fiat	4737755	4807375V
Fiat	4755109	4807375V
Fiat	4807375	4807375V
Ford/Motorcraft	F3HT-11001-BA	294165V91
Ford/Motorcraft	F3HZ-11002-C	294165V91
Ford/Motorcraft	SA-809	294165V91
Ford/Motorcraft	C8TF-11000-C	30V3066940
Ford/Motorcraft	C8TZ-11002-B	30V3066940
Ford/Motorcraft	D3HF-11000-BA	30V3066940
Ford/Motorcraft	D3TF-11000-CA	30V3066940
Ford/Motorcraft	D4TZ-11002-E	30V3066940
Ford/Motorcraft	D4TZ-11002-F	30V3066940
Ford/Motorcraft	D9PZ-11002-A	30V3066940
Ford/Motorcraft	E1HT-11001-CA	30V3066940
Ford/Motorcraft	E1HT-1101C-B	30V3066940
Ford/Motorcraft	E2HT-11001-A	30V3066940
Ford/Motorcraft	E2HZ-11002-A	30V3066940
Ford/Motorcraft	E6HT-11001-AA	30V3066940
Ford/Motorcraft	E6HZ-11002-B	30V3066940
Ford/Motorcraft	SA-655	30V3066940
Ford/Motorcraft	SA-655A	30V3066940
Ford/Motorcraft	SA-655B	30V3066940
Ford/Motorcraft	SA-655C	30V3066940
Ford/Motorcraft	SA-655D	30V3066940
Ford/Motorcraft	SA-736	30V3066940
Ford/Motorcraft	SA-757	30V3066940
Ford/Motorcraft	E3TF-11000-AA	30V3431517
Ford/Motorcraft	E3TZ-11001-B	30V3431517
Ford/Motorcraft	E3TZ-11002-B	30V3431517
Ford/Motorcraft	E4TF-11000-A	30V3431517
Ford/Motorcraft	E4TF-11000-AA	30V3431517
Ford/Motorcraft	SA-739	30V3431517
Hitachi	S13-120B	3706495V91
Hitachi	S13-82	3706495V91
Hitachi	S13-82A	3706495V91
Hitachi	S13-82B	3706495V91
International, IH	1654386C91	102341V91

# Starter Cross-Reference Chart

ELECTRICAL

Manufacturer	OEM Part No.	Heritage Part No.
International, IH	283804C91	30V3066940
International, IH	430138C91	30V3066940
International, IH	534721C91	30V3066940
International, IH	599102C91	30V3066940
International, IH	673796C92	30V3066940
International, IH	789355C91	30V3066940
International, IH	844334C91	30V3066940
International, IH	897593R91	30V3066940
International, IH	998356R91	30V3066940
International, IH	1273112C91	3755718V91
International, IH	394906R91	W1227413V
International, IH	528012R91	W1227413V
International, IH	680559R91	W1227413V
Isuzu	5-81100-071-0	33V0049905
Isuzu	5-81100-108-1	33V0049905
Isuzu	5-81100-169-0	33V0049905
Isuzu	5-81100-169-1	33V0049905
Isuzu	5-81100-169-2	33V0049905
Isuzu	5-81100-169-3	33V0049905
Isuzu	8-94136-400-0	3706495V91
Isuzu	8-94136-400-1	3706495V91
Isuzu	8-94453-211-1	3706495V91
Isuzu	8-94453-212-0	3706495V91
Isuzu	1-81100-245-1	72165254V
John Deere	AR62153	30V3066940
John Deere	RE13942	30V3066940
John Deere	TY1902	30V3066940
John Deere	TY6697	30V3066940
John Deere	RE69591	30V3431517
John Deere	AR34406	W1227413V
John Deere	AR41627	W1227413V
John Deere	AR55638	W1227413V
John Deere	AR62227	W1227413V
John Deere	AR62267	W1227413V

Manufacturer	OEM Part No.	Heritage Part No.
John Deere	TY1597	W1227413V
John Deere	TY6667	W1227413V
John Deere	TY6710	W1227413V
Leece NeVille	35259200	30V3480429
Lucas	26390	72093256V
Lucas	27430	72093256V
Magneti Marelli	63213853	31V2904907
Magneti Marelli	M125312	31V2904907
Magneti Marelli	MT38QA	31V2904907
Magneti Marelli	MT38QB	31V2904907
Magneti Marelli	63216800	4807375V
Magneti Marelli	63216825	4807375V
Magneti Marelli	63216826	4807375V
Magneti Marelli	63216827	4807375V
Magneti Marelli	MT38TB	4807375V
Magneti Marelli	MT68AA	4807375V
Magneti Marelli	MT68AB	4807375V
Magneti Marelli	MT68AC	4807375V
Magneti Marelli	MT68AD	4807375V
Magneti Marelli	63223800	671434ASV
Magneti Marelli	63223830	671434ASV
Magneti Marelli	63223897	671434ASV
Magneti Marelli	E115324	671434ASV
Magneti Marelli	MT68R	72272339V
Magneti Marelli	MT68RA	72272339V
Mitsubishi	M2T50371	3755718V91
Mitsubishi	M2T50381	3755718V91
Mitsubishi	M2T52381	3755718V91
Mitsubishi Motors	MM409410	3755718V91
Mitsubishi Motors	MM433174	3755718V91
Nikko	0-23000-1420	72165254V
White GMC	V1116155	102341V91
White GMC	V1114240	30V3066940
White GMC	V1114242	30V3066940

# Alternator Cross-Reference Chart

Manufacturer	OEM Part No.	Heritage Part No.
Bosch	0 120 339 515	72091669V
Bosch	0 120 339 516	72091669V
Bosch	0 120 339 527	72091669V
Bosch	0 120 339 528	72091669V
Case, Case IH	A-163085	79009642V
Case, Case IH	A-181766	79009642V
Caterpillar	0R-3527	71370306V
Caterpillar	0R-9480	71370306V
Caterpillar	121-4134	71370306V
Caterpillar	9X-6796	71370306V
Caterpillar	9X-9096	71370306V

Manufacturer	OEM Part No.	Heritage Part No.
Champion Machinery	42094	79009642V
Cummins	3604667RX	71370306V
Cummins	3606667RX	71370306V
Cummins	3604474RX	79009642V
Cummins	3909982	79009642V
Cummins	Ee9021	79009642V
Delco	10459040	71370306V
Delco	10459048	71370306V
Delco	10459159	71370306V
Delco	1117909	71370306V
Delco	1117910	71370306V
Delco	1117923	71370306V

# Alternator Cross-Reference Chart

Manufacturer	OEM Part No.	Heritage Part No.
Delco	1117941	71370306V
Delco	1117943	71370306V
Delco	1117966	71370306V
Delco	19010145	71370306V
Delco	19010147	71370306V
Delco	1100110	79004870V
Delco	1100151	79004870V
Delco	1100158	79004870V
Delco	1100198	79004870V
Delco	1100201	79004870V
Delco	1100204	79004870V
Delco	1100227	79004870V
Delco	1100228	79004870V
Delco	1100230	79004870V
Delco	1100231	79004870V
Delco	1100232	79004870V
Delco	1100266	79004870V
Delco	1100280	79004870V
Delco	1100297	79004870V
Delco	1100492	79004870V
Delco	1100493	79004870V
Delco	1100495	79004870V
Delco	1100496	79004870V
Delco	1100498	79004870V
Delco	1100550	79004870V
Delco	1100551	79004870V
Delco	1100561	79004870V
Delco	1100562	79004870V
Delco	1100565	79004870V
Delco	1100573	79004870V
Delco	1100598	79004870V
Delco	1100826	79004870V
Delco	1100831	79004870V
Delco	1100832	79004870V
Delco	1100833	79004870V
Delco	1100853	79004870V
Delco	1100859	79004870V
Delco	1100880	79004870V
Delco	1100899	79004870V
Delco	1100901	79004870V
Delco	1100902	79004870V
Delco	1100929	79004870V
Delco	1100930	79004870V
Delco	1100934	79004870V
Delco	1101155	79004870V
Delco	1101159	79004870V
Delco	1102311	79004870V
Delco	1102355	79004870V
Delco	1102356	79004870V
Delco	1102358	79004870V
Delco	1102394	79004870V
Delco	1102397	79004870V

Manufacturer	OEM Part No.	Heritage Part No.
Delco	1102462	79004870V
Delco	1102471	79004870V
Delco	1102473	79004870V
Delco	1102483	79004870V
Delco	1102489	79004870V
Delco	1102492	79004870V
Delco	1102493	79004870V
Delco	1102499	79004870V
Delco	1102593	79004870V
Delco	1102841	79004870V
Delco	1102877	79004870V
Delco	1102881	79004870V
Delco	1102899	79004870V
Delco	1103039	79004870V
Delco	1103043	79004870V
Delco	1103047	79004870V
Delco	1103053	79004870V
Delco	1103060	79004870V
Delco	1103069	79004870V
Delco	1103073	79004870V
Delco	1103074	79004870V
Delco	1103075	79004870V
Delco	1103101	79004870V
Delco	1103109	79004870V
Delco	1103118	79004870V
Delco	1103139	79004870V
Delco	1103145	79004870V
Delco	1103148	79004870V
Delco	1103154	79004870V
Delco	1103158	79004870V
Delco	1103162	79004870V
Delco	1103187	79004870V
Delco	1105050	79004870V
Delco	1105078	79004870V
Delco	1105079	79004870V
Delco	1105181	79004870V
Delco	1105351	79004870V
Delco	1105520	79004870V
Delco	1105522	79004870V
Delco	1105556	79004870V
Delco	1105608	79004870V
Delco	1105649	79004870V
Delco	1105677	79004870V
Delco	1105704	79004870V
Delco	1105705	79004870V
Delco	1979859	79004870V
Delco	10459367	79009642V
Delco	10479924	79009642V
Delco	10479925	79009642V
Delco	10479926	79009642V
Delco	10479927	79009642V
Delco	10479930	79009642V



# Alternator Cross-Reference Chart

ELECTRICAL

Manufacturer	OEM Part No.	Heritage Part No.
Delco	10497083	79009642V
Delco	1101194	79009642V
Delco	1101205	79009642V
Delco	1101439	79009642V
Delco	1101440	79009642V
Delco	1102551	79009642V
Delco	1105418	79009642V
Delco	1105535	79009642V
Delco	1105536	79009642V
Delco	1105538	79009642V
Delco	1105539	79009642V
Delco	1105540	79009642V
Delco	1105560	79009642V
Delco	1105579	79009642V
Delco	1105605	79009642V
Delco	1105609	79009642V
Delco	1100118	79023140V
Delco	1100123	79023140V
Delco	1100490	79023140V
Delco	1100491	79023140V
Delco	1100580	79023140V
Delco	1100581	79023140V
Delco	1100582	79023140V
Delco	1100583	79023140V
Delco	1100584	79023140V
Delco	1100585	79023140V
Delco	1100587	79023140V
Delco	1101282	79023140V
Delco	1102359	79023140V
Delco	1102361	79023140V
Delco	1102362	79023140V
Delco	1102363	79023140V
Delco	1102375	79023140V
Delco	1102498	79023140V
Delco	1102578	79023140V
Delco	1102847	79023140V
Delco	1102866	79023140V
Delco	1102876	79023140V
Delco	1102879	79023140V
Delco	1102896	79023140V
Delco	1102898	79023140V
Delco	1102900	79023140V
Delco	1102914	79023140V
Delco	1103040	79023140V
Delco	1103150	79023140V

Manufacturer	OEM Part No.	Heritage Part No.
Delco	1105193	79023140V
Delco	1105361	79023140V
Delco	1105362	79023140V
Delco	1984281	79023140V
Hitachi	LR135-116	33V0134376
Hitachi	LR135-127	33V0134376
Hitachi	LR135-86	33V0134376
Hitachi	LR135-86C	33V0134376
Hitachi	LR135-86F	33V0134376
Hitachi	LR135-95	33V0134376
Hitachi	LR135-95B	33V0134376
International, IH	107601C91	30V3302873
International, IH	107602C91	30V3302873
International, IH	146467C91	30V3302873
International, IH	146475C91	30V3302873
International, IH	998521R91	79004870V
International, IH	998659R91	79023140V
Iseki	6581-200-338-80	33V0134376
Iseki	6581-200-338-80A	33V0134376
Iseki	6581-200-349-90	33V0134376
Isuzu	5-81200-338-1	33V0134376
Isuzu	5-81200-341-0	33V0134376
Isuzu	5-81200-341-1	33V0134376
Isuzu	8-94423-756-0	33V0134376
John Deere	TY6753	71370306V
John Deere	AT117390	79009642V
John Deere	TY6751	79009642V
John Deere	AR54793	79023140V
John Deere	AR54796	79023140V
John Deere	AR56728	79023140V
John Deere	TY6772	79023140V
Magneti Marelli	63300900	72091669V
Magneti Marelli	63300901	72091669V
Magneti Marelli	63300921	72091669V
Magneti Marelli	AA10814V33A	72091669V
Motorola	110-747A	30V3432467
Niehoff	A1-125	30V3302873
Niehoff	N1028	30V3302873
Niehoff	N1029	30V3302873
Niehoff	N1030	30V3302873
Niehoff	N1034	30V3302873
Niehoff	N1035	30V3302873
Niehoff	N1051	30V3302873
Niehoff	N1052	30V3302873



# Electrical



105678V

MUO



72163174V



10V22293



72162639V

Switch  
Part No.

Key  
Part No.

IGNITION SWITCHES AND KEYS		
Oliver, Cockshutt, M-M - Push button with rubber cap	79024378V	na
Cockshutt - 540, 570	na	105678AV
White - 700	31V2906469	5170782V
White - FB 2-70, FB 2-80, FB 2-85, FB 2-105, FB 2-110, FB 2-135 Series III, FB 2-155 Series III, FB 2-150, FB 2-155, FB 2-180, FB 100, FB 120, FB 140, FB 160, FB 185, FB 4-150, FB 4-175, FB 4-180, FB 4-210, FB 4-225, FB 4-270, 60 & 80 American Series	72163174V	72162639V
Oliver - 1755, 1855, 1955 (Eff. SN 220000), 1870, 2270		
M-M - G955, G1355		
White - FB 2-50, FB 2-60	72093812V	Lever
Oliver - 1250A, 1255, 1265, 1270, 1355, 1365, 1370		72093811V
Oliver - 66, Super 66, 660, 77, Super 77, 770, 880	72163174V	70241977V
Oliver - Super 99 GM Diesel (Eff. SN 519300)	70253322V	na
Oliver - 1250-A, 1255, 1265, 1270, 1355, 1365, 1370, 1465, 1470	72093881V	72090051V
M-M - GVI	30V3365891	70241977V
M-M - Jet Star 3 Super, G1000 Vista, Row Crop, Wheatland, Rice Special, M670, M670 Super	10V22293	70241977V
Oliver - 2155, 2655, A4T 1400, A4T 1600 MM - G900, G950, G1050, G1350	10V27761	70241977V
M-M - Jet Star 3, Jet Star 4 Star, 4-Star Super, Jet Star 5 Star, G705, G706, M5, M504, M602, M604	10V7473	70241977V
M-M - G707, G708	10V23929	70241977V
Oliver - 1550-2255	na	105678AV

ELECTRICAL

MUO

Part No.

## VOLTAGE REGULATORS

### WHITE

FB 2-135 Series III, FB 2-155 Series III, FB 4-150	30V3203433
FB 2-70, FB 2-85, FB 2-88, FB 2-105, FB 2-110, FB 2-150, FB 4-150, FB 4-180	71308106V
FB 2-50, FB 2-60	72093853V
FB 2-70, FB 2-85, FB 2-88, FB 2-110, FB 2-150, FB 2-155, FB 2-180, FB 4-150, FB 100, FB 120, FB 140, FB 160, FB 185	72161801V
FB 2-30, FB 2-35	33V0020621
FB 2-55, FB 2-62, FB 2-65, FB 2-75	33V0056863

### MUO

Part No.

### OLIVER

550 (SN 60501-127369), 1850	K7786DV
1550, 1555 (Eff. SN 168919), 1650, 1655 (Eff. SN 147569), 1750 (Eff. SN 180537), 1755 (SN 220000-247283), 1850, 1950 (Eff. SN 150421), 1855 (SN 220000- SN 247435), 1950T (Eff. SN 194080), 1955 (SN 220000- SN247870), 2050, 2150 (Eff. SN 204001)	30V3001806
1450 (Eff. SN 132382)	675772ASV
1800, 1900 (Eff. SN 90525), 550 (Eff. SN 117379), 770 & 880 (SN 116746- SN 156836)	70229484V
1755, 1855, 1955, 2255	71308106V
550 (SN 60501- SN 117378), 770, 880 (SN 60501- SN 116745), 950, 990	79004813V
1250-A, 1255 (Eff. SN 303397), 1265, 1270, 1355, 1365, 1370, 1465, 1470	72093853V

### MUO

Part No.

### MINNEAPOLIS-MOLINE

G750 (Eff. SN 147569)	30V3001806
G1355, G955	71308106V
Big Mo 500-600 Industrial Wheelers, Big Mo 400M w/M220A-4 Engine, Big Mo 400 Industrial Wheeler, GTB, GTBD, GTC, G VI, Jet Star Orchard, Jet Star 3, Jet Star 4-Star Super, Jet Star 5-Star, M5, M504, M602, M604 -2wd and 4wd, UTI, UTIL Industrial Wheelers, ZB, ZAS, 445	K7786DV



79004813V



30V3001806

FB = Field Boss  
WH = Work Horse

# Electrical

ELECTRICAL



72093811V



72094115V



70208197V



72091942V

MUO	Description	Part No.
<b>SWITCHES AND RELAYS</b>		
<b>WHITE</b>		
FB 2-50, FB 2-60	Switch Assembly, Safety Start (includes boot)	72091942V
FB 2-50, FB 2-60	Lever, Engine Starting Switch	72093811V
FB 2-105, FB 2-135, FB 2-155, FB 2-150, FB 2-155, FB 2-180, FB 2-85	Switch, Blower (3 speed)	70577454V
FB 2-50, FB 2-60	Switch, Lights	72093881V
FB 2-135 Series III, FB 2-105, FB 2-150, FB 2-50, FB 2-60, FB 2-105, FB 2-180, FB 2-70, FB 2-85, FB 2-155, FB 2-110, FB 2-88, FB 4-175, FB 4-210, FB 4-225, FB 4-270, FB 100, FB 120	Flasher, Dual Rate (turn signal)	71362888V
FB 2-50, FB 2-60	Switch, Relay	72094115V
<b>MUO</b>		
<b>OLIVER</b>		
1250-A, 1255, 1265, 1270, 1355, 1365, 1370, 1465, 1470	Lever, Engine Starting Switch	72093811V
1250-A, 1255, 1365, 1270, 1355, 1365, 1370	Switch Assembly, Safety Start	72091942V
1265, 1270, 1365, 1370, 1465, 1470	Switch, Relay	72094115V
<b>MUO</b>		
<b>COCKSHUTT</b>		
30, 40	3-position Switch w/ Knob-lights	70208197V
	Replacment 3-position Knob	79024774V



108016AV

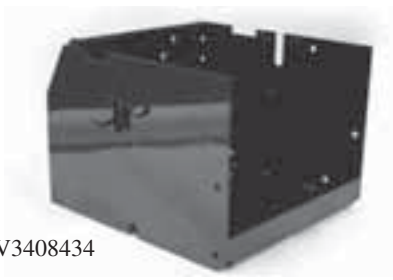

30V3408434



30V3501647

MUO	Part No.
<b>BATTERY BOXES</b>	
<b>Oliver</b> - 1550, 1555 (Eff. SN 160000), 1650, 1655 (Eff. SN 147569), 1750 (Eff. SN 180537), 1800 & 1900 (Eff. SN 134684), 1850 (Eff. SN 150421), 1950 (Eff. SN 150421), 1950T (Eff. SN 194080)	108016AV
<b>MM</b> - G750 (Eff. SN 147569)	
<b>White</b> - FB 2-135, FB 2-155, FB 2-135 Series III, FB 2-155 Series III (Eff. SN 300928), FB 2-155, FB 2-180, FB 2-180 Series III (Eff. SN 300928), FB 160, FB 185, FB 100, FB 120, FB 140, FB 160, FB 185, WH 125	30V3408434 Battery Box 30V3501647 Step

Description	Part No.
<b>BATTERY BOX LID PARTS</b>	
<b>COCKSHUTT</b>	
Rubber Bushing (short)	79024772V
Rubber Bushing (long)	79024770V
Retainer Puller Bushing	79024771V

FB = Field Boss  
WH = Work Horse

# Lighting



H7379AV



70276913V



79024614V



70267185V



KT1360V

ELECTRICAL

MUO

Part No.

## HEADLIGHT

**White** - FB 2-50, FB 2-60, 700  
**Oliver** - 1250-A, 1255, 1265, 1270, 1355, 1365, 1370, 1450, 1465, 1470, 1550, 1555, 1650, 1650, 1750, 1755, 1850, 1855, 1950T, 1955, 2050, 2150, 550, 60, 66, Super 55, Super 66, 70, 77, Super 77, 770, 880, 80, 88, Super 88, 90, 950, 990, 1850, Super 99  
**M-M** - ZA Series ZAU, ZAS, ZAN, AZE, R, 445, G750, GTB, GTBD, GTC, Jet Star 5-Star

70276913V

MUO

Description

Part No.

## HEADLIGHT ASSEMBLIES AND PARTS

<b>Cockshutt</b> - 20, 30, 40, 50, 540, 560, 570, <b>Oliver</b> - 1937-1958	<b>Bullet Style-5" Curved Lens 6-volt</b>	79024614V
	<b>Bullet Style-5" Curved Lens 12-volt</b>	79024615V
	<b>Replacement Parts</b>	
	Lens	79024726V
	Ring	79024727V
	6-Volt Bulb	79024728V
	12-Volt Bulb	79024731V
	Gasket	79024729V
	Reflector	79024751V
	Light Terminal	79024733V
<b>Cockshutt</b> - 60, 70 <b>M-M</b> - JetStar and up <b>Oliver</b> - 770 and up (all flat top fenders)	<b>Assembly-7" Flat Lens 6-volt</b>	79024382V
	<b>Assembly-7" Flat Lens 12-volt w/ rubber Trim</b>	79026185V
	<b>Replacement Parts</b>	
		79024765V
	Scaled beam bulb	79024745V
	Lens	79024749V
	Ring	H7379AV
	6-Volt, w/ ring (single contact)	79024685V
	6-Volt, w/ ring (single contact)	79024767V
	12-Volt, w/ ring (double contact)	79024768V
12-Volt, w/ ring (double contact)	79024759V	
Gasket	79024762V	
Reflector	79024733V	
<b>MM</b> - R Series, U Series, Z Series <b>Oliver</b> - 60, 66, 77, 88, Super 55-99 (through 1956)	<b>Assembly-5-3/4" Curved Lens 6-volt</b>	KT1360V
	<b>Assembly-5-3/4" Curved Lens 12-volt</b>	10V3750
	<b>Replacement Parts</b>	
	Bulb 6-Volt (Oliver Only)	79024728V
	Bulb 12-Volt (Oliver Only)	79024731V
	6-Volt, w/ ring (single contact)	H7379AV*
	6-Volt, w/ ring (double contact)	79024685V*
	12-Volt, w/ ring (single contact)	79024767V*
	12-Volt, w/ ring (double contact)	79024768V*
	Gasket	79024677V*
Reflector	79024678V*	
Light Terminal	79024679V*	

\* Will fit O.E.M. Headlamps

# Lighting

ELECTRICAL



K7361BV



K7361AV



79024683V

MUO	Description	Part No.
<b>TAIL LIGHT ASSEMBLY</b>		
<b>Oliver</b> - 77, 88, 99, Super 55, Super 99, 950, 990, 995, 1550, 1600, 1650, 1655, 1750, 1800, 1850 <b>M-M</b> - GB, GTB, GVI, 3 Star, Jet Star 4, 5 Star, 335, M5, M602, U, Z, G1355, G1365  5-3/4" red-dot combo	<b>6-Volt</b>	79024683V
	<b>12-Volt</b>	79024684V
	<b>Replacement Parts</b>	
	Red Jewel Lens	79024608V
	Light Switch w/knob	79024607V
	Lens w/guide name	79024677V
	Ring	79024678V
	Gasket	79024679V
	Light Terminal	79024733V
	6-Volt Bulb	79024728V
12-Volt Bulb	79024731V	
<b>MUO Description Part No.</b>		
<b>TAIL LIGHT ASSEMBLY, BULLET STYLE</b>		
<b>Oliver</b> - 66, Super 66, 77, Super 77, 88, Super 88, 660, 770, 880, 990 <b>M-M</b> -Jet Star, 4 Star, 5 Star, 445, Big Mo 400, Big Mo 500, Big Mo 600	<b>12-Volt - Chrome</b> (Does not have restoration appearance)	K7361AV
	<b>12-volt - Green</b> (Gas & Diesel)	K7361CV
	<b>6-volt - Green</b> (Gas & Distillate) (Has Restoration Appearance)	K7361BV
	<b>Replacement Parts</b>	
	6-Volt bulb	79024385V
	12-Volt bulb	79024386V
	Lens, Red Plastic	79024394V
Lens, Red Glass	79024399V	
Trim ring	79024681V	
Gasket	79024682V	
<b>MUO Description Part No.</b>		
<b>DASH LAMP</b>		
<b>OLIVER</b>		
Oliver 60, 66, 77, 88	12-Volt	K7357AV
	6-Volt- Replacment Bulb	79024385V
	12-Volt Replacment Bulb	79024386V



K7357AV

# Intake



70651270V



71125804V

MUO	Description	Part No.
<b>HOSES</b>		
White - FB 2-70 Gas	Hose, Elbow, Air Cleaner Outlet, 2-1/2 I.D.	158680AV
Oliver - 1550, 1555, 1650, 1655 (Eff. SN 147569)		
M-M - G750		
White - FB 2-135, FB 2-155, FB 2-135 Series III, FB 2-155 Series III	Pipe, Air Inlet	166936AV
Oliver - 2050, 2150 (Eff. SN 204001)		

MUO	Description	Part No.
<b>PRE-CLEANER BODY</b>		
White - FB 2-135, FB 2-155, FB 2-155, FB 2-135 Series III, 2-155 Series III (Eff. SN 300928)	Plastic	70269385V
White - FB 2-70	Plastic	71125804V
Oliver - 1550, 1555, 1755, 1800, 1850, 1855, 1900, 770 & 880 (Eff. SN 60501), 950, 990, 995, 77, Super 77		
M-M - GVI, G705 & G706 -2wd and 4wd, G955, M5, M504 2wd and 4wd, M602, M604 2wd and 4wd, G750		
M-M - Z, ZA, ZB, UBD, GTBD		
M-M - 5-Star, M5, GB, GVI, GTB Gas	Plastic	70257382V
Oliver - 1855, 1955, 1850, 90 Series	Plastic	70651270V
M-M - G900 & G950, G1000 -Row Crop Wheatland Rice-Special, G1000 Vista, G1050 (PCR2193 & R2193), G705, G706, G707, G708		



79026389V

MUO	Description	Part No.
<b>AIR CLEANER CAPS</b>		
Cockshutt - 30, 40, 50; Co-op - E3, E4, E5	4-1/8" Body Dia., 1-7/8" O.D. (Fits inside pipe)	10V8040
M-M - BF		79026389V
Avery - A		



10V8040

INTAKE & EXHAUST



# Exhaust



166871AV



161707AV



7416AV



72511206V



166869AV



KE821GV



**Manifold Elbow (Support)**  
Oliver - 70 Part No. B423AV



**Exhaust Elbow (with Muffler)**  
Oliver - 70 Part No. B453AV

SERIAL NO.	Description	Part No.
<b>MANIFOLD TURBO ELBOWS</b>		
<b>WHITE 2-105</b>		
Eng. SN 354UA8917T - SN 354UA16469T	5" Length to Turbo	30V3159027
Eff. Engine SN 354UA16470T	4.5" Length to Turbo	740695V1
Seal - Turbo Elbow (Cast Iron)		740838V1

INTAKE & EXHAUST

MUO	Notes	Exhaust Manifold Part No.	Front Manifold Part No.	Rear Manifold Part No.	Exhaust Manifold Gasket Part No.	Intake Manifold Part No.
-----	-------	---------------------------	-------------------------	------------------------	----------------------------------	--------------------------

## EXHAUST MANIFOLD & GASKET

### WHITE

FB 2-60		4606570V	Not Required	Not Required	(4) 98489690V	na
FB 2-70 Gas		161707AV	Not Required	Not Required	(1) K426V, KA422V	na
FB 2-85 Perkins Diesel		735556V1	Not Required	Not Required	735528V1 Gasket Set	na
FB 2-135, FB 2-155	Eff. SN 300928	Not Required	166871AV	166872AV	(2) 40V3891130	166869AV
FB 2-135 Series III, FB 2-155 Series III		Not Required	166871AV	166872AV	(2) 40V3891130	166869AV

MUO	Notes	Exhaust Manifold Part No.	Front Manifold Part No.	Rear Manifold Part No.	Exhaust Manifold Gasket Part No.	Intake Manifold Part No.
-----	-------	---------------------------	-------------------------	------------------------	----------------------------------	--------------------------

### OLIVER

OC3 4-Cylinder Hercules Gas, HG Crawler	Intake & Exhaust Manifold Assembly	113315V	Not Required	Not Required	79024666V	na
Super 44, 440		7416AV	Not Required	Not Required	79024631V	na
60 Gas		H415AV	Not Required	Not Required	(6) H422V, (1) 72516538V	na
66 Gas		79024696V	Not Required	Not Required	na	na
70 Gas	Intake - Eff. SN 223151, Exhaust - Eff. SN 200126, 2-piece intake & exhaust manifold assembly	79024673V Complete Assembly, B415AV Exhaust Manifold Assembly	Not Required	Not Required	B422AV	na
77, Super 77, 770, 1550, 1555 Gas		79024903V	Not Required	Not Required	(1) K426V, (9) MA422V	79024787V
88, 880 Gas		161707AV	Not Required	Not Required	(9) KA422V	101339AV*
1355	Eff. SN 503289	4606570V	Not Required	Not Required	(4) 98489690V	na
1365		4606570V	Not Required	Not Required	(4) 98489690V	na
1370		4606570V	Not Required	Not Required	(4) 98489690V	na
1600, 1650, 1655 Gas		161707AV	Not Required	Not Required	(9) KA422V	155896V**

\* 2-3/8" C. C. Carburetor bolt hole

\*\* 2-5/8" C. C. Carburetor bolt hole

FB = Field Boss

# Exhaust



MUO	Notes	Exhaust Manifold Part No.	Front Manifold Part No.	Rear Manifold Part No.	Exhaust Manifold Gasket Part No.	Intake Manifold Part No.
-----	-------	---------------------------	-------------------------	------------------------	----------------------------------	--------------------------

**EXHAUST MANIFOLD & GASKET**

**OLIVER CONTINUED**

1850 w/ A6.354 Perkins Diesel	Prior to SN 216385	158426ASV	Not Required	Not Required	(1) 3638258V1, (2) 744162V1	na
2050, 2150	Eff. SN 204001	Not Required	166871AV	166872AV	(2) 40V3891130	166869AV

MUO	Notes	Exhaust Manifold Part No.	Front Manifold Part No.	Rear Manifold Part No.	Exhaust Manifold Gasket Part No.	Intake Manifold Part No.
-----	-------	---------------------------	-------------------------	------------------------	----------------------------------	--------------------------

**MINNEAPOLIS-MOLINE**

U, UB, UTS Gas, Early 5 Star	Heat Riser Valve	KE821GV KE823V	Not Required	Not Required	79024652V	na
U, UB Gas		na	Not Required	Not Required	na	KE822AV
U Delux (UDLX)		79024655V	Not Required	Not Required		na
5 Star, M5, 602, 604, Super 670	(2 Piece)	79024653V	Not Required	Not Required	79024652V Set	na
Late U, UB, 5 Star, M5, 602, 604	(1 Piece)	10V9465	Not Required	Not Required	79024652V Set	na
Jet Star, Jet Star 2, Jet Star 3, 4 Star, U302, 335, 445	Exhaust Elbow Plate	10V7695 10V9363 10V7931	Not Required	Not Required	79024654V	na
M-M V with Hercules ZX B3 65 C.I. Engine		VT149V	Not Required	Not Required	79024413V	na
BG with Hercules 133 C.I. Engine		113315V	Not Required	Not Required	79024666V	na

MUO	Exhaust Manifold Part No.	Front Manifold Part No.	Rear Manifold Part No.	Exhaust Manifold Gasket Part No.	Intake Manifold Part No.
-----	---------------------------	-------------------------	------------------------	----------------------------------	--------------------------

**COCKSHUTT**

20, 540 and many Continental engines, Replaces Continental Part No. F400E-502	7416AV	Not Required	Not Required	79024631V	na
30, Co-op E3	79024414V - Intake & Exhaust Manifold Assembly	Not Required	Not Required	79024415V	See Exhaust Manifold
40, 50, Co-op E4, E5 Gas	79024416V - Intake & Exhaust Manifold Assembly	Not Required	Not Required	na	See Exhaust Manifold

MUO	Description	Part No.	MUO	Part No.
<b>MANIFOLD HARDWARE</b>			<b>GLOW PLUGS</b>	
White - FB 2-135, FB 2-155, FB 2-135 Series III, FB 2-155 Series III	Stud, Exhaust Manifold, 1-7/8" (1 per package)	40V1094703	Oliver - 1250A, 1255, 1265, 1355, 1365	72094514V
Oliver - 2050 & 2150		166805AV		
White - FB 2-135, FB 2-155 Oliver- 2050, 2150	Stud, Intake Manifold, 1-1/2" (2 per package)	166874AV		
White - FB 2-135, FB 2-155	Washer, Exhaust Manifold			
Oliver - 2050, 2150 (Eff. SN 204001)	(12 per package)			

INTAKE & EXHAUST

# Exhaust

INTAKE &amp; EXHAUST

MUO	Description	Part No.
<b>EXHAUST GASKETS</b>		
<b>WHITE</b>		
FB 2-50, FB 2-60	Exhaust Manifold	98489690V
FB 2-50, FB 2-60	Exhaust Pipe	72094474V
FB 2-70 Diesel	Exhaust Manifold	70277001V
FB 2-70 Diesel	Intake Manifold	30V3022579
FB 2-44 Diesel (SN 60501 - SN 72831) Gas (Eff. SN 72832), FB 2-70, FB 2-78, FB 4-78 (Eff. SN 147569 )	Exhaust Manifold	KA422V
FB 2-85 (SN 263341 - SN 297446), FB 2-105 (SN 255216 - SN 297446)	Exhaust Manifold (End Port)	735528V1
FB 2-85 (SN 272595 - SN 296610), FB 2-105 (SN 255216 - SN 297446)	Exhaust Manifold	3638593V1
FB 2-85 (SN 272595 - SN 296610), FB 2-105 (SN 255216 - SN 297446)	Exhaust Manifold	3638594V1
FB 2-85, FB 2-105, FB 2-110	Exhaust Manifold (Center)	744162V1
FB 2-105 (Eff. SN 297447)	Exhaust Manifold (Steel Center)	3638258V1
FB 2-150	Exhaust Manifold to Cylinder Head	10V24202
	Outlet Manifold	20V0006332
	Intake Manifold to Cylinder Head	20V0000325
<b>MUO</b>		
<b>OLIVER</b>		
550 (SN 60501-SN 72831), 80, 88, Super 88 (Eff. SN 952460), Super 99 Diesel (Prior to SN 519300), 950, 990, 995 (Eff. SN 530001), 1550, 1555 (Eff. SN 160000), 1650 1655 (Eff. SN 147569)	Exhaust Manifold	KA422V
66, Super 66, 660 (Eff. SN 73132), 550 (Eff. SN 72832), 1650, 1655 (SN 147569 - SN 187585), 1800, 1900 (Eff. SN 90525)	Exhaust Manifold (Diesel)	103005AV
550 (SN 60501 - SN 72831), 1550 & 1555 (Eff. SN 160000)	Intake and Exhaust Manifold	MA422V
550 (SN 60501 - SN 72831), 1550, 1555 (Eff. SN 160000)	Exhaust Manifold	M426AV
1250-A (Eff. SN 360745), 1255 (Eff. SN 303397), 1265, 1270 (Eff. SN 000001), 1355 (Eff. SN 503289), 1365, 1370	Exhaust Pipe	72094474V
1250-A, 1255 (Eff. SN 303397), 1265, 1270 (Eff. SN 000001), 1355 (Eff. SN 503289), 1365, 1370	Exhaust Manifold	98489690V
1450 (Eff. SN 132382), 1465 & 1470 (Eff. SN 000001)	Exhaust Manifold	8009824V
1650, 1655 (Eff. SN 187586), 1750 (Eff. SN 180537), 1755, 1855, 1955 (Eff. SN 220000), 1950T (Eff. SN 194080)	Exhaust Manifold (Diesel)	70277001V
1650, 1655 (Eff. SN 187586), 1750 (Eff. SN 180537), 1755, 1855, 1955 (Eff. SN 220000), 1950T (Eff. SN 194080)	Intake Manifold (Diesel)	30V3022579
1650, 1655 (SN 147569 - SN 187585), 1800 (Eff. SN 124396)	Intake Manifold	72516524V
1850 Diesel (Eff. SN 216386)	Exhaust Manifold (Center)	3638593V1
	Exhaust Manifold (End Port)	735528V1
	Exhaust Manifold (Center)	3638594V1
		3638593V1
		744162V1
2050 & 2150 (Eff. SN 204001)	Exhaust Manifold	40V3891130
2155, 2655 (585-6 LP)	Intake Manifold	10V8991
2155, 2655 (504-4B LP)	Exhaust Manifold Gasket (Steel)	10V26441
2155, 2655 (D585-6 Diesel)	Exhaust Manifold to Cylinder Head	10V24202
2155, 2655 (D585-6 Diesel)	Outlet Manifold	20V0006332
2155, 2655 (D585-6 Diesel)	Intake Manifold	20V0000326
2655 (D504-4A Diesel)	Exhaust Manifold to Cylinder Head	10V8622

FB = Field Boss

# Exhaust



B422AV

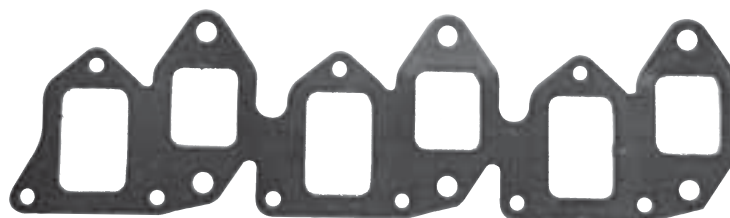

40V3891130

INTAKE & EXHAUST

MUO	Description	Part No.
<b>EXHAUST GASKETS</b>		
<b>MINNEAPOLIS-MOLINE</b>		
G750 (Eff. SN 147569)	Exhaust Manifold - Gas	KA422V
G750 (Eff. SN 187586)	Exhaust Manifold - Diesel	70277001V
G750 (Eff. SN 187586)	Intake Manifold - Diesel	30V3022579
G750 (SN 147569 - SN 187585)	Exhaust Manifold - Diesel	103005AV
G750 (SN 147569 - SN 187585)	Intake Manifold	72516524V
G1350, G1355	Exhaust Manifold to Cylinder Head	10V24202
G1350, G1355	Intake Manifold	20V0000326
G1350, G1355	Outlet Manifold	20V00006332
G VI, G1000 Row Crop Wheatland & Rice-Special, G705, G706, G707, G708 2wd and 4wd, GTB, GTBD, GTC, Jet Star 5-Star, M5 M504, M602, M604 2wd and 4wd, M670, M670 Super	Intake Manifold to Cylinder Head	10V3016
G900, G1000 Row Crop Wheatland & Rice-Special, G1350, G1355	Carburetor to Manifold	10V19881
UTI, UTIL, U, G VI, G1000 Row Crop Wheatland, Rice Special, G1000 Vista, G1050 (PCR2193, R2193), G705, G706, G707, G708 2wd and 4wd, G900, G950, G955, GTB, GTBD, GTC, Jet Star 5-Star, M5, M504, M602, M604 2wd and 4wd, M670, M670 Super	Exhaust Manifold to Cylinder Head	10V8622
UTI, UTIL, U, G VI, G1000 Row Crop Wheatland, Rice Special, G1000 Vista, G1050 (PCR2193 & R2193), G1350, G1355, G705, G706, G707, G708 2wd and 4wd, G900, G950, G955, GTB, GTBD, GTC, Jet Star 5-Star, M5, M504 2wd and 4wd, M602, M604 2wd and 4wd, M670, M670 Super	Intake Manifold	10V8991
GB	Exhaust Manifold	9617HV
G1000 Row Crop Wheatland, Rice Special, G1000 Vista, G1050 (PCR2193, R2193), G1350, G1355, G900, G950, G955, M670, M670 Super	Exhaust Manifold (Steel)	10V26441

# Exhaust



30V3301702



B452V



K452V

## Muffler Paint

Hi-Temperature

Aluminum 79015023

Black 79014480

Aerosol (6 cans per case)

Dealers: Order on Promo 265

MUO

Part No.

### HEAT SHIELD

WHITE

FB 2-180, FB 2-180 Series III (Eff. SN 301922),  
FB 4-175, FB 4-210, FB 4-225

30V3301702

MUO

Description

O.E.M. Part No.

Heritage

Part No.

### MUFFLERS

WHITE

FB 2-45, FB 2-62	Vertical Round Body	33-0031992	33V0031992*
FB 2-50, FB 2-60	Vertical Round Body (1-3/4")	673066A	673066AV*
	Vertical Round Body (2")	31-2990451	31V2990451*
FB 2-55, FB 2-65, FB 2-75	Vertical Round Body	33-0031992	33V0031992*
FB 2-70	Vertical Oval Body	166486A (Gas),	30637V91
		164080A (Diesel)	
FB 16, FB 2-85 (Eff. SN 262390)	Vertical Round Body	30-3040828	30V3040828
FB 2-85	Vertical Round Body	164080A	164080AV*
	Vertical Oval Body, Aspirated	30-3335690	30V3335690*
FB 2-88	Aspirated	30-3335927	30V3335927*
FB 2-105 (Eff. SN 288738) Diesel	Vertical Oval Body, Aspirated	30-3387712	30V3387712
FB 2-110	Vertical Oval Body, Aspirated	30-3375935	30V3375935*
FB 2-150	Vertical Oval Body, Aspirated	30-3156451	30V3156451*
FB 2-135, 2-155 (Eff. SN 287528), FB 2-135 Series III, FB 2-155 Series III, FB 2-105 (Eff. SN 287528)	Vertical Oval Body, Non-Aspirated	30-3322734	30V3322734
FB 2-135, 2-155 (SN 272595-SN 287811), FB 2-135 Series III, FB 2-155 Series III, FB 2-105 (SN 276762-SN 288737)	Vertical Oval Body, Aspirated	30-3364178	30V3364178
60 and 80 American Series	Vertical Oval Body	30-3463427	30V3463427
FB 2-180, 2-180 Series III (Eff. SN 301922)	Vertical Oval Body, Aspirated,	30-3463427	30V3216462*
	Exhaust Pipe	30-3286614	30V3286614*
FB 4-150, FB 4-180	Vertical Oval Body	30-3224732	30V3224732*
FB 4-175, FB 4-210	Vertical Oval Body, Aspirated	30-3392694	30V3392694*
FB 4-225, FB 4-270	Vertical Oval Body	30-3373193	30V3373193*
FB 100	Horizontal Round Body	30-3449130	30V3449130*
FB 120, FB 140	Horizontal Round Body	30-3449149	30V3449149*
FB 160, FB 185	Vertical Oval Body, Aspirated	30-3432246	30V3432246*

\* Manufactured to O.E.M. Specifications



# Exhaust

MUO	Description	O.E.M. Part No.	Heritage Part No.
<b>MUFFLERS</b>			
<b>OLIVER</b>			
55, 550 (1-7/8" Inlet I.D., 2" Outlet O.D., 35-1/2" Length)	Exhaust Pipe	na	79024907V
550 Gas & Diesel (Eff. SN 60501)	Horizontal Round Body	161386A	161386AV
	Vertical Exhaust Pipe	102079A	102079AV
66, Super 66, 660 (RC 420001- SN 6502)	Vertical Round Body	L452	L452V
66, Super 66, 660 (Std. 470001- SN 6502)	Vertical Round Body	na	79015992V
66, Super 66, 660 (Gas & Diesel)	Extention Pipe	na	79023477V
70	Horizontal Round Body	B452	B452V
70 (Std. Eff. SN 300001)	Horizontal Round Body	na	79015985V
77, 88 Diesel	Vertical Round Body	XK452	XK452V
77, Super 77	Vertical Round Body	na	79015992V
77, 88	Extention Pipe	na	79023477V
77, 88 Diesel	Under Hood Vertical Round Body	XK452	K452V
66, 77, 88 (1-3/4" Inlet I.D., 1-3/4" Outlet O.D., 24" Length)	Exhaust Pipe		79024675V
770, 880, 1550, 1600 Gas & Diesel; 1650 Gas	Vertical Round Body	na	30637V91
1650 Diesel; 1750, 1800, 1850 Gas, LP, Diesel	Vertical Round Body with Heat Shield	na	30638V91
1650 Diesel; 1855 Gas; 1655 (Eff. SN 147569), 1750, 1755 (Eff. SN 220000), 1850 Gas & Diesel	Vertical Oval Body	30-3040828	30V3040828
1870	Vertical Oval Body	20-0008813	20V0008813*
1850, 1950T, 1955, 2050, 2150 Diesel	Vertical Oval Body	164961A	164961AV
1800, 1900 (Eff. SN 124396), 1950 (Eff. SN 150421), 2050, 2150 (Eff. SN 204001), 1950T	Vertical Round Body	na	79015996V
2155, 2655 Diesel	Vertical Round Body	na	79015981V
<b>MUO</b>	<b>Description</b>	<b>O.E.M. Part No.</b>	<b>Heritage Part No.</b>
<b>MINNEAPOLIS-MOLINE</b>			
ZB, ZAS, ZAU, ZAN, AZE, R	Horizontal Round Body	10A759B	30635V91
Jet Star 3 Super	Vertical Round Body	10A25865	na
G1000 Row Crop, Wheatland Special, Rice Special, G1000 Vista, G705, G706	Vertical Round Body	10A17881	10A17881V
Jet Star 3 Gas & Diesel, Jet Star 4-Star, 4-Star Super	Vertical Oval Body	na	79015983V
Jet Star (Early Serial Numbers)	Vertical Round Body	na	79015984V
GTB, GTBD, GTC, UTI & UTIL Industrial Wheelers, G (Early), U, G-6, GVI, Jet Star 5 (Late)	Vertical Round Body	KE846 30-3040828	KE846V 30V3040828
G750 (Eff. SN 147569)	Vertical Oval Body	na	na
G955	Vertical Oval Body	20-0008813	20V0008813*
G1000 (Late), G1350	Vertical Oval Body	na	79015981V
G1355	Vertical Oval Body, Aspirated	30-3156451	30V3156451*
445 - All Universal and Utility	Vertical Round Body	na	79015980V
M-5, M602, M604, M670	Vertical Round Body	10A23891	10A23891V
Combines; 2890, 3490, 3496, 4290, 4296 (Gas)	Vertical Round Body	W1130270	W1130270V
<b>MUO</b>	<b>Description</b>	<b>O.E.M. Part No.</b>	<b>Heritage Part No.</b>
<b>COCKSHUTT</b>			
E3, 30	Vertical Round Body	na	79024723V
E4, 40, E5, 50, 560, 570 Golden Eagle	Vertical Round Body	na	79024724V

\* Manufactured to O.E.M. Specifications

# Universal Exhaust Accessories



70256539V



2700058V91

INTAKE & EXHAUST

Description	Part No.
<b>RAIN CAPS</b>	
For 1-1/2" O.D. Pipe	70244381V
For 1-3/4" O.D. Pipe	70244342V
For 2" O.D. Pipe	70236922V
For 1-3/4" O.D. Pipe	70253310V
For 2-1/2" O.D. Pipe	70252842V
For 2-7/8" O.D. Pipe	70244343V
For 3" O.D. Pipe	1498008V1
For 3" O.D. Pipe	70244344V
For 3-1/4" O.D. Pipe	70275328V
For 3-1/2" O.D. Pipe	70256539V
For 4" O.D. Pipe	70269408V
For 2-3/4" O.D. Pipe	1092639V1
For 3-1/2" O.D. Pipe	166206AV
For 3-1/2" O.D. Pipe	1498008V1
For 4" O.D. Pipe	70269408V
For 5" O.D. Pipe	20V7003002
For 2.38" O.D. Pipe	70253311V
For 2.20" O.D. Pipe	192791V91

Description	Part No.
<b>MUFFLER CLAMPS*</b>	
For 1-1/2" Pipe	79023401V
For 1-5/8" Pipe	79023402V
For 1-3/4" Pipe	79023403V
For 1-7/8" Pipe	79023404V
For 2" Pipe	79023405V
For 2-1/4" Pipe	79023406V
For 2-1/2" Pipe	79023407V
For 2-5/8" Pipe	79023408V
For 2-3/4" Pipe	79023409V
For 3" Pipe	79023410V
For 3-1/4" Pipe	79023411V
For 3-1/2" Pipe	79023412V
For 4" Pipe	79023413V
For 4-1/2" Pipe	79023414V
For 5" Pipe	79023415V

\* Saddle type

Description	Part No.
<b>BLACK STRAIGHT PIPES</b>	
<b>24" Length Pipe</b>	
1-1/2"	79023430V
1-3/4"	79023431V
2"	79023432V
2-1/4"	79023433V
2-3/8"	79023434V
2-1/2"	79023435V
2-5/8"	79023436V
2-3/4"	79023437V
3"	79023438V
3-1/2"	79023439V
3-3/4"	79023440V
4"	79023441V
4-1/2"	79023442V
5"	79023443V

Description	Part No.
<b>BLACK STRAIGHT PIPES</b>	
<b>48" Length Pipe</b>	
1-1/2"	79023444V
1-3/4"	79023445V
2"	79023446V
2-1/4"	79023447V
2-3/8"	79023448V
2-1/2"	79023449V
2-5/8"	79023450V
2-3/4"	79023451V
3"	79023453V
3-1/2"	79023454V
3-3/4"	79023455V
4"	79023456V
4-1/2"	79023457V
5"	79023458V

I.D.	Length	Part No.
<b>CURVED EXHAUST EXTENDER</b>		
<b>48" Length Pipe</b>		
1-1/2"	18"	79023416V
1-3/4"	18"	79023417V
2"	18"	79023418V
2-1/4"	18"	79023419V
2-1/2"	18"	79023420V
2-3/4"	18"	79023421V
3"	18"	79023422V
2-5/8"	18"	79023423V
3-1/2"	20"	79023424V
3-3/4"	20"	79023425V
4"	20-1/2"	79023426V
4-1/8"	20-1/2"	79023427V
4-1/2"	20-1/2"	79023428V
5"	20-1/2"	79023429V



79024753V

Description	Part No.
<b>ORIGINAL STYLE CLAMPS</b>	
2"	79024753V
2-1/2"	79024763V

MUO	Description	Part No.
<b>CHROME EXHAUST STACKS</b>		
Oliver - 66, 77, 88	Exhaust Stack Straight, Double Wall Lined	79024693V
Universal Applications	Exhaust Stack w/ bends 24" high by 3-1/2" O.D., 2-5/16" Inlet I.D.	79024694V



79024693V

# Steering



H767V



10V8502



B767V



RT479V



E1082V

**MUO** Description Part No.

**STEERING WHEELS-ORIGINAL REPLACEMENT  
COCKSHUTT**

30, 35, 40, 50, 550, 560, 570, Co-op E2, E3, E4, E5	18" Diameter, black, smooth hub w/ pin, 7/8" shaft, 3 spokes	1146510V
--	--	----------

**MUO** Description Part No.

**OLIVER**

60	16" diameter, keyed 7/8" hub, 3 straight spokes	HA767V
Most 60s, Early 66	16" diameter, keyed, 3 covered-to-center spokes	H767V
Early 70	17 5/8" diameter, tapered and keyed hub, 3 spokes	B767AV
55, 550, Late 60, 66, 660, 70, 77, 770, 88, 880, Super 66, Super 77, Super 88. Will fit 99 and Super 99 but is not 4- spoked like the original, 1600, 1650, 1800 w/ manual steering	18" diameter, keyed hub, 3 covered-to-center spokes	B767CV
Super 55, 550, 1600	18" diameter, splined hub, 3 covered-to-center spokes	E767V
Late 550 (Eff. SN 1977), 1550, 1555, 1650, 1750, 1755, 1850, 1855, 1950, 1950T, 1955, 2050, 2150	15" Diameter, splined hub, 11/16" shaft, 3 covered-to-center spokes, dished	79024911V
White - 2-44 Backhoe		

**MUO** Description Part No.

**MINNEAPOLIS-MOLINE**

Early R	16" diameter, keyed 7/8" hub, 3 spokes	RT479V
G, GB, GTA, GTB, R, RTI, U, UB, Z, ZB, 5 Star (Early), Jet Star, Jet Star 2	17 5/8" diameter, tapered and keyed hub, 3 spokes	10V8502
Avery BF, R and V	15" diameter, tapered and keyed stepped 11/16" hub, 3/4" shaft	850071V1
	16" diameter, tapered and keyed stepped 11/16" hub, 3/4" shaft	70261861V

**MUO** Part No.

**STEERING WHEEL CAP (STEEL)  
OLIVER**

Super 55, 60, 66, Super 66, 70, 77, Super 77, 88, Super 88,	E1082V
--	--------

*Counter Sink is correct for 66, 77, 88. differs slightly for Super Series.*



HA767V



1146510V

STEERING, AXLE

# Steering, Front Axle



101431AAV



101431AV



101432AAV



101432AV

## OLIVER FACT

Oliver began using branded, colored caps in 1958. During 1962, the company switched from white-faced to black-faced caps.

MUO	Description	Part No.
<b>OLIVER BRAND STEERING WHEEL CAPS</b>		
550, 660, 770, 880, 990, 950,	White faced	101431AV
995, 1600, 1800, 1900, 1550,	Black faced	101431AAV
1650, 1750, 1850, 1950, 2050,	White faced	101432AV
2150	Black faced	101432AAV

STEERING, AXLE



T020967V

MUO	Description	Part No.
<b>UNIVERSAL STEERING JOINT REPAIR KIT</b>		
Oliver - 66, Super 66, 660, 77, Super 77, 770, 88, Super 88, 880	Includes yolks, pins, and grease fitting, 7/8" diameter shaft on both ends	T020967V
Cockshutt - 20, 30, Co-op E2, E3, E4, E5		

MUO	Description	Part No.
<b>POWER STEERING</b>		
<b>OLIVER</b>		
1600, 1800, 1900	Power Steering Kit	79024680V

*To convert Saginaw steering unit to Charlynn*

*Includes adapter fittings to convert hose, bracket and steering wheel. Hose not included.*

Base	Height	Hole I.D.	Part No.
<b>TIE ROD BOOTS</b>			
1-13/16"	7/8"	5/8"	79024775V
1-13/16"	9/16"	5/8"	79024776V
1-9/16"	1"	1/2"	79024778V
1-15/16"	3/4"	3/4"	79024777V

# Steering, Front Axle



MUO	Serial No.	Ends Part No.	Assemblies Part No.	Rod w/ End Part No.	Tube Part No.
<b>TIE ROD ASSEMBLIES AND COMPONENTS</b>					
<b>WHITE</b>					
FB 2-50	Power Steering	72090115V	72091309V	na	720932300V
	2wd Power Steering	na	na	72090710V	72090708V
	4wd Power Steering	72093231V	na	na	Includes End
FB 2-60	Power Steering	72090115V	72091309V	na	na
	4wd Power Steering	72093231V	na	na	na
FB 2-70	(Right Hand) For use with Tie Rod 30-3202747	72161865V	164210V	na	164367V
	2wd Power Steering	25V1001398	na	72090710V	72090708V
FB 2-78		107075ASV LH 107291ASV RH	na	106673ASV	na
FB 2-85	RH - For Use with Tie Rod 30-3202747, 30V3202712, 30-3219372	72161865V	164210V	164365V	164367V
	(SN 271720 - 284964)	25V1001398	30V3202712	30V3211029	na
	Eff. SN 285183	na	30V3442837	na	72162854V
FB 2-88		72161865V	30V3442837	30V3443132	72162854V
FB 2-105	RH - For Use with Tie Rod 30-3202747, 30V3202712, 30-3219372	72161865V	164210V	164365V	164367V
	(SN 271914 - 285182)	25V1001398	30V3202712	30V3211029	na
	(Eff. SN 285183)	na	30V3442837	na	72162854V
		na	30V3442837	30V3443132	na
FB 2-110		72161865V	30V3442837	30V3443132	72162854V
FB 2-135		72161865V	72161861V	na	72162854V
FB 2-135 Series III		na	72161861V	na	72162854V
FB 2-150		na	30V3083063	na	na
FB 2-155, FB 2-155 Series III		72161865V	72161861V	na	72162854V
FB 2-180 , FB 2-180 Series III	FB 2-180 Series III: (Eff. SN 301922)	72161867V	72161862V	72161868V	72162105V
FB 120, FB 140		72161865V	72161861V	72161866V	72162854V
FB 160, FB 185		72161867V	na	na	na
WH 125, WH 145		72161865V	72161861V	72161866V	72162854V
WH 170, WH195		72161867V	na	na	na
700	(2WD) Power Steering	31V2906277	na	31V2906278	na
	(4WD) Power Steering	72093231V	na	na	na

STEERING, AXLE



# Steering, Front Axle



72093230V



72093231V

MUO	Serial No.	Ends Part No.	Assemblies Part No.	Rod w/ End Part No.	Tube Part No.
-----	------------	---------------	---------------------	---------------------	---------------

## TIE ROD ASSEMBLIES AND COMPONENTS

### OLIVER

60 and 80 American Series		72161865V	na	na	na
770, 880	Eff. SN 60501	107291ASV	164210V	106673ASV	na
1250	Eff. SN 701881	72090115V	na	na	na
1250 -A	Eff. SN 360745	72090115V	na	na	72090448V
1255	Eff. SN 303397	72090115V	na	na	72090448V
1265	Eff. SN 000001	72093231V	72091309V	72090710V	72090448V
		72090115V	na	na	na
	Eff. SN 310481	72093230V	na	na	72090708V
1270	Eff. SN 000001	72093231V	72091309V	72090710V	72090448V
		72090115V	na	na	na
	Eff. SN 310481	72093230V	na	na	72090708V
1355	Eff. SN 503289	72090115V	na	72090710V	72090708V
	Eff. SN 503289	72093230V	na	na	na
1365, 1370	Eff. SN 000001	72093231V	72091309V	72090710V	72090708V
		72090115V	na	na	na
	Eff. SN 000001	72093230V	na	na	na
1465, 1470		72093231V	na	na	na
1550, 1555		10V2901,	164210V	164365V	164367V
		25V1001398		106673ASV	
1650, 1655	Eff. SN 147569	10V2901,	164210V	164365V	164367V
		25V1001398		106673ASV	
1750		na	164210V	na	na
1755		10V2901,	164210V	164365V	164367V
		25V1001398			
1800	Eff. SN 115377	10V2901	164210V	106673ASV SN 90525 - SN 115376	na
1850		na	164210V	na	na
1855	Eff. SN 220000	10V2901,	164210V	164365V	164367V
		25V1001398			
1870		na	30V3083063	na	na
1900	Eff. SN 115377	10V2901	164210V	106673ASV SN 90525 - SN 115376	na
1950		na	164210V	na	na
1950T		na	164210V	na	na
1955	Eff. SN 150421	10V2901,	164210V	na	164367V
		25V1001398			
2050		na	1028268V92	na	na
2150	Eff. SN 220000	na	1028268V92	na	na
2255		25V1001398	na	30V3094219	72162854V
2270	Eff. SN 204001	72161865V	30V3083063	30V3109313	30V3109321

# Steering, Front Axle

MUO	SN. Breaks	Ends Part No.	Assemblies Part No.	Rod w/ End Part No.	Tube Part No.
-----	------------	---------------	---------------------	---------------------	---------------

## TIE ROD ASSEMBLIES AND COMPONENTS MINNEAPOLIS-MOLINE

445		10V2901	na	10V1096	na
G750	Eff. SN 147569	10V2901	164210V	106673ASV	107244V
G750		25V1001398	164210V	164365V	164367V
G900		10V2901	na	10V2900	na
G950		10V2901	na	10V2900	na
G1000 Vista		10V2901	na	10V2900	na
G1000 Row Crop Wheatland, Rice Special		10V2901	na	10V2900	na
G955,G1355		72161865V	30V3083063	30V3109313	30V3109321
Jet Star 3 Super, Jet Star 3, Jet Star 4 Super, Jet Star 5 Star, M5, M504, M603, M604, M670, M670 Super		10V2901	na	10V1096	na



MUO	Left Part No.	Size	Right Part No.	Size	Bushing Part No.	Notes
-----	---------------	------	----------------	------	------------------	-------

## SPINDLES WHITE

FB 2-60	72090685V		72090684V		72094403	Includes Dowels
FB, 2-135, FB 2-150, FB 2-155, FB 2-180	72160101V	12" Length	72160101V	12" Length	72160032	

MUO	Left Part No.	Size	Right Part No.	Size	Bushing Part No.	Notes
-----	---------------	------	----------------	------	------------------	-------

### OLIVER

770, 880	161340AV	1.50" Dia.	161340AV	1.50" Dia.	XK719	
1365 and 1370 (Eff. SN 721488)	72090685V	na	72090684V	na	72094403	Includes Dowels
1550 and 1555 (Eff. SN 160000)	161340AV	1.50" Dia.	161340AV	1.50" Dia.	XK719	
1650 and 1655 (Eff. SN 147569)	161340AV	1.50" Dia.	161340AV	1.50" Dia.	XK719	
1650 and 1655 (Eff. SN 147569)	161959AV	1.750" Dia.	161959AV	1.750" Dia.	161958A	
1750 (SN 180537 - SN 201090)	161340AV	1.50" Dia.	161340AV	1.50" Dia.	XK719	Narrow Tread
1750 (Eff. SN 180537)(Eff. SN 201091)	161959AV	1.750" Dia.	161959AV	1.750" Dia.	161958A	Regular Tread
1850, 1950 (SN 150421 - 169758)	161340AV	1.50" Dia.	161340AV	1.50" Dia.	XK719	
1850, 1950 (Eff. SN 169759)	161959AV	1.750" Dia.	161959AV	1.750" Dia.	161958A	
2155 Type E Front Axle, 2255 (Eff. SN 235650)	72160101V	na	72160101V	na	72160032	

MUO	Left Part No.	Size	Right Part No.	Size	Bushing Part No.	Notes
-----	---------------	------	----------------	------	------------------	-------

### MINNEAPOLIS-MOLINE

G950, G900, G1050 (PCR2193) (R2193) Type E Front Axle, G1350, G1355	72160101V	12" Length	72160101V	12" Length	72160032	
Jet Star 3, Jet Star 4	11V7436	13.75" Length	11V7436	13.75" Length	10A7092	

STEERING AXLE

# Steering, Front Axle



72160484V



155193AV

**MUO**

**Part No.**

**FRONT WHEEL HUBS**

<b>White</b> - FB 2-135 and FB 2-155 w/ adjustable front axle, FB 2-135 Series III, FB 2-155 Series III (Eff. SN 300928), FB 2-150, FB 2-155, FB 2-180, FB 2-180 Series III (Eff. SN 301922), FB 140, WH 170, WH 195	72160484V
<b>White</b> - FB 2-70, FB 2-85 <b>Oliver</b> - 1550, 1555 (Eff. SN 160000), 1650, 1655 (Eff. SN 201091), 1750 (Eff. SN 180537), 1755, 1855, 1955 (Eff. SN 220000), 1850, 1950 (Eff. SN 150421), 1950T (Eff. SN 194080), 77, Super 77, 770, 880 (Eff. SN 60501) <b>M-M</b> - G750 Extra High Clearance	161963AV
<b>White</b> - FB 2-44 (Eff. SN 121808), FB 2-85, FB 2-78, FB 4-78 (SN 147569) <b>Oliver</b> - 1550, 1555 (Eff. SN 160000), 1650, 1655 (Eff. SN 147569), 1750 (Eff. SN 180537), 1800, 1900 (Eff. SN 90525), 1850, 1950 (Prior to SN 150421), 1950T (Eff. SN 194080), 550 (Eff. SN 121808), 66, Super 66, 77, Super 77, 88 and Super 88 <b>M-M</b> - G750, RC (Eff SN 147569)	155193AV

MUO	Serial No.	LH Arm Part No.	RH Arm Part No.
-----	------------	-----------------	-----------------

**STEERING ARMS**

<b>WHITE</b>			
FB 2-70		30V3089983	30V3089975
FB 2-85	SN 26341 - SN 271719	30V3089983	30V3089975
	Eff. SN 271720	30V3202720	30V3202739
FB 2-88		30V3202720	30V3202739
FB 2-105	Eff. SN 271914	30V3202720	30V3202739
	SN 255216 - SN 271913	30V3089983	30V3089975
FB 2-110, FB 100, FB 120		30V3202720	30V3202739

MUO	Serial No.	Center Arm Part No.
-----	------------	---------------------

<b>OLIVER</b>		
1550	SN 160000 - SN 206713	160289AV
	SN 206714 - SN 227210 3/4" Bolt Hole	166446AV
	Eff. SN 227211	30V3045692
1555	SN 160000 - SN 206713	160289AV
	Eff. SN 22721	30V3045692
	SN 206714 - SN 227210	166446AV
1650	SN 147569 - SN 206713	160289AV
	SN 206714 - SN 227210	166446AV
1655	SN 147569 - SN 206713	160289AV
	SN 206714 - SN 227210	166446AV
1755	Short Wheel Base - Row Crop	166446AV
	Standard Wheel Base	30V3045692
1850	SN 150421 - SN 208224	160289AV
	Eff. SN 207366	166446AV
1855	Row Crop	166446AV
	Row Crop Eff. SN 220000	30V3045692
1950	Eff. SN 207366	166446AV
	SN 194080 - SN 207365	160289AV
1950T	Eff. SN 207366	166446AV
	SN 150421 - SN 207365, Short Wheel Base 5/8" Bolt Hole	160289AV
1955	Row Crop Eff. SN 220000, Short Wheel Base	166446AV
	Standard	30V3045692

STEERING AXLE



161963AV



30V3202739



30V3202720

FB = Field Boss  
WH = Work Horse

# Front Axle and Steering



166446AV



## Front Wheel Retainer

Cockshutt - 20  
For Front Wheel Seals  
Part No. T11307V



## Front Wheel Retainer

Cockshutt - 30, 570 Super  
For Front Wheel Seals  
Part No. T8827V

MUO

Notes

Center Arm  
Part No.

### STEERING ARMS

#### MINNEAPOLIS-MOLINE

MUO	Description	Part No.
G750	Row Crop SN 206714 - SN 227210, Short Wheel Base - 5/8" Bolt Hole	160289AV
	Row Crop SN 206714 - SN 227210, Short Wheel Base - 3/4" Bolt Hole	166446AV

MUO

Description

Part No.

### STEERING ARMS-POWER STEERING

#### OLIVER

1550, 1555, 1650 & 1655 (Eff. SN 147569), 1750 (Eff. SN 180537), 1755, 1850, 1855 (Eff. SN 220000), 1950, 1950T, 1955 (Eff. SN 220000)	Power Steering Arm	30V3106772
1250-A (Eff. SN 360745), 1255 (Eff. SN 303397), 1265, 1270 (SN 000001-SN 310480), 1355 (Eff. SN 503289), 1365, 1370	Head, Steering Cylinder	72090449V

MUO

Description

Part No.

### STEERING ARMS-BEARINGS

#### WHITE

FB 2-30, FB 2-35, FB 2-32, FB 37, FB 43	Bearing, (Front Wheel Assist)	1442561V1
FB 2-55, FB 2-65, FB 2-62		1110002V
FB 2-32		70276826V
FB 2-30, FB 2-35, FB 2-45, FB 2-55, FB 2-65, FB 2-62, FB 2-75, FB 31		1109956V
FB 2-30, FB 2-35, FB 2-32, FB 2-45, FB 2-50, FB 2-55, FB 2-65, FB 2-60, FB 2-62		70528519V
FB 100, FB 120	Bearing, King Pin (Front Wheel Assist)	1042596V1
FB 2-50, FB 2-60	Spider Joint, Front Axle	9962244V

MUO

Part No.

### POWER STEERING PUMPS

White - FB 2-60, 700		31V2906468
Oliver - 1355 (Eff. SN 503289), 1365, 1370, 1465, 1470, 1850		
White - FB 2-88, FB 2-110, FB 2-135, 2-155 (Eff. SN 299366) 2wd, FB 2-135, 2-155 Series III (Eff. SN 300928) 2wd, FB 100 2wd, FB 120 2wd, FB 140, WH 125		72161101V
White - FB 2-135, 2-155 (Eff. SN 299366) FWA, FB 2-180 Series III (Prior to SN 6175) 2wd, FB 100 FWA, FB 120 FWA, FB 140, WH 125		72161102V
Oliver - 2255 (Eff. SN 235650)		
White - FB 2-135 Series III, 2-155 Series III (Eff. SN 300928) FWA, FB 2-180 Series III (Prior to SN 6175) FWA		72161214V
Oliver - 1650, 1655, 1950		167908ASV
M-M - G750, (Eff. SN 213044)		



31V2906468



72161101V

STEERING AXLE

# Troubleshooting Clutch Problems

Since all major clutch repairs involve splitting the engine and transmission, if either the disc or cover assembly is replaced due to wear or damage, you should also replace the drive plate, bearings and, in the case of a disc replacement, the cover assembly. By doing so, you'll help ensure peak clutch performance while making the most of having the tractor split. You'll also make it less likely you'll have to split the tractor again for a clutch issue for a very long time.

## Clutch Does Not 'Clear' (Drags or Spins)

Culprit	Possible Causes	Solutions
Hub is sticking to the splined input shaft	Splines were damaged during fitting	Remove burrs from the spline; replace w/ a new plate
	Hub splines or input shaft are damaged	Replace the plate, shaft, or both
	Hub is rusted solid on the shaft	Clean the hub and the shaft to free the hub; grease shaft slightly
Linings 'rested' into the flywheel or pressure plate	Clutch was engaged while the machine stood unused for a long period of time	Sandpaper the parts, including the facings
Clutch disc too thick	Wrong drive plate for the application	Replace w/ the correct drive plate
Pilot bearing not operating correctly	Bearing is jammed or defective	Replace the pilot bearing
Clutch not disengaging cleanly	Release bearing clearance too great	Adjust bearing to the specified setting
	Release system worn	Replace worn and defective parts
	Clutch not properly tightened	Properly tighten clutch bolts
	During fitting, the hub was bent or the spline was damaged	Replace w/ a new drive plate
	The lever or diaphragm spring fingers were bent when the housing was assembled to the engine	Replace clutch
	Clutch overstroked	Check pedal travel stop, adjusting as necessary
	Clutch reservoir lacks fluid	Refill clutch reservoir
	Hydraulic system leaking	Replace defective parts
	Air in the hydraulic system	Remove air from system

## Clutch Noise

Culprit	Possible Causes	Solutions
Drive plate	Wrong plate was installed	Replace w/ the correct drive plate
Pilot bearing	Pilot bearing is defective or was not properly installed	Replace w/ a new pilot bearing
Release bearing	Bearing is defective, runs dry, or is running unaligned	Properly align the bearing, or replace w/ a new one
Release linkage	Release linkage or pedal brushing is worn or defective	Repair the linkage or brushing, or replace w/ new
Torsion damper	Damper is worn or was broken due to wrong driving habits, with low revolutions at full throttle in high gears	Replace w/ a new drive plate



# Troubleshooting Clutch Problems

## Clutch Slipping

Culprit	Possible Causes	Solutions
Facings worn	Normal wear	Replace w/ new drive plate and, if possible, a new clutch cover
	Driver allowed the clutch to slip too long, or 'rode' the clutch pedal	
	Clutch pressure springs insufficient for operating requirements	
Facings are oily	Engine or transmission oil is contaminated	Replace w/ a new drive plate and clean the clutch cover (Do not attempt to clean the linings!)
	Seal is leaking	
	Input shaft splines were lubricated too much during fitting	
Clutch is only partially engaged during operation	Release bearing clearance is set too narrowly	Adjust bearing clearance to the specified setting
	Too much friction in the release linkage	Repair the linkage
Flywheel depth does not meet specifications	The bolt-on facing was not reground together correctly for the proper flywheel contact area	Grind bolt-on facing correctly. It may be necessary to replace the flywheel if re-grinding does not solve the problem
Clutch cover, lever or diaphragm bent	Improper handling during assembly or disassembly	Replace w/ a new clutch following the assembly instructions
Clutch overheating	Improper use	Replace w/ a new clutch cover and drive plate
	One of the causes listed above	
Facing contact area on flywheel is worn or defective	Flywheel contact area is nicked or 'scored'	Regrind flywheel contact area and the bolt-on facing according to specified settings

### Test For Clutch Slippage

- (1) Engage the parking brake.      (2) Shift the transmission gears to top speed  
If the engine stops, the clutch is normal. If the engine does not stop, the clutch is slipping.

## Clutch 'Grabbing'

Culprit	Possible Causes	Solutions
Linings are oily	Oil is seeping through gear or crankshaft seals	Replace w/ a new drive plate and clean the clutch cover (Do not try to clean the linings!)
	Splines on the input shaft were over-lubricated	
	Release bearing is losing grease	
Linings are incorrect for the application	A non-specified drive plate w/ improper linings was used	Replace w/ the correct drive plate with the proper lining
Clutch linkage is stiff	Specific components are worn or defective; those components include the clutch cable or release bearing quill	Repair or replace the defective part(s)
Clutch will not fully disengage	Release bearing's mounting position is incorrect	Check and adjust the bearing mounting position to the specified setting
	Someone tampered w/ the clutch cover toggle setting	Replace w/ a new clutch
	The cover, lever or diaphragm were bent during assembly	Replace w/ a new clutch
	Hub of the driven plate was distorted or dented during assembly	Replace w/ a new drive plate
	Crankshaft is not aligned with the input shaft	Check the centering of engine and transmission housing and repair if necessary.

# Clutch, Bearings and Components

• Backed by 12-Month Warranty  
(Your Assurance of Quality)

• Sets Includes Cover,  
Pressure Plate Assembly  
and Clutch Disc

• All Heritage Clutch parts are new,  
not remanufactured

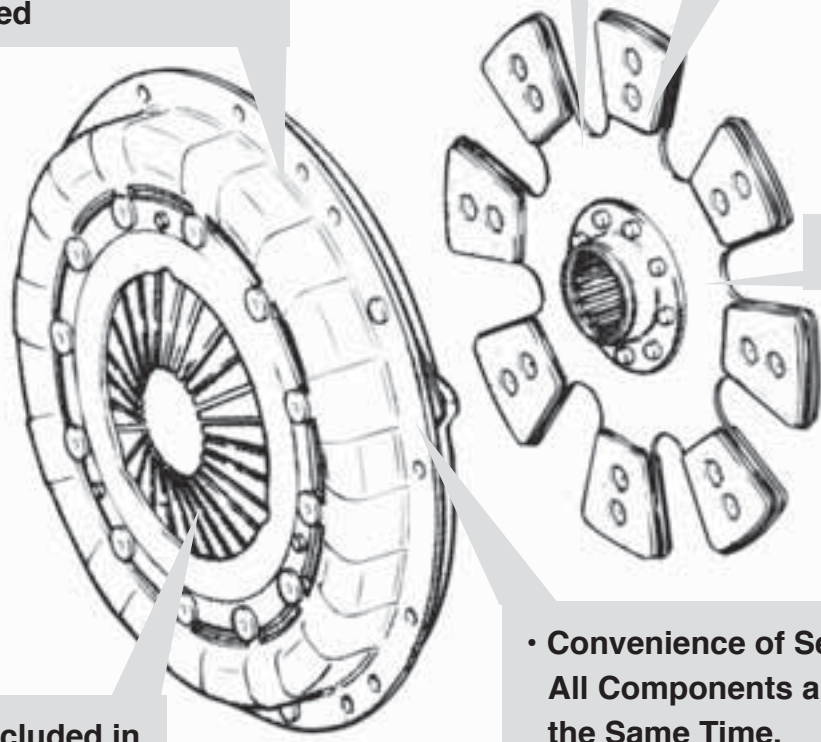

• U.S.A. Made for Quality

• Convenience of Set Also Ensures  
All Components are Replaced at  
the Same Time.

• Bearings Not Included in  
Set but Referenced Here  
for Convenience

CLUTCH

MUO	Notes	Cover Assembly Part No.	Clutch Disc Part No.	Heritage Set Part No. Cover & Disc	O.E.M. Equiv. Part No. Cover & Disc	Description
<b>WHITE</b>						
60 & 80 American Series		na	na	79021985	30-3151239 30-3462412	Cover Disc
FB 100, FB 120, FB 140 WH 125, WH 145		72161849V	na	79021987	30-3412547 30-3295850	Cover Disc
FB 160, FB 185, WH 170, WH 195	See Technical Note for Flywheel Specs Included with Clutch Set  With Cummins 504 Engine and 30-3419843 flywheel FW 9101	na	na	72508717V	72163225/72508717 Flywheel Adapter 72163039 72161808 72163039	Cover Adapter Disc Center Plt Disc
FB 2-30, FB 2-35B 9" Dual clutch		na	na	79021983	33-0047236 33-0013595 Ref. 72165145 CA Ref. 72165108 PTO CD	Cover Disc

# Clutch, Bearings and Components



79022064



79021987



10V20990  
Located on page 182



79021985



79022018

Release Bearing Part No.	Pilot Bearing Part No.	Plate Size	Plate Type	Flywheel Specification	Spline Depth - # Teeth	Friction Type
30-3056287	72160313	12"	Push	Flat	1.750-27 D	4-pad
72160065V - 100, 120, 140, 125, 145	72505492V - 100, 120, 125 72160313 - 140, 145	14"	Push	1.187"	1.750-27 D	6-pad
72160065V	72505492V	13/13	Push	Flat	1.750-27 D	6-pad
		4 external lugs			1.750-27 D	6-pad
3702563M1	1140823V	9/9	Push	.028 step	36mm-19 R 25mm-13 R	Woven Woven

D = Dampened  
R = Rigid

# Clutch, Bearings and Components

MUO	Notes	Cover Assembly Part No.	Clutch Disc Part No.	Heritage Set Part No. Cover & Disc	O.E.M. Equiv. Part No. Cover & Disc	Description
<b>WHITE CONTINUED</b>						
FB 2-45		na	na	79021976	33-0024007 33-0024104	Cover Disc
FB 2-50, FB 2-60 Early Production	3-lever with diaphragm 6-bolt flywheel	na	72091671V	79022028	30-3011259 5145715	Cover PTO disc
FB 2-50, FB 2-60 Late Production	6-lever 12-bolt flywheel	na	72091671V	79022018	72094463 72091671	Cover PTO disc
FB 2-62		na	na	79021976	na na	Cover Disc
FB 2-70	Original 3-Lever version, Disc is too thin for diaphragm cover Do Not Mix	168823AV	na	79022008	168823AS 163935AS	Cover Disc
FB 2-70	Diaphragm spring option. Disc is too thick for 3-lever cover. Do Not Mix.	168823AV	na	79022003	168823AS 163935A	Cover Disc
FB 2-78 Prior to SN 187586	Original 3-lever version	na	160971AV	79022014	160970AS 160971AS	Cover Disc
FB 2-78 Prior to SN 187586	Diaphragm spring option	na	na	79022012	160970AS 160971AS	Cover Disc
FB 2-78 Eff. SN 187586	Original 3-lever version, disc is too thin for diaphragm cover. Do Not Mix.	168823AV	na	79022008	168823AS 163935A	Cover Disc
FB 2-78 Eff. SN 187586	Diaphragm spring option, disc is too thick for 3- lever cover) Do Not Mix	168823AV	na	79022003	168823AS 163935A	Cover Disc
FB 2-85, FB 2-88		na	na	79021985	30-3151239 30-3462412	Cover Disc
FB 2-105, FB 2-110		30V3137503	na	79021984	30-3137503 30-3295842	Cover Disc
FB 2-115		na	na	79022023	168668AS 157327AS	Cover Disc
FB 2-135, FB 2-135 Series III		na	na	79021987	30-3412547 30-3295850	Cover Disc
FB 2-150		na	na	79022048	30-3073211 30-3295850	Cover Disc
FB 2-155, FB 2-155 Series III		na	na	79021987	30-3412547 30-3295850	Cover Disc
FB 2-180, FB 2-180 Series III	See technical note for flywheel specs that is included w/ Clutch Set.  W/ Caterpillar 3208 Engine and 4N 4853 Flywheel	72508717V	na	79022268	72163225 Flywheel Adapter 72163039 72161808 72163039	Cover Adapter Disc Center Plt Disc
FB 4-70, FB 4-78	Original 3-lever version, disc is too thin for diaphragm cover. Do Not Mix.	168823AV	na	79022008	168823AS 163935A	Cover Disc

**CLUTCH**

# Clutch, Bearings and Components

Release Bearing Part No.	Pilot Bearing Part No.	Plate Size	Plate Type	Flywheel Specification	Spline Depth - # Teeth	Friction Type
3702563M1	na	11"	Push	Recessed 1.443"	1-1/8-10 D	6-pad
72093894V - 2-50 30V3011003 - 2-60	na	11/11	Push	Flat	45mm-14 R 25mm-10 R	5-pad Woven
72093894V - 2-50 30V3011003 - 2-60	na	11/11	Push	2mm step	45mm-14 R 25mm-10 R	5-pad Woven
na	na	11"	Push	Recessed 1.443"	1-1/8-10 D	6-pad
30V3056295	30V3065162	12"	Push	0.125"	1.563-19 D	4-pad
30V3056295	30V3065162	12"	Push	0.125"	1.563-19 D	4-pad
30V3056295	30V3065162 (Eff. SN 147569)	12"	Push	Flat	1.563-19 D	Woven
30V3056295	30V3065162 (Eff. SN 147569)	12"	Push	Flat	1.563-19 D	Woven
30V3056295	30V3065162 (Eff. SN 147569)	12"	Push	0.125"	1.563-19 D	4-pad
30V3056295	30V3065162 (Eff. SN 147569)	12"	Push	0.125"	1.563-19 D	4-pad
30-3056287	72160313	12"	Push	Flat	1.750-27 D	4-pad
30-3056287	72160313	13"	Push	Flat	1.750-27 D	6-pad
na	na	14"	Push	1.160"	1.750-27 R	Woven
72160065V	72160313	14"	Push	1.187"	1.750-27 D	6-pad
AS5022B	72160313	14"	Push	Flat	1.750-27 D	6-pad
72160065V	72160313	14"	Push	1.187"	1.750-27 D	6-pad
72160065V	72160313	13/13 4 external lugs	Push	Flat	1.750-27 D 1.750-27 D	6-pad 6-pad
30V3056295	30V3065162	12"	Push	0.125"	1.563-19 D	4-pad

CLUTCH



# Clutch, Bearings and Components

MUO	Notes	Cover Assembly Part No.	Clutch Disc Part No.	Heritage Set Part No. Cover & Disc	O.E.M. Equiv. Part No. Cover & Disc	Description
<b>WHITE CONTINUED</b>						
FB 4-70, FB 4-78	Diaphragm spring option. Disc is too thick for 3-lever cover. Do Not Mix.	168823AV	na	79022003	168823AS 163935AS	Cover Disc
FB4-115		na	na	79022023	168668AS 157327AS	Cover Disc
FB 4-150, FB 4-175		na	na	79022048	30-3073211 30-3295850	Cover Disc
FB 4-180, FB 4-210, FB 4-225	See technical note for flywheel specs, which are included w/ Clutch Set.  W/ Caterpillar 3208 engine and 4N 4853 flywheel	na	na  na	72508717V	72163225 Flywheel Adapter 72163039 72161808 72163039	Cover Adapter Disc Center Plt Disc
6065		na	na	79021980	72214437 72271186	Cover Disc
6085 (Prior to SN 1431)		na	na	79021980	72214437 72271186	Cover Disc
6085 (Eff. SN 1431)		na	na	79021979	72214356 72272022	Cover Disc
6090		na	na	79021980	72214437 72271186	Cover Disc
6105		na	na	72508717V	72214356 72271187	Cover Disc
6124, 6144	See technical note for flywheel specs, which are included with Clutch Set.  W/ Cummins Engine and Flywheel FW9101	na	na	72508717V	72163225 72163039 72161808 72163039	Cover Adapter

CLUTCH

MUO	Cover Assembly Part No.	Clutch Disc Part No.	Heritage Set Part No. Cover & Disc	O.E.M. Equiv. Part No. Cover & Disc	Description
-----	-------------------------	----------------------	------------------------------------	-------------------------------------	-------------

## OLIVER

55, Super 55, 550	na	100687ASV Woven, 30V3016668 6 - Pad	na	100687AS, 30-3016668 100691AS	Disc
55, Super 55, 550	na	100687ASV Woven, 30V3016668 6 - Pad	na	100687AS, 30-3016668 1A870569 ESA569 (See Service Bulletin)	Disc

# Clutch, Bearings and Components

Release Bearing Part No.	Pilot Bearing Part No.	Plate Size	Plate Type	Flywheel Specification	Spline Depth - # Teeth	Friction Type
30V3056295	30V3065162	12"	Push	0.125"	1.563-19 D	4-pad
na	na	14"	Push	1.160"	1.750-27 R	Woven
30-3056309 - 4-150 AS5022B - 4-175	72160313	14"	Push	Flat	1.750-27 D	6-pad
30-3056287 - 4-180 72160065V - 4-210, 4-225	72160313	13/13  4 external lugs	Push	Flat	1.750-27 D  1.750-27 D	6-pad  6-pad
72290686	na	310mm	Push	Flat	40mm-24D	6-pad
72290686	na	310mm	Push	Flat	40mm-24D	6-pad
72290686	na	330mm	Push		40mm-24 D	7-pad
72290686	na	310mm	Push	Flat	40mm-24 D	6-pad
72277906	na	330mm	Push		44mm-21 D	7-pad
72505831	72505492V	13/13	Push	Flat	1.750-27 D  1.750-27 D	6-pad  6-pad
Release Bearing Part No.	Pilot Bearing Part No.	Plate Size	Plate Type	Flywheel Specification	Spline Depth - # Teeth	Friction Type
KS5022V (SN 6000 - SN 46000) 100565AV (Eff. SN SN 46001)	103300AV	10"	SST-19	Flat	1"-10 R	Woven
KS5022V (SN 6000 - SN 46000) 100565AV (Eff. SN 46001)	103300AV	10"	SST-r 24	Flat	1"-10 R	6-pad

D = Dampened  
R = Rigid

CLUTCH

# Clutch, Bearings and Components

MUO		Cover Assembly Part No.	Clutch Disc Part No.	Heritage Set Part No. Cover & Disc	O.E.M. Equiv. Part No. Cover & Disc	Description
<b>OLIVER CONTINUED</b>						
66, Super 66, 660		LAS569V	na	na	801569AS 660660AS	Cover
77, Super 77		LAS569V	na	na	801569AS 877572AS	Cover
77, Super 77, 770		na	na PTO 156086AV	79022033 na	163018AS 102093AS 156086A	Cover Disc PTO Clutch
88, Super 88		na	na	79022033	163018AS 102093AS	Cover Disc
88 (Eff. SN 6503), Super 88, 880 (Eff. SN 60501)		na	na PTO 156086AV	79022032 na	870880AS 161153AS 156086A	Cover Disc PTO Clutch
950, 990		na	na	79022023	168668AS 157327AS	Cover Disc
1255, 1265, 1270		na	30V3052249 30V3052257	na	30-3052249 30-3052257	Dual Cover Trans Disc PTO Disc
1355, 1365, 1370 Early Production	3-lever diaphragm version 6-bolt flywheel	na	72091671V	79022028	30-3011259 5145715	Cover PTO Disc
1355, 1365, 1370 Late Production	6-lever version 12-bolt flywheel	na	72091671V	79022018	72094463 72091671	Cover PTO Disc
1550, 1555		na	na PTO 156086AV	79022016 na	155916AS 161153AS 156086A	Cover Disc PTO Clutch Disc
1600		na	na	79022016	155916AS 161153AS	Cover Disc
1650, 1655 (Eff. SN 187586)	Original 3-lever version	na	160971AV	79022014	160970AS 160971AS	Cover Disc
1650, 1655 (Prior to SN 187586)	Diaphragm spring option	na	160971AV	79022012	160970AS 160971AS	Cover Disc
1650, 1655 (Eff. SN 187586)	Original 3-lever version. Disc is too thin for diaphragm cover. Do Not Mix.	na	na	79022008	16882AS 163935AS	Cover Disc
1650, 1655 (Eff. SN 187586)	Diaphragm spring option. Disc is too thick for 3-lever cover. Do Not Mix.	168823AV	na	79022003	168823AS 163935AS	Cover Disc

**CLUTCH**

# Clutch, Bearings and Components

Release Bearing Part No.	Pilot Bearing Part No.	Plate Size	Plate Type	Flywheel Specification	Spline Depth - # Teeth	Friction Type
KS5022V (RC SN 420001 - SN 436672), STD. (Eff. SN 470001), IND. (SN 462001 - SN 62175) 831788V1 (RC Eff. SN 4365), (IND. Eff. SN 462176)	1139517V	9"	Push	Flat	1-3/8-17 R	Woven
na	na	9"	Push	Flat	1-1/2-19 R	Woven
na	na	10"	Push	Flat	1-3/4-27 D	Woven
na	na	10"	Push	Flat	1-3/4-27 D	Woven
na	na	11"	Push	Flat	1.563-19 D	Woven
na	na	14"	Push	1.160"	1.750-27 R	Woven
na	na	10/10	Push		40mm-14 R 25mm-10 R	6-pad Woven
na	na	11/11	Push	Flat	45mm-14 R 25mm-10 R	5-pad Woven
na	na	11/11	Push	2mm step	45mm-14 R 25mm-10 R	5-pad Woven
831788V1	30V3065162	11"	Push	Flat	1.563-19 D	Woven
831788V1	30V3065162	11"	Push	Flat	1.563-19 D	Woven
30V3056295	30V306152	12"	Push	Flat	1.563-19 D	Woven
30V3056295	30V306152	12"	Push	Flat	1.563-19 D	Woven
30V3056295	30V306152	12"	Push	0.125"	1.563-19 D	4-pad
30V3056295	30V306152	12"	Push	0.125"	1.563-19 D	4-pad

D = Dampened  
R = Rigid

# Clutch, Bearings and Components

MUO	Cover Assembly Part No.	Clutch Disc Part No.	Heritage Set Part No. Cover & Disc	O.E.M. Equiv. Part No. Cover & Disc	Description
<b>OLIVER CONTINUED</b>					
1750 (Prior to SN 190958) (SN 191356 - SN 191513) Gas & Diesel	na	na	79022000	169073AS 160974AS	Cover Disc
1750 (Eff. SN 191514) (SN 190958 - SN 191355)	168823AV	na	79021995	168823AS 30-3462412	Cover Disc
1755	168823AV	na	79021995	168823AS 30-3462412	Cover Disc
1800 (Prior to SN 90525)	na	156217ASV	na	107175AS 156217AS	Cover Disc
1800 (Eff. SN 90525)	160973AV	na	79022000	160973AS 160974AS	Cover Disc
1800 (Eff. SN 90525)	na	na	79022023	168668AS 157327AS	Cover Disc
1850 (SN 150241 - SN 198393) Gas	160973AV	na	79022000	160973AS 160974AS	Cover Disc
1850 (SN 150241 - SN 194007) Diesel	na	na	79021991	168011AS 30-3295842	Cover Disc
1855	na	na	79021991	168011AS 30-3295842	Cover Disc
1900, 1950 GM	na	na	79022023	168668AS 157327AS	Cover Disc
1950T, 1955	na	na	79021991	168011AS 30-3295842	Cover Disc
2050	na	na	79021991	168011AS 30-3295842	Cover Disc
2150	na	na	79021987	30-3412547 30-3295850	Cover Disc
2255, 2270	na	na	79022048	30-3073211 30-3295850	Cover Disc
2655	na	na	79022053	10A21321 10A22726	Cover Disc
<b>MINNEAPOLIS-MOLINE</b>					
335 Gas	na	na	79022073	10A13862 10A13863	Cover Disc
445, 455	na	na	79022069	10A13865 10A18593	Cover Disc
445, 455	na	na	79022064	10A13865 10A30017	Cover Disc

CLUTCH



# Clutch, Bearings and Components

Release Bearing Part No.	Pilot Bearing Part No.	Plate Size	Plate Type	Flywheel Specification	Spline Depth - # Teeth	Friction Type
30-3056287	72160313	13"	Push	Flat	1.750-27 D	Woven
30-3056287	72160313	12"	Push	0.125"	1.750-27 D	4-pad
30-3056287	72160313	12"	Push	0.125"	1.750-27 D	4-pad
30-3056287	72160313	12"	Push	Flat with spacers	1.750-27 D	Woven
30-3056287	72160313	13"	Push	Flat	1.750-27 D	Woven
AS5022B	72160313	14"	Push	1.160"	1.750-27 R	Woven
30-3056287	72160313	13"	Push	Flat	1.750-27 D	Woven
30-3056287	72160313	13"	Push	0.125"	1.750-27 D	6-pad
30-3056287	72160313	13"	Push	0.125"	1.750-27 D	6-pad
30-3056287	72160313	14"	Push	1.160"	1.750-27 R	Woven
30-3056287	72160313	13"	Push	0.125"	1.750-27 D	6-pad
30-3056287	72160313	13"	Push	0.125"	1.750-27 D	6-pad
30-3056287	72160313	14"	Push	1.187"	1.750-27 D	6-pad
30-3056309	72160313	14"	Push	Flat	1.750-27 D	6-pad
72160065V	106049AV	14"	Push	2.048"	1.750-20 D	6-pad
Release Bearing Part No.	Pilot Bearing Part No.	Plate Size	Plate Type	Flywheel Specification	Spline Depth - # Teeth	Friction Type
72160065V	na	10"	Single	Flat	1.750-13 R	Woven
72160065V	na	11"	Single	Flat	1.750-13 R	Woven
72160065V	na	11"	Single	Flat	1.750-13 D	4-pad

D = Dampened  
R = Rigid

CLUTCH

# Clutch, Bearings and Components

MUO		Cover Assembly Part No.	Clutch Disc Part No.	Heritage Set Part No. Cover & Disc	O.E.M. Equiv. Part No. Cover & Disc	Description
<b>MINNEAPOLIS-MOLINE CONTINUED</b>						
3-Star, 4-Star, 4-Star Super		na	na	79022069	10A13865 10A18593	Cover Disc
3-Star, 4-Star, 4-Star Super		na	na	79022064	10A13865 10A30017	Cover Disc
5-Star		na	na	79022062	10A23740 10A13874	Cover Disc
5-Star		na	na	79022058	10A23740 10A29113	Cover Disc
A4T 1400 & 1600		na	na	79022053	10A21321 10A22726	Cover Disc
Big Mo 400 Industrial Wheeler		na	na	79022069	10A13865 10A18593	Cover Disc
Big Mo 500 & 600 Industrial Wheeler		na	na	79022064	10A13865 10A30017	Cover Disc
G450	3-lever with diaphragm 6-bolt flywheel	na	72091671V	79022028	30-3010945 5145715/72091671	Cover PTO Disc
G450	6-lever 12-bolt flywheel	na	72091671V	79022018	72094463 72091671	Cover PTO disc
G750 (Eff. SN 215506)		168823AV	na	na	168823AS	Cover
G900, G950		na	na	79022058	10A23740 10A29113	Cover Disc
G955		na	na	79022048	30-3073211 30-3295850	Cover Disc
G1050, G1000, G1000 Vista		na	na	79022053	10A21321 10A22726	Cover Disc
G1350		na	na	79022053	10A21321 10A22726	Cover Disc
G1355, G2270		na	na	79022048	30-3073211 30-3295850	Cover Disc
Jet Star Orchard		na	na	79022064	10A13865 10A30017	Cover Disc
Jet Star 3		na	na	79022069	10A13865 10A18593	Cover Disc
Jet Star 3 Super, Jet Star 4		na	na	79022064	10A13865 10A30017	Cover Disc
5-Star		na	na	79022062	10A23740 10A13874	Cover Disc
M5		na	na	79022053	10A21321 10A22726	Cover Disc
M5, M504		na	na	79022058	10A23740 10A29113	Cover Disc
M602, M604, M670, M670 Super		na	na	79022058	10A23740 10A29113	Cover Disc
U Hand Clutch		na	10V20990	na	10A20990	Gear-Tooth Disc A5579L T-D

**CLUTCH**

# Clutch, Bearings and Components

Release Bearing Part No.	Pilot Bearing Part No.	Plate Size	Plate Type	Flywheel Specification	Spline Depth - # Teeth	Friction Type
72160065V	na	11"	Single	Flat	1.750-13 R	Woven
72160065V	na	11"	Single	Flat	1.750-13 D	4-pad
72160065V	na	12"	Single	1.406"	1.750-20 D	Woven
72160065V	na	12"	Single	1.406"	1.750-20 D	4-pad
72160065V	na	14"	Single	2.048"	1.750-20 D	6-pad
72160065V	na	11"	Single	Flat	1.750-13 R	Woven
72160065V	na	11"	Single	Flat	1.750-13 D	4-Pad
na	na	11/11	Dual	Flat	45mm-14 R 25mm-10 R	5-pad Woven
na	na	11/11	Dual	2mm step	45mm-14 R 25mm-10 R	5-pad Woven
na	na		Button			
72160065V	1440551X1	12"	Single	1.406"	1.750-20 D	4-pad
na	na	14"	Single	Flat	1.750-27 D	6-pad
na	na	14"	Single	2.048"	1.750-20 D	6-pad
na	na	14"	Single	2.048"	1.750-20 D	6-pad
na	na	14"	Single	Flat	1.750-27 D	6-pad
na	na	11"	Single	Flat	1.750-13 D	4-pad
na	na	11"	Single	Flat	1.750-13 R	Woven
na	na	11"	Single	Flat	1.750-13 D	4-pad
na	na	12"	Single	1.406"	1.750-20 D	Woven
na	na	14"	Single	2.048"	1.750-20 D	6-pad
na	na	12"	Single	1.406"	1.750-20 D	4-pad
na	na	12"	Single	1.406"	1.750-20 D	4-pad
na	na	11.5"	Single		72 ext teeth	Fiber

*D = Dampened*  
*R = Rigid*

CLUTCH

# Clutch

MUO	Cover Assembly Part No.	Clutch Disc Part No.	Heritage Set Part No. Cover & Disc	O.E.M. Equiv. Part No. Cover & Disc	Description
<b>MINNEAPOLIS-MOLINE CONTINUED</b>					
UTC, UTE, UTN, UTU, UTS, UTZ Hand Clutch	na	na	79022046	na	Gear-Tooth Disc A5878 T-D
ZAS-1	na	na	79022045	10P232 JT9309	Cover Disc

# Hydraulics

## Universal Directional Hydraulic Control Valves

### Features

- 30 gpm, 2500 PSI
- Built-in adjustable relief preset @ 2000 PSI
- Forward, reverse and neutral positions
- 3/4" NPTF inlet and outlet, 1/2" NPTF work ports
- Built-in load check for lifting
- Good spool metering for handling feathering action
- Spools with float position allow a loader, snow plow or dozer blade to ride the contour of the ground as the machine tractor forward

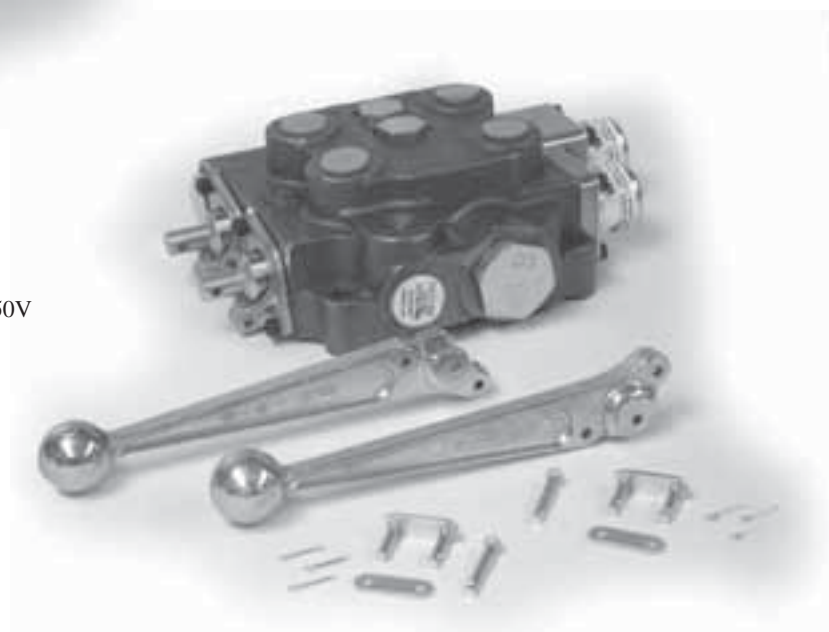
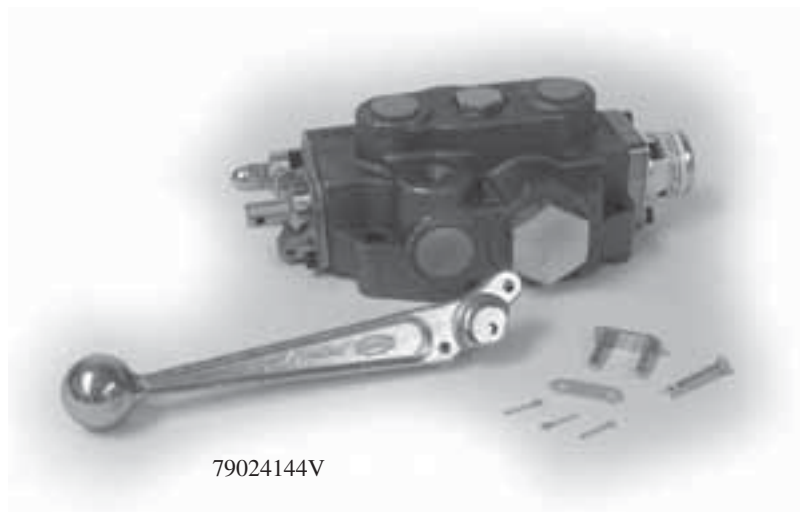

# Clutch

Release Bearing Part No.	Pilot Bearing Part No.	Plate Size	Plate Type	Flywheel Specification	Spline Depth - # Teeth	Friction Type
na	na	10"	Single		63 ext teeth	Fiber
na	na	11"	Single	Flat	1.500-10 R	Woven

R = Rigid

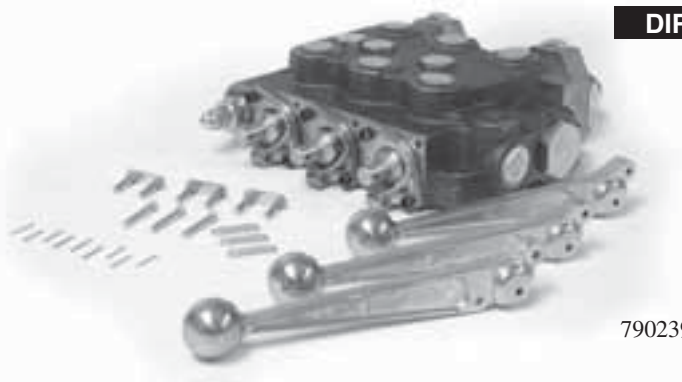

79023993V

**Description** **Part No.**  
**DIRECTIONAL HYDRAULIC CONTROL VALVES - REPAIR PARTS**

Valve Handle	1045132M1
Handle Bracket	1045130M1
Handle/Bracket Pin Connector Kit	1045133M9I
Closed-Center Dual Plug Kit	79024152V
Closed-Center Single Plug	8046757
Power Beyond Sleeve Assembly	79024153V
No-Relief Plug	1040749M9I
3 Spool Seal Kit	837038M9I
2 Spool Seal Kit	837805M9I
1 Spool Seal Kit	7734155

Open Center Part No.	Closed Center Part No.	Spool	Description	Force Action	Common Uses
----------------------	------------------------	-------	-------------	--------------	-------------

**DIRECTIONAL HYDRAULIC CONTROL VALVES**  
**WHITE**

79024144V	79024145V	Single	3-position, spring centered	Double Acting	General
79024146V	79024147V	Double	3-position, spring centered	Double Acting	Loader
79024149V	79024150V	Double	1st spool 4-position w/ float; 2nd spool 3-position, spring centered	Double Acting	Loader
79023992V	79024148V	Triple	3-position, spring centered	Double Acting	General
79023996V	79024151V	Triple	1st spool 4-position w/ float; 2nd & 3rd spool 3-position, spring centered	Double Acting	Loader w/ extra function
na	79023993V	Triple	3-position, 1st & 3rd spool w/ detent (In Position); 2nd spool spring centered	Double Acting	Mower
79023994V	79023995V	Triple	3-position, 1st & 3rd spool w/ float (In Position); 2nd spool spring centered	Single Acting	Mower

MUO	Part No.
<b>HYDRAULIC PUMPS (SINGLE)</b>	
White - FB 2-50	5179722V
Oliver - 1250-A (Eff. SN 360745), 1255 (Eff. SN 303397), 1265	

MUO	Description	Part No.
<b>HYDRAULIC ACCESSORIES</b>		
Oliver - 55, 2255	Lift Cover Friction Disc	10889V1
Oliver - Super 55, 550	Pump Vane-Rotor Kit - 5/8" wide	79024592V
White - FB 2-44		

MUO	Description	Part No.
<b>HYDRAULIC LIFT PUMP KIT</b>		
Oliver - 1355, 1365, 1370	Lift Pump Kit - Includes Lift Pump 31V2906458 and Gasket Set	20V7101188
	Lift Pump	31V2906458

HYDRAULICS



# Differential

3-PT. HITCH, PTO



182642V93



T12346V



T12347V

MUO	Description	Part No.
<b>BEARINGS</b>		
<b>WHITE</b>		
FB 2-50, FB 2-60 (SN 780725 - SN 784736), 700	Bearing, Rear Differential	72090067V
FB 2-60 - Ratio 12/47 12 Speed (Tractor SN 780725 - SN 784736)	Bearing, Rear Differential	3009853V1
FB 2-50, FB 2-60, FB 2-30, FB 2-35, FB 2-32	Bearing, Differential	834869V1
FB 2-50, FB 2-60	Bearing, Differential	1440640V1
FB 2-45, FB 2-55 (2wd SN 00097- SN 00311; 4wd SN 00173- SN 00391), FB 2-62 (early models) FB 2-65 (2wd SN 00099- SN 00433; 4wd SN 00113- SN 00430), FB 2-65	Bearing, Differential	1101386V
FB 2-45, FB 2-55 (2wd SN 00097- SN 00311; 4wd SN 00173- SN 00391), FB 2-62 FB (early models), FB 2-65 (2wd SN 00099 - SN 00433; 4wd SN 00113- SN 00430), FB 2-65	Bearing, Differential	1110003V
WH 125, WH 145, WH 170, WH 195, FB 140, FB 2-135, 2-155, FB 2-135 Series III, FB 2-155 Series III (Eff. Tractor SN 300928), FB 2-180, FB 2-180 Series III (Eff. SN 301922)	Bearing Cone, Differential Support RH	185251V1
WH 125, WH 170, WH 195, FB 140, FB 2-135, 2-155, FB 2-135 Series III, FB 2-155 Series III, FB 2-180, FB 2-180 Series III (Eff. SN 301922)	Bearing Cup , Differential Support RH	185252V1
700	Bearing, Rear Differential	391339V1

# PTO, 3-Pt. Hitch



T19396V



103669ASV

MUO	Description	Part No.
<b>PTO COUPLER</b>		
<b>COCKSHUTT</b>		
540	PTO Drive Coupler (Live Power Gear) Mounts on Flywheel	T19396V
<b>SHAFTS</b>		
<b>WHITE</b>		
60, 80 American Series	Drive Shaft, P.T.O.	30V3422690
<b>PTO SHIELDS</b>		
Oliver - Super 55 (Eff. SN 6000), 550 (Eff. SN 60501)		103669ASV
White - FB 2-44		
Oliver - 66, Super 66, 660, Super 77 (RC Eff. SN 32001) (Ind. Eff. SN 403001), 770, 880 (Eff SN 60501)		79024695V
<b>3-POINT HITCH LEVELING CRANK</b>		
<b>OLIVER</b>		
50, 550	RH Crank w/Yoke	182642V93
<b>LIFT ARMS</b>		
Cockshutt - 20, 30	LH - Upper Lift Arm	T12347V
Oliver - Super 55 (Eff. SN 6000), 550 (Eff. SN 60501)		
White - FB 2-44	RH - Upper Lift Arm	T12346V
Oliver - 66, Super 66, 660, Super 77 (RC Eff. SN 32001) (Ind. Eff. SN 403001), 770, 880 ( Eff. SN 60501)		

# Brakes



JT9101V

MUO	Part No.
<b>BRAKE CABLE ASSEMBLY MINNEAPOLIS-MOLINE</b>	
ZB, ZAS, ZA, U	JT9101V

MUO	Description	Part No.
<b>HAND BRAKE WHITE</b>		
700 (Eff. SN 858036)	Strut (double-disc)	86502678V

MUO	Description	Part No.
<b>BRAKES-ACTUATING BRAKE ASSEMBLIES</b>		
White - FB 2-70	Actuating Disc	10V3139
	Plate	10V3140
	Ball	50V4272
	Spring	10V132
White - FB 100, FB 120, FB 140	Reaction Plate	72512440V
	Pressure Plate	72162104V
	"O" Ring	72160214V
White - FB 2-135, FB 2-155, FB 2-180, FB 4-210, WH 160, WH 185	Reaction Plate	72512440V
White - FB 4-150, FB 4-180	Actuator Assembly	105725ASV
	Ball	50V4273
	Spring	70261838V
White - FB 4-225, FB 4-270	Reaction Plate	72512440V
	Pressure Plate	72162104V
Oliver - 77, Super 77, 770 (Prior to SN 71318), 88, Super 88, 880 (Prior to SN 73638)	Actuating Disc	10V244
	Middle Disc	10V996
M-M - GVI, G705, G706, G707, G708, GTB, GTBD, GTC, UTI, UTIL	Ball	72504718V
	Spring	72504717V
Oliver - Super 55, 550 (Prior to SN 72830), 66, Super 66, 660 (Prior to SN 72830)	Actuating Disc	10V251
M-M - ZB Tractors	Middle Disc	10V783
	Ball	72504718V
	Spring	2713667V
Oliver - 550 (Eff. SN 72831), 66, Super 66, 660 (Eff. SN 72831)	Actuating Disc Assembly	103082ASV
	Actuating Disc	103083AV
	Ball	72504718V
	Spring	2713667V
Oliver - 770 (Eff. SN 71319), 880 (Eff. SN 73639), 1550, 1555, 1600, 1650, 1655	Actuating Disc Assembly	10V3139
	Actuating Disc	10V3140
	Ball	72504718V
	Spring	72504717V
Oliver - 1750, 1800, 1850, 1900, 1950, 1950T, 2050, 2150	Actuating Disc Assembly	105725ASV
M-M - G900 Gas (Prior to SN 33000110), G900 Diesel (Prior to SN 33100315), G1000, G1000 Vista	Actuating Disc	10V1404
	Ball	50V4273
	Spring	70261838V
	Separator	168487AV
White - FB 2-85, FB 2-88, FB 2-105, FB 2-110, FB 2-150, FB 4-175	Adjuster	30V3073246
Oliver - 1755, 1855, 1955, 2255	Insulator	168492AV
M-M - G955, G1355	Spring	72161739V
	O Ring	941690V
	O Ring	941640V



86502678V



72512440V



10V3139

BRAKES

MUO	Description	Part No.
<b>PTO BRAKE</b>		
White - FB 2-45, FB 2-55, FB 2-62, FB 2-65, FB 2-75	PTO Brake	33V0031577
White - FB 2-70	PTO Brake	158317AV
White - FB 2-85, FB 2-88, FB 2-105, FB 2-110, FB 2-150, FB 4-150, FB 4-175, FB 4-180	PTO Reaction Plate	30V3312038
White - FB 2-135, FB 2-155, FB 2-180, FB 4-210, FB 4-270	PTO Reaction Plate	72160655V

MUO	Description	Part No.
<b>BAND SHOES, BRAKE DISCS</b>		

White - FB 2-30, FB 2-35		72165212V
White - FB 2-32		3705294V91
White - FB 2-45, FB 2-55, FB 2-62, FB 2-65, FB 2-75		33V0026387
White - FB 2-50, FB 2-60		72094484V
White - FB 2-70		72514388V
White - FB 2-85, FB 2-88, FB 2-105, FB 2-110, FB 2-150, FB 4-150, FB 4-175, FB 4-180		72514391V
White - FB 2-180, FB 2-155 Series III, FB 2-135 Series III, FB 4-210, FB 4-225, FB 4-270, FB 100, FB 120, FB 140, FB 160, FB 185, WH 125, WH 145, WH 170	19-3/4"	72506044V
Oliver - Super 55, 550		70277353V
Oliver - 60 Series	RC(Eff. SN 600001) STD. (Eff. SN 410001) IND. (Eff. SN 460001)	L775V
Oliver - Super 66, 66, 660	Row Crop (Prior to SN 431472) Standard, Row Crop (Eff. SN 431473)	10V783 70277353V
Oliver - 77	RC (SN 347904- SN 348579), STD. (SN 273375- SN 273775)	70277355V
	RC (Eff. SN 348560), STD.(Eff. SN 273776)	72514388V
Oliver - 770, 880		72514388V
Oliver - 88, Super 88	RC (SN 136899-138871), STD (SN 826416-826917), RC (SN 138872-3500976) STD. (826918-3500976)	70277355V 72514388V
Oliver - 88, Super 88	(SN 3500977-3508424) (Eff. SN 3508425)	70277355V 72514388V
Oliver - Super 99		7A2604AV
Oliver - 1520A, 1255, 1265, 1355, 1365		72094484V
Oliver - 1550, 1555, 1600, 1650, 1655		72514388V
Oliver - 1750, 1755, 1800, 1855, 1900, 1950, 1950T, 1955, 2050, 2150, 2255	8"	72514391V
M-M - GTB, GTBD, GTC, GB, UTI, UTIL, G707, G708		10V996
M-M - UTU, UTS, UTC, UTN, UTE		10V986
M-M - 445, Jet Star 3, Jet Star 3 Super, Jet Star 4, Jet Star 4 Super, U302	6"	70277354V
M-M - M5, M504, M602, M604, M670, M670 Super	7"	70277355V
M-M - G900	8" (Gas - Prior to SN 33000110) (Diesel - Prior to SN 33100315)	70277357V
M-M - G900	7" (Gas Eff. SN 33000111) (Diesel - Eff. SN 33100316)	70277355V
M-M - G900	7"	70277355V
M-M - G1000, G1000 Vista, G1050, G1350, A4T	8"	70277357V
M-M - G955, G1355	8"	72514391V



72160655V



72506044V

# Tires, Rims and Weights

Description	Part No.
<b>TIRES &amp; TUBES</b>	
5.50 x 16" Triple Rib Tire (6 Ply)	79024718V
6.00 x 16" Triple Rib Tire (10 Ply)	79024719V
6.50 x 16" Triple Rib Tire (8 Ply)	79024720V
Replacment Tube for 5.50, 6.00. 6.50 x 16" Tires	79024721V
4" x 19" Single Rib Tire W/Tube (4 ply)	79024571V
4" x 19" Single Rib Tire only (4 ply)	79024572V
4" x 19" Multi Rib Tire Only (4 ply)	79024574V
Replacement Tube for 4" x 19" Tires	79024573V



70231520V

## Cockshutt

MUO	Description	Part No.
<b>REAR RIM</b>		
20	8" x 24", 4 loops	79024698V
	10" x 24", 4 loops	79024699V

MUO	Description	Part No.
<b>REAR RIM, DOUBLE BEVEL</b>		
Eff. Late 40	12" x 38"	79024711V
	14" x 38"	79024707V

MUO	Description	Part No.
<b>REAR SPINOUT RIM</b>		
540	11" x 28", 4 rails	70220011V*

\*Holes for stop adjustment are drilled 90 degrees perpendicular to side of rim.

Description	Part No.
<b>CENTER DISC</b>	
Weld in Center Disc 9" x 38"	79024712V
Reinforcing Weld-in Ring (To repair existing 9-bolt rim)	79024717V



195638V91

## Minneapolis-Moline

MUO	Description	Part No.
<b>FRONT RIM</b>		
BG	4.5" x 16", 6-bolt	195638V91
335 & up	3" x 15", 5-bolt	70231520V

MUO	Description	Part No.
<b>REAR RIM</b>		
335 Industrial	10" x 24", 4 loops	79024699V
335 & up	10" x 28", 6 loops	79024700V
	11" x 28", 6 loops	79024701V
	12" x 28", 6 loops	79024702V

MUO	Description	Part No.
<b>REAR RIM, DEEP DROP CENTER</b>		
U w/cast wheel	10" x 38"	79024708V
	11" x 38"	7632252V1
	14" x 28"	79024706V



70220011V

## Minneapolis-Moline Continued



79024708V

MUO	Description	Part No.
<b>REAR RIM, DOUBLE BEVEL</b>		
M-M	10" x 38"	79024710V
	12" x 38"	79024711V



79024712V

MUO	Description	Part No.
<b>REAR RIM, SPINOUT</b>		
335 & up	11" x 28", 4 rails	70220011V*
	12" x 28", 4 rails	70226270V*
	13" x 28", 4 rails	70237574V*

\*Holes for stop adjustment are drilled 90 degrees perpendicular to side of rim.

Description	Part No.
<b>CENTER DISC</b>	
Weld-in Center Disc 9" x 38"	79024712V
Reinforcing Weld-in Ring (to repair existing 9-bolt rim)	79024717V

## Oliver, White



79024606V

MUO	Description	Part No.
<b>FRONT RIM</b>		
55, 550, 2-44	4.5" x 16", 6-bolt	195638V91
66	3" x 15", 6-bolt	79024705V

MUO	Description	Part No.
<b>REAR RIM</b>		
55 & up	9" x 28", 6 loops	79024703V
	10" x 28", 6 loops	79024700V
	11" x 28", 6 loops	79024701V
	12" x 28", 6 loops	79024702V

MUO	Description	Part No.
<b>REAR RIMS, BLANK</b>		
60	8" x 32"	79024709V

MUO	Description	Part No.
<b>REAR RIM, DOUBLE BEVEL</b>		
1550 & up	10" x 38"	79024710V
	12" x 38"	79024711V

MUO	Description	Part No.
<b>REAR RIM, SPINOUT</b>		
55 & up	12" x 26", 4 rails	70228211V*
	11" x 28", 4 rails	70220011V*
	12" x 28", 4 rails	70226270V*
	13" x 28", 4 rails	70237574V*

\*Holes for stop adjustment are drilled 90 degrees perpendicular to side of rim.

Description	Part No.
<b>CENTER DISC</b>	
Weld-in Center Disc 9" x 38"	79024712V
Reinforcing Weldiin Ring (to repair existing 9-bolt rim)	79024717V

MUO	Description	Part No.
<b>WHEEL WEIGHTS</b>		
55 and 550 with 28" Tires	Rear Weight Set, 16" c.c.holes	79024606V*

\*Set includes two rear weights



# Trademark Acknowledgement

For companies outside AGCO® whose trademarks are referenced in this catalog

3M® is a registered trademark of 3M Corporation, St. Paul, MN, USA. Allison® is a registered trademark of Rolls-Royce Corporation, Indianapolis, IN, USA. API® is a registered trademark of American Petroleum Institute, Washington, DC, USA. ASTM® is a registered trademark of American Society for Testing and Materials, West Conshohocken, PA, USA. Auto-Lite® is a registered trademark of Allied Signal Inc., Morristown, NJ, USA. Bosch® is a registered trademark of Robert Bosch GMBH, Gerlingen, Federal Republic of Germany. Case®, Case IH®, Hy-Tran®, Hy-Tran Plus®, IH®, New Holland®, Poclain® and Steiger® are registered trademarks of CNH America LLC, Racine, WI, USA. Caterpillar® and Challenger® are registered trademarks of Caterpillar Inc., Peoria, IL, USA. Chrysler® is a registered trademark of Daimler Chrysler, Auburn Hills, MI, USA. Cincinnati Milacron® is a registered trademark of Cincinnati Milacron, Cincinnati, Ohio, USA. Clark® is a registered trademark of Clark Equipment Company, South Bend, IN, USA. Continental® is a registered trademark of Teledyne Technologies Inc., Los Angeles, CA, USA. Cummins® is a registered trademark of Cummins Engine Company, Columbus, IN, USA. Denison® is a registered trademark of Parker Intangibles, Cleveland, Ohio, USA. Denso® is a registered trademark of Denso Corporation, Showa-cho Kariya-city, Aichi-pref., Japan. Detroit Diesel® is a registered trademark of Detroit Diesel Company, Detroit, MI, USA. Deutz® is a registered trademark of Deutz Aktiengesellschaft, Cologne, Federal Republic of Germany. Chevy®, Delco®, Delco-Remy®, Dex-Cool®, Dexron®, GM®, GMC® and General Motors® are registered trademarks of General Motors Corporation, Detroit, MI, USA. Eaton® is a registered trademark, and Vickers™ is a trademark, of Eaton Hydraulics Inc., Cleveland, Ohio, USA. Fiat™ is a trademark of Fiat S.p.A., Torino, Italy. Firestone® is a registered trademark of Bridgestone Firestone Brands LLC, Nashville, TN, USA. Ford®, Mercon® and Motorcraft® are registered trademarks of Ford Motor Company, Dearborn, MI, USA. Freightliner® is a registered trademark of Freightliner LLC, Portland, OR, USA. Goodrich® is a registered trademark of Goodrich Corporation, Charlotte, NC, USA. Grove® is a registered trademark of Grove Manufacturing Company, Shady Grove, PA, USA. Hitachi® is a registered trademark of Hitachi Ltd., Tokyo, Japan. Holley® is a registered trademark of Holley Performance Products Inc., Bowling Green, KY, USA. Honda® is a registered trademark of Honda Motor Company, Tokyo, Japan. Hy-Gard® and John Deere® are registered trademarks of Deere & Company, Moline, IL, USA. International® is a registered trademark of Navistar International Transportation Corporation, Chicago, IL, USA. Iseki® is a registered trademark of Iseki & Co. Ltd., Matsuyama, Japan. Isuzu® is a registered trademark of Isuzu Motors Ltd., Tokyo, Japan. Jeffrey® is a registered trademark of Dresser Industries, Dallas, TX, USA. Komatsu® is a registered trademark of Kabushiki Kaisha Komatsu Seisakusho, Tokyo, Japan. Kubota® is a registered trademark of Kubota Corporation, Osaka, Japan. Lucas® is a registered trademark of Lucas Industries Ltd., West Midlands, UK. Mack® is a registered trademark of Mack Trucks Inc., Allentown, PA, USA. Marvel-Schebler® is a registered trademark of Raymond Beutel, Lockport, NY, USA. Mazda® is a registered trademark of Mazda Motor Corporation, Hiroshima-Ken, Japan. Mercedes-Benz® is a registered trademark of Mercedes-Benz Aktiengesellschaft Corp., Stuttgart (Unterturkheim), Federal Republic of Germany. Mallory® is a registered trademark of Emerson Electric Co., St. Louis, MO, USA. Mitsubishi® is a registered trademark of Mitsubishi Shoji Kaisha Ltd., Tokyo, Japan. Motorola® is a registered trademark of Motorola Inc., Schaumburg, IL, USA. Mylar® is a registered trademark of DuPont Teijin Films U.S., Wilmington, DE, USA. NLGI® is a registered trademark of National Lubricating Grease Institute, Kansas City, MO, USA. Niehoff® is a registered trademark of BWED Automotive Corporation, Branford, CT, USA. Nikko® is a registered trademark of Yamato-Shokai Inc., Miami, FL, USA. Nissan® is a registered trademark of Nissan Motor Corporation, Kanagawa-Ken, Japan. Perkins® is a registered trademark of Perkins Holdings Ltd., Peterborough, UK. Peterbilt® is a registered trademark of PACCAR Inc., doing business as Peterbilt Motors Company, Bellevue, WA, USA. Renk® is a registered trademark of Renk Aktiengesellschaft, Augsburg, Federal Republic of Germany. Rockwell International® is a registered trademark of Rockwell International Corporation, Pittsburgh, PA, USA. Sauer-Danfoss® is a registered trademark of Sauer-Danfoss Inc., Ames, IA, USA. SAE® is a registered trademark of Society of Automotive Engineers, Warrendale, PA, USA. Toyota® is a registered trademark of Toyota Motor Corporation, Toyota-Shi Aichi-Ken, Japan. Versatile® is a registered trademark of Buhler Versatile Inc. Ltd., Winnipeg, MB, Canada. VW® is a registered trademark of Volkswagen Aktiengesellschaft Corporation, Wolfsburg, Federal Republic of Germany. Volvo® is a registered trademark of Volvo Trademark Holding, Goteborg, Sweden. Waukesha® is a registered trademark of Dresser Industries Inc., Dallas, TX, USA.





# HERITAGE

## LINE



Heritage® parts bring Original-Equipment quality for older equipment, with the peace-of-mind protection afforded by a full 12-month warranty. This catalog represents just a small offering of

the Heritage® parts currently available for older AGCO® family of brand equipment. See your participating AGCO® dealer for more information.