



Plant Ecology

E.-D. Schulze

E. Beck

K. Müller-Hohenstein



Springer

Ernst-Detlef Schulze • Erwin Beck • Klaus Müller-Hohenstein

Plant Ecology

Ernst-Detlef Schulze • Erwin Beck • Klaus Müller-Hohenstein

Plant Ecology

With 506 Figures, most of them in colour, and 101 Tables

Professor Dr. ERNST-DETLEF SCHULZE
Max-Planck-Institute for Biogeochemistry
P.O. Box 1001 64
07701 Jena
Germany

Professor Dr. ERWIN BECK
Department of Plant Physiology
University of Bayreuth
95440 Bayreuth
Germany

Professor Dr. KLAUS MÜLLER-HOHENSTEIN
Department of Biogeography
University of Bayreuth
95440 Bayreuth
Germany

Translated by:

GU DRUN LAWLOR, FIL
Dr. KIRSTEN LAWLOR
Dr. DAVID LAWLOR
9 Burywick
Harpenden
Hertfordshire
AL5 2AQ
UK

Original title:

Ernst-Detlef Schulze/Erwin Beck/Klaus Müller-Hohenstein, Pflanzenökologie
Copyright © 2002 Spektrum Akademischer Verlag GmbH, Heidelberg

ISBN 3-540-20833-X Springer-Verlag Berlin Heidelberg New York

Library of Congress Control Number: 2004107209

This work is subject to copyright. All rights are reserved, whether the whole or part of the material is concerned, specifically the rights of translation, reprinting, reuse of illustrations, recitation, broadcasting, reproduction on microfilm or in any other way, and storage in data banks. Duplication of this publication or parts thereof is permitted only under the provisions of the German Copyright Law of September 9, 1965, in its current version, and permission for use must always be obtained from Springer-Verlag. Violations are liable for prosecution under the German Copyright Law.

Springer is a part of Springer Science+Business Media
springeronline.com

© Springer Berlin · Heidelberg 2005
Printed in Germany

The use of general descriptive names, registered names, trademarks, etc. in this publication does not imply, even in the absence of a specific statement, that such names are exempt from the relevant protective laws and regulations and therefore free for general use.

Editor: Dr. Dieter Czeschlik, Heidelberg
Desk editor: Dr. Andrea Schlitzberger, Heidelberg
Production: Karl-Heinz Winter, Heidelberg
Cover design: design & production GmbH, Heidelberg, Germany
Cover illustration: Claus Diercks, Willy Giltmann, Hamburg, Germany
Typesetting: K & V Fotosatz GmbH, Beerfelden
31/3150 5 4 3 2 1 0 – Printed on acid-free paper

Preface

Content: This textbook starts at the level of the cell and molecular aspects of plant responses to the environment, which is never stress free. Building on this molecular ecophysiology, the organisation and regulation of metabolism of whole plants will be described from an autecological perspective. In the following parts, this book deals with the interactions with other organisms at the level of the ecosystem. Finally, geographical and long-term conditions for the expansion and dynamics of plant populations and species on earth are discussed. The book closes with the element cycles on earth and thus stresses the influence of man on original, so-called natural ecosystems.

As the book covers several different conceptual levels, many aspects and facts will be illuminated from very different viewpoints: the cell, the plant, the ecosystem, the zones of distribution and earth as a whole. Thus, the authors have tried to fully consider the enormous width and complexity of plant ecology.

The reader: The textbook is aimed at advanced students and their teachers. Knowledge in various disciplines of natural sciences is expected, from molecular biology to the earth sciences. The authors have tried to recommend textbooks and articles from the relevant literature in each chapter. This “further reading” is intended to deepen the relevant knowledge and to help develop an understanding in relation to neighbouring fields. Additionally, basic knowledge is revisited in concise box-type texts. Conceptual knowledge is abstracted and strengthened in extensive summaries at the end of each section.

Thanks: Writing this textbook has been a pleasure, but has also cost the authors much of the one commodity which they lack most: time. A great deal of what could and should have been done was left by the wayside. We therefore ask all those whom we did not give enough of our time to make allowances, in particular our as-

sociates and last, but not least, our families. Without the support and help of many colleagues, friends and coworkers, it would not have been possible to finish this book in time so that it does not contain chapters which are outdated before publication. Particular thanks are given to Mrs Barbara Lühker, without whose thorough editorial work this book probably would have never been completed. For the critical reading of individual chapters, for advice and pointers to the literature, the authors would like to thank many colleagues, in particular: A. Arneth (Jena), K. Beierkuhnlein (Bayreuth), C.M.P. Blum (Utrecht), H. Bohnert (Urbana), U. Deil (Freiburg), W.H.O. Ernst (Amsterdam), S. Fettig (Bayreuth), E. Gloor (Jena), G. Guggenberger (Halle), F. Haakh (Stuttgart), U. Heber (Würzburg), H.W. Heldt (Göttingen), J. Kaplan (Jena), O. Kolle (Jena), U. Küper (Bayreuth), O.L. Lange (Würzburg), W. Larcher (Innsbruck), C. Neßhöfer and G. Orlich (Bayreuth), C. Ploetz (Wuppertal), M. Popp (Vienna), R. Voesebeck (Utrecht), R. Scheibe (Osnabrück), W. Schulze (Tübingen), E. Steudle (Bayreuth), C. Wirth (Jena) and W. Zech and P. Ziegler (Bayreuth).

Special thanks are also extended to Springer-Verlag for having translated the original German book published by Spektrum Akademischer Verlag. Both publishers obliged most of the requests by the authors in a constructive manner and respected the individuality of the authors, even though they had to consider the homogeneity of the final product.

The authors hope for a good reception of *Plant Ecology* by interested readers and welcome constructive criticism in the knowledge that the writing of a textbook about plant ecology in its entirety is an almost insurmountable task.

E.-Detlef Schulze, Erwin Beck and
Klaus Müller-Hohenstein
Bayreuth and Jena, October 2004

Contents

Introduction	1	1.5 Water Deficiency (Drought) ..	117
Chapter 1		1.5.1 Water Balance of Drought-Stressed	
Stress Physiology	5	Cells	119
1.1 Environment as Stress Factor:		1.5.2 Cellular Reactions to Drought Stress	123
Stress Physiology of Plants ..	7	1.5.3 CAM	
1.1.1 Abiotic and Biotic Environments		(Crassulacean Acid Metabolism) ...	135
Cause Stress	7	1.5.4 Anatomical-Morphological Adapta-	
1.1.2 Specific and Unspecific Reactions		tion to Drought	140
to Stress	9	1.6 Salt Stress (Osmotic Stress) ..	145
1.1.3 Stress Concepts	11	1.6.1 Physiological Effects of Salt Stress	
1.1.4 Perception of Stress and Creation		(NaCl)	146
of Signals	13	1.6.2 Adaptive Responses of Plant Cells	
1.1.5 How to Measure Stress on Plants? ..	16	to Salt Stress	149
1.1.6 Production of Stress-Tolerant Plants		1.6.3 Avoidance of Salt Stress	171
by Genetic Engineering?	16	1.7 Heavy Metals	175
1.1.7 Gene Silencing	19	1.7.1 Availability of Heavy Metals	176
1.2 Light	23	1.7.2 Heavy Metal Deficiency – Example	
1.2.1 Visible Light	24	Iron	176
1.2.2 UV Radiation	37	1.7.3 Stress by Heavy Metal Ion Toxicity	182
1.3 Temperature	45	1.7.4 Reaction of Plants to Excess Supply	
1.3.1 Temperature Ranges and Tempera-		of Heavy Metals	184
tures Limiting Life	45	1.7.5 Heavy Metal Resistance (Tolerance)	191
1.3.2 Temperature-Dependent Biochemical		1.7.6 Heavy Metal Extraction and Soil	
Processes, Q_{10} and Activation Energy	48	Decontamination by Plants	
1.3.3 Temperature and Stability/Function		(Phytomining, Phytoremediation) ..	191
of Biomembranes	49	1.8 Aluminium	195
1.3.4 Heat (Hyperthermy)	50	1.8.1 Forms of Aluminium Available to	
1.3.5 Cold	61	Plants	196
1.3.6 Frost	72	1.8.2 Aluminium Toxicity	196
1.3.7 Concluding Comments	94	1.8.3 Al^{3+} Resistance	200
1.4 Oxygen Deficiency		1.8.4 Al^{3+} Tolerance	203
(Anaerobiosis and Hypoxia) ..	99	1.9 Xenobiotica	207
1.4.1 Energy Metabolism of Plants Lacking		1.9.1 Herbicides	210
Oxygen	101	1.9.2 Gaseous Air Pollutants	215
1.4.2 Anatomical-Morphological Changes			
During Hypoxia	105		
1.4.3 Post-anoxic Stress	114		

1.10 Biotic Stress: Herbivory, Infection, Allelopathy	235	3.2 Processes in Stands and Ecosystems	403
1.10.1 Signal Chain in Wounding	235	3.2.1 Self-Thinning	403
1.10.2 Pathogen Attack and Defence	246	3.2.2 Reversible and Irreversible Site Changes Related to Resource Exploitation	406
1.10.3 Allelopathy	250	3.2.3 Complexity and Non-linear Behaviour	409
Chapter 2		3.2.4 Number of Species and Habitat Partitioning	411
Autecology: Whole Plant Ecology	253	3.2.5 Disturbances	417
2.1 Thermal Balance of Plants	255	3.3 The Biogeochemical Cycles	425
2.1.1 The Atmosphere as Habitat	257	3.3.1 Water Turnover	426
2.1.2 Climate of Air Near the Ground	263	3.3.2 Carbon Turnover	427
2.1.3 Energy Balance of Leaves	269	3.3.3 Nitrogen Cycle	438
2.1.4 Adaptation to Temperature Extremes	270	3.3.4 Cation Turnover	444
2.2 Water Relations of Plants	277	3.4 Biodiversity and Ecosystem Processes	449
2.2.1 Water as an Environmental Factor	277	3.5 Case Studies at the Scale of Ecosystems	455
2.2.2 Water Transport in the Plant	283	3.5.1 Soil Acidification and Forest Damage	456
2.2.3 Regulation of Stomata	296	3.5.2 Effect of Deciduous and Coniferous Forests on Processes in Ecosystems	460
2.2.4 Transpiration of Leaves and Canopies	303	3.5.3 Plants of Limestone and Siliceous Rocks	462
2.3 Nutrient Relations of Plants	313	Chapter 4	
2.3.1 Availability of Soil Nutrients and Ion Uptake	313	Syndynamics, Synchorology, Synecology	465
2.3.2 Nitrogen Nutrition	324	4.1 Historic-Genetic Development of Phytocenoses and Their Dynamics	467
2.3.3 Sulfur Nutrition	335	4.1.1 History of Vegetation to the End of the Tertiary	469
2.3.4 Phosphate Nutrition	337	4.1.2 Change of Climate and Vegetation in the Pleistocene	472
2.3.5 Nutrition with Alkaline Cations	338	4.1.3 Late and Postglacial Climate and Vegetation History	475
2.4 Carbon Balance	347	4.1.4 Changes in Vegetation Because of Human Influence	479
2.4.1 Net Photosynthesis: Physiological and Physical Basis	347	4.1.5 Basis of General Vegetation Dynamics	507
2.4.2 Specific Leaf Area, Nitrogen Content and Photosynthetic Capacity	357	4.1.6 Stability of Plant Communities	534
2.4.3 Response of Photosynthesis to Environmental Factors	361		
2.4.4 Growth and Storage	373		
2.4.5 C and N Balance in Different Types of Plants	379		
Chapter 3			
Ecology of Ecosystems	397		
3.1 The Ecosystem Concept	399		
3.1.1 What is an Ecosystem?	400		
3.1.2 Boundaries of Ecosystems	400		
3.1.3 Compartmentalisation	401		
3.1.4 System Characteristics	401		

4.2	Synchorology: Basis of Spatial Distribution of Plants	541	5.2.3	Nitrogen Cycle	636
4.2.1	Distribution of Plants	542	5.2.4	Sulfur Cycle	638
4.2.2	Basis of Spatial Distribution (Phytogeography)	548	5.3	Human Influence on Carbon Balance and Significance for Global Climate	641
4.2.3	Relationship Between Area and Species	555	5.4	Significance of Changes in Land Use for Carbon Cycles . .	649
4.2.4	Biodiversity	562	5.4.1	Land Use and CO ₂ Emissions	649
4.3	Interactions Between Vegetation and Abiotic and Biotic Environments – Synecology . .	579	5.4.2	The Kyoto Protocol: Attempts To Manage the Global Carbon Cycle . .	651
4.3.1	Influences of Vegetation on the Site	580	5.4.3	Importance of Climate Change for Europe	659
4.3.2	Interactions Between Plants and Animals	585	5.5	Influence of Human Activities on Biodiversity	663
4.3.3	Interactions Between Plants	602	5.5.1	Decrease in Biodiversity	663
Chapter 5	Global Aspects of Plant Ecology	623	5.6	Socio-economic Interactions	669
5.1	Global Change and Global Institutions	625	5.6.1	Syndromes	670
5.2	Global Material Cycles	633	5.6.2	Evaluation of Risks to Biodiversity in Ecosystems	673
5.2.1	Water Cycle	633	Subject Index		679
5.2.2	Carbon Cycle	635			

Introduction

The term “ecology” was defined by Ernst Haeckel in 1906 in his book, *Principles of General Morphology of Organisms*, as follows: “Ecology is the science of relations of the organism to the surrounding environment which includes, in its broadest sense, all ‘conditions for existence’. These conditions may be organic or inorganic; both are of the greatest importance for the form of organisms, because they force the organism to adapt.”

Haeckel included in the science of ecology the areas physiology, morphology and chorology (the science of the distribution of organisms) to understand the “conditions for existence” and “adaptation”. In this book, we try to comply with Haeckel’s understanding of plant ecology and to include the breadth of ecology as it was demanded by Haeckel. **Adaptation** to the environment starts at the molecular and cellular level where environmental conditions are detected and the responses to changes in the environment are accomplished. Starting from these physiological mechanisms, the morphological characteristics of organisms/plants become important at the level of the whole plant. Cellular metabolic reactions and structural (morphological and anatomical) organisation are the biological “tools” with which organisms make use of certain environmental conditions, avoid them or “adapt” to them. The combination of physiological and morphological “adaptation” is particularly important for plants, as they are fixed in their habitat and the conditions for life are determined by the variety and numbers of the organisms of the ecosystem and not by the individual plant alone. These environmental conditions and the interaction of a plant with the environment determine “fitness”, i.e. the possibility for growth and reproduction in a spatial and temporal dimension, thus resulting in an association with Haeckel’s “chorology”. Haeckel’s understanding of ecology was broader than our present botanical usage. The present book views ecology in as broad a context as Haeckel did, ranging from

molecular stress physiology via ecology of whole organisms and the ecosystem to the temporal and spatial differentiation of vegetation.

Figure 1 shows the relations between (cellular) **stress or ecophysiology**, **whole plant physiology** and **synecology** (i.e. the ecology of vegetation cover) and **ecosystem science** where other organisms, not only plants, are increasingly considered. The interrelations between stress physiology, whole plant physiology and synecology are very close and obvious. In contrast, the path from stress physiology to ecosystems runs via whole plant ecology and synecology because morphology, i.e. the structure of plants, and the responses of populations are not primarily metabolic. **Applied ecology** includes all disciplines related to human activities. These include not only **agriculture** and **forestry**, but also **global change**. Agriculture and forestry contain also physiological aspects of high-yielding and pest-free varieties of crops and the biological interactions between crop plants and other organisms,

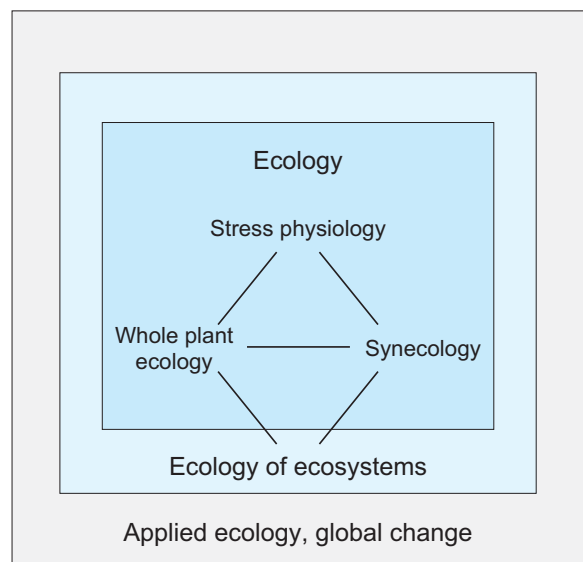


Fig. 1. Areas of ecology and their position within botany, ecosystem studies and in applied ecology

e.g. for pollination. Research on global change also includes the assessment of possible management systems for earth with respect to their effects on climate and maintaining biodiversity. Research on global change leads to model predictions on future effects of human activities.

In this book, an attempt is made, for the first time, to bring together and clearly organise the large subdisciplines of plant ecology. We start from the molecular **stress** and **ecophysiology** of plants in the broadest analysis yet attempted. **Chapter 1** lays down the molecular basis for ecological “adaptations” to all essential environmental factors. This ranges from climatic factors via salt stress in the soil to environmental pollutants. The **stress theory** considers the basic possibilities of stress responses resulting from **strains** and leading to **resistance**; finally, these provide the basis for understanding adaptive radiation of genotypes, and the processes leading to the evolution of new species. Plants not only react to stress in the sense of a response, the so-called **feed-back** response. There are also preparatory adaptations to changing environmental conditions, the so-called **feed-forward** reactions, setting off before an organism is stressed (e.g. pre-winter frost hardening). In both cases, signal chains are activated, leading to changes in the physiological/cell biological performance of plants, enabling them to continue to exist under new conditions. The response to one stress factor often protects the organism also from damage by other stresses (“**cross-protection**”). This results in responses to a variety of stresses resulting from a changing environment where not one single factor (e.g. heat or drought), but multiple stress types are acting in combination. The basic principles of avoidance (as a sort of feed-forward response) and tolerance (as a sort of feed-back response) to stress are not only restricted to the level of ecophysiology, but occur also in responses of whole plants, in the distribution of species and plant communities, particularly at extreme sites.

At the level of the organism, we consider the plant as a whole and the relations between its organs from the root to the leaf, flower and seed. At the level of **whole plant ecology** new, not (primary) metabolic characteristics are added: although these are genetically determined, they may be modified within limits. These include **plant structures** including size and the **life cycle** (phenology, life span, strategies for reproduction and distribution). Because

of these strategies, certain species are able to avoid extreme conditions and use or change their habitat. Annual plants form the largest proportion of plant species in dry areas. However, their active life is limited to favourable conditions after rain, even if this only occurs sporadically, perhaps only every few years or even decades. In contrast, perennial species have mechanisms that regulate the water relations and enable survival in unfavourable climatic periods. These include, for example, special leaf and root anatomy that allows the species to survive with intact shoot systems or to change their site conditions. **Hydraulic lift**, for example, enables roots to transport water from deep soil layers to the upper horizons and thus moisten the upper soil layers. In temperate climates, the accumulation of carbon in the soil changes site fertility. The scope for “adaptations” by whole plants is very broad, as are the responses of cells to stress. They range from leaf structure and leaf movement, via the formation of variably dimensioned vessels in the stem, to differentiation of the roots. In **Chapter 2**, the use of resources by whole plants is discussed. This includes the plant–water relations, the heat and nutrient balances and the carbon relations.

Cellular metabolism and structural characteristics are not only the basis for the spatial and temporal patterns of plant species, dealt within synecology (**Chap. 4**), but also the basis for **element cycles** in ecosystems, which are characterised by the diversity of species and forms of organisation. These include indirect interactions between individual plants and other plant species. Here applies the wisdom that: “Even the most pious cannot live in peace if it does not please the nasty neighbour“. **Competition** exists in the effective use of resources on limited space. If the resources become scarce, “**efficiency**” means a better use of limiting resources at the cost of the neighbour. This, of course, does not always imply saving resources or using them most economically. Indeed, it may be more useful to use more resources than required, if this brings advantages in competition with the neighbours. Growth also plays an important role in ecosystems, and the “ecological equilibrium” of an ecosystem probably does not exist in “nature” as it is. Metabolic cycles in ecosystems are not as closed as previously assumed. This means that the actual status as it may be observed as a momentary picture of a system is in the long term very dynamic. Not all processes of a system move

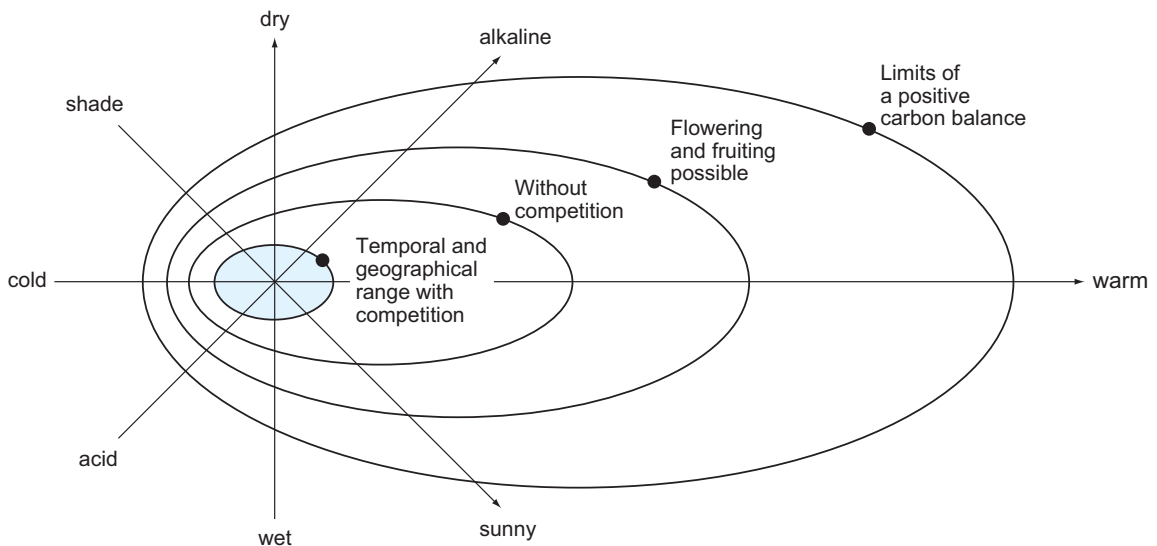


Fig. 2. Distribution of a species depends on different environmental factors. The actual distribution area is significantly smaller than the potential areas of distribution which are reached without competition at the extreme limits of flowering or at the boundaries of a positive material balance. In the example shown, temperature is the dominant factor, but this may differ in other cases. According to the species, the limits of distribution change

linearly in one direction. There are strengthening and weakening processes with a consequential complex, non-linear temporal behaviour. The scientific basis of ecosystems is, for the first time, presented in **Chapter 3** of this volume. General conclusions are drawn about how individual organisms interact within the diversity of vegetation. This leads to the question about the degree to which vegetation is more than the sum of its individual plants. Many characteristics of vegetation result from material fluxes which dictate the performance of individual plants. For example, the “aero-dynamic roughness” of the surface of vegetation determines coupling to the meteorological conditions in the atmosphere and thus determines the survival of plant individuals or a species in the vegetation. It is only by large numbers of individuals of the same species which, through distribution of seeds or other ways of propagation, determine the habitat in relation to a dynamic diversity of other species.

Synecology is the next higher level of plant ecology, extending to populations based on the strategies of propagation and distribution. Synecology does not consider the fate of a single individual, but the dynamic spatial and temporal behaviour of populations, including population growth, homeostasis and decline. Only in exceptional cases does a single species form a vegetation. Generally, natural vegetation includes a diversity of species which make complementary

use of the available resources. In synecology, the broad spectrum of responses at the cellular and whole plant level is replaced by the enormous diversity of species (350,000 species of vascular plants) which determine in different proportions the composition of the vegetation cover of the earth. In **Chapter 4**, the historical and spatial dimensions of species distributions and their biological interactions are discussed.

Combining the ecology of ecosystems with the field of synecology enables us to understand also the distribution of species. Both the potential and actual areas (**Fig. 2**) are determined by several parameters. For example, considering only the carbon balances, a plant species could grow on a much larger area than the region in which it actually reproduces. However, even this region is limited by different types of competition with other species, so that the area eventually occupied is even further restricted. Agricultural crop plants (maize, beans, wheat, potato, soya and many others) are an interesting example of evolution in a geographically limited area (the so-called genetic centres of origin), but these species are now distributed worldwide after domestication and management by humans.

The science of geobotany relates to global aspects in plant ecology, which are included in the term **global change**, where the direct and indirect influences of man through land use, changes in land use and the subsequent changes

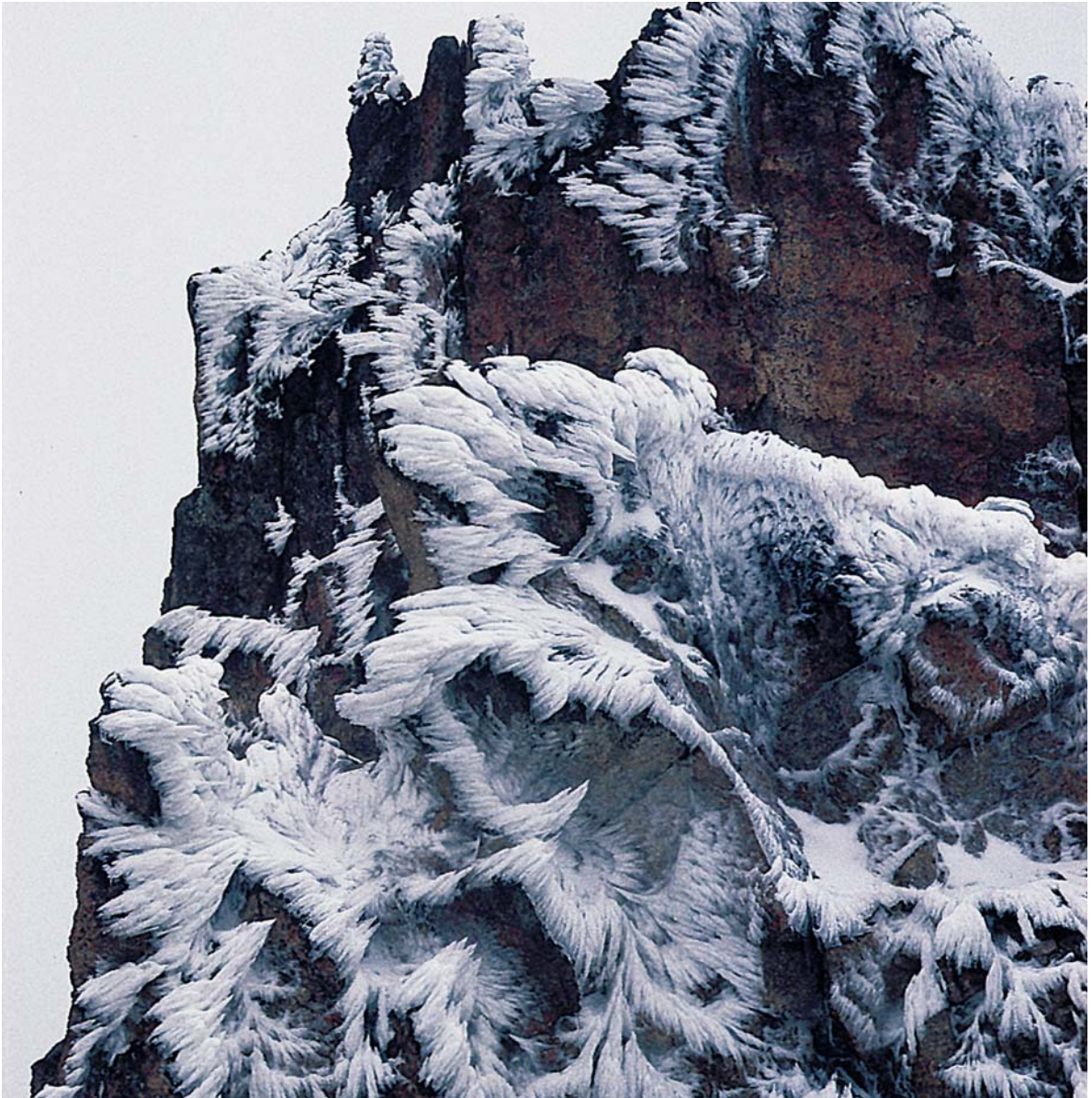
in climate are becoming increasingly felt. The pivotal question in **Chapter 5** is: “How are conditions for human existence affected by the reactions of the vegetation cover of the earth?” In this book, plant ecology is broadened to include the effects of plant life on global element cycles. At present, the primary focus is on the “management” of the global carbon cycle by humans. It is obvious that in future questions concerning global management of water and nutrient cycles will have to be considered as being just as important. Here, ecology is no longer “pure” science and will play an important and even vital role in providing information for politicians

on questions concerning humanity as a whole. Research into global change is developing very fast at present, similarly to the development of molecular plant ecophysiology.

Based on these considerations, the book deals with the main areas of plant ecology in the following chapters:

- Stress physiology
- Whole plant physiology
- Ecology of ecosystems
- Synecology
- Global aspects of plant ecology

Stress Physiology



The cold tropics: The author of this chapter has been working for more than 20 years on plant stress in high tropical mountains. The photograph, taken in the morning of a day during the rainy season (in July) at about 4700 m on Mt. Kenya, shows that man and plants can suffer from cold, even right on the equator. Several species of flowering plants can grow even at this altitude in moist sites

1.1

Environment as Stress Factor: Stress Physiology of Plants



Plants are bound to places. They, therefore, have to be considerably more adaptable to stressful environments and must acquire greater tolerance to multiple stresses than animals and humans. This is shown very clearly by the limitations in the distribution of particular types of vegetation, for example, the tree line on mountains. Extremely high light intensities, mechanical stress by wind, frequent periods of frost, and a winter period of many months have left their marks on these spruces and pines at about 3000 m altitude on Mt. Hood in Oregon (USA). Photo E. Beck

Recommended Literature

- Aarts MGM, Fiers MWEJ (2003) What drives plant stress genes? *Trends Plant Sci* 8:99–102
- Bohnert HJ, Nelson DL, Jensen RG (1995) Adaptations to environmental stress. *Plant Cell* 7:1099–1111
- Couzin J (2002) Breakthrough of the year. Small RNAs make big splash. *Science* 298: 2296–2297
- <http://www.ambion.com/hottopics/rnai> RNA interference
- <http://www.nature.com/nature/fow/000316.html> RNA interference
- Larcher W (ed) (2003) *Physiological plant ecology*, 4th edn (chapter: Plants under stress). Springer, Berlin Heidelberg New York, pp 345–450
- Robertson D (2004) VIGS vectors for gene silencing: many targets, many tools. *Annu Rev Plant Biol* 55:495–519
- Stokes T (2003) DNA-RNA-protein gang together in silence. *Trends Plant Sci* 8:53–55
- Taiz L, Zeiger E (eds) (2002) *Plant physiology*, 3rd edn (chapter: Stress physiology). Sinauer Associates, Sunderland, MA
- Waterhouse PM, Wang M-B, Finnegan EJ (2001) Role of short RNAs in gene silencing. *Trends Plant Sci* 6:297–301

1.1.1

Abiotic and Biotic Environments Cause Stress

The environment affects an organism in many ways, at any time. To understand the reactions of a particular organism in a certain situation, individual external influences, so-called **environmental factors**, are usually considered separately, if at all possible. Environmental factors can be of abiotic and biotic nature. **Biotic environmental factors**, resulting from interactions with other organisms, are, for example, infection or mechanical damage by herbivory or trampling, as well as effects of symbiosis or parasitism. **Abiotic environmental factors** include temperature, humidity, light intensity, the supply of water and minerals, and CO₂; these are the parameters and resources that determine the growth of a plant. Many other influences, which are only rarely beneficial to the plant (wind as distributor of pollen and seeds), or not at all beneficial or are even damaging (ionising rays or pollutants), are also classified as abiotic factors. The effect of each abiotic factor depends on its quantity. With optimal quantity or intensity, as may be provided in a greenhouse, the plant grows “optimally” and thus achieves its

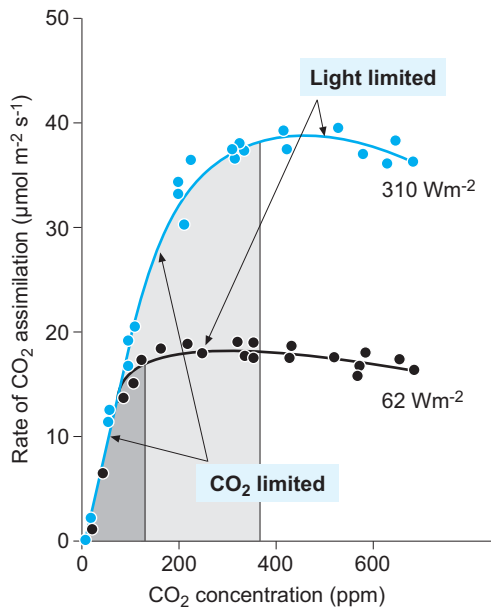


Fig. 1.1.1. Limitation of photosynthesis by CO_2 and light. The rate of photosynthesis of a sorghum leaf (*Sorghum sudanense*) is shown at different light intensities and CO_2 concentrations in air. (After Fitter and Hay 1987)

“physiological normal type”, maximising its physiologically achievable performance.

Plants almost never find the optimal quantities or intensities of all essential abiotic factors (Fig. 1.1.1). Thus the “physiological normal type” is rather the exception and deviation from the rule. It is very important to realise that growth is only one of many reactions of a plant to its environment. Flowering and fruiting determine the plant’s success in reproduction and propagation and might equally be used as a measure of the plant’s reaction to the environment. The value of the factors might, in this case, change but the principal behaviour would be similar.

Deviations from the physiological normal type are regarded as reactions to suboptimal or damaging quantities or intensities of environmental factors, i.e. situations for which we use the term **stress**. Thus stress and reactions caused by it (**stress reactions**) can be used as a measure of the strength of the stress on a scale of intensity, ranging from deficiency to excessive supply. Environmental factors deviating from the optimal intensity or quantity for the plant are called **stress factors**. The optimal quantity can, in fact, be zero, e.g. with xenobiotics. Stress factors which could potentially influence the plant are listed in Fig. 1.1.2.

If the dosage is inappropriate, stress is caused, as is obvious with the effects of the following factors: **light** (weak light, strong light), **temperature** (cold, heat), **water** (drought, flooding), **nutrients** (lack of ions, over-fertilisation, salt stress), **carbon dioxide and oxygen** (photosynthesis, respiration/photorespiration, oxidative stress, anaerobiosis; Fig. 1.1.3). Optimal intensities and concentrations of these may also differ not only for individual organisms, but also for particular organs of the same organism.

Environmental noxae are stress factors which trigger stress reactions when applied in any concentration or intensity: UV-B, ozone, ionising radiation, xenobiotics, heavy metals and aluminium. In this context, electrical and strong magnetic fields can also be considered as stress factors.

Endogenous stress may also occur, for example, by separating an organ from its water supply, as is the case during ripening of seeds and the desiccation of embryo and endosperm.

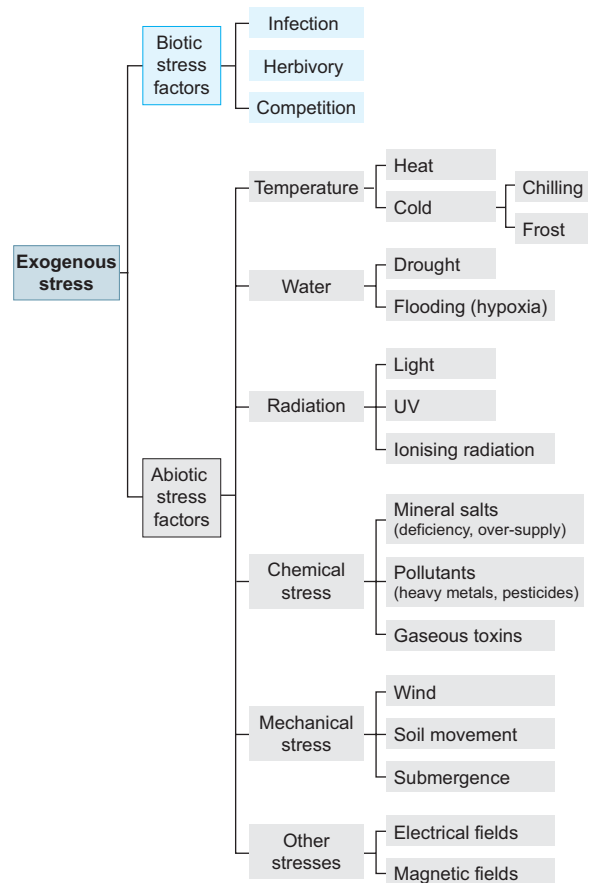


Fig. 1.1.2. Biotic and abiotic environmental factors creating stress for plants

Symptoms of deficiency

Stunted growth, small pale leaves, stiff habitus, root/shoot ratio large, lodging resistance high, premature ripening. Limited reproductive production. Reduced resistance to drought, increased susceptibility to fungal infections.

Symptoms of excess fertilisation

Luxuriant, large deep green leaves, soft growth, root/shoot ratio small, lodging resistance low (often lodges), maturation delayed. Limited reproductive production. Reduced resistance to drought, increased susceptibility to fungal infections.

Winter wheat: N requirements in spring

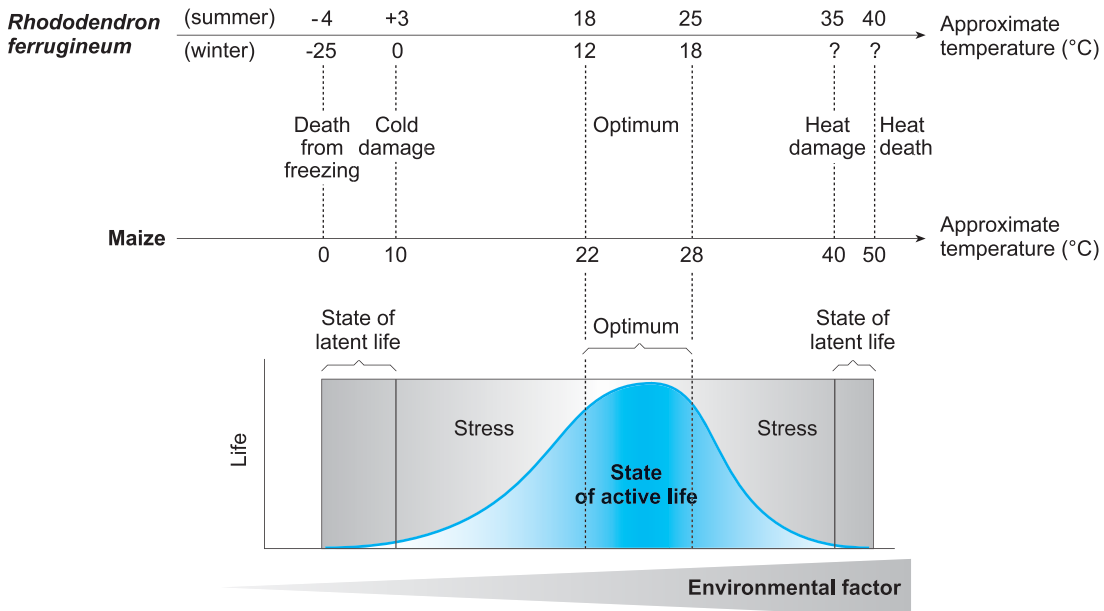
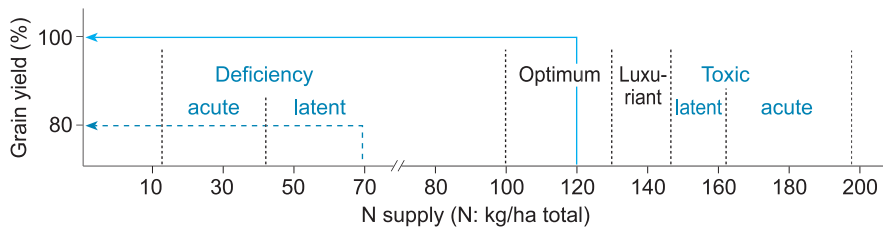


Fig. 1.1.3. Life processes of an organism described as a function of an (abiotic) environmental factor. The **relative growth rate, R**, may be used as a measure of life processes:

$$R = \frac{\Delta \text{biomass}}{\Delta t} \times \frac{1}{\text{biomass}}$$

Usually, an organism is subjected to several stress factors, e.g. lack of water and heat, or a “secondary” stress factor follows a “primary” one: When the plant lacks water and closes its stomata, internal CO₂ deficiency occurs when the plant is illuminated, and as a further consequence oxidative stress ensues. Combination of several stress factors is the normal case and is referred to as **multiple stress**.

1.1.2

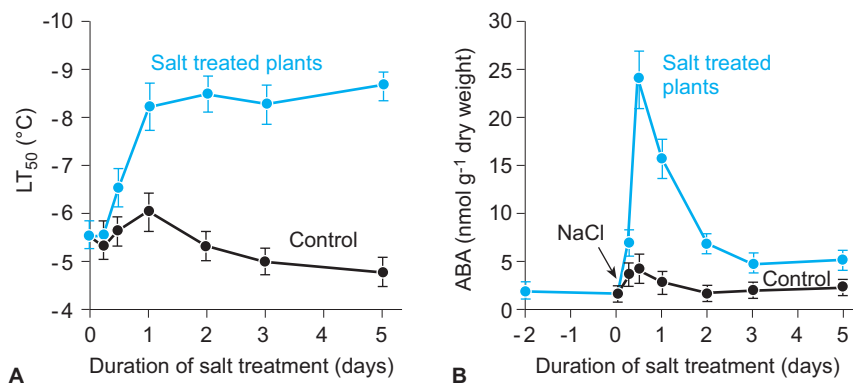
Specific and Unspecific Reactions to Stress

An organism that is stressed, for example, by elevated temperature, not only increases its metabolic rate, but other reactions occur which are usually not observed in the unstressed organism,

or take place only to a very small degree. An example of this is the formation of “heat shock proteins” (see Chap. 1.3.4.2). The modification of the basic metabolism could be interpreted as an **unspecific** reaction, whilst the production of heat shock proteins would be considered a **specific stress reaction** of the organism. The differentiation of these two components of a stress reaction is based on the findings of Hans Selye (1973), a Canadian general practitioner, who, in the 1970s, summarised the various complexes of stress reactions of human beings as follows: “Everything which endangers life causes stress reactions and adaptive reactions. Both types of reactions are partly specific and partly unspecific.” Contrary to plants there is, in humans, also a strong psychic-humoral stress component. The concept of both components of the stress reaction is complicated by the fact that even the specific reactions often lack specificity: The above-mentioned heat shock proteins also assist the folding of proteins during synthesis and after denaturing (see Chap. 1.3.4.2), not only by high-temperature stress, but also under other stresses. They are produced in high amounts, for example, under stress by xenobiotics (e.g. heavy metals). This does not exclude that there are in addition more specific responses by which an organism differentiates between stress by heat and by heavy metals (see Chap. 1.7.5).

There is yet another facet to the question of specificity of stress reactions which is described by the term **cross-protection**. Previous drought stress or salt stress (osmotic stress) is known to harden plants against temperature stress, and particularly cold stress (Fig. 1.1.4). Is this an unspecific stress response? The apparent lack of specificity of the adaptation is explained, on the

one hand by considering the physiological effects of salt and drought stress on cells and, on the other, the effects of frost. All three factors lead to a partial dehydration of cells (in an ivy leaf at -7°C , ca. 90% of the total leaf water is frozen, forming ice, and thus is no longer available as free water; see Fig. 1.3.25). This causes problems with the stability of biomembranes in particular, as the lipid bilayers are stabilised by so-called hydrophobic interactions, which are disturbed if the availability of water, or the ion concentration at the surface of membranes, is drastically changed (see also Chap. 1.3.5.2). If too much water is removed from the aqueous environment of the biomembranes (by evaporation or freezing), the concentration of solutes increases, e.g. in the cytosol or the chloroplast stroma. Increase in the ion concentrations in turn changes the charges at the surface of membranes, and as a consequence the membrane potentials. This usually leads to destabilisation of membrane structure. High charge densities, however, not only result from water deficiency, but also from excessive salt concentration. A general reaction to stress is the synthesis of hydrophilic low molecular protectants, so-called compatible solutes (sugars, sugar alcohols and cyclitols, amino acids and betaines, see Chaps. 1.5.2.6 and 1.6.2.3), which replace water at the membrane surfaces and dislodge the ionic compounds upon loss of cellular water. Production of compatible solutes requires, of course, synthesis of respective enzymes, triggered by stress. Synthesis of these enzymes is often preceded by signals transmitted by certain phytohormones – particularly abscisic acid (ABA) or the stress hormone jasmonate, but also ethylene, may transiently change their concentration. One ex-



■ Fig. 1.1.4. Frost hardening through salt treatment. Cuttings of potato plants (*Solanum commersonii* Dun PI 458317) were grown in Murashige-Skoog medium to which NaCl was added (100 mM final concentration). A Frost hardiness of plants and B ABA content of plants. (After Ryu et al. 1995)

ample of such cross-protection is induction of frost hardening in wild potatoes by salt stress (Fig. 1.1.4). Potato plants treated with NaCl are able to tolerate lower temperatures than untreated controls. A transient increase in ABA concentration mediates this hardening reaction.

1.1.3

Stress Concepts

Based on physical principles, Levitt (1980) published a theoretical understanding of stress reactions that is applicable to all groups of organisms, as illustrated by an abstract experiment. It is known as the **physical stress concept** (Fig. 1.1.5). A body is deformed if it is stretched by a force (**stress**); this deformation is at first reversible (“**elastic**”), but upon intensifying the force it becomes irreversibly (“**plastic**”) deformed and finally breaks. The change in the body caused by the force is called **strain**. The force required to produce a unit of change is the **elastic modulus, M**. In this sense, elasticity does not mean expansion in the sense of maximum elastic deformation. The modulus of elasticity *M* corresponds in principle to ϵ , the elastic modulus of a cell wall, which is a measure of the cell wall’s flexibility (see, e.g., Fig. 1.5.2)

$$M = \frac{\text{force}}{\text{deformation}} = \frac{\text{stress}}{\text{strain}} \quad (1.1 a)$$

According to this relation, *M* is also a measure of the resistance of the system to an externally applied force on the system.

In biological systems, stress is not commonly a single physical force affecting the organism, but a load from many individual environmental factors. Primarily, metabolic processes are changed or deformed. The concept by Levitt convincingly explains the relation of stress and strain, but it can be applied to biological systems only to a limited extent, as the following, biologically important parameters are lacking:

- **Time factor:** In a physical system, the amount of stress equals the strength of stress; in a biological system, the amount of stress is the **product of the intensity of stress and duration of stress**. For example, if one cools the tropical ornamental *Saintpaulia ionantha* (African violet) for a short time (6 h) to 5°C

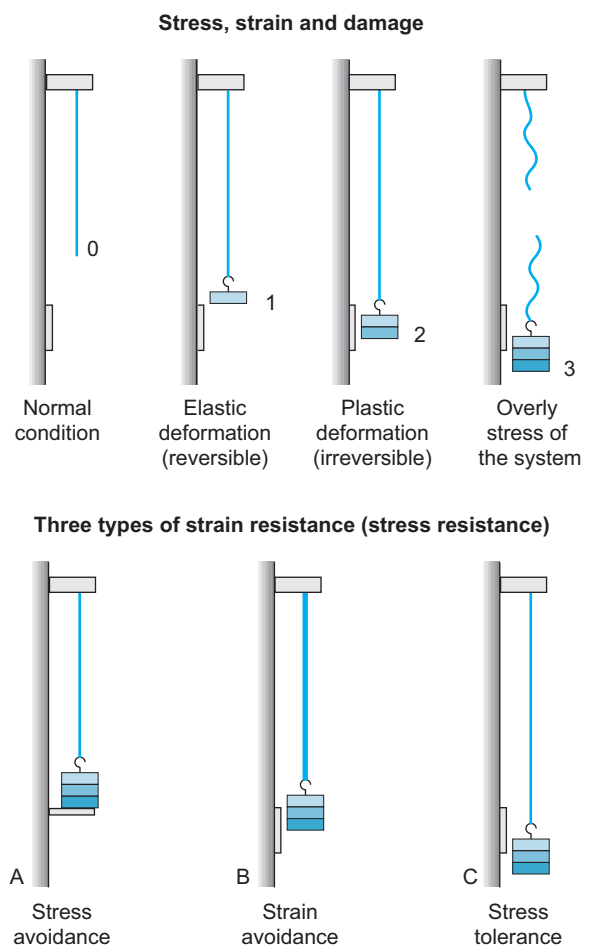


Fig. 1.1.5. The physical stress concept of Levitt (1980)

and then returns it to the original temperature, some of the metabolic reactions may change their rates in accordance with their activation energy (Q_{10}), but the increase or decrease in metabolite pools is not changed so dramatically that the plant is damaged. However, if the plant is left for a longer period (48 h) at 5°C, metabolic chaos results, as individual metabolite pools empty whilst others grow disproportionately. The plant is damaged, in other words: **Elastic strain has passed into plastic strain** (Fig. 1.1.6).

- **Repair:** Plastic change or deformation is not completely irreversible. In most cases, the organism is able to repair the damage, if it is not too severe. One example is DNA repair after damage by UV irradiation. **Plastic strain can change to elastic strain** (see Box 1.2.4). Because of the open life form of plants, “repairs” can also be accomplished through premature senescence or shedding of damaged

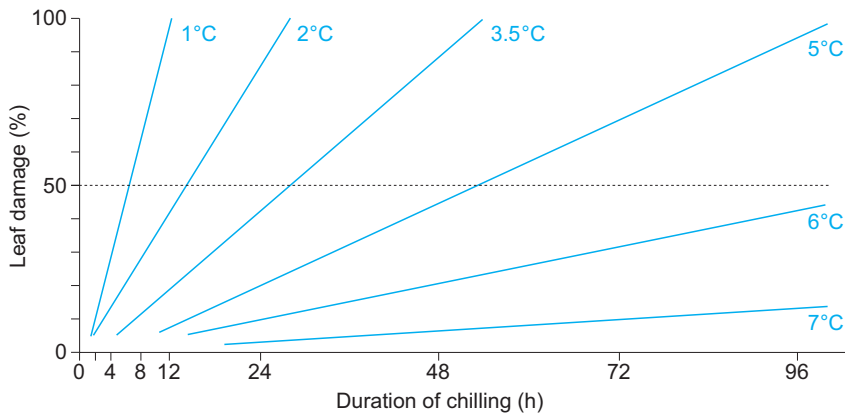


Fig. 1.1.6. Chilling damage to the African violet (*Saintpaulia ionantha*). Below the threshold temperature of +8°C leaves suffer chilling damage, recognisable by the incidence of necroses. Strength of stress can be estimated as the product of cold stress (above the freezing point) multiplied by the duration of exposure; it is proportional to the extent of damage. (After Larcher and Bodner 1980)

organs, for example, of leaves damaged by radiation or drought.

- **Adaptation:** Under stress conditions organisms are able to adapt to more stressful living conditions by changing their elastic modulus and thus their resistance to stress. Such adaptations occur in stress reactions which are not part of the “normal” metabolic changes, for example, the induction of CAM by salt stress or drought (see Chap. 1.5.3.1). Adaptation may be achieved in two different ways, by **avoidance** of the stress or strain, as in CAM plants, which can close their stomata during the hot and dry daytime because of

their ability to fix CO₂ during the night, or by developing an **intrinsic tolerance**, for example, by water storage and by increasing (numerically decreasing) the water potential of the plant.

- **Seasonally recurring stress** requires timely hardening of the plants, for example, development of frost resistance in the case of perennials (see Chap. 1.3.6.7). It might be assumed that such plants, once they have become frost-resistant, would maintain this capacity. However, frost hardening involves not only metabolic changes, but also alterations of the cellular ultrastructure. Frost-hardened plants

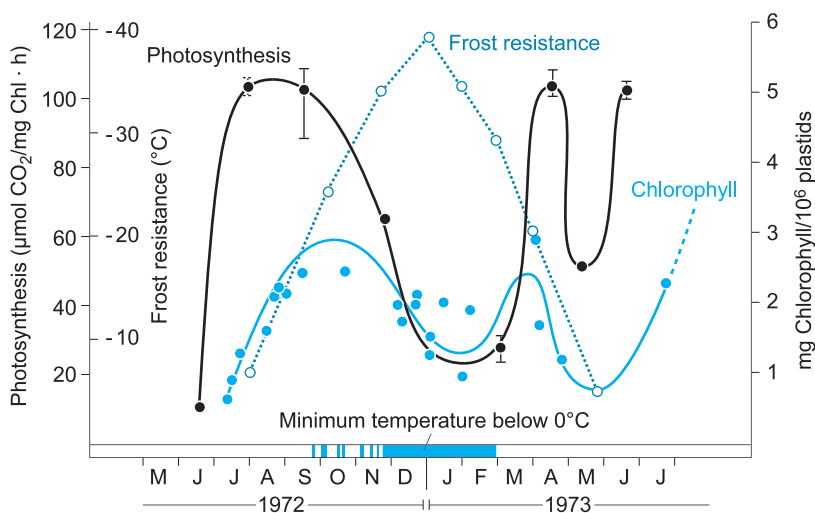


Fig. 1.1.7. Frost resistance and photosynthetic capacity (CO₂ uptake at saturating light and 1% CO₂ concentration) of one generation of spruce needles measured under identical conditions over the course of a year. Note that the annual fluctuation of photosynthesis shows the same dynamics as the chlorophyll content of the chloroplasts. Needles were taken from a 50-year-old spruce tree in the Botanical Garden in Munich. (After Senser and Beck 1979)

are significantly less efficient (measured in terms of their productivity) than in the frost-sensitive state. Upon decrease of the stress they therefore undergo a dehardening process, in which they regain their former efficiency (Fig. 1.1.7). They thus adapt to their particular environmental conditions within the limits of their genetic disposition.

- Normally, plants react to stresses with a change of their metabolism (strain) which may be interpreted as an **alarm signal**. If this strain is tolerated, **hardening** occurs. If the strain exceeds the range of tolerance, the organism is injured and, if the damage overstrains the plant's capability of repair, it will not survive.
- **Multiple stress and multiple stress responses:** Let us continue with the above example of frost hardening and dehardening. When subjected to subfreezing temperature, a large portion of the water in the plant freezes, also in frost-hardened tissue, and crystallised water is not available to the plant. Nevertheless, during bright winter days, leaves, for example, needles of conifers, are exposed to very high radiation intensities. The photosynthetic apparatus is energised, as the absorption of solar radiation does not depend on temperature, but this energy cannot be used because of frost dehydration of the tissue and the low temperatures. Various other possibilities of energy dissipation, for example, photorespiration or photosynthetic oxygen reduction (Mehler reaction), are, for the same reason, not functional (see Chap. 1.2.1.3). An increased energy dissipation via radicals would result in so-called oxidative stress, which can easily be observed by the destruction of pigments. Frost hardening thus not only requires development of tolerance to freeze-desiccation of the cells, but also of protective measures against the damaging effects of oxidative stress, and of strategies to avoid the formation of radicals. **Multiple stress requires a multiple stress response** and thus frost hardening and dehardening are not simple reactions, but concerted reaction complexes (often termed syndromes) where avoidance strategies and the development of tolerance are combined and usually cannot be clearly differentiated from one another.

Larcher (1987) developed a new concept of stress based on the concepts of Levitt and Selye,

but incorporating the additional points mentioned above. Starting with the stress induced, a beneficial stress (**eustress** after Selye) and a detrimental stress (**distress**) are differentiated. In the reaction coordinate "time", this component is also included and shows that hardening is reversible and that increased stress or multiple stress can also overstrain even a hardened organism and damage it lethally. However, these additional modes of reaction are difficult to include in a two-dimensional diagram.

In Fig. 1.1.8, a three-dimensional model is shown where stress, strain (deformation) and time are shown as the three coordinates.

1.1.4

Perception of Stress and Creation of Signals

How is stress, as a multifactorial complex, detected and how is the signal triggering the stress reaction produced? It is known that pathogens produce degradation products of their own cell walls or of the cell walls of the host plant, termed elicitors, which trigger a response, mostly synthesis of so-called phytoalexins (see Chaps. 1.3.5.1 and 1.10.2). But how does abiotic stress – cold, heat, mechanical stress, osmotic stress, lack of oxygen – become a signal? How specific are such signals? Can hardening occur even without stress?

Little is known about the perception of abiotic stress at the molecular level. An example is the perception of osmotic stress in the unicellular green alga *Dunaliella salina*. This alga does not produce a firm cell wall but it is able to adapt its osmotic potential to that of the medium (0.1–5.5 M NaCl in the medium) and so avoids dramatic changes in volume. Adaptation to the osmotic potential of the medium is accomplished exclusively through the metabolite glycerol, one of the compatible solutes which in a medium saturated with NaCl accumulates up to 60% of the cell weight. Upon hyperosmotic shock the cell shrinks transiently, but is able to regain its original volume within 30–120 min through glycerol production. The mechanism by which glycerol accumulates in cells without leaching into the medium is not known. De novo synthesis of new proteins is apparently not involved. Furthermore, stressor specificity is

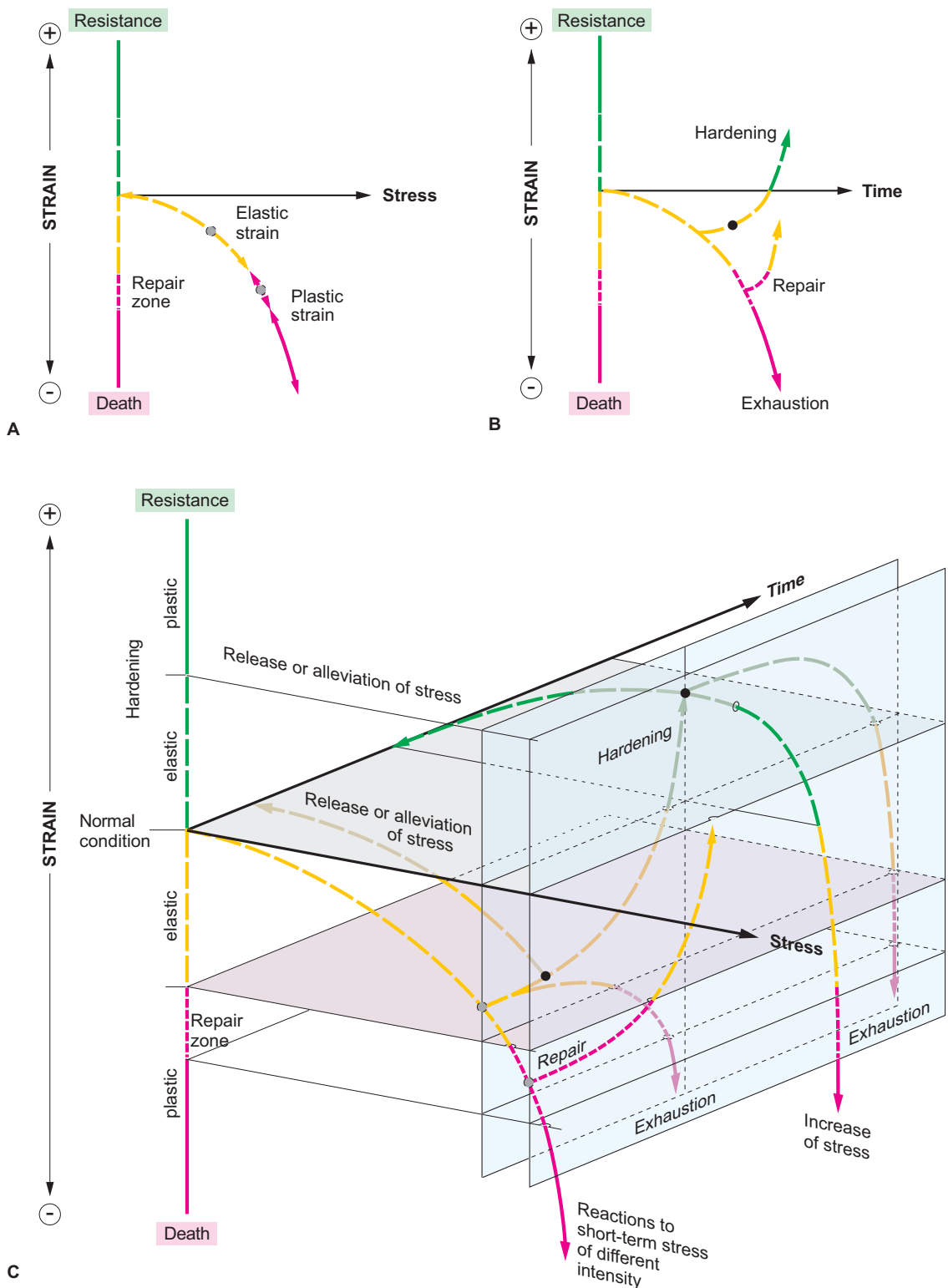


Fig. 1.1.8. The stress concept according to Beck and Lüttge. **A** Relationship between stress and strain in a system that is not capable of hardening (e.g. chilling of the African violet, cf. Fig. 1.1.6). The stress factor time is not considered. **B** Relationship between strain and duration of stress in a system capable of repair and hardening. **C** Relationship of strain and stress allowing also for time as a factor that increases or alleviates stress. The system under consideration is capable of hardening (e.g. frost hardening of spruce needles in autumn). For clarification, two panels are inserted into the three-dimensional coordinate system in the transition zone between elastic and plastic strain. (After Beck and Lüttge 1990)

low, as other osmotica, e.g. polyols, if producing hyperosmotic stress, likewise trigger glycerol accumulation. It is assumed that the transient shrinking process itself produces the signal (see Fig. 1.3.18). Consequently, there are two possibilities for the creation of signals: a sensor located in the plasma membrane (see Chap. 1.2.2.1) or, arising from the contraction of volume, exceeding a threshold concentration of a metabolite in the cytosol. There is more support for the first possibility. A transient, short-term stiffening of the membrane appears to be important, which results in a closer packing of the lipid molecules in the bilayer (a volume contraction must, after all, also lead to a decrease in the surface of the plasma membrane, see Fig. 1.3.18). The high sterol content of the plasma membrane appears to be important in this respect for signal creation (sterols form 35–45% of the total lipids of the cell!). If cells are stressed in the presence of an inhibitor of sterol biosynthesis (“tridemorph”), the sterol content of the membrane is dramatically decreased. At the same time, the ability of the cell to regain its volume by glycerol accumulation after a hyperosmotic shock is lost. The effect of the inhibitor can be completely reversed if an artificial sterol (cholesterol hemisuccinate) is applied to the cells via the medium. It is assumed in the model shown in Fig. 1.1.9 that

sterols interact in such a way with an osmosensor protein located in the membrane that the protein is activated by membrane stiffening. Perception of cold is probably also via cold-triggered stiffening of the membrane (Sung et al. 2003).

With respect to regularly recurring stresses, as for example frost in winter, “feed-forward” signals could be suggested, which might trigger the hardening process without the perception of a stress. It has been shown that shortening of day length induces frost hardening in pine. Temperatures around freezing point are also effective (even under a long-day light period). In the end, both signals lead to the same frost hardening, but the process induced by short days takes considerably longer (0.4 °C/day) than that triggered by cold (0.9 °C/day; Hansen and Beck 2002). A transient increase in viscosity of biomembranes appears to act as a cellular signal as in *Dunaliella* (see also Vigh et al. 1993). In nature, both factors perform synergetically, but the decreasing day length in autumn is probably always the first triggering signal. It has been proven that the phytochrome and cryptochrome systems both take part in the triggering of frost hardening (and dehardening). However, little is known about signal transduction in the cell (cf. Chap. 1.3.6.1).

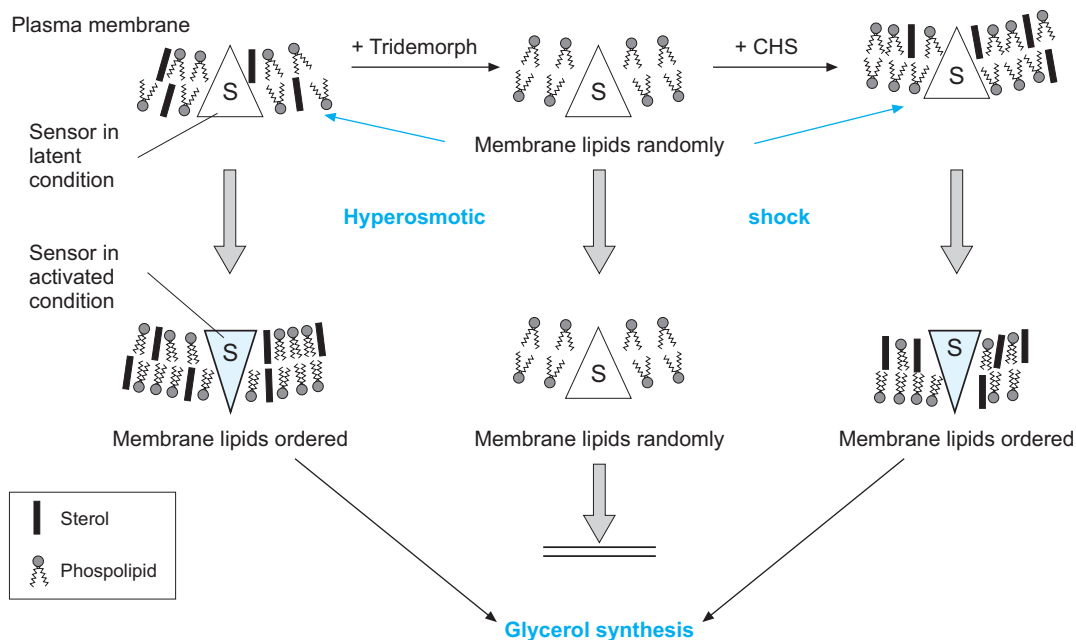


Fig. 1.1.9. Hypothetical model of the osmosensor of the cell wall-free alga *Dunaliella salina*. Tridemorph is an inhibitor of sterol biosynthesis, cholesterol hemisuccinate (CHS) is an exogenous sterol that can be incorporated into the plasma membrane of *D. salina*. (After Zelazny et al. 1995)

Most of the strains imposed on a plant by its environment are spontaneously rather than regularly recurring. A feed-forward signal causing stress avoidance therefore appears to be fairly exceptional. Most of the adaptation reactions are triggered by actual stress and thus correspond more to the feed-back mode (see also Chap. 2.2). Our knowledge about the signal transduction in the cell is still rather patchy (see Chap. 1.5.2.4). Signal transduction and effects of signals constitute a broad field of research in molecular ecophysiology.

1.1.5

How to Measure Stress on Plants?

Stress as such, of course, cannot be measured as it is only effective in the interaction between environmental factors and organisms. However, the strain, as caused by the action of stress on an organism, can be measured. Switching protein synthesis from the normal protein metabolism to the formation of heat shock proteins is a measurable parameter for particular strains (see Chap. 1.3.4.2) which might be well bearable or only just bearable. However, ecologists working in the field do not usually have access to a laboratory for molecular biological research. Therefore, it must suffice to quantify the strain by a measure of survival, i.e. the degree of damage incurred. Several, usually unspecific quantitative assays have been developed. In addition, non-invasive techniques can be employed to measure specific strains, e.g. on photosynthesis via chlorophyll fluorescence (Lichtenthaler and Miehe 1997). This is particularly practicable if the parameter in question is the “weak point” of the entire reaction complex. Unspecific methods usually allow only the determination of the limits of tolerance, e.g. the so-called LD50, i.e. at which dosage 50% of the cells are killed. The LD50 value, however, does not provide information about the degree of alterations within the range of tolerance. Box 1.1.1 shows the most frequently employed methods for quantification of damage after stress treatment.

A completely different strategy for strain detection is the molecular analysis of stress-induced gene expression or suppression of expression. DNA, representing genes from the organisms of interest, preferentially from those whose genome has been sequenced, can be spotted on

so-called chips or microchips. Then the plant is subjected to a stressful treatment and the mRNA is isolated and labelled by coupling to a dye. This sample is then hybridised with the DNA on the chip. Binding of the colour-coded RNA shows which genes have undergone strong expression (and produced much RNA). If the position of the individual genes on the chip is known, stress-induced gene expression can be assessed.

1.1.6

Production of Stress-Tolerant Plants by Genetic Engineering?

Recommended Literature

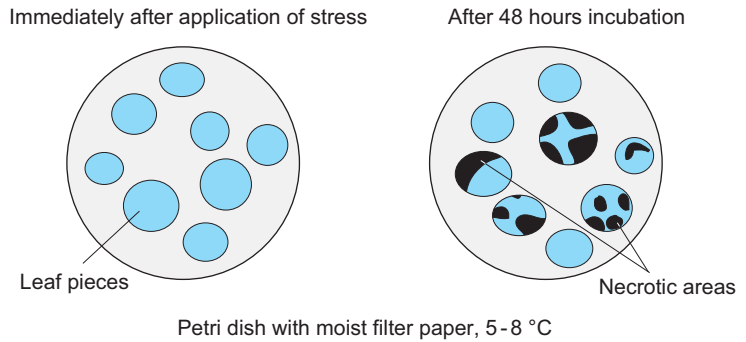
- Holmberg N, Bülow L (1998) Improving stress tolerance in plants by gene transfer. *Trends Plant Sci* 3:61–66
- Pilon-Smits EAH, Ebskamp MJM, Paul MJ, Jeuken MJW, Weisbeek PJ, Smeekens SCM (1995) Improved performance of transgenic fructan-accumulating tobacco under drought stress. *Plant Physiol* 107:125–130
- Tarczynski MC, Jensen R, Bohnert HJ (1993) Stress protection of transgenic tobacco by production of the osmolyte mannitol. *Science* 259:508–510

The concept of producing stress-tolerant plants by genetic engineering contradicts the idea in Chapter 1.1.3 that strain and strain tolerance are not single reactions but reaction complexes, so-called syndromes. It is therefore not possible, even by targeted alterations of one characteristic, to change a stress-sensitive plant into a tolerant one. However, it is possible, if the most sensitive component of the stress syndrome is known, to reduce the total sensitivity and to improve the resistance. Aims of this strategy are, for example, production and accumulation of compatible solutes to protect membranes, decrease in the viscosity of biomembranes by fatty acid desaturation to increase the cold tolerance, or the increase in desiccation tolerance by gene transfer for so-called LEA proteins (late embryogenesis abundant proteins), which protect the embryo from drying out during seed maturation. Currently, not all crop plants are useful targets for stable genetic transformation. This ap-

Box 1.1.1 Quantification of damage to plant tissues

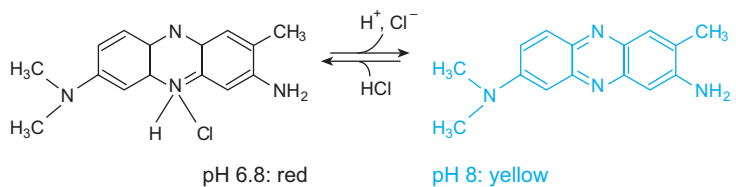
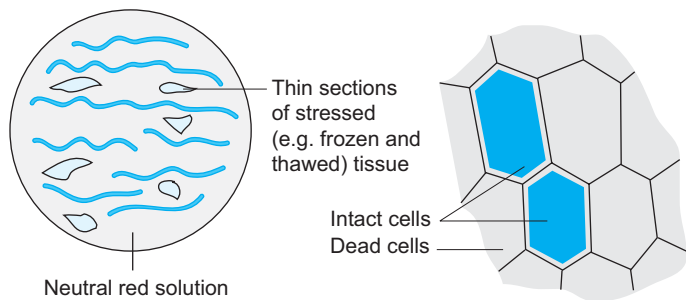
1. Counting necrotic areas after stress application.

Plant tissue, for example, pieces of a leaf, are exposed to a defined stress and then placed for 2 days on moist filter paper. Damage is shown by the formation of necroses (brown, often soggy areas).



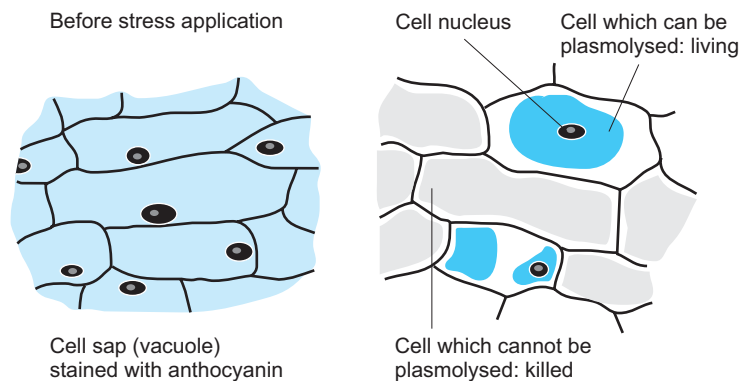
2. Absorption and accumulation of neutral red in the vacuole of undamaged cells.

Only living cells can accumulate neutral red in the vacuole; this is generally accompanied by a change in colour of the indicator, because the vacuolar pH is slightly acidic.



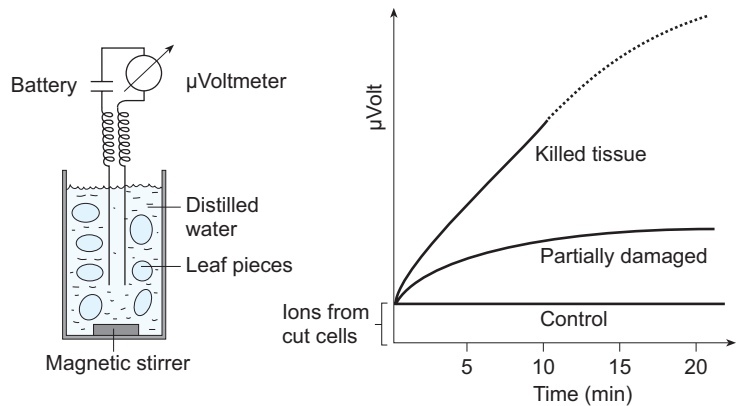
3. Plasmolysis of undamaged cells.

Only intact cells can undergo plasmolysis. This reaction is tested after stressing the tissue.

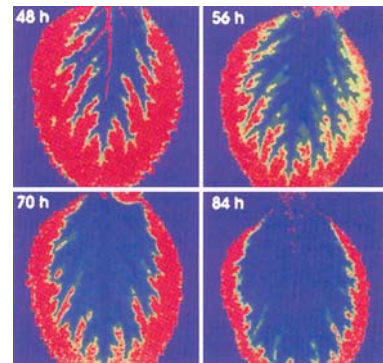


Box 1.1.1**Quantification of damage to plant tissues (continued)**

4. Measurement of electrical conductivity: loss of ions from damaged cells into distilled water. Damage to plant tissues leads initially to loss of selective permeability of the cell membranes. In consequence, solutes leak from the cells. When pieces of tissue (e.g. leaf discs) are floated on distilled water, low molecular weight compounds diffuse into the medium. They include many ions so that the conductivity of the water increases. This can be measured conductimetrically. Conductivity is expressed in μ Siemens.



5. Measurement of chlorophyll fluorescence in photosynthesis. Photosynthetic electron transport may be measured by means of the chlorophyll fluorescence from photosystem II (red colour). With modern imaging systems, the impact of stress on photosynthesis may be seen immediately as a fluorescence quenching. In the example shown, a foxglove (*Digitalis*) plant was treated by applying the herbicide Diuron (DCMU) to the roots. The increase in fluorescence quenching can be seen within 3.5 days (after Lichtenthaler and Miehe 1997).



plies particularly to genetically complicated cereals like wheat and to Chenopodiaceae (e.g. sugar beet), where regeneration of plants from transformed cells is the major problem (see also

Chap. 1.1.7). Considering the actual progress in molecular gene technology, transformation of the more difficult species will be achieved in the foreseeable future. However, the conditions un-

Table 1.1.1. Increased drought and salt resistance in rice plants by introduction of the HVA 1 gene (LEA protein) of barley (*nd* not determined) (Xu et al. 1996)

Transgenic line and wild type, respectively	Amount of HVA1 protein in soluble protein (%) in		Growth				Surviving plants (%)
	Leaves	Roots	Under drought stress		Under salt stress		
			Height of plants (cm)	Fresh weight of roots (g)	Height of plants (cm)	Fresh weight of roots (g)	
Wild type	0	0	22±1.4	0.9±0.1	19±1.1	1.2±0.1	0
30	0.5	0.3	29±1.1	1.4±0.1	23±0.9	1.9±0.1	60
36	1.5	1.0	37±1.8	2.1±0.1	29±0.8	nd	80
41	1.0	0.7	33±1.8	2.3±0.3	26±0.8	2.6±0.1	80

der which these transformed plants will then be capable of making use of their increased stress tolerance (which undoubtedly has been proven in some cases) to increase yields can only be determined experimentally. Table 1.1.1 shows the effect of transforming rice with LEA protein from barley (*Hordeum vulgare*, “HVA1”). In this case, growth (fresh weight production) and the capacity for survival under drought and salt stress were significantly increased. Whether this advantage is sufficient to achieve increased grain yields can only be shown in field experiments.

1.1.7

Gene Silencing

Recommended Literature

- Kooter JM, Matzke MA, Meyer P (1999) Listening to the silent genes: transgene silencing, gene regulation and pathogen control. *Trends Plant Sci* 4:340–347
- Meyer P, Saedler H (1996) Homology-dependent gene silencing in plants. *Annu Rev Plant Physiol Plant Mol Biol* 47:23–48

In several cases, the transferred genes were not expressed, although the transformation of the receiver plant had been successful. This failure occurred frequently when the genes were introduced by the biolistic technique, i.e. by shooting DNA-coated particles with a so-called particle gun into the cells. Transformation with *Agrobacterium tumefaciens* with the Ti-plasmid as vector was also susceptible to that effect. Meanwhile, this phenomenon has been identified as part of a regulatory mechanism termed “**gene silencing**”. Obviously, there is a connection between the incidence of gene silencing and the number of copies of the heterologous gene. Multicopy genes are silenced more frequently than single copy ones. Gene silencing has been recognised as an important mechanism for the regulation of the development of an organism. Expression of many genes, the products of which are not required or even deleterious at a given developmental phase, must be suppressed and the multifaceted complex of gene silencing comprises several biochemical mechanisms. On a high hierarchical level the formation of transcriptionally silent, highly condensed heterochromatin

prevents gene transcription. The same gene can be well expressed or completely shut off, depending on whether it lies in the easily accessible regions of euchromatin or in the compacted heterochromatin (Bender 2004). Formation of heterochromatin requires prior methylation of the cytosine by a specific DNA-methyltransferase (Stokes 2001). Methylation is preferentially targeted to repeated sequences which could explain the above-mentioned silencing of multicopy genes. The question arises which component targets the methylation of DNA. Evidence is accumulating that an aberrant RNA aligns with homologous sequences of the DNA and thereby marks the regions for cytosine methylation. Silencing of DNA regions by the formation of heterochromatin is known as **epigenetic changes** or effects. Whether the so-called **position effects**, resulting from the positioning of the transgene in the neighbourhood to heterochromatin also results from cytosine methylation, is not quite clear. If so, extension of the methylation to the promoter of the transgene must be concluded. Whereas epigenetic gene silencing is triggered by an RNA–DNA interaction, the so-called **post-translational gene silencing (PTGS)** results from an RNA–RNA interaction. For this type of silencing, homologous RNA molecules act as catalysts forming regions of double-stranded RNA (dsRNA) with the messenger RNA. Regions of dsRNA are cleaved by a “dicer-ribonuclease” (Schauer et al. 2002) into small (about 25 nt long) fragments which target homologous mRNA into a multiprotein **RNA-induced silencing complex (RISC)**. Several types of small RNAs have been identified and their nomenclature (siRNA, small interfering or inhibitory RNA; miRNA, microRNA; stRNA, small temporal RNA) is still somewhat confusing. Interestingly, the small RNA fragments can pass plasmodesmata and travel into neighbouring cells where they likewise trigger RNA destruction. Such PTGS is not confined to transgenes, but often occurs between corresponding sequences of transgenes and endogenous genes, and in this case has been termed “**cosuppression**”. This suggests that the small RNAs or their precursors could help to coordinate development at the whole-plant level in a non-cell-autonomous manner and that PTGS is a molecular mechanism that can be used to control gene expression by selective destruction of specific endogenous or viral RNA species. In virus-infected plants, the process is triggered by the cytosolic

accumulation of double-stranded replicative forms of viral RNA (Wood 2002). It not only leads to degradation of cognate mRNAs in the invaded cell, but also to the spread of a systemic silencing signal, conferring virus resistance (**RNA-mediated resistance**) to distant tissues. However, as everywhere in evolution, counter-defence strategies have been developed by viruses which produce PTGS suppressors. In molecular engineering, the use of small inhibitory RNAs for gene silencing and creation of loss of function transformants, the so-called RNA-interference technique (RNAi), has gained enormous importance.

Based on the general considerations of stress and strain outlined in this chapter, the effects of various abiotic and biotic environmental factors will be discussed in some detail. Stress and strain will be explained, subject to available knowledge, down to the molecular level; in some areas, but not in all, this part could also be termed “molecular ecophysiology” of plants.

Summary

1. All organisms are limited in their development by the environment. These limitations and impacts can be abiotic or biotic. Effects of abiotic factors such as light, temperature or water on an organism usually follow an optimum characteristic. Deviation from the optimal intensity or concentration creates stress and the environmental factors become stressors. There is no optimum for the biotic factors. The stronger the effect (e.g. infection, competition or herbivory), the stronger the stress. Usually, an organism is subjected to several stressors at the same time.
2. If subjected to stress, an organism reacts with a stress reaction (so-called strain) whose intensity corresponds to the strength of the stress. Strain reactions are, with regard to the stress factor, specific as well as unspecific and are reactions which would not occur, or to a small extent only, without the imposed stress. Unspecific stress reactions lead to hardening also against other stressors. Depending on the strength of stress and the strain reaction, the term eustress is used in the case of hardening and distress in the case of damage.
3. Organisms are capable of altering their stress tolerance by adaptation and, to a certain extent, can repair damage. Stress and strain, repair and adaptation, are summarised in so-called stress concepts explaining the reaction patterns deviating from the “normal performance”, the strain reactions.
4. Whilst stress reactions are usually relatively easily recognised, the perception of stress by an organism is not yet fully understood. The question, which molecular signal a stressor creates in an organism can be answered only in a few cases. Feed-forward hardening is typical of regularly recurring stress situations, for example, frost hardening of plants in regions subjected to cold winters. However, usually adaptation is triggered by the stress itself. Adaptations lead to an increased stress tolerance or to a more effective stress avoidance.
5. Stress can be demonstrated experimentally by the intensity of strain reactions. These are mostly unspecific and only the degree of damage is quantifiable. Usually, an actual “weakest point” in sensitivity to stress cannot be defined.
6. Strain usually consists of several reactions, so it is principally difficult to produce stress-tolerant plants with gene technology. Obvious “weakest points” in the plant’s defence against stress may, however, be improved by genetic engineering, for example, drought resistance of cereals by transformation with genes encoding for membrane-protecting proteins or for biosynthesis of low molecular weight solutes (compatible solutes). Such transformation often does not lead to success, as heterologous genes, particularly if introduced in multiple copies, are not expressed because of the mechanisms of gene silencing.

References

- Bender J (2004) DNA methylation and epigenetics. *Annu Rev Plant Biol* 55:41–68
- Finnegan EJ, Genger RK, Peacock WJ, Dennis ES (1998) DNA-methylation in plants. *Annu Rev Plant Physiol Plant Mol Biol* 49:223–248
- Fitter AH, Hay RKM (1987) Environmental physiology of plants. Academic Press, London, p 8
- Hansen J, Beck E (2002) Kälte und Pflanze: Updating classical views. *Schriften des Vereins zur Verbreitung naturwissenschaftlicher Kenntnisse* 137(140):337–381
- Larcher W (1987) Stress bei Pflanzen. *Naturwissenschaften* 74:158–167
- Larcher W, Bodner M (1980) Dosisletalität-Nomogramm zur Charakterisierung der Erkältungsempfindlichkeit tropischer Pflanzen. *Angew Bot* 54:273–278

- Levitt J (1980) Responses of plants to environmental stresses, vol I. Academic Press, London
- Lichtenthaler HR, Miehe JA (1997) Fluorescence imaging as a diagnostic tool for plant stress. *Trends Plant Sci* 2:316–320
- Ryu SB, Costa A, Xin Z, Li PH (1995) Induction of cold hardiness by salt stress involves synthesis of cold- and abscisic acid-responsive proteins in potato (*Solanum commersonii* Dun). *Plant Cell Physiol* 36:1245–1251
- Schauer ES, Jacobsen SE, Meinke DW, Ray A (2002) DICER-LIKE1: blind men and elephants in *Arabidopsis* development. *Trends Plant Sci* 7:487–491
- Selye H (1973) The evolution of the stress concept. *Am Sci* 61:693–699
- Senser M, Beck F (1979) Kälteresistenz der Fichte. *Ber Dtsch Bot Ges* 92:243–259
- Stokes T (2001) Methylation of a different kind. *Trends Plant Sci* 6:503
- Sung D-Y, Kaplan F, Lee K-J, Guz CL (2003) Acquired tolerance to temperature extremes. *Trends Plant Sci* 8:179–187
- Vigh L, Los DA, Horvath I, Murata N (1993) The primary signal in the biological perception of temperature: Pd-catalyzed hydrogenation of membrane lipids stimulated the expression of the desA gene in *synechocystis* PCC6803. *Proc Natl Acad Sci USA* 90:9090–9094
- Wood NT (2002) Unravelling the molecular basis of viral suppression of PTGS. *Trends Plant Sci* 7:384–385
- Xu D, Duan X, Wang B, Hong B, Ho T-HD, Wu R (1996) Expression of a late embryogenesis abundant protein gene, HVA1, from barley confers tolerance to water deficit and salt stress in transgenic rice. *Plant Physiol* 110:249–257
- Zelazny AM, Shaish A, Pick U (1995) Plasma membrane sterols are essential for sensing osmotic changes in the halotolerant alga *Dunaliella*. *Plant Physiol* 109:1395–1403

1.2

Light



Light stress is not always a consequence of too much light; competition for light in the shade of a tree canopy is likewise stressful and can lead to complex morphological and physiological changes. One characteristic of shade leaves is a large leaf area but a low leaf weight. This feature increases the light-harvesting area, and also shades competing neighbouring plants. The genus *Cecropia* is particularly successful in adapting to light conditions in forming enormous leaves. *Cecropia* trees also live in symbiosis with the ants that colonise the hollow stems. The ants chase damaging insects and provide the host with nitrogen and phosphate, nutrients which are limiting factors in tropical forests. La Carbonnera Reserve near Merida, Venezuela. Photo E.-D. Schulze

Recommended Literature

- Dekker JP, Boekema EJ (2004) Supramolecular organization of thylakoid membrane proteins in green plants. *Biochim Biophys Acta (Bioenergetics)* in press
- Huner NPA, Öquist G, Sarhan F (1998) Energy balance and acclimation to light and cold. *Trends Plant Sci* 3:224–230
- Long SR, Humphries S (1994) Photoinhibition of photosynthesis in nature. *Annu Rev Plant Physiol Plant Mol Biol* 45:633–662
- Lüttge U (1997) *Physiological ecology of tropical plants*. Springer, Berlin Heidelberg New York
- Pessaraki M (1997) *Handbook of photosynthesis*. Marcel Dekker, New York
- Wada M, Suetsugu N (2004) Plant organelle positioning. *Curr Op Plant Biol* 7:626–631

Sunlight, by far the dominating energy source for all life on earth, varies from place to place, time of day to time of day, and season to season, in intensity and also in spectral composition (UV light will be discussed in a separate chapter). As primary producers, plants need to adapt to different light environments. Too little light means a negative energy balance, i.e. gain from photosynthesis does not cover energy require-

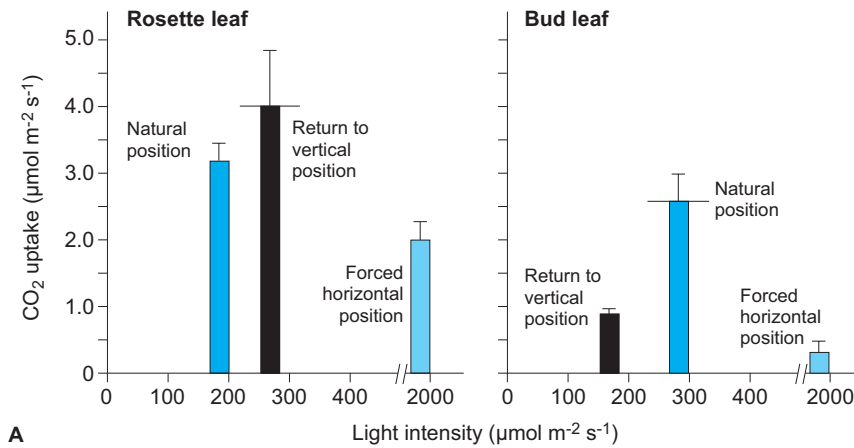


Fig. 1.2.1. Demonstration of photoinhibition in *Lobelia rhynchoptelum* of high mountains in East Africa [Sanetti Plateau (3900 m), Ethiopia]. **A** Net photosynthetic rate of a leaf from the rosette and from the bud in natural positions, when held horizontally (excess radiation) and after their return to the natural position. Whilst the rosette leaves are only marginally affected by the high light intensity and even have a higher rate when returned to the normal position, the photosynthetic rate of the outer leaves of the leaf bud is inhibited by more than 90% by the excess light and returning them to the normal position results in only a small recovery. **B** Structure of the terminal leaf rosette of *L. rhynchoptelum*. Photo E. Beck

ments. Excess light enters the chloroplast, is absorbed, but the energy is not used by assimilation, fluorescence or dissipated as heat, and so may lead to severe oxidative stress.

Adaptation to each light environment is present at all levels from the molecular to the morphological and may be permanent, e.g. formation of sun or shade leaves, or dynamic as observed in the movement of chloroplasts or leaves.

1.2.1

Visible Light

1.2.1.1

Morphological and Structural Adaptation

Lack of light is the main stressor for vegetation on the forest floor. At the edge of the forest, stems or shoots of plants of the forest floor bend so that the leaf area is able to absorb as much light as possible. This can be easily observed with bracken (*Pteridium*) that is often

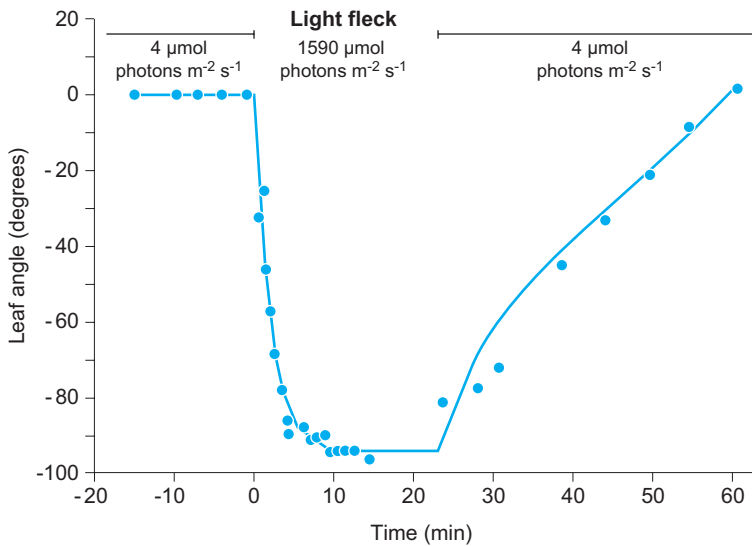


Fig. 1.2.2. Avoidance of light stress by changing the leaf angle. In the shade plant *Oxalis oregana*, the lowering of leaflets upon exposure to a light fleck, and then return to the normal day position after the light fleck moves away, are shown. (After Björkman and Powles 1981)

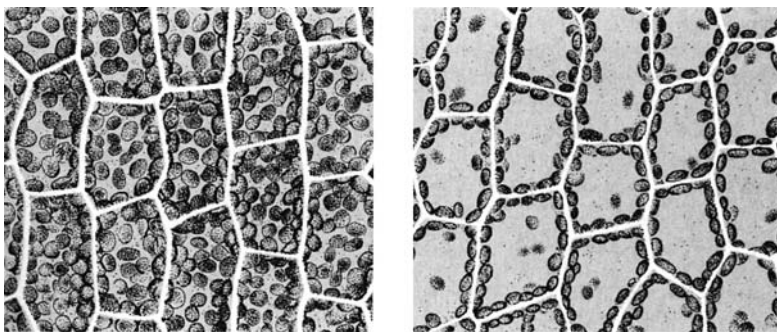


Fig. 1.2.3. Minimisation of light stress by chloroplast movement. Surface view of leaf cells of the moss *Funaria hygrometrica*. **A** Position of the chloroplast on the horizontal cell surface in weak light. **B** Position on the side walls of cells under high light. (Nultsch 1996)

found at the edges of clearings in a forest. Lianas and epiphytes are light parasites avoiding the scarcity of light within the stand by using trees as support, and thus capturing resources which are then available for the development of their own leaves and flowers in the canopy of the supporting plant.

It is different for **surplus of light**: leaves often avoid excessive radiation by adopting a parallel position to the incident light (see also Chap. 2.1, Fig. 2.1.14). The hanging leaves of *Eucalyptus* are well known, forming the “shade-less forests” in Australia. The vertical position of leaves has been shown to be an important avoidance strategy for tropical plants in high tropical mountains (Fig. 1.2.1).

The position of the leaves of many plants changes during the day, affecting the angle of the incoming light and thus the intensity of incoming radiation. Such leaves often have pulvini (particularly Leguminosae), which enable plants to change the position of their leaves or pin-

nules (see also Fig. 2.1.14). The reaction of the North American wood sorrel to a short-term light stress of strong intensity caused by a sun ray (“light fleck”) is shown in Fig. 1.2.2. The sensor for the light intensity is possibly a pigment absorbing blue light.

Avoidance of light stress in shade plants can also be observed at the cellular level. In many algae and mosses, but also in some cormophytes, chloroplasts move to the lesser irradiated, vertical surfaces of the cell and turn their front side towards the incoming light. In weak light they are found in positions with their larger surface exposed to the incident light (Fig. 1.2.3).

Besides such short-term adaptations (reaction time within minutes), the development of leaves is also affected by the light environment, with the formation of sun and shade leaves (Fig. 1.2.4 and Table 1.2.1).

Sun leaves are usually small, but thick, because they possess a well-developed mesophyll, frequently with several layers of palisade cells.

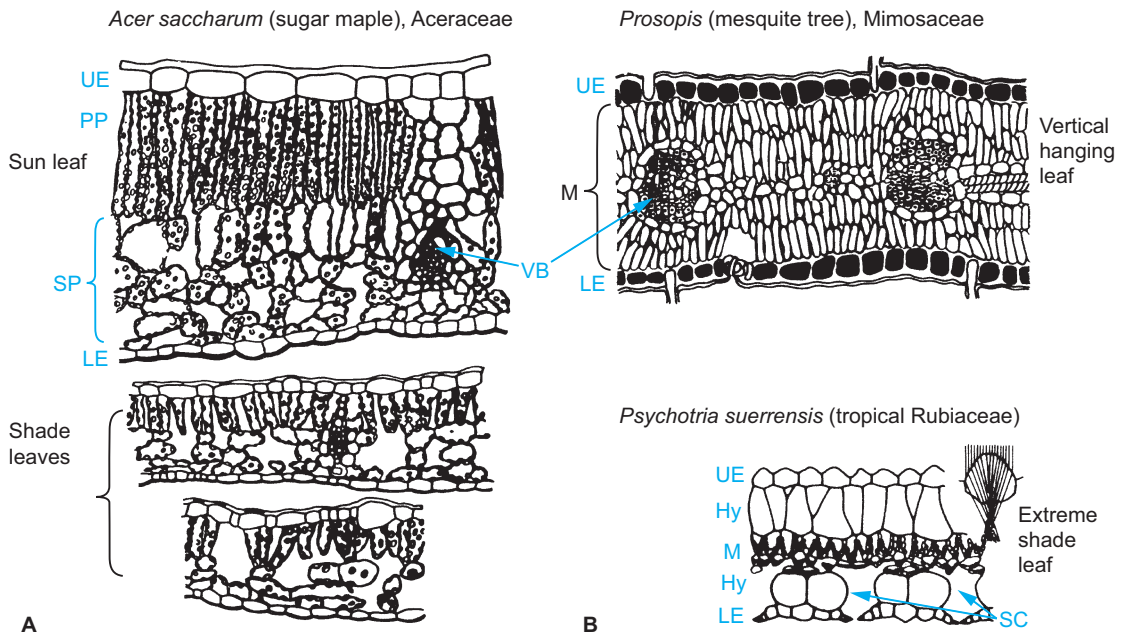


Fig. 1.2.4. Anatomical adaptation of leaves to the light environment. **A** The anatomical structure of leaves from light and shade positions in the crown of sugar maple is shown. The weaker the light intensity, the less developed is the photosynthetic parenchyma. **B** The mesquite tree has hanging leaves of equifacial anatomical structure which only absorb diffuse solar light when the sun is at its highest. The vacuoles of the thick-walled epidermal cells are filled with protective pigments. *Psychotria*, a relative of coffee, grows in deep shade in tropical rain forests in very low light. Lens-shaped cells in the upper epidermis are very characteristic and could gather light for the weakly developed mesophyll. *UE* Upper epidermis; *LE* lower epidermis; *PP* palisade parenchyma; *SP* spongy parenchyma; *M* mesophyll; *Hy* hypodermis; *VB* vascular bundle; *SC* substomatal cavity. (After Larcher 1994)

Table 1.2.1. Comparison of characteristics of sun and shade leaves of beech (*Fagus sylvatica*) and ivy (*Hedera helix*), and the range of adaptation of various characters. (Larcher 1994)

Characteristic		<i>Fagus sylvatica</i>		<i>Hedera helix</i>	
		Sun	Shade	Sun	Shade
Leaf surface	[cm ²]	28.8	48.9		
Thickness of leaf	[μm]	185	93	409	221
Density of stomata	[dm ² ·g ⁻¹ TS]			0.97	2.6
Stomatal conductance	[N·mm ⁻²]	214	144		
Number of chloroplasts					
per surface of leaf	[N·10 ⁹ ·dm ⁻²]			5.09	2.45
per volume of leaf	[N·10 ⁹ ·cm ⁻³]			1.24	1.11
Chlorophyll concentration (a+b)					
Chl/leaf	[mg]	1.6	1.9		
Chl/surface	[mg·dm ⁻²]			8.7	5.5
Chlorophyll a/b		3.9	3.9	3.3	2.8
RuBP-carboxylase activity	[μmol CO ₂ ·dm ⁻² h ⁻¹]			398	202
Net photosynthesis	[mg CO ₂ ·dm ⁻² h ⁻¹]	3.5	1.3	22.3	9.4
Light compensation point	[W·m ⁻²]	2.5	1		
Light saturation	[W·m ⁻²]	8.5	44		
of net photosynthesis	[μmol·m ⁻² s ⁻¹]			600	250
Dark respiration	[mg·dm ⁻² h ⁻¹]	0.5	0.16		

Leaves with predominantly vertical orientation are usually equifacial, i.e. palisade cells are found on both sides. **Shade leaves**, on the other hand, are large and tender with a rather weakly developed mesophyll and may possess additional facilities to trap light, e.g. with the epidermis or hypodermal cells acting like lenses (*Psychotria*, Fig. 1.2.4B). Further differentiation of the epidermis, e.g. by production of dense hairs that reflect incident light, in contrast reduces the light intensity on chloroplasts (see also Chap. 2.1, Fig. 2.1.12). Protective pigments, called chymochromes, in epidermal cells are particularly effective against short-wave radiation. A typical example of that is the so-called juvenile anthocyanin, which protects not yet fully green leaves against the destructive effects of high light intensities (see Fig. 1.2.15).

1.2.1.2

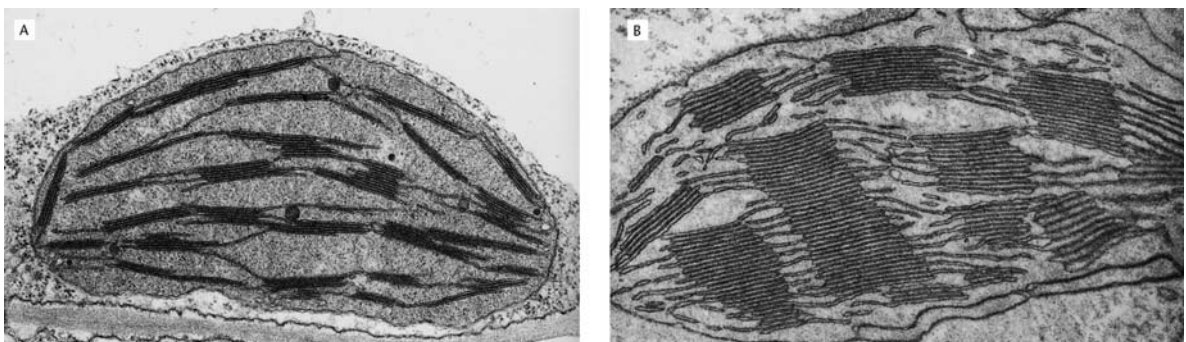
Ultrastructural Adaptation

Adaptation at the subcellular level is, of course, also observed in chloroplasts (Fig. 1.2.5). Chloroplasts of sun leaves possess only small thylakoid grana and only a few individual stromal thylakoids, but plastids of shade leaves possess very large grana and many stromal thylakoids. The importance of the size of the grana and distribution of thylakoids becomes obvious when considering the molecular structure of thylakoid membranes (Box 1.2.1).

As photosystem II (PS II) has a larger antenna apparatus than photosystem I (PS I), over half of chlorophyll-a, almost all chlorophyll-b and most of the xanthophylls are associated with PS

II. The largest part of a cross section of a photosystem consists of antenna. Thus a **shade chloroplast** possesses, because of the large proportion of appressed regions (contact areas of thylakoids), a very large proportion of antennae and very few reaction centres relative to the number of chloroplasts. **Chloroplasts of sun leaves**, in contrast, contain very small antennae, but many reaction centres. This can be interpreted as adaptation, as both combinations allow optimal utilisation of the incident light. Such differences are not only found in shade and sun leaves, but also within a single leaf. Chloroplasts on the upper side of the leaf, usually in better light, correspond to the sun type whilst those on the lower side correspond to the shade type. If a leaf is fixed with the upper side down, the thylakoid structures change accordingly.

The dimensions of the antenna complexes may change as well as the proportion of antennae to reaction centres. The so-called major antenna of PS II, LHC II (**light-harvesting chlorophyll protein**), is subdivided into a smaller, inner complex, termed the **core antenna**, and into a larger, outer circle, the **peripheral or mobile antenna**. Excessive energy pressure on PS II leads to “**photoinhibition**”, a transient destruction of the D1 protein of the affected reaction centre (see Fig. 1.2.8). Permanent photoinhibition leads also to greater damage, resulting in destruction of the thylakoid. When the energy pressure on the reaction centre is high, a large phosphorylation potential is produced; protein kinases are activated which phosphorylate threonine residues in the mobile antenna proteins. The negative charges accumulated as a consequence of the added phosphate groups dissociate



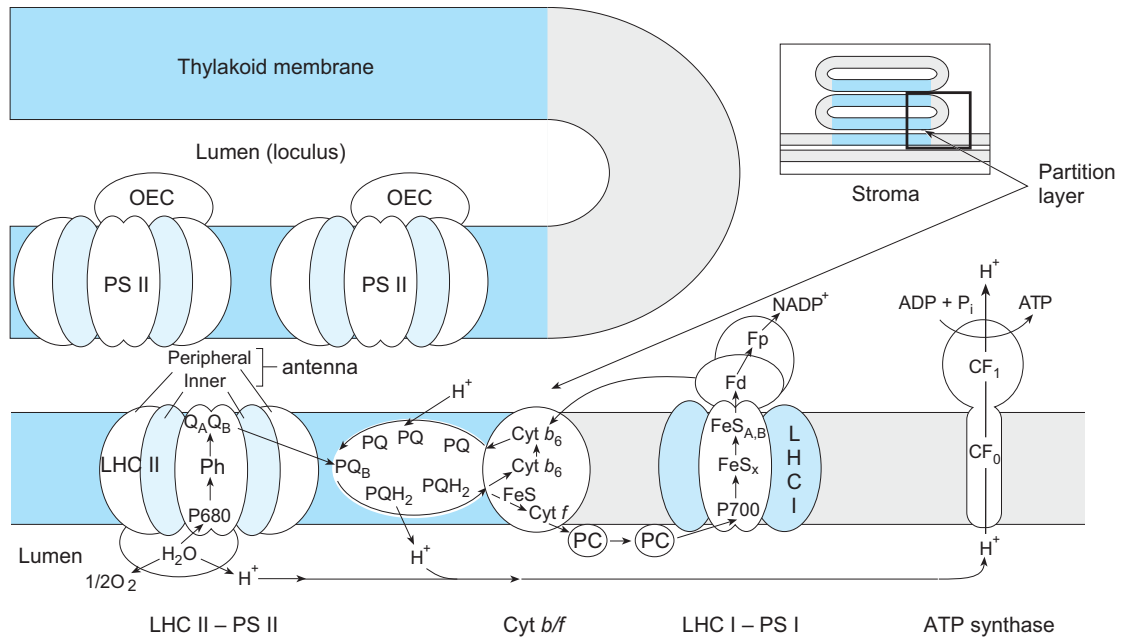
■ **Fig. 1.2.5.** Adaptation of chloroplast ultrastructure to the light environment. **A** Chloroplast from a sun leaf of tobacco. The small granal stacks are typical of chloroplasts from “high-light leaves” (Hall and Rao 1994). **B** Transverse section of a chloroplast from a shade leaf of antirrhinum (*Antirrhinum majus*) showing substantial thylakoid stacking. (Strasburger 1983)

Box 1.2.1

Ultrastructure of thylakoid membranes

Photosystem I and ATP-synthase occur predominantly in the non-appressed regions of the thylakoid and in those parts of the thylakoid system that have direct contact with the chloroplast stroma; in contrast, photosystem II is predominantly found in the appressed regions or the partition regions and also in the stacks (*blue*). The cytochrome- b_6/f complex is distributed in both regions of the thylakoid

systems. The reason for this uneven distribution (“lateral heterogeneity”) is not completely clear. As a rule, a chloroplast contains substantially more PS II than PS I. The ratio of PS II to PS I is variable not just between different plants but even within the same plant, and can also change, in the short term, in a single chloroplast (Fig. 1.2.6, from Anderson and Andersson 1988).



OEC Oxygen-evolving complex; LHC II light-harvesting chlorophyll protein II; PQ plastoquinone; Q_A , Q_B quinones bound to PS II; Ph pheophytin; P_{680} , P_{700} chlorophyll dimers of the reaction centres of PS II and PS I; FeS Rieske protein; FeS_x , $FeS_{A,B}$: iron-sulfur proteins in PS I; Fd ferredoxin; Fp flavin; CF_0 integral membrane proton channel of ATP-synthase; CF_1 coupling factor of ATP-synthase.

the phosphorylated external antennae from PS II. This, in turn, reduces their light-absorbing cross section (Fig. 1.2.6). The accumulation of negative charges is also thought to cause a “loosening” of the appressed regions, enabling the lateral movement of protein complexes. There are indications that mobile antennae partially associate with PS I and thus guarantee a more uniform excitation of PS II and PS I and avoid over-reduction of PS I. With decreasing light intensity, protein phosphatases are thought to cause dephosphorylation of LHC II and, subsequently, the mobile antennae return to PS II. This shift of mobile antennae triggered by the

over-excitation of PS II, resulting in a higher efficiency of the total electron transport, was described in the early phases of photosynthetic research as state transitions or state I \Rightarrow state II transition without, however, the molecular mechanisms being understood.

1.2.1.3

Physiological Adaptation

Besides the morphological and structural adaptations of plants to the dominant light environment, physiological-biochemical mechanisms of

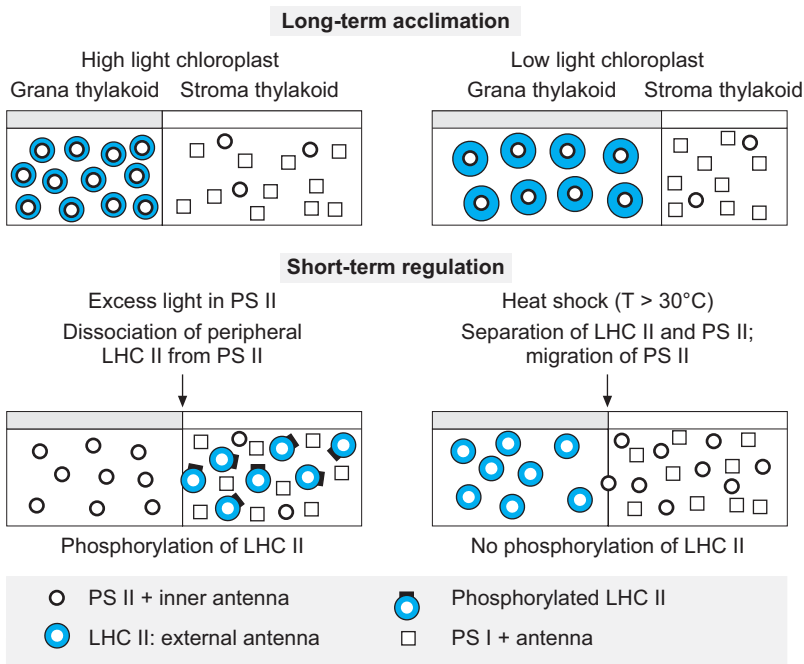


Fig. 1.2.6. Dynamics of the photosynthetic membranes in response to light climate and temperature. (After Anderson and Andersson 1988)

adaptation are known. These mechanisms are able to react even faster than the structural adaptations and thus always take place, regardless of whether structural or morphological changes occur or not.

Starting from the photosynthetic reductive pentose phosphate cycle (Calvin cycle), 2 mol NADPH is required for the assimilation of 1 mol CO₂, corresponding to 4 mol electron and 8 mol light quanta. The cycle also consumes 3 mol ATP. As four electrons produce about 2.7 molecules of ATP, the real requirements for photons or quanta are a little higher. Lowest measured values are 9.4 quanta per mol assimilated CO₂. Light must be the limiting factor to achieve such measured values, i.e. measurements must be in the linear range of the light response curve (see Fig. 1.1.1).

If it is CO₂ supply or activities of the photosynthetic enzymes (e.g. because of cold) rather than light intensity that limit CO₂ assimilation, then more light energy is absorbed than is required. However, what happens to the excess light energy? This energy must be safely dissipated. The plant has several ways of doing this:

- The **glycolate pathway** associated with photorespiration (Box 1.2.2). If the CO₂ supply limits photosynthesis, photorespiration is able to keep the Calvin cycle running by making phosphoglycerate available and thus maintain-

ing a certain consumption of reducing and energy equivalents.

- The **reduction of nitrite and sulphate** also consumes electrons and ATP. However, it plays a relatively minor role in photosynthetic electron flow.
- **Oxygen** may also be **reduced photosynthetically** (see Chap. 1.3.5 concerning reactive oxygen species). This is called the Mehler reaction. Chloroplasts require NADPH to detoxify the reduced oxygen.
- **Non-photochemical energy quenching (NPQ) and photoinhibition.**

If sufficient electrons are able to flow from water to one of the acceptors, they do not accumulate in one of the components of the electron transport chain. If the rate of consumption falls below the rate of production of reducing power and energy equivalents, other mechanisms of energy dissipation (as yet unexplained) are activated.

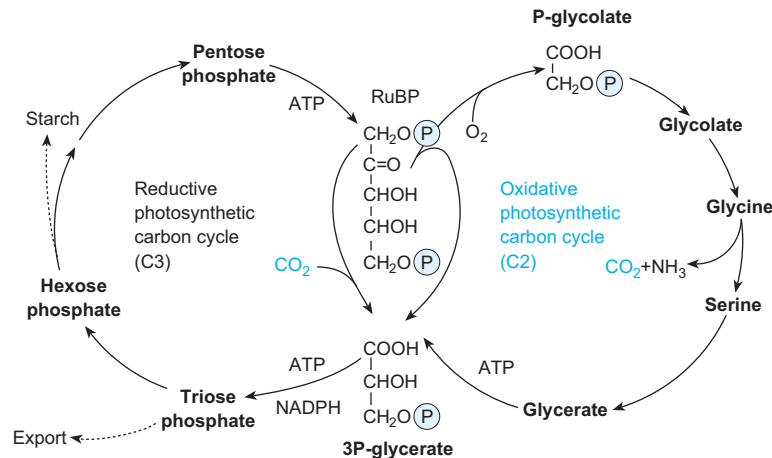
Plotting the rate of photosynthesis in relation to increasing light, the initial slope of the curve is linear before the rate becomes constant as photosynthesis is saturated (Fig. 1.2.7). The difference between extrapolation of the initial straight line and the rates measured at higher light intensities shows the incident light energy which cannot be used photosynthetically. The higher this value, the more “closed” the reaction centres, i.e. they

Box 1.2.2

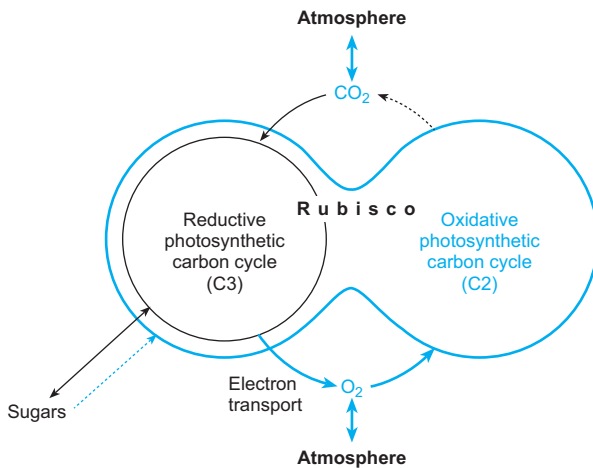
Schematic of the photosynthetic reactions determining gas exchange in a leaf

Even when the stomata are closed, CO_2 is produced via photorespiration from the oxidative photosynthetic carbon cycle, and the CO_2 is re-assimilated by the reductive photosynthetic

carbon cycle. Consequently, under these conditions, at least part of the absorbed light energy is used. A Formal scheme, B schematic of gas exchange (after Tolbert 1994).



A



B

are unable to reoxidise by passing on the excited electrons because of the lack of acceptors: the excited reaction centres cannot become photochemically active. A small proportion of the excitation energy will be dissipated as fluorescence with an emission maximum at 685 nm (see Box 1.2.3, Fig. 1). At room temperature this fluorescence is derived exclusively from PS II; excited PS I fluoresces only at -70°C or at even lower temperatures. Even though the proportion of fluorescent light

emitted from the excited PS II is very low, it nevertheless can provide much information about the status of the photosynthetic electron transport chain and the CO_2 assimilation (Schreiber et al. 1994). The most important parameters measured in this way are the dynamics and the proportion of the absorbed light energy used and the proportion of accumulated electrons (over-excitation) dissipated as heat (thermal dissipation; non-photochemical fluorescence quenching; Box 1.2.3). Change

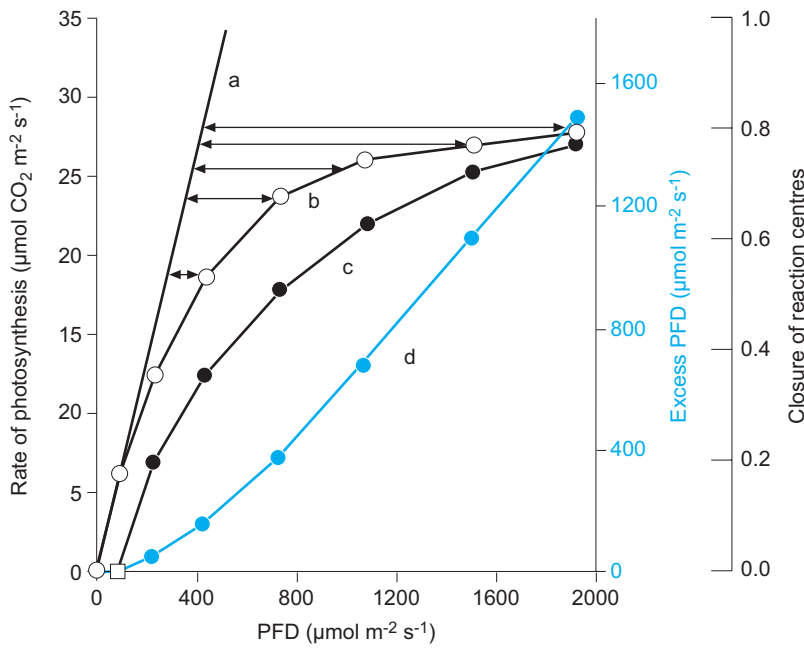


Fig. 1.2.7. Interpretation of a light response curve. Curve a Linear increase of the photosynthetic rate in weak light. Curve b Photosynthetic rate. Curve c Calculated closure of reaction centres of PS II with excess light. Curve d Excess light energy (corresponds to the horizontal arrows between a and b). PFD Photon flux density. (After Schäfer and Björkman 1989)

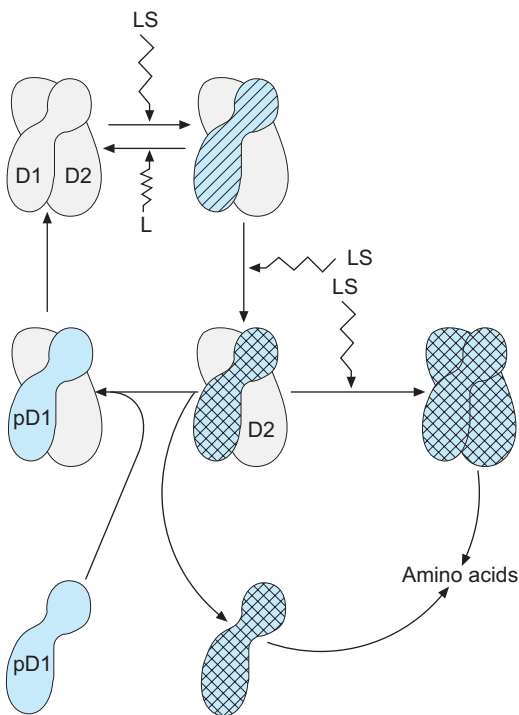


Fig. 1.2.8. Model of the sequence of reactions during damage and repair of the reaction centres of photosystem II. Light stress (LS) leads to transient or irreversible damage to the D1 protein (hatched or cross-hatched, respectively). Irreversible damage triggers cleavage and the subsequent degradation of the D1 protein (presumably to amino acids). A precursor (pD1) forms a new reaction centre with the persistent D2 protein which associates again with the antenna protein. In particularly high light stress the D2 protein is also attacked (cross-hatched). In the plant cell, the D1 protein has a high turnover rate; the D1 protein is coded in the chloroplast genome. L Light. (Schäfer and Schmid 1993)

in these proportions, the so-called rate constants, in favour of thermal energy dissipation is an efficient short-term de-energising reaction which operates during over-excitation of PS II. Upon long-term exposure to high light, or during particularly strong light stress and during irradiation with UV-B light, this mech-

anism is not sufficient protection, however. In this case, the core protein, D1, of the PS II reaction centre is degraded, probably with the help of active oxygen species (Fig. 1.2.8) at a specific site and thus the photosystem is deactivated. This process is called **photoinhibition** (of photosynthesis) and is being investigated in many laboratories. It is assumed that

Box 1.2.3

Chlorophyll a fluorescence as an indicator of excitation and redox states

On illumination the chlorophyll molecule can be excited to both states, singlet 2 (absorption of blue light) and singlet 1 (absorption of red light) (Fig. 1). Singlet 2 is too short-lived to induce a photochemical reaction. The singlet 2 state can change to singlet 1 or to the ground state by dissipating energy as heat. Singlet 1 is produced by absorption of a quantum of red light and is sufficiently long-lived to donate an electron to an acceptor and thereby to initiate a photochemical process. Emission of fluorescence is also related to singlet 1. By losing energy as heat, singlet 1 transfers to the ground state but may also, to a lesser extent, convert to the triplet state. Production of the triplet state is dangerous because this excited chlorophyll molecule can

react with the normal triplet oxygen, producing singlet oxygen which is a particularly strong oxidising molecule.

If a pre-darkened leaf is illuminated, the absorbed light energy can be used in three ways: by emission of heat (which is the major part), by “photochemistry” and by emission of fluorescence photons. Photochemistry and fluorescence change in opposite ways and in particular proportions, i.e. the distribution (the so-called rate constants) of energy flux to heat and [photochemistry+fluorescence] is constant within the leaf. Maximum fluorescence results when there are no photochemical processes, i.e. when there is no acceptor for the excited electrons in PS II.

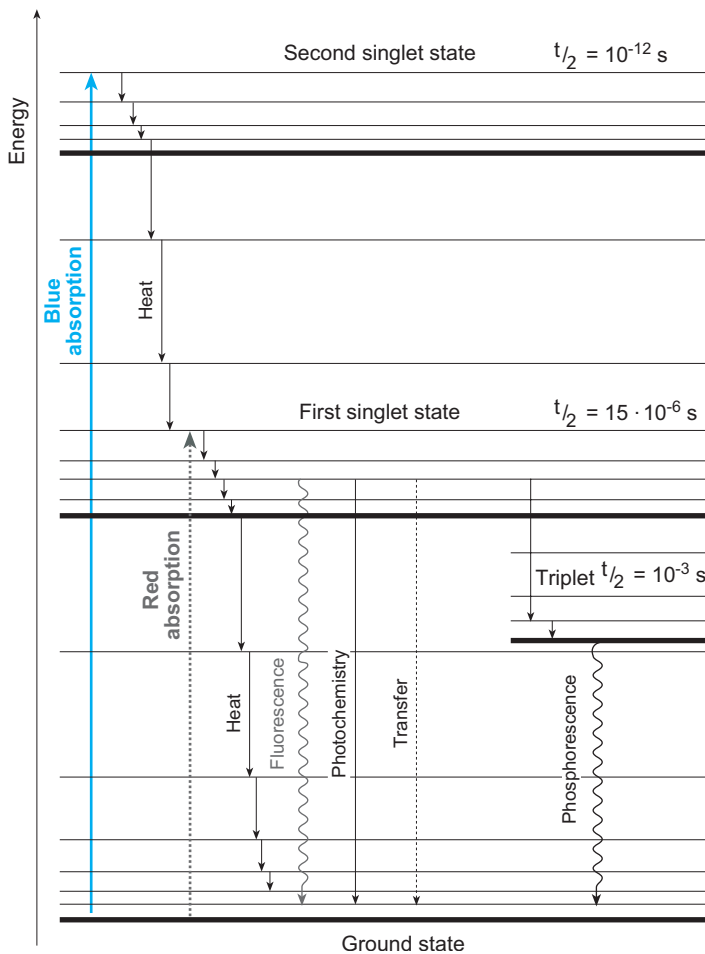


Fig. 1. Different excited states of chlorophyll a caused by light absorption and energy conversion into heat, fluorescence, photochemical work, state 1–state 2 transfer and phosphorescence. (After Heldt 1999)

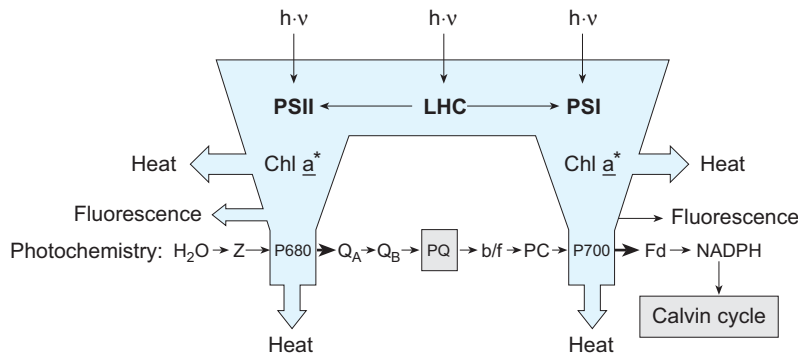
Box 1.2.3 (continued)


Fig. 2. Use and dissipation of light energy in the photosynthetic apparatus. Light energy absorbed by the photosynthetic apparatus is mainly lost as heat. A small proportion (<10%) is emitted as fluorescence. A variable proportion can be used for photochemical work. With strong illumination the external antenna of PS II can dissociate and, at least in part, associate with PS I. Thereby PS II absorbs less and PS I more light energy. This type of balancing is called “state 1–state 2 transition”. The rate constants (thickness of the *arrows*) can be changed by over-energetisation. (After Schreiber et al. 1994)

The photosystem is then closed. The more photosystems that are “open”, the more oxidised acceptor is available, the smaller is the fluorescence. From the rate constants of fluorescence, i.e. its intensity, it is possible to determine the rate (efficiency) of the actual photosynthetic process. It is interesting that with a long period of excitation during which electrons are not transferred completely to $NADP^+$ and further to CO_2 or another reducible substrate, a strong decrease in the maximum fluorescence occurs. This reduction of fluorescence with closed reaction centres shows the redistribution of the rate constants in favour of heat emission (thermal dissipation). This is called “non-photochemical quenching” (Figs. 2 and 3).

A number of parameters can be derived from the analysis of chlorophyll fluorescence (Fig. 3). The maximum fluorescence upon il-

lumination of a pre-darkened leaf: F_m . The reduced maximum fluorescence after a saturating light flash: F_m' . The minimal fluorescence of the antenna pigments of a pre-darkened leaf in which photosynthesis does not occur: F_0 ; in an illuminated leaf, this is generally slightly reduced; it is then called F_0' . The difference between F_m and F_0 is the theoretical maximal useful energy available for photochemistry: $F_v = F_m - F_0$. The actual fluorescence F , which is between F_0' and F_m' , shows the portion of energy which is not used for photochemistry, although in theory this could be used. The maximum quantum efficiency of PS II (Φ_{II}) is shown through the relation of F_v and F_m $\Phi_{II} = F_v / F_m$. The effective quantum efficiency is $\Phi' = (F_m' - F) / F_m'$. The fluorescence quenching by photochemistry (“non-photochemical quenching”): $q_p = 1 - (F_m' - F_0') / F_v$ is a measure of increased thermal dissipation.

Box 1.2.3 (continued)

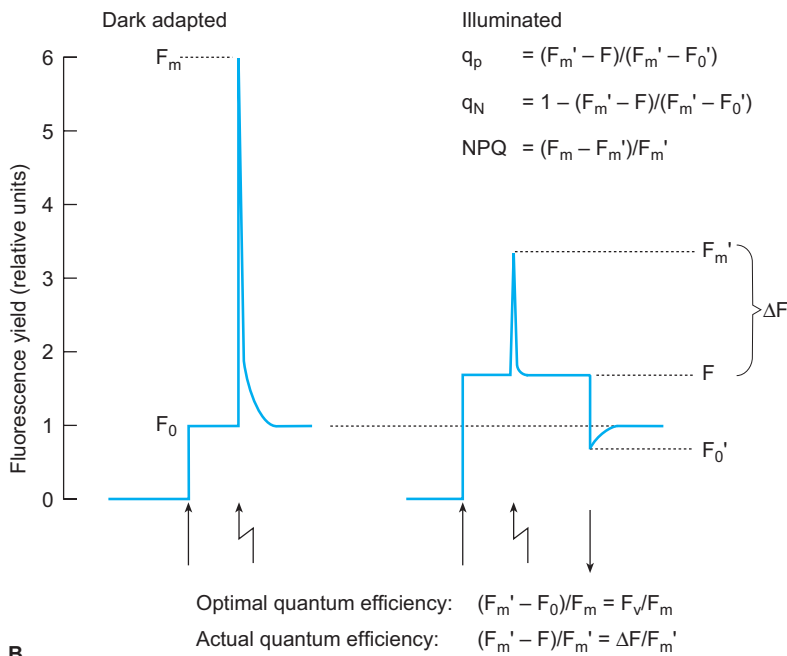
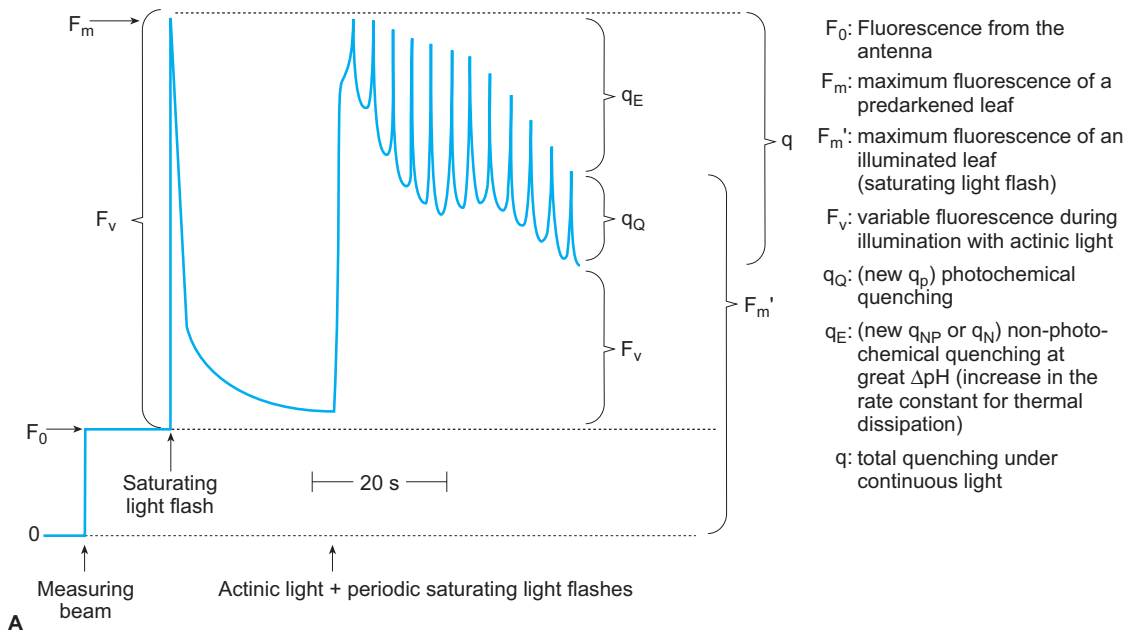


Fig. 3. Analysis of chlorophyll fluorescence from photosystem II. **A** Kinetics of fluorescence and explanation of the parameters (after Walker 1992). **B** Nomenclature used for characteristic fluorescence parameters, definition of quenching coefficients and calculation of the quantum efficiency of photosystem II. (After Schreiber et al. 1994)

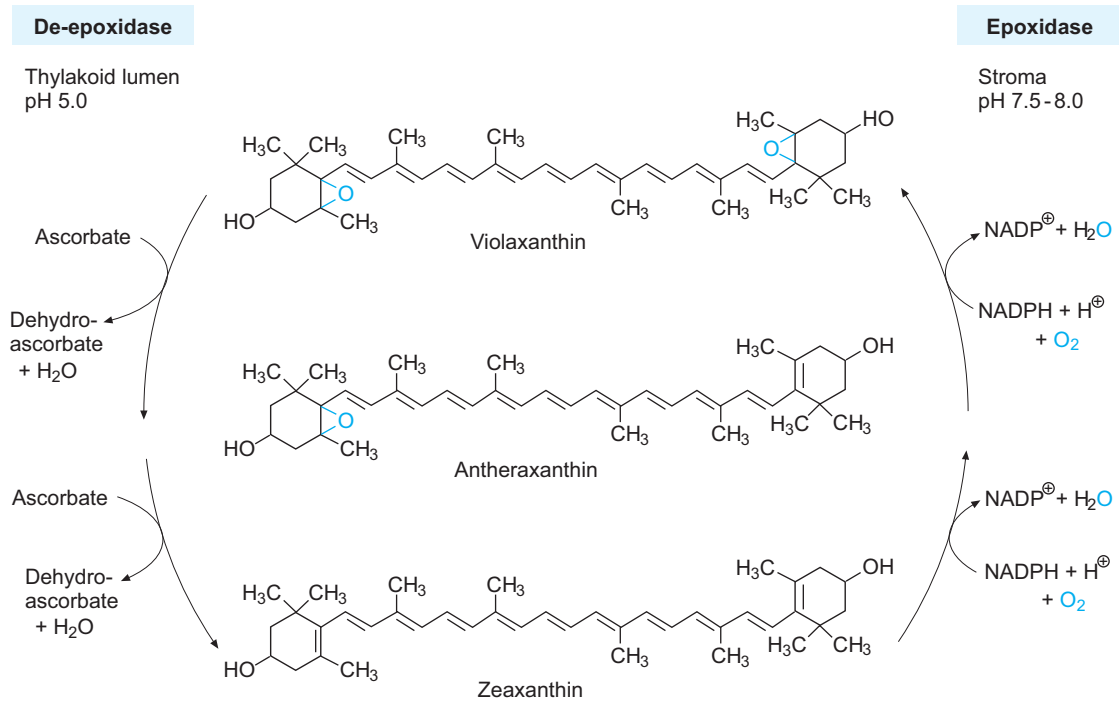


Fig. 1.2.9. The xanthophyll cycle in chloroplasts. In high light violaxanthin is converted into zeaxanthin by the de-epoxidase; in darkness re-oxidation is catalysed by the epoxidase. (Heldt 1999)

defence against light stress developed during evolution in the form of the extremely easily degradable D1 protein. A special metabolic cycle for the replacement of the damaged D1 protein via an undamaged D1 precursor, followed by processing of the preprotein, is associated with this repair cycle (Fig. 1.2.8). Photoinhibition is reversible, as the D1 protein has a very fast turnover (it is exchanged after 10^6 – 10^7 excitation cycles). **Photodestruction** occurs if the capacity for replacement of D1 is overstretched, leading to loss of photosynthetic capacity.

Photoinhibition of PSI has also been described (Sononike 1996 a, Jiao et al. 2004). It is particularly strong for algae and higher plants during cold. The primary damage probably occurs at the acceptor side of PS I, upon which the B protein (which corresponds to the D1 of PS II) is degraded. This photoinhibition is, surprisingly, also observed during weak light and is also attributed to reactive oxygen species (Sonoike 1996 b). It is thought that PS I is more robust, with photoinhibition or damage only occurring under extreme conditions.

- **Dissipation of excitation energy in the xanthophyll cycle.** Non-photochemical energy quenching requires a large proton gradient

across the thylakoid membranes and thus an acid pH in the lumen of thylakoids. An acid environment of the thylakoid membrane activates an enzyme in the membrane, **violaxanthin de-epoxidase** (maximum activity at pH 5, Fig. 1.2.9).

In dark or low light the pH value of the lumen increases and another enzyme, **zeaxanthin-epoxidase**, is activated. Both reactions result in a light-dependent reaction cycle involving the xanthophylls violaxanthin, antheraxanthin (as an intermediary compound) and zeaxanthin (Fig. 1.2.9).

These xanthophylls are in the antenna complexes of PS II and probably also in PS I. Although the physiological importance of the xanthophyll cycle may be different in various species, there is no doubt that this cycle plays an important role in quenching excess photosynthetic energy.

- In the short term, in excess light, violaxanthin is converted into zeaxanthin, which de-energises the triplet excitation state of the chlorophyll which can form easily from excess energy. Zeaxanthin is probably able to react also with the first singlet state of chlorophyll and take up its energy. However, this has not yet been proven conclusively. Excitation energy

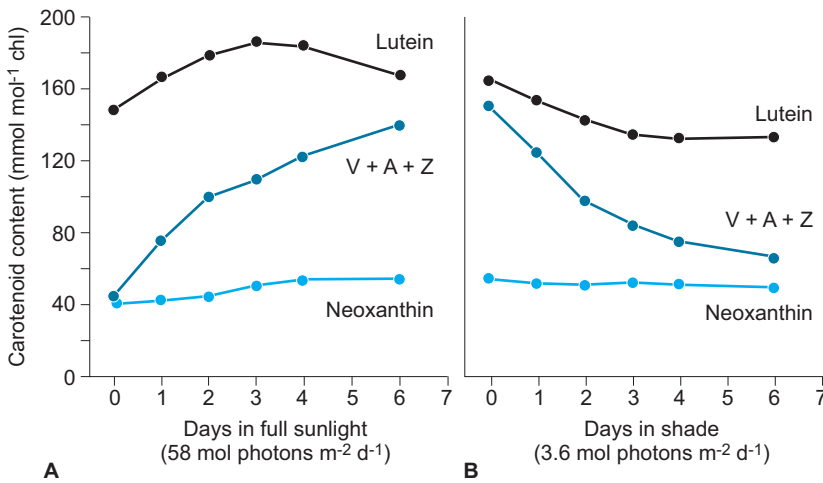


Fig. 1.2.10. Dynamic changes in the xanthophyll pools of young leaves of cotton in strong and weak light. The *left-hand diagram* shows the effects of transferring plants from shade into full sun light; the *right-hand diagram* the transfer from sunlight into shade. Note that the pools of lutein and also neoxanthin change relatively little in comparison with the total pool of violaxanthin, antheraxanthin and zeaxanthin. (Björkman and Demming-Adams 1994)

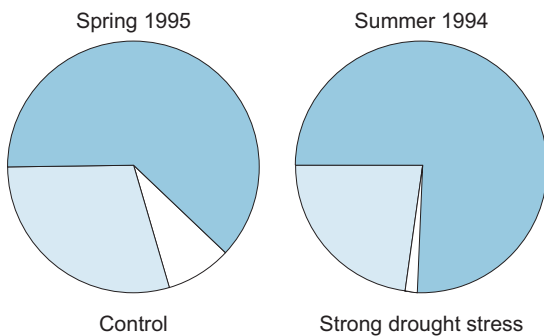


Fig. 1.2.11. Use of absorbed light energy in leaves of the Pacific madrone (*Arbutus menziesii*) in full sunlight. *Blue* Dissipation as heat; *white* photosynthetic CO₂ assimilation; *light blue* all additional uses including photorespiration and the Mehler reaction. (After Osmond et al. 1997)

transferred to zeaxanthin is released as heat; it is still an open question whether the formation of zeaxanthin from violaxanthin is the cause of the changes in membrane leading to NPQ, or whether the changes run in parallel. The physiological importance of the xanthophyll cycle is also shown in the selective and reversible accumulation of the three xanthophylls involved in the photosynthetic membranes during longer exposure to excess light (Fig. 1.2.10).

If one considers all physiological reactions for adaptation to, and avoidance of, excess light, and all the possibilities for repair in PS II, it is not surprising that many reactions and mechanisms are more or less attuned to each other. However, not all plants have all these possibilities available to the same extent; there are plants in which, for example, the xanthophyll cycle

does not play an important role because these pigments only occur in very small concentrations and do not accumulate even after longer stress. That the removal of excessive energy can become a problem is shown by the various paths for the de-activation of absorbed light energy in the chloroplast (Fig. 1.2.11).

During drought stress (closed stomata and therefore secondary light stress through lack of CO₂), only a very small proportion of the light energy is used for photosynthesis and almost all available energy must be disposed of safely. It is obvious that one single mechanism is not sufficient for this.

Another argument for the use of many mechanisms for adaptation is the large variation in light intensities to which plants are subjected; e.g. with changing cloud cover or with light flecks on forest floors, light intensity can vary by a factor of 10³ within seconds and plants must be able to cope with this stress (see Fig. 1.2.2 and Chap. 2.4, Fig. 2.4.9).

Summary

1. Light is the indispensable precondition for all plant life. Plants adapt to light intensities at all levels of organisation, from the molecular to the morphological, as light environments vary on earth not only in regions, but also in time. Continuously changing light conditions, or extremely low or high light intensities, together with other stressors, for example, lack of water, heat or cold, are particularly challenging to plants. Plants in those environ-

ments display very dynamic, adaptive behaviour.

2. The stressor “weak light” means lack of energy. Plants have adapted to this situation by developing different life forms (lianas, epiphytes as light parasites) and by adjusting the positions of their leaves (positive phototropic reaction). A weakly developed mesophyll, but very large stacks of thylakoids in chloroplasts, are features of the anatomical and ultrastructural design of shade leaves. Shade leaves are characterised at the molecular level by a relatively low density of PS II reaction centres, but a correspondingly large area of antenna complexes.
3. Stress through high light intensity damages plants acutely because of over-excitation and formation of chemical radicals. These radicals easily react with oxygen to form reactive oxygen species (ROS). ROS destroy membranes, including proteins and other components (e.g. chlorophyll). Plants possess detoxification systems for ROS (see [Chap. 1.3.5.3](#)).
4. Because of the very substantial damage arising from over-excitation, there are many different mechanisms for avoidance and adaptation. Adaptation at the morphological level is explained in Chapter 2 “Autoecology”. Many plants deal with high light energy by reactions which alter the position of the leaf. These positions may be permanent or dynamic. Sun leaves have a highly developed mesophyll, often with several layers of palisade cells. Chloroplasts are able to position themselves on the sides of the cell according to the light intensity, moving from the position with the stronger to the weaker radiation, and vice versa. The thylakoid system of sun leaves is not well developed, but consists of many photosynthetic reaction centres and a smaller antenna area (particularly the LHC II is more weakly developed). Dissociation of peripheral antenna from PS II, and a partial association with PS I, is often observed, resulting in a better balanced electron flow.
5. At the biochemical level strong light produces a change in the rate constant of energy flow in favour of heat (non-photochemical quenching). If this mechanism does not suffice, the absorbed light energy is disposed of via zeaxanthin, which is produced in the xanthophyll cycle from violaxanthin. At the same time, particularly because of closed stomata in heat or drought, light energy is dissipated with the help of photorespiration. This process produces CO₂ which is then photosynthetically assimilated.
6. If energetisation still exceeds the capacity of these quenching systems, D1, one of the core proteins of PS II, is degraded. The resulting inhibition of photosynthesis is reversible as long as the capacity of the specific repair system, the “D1 cycle”, is sufficient. This reversible inhibition is called photoinhibition. If strain on the D1 cycle is persistent, “photodestruction” occurs with strong bleaching of the chloroplast.
7. Light energy can also be absorbed by pigments in the epidermis, as well as by the photosynthetic apparatus. Light can be reflected by the surface of the epidermis. A hairy tomentum can increase the proportion of reflected light.

1.2.2

UV Radiation

Recommended Literature

- Gyula P, Schäfer E, Nagy F (2003) Light perception and signalling in higher plants. *Curr Opin Plant Biol* 6:446–452
- Jansen MAK, Gaba V, Greenberg BM (1998) Higher plants and UV-B radiation: balancing damage, repair and acclimation. *Trends Plant Sci* 3:131–135
- Short FT, Neckles HA (1999) The effects of global climate change on seagrasses. *Aquatic Botany* 63:169–196
- Stratmann J (2003) Ultraviolet-B radiation coopts defense signaling pathways. *Trends Plant Sci* 8:526–533

Ultraviolet radiation coming from the sun is divided into three ranges: The long wave UV-A (315–400 nm), the biologically effective UV-B (280–315 nm) and the even shorter wavelength and therefore particularly energy-rich UV-C (100–280 nm). The atmospheric ozone layer absorbs very little UV-A, a considerable amount of UV-B and all the UV-C. Therefore, the population of the world is currently very concerned about the **ozone hole**, i.e. the decrease in stratospheric ozone concentration particularly in the polar and subpolar regions ([Fig. 1.2.12](#)).

It should, however, be realised that, because of the sun’s position above the equator, solar radiation crosses the atmosphere in regions of high geographical latitude at an angle and thus

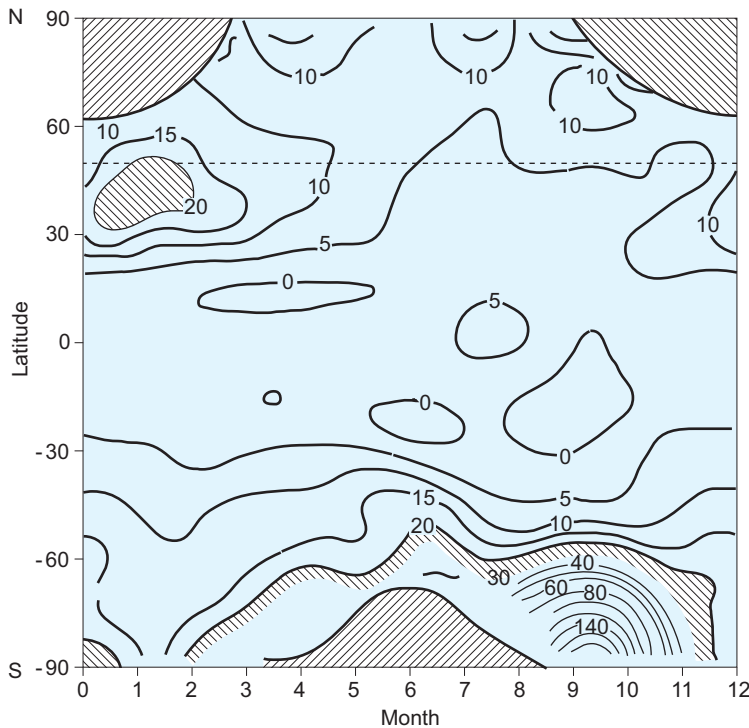


Fig. 1.2.12. UV-B radiation and the “ozone hole.” The trends in daily UV dose (in DNA destruction units) in % for a 10-year period in different geographical latitudes and throughout the year are shown. (Zellner 1996)

encounters a considerably “thicker” ozone layer than at the equator, where it takes the shortest path through the atmosphere. The UV radiation is thus relatively high in the tropics and relatively low in polar regions. The higher intensity of UV radiation with increasing elevation above sea level is also known. This is caused by an attenuation of the tropospheric ozone layer as well as by a decrease in the intensity of haze.

UV radiation may damage cells and so is dangerous to organisms (Table 1.2.2); its intensity is therefore often not given as the flux of quanta, but in units expressing the damaging effects, e.g. as **DNA thymine dimerisation** or erythema formation (reddening of skin, sunburn). There is consensus that plants may suffer UV damage; thus the debate is how much UV radiation is tolerated by plants, or the extent to which damage can be repaired. Scientists vary considerably in their opinions. The phytoplankton of cooler seas appears to be particularly susceptible and significant reduction in their mass has been repeatedly shown, despite the shallow depth to which UV light penetrates into a body of water (Fig. 1.2.13). The effect of increased UV-B radiation on the growth and yield of food plants has been extensively studied. Significant differences in sensitivity of various cultivars, e.g. of soya bean or maize, have been shown. Decreased yields

Table 1.2.2. Physiological effects of increased UV-B radiation

DNA damage	Dimerisation of thymine; breakage of strands
Biomembranes	Lipid peroxidation
Photosynthetic apparatus	Inactivation of PS II; acceleration of the turnover of D1 (and D2?); damage to thylakoid membranes; bleaching of pigments; decrease in the activity of photosynthetic enzymes (particularly Rubisco); inactivation of photosynthetic genes
Phytohormones	Photooxidation of auxin
UV avoidance:	
Secondary metabolism	Activation of the UV-B/blue light receptors; activation of expression of the key genes of phenylpropane metabolism and accumulation of flavonoids; accumulation of alkaloids, waxes and polyamines
Radical scavengers	Increased capacity of the antioxidative system (ascorbate peroxidase, SOD, glutathione reductase, and others)

have been statistically established occasionally, but the reductions were relatively small (usually <10%). For sensitive species, the onset of flowering was delayed. However, by harvest, this delay was usually balanced out. For a long-day plant (*Hyoscyamus niger*, henbane), UV even stopped the induction of flowering.

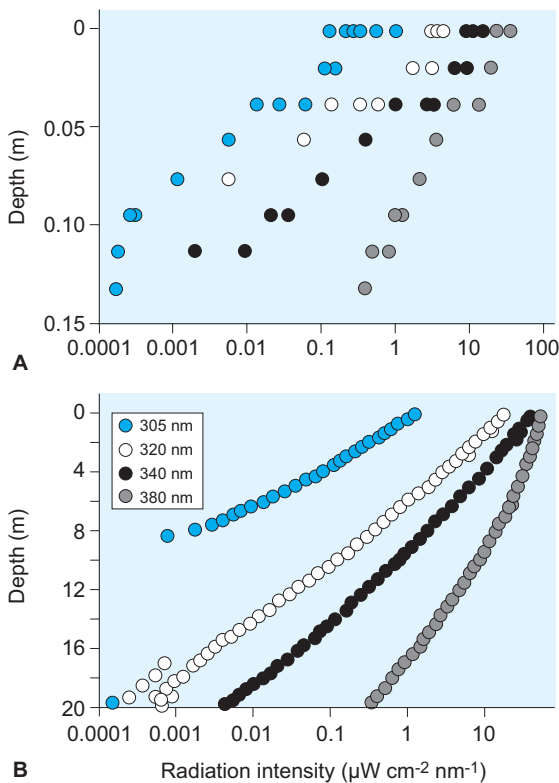


Fig. 1.2.13. Decrease in UV radiation with depth of water. **A** In the humin-rich Lake Neusiedler (Austria) and **B** in the northern Adriatic. Both measurements were made on a cloud-free August day. The intensity of UV radiation at a depth of 5 cm in Lake Neusiedler corresponds approximately to a depth of 5 m in the Adriatic. (Herndl 1996)

1.2.2.1

UV-B Damage and Its Repair

Recommended Literature

- McCullough AK, Dodson ML, Lloyd RS (1999) Initiation of base excision repair: glycosylase mechanisms and structures. *Annu Rev Biochem* 68:255–285

Morphological-anatomical symptoms of a UV-B stress that is still tolerated are swollen but shorter internodes, smaller leaves with the edges usually rolled in at the top surface, and increased growth of lateral buds (Ballaré et al. 1996). Leaves tend to be succulent, have a particularly thick, usually pigmented epidermis and low density of stomata. Tolerated UV stress often results in accumulation of vitamin C and soluble sugars in fruits, thus increasing the quality of foods.

The damage caused to organisms by UV radiation is undisputed, but there is considerable discussion about if – and to what extent – damage is caused by this radiation in the open field (Searles et al. 2001). Contradictory results could have methodological causes, e.g. the relative proportions of UV-B and PAR or the use of plant species differing in sensitivity. The main reason for different scientific statements is the type and dosage of UV radiation. Often, because of the experimental limitations, the increased UV radiation is applied as a pulse, with unnaturally high intensity, to compensate for the short duration of exposition. The same stressful radiation may be applied using long-term, slightly increased amounts of radiation, but completely different physiological reactions (strain) result. With the UV stress applied in short pulses, the damage, and its possible repair, are the dominant effects, whilst continuous but low-intensity stress leads to hardening and avoidance (e.g. by protective pigments). Table 1.2.2 shows the various physiological reactions of plants to UV-B stress. The effects of UV-B on DNA have been particularly well studied, namely the dimerisation of thymine, where cyclobutyl pyrimidine dimers or 4,6-thymine dimers are formed.

Higher doses of UV lead to breakage of single or double strands of DNA and finally to loss of DNA. Naked DNA of mitochondria and probably also of the chloroplasts is particularly sensitive. UV radiation of yeast cells caused a 10% loss of nuclear DNA, but at the same time a 50–60% loss of mitochondrial DNA.

There are several mechanisms to repair such damage, of which two are mentioned here: photolyase, and base excision and recombination reactions. DNA of mitochondria can also be repaired if the damage is not too severe. Repair usually takes only a few hours. Strong UV stress, however, leads directly to irreparable chromosome breakage and deletions; this is the basis for sterilisation of rooms and instruments with intense UV light.

In addition to the damage to DNA, photooxidation of UV-absorbing pigments is known: Yellowing and complete bleaching of leaves of house plants after abrupt transfer to the open air are frequent phenomena. Here, the protective effect of photosynthetic pigments which absorb short-wave radiation like proteins can be seen. Photodestruction of thylakoid pigments leads to a significant reduction of the Rubisco content.

1.2.2.2 UV Detection

In plants and animals UV radiation triggers protective reactions which means that these organisms must possess photoreceptor systems for detecting this radiation. It is known that plants have a sensor for UV-B and two further sensors (cryptochrome or phototropin 1 and 2) for UV-A/blue light, which cooperate with the phytochrome system, i.e. they determine the sensitivity of the plant for visible and UV light (Ballaré 1999; Fig. 1.2.14).

Signal transduction chains from the UV-A/blue light and UV-B receptors possibly react only with the signal from phytochrome A, i.e. from that phytochrome form which accumulates in seeds and controls germination, for example. In addition to the morphogenetic effects mentioned above, the effects of UV radiation on me-

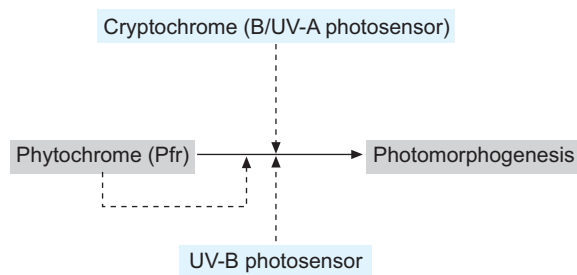


Fig. 1.2.14. Model of the interaction between phytochrome and the blue/UV-light receptor. Activation of the blue/UV-light sensor regulates the sensitivity of the photo-response to activate phytochrome (Pfr). Pfr itself can autocatalytically increase the efficiency of the phytochrome system. (Mohr 1996, see also Elliott et al. 2004)

tabolism, particularly on **secondary metabolism**, have also been studied in detail. Products of **phenylpropane metabolism** exhibit strong absorbance of short-wave irradiation and are thus able to function as effective UV filters. Also, the anthocyanins (Fig. 1.2.15), mentioned above, are protective pigments because they absorb visible as well as UV light.

The key enzyme of the phenylpropane metabolism (Box 1.2.4, Fig. 2) is chalcone synthase (CHS), whose formation is strongly induced by UV-B as well as UV-A/blue light. Both wavebands of light achieve their effects via the Ca^{2+} -dependent signal transduction pathways. Upon UV stress, calcium is released from cellular stores. However, the transduction pathways differ in their degrees of dependence on calcium.

1.2.2.3 Avoidance of UV-B Stress and Development of UV-B Resistance

Research with pine needles and beech leaves has shown that, in addition to the various flavonoids formed constitutively and independently of UV, there are other related compounds in the epidermis. For example, after UV-B radiation, the concentration of 3'', 6''-DCA and 3'',6''-DCI (=3'',6''-di-*para*-coumaroylstragalol and 3'',6''-di-*para*-coumaroylquercetin) for pines, as well as 2'',2''-di-*para*-coumaroylkaempferol-3*a*-D-arabinoside for beech had risen five-fold (Table 1.2.3; Figs. 1.2.16 and 1.2.17).

Compounds which can be induced by UV are exclusively located in the epidermis, while those

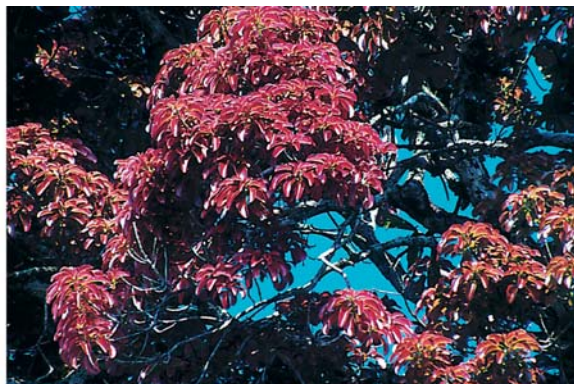


Fig. 1.2.15. Anthocyanins in the young leaves of the tropical Sapotaceae *Inhambanella henriquesii* in the coastal forests of Kenya. The anthocyanin is contained in the vacuoles of the leaf epidermis and protects the leaves, which are not yet fully green, from radiation damage. The close-up (right) clearly shows the mixture of colours between the red anthocyanins and the chlorophyll. (Photo E. Beck)

Box 1.2.4 Plant phenols

A large number of the phenolic compounds formed by plants are synthesised by the so-called shikimate pathway named after the characteristic intermediate shikimic acid. The

second aromatic ring of the C₁₅-derived phenylpropane derivatives (flavonoids) results from the condensation of three acetyl residues from malonyl-CoA (Fig. 1).

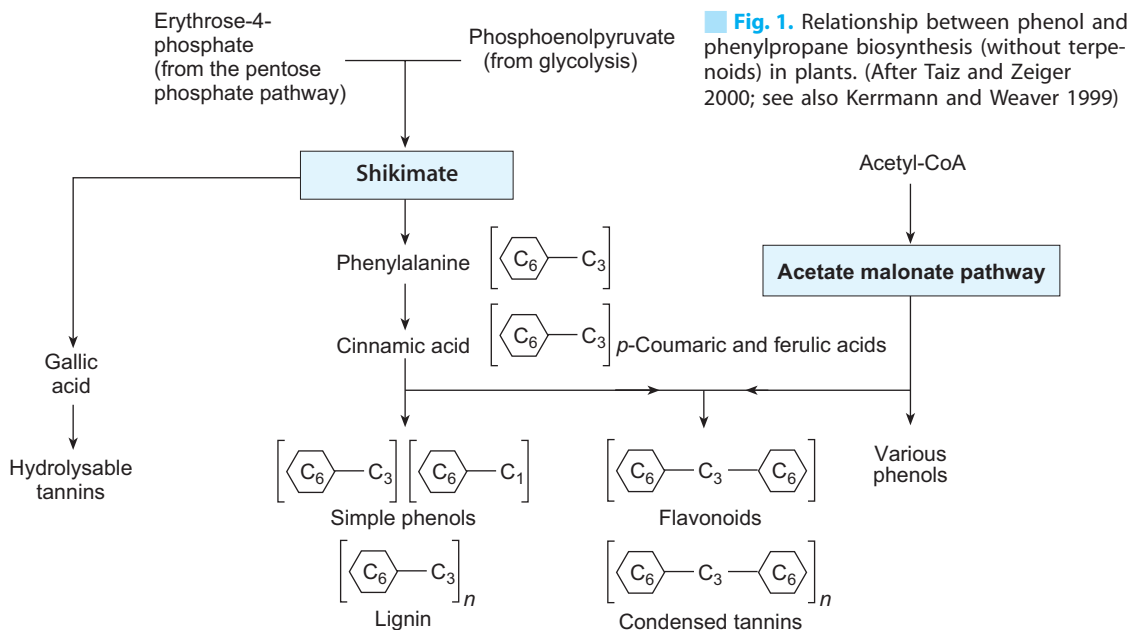


Fig. 1. Relationship between phenol and phenylpropane biosynthesis (without terpenoids) in plants. (After Taiz and Zeiger 2000; see also Kerrmann and Weaver 1999)

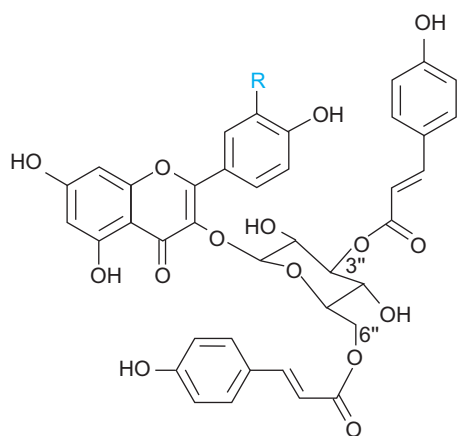
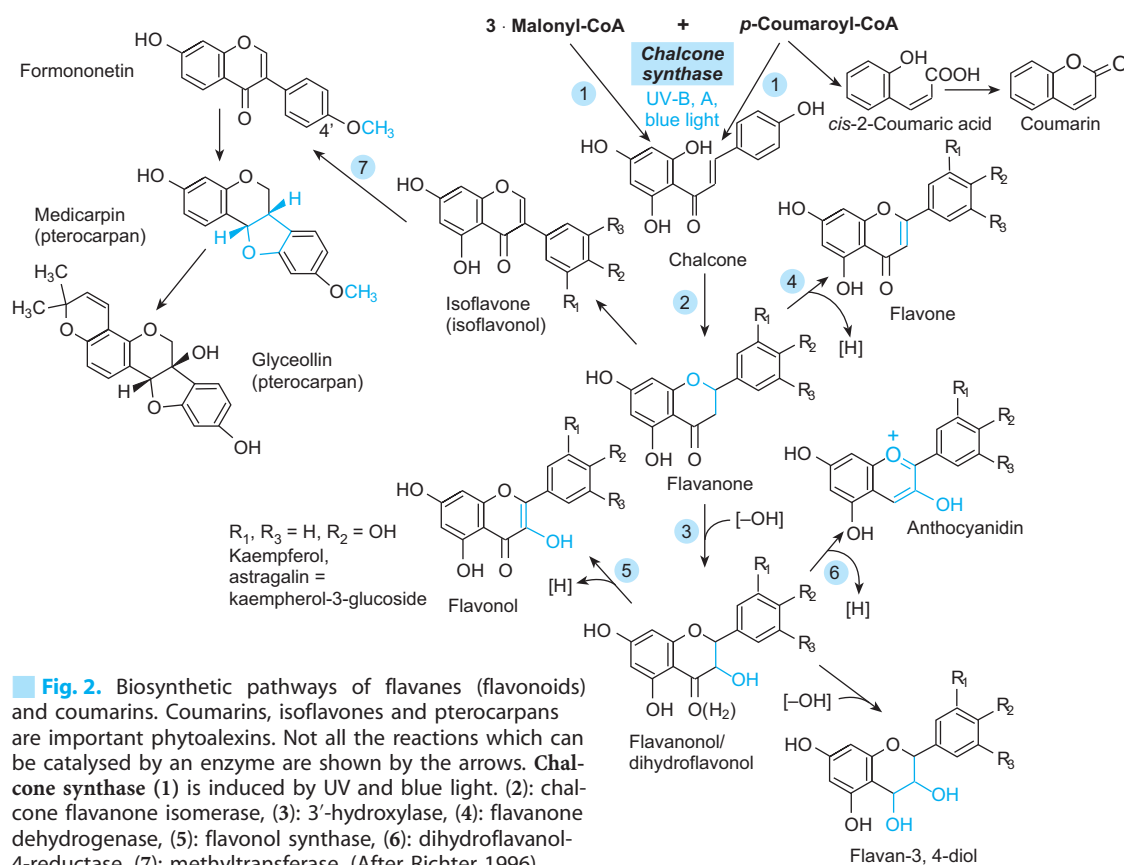
Table 1.2.3. Calculated concentrations and shielding effects of UV-B-absorbing pigments in the epidermis of needles of pine seedlings. The volume of the epidermis (ca. 104 μl/g fresh weight) was calculated from the needle surface and the mean thickness of the epidermis. The absorption at 300 nm, and the corresponding value of transmission, were calculated using the Lambert-Beer law. (After Schnitzler et al. 1996)

	Control needles			UV-irradiated needles		
	Concentration (mM)	Total absorption at 300 nm (%)	Transmission at 300 nm (%)	Concentration (mM)	Total absorption at 300 nm (%)	Transmission at 300 nm (%)
Cell wall-bound pigments						
<i>p</i> -Coumaric acid	13.4	7.9	30.8	13.0	6.1	31.8
Ferulic acid	1.6	1.2	83.9	1.9	1.1	81.5
Astragalol	16.7	10.7	20.1	19.1	9.8	15.9
Lignin	6.5	1.2	83.6	6.5	0.9	83.5
Sum	–	21.0	4.3	–	17.9	3.45
Soluble pigments (vacuole)						
Diacylated flavonoids	35.4	79.0	0.0007	46.1	82.1	0.00002
All pigments	–	100.0	0.00003	–	100.0	0.000009

that are formed constitutively are distributed throughout the mesophyll. The non-conjugated (*p*-coumaric acid) phenylpropanes are localised in the epidermal cell wall, while the conjugates are mainly sequestered into the vacuoles of these

cells (Fig. 1.2.17). The anthocyanin accumulation induced during leaf flushing by tropical trees (see Fig. 1.2.15) takes place in the vacuoles of the epidermal cells.

Box 1.2.4 Plant phenols (continued)



3'',6''-di-*p*-cumaroylastragalins (DCA; R=H) and 3'',6''-di-*p*-cumaroylisoquercitrins (DCI; R=OH)

Fig. 1.2.16. 3'',6''-Di-*p*-cumaroylastragalins (R=H) and 3'',6''-di-*p*-cumaroylisoquercitrins (R=OH) as examples of diacylated flavonoids (see Table 1.2.3)

However, the particularly effective UV absorbers *p*-coumaric acid and astragalins are deposited in the cell wall. It is estimated that the outer cell walls of the epidermis allow about 4% of the UV-B to pass through. Diacylated flavonoids, dissolved in the cell, are able to filter out the residual UV-B radiation because of their greater absorbing capacity.

It is likely that plants with low or even no capability of synthesising such protective pigments are UV-sensitive. Other types of protective pigments, belonging to the class of mycosporines, are found in phytoplankton and other marine algae; they are not degraded in the nutritional chain and provide organisms of the next trophic level with a certain degree of UV protection.

In addition to flavanoid metabolism, other enzymes producing or activating radical acceptors are formed: Glutathione reductase, ascorbate- and glutathione-peroxidase.

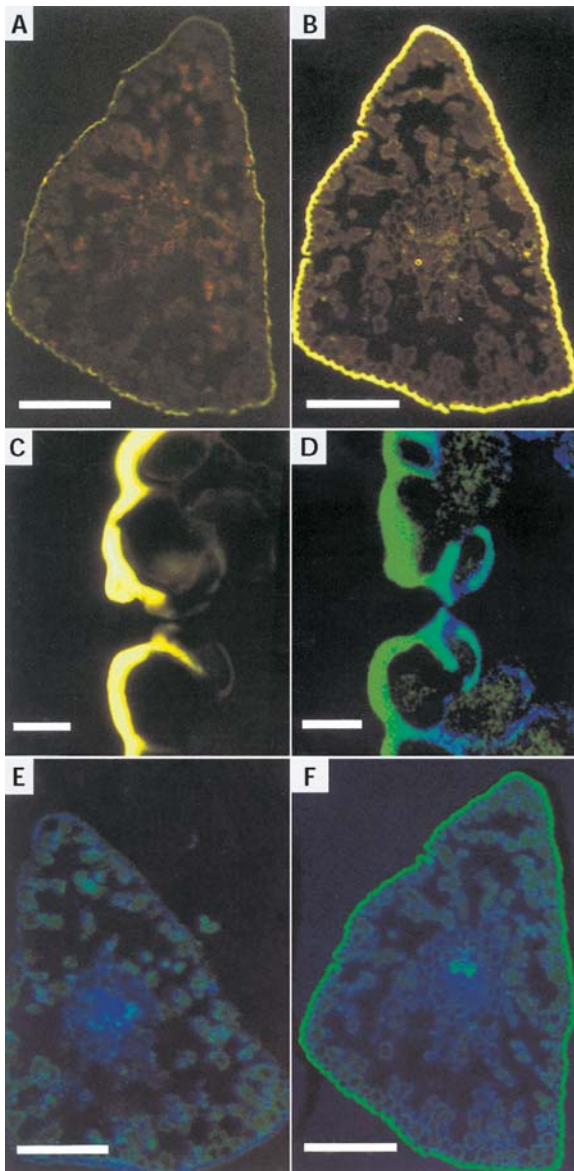


Fig. 1.2.17. Histochemical evidence for UV-absorbing substances in the epidermis of pine needles. **A–C** Fluorescence (excited by light of 450–490 nm wavelength, determined at $\lambda > 520$ nm); **A** control, **B** and **C** after treatment with a reagent which intensifies flavonoid fluorescence. **D–F** Observation with a confocal laser microscope (which shows the cells and their contents more clearly). **E** control, **D** and **F** after staining as above. **A, B, E, F** Transverse section of a needle, **C, D** stomata. (After Schnitzler et al. 1996)

Summary

1. The ultraviolet spectrum is divided according to the energy content of the radiation (wavelength); UV-C (100–280 nm), UV-B (260–315 nm) and UV-A (315–400 nm). The shorter the wavelength of the UV radiation, the

stronger is its destructive effect, but the more it is absorbed by atmospheric ozone. UV-C is completely absorbed when passing through the atmosphere; UV-A does not damage most organisms. The biologically effective UV light is UV-B.

2. Strong UV-B radiation damages plants, particularly DNA (breakage of strands and deletions) of nuclei, chloroplasts and mitochondria, and also damages the photosynthetic apparatus (bleaching of photosynthetic pigments, destruction of photosynthetic enzymes). The strength of UV radiation required to produce such damage probably does not occur in nature or only in extreme cases. Organisms have very efficient repair systems, particularly for damaged DNA.
3. Tolerable UV-B radiation is morphologically effective: thickening and shortening of internodes, reduced growth in area but increased thickness of leaves, increased growth of side shoots.
4. At the biochemical level, UV leads to increased phenylpropane metabolism and the formation of UV-absorbing protective pigments in the epidermis, and to increased detoxification systems for ROS.
5. Plants possess a UV-B receptor and at least two UV-A/blue light receptors (cryptochromes). These receptors cooperate with the phytochrome system.

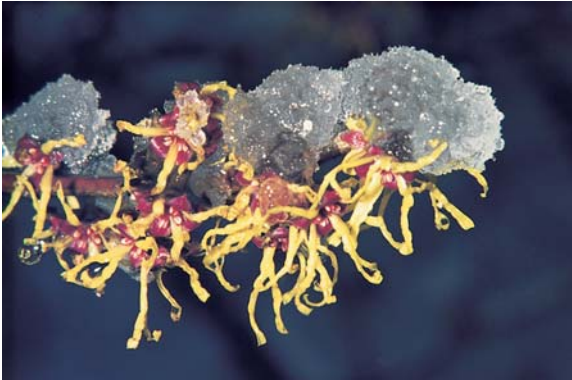
References

- Anderson JM, Andersson B (1988) The dynamic photosynthetic membrane and regulation of solar energy conversion. *Trends Biochem Sci* 13: 351–355
- Ballaré CL (1999) Keeping up with the neighbours: phytochrome sensing and other signalling mechanisms. *Trends Plant Sci* 4:97–102
- Ballaré CL, Scopel AL, Stapleton AE, Yanovsky MJ (1996) Solar ultraviolet-B radiation affects seedling emergence, DNA-integrity, plant morphology, growth rate, and attractiveness to herbivore insects in *Datura ferox*. *Plant Physiol* 112:161–170
- Björkman O, Demmig-Adams B (1994) Regulation of photosynthetic light energy capture, conversion, and dissipation in leaves of higher plants. *Ecological studies* 100. Springer, Berlin Heidelberg New York, pp 17–47
- Björkman O, Powles SB (1981) Leaf movement in the shade species *Oxalis oregana*. I. Response to light level and light quality. *Carnegie Inst Wash Yearb* 80:59–62
- Elliott RC, Platten JD, Watson JC, Reid JB (2004) Phytochrome regulation of pea phototropin. *J Plant Physiol* 161:265–270
- Hall DO, Rao KK (1994) *Photosynthesis*. Cambridge University Press, Cambridge

- Heldt HW (1999) Pflanzenbiochemie. Spektrum Akademischer, Heidelberg
- Herndl GH (1996) Ultraviolett-Strahlung und Bakterioplankton. *Biol Unserer Zeit* 26:234–239
- Jiao S, Emmanuel H, Guikema JA (2004) High light stress inducing photoinhibition and protein degradation of photosystem I in *Brassica rapa*. *Plant Science* 167:733–741
- Kerrmann KM, Weaver LM (1999) The shikimate pathway. *Annu Rev Plant Physiol Plant Mol Biol* 50:473–504
- Larcher W (1994) Ökophysiologie der Pflanzen. UTB, Eugen Ulmer, Stuttgart
- Mohr H (1996) Sind Landpflanzen durch erhöhte UV-Strahlung besonders gefährdet? *Biol Unserer Zeit* 26:240–244
- Nultsch W (1996) Allgemeine Botanik. Thieme, Stuttgart
- Osmond B, Badger M, Maxwell K, Björkman O, Leegood R (1997) Too many photons: photorespiration, photoinhibition and photooxidation. *Trends Plant Sci* 2:119–120
- Richter G (1996) Biochemie der Pflanzen. Thieme, Stuttgart
- Schäfer C, Björkman O (1989) Relationship between efficiency of photosynthetic energy conversion and chlorophyll quenching in upland cotton (*Gossypium hirsutum* L.). *Planta* 178:367–376
- Schäfer C, Schmid V (1993) Pflanzen im Lichtstress. *Biol Unserer Zeit* 23:55–62
- Schnitzler JB, Jungblut TP, Heller W, Köfferlein M, Hutzler P, Heinzmann U, Schmelzer E, Ernst D, Langebartels C, Sandermann H Jr (1996) Tissue localization of UV-B-screening pigments and of chalcone synthase mRNA in needles of Scots Pine seedlings. *New Phytol* 132:247–258
- Schreiber U, Bilger W, Neubauer C (1994) Chlorophyll fluorescence as a noninvasive indicator for rapid assessment on in vivo photosynthesis. *Ecological studies* 100. Springer, Berlin Heidelberg New York, pp 17–47
- Searles PS, Flint SD, Caldwell MM (2001) A meta-analysis of plant field studies simulating stratospheric ozone depletion. *Oecologia* 127:1–10
- Sonoike K (1996a) Photoinhibition of photosystem I: 1st physiological significance in the chilling sensitivity of plants. *Plant Cell Physiol* 37:239–247
- Sonoike K (1996b) Degradation of psaB gene product the reaction center subunit of photosystem I, is caused during photoinhibition of photosystem I: possible involvement of active oxygen species. *Plant Sci* 115:157–164
- Strasburger F (1983) Lehrbuch der Botanik. Fischer, Stuttgart
- Taiz L, Zeiger E (2000) Physiologie der Pflanzen. Spektrum Akademischer, Heidelberg
- Tolbert NE (1994) Role of photosynthesis and photorespiration in regulating atmospheric CO₂ and O₂. In: Tolbert NE, Preiss J (eds) Regulation of atmospheric CO₂ and O₂ by photosynthetic carbon metabolism. Oxford University Press, Oxford, pp 8–33
- Walker D (1992) Energy plant and man. Packard, Brighton
- Zellner R (1996) Stratosphärischer Ozonabbau: Ausmaß, Ursachen und Folgen. *Biol Unserer Zeit* 26:209–214

1.3

Temperature



Winter flowering: The shrivelled petals of the witch hazel (*Hamamelis virginiana*) clearly show the effects of water loss from the cells caused by frost. As a consequence of the low average temperatures, the flowers of the North American or Japanese (*H. mollis*) witch hazel persist for many months. Witch hazel does not tolerate extreme cold and dryness, but is well adapted to the moderate winters of central Europe, where it is much prized as an ornamental shrub. Its green leaves in summer are like those of hazel. Photo K. Liedl, Munich

Recommended Literature

- Allen DJ, Ort DR (2001) Impacts of chilling temperatures on photosynthesis in warm-climate plants. *Trends Plant Sci* 6:36–42
- Apel K, Hirt H (2004) Reactive oxygen species: metabolism, oxidative stress, and signal transduction. *Annu Rev Plant Biol* 55:373–399
- Hoffmann WA, Orthen B, Nascimento PKV (2003) Comparative fire ecology of tropical savanna and forest trees. *Functional Ecology* 17:720–726
- Körner Ch (1999) Climatic stress. In: *Alpine plant life*. Springer, Berlin Heidelberg New York, chap 8
- Larcher W (2003) *Physiological plant ecology*, 4th edn (chapter: Plants under stress). Springer, Berlin Heidelberg New York, pp 345–450
- Taiz L, Zeiger E (2002) (eds) *Plant physiology*, 3rd edn (chapter: Stress physiology). Sinauer Associates, Sunderland, MA, USA
- Thomashow MF (2001) So what's new in the field of plant cold acclimation? Lots! *Plant Physiol* 125:91–95
- Xin Z, Browse J (2000) Cold comfort farm: the acclimation of plants to freezing temperatures. *Plant Cell Environ* 23:891–907

1.3.1

Temperature Ranges and Temperatures Limiting Life

For many organisms temperature limits for active life can be determined, as well as those beyond which life is no longer possible. Before an organism reaches lethal temperatures of heat or cold, it usually falls into a “rigid” or “stiff” condition in which the active processes of life only occur at minimal, hardly measurable rates without lethal damage. This is termed the “condition of latent life”. The stages of cold death, cold rigidity, range of active life, heat rigidity and heat death are designated as the **cardinal points of temperature tolerance**. These differ in their totality from species to species (see [Fig. 1.1.3](#)), whereby different cardinal points can be exhibited even among the individual tissues and organs of a single plant. Active life is quite generally dependent on the temperature range of liquid water. Hydrated plant tissues thus have cardinal points which are closer together than those of dry plant tissues (e.g. seeds or plants resistant to drying out – poikilohydric plants). [Tables 1.3.1](#) and [1.3.2](#) show some examples. Limiting temperatures, however, are not decisive for the growth and development of a plant, but

Table 1.3.1. Maximum temperature resistance of microorganisms and poikilohydric plants in the turgescient state and in the rigid states caused by drought. (Larcher 2003)

Plant group	Cold damage ^a at °C		Heat damage ^b at °C	
	Moist	Dry	Moist	Dry
Bacteria				
Archaeobacteria			100–110	
Cyanobacteria and other photo- autotrophic bacteria			55–75	
Saprophytic bacteria			60–70	
Thermophilic bacteria			Up to 95	
Fungal fruiting bodies				
Bacterial spores		LN ₂ ^c	80–120	Up to 160
Fungi				
Plant pathogenic fungi			45–65 (70)	
Saprophytic fungi	0 to below –10		40–60 (80)	75–100
Fungal fruiting body	–5 to –10 (–30)			
Fungal spores		LN ₂	50–60 (100)	Above 100
Algae				
Marine algae				
Tropical seas	+14 to +5 (–2)		32–35 (40)	
Temperate seas				
Eulitoral	–2 to –8		25–30	
Tidal zones	–8 to –40		30–35	
Polar seas	–10 to –60		(15)20–28	
Fresh water algae	–5 to –20 (–30)		35–45 (50)	
Airborne algae	–10 to –30	LN ₂	40–50	
Eukaryotic thermal algae	+20 to +15		40–50	
Lichens				
Polar regions, high mountains, deserts	–80	LN ₂		
Temperate climate zones	–50	LN ₂	33–45	70–100
Mosses				
Humid tropics	–1 to –7			
Temperate zone				
Humid locations	–5 to 15		40–45	
Ground mosses in forests	–15 to –25		40–50	80–95
Epiphytic and epipetric mosses	–15 to –35	LN ₂		100–110
Polar regions	–50 to –80	LN ₂		
Poikilohydric ferns	–20	LN ₂	47–50	60–100
Seed plants				
<i>Ramonda myconi</i>	–9	LN ₂	48	56
<i>Myrothamnus flabellifolia</i>		LN ₂		80

^a After at least 2 h of exposure to cold^b After 30 min of heat treatment^c Temperature of liquid nitrogen (–196 °C)

rather the temperature range of active life is. Plants are much more similar in this respect than they are with regard to their limiting temperatures. Day temperatures (air temperatures) of between 15 and 25 °C and night temperatures of about 10 K lower are, on average, optimal for plant growth. Organisms inhabiting extreme locations, such as snow and ice algae (*Haematococcus pluvialis*, and various Diatomeae) with a life range of between +5 and –5 °C or cyanobacteria and bacteria living in geysers or in the

black smokers of the deep sea with optimal temperatures of between +80 and above 100 °C, are exceptions.

Types of organisms constitutively adapted to cold are called **psychrophiles** and those requiring high temperatures are called **thermophiles** (or extreme thermophiles), but most organisms are **mesophiles**.

Not all life processes of a plant have the same optimal temperatures. The temperature requirements of these processes must be adapted to the

Table 1.3.2. Temperature resistance of the leaves of cormophytes from various climate zones. The data quoted correspond to the limiting temperatures causing 50% damage (TL_{50} in °C) after at least 2 h of exposure to cold or after 30 min of heat treatment. (After Larcher 2003)

Plant group	Cold damage in hardened state	Heat damage during vegetative period
Tropics		
Trees	+5 to -2	45–50
High mountain plants	-5 to -15 (-20)	about 45
Subtropics		
Evergreen woody plants	-8 to -12	50–60
Palms	-5 to -14	55–60
Succulents	-5 to -10 (-15)	58–67
C4 grasses	-1 to -5 (-8)	60–64
Winter annual desert grasses	-6 to -10	50–55
Temperate zones		
Evergreen woody plants of mild winter coastal areas	-7 to -15 (-25)	46–50 (55)
Dwarf shrubs of Atlantic heathlands	-20 to -25	45–50
Summer green trees and shrubs	(-25 to -35) ^a	about 50
Herbaceous plants		
Sunny sites	-10 to -20 (-30)	47–52
Shady sites	-10 to -20 (-30)	40–45
Halophytes	-10 to -20	
Water plants	-5 to -12	38–44
Homeohydric ferns	-10 to -40	46–48
Winter cold areas		
Evergreen conifers	-40 to -90	44–50
Boreal deciduous trees	(to LN ₂)*	42–45
Arctic-alpine dwarf shrubs	-30 to -70	48–54

^a Vegetative buds

conditions under which the individual steps of development take place. This can be illustrated by the example of germination in contrast to growth and development. Seeds which germinate in the autumn or winter (such as those of winter cereals) do so at temperatures that are considerably lower than those relevant for germination in the spring or summer. Independently of the temperature range in which germination is possible, the rate of germination itself shows the typical temperature dependence of biological processes (Q_{10} between 1.5 and 2.5; see Chap. 1.3.2). Such germination behaviour can be modified by inhibitory mechanisms (e.g. the requirement for a prolonged exposure of imbibed seeds to cold – **stratification** – or the fire-dependent opening of seeds in **pyrophytes**), which prevent premature germination at unfavourable times.

Frost represents a long-term stress situation in contrast to, for example, fire, and can last for hours, days and even months. Frost acts not only as a temperature stress, but primarily as a drought stress due to the freezing of tissue water. Plants undergo a process of hardening during the advent of the colder season or in the presence of permanent frost during their juve-

nile development. This enables them to withstand even the sometimes extremely severe frosts which occur in nature (air temperatures as low as -70°C have been recorded in Siberia).

Temperature stress does not occur only in extreme locations, and plants can be subjected to large ranges of temperature even during the course of a “normal” day (see Chap. 2.1, section on radiation climate). Temperatures of above $+50^{\circ}\text{C}$ occur frequently at the immediate surface of the soil during extended periods of solar irradiation, particularly if there is no plant growth and the soil is dark and thus reflects little of the incident sunlight. However, air temperature decreases rapidly with the distance from the soil surface, and the temperature gradient within the soil itself is even steeper (see Figs. 4.3.2 and 2.1.6). Whereas an air temperature of $+40^{\circ}\text{C}$ was measured about 10 cm above soil exhibiting a surface temperature of $+50^{\circ}\text{C}$, the soil temperature at a depth of 10 cm was below 25°C (see Fig. 2.1.6). Temperature gradients within the soil and within the surface-near air layer also occur on clear nights, whereby their direction is reversed and their amplitude is of a lesser magnitude. Cooling of surfaces to tempera-

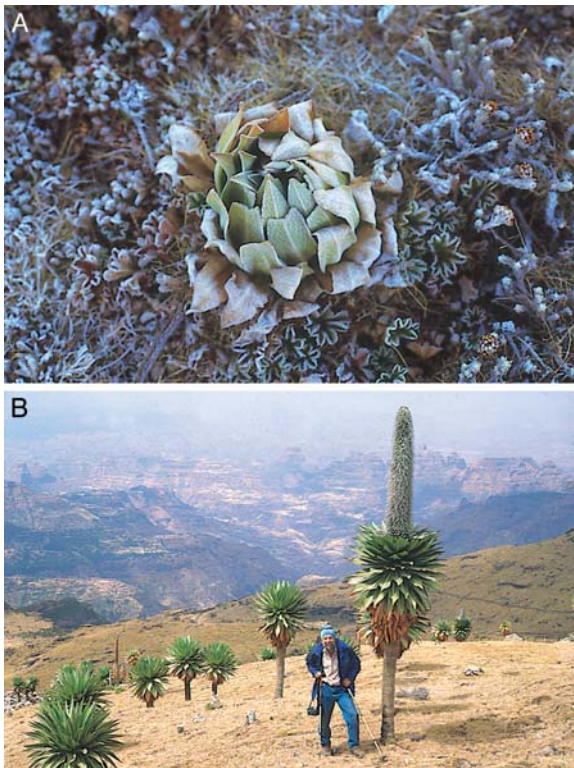
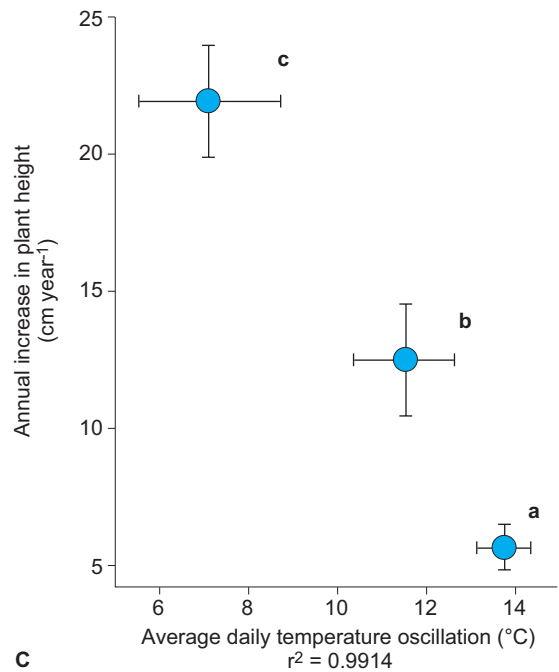


Fig. 1.3.1. Influence of the microclimate on the growth of *Lobelia rhynchopetalum* in the Ethiopian Highlands. **A** Night ground frosts (hoar frost on the leaves) stimulate the plant to form “night buds” (cf. Chap. 1.3.6.7). **B** The leaf crowns of the specimens which have already developed a trunk are subjected to a considerably milder microclimate, i.e. they are exposed to significantly smaller temperature fluctuations. The rate of growth therefore increases the further the leaf rosette is removed from the soil on the growing trunk (**C**). (After Fetene et al. 1998; photos E. Beck)

tures below that of the air is caused by radiation from all horizontal and sloping areas. This type of heat radiation also occurs during the daytime; the heat gain via absorption of the sun’s rays is then, however, considerably greater than the heat lost through radiation. Young plants situated directly on the soil surface are understandably subjected to greater temperature stress than plants which have formed a stem, and they therefore grow only slowly. As soon as a stem is formed and leaves have grown away from the severe microclimate near the soil surface, the plant’s rate of growth increases considerably (Fig. 1.3.1).



1.3.2

The Temperature Dependence of Biochemical Processes, Q_{10} and Activation Energy

Recommended Literature

- Nelson DL, Cox MM (2005) Lehninger Principles of Biochemistry, 4th edn. Freeman, New York

The rate of reaction of uncatalysed reactions, as well as of enzymatic reactions, depends on temperature.

The measure for the temperature dependency is the so-called Q_{10} (quotient of the rates of reaction at two temperatures differing by 10 K):

$$Q_{10} = \frac{v_{T+10}}{v_T}$$

If the rate constants k_{T_1} and k_{T_2} are inserted instead of the rate of reaction v , the activation energy E_a can be calculated with the following equation:

$$\ln \frac{k_{T_1}}{k_{T_2}} = \frac{E_a}{R} \left(\frac{1}{T_1} - \frac{1}{T_2} \right)$$

The Q_{10} is a readily illustrative measure of the activation energy of a reaction. For enzymatic reactions it is between 1.4 and 2.5, for biophysical processes between 1.03 and 1.3.

An increase in temperature leads to a speeding up, and a decrease in temperature to a slowing down of biological processes.

1.3.3

Temperature and the Stability/Functionality of Biomembranes

1.3.3.1

Influence of Temperature on the Lipid Composition of Biomembranes

In addition to its influence on the rate of metabolism, temperature affects the stability and accordingly also the chemical structure of biomembranes. Active life is absolutely dependent on functional biomembranes. The lipids of these extremely complex structures must be present in a viscous-fluid state for the proteins and protein complexes anchored within them to fulfil their function. The melting point and viscosity of the lipids depend on the length of the component fatty acids and the degree of their unsaturation. The longer the chain length of the fatty acids and the lower the number of double bonds, the higher the melting point is (Box 1.3.1).

Box 1.3.1

Chemical structures and melting points of the fatty acids most commonly found in plant biomembranes

Carbon skeleton	Structure	Common name	Melting point (°C)
16:0	$\text{CH}_3(\text{CH}_2)_{14}\text{COOH}$	Palmitic acid	63.1
18:0	$\text{CH}_3(\text{CH}_2)_{16}\text{COOH}$	Stearic acid	69.6
20:0	$\text{CH}_3(\text{CH}_2)_{18}\text{COOH}$	Arachidic acid	76.5
16:1 (Δ^9)	$\text{CH}_3(\text{CH}_2)_5\text{CH}=\text{CH}(\text{CH}_2)_7\text{COOH}$	Palmitoleic acid	-0.5
18:1 (Δ^9)	$\text{CH}_3(\text{CH}_2)_7\text{CH}=\text{CH}(\text{CH}_2)_7\text{COOH}$	Oleic acid	13.4
18:2 ($\Delta^9,12$)	$\text{CH}_3(\text{CH}_2)_4\text{CH}=\text{CHCH}_2\text{CH}=\text{CHCH}_2\text{COOH}$	α -Linoleic acid	-5.0
18:3 ($\Delta^9,12,15$)	$\text{CH}_3\text{CH}_2\text{CH}=\text{CHCH}_2\text{CH}=\text{CHCH}_2\text{CH}=\text{CH}(\text{CH}_2)_7\text{COOH}$	α -Linolenic acid	-11
20:4 ($\Delta^{5,8,11,14}$)	$\text{CH}_3(\text{CH}_2)_4\text{CH}=\text{CHCH}_2\text{CH}=\text{CHCH}_2\text{CH}=\text{CHCH}_2\text{CH}=\text{CH}(\text{CH}_2)_3\text{COOH}$	Arachidonic acid	-49.5

Table 1.3.3. The effect of growth temperature on the lipid composition of the biomembranes of the cyanobacterium *Synechocystis*. Increasing growth temperature results in a lesser degree of desaturation of the fatty acids. The chemical structures of the individual fatty acid species are shown in Box 1.3.1. X denotes a phospho-component ("phospholipid"). (Murata et al. 1993; Gombos et al. 1996)

Cultivation temperature (°C)		Fatty acid species					
		$\begin{array}{l} \text{---} 16:0 \\ \text{---} 16:0 \\ \text{---} X \end{array}$	$\begin{array}{l} \text{---} 18:1 \\ \text{---} 16:0 \\ \text{---} X \end{array}$	$\begin{array}{l} \text{---} 18:2 \\ \text{---} 16:0 \\ \text{---} X \end{array}$	$\begin{array}{l} \text{---} 18:3\gamma \\ \text{---} 16:0 \\ \text{---} X \end{array}$	$\begin{array}{l} \text{---} 18:3\alpha \\ \text{---} 16:0 \\ \text{---} X \end{array}$	$\begin{array}{l} \text{---} 18:4 \\ \text{---} 16:0 \\ \text{---} X \end{array}$
		Total fatty acid species (%)					
22	2	4	16	42	16	16	
34	16	16	24	34	0	0	

Table 1.3.4. Changes in the composition of the lipids of a defined biomembrane (chloroplast envelope membrane of spruce needles) during the course of frost hardening ("winter") or dehardening ("summer"). (Senser and Beck 1992)

Lipid	Fatty acids (%)	
	16:0+18:0 (+18:1 ^{tr})	16:3+18:1+18:2+18:3+18:4+18:2-hydroxy+20:3
Phospholipids		
Summer	55.4	41.2
Winter	25.6	66.0
Galactolipids		
Summer	33.4	64.4
Winter	9.4	84.8

Organisms are able to adapt the viscosity of their biomembranes to temperature to a certain extent by exchanging certain types of fatty acids for others. This enables metabolism to proceed in an orderly manner upon temperature changes. For example, more saturated fatty acids are incorporated into the membranes upon an increase in temperature (Table 1.3.3).

Changes in lipid composition also take place during frost hardening and dehardening, which can be related to the maintenance of optimal viscosity and functionality of the biomembranes. Here, the viscosity is decreased by increasing the degree of unsaturation of the membrane lipids (Table 1.3.4).

1.3.4

Heat (Hyperthermy)

Recommended Literature

- Scharf K-D, Höhfeld I, Nover L (1998) Heat stress response and heat stress transcription factors. *J Bioscience* 23:313–329
- Sun W, Van Montagu M, Verbruggen N (2002) Small heat shock proteins and stress tolerance in plants. *BBA* 1577:1–9

Heat should be understood here as the upper temperature range in which active life is possible. In this range strain increases with increasing temperature, and there is a direct correlation between the stressor and strain. In addition to this obvious relationship, however, biphasic relations, i.e. discontinuity between stressor and strain, have also been observed. Figure 1.3.2 shows such a stress response for poplar leaves in the month of September. Similar observations have been made for privet and for bindweed. In all three cases, the damage within two different temperature ranges was only observed in late summer, possibly an indication of the transition into the frost-hardening phase. During this stage, there are evidently two temperature ranges in which metabolic flows and metabolic pools are relatively well balanced and therefore no damage occurs. However, this phenomenon must still be studied in more detail.

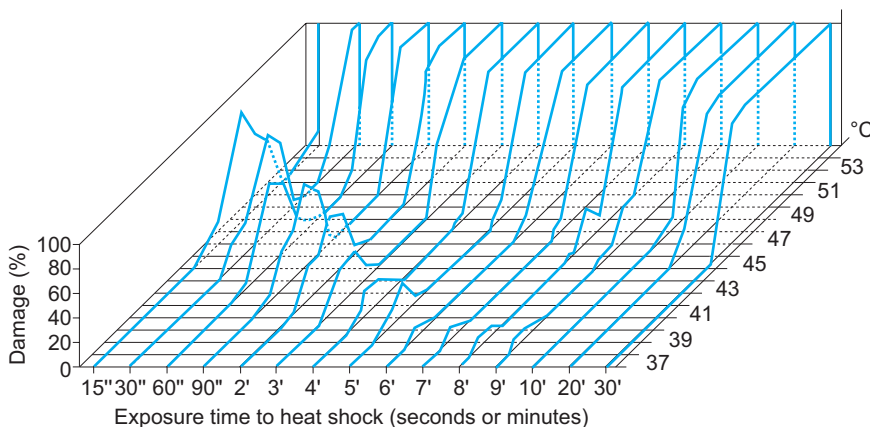


Fig. 1.3.2. Course of heat damage in poplar leaves (*Populus deltoidis* x *simonii*) in dependence on the amount of heat (stress duration × exposure time) during September. The heat treatment corresponded to, in principle, the cold treatments described in Box 1.3.6. Damage was quantified by determining the frequency of necroses (compare Box 1.1.1). (After Kappen and Zeidler 1977)

Box 1.3.2**The effect of heat stress on the growth, tuber formation, carbohydrate level and enzyme activities of a heat-tolerant potato (*Solanum tuberosum*) variety ("Norchip") and a heat-sensitive variety ("Up-to-Date") (Lafta and Lorenzen 1995)**

Both varieties were grown initially at 19/17 °C day/night temperatures and a daily 14-h light period. In experiment 1 the heat stress was applied at the onset of tuber formation (Tables 1 and 2) and in experiment 2 (Table 3) after the

induction of the tubers. The heat stress consisted of raising the temperature from 19/17 °C to 31/29 °C in experiment 1 and to 29/27 °C in experiment 2. The duration of exposure to the heat treatment is given in the tables

Table 1. Biomass production and growth of the potato plants after a 4-week heat stress. 19/17 °C: control; 31/29 °C: growth at increased day/night temperatures. The variety "Norchip" is considered to be heat-tolerant, "Up-to-Date" is a temperature-sensitive variety. (Lafta and Lorenzen 1995)

Cultivar	Temp. (°C)	Shoot (g/plant)	Tuber (g/plant)	Total weight (g/plant)	Plant height (cm)
"Norchip"	19/17	244±6	134±3	378±4	35±1
	31/29	253±4	5±3	258±4	45±2
"Up-to-Date"	19/17	197±17	131±14	328±13	42±1
	31/29	96±2	0.6±0.6	96±3	57±0.5

Table 2. The influence of temperature on the carbohydrate level in the fully developed leaves of the heat-tolerant and -sensitive potato plants. The carbohydrate pools are filled by photosynthesis at the end of the day; at the end of the night they have been depleted. (Lafta and Lorenzen 1995)

Cultivar	Temp. (°C)	Carbohydrate	3 Days after temperature increase		8 Days after temperature increase	
			End of day	End of night	End of day	End of night
Norchip	19/17	Glucose (mg g ⁻¹ dry wt.)	3.3±0.2	2.8±0.1	5.2±0.9	3.8±0.3
	31/29		5.3±1.1	2.5±0.0	6.2±0.9	3.0±0.1
Up-to-Date	19/17		3.0±0.1	2.9±0.3	3.5±0.0	2.9±0.2
	31/29		4.2±0.2	2.6±0.2	6.2±0.6	3.1±0.7
Norchip	19/17	Sucrose (mg g ⁻¹ dry wt.)	10.6±0.1	6.4±0.8	10.1±1.0	3.4±0.2
	31/29		13.1±1.4	3.8±1.0	17.6±0.9	4.8±0.6
Up-to-Date	19/17		9.8±0.3	5.2±0.8	12.5±0.8	4.6±0.3
	31/29		12.9±1.3	3.6±0.3	17.0±1.2	4.5±0.9
Norchip	19/17	Starch (mg g ⁻¹ dry wt.)	294±2	195±9	290±9	180±12
	31/29		202±14	92±9	129±2	72±3
Up-to-Date	19/17		222±32	117±19	242±14	126±12
	31/29		168±16	64±1	99±12	50±6

however, solely due to an acceleration of the normal housekeeping reactions.

The so-called **heat shock reaction** of the cell is quite a different matter. For plants with a temperature optimum between 15 and 25 °C, this reaction takes place at temperatures above +35 °C and consists of:

- the slowing down of housekeeping reactions, particularly of the expression of the housekeeping genes;
- an almost exclusive synthesis of so-called **heat shock proteins (HSPs)**;
- cessation of the production of the HSPs after 6–8 h; and
- a gradual resumption of the expression of the **housekeeping genes**.

Box 1.3.2 (continued)

Table 3. Enzyme activities in the potato tuber tissue after 2 weeks of exposure to the day/night conditions quoted in column 2. The increased temperature treatment began 10 days after the initiation of tuber formation. (Lafta and Lorenzen 1995)

Cultivar	Temp. (°C)	Sucrose synthase (mg starch g ⁻¹ h ⁻¹)	AGPase (μmol g ⁻¹ min ⁻¹)	UGPase (μmol g ⁻¹ min ⁻¹)	Sucrose-P-synthase (mg sucrose g ⁻¹ h ⁻¹)	
					V _{max}	V _{lim}
Norchip	19/17	33.4±11.9	1.2±0.11	40.2±5.1		
	29/27	13.7±3.8	0.93±0.05	39.9±5.2	21±1 ^a	6±0.9 ^a
Up-to-Date	19/17	15.0±4.2	1.17±0.12	27.8±3.1	15.2±1.5 ^a	5±0.5 ^a
	29/27	4.2±2.3	0.84±0.08	24.4±3.1		

^a In these cases potatoes grown under the 31/29°C treatment were used; there was no statistical difference between the two cultivars. V_{max}: in the enzyme assay the substrates UDP glucose and fructose-6-P were saturating; V_{lim}: the concentrations of both substrates were reduced to about one-third, i.e. they were limiting in relation to the amount of enzyme used. Sucrose-synthase: sucrose+UDP↔UDP glucose+fructose; sucrose-phosphate-synthase: UDP glucose+fructose-6-P↔sucrose-6-P+UDP; AGPase=ADP glucose pyrophosphorylase: glucose-1-P+ATP↔ADP-glucose+PP_i; ADP glucose→→starch; UDPase=UDP glucose pyrophosphorylase: glucose-1-P+UTP↔UDP-glucose+PP_i; UDP glucose→→sucrose

From the selection of data presented in Tables 1, 2 and 3 the following can be derived:

1. Biomass production (growth) is inhibited at temperatures above the optimum. This inhibition was significantly less in the heat-tolerant than in the heat-sensitive variety.
2. Tuber formation was almost completely suppressed in both varieties.
3. Heat-stressed plants exhibited greater growth length than the controls.
4. The total levels of carbohydrate in the leaves of the heat-stressed plants were drastically reduced, primarily due to the starch contents. The comparatively low levels of soluble carbohydrates were not (glucose) or only slightly (sucrose) affected.
5. The sucrose-phosphate synthase activity (SPS) in the leaves was significantly in-

creased at elevated temperature, whereby there was no difference in the responses of the two cultivars.

6. In the rudimentary tubers of the high-temperature plants the activities of both the enzymes involved in starch metabolism sucrose synthase (active phloem unloading: sucrose+UTP↔UDP glucose+fructose+P_i) and ADP glucose-pyrophosphorylase (supplies the substrate for starch synthase: glucose-1P+ATP↔ADP glucose+PP_i) were clearly decreased, while UDP glucose-pyrophosphorylase (sucrose synthesis) showed no noticeable differences in activity. SPS activity of the tubers was also reduced in the high-temperature plants. Thus neither starch nor sucrose synthesis takes place in these plants: the tubers have no sink strength.

The total redirection of protein synthesis in favour of HSPs occurs, in principle, only a few K above the optimal temperature of the organism. In other words: Many organisms already live near the upper temperature limit at which the stress reaction occurs, i.e. where activation of the heat shock genes starts. For example, *E. coli* has a optimum temperature of 37°C versus 42°C for the heat shock reaction; baking yeast: 23/

37°C; human beings: 37/42–45°C; *Euglena*: 25/37°C; tomato: 25/37°C.

At present ten families of HSPs are known, which are ordered according to their molecular weight (Box 1.3.3). They occur in all compartments of cells.

Most HSPs are constitutively expressed proteins, so-called **molecular chaperones** (“governesses”), and are present under “normal” condi-

Box 1.3.3

Overview of the heat shock protein families
(After Nover and Höhfeld 1996)

HSP family	Group of organisms	Cellular localisation			Comments
		Cytoplasm/nucleus	ER/Golgi	Mitochondria (m)/chloroplasts (c)	
HSP100 family (Ec-ClpA/B)					
Mammals		HSP110	?	?	ATP-binding proteins with chaperone activity which are part of a protease complex in bacteria; in mammalian cells HSP110 is in the nucleolus
Plants		ClpB, HSP101	?	ClpCc	
Yeast		HSP104	?	ClpB (HSP78)	
HSP90 family (Ec-HtpG)					
Mammals		HSP90α,β	GRP94	–	ATP-binding, autophosphorylating proteins; interact with Ca-calmodulin; cytoplasmic representatives form complexes with steroid hormone receptors, protein kinases and HSP70
Plants		HSP80	GRP94	HSP90c	
Yeast		HSP90 , HSC90	–	–	
HSP70 family (Ec-DnaK, Ec-Hsc66)					
Mammals		HSP70, A, B	GRP78 (BIP)	HSC70m	ATP-binding autophosphorylating proteins; bind to denatured/unfolded proteins; part of a chaperone machinery together with representatives of the HSP40 and HSP23 families
Plants		HSC72, p73 HSP70 , HSC70	GRP78	HSC70c HSP68m	
Yeast		SSA 1–4 , SSB1,2 MSI3 , SSE1/2	KAR2	SSC1m	
HSP40 family (Ec-DnaJ, Ec-CbpA)					
Mammals		HDJ-1, HDJ-2	?	?	Always closely associated with representatives of the HSP70 family; responsible for recognition of unfolded protein substrates by HSP70; ANJ1 with farnesyl side chains integrated into the glyoxysome membrane
Plants		ANJ1	+	?	
Yeast		YdJ1, SIS1	SEC63	SCJ1 , Mdj1	
HSP60 family (Ec-GroEL)					
Mammals		TCP1	–	Cpn60m	ATP-binding, oligomeric protein complexes; interact with representatives of the HSP10 family; essential role in protein folding; various TCP1-type proteins in the cytoplasm form complexes of ~ 900 kDa which interact with actin and tubulin systems
Plants		TCP1	–	HSP60c HSP60m	
Yeast		TCP1 α,β BIN2/3 ANC2	–	HSP60m	
HSP10 family (Ec-GroES)					
Mammals		?	–	Cpn10m	Heptameric complexes which work together with the HSP60 complexes; presence of corresponding subunits for TCP1 complex is still not clear
Plants		?	–	Cpn10m Cpn12c	
Yeast		?	–	Cpn10m	
HSP23 family (Ec-GrpE)					
Mammals		?	?	?	Little studied subunits of the HSP70 chaperone machinery; binds to SSC1 in yeast mitochondria; essential for protein import into mitochondria; nucleotide exchange factor
Plants		?	?	?	
Yeast		?	?	Mge1p	

Box 1.3.3 (continued)

HSP family	Group of organisms	Cellular localisation			Comments
		Cytoplasm/nucleus	ER/Golgi	Mitochondria (m)/chloroplasts (c)	
HSP20 family (Ec-lbp A/B)					
Mammals		HSP 25/27, α, β-Crystallin	?	?	More variable in number and sequence than other HSP families; sequence relationship to eye lens proteins (α, β -crystallin); frequently forms oligomeric aggregates of 200–500 kDa; protective function for mRNA in plants
Plants		HSPs 15–18	HSP22	HSP 21/22c	
Yeast		HSP26	–	–	
HSP8,5 family (Ec not present)					
Mammals		Ubiquitin	–	–	Small protein which is considered to act as a marker for protein breakdown via isopeptide links with Lys side chains (substrate for proteasome complexes)
Plants		Ubiquitin	–	–	
Yeast		Ubiquitin	–	–	
Immunophilins (Ec-cyclophilin/-FKBP)					
Mammals		FKBP 12, 25 CYP 18, 22, 40 HSP56	FKBP 13 CYP 22	?	Proteins with prolyl- <i>cis,trans</i> isomerase activity with ubiquitous distribution; activity is inhibited by immunosuppressants (cyclosporin A, FK 506)
Plants		CYP	–	CYP, FKBP	
Yeast		CYP 1, 2	FKBP 13	CYP 20	

The multiprotein families are summarised on the basis of sequence homologies and functional similarities. The representatives that are induced by heat stress are shown in **boldface type**. The family name is followed by the designation of the proteins which have been

identified in *Escherichia coli* (Ec). Designations which deviate from the standard nomenclature for heat stress proteins (e.g. HSP70) often originate from the identification of the corresponding gene defects in microorganisms

tions only in very small amounts. During stress, the housekeeping genes are “switched off” and subsequently only HSPs are produced.

Every stress that leads to a denaturing of proteins and to the formation of “false” proteins, i.e. which attacks at the level of proteins (heavy metals, insertion of amino acid analogues into proteins, inhibitors of protein biosynthesis, alcohol), triggers heat shock reactions, which are thus a general and not a specific stress reaction. Heat shock reactions are currently one of the best-investigated reactions to stress and confer a number of highly interesting insights into cell physiological aspects at the molecular level. These are, in particular:

- the switching off of the expression of the housekeeping genes;

- the reaction of existing proteins to heat shock;
- the switching on of the heat shock genes: what is the molecular signal and how does the switch function?
- the function of the HSPs;
- the function of the HSPs in the unstressed cell;
- the return of the cell to “normal” life after the heat shock and the switching off of the heat shock response.

These aspects are discussed in the following sections. At times it will be necessary to consider results from microorganisms and animals, when research in plants has not yet progressed far enough in itself.

How is the Expression of Housekeeping Genes Switched Off During Heat Shock?

After its synthesis, mRNA is normally packed with small nuclear ribonucleoproteins (snRNPs), which together with small nuclear RNA molecules (snRNAs) form the spliceosome. This excises the introns from the pre-mRNA, and thus plays an essential part in mRNA processing. This splicing reaction does not occur after heat stress, so that no functional mRNA of the housekeeping genes is formed. The processing of ribosomal precursors in the nucleolus also ceases at the same time, i.e. no new ribosomes are formed.

Translation is also interrupted: Heat stress leads to the inactivation of initiation factors. In biochemical terms this happens via the dephosphorylation of an initiation factor (the eukaryotic IF-4F α) which binds to the 5' cap [7mG(5')ppp(5')nucleotide] of the mature mRNA and thus contributes to the formation of the initiation complex. Protein synthesis, which is still ongoing, ceases after a few minutes, as the still-active polysomes can no longer bind to new mRNA molecules and thus dissociate into their subunits.

Heat shock genes do not possess introns; they need not be spliced and thus form functional mRNA (or functional mRNPs) even when the splicing reaction is inhibited. This can then form functional ribosomes and polysomes with the dissociated ribosomal subunits. The formation of the HS mRNA-ribosome complex evidently does not require the formation of an initiation complex with "capped" mRNA.

Most of the no longer active housekeeping mRNA is conserved and deposited in so-called **heat shock granules**, where it is associated with two heat shock proteins, an HSP70 and an HSP17. These granules are held in the immediate vicinity of the cell nucleus by the cytoskeleton.

How Does Heat Shock Affect Proteins?

Heat causes denaturation of proteins. Denaturation means partial or total unfolding of the tertiary structure and the dissociation of subunits, in short the production of non-functional polypeptides. Partial unfolding can explain how hydrophobic side chains are no longer "shielded" within the protein (hydrophobic interactions), but are exposed. As a consequence, several proteins associate via hydrophobic interactions: they aggregate and form insoluble complexes,

which can only be removed by proteolysis. Heat shock thus causes a disturbance of the protein homeostasis of the cell via denaturation; the "internal equilibrium" of the cell is disrupted.

Switching On Heat Shock Genes: What Is the Molecular Signal and How Does the Switch Function?

The promoters of the heat shock (HS) genes are of prime importance for switching on the expression of these genes. These promoters exhibit conserved motifs, so-called **heat shock elements** (HSEs), which display a mirror sequence in the two complementary strands (a so-called **palindrome**):

- 5'... AGAA n n TTCTAGAA n n TTCT3'
- 3'... TCTT m m AAGATCTT m m AAGA5'
... n and m are variable and not fixed.

Heterologous insertion of these HSEs into other promoters makes these promoters responsive to heat stress.

The simplest type of HS promoter contains a TATA box for association with the transcription apparatus about 30 base pairs upstream of the start of transcription, and one to several HSEs a further 20–30 base pairs upstream. Such promoters could be of great importance in biotechnology: They enable genes to be switched on in a specific manner.

Which Factors Activate Heat Shock Promoters By Reaction with Heat Shock Elements (*cis*-Responsive Elements)?

These are proteins which interact with the DNA of HS elements, the so-called **HS-transcription factors** (HSFs). These proteins exhibit similar sequencing motifs associated with particular functions in all eukaryotes. Their expression is activated by heat. They are divided into families according to their size. Any one plant will contain HSFs from different families.

Ubiquitous functional motifs of heat shock factors are (Fig. 1.3.3):

- a DNA binding domain of about 100 amino acids near the N-terminus which binds to the *cis* elements (HS elements);
- an adjacent region in the C-terminal direction with repetitive hydrophobic heptapeptides which is important for the association of several monomer HSFs via hydrophobic interactions (the so-called oligomerisation domains: HR 1, HR 2 and sometimes also HR 3). Only

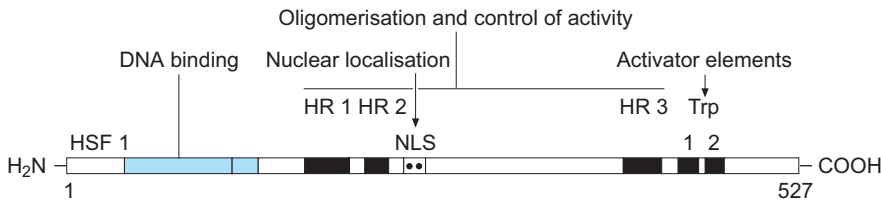


Fig. 1.3.3. Structure of a heat shock (transcription) factor from tomato. *H₂N*- N-terminus; *DNA-binding* binding domain on the HSE; *HR 1,2,3* regions for oligomerisation via hydrophobic interactions; *NLS* nuclear localisation sequence; *Trp* central tryptophan of the activator element. (After Nover and Höhfeld 1996)

the oligomerised HSF (trimer) is active, i.e. binds to DNA and HSPs;

- a cluster of alkaline amino acids C-terminal to HR 1, 2: the signal peptide for import into the nucleus (NLS: nucleus localisation signal);
- peptide motifs with a central tryptophan (Trp) as activator element which can interact with the transcription apparatus and thereby activate it. In larger HSFs the activator region contains a further hydrophobic heptade.

A Heat Shock Factor Must First Be Activated

Monomeric HSFs are inactive, i.e. they cannot bind to a heat shock element. The pool of HSFs is probably kept small in the normal state of the cell because of binding to the free HSPs (HSP70 and probably also HSP90). After dissociation from the HSP70/90 (and perhaps due to heat),

the HSF changes its form so that it is able to form trimers. The trimer formed in the cytoplasm must now be imported into the nucleus to bind to the heat shock element of the promoter. The activator region becomes active because of binding to the HSE, and transcription can start.

What is the “actual signal” in the reaction chain leading to the activation of HSFs? The prerequisite for the activation of the HSFs is the dissociation of the HSF-HSP70/90 complex. Such dissociation would, of course, be favoured by a decrease in the free pools of HSP70/90. But how can the free pool of these HSPs decrease as a result of heat shock? These proteins bind as a consequence of the heat shock to other, denatured, proteins. It may be readily assumed that heat-denatured housekeeping proteins bind the free HSP70.

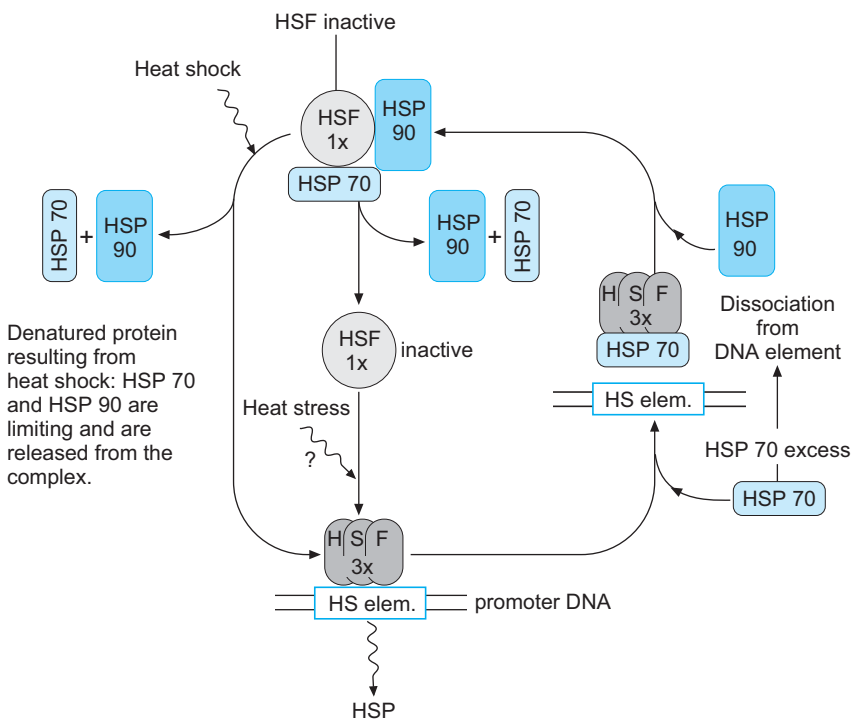


Fig. 1.3.4. The heat shock factor (HSF) cycle. (After Nover and Höhfeld 1996)

Box 1.3.4**Do HSPs have functions in non-stressed cells?**

Most heat shock proteins (HSPs) are produced in small quantities even in non-stressed cells. This is the basis for the genesis of the signal for the activation of the HSF described in the text by the lowering of the homeostatic HSP level due to binding to denatured or partially denatured housekeeping proteins. It can be asked whether the HSPs also have other functions in cellular processes. The answer comes from protein biochemistry: Nascent polypeptides already tend to fold while still attached to the ribosome during their synthesis. The structural elements of the α -helix and the β -folded sheets arise more or less spontaneously in this way via H-bonds, van der Waals forces and hydrophobic interactions between the adjoining amino acid residues. Further folding, and in particular the formation of domains, requires, however, a fully synthesised polypeptide. This is because the active form of a protein is not always that possessing the lowest energy, but is rather a metastable form which is more flexible. Two phenomena must thus be counteracted: the formation of a basically incorrect domain during the synthesis of the polypeptide and (inappropriate) folding into the lowest energy state.

First, the nascent protein must be protected. A chaperone of the HSP70/DnaK family therefore associates with the growing polypeptide during its synthesis and prevents misfolding under ATP consumption (see Fig. 1.3.5). In order to fold correctly, the complete protein is transferred to HSP60/GroEL-ES (TCP-1). These chaperones form two rings, in the central cavity of which the folding proceeds; this once again requires the consumption of ATP.

The cell thus requires an effective system of molecular chaperones to ensure the correct folding of its proteins. These chaperones present in the non-stressed cells are considered to be related to the HSPs and have been termed HSCs, i.e. heat shock cognates, by some authors.

A second important function of chaperones relates to **topogenesis**: Most of the proteins of a cell are synthesised in the cytosol. Many of them, however, are part of the protein complement of organelles, i.e. the proteins must first find their way into the correct organelle. This takes place with the help of additional sequences, so-called signal peptides, which are mostly N-terminal sequences but can also be localised within polypeptides or at the C-terminus. The organelles possess receptors for the relevant signal peptides, which bind to the protein to be imported and are mostly also involved in the transport of the protein across the membrane. The signal peptides are usually removed upon import into a specific organelle or incorporation into a specific membrane, a process termed protein maturation. A complicated pathway can be dependent on several signal sequences, e.g. the incorporation of a protein into the thylakoid membrane requires the sequential removal of four such signal peptides.

In order to pass through a biomembrane a polypeptide (pre-protein) must unfold, i.e. it must be stretched out as linearly as possible. It must thus depart from its energetically favourable tertiary structure, for which chaperones are once again required. The movement through the membrane is furthermore favoured in that the polypeptide assumes a different configuration on the inner side; for this HSCs are also necessary. When it has arrived at its destination, the protein must be brought into its functional form and in some cases be incorporated into the membrane; these processes also require HSCs. Since the function of the HSP/HSCs is usually coupled with energy consumption, it is not surprising that up to 100 ATP molecules must be used up to ensure that a newly synthesised protein arrives at its final destination. The large number of HSP/HSCs in an organism (Hartl et al. 1994) is quite understandable when one assumes that these polypeptides are also specific for particular organelles and are correspondingly widely distributed.

This process may be illustrated as the HSF cycle (Fig. 1.3.4), which provides a fine example of a self-regulating system.

The question as to why HSPs bind to denatured proteins goes far beyond the aspect of “heat shock” itself and points to the function of constitutively expressed heat shock or stress proteins (Box 1.3.4).

What Is the Function of Heat Shock Proteins in the Cell Stressed by Heat?

Heat shock proteins have at least three different functions in relation to the stresses which denature proteins:

- chaperone function,
- conservation of housekeeping mRNA in HS granules,
- catalysing proteolysis of irreversibly denatured, aggregated proteins.

Heat Shock Proteins as Chaperones

The system of the HSP70 chaperones is that having been best investigated. It consists of at least three HSPs – HSP70, HSP40 and HSP23; in the bacterial system they are called DnaK, DnaJ and GrpE. The mechanism of chaperone operation is best understood for prokaryotes and the prokaryote system will therefore be explained here as a model (Fig. 1.3.5).

HSP70 (DnaK) has an N-terminal ATP- or ADP-binding domain and a C-terminal domain for interaction with proteins. HSP40 (DnaJ) binds to the partially unfolded protein (“U” in Fig. 1.3.5) via a cysteine-rich C-terminal zinc finger domain. After hydrolysis of the bound ATP (\rightarrow ADP-DnaK), the ADP-DnaK binds to the N-terminal J domain of DnaJ-U. Denatured proteins (probably in the form of HSP40 complexes) stimulate the ATPase activity of HSP70/DnaK. A ternary complex is formed, in which the partially unfolded protein U is bound to both HSPs. The ternary complex interacts with

HSP23 (GrpE: nucleotide exchange factor), which leads to the dissociation of ADP from the complex and the weakening of the interaction of U with HSP70/DnaK. The complex dissociates completely upon renewed binding of ATP to HSP70/DnaK, and U is now able to fold back into its native state or to enter into the cycle again if it possesses other denatured components. How many and how often HSP70 molecules react with U is not known. The energy required to completely fold a medium-sized protein corresponds to around 100 ATP.

HS Granules

Since it is non-functional upon heat stress, housekeeping mRNA would be predestined for rapid degradation by RNases. The return to normal cell metabolism, however, requires large amounts of housekeeping mRNA, and it is therefore advantageous to conserve this mRNA during the heat stress response. Association of released mRNA with HSPs protects the housekeeping mRNA from degradation. This association leads to the formation of heat stress granules of 40 nm in size with a molecular mass of about 500 kDa, which are held in the vicinity of the nucleus by the cytoskeleton and contain mainly proteins of the HSP70 and HSP20 types. The HS granules dissociate again after the heat stress response subsides, whereby it is not clear how this dissociation is triggered.

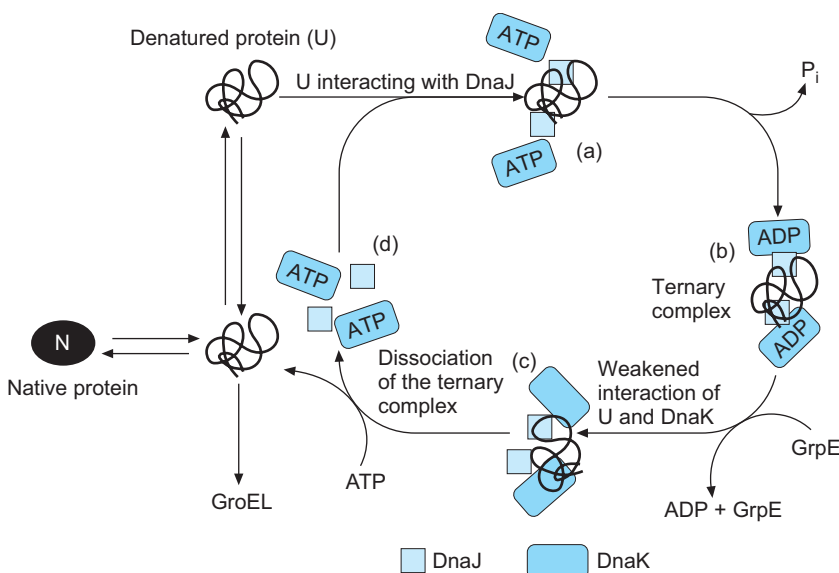


Fig. 1.3.5. Model of the HSP cycle using the bacterial DnaK, DnaJ, GrpE and GroEL system as an example. Explanations in the text. (After Hartl et al. 1994; see also Georgopoulos 1992; Nover and Höhfeld 1996)

Catalysis of Proteolysis of Irreversibly Denatured and Aggregated Proteins

Some proteins cannot be rescued after a heat pulse: They are irreversibly denatured, i.e. incorrectly folded, and have already formed aggregates with each other to some extent. Incorrectly or irreversibly denatured proteins must be removed from the cell rapidly and efficiently; this also costs energy. First, these proteins must be recognised and marked. This takes place upon cleavage of the N-terminal methionine by the protein **ubiquitin**, which exhibits enhanced expression in stressed cells. The expression of the helper enzymes of the ubiquitin conjugation reaction pathway, which are required for marking, is also enhanced. The protein marked repeatedly by ubiquitin is now broken down in **26S proteasomes** under consumption of ATP. The manner in which the HSPs are involved in the proteolytic degradation of “protein rubbish” has not yet been convincingly elucidated. Mutants which cannot form HSP70/DnaK also have a defect in ATP-dependent, rapid protein degradation.

How Does the Cell Return to “Normal Life” After Heat Shock, i.e. How Is the Heat Stress Response Switched Off?

If the depletion of the free pool of HSP70 is the signal for triggering the heat shock response, the growth of this pool, e.g. after the removal of defective protein, should lead to normal protein synthesis again. A higher concentration of free HSP70 leads to inactivation of the heat protection factors, and this would also stop the synthesis of HSPs or at least reduce it to the normal level. At the same time, the transiently immobilised, but conserved housekeeping functions, which also include the processing of the large precursor rRNPs accumulated in the nucleolus, could be activated again. Many of the questions as to the switching on of the housekeeping functions are not understood at present. This applies particularly to the other stressors which disturb protein homeostasis, such as in heavy metal stress, etc.

As mentioned earlier, long-term exposure of plants to temperatures 10 K above the optimum suffices to induce heat stress reactions. This means that plants already live close to the verge of this reaction. There is a relatively great danger that overheating during the day can progress to the point where this complete rearrangement of metabolism can occur. Figure 2.1.15 shows that irradiated leaves can rapidly reach such

temperatures. Avoidance mechanisms to reduce overheating are therefore of great importance.

1.3.4.3

Avoidance of Heat Stress

Avoidance mechanisms may be morphological (see also Chap. 2.1): Slit leaves heat up less than do undivided leaves, and hairy leaves reflect more radiation than do those without hair. The position of the leaf, and thus the extent of direct (solar) radiation it absorbs, also plays an important role. Transpiration cooling is an important physiological avoidance mechanism which can result in considerable lowering of leaf temperatures (see Fig. 2.1.15). The combination of heat and drought is problematic for plants in this regard, in which transpiration is substantially limited (see Chap. 2.2).

1.3.4.4

Hardening

In addition to heat avoidance, there is, naturally, also heat tolerance acquired through hardening. The changes in membrane lipids which take place during the course of the year have already been mentioned (Chap. 1.3.3.1). It is not known to what extent heat shock proteins (HSPs) play a role in hardening. The mechanism of the heat shock response would suggest that a certain degree of hardening occurs within the period of the accumulation of HSPs – hours or days, at most. It is difficult to envisage long-term hardening occurring via HSPs.

Hardening based on damage repair was shown by Larcher (1987) for fir needles (Fig. 1.3.6). In this example, recuperation from the initial heat stress takes 5–6 days, i.e. it took this much time to effect repair and to switch from heat stress reactions to normal housekeeping photosynthesis. It can be assumed that a higher level of HSPs was still present at the time of the second heat stress. On the other hand, there are also so-called **chemical chaperones** which can increase the heat resistance of cells and shift the triggering of the HS response toward higher temperatures. These are the compatible solutes, such as glycerol, proline and betaine, which stabilise the native folding of mature proteins. It is not known to what extent such effects play a role in heat stress hardening.

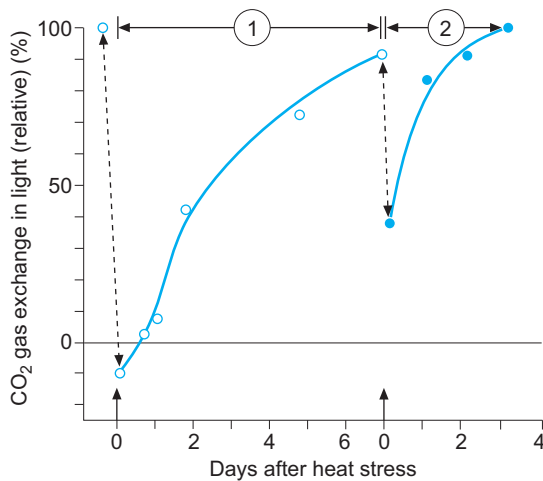


Fig. 1.3.6. Hardening of fir needles after a heat stress treatment. Damage and hardening were measured by the photosynthetic activity of the needles. 1 Recovery phase after the initial heat stress treatment; 2 after the second heat stress treatment (44 °C, 30 min). The extent of damage and the length of the recovery phase (repair) are clearly less after the second stress treatment than they were upon the first heat pulse. (Larcher 1987)

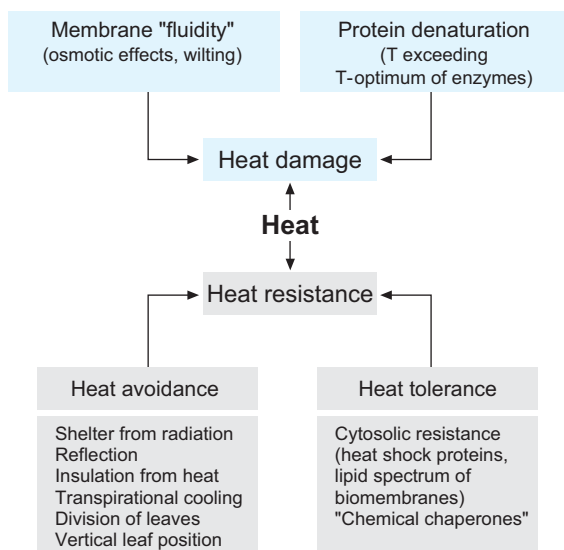


Fig. 1.3.7. The effects of heat on plants and the ways in which they react to the heat stress

The aspects of heat damage, heat avoidance and heat tolerance described above are summarised in Fig. 1.3.7.

1.3.5

Cold

Recommended Literature

- Bigras FJ, Colombo SJ (2001) Conifer cold hardiness. Kluwer, Dordrecht
- Guy CL (1990) Cold acclimation and freezing stress tolerance: role of protein metabolism. *Annu Rev Plant Physiol Plant Mol Biol* 41:187–223
- Hughes MA, Dunn MA (1996) The molecular biology of plant acclimation to low temperature. *J Exp Bot* 47:291–305
- Li PH, Chen THH (1997) Plant cold hardiness. In: *Molecular biology, biochemistry and physiology*. Plenum Press, New York
- Sakai A, Larcher W (1987) Frost survival of plants: responses and adaptation to freezing stress. In: *Ecological studies*, vol 62. Springer, Berlin Heidelberg New York
- Thomashow MF (1999) Plant cold acclimation: freezing tolerance genes and regulatory mechanisms. *Annu Rev Plant Physiol Plant Mol Biol* 50:571–600

On about two-thirds of the land mass of the earth the annual minimum temperatures fall to below 0 °C, on half of the land mass to –10 °C. Thus it is not surprising that cold is the best studied of any abiotic stressor for plants and animals, and it is of enormous economic importance.

In comparison with the stressor heat, where the primary reaction affects membranes and metabolic and protein homeostasis, the environmental factor cold additionally causes stress by desiccation of tissues with accompanying ice formation at temperatures below the freezing point (freeze-desiccation). Distinction is therefore made between cold stress above the freezing point, so-called **chilling**, and stress by frost, i.e. at temperatures below the freezing point, which always includes a temperature component and a desiccation component caused by ice formation (Fig. 1.3.8).

The phenomena of chilling (see Allen and Ort 2001), rather than those of freezing, are thus analogous to heat stress. In heat stress the physiological strain occurs through the (dissimilar) speeding up of metabolic processes culminating in the specific heat stress response. While metabolic processes also get out of equilibrium during cold stress due to the different activation en-

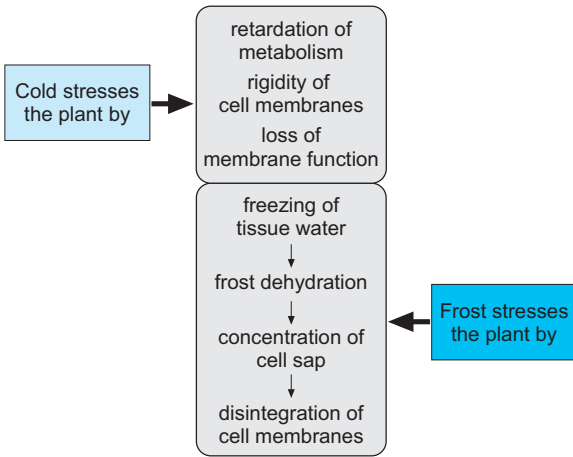


Fig. 1.3.8. Stress from cold and frost

ergies of individual reactions, the strain is altogether less because all of the reactions are slowed down. A rapid cold stress response like that of heat shock in the form of heat shock proteins is therefore not to be expected, even though the term “cold shock proteins” is used at times in the literature. These are not proteins with chaperone functions, but rather proteins whose names indicate their various functions: antifreeze proteins, cold acclimation proteins or proteins of the group of “dehydrins”.

A problem specific to cold stress is the increase in viscosity of the membranes. An organism which cannot react rapidly due to low temperatures and possibly also due to severe tissue desiccation is much more prone to secondary

Box 1.3.5

Measurement of cold and frost damage

In order to determine damage due to cold or frost or to determine the limits of resistance, a standardised stress treatment is required. In contrast to the case with heat shock, a com-

paratively slow change in temperature is preferred when analysing the effects of cold, in order to allow for the slower rate of biochemical reactions at lower temperatures.

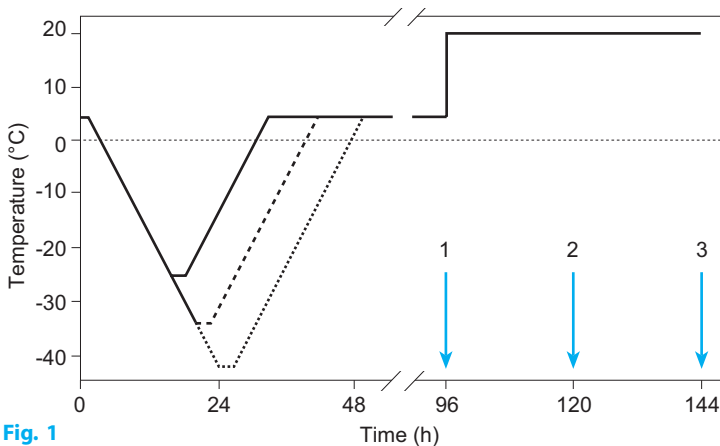


Fig. 1

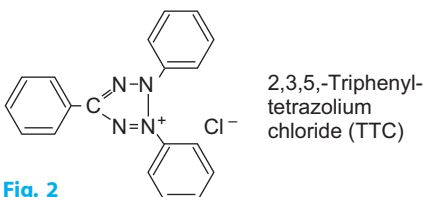
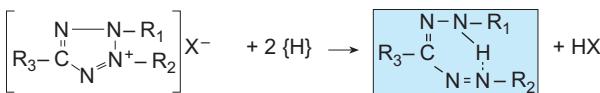


Fig. 2

Fig. 1. shows the temperature course during the entire test. First, the sample is slowly cooled (1–2 K/h). It is then exposed to a defined final temperature for 2 h before being slowly warmed (1–2 K/h) again. The sample is then held at +5 °C for 48 h to enable any incurred damage to develop. It is then placed in a solution of TTC. Dehydrogenases now reduce the tetrazolium to coloured formazan (Fig. 2, formazan is shown in blue). After 24 h this is extracted (for ca. 12 h) and quantified photometrically.

In addition to this test, the vitality tests presented in Box 1.1.1 can also be used.

stressors. Particularly interesting in this regard is the stress combination of cold and high light energy, which leads to considerable damage in non-hardened plant organs, especially in the photosynthetic apparatus (see Chap. 1.2.1.3). Frost hardening and frost dehardening are, therefore, classical topics for the study of adaptation reactions. The response of plants to cold takes the form of both specific adaptations and general stress reactions (strain). The latter relate to changes in membranes, as well as to strengthening of systems for the detoxification of radicals and reactive oxygen species (see Fig. 1.3.32).

Because of the slower rate of metabolism in the cold, experiments to measure cold tolerance and cold damage must be very carefully designed. Plants must not be cooled too rapidly, nor should they be warmed up too quickly at the end of the experiment. Box 1.3.5 shows an appropriate procedure.

1.3.5.1

Stress by Cold Above the Freezing Point (Chilling): Cold Damage Is Predominantly Membrane Damage

Damage due to temperatures which are low, but above the freezing point, occurs practically only in tropical and subtropical plants which are ge-

netically adapted to a temperature range of between +5 and about 50 °C (see Table 1.3.1). Palms, mangroves, coffee plants and some tropical herbs known to us as houseplants, such as *Peperomia* and the African violet (*Saintpaulia ionantha*), have been studied particularly intensively. As is the case for temperature stress in general, the individual organs of a plant show different sensitivities. A good example is the coffee plant (*Coffea arabica*, Fig. 1.3.9). It is typical of chilling that the old leaves (as well as the cambium in the root) are most sensitive to cold, not the young leaves. Individual metabolic processes also exhibit different sensitivities. Among the most sensitive are membrane-bound processes, such as ion homeostasis and photosynthesis. Certain stages in the development of a plant are also particularly cold sensitive, namely germination and fruit ripening. In general, those stages are most sensitive in which the system for the detoxification of radicals and aggressive oxygen species is not yet, or no longer, very efficient. Pollen ripening is, at any rate, the most sensitive stage.

The actual amount of chilling stress is, as far as is known, the product of intensity and the duration of the stress, i.e. a 4-h period of cooling to +1 °C results in approximately the same degree of damage as lowering the temperature to 3.5 °C over a 20-h period (Chap. 1.1.3, Fig. 1.1.6). At the subcellular level, chilling damage

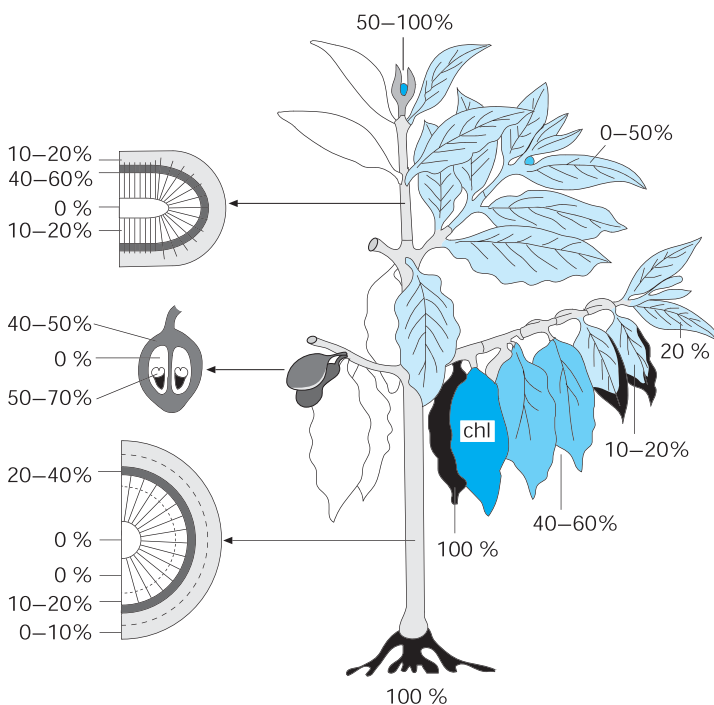


Fig. 1.3.9. Differences in sensitivity to cold in organs of the coffee tree. Percentual damage after 3 days of continual cooling to +1 °C. Black Complete damage; chl chlorotic. (Larcher 2003)

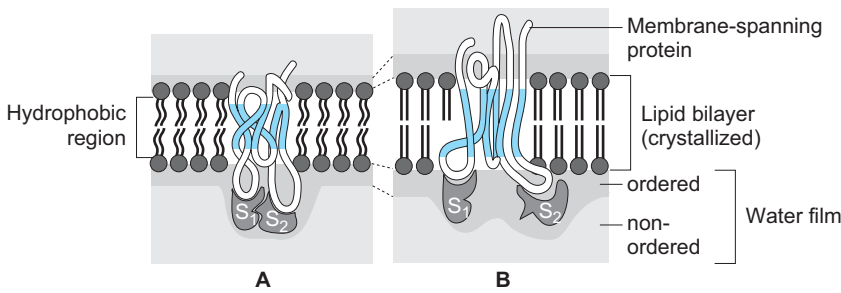


Fig. 1.3.10. Model of a biomembrane in cross section, in a fluid (active A) and in a rigid (inactive B) state. S₁, S₂ substrates. (After Wolfe 1978)

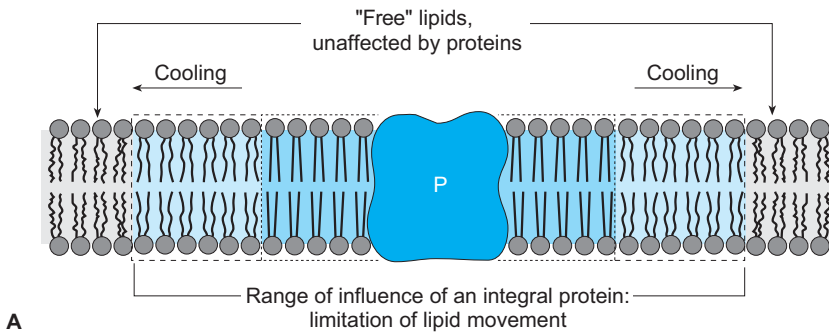


Fig. 1.3.11. A Schematic representation of the interactions between proteins and lipids in thylakoid membranes during cooling. B Influence of frost hardening on the processes taking place during cooling of the thylakoid membranes of *Pinus sylvestris*. (After Vogg et al. 1998)

occurs through metabolic imbalances and membrane “stiffening”.

How does cold inactivate membranes? The classical conception is that when cells which are not cold resistant are cooled, the biomembrane lipids change from the fluid aggregation state to the crystalline, inflexible state. This is accompanied by a thickening of the biomembrane and a deformation (inactivation) of integral membrane proteins (**thermotrophic phase transition**). This explanation is plausible, but is certainly oversimplified (Fig. 1.3.10).

It is much more likely that a zone of lipid molecules with limited mobility surrounds the proteins spanning the membrane. This zone expands during cooling; at dense protein packing, i.e. at high membrane protein content, such zones can aggregate and form larger areas with high viscosity (Fig. 1.3.11).

In such regions membranes appear to be no longer “tight”, making it difficult to form and maintain concentration gradients. Furthermore, ion pumps are inactivated by cold, which also results in a progressive breakdown of compartmentation. This applies particularly to the proton gradients which are required for the supply of ATP in the cell. It is still unresolved as to whether the water loss which is often observed from damaged cells is merely a consequence of the loss of solutes from the cell (passive flux) or whether aquaporins play a role (see Box 1.5.2).

The sensitivity with which particular membranes react to cold appears to depend on the type of plant involved. In some cases the plasma membrane has been identified as the site of primary damage (e.g. for *Eucalyptus* cell cultures), in other cases the tonoplast is probably particularly cold sensitive (e.g. in spruce).

In contrast to the annual cycle of frost hardening and dehardening, there is almost no acclimation to chilling. No appreciable shifts to lower LD50 values could be observed with either mangroves or palms. However, there are genotypes with different cold sensitivities within the same plant species. The less cold-sensitive genotypes are usually found in the subtropics (10 to 23°N and S of the equator), and the more sensitive ones in the tropics (10°N and S of the equator). Molecular mechanisms effecting hardening in the more resistant genotypes are usually based

above all on a higher degree of unsaturation of the membrane lipids.

It is of particular interest in this connection to modify the membrane lipids of important crop plants to confer greater cold tolerance. One way of achieving this is to lower the proportion of saturated fatty acids (see Box 1.3.6 and Table 1.3.4) in favour of unsaturated fatty acids. In principle, this concerns the group of the glycerol lipids which can be either phosphatides or glycolipids. Initial genetic engineering attempts to increase the amount of unsaturated fatty acids

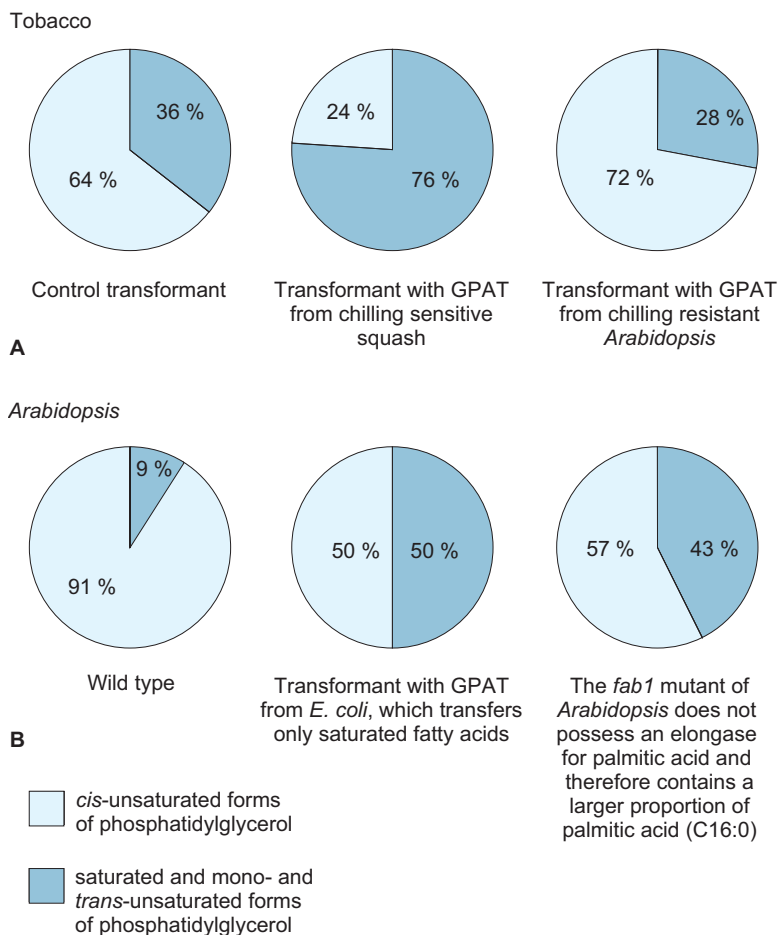
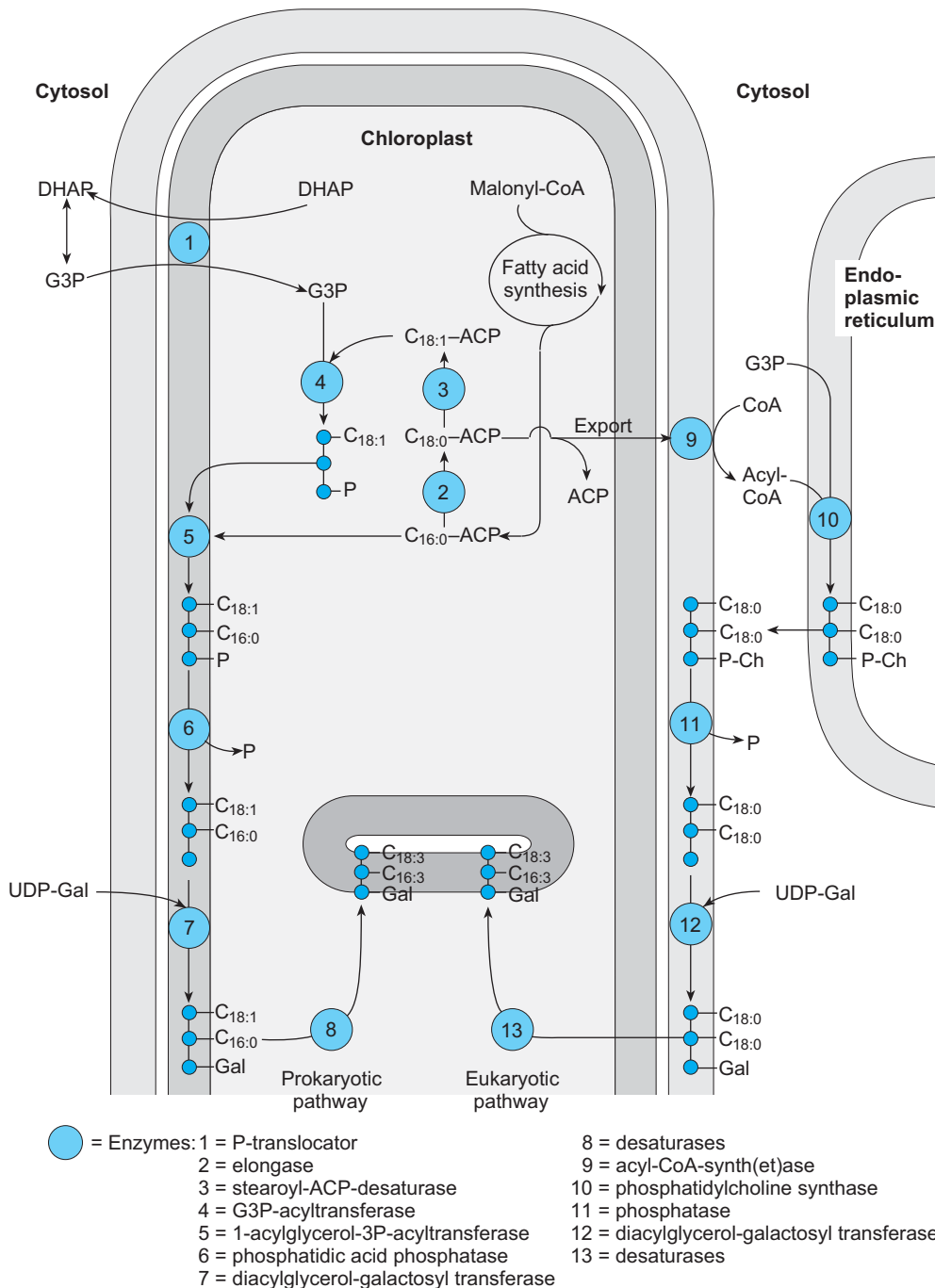


Fig. 1.3.12. Changing chilling sensitivity by altering the degree of unsaturation of the fatty acids in phosphatidylglycerol. Chilling-resistant and -sensitive plants are available for gene transfer. It is important that chloroplastic glycerol-3P-acyltransferase (GPAT) from chilling-resistant plants (*Arabidopsis*) uses almost exclusively 18:1-ACP as substrate, whereas the enzyme from chilling-sensitive plants (e.g. cucurbits) can transfer fatty acids from both 18:1-ACP and from 16:0-ACP (see Box 1.3.6). When glycerol-3P-acyltransferase from cucurbits is overexpressed in tobacco (A), a transgenic plant is produced with a large proportion (76%) of saturated fatty acids in phosphatidylglycerol: If, in contrast, the enzyme from *Arabidopsis* (B) is used, the percentage of unsaturated fatty acids in this lipid increases. In *Arabidopsis* the wild type exhibits hardly any saturated fatty acids in phosphatidylglycerol, so that the proportion of unsaturated fatty acids cannot be increased any further; but the opposite experiment – to increase the proportion of saturated fatty acids – is feasible by means of gene technology. What influence does the altered proportion of unsaturated fatty acids have on sensitivity to low temperatures? Increasing the proportion of *cis*-unsaturated fatty acids increases chilling tolerance, both of photosynthesis and with regard to macroscopically visible damage after exposure to cold. Conversely, the resistance decreased when the proportion of saturated fatty acids was increased. (After Nishida and Murata 1996)

Box 1.3.6

Lipid biosynthesis in plants (After Frentzen and Heinz 1983, see also Ohlogge and Browse 1995)



Desaturases are important for the development of chilling resistance in plants: acyl-ACP desaturase (3), acyl-lipid desaturases (13) [including prokaryotic acyl lipid desaturase (8)], glycerol-

3P-acyltransferase (4) and possibly also the 1-acylglycerol-3-P-acyltransferase (5), which can only use fatty acids as substrates which are esterified or occur as thioesters (ACP).

have indeed resulted in increased cold resistance (Fig. 1.3.12).

1.3.5.2

Imbalances in Metabolism Caused by Cold

There have been extensive investigations on damage caused by imbalances of metabolism which has been slowed due to low temperatures. Such imbalances usually result primarily from the different Q_{10} values for the biophysical and biochemical processes involved.

Metabolic Imbalances

Diurnal fluctuations of enzyme activities and their metabolite pools of plants favouring warm conditions are particularly sensitive to cold. If such plants are kept in permanently weak light under otherwise normal surrounding conditions, an endogenous metabolic rhythm of so-called free **circadian** (i.e. periodicity of about 24 h) **oscillations** becomes evident. Two key cytosolic enzymes, **sucrose phosphate synthase (SPS)** and **nitrate reductase**, show this phenomenon. In correspondence with photosynthetic processes, their activities are higher during the light period and lower during the night, with a free periodicity of about 26 h. If the photosynthetic production of triosephosphate in the chloroplast and its further metabolism to sucrose in the cytosol are not synchronised, imbalances naturally result. One reason for this is that phosphate released in the cytosol during sucrose synthesis must be returned to the chloroplast from which it was withdrawn due to its having been bound to triose during the export of carbohydrate into the cytosol. In the example shown in Fig. 1.3.13 the free oscillations of SPS during a 12 h lowering of the temperature from 26 to 4 °C were disturbed to the extent that an exactly phase-reversed oscillation resulted upon a return to normal temperatures, in which minimal activity was exhibited during the light period and maximum activity during the dark period. A corresponding shift in rhythm also occurred with nitrate reductase. However, not all endogenous rhythms of warmth-loving plants are affected by chilling. For example, the endogenous oscillations of stomatal movement in avocado leaves maintained their original frequency even upon cooling, despite photosynthesis itself being strongly inhibited (Allen and Ort 2001).

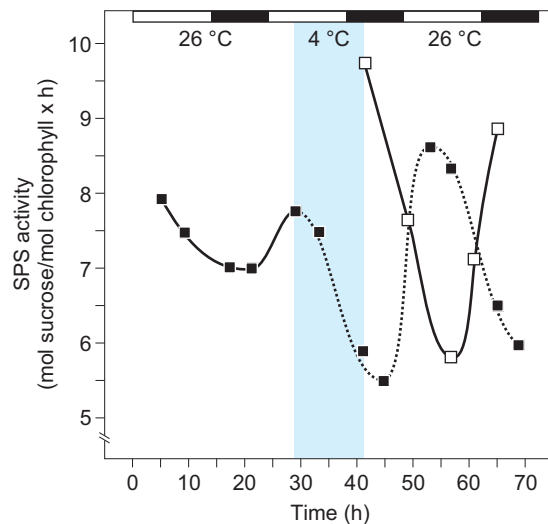


Fig. 1.3.13. Shift in endogenous metabolic rhythm caused by chilling. Tomato plants were grown at normal temperature (26 °C) in continuous weak light and the endogenous oscillation of SPS activity was observed (■). The oscillation period was about 26 h (“circadian”). The rhythm of the previously applied light–dark phases is shown in the bar at the top of the diagram. In a second experiment, plants having been treated in the same way were cooled to 4 °C between 29 and 41 h; this resulted in a reversal of the endogenous oscillation of SPS (□) because the rhythm was delayed. (Jones et al. 1998)

Chilling is also very important when it occurs together with high light intensity (Fig. 1.3.14). In such a stress combination the thylakoid system is usually overloaded, as the photosynthetic carbohydrate metabolism cannot keep up with the light reactions because of the low temperatures. As a consequence, photosystem II (PS II) in particular is inhibited, so-called **photoinhibition** due to light inactivation of the sensitive D1 protein (see Chap. 1.2.1.3). To regenerate complete photosynthetic capacity, the damaged D1 protein must be replaced. According to current knowledge, the five steps shown in Fig. 1.2.8 are required: removal of the inactivated D1 protein; synthesis of new pre-D1; insertion of pre-D1 into PS II; processing of the pre-D1; and reconstitution of the entire core of PS II.

The degree of unsaturation of the thylakoid lipids affects particularly the insertion and the processing of pre-D1. It is therefore assumed that the chilling tolerance of plants with a higher degree of unsaturation is based on a more efficient exchange of damaged for intact D1 proteins.

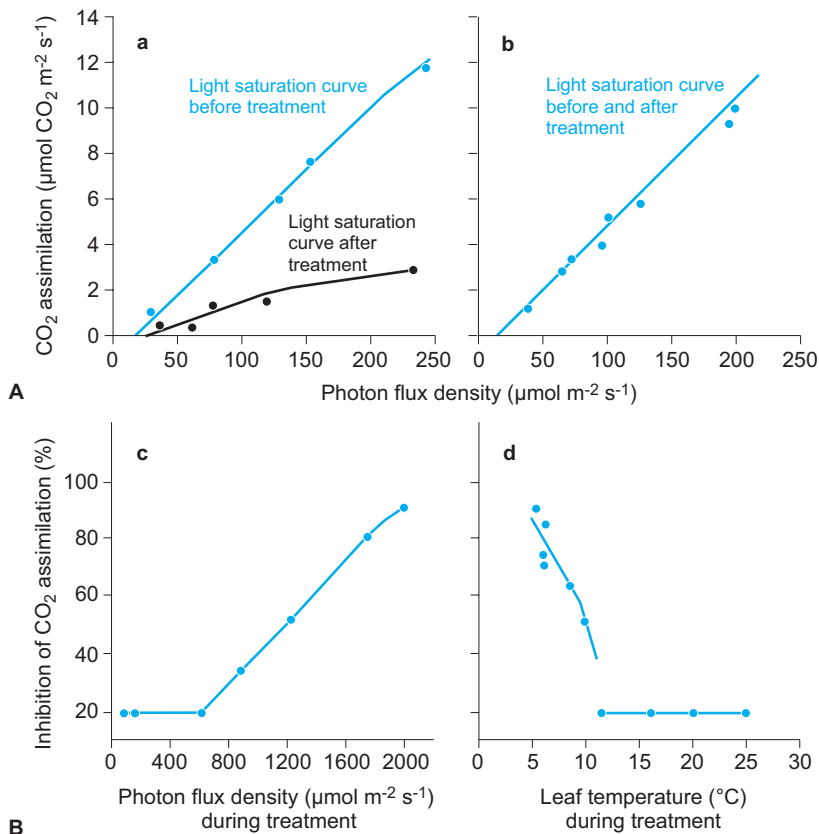


Fig. 1.3.14. The impact of a combination of stresses: The effect of chilling and light on photosynthesis. **A** Runner bean leaves (runner beans are tropical plants and thus chilling sensitive) were kept for 6 h at 6°C under intense illumination (a $2000 \mu\text{mol photons m}^{-2} \text{s}^{-1}$) and the light saturation curves for CO_2 assimilation were measured before and after the treatment. The stressed leaves showed a drastic inhibition of photosynthesis, even 1 h after treatment. When the leaves were exposed to only weak light (b $70 \mu\text{mol photons m}^{-2} \text{s}^{-1}$) during the chilling, no inhibition was observed. However, light saturation curves were only measured up to about $250 \mu\text{mol photons m}^{-2} \text{s}^{-1}$. **B** In this experiment, the bean leaves were exposed to different light intensities during a 3-h chilling period (5.5°C). Above about $500 \mu\text{mol photons m}^{-2} \text{s}^{-1}$ photosynthesis begins to become inhibited (**c**). If the light intensity is held constant at $2000 \mu\text{mol photons m}^{-2} \text{s}^{-1}$ and the temperature is varied, the inhibition decreases as expected with rising temperature and does not occur at all at above about 10°C (**d**). (After Powles et al. 1983) see also Powles 1984)

1.3.5.3

Metabolic Imbalances Often Lead to Oxidative Stress

It is nowadays thought that photosystems are mainly damaged by so-called oxidative stress. The stressors are termed ROS – reactive O_2 species. These not only consist of oxygen as such, but also include the products of the reactions of activated oxygen with metabolites and structural components of the cell, e.g. biomembranes (Box 1.3.7). In an undamaged cell living without particular stress, these ROS form at only very slow rates which present no problem for the endogenous detoxification and repair systems. Such reactive molecules, however, are produced in much larger amounts upon metabolic imbal-

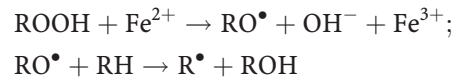
ances, under stress or in senescing cells, and can cause damage before they are detoxified. In the following, some situations and reactions are described in which ROS are formed:

Oxygen in the air possesses two unpaired electrons and thus occurs in the rather unreactive triplet state. Oxygen in this state is not able to react with molecules in the singlet state, but can react with others in the triplet state. An example is the reaction with chlorophyll, which has passed from the first singlet state into the first triplet state due to the loss of excitation energy. This chlorophyll is able to transfer its remaining energy to the O_2 molecule (exciton transfer), which is thus subjected to spin reversal and becomes extremely reactive **singlet oxygen** ($^1\text{O}_2$). $^1\text{O}_2$ has a pair of very labile electron

Box 1.3.7 Oxygen-activating reactions

1. Photodynamic reactions

$P^* + {}^3O_2 \rightarrow P + {}^1O_2$; singlet oxygen ${}^1O_2 + RH \rightarrow ROOH$; if RH is, for example, an unsaturated fatty acid, a fatty acid hydroperoxide is produced. ROOH can be reduced via electron donation (Fe^{2+} , Cu^{1+}) and so form alkoxyradicals:



this can be the start of a chain reaction

2. Reductive oxygen activation

In the presence of reducing agents with an ϵ value < -160 mV, oxygen can accept an elec-

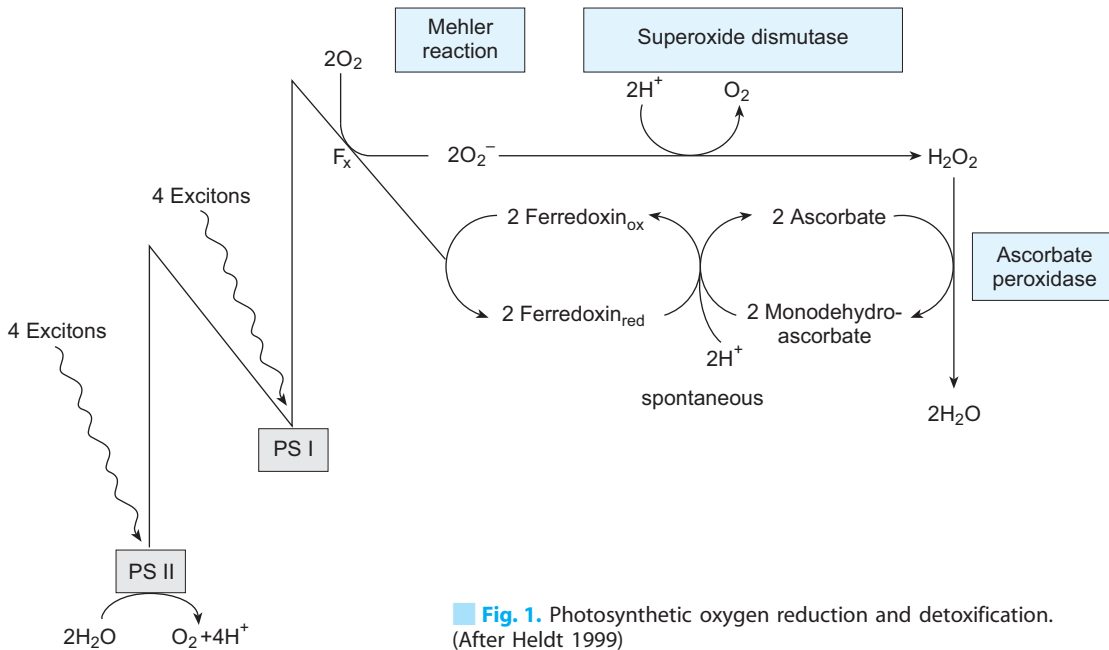


Fig. 1. Photosynthetic oxygen reduction and detoxification. (After Heldt 1999)

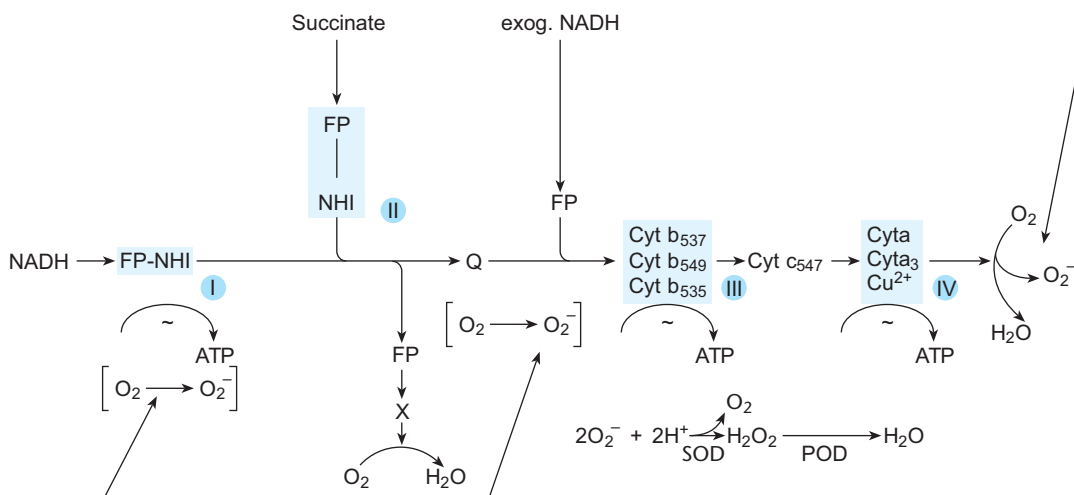
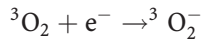


Fig. 2. Oxygen activation in the mitochondrial respiratory chain. FP Flavoprotein; NHI non-haeme-iron; POD cytochrome-c-peroxidase; I, II, III, IV protein complexes of the respiratory chain; SOD superoxide dismutase. (After Elstner 1996)

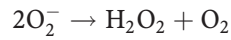
Box 1.3.7 (continued)

tron and become superoxide or an oxygen radical:



Superoxide can originate in photosynthesis (electron transfer to O_2 instead of to NADP), in the respiratory chain (from iron-sulfur proteins or from hydroquinone, during the step-wise reduction of oxygen by cytochrome a/a_3), as well as in reactions with monooxygenases.

Superoxide dissimilates spontaneously (10^4 times faster with SOD, however);



H_2O_2 can be reduced monovalently, e.g. by Fe^{2+} : **Haber-Weiss reaction, Fenton chemistry**:

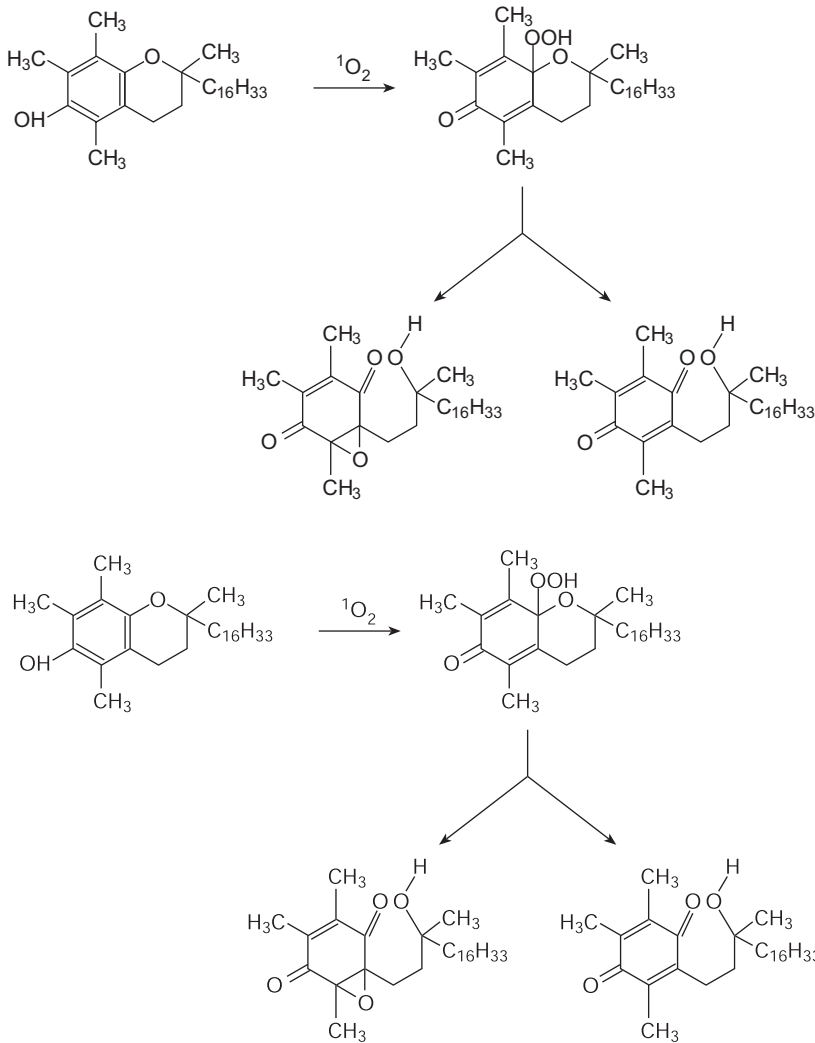


Fig. 3. Detoxification of singlet oxygen by tocopherol. (After Neely et al. 1988)

pairs which react with many organic substances, particularly readily with unsaturated compounds under formation of hydroperoxides.

Oxygen can also be activated by reduction. This happens, for example, in photosynthesis (see [Box 1.3.7, Fig. 1](#)) when no other electron acceptor is available for reduction by Fd, or when reduction is catalysed by the total herbicide methyl viologen (Paraquat). Oxygen can also be reduced by the respiratory chain (see [Box 1.3.7, Fig. 2](#)), via sulfur-iron proteins, via hydroquinone or via damaged endooxidases which have effected only partial electron transfer to O₂. The superoxide or oxygen radical anion is formed, which dismutates spontaneously to hydrogen peroxide and oxygen, a reaction which takes place 10,000-fold more rapidly in the presence of superoxide dismutase.

Hydrogen peroxide can be reduced monovalently [e.g. via the oxygen radical ion and iron(III) ions], whereby the **Haber-Weiss reaction** gives rise to the even more reactive **OH radical**, which immediately causes oxidative damage in its immediate environment.

In the case of chilling, the rate of metabolic NADPH consumption (re-oxidation of NADPH to NADP) is less than the rate of NADP reduction due to the low temperature, i.e. NADPH accumulates and the NADP pool becomes “over-reduced”. The photosynthetic electrons are then transferred by linear electron transport to oxygen (**Mehler reaction**) and superoxide is thus formed. This and ROS formed in this connection oxidise methionine and histidine residues of the D1 protein and thus cause its inactivation.

As shown in the above, ROS are not only formed at low temperatures, but also under the influence of other stressors, such as light. The establishment of a multifaceted **anti-oxidative system** is thus a general stress reaction, not a specific one. This anti-oxidative system consists of a number of enzymes and their substrates, the so-called radical scavengers.

The Anti-oxidative System Detoxifies Reactive Oxygen

Plants have recourse to several biochemical mechanisms to detoxify ROS ([Box 1.3.7, Fig. 3](#)):

1. Quenchers and Scavengers

The group of quenchers and scavengers consists of small molecules which react with ROS in often non-enzymatic reactions and thus de-

toxify them. These are protective compounds localised in the membranes such as tocopherol and many carotenoids, but they also include water-soluble compounds such as ascorbic acid and phenol derivatives – particularly flavonoids and coumarins. They react with ¹O₂ as well as with the OH radical and thus intercept the most toxic ROS (thus the terms quencher, scavenger). The OH radical, which is very effective in its own vicinity, reacts particularly well with flavonoids. It is thus not surprising that the key enzymes of flavonoid biosynthesis, phenylalanine-ammonium lyase and chalcone synthase, are formed to a particularly great extent in frost-hardy plant organs during frost hardening or during stress by chilling coupled with high light intensities (see [Chap. 1.2; Box 1.2.5](#)). Flavonoids are also formed in response to infections and wounding, and are then called **phytoalexins**. They thus have a multiple role in stress defence.

2. Enzymatic ROS Detoxification

ROS are enzymatically detoxified in the compartments in which they are most frequently formed, i.e. in the chloroplasts, mitochondria and peroxisomes, during the course of which water is usually produced. Corresponding enzymes have also been observed in the cytosol ([Box 1.3.7, Fig. 3](#)).

The water-soluble, detoxifying enzyme system consists of superoxide dismutase (SOD), a peroxidase – usually ascorbate peroxidase, (mono)-dehydroascorbate reductase and the NAD(P)H-dependent glutathione reductase, and is known as the **ascorbate-glutathione cycle** ([Box 1.3.7, Fig. 3](#)). The enzyme activities present in the individual compartments can be very high, so that the system works very efficiently. During frost hardening the individual enzymes of this detoxification pathway are additionally activated or more strongly expressed.

1.3.5.4

Repair Systems Mend Damage to Biomembranes, Nucleic Acids and Proteins

A number of repair mechanisms are known which remove peroxidised fatty acids and their resultant products (hydroxyoctadecadiic acids, so-called HODEs) from membranes (most membrane lipids remain quite generally for only a very short time in the membrane), detoxify

them and replace them with intact fatty acids. Such repair mechanisms also exist for damaged nucleic acids (see [Box 1.2.4](#)). Damaged proteins are repaired by means of the chaperone system or are degraded after marking with ubiquitin.

1.3.6

Frost

Stress caused by low temperatures is greatly increased in the case of frost due to freeze-desiccation. Secondary strains such as high light intensity play, of course, an additional important role at temperatures below 0°C. Frost also occurs in tropical climates, namely in tropical high mountains. As the temperature in these regions only falls below the freezing point for a matter of hours, freezing avoidance mechanisms are very important. In contrast to chilling, frost is characterised by seasonal hardening (acquisition of frost resistance or frost tolerance) and dehardening. These processes involve many physiologically important aspects. Particularly topical are the many so-called cold-related proteins (CORs) which have been discovered recently. These constitute an important starting point for introducing frost hardening into cold-sensitive crop plants, in addition to the genetic engineering of biomembrane frost hardening described in [Chapter 1.1.6](#). It should be mentioned in this regard that 70% of the annual harvest losses in the USA was caused by cold and drought in the 1980s, while insects, weeds and pathogens together were responsible for only about 10%. Late frosts caused damage of more than US\$ 1 billion during 1981–1985 in southern Florida (Yelenosky 1985).

1.3.6.1

Freezing Temperatures and Biomembranes

The manner in which chilling affects membrane fluidity applies in principle to frost as well, but to a more severe extent. Measurements of fluidity by means of electron spin resonance or fluorescence polarisation show primarily the stiffening effect which a high protein/lipid ratio has on the fluidity of biomembranes at low temperatures. Particularly protein-rich biomembranes, such as those of the thylakoids, reduce the protein/lipid ratio during frost hardening. In addition,

a desaturation of the fatty acids in the membrane lipids is often observed. More details in this regard will be given in [Chapter 1.3.6.9](#).

It is important to realise that the freeze-desiccation of frost-hardened tissues is inevitably accompanied by a more or less pronounced shrinkage of the protoplast.

As the biomembrane cannot expand or shrink like a balloon would [the intrinsic elastic flexibility of a biomembrane should not exceed 2–3% (Wolfe and Steponkus 1983)], shrinking processes are often associated with a removal of lipids from the membrane and expansion processes with the insertion of lipids. During reversible freeze-desiccation, this material must be deposited in such a way as to be immediately available upon thawing ([Fig. 1.3.15](#)).

A quite similar problem occurs during plasmolysis. Steponkus et al. (1983) showed with isolated protoplasts from rye mesophyll cells that damage to frost-sensitive cells occurs during thawing, because the amount of material available for re-incorporation is no longer sufficient for the “areal growth” of the plasma membrane. The resulting lysis of the cells was called “expansion-induced lysis”. Protoplasts of frost-hardy winter rye leaves did not show this phenomenon. They do not deposit the material removed from the membrane during contraction within the cell, but deposit it at the external side of the membrane where it is not accessible to lipases. The different behaviour of the lipids depends on the degree of their unsaturation: Frost-sensitive plasma membranes of protoplasts can be artificially “hardened” if they are treated with a surplus of unsaturated lipids (in the experiments phosphatidylcholine with one- or two-fold unsaturated fatty acids was used) and a partial exchange of the membrane lipids takes place. Even though protoplasts are an excellent *in vitro* system for the study of many processes, they can only provide answers to some partial aspects of frost hardening in biomembranes.

In considering the freezing of cellular water, it is very important to regard the involvement of the cell wall in stabilising the protoplast. The freezing of cell water has often been compared to plasmolysis – a very different process. During freezing, the cellular fluid must crystallise in the intercellular spaces, as otherwise biomembranes bordering the ice crystals would disintegrate, because the hydrophobic interactions of the lipids which stabilise the membranes require the presence of liquid water. This also means that no ice

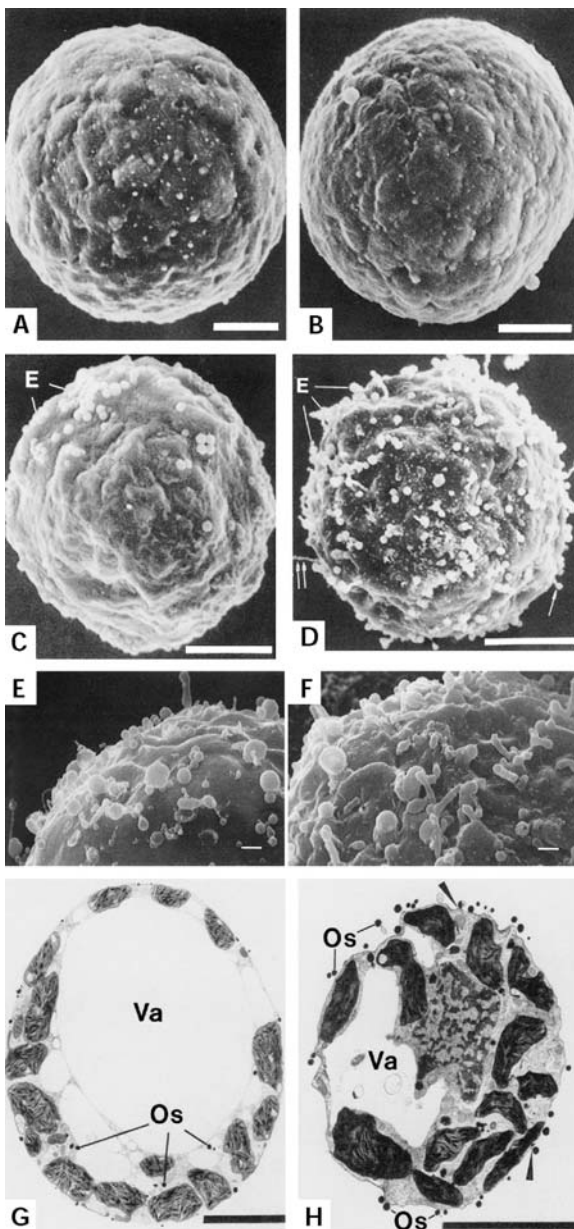


Fig. 1.3.15. Behaviour of isolated protoplasts from rye leaves in isotonic and hypertonic solutions. Protoplasts were isolated from leaves of frost-sensitive (A,B) and frost-hardened (C,D) rye plants and incubated in isotonic medium (A,C,G) and in a medium with a concentration double that of the isotonic medium (B,D,H). The outer surface of the non-hardened protoplasts remained almost smooth on shrinking (B), i.e. lipids excluded from the membrane were displaced to the interior of the protoplast. Protoplasts from frost-hardened cells deposited their excluded lipids in extrusions of various shapes (E) on the outside of the plasma membrane when they shrank, where they cannot be degraded by endogenous lipases (D). The transmission electron micrographs (G,H) also show the shrinking (compare the size of the vacuoles in G and H) and the lipid extrusions (arrow) which are strongly contrasted by osmium staining (Os). The bar corresponds in each case to 5 μm . E An enlarged section of a protoplast from frost-hardened leaves in hypertonic medium. F The surface of a protoplast from non-hardened leaves in hypertonic medium, after fusion of the protoplast with liposomes consisting of dilinoleoylphosphatidylcholine. Protoplasts which deposit lipids internally on shrinking burst upon swelling in isotonic medium, because the lipids are degraded by phospholipases. Lipids which are deposited externally can be reintegrated into the membrane upon swelling of the protoplast. The bar corresponds to 1 μm . (After Steponkus et al. 1983, 1988)

may be formed between the plasma membrane and the cell wall. This space, which in the case of plasmolysis is filled with the plasmolyticum, would have to fill with air during the extracellular freezing of cellular liquid if the protoplast were to withdraw from the cell wall. The air would have to enter through the pores of the cell wall. These pores are very small (about 4 nm diameter in the primary wall), and they are filled with water due to the high matrix potential of the cell wall. It would require a suction of more than 80 MPa to suck air through the cell wall pores (Zhu and Beck 1991). Such high suction

has never been observed in living cells, however. The protoplast is therefore not normally able to detach itself from the cell wall during the exogenous freezing of the cellular liquid of the protoplast, and the entire cell must collapse upon the dehydration resulting from freezing (Fig. 1.3.16).

Cells which are not particularly rigid, e.g. those of the mesophyll, indeed wrinkle and fold under these conditions (**freezing cytorrhysis**). Since the cell wall itself cannot shrink, the plasma membrane must not reduce its surface significantly. The problem as to the extra- or intracellular deposition of membrane material de-

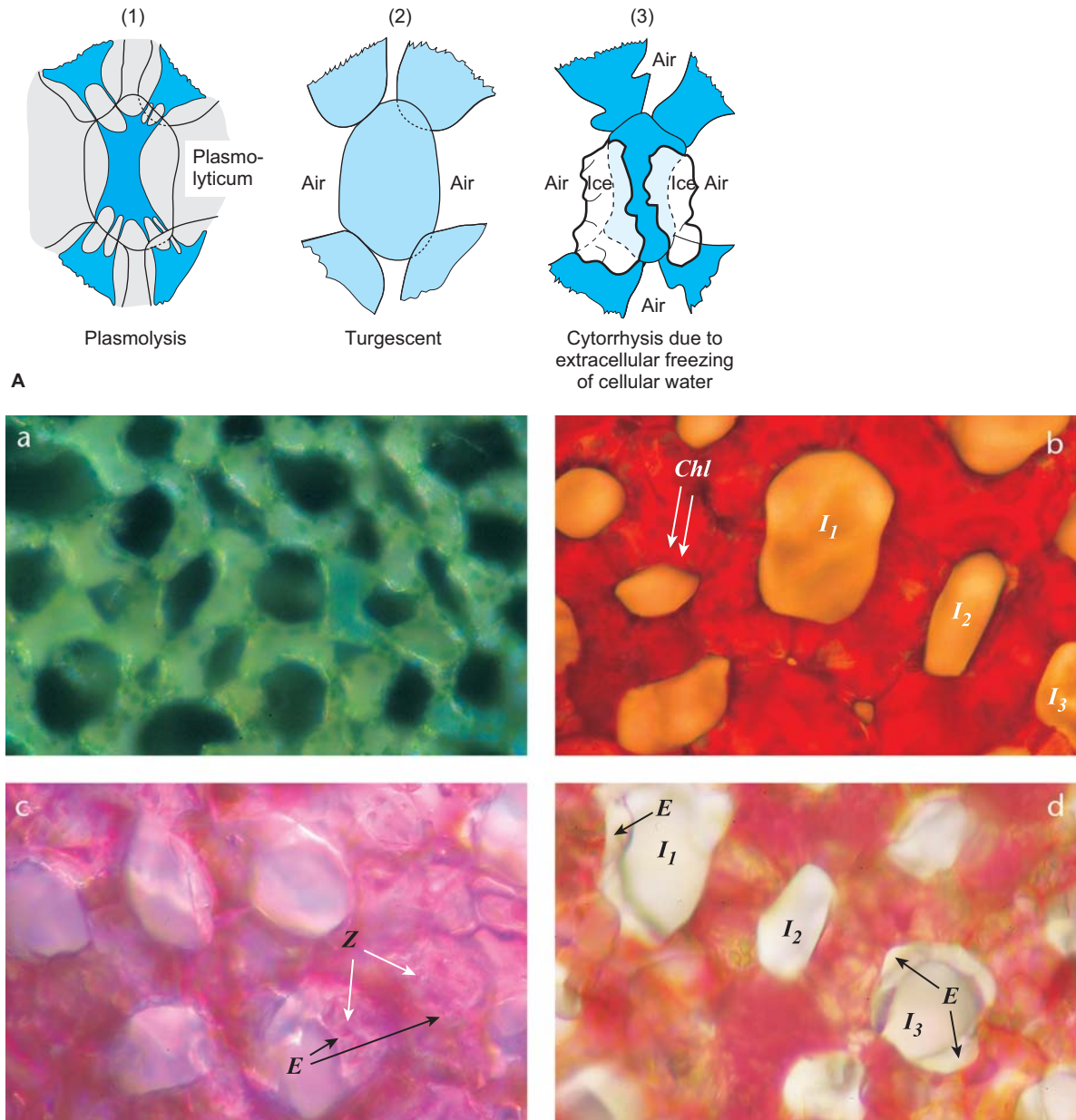


Fig. 1.3.16. A Plasmolysis and freezing of mesophyll cells from a leaf of *Pachysandra terminalis*. During plasmolysis (1), the plasmolyticum intrudes into the space between the cell wall and the protoplast, and the cell wall is relaxed. During freezing (3) the protoplast remains attached to the cell wall despite the export of cell fluids into the intercellular spaces, because the cell wall is air-tight in the swollen state. The cell wall dents or buckles, depending on the extent of the freeze-desiccation. Since crystallisation takes place extracellularly, no ice is formed between the cell wall and the protoplast. B: a–d Spongy parenchyma of a leaf of *Pachysandra terminalis*. a Surface view of the spongy parenchyma following removal of the lower epidermis; chloroplasts can be clearly seen in the cells. b Spongy parenchyma after taking up neutral red through the leaf stalk. *Chl* Chloroplasts. d The same section of the spongy parenchyma at -12°C (I_1 – I_3 indicate the same intercellular spaces). Deposition of colourless ice (*E*) can be clearly recognised within the intercellular spaces. c Spongy parenchyma was stained with neutral red and then killed before cooling to -12°C . The ice crystals are not restricted to the intercellular spaces, and they contain drops of coloured cell sap (*Z*). Note also the change in the neutral red colour resulting from acidification as a consequence of killing the tissue. (Photos J.J. Zhu)

scribed above is thus of hardly any consequence in this regard. Freezing plasmolysis does not occur even in rigid cells which are tightly integrated into a tissue if the cells are to survive the freezing (see [Chap. 1.3.6.3](#)).

1.3.6.2 Intra- and Extracellular Formation of Ice

Amphiphilic lipids (lipids with a hydrophobic and a hydrophilic pole) only unite to form micelles and membrane surfaces if they are in a sufficiently hydrophilic medium, i.e. stabilised by a structured water film. If this structured water film is removed, the stabilising effect of the hydrophobic interactions is lost and the lipids aggregate in droplets: This is called the lipid hexagonal II phase ([Fig. 1.3.17](#)). An example of lipids in this hexagonal II phase is the lipid droplets (plastoglobuli) in senescing chloroplasts. Intracellular ice formation probably starts at biomembranes, because of the structured water film associated with them. This ice formation, however, would remove the membrane-stabilising component and consequently the membrane would disintegrate. Earlier research described this as the perforation of biomembranes by ice crystals, because it is the hexagonal, pointed forms of the ice crystals that form at temperatures above -100°C which cause the dehydration. Extremely rapid cooling (cooling rates of $>1000^{\circ}\text{C}/\text{min}$) down to the temperature of liquid nitrogen, so-called **vitrification** (which can only be carried out with very small sample volumes of a few mm^3), leads to solidification of the cell liquid into amorphous ice, which does not have the destructive effect just described. However, there is a danger of recrystallisation of

the amorphous ice into hexagonal, damaging crystal forms upon the slow thawing of the samples. Vitrification is an artificial, special case which does not take place in nature because of the very rapid cooling rates required. However, it is important for the preservation of bacterial cultures, for example.

Whether the crystallisation takes place inside or outside the cell depends on several factors. One of these is the rate of cooling: The faster the tissue cools, the greater is the danger of intracellular ice formation ([Fig. 1.3.18](#)). This is not damaging in the case of vitrification, due to the very abrupt and sudden deep-freezing of the entire tissue. Another factor which determines where ice is deposited is the state of the plasma membrane: Frost-hardened membranes allow water (more exactly: the liquid of the cell) to exit into the apoplast more easily than do frost-sensitive membranes.

The mechanism of this efflux of water has not yet been explained. It is often assumed that ion pumps (especially H^+ -ATPases) are inactivated in the cold, and that ions and other dissolved materials diffuse out of the cell into the water film surrounding the intercellular spaces and are followed by water. The liquid accumulating in the intercellular spaces now requires a trigger for crystallisation. Such a nucleation stimulus can originate from the xylem if the formation of ice first starts there (Gross et al. 1988) or if it rapidly spreads from a nearby nucleation centre. On the other hand, certain surface structures of the cell walls or of microorganisms which are found predominantly in the substomatal respiratory cavity can also trigger the nucleation.

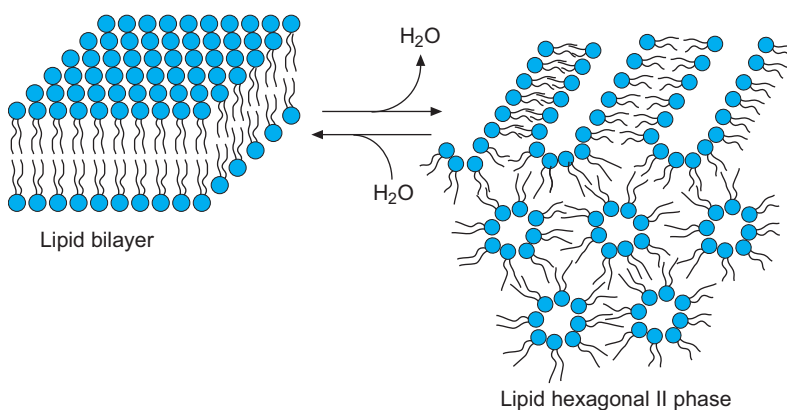


Fig. 1.3.17. Disintegration and reconstruction of a phospholipid bilayer by water removal (e.g. freeze-dehydration) and rehydration. Phospholipids form lipid drops or threads in the hexagonal II phase. (After Crowe et al. 1983)

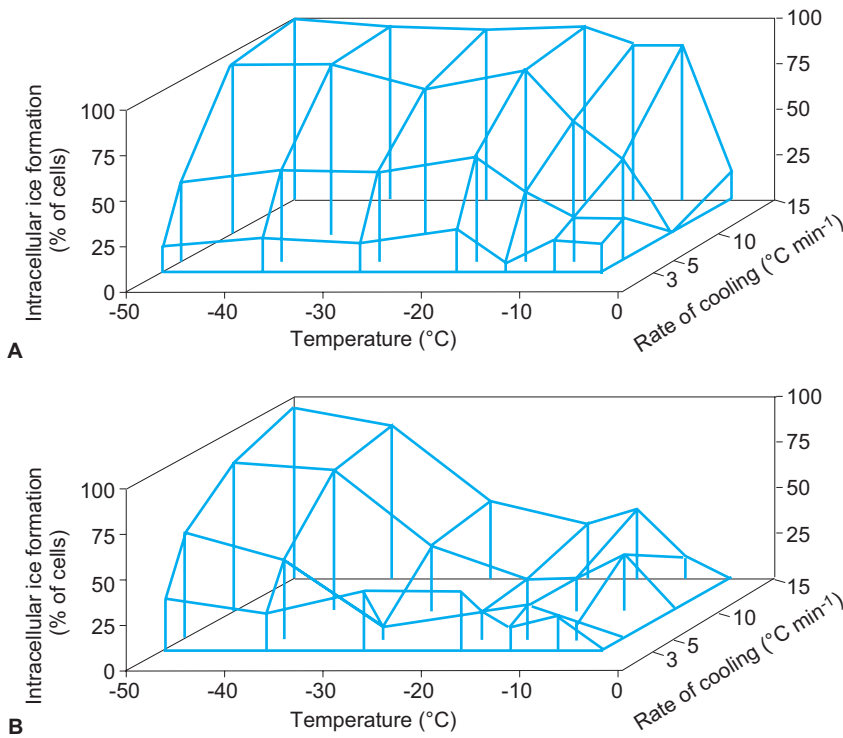


Fig. 1.3.18. Formation of intercellular ice in protoplasts of frost-sensitive (A) and frost-hardened (B) rye leaves as a function of the rate of cooling and the minimum temperature (*abscissa*). Protoplasts from frost-sensitive leaves do not permit the exclusion of cellular liquids during cooling, so that ice forms intracellularly. Consequently, the cells are lethally damaged. (After Döwger and Steponkus 1983)

1.3.6.3

Heterogeneous Nucleation; the Example of INA Bacteria

The molecular details of the surface structures of plant cell walls which are active in nucleation, i.e. which trigger the formation of crystals at relatively low frost temperatures, are not yet known. However, it is known that such a phenomenon does exist. Examples are winter cereals and leaves of other winter-hardy plants, e.g. speedwell (*Veronica* spp.) and some species of box trees. Extracts of the internal surfaces (intercellular spaces) of these plants contain proteins which are formed during frost hardening. It is very probable that these proteins trigger the early nucleation, but this has not yet been shown definitely. The principle of nucleation initiation has been investigated thoroughly for a number of microorganisms which live on plant surfaces and trigger the crystallisation of water there (so-called heterogeneous nucleation). These microorganisms are called INA bacteria (*ice nucleation active bacteria*). The more effective their surface structures are in ordering the water clusters into a matrix-like arrangement, the more efficient they are as catalysts for crystallisation, and the lower is the degree of supercooling required for crystallisation (Fig. 1.3.19 and Table 1.3.6).

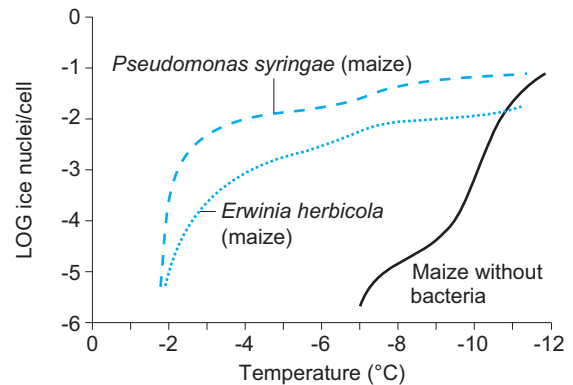


Fig. 1.3.19. The effect of INA bacteria on ice formation in maize leaves. Upon incubation with *Pseudomonas syringae* at -4°C , 0.01 ice crystals per bacterial cell were determined, i.e. one ice crystal per 100 bacteria. (After Lindow 1982)

In these cases, the nucleation activity can be related at least in part to certain proteins, the so-called ice nucleating proteins (INPs). The amino acid sequence for one INP from *Pseudomonas syringae* is known: a particular octapeptide repeats itself 122 times in this polypeptide. Deletion mutants show that a 68-fold repetition of the motif is sufficient to trigger nucleation. If the periodicity of the octapeptide is changed, the nucleating activity is lost immediately

Table 1.3.6. Ice nucleation activity of bacterial cultures. Thirty drops (each 0.01 ml) of test material were placed on a controlled surface and the temperature was slowly lowered from room temperature to -25°C . The temperature at which the first ice crystals formed (T_1) and the temperature at which 90% of the drops were frozen (T_{90}) were recorded. (Maki et al. 1974)

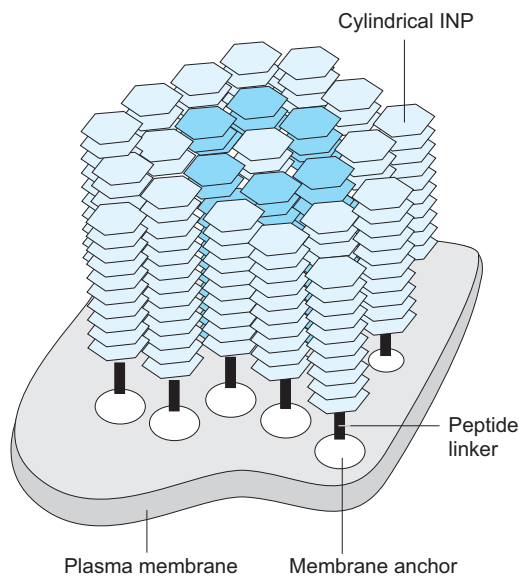
Bacterial species	(Ice) nucleation temperature ($^{\circ}\text{C}$)	
	T_1	T_{90}
<i>Pseudomonas syringae</i> C9	-2.9	-3.5
<i>Pseudomonas syringae</i>	-3.2	-3.9
<i>Pseudomonas aeruginosa</i>	-7.5	-17.8
<i>Staphylococcus epidermidis</i>	-6.9	-19.5
<i>Escherichia coli</i>	-8.3	-17.1
<i>Enterobacter aerogenes</i>	-9.6	-17.0
<i>Proteus mirabilis</i>	-8.0	-19.4
<i>Proteus vulgaris</i>	-7.8	-17.0
<i>Bacillus subtilis</i>	-10.6	-18.0
<i>Bacillus cereus</i>	-6.9	-17.0
Pure culture medium	-9.2	-17.0

(Green and Warren 1985). No relationship between the periodicity and the dimension of the distance between the water molecules in the hexagonal ice crystal could be shown. Such proteins could force a *quasi* crystalline fixation of the water molecules which would minimise the supercooling required to “quieten” the water clusters (see Box 1.3.8).

INA bacteria often cause great economic damage when they settle on plants which are able to tolerate moderate cold, but not ice formation, such as maize, strawberries and citrus fruits. In the presence of *Pseudomonas syringae*, an ice crystal is formed per 100 bacteria already at -4°C . The natural occurrence of such bacteria on plants varies with the season (Fig. 1.3.20), among other things.

INA bacteria are used in meteorology (after killing by γ -radiation) for the production of artificial snow and to induce cloud formation above dry areas. They have also been used for the protection of cereal seed against seed beetles: Bacterial powder eaten by the beetles reduced the

Box 1.3.8 Ice nucleators



Nucleation temperature ($^{\circ}\text{C}$)	Estimated molecular mass (kDa)	Number of INPs required for nucleation
-12 to -13	150	1
-3	870	60
-2	19800	132
-1	83700	558

The schematic diagram shows an INP superstructure (“ice nucleator”) on a bacterial membrane. It is assumed that the membrane lipid phosphatidylinositol is the anchor of the individual INPs in the membrane (after Hew and Yang 1992, see also Burke and Lindow

1990). The table shows the correlation between the size of an ice nucleator and the reduction in supercooling temperature. (After Hew and Yang 1992, see also Burke and Lindow 1990).

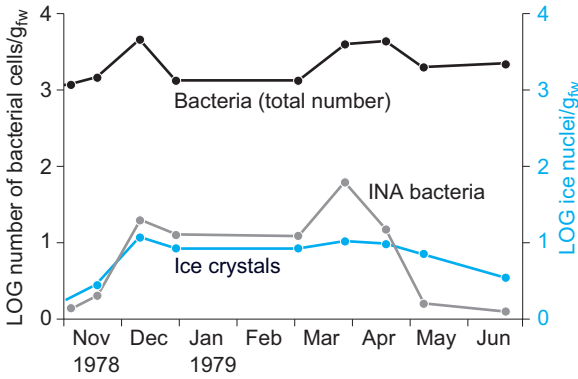


Fig. 1.3.20. Seasonal dependence of the number of all bacteria (total number) and INA bacteria, as well as the formation of ice nuclei at -9°C , on avocado leaves. (After Lindow 1982)

ability of the insects to supercool to such an extent that they were killed by internal ice formation upon a frost shock of -10°C , a temperature which is completely harmless to the seed (Fields 1993). In agriculture, however, attempts are being made to dilute out the INA bacterial infestation of crop plants by replacement with antagonists. These are obtained by plating out wash solutions from leaves and cooling them to -5 or -9°C . Antagonists of the INA bacteria should be present wherever there is no ice formation. These organisms are mostly natural mutants of the original bacterial strains (Fig. 1.3.21 and Table 1.3.7).

Successful production of antagonists has also been achieved by altering the octapeptide periodicity of the INPs. However, the release of these transformed bacteria into the environment has not been permitted (Wilson and Lindow 1993),

Table 1.3.7. The effect of INA antagonists on the formation of ice nuclei upon frost

Bacterial culture	Damage Change in leaf colour after 1 week
Control (<i>Pseudomonas syringae</i>)	95%
Mutant A 510	12%
Mutant A 509	18%
Mutant A 507	27%
Mutant A 506	33%
Mutant A 508	51%

Pear leaves were inoculated with the respective bacterial culture 3 weeks prior to frost, to give the bacteria time to establish themselves. Frost damage was quantified by assessing necrosis. (After Lindow 1982)

partially because of fears that they would interact with meteorological processes, particularly with cloud formation. Plants able to tolerate extracellular freezing appear to profit from an early triggering of nucleation, however, as this minimises the very unstable state of supercooling.

1.3.6.4 How Much Water Freezes in Frost-Hardy Tissues?

Liquid water can be distinguished from frozen water by nuclear magnetic resonance (NMR) spectroscopy. If the total water content of, for example, a leaf is known and the residual liquid water content is determined at different frost temperatures, so-called freezing curves are obtained which display the percentage of frozen water at each frost temperature (Fig. 1.3.22).

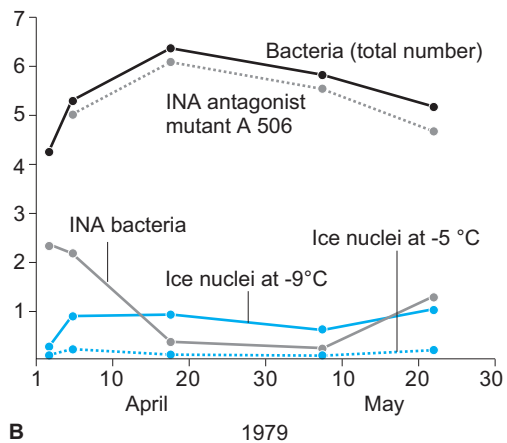
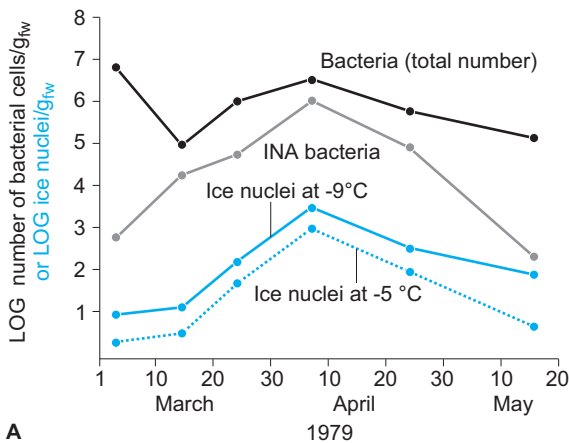


Fig. 1.3.21. Formation of ice crystals by INA bacteria on pear leaves (A) and displacement of the INA bacteria by mutants which are ineffective in nucleation (B). (After Lindow 1982)

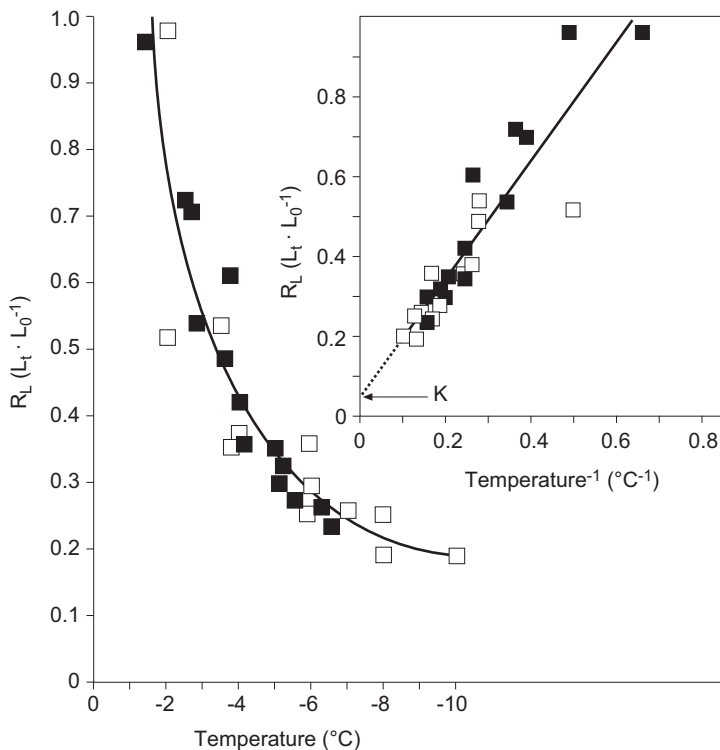


Fig. 1.3.22. Freezing curve of frost-hardened ivy (*Hedera helix*). The curve shows the proportion of liquid water (R_L) of the total water content (L_0) in dependence on the frost temperature (t). Ideally, a rectangular hyperbola is obtained which can be depicted as a simple linear reciprocal relationship (*insert*). The point at which the line cuts the ordinate ($K=4.9\%$) indicates the proportion of the water which can theoretically not freeze. ■ R_L calculated from $P_{(t)}/V_{(t)}$ and $\Psi_{\text{leaf}(t)}$. □ R_L measured. (After Hansen and Beck 1988)

The lower the temperature, the more water is present in the form of ice, i.e. the water must be excreted from the cells into the apoplast. The curve can be mathematically transformed to obtain a straight line which cuts the ordinate at the so-called K-value. This specifies the proportion of the water which cannot freeze due to binding to macromolecules. This value is in the order of a few percent of the total water content.

The proportion of frozen tissue water also depends, of course, on the original concentration of the cellular liquid. It may be assumed in a first approximation that there is a physicochemical balance in a frozen leaf between the unfrozen, residual solution of the cells and the extracellular ice. This is because the vapour pressure of water is reduced over both ice and a solution, and the water potential is thus correspondingly larger (numerically more negative: see [Box 1.3.9](#)):

$$\Psi_{\text{ice}} = \Psi_{\text{cell}} = \Psi_{\text{tissue}} \approx \Psi_{\text{leaf}}$$

The water potential of a cell consists of the osmotic potential π , the matrix potential τ and the pressure potential (“wall pressure”, P). Water potential, osmotic potential and matrix potential have negative signs, whereas the pressure potential, the wall (+ tissue) pressure, has a positive sign.

$$(-)\Psi_{\text{tissue}} = (-)\pi + (-)\tau + P$$

At moderate frost and only little freeze-desiccation, τ is still 0, but P already approaches 0. At the turgor-loss point ($P=0$) the following applies:

$$(-)\Psi_{\text{tissue}} = (-)\pi = (-)\Psi_{\text{ice}}$$

and dehydration stops. In this case, the degree of dehydration is determined solely by the concentration of the cellular liquid. There is a steady-state water potential between cell compartments; otherwise the intracellular water fluxes would change the volumes of the compartments. If this relation applies, and this is usually so in the case of mild frosts, an **ideal equilibrium freezing** takes place ([Fig. 1.3.22](#)).

If more water remains in the liquid state than would be expected upon ideal equilibrium freezing, a **non-ideal equilibrium freezing** occurs. This is usually observed at moderate frosts of below -8°C , at which rates of water loss of about 90% frequently occur. In such a case $(-)\tau$ and/or P must contribute to the water potential of the frozen plant organ. During severe freeze-desiccation, the cell wall is strongly invaginated and thus develops a suction instead of the pressure which it usually exerts: P becomes negative

Box 1.3.9 Freezing of water and aqueous solutions

In liquid water, clusters of water molecules are in temperature-dependent motion (**Brownian molecular motion**). For crystallisation to take place, this movement must be minimised as far as possible. If factors which trigger crystallisation can be avoided, it is possible to cool pure water to -39°C , whereupon it suddenly freezes. At this temperature larger clusters are formed as a consequence of the limited mobility of the water molecules, so-called critical embryos of about 190 H_2O molecules, which then initiate crystallisation. As the nucleation in this case originates from water itself, it is called **homogeneous nucleation**. The cooling energy expended for this crystallisation is released as heat of crystallisation. This spontaneous development of heat can be measured as a **freezing exotherm** and thus serves to monitor the freezing process (Fig. 1).

The melting process during thawing also requires energy, which is called the heat of fusion and can be recognised by a delay in warming during the course of the thawing process.

If nucleation is initiated in other ways, e.g. by seeding with ice crystals, supercooling does not need to take place to such a great degree. Depending on the type of initiation, crystallisation can already take place upon supercooling to only a few degrees. This is called **heterogeneous nucleation**, and is again dependent on the production of critical embryos, i.e. the reduction of Brownian molecular motion. Particular hydrophilic surface structures can force the water cluster into a

type of lattice structure which facilitates crystallisation. An only small degree of supercooling is then required to initiate nucleation.

The vapour pressure (P) of water over ice is less than that over supercooled liquid water (see Table), and the water potential Ψ of ice is accordingly more strongly negative (“larger”) than that of supercooled water at the same temperature. Put another way: More energy must be expended to remove a water molecule from crystalline ice than to remove it from liquid water.

$$P_{\text{ice}} < P_{\text{supercooled water}}$$

$$\Psi_{\text{ice}(T)} = \frac{R \times T(\text{K})}{\bar{V}} \times \ln \frac{P_{\text{ice}(T)}}{P_{\text{water}(T)}}$$

\bar{V} = mole volume of ice

$$\Psi_{\text{ice}} = \frac{RT}{V_{\text{W}}} \ln \frac{P_{\text{ice}}}{P_{\text{water}}}$$

The dependence shown by the black triangle is calculated from the following equation:

$$\Psi_{\text{ice}} = \frac{\Delta H_{\text{f}}}{V_{\text{W}} 273} t$$

The values of the dots showing the dependence were determined psychrometrically. For the theoretical basis of the equations, see Hansen and Beck (1988).

As the vapour pressure of water above ice (as well as above water) is directly dependent

Table. Partial pressure of water vapour (mbar) above ice and above supercooled water in relation to temperature

(°C)	0	1	2	3	4	5	6	7	8	9
Ice										
-30	0.38	0.34	0.31	0.27	0.25	0.22	0.20	0.18	0.16	0.14
-20	1.0	0.94	0.85	0.77	0.70	0.64	0.57	0.52	0.47	0.42
-10	2.6	2.4	2.2	2.0	1.8	1.7	1.5	1.4	1.2	1.1
0	6.1	5.6	5.2	4.8	4.4	4.0	3.7	3.4	3.1	2.8
Water										
-30	0.51	0.46	0.42	0.38	0.35	0.31	0.28	0.26	0.23	0.21
-20	1.3	1.2	1.1	1.0	0.88	0.81	0.74	0.67	0.61	0.51
-10	2.9	2.6	2.4	2.3	2.1	1.9	1.8	1.6	1.5	1.4
0	6.1	5.7	5.3	4.9	4.5	4.2	3.9	3.6	3.3	3.1

Box 1.3.9 (continued)

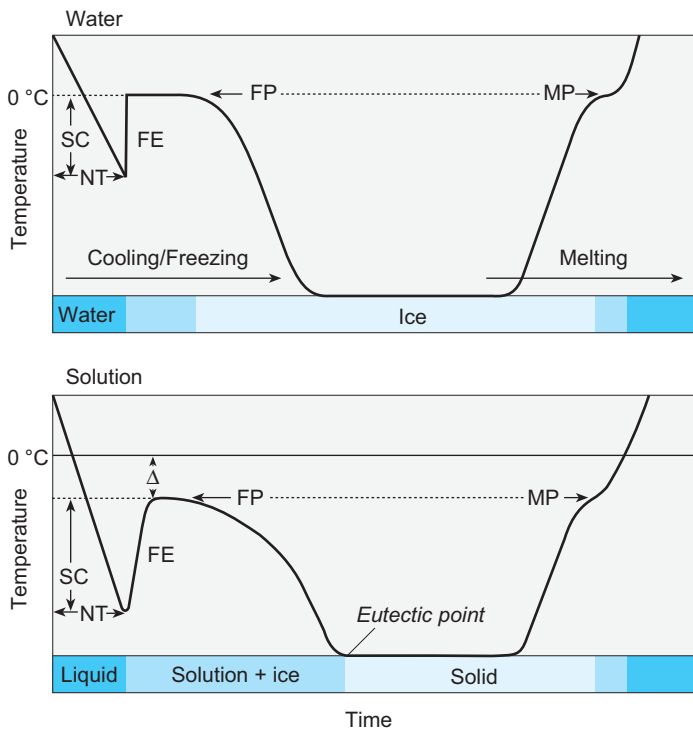


Fig. 1. Temporal sequence of freezing and melting of water and an aqueous solution. *FP* Freezing point; *FE* freezing exotherm; *MP* melting point; *SC* supercooling; *NT* nucleation temperature; *D* lowering of the freezing point of the solution. (After Sakai and Larcher 1987)

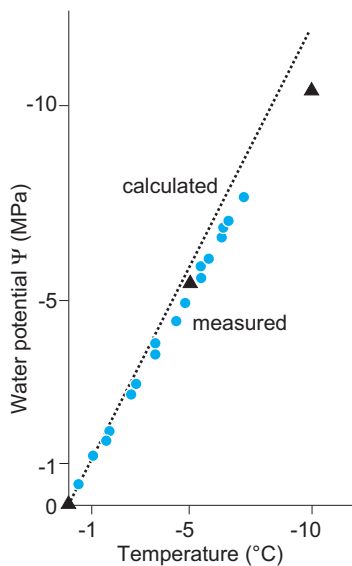


Fig. 2. Temperature dependence of the water potential of ice. The *dotted line* is calculated from the equation

on the temperature, the water potential of ice is also linearly dependent on the temperature (Fig. 2).

The vapour pressure of water over aqueous solutions is also lowered. The extent of the reduction depends on the concentration of the solution, more precisely on the mole fraction (*M*) of the water in the solution (**Raoult's law**):

$$P = P_0 \times M_{\text{water}}$$

$$M_{\text{water}} = \frac{\text{mol}_{\text{solvent}}}{\text{mol}_{\text{solvent}} + \text{mol}_{\text{solute}}}$$

[mole fraction]

In the same way, it follows that the free energy of the water in a solution depends on its mole fraction:

$$G_{\text{water}} = G_{0\text{water}} + RT \ln M_{\text{water}}$$

and

$$\Delta G = RT \ln M_{\text{water}}$$

It follows from this that the water potential of solutions Ψ_{π} or following the modern nomenclature π , is more negative than that of pure water:

Box 1.3.9 (continued)

$$\pi = \frac{RT}{V_{\text{water}}} \ln(1 - M_{\text{solute}})$$

since M_{solute} is generally small, then

$$\ln(1 - M_{\text{solute}}) \approx -M_{\text{solute}};$$

substituting the equation for the mole fraction of the solute into the equation

$$M_{\text{solute}} = \frac{\text{mol}_{\text{solute}}}{\text{mol}_{\text{solute}} + \text{mol}_{\text{water}}},$$

gives

$$\pi \approx -\frac{n_s RT}{\bar{V}_{\text{water}}(n_s + n_{\text{water}})};$$

in a dilute solution

$$\bar{V}_{\text{water}}(n_s + n_{\text{water}}) \approx \bar{V}_{\text{water}} n_{\text{water}} = V_{\text{water}}$$

and

$$\frac{n_s}{V_{\text{water}}} = C_s \text{ [concentration]}$$

$$\pi = -RT \times C_s$$

It follows, furthermore, that the freezing point/melting point is lower than that of pure water and that it, too, depends on the mole fraction or concentration of the dissolved substances (s):

$$\Delta T_m = 1.86 \times n_s$$

$$n_s = \text{mol}_{\text{solute}} \text{ in 1 kg water (molality)}$$

The molal constant for the lowering of the freezing point of water is 1.86°C . The more concentrated the solution is, the greater is the lowering of the freezing point.*

In ideal solutions pure water freezes first, whereupon the remaining solution becomes concentrated. At a particular temperature, the **eutectic point**, the remaining solution then also freezes. In colloidal solutions such as are present in a cell, a small proportion of the water which is firmly bound to the macromolecules remains liquid even at very low temperatures, e.g. in liquid nitrogen. This proportion of the water can be determined by means of a diagram, in which the proportion of liquid water at various frost temperatures is plotted against the reciprocal of the temperature, and is given at the point at which the line crosses the ordinate (cf. Fig. 1.3.22). This residual water, in which enzymes are dissolved, is a problem in frozen food. At freezer temperatures these enzymes naturally function only very slowly, but hydrolytic enzymes in particular are quite stable and are usually not destroyed during freezing. Only few degradation products are to be reckoned with when frozen foods are used immediately after thawing. However, if the thawed material is later refrozen, the hydrolases (e.g. proteases) will have been provided with favourable conditions for their activity and the frozen products can suffer from a loss of quality.

* This applies strictly only to dilute, i.e. ideal solutions. In concentrated solutions, interactions occur between the dissolved particles, which result in an apparent reduction of the concentration. The factor a , by which the concentration appears to decrease, is termed the activity factor.

(negative turgor) and strengthens the osmotic potential. A matrix potential develops similarly during strong dehydration. All three potentials now act together:

$$(-)\Psi_{\text{tissue}} = (-)\pi + (-)\tau + (-)P = (-)\Psi_{\text{ice}}$$

This occurs even at only moderate frost in the ground-covering plant *Pachysandra terminalis* (Fig. 1.3.23).

Significantly less water freezes in this case than would be expected from the prevailing osmotic relations, and the effect of the negative pressure potential becomes particularly evident. However, the influence of the matrix potential may also become apparent during such strong dehydration. At the extent of the freeze-desiccation shown, 12% more liquid water (32% residual water compared with 20% at -7°C) signifies considerably less strain on the cells.

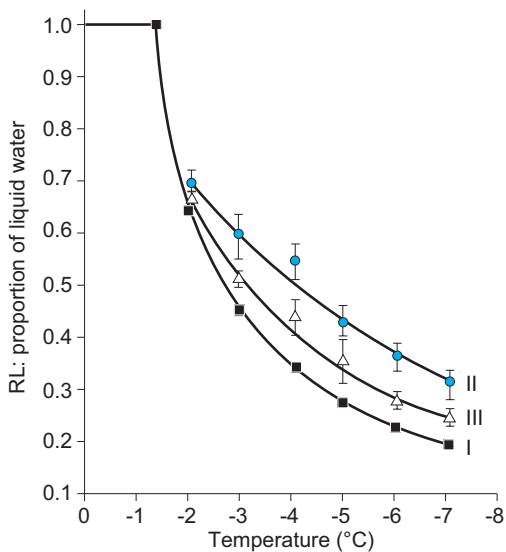


Fig. 1.3.23. Freezing curves for *Pachysandra terminalis*. *Pachysandra* leaves show non-ideal equilibrium freezing: the residual amount of unfrozen water measured in the tissue at various frost temperatures (curve II) is significantly greater than that calculated from the concentration of the cellular solutions (curve I). In this case, the cell wall as well as the cell sap must therefore develop a “negative pressure potential” corresponding to suction. This is the result of the close contact between the plasma membrane (protoplast) and cell wall. The share of the matrix potential in the suction can be determined by killing the tissue prior to the freeze-desiccation (curve III). The more severe the frost is, the greater is the proportion of the total potential due to the matrix potential. (After Zhu and Beck 1991)

1.3.6.5

Antifreeze Proteins

A further possibility to impede ice formation and thus to decrease cell desiccation is constituted by special proteins which are excreted from the protoplast into the apoplast and influence the formation of ice there. These have been termed antifreeze proteins (AFPs) or thermal hysteresis proteins (THPs). Antifreeze proteins have long been known in fish and insects (DeVries and Cheng 1992; Duman et al. 1992), where they apparently prevent or alleviate the freezing of body fluids. In these animals they do appear to significantly reduce the freezing point in a non-colligative (non-physicochemical) manner.

An effect of these proteins is illustrated in the test carried out to detect their presence: The growth of an ice crystal and the formation of new ice crystals in a very diluted AFP solution can be observed under the microscope during cooling. It is thereby observed that the tempera-

Table 1.3.8. Reduction of the freezing point by antifreeze proteins as measured by thermal hysteresis

Organism	Tissue	Reduction in freezing point (°C)
Bony fish	Muscle	0.7–1.5
Insects	Digestive tract, muscle	3–6
Bacteria		0.3–0.35
Fungi	Fruiting body	0.3–0.35
Mosses	Whole plant	0.3–0.68
Horsetail or Dutch rush (<i>Equisetum hyemale</i>)	Rhizome	0.2
Ferns	Shoot	0.25
Winter wheat	Leaves	0.2
Carrot	Tuber	0.4
Carrot	Shoot	0.15
Poplar	Twig	0.22

ture required for nucleation is significantly lower, and an existing ice crystal grows much more slowly during cooling than in pure water; the melting point, however, is not affected. This results in hysteresis during freezing and thawing, and is the reason why these proteins are also called THPs (Table 1.3.8).

Antifreeze proteins are a mixture of small to medium-sized proteins which can be extracted from the tissue of frost-hardy leaves, but not of frost-sensitive leaves (Urrutia et al. 1992). They are divided into several groups: Antifreeze proteins and antifreeze glycoproteins are both subdivided into further groups based on the tertiary structures of the two major types of protein. There are clear conceptions as to how these proteins function at the molecular level, although this is not yet true of plant AFPs.

The already classical antifreeze glycoproteins of cold-water fish are built around the repeating tripeptide $-[\text{Ala-Ala-Thr}]_n-$, where the threonine bears a sugar residue.

The AFP of the winter flounder is also characterised by such repetitive sequences, namely of an undecapeptide. The 11 amino acid units consist mainly of alanine with rhythmically interspaced polar amino acids (Thr, Asp and Asn). These are ordered in such a way that their polar residues are all on one side of the helix (Fig. 1.3.24), so that the protein has a hydrophilic and a hydrophobic side. The hydrophilic face of these proteins is thought to attach to the main growing surface of the ice crystal, and the hydrophobic side of the protein, which is now turned to the outside, makes it difficult for further water clusters to associate with the ice

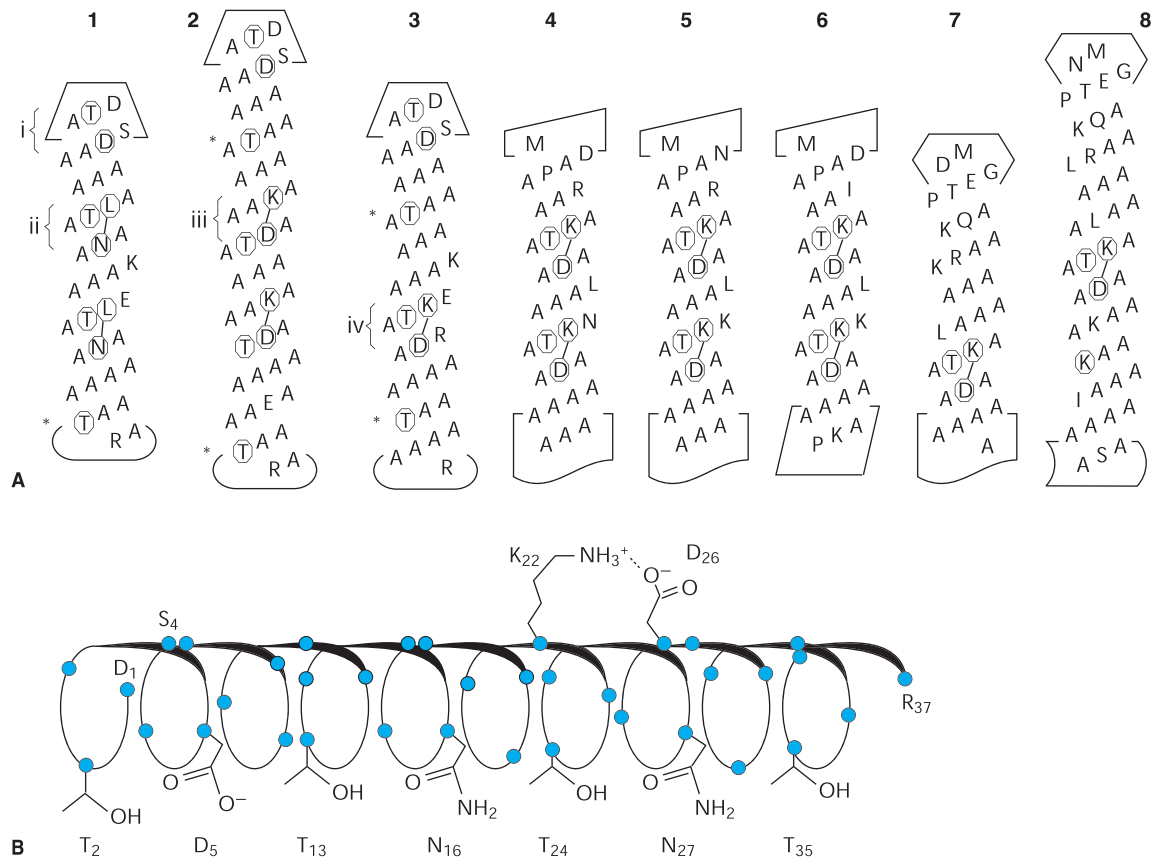


Fig. 1.3.24. Antifreeze proteins (AFPs) of fish. **A** Various alanine-rich α -helical AFPs. 1 Winter flounder; 2 yellow tail flounder; 3 plaice; 4–8 different AFPs from sculpin. The N- and C-terminal caps, which stabilise the α -helical structures, are shown by structure symbols. Ice- (water-) binding motifs (*i–iv*) are shown by circles. **B** Side view of the AFP B of the winter flounder, in which the unilateral orientation of the hydrophilic groups can be clearly recognised. K22 and D26 form a salt bridge (amino acids are specified in single letter code). (After Sicheri and Yang 1995)

crystal. The matrix for this attachment is set by the ice crystal, while the manner in which the attachment takes place is determined by the protein. Since α -helical polypeptides are dipoles, the AFP preferentially attaches to the prism surfaces of the ice crystal in an antiparallel manner. Due to the blocking of its normal growth surfaces, the ice crystal now grows less rapidly and extends mainly in the direction of the c-axis. This leads to the formation of small, needle-like crystals (Antikainen et al. 1996; Fig. 1.3.25).

It is quite evident that the effect of AFPs in delaying freezing depends on the concentration of the proteins. Since they must be bound to the surface of the ice to achieve their effect, they can be said to be used up. This also explains why AFPs do not provide a general protection against freezing. AFPs reduce the formation of ice in the organism, but they cannot suppress it completely. The partially frozen state of the tis-

sue liquid arrived at in this manner is certainly more stable during supercooling than the completely liquid state, which tends to freeze abruptly. It is quite plausible that many small ice crystals which are inhibited in their growth and cloaked in proteins are less damaging to the organism than is a large crystal. The protein cloak of the ice crystal is possibly the deciding factor in frost protection by AFPs. A further effect of AFPs could be to prevent recrystallisation of ice concomitant with the formation of larger ice crystals during the thawing process (Carpenter and Hansen 1992). This is of particular importance with regard to ice crystals in the body fluids of cold-water fish and insects, where the formation of larger ice crystals would lead to circulatory damage. The combination of INPs and AFPs could constitute an effective method of regulating the formation of ice crystals in tissues (Griffith et al. 1993; Worland and Block

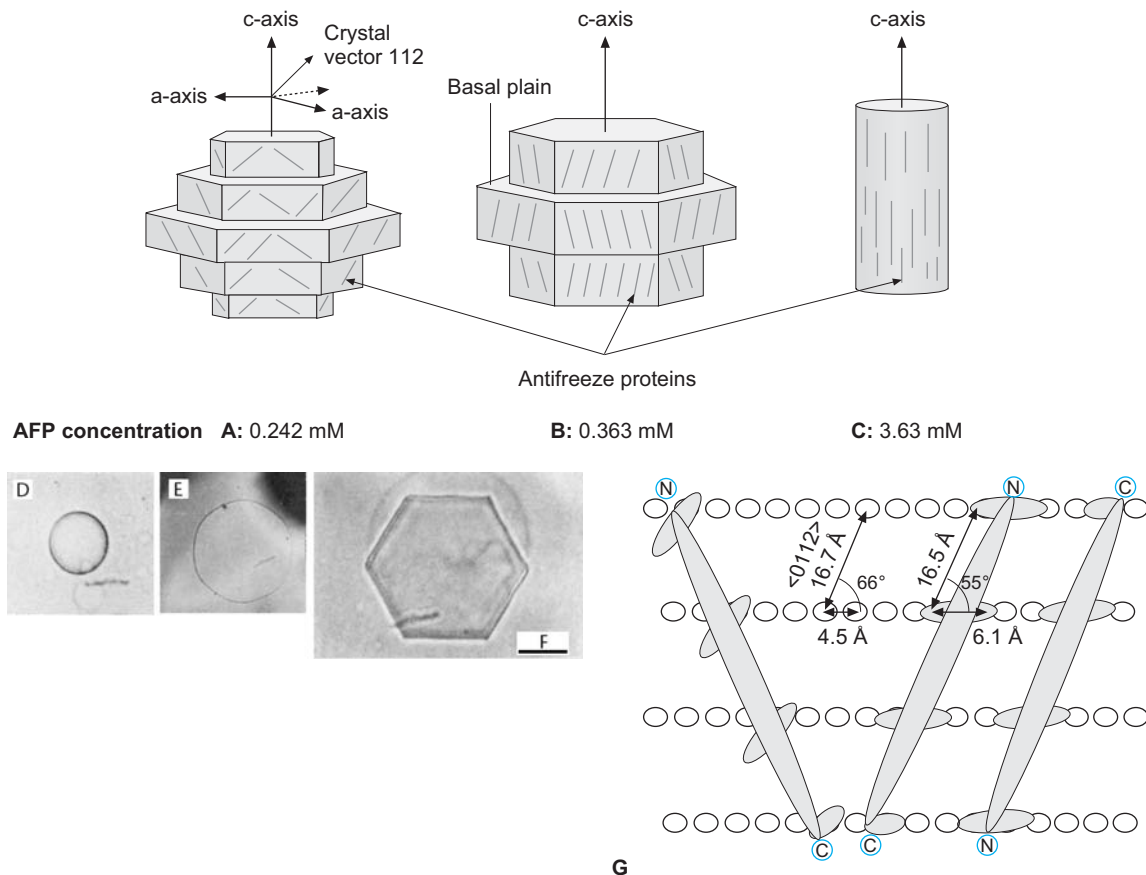


Fig. 1.3.25. The effect of antifreeze proteins (AFPs) on the formation of ice crystals. **A–C** Schematic drawings of crystals in the presence of increasing concentrations of winter flounder AFP. In the most dilute solution, there is not yet any interaction between the individual protein molecules, which orient themselves mainly according to the ice crystal vectors. In the more concentrated solutions, the protein molecules interact and bind in an antiparallel manner to the prism surfaces. **E, F** Micrographs of ice crystals which have formed in the presence of protein extracts from the apoplast of unhardened (**E**) and frost-hardened rye leaves (**F**). Length of the bar: 25 μm . For comparison an ice crystal in pure water is shown in **D**. **G** Molecular model of the binding of the winter flounder protein (grey) to an ice crystal (circles denote water molecules). The four ice-binding motifs correspond to the distance between the water molecules in the ice crystal. (**A–C** after Yang et al. 1988; **D–F** after Griffith et al. 1992; **G** after Sicheri and Yang 1995)

1999). Attempts to transform potato plants with the AFP of flounder genetically engineered to optimise codon usage yielded plants with significantly increased cold tolerance (Wallis et al. 1997).

1.3.6.6

Protection of Biomembranes and Freezing Tolerance

Soluble material accumulates in the residual liquid of the cell to an enormous extent during extracellular freezing. In addition to the danger of membrane disintegration as a consequence of water withdrawal (see above), severe stress is incurred by the concentration of ions at membrane

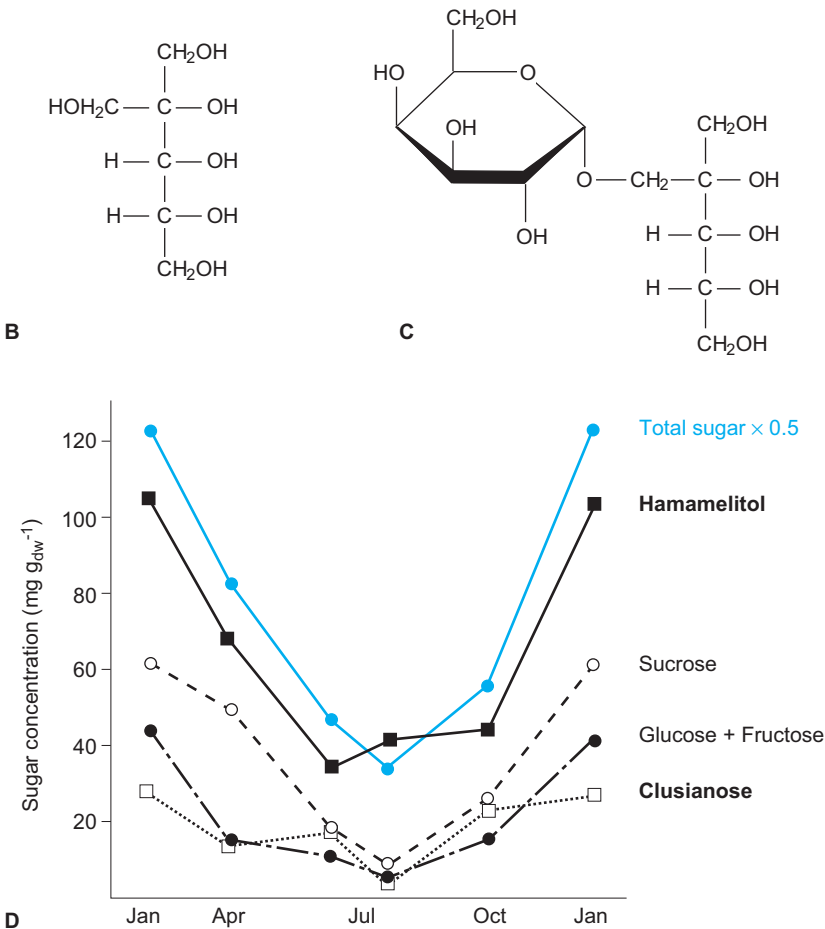
surfaces. High ionic charge at the membrane surface changes the membrane potential, and can thus also lead to membrane disintegration or at least to the dissociation of peripheral proteins.

The Degree of Frost Hardiness Depends on the Extent and Quality of Membrane Protection

Relatively high concentrations of soluble, low molecular weight, so-called cryoprotective substances can be found in frost-tolerant plants [polyols, sucrose and its galactosides raffinose and stachyose, poorly degradable carbohydrates such as hammamelitol (Fig. 1.3.26), amino acids, polyamines and many more]. These compounds “dilute” the ionic charge at the membrane surface and, at the same time, stabilise the bilayer struc-

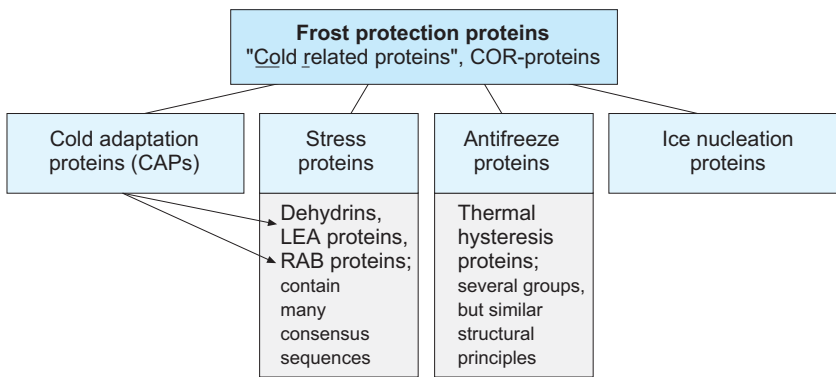


Fig. 1.3.26. Frost protection in the eastern Alpine *Primula clusiana* Tausch (A). Hamamelose=2-hydroxymethyl-D-ribitol (B), and its galactoside clusianose (C), accumulate irreversibly in the overwintering leaves during the cold season (D). These old leaves die subsequent to the formation of new leaves in the following vegetation period without the branched chain sugar derivatives, which are present in high amounts, having been removed for further use. The accumulation of hamamelose can also be induced by cooling the plant in summer. (Photo E. Beck)



ture in being weakly polar (as is water). The main effect of cryoprotective substances is thus to protect membranes. Their effect in lowering the freezing point first comes into play during freeze-desiccation of the cells. For example, the sap expressed by pressure from frost-hardy spruce needles is only 1.5 osmolar, corresponding to a reduction of the freezing point by 2.8 K. This is physiologically insignificant, as a greater degree of supercooling is required to trigger crystallisa-

tion. The cell liquid becomes more concentrated during freeze-desiccation, however, and would be ten-fold more concentrated at a residual volume of 10%. The colligative (physicochemical) properties of the cryoprotective substances would then, of course, be of considerable importance. In the example of spruce needles, this would result in the lowering of the freezing point by 28.5 K, which would prevent the freezing of the residual liquid water.



■ **Fig. 1.3.27.** The different types of frost protection proteins

Freezing Protection Proteins

So-called cold protection proteins (CORs) or cold adaptation proteins (CAPs), which can play an essential role in the development of frost hardiness, are of particular contemporary interest. Many such proteins and corresponding genes, which become expressed upon cold treatment, have been described since the late 1980s (Fig. 1.3.27). Among them are antifreeze proteins and isoforms of housekeeping enzymes with a lower temperature optimum such as, e.g., lactate dehydrogenase (in animals) or PEP carboxykinase (Sáez-Vásquez et al. 1995), as well as enzymes for the biosynthesis of cryoprotectants.

Membrane-protective proteins also belong to this group, proteins which interact with the surfaces of membranes and stabilise these during freeze-desiccation. They are similar to the so-called dehydrins, extremely hydrophilic protective proteins which are formed during drought stress or during regulated desiccation, e.g. during seed ripening. They usually have a molecular mass of between 15 and 50 kDa (see Chap. 1.5.2.5), but very large (~200 kDa) CORs have also been described recently. These proteins are rich in glycine, are boiling- and acid-stable and possess a high proportion of random-coil secondary structure. On a molar basis they are about 20,000–40,000 times more effective than sucrose in conserving membranes. These proteins are described in detail in Chapter 1.5 on drought stress. There are some indications that cold protection proteins can be membrane-specific; e.g. a 7-kDa protein has been found which specifically protects chloroplast thylakoids (Hincha and Schmitt 1992). Even though heat shock proteins have been linked with cold tolerance, the CORs and CAPs are not related to them in any way either in structure or function. Like antifreeze proteins, most CORs and CAPs

are amphiphilic but, in contrast to the AFPs, they attach with their hydrophobic side to the structures they are protecting, e.g. membrane surfaces. Their hydrophilic side faces the cytosol. This attachment results in the displacement of lower molecular weight solutes such as ions from the membrane surface. As is the case with dehydrins, it is possible to induce the synthesis of CAPs by treatment with abscisic acid (ABA, see Chap. 1.5.2.3) in place of cold treatment. Treatment of citrus plants with ABA and other growth regulators was successful in conferring cold tolerance, but had a number of negative side effects such as disadvantageous biomass distribution and premature fruit shedding. Thus spraying with such chemicals cannot be recommended as a general method for artificially improving the frost-hardiness of threatened crops (Yelenosky et al. 1987).

1.3.6.7

Avoidance of Freezing

Supercooling

The avoidance of the formation of ice crystals at freezing temperatures leads to **supercooling**. The supercooled state of plant tissues can usually be maintained for only some hours, in which case it can, for example, help plants to cope with the nightly radiation frosts which occur regularly in high mountain regions of the tropics. Supercooling has been observed to persist at length only in tissues possessing very rigid cell walls. Leatherly leaves, for example, can remain unfrozen at temperatures of -12°C , and the buds of trees and the wood of certain species (e.g. of the North American *Cornus stolonifera*) are able to supercool at -30 to -50°C for long periods (Ashworth 1993). Supercooling has the advan-

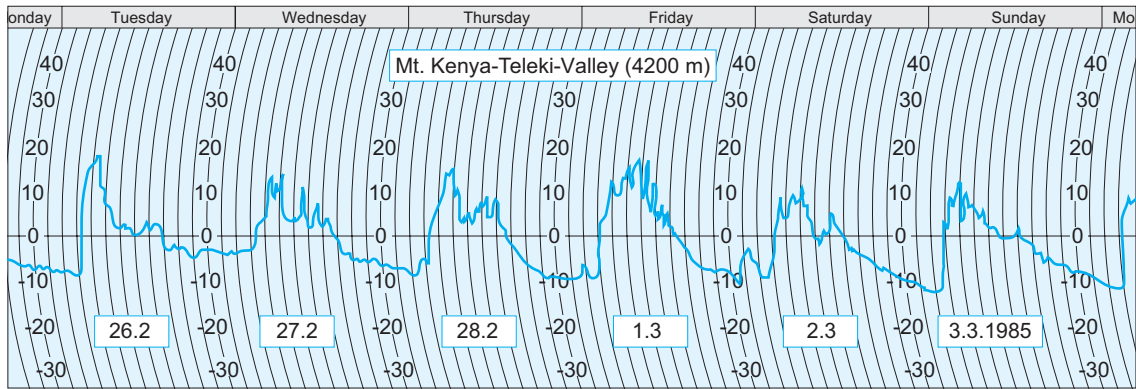


Fig. 1.3.28. Temperature courses (close to the ground) in tropical high mountains during the dry period: Hedberg (1964) characterized this recurrent-frost climate as summer every day, winter every night. Night frosts occur even during the rainy season, although the temperature then seldom drops to below -5°C

tage over freezing tolerance in that the hydration of the cells is maintained and no dehydration stress occurs. Metabolic reactions are extremely slow at the low temperatures of supercooling to be sure, but during freeze-desiccation they cease completely. Supercooling also brings the risk of **intracellular ice formation** upon sudden nucleation, however (see Fig. 1.3.18), which then leads irrevocably to the death of the cell. This may be triggered by movement due to wind or animals in open spaces, for example. In general, those plants possessing nucleation barriers are not tolerant of freezing. Supercooling as a strategy may be regarded as a form of stress avoidance (avoidance of freezing).

Transient Avoidance of Freezing in Plants of Tropical High Mountain Regions

Typical of high mountain areas in the tropics is the so-called recurrent-frost climate: this is a special version of the daily fluctuation type of climate characteristic of the tropics, in which several hours of frost usually occur during the course of the night (Fig. 1.3.28).

Even though these frosts occur regularly, they do not last long and are only moderate (temperatures below -15°C are very rare and occur at most in hollows), and the indigenous flowering plants have developed special facilities to provide temporary avoidance of freezing.

This is particularly evident in the tropical alpine giant rosette plants of the genera *Senecio*, *Lobelia* and *Espeletia*. These seemingly archaic plants (Fig. 1.3.29) bear a single large rosette of leaves of up to over 1 m in diameter and consisting of usually more than 100 large leaves at the end of the above- or below-ground stem.

There are no marked quiescent periods during the course of the year and, therefore, young leaves are continuously formed and older leaves also die continuously. At least the first half of the development of the leaf takes place in a conical leaf bud in the centre of the leaf rosette, from which the leaves emerge after greening and carry out the rest of their longitudinal growth in the rosette. The principle means by which these plants avoid freezing are **supercooling** and **delayed cooling** (Beck 1994).

Supercooling has been shown above all for the South American *Espeletias*, the cell sap of which does not freeze even at -8°C . Temperatures lower than this almost never occur in areas colonised by these plants, which are lethally damaged if ice formation is artificially induced. Delayed cooling can be achieved by insulation and via heat buffers. **Cloaking** of the above-ground stems of these plants confers permanent heat insulation through the dead, partly rotted leaves, which delay cooling but do not prevent the stem temperature from rising to $15\text{--}20^{\circ}\text{C}$ during the day under intense solar radiation (Fig. 1.3.29). A stem temperature in the range of between 0 and 20°C is important, as a large share of the water required by the leaf rosette is supplied by the living pith tissue and does not stem from the weakly developed xylem with its extremely narrow vessel lumens. Water transport via living cells depends to a large degree on the temperature.

The so-called **night buds** of the giant rosettes provide thermal insulation in accordance with the prevailing temperature (Fig. 1.3.30): When the temperature falls at night the rosette leaves bend in towards the top and thus form a closed

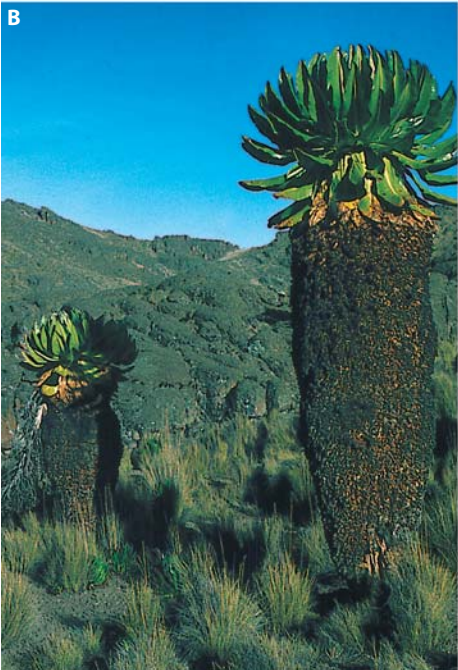
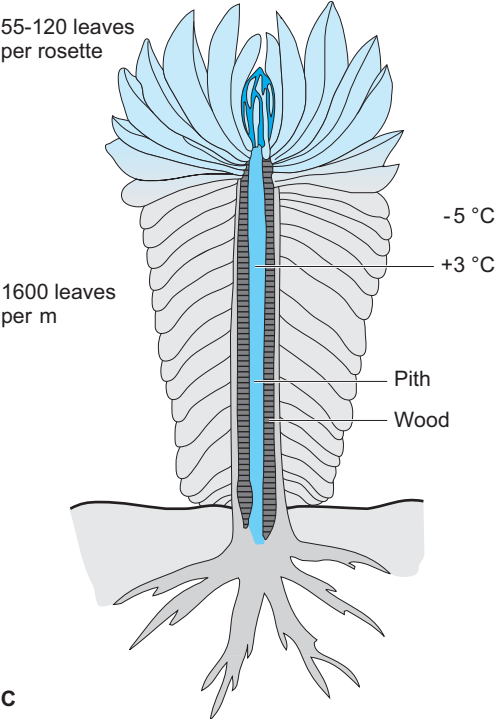


Fig. 1.3.29. Rosette plants of the genera *Senecio* (A–C) and *Espeletia* (D) from the alpine tropics. Neither the East African *Senecio keniodendron* (endemic to Mt. Kenya) nor *Espeletia corymbosa* from the Andes lose their dead leaves, but retain them as an insulating cloak around the stem. The effect of this insulating layer is indicated in the schematic diagram (C) which illustrates the inner structure of the plant. The massive pith serves as a water reservoir, as the xylem itself is only relatively weakly developed. The *Espeletias* are called “Freilejones” (fat monks) on account of the appearance of the cloak of dead leaves. (Photos E. Beck)

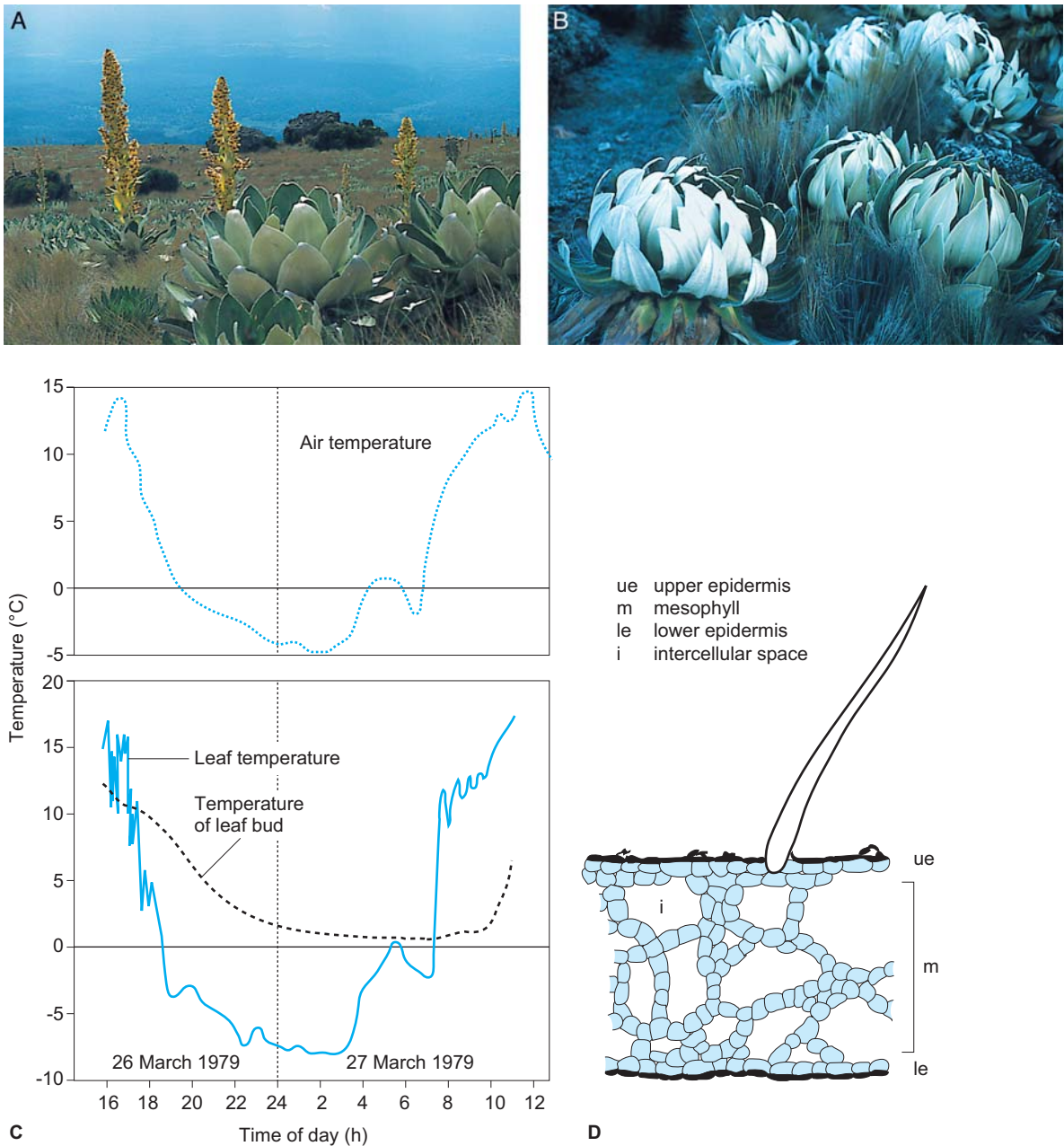


Fig. 1.3.30. Protection against freezing by adaptive insulation in *Senecio keniensis* (endemic to Mt. Kenya). Rosettes open during the day (**A**) and close when it becomes cold, forming a so-called night bud (**B**). The insulative effect (**C**) applies to only the young leaves in the interior of the rosette. While the outer leaves are frozen stiff, the inner ones remain at above the freezing point. The leaves of the giant rosette plants (**D**) frequently exhibit a “polystyrene foam” structure which increases the insulative effect (*Lobelia keniensis*). (Photos E. Beck)

shell around the still-growing buds and young leaves still in the bud cone (**Fig. 1.3.30 B**). This night bud consists of many layers of leaves and thus provides considerable insulation. Although the outer leaves are frozen stiff in the morning, the temperature inside does not fall below the freezing point (**Fig. 1.3.30 C**). Upon warming in

the morning, the rosette opens within a few minutes and is then immediately ready for photosynthesis.

Water is a very effective heat buffer on account of its high specific heat and its even higher latent heat of crystallisation (**Fig. 1.3.31**). The inflorescence of *Lobelia telekii* contains several

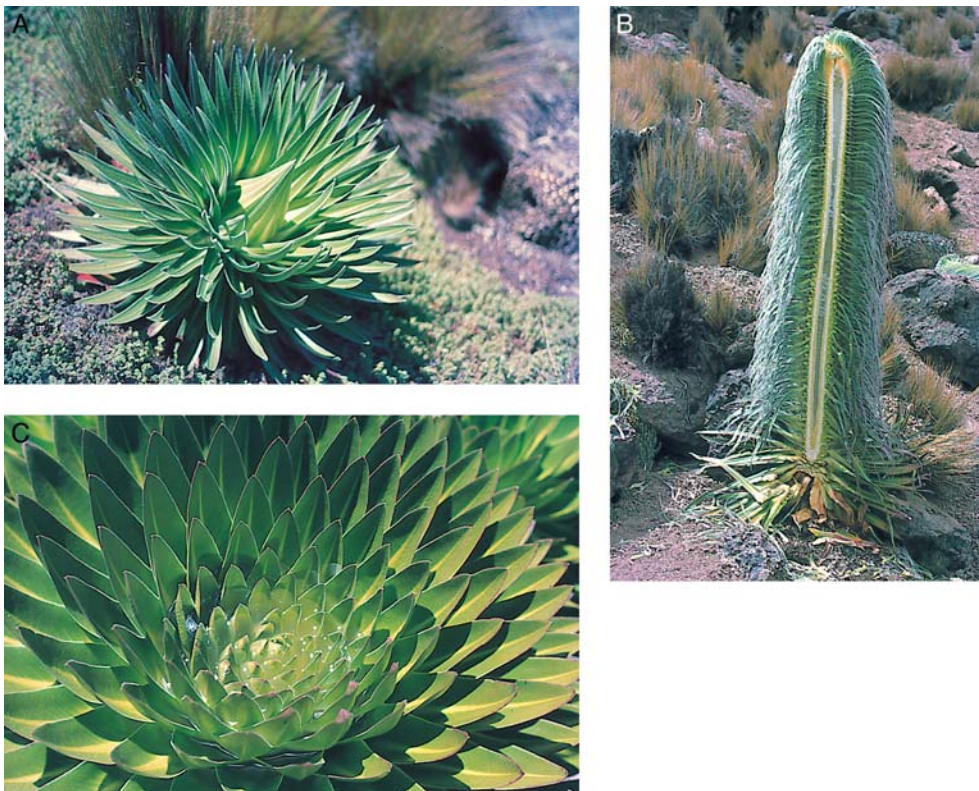


Fig. 1.3.31. Water or aqueous solution as a thermal buffer. **A, B** *Lobelia telekii* in the rosette stage and during flowering, respectively. The rosette clearly shows the structure of a “giant rosette”. The young leaves develop in the centre of the rosette and, closely appressed, form a cone-shaped leaf bud. The inflorescence is up to 3 m in height (**B**) and contains 3 l of watery pith fluid according to Kroog et al. (1979). From the specific heat of water ($4.2 \text{ J/g} \times \text{K}$) and the heat of its crystallisation (331 J/g), a thermal buffering capacity of 1005 kJ can be calculated. At -6°C only 2% of the liquid in the pith was frozen, according to which only 1.8% of the total heat buffering capacity was used. **C** The numerous leaves (>150) of the rosette of *Lobelia deckenii* (Mt. Kilimanjaro) form cisterns in which rain as well as gutated liquids accumulate. A rosette contains more than 2 l of such liquid. This liquid is pushed up during the formation of the night buds and surrounds the leaf bud as an additional heat buffer. (Photos E. Beck)

litres of water in its pith cavity with an enormous heat capacity: At an exterior temperature of -6°C only about 2% of this liquid was frozen and only 1.8% of the heat storage capacity was made use of. The cistern-like bases of the rosette leaves also collect litres of water, which is only partially frozen after cold nights and thus constitutes a considerable heat reservoir (**Fig. 1.3.31C**). Investigations have shown that all of the leaves of a giant rosette (except, seemingly, the leaves of the genus *Espeletia*), including those still in the bud, can tolerate freezing. What is, then, the value of the avoidance of freezing? Daily de- and rehydration processes evidently put a great strain on tissues: Outer rosette leaves that more or less freeze every night age relatively quickly. Tips of leaves which are exposed to the sunlight in their frozen state yellow after only a few days. It therefore appears to be ad-

vantageous for tissues to avoid freezing stress even when they are frost-hardy.

1.3.6.8 Seasonal Tolerance to Freezing

Phases of frost hardening and dehardening alternate with the seasons in native “lowland” plants. Signals for hardening or dehardening are the day length and temperature. In nature both factors work together; in experiments they also act individually. Short day length and a slow decrease in temperature to a low, but not yet damaging, value induce rapid hardening ($\sim -1 \text{ K/day}$). The phytochrome system participates in the signalling that leads to the effect of day length: far-red light stimulates hardening, red light dehardening. Since resistance to freezing is

a process that affects the whole plant, hardening and dehardening are extremely complex processes which are currently being intensively studied at the level of cell biology. Some well-investigated individual processes, such as the formation of cryoprotective substances including proteins, have already been mentioned. A particularly important process is the adaptation of biomembranes to heat and cold. According to present knowledge, frost hardening is not possible during the main growth period because the cell wall is probably not able to cope with the strain of water loss during freeze-desiccation.

Molecular Biology of Frost Hardening

Even though *Arabidopsis thaliana* can develop at most only moderate frost resistance, research using this plant has yielded important insights into frost hardiness due to the complete sequencing of the *Arabidopsis* genome and the relative ease of carrying out mutant studies (Thomashow 1999). The constitutive “frost hardiness” of this plant has been shown to be genetically independent of its ability to harden to frost. Constitutive frost hardiness is understood as the degree of frost hardiness which can be measured with plants grown at room temperature. Constitutive as well as induced frost hardi-

ness constitute a syndrome, i.e. they involve the concerted action of many genes (more than 100 genes have been reported: Xin and Browse 2000). The most important features which occasion frost hardiness have been treated in detail in earlier chapters. The existence of the syndrome “frost hardiness” or “frost hardening” suggested a search for “master genes” which regulate the frost-hardening process. Such master genes were found at the level of transcription factors and transcription activators (Fig. 1.3.32), e.g. the activators of the CBF group (C**R**T-Repeat **B**inding **F**actor) that bind to the promoter element AAGAC which occurs in many COR genes. CBF1 has also been described as D**R**E**B**1**B** (D**r**ought **R**egulated **E**lement **B**inding factor 1B; see Chap. 1.5: stress due to drought), which again illustrates the phenomenon of cross-protection. The induction of some COR genes by abscisic acid (ABA) via the transcription activator “bZip” (alkaline leucine zipper) can be understood in the same context. Figure 1.3.32 shows how such master genes can activate several other genes at the transcription level, and how the regulatory effects of several master genes can overlap. The identification of a master gene begs the retrogressive question as to how this master gene is activated. An increase in cal-

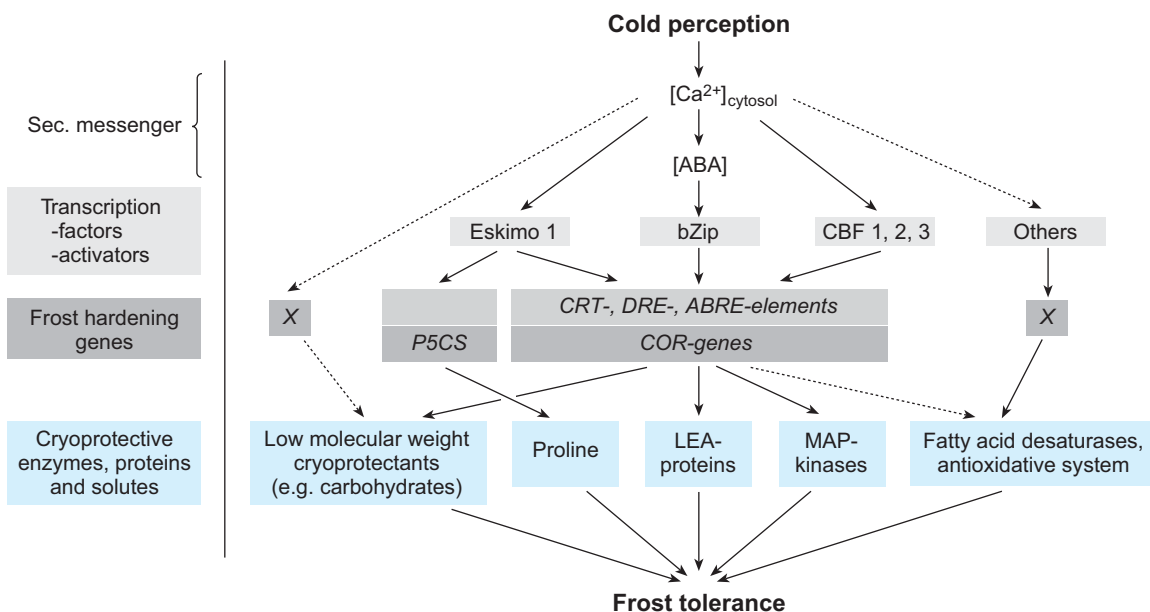


Fig. 1.3.32. Molecular biology of the induction of frost hardening. Overview of the established (continuous arrows) and presumed (dotted arrows) signal transduction pathways in *Arabidopsis thaliana* which lead from the perception of the cold signal (molecular basis unknown) to the development of frost hardiness (maximum degree of resistance is to -12°C). ABA Abscisic acid; bZIP alkaline leucine zipper; CBF CRT-repeat binding factor; DRE drought-regulated element; ABRE ABA-responsive element; P5CS gene for Δ -1-pyrroline-5-carboxylate synthetase (cf. Box 1.5.5). (After Xin and Browse 2000)

cium concentration in the cytosol appears to be a decisive trigger in this regard (Tahtiharju et al. 1997). At any rate, such an increase is observed immediately after the onset of a frost hardening program and precedes gene activation. It is not yet known how the increase in the cytoplasmic calcium concentration is triggered. It is supposed, however, that the membrane stiffening due to cold is involved in the stress perception (Vigh et al. 1993; see also the section on stress perception in [Chap. 1.1](#)).

1.3.6.9

Frost Hardening Decreases Efficiency

The “strategy” of winter-green plants such as conifers for coping with frost is to promote the extracellular freezing of tissue water. Photosynthesis ceases when the formation of ice takes place due to the severe dehydration and low temperatures. About 30% of the chlorophyll-binding antenna proteins of the chloroplasts of Scots pine are degraded during the course of frost hardening (pines appear somewhat yellow-green in winter). This can be seen as a protection of the photosynthetic membranes against light stress during sharp frosts (Hansen 2000). It results in a considerable restriction of photosynthetic function in the non-frozen state, however. Experiments in this regard on the CO₂ assimilation of pine needles have shown an about 80% reduction in potential photosynthetic capacity (see [Chap. 1.1.3](#), [Fig. 1.1.7](#)). This limitation of photosynthesis does not necessarily have negative consequences, however, as respiration is also considerably restricted at lower temperatures (Hansen and Beck 1994).

1.3.6.10

Secondary Stress: Frost Drought

Plants cannot take up water from frozen soil, and thus are in danger of suffering drought damage during permanent frost. Since the activity of roots depends on temperature, the uptake of water and nutrient salts deteriorates even at temperatures of a few degrees above the freezing point ([Chap. 2.3](#)). Plants of warmer regions already have similar difficulties at temperatures of about 5–10 °C: In various citrus species cold-induced drought damage is already evident at +5 °C.

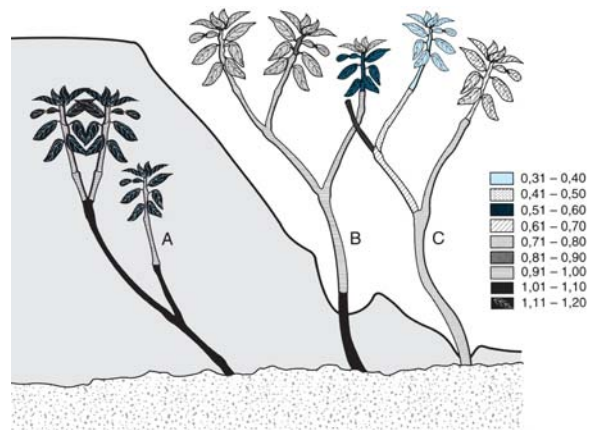


Fig. 1.3.33. Frost drought. Water contents (in g H₂O/g dry wt.) in leaves and shoots of the Alpine rose (*Rhododendron ferrugineum*) in winter. **A** Continually covered with snow; **B** only the stem basis covered by snow; **C** on frozen ground without any snow cover during the entire winter (measurement in March). (After Larcher 2003)

Frost drought occurs particularly at sites bearing little snow, when the soil is deeply frozen and the sun’s rays induce transpiration while an effective water delivery from the frozen stem and soil is impossible ([Fig. 1.3.33](#)). This is accompanied by increased danger of embolism in the xylem and in the cells as well. During prolonged frost drought, the volume of the cells, e.g. in conifer needles, shrinks to a fraction of the volume in the turgescence state. According to Larcher (2001), the tree line is determined by the duration and the severity of soil frost and by the extent of snow cover. Snow cover provides protection against desiccation and extremely low temperatures during severe frosts.

Snow cover also causes considerable strain, however: The pressures incurred lead to snow and ice breakage, light incidence is reduced (under a 20-cm-thick snow cover the residual light is 1–15% of that in the open) and gas exchange is impeded. The situation under prepared ski runs is particularly critical: Reductions of biomass production by 20–30% and in extreme cases by up to 70% have been observed (Cernusca 1984).

Table 1.3.9. Plants and cold: an overview

Temperature range (°C)	Plant response	Survival strategy	Example	Description
+8 to 0	Sensitive	None; unable to adapt	African violet	“Chilling-sensitive”
+8 to 0	Tolerant	None; unable to adapt	Tomato, potato	“Chilling-tolerant”
0 to -12, possibly lower	Tolerant	Lipid desaturation, cryoprotective substances	Spruce, pine, ivy in summer state	Frost-tolerant, but not tolerant to freezing
0 to -70, possibly lower	Tolerant	Lipid saturation, cryoprotective substances, lipid enrichment	Spruce, pine, ivy in winter state	Tolerant to frost and freezing

1.3.7

Concluding Comments

The expositions having been made in the section on “cold” show that the stressor low temperatures gives rise to a whole battery of strain reactions. The rather ambiguous term “syndrome” is often used in the literature to designate the multilayered changes which are thereby brought about, e.g. the frost-hardening syndrome. [Table 1.3.9](#) summarises the various aspects of the cold syndrome of plants.

Summary

1.

General

1. Every organism in nature is subject to limiting temperatures which define the temperature range in which active life is possible; these can in some cases significantly exceed or be lower than the limits of the temperature range of liquid water. Living beings (microorganisms) which have a temperature optimum of above 100°C are able to exist only under high pressure, in the deep oceans. All living organisms evidence so-called cardinal points of temperature compatibility: Cold death, cold rigidity, the range of active life, heat rigidity and heat death. Living organisms which are adapted to low temperatures are said to be psychrophilic, those requiring high temperatures are thermophilic to extremely thermophilic, while most organisms are mesophilic. Not all parts of a plant have the same temperature compatibility; this also applies to the different stages of their development.

2. Plants are able to adapt to conditions other than their “normal” temperature conditions, within certain limits. This requires that the lipid composition of the biomembranes be modified, so that the membranes are able to maintain the liquid-viscous state at all temperatures which may occur. If the temperature conditions significantly approach the limits of active life, high or low molecular mass protective substances (“chemical chaperones”) are additionally formed. Plants are also able to adapt in this way to large temperature fluctuations occurring during the course of a day.

2.

Heat

1. The typical strain triggered by heat is the production of heat shock proteins and the switching off of housekeeping genes. These reactions already start at only a few degrees above the optimal temperature of an organism; this means that plants live close to their heat stress limits. Heat avoidance mechanisms are, therefore, of great importance. A small leaf area, appropriate phyllotaxis, a strong indument and transpirational cooling all work against the overheating of leaves.

2. The heat shock response is one of the best-understood stress reactions at the molecular level. Proteins denatured by heat associate with heat shock proteins (HSPs, chaperones). Certain HSPs are normally present in association with heat shock transcription factors (HSFs). The HSFs are released and activated (trimer formation) as a result of the reaction with denatured proteins. The active HSF then reacts with corresponding palindromic sequences in the promoter region of the heat

shock genes, the so-called heat shock elements. This leads to the expression of these genes and to the production of HSPs. The HSPs “re-nature” heat-damaged proteins or mark them for proteolytic degradation. Their concentration then increases in the cell and they thus bind free HSFs again, which leads to the switching off of the production of further HSPs.

3. The way in which housekeeping genes are switched off is also at least basically understood at the molecular level. Heat prevents the association of the subunits of the spliceosome and thus the processing of mRNA. The unspliced mRNA of the housekeeping genes is stored in conjunction with HSPs in heat shock granules. Translation is also switched off by inactivation of an initiation factor. Heat shock proteins evidently do not require this initiation factor and their mRNA does not contain introns, so that it does not need to be spliced.

3.

Cold

1. With respect to the stressor cold, a distinction is made between damage arising at temperatures above the freezing point (damage through chilling in subtropical and tropical plants) and damage occurring upon frost and the subsequent formation of ice in the plant. Ice formation results in freeze-desiccation of tissues and cells, and frost damage is often damage due to dehydration. The freezing of water within the cell (intracellular ice formation) is always lethal (the exception is the artificial “vitrification” employed to conserve organisms).
2. Cold damage is primarily damage to membranes. This applies to chilling as well as to frost. If the proportion of high melting point lipids or the protein/lipid ratio is too high, large membrane domains are immobilised and their functions are lost when the temperature is lowered. Membrane damage is also caused by severe freeze-desiccation and the resulting accumulation of charged solutes (e.g. salt ions) at membrane surfaces.
3. Tropical and subtropical crop plants usually cannot harden to cold, or only to a very small extent. Metabolic imbalances and disturbances of cellular metabolism occur due to the different temperature tolerances of various metabolic reactions, even at temperatures not yet low enough to account for membrane damage. The inactivation of ion pumps, particularly of those associated with the energy supply or the homeostasis of membrane potentials, is the major cause of the damage referred to as being due to membrane “leakiness”.
4. Energisation of the photosynthetic apparatus when photosynthetic metabolism is disturbed leads to the formation of reactive oxygen species (ROS) which cause further damage, particularly through the formation of radicals in the biomembranes. This then exceeds the capacity of the plant’s well-developed detoxication system to intercept the ROS and the reactive products which they subsequently form. The photo-inhibition observed during the over-energisation of photosystem II, particularly in connection with chilling, is mainly triggered by ROS. ROS are not formed only in the context of photosynthesis, but also during dysfunction of the respiratory chain and in other reactions in which molecular oxygen participates. ROS detoxication systems occur, on the one hand, in membranes, e.g. as evidenced by tocopherol and xanthophylls in the photosynthetic membranes. In the cytosol or in the stroma of the chloroplasts, ascorbate and glutathione are the main compounds involved in the detoxification of ROS, but flavonoids also play a role.
5. Frost causes stress not only because of the low temperatures involved, but additionally due to (freeze-)desiccation. Therefore, the exact cause of the incurred damage cannot always be determined unequivocally. Freezing of tissue and cell water must always occur outside the cells in the intercellular spaces. Water must thus exit from the cells into the intercellular spaces prior to freezing. Cold inactivation of pumps in the plasma membrane could be a reason for this phenomenon. Ice formation in the intercellular spaces requires a nucleation trigger. Bacteria are often found on the epidermal surface of the plant, but also in the substomatal intercellular spaces, which act as nucleation triggers.
6. Bacteria which are active in nucleation, the so-called INA bacteria, possess “nucleators” consisting of aggregates of INPs (ice-nucleating proteins), whose molecular construction favours the fixation of water clusters into ice matrix-like structures and thus reduces the supercooling required for crystallisation. Nucleation-active proteins have also been ex-

tracted from the intercellular spaces of plant tissues, but their molecular effect has not yet been clarified. Ice formation, which takes place at relatively mild freezing temperatures, reduces the danger of the sudden intercellular freezing of cell water which takes place when supercooling has progressed too far. On the other hand, there are many plants that are frost-tolerant but not tolerant to freezing. Avoidance of nucleation is the only means of surviving frost for these plants (which include many crop plants).

7. The desiccation of cells stemming from the freezing of cellular water is enormous even upon moderate frost. As a rule, more than 80% of tissue water is already frozen at temperatures of about -10°C . Freezing ceases when the water potential of the (extracellular) ice, which depends on the (freezing) temperature, equals the water potential of the cell. This is called “equilibrium freezing”, whereby ideal and non-ideal equilibrium freezing are distinguished. In ideal equilibrium freezing, the water potential of the freeze-desiccated cell is determined solely by its osmotic potential. In non-ideal equilibrium freezing, a negative wall pressure (suction) which arises during the desiccation of the cell augments the water potential of the cell, so that more water remains in the liquid state than would be expected from the osmotic potential. The plasma membrane must always remain in contact with the cell wall in an intact cell during freeze-desiccation, as the matrix potential of the cell wall prevents the penetration of air from the intercellular spaces. Shrinkage of the cell volume caused by freeze-desiccation therefore leads to (reversible) deformation of the whole cell and even to wrinkling of the cell wall (freezing cytorrhysis).
8. Extreme freeze-desiccation leads to the breakdown of biomembranes, as the ordering of hydrophobic interactions between membrane lipids requires the presence of liquid water. Membrane breakdown is further stimulated by high concentrations of charged solutes, which can drastically alter the membrane potential.
9. The degree of frost hardening depends not only on the composition of the lipids (and the protein/lipid ratio) of the biomembranes, but also on the effectiveness of so-called cryoprotectants. These are low molecular weight solutes such as many carbohydrates, which take over the membrane-stabilising role of water molecules during freeze-desiccation, and at the same time prevent the accumulation of ions at the membrane surfaces. In addition to low molecular weight cryoprotectants, frost-hardy plants also synthesise proteins which protect membranes and other proteins. These are, for example, proteins from the family of the dehydrins, which associate protectively with membranes during dehydration. The formation of such proteins is a good example of cross-protection, i.e. of a multiple protective system, the formation of which is triggered by one particular stressor but then also hardens the plant against other stressors (e.g. frost, drought and high salt concentrations). The synthesis of such proteins may also be induced by the plant hormone abscisic acid.
10. The phenomenon of cross-protection suggests the existence of a molecular “master switch”. Indeed, in addition to the presence of plant hormones, there appears to be a higher hierarchical level of genes, the products of which activate a whole series of further genes. The products of these lower-level genes contribute to stress management either directly or indirectly (e.g. via the synthesis of low molecular weight osmolytes – here cryoprotective solutes). Such a system is called a “regulon”. Finding such master-switch genes would be of particular interest with regard to increasing the stress tolerance of plants by genetic transformation. It seems more feasible at present, however, to transform plants by introducing several genes from the lower hierarchical level into a crop plant (Holmberg and Bülow 1998). Candidate genes for transforming plants with a master switch would be, for example, those encoding transcription activators such as DREB 1A, B, C and others (see [Chap. 1.6](#): “proline”). These genes are high up in the cascade hierarchy for drought tolerance (Sarhan and Danyluk 1998).
11. So-called antifreeze proteins are well known in the animal kingdom, and have recently also been found in plants. They impede crystallisation of water and hinder the growth of ice crystals, thus delaying freezing, but not thawing. They are, therefore, also called THPs (thermal hysteresis proteins). The molecular structures and mechanisms of action of some of these proteins are known. They attach to ice crystals and turn their hydrophobic side towards the aqueous medium, thus making it difficult

for other water molecules to associate with the ice. The formation of many, small ice crystals instead of fewer large ones is the consequence.

12. Perennial plants from moderate and higher latitudes exhibit the phenomenon of seasonal frost hardening and dehardening. Frost hardening is accompanied at the molecular level by desaturation of membrane lipids, reduction of the protein/lipid ratios in biomembranes, and the synthesis of cryoprotective and ROS-detoxifying compounds and possibly also of proteins which promote or hinder ice nucleation. Plants have only a low photosynthetic capacity in the frost-hardened state. This is predominantly due to the degradation of the photosystems in the thylakoid membranes, but it also significantly reduces the danger of over-energisation in the frozen state. Arctic and tropical high mountain plants are permanently frost-hardy. The latter have developed various mechanisms to avoid freezing in accordance with the daily-frost climate, such as insulation and heat storage which can be of a permanent (cloaking of the stem) or transient (night buds) nature. Such mechanisms only work, however, because the nightly frost periods last, at most, for only a few hours before the tropical sun raises the temperature above the freezing point again.
13. Frost drought comprises a stress situation for the entire plant, for which there is no avoidance response except leaf shedding and also no specific tolerance. Frost drought results from the transpiration of above-ground plant parts when water cannot be taken up from the frozen soil. Frost-hardened plant organs can survive this situation only as long as the mechanisms for damage avoidance are not overtaxed.

References

- Allen DJ, Ort DR (2001) Impacts of chilling temperatures on photosynthesis in warm-climate plants. *Trends Plant Sci* 6:36–42
- Antikainen M, Griffith M, Zhang J, Hon W-C, Yang DCS, Pihakashi-Maunsbach K (1996) Immunolocalization of antifreeze proteins in winter rye leaves, crowns, and roots by tissue printing. *Plant Physiol* 110:845–857
- Ashworth EN (1993) Deep supercooling in woody plant tissues. In: Li PH, Christersson L (eds) *Advances in plant cold hardiness*. CRC Press, Boca Raton, pp 203–213
- Beck E (1994) Cold tolerance in tropical alpine plants. In: Rundel PW, Smith AP, Meinzer FC (eds) *Tropical alpine environments. Plant form and function*. Cambridge University Press, Cambridge, pp 77–110
- Burke MJ, Lindow SE (1990) Surface properties and size of the nucleation site in ice nucleation active bacteria: theoretical considerations. *Cryobiology* 27:80–84
- Carpenter JF, Hansen TN (1992) Antifreeze protein modulates cell survival during cryopreservation: mediation through influence on ice crystal growth. *Proc Natl Acad Sci USA* 89:8953–8957
- Cernusca A (1984) Beurteilung der Schipistenplanung in Tirol aus ökologischer Sicht. *Verh Ges Ökol* 12:137–148
- Crowe JH, Crowe LM, Mouradian R (1983) Stabilization of biological membranes at low water activities. *Cryobiology* 20:346–356
- DeVries AL, Cheng CHC (1992) The rule of antifreeze glycopeptides and peptides in the survival of cold water fishes. In: Somero GN, Osmond CB, Bolis CL (eds) *Water and life*. Springer, Berlin Heidelberg New York, pp 301–315
- Dowgert ME, Steponkus PL (1983) Effect of cold acclimation on intracellular ice formation in isolated protoplasts. *Plant Physiol* 72:978–988
- Duman JG, Wu DW, Yeung KL, Wolf EE (1992) Hemolymph proteins involved in the cold tolerance of terrestrial arthropods: antifreeze and ice nucleator proteins. In: Somero GN, Osmond CB, Bolis CL (eds) *Water and life*. Springer, Berlin Heidelberg New York, pp 282–300
- Elstner EF (1996) Die Sauerstoffaktivierung als Basis pflanzlicher Stressreaktion. In: Brunold C, Rügsegger A, Brändle R (Hrsg) *Stress bei Pflanzen*. UTB Paul Haupt, Bern, pp 347–363
- Fetene M, Gashaw M, Nauke P, Beck E (1998) Microclimate and ecophysiological significance of the tree-like life-form of *Lobelia rhynchopefalum* in a tropical alpine environment. *Oecologia* 113:332–340
- Fields PG (1993) Reduction of cold tolerance of stored-product insects by ice-nucleating-active bacteria. *Environ Entomol* 22:470–476
- Frentzen M, Heinz E (1983) Membranlipid-Biosynthese in Chloroplasten. *Biol Unserer Zeit* 13:178–187
- Georgopoulos C (1992) The emergence of the chaperone machines. *Trends Biochem Sci* 17:295–299
- Gombos Z, Wada H, Varkonyi Z, Los DA, Murata N (1996) Characterization of the Fad12 mutant of synechocystis that is defective in delta 12 acyl lipid desaturase activity. *Biochim Biophys Acta* 1299:117–123
- Green RL, Warren GJ (1985) Physical and functional repetition in a bacterial ice nucleation gene. *Nature* 317:645–648
- Griffith M, Ala P, Yang DSC, Hon W-C, Moffatt B (1992) Antifreeze protein produced endogenously in winter rye leaves. *Plant Physiol* 100:593–596
- Griffith M, Marentes E, Ala P, Yang DSC (1993) The role of ice-binding proteins in frost tolerance of winter rye. In: Li PH, Christersson L (eds) *Advances in plant cold hardiness*. CRC Press, Boca Raton, pp 177–186
- Gross DC, Proebsting EL Jr, Maccrindle-Zimmerman H (1988) Development, distribution, and characteristics of intrinsic, nonbacterial ice nuclei in *Prunus* wood. *Plant Physiol* 88:915–922
- Hansen J (2000) Überleben in der Kälte – wie Pflanzen sich vor Froststress schützen. *Biol Unserer Zeit* 30:24–34
- Hansen J, Beck E (1988) Evidence for ideal and non-ideal equilibrium freezing of leaf water in frost hardy ivy (*Hedera helix*) and winter barley (*Hordeum vulgare*). *Bot Acta* 101:76–82
- Hansen J, Beck E (1994) Seasonal changes in the utilization and turnover of assimilation products in 8-year-old Scots pine (*Pinus sylvestris* L.) trees. *Trees* 8:172–182

- Hartl F-U, Hlodan R, Langer T (1994) Molecular chaperones in protein folding: the art of avoiding sticky situations. *Trends Biochem Sci* 19:20–25
- Hedberg O (1964) Features of afro-alpine plant ecology. *Acta Phytogeogr Suecica* 48:1–144
- Heldt HW (1999) *Pflanzenbiochemie*. Spektrum, Heidelberg
- Hew CL, Yang DCS (1992) Protein interaction with ice. *Eur J Biochem* 203:33–42
- Hincha DK, Schmitt JM (1992) Freeze-thaw injury and cryoprotection of thylakoid membranes. In: Somero GN, Osmond CR, Bolis CL (eds) *Water and life*. Springer, Berlin Heidelberg New York, pp 316–337
- Holmberg N, Bülow L (1998) Improved stress tolerance in plants by heterologous gene transfer: Recent achievements and future prospects. *Trends Plant Sci* 3:61–66
- Jones TL, Tucker DE, Ort DR (1998) Chilling delays circadian pattern of sucrose phosphate synthase and nitrate reductase activity in tomato. *Plant Physiol* 118:149–158
- Kappen L, Zeitler A (1977) Seasonal changes between one- and two-phasic response of plant leaves to heat stress. *Oecologia* 31:45–53
- Kroog JO, Zachariassen KE, Larsen B, Smidsrod O (1979) Thermal buffering in afro-alpine plants due to nucleating agent-induced water freezing. *Nature* 282:300–301
- Lafta AM, Lorenzen JH (1995) Effect of high temperature on plant growth and carbohydrate metabolism in potato. *Plant Physiol* 109:637–643
- Larcher W (1987) Stress bei Pflanzen. *Naturwissenschaften* 74:158–167
- Larcher W (2001) *Ökophysiologie der Pflanzen*, 6 Aufl. UTB, Eugen Ulmer, Stuttgart
- Larcher W (2003) *Physiological plant ecology*, 4th edn (chapter: Plants under stress). Springer, Berlin Heidelberg New York, pp 345–450
- Lindow SE (1982) Population dynamics of epiphytic ice nucleation active bacteria on first sensitive plants and frost control by means of antagonistic bacteria. In: Li PH, Sakai A (eds) *Plant cold hardiness*. Academic Press, New York, pp 395–416
- Maki LR, Galyan ME, Chien ME, Caldwell DR (1974) Ice nucleation induced by *Pseudomonas syringae*. *Appl Microbiol* 28:456–459
- Murata N, Wada H, Gombos Z, Nishida I (1993) The molecular mechanism of the low-temperature tolerance of plants studied by gene technology of membrane lipids. In: Jackson MB, Black CR (eds) *Interacting stresses on plants in a changing climate*. NATO ASI Series 16. Springer, Berlin Heidelberg New York, pp 715–723
- Neely WC, Martin JM, Barker SA (1988) Products and relative reaction rates of the oxidation of tocopherols with singlet molecular oxygen. *Photochem Photobiol* 48:423–428
- Nishida I, Murata N (1996) Chilling sensitivity in plants and cyanobacteria. *Annu Rev Plant Physiol Plant Mol Biol* 47:541–568
- Nover L, Höhfeld I (1996) Hohe Temperaturen. In: Brunold C, Rügsegger A, Brändle R (Hrsg) *Stress bei Pflanzen*. Paul Haupt, Bern, pp 49–70
- Ohlrogge JB, Browse J (1995) Lipid biosynthesis. *Plant Cell* 7:957–970
- Powles SB (1984) Photoinhibition of photosynthesis induced by visible light. *Annu Rev Plant Physiol* 35:15–44
- Powles SB, Berry JS, Björkman O (1983) Interaction between light and chilling temperature on the inhibition of photosynthesis in chilling-sensitive plants. *Plant Cell Environ* 6:117–123
- Sáez-Vásquez J, Raynal M, Delseny M (1995) A rapeseed cold-inducible transcript encodes a phosphoenolpyruvate carboxykinase. *Plant Physiol* 109:611–618
- Sakai A, Larcher W (1987) Frost survival of plants: responses and adaptation to freezing stress. *Ecol Studies* 62
- Sarhan F, Danyluk J (1998) Engineering cold-tolerant crops – throwing the master switch. *Trends Plant Sci* 3:289–290
- Senser M, Beck E (1982) Frost resistance in spruce [*Picea abies* (L.) Karst]: IV. The lipid composition of frost resistant and frost sensitive spruce chloroplasts. *Z Pflanzenphysiol* 105:241–253
- Sicheri F, Yang DCS (1995) Ice-binding structure and mechanism of antifreeze protein from winter flounder. *Nature* 375:427–431
- Steponkus PL, Dowgert MF, Gordon-Kamm W (1983) Destabilization of the plasma membrane of isolated plant protoplasts during a freeze-thaw cycle: the influence of cold acclimation. *Cryobiology* 20:448–465
- Steponkus PL, Uemura M, Balsamo RA, Arvinte T, Lynch DV (1988) Transformation of the cryobehavior of rye protoplasts by modification of the plasma membrane lipid composition. *Proc Natl Acad Sci USA* 85:9026–9030
- Tahtiharju S, Sangwan V, Monroy AF, Dhindsa RS, Borg M (1997) The induction of kin genes in cold-acclimating *Arabidopsis thaliana*. Evidence of a role of calcium. *Planta* 203:442–447
- Thomashow MF (1999) Plant cold tolerance: freezing tolerance genes and regulatory mechanisms. *Annu Rev Plant Physiol Plant Mol Biol* 50:571–599
- Urrutia ME, Duman JG, Knight CA (1992) Plant thermal hysteresis proteins. *Biochim Biophys Acta* 1121:199–206
- Vigh L, Los DA, Horvath I, Murata N (1993) The primary signal in the biological perception of temperature: Pd-catalyzed hydrogenation of membrane lipids stimulated the expression of the desA gene in *Synechocystis* PCC6803. *Proc Natl Acad Sci USA* 90:9090–9094
- Vogg G, Heim R, Gotschy B, Beck E, Hansen J (1998) Frost hardening and photosynthetic performance of Scots pine (*Pinus sylvestris* L.). II. Seasonal changes in the fluidity of thylakoid membranes. *Planta* 204:201–206
- Wallis JG, Wang H, Guerra DJ (1997) Expression of a synthetic antifreeze protein in potato reduces electrolyte release at freezing temperatures. *Plant Mol Biol* 35:323–330
- Wilson M, Lindow SE (1993) Release of recombinant microorganisms. *Annu Rev Microbiol* 47:913–944
- Wolfe J (1978) Chilling injury in plants – the role of membrane lipid fluidity. *Plant Cell Environ* 1:241–247
- Wolfe J, Steponkus PL (1983) Mechanical properties of the plasma membrane of isolated plant protoplasts. *Plant Physiol* 71:276–285
- Worland MR, Block W (1999) Ice-nucleating bacteria from the guts of two sub-antarctic beetles *Hydromedion sparsum* and *Perimylops antarcticus* (Perimylopidae). *Cryobiology* 38:60–67
- Yang DSC, Sax M, Chakrabarty A, Hew CL (1988) Crystal structure of an antifreeze polypeptide and its mechanistic implications. *Nature* 333:232–237
- Yelenosky G, Mauk CS, Bausher MG, Kushad MM (1987) Chemical bioregulation of growth and cold hardiness in citrus. In: Li PH (eds) *Plant cold hardiness*, vol 5. Liss, New York, pp 299–321
- Yelenosky G (1985) Cold hardiness in citrus. *Hort Rev* 7:201–237
- Zhu JJ, Beck E (1991) Water relations of *Pachysandra* leaves during freezing and thawing: evidence for a negative pressure potential alleviating freeze-dehydration stress. *Plant Physiol* 97:1146–1153
- Xin Z, Browse J (2000) Cold comfort farm: the acclimation of plants to freezing temperatures. *Plant Cell Environ* 23:893–907

1.4

Oxygen Deficiency (Anaerobiosis and Hypoxia)



Nelumbo nucifera, the lotus flower, is a typical swamp plant in the monsoon climate of northern Australia. The rhizomes grow in the oxygen-deficient mud and are supplied with oxygen via an aerenchyma. The flow of air in the aerenchyma is driven by thermo-osmosis. Because of crocodiles, researchers in this area should exercise caution. Kalgam Northern Territories. Photo E.-D. Schulze

Recommended Literature

- Blom CWPM, Voeselek LACJ (1996) Flooding: the survival strategies of plants. *Trends Ecol Evol* 11:290–295
- Chang C, Bleeker AB (2004) Ethylene Biology. More than a Gas. *Plant Physiol* 136:2895–2899 (and subsequent articles in this issue)
- Drew MC (1997) Oxygen deficiency and root metabolism: injury and acclimation under hypoxia and anoxia. *Annu Rev Plant Physiol Plant Mol Biol* 48:223–250

Common soils consist of **four components**: soil particles, water, air and organisms including plant roots (Fig. 1.4.1). Freely draining soils can only retain water in pores with diameters smaller than 10–60 μm . Even at water saturation up to the field capacity (see Chap. 2.2) the air-filled pore volume is 10–30% of the total soil volume. However, in partially or permanently waterlogged soils, there are almost no air-filled pores, as the air dissolves in the water.

Gas exchange in well-aerated soils is mainly through diffusion in the continuum of the air-filled pores, but is accelerated by a number of active processes in the soil and thus becomes a relatively fast process. For example, if oxygen is consumed by the respiratory activity of microorgan-

isms and plant roots, oxygen from the atmosphere flows quickly into the soil following the concentration gradient. As a result, the partial pressure of O_2 in the soil air, at least in pore-rich soils, remains in the range of 15–20%. Similarly, CO_2 that accumulates in the soil pores quickly leaks out from the soil. The situation is completely different when gas exchange is via the water-filled pores of waterlogged soils. **Fick's first law of diffusion** describes the amount of gas diffusing per unit of time, i.e. the net gas flux, as depending on the diffusion coefficient D , on the size of the exchange area, and on the concentration gradient. At the same temperature, the diffusion coefficient of oxygen in water is about 10,000 times (exactly 11,300 times) smaller than in air. Oxygen has also a very low solubility in water ($0.03 \text{ ml O}_2 \text{ l}^{-1} \text{ H}_2\text{O}$). Thus, gas exchange in waterlogged soils is very slow and oxygen becomes one of the limiting factors for growth and the development of plants. Oxygen supply to roots is enhanced by a temperature gradient as well as by water flow in the soil. For roots, the critical oxygen concentration is generally 5–10%, although some plants are able to grow at lower O_2 concentrations, e.g. cotton grass (*Eriophorum angustifolium*) roots grow at 2–4% O_2 (Armstrong and Gaynard 1976). The apparent tolerance of these plants is easily explained by the large intracellular channels extending from the

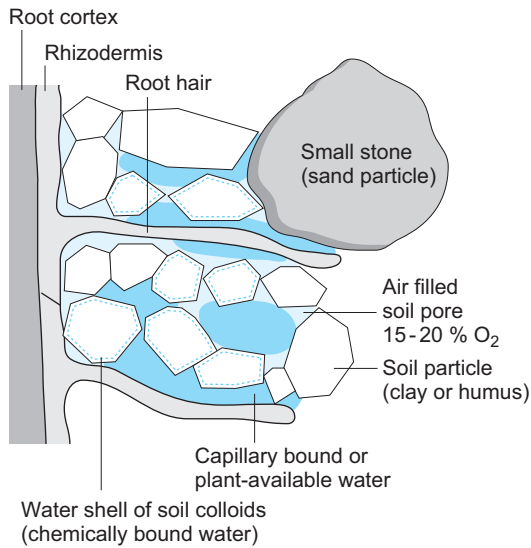


Fig. 1.4.1. Four-component system: Root/soil organism, soil particle, soil water (solution), soil air

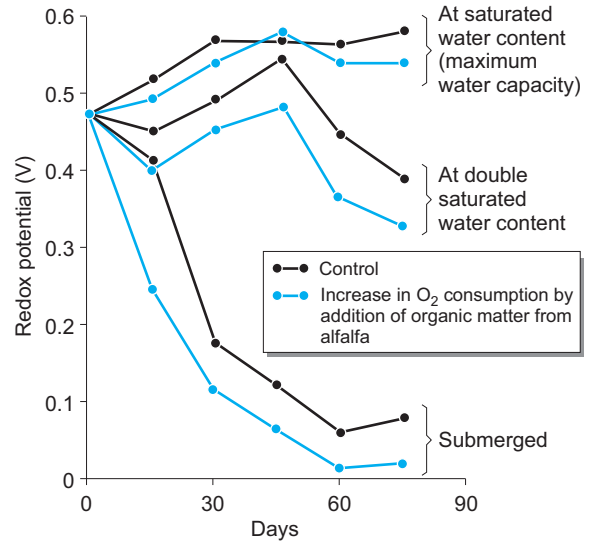


Fig. 1.4.2. Development of redox potential of a loamy clay soil as influenced by the water content and the amount of organic matter. (After Amberger 1988)

shoot and leaves into the roots maintaining a sufficiently high oxygen concentration in the root tissue. A similar **aeration tissue** (termed **aerenchyma**) is found in deep-water rice, the roots of which are able to grow at 0.8% oxygen (Armstrong and Webb 1985). In such cases, a corky exodermis is often produced, forming a gas-tight outer cell layer of the root that renders the escape of gases from the interior of the root into the soil very difficult. If such a diffusion barrier tissue is missing, oxygen leaks out of the aerenchyma to the surrounding soil, where the heavy metal ions in the immediate proximity of roots are oxidised forming “rusty spots and root channels” in pseudogley and are, thus, “detoxified” for soil organisms.

Regarding the relationship between oxygen concentration and metabolism, a situation, where biochemical reactions are not limited by partial oxygen pressure, is called **normoxia**. If mitochondrial ATP synthesis is affected, but not completely inhibited by low O₂, it operates under **hypoxia**. In the absence of oxygen (**anoxia**), oxidative phosphorylation in the mitochondria is negligible, compared with ATP synthesis by glycolysis and fermentation.

Long-term waterlogged soils have a negative redox potential because of the low oxygen partial pressure (see [Box 1.7.1](#)), i.e. they exhibit reducing properties. Oxygen entering such soils (e.g. through root or earth worm channels) is readily consumed by soil organisms.

The redox potential of soils decreases dramatically already after a few days of flooding ([Fig. 1.4.2](#)) and microaerophilic and anaerobic microorganisms start to grow. They mainly live on the organic matter of the soil as energy source, but require ions as electron acceptors that can be reduced. If nitrate is used as electron acceptor, giving rise to nitrite, N₂O and finally N₂ (denitrification), the process is termed nitrate respiration and, accordingly, in sulfate respiration sulfide is formed from SO₄²⁻ (see [Chap. 3.3.3](#)). Similarly, three-valent iron and four-valent manganese can be reduced to two-valent ions. In addition, CO₂ may be used as electron acceptor, resulting in the production of methane. [Table 1.4.1](#) shows the sequence of redox reactions occurring in the soil when the redox potential decreases. Such reactions often consume protons, i.e. result in an alkalisation of the soil.

However, reduced heavy metal ions are toxic. Thus, the growth of roots is not only inhibited by the lack of oxygen, but also by toxic ions in the vicinity of roots ([Fig. 1.4.3](#)). This applies particularly to the very sensitive symbiosis of plant roots with mycorrhizal fungi: Plants growing on waterlogged soils are very sensitive to pathogens and rarely form mycorrhizae; therefore, their capability of nutrient acquisition and growth is usually very limited ([Table 1.4.2](#)).

Two-thirds of the earth's land mass is flooded, at least occasionally (e.g. the monsoon regions of Southeast Asia or the areas at the lower

Table 1.4.1. Sequence of soil-bound redox reactions. The redox potential provides important information about the reactions in the soil, as these reactions take place in the sequence listed [i.e. sulfate is not reduced if iron(III) ions are still present]. (After Marschner 1986)

Redox reaction		Redox potential E (mV) at pH 7
Start of nitrate reduction (denitrification)	$\text{NO}_3^- \rightarrow \text{NO}_2^-$	450–550
Start of manganese reduction	$\text{MnO}_2 + 4\text{H}^+ + 2\text{e}^- \rightarrow \text{Mn}^{2+} + 2\text{H}_2\text{O}$	350–450
Absence of free oxygen	$\text{O}_2 + 4\text{H}^+ + 4\text{e}^- \rightarrow 2\text{H}_2\text{O}$	350
Absence of nitrate	($\rightarrow \text{N}_2\text{O} \rightarrow \text{N}_2$)	250
Start of Fe^{2+} formation	$\text{Fe}(\text{OH})_3 + 3\text{H}^+ + 1\text{e}^- \rightarrow \text{Fe}^{2+} + 3\text{H}_2\text{O}$	150
Fe^{3+} completely consumed		120
Start of sulfate reduction	$\text{SO}_4^{2-} + 10\text{H}^+ + 8\text{e}^- \rightarrow \text{H}_2\text{S} + 4\text{H}_2\text{O}$	-50
Sulfate completely consumed		-180
Methane formation	$\text{CO}_2 + 8\text{H}^+ + 8\text{e}^- \rightarrow \text{CH}_4 + 2\text{H}_2\text{O}$	<-180

Table 1.4.2. Effect of flooding on biomass production, and on nutrient content of leaves, of two flooding-sensitive and one flooding-tolerant representatives of the genus *Rumex*. (After Laan et al. 1989a,b)

Species/conditions for growth	Dry weight of shoot (g)	Nutrient content of leaves (mol per g dry weight)				
		Nitrogen	Phosphorus	Sodium	Calcium	Magnesium
<i>R. thrysiflorus</i>						
Dry site	15.2 ± 1.4	1878 ± 45	143 ± 10	1238 ± 37	323 ± 11	435 ± 22
Flooded	7.2 ± 1.4	1006 ± 64	44 ± 2	355 ± 15	190 ± 2	218 ± 3
<i>R. crispus</i>						
Dry site	13.6 ± 1.4	1372 ± 54	90 ± 5	857 ± 39	532 ± 27	311 ± 7
Flooded	12.7 ± 2.5	702 ± 35	58 ± 10	347 ± 23	315 ± 13	160 ± 8
<i>R. maritimus</i>						
Dry site	24.8 ± 2.6	1018 ± 91	59 ± 2	478 ± 11	615 ± 19	401 ± 4
Flooded	25.4 ± 3.9	1052 ± 52	59 ± 2	272 ± 10	761 ± 40	398 ± 11

Data are average values of five identical experiments ±SD

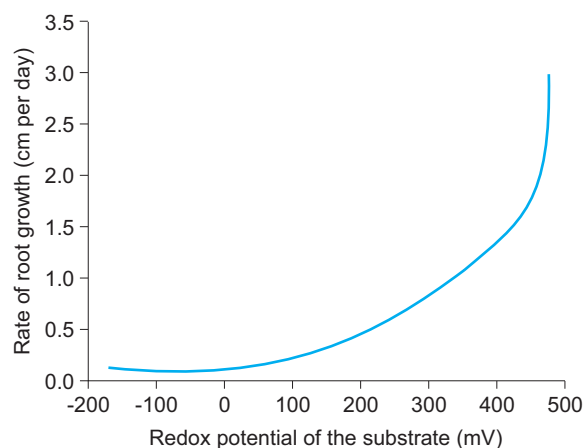


Fig. 1.4.3. Dependence of root growth of the grass *Spartina patens* on the redox potential of the soil. (After DeLaune et al. 1993)

tain species, can be extrapolated from the zonation of the riparian vegetation.

Physiologically, **primary** and **secondary hypoxia** or anaerobiosis should be differentiated. In primary hypoxia, germination of a plant already takes place in an oxygen-deficient environment, which does not change during the whole lifetime of the plant. This applies, for example, to obligate marsh plants ([Chap. 1.4.1.1](#)). Secondary hypoxia occurs when plants normally growing in well-aerated soils are temporarily flooded.

1.4.1

Energy Metabolism of Plants Under Oxygen Deficiency

reaches of the large Siberian rivers). Many higher plants, therefore, have developed mechanisms to survive hypoxia, the major stress factor. The frequency of flooding, and the tolerance of cer-

The daily oxygen demands of soils during the growth period of plants are in the range of 10–20 l/m², depending on the density of the roots and the activity of soil microbes. The minimum

Box 1.4.1 Energy metabolism of heterotrophic organs in normoxia and hypoxia

Energy charge of cells is usually determined by the degree of phosphorylation of the adenylate system (adenylate energy charge, AEC, often called EC).

The following formula is applied:

$$(A)EC = \frac{[ATP] + 0.5[ADP]}{[ATP] + [ADP] + [AMP]}$$

By definition, maximum EC equals 1. Since ADP possesses only one energy-rich phosphate bond, its concentration has to be multiplied by the factor 0.5. A cell supplied with sufficient oxygen has an AEC between 0.8 and 0.95. Under anaerobic conditions the energy charge may drop to 0.2 (see Fig. 1.4.4). Acute ATP deficiency leads to the breakdown of compartmentation as the energy-driven ion pumps are no longer sufficiently energised.

oxygen partial pressure in the soil for the growth of flooding-sensitive plants is at 2–3% (about 5 kPa). Inhibition of growth under hypoxic conditions is a multifactorial phenomenon, which is basically caused by the very low efficiency of the energy metabolism. During inhibition of mitochondrial respiration, many heterotrophic organisms and plant tissues are able to switch to fermentative metabolism. This type of metabolism, however, requires increased throughput of energy carriers such as glucose. Under these conditions, reserve material is quickly consumed and poisonous or stressful end products, such as ethanol or lactic acid, accumulate. Despite stimulation of glycolysis and fermentation by the so-called **Pasteur effect**, the **energy charge** of cells remains low so that during extended periods of hypoxia, or even short-term anaerobiosis, values of below 0.5 result (see Box 1.4.1). These values are too low for anabolic metabolism, i.e. for growth. Inhibition of phloem transport and phloem unloading is another consequence of the low-energy charge of the plant tissues. Thus cells are depleted not only because of the faster turnover of storage material, but also because of the shortage of stock. **Helophytes** (swamp plants) avoid the problems caused by hypoxia by the development of an **aerenchyma**.

1.4.1.1

Primary Hypoxia: Germination Under Hypoxic Conditions

Dry cereal seeds contain carbohydrates, mainly starch; to germinate they require catabolising enzymes: α - and β -amylase, amylopectin-de-

branching enzymes and α -glucosidases (maltase, diastase). Neither wheat nor barley seeds are able to germinate under anaerobic conditions, but rice can (Fig. 1.4.4). In the rice grain, starch debranching enzymes and α -glucosidases are present as inactive precursors, which are activated during germination, even without oxygen. Upon germination in the absence of oxygen, α - and β -amylases are synthesised de novo (Guglielminetti et al. 1995). This happens during the first 2 days of germination when the soluble carbohydrates already present serve as the energy source. After this, starch-catabolising enzymes become active and starch is hydrolytically degraded and the degradation products become available for further metabolism, predominantly as glucose-6-P and fructose-6-P.

1.4.1.2

Changes in Metabolism Caused by Hypoxia

Energy Metabolism Under Hypoxia and Anoxia

In addition to the energy deficit caused by hypoxia and anaerobiosis, toxic metabolic products accumulate, e.g. ethanol (see Box 1.4.1). Higher concentrations of this poisonous compound destroy the selective permeability of membranes and prevent formation of proton gradients and in turn the gain of energy. On the other hand, ethanol easily permeates through biomembranes and cell walls and thus only rarely reaches damaging concentrations of 50–100 nM in the cell. Acetaldehyde, the biochemical precursor of ethanol, is much more poisonous than ethanol, but is usually immediately reduced. It only accumulates when alcohol dehydrogenase is inhibited or

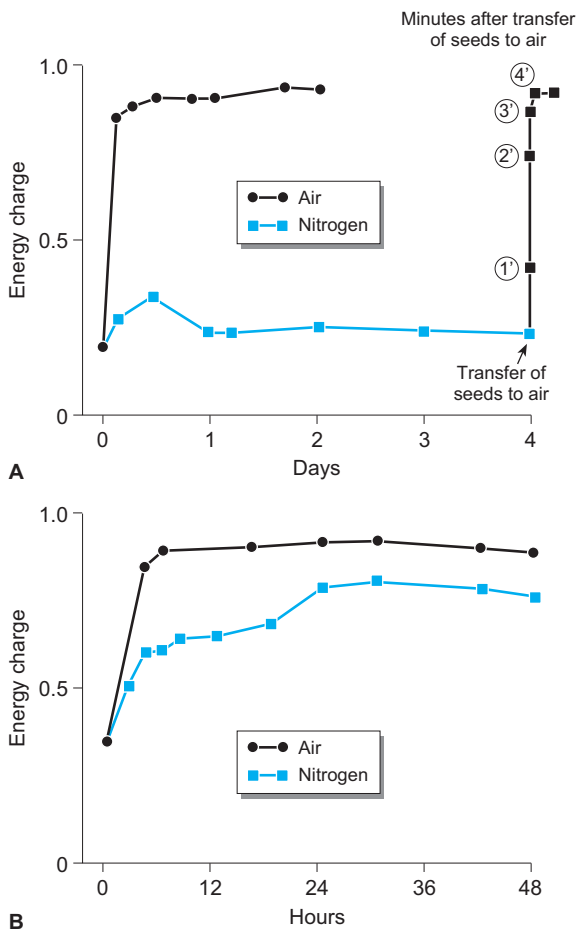


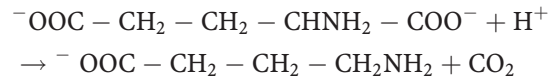
Fig. 1.4.4. The energy charge of lettuce seeds (A) or rice grains (B) during germination in air or under nitrogen. (After Pradet et al. 1985)

switched off by mutation or genetic modification. Acidification of the cytosol by lactic acid is another metabolically detrimental effect of hypoxia. When oxygen deficiency sets in, **lactate dehydrogenase (LDH)** is the first enzyme to be activated and the pH in the cytosol decreases as lactic acid forms and accumulates. As the pH optimum of LDH is in the neutral range, it inhibits itself upon acidification of the cytosol. **Pyruvate decarboxylase** is less susceptible to acidity and therefore takes over, producing acetaldehyde and, together with alcohol dehydrogenase, ethanol.

Biochemical Adaptation to Oxygen Deficiency

Besides anatomical-morphological strain reactions to the shortage of oxygen (as explained later), biochemical adaptation can take place: In addition to lactate, rice seedlings and sweet flag (*Acorus calamus*) rhizomes mainly produce basic

amino acids [asparagine, arginine, γ -amino butyric acid (GABA)]. Synthesis of GABA from glutamate releases CO_2 and consumes protons, and is a reliable marker for metabolism under hypoxia:



1.4.1.3

“Anaerobic Polypeptides”

Fine root systems and root meristems are particularly sensitive to oxygen deficiency. In species not tolerant to flooding, those parts of the root system used for water and ion uptake die off at oxygen partial pressures below 0.5–5 kPa and the plant becomes drought stressed, even if standing in water. Drought stress is indicated by an increased production of ABA that is distributed via the xylem sap, and leads to stomatal closure. As a consequence, the rate of photosynthesis decreases as well as growth and the plants finally become stunted while their leaves show strong **epinasty** (downward bending of the leaves and petioles because of increased growth of the upper side). Such phenomena are often observed in indoor plants which are watered too much, where hypoxia in the water-saturated soil leads to death of the root system and withering of the shoot.

In flooding-tolerant plants hypoxia triggers a change in gene expression. Synthesis of normal housekeeping proteins (see Chap. 1.3.4.2) attenuates and synthesis of about 20 or more so-called **anaerobic polypeptides (ANPs)** or **anaerobic stress proteins (ASPs)** is induced (Fig. 1.4.5). These are predominantly fermentative enzymes: **Alcohol dehydrogenase**, pyruvate decarboxylase, lactate dehydrogenase, glyceraldehydephosphate dehydrogenase, aldolase, glucose-6-P-isomerase, alanine aminotransferase and enolase have been identified. The promoters of the ANPs contain a consensus sequence, the so-called **anaerobic response element (ARE)** (Christopher and Good 1996).

The trigger and signal chain leading to the induction of ANPs are still unknown. The formation of ANPs is suppressed above O_2 concentrations of 2–5%. In anoxia-tolerant plants mainly ethanol is formed due to the kind of ANPs which promote glycolysis and fermenta-

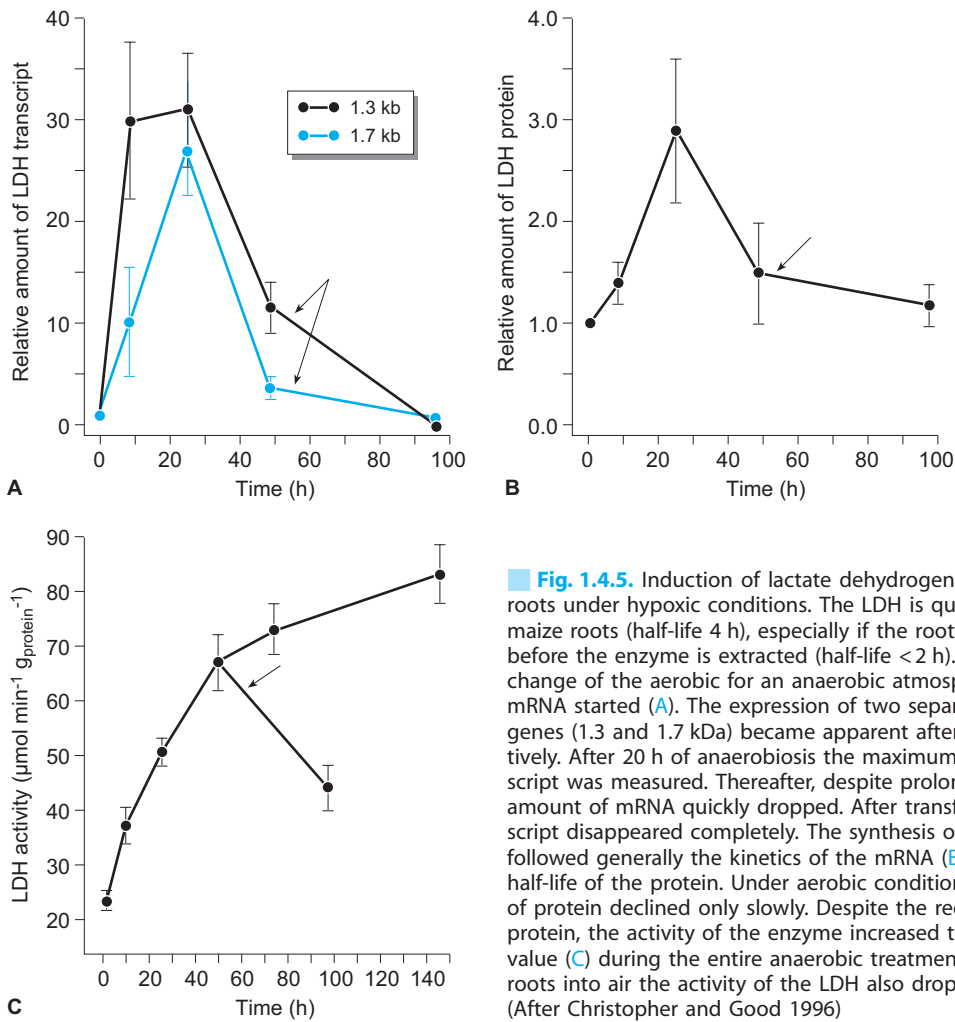


Fig. 1.4.5. Induction of lactate dehydrogenase (LDH)-ANP in maize roots under hypoxic conditions. The LDH is quickly broken down in maize roots (half-life 4 h), especially if the roots are kept in nitrogen before the enzyme is extracted (half-life <2 h). Immediately after the change of the aerobic for an anaerobic atmosphere, synthesis of LDH mRNA started (A). The expression of two separately regulated LDH genes (1.3 and 1.7 kDa) became apparent after 8 and 24 h, respectively. After 20 h of anaerobiosis the maximum amount of LDH transcript was measured. Thereafter, despite prolonged anaerobiosis, the amount of mRNA quickly dropped. After transfer into air the transcript disappeared completely. The synthesis of the LDH-ANP protein followed generally the kinetics of the mRNA (B), due to the short half-life of the protein. Under aerobic conditions (*arrow*) the amount of protein declined only slowly. Despite the reduction of the LDH protein, the activity of the enzyme increased to 3.5 times its original value (C) during the entire anaerobic treatment. Upon transfer of the roots into air the activity of the LDH also dropped drastically (*arrow*). (After Christopher and Good 1996)

tion and the energy charge of the tissue is kept high, thus maintaining gross metabolic activities.

Longer phases of anoxia (e.g. during winter) may be bridged in rhizomes and roots by periods of suspended metabolism, called **anaerobic retreat**. In spring, elongation growth starts again, but how this happens is still unknown.

Differences between anoxia-tolerant and anoxia-sensitive plants are gradual: There are neither absolutely tolerant nor absolutely intolerant species. Membrane lipids appear to play a crucial role: It appears to be important how fast membrane lipids are damaged and can subse-

quently be replaced. In intolerant species membrane lipids are damaged readily, while those of the tolerant species are more persistent (Fig. 1.4.6). Oxygen-dependent desaturation of lipids appears to be inhibited. In anoxia-sensitive plants, a higher proportion of saturated membrane lipids was found, in contrast to tolerant species where a higher degree of desaturation can be maintained for a longer period. Membranes of mitochondria and of the endoplasmic reticulum are particularly endangered. In pea seeds, mitochondria are destroyed after only 3–4 days of anoxia, whereas biomembranes of tolerant species remain functional for a long period.

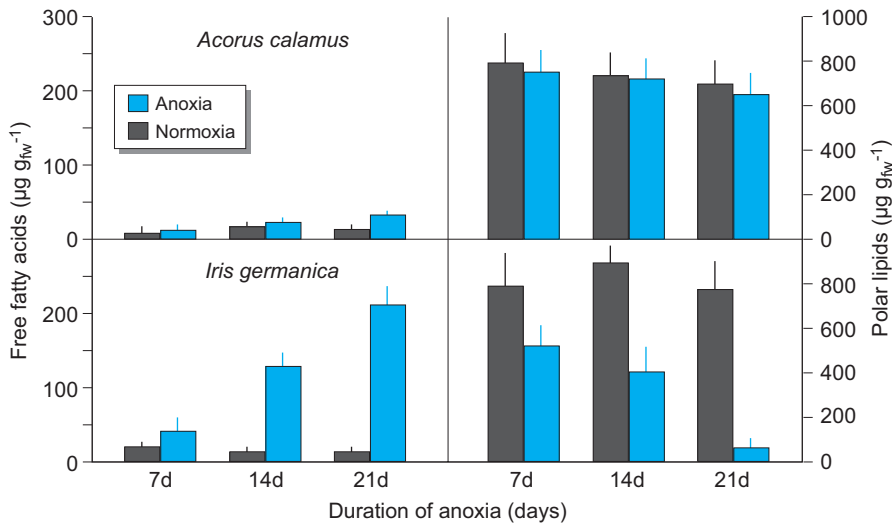


Fig. 1.4.6. Lipid degradation in rhizome tissue of iris which is sensitive to anoxia, and sweet flag (*Acorus*) which is insensitive. (After Jackson and Black 1993)

1.4.2

Anatomical-Morphological Changes Caused by Hypoxia

1.4.2.1

Elongation of Internodes

As with other stresses, there are also obvious avoidance reactions induced by hypoxia and anaerobiosis. Submerged plants usually produce strikingly long internodes. By such elongation growth, the apical parts of the shoots quickly reach the surface of the water and thus escape the hypoxic environment. This reaction has been particularly well studied in deep-water rice, where the submerged shoots elongate up to 25 cm/day.

A marked increase in the intercellular ethylene concentration is regarded as the phytohormonal signal which stimulates elongation growth. However, the real initial signal is the low oxygen partial pressure in the submerged internode, leading to increased expression of the ACC-oxidase gene (ACC: aminocyclopropane carboxylic acid) and finally to increased ethylene synthesis (Box 1.4.2). The ACC produced by the hypoxic roots is transported by the xylem stream into the better aerated shoot since the ACC-oxidase requires molecular oxygen as substrate. The increased ethylene partial pressure triggers the decrease in the endogenous ABA level and thus in turn increases the effectiveness

of the elongation hormone gibberellic acid. Thus, at least four phytohormones participate in the elongation growth of shoots and petioles triggered by hypoxia: ethylene, ABA, auxin and gibberellin.

Expansins are cell wall proteins with a molecular mass of 24.5 kDa (Box 1.4.3). In the shoots of deep-water rice, two such proteins occur in the intercalary meristem and in the adjacent extension zone (but not in the differentiation zone) mainly around the vascular bundles and in the tissue lining the inner epidermis, i.e. towards the pith channel (Cho and Kende 1997 a, b).

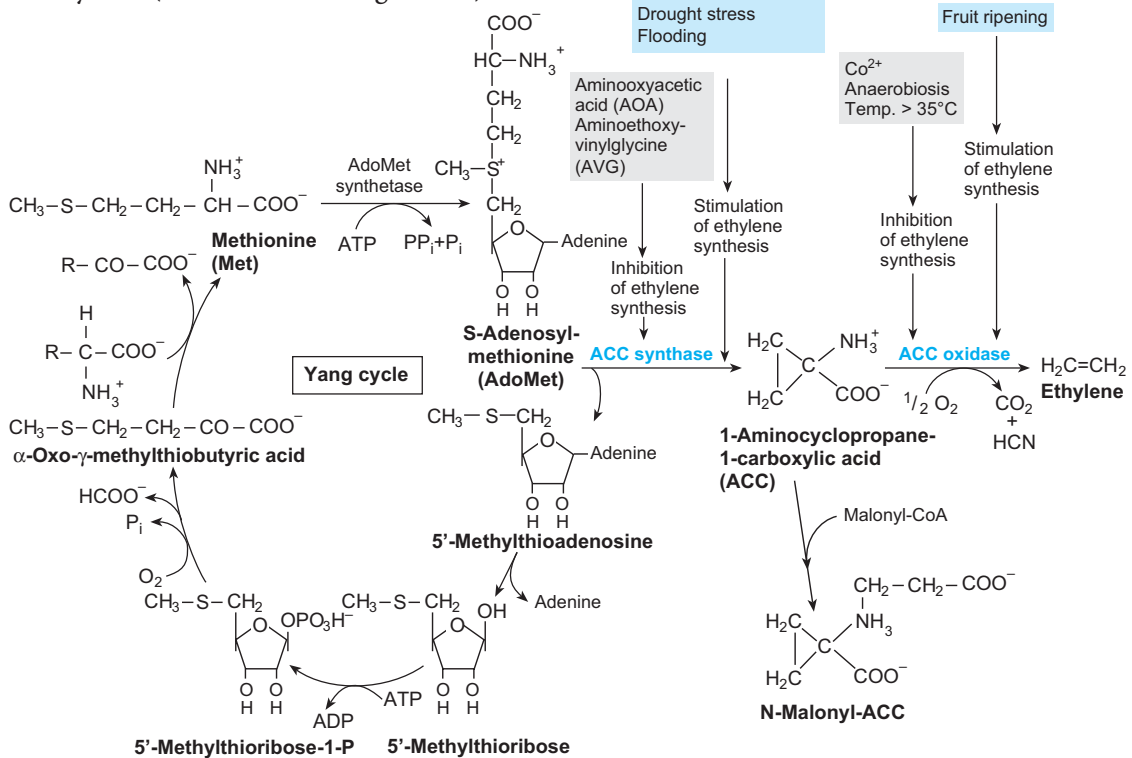
Submerged internodes accumulate considerably more expansins than those in air, and substantially expand their elongation zone. The molecular mechanism of expansins is still not well understood; it is assumed that they loosen the hydrogen bridges between the hemicellulose [(1 → 3), (1 → 4)-β-D-glucans] and the paracrystalline segments of the cellulose microfibrils and thus increase the extensibility of the cell wall. Although this effect suggests a catalytic mechanism, expansins do not show any hydrolase activity.

Auxin also plays a role in shoot expansion: It stimulates acidification of the cell wall, probably by activating the ATP-dependent proton pumps in the plasma membrane. The effect of expansins can be mimicked by acidification of the cell wall. When rice grains were germinated under aerobic and anaerobic conditions, respectively, a

Box 1.4.2

Ethylene biosynthesis from S-adenosylmethionine (AdoMet) and formation of the precursor

In addition to the biochemical pathways, the scheme shows internal and external factors that influence the synthesis or accumulation of ethylene. (After Taiz and Zeiger 2000)



fast breakdown of auxin took place in air, but not under anaerobiosis (Mapelli and Bertani 1993; Mekhedov and Kende 1996). Persistence of auxin contributes to a prolonged elongation growth of the shoot.

1.4.2.2

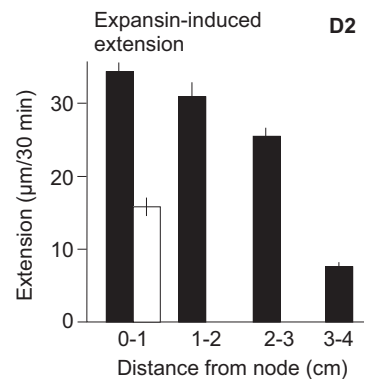
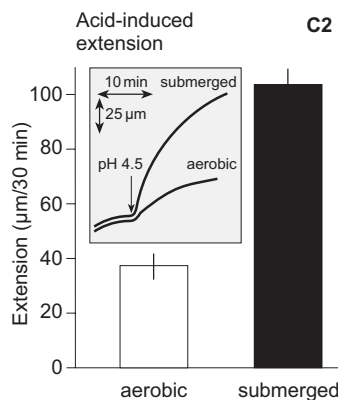
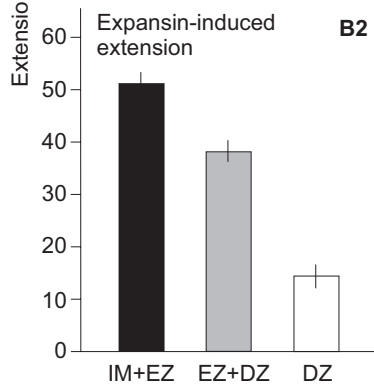
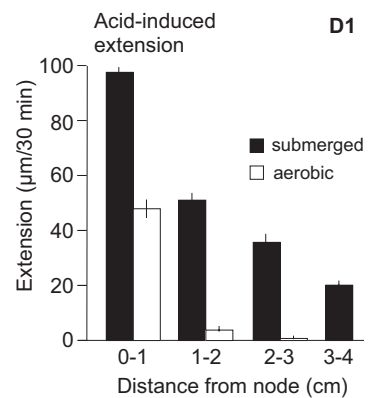
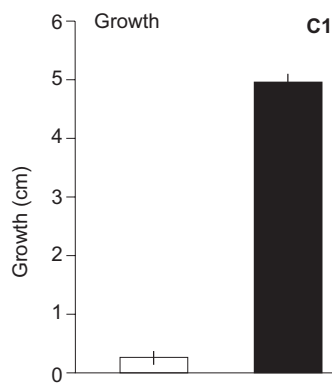
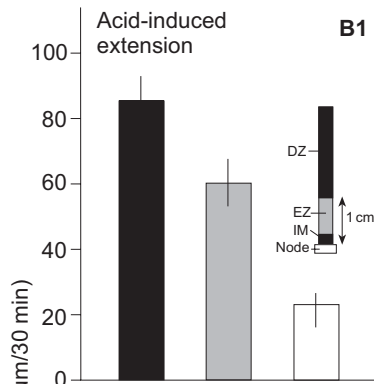
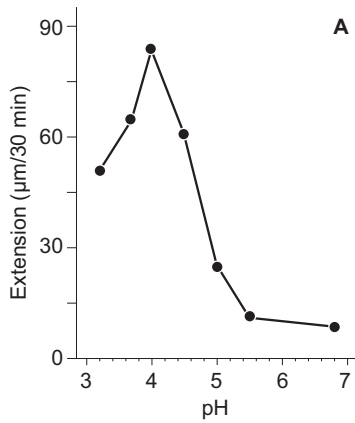
Formation of Aerenchyma

Under hypoxic conditions ethylene formation is increased, and it accumulates in and around roots and submerged shoots because of its low solubility in water. Concentrations of 0.1–0.5 ppm are sufficient to induce formation of intercellular space-rich tissues by **programmed cell death (PCD)** or **apoptosis**. PCD does not take place in differentiated older cells, rather an aerenchyma is initiated already at the end of the

elongation zone of the organ. Formation of aerenchyma is lytic, e.g. in maize, *Luronium*, and *Nymphoides*, but usually schizogenous in petioles, e.g. of *Caltha*, *Rumex*, or *Filipendula*. Formation of aerenchyma is not restricted to helophytes and submerged plants; even terrestrial plants, such as maize and sunflower, may develop aerenchyma in roots and the basal part of the shoot. In many helophytes (such as rice and arrowhead), the formation of aerenchyma is genetically fixed (constitutive), and the induction of PCD is not dependent on oxygen deficiency or ethylene accumulation. Aerenchyma formation caused by hypoxia commonly results in irregular air spaces, whereas those constitutively developed show regular patterns of air channels. Aerenchyma allows air circulation in tissues, additionally supported by pressure ventilation (misleadingly often termed “thermo-osmosis”,

Box 1.4.3 Expansin(s) and internode extension in deep-water rice

A shows the dependence of the extensibility of isolated cell walls on the pH. Cell wall preparations were incubated in media of different pH and subsequently subjected to tension; the stretching rate is shown. This technology was also used in the experiments presented in B-D. In B, the extensibility of different sections of the internode upon acid-induced growth (B1) and after addition of a protein extracted from cell walls (“expansin” preparation) (B2) is shown. IM Intercalary meristem; EZ elongation zone; DZ differentiation zone. C shows the effect of submergence on the elongation growth of the internode (C1) and the acid-induced extension of shoots which have grown aerobically and submerged (C2); the insert shows the plot of the recordings. D shows the influence of submergence on the length of the elongation zone. Shoots grown submerged have a considerably longer elongation zone than those grown in air. (After Cho and Kende 1997 a, b).



Box 1.4.4 Thermo-osmosis

Table. Position of thermo-osmotically active layers and their average pore diameter. (After Grosse 1997)

Plant species	Tissue	Pore diameter (nm)
<i>Nuphar lutea</i> (yellow water lily)	Young leaf	700–1200
	Old leaf	> 15 000
<i>Nelumbo nucifera</i> (lotus)	(Air) leaf	30
<i>Nymphoides peltatum</i> (fringed water lily)	Young leaf	29
<i>Alnus glutinosa</i> (alder)	Cork cambium	14–113
	Cambium	>> 100

Convictional air flow in intercellular spaces improves the gas exchange of plant tissues. This **thermo-osmosis**, in combination with aerenchyma formation, is often put forward as a mechanism to improve gas flow in tissues of helophytes, mangroves and plants of river basins. Thermo-osmosis includes several phenomena which are not dependent on biological activity but are of a purely physical nature. Easiest to understand is the efflux of gas from the tissue caused by evaporation of water from those cell surfaces bordering intercellular spaces; the more water evaporates, the greater is the partial pressure of the intercellular water vapour, but the volume of that gas efflux is very small. Gas fluxes arising from differences in temperature, e.g. between the

leaves floating on the water surface and the rhizomes in the anoxic bottom of the pond, are more effective, as is also gas exchange caused by the differences in molecular mass of the gases involved. Such gas fluxes are called thermo-osmosis, as they require gas-filled pores or cavities, the dimensions of which are smaller than the mean free path of the gas molecules in Brownian motion (ca. 100 nm at atmospheric pressure and 20 °C). Therefore, not only plant tissues, but also ceramic filters or other porous materials with pore diameters of similar size to the intercellular spaces of plant material are used as **thermo-osmotic active layers** in studies (Table).

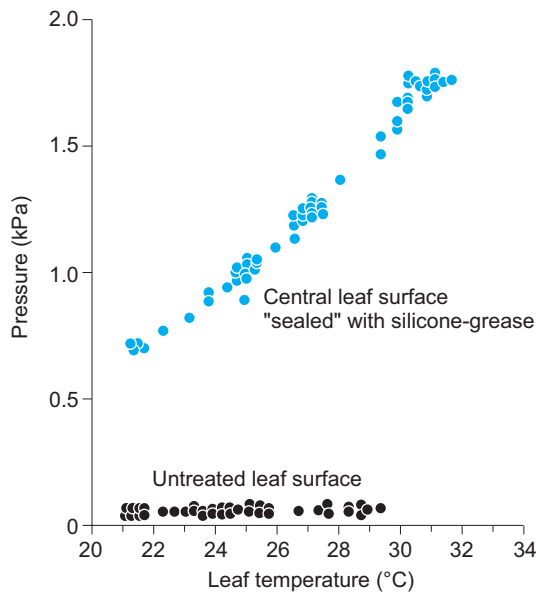


Fig. 1. The relationship between thermo-osmotically created pressure ("lacunar pressure") and temperature in a petiole of a young leaf of *Nelumbo nucifera*. An untreated leaf with open stomata was compared with a leaf in which the central portion of the surface (where the lacuna joins the petiole) was sealed with silicone. (After Dacey 1987)

Box 1.4.4 (continued)

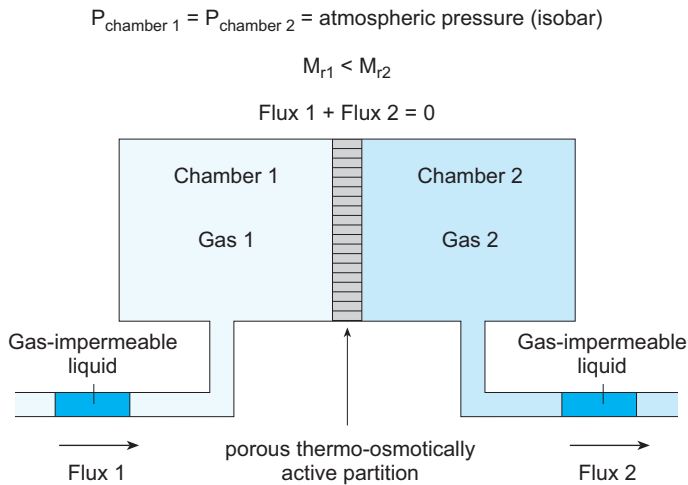


Fig. 2. Model of the isothermic formation of a thermo-osmotic gas flow in a porous layer. Gas flux originates from a concentration gradient of the gas on both surfaces of the porous layer. This gradient originates from the resistance to gas permeation of the thermo-osmotic layer whose pores are smaller than the mean free path length of the moving gas molecules. Gas 1, due to its smaller molecular mass, permeates through the layer easier than gas 2; therefore, there is a net gas flow from chamber 1 to chamber 2. The flow can be measured with the shift of liquid in the tubes. (After Schiwinisky et al. 1996)

Gas fluxes by thermo-osmosis are explained on the basis of two principles: A pressure difference because of a temperature gradient (when diffusion is limited, Fig. 1) and at the same pressure and temperature if the gases have different molecular masses (according to Graham's law, the relation of counter-fluxes of two gases through a thermo-osmotically active surface is inversely proportional to the square root of their molecular masses). Pressure always builds up if the mean free path of the gas molecules is longer than the available actual space and the gas molecules collide with the walls of the pores (Fig. 2). The major gas fluxes in a plant are those of nitrogen and oxygen; however, exchange of CO_2 and O_2 , the molecular masses of which are substantially different (42 vs. 32), is physiologically more important.

The upper part of a lotus leaf consists of a very dense palisade parenchyma whose intercellular spaces are sufficiently narrow to create a thermo-osmotic pressure, whereas the diameters of the intercellular channels in the petiole and rhizome are much too wide to create such a pressure. It is assumed that the gas pressure produced especially in the young leaves pushes air predominantly into the rhizomes from which it is released into the atmosphere via the lacunae of the old leaves. Gas flow occurs also within an individual leaf from the margin to the centre where the intercellular lacunae are located. Depending on

the pressure in the interior of the aerenchyma, this leaks out of the leaf or enters the petioles and subsequently the rhizomes. Likewise, respiratory CO_2 produced in the rhizomes can escape from the plant via the lacunar systems of the rhizomes and the leaves.

The extent of gas fluxes may be considerable. In leaves of *Nuphar luteum* the thermo-osmotically produced pressure of 0.2 kPa (see Fig. 1) creates a gas flow of 50 ml min^{-1} through the lacunar system of the petioles (Dacey 1981; see also Armstrong 1990 and Kohl et al. 1996).

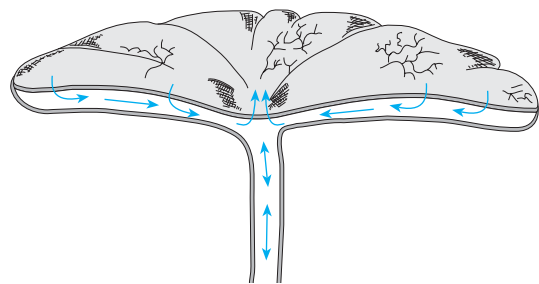


Fig. 3. Thermo-osmotic gas fluxes in an illuminated leaf of *Nelumbo nucifera*. Thermo-osmosis leads to a pressure resulting in an air flow towards the centre of the leaf. Much of that air exits from the leaf in its adaxial centre where the lacunae enter the petiole. Part of the gas can also flow into the rhizomes, following the pressure gradient. Conversely, air from the rhizome may also enter the atmosphere via the lacuna system of the petiole. (After Dacey 1987)

Box 1.4.5 The ethylene receptor

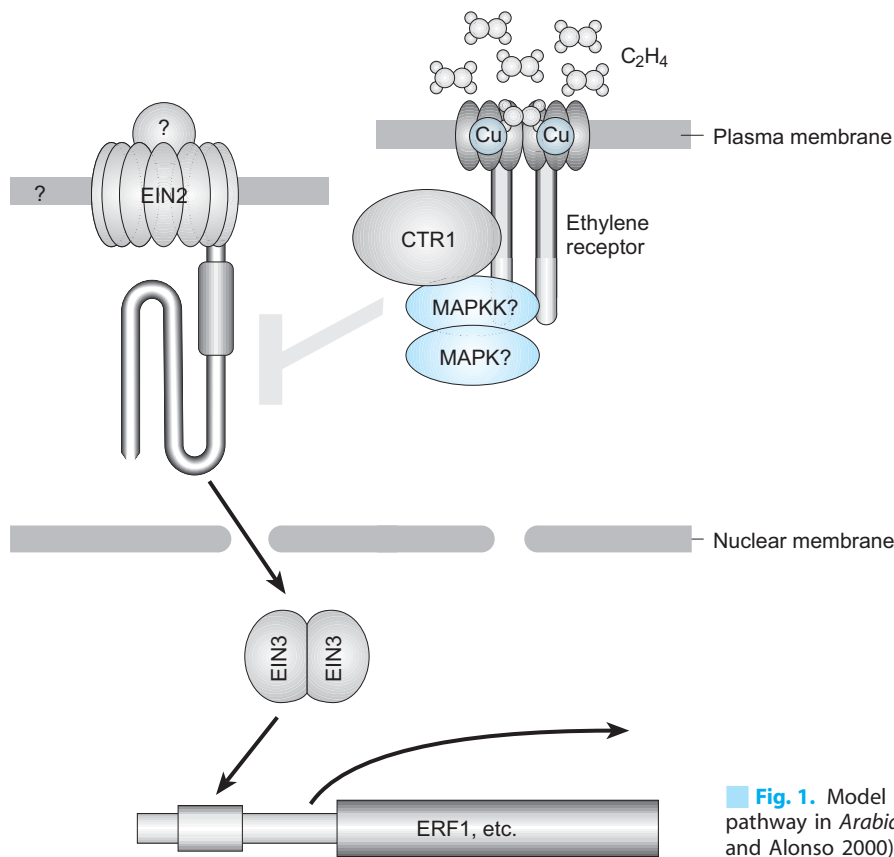


Fig. 1. Model of the ethylene signal pathway in *Arabidopsis*. (After Hirayama and Alonso 2000)

The ethylene receptors of *Arabidopsis thaliana* (Fig. 1) are relatively well understood. Ethylene induces in dark-grown *Arabidopsis* seedlings the so-called triple response consisting of an increased apical hook of the cotyledons, thickening of the hypocotyl instead of extension growth, and loss of gravitropical sensitivity. With the triple response mutants differing in reaction to ethylene may be found. Such mutants are divided into three groups: ethylene-insensitive mutants (*etr*, *ein*), constitutive ethylene-response mutants (*eto*, *ctr*) and tissue-specific ethylene-response mutants (*his*, *eir*). There are also “response to antagonist” (*ran*) mutants showing the ethylene response in the presence of the ethylene antagonist *trans*-cyclooctene. It has been shown, with the help of the *ran* mutants, that the ethylene receptor requires copper ions for the binding of ethylene. Probably they change their coordination number upon reaction with ethylene.

The structure of the ethylene receptor ETR1 is known. The active receptor is a homodimer that is probably located in the plasma membrane. ETR1 (as ETR2 and EIN4) belongs to the group of two-component histidine kinases (phospho-relay signal transducers, Fig. 2). These consist of a sensor (histidine kinase) and a response regulator. The histidine kinase contains an N-terminal signal input domain and a C-terminal kinase domain with a conserved histidine residue. The response regulator contains an N-terminal receiver domain with a conserved aspartate residue and a C-terminal signal output domain. The figure shows the well-analysed osmolarity sensor of *E. coli* as a simple example of the two-component histidine-kinase receptors. In this case, high osmolarity leads to auto-phosphorylation of the histidine residue of the sensor and to a transfer of phosphate to the aspartate residue of the receiver domain OmpR. The phosphorylation state of the (*E.*

Box 1.4.5 (continued)

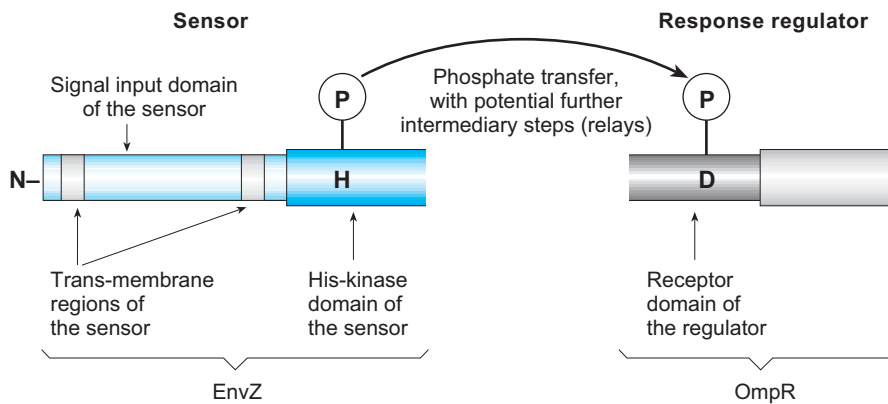


Fig. 2. Model of a two-component signal receptor. (After Urao et al. 2000)

coli) signal output domain changes its DNA-binding activity and thereby gene expression. In ETRI, for the internal transfer of the phosphate residue, a relay amino acid residue is positioned between the sensor and the regulatory domain and the phosphorylated regulatory domain does not react directly with the DNA in the nucleus, but with another protein, the CTR1 (constitutive triple response). CTR1 could react directly or indirectly via a cascade of MAP-kinases with another cell internal sensor (e.g. for divalent cations), the EIN2 protein, which is also membrane-bound. EIN2

would activate effector proteins (e.g. EIN3), which would then bind, after passing the nuclear membrane, to the promoter region of the ethylene response genes. Understanding the transduction of the ethylene signal is difficult because of the fact that the CRT must be inactivated for the ethylene response to occur. This means that binding of ethylene to the receptor inactivates the receptor and, in turn also CTR, so the inhibition of EIN is released and the signal chain becomes activated. For PCD triggered by ethylene, individual steps are not yet fully clear.

see Box 1.4.4). If light and CO₂ are available, submerged plants are able to produce oxygen photosynthetically, thus counteracting hypoxia.

Primary roots of terrestrial plants usually cannot tolerate hypoxia and die. Hypoxia-resistant plants (e.g. maize, ash, willow, *Forsythia*, *Rumex palustris*) are able within a few days to produce adventitious roots with a well-developed aerenchyma from basal shoot parts or the lower nodes (Fig. 1.4.7). These roots do not penetrate as deeply into the soil as the primary root system into a well-aerated substrate.

The individual cell layers of young adventitious roots are differently supplied with oxygen. The exodermis is the only cell layer which is usually oxygen-free; cell walls of this layer are often suberised, thus preventing diffusion of oxygen from the interior of the root to the external medium. Formation of aerenchyma not only guarantees the aeration of tissues, but also re-

duces the number of oxygen-consuming cells in that tissue.

Lytic aerenchyma formation (i.e. from disintegration of cells; Drew et al. 2000) occurs selectively in the cortex of adventitious roots, starting in those parts of the tissue that are least supplied with oxygen. Lysis of cells often requires not more than 24 h. Ethylene induces this process more or less independently of normoxia or hypoxia, but hypoxia stimulates ethylene synthesis in root tips. Increased concentrations of CO₂ and ethylene itself also stimulate ethylene synthesis. Inhibition of ethylene synthesis, on the other hand, suppresses formation of aerenchyma. The genus *Rumex* comprises hypoxia-sensitive (*R. acetosa*, *acetosella*) as well as hypoxia-tolerant species (*R. palustris*). In the flooding-tolerant *R. palustris* ethylene production is relatively low and almost the same under aerobic and anaerobic conditions. The internal ethyl-

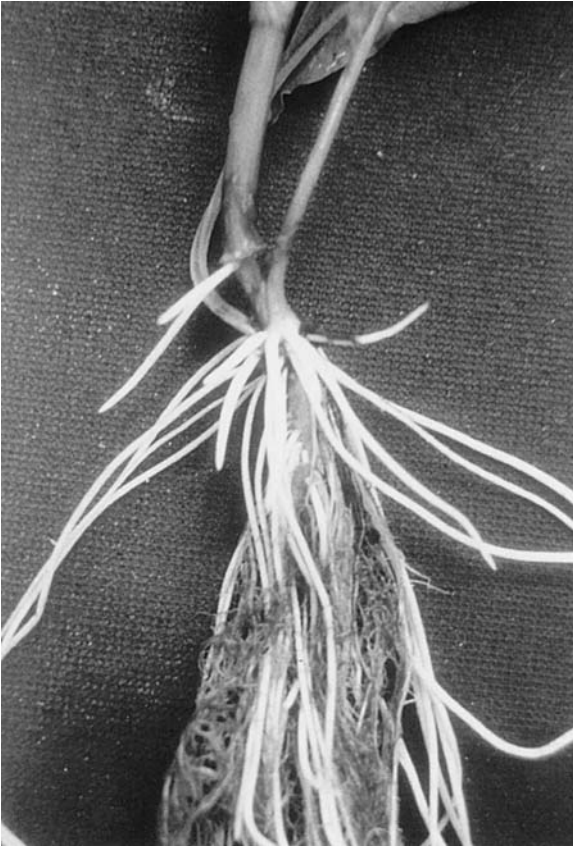


Fig. 1.4.7. The formation of adventitious roots in the flooding-tolerant *Rumex palustris* upon flooding of the root bed. The newly formed roots appear white as a consequence of the air-filled spaces in the aerenchyma and are thus clearly distinguished from roots grown under aerobic conditions which senesce under prolonged hypoxia. (After Laan et al. 1989 a,b, 1991)

ene concentration even slightly decreases upon long-term submergence. In the flooding-intolerant sorrel, however, internal ethylene concentration increases with the duration of submergence (Fig. 1.4.8). A constant, low concentration of ethylene increases elongation growth, while a long-term increasing ethylene concentration, as in *R. acetosella*, causes premature senescence of the whole organ.

In addition to the above-mentioned elongation of internodes or senescence of individual cells (PCD) and whole organs (senescence), ethylene also induces ripening of fruits. Therefore, research has since long focused on the transduction of the signal emitted from ethylene. The first element of such a signal chain is the receptor and the ethylene receptor was the first receptor of a phytohormone to be elucidated; it be-

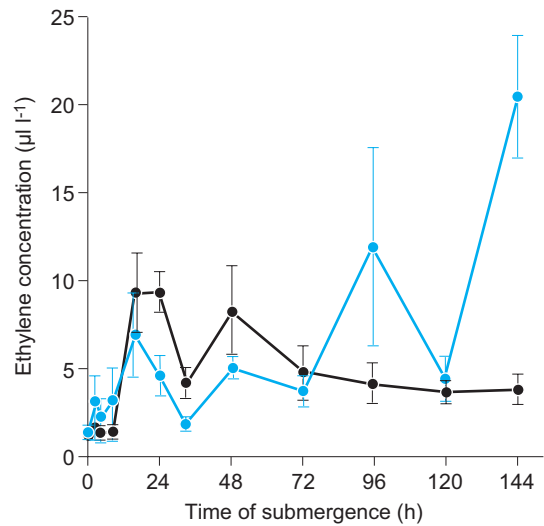


Fig. 1.4.8. The internal ethylene concentration in the tissues of two *Rumex* species of different flooding tolerance during extended waterlogging; *Rumex palustris* (•) is flooding-tolerant while *Rumex acetosella* is (●) flooding-sensitive. Decrease in the internal ethylene concentration results from inhibition of ethylene synthesis during the daily light period. (After Banga et al. 1996)

longs to the group of so-called two-component sensors (Box 1.4.5).

By combining various experimental setups and by using specific biochemical effectors, further insight could be gained into the mechanism of aerenchyma formation by PCD in the cortical tissue of maize roots (Fig. 1.4.9).

It has been shown that ethylene as a signal induces the protein kinase signal transduction pathway via a G-protein, Ca^{2+} and inositol-P, which leads to synthesis of lytic enzymes, e.g. cellulase and hemicellulase (Saab and Sachs 1996). Calcium activates endonucleases, so that the cell death is caused by a controlled breakdown of nucleic acid (by an endonuclease, activated by caspases) and not through breakdown of cell membranes, as after cell damage. Formation of aerenchyma is promoted by further effectors: For example, mechanical resistance of a heavy soil stimulates ethylene synthesis by the growing root and scarcity of minerals increases the sensitivity of the plant tissue to ethylene. Figure 1.4.10 shows a model of the biochemical processes that take place in the formation of aerenchyma.

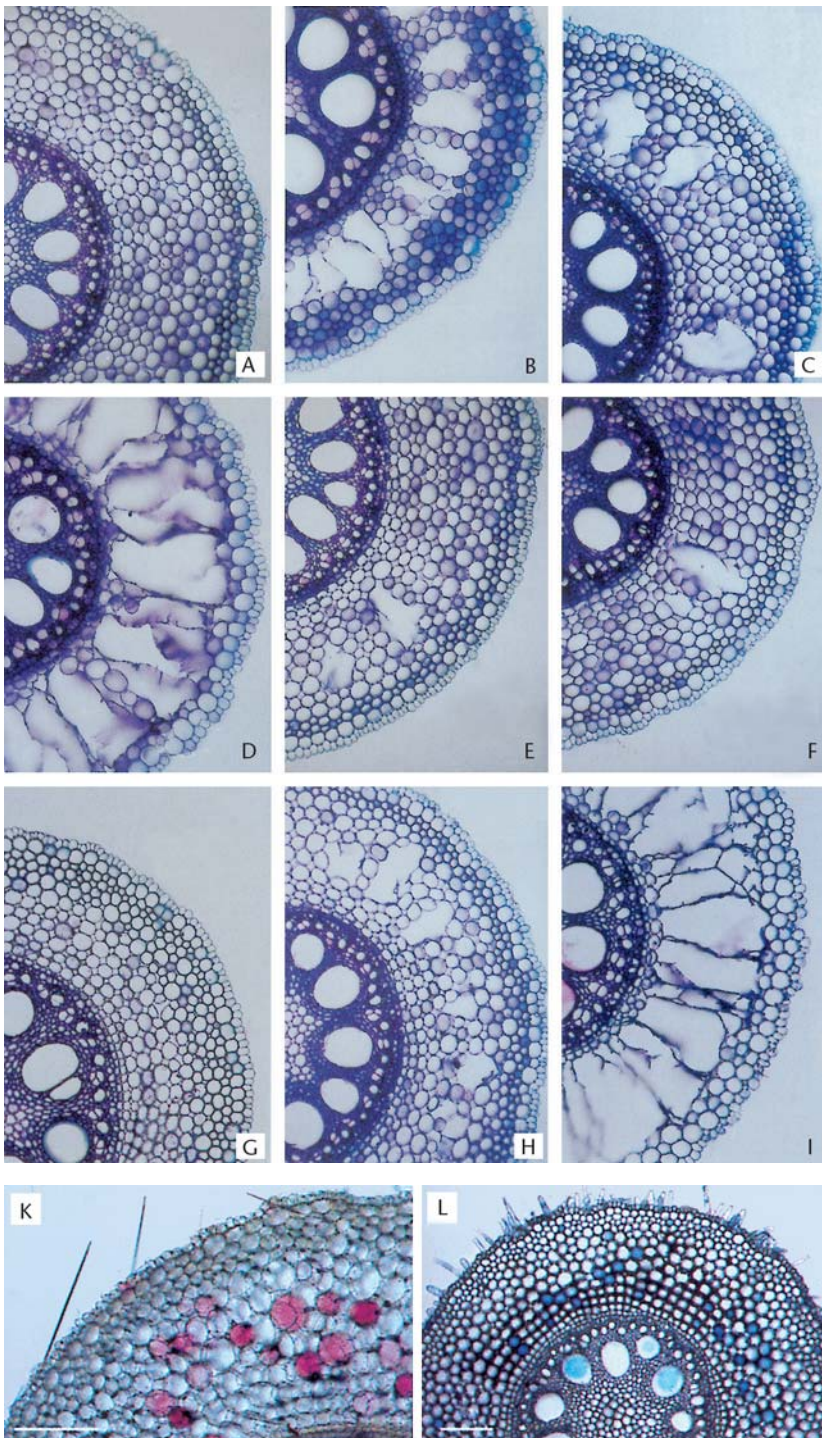
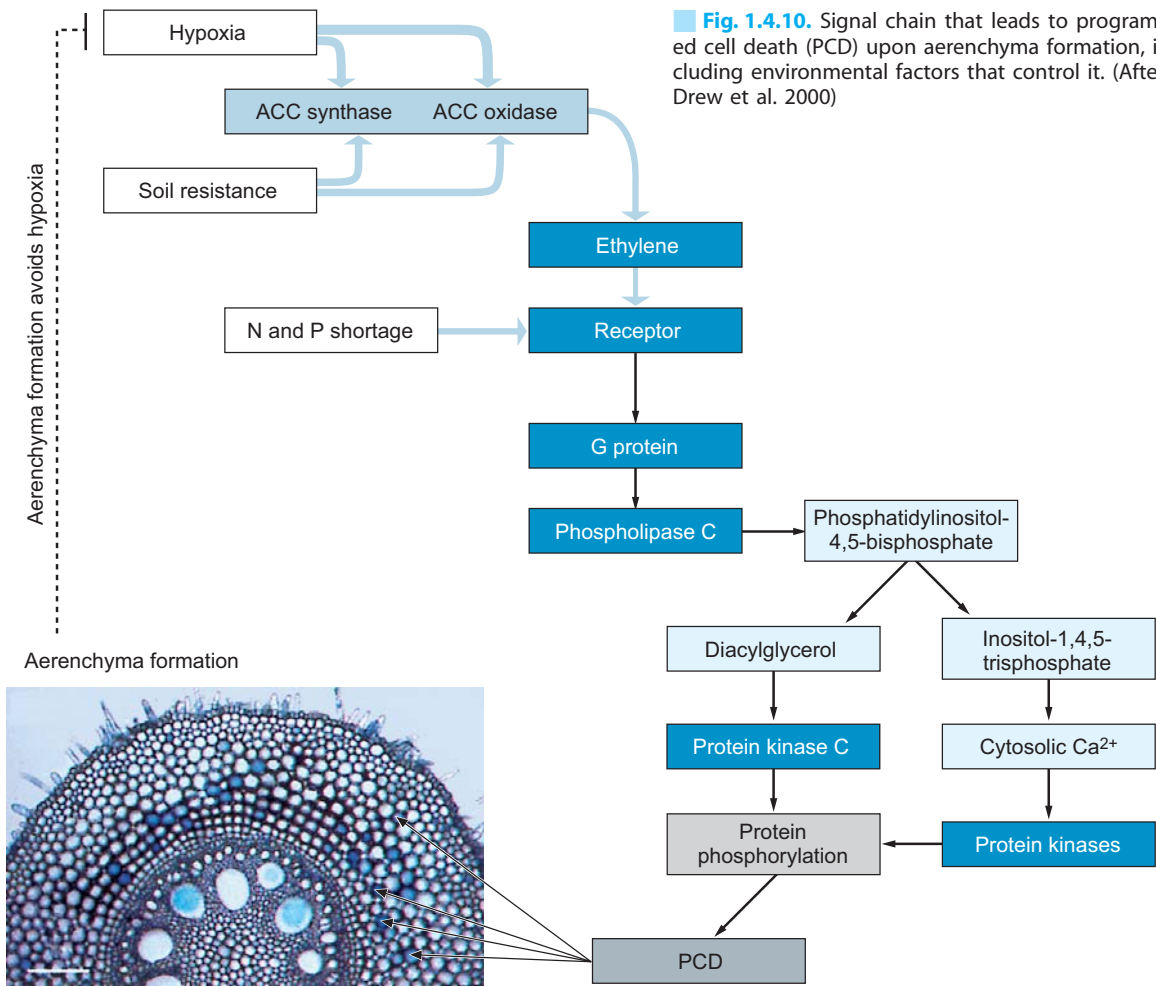


Fig. 1.4.9. Analysis of aerenchyma formation in a maize root. Ocadaic acid blocks protein phosphatases; GTP- γ -S activates G proteins; K252a inhibits protein kinases; neomycin inhibits inositol phosphate metabolism; EGTA complexes Ca^{2+} ; disintegrating cells are coloured purple by neutral red and Evans blue accumulates in dying cells. (After He et al. 1996; Drew et al. 2000). **A** Normoxic; **B** hypoxic; **C** normoxic+ocadaic acid; **D** hypoxic+ocadaic acid; **E** hypoxic+neomycin; **F** hypoxic+K252a; **G** hypoxic+EGTA; **H** normoxic+GTP- γ -S; **I** hypoxic+GTP- γ -S; **K** hypoxic+neutral red; **L** hypoxic+Evans blue



1.4.3 Post-anoxic Stress

Tissues tolerating hypoxic stress are often damaged by subsequent aeration. This post-anoxic stress usually results from ROS (see Chap. 1.3.5.3). Cells in which metabolism is adapted to hypoxic or anaerobic conditions have a relatively negative redox potential, i.e. high electron pressure from a high NADH/NAD⁺ ratio. In the presence of O₂ this leads to oxygen reduction and to the formation of ROS. During the hypoxic phase, activities of enzymes detoxifying ROS are decreased and the pools of scavenger metabolites are reduced so that the tissue is not capable of coping with increased oxidative stress. However, some plants are known to tolerate post-anoxic stress as, e.g., the yellow iris, where the enzyme superoxide dismutase is part of the ANP.

Summary

1. Lack of oxygen occurs after extended periods of soil flooding because the diffusion of oxygen in water is about 10,000 times slower than in air. The critical oxygen content required for growth of roots is about 5–10%. Helophytes (swamp-inhabiting plants) and submerged plants are able to live in partly hypoxic environments by supplying their roots and rhizomes with oxygen through an intercellular aeration system (aerenchyma). Gas flow in the interior of the plant is substantially accelerated by thermo-osmosis.
2. Normoxia, hypoxia and anoxia describe the conditions of sufficient, insufficient and deficient oxygen supply to organisms. Hypoxia and anoxia produce negative redox potentials of the soils, under which conditions oxidised heavy metal ions become reduced and in this form are poisonous. As a consequence of bio-

- logical activity, the pH of the soil shifts into the alkaline range. Mycorrhizae are particularly sensitive to such changes in the soil.
3. Low oxygen partial pressure in particular affects the energy metabolism of plant organs. Switching from the aerobic respiratory metabolism to fermentation is uneconomic and creates problems in cell biology, but enables the plant to survive for a limited time. Roots and rhizomes of certain plants are capable of surviving longer periods of anoxia or hypoxia in a metabolically quiescent state which is called anaerobic retreat.
 4. Upon switching to fermentative metabolism, so-called anaerobic polypeptides (ANPs) are formed and, at the same time, synthesis of many housekeeping proteins is reduced. Insofar as they have been identified, ANPs are predominantly enzymes of fermentative metabolism. Promoters of their genes contain a specific anaerobic response element (ARE).
 5. Constitutive tolerance of anoxia is usually based on avoidance of anoxia. In addition to the already mentioned formation of aerenchyma, elongation of internodes and of petioles is frequently observed. By elongation growth, apical parts of plants quickly extend into an environment with a better oxygen supply. Lack of oxygen activates the expression of the ACC-oxidase gene, the product of which is a pacemaker in ethylene synthesis. Increased ethylene partial pressure triggers the lowering of the ABA concentration, resulting in an increased efficacy of gibberellin and auxin as elongation hormones. Certain cell wall proteins, so-called expansins, play a vital role in the elongation reaction, as they are able to loosen the bonds between individual cell wall polymers. Hypoxia leads to increased formation and accumulation of such expansins.
 6. In addition to the elongation of the internodes, ethylene induces, under hypoxic conditions, also the formation of aerenchyma via programmed cell death (PCD). Aerenchyma formation triggered by hypoxia and mediated by ethylene is partially understood at the molecular level. G-proteins and intracellular calcium play important roles as signal transmitters in this process. The ethylene signal receptor is principally understood at the molecular level. It belongs to the so-called two-component signal receptors. Genetically fixed aerenchyma formation of helophytes is independent of ethylene.
 7. Damage often occurs during re-aeration of plant organs which have adapted to hypoxia, as the ROS-detoxifying system is decreased under anoxic and hypoxic conditions. This phenomenon is called "post-anoxic stress".

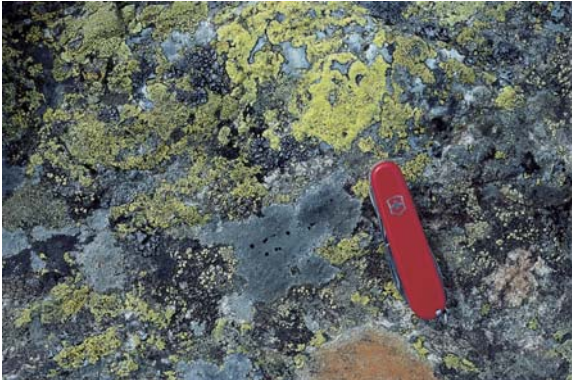
References

- Amberger A (1988) Pflanzenernährung. UTB Ulmer, Stuttgart, p 41
- Armstrong JAW (1990) Light enhanced convective through-flow increases oxygenation in rhizomes and rhizosphere of *Phragmites australis* (Cav.) Trin ex Steud. *New Phytol* 114:121–128
- Armstrong W, Gaynard TJ (1976) The critical oxygen pressure for respiration in intact plants. *Physiol Plant* 37:200–206
- Armstrong W, Webb T (1985) A critical oxygen pressure for root extension in rice. *J Exp Bot* 36:1573–1582
- Banga M, Slaa EJ, Blom CWPM, Voesenek LACJ (1996) Ethylene biosynthesis and accumulation under drained and submerged conditions – a comparative study of two *Rumex* species. *Plant Physiol* 112:229–237
- Cho HT, Kende H (1997a) Expansins and internodal growth of deepwater rice. *Plant Physiol* 113:1145–1151
- Cho HT, Kende H (1997b) Expansins in deepwater rice internodes. *Plant Physiol* 113:1137–1143
- Christopher ME, Good AG (1996) Characterization of hypoxically inducible lactate dehydrogenase in maize. *Plant Physiol* 112:1015–1022
- Dacey JWH (1981) Pressurized ventilation in the yellow waterlily. *Ecology* 62:1137–1147
- Dacey JWH (1987) Knudsen-transitional flow and gas pressurization in leaves of *Nelumbo*. *Plant Physiol* 85:199–203
- DeLaune RD, Pezeshki SR, Patrick WH Jr (1993) Response of coastal vegetation to flooding and salinity: a case study in the rapidly subsiding Mississippi River deltaic plain, USA. In: Jackson MB, Black CR (eds) *Interacting stresses on plants in a changing climate*. NATO ASI Series I 16. Springer, Berlin Heidelberg New York, pp 211–229
- Drew MC, He Ch-J, Morgan PW (2000) Programmed cell death and aerenchyma formation in roots. *Trends Plant Sci* 5:123–127
- Grosse W (1997) Gas transport in trees. In: Rennenberg H, Eschrich W, Ziegler H (eds) *Trees – contribution to modern tree physiology*. Backhuys, Leiden, pp 57–74
- Guglielminetti L, Perata P, Alpi A (1995) Effect of anoxia on carbohydrate metabolism in rice seedlings. *Plant Physiol* 108:735–741
- He Ch-J, Morgan PW, Drew MC (1996) Transduction of an ethylene signal is required for cell death and lysis in the root cortex of maize during aerenchyma formation induced by hypoxia. *Plant Physiol* 112:463–472
- Hirayama T, Alonso JM (2000) Ethylene captures a metal! Metal ions are involved in ethylene perception and signal transduction. *Plant Cell Physiol* 41:548–555
- Jackson MB, Black CR (1993) *Interaction of stresses on plants in a changing climate*. NATO ASI Series I 16. Springer, Berlin Heidelberg New York, pp 243–266
- Kohl J-G, Henze R, Kühl H (1996) Evaluation of the ventilation resistance to convective gas-flow in the rhizomes of

- natural reed beds of *Phragmites australis* (Cav.) Trin ex. Steud. *Aquat Bot* 54:199–210
- Laan P, Clement JMAM, Blom CWPM (1991) Growth and development of *Rumex* roots as affected by hypoxic and anoxic conditions. *Plant Soil* 136:145–151
- Laan P, Smolders A, Blom CWPM, Armstrong W (1989a) The relative roles of internal aeration, radial oxygen losses, iron exclusion and nutrient balance in flood-tolerance of *Rumex* species. *Acta Bot Neerl* 38:131–145
- Laan P, Berrevoets MJ, Lythe S, Armstrong W, Blom CWPM (1989b) Root morphology and aerenchyma formation as indicators for the flood-tolerance of *Rumex* species. *J Ecol* 77:693–703
- Mapelli S, Bertani A (1993) Endogenous phytohormones and germination of rice under anoxia: indoleacetic acid and abscisic acid. *NATO ASI Series I* 16. Springer, Berlin Heidelberg New York, pp 353–363
- Marschner H (1986) Mineral nutrition of higher plants. Academic Press, London, 674 pp
- Mekhedov SL, Kende H (1996) Submergence enhances expression of a gene encoding 1-amino-cyclopropane-1-carboxylate oxidase in deepwater rice. *Plant Cell Physiol* 37:531–537
- Pradet A, Mocquot B, Raymond P, Morisset Ch, Aspart L, Delseny M (1985) Energy metabolism and synthesis of nucleic acids and protein under anoxic stress. In: Key JL, Kosuge T (eds) *Cellular and molecular biology of plant stress*. Liss, New York, pp 227–245
- Saab IN, Sachs MM (1996) A flooding-induced xyloglucan-endo-transglycosylase homolog in maize is responsive to ethylene and associated with aerenchyma. *Plant Physiol* 112:385–391
- Schiwinsky K, Grosse W, Woermann D (1996) Convective gas flow in plant aeration and Graham's law of diffusion. *Z Naturforsch* 51c:681–690
- Taiz L, Zeiger E (2000) *Physiologie der Pflanzen*. Spektrum, Heidelberg, 773 pp
- Urao I, Yamaguchi-Shinozaki K, Shinozaki K (2000) Two-component systems in plant signal transduction. *Trends Plant Sci* 5:67–74

1.5

Water Deficiency (Drought)



Poikilohydric lichens are “world champions” in tolerating drought stress, which usually is accompanied by heat or cold and high light intensities. Despite the extremely harsh habitat, every square millimetre of this gneiss boulder in the Austrian Alps is occupied by more or less colourful crustose lichens. The community is dominated by the yellowish green *Rhizocarpon cf. geographicum*. Photograph E. Beck.

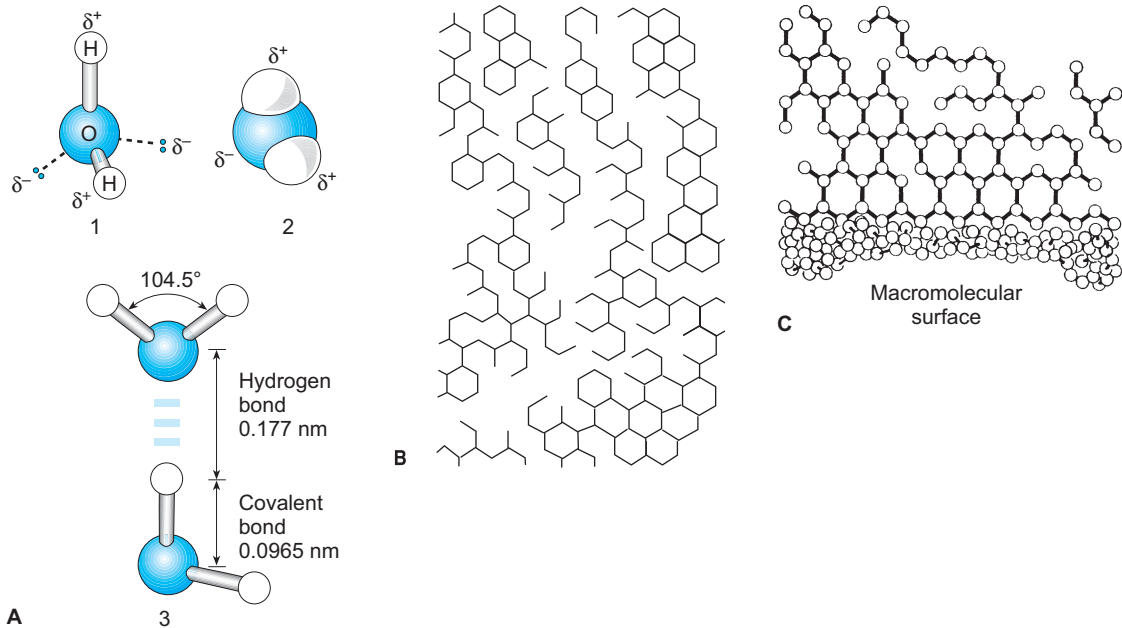
Recommended Literature

- Blatt MR (2000) Cellular signaling and volume control in stomatal movements of plants. *Annu Rev Cell Dev Biol* 16:221–242
- Close TJ, Bray EA (1993) Plant responses to cellular dehydration during environmental stress. *Current topics in plant physiology* 10. American Society of Plant Physiology, Rockville
- Errington JR, Debenedetti PG (2001) Relationship between structural order and the anomalies of liquid water. *Nature* 409:318–321
- Hoekstra FA, Golovina EA, Buitink J (2001) Mechanisms of plant desiccation tolerance. *Trends Plant Sci* 6:431–438
- Ingram J, Bartels O (1996) The molecular basis of dehydration tolerance in plants. *Annu Rev Plant Physiol Plant Mol Biol* 47:377–403
- Maurel C (1997) Aquaporins and water permeability of plant membranes. *Annu Rev Plant Physiol Plant Mol Biol* 48:399–430
- Zhu J-K (2002) Salt and Drought Stress Signal Transduction in Plants. *Annu Rev Plant Biol* 53:247–273

Life requires water in the liquid state and is, thus, based on the physicochemical properties of the **water molecule** causing the so-called **anomalies** (Box 1.5.1). These properties result from the di-

pole nature of the molecule $H^{\delta+}-O^{\delta-}-H^{\delta+}$; the dipoles produce H-bonds between the individual molecules and thus guarantee a high degree of cohesion with, at the same time, low viscosity. The results are variable or flickering (mobile) clusters or aggregates, which continuously exchange individual molecules. Despite the low molecular mass of the water molecule, water is, therefore, in the liquid rather than the gaseous state at temperatures between 0 and 100°C and standard air pressure. Also based on the dipole nature of water is its adhesion to polar surfaces, for example, cell walls, and its capillary action based on the high surface tension. Adhesion, capillary action, together with cohesion and low viscosity, are decisive factors for the transport of water from roots to leaves (cohesion theory of water conductance). Another consequence of the dipole nature of the water molecule is its suitability as solvent for polar and polarisable compounds. In addition, water develops a structuring force in amphiphilic systems (hydrophilic–hydrophobic) giving rise to lipid micelles and contributing to the tertiary structures of proteins. These so-called hydrophobic interactions are based on the strength of the interaction between the hydrophilic domains of the molecules with each other and with the water clusters, as well as on the hydrophobic domains between one another. The term **hydrophobic in-**

Box 1.5.1 The physico-chemical properties (anomalies) of water



Due to their dipole nature, water molecules [Fig. A (1), (2)] associate via hydrogen bonds to a three-dimensional lattice (clusters; B, from Larcher 1994), which is in permanent molecular rearrangement. The physico-chemical anomalies of water can be explained as a consequence of this cluster formation.

Water forces amphiphilic molecules into particular associative structures, e.g. biomembranes (C, from Larcher 1994). These, in turn, interact with the water molecules, forming an ordered water layer which at some distance from the membrane surface again takes on the nature of flickering (mobile) clusters.

Compound	Molecular weight	Melting point (°C)	Boiling point (°C)
H ₂ O	[18] _x	0	100
H ₂ S	34	-86	-61

Further biologically important physical properties of water are listed below.

Specific heat capacity	1 cal g ⁻¹ = 4.2 J g ⁻¹
Latent heat of crystallisation	333.6 J g ⁻¹
Latent heat of evaporation	2441 J g ⁻¹
Surface tension (at 15 °C)	73.5 g sec ⁻¹

teraction is slightly misleading, as there are also interactions between the water molecules and the hydrophobic domains of the amphiphilic molecules, which are, however, weaker than the interactions of the hydrophobic domains with one another. Water is a very effective heat buffer for organisms, because of its relatively high heat of crystallisation (freezing avoidance) and very high heat of evaporation (transpiration cooling). As its radiation absorption is beyond the borders of the visible spectrum, water does not absorb visible light and thus does not interfere with photosynthesis or processes regulated by blue or red light.

Water Potential

The thermodynamic state of water is described by the water potential, ψ , which is, figuratively speaking, a measure of the energy required to remove water molecules from any water-containing system. As the (chemical) potential of pure water is taken as a reference system, and under the actual conditions is defined as zero, ψ is a measure of a difference in the chemical potentials. Commonly, the water potential of a system is expressed in the dimension of pressure and not of energy: If the chemical potential of water is related to the molar volume, the dimension

“pressure” results. Other details and the derivation of the definition of water potential are given in Chapter 2.2, Eq. (2.2.7) (see also Chap. 1.3).

The water potential of a cell is made up of several components:

$$(-)\psi = (-)\pi + (-)\tau + P,$$

where π is the **osmotic potential** (negative sign) of the equilibrated cellular solutions in a steady state [see Chap. 2.2, Eq. (2.2.6)], τ the **matrix potential** (negative sign) and P the **pressure potential** (cell wall and tissue pressure, positive sign). The pressure of the wall (plus tissue) is numerically equal to the **turgor pressure** (the pressure of the protoplast on the cell wall) and has the opposite, positive, sign in the water potential equation. In a hydrated cell, τ cannot be measured. It becomes apparent only after the cell has been desiccated to such an extent that only the water bound to cellular and subcellular structures remains. To remove that portion of cellular water requires either extreme low (negative) water potentials or extreme high pressures (see Chap. 1.3.6.4).

Intercellular and Intracellular Water Flow, Aquaporins

A water potential difference between two systems (e.g. two cells) corresponds to a voltage in an electrical circuit and causes the flux of water in the direction of the system with the more negative potential, provided that the pathway is conductive to water (**hydraulic conductivity**). The flux of water may be in the apoplast, i.e. through and along the cell walls (**apoplastic path**) or also through the protoplasts (**symplastic path**; see Chap. 2.2, Fig. 2.2.8). The importance of the symplastic path for water transport has been greatly underestimated, but the discovery of **aquaporins** (Box 1.5.2) has gained more attention. Aquaporins are specific proteins, with a molecular mass of 15–30 kDa, which form water channels through cellular membranes (Johansson et al. 2000). Usually, oligomers accumulate to complexes. The density of such aquaporin aggregates in a membrane determines its hydraulic conductivity, which is in the range 2×10^{-8} to $10^{-5} \text{ m s}^{-1} \text{ MPa}^{-1}$. Water flow through these channels is characterised by the high permeability of the membrane ($P_f \approx 700 \mu\text{m s}^{-1}$) and a low activation energy of the transport ($E_a = 8\text{--}12 \text{ kJ mol}^{-1}$). Additional to this pathway is the

so-called **lipid pathway**, namely the diffusion of water molecules through the lipid bilayer of the biomembrane, which is characterised by a low permeability and a high activation energy ($P_f \approx 10 \mu\text{m s}^{-1}$; $E_a = 48\text{--}64 \text{ kJ mol}^{-1}$). Water transport by these two pathways can be differentiated by the kinetic data, and by blocking the aquaporins with heavy metals, for example, Hg^{2+} , as most of the aquaporins contain cysteine in the helices spanning the membrane.

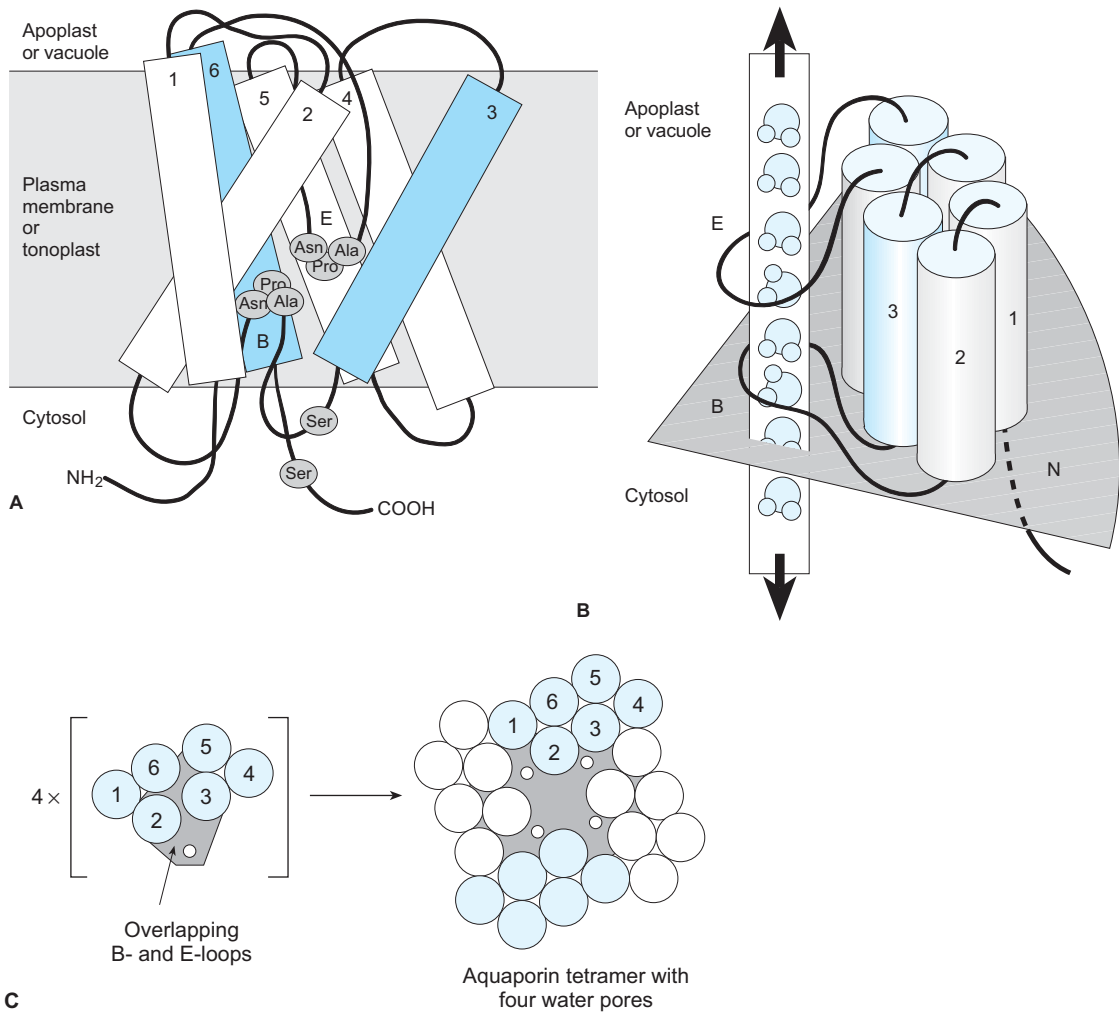
Usually, the permeability for water of the tonoplast is considerably higher than that of the plasma membrane. As the water relations of the cell are dominated by the vacuole, the high water permeability of the tonoplast guarantees fast equilibration of the intracellular water potentials upon changes in the cell's water status. In *Arabidopsis* aquaporin clusters, so-called **plasmalemmasomes** (Robinson et al. 1996) have been described. They are thought to establish a direct connection between the plasmalemma and the tonoplast. Other membrane transport proteins, e.g. ion channels, also contribute to water transport, as they form hydrated pores. Depending on the structure of these pores, each transported molecule or ion carries up to 25 water molecules over the membrane. The effectiveness of an aquaporin, however, is about 20 times higher.

1.5.1

Water Balance of Drought-Stressed Cells

Upon drought plants lose water to the atmosphere: if water uptake cannot keep pace with water loss, transpiration is mainly fed from the vacuoles. It flows via the plasmalemma into the apoplast from where it evaporates into the intercellular spaces. Because of the decrease in volume caused by water loss, the osmotic potential in the protoplast is increased (i.e. becomes numerically more negative). At the same time, the turgor pressure as well as the cell wall pressure decrease. At the so-called turgor-loss point the cell wall is completely relaxed and both pressures are zero. Consequently, the water potential of the cell is then equal to its osmotic potential. In this state plants show substantial wilting. With further loss of water, wilting increases, as the cell walls are not only relaxed, but in responding to the intracellular suction bend in-

Box 1.5.2 Aquaporins



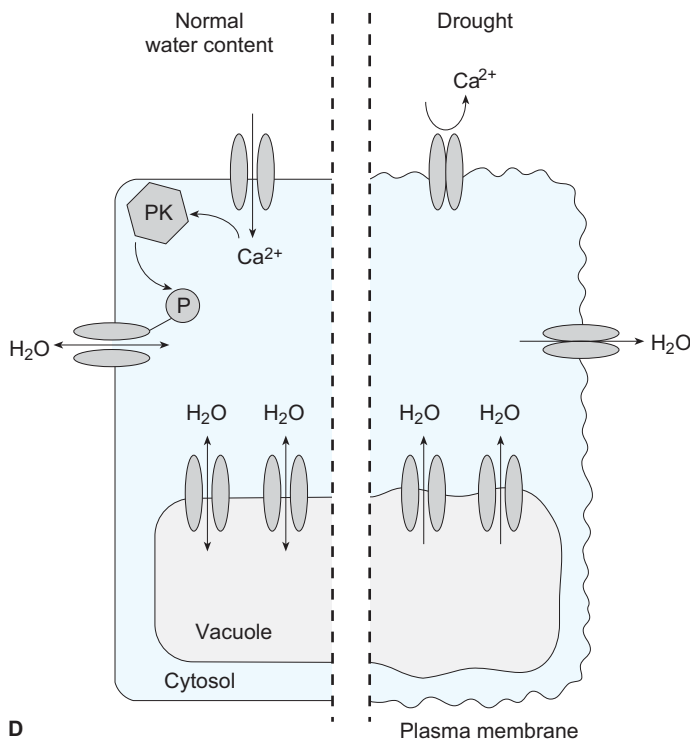
A shows the hourglass model of an aquaporin monomer. The labelled amino acids in the centre form the constriction of the hourglass, while the membrane-spanning helices, 1, 2, 3, and their counterparts, 4, 5, 6, form the “con-

tainer”. The loops *B* and *E* form the actual water pore (**B**). The two halves of the hourglass are homologous, but inverted in their orientation in the membrane: Helix 1 corresponds to helix 4, helix 2 to 5 and helix 3 to 6. Aqua-

wards giving rise to cell cytorrhysis (**Chap. 1.3.6.1**), if their rigidity is low enough to allow folding. As described for the case of freezing dehydration, this happens because the water-imbibed cell wall (**Fig. 1.5.1**) does not allow any air to penetrate. Suction develops and correspondingly a negative pressure potential (–1 to –2 MPa) increases the water potential of the cell. As a consequence, more water is retained in the

cell than would correspond to the osmotic potential alone. Despite the increase in the water potential of the cells by a negative pressure potential, during prolonged drought, cells can lose so much of their water that dehydration damage arises, breaking down the bilayer structure of the membranes whereupon the osmotic system of the cell collapses.

Box 1.5.2 Aquaporins (continued)



porins form complexes (C). A model with four monomers is shown (CHIP 28 from erythrocytes), which also represents the most common form of water pores in plants. The model applies to the aquaporins of the plasma membrane (PIPs) and of the tonoplast (TIPs). The efficiency of some aquaporins can be controlled by protein phosphorylation and dephosphorylation (D). The model shows the state under sufficient water supply (*left*) and under drought (*right*). An as yet unidentified osmoregulator holds the cytosolic Ca^{2+} concentration high and a protein kinase keeps

the aquaporin phosphorylated, which keeps the pore open. Protein phosphorylation takes place at the serine residues labelled in A. Under drought stress the cytosolic Ca^{2+} concentration decreases, the aquaporin becomes dephosphorylated and the pore closes. In this way, water loss is reduced. It is presumed that selective regulation of the protein phosphorylation keeps the pores in the tonoplast open, so that the water potential of the cytosol is little affected by water loss from the cell (A and D after Kjellbom 1999; B after Schäffner 1998; C after Jung et al. 1994).

Water Storage

Water storage tissues, for example, of succulents, have special cellular water relations. Cell walls of succulents are very flexible (but not extendable) and thus convey a high water storage capacity (**hydraulic capacity**) to the cells. Upon water loss, the cell walls of these living tissues fold like a concertina, or the cells as a whole collapse cytorrhytically, and this reduces the cell volume. The flexibility (elasticity) of the cell wall, with

which they react to pressure changes, must not be mistaken for expansion or contraction. It is a passive change in the shape of the cells depending on the **elasticity modulus** ε of the cell wall:

$$\varepsilon = \frac{dP}{dV/V} \text{ [MPa]}$$

where dP is the change in turgor and dV/V the relative change in volume.

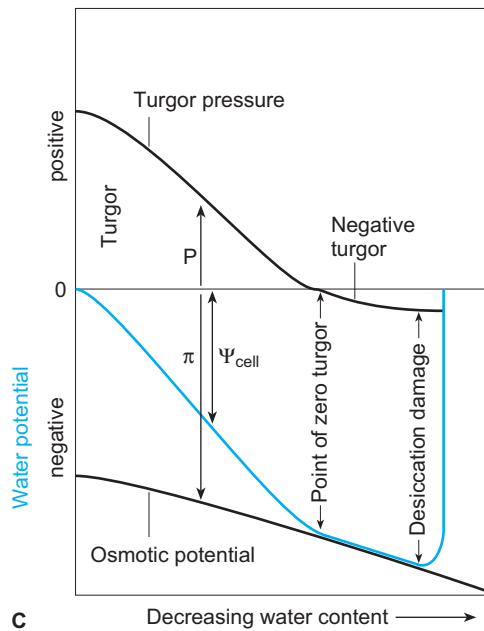
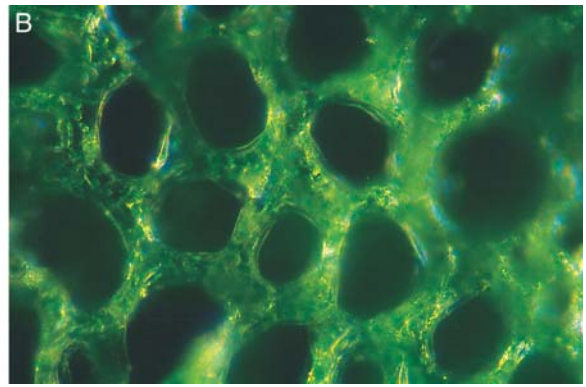
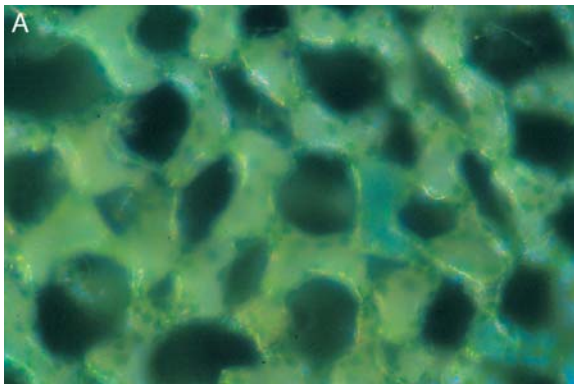


Fig. 1.5.1 Desiccation of plant cells upon exposure to air. **A** Spongy parenchyma of *Pachysandra terminalis* in turgid state. **B** The same tissue after 2 h exposure to air. The collapse of the cells, whose volume has shrunk by more than 50%, is clearly visible. **C** Water relations of a cell in the course of desiccation. After loss of turgor the protoplast remains attached to the cell wall, due to the matrix potential of the latter, and a negative wall pressure (tension) develops. A, B, photos by J.J. Zhu, C after Larcher (1994), modified

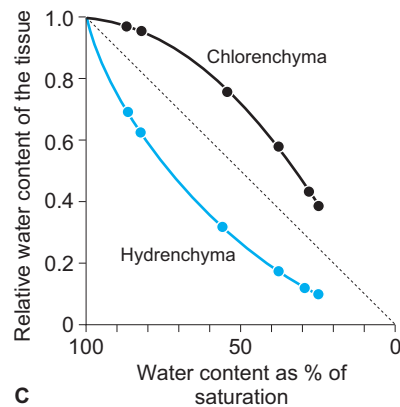
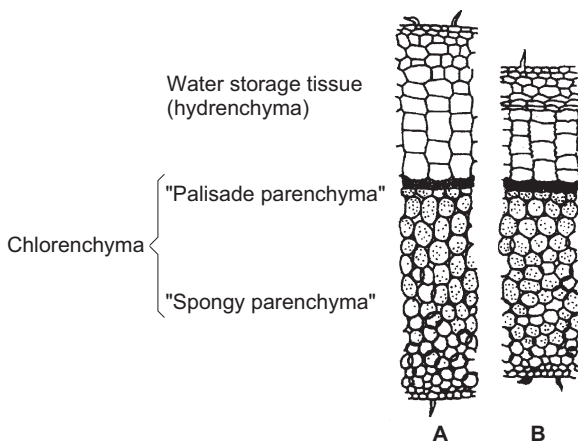


Fig. 1.5.2. Water storage in leaves of peperomia (*Peperomia trichocarpa*). **A, B** Cross sections of water-saturated leaves (**A**) and the leaves after drying (**B**). The hydrenchyma shrinks much more than the chlorenchyma. This phenomenon is shown quantitatively in **C**: at a total water content of 50% saturation, the portion of water in the hydrenchyma has dropped to 25%, whilst the water content of the chlorenchyma is still 75%. (After Larcher 1994)

For soft plant tissues, $\epsilon \leq 5$ MPa, so larger changes in volume create only small changes in turgor (P). For leaves of sclerophyllous trees, ϵ is between 30 and 50 MPa, and they have only limited ability to change their shape upon water loss. Thus, softer tissues are able to shrink substantially, whilst harder tissues cannot. Water storage tissue (**hydrenchyma**) possesses cells with a particularly low elasticity module, i.e. they can easily take up and release lots of water. Leaves with marked water storage tissue, usually surrounded by the chlorenchyma (e.g. *Peperomia*), therefore change their cross section in accordance to their state of water. Because of the different elasticity modules, only the water storage tissue, but not the chlorenchyma, shrinks (Fig. 1.5.2).

Many water storage tissues consist of dead cells, for example, the *velamen radicum* of the air roots of orchids, where water uptake and storage depend mainly on capillary forces.

1.5.2

Cellular Reactions to Drought Stress

At the cell level, water deficit is not only a result of drought, but also of salt stress and of frost. The loss of up to 90% of the cell water is a necessary process during seed and fruit ripening and thus is a regular component of a plant's development. Plants have, therefore, developed biochemical mechanisms to cope with drought stress. Our understanding of the molecular processes triggered by drought and of the adaptation to water shortage is, however, still patchy. There is no doubt that each cell has more than one mechanism for reacting to drought; there is, so to say, a multiple safety net. However, not all changes in cell biology occurring upon drought stress are specific to that situation. Some strains are primarily targeted to other stressors, e.g. metabolic changes triggered by cold or pathogen attack can also be effective to cope with dehydration stress. In addition to specific stress-directed reactions, desiccation interferes with the normal housekeeping machinery of the cell. This holds in particular for **poikilohydric plants** (see Chap. 2.2.1.1) where photosynthesis is reduced in order to minimise the danger of photooxidation. In the resurrection plant *Craterostigma plantaginea* expression of genes of the photosynthetic machinery is attenuated, probably concomitantly with the induction of genes whose products – proteins and metabolites

– increase drought resistance of cells directly or indirectly. A key role in coping with **dehydration stress** is attributed to the phytohormone **abscisic acid** (ABA; see Fig. 1.5.3 and Box 1.5.3), which triggers fast reactions as well as long-term adaptation. Complying with the above-mentioned complexity of stress-induced cellular reactions, ABA-independent reactions are also well known. Current knowledge shows cellular responses to drought to be no less complicated than the responses to heat stress.

1.5.2.1

Perception of Dehydration Stress

Water loss may cause the following changes:

- shrinkage of the protoplast,
- concentration of cellular solutions,
- decrease or loss of turgor,
- changes in the water potential gradient across membranes,
- in the worst cases, disintegration of biomembranes and denaturing of proteins.

Which of these phenomena play a role as cellular signals in plants has not yet been determined. Probably it is the change in the water potential or pressure gradient across membranes. **Osmosensors** are known from *E. coli* and yeast. Their functions were shown in complementation studies with mutants deficient in osmotic adaptation (Wurgler-Murphy and Saito 1997; see also Box 1.4.5). One of the transmembrane osmosensors of yeast, Sho1p, forms a protein of four closely packed membrane-spanning peptides with a peripheral C-terminal domain that is responsible for triggering signal transduction. If the osmotic gradient across the plasma membrane is increased, Sho1p activates a four-step MAP kinase cascade, leading finally to the production and accumulation of glycerol, which is an osmoprotectant of yeast. Successful complementation of the osmosensor-deficient mutant of yeast with a corresponding gene of *Arabidopsis* (*ATHK1*; Shinozaki and Yamaguchi-Shinozaki 1997) leads to the assumption that similar systems of drought perception are also effective in plants. Due to the multiplicity of stress responses of plants, it must be concluded that plant cells have several receptor systems which might render tissue specificity (Bonetta and McCourt 1998). Receptors for ABA should be differentiated from direct osmosensors, as

Box 1.5.3 Biosynthesis, metabolism and inactivation of ABA

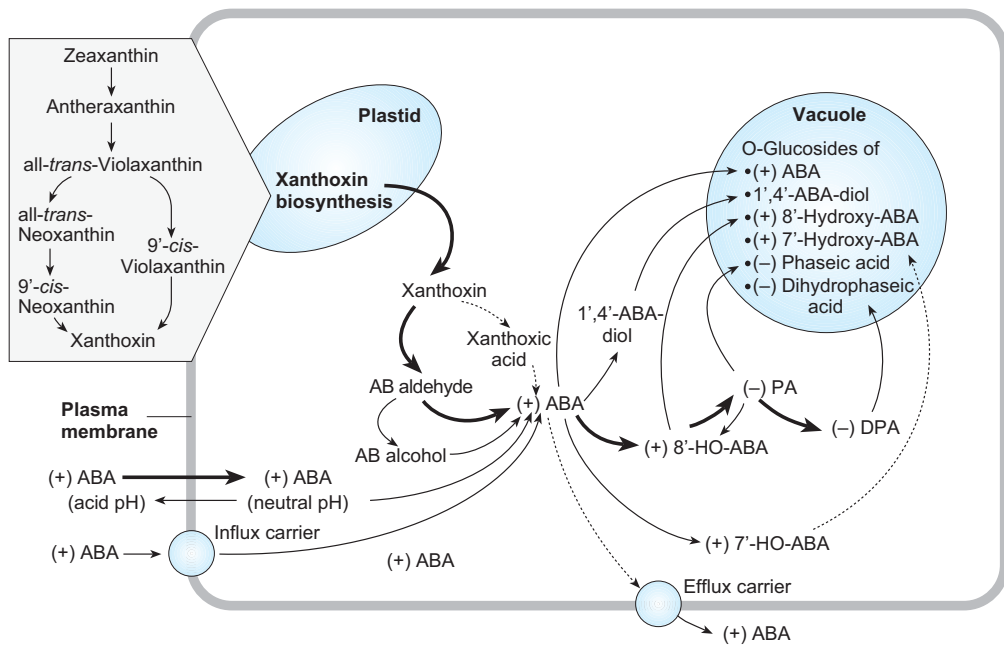


Fig. 1

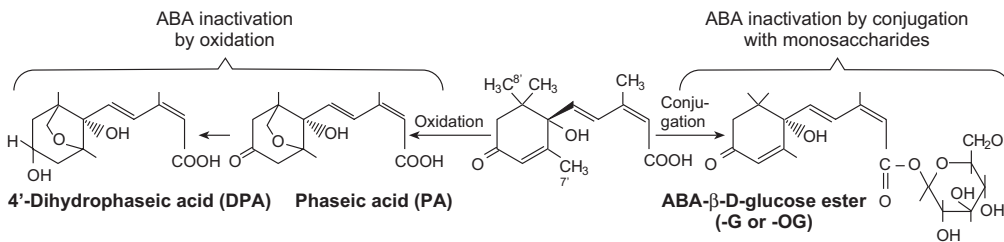


Fig. 2

As far as is currently known, ABA is a derivative of chloroplastic xanthophylls. These are not synthesised via the mevalonate pathway, but originate from the chloroplastic DOXP pathway (1-deoxy-D-xylulose-5-phosphate pathway; Lichenthaler 1999). Key enzymes of ABA biosynthesis are zeaxanthin epoxidase (ZEP), encoded for by the gene *ABA2*, and 9-*cis*-epoxycarotenoid dioxygenase (NCE), encoded for by the gene *VP14*. NCE can cleave the xanthophylls: all-*trans*-violaxanthin, all-*trans*-neoxanthin, 9-*cis*-neoxanthin (Cutler and Krochko 1999).

Figure 1 shows the metabolism of (+)-ABA at the cellular level. The first steps of ABA biosynthesis, until cleavage of the 9'-epoxycarotenoids by the dioxygenase, occur in the plastids. The cleavage product xanthoxin after export from the plastid (by an unknown mechanism) is metabolised in the cytoplasm to (+)-ABA. The *bold arrows* show the main route and *fine*

arrows the shunt via ABA-alcohol, whilst the pathway via xanthoxic acid is still disputed (*dotted line*). The fast import of ABA from the apoplasm into the cell is induced by the neutral pH of the cytoplasm (after Cowan 2000).

The main pathway of ABA degradation as shown in Fig. 2 starts with the hydroxylation of the 8'-carbon, followed by a cyclisation to phaseic acid which is converted by a reductase to dihydrophaseic acid. The three degradation products are physiologically inactive. Hydroxylation of the 7'-carbon is also known, but similar to the direct reduction of the ABA keto group to 1',4'-ABA diol is quantitatively insignificant. The formation of conjugates of ABA and its derivatives, in particular with glucose, is physiologically relevant, as these compounds are water-soluble and are exported from the cytoplasm into the vacuole (after Taiz and Zeiger 2000).

ABA is already a stress signal at the cellular or subcellular level. The biochemical structure of ABA sensors has not yet been elucidated.

1.5.2.2

ABA-Mediated Stress Response

Mild drought stress leads to a ten-fold increase in the endogenous ABA concentration (Fig. 1.5.3). This applies to higher, as well as to lower, plants. Mutants lacking the ability to synthesise ABA are not viable, as they wilt even with the slightest drought stress. However, they may be kept alive by adding ABA¹. The receptor for the dehydration signal leading to ABA synthesis and accumulation is unknown.

Even though the biochemistry of ABA sensing is not yet known, it is clear that there are ABA receptors on the outside of the cell membrane and inside the protoplast (Bray 1997). The receptors may be activated or inactivated by interaction with an effector protein. Prenylation (farnesylation) of that protein leads to its binding to the receptor and to its inactivation. In this way, the sensitivity of the cell for ABA may be adjusted (Bonetta and McCourt 1998). However, ABA is not the only signal molecule that is recognised by the ABA receptors. The derivative (+)-8'-methylene-ABA is more efficient, probably because this compound persists longer than ABA, i.e. is metabolised more slowly. The cyclic ADP-ribose (cADP-Rib) and nicotinic acid-adeninedinucleotide phosphate have been identified as **secondary intracellular messengers** of the ABA signal (Quatrano et al. 1997). They probably react to the ABA signal and affect intracellular calcium

stores, triggering increase in free cytosolic Ca²⁺. This acts as a further secondary messenger, starting one or more phosphorylation cascades which directly or indirectly lead to metabolic responses (strain reactions) to drought stress.

Processes induced by ABA are either fast reactions, as seen in stomatal closure, or slow reactions connected to the expression of ABA-responsive genes.

Reaction of Stomates to ABA

The ABA signal is detected at the outer face of the plasma membrane of guard cells, causing a fast decrease in the turgor and closure of the stomates (Schroeder et al. 2001).

The compartment that is effective in the control of ABA-triggered reactions is thus the apoplast of the guard cells. ABA, as a **signal originating in the roots**, reaches the leaves via the xylem stream and, by **ion trapping**, is quickly absorbed by the protoplast. Usually, the apoplast is more acidic than the cytosol, whose pH is around 7. Thus ABA, as an acid, is protonated to a higher extent in the apoplast (pH 5–5.5) than in the cytoplasm. The protonated, i.e. undissociated, acid easily diffuses through the plasma membrane into the cytosol where it is trapped after dissociation. The apoplastic concentration of ABA, which is that concentration perceived by the outer face of the plasma membrane, is, therefore, low. It has been recently shown that stressful situations, such as low water availability in the soil, lead to an alkalinisation of the xylem sap by up to one pH unit (Wilkinson 1999). This decreases the efficacy of the cytosolic ion trap and shifts the pH-dependent equilibrium between the intra- and extracellular ABA concentrations in favour of the apoplast

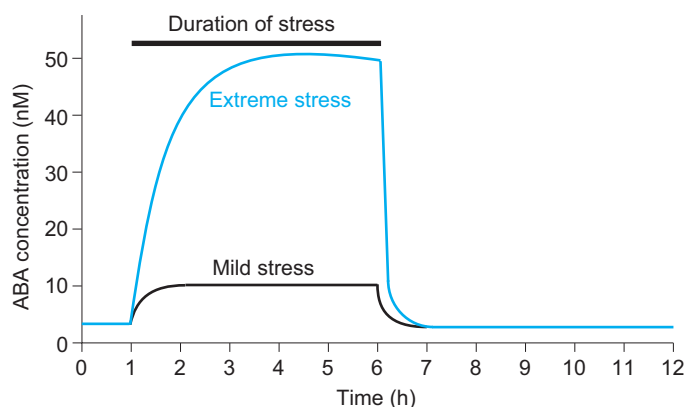


Fig. 1.5.3. Computer simulation of ABA export from the guard cell protoplasts into the surrounding apoplasts following alkalinisation of the latter upon drought stress. The simulation of the distribution of ABA is based on the ion trap principle. Following rehydration, the original pH relations are restored and ABA diffuses back into the cytoplasm. The duration of the applied stress is shown by the *black bar* at the top of the figure. (Hartung 1996)

¹ Fungi also synthesise ABA, probably directly from mevalonic acid (Walton and Li 1995)

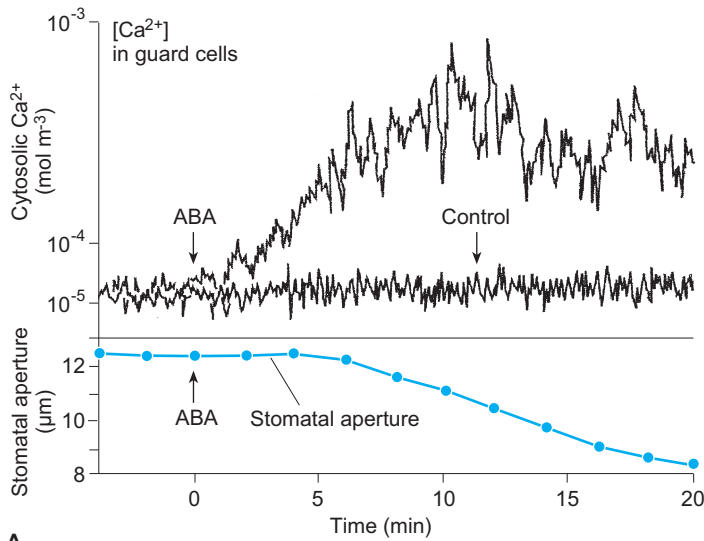
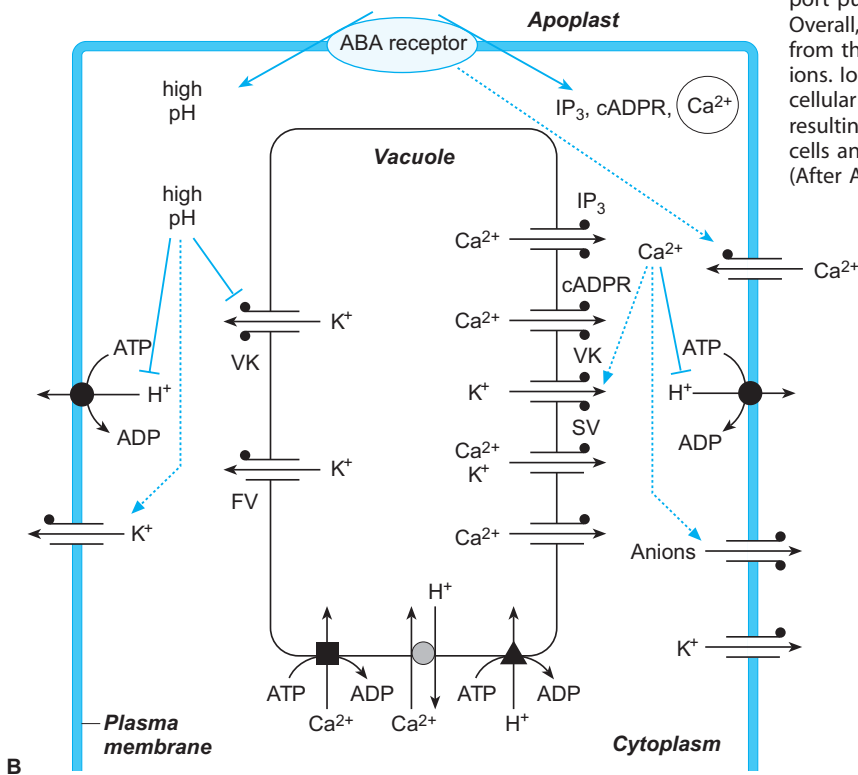


Fig. 1.5.4. Regulation of stomatal closure by ABA. **A** Immediately after application of ABA to isolated epidermal strips the concentration of free Ca^{2+} in the guard cells increases. Only 5 min later the stomates begin to close (after Taiz and Zeiger 2000). **B** Simplified scheme of stoma closure caused by ABA. ABA affects the ion relations in the guard cells in many ways, but mainly by increasing the intracellular pH (left part of figure) and by directly and indirectly increasing the intracellular concentration of free calcium (right part of figure). Many ion channels are regulated by Ca^{2+} or metabolites (gated channels), and others open or close in response to the membrane potential and are thus dependent on the pH gradient across the plasma membrane. Some reactions are controlled by both pH and the concentration of free Ca^{2+} (e.g. proton export pumps of the plasma membrane). Overall, there is a gross net export of K^+ from the cell, followed by export of anions. Ion export leads to the shift of cellular water to the neighbouring cells, resulting in turgor loss of the guard cells and finally to closure of the stoma. (After Assman and Shimazaki 1999)



- ■ ▲ ● Transporters
- Ligand-gated channels
- Channels
-> Activation and/or stimulation
- | Inhibition
- SV Slow vacuolar cation channel
- VK Vacuolar K^+ channel
- FV Fast vacuolar cation channel

and, in turn, increases the strength of the ABA signal (Fig. 1.5.3).

Moreover, the ABA concentration in the xylem fluid increases under that kind of stress. Neither the structure of the ABA receptor nor the biochemistry of its reaction with ABA is known. Knowledge of the ABA signal cascade starts with an increase in the cytosolic calcium concentration by import of Ca^{2+} from the apoplast and by release from intracellular reservoirs. In addition, the cytosolic pH also increases. Because of this and the increased calcium level, proton-exporting pumps and potassium-importing channels are inactivated and potassium-exporting channels are activated. Ca^{2+} also activates anion channels (chloride or malate) in the plasma membrane. Flow of such anions from the vacuole into the cytoplasm has been shown, but the transport mechanism and the nature of the activator of the channels are still debated. For many of these channels, a guard cell-specific control is assumed. Thus, there is a direct and a calcium-dependent signal transduction pathway (Fig. 1.5.4) and both have the same effect, i.e. a concerted reaction of ion channels resulting in an export of potassium and anions (e.g. chloride and malate) from the guard cell protoplast. As a consequence of the decreasing osmotic potential of the guard cells and the corresponding increase in the water potential of the neighbouring cells, water moves from the guard cells to the neighbouring cells. Because of the concomitant decrease in the turgor in the guard cells, the stomata close. As mentioned above, the sensitivity of the plasma membrane towards ABA can change in the course of the day; this could be due to salts or other phytohormones transported in the xylem sap.

Besides the reaction to ABA, guard cells also react to other signals, e.g. CO_2 concentration or light (see also Chap. 2.2, Fig. 2.2.17). Increased concentrations of CO_2 reduce stomatal conductivity (Morison 1998) while light acts as a signal for the opening of stomata. It has been shown that it is mainly the blue light portion of the daylight that triggers ion influx and stoma opening (Zeiger and Zhu 1998).

Regulation of Gene Expression by ABA

The control of gene expression mediated by ABA aims at two different groups of gene products: **functional** and **regulatory proteins**. The latter may be components of regulation cascades leading to the synthesis of functional proteins (enzymes or protective proteins; Fig. 1.5.5).

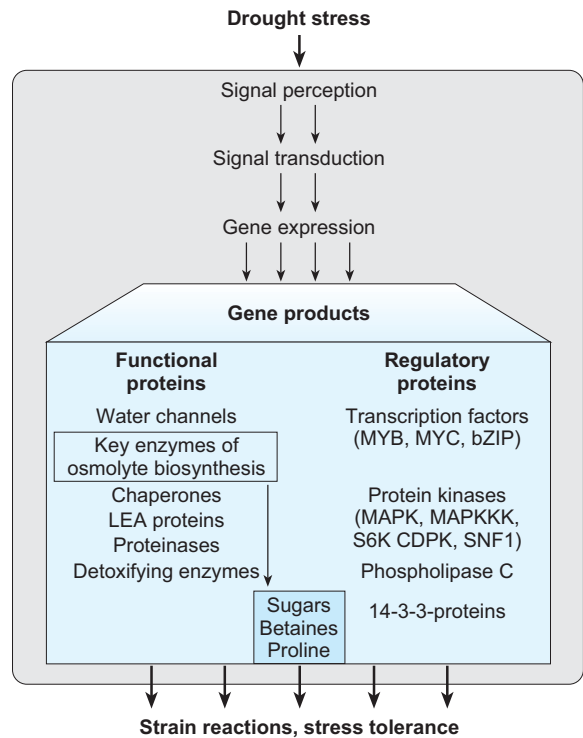


Fig. 1.5.5. The response of plant cells to stress caused by desiccation. (After Shinozaki and Yamaguchi-Shinozaki 1997)

The regulation of gene expression at the transcription level requires the interaction of *cis*-acting elements in the promoters with corresponding transcription factors, usually DNA-binding proteins. The *cis*-elements are fairly well known, but knowledge of transcription factors is still patchy. The **ABA responsive *cis*-element** is a highly conserved motif, the so-called **ABRE** (ABA-responsive element), which consists of the base sequence PurPyrACGTGGPyrPur (Pur, Pyr: purine base, pyrimidine base). The central piece of this element is the sequence CACGT(G,C), the so-called **G-box**, which is typical of promoters of many stress- and light-responsive genes.

Changing of only two of the conserved bases in ABRE reduces the responsiveness of this *cis*-acting element enormously. The transcription factors binding to ABRE are the G-box-binding proteins, which belong to the so-called **basic leucine zipper** (so-called **bZIP** proteins), containing several basic amino acids after the zipper motif. How ABA activates the bZIP protein so that it binds to the ABRE is not yet known.

Natural genes usually contain several ABREs (Fig. 1.5.6 A). Thus, those promoters that contain a single ABRE react only weakly to ABA. They

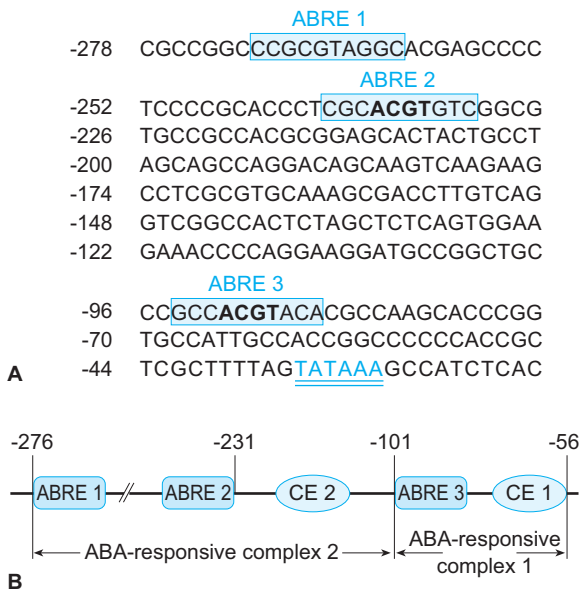


Fig. 1.5.6. The HVA22 promoter from barley (*Hordeum vulgare*) contains several ABA-responsive elements (ABREs) and further *cis*-active elements (CEs). **A** The complete HVA22 promoter with the ABREs 1–3 and the TATA box. **B** ABREs and CE1 form a complex that determines signal specificity. (After Shen and Ho 1995)

require a second promoter element for strong reactions. The dehydration protective protein of barley is called the coupling element (CE3), with a base sequence similar to that of ABRE (Pur-ACGCGTGTC) and can even be experimentally replaced by it, without affecting gene expression. Both elements bind the same ABA-responsive bZip-factor TRAB1 (Hobo et al. 1999). This factor also binds to other *non-G-box*-ABREs.

The specificity of the gene response to ABA requires further DNA-binding proteins. In the *rab17* gene of maize, nine promoter elements have been identified, which bind to such proteins. Five of these elements are ABREs, four contain other motifs. Six of these *cis*-elements induce the strong expression of the *rab 17* gene in the course of embryo maturation in the ripening seed, three are responsible for expression of the gene specifically in leaves (Busk et al. 1997). The principle of combining two or several promoter elements (“bipartite promoter”), for example, a general ABA-responsive element with one element mediating signal and site specificity, is widespread (Fig. 1.5.6 B; Shen and Ho 1995).

It is assumed that certain DNA-binding proteins, such as the VPI, represent a new class of nucleus-specific factors, so-called DNA chaper-

ones, which modify the structure of DNA in a way which is not sequence-specific and thus enables the binding of other regulatory factors.

Not all ABA-responsive genes possess a G-box containing ABRE. They are activated by products of other genes, the synthesis of which is induced by ABA (Fig. 1.5.7). The gene *Rd22*, expressed in drought-stressed *Arabidopsis* plants, probably coding for a protective protein, reacts to ABA but does not possess an ABA-responsive element in its promoter. This promoter possesses motifs known to bind frequently occurring transcription factors, e.g. homologues of the human gene activators MYC and MYB (Hiroshi et al. 1997). The bZIP proteins mentioned above belong also to that group of transcription factors. In this case, they react with motifs similar to the G-box in the promoter. This mode of ABA-mediated induction of genes whose promoters do not contain an ABRE is apparent in drought but has been shown also for salt and cold stress and, of course, after application of ABA.

1.5.2.3

ABA-Independent Gene Activation by Drought

Besides gene expression mediated by ABA, there are several examples in which drought alone or together with salt or cold stress lead to activation of a promoter without participation of ABA. The best-investigated gene of this type is *Rd29A*, which is activated in all vegetative tissues of *Arabidopsis* upon desiccation and probably codes for a thiolprotease. Such ABA-independent genes contain also a consensus sequence in the promoter (TACC-GACAT), the so-called **dehydration responsive element (DRE)** or **C-repeat** (Yamaguchi-Shinozaki and Shinozaki 1994). It is assumed from the frequent occurrence of this motif that specific DNA-binding proteins (DRE-binding proteins) exist. It could be shown that the *Rd29A* promoter contains a DRE as well as an ABRE. However, the ABRE is only activated during prolonged drought stress. The DRE was also found in promoters of genes activated by cold, the so-called COR genes (cold response), but then was ultimately controlled by ABA via a further cascade.

Figure 1.5.7 presents an overview of the pathways leading to gene expression induced by drought.

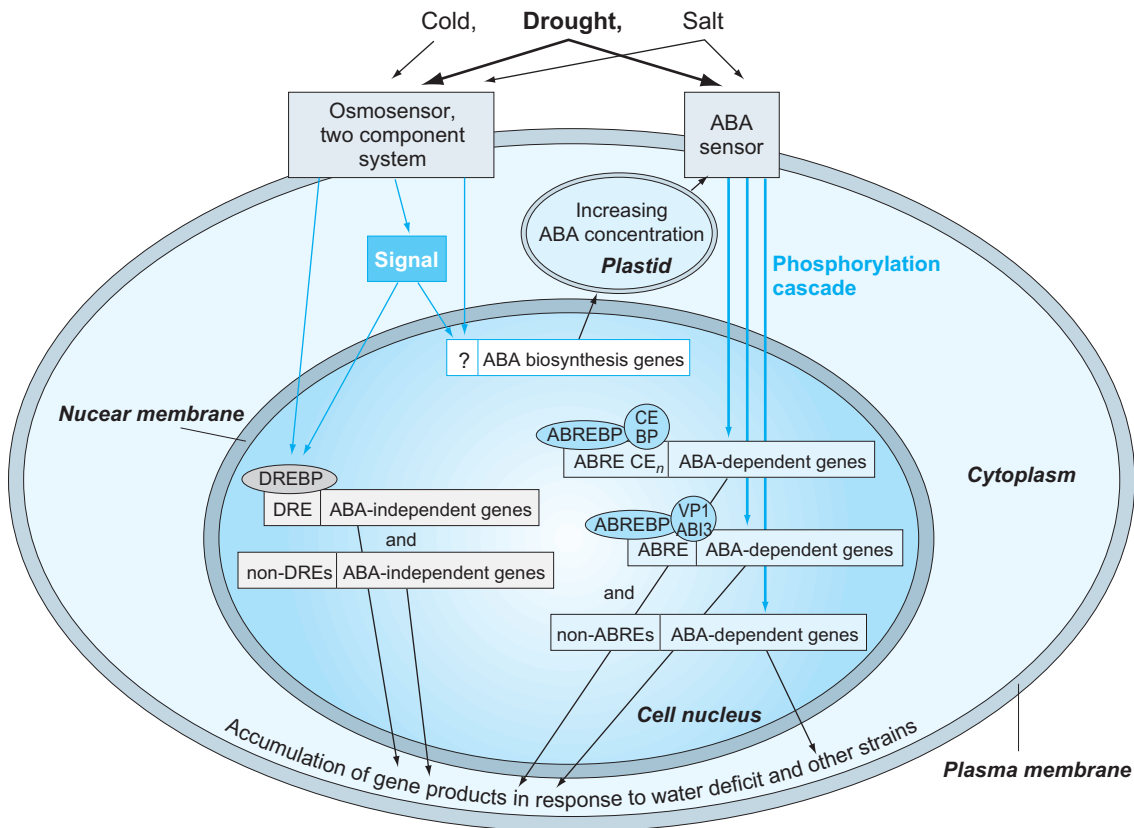


Fig. 1.5.7. Multiple pathways which lead to induction of gene expression upon stress by desiccation. *DRE* Dehydration responsive element; *DREBP* DRE-binding protein; *ABRE* abscisic acid binding element; *ABREBP* ABRE-binding protein; *CE* coupling element; *CEBP* protein binding to CE; *VP1/ABI3* sequentially akin proteins which regulate a MYB-related transcription factor. (After Bray 1997)

1.5.2.4 Signal Transduction

There is very little information on transduction cascades, from the various drought signals to the promoters of genes. It is well established that Ca^{2+} and inositol 1,4,5-trisphosphate, liberated from the membrane lipid phosphatidylinositol by phospholipase C, act as secondary messengers, giving rise to protein phosphorylation and dephosphorylation at the next lower level of the signal transduction cascade. In some cases, the participation of MAP kinases (mitogen-activated protein kinases) has been shown (Neill and Burnett 1999). It should also be noted that there are internal receptors for ABA in the cell (see Sect. 1.5.2.2) and that an interaction of various signals, a so-called signal cross talk with signals like gibberellins, requires further biochemical mechanisms (Shinozaki and Yamaguchi-Shinozaki 1997).

1.5.2.5 Function of Proteins Induced by Dehydration Stress

As mentioned above, water deficit induces proteins, some of which increase the stress tolerance of cells more or less directly (functional proteins), and others which are part of a signal transduction chain (regulatory proteins; see Fig. 1.5.5), leading finally to the synthesis of functional proteins.

Functional proteins are mainly aquaporins, or enzymes which catalyse the biosynthesis of **osmolytes** (compatible solutes, e.g. various carbohydrates, amino acids and betaines), also proteases for the degradation of damaged proteins (ubiquitin, thiolproteases) and ROS-detoxifying enzymes², such as catalase, SOD, ascorbate peroxi-

² During drought, stomata close (see Chap. 2.2, Fig. 2.2.19), resulting in CO_2 shortage if the light intensity is high. This leads to the formation of ROS and radicals.

dase, glutathione-S-transferase, etc. Overexpression of these genes or of gene constructs, in which the corresponding proteins are directed by specific signal peptides into sensitive cell compartments, leads to increased drought tolerance and to a stabilisation of metabolic processes, such as photosynthesis (this will be discussed in greater detail in [Chap. 1.6.2](#), salinity stress).

A special group of protective proteins are **dehydrins**, **LEA** or **Rab proteins**, which occur in all plants (Campbell and Close 1997); apparently, they do not possess any enzymatic activity, but are very effective in protecting the cellular membranes and proteins with quaternary structures (Close 1996). Unfortunately, the nomenclature of these protective proteins is not yet conclusive³.

These protective proteins occur regularly during desiccation of the embryo and the endosperm when seeds ripen. Discovered in 1981, they were therefore called **late embryogenesis abundant (LEA) proteins**. They belong to the group of drought-induced proteins, the promoters of which contain one or several ABREs, and thus can be directly induced by ABA. Therefore, they have also been termed **Rab (responsive to ABA) proteins**. Most of them occur not only during seed ripening, but form and accumulate also during dry periods and upon osmotic stress in all plant organs. Being of particular importance for poikilohydric plants, they are also known as **dehydrins**. According to their structural characteristics (consensus sequences) and the high proportion of certain, usually hydrophilic, amino acids, LEA proteins were classified into 18 families, representatives of four of which are widely distributed.

Most of the known LEA proteins have not yet been isolated as proteins but are only known as genes or as mRNAs, which become prominent during drought. They are all nuclear coded and occur mainly in the cytoplasm, but also in the nucleus. Most strikingly, they cannot be denatured by boiling or acid treatment, probably because they do not have a globular structure, but rather form **random coils** or **amphiphilic α -helices**. Such helices carry on one lateral side hydrophobic, on the other side, hydrophilic functional groups ([Fig. 1.5.8](#)). Random coil proteins contain significantly more water than helical proteins. The size of the LEA proteins, however, is very variable, ranging from 15 to almost 200 kDa.

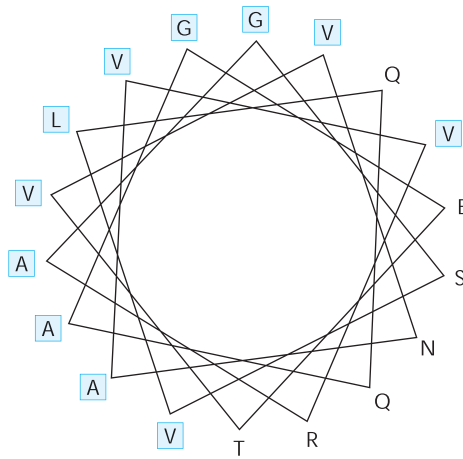


Fig. 1.5.8. Representation of a LEA protein as a helical wheel. Hydrophobic amino acid residues are highlighted by boxes, thus illustrating the amphiphilic character of the helix. Amino acids are represented by the *single letter code*. (After Curry and Walker-Simmons 1993)

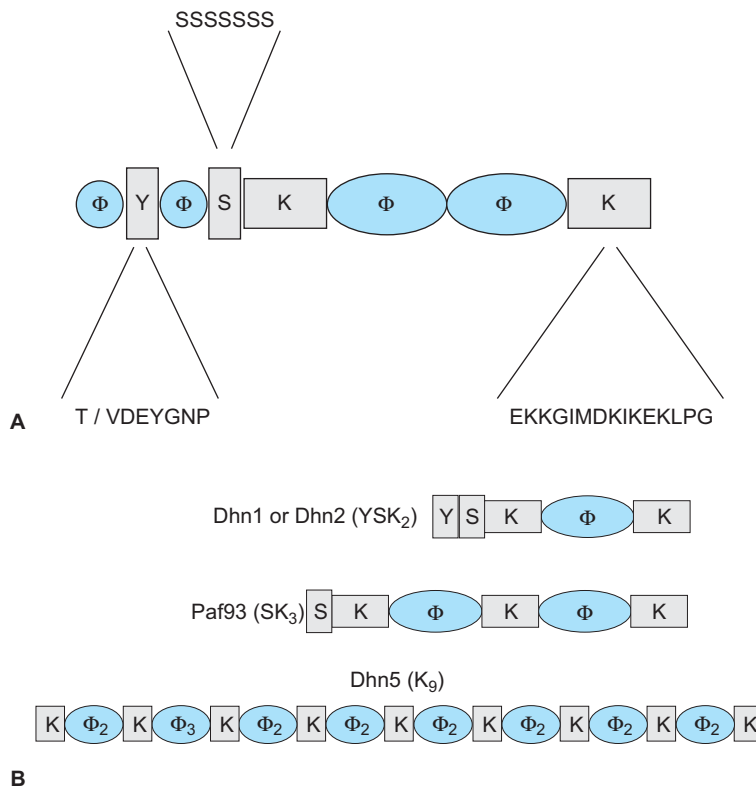
Individual families of these proteins will not be discussed here in detail, only dehydrins as prominent representatives shall be described, as there are about 80 currently known types belonging to the LEA-D11 family. Of this family, a further 200 or so species are known from partial gene sequences or cDNAs. In some plant species, they are constitutively expressed, but always accumulate under dehydration, forming then between 0.1 and 5% of the total soluble protein or of the total mRNA. These proteins contain between 82 and 575 amino acids, and are modularly structured with many repeats. The 15 amino acids comprising **K(rich)segment** (EKK-GIMDKIKEKLPG, the antigenic component of dehydrins) is highly conserved in cyanobacteria, lower and higher plants, and often occurs in several copies. There is also the **S(rich)segment** containing up to seven serine residues which can be phosphorylated. The **Y(rich)segment** (T/VDEYGNP) is commonly at the N-terminus of many dehydrins in one or several copies. These modules are interconnected by less conserved segments, the so-called **Φ -segments**. The amino acids cysteine and tryptophan are completely missing, which could explain the stability of these proteins against denaturing treatment and chemicals. The YSK₂ dehydrin from maize seeds is given as an example of the modular structure of dehydrins ([Box 1.5.4](#)).

Many dehydrins contain a bipartite nuclear localisation sequence, suggesting a protective role of these proteins in the cell nucleus. They

³ One of these proteins is also known under the name of osmotin (see [Chap. 1.6.2.3](#)).

Box 1.5.4

Typical structure of dehydrins



The YSK₂-dehydrin from maize seeds shows the typical structure of a dehydrin with Y- and K-consensus sequences (A). The number of serine residues in the S-segment is variable. Φ indicates less conserved sequences,

which may be repetitive in individual dehydrins (after Close 1997). B shows dehydrins from barley with different combinations of the conserved motifs: YSK₂, SK₃, and K₉ (after Campbell and Close 1997).

can accumulate in “protein bodies”, but also can stabilise cellular membranes by preventing the disintegration of the bilayer into lipid droplets (hexagonal structure of lipids; see Fig. 1.3.16) upon attenuation of the stabilising water film. The hydrophobic stretches of the amphiphilic α -helices interact with the surface of the membranes, whilst the hydrophilic parts are oriented towards the cytoplasm (see Fig. 1.3.24). Preventing the formation of globular lipid structures, they have been called “reversible chaperones”. Protection of membranes with dehydrins hinders the accumulation of low-molecular ions at the membrane surface upon withdrawal of cellular water which would result in a change of the membrane potential of that membrane. Dehydrins are very suitable for genetic transforma-

Table 1.5.1. Growth of rice plants, transformed with the *HVA1* gene from barley under drought stress. The plants were exposed to several cycles, each consisting of 5 days of drought and 2 days of recovery. Leaf growth was measured before, and 3 days after, the onset of drought. Leaf growth rates of the two youngest leaves were measured. The height of the plants was measured after four stress cycles and an additional 2 days of recovery (Xu et al. 1996)

Line	Leaf growth rate (%)	Height of plant (cm)	Root fresh weight (g)
Wild type	69	22 ± 1.4	0.9 ± 0.1
Line 30	90	29 ± 1.1	1.4 ± 0.1
Line 36	129	37 ± 1.8	2.1 ± 0.1
Line 41	113	33 ± 1.8	2.3 ± 0.3

tion in drought-sensitive plants. For example, the *HVA1* gene from barley (*Hordeum vulgare*) was successfully transferred to rice; transgenic rice plants were considerably more tolerant to drought and salt (Table 1.5.1; Xu et al. 1996).

1.5.2.6 Accumulation of Osmolytes (Compatible Solutes) During Drought

In addition to desiccation-induced synthesis and accumulation of dehydrins, protection of cells and tissue by low molecular (mass) solutes is also very important. Formation of enzymes which catalyse the synthesis of such protective substances (**compatible solutes**) is also directly

or indirectly induced by ABA (see Fig. 1.5.5). The protective action of compatible solutes on stressed cells is attributed to two effects:

1. Increase in the osmotic potential counteracts the osmotic dehydration of the cells. Compatible solutes, therefore, are also called **osmolytes**. They can achieve considerable concentrations, often 5–10% of the dry weight. Upon extreme water loss, e.g. during the drying of poikilohydric plants, solutions of sugars such as sucrose adopt a glassy almost solid state, which effectively prevents the disintegration of biomembranes into lipid droplets (the so-called hexagonal-II phase, see Fig. 1.3.16). However, only solutions of such carbohydrates which do not readily crystallise can achieve this state.

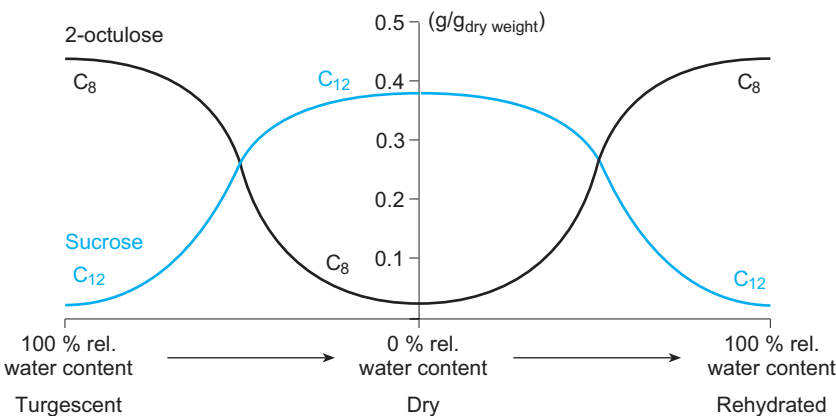


Fig. 1.5.9. Changes in the proportions of soluble carbohydrates in correspondence with the water relations of the resurrection plant *Craterostigma plantaginea*. In the fully hydrated state, leaves mainly contain the C₈ sugar octulose, which upon desiccation is almost quantitatively converted to sucrose, a compatible solute. This reaction is reversible. (After Bartels et al. 1993)

Table 1.5.2. Accumulation of metabolic products in organs of terrestrial plants under drought stress and their physiological effects

Type of compound	Compounds	Function upon drought	Cross-protection
Ions	Potassium	Osmotic balance, acquisition of macronutrients, sodium exclusion and export	Salt
Proteins	LEA/dehydrins, osmotin, SOD/catalases	Membrane and protein protection, pathogen-related proteins, detoxification of radicals	Frost, defense against pathogens
Amino acids	Proline, ectoin	Osmotic balance, membrane and protein protection	Frost
Sugars	Sucrose, fructans	Osmotic balance, membrane and protein protection, storage of carbohydrates	Frost
Polyols	Acyclic (e.g. mannitol), cyclic (e.g. pinitol)	Osmotic balance, membrane protection, storage of carbohydrates, radical scavengers	Frost, salt
Polyamines	Spermine, spermidine	Ion balance, protection of chromatin	Anaerobiosis
Quaternary amines	Glycinebetaine, β-alaninebetaine	Membrane protection	Frost, salt
Tertiary sulfonium compounds	Dimethyl sulfoniopropionate	Membrane protection	Frost, salt
Pigments and carotenoids	Carotenoids, anthocyanins and betalains	Protection against excess light and photoinhibition	

2. Because of their increased concentration and high water solubility, compatible solutes compete with other dissolved materials, particularly with ions of high charge density, displacing them from the surfaces of biomembranes and proteins. Owing to their hydrophilic characteristics, they are able to become a constituent part of the structured portion of the water film on the membrane surface. Carbohydrates which provide only relatively weak protection may become reversibly converted into more effective ones, such as sucrose during drought stress (Fig. 1.5.9).

Besides carbohydrates and their derivatives (sugar alcohols, cyclitols) in drought stress, quaternary ammonium bases (so-called betaines) and tertiary sulfonic acids (Fig. 1.5.10), amino acids (mostly proline, Box 1.5.5) and polyamines may accumulate as protective osmolytes (Fig. 1.5.11). In Table 1.5.2 such osmolytes are listed and characterised.

Besides dehydrins, enzymes which catalyse the biosynthesis of compatible solutes are also suitable targets for genetic transformation, in order to produce crop plants that are less sensitive to drought stress (Fig. 1.5.12).

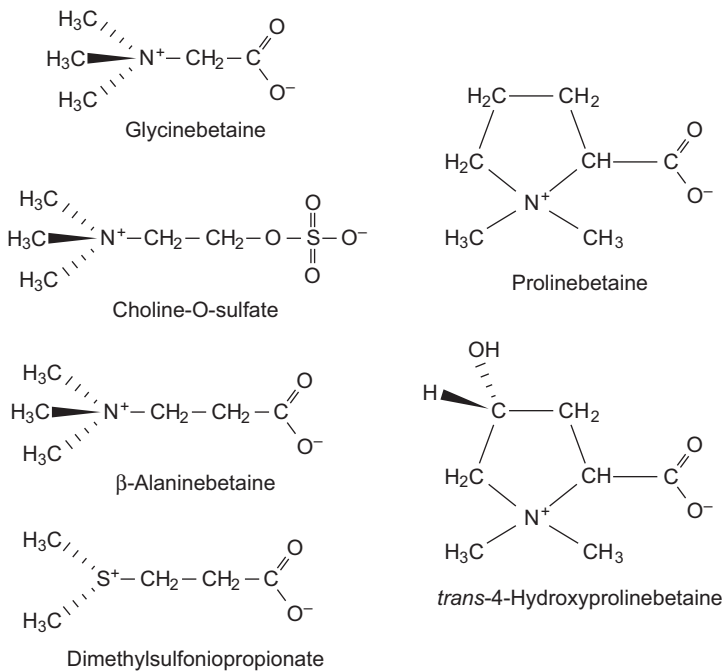


Fig. 1.5.10. Some quaternary amino compounds and tertiary sulfonium compounds which have been identified as compatible solutes in plants. The amphiphilic group (CH₃)₃-N⁺...O⁻ renders these compounds their membrane-protective capacity. (Hanson 1993)

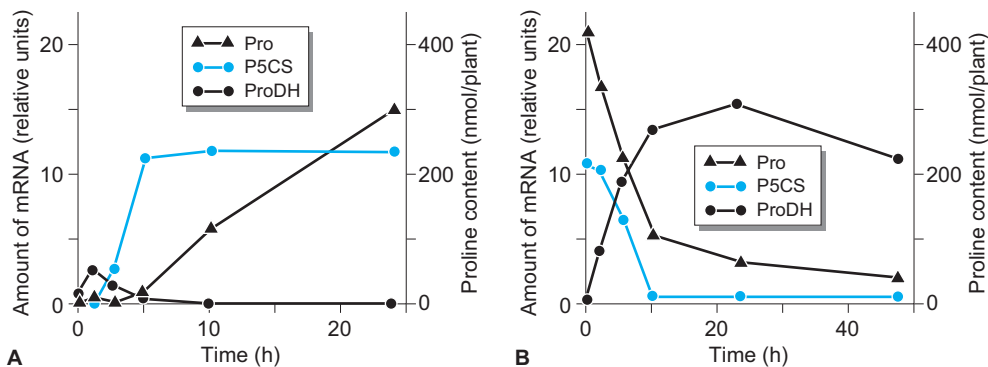
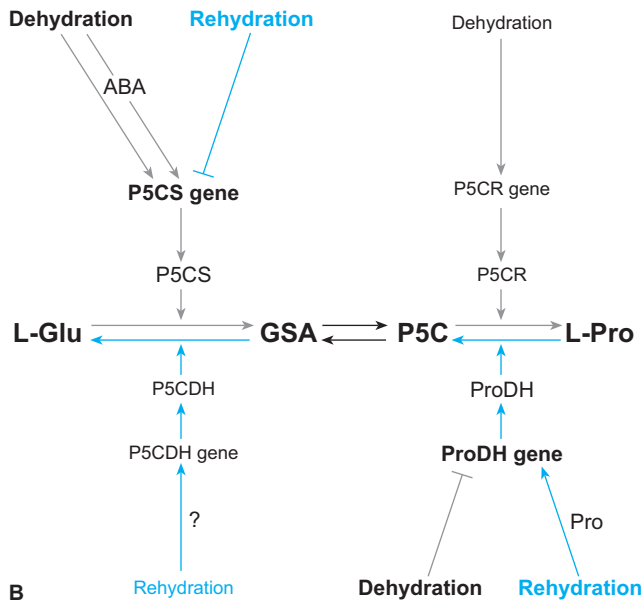
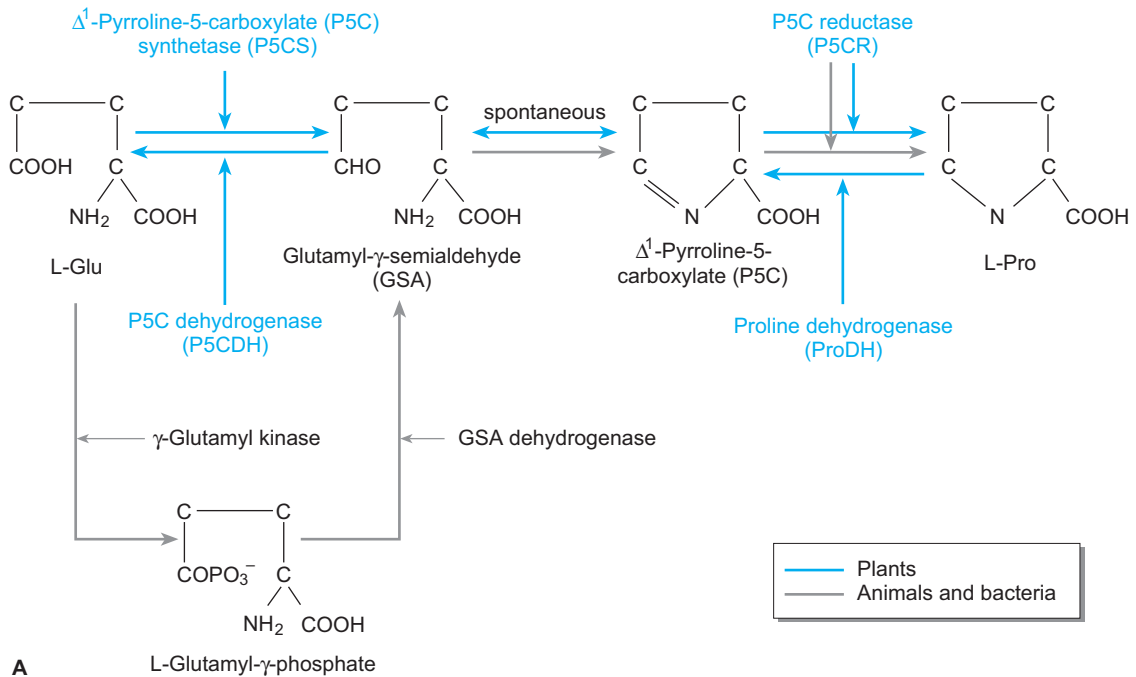


Fig. 1.5.11. Time course of accumulation and decrease in proline (Pro), the mRNAs for Δ^1 -pyrroline-5-carboxylate synthase (P5CS), and for proline dehydrogenase (proline oxidase, ProDH) in *Arabidopsis* during the development of drought (A), and 10 h after rehydration (B). (After Yoshiba et al. 1997)

Box 1.5.5 Proline metabolism



B shows the regulation of proline synthesis under drought stress and subsequent rehydration. In the unstressed plant, proline synthesis and degradation are in balance and the cellular proline concentration is very low. The rise in the proline level occurs by activation of the gene for Δ^1 -pyrroline-5-carboxylate synthetase and concomitant inhibition of expression of the proline dehydrogenase (proline oxidase) gene. Activation of P5CS gene expression takes place dependently as well as independently of ABA. In the well-watered status, expression of this gene is extremely low. Upon rehydration proline dehydrogenase is activated by the high concentration of proline that accumulated during the period of drought. In contrast, the second gene involved in proline synthesis, the P5CR gene, is neither significantly influenced by drought nor by ABA (after Yoshiba et al. 1997).

A shows a comparison of biosynthesis and metabolism of L-proline in plants and in bacteria. In green plants, the main precursor of proline is L-glutamic acid. However, when subjected to osmotic stress and N limitation, ornithine can be the precursor. The initial enzyme in proline metabolism is proline dehydrogenase, often also called proline oxidase (after Yoshiba et al. 1997).

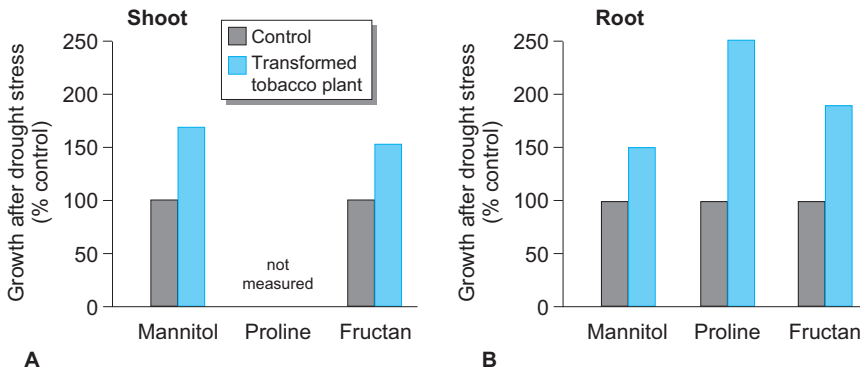


Fig. 1.5.12. Accumulation of osmolytes in genetically modified tobacco plants under drought stress. The gene for mannitol-1-phosphate dehydrogenase (from *E. coli*) or P5CS (from *Vigna aconitifolia*) or levan-sucrase (from *Bacillus subtilis*) was transferred into tobacco using *Agrobacterium tumefaciens*. All three metabolites accumulate in the transformed plants in comparison to the controls, and there was a significant increase in growth of the transgenic plants compared with the controls under drought, and in the case of P5CS also upon salt stress. (After Bray 1997)

1.5.3

CAM (Crassulacean Acid Metabolism)

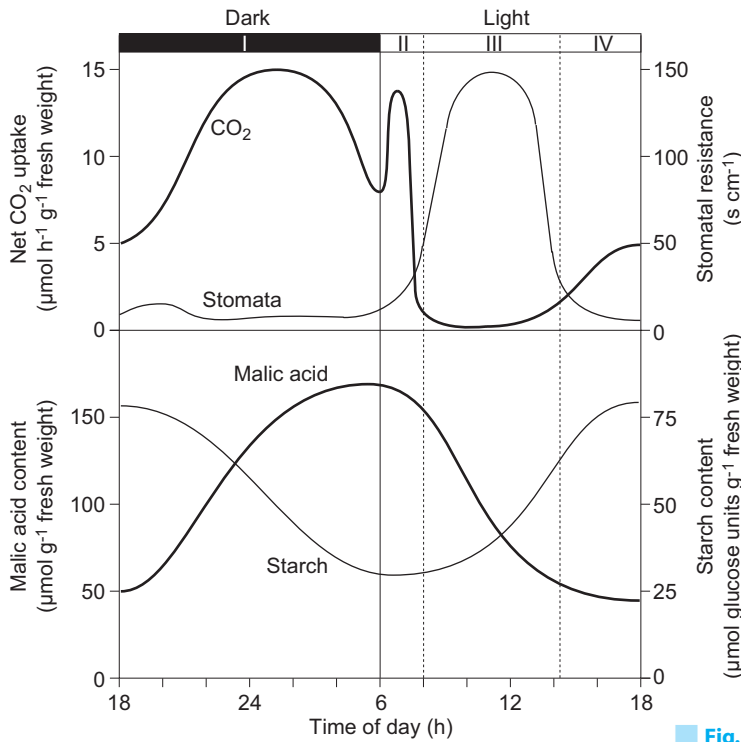
Recommended Literature

- Cushman JC, Bohnert HJ (1999) Crassulacean acid metabolism: molecular genetics. *Annu Rev Plant Physiol Plant Mol Biol* 50:305–332
- Griffith H (1989) Carbon dioxide concentrating mechanisms and the evolution of CAM in vascular epiphytes. In: Lüttge U (ed) *Vascular plants as epiphytes. Evolution and ecophysiology. Ecological studies* 76. Springer, Berlin Heidelberg New York
- Lüttge U (1993) The role of crassulacean acid metabolism (CAM) in the adaptation of plants to salinity. *New Phytol* 125:59–71

A particular type of metabolic response to drought is the so-called **crassulacean acid metabolism (CAM)**, which is also addressed in Chapter 2.4.1.2 (Fig. 2.4.3). Plants growing in dry and hot regions (where transpiration often greatly exceeds water loss) with this type of metabolism avoid “dying of thirst” and “dying of hunger” (due to limitation of photosynthetic CO₂ uptake by closed stomata) by opening their stomata only at night, when the humidity deficit of air due to low temperatures is fairly small. In this case, CO₂ is taken up in the dark and, catalysed by **PEP carboxylase**, bound to phosphoenolpyruvate (PEP). The resulting oxaloacetic acid is converted into malic acid by **NAD-dependent malate dehydrogenase** in the cytosol. Malic acid

is then stored in large amounts in the vacuoles (acidification up to pH 3), which can easily be tasted! During the day, malate is released from the vacuole (de-acidification) and converted, in the chloroplast, by the **NADP-dependent malic enzyme** into CO₂, reduction equivalents (NADPH) and pyruvate. CO₂ is assimilated in the reductive photosynthetic carbon cycle (Calvin cycle). Pyruvate may be metabolised in different ways: direct respiration (in the mitochondria) as well as phosphorylation to PEP by **pyruvate P_i dikinase** in the chloroplast are discussed. Phosphoenolpyruvate may leave the chloroplast via a specific **PEP translocator** and contribute to glycolytic or gluconeogenic carbon flow. The product of photosynthesis, starch, is stored in the chloroplast and used for PEP formation during the night.

As CAM plants are able to fix only as much CO₂ by PEP carboxylation as PEP is supplied, those only relying on the CAM cycle would not be able to grow. In the extreme, CAM is thus a mechanism for survival but does not allow growth. With sporadic precipitation, and in the early morning hours and perhaps also in late afternoon, stomata usually open or are at least not fully closed, so that direct net photosynthesis and growth are possible. Gas exchange, content of malic acid and starch, as elements of photosynthesis, are shown for the course of a day in Fig. 1.5.13.



A

Fig. 1.5.13. Typical gas-exchange curve (CO_2 uptake rate and stomatal resistance= $\text{stomatal conductance}^{-1}$) of a CAM plant. The changes in concentration of the typical metabolites starch and malate are also presented. Gas exchange shows the phases *I* nocturnal CO_2 fixation; *II* dawn with the start of CO_2 fixation by Rubisco; *III* assimilation of the internally released CO_2 by Rubisco with stomates closed; *IV* stomates begin to open after the internal CO_2 has been depleted and daytime temperatures are dropping. In **B**, the time courses of the different reactions are shown in different shades of blue. A from Lüttge et al. (1994); B from Cushman and Bohnert (1999)

Phase	I	II	III	IV
Net CO_2 fixation	From the atmosphere	(From respiration)		
Malic acid accumulation	Vacuolar influx	Vacuolar efflux		
Storage glucan	Glycolysis	Gluconeogenesis		
PEPC	Active	Inactive		
PEPC kinase	Active	Inactive		
Rubisco	Inactive		Active	
ME/PEPCK	Inactive		Active	
Stomata	Open		Closed	
Photoperiod	Dark		Light	

B

1.5.3.1 Flexibility of CAM

CAM plants are superior to other photosynthetic types in their **water use efficiency (WUE)**, but their photosynthetic rates and growth rates are much lower (Table 1.5.3).

During long periods of drought, stomata remain continuously closed, even at night; fixation and assimilation of CO_2 are limited to carbon dioxide generated internally in the plant tissue by respiratory processes. This state is called **CAM idling** (Fig. 1.5.14). The photosynthetic assimilation of internal CO_2 provides some protection from photooxidation. However, the low in-

ternal CO_2 content, at the usually extremely high radiation, is not sufficient to allow a substantial flow of electrons and full relief of the photosystems. Consequently, radicals are formed and oxidative stress occurs. Therefore, CAM idling is of only limited use, as it can only be sustained for a relatively short time, and because even with closed stomata water is lost by cuticular transpiration.

Many bromeliads show diurnal CAM metabolism, even though their stomata are not – or are only partially – closed during the day when they perform “normal” C_3 photosynthesis. This is called **CAM cycling**. An extreme example of CAM cycling occurs in the usually submerged

Table 1.5.3. Water use efficiency, photosynthesis and biomass production of C₃, C₄ and CAM plants. (After Lüttge et al. 1994)

Type of photosynthesis	C ₃	C ₄	CAM
Water use efficiency (g water/g C)	450–950	250–350	18–100 (nighttime); 150–600 (daytime)
Maximum rate of net photosynthesis ($\mu\text{mol CO}_2 \text{ m}^{-2} \text{ s}^{-1}$)	9–25	25–50	0.6–8
Growth (g biomass $\text{m}^{-2} \text{ day}^{-1}$)	50–200	400–500	1.5–1.8

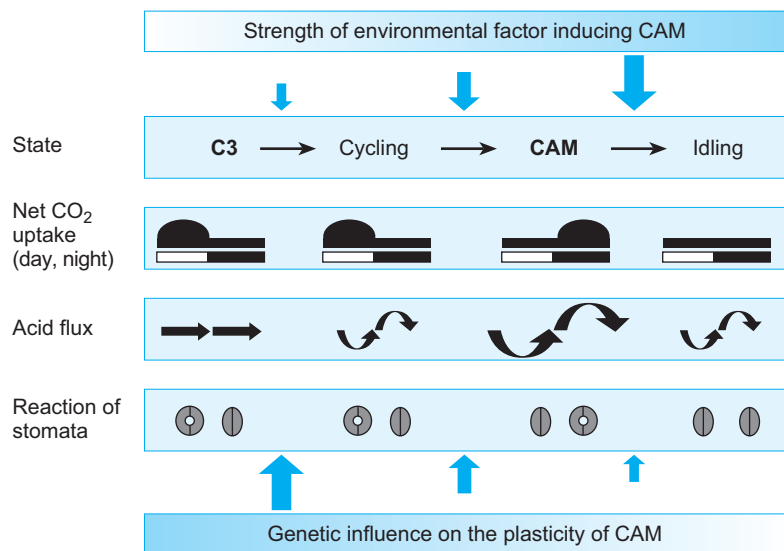


Fig. 1.5.14. Plasticity of CAM in facultative CAM plants. (After Cushman and Bohnert 1999)

water plant *Isoetes (howellii)*. The epidermis of this plant has, of course, no stomates and the plant does not experience water stress (Keely 1998); the reason for the CO₂ fixation during the night is assumed to be lack of CO₂ in the usually acidic waters where *Isoëtis* grows.

Many CAM plants, particularly those from the families of Crassulaceae and Aizoaceae, are C₃ plants with a facultative, i.e. inducible, CAM. Perennial facultative CAM plants are able to switch between the two modes of photosynthesis many times during their life: C₃ photosynthesis – CAM – CAM idling – C₃ photosynthesis, ...

Drought or high salinity, and in some cases also day length (short day in *Kalanchoë*, *Aloe* and *Opuntia*), can also induce CAM. In some species, dependence of CAM induction on the age of the individual plant has been described: This holds for agaves or cacti, whose saplings cannot produce vacuoles that are large enough for the storage of sufficient malic acid, as do the adult individuals (Fig. 1.5.15).

CAM induction need not occur in all photosynthesising organs of a plant. The succulent stem of *Frerea indica* (an asclepiad) performs

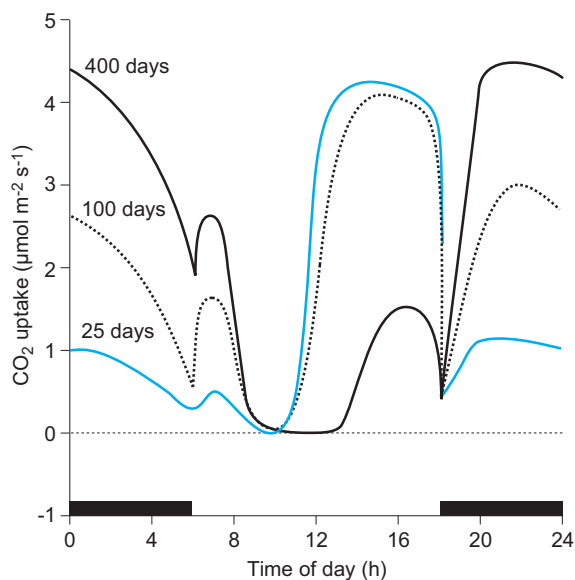


Fig. 1.5.15. Daily net CO₂ uptake by seedlings and plantlets of *Agave deserti* in its first 13 months. The seedlings were 25 days old and 14 mm in height; at 100 days their average height was 31 mm, and 400-day-old plantlets were 63 mm in height. The four phases of diurnal CO₂ uptake typical of CAM plants were only clearly visible after 1 year of growth, despite the fact that the young plants are capable of CO₂ fixation at night. (After Nobel 1988; Larcher 1994)

CAM, whilst the green leaves at least in rainy periods photosynthesise by the C3 mode; in tropical *Clusia* species, with opposite leaves at a node, one leaf may perform C3 photosynthesis, whilst the opposite leaf uses CAM (Lüttge 1987). This ecophysiological plasticity allows the C3-CAM intermediates optimal adaptation of their photosynthetic capacity to the prevailing conditions, making effective use of the humid season or of sporadic precipitation.

Whether a facultative CAM plant, or a part of the plant, follows C3 photosynthesis or CAM photosynthesis can be realised using the $\delta^{13}\text{C}$ value. Carbon dioxide in the air consists of 98.89% of the ^{12}C isotope and 1.11% of ^{13}C . The content of the radioactive isotope ^{14}C is, compared with those values, negligible ($10^{-10}\%$). Rubisco consumes CO_2 as substrate and discriminates more strongly between ^{12}C and ^{13}C than does PEP carboxylase (PEPC), which uses HCO_3^- instead of CO_2 . Carbon assimilated only by Rubisco thus contains less ^{13}C than that fixed first by PEPC. The change of ^{13}C in the biomass, therefore, allows the realisation of the mode of CO_2 . The ratio of $^{13}\text{C}:^{12}\text{C}$ is determined by mass spectrometry and calculated with the following formula:

$$\delta^{13}\text{C}[\text{‰}] = \left(\frac{^{13}\text{C}/^{12}\text{C} \text{ of sample}}{^{13}\text{C}/^{12}\text{C} \text{ of standard}} - 1 \right) \times 1000$$

The standard is a defined limestone.

$\delta^{13}\text{C}$ values of C3 plants are around -28% , those of C4 plants at -14% , and for CAM plants with predominantly nocturnal CO_2 fixation between -10 and -20% , and for daytime CO_2 fixation between -25 and -34% .

1.5.3.2

CAM Causes Problems in Biochemical Regulation

Various instructive reaction schemes were developed to show the biochemistry of CAM (see Lüttge et al. 1994; Heldt 1997) and therefore need not be presented here.

The understanding of CAM as PEPC-mediated dark fixation of carbon dioxide, more exactly of HCO_3^- , the transient storage in the form of malic acid in the vacuole and the release by the malic enzyme for the final assimilation by Rubisco, assumes a complicated network of regulatory characteristics and processes.

Two of these metabolic processes will be discussed in more detail, namely the storage of malic acid in the vacuole and the competition for CO_2 between PEPC and Rubisco.

Storage of Malic Acid in Vacuoles

The tonoplast is the membrane that solves the problem of regulating transitory malic acid storage in the vacuole: During dark fixation of carbon dioxide, malic acid must be imported against the concentration gradient into the vacuole (and be retained there), but, during daytime, flow (probably even controlled) in the opposite direction must be enabled. The import of malic acid is well understood, but export still poses certain unsolved questions. A pH value of 7 (to perhaps 8) is assumed in the cytosol; at those values malic acid is dissociated as the pH value of both carboxyl groups is in the acidic range (C1: at pH 3.1; C4: at pH 5.1). Import of divalent malate ions into the vacuole would soon come to an end and can only be maintained if the negative charges are balanced by positive charges. This is achieved through the **proton-ATPase of the tonoplast (V-ATPase)**, which is supplied with energy from glycolysis together with a **pyrophosphate-dependent proton pump**. Uptake of the divalent malate ion into the vacuole takes place via **dicarboxylate channels** which transport malate as well as fumarate. Because of the acidification of the vacuole (to pH 3.5–3.0) malate becomes increasingly protonated and finally only malic acid is present. This is also important for osmotic reasons, because three osmotically active solutes ($2 \times \text{H}^+$ and malate) unify. Little is known about the efflux of malic acid from the vacuole. The undissociated acid could permeate the tonoplast via the “lipid path” (see Sect. 1.5.1). Some results also suggest a carrier in the tonoplast which catalyses a malate/ 2H^+ symport. However, why this carrier is not active during dark fixation has not yet been elucidated. It is interesting that a decrease in temperature during the night is an absolute requirement for acidification: During warm nights, there is no accumulation of malic acid in vacuoles (Lüttge et al. 1996).

The CAM-PEP Carboxylase as Pacemaker Enzyme

PEPC is a cytosolic enzyme which binds bicarbonate to PEP in an irreversible reaction:

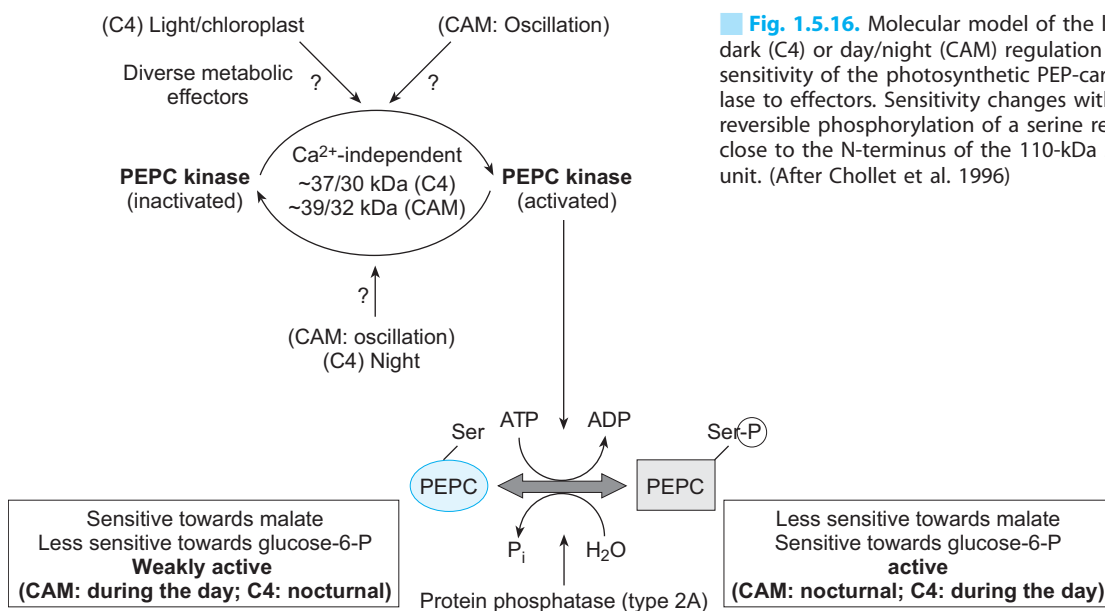
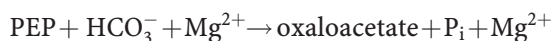


Fig. 1.5.16. Molecular model of the light/dark (C4) or day/night (CAM) regulation of the sensitivity of the photosynthetic PEP-carboxylase to effectors. Sensitivity changes with the reversible phosphorylation of a serine residue close to the N-terminus of the 110-kDa subunit. (After Chollet et al. 1996)



In the reaction, the energy-rich phosphate group of PEP is transferred to the bicarbonate ion forming carboxyphosphate as an intermediate.

The final product of the reaction, oxaloacetate, is an unstable β -keto acid and is reduced by NAD malate dehydrogenase to the stable malate. The NADH originates from glycolysis.

Since PEPC does not react with CO_2 but with HCO_3^- , the carboxylation of PEP is insensitive to O_2 , in contrast to the carboxylation of RuBP by Rubisco.

PEPC is an extensively analysed plant enzyme because of its function as the pacemaker enzyme of CAM. Differences in the reported kinetic parameters (Michaelis constant, v_{max}) are not because of the different sources of the enzyme but are due, most of all, to differences in the isolated protein; often a protein was isolated which had been partially truncated by proteolysis. Furthermore, the enzyme also reversibly forms dimers or tetramers, which originally was regarded as allosteric regulation of the mechanism. The activity of the enzyme is allosterically influenced by effectors. Glucose-6-phosphate and triose-phosphate stimulate activity, whilst malate and aspartate have a strong inhibitory effect, particularly at a slightly alkaline (cytosolic) pH. The regulation of the CAM-PEPC has been shown to take place via the reversible phosphorylation of

a serine residue of the 110-kDa subunit (e.g. Ser 8 for millet, Ser 15 for maize) near the N-terminus. Phosphorylation at this single site renders the enzyme insensitive to malate; even in the presence of this allosteric inhibitor it remains in the active form, in particular as it now reacts more sensitively to the positive effectors mentioned above. The phosphorylation of CAM-PEPC occurs through a strongly regulated **protein kinase**, dephosphorylation (and inactivation) by a **protein phosphatase** of the type 2A. This phosphatase does not show any fluctuations in activity, in contrast to the kinase. The activity of the protein kinase is controlled diurnally, which, in contrast to the C4-PEPC, does not react to a change from dark to light (Fig. 1.5.16).

The question why CAM-PEPC does not compete during the day for CO_2 released by malic enzyme (in the chloroplast) can be answered by the consideration that the dephosphorylated enzyme is inhibited by malate. In addition to the post-translational regulation of activity by phosphorylation and dephosphorylation, there is another regulation through gene expression, which was observed during the induction of CAM in *C3/CAM* intermediates. The genome of *Mesembryanthemum crystallinum*, for example, contains two genes for PEPC, *Ppc1* and *Ppc2*. Regulation of expression is induced by drought, ABA and high salinity, where certain transcription factors recognise AT-rich regions in the promoter.

The problems of transitory malic acid storage in the vacuole and the diurnal oscillations of CAM-PEPC activity have been discussed here in more detail, but CAM also shows other peculiarities which are only partly understood, e.g. the question of what happens to the pyruvate formed during the release of CO₂ in the chloroplast. Some scientists assume it is used in regeneration of PEP catalysed by pyruvate P_i dikinase, analogous to the C4 pathway of photosynthesis, whilst others believe that respiration in the mitochondria is more probable. A further unsolved question is the opening of the stomates during the dark period, as stomata usually close in the dark (blue light is the effective component of the white light for the opening of stomata, see Fig. 2.2.15).

1.5.4

Anatomical and Morphological Adaptation to Drought

Besides physiological adaptations to drought, there are several anatomical and morphological responses of plants to this stressor: enlargement of root systems, improvement of hydraulic conductance and water transport systems, reduction of transpiring surfaces, increase in the stomatal density, production of a hairy tomentum, apoptosis of assimilation organs (shedding of leaves at the beginning of dry periods), and many more (see Chap. 2.2). All these changes are, of course, based on physiological processes; these and their regulatory mechanisms are still, to a large extent, poorly understood.

Summary

1. Life requires liquid water and is thus based on its particular physico-chemical properties which result from the dipole nature of the water molecule (the so-called anomalies of water).
2. The water potential, ψ , is a measure of the thermodynamic state of water in any system and is given in the dimension of pressure. The components are the osmotic potential of the cellular liquids, π , the water potential of the solid cell components (e.g. the cell wall), the so-called matrix potential, τ , and the pres-

sure potential, i.e. the pressure of the cell wall on the protoplast which is numerically equal to the turgor pressure, i.e. the pressure of the protoplast on the cell wall.

$$(-)\psi = (-)\pi + (-)\tau + P$$

3. A water potential gradient between two systems (e.g. plant–air or plant–soil) causes water flow from the system with the lower (numerically less negative) water potential to that with the higher (numerically more negative) water potential. This is the reason for water loss from plants to the atmosphere. As a consequence of large water loss the protoplasts of the plant cells shrink concomitantly with a decrease of the wall pressure (which completely disappears at the turgor loss point or may even convert to a suction) and the plant wilts. During prolonged drought, so much water may be lost by transpiration that cellular membranes disintegrate, as can happen upon the loss of water by freezing dehydration.
4. The capacity of the “lipid path”, i.e. the permeation of water through the lipid bilayer of the biomembrane, is not sufficiently high for a fast equilibration of water potential gradients in a cell. In these membranes, special integral proteins, so-called aquaporins, give rise to the high permeability of most biomembranes for water. The highest hydraulic conductivity of cellular membranes is usually with the tonoplast.
5. Desiccation is a natural phenomenon in the life cycle of a plant, for example, during seed ripening. Therefore, plants must have the capability to react in a manifold way to this stress. One reaction sequence is triggered by the phytohormone abscisic acid (ABA), but at least one other is ABA-independent. In these reaction cascades, transcription factors are synthesised, which upon interaction with other promoters switch on several genes: these genes may code for further regulatory factors or for proteins which contribute either directly (e.g. protective proteins) or indirectly (compatible solutes) to the maintenance of cell viability. The desiccation sensor or osmo-sensor of plants is not yet known; from yeast and bacteria such proteins are known however.
6. ABA synthesis is not via the mevalonate pathway, as previously assumed, but results from

degradation of the xanthophyll zeaxanthin. Biosynthesis of zeaxanthin, in turn, is synthesised in the recently discovered DOXP pathway (1-deoxy-D-xylulose-5-phosphate pathway).

7. Receptors for ABA are on the outer surface of the plasma membrane, as well as in the interior of the cell. Though their molecular structure is not yet known, modes of changing their effectiveness have been elucidated. In addition, details are known about secondary intracellular messengers (e.g. cyclic ADP ribose). Calcium, inositol-trisphosphate, protein kinases and protein phosphatases further take part in signal transduction. Reactions induced by ABA are either fast reactions such as the regulation of the stomates or slow reactions resulting from the expression of ABA-sensitive genes.
8. In stomatal movement, the apoplastic ABA signal is perceived by a receptor in the plasma membrane and the increase in the intracellular concentration of free calcium is one of the early steps in signal transduction. This activates anion channels, through which anions (malate, chloride) leave the cell, changing the membrane potential and triggering K^+ efflux. More than 90% of the ions exported from cells must first be released from the vacuole into the cytosol. The corresponding channels are also regulated by cytosolic free Ca^{2+} . Because of ion export from the guard cells and the concomitant release of water, turgor declines and the stomates close. In addition to their reaction to ABA, guard cells also react to other signals, e.g. blue light or the internal CO_2 concentration.
9. Cellular reactions to drought result from ABA-induced as well as from ABA-independent gene expression. The promoters of ABA-responsive genes contain the ABRE motif. This motif, in turn, contains the so-called G-box as "core motif", that is typical of promoters of many stress- and light-responsive genes. In order to bind the corresponding transcription factor, the promoter requires either several ABREs and/or binding enhancing elements. Further elements are required for organ-specific expression. Such functionally diversified promoters are called "bipartite promoters".
10. ABA-independent reactions to drought result from gene expression triggered by desiccation, high salinity or even cold. Promoters of such genes contain the so-called DRE element, to which specific transcription factors bind. There are also promoters which possess both elements, the DRE and the ABRE motif. As far as is known, the latter becomes effective only during prolonged drought or cold. Under these conditions the promoter changes to an ABA-responsive one.
11. The final gene products are proteins, which immediately or by their products improve the stress tolerance of cells: aquaporins, proteases, ROS-detoxifying enzymes, and enzymes which catalyse the synthesis of compatible solutes. A special group of protective proteins are the LEA or Rab proteins, which are attributed to the family of dehydrins. They are not catalytically active, but are very efficient in protecting membranes and protein complexes. Dehydrins are usually medium-sized proteins which either form amphiphilic helices or only random coils. Usually, they have a modular (segmented) structure and are resistant to boiling and denaturing by acids as they do not contain cysteine or tryptophan. In some cases, detailed understanding of the protective effect of these proteins has been achieved. Dehydrins and compatible solutes are the major components of membrane stabilisation in poikilohydric plants.
12. Dehydrins have proven useful for the transformation of drought-sensitive plants (crop plants). The same applies to enzymes which catalyse the synthesis of compatible solutes.
13. CAM is a special physiological adaptation of plants in hot and dry regions. Their stomata remain closed during the hot day and open only at night. CO_2 originating from bicarbonate is bound to PEP by phosphoenolpyruvate carboxylase (PEPC). The resulting chemically unstable oxaloacetate is stabilized by reduction to L-malate (malate dehydrogenase). Malic acid accumulates in the vacuole as an ATP-dependent proton pump shuffles protons into that organelle. During daytime, malic acid is released from the vacuole and after entering the chloroplast is decarboxylated by malic enzyme. The CO_2 is fixed by Rubisco and the pyruvate formed from the original PEP is either phosphorylated with pyruvate-P-dikinase to PEP or broken down in respiratory metabolism. Loading and unloading malic acid into and from the vacuole create particular biochemical problems

which are partly solved by using different pathways. Another problem is the reversible inhibition of PEPC during daytime to allow the CO₂ to be assimilated by Rubisco: A CAM plant-specific PEPC has been demonstrated which in its dephosphorylated form (daytime) is inhibited by malate, whereas the activity of the phosphorylated enzyme (nighttime) is not affected.

14. CAM plants have a much higher water use efficiency (WUE) than plants photosynthesising by the C3 or the C4 mechanism, but their growth is considerably slower than that of other homoiohydric plants.
15. Many CAM plants are able to switch from CAM to C3 photosynthesis if the environmental conditions are favourable (facultative CAM plants). Such change may be seasonal or diurnal, e.g. C3 photosynthesis may be performed for a short time in the early morning or late in the afternoon, when the stomata are not yet fully closed as for the rest of the day. During prolonged periods of drought, stomata remain closed even at night and photosynthesis is restricted to internally produced CO₂. Under these conditions growth is not possible (CAM idling). Crassulacean acid metabolism with completely or partly open stomates during the daytime is called "CAM cycling".
16. From the stable carbon isotope ratio (the so-called δ^{13} value), it is possible to detect whether a plant has photosynthesised by the C3, C4 or CAM mode: C3: -28‰, C4: -14‰, CAM: -10 to -20‰.

References

- Assman SM, Shimazaki K-I (1999) The multisensory guard cell. Stomatal responses to blue light and abscisic acid. *Plant Physiol* 119: 809–815
- Bartels D, Alexander R, Schneider K, Elster R, Velasco R, Alamillo J, Bianchi U, Nelson D, Salamini F (1993) Desiccation-related gene products analyzed in a resurrection plant and in barley embryos. In: Close TJ, Bray EA (eds) *Plant responses to cellular dehydration during environmental stress*. The American Society of Plant Physiologists, Rockville, Maryland, pp 119–127
- Bonetta D, McCourt P (1998) Genetic analysis of ABA signal transduction pathways. *Trends Plant Sci* 3:231–235
- Busk PK, Jensen AB, Pages M (1997) Regulatory elements in vivo in the promoter of the abscisic responsive gene *rab17* from maize. *Plant J* 11:1285–1295
- Campbell SA, Close TJ (1997) Dehydrins: genes, proteins, and association with phenotypic traits. *New Phytol* 137: 61–74
- Chollet R, Vidal J, O'Leary MH (1996) Phosphoenolpyruvate carboxylase: a ubiquitous, highly regulated enzyme in plants. *Annu Rev Plant Physiol Plant Mol Biol* 47:273–298
- Close TJ (1996) Dehydrins: emergence of a biochemical role of a family of plant dehydration proteins. *Physiol Plant* 97:795–803
- Close TJ (1997) Dehydrins: a commonality in the response of plants to dehydration and low temperature. *Physiol Plant* 100:291–296
- Cowan AK (2000) Is abscisic aldehyde really the immediate precursor to stress-induced ABA. *Trends Plant Sci* 5:191–192
- Curry J, Walker-Simmons MK (1993) Sequence analysis of wheat cDNAs for abscisic acid-responsive genes expressed in dehydrated wheat seedlings and the Cyanobacterium, *Anabaena*. In: Close TJ, Bray EA (eds) *Plant responses to cellular dehydration during environmental stress*. The American Society of Plant Physiologists, Rockville, Maryland, pp 128–136
- Cushman JC, Bohnert HJ (1999) Crassulacean acid metabolism: molecular genetics. *Annu Rev Plant Physiol Plant Mol Biol* 50:305–332
- Cutler AJ, Krochko JE (1999) Formation and breakdown of ABA. *Trends Plant Sci* 4:472–478
- Hanson AD (1993) Accumulation of quaternary ammonium and tertiary sulfonium compounds. In: Close TJ, Bray EA (eds) *Plant responses to cellular dehydration during environmental stress*. The American Society of Plant Physiologists, Rockville, Maryland, pp 30–36
- Hartung W (1996) Trockenheit. In: Brundold Ch, Rügsegger A, Brändle R (Hrsg) *Stress bei Pflanzen*. UTB, P Haupt, Berlin, pp 119–131
- Heldt H-W (1997) *Plant Biochemistry & Molecular Biology*. Oxford Univ Press, Oxford New York Tokyo, 597 pp
- Hiroshi A, Yamaguchi-Shinozaki K, Takeshi U, Toshisuke I, Daijro H, Shinozaki K (1997) Role of *Arabidopsis* MYC and MYB homologs in drought- and abscisic acid-regulated gene expression. *Plant Cell* 9:1859–1868
- Hobo T, Asada M, Kowyama Y, Hattori T (1999) ACGT-containing abscisic acid response element (ABRE) and coupling element 3 (CE3) are functionally equivalent. *Plant J* 19:679–689
- Johansson I, Karlsson M, Johanson U, Larsson C, Kjellbom P (2000) The role of aquaporins in cellular and whole plant water balance. *Biochem Biophys Acta* 1465:324–342
- Jung JS, Preston GM, Smith BL, Guggino WB, Agre P (1994) Molecular structure of the water channel through aquaporin CHIP. *J Biol Chem* 269:14648–14654
- Keeley JE (1998) CAM photosynthesis in submerged aquatic plants. *Bot Rev* 64:121–175
- Kjellbom P, Larsson Ch, Johansson I, Karlsson M, Johanson U (1999) Aquaporins and water homeostasis in plants. *Trends Plant Sci* 4:308–314
- Larcher W (1994) *Ökophysiologie der Pflanzen*. UTB Eugen Ulmer, Stuttgart, 394 pp
- Larcher W (2001) *Ökophysiologie der Pflanzen*. UTB Eugen Ulmer, Stuttgart
- Lichtenthaler HK (1999) The 1-deoxy-D-xylulose-5 phosphate pathway of isoprenoid biosynthesis in plants. *Annu Rev Plant Physiol Plant Mol Biol* 50:47–63
- Lüttge U (1987) Carbon dioxide and water demand: crassulacean acid metabolism (CAM), a versatile ecological adaptation exemplifying the need for integration in ecological work. *New Phytol* 106:593–629
- Lüttge U, Grams TEE, Hechler B, Blasius B, Beck F (1996) Frequency resonances of the circadian rhythm of CAM under external temperature rhythms of varied period length in continuous light. *Bot Acta* 109:422–426

- Lüttge U, Kluge M, Bauer G (1994) Botanik. VCH, Weinheim, 600 pp
- Morison JIL (1998) Stomatal response to increased CO₂ concentration. *J Exp Bot* 49: 443–452
- Neill SJ, Burnett EC (1999) Regulation of gene expression during water deficit stress. *Plant Growth Regul* 29:23–33
- Nobel PS (1988) Environmental biology of agaves and cacti. Cambridge University Press, Cambridge
- Quatrano RS, Bartels D, Ho T-HD, Pages M (1997) New insights into ABA-mediated processes. *Plant Cell* 9:470–475
- Robinson DG, Sieher H, Kammerloher W, Schäffner AR (1996) PIP1 aquaporins are concentrated in plasmalemmasomes of *Arabidopsis thaliana* mesophyll. *Plant Physiol* 111:645–649
- Schäffner AR (1998) Aquaporin function, structure, and expression: are there more surprises to surface in water relations? *Planta* 204:131–139
- Schroeder JI, Kwak JM, Allen GJ (2001) Guard cell abscisic acid signalling and engineering drought hardiness in plants. *Nature* 410: 327–330
- Shen Q, Ho T-HD (1995) Functional dissection of an abscisic acid (ABA)-inducible gene reveals two independent ABA-responsive complexes each containing a G-box and a novel *cis*-acting element. *Plant Cell* 7:295–307
- Shinozaki K, Yamaguchi-Shinozaki K (1997) Gene expression and signal transduction in water stress response. *Plant Physiol* 115:327–334
- Taiz L, Zeiger E (2000) Physiologie der Pflanzen. Spektrum, Heidelberg, 773 pp
- Walton DC, Li Y (1995) Abscisic acid biosynthesis and metabolism. In: Davies PJ (eds) Plant hormones: physiology, biochemistry and molecular biology. Kluwer, Dordrecht
- Wilkinson S (1999) pH as a stress signal. *Plant Growth Regul* 29:87–99
- Wurgler-Murphy SM, Saito H (1997) Two-component signal transducers and MAPK cascades. *Trends Biochem Sci* 22:172–176
- Xu D, Duan X, Wang B, Hong B, Ho T-HD, Wu R (1996) Expression of a late embryogenesis abundant protein gene, HVA1, from barley confers tolerance to water deficit and salt stress in transgenic rice. *Plant Physiol* 110: 249–257
- Yamaguchi-Shinozaki K, Shinozaki K (1994) A novel *cis*-acting element in an *Arabidopsis* gene is involved in responsiveness to drought, low-temperature, or high-salt stress. *Plant Cell* 6:251–264
- Yoshida Y, Kiyosue T, Nakashima K, Yamaguchi-Shinozaki K, Shinozaki K (1997) Regulation of levels of proline as an osmolyte in plants under water stress. *Plant Cell Physiol* 38:1095–1102
- Zeiger E, Zhu J (1998) Role of zeaxanthin in blue light photoreception and the modulation of light-CO₂ interactions in guard cells. *J Exp Bot* 49: 433–442

1.6

Salt Stress (Osmotic Stress)



Salt lakes are almost uninhabitable for plants because of the enormous osmotic potential of the substrate, which is often also very alkaline due to the high soda (NaCO_3) content. Nevertheless, plant life can be found in such habitats. The white expanses in the picture of Lake Magadi in southern Kenya are not snow, but salt incrustations. The banks of sediment in the lake are overgrown with thick layers of algae. The shoreline also supports, in part, a vegetation of halotolerant bushes. Photo E. Beck

Recommended Literature

- Blumwald E (2000) Sodium transport and salt tolerance in plants. *Curr Opin Cell Biol* 12:431–434
- Hasegawa PM, Bressan R, Pardo JM (2000) The dawn of plant salt tolerance genetics. *Trends Plant Sci* 5:317–319
- Larcher W (2003) *Ecophysiology of plants*, 3rd edn. Springer-Telos
- Marschner H (1995) *Mineral nutrition of higher plants*, 2nd edn. Academic Press, chap 16.6
- Osmond CB, Björkman O, Anderson DJ (1980) Physiological processes in plant ecology: towards a synthesis with *Atriplex*. *Ecological Studies* 36. Springer, Berlin Heidelberg New York
- Zhu J-K (2002) Salt and drought stress signal transduction in plants. *Annu Rev Plant Biol* 53:247–274

That stress occurs when certain environmental factors exceed or are below the useful or tolerable range of intensities becomes particularly obvious with nutrients. The concentrations at which nutrients occur or exert their effect often differ greatly from element to element and from plant to plant (see also Chap. 2.3). This is partic-

ularly apparent for ions which are not obligate nutrients, such as sodium. This ion – in contrast to the case with animal metabolism – plays no essential role in the metabolism of plants, but it often occurs at high concentrations as sodium chloride where plants grow. Salts found in nature (mainly NaCl and CaSO_4) may occur at concentrations which are either toxic, tolerated or even required as an osmoticum, and plants are accordingly referred to as **glycophytes** (non-salt plants) or **halophytes** (salt plants). In the following, stress caused by high **NaCl concentrations** will be the main topic of discussion.

The electrical conductivity (EC_e) of salts in liquid solutions is used for the standardisation of salt contents and is expressed in [Siemens (S)/m] or [mS/cm]:

$$1 \text{ S} = \frac{1}{\text{Ohm}} [\text{Mho}]$$

1 S/m corresponds to -0.36 MPa and the dimension Mho is the reciprocal of Ohm, the measure of electrical resistance.

The conductivity of seawater corresponds to 4.4 S/m; that of water used for irrigation must be lower than 0.2 S/m. Soils with a conductivity of $>0.4 \text{ S/m}$ are termed saline soils. The salt concentration of seawater (3%: 480 mM Na^+ , 50 mM Mg^{2+} and 560 mM Cl^-) corresponds to

Table 1.6.1. Salt tolerance of important agricultural plants grown under a range of high salt concentrations. EC_e is a measure of salinity and is the electrical conductivity of the water extracted from the saturated soil solution. (After Marschner 1986)

Plant type	Maximum tolerance (EC_e in mMho/cm)	Reduction of harvest per EC_e unit above the tolerance value (%)
Barley	8.0	5.0
Sugar beet	7.0	5.9
Wheat	6.0	7.1
Soybean	5.0	20.0
Tomato	2.5	9.9
Maize	1.7	12.9
Green bean	1.0	19.0

Table 1.6.2. Yields of salt-tolerant barley plants from the gene and seed banks of the USA upon cultivation on Californian sand dunes and irrigation with seawater supplemented with phosphate and nitrogen fertilisers. (After Lüttge et al. 1994)

Barley variety	Yield (t/ha)
Standard variety on saline soil (average)	0.83
Var. XXI, 1st experiment	1.08
Var. XXI, 2nd experiment	1.50
World average on non-saline soil	2.00

an osmotic potential of -2.7 MPa. Table 1.6.1 shows the salt tolerance of various crop plants.

Irrigation water in dry areas contains between 0.1 and 1 kg mineral salts per cubic metre. While this is significantly below the damage threshold (-0.15 MPa), it can still lead to soil salinity and to the loss of useful agricultural land in a few years due to the intense evaporation.

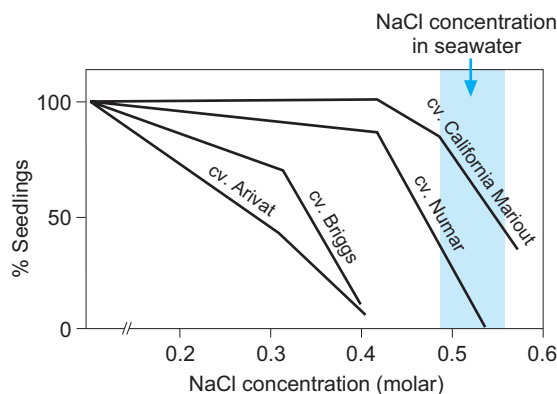


Fig. 1.6.1 Salt tolerance of various barley varieties, measured by the development of young plants on salt-containing substrates. (After Lüttge et al. 1994)

It follows from the theory that life arose in the sea that salt tolerance must have been an original characteristic of living systems; sensitivity to salt should then be seen as a loss of this original characteristic. “Regaining” salt tolerance of important crop plants is accordingly one of the most important aims of plant breeding. An example is the improvement of salt tolerance in barley (Fig. 1.6.1 and Table 1.6.2), which has per se the highest salt tolerance of all cereals (see Table 1.6.1).

1.6.1

Physiological Effects of Salt Stress (NaCl)

- Barkla BJ, Pantoja O (1996) Physiology of ion transport across the tonoplast of higher plants. *Annu Rev Plant Physiol Plant Mol Biol* 47:159–184

1.6.1.1

Effects on the Ion Metabolism of the Cell (“Primary Effects”)

Sodium and chloride ions are regarded as being biologically aggressive osmolytes on account of their small ionic diameters and high surface charge densities and their consequent strong tendency to attract water. High concentrations of these ions in the apoplast accordingly lead to imbalances in water and ion relations. Stress caused by salinity is thus both **dehydration stress** and **ionic stress**. The latter rapidly leads to destruction of biomembranes, because ion imbalances result not only in altered concentration relations, but also in changes of membrane potential. Homeostatic ion concentrations, i.e. cytosolic concentrations maintained at equilibrium in glycophytes not subject to salinity stress, are in the ranges of 100–200 mM K^+ , 1–10 mM Na^+ and Cl^- and 0.1–0.2 mM Ca^{2+} (Fig. 1.6.2; Niu et al. 1995).

These ion concentrations are kept constant in plant cells in the main by electrophoretic flows, i.e. passive flows which are coupled to H^+ -AT-Pases and H^+ -pyrophosphatases in the plasma membrane and the tonoplast (in contrast to animal and yeast cells, plant cells do not possess Na^+/K^+ -ATPase pumps). In addition, import and

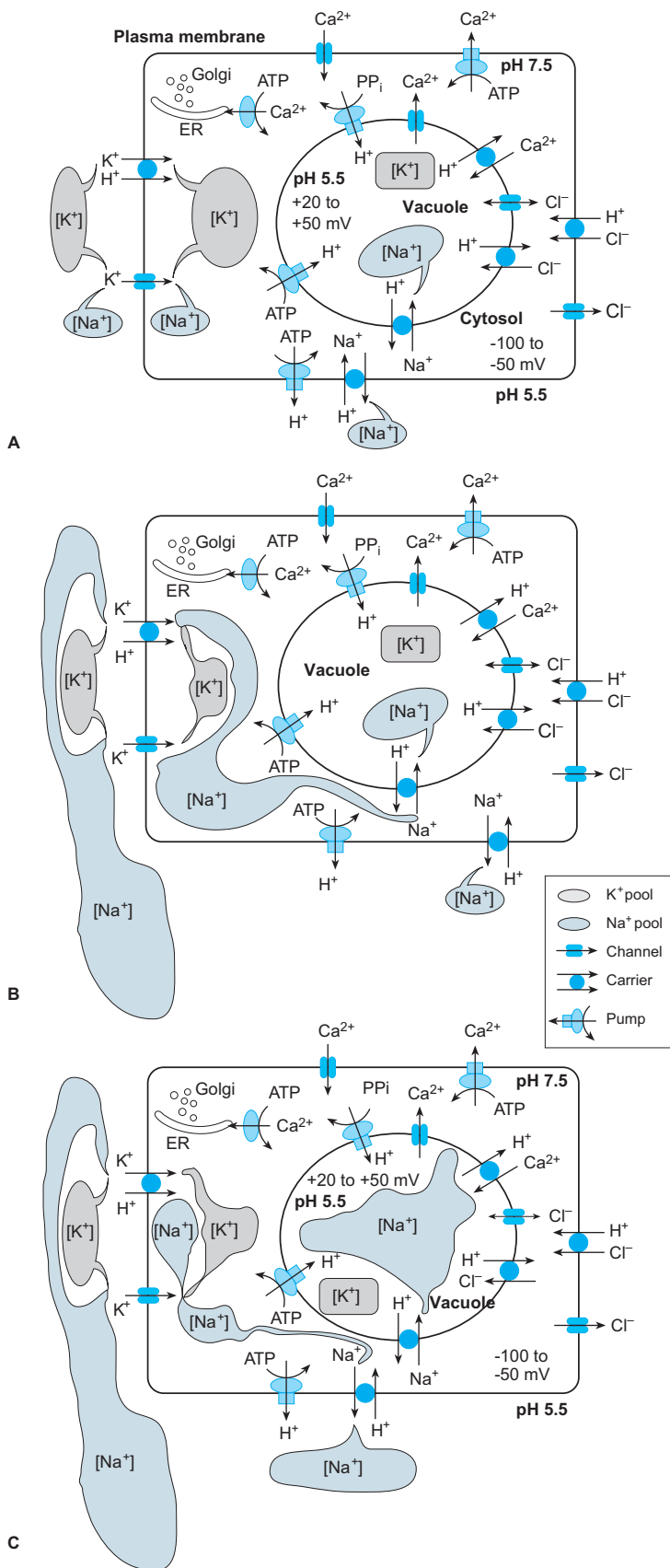


Fig. 1.6.2. Ion relations in plant cells in the non-stressed (A) and strongly salt-stressed (B) states, as well as subsequent to adaptation to high salt concentrations (C). The schematic overview incorporates all hitherto described types of transport systems that have been associated with ion homeostasis under salt stress. (After Niu et al. 1995)

Table 1.6.3. Transport systems potentially involved in ion homeostasis in the plasma membrane and the tonoplast. (After Hasegawa et al. 2000 b)

Substrate	Subcellular localisation	Direction	Source of energy or counter ion
Pumps			
H ⁺	Plasma membrane	Apoplast	ATP
H ⁺	Tonoplast	Vacuole	ATP
H ⁺	Tonoplast	Vacuole	PPi
Ca ²⁺	Plasma membrane	Apoplast	ATP
Ca ²⁺	Tonoplast	Vacuole	ATP
Channels			
K ⁺ (Na ²⁺)	Plasma membrane	Cytosol	Membrane potential
K ⁺ (Na ²⁺)	Plasma membrane	Cytosol	H ⁺ (symport)
K ⁺	Plasma membrane	Cytosol	H ⁺ , Na ⁺ (symport)
Ca ²⁺	Plasma membrane	Cytosol	Membrane potential
Ca ²⁺	Tonoplast	Cytosol	Membrane potential
Cl ⁻ (anion)	Plasma membrane	Apoplast	Membrane potential
Cl ⁻ (anion)	Tonoplast	Vacuole	Membrane potential
Carriers			
Na ⁺	Plasma membrane	Apoplast	H ⁺ (antiport)
Na ⁺	Tonoplast	Vacuole	H ⁺ (antiport)
Ca ²⁺	Tonoplast	Vacuole	H ⁺ (antiport)
Cl ⁻ (anion)	Plasma membrane	Cytosol	H ⁺ (symport)
Cl ⁻ (anion)	Tonoplast	Vacuole	H ⁺ (antiport)

export channels for K⁺ and anions which are regulated by the membrane potential (so-called gated channels) have been described, as well as a Ca²⁺-ATPase for Ca²⁺. The activity of these pumps and channels results in a membrane potential of 0.2 V at the plasmalemma (the cytosolic side is negatively charged) and a tonoplast potential of between 0 and +20 mV, with the cytosolic side again being negatively charged. When the volumes of the participating apoplast, cytosol and vacuole compartments are taken into account, the membrane potentials give rise to pH gradients, whereby the normal pH value for the cytosol is always 7 and that of the apoplast and the vacuole is 1–2 units more acidic. An overview of the transport systems at present known to participate in the ion homeostasis of higher plants is given in [Table 1.6.3](#).

High salinity places this homeostasis under considerable stress, because particularly Na⁺, but also Ca²⁺, enter passively into the cell along the concentration gradient and form large pools there. The accumulation of positive charges in the cytosol breaks down the natural barrier of the membrane potential for Cl⁻ and, consequently, leads to a massive influx of this anion through the anion channels.

In particular the potassium relations of the cell are threatened by high sodium concentrations. On the one hand, K⁺ and Na⁺ compete for the not particularly selective, but very efficient,

K⁺ uptake systems. These are channels and K⁺/Na⁺-symporters: low affinity cation transporters, or LCTs. At high apoplastic Na⁺ concentrations the potassium uptake by the cell is accordingly strongly reduced, and the cytosolic potassium pool shrinks ([Fig. 1.6.2 B](#)).

On the other hand, the flooding of the cytosol with Na⁺ results in increased activity of proton pumps, especially of the plasma membrane ATPases but also of the tonoplastic Na⁺/H⁺ antiport system, and thus in an increase in ATP consumption.

The situation becomes further aggravated in that increased proton transport also results in changes in the intracellular pH relations. External application of NaCl at seawater concentrations results in an alkalinisation of the cytosol of barley roots of between 0.5 and 1 pH unit. This alkalinisation detrimentally affects the activity of various cytosolic enzymes, particularly of those of catabolic energy metabolism (Katsuhara et al. 1997).

Uptake of Na⁺ into the vacuole, which effects salt removal from the cytosol, requires a Na⁺/H⁺ antiporter (sodium-H⁺ exchange) which has been found in barley roots and beet in addition to the above-mentioned H⁺-transporting system. This antiporter couples the increased proton charge of the vacuole with sodium uptake. The synthesis of this transport system can be induced by salinity stress ([Fig. 1.6.2 C](#)). The so-

dium and chloride concentrations in the vacuoles of salt-stressed tobacco cell cultures were eight-fold greater than those in the cytosol (Binzel et al. 1988). A consequence of this is a further alkalisation – now of the vacuole – due to the proton-sodium antiport.

Flooding of the cell with Na^+ leads finally to an increased uptake of calcium by the cell and release of Ca^{2+} from cellular compartments, and thus to an increase in the size of the cytosolic Ca^{2+} pool. Since the cytosolic pool of free Ca^{2+} has signal function, the augmentation of this pool triggers regulatory processes in the cell, which can in the main be interpreted as constituting repair or adaptation reactions. The increase in the cytosolic Ca^{2+} concentration could take place due to water potential-induced calcium uptake similar to that occurring in the stomata (see also Chap. 1.5.2.4), or upon the opening of Ca^{2+} channels in the ER or tonoplast in connection with the inositol-triphosphate system.

1.6.1.2

Secondary Damage Caused by Severe Salt Stress

Salt stress, which makes excessive demands on the cell's ability to maintain homeostasis and thus leads to increased salt concentrations in the cell, results in functional disturbances. On the one hand, processes requiring balanced water relations, such as cell elongation, react particularly sensitively. Since a great deal of energy is consumed by the strain reactions and a considerable proportion of produced photosynthate is used in the production of compatible osmolytes, **cell division growth** is also detrimentally affected due to lack of building blocks and energy.

In salt-sensitive plants, e.g. maize and beans, even relatively low internal salt concentrations result in considerable reductions in growth (see Table 1.6.1). Indeed, the constitutive types of glycophytes and halophytes introduced at the beginning of this chapter can be relatively easily identified and even further subdivided on the basis of the sensitivity of growth to salt. Most of our highly efficient crop plants are unfortunately glycophytes which exhibit significantly reduced yields at even only relatively low salt concentrations.

In addition to growth processes, **photosynthesis**, particularly that of C3 plants, is detrimen-

tally affected by elevated intracellular salt contents. Even though enzyme activities may be influenced by salt, the salt concentrations which build up in the chloroplast are usually too low to result in significant inhibition of the Calvin cycle. On the other hand, photosynthetic electron transport is impaired at even relatively low salt concentrations, whereby the nature of the detrimental effect has not yet been clarified. It is known that enhanced ROS formation takes place in the chloroplasts of plants under salt stress upon illumination (see Chap. 1.3.5). These ROS lead to damage of the photosystems, to chlorophyll degradation and, finally, to necrotic death of cells and tissues. Typical **salinity damage** symptoms become apparent (see Fig. 2.3.7G), above all necroses at the edges of leaves and in the youngest generation of needles of conifer needles. It is interesting that the inhibition of photosynthetic CO_2 assimilation is not primarily due to an effect of salt on the opening of the stomata. The stomata remain functional even at high salinity. It must thereby be borne in mind that the damage having been caused results from NaCl taken up by the roots, in contrast to the direct effects of salt in salt sprays and splashings (e.g. at road edges) which damage old and young tissues in the same manner.

1.6.2

The Adaptive Response of the Plant Cell to Salt Stress

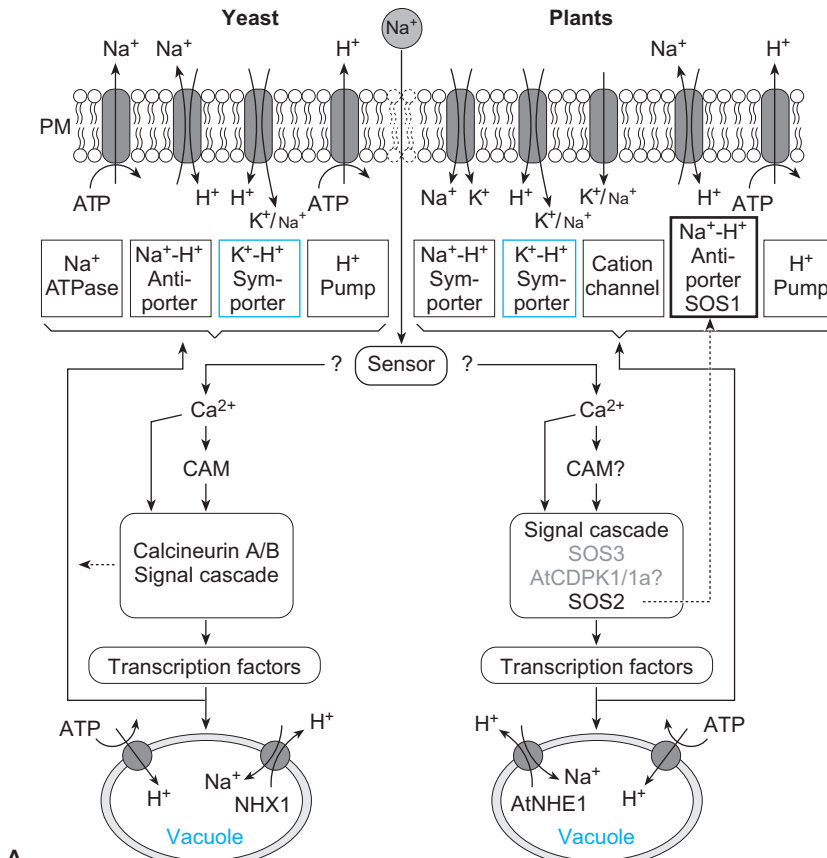
An osmotic stressor such as salt causes strain in plant cells, which can be interpreted as adaptation to the new osmotic conditions. Adaptation means new synthesis of proteins to alleviate the stress. In the case of osmotic stress, this alleviation comprises:

- reactions to regain ion homeostasis,
- reactions to adapt to the osmotic potential,
- synthesis of specifically acting, protective proteins.

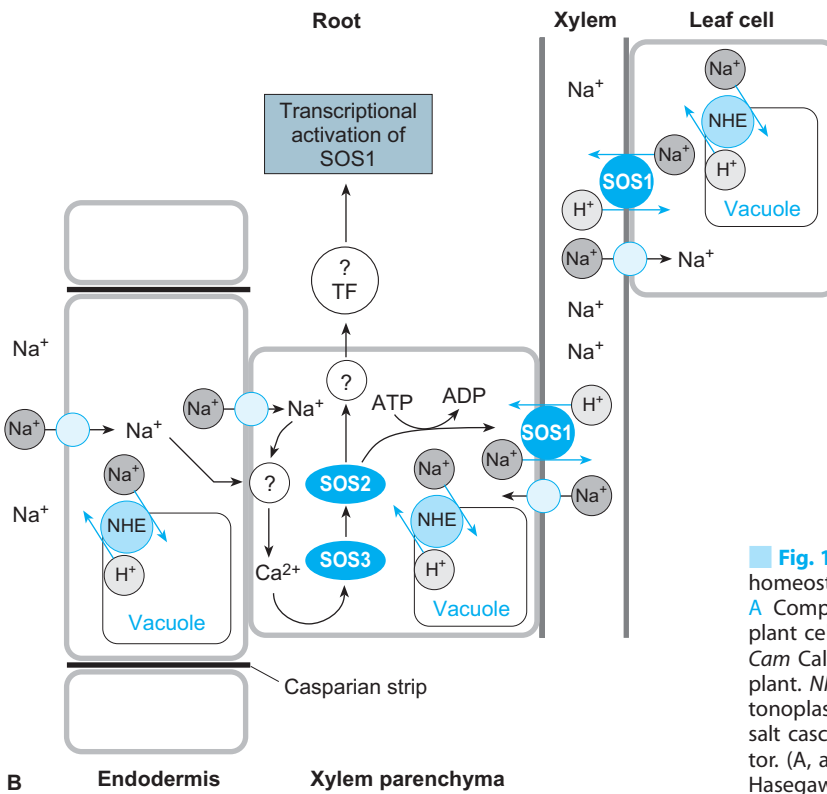
1.6.2.1

Intracellular Signals

The adaptation commences with the perception of the osmotic stress. This has already been discussed for *Dunaliella* (see Chap. 1.1.4). Since lit-



A



B

Fig. 1.6.3. Model of the regulation of ion homeostasis by Ca^{2+} under salt stress. **A** Comparison of the response of yeast and plant cells to salt stress modulated by Ca^{2+} . *Cam* Calmodulin. **B** The SOS system in a plant. *NHE* Sodium-proton antiporter in the tonoplast; *SOS* protein of the overly sensitive salt cascade (see text); *TF* transcription factor. (A, after Bressan et al. 1998; B, after Hasegawa et al. 2000 b)

tle is known about osmosensors, particularly as they apply to salt stress, the next step – the genesis of the signal – will now be considered. Genes and proteins have recently been identified which point to a biochemical connection between the osmotic adaptation of the plant and an increase in the cytosolic Ca^{2+} level. Yeast has served in this regard as a model, for which it has been known for some time that there is an interaction between Ca^{2+} , the subunit B of the calcium-binding protein calcineurin and salt tolerance. In this organism the protein phosphatase calcineurin activates on the one hand transcription factors, which lead to increased expression of a plasma membrane Na^+ -ATPase and a tonoplast Na^+/H^+ antiporter. On the other hand, active calcineurin modulates a not very selective K^+/H^+ symporter in such a way that it becomes both more effective and more strongly selective for K^+ (Fig. 1.6.3 A). A gene family has been correspondingly discovered in *Arabidopsis*, a mutation in which makes plants particularly sensitive to Na^+ and also to Li^+ (“salt overly sensitive”: SOS). The functions of three SOS proteins have now been elucidated: SOS1 is a Na^+/H^+ antiporter in the plasma membrane, SOS2 is a serine-threonine protein kinase which activates SOS1, and SOS3 is a calcium-binding protein with an EF-hand domain typical of such proteins, which – after being activated – itself activates SOS2 (Fig. 1.6.3 B; Hasegawa et al. 2000). In addition to the direct activation of SOS1, the SOS cascade also positively influences the activation of transcription factors and leads to increased expression of the antiporter.

Corresponding to the ways in which plant cells respond to drought, there are several parallel calcium-dependent regulatory systems which apply to NaCl stress as well. These are only understood in part, however, e.g. a protein kinase (calcium-dependent protein kinase, CDPK) involved in the expression of a LEA protein or non-stress-specific MAP kinases. It is known that certain phytohormones also act as signals.

A strongly elevated abscisic acid (ABA) level has often been determined in salt-stressed plants (Fig. 1.6.4). An enhanced formation of ethylene has also been observed, whereas the cytokinin content usually decreases.

Since salinity has an ionic as well as a dehydration component (due to the binding of water to ions) and ABA plays an important role as a phytohormonal signal during drought (see Fig. 1.5.8), it cannot be excluded that the in-

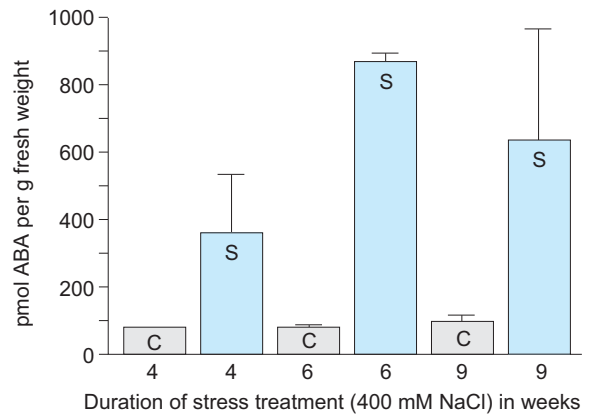


Fig. 1.6.4. Reaction of the endogenous ABA levels in leaves of *Mesembryanthemum crystallinum* to salt stress. The concentrations of the osmolytes proline, pinitol and ononitol, as well as the amounts of the CAM form of PEP carboxylase and the protective protein osmotin, increased along with the level of ABA. C Control (without salt); S 400 mM NaCl in the nutrient solution. (After Thomas and Bohnert 1993)

creased ABA level is – according to the type of plant and the conditions – related to the dehydration syndrome rather than to salt toxicity (Fig. 1.6.5).

Nevertheless, a physiological relation between an increase in the ABA level and adaptation to salt stress does exist, as shown in an experiment in which the autonomous osmotic adaptation of tobacco cultures to salt was compared with an accelerated adaptation resulting from exogenous ABA supply.

As is the case with drought stress, numerous specific proteins can be shown to be expressed upon salt stress (see Chap. 1.5.2.2); the induction paths can be ABA-dependent or ABA-independent (Jin et al. 2000). However, it is again not clear with regard to these strain reactions whether the induction is due to drought or to ion effects.

In addition to the ABA level, the level of jasmonates in the plant responds to salinity. However, the behaviour of this group of hormones is very different to that of ABA. While the concentration of ABA increases only transiently upon salt shock (transferring plants from a salt-free medium to one with an elevated NaCl content) and then falls off again (Fig. 1.6.6), the concurrent increase in jasmonate is maintained over a longer period. Jasmonate accumulates about 20-fold upon longer-term salinity stress, whereas the ABA level increases only about 4-fold. Each of the hormones, if applied externally, induces

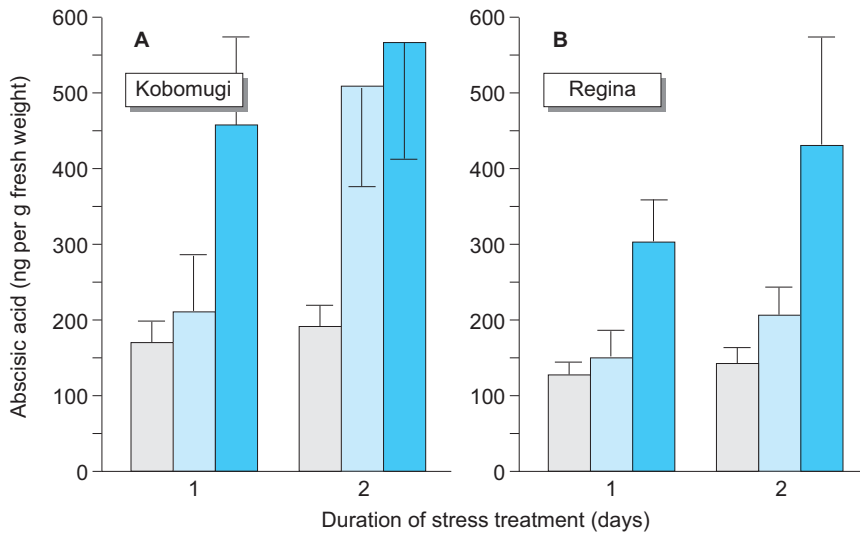


Fig. 1.6.5. The reaction of the ABA level in the leaves of two wheat varieties subjected to salt stress and to combined salt and drought stress. Control (grey), salt stress (200 mM, light blue), salt and drought (200 mM salt and 21% polyethyleneglycol, blue). (After Nagy and Galiba 1995)

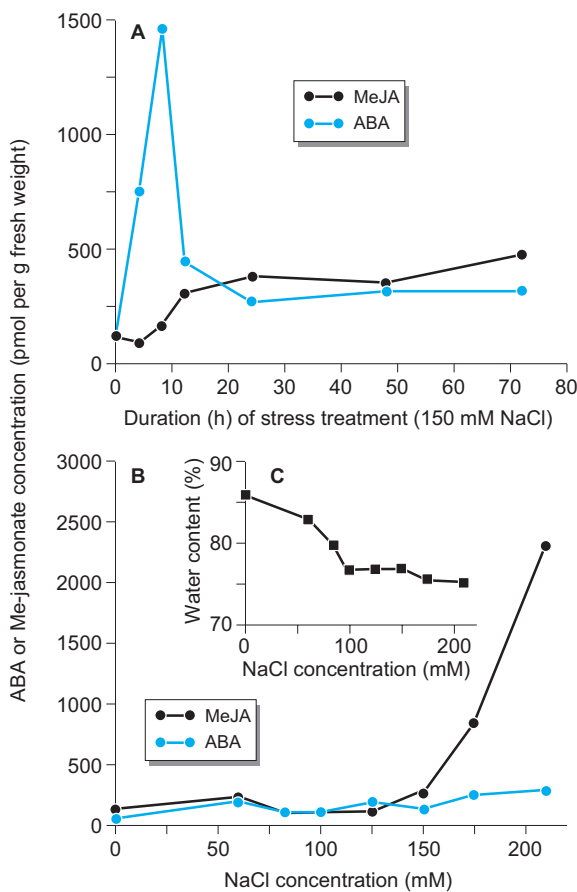


Fig. 1.6.6. Endogenous concentrations of ABA and methyl jasmonate in roots of rice plants subjected to different forms of salt stress. **A** "Salt shock": Transfer of seedlings from a salt-free medium to a salt-containing medium (150 mM). **B** ABA and methyl jasmonate contents of rice seedlings after 2 days of treatment with different salt concentrations. **C** Water content of the shoots after 2 days of exposure to salt stress of different intensities. (After Moons et al. 1997)

the expression of specific genes with only limited overlap. Together they tend to act antagonistically, however, with regard to gene expression (Moons et al. 1997).

1.6.2.2 Adaptation Reactions to Restore Ion Homeostasis

Glyphytes and halophytes basically make use of the same mechanisms to deal with salinity stress. Halophytes are able to adapt faster and to tolerate extreme salinity, whereas glycophytes adapt stepwise to develop tolerance to a moderate degree of salinity. In both constitutive types salt tolerance requires the expression of certain, similar genes. However, the transition from extremely salt-sensitive plants to extremely salt-tolerant plants is not clear cut, and differentiation between the two types is difficult because of the plant's ability to adapt.

Considering the many examples of salt-stressed glycophytes and halophytes having been investigated, it becomes clear that adaptation serves to regain ion homeostasis and the original membrane potentials and pH values. The better the plant is able to achieve this, the better it becomes tolerant of osmotic stress. However, regaining ion homeostasis does not signify a "return" to the original ion concentrations. Rather, the plant attempts to achieve homeostasis with the entire ionic load, including the NaCl that has been taken up (see Fig. 1.6.2 C). Depletion of the aggressive NaCl ions in the cyto-

plasm during adaptation requires considerable energy, which cannot be supplied with the normal provision of the cellular transport systems. Therefore, more of those proteins are synthesised which contribute either directly or indirectly to the removal of NaCl from the cytoplasm. Both the apoplast and the vacuole can be compartments for the “final” deposition.

Relief of the cytosol by removal of the Na⁺ ions from the cytoplasm and their transport into the vacuole and the apoplast is effected mainly by means of Na⁺/H⁺ antiporters, both in the plasmalemma (e.g. in *Atriplex nummularia*; Hassidim et al. 1990; see also Chap. 1.6.2.1) and in the tonoplast (NHE, Fig. 1.6.3 B), e.g. in *Beta vulgaris* (Barkla and Blumwald 1991). These antiporters are induced by elevated cytosolic Na⁺ (NaCl) concentrations and require high proton concentrations in the external medium and in the vacuole, i.e. effective H⁺ pumps. These pumps are synthesised to a greater extent upon salt stress. If ion homeostasis is established, the increased expression of, e.g., the plasma membrane H⁺-ATPase decreases once more. Adapted cells no longer exhibit enhanced pump activity. Figure 1.6.2 C shows the result of salt adaptation with regard to the distribution of ions. The Na⁺ concentration in the cytosol has returned to the original value (Fig. 1.6.2 A), while that in the vacuole has increased many-fold. The original membrane potential and pH value have nevertheless been reestablished. Over-expression of a vacuolar Na⁺/H⁺ antiporter gene in *Arabidopsis* increased salt tolerance considerably (Apse et al. 1999). The K⁺ status is the weak point in the

cellular ion budget subsequent to an adaptation process, irrespective of ion homeostasis. The reduced growth of halophytes and glycophytes under salt stress is possibly related to the problematical provision of the cell with K⁺ (see Box 1.6.1).

The effectiveness of salt elimination into the apoplast is supported, in many halophytes, by salt glands (Fig. 1.6.7), which lead to the deposition of NaCl onto the surface of the leaf, where it then crystallises. This applies particularly to some mangrove species, but also to desert plants (e.g. the genus *Reaumuria* and other Chenopodiaceae).

Other halophytes can enhance the sequestration of salt in the vacuole by developing large salt-storing mesophyll cells (salt succulence, Fig. 1.6.8 A) or by loading large bladder hairs with NaCl (Fig. 1.6.8 B). Both these excretion mechanisms are also termed **recretion**. Leaves which have accumulated high concentrations of salt are shed.

1.6.2.3

Adaptation of Osmotic Potential

Plants must possess a higher osmotic potential than their medium if they are to take up water and nutrients from a saline milieu, i.e. they must increase their own osmotic potential. It is thus inevitable that changes in their internal concentration relations must take place, something which necessitates further adaptive action. In addition to maintaining ion homeostasis, in-

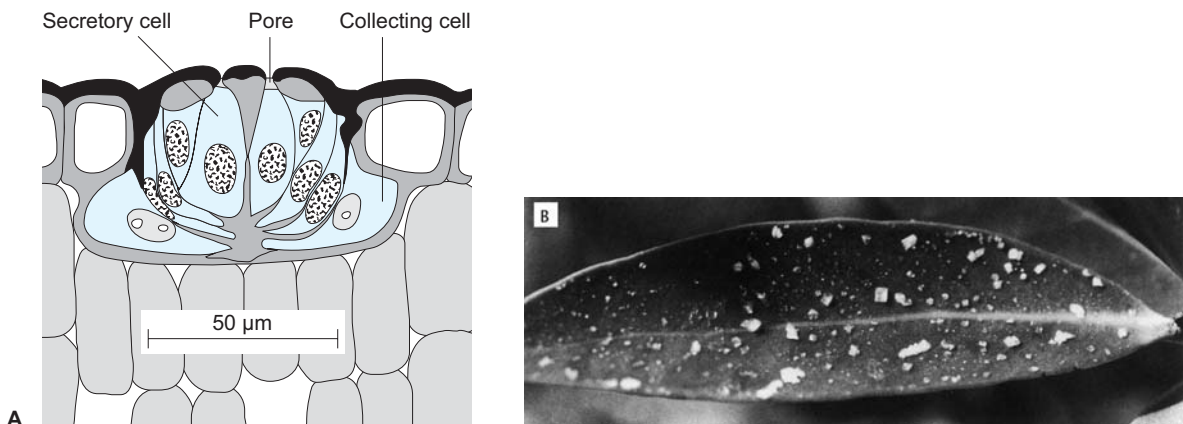


Fig. 1.6.7. Salt elimination (“recretion”) via the apoplast. **A** Salt gland in the leaf of sea lavender (*Limonium vulgare*). **B** Leaf of the mangrove plant *Avicennia germinans* (*Verbenaceae*) showing salt crystals excreted via the salt glands. (Lüttge et al. 1994)

Box 1.6.1

Ion relations of salt-sensitive and salt-tolerant glycophytes under salt stress (after Speer and Kaiser 1991)

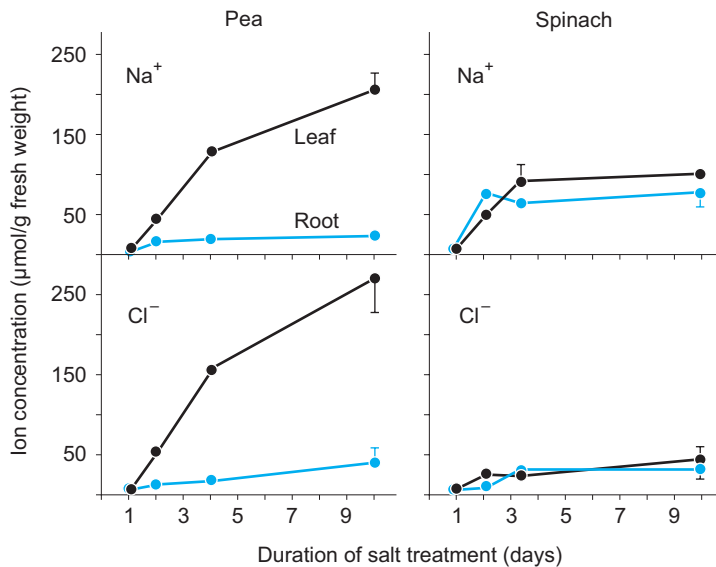


Figure. Salt content of the leaves and roots of pea and spinach plants during the course of growth on nutrient solution containing 100 mM salt for 10 days

Seedlings of pea (salt-sensitive) and spinach (salt-resistant, *Chenopodiace*) were transferred to nutrient solution and exposed to 100 mM NaCl. The ion concentrations of the roots and leaves (see Fig.), as well as the intercellular distribution of the ions, were monitored (see Table).

In both plants the salt concentration in the roots remains distinctly lower than the salt concentration externally applied, whereas the leaves of the salt-sensitive pea plant accumulate salt to a concentration 2.5-fold higher than that applied. In the relatively salt-resistant spinach, Na⁺ accumulates in the roots and leaves up to the applied concentration, while Cl⁻, as is the case with pea shoots, accumulates to only 50% of the concentration present in the medium.

It can be assumed that the ion concentrations in the cytosol are similar to those in the

chloroplast, mitochondria and other organelles. Together with data from the figure, the following picture of adaptation becomes apparent:

The total ion load in the cytosol has remained the same or has even been reduced somewhat (spinach), while that in the vacuole has increased slightly. In contrast, the ion concentration has increased two- to four-fold in the apoplast, where it constitutes the least physiological inconvenience. However, the concentration relations of the individual ions have clearly been altered: The proportion of NaCl has increased drastically – with the exception of the cytoplasm – mainly to the detriment of K⁺ and NO₃⁻. This of course induces nutritional problems. These changes are considerably greater for pea than for spinach.

creasing the osmotic potential is the most immediate requirement for adaptation.

Halophytes make use of the available salt for this purpose (Fig. 1.6.9A). The salt must be re-

tained within the cell, and thus not eliminated. Figure 1.6.9B shows that most of the salt is compartmented in the vacuole¹. Only one fifth of the Na⁺ concentration and one quarter of the Cl⁻ concentration present in the vacuole is found in the cytoplasm and its other organelles. Since, however, osmotic equilibrium must prevail within the symplast (protoplast), the cytosol must

¹ Of course, the capacity of the vacuole to store NaCl is limited. Long-term utilisation of the full capacity leads to rapid senescence of the tissue and to shedding of the leaves.

Box 1.6.1 (continued)

Table. Intracellular ion distribution and budgets in pea and spinach leaves grown without salt and after 10 days of adaptation to treatment with 100 mM NaCl. Only the most important ions are shown

Ion	Control/salt (C/S)	Pea [ion concentration (mM) in mesophyll]			Spinach [ion concentration (mM) in mesophyll]		
		Vacuole	Cytosol	Apoplast	Vacuole	Cytosol	Apoplast
K ⁺	C	104±23	53±5	13±4	260±31	147±25	10±4
	S	42±12	29±17	14±4	172±33	78±18	18±4
Na ⁺	C	3±1	19±4	1.5±1	0.5±0.1	26±16	1±1
	S	114±7	60±19	50±16	109±15	43±15	6±1
Mg ²⁺	C	12±3	6±2	4±2	37±6	17±6	2±1
	S	6.5±1	4±3	2±1	29±5	15±7	3±1
Cl ⁻	C	4±1	5±3	6±2	1±1	6±5	4±1
	S	245±34	60±35	89±67	50±5	9±4	14±6
NO ₃ ⁻	C	33±15	6±2	2.1±1.1	29±13	10±6	5±1
	S	0	1±1	0	19±8	4±1	6.6±5
Σ _{cations}	C	131	84	22.5	334.5	207	15
	S	169	97	68	339	151	30
Σ _{anions}	C	289	55	20	73	88	13
	S	292	77	96	106	53	26

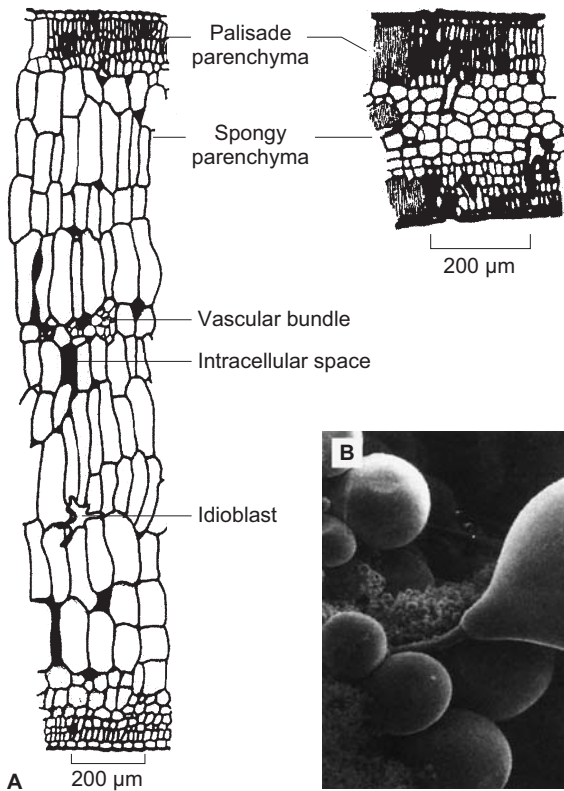


Fig. 1.6.8. Sequestration of salt in the vacuole. **A** Salt succulence in mangrove plants: development of salt-storage tissue from the spongy mesophyll of the leaves. *Right* Young leaf with still small, isodiametrical spongy parenchyma cells. *Left* Cross section of a fully grown leaf with large, elongated spongy parenchyma cells, in the vacuoles of which salt is deposited. The stone cell-like idioblast serves to stiffen the tissue. **B** "Bladder hairs" of the halophyte *Atriplex hymenelytra* (Chenopodiaceae). The salt is sequestered in the large vacuoles of the numerous bladder hairs and is thereby removed from the mesophyll. (A, after Larcher 1994; B, from Lüttge et al. 1994)

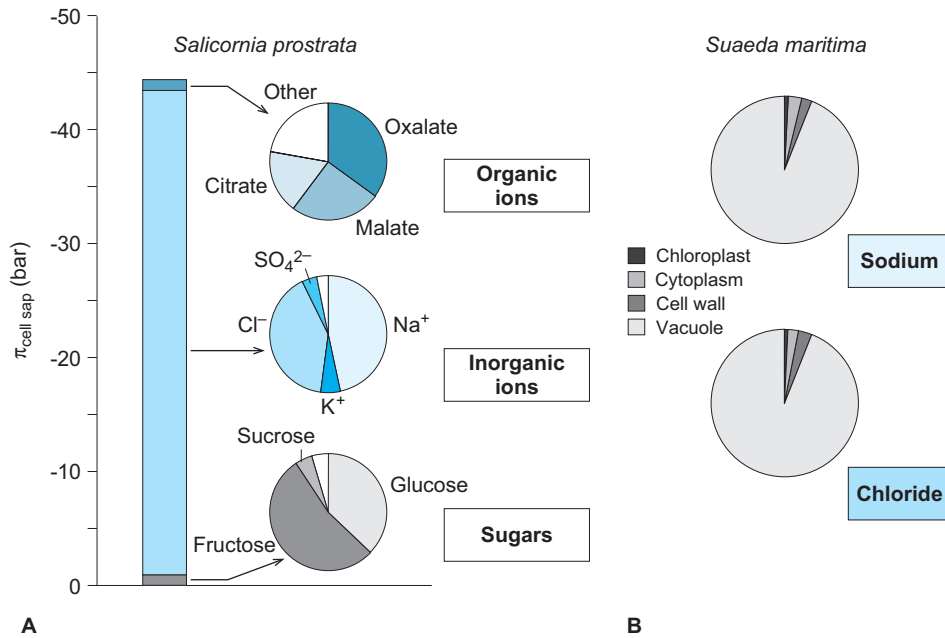


Fig. 1.6.9. A Osmotic potential of the cell sap of leaves of the halophyte *Salicornia prostrata* (Chenopodiaceae) with the components specified in the segments of the pie charts. B Intracellular distribution of the salt ions present in the leaves of the halophyte *Suaeda maritima* (Chenopodiaceae). (Larcher 1994)

have the same osmolarity as the vacuole. This is achieved in that the cell enriches the cytoplasm with compatible organic osmolytes. The adjustment of the osmotic potential of the cytoplasm by means of low molecular weight organic compounds is not as costly as it might appear at first sight. The volume of this compartment (with all its constituent organelles) is usually less than 10% of the volume of the vacuole, so that the required osmolarity is effected with a relatively small amount of solutes. The chemical nature of the organic osmolytes is discussed in the following section.

Compatible Solutes, Osmolytes

Salt adaptation is the classical field of osmolyte research, which has already been briefly considered in relation to dehydration stress (Chap. 1.5.2.2) and will be discussed in more detail here.

Stress osmolytes have two coupled functions:

1. Increasing the osmotic potential (“osmolyte”) and thus the retention of water in the cytoplasm;
2. Multiple protective functions:
 - to maintain the integrity of membranes and proteins (dilution and displacement of aggressive ions from the surfaces),

- to scavenge ROS, which are in general formed to an increased extent under stress, including salt stress.

Several groups of low molecular weight organic compounds, which belong to the carbohydrates and amino compounds, fulfil these functions (see Chap. 1.5.2.6, Fig. 1.5.11). In the following, the various osmolytes are discussed individually:

1. glycerol
2. polyols
3. proline
4. QACs and TSCs

1. Glycerol

The simplest osmolyte is **glycerol**. The green alga *Dunaliella*, which does not have a cell wall (see Chap. 1.1.4), adjusts to salt stress in the cytoplasm by rapid synthesis of glycerol. In this instance it is a predominantly osmotic phenomenon, as a cell without a cell wall is, of course, particularly endangered by changes in the osmotic potential of the medium. *Dunaliella* also responds with glycerol synthesis if the osmotic stress is artificially generated by polyols (Zelazny et al. 1995).

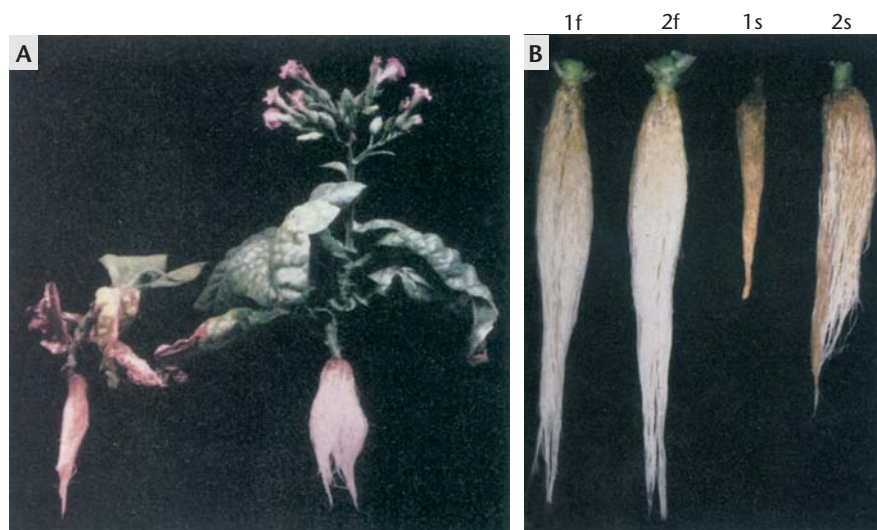


Fig. 1.6.10. Alleviation of salinity stress by constitutive expression of mannitol-1-phosphate dehydrogenase in transformed tobacco. The transformed plants synthesise and accumulate the osmolyte mannitol. **A** Control plants (*left*) and transformed plants (*right*) after 30 days of growth in nutrient solution containing 250 mM NaCl. **B** Roots of control (1) and transformed (2) plants in salt-free (f) and salt-containing (s) nutrient solution after 30 days of growth. (Tarczynski et al. 1993)

2. Polyols

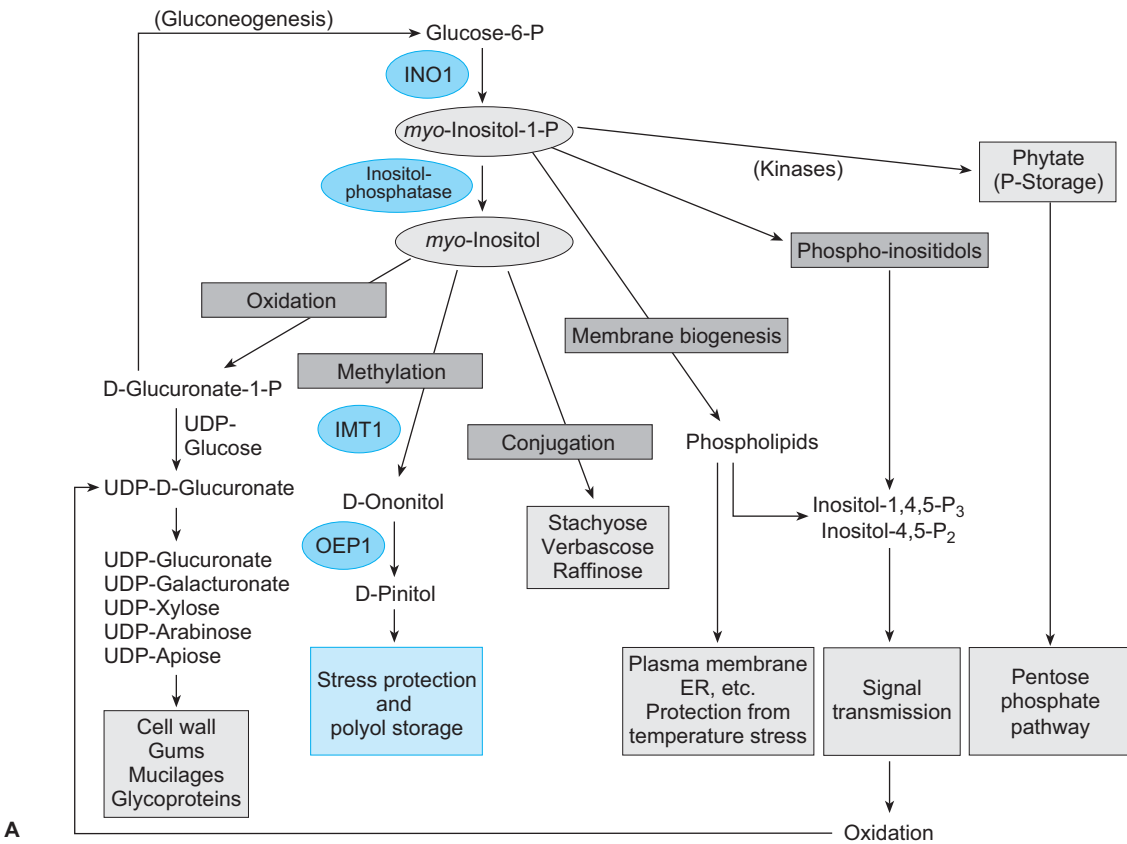
The second important subgroup of carbohydrates is composed of **polyols** (sugar derivatives). Their numerous hydroxyl groups bestow these compounds with hydrophilic properties, i.e. properties which closely approximate those of water clusters. Many algae of brackish water synthesise polyols rapidly and effectively as reduced derivatives of monosaccharides in response to osmotic stress; they possess the corresponding dehydrogenases.

The **manna** of the Bible could well have been a polyol produced by desert plants (Crum 1993). Since the synthesis of these sugar alcohols requires only a single enzyme – a dehydrogenase which reduces the corresponding sugar – the sugar alcohols can easily be made use of to artificially enhance salt tolerance. [Figure 1.6.10](#) shows the effect of the constitutive expression of mannitol in tobacco plants transformed with mannose dehydrogenase under the control of the S35 promotor. The mannitol accumulates, because wild-type tobacco plants do not produce the polyol and cannot further metabolise it when it is synthesised. Despite the carbohydrate expenditure required to produce this osmolyte, the transgenic tobacco plant does not grow notably more poorly than does the wild type in the absence of salt stress, but it does grow considerably better when stressed with salt.

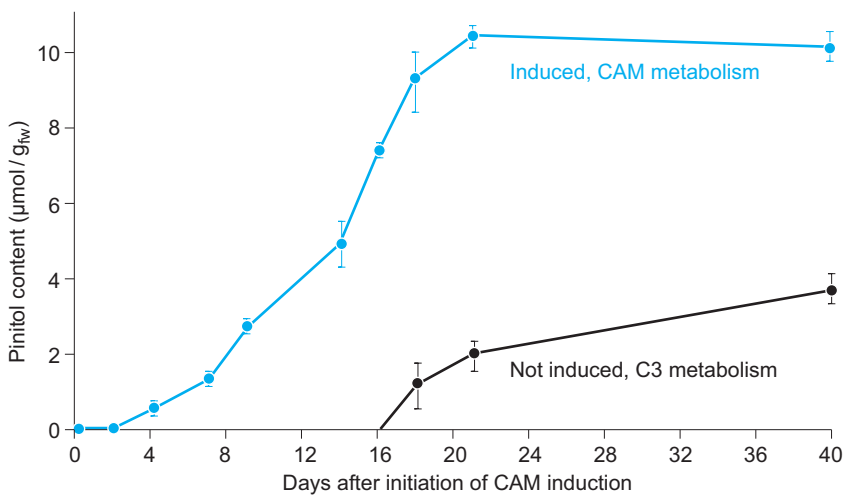
Open-chain polyols occur in many plants, but they are more frequently found in glycophytes (e.g. in many Rosaceae) than in halophytes.

In addition to their osmotic effect, glycerol and open-chain sugar alcohols also provide protection against ROS when they accumulate (see [Chap. 1.3.5](#)). The reduction of monosaccharides (glyceraldehyde-3-phosphate and mannose- or fructose-6-phosphate) to their corresponding sugar alcohols requires reduction equivalents, i.e. electrons, which could also be transferred to oxygen under appropriate circumstances and would then contribute to the formation of ROS. Glycerol is a far more favourable osmolyte than a hexose in terms of the carbohydrate-to-hydrogen consumption rate. Transgenic organisms producing glycerol as an osmolyte thus show better growth than those making use of equiosmolar concentrations of higher sugar alcohols (Shen et al. 1999).

Cyclic sugar alcohols, so-called **inositols** or **cyclitols**, are very often accumulated as osmolytes in halophytes. They have the cell biological advantage over open-chain polyols in turning over slowly, i.e. they are withheld from rapid metabolism under deficiency situations (e.g. when photosynthesis is severely restricted because of stomatal closure) and are thus retained to function osmotically. Their biosynthesis originates from glucose-6-phosphate, and the great



A



B

Fig. 1.6.11. A The physiological functions of *myo*-inositol and its derivatives in plant cells (after Bohnert et al. 1995). B Pinitol accumulation during the induction of CAM in *Mesembryanthemum crystallinum* by irrigation with 400 mM NaCl solution. On day 21 the share of D-pinitol of the soluble carbohydrate fraction was 71% in the salt-treated plants and only 5% in the control plants. The experiment shows that a slight amount of pinitol synthesis also takes place in plants not subjected to salinity stress. (After Paul and Cockburn 1989)

Table 1.6.4. Contents of osmolytes in leaves of 6-week-old transgenic tobacco plants after 2 weeks of drought. The plants had been transformed with the gene for inositol methyltransferase from *Mesembryanthemum crystallinum*. (After Sheveleva et al. 1997)

Osmolyte	Leaf 11		Leaf 7	
	Day ($\mu\text{mol/g FW}$)	Night (% of value during the day)	Day ($\mu\text{mol/g FW}$)	Night (% of value during the day)
Proline	4.2	39	1.6	17
Glucose	7.0	7	5.7	25
Fructose	7.6	5	15.7	27
Sucrose	8.4	19	6.8	12
K ⁺	352	79	236	72
Na ⁺	24	113	11.1	96
Cl ⁻	200	91	129	88
<i>myo</i> -Inositol	6.4	137	3.8	88
Ononitol	34.6	89	25.8	77

variety of these cyclitols is synthesised by means of relatively few biochemical reactions (Box 1.6.2). As is shown in Fig. 1.6.11, inositol metabolism is linked with many cellular functions. The metabolically centrally placed *myo*-inositol is not accumulated as an osmolyte, but its metabolically inactive methyl derivatives are. Well known in this regard are mangroves, which accumulate above all bornesitol, pinitol and quebrachitol in their leaves (Popp and Smirnoff 1995).

In the facultative CAM plant *Mesembryanthemum crystallinum*, the gene for inositol methyltransferase is activated primarily by salinity and cold. Salinity additionally induces the transition from C3 to CAM metabolism. In this process the expression of inositol methyltransferase is induced in the leaves, and the synthesis of the key enzyme for inositol biosynthesis – inositol-1-phosphate synthase – is intensified coordinately (Nelson et al. 1998). D-Ononitol and D-pinitol thus accumulate in *Mesembryanthemum* during salt stress (and drought) (Fig. 1.6.11 B). The synthesis of the latter compound requires a further epimerase (OEP1), which transforms D-ononitol into D-pinitol (Box 1.6.2). At the same time, the osmolyte proline accumulates ten-fold. The induction of CAM and the accumulation of proline are both independent of ABA.

The induction of CAM and the production of osmolytes are not, however, obligately coupled in *Mesembryanthemum*: In young plants, which do not yet possess sufficiently large cells (vacuoles to store malic acid), CAM cannot be induced, or only to a small extent. Full CAM induction is only possible in plants older than

5 weeks. Younger plants are, however, able to activate specific protective measures under salt stress (polyol accumulation, regulation of ion homeostasis, facilitated water uptake).

Considering the many ways in which cyclitols are incorporated into cell metabolism, it is difficult to ascribe a particular protective function to them. Whereas concentrations of metabolically active sugars (and also of proline) vary markedly between day and night, the concentrations of the cyclitols (and of the ionic osmolytes) remains largely constant during the day-night cycle (Table 1.6.4). This demonstrates, on the one hand, the sluggish metabolism of the methylated cyclitols, but this is also understandable in a cell biology context, as the osmotic stress is not subjected to day-night cycles either. The cyclitols are most probably also ROS scavengers (Smirnoff and Cumbes 1989).

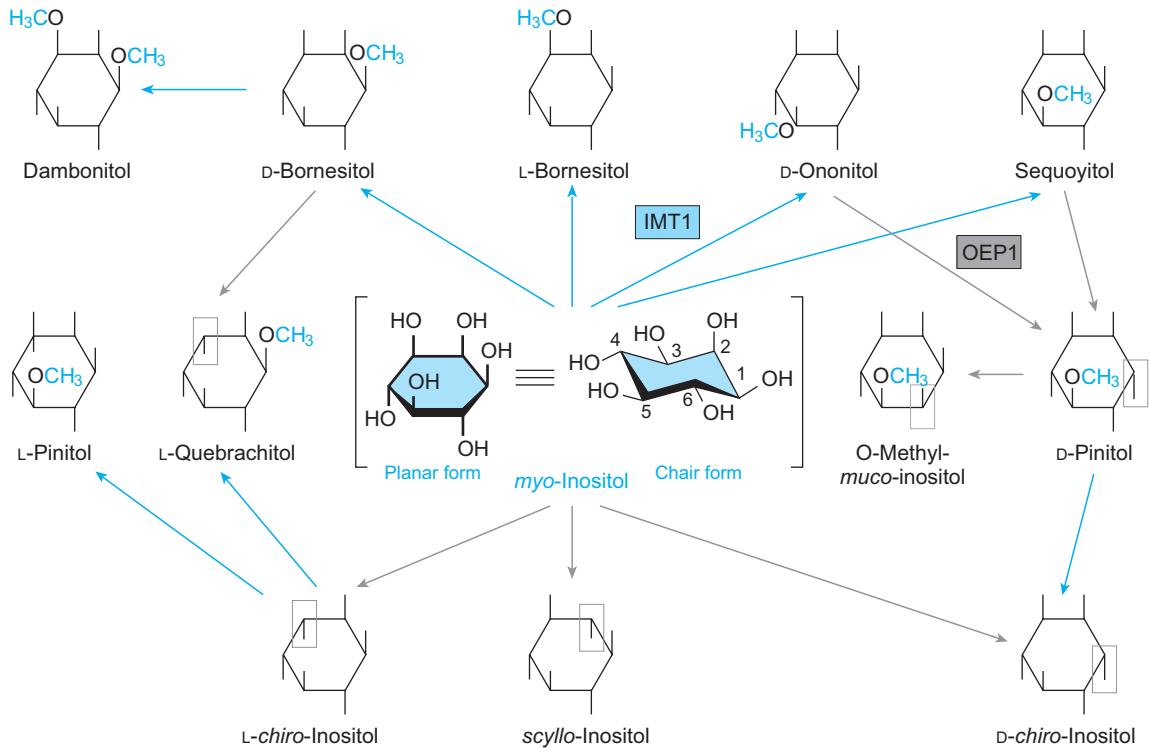
3. Proline

In addition to methylated cyclitols, the amino acid L-proline (Box 1.6.3) accumulates during salt stress in a similarly ABA-independent manner. Proline is regarded as a general stress metabolite and accumulates at up to enormous concentrations in a great variety of stress situations, particularly also in relation to water deficiency. Proline is produced by microorganisms and green plants in different ways (see Box 1.5.5). *E. coli* synthesises proline from glutamate via glutamate- γ -semialdehyde and Δ^1 -pyrroline-5-carboxylate. In eukaryotes, proline may also be formed from ornithine by δ -transamination. Upon osmotic stress, however, the activity of Δ^1 -pyrroline-5-carboxylate synthetase (P5CS) increases, so that the

Box 1.6.2 Metabolism of *myo*-inositol

myo-Inositol is shown with its natural isomers; the formation of further inositols by methylation is indicated by *blue arrows* (methyltransferases, e.g. inositol methyltrans-

ferase 1, IMT1) and that by epimerisation is shown by *grey arrows* (e.g. ononitol epimerase 1, OEP1). The *grey boxes* show the site of epimerisation. (After Kindl 1994)



prokaryote pathway then dominates in all organisms (Delauney et al. 1993).

The endogenous proline level in tobacco (a glycophyte)² was drastically increased by the over-expression of Δ^1 -pyrroline-5-carboxylate synthetase (P5CS; Fig. 1.6.12). Both the wild type and plants transformed with the plasmid pBI121 lacking the P5CS gene served as controls in these experiments. As shown in Fig. 1.6.12 A,B, proline synthesis was controlled by the availability of both water and – obviously – nitrogen. The proline level rose distinctly in the P5CS transformants upon water stress; however, the observed concentration of 6 mg Pro/g FW (~0.6%) was still far below that usually exhib-

ited by salt plants. The osmotic potential thus did not differ from that of the wild-type. The osmotic potential of the wild-type and of the control transformant increased under salt stress (Fig. 1.6.12A), but not that of the plant transformed with P5CS. This is because the P5CS transformant has a distinctly better developed root system³. In this case the stress-alleviating effect (Fig. 1.6.12C–F) could indeed be traced to the accumulation of an osmolyte, namely proline, while in most wild plants other osmolytes accumulate in addition to proline (see Box 1.6.3).

4. QACs and TSCs

The last group of low molecular mass osmolytes to be discussed are the quaternary ammonium compounds (QACs) and tertiary sulfonium com-

² The fact that transgenic tobacco is used in so many experiments is not due to molecular geneticists being smokers, but is based on the ease with which tobacco can be genetically transformed!

³ The reason for the better root growth is not known.

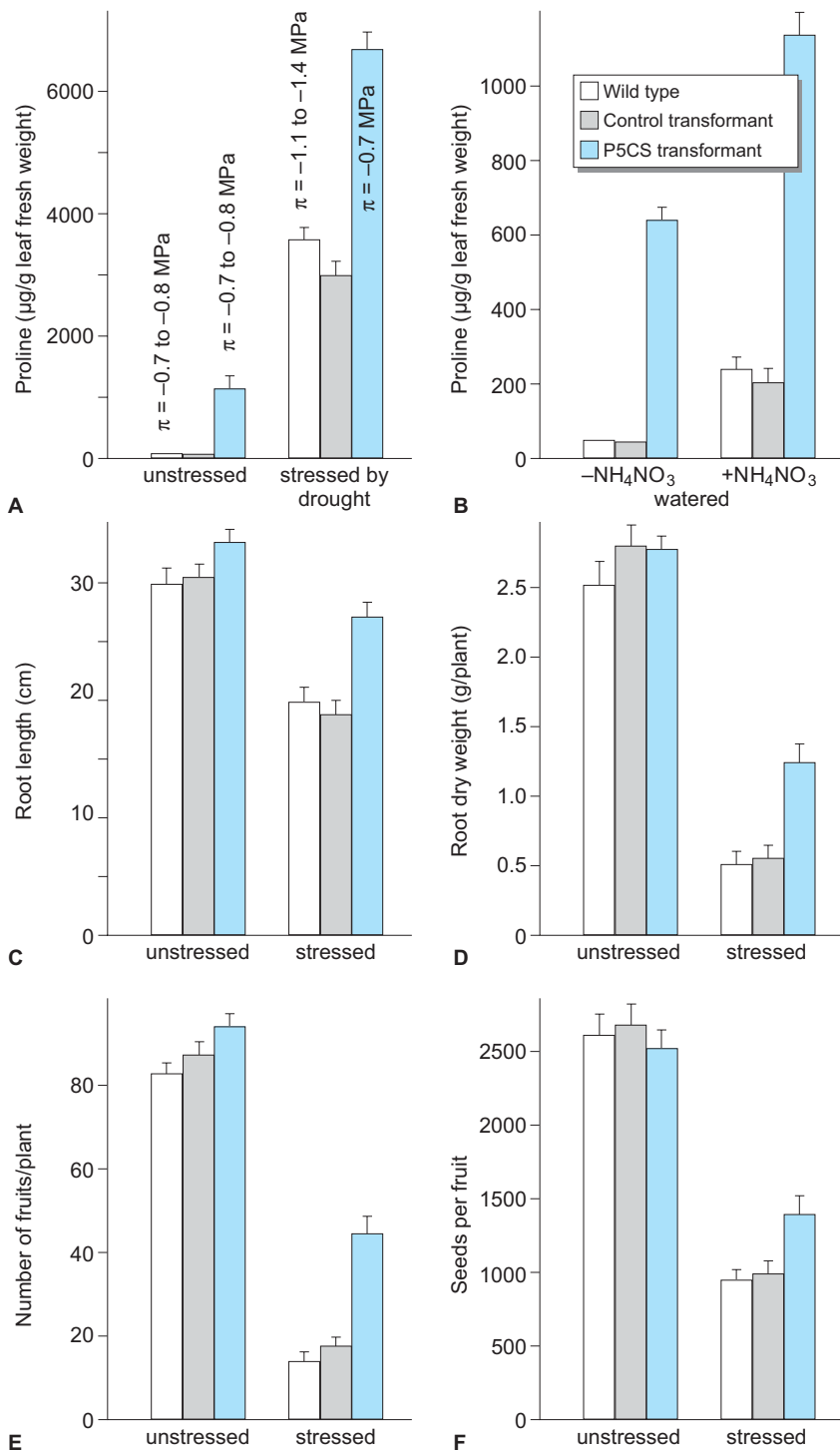


Fig. 1.6.12. Proline as an osmolyte. Tobacco plants were transformed by over-expression of Δ^1 -pyrroline-5-carboxylate synthetase and thereby made less sensitive to osmotic stress. **A** Increase in the proline level in the leaves. **B** Dependence of the over-production of proline on the nitrogen supply to the tobacco plants. **C–F** Morphometric data for the wild-type and the transformants upon cultivation without stress and under salinity stress (500 mM NaCl). (After Kavi Kishor et al. 1995)

Box 1.6.3

How does proline function, and why is this particular amino acid suitable for stress amelioration?

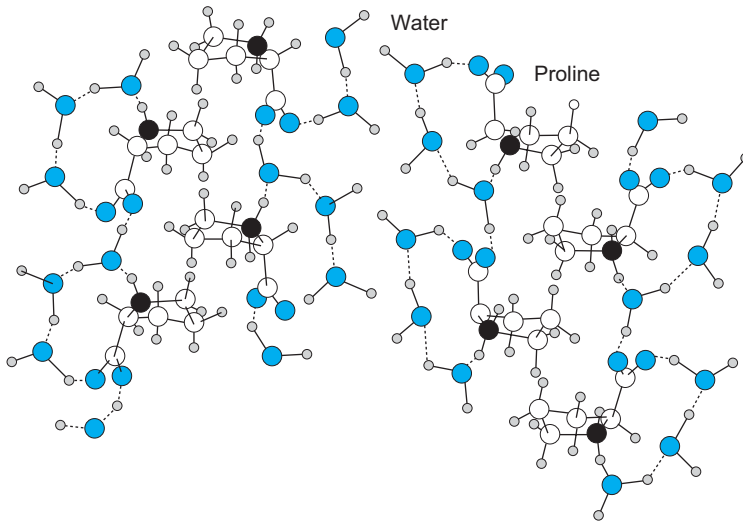


Fig. 1. Molecular model of an aqueous solution of proline. Both the water and the proline molecules form clusters. (After Schobert and Tschesche 1978)

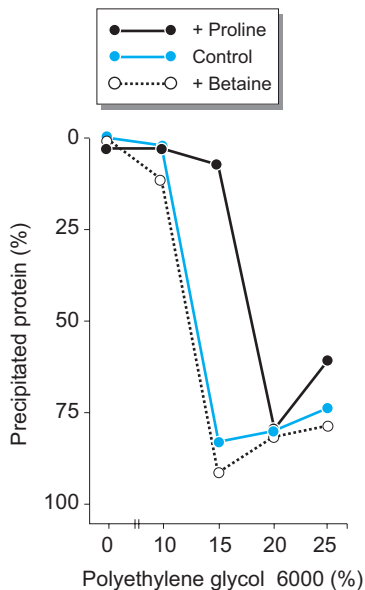


Fig. 2. Reduced precipitability of proteins due to water removal by polyethylene glycol in the presence of proline. (After Schobert and Tschesche 1978)

Proline (Pro) is a special amino acid which, due to its chemical structure, shows unusual properties in aqueous solution. It has the highest solubility of all the proteinogenic amino acids, but at higher concentrations it forms clusters which aggregate via hydrogen bonds between the hydrophilic side chains (Fig. 1). These clusters are strengthened by

hydrophobic interactions between the rings. The amphiphilic Pro-multimers attach themselves readily to poorly soluble proteins, with the hydrophobic side to the protein surface and the hydrophilic side facing outwards, thus increasing the hydrophilic surface of the proteins. Pro accordingly works against the unfolding and denaturation of proteins which result from water removal, e.g. during salting-out by ammonium sulfate or precipitation with ethanol or polyethylene glycol (Fig. 2). It is interesting that another group of osmolytes, the betaines, does not work at all in this manner. It appears that there is something akin to a specificity for osmolytes, as if the individual classes of osmolytes have particular target structures and target molecules in the cell. This would also explain the parallel appearance of several different osmolytes in a single organism. Unfortunately, our knowledge in this regard is still extremely incomplete. Rice seedlings produce a large number of compatible solutes under salt stress, including many carbohydrates. It was thereby observed that Pro does not, e.g., protect against secondary oxidative stress (measured as chlorophyll bleaching), whereas trehalose effectively reduces this stress, as does also, e.g., mannitol and perhaps also cyclitols. Pro has no protective effect in these plants, at least not at low concentrations.

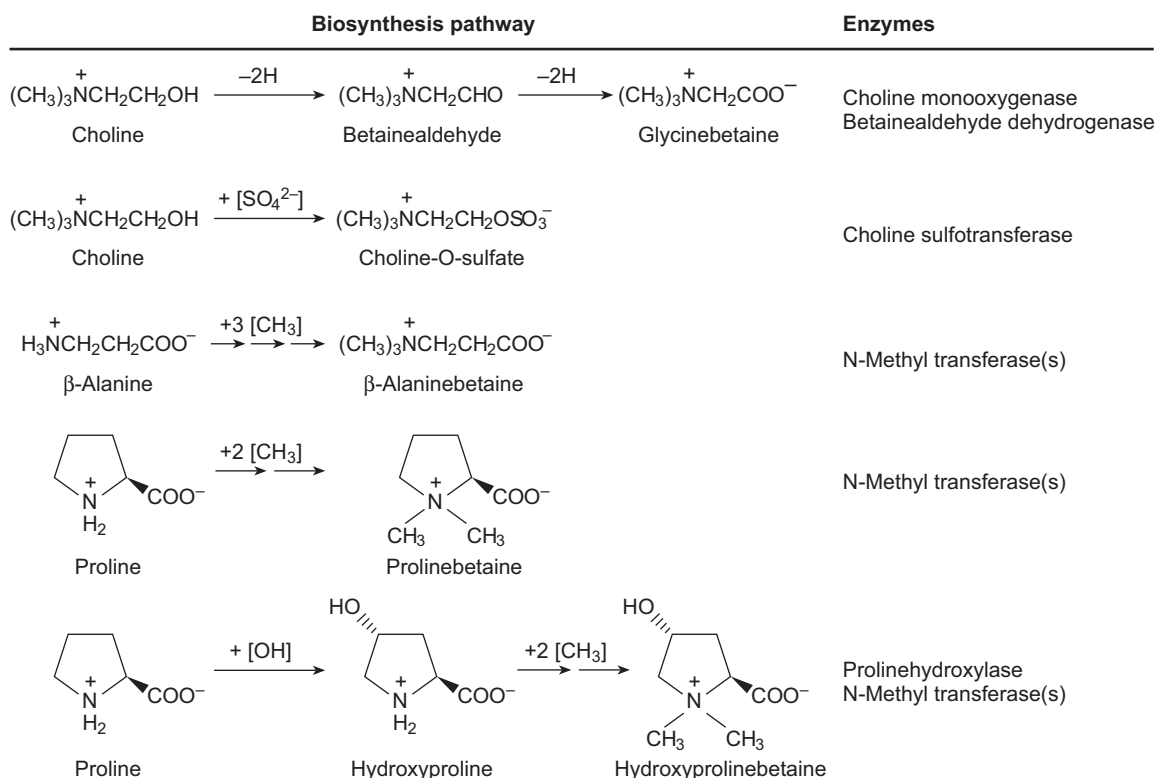


Fig. 1.6.13. Biosynthesis and structures of the zwitterionic QACs in higher plants. (After Hanson et al. 1994)

pounds (TSCs). These compounds are regularly found at high concentrations ($>5 \mu\text{mol/g}$ dry weight; Rhodes and Hanson 1993) in halotolerant representatives of the Chenopodiaceae, the Poaceae and the Asteraceae, as well as in some halophilic genera of the Convolvulaceae and the Plumbaginaceae. They occur in heavy metal-tolerant species, too, and are by no means restricted to plants alone; bacteria, cyanobacteria and animals are also capable of producing these substances. A selection of these osmolytes has already been briefly referred to (see Chap. 1.5.2.6, Fig. 1.5.11).

The biosynthetic pathways leading to these compounds are now known (Fig. 1.6.13), and the corresponding genes have largely been cloned. **Glycine betaine**, the simplest representative of this family of substances, is not formed – as one might assume – by the methylation of glycine, but rather by the oxidation of choline by means of a ferredoxin-dependent monoxygenase. β -Alanine betaine, proline betaine and hydroxyproline betaine are, however, indeed formed by the transfer of a methyl group from S-adenosyl methionine. These osmolytes are zwitterionic, i.e. they have a cationic as well as an anionic centre.

It has been shown in the example of the salt-tolerant Plumbaginaceae that individual plants can synthesise and accumulate various species of these zwitterionic osmolytes. All accumulate **choline sulfate** and – with the exception of the mangrove *Aegialitis* – at least one betaine, some species even several. Since the mangrove plant *Aegialitis* actively secretes salt, it is probably less dependent on osmolytes and therefore produces only choline sulfate. For most representatives of the family, the stress consists of salinity and drought, and is sometimes compounded by oxygen deficiency due to the presence of salt crusts. Although there is no direct relationship between stressor combinations resulting from particular habitats and preferentially accumulated osmolytes, there appears to be a vague coincidence of choline sulfate and its derivative glycine betaine with drought stress, and of alanine betaine with salt stress (Hanson et al. 1994).

In addition to its osmotic function, choline sulfate undoubtedly also plays a role in the disposal of sulfate, which is important at marine sites. This is because sulfate cannot be excreted via the epidermal salt glands.

Table 1.6.5A. Composition of the sap of maize leaves of the glycine betaine-producing line *Bet1/Bet1* and the *bet1/bet1* line lacking glycine betaine. The plants were grown on a defined soil mixture and watered with an inorganic nutrient solution. The salt treatment took place 3 weeks after sowing by means of a gradual adaptation from 42.5 to 127.5 mM NaCl during the course of 4 weeks. (After Saneoka et al. 1995)

Conditions of growth	Genotype	Organic solutes (mM)			Ions (mM)					
		Betaine	Amino acids	Sugars	K ⁺	Na ⁺	Ca ²⁺	Mg ²⁺	Cl ⁻	NO ₃ ⁻
NaCl-free	<i>bet1/bet1</i>	0.2	17.0	156.9	97	0.2	11.2	13.5	48.3	54.7
	<i>Bet1/Bet1</i>	3.2	21.0	149.5	102	0.2	11.4	14.0	43.9	46.8
With NaCl	<i>bet1/bet1</i>	0.2	22.4	88.1	112	13.3	13.0	13.0	194	32.7
	<i>Bet1/Bet1</i>	10.9	23.4	110.9	120	13.6	14.4	14.4	231	24.0

Table 1.6.5B. Growth rates of the lines *bet1/bet1* and *Bet1/Bet1* under salt-free and saline conditions. Plants were grown as specified in Table 1.6.5A; the salt treatment commenced 30 days after sowing. (After Saneoka et al. 1995)

Growth conditions	Genotype	Leaf growth rate (cm ² /day) after salt application			
		Days 5–10	Days 10–15	Days 15–20	Days 20–25
NaCl-free	<i>bet1/bet1</i>	289	268	233	175
	<i>Bet1/Bet1</i>	260	260	224	184
With NaCl	<i>bet1/bet1</i>	207	168	82	84
	<i>Bet1/Bet1</i>	218	190	121	121

Since glycine betaine has long been thought to be an efficient osmolyte, efforts have been made to develop lines of crop plants which produce large amounts of this compound upon salt stress by classical breeding. This has been achieved with maize: The sister lines *Bet1/Bet1* are glycine betaine producers, the homozygotic *bet1/bet1* are glycine betaine-deficient.

Table 1.6.5A shows the enhanced glycine betaine accumulation of the *Bet1/Bet1* maize, particularly in relation to salt stress; the contents of Na⁺ and particularly Cl⁻ are also distinctly higher on salt. The decrease in the concentration of carbohydrates in the expressed sap of the leaves (which is much higher than that of glycine betaine) correlates with the increase in the glycine betaine concentration. Presumably some of the carbohydrate carbon was used for the synthesis of the physiologically superior osmolyte glycine betaine.

Salt inhibits growth, but in this regard *Bet1/Bet1* is seen to suffer considerably less (i.e. it exhibits better leaf growth) than does *bet1/bet1* under salt stress (Table 1.6.5B). The less impaired growth correlates with an at least partial maintenance of cell turgor under salt stress (0.06 MPa in *bet1/bet1* and 0.2 MPa in *Bet1/Bet1*; Saneoka et al. 1995).

Glycine betaine accumulates particularly in young tissues, where it competes with NaCl and

somewhat reduces the content of the salt. There is, however, no indication that glycine betaine is transported within the plant. It evidently is stored at the site at which it is produced from choline (Nakamura et al. 1996).

Because glycine betaine ameliorates stress and plants are evidently unable to metabolise this compound and thus accumulate it, attempts have long since been made to transform crop plants lacking glycine betaine with the key gene encoding choline monooxygenase (CMO), which is required for glycine betaine synthesis. This is difficult in that this enzyme contains a Rieske-[2Fe-2S]-centre. Since glycine betaine synthesis takes place in the chloroplast, it must also be taken into consideration that the recombinant protein (CMO) would have to be transported into the chloroplasts. Such a transformation has recently been successful with tobacco (Nuccio et al. 1998). Accumulation of glycine betaine was, however, only weakly pronounced, because tobacco produces choline – the starting compound for glycine betaine synthesis – only in very small amounts (McNeil et al. 1999).

What Is the Special Protective Effect of QACs?

Transformation of the cyanobacterium *Synechococcus* with an *E. coli* glycine betaine synthesis cassette consisting of choline monooxygenase, betaine aldehyde dehydrogenase, a choline

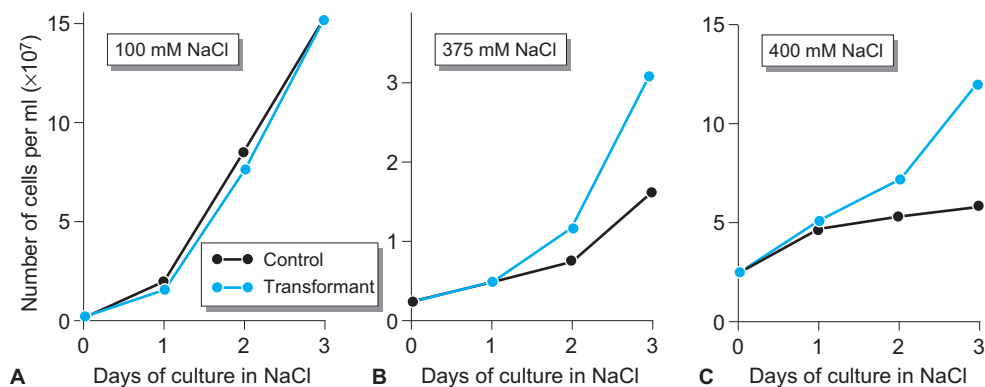


Fig. 1.6.14. Growth of wild-type and transformed *Synechococcus* cells under salinity stress. The cells were grown in choline-containing medium which was supplemented with NaCl at the indicated concentrations after 2 days (time 0 in the graph). The transformants contained the glycine betaine cassette. The glycine betaine concentration in the cells stressed with the higher NaCl concentrations was about 15 times higher than in the unstressed cells. (After Nomura et al. 1995)

Table 1.6.6. Effect of salinity on the photosynthetic electron transport of glycine betaine-accumulating *Synechococcus* cells (transformants) and non-accumulating *Synechococcus* (control) cells. *DADH₂* reduced 2,3,5,6-tetramethylphenylenediamine; *MV* methyl viologen; *PBQ* phenyl-1,4-benzoquinone. The reaction of photosystem I consumes (reduces) O_2 and that of photosystem II produces O_2 . (After Nomura et al. 1995)

Reaction	O_2 production or uptake ($\mu\text{mol}/\text{mg Chl}\times\text{h}$)			
	<i>Synechococcus</i> control cells		<i>Synechococcus</i> transformants	
	-NaCl	+200 mM NaCl	-NaCl	+200 mM NaCl
$H_2O \rightarrow CO_2$	57	40	52	39
PS I ($DADH_2 \rightarrow MV$)	-152	-96	-217	-177
PS II ($H_2O \rightarrow PBQ$)	71	60	78	77

transport protein and a regulatory protein led to glycine betaine accumulation in the transformants, in particular under high salt stress. These cells grew significantly better under salt stress than did control cells, although their growth was distinctly slower than at low salt stress (Fig. 1.6.14).

The reason for the improved growth is that the photosynthetic electron transport is less impaired by salt in the glycine betaine-containing cells (Table 1.6.6). Glycine betaine is synthesised in the chloroplast and performs its protective function principally in this organelle, where it appears to stabilise mainly the protein complexes of the photosynthetic membrane (Papa-georgiou and Murata 1995). In this it differs markedly from the osmolyte glycerol, which has no stabilising effect on the protein complexes. Betaines are so-called **chaotropic compounds**, i.e. zwitterions, which counteract effects caused by ionic forces. They develop their maximum protective effect specifically at those sites where

complexes or subunits of proteins threaten to dissociate as a result of salt stress.

DMSP (3-Dimethyl Sulfoniopropionate)

Less is known about TSCs than about QACs. The best-known osmolyte of this group is dimethyl sulfoniopropionate (DMSP), which has been found mainly in algae, but it has also been recently found in certain grasses and Compositae⁴. The starting material for the synthesis of DMSP is the amino acid methionine, which is metabolised to DMSP in marine algae and terrestrial plants according to different pathways. Since the starting compound and the end product are the same in each case, the pathways differ in principle only in the sequence of the individual steps involved (removal of the amino group, addition of a methyl group, decarboxyla-

⁴ DMSP is the biogenetic precursor of the atmospheric trace gas dimethyl sulfide, which is released above all by algae.

tion). The various groups of land plants do synthesise DMSP in different ways, however, whereby they all require betaine aldehyde dehydrogenase for the last enzymatic step.

1.6.2.4 Induction of Protective Proteins by Salt Stress

The previous sections have made it clear that salt stress triggers numerous cellular reactions which are all interrelated and complement each other synergistically.

These reactions also include the synthesis of more or less specific protective proteins (Fig. 1.6.15). These may be, on the one hand, osmolyte-producing enzymes or, on the other, proteins from the LEA group (see Chap. 1.5.2.5) which ameliorate the dehydration stress triggered by high salt impact. In addition to these rather specifically acting proteins, another group of polypeptides is formed and accumulated during salinity stress whose function in relation to the stressor salt is not evident. This group includes both proteins which are also often formed during pathogen attacks and proteins of the cell wall and extracellular matrix.

The great variety of proteins which are synthesised and in some cases also strongly accumulated due to the effect of salt makes it difficult to assign the proteins to particular stress responses. The fact that LEA proteins are typical dehydration protection proteins (see Chap. 1.5.2.5) of course does not mean that they specifically ameliorate only the dehydration stress component of salinity.

One explanation for the occurrence of proteins which are not specific for salt stress in organisms subjected to salinity stems from the signal compounds leading to the strain resulting from salinity (see Chap. 1.6.2.1). Salt stress leads to an increase in the levels of ABA and jasmonate in the cell. ABA mediates the linkage of the responses of the cell to salt stress and drought. This stress response is carried over into the re-

sponses to stress caused by wounding or pathogen attack via the jasmonates (see Chaps. 1.10.1 and 1.10.2). However, a NaCl-dependent gene expression has been observed which can be assigned to neither ABA, nor jasmonate, nor the ethylene which is occasionally detected in connection with salt stress. This corresponds to the circumstances during drought stress which were described earlier (see Chap. 1.5.2.3).

Osmotins

Osmotins are proteins which accumulate in cells under salt stress and may constitute, e.g. in tobacco cell cultures, up to 12% of the total protein content. To the extent to which their expression is induced via ABA, they can also be synthesised and accumulated under drought conditions (Singh et al. 1989). If their expression is regulated via the jasmonate signal, they are also found upon pathogen attack. Although they were discovered during investigation of the cellular reaction to salt stress and were accordingly termed osmotins, these proteins are not specific for salt stress. Nowadays, they are rather classified as pathogen-related proteins (see Chap. 1.10.2) and referred to as osmotin-like proteins (OLPs), which are products of a multigene family.

Osmotins are relatively small proteins (M_r between 24 and 50 kDa) which are conspicuous in terms of their alkaline isoelectric point (Table 1.6.7). They have a net positive charge at the pH values of the cell, i.e. they are cations. As such, they are probably able to interact efficiently with most anionic membrane proteins (Kononowicz et al. 1993). They possess a large number of disulfide bridges, but no free SH groups (Zhu et al. 1995).

Several osmotins have been found in each of the plants that have been subjected to detailed study; they differ not so much in their molecular mass as in their isoelectric points and other protein characteristics. For tobacco, the best-studied species, a pre-protein has been discovered in addition to the mature protein, from which it could be concluded that mature osmo-

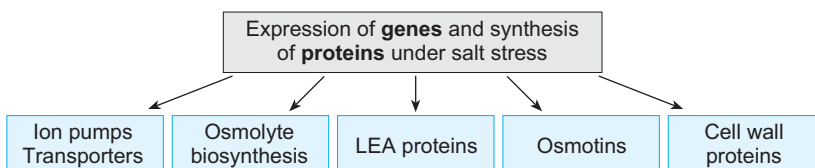


Fig. 1.6.15. The various groups of proteins induced by salinity stress

Table 1.6.7. Characterisation of osmotin and some related proteins ("OLPS"). a: known from the cDNA; b: probably targeted to the vacuole. (From various publications, above all Singh et al. 1989)

Type/constitutive type/ protein designation	Molecular mass (M _r) kDa	Isoelectric point	Expression	Characteristics
<i>Atriplex nummularia</i> /halophyte				
pA8	23.8	8.3	Constitutive and ABA-controlled	a
pA9	23.8	6.9	NaCl-inducible, ABA-independent	a
Tobacco/glycophyte				
Pre-osmotin	28.5		ABA-, jasmonate-, and NaCl-inducible	
Osmotin I	26.0	7.8		Signal peptide present, soluble, protease-sensitive, probably ubiquitous in the cell
Osmotin II		8.2		Vacuolar inclusion bodies, protease resistant
Potato (<i>S. comersonii</i>)/glycophyte				
pA13	26.7	6.7	ABA-, cold-, NaCl-, wounding-, and infection-inducible	a, b
pA35	26.7	5.7	ABA-, cold-, NaCl-, wounding-, and infection-inducible	a, b
pA81	27.5	8.0	ABA-, cold-, NaCl-, wounding-, and infection-, inducible	a, b
Tomato/glycophyte				
Osmotin 24	24.0		Constitutive, ABA-controlled	
Osmotin 26	26.0		NaCl-inducible	
<i>Thaumatococcus daniellii</i> /glycophyte				
Thaumatocin I and II	22.1	12.0		Weight for weight 3000 times sweeter than sucrose
Maize/glycophyte				
α -Amylase/trypsin inhibitor	22.1		Inducible by infection and wounding	

tins occur in specific compartments. However, the sequence which is considered to represent a signal peptide gives no indication as to the compartment to which the protein is targeted.

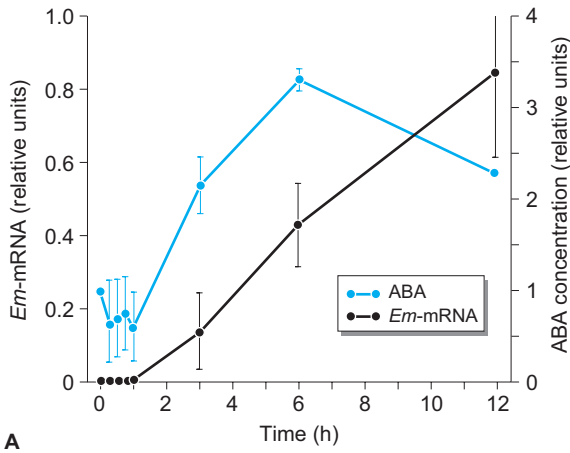
In tobacco cells, osmotin is found in a soluble form (osmotin I) and an insoluble form (osmotin II), the latter in the form of inclusion bodies in the vacuole. Because both forms react with the same antibody, it is presumed that osmotin II is an aggregation product of osmotin I (Singh et al. 1989).

It is striking that there is a high degree of homology between the amino acid sequences of the osmotins and of proteins involved in defence against plant pathogens (the so-called PR proteins; see Chap. 1.10.12) or of proteins that can be induced by wounding (e.g. the inhibitor of animal α -amylase and of the trypsin of maize and other cereals). Although these proteins do not interact with antibodies against osmotins, much speaks for including them in the family of the osmotins (therefore the term OLPS, see above). It is particularly noteworthy that they

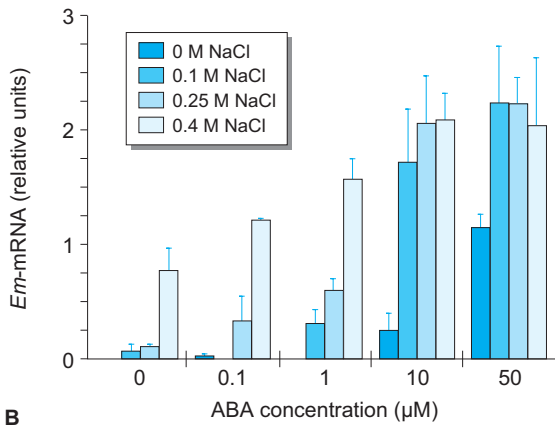
are similar to **thaumatin**, a related protein from the East African plant *Thaumatococcus daniellii* (Marantaceae) which tastes 100,000 times sweeter than sucrose on a molar basis. This protein has an extremely alkaline isoelectric point (IEP) on account of its particularly high content of basic amino acids. The secondary structure of thaumatin is known (de Vos et al. 1985), and it is thought that osmotins have a similar hydrophobic barrel structure of antiparallel pleated sheets with projecting hydrophilic loops. An interaction with biomembranes might be initiated via these loops (see below). At any rate, however, no other osmotins have any taste.

Expression of Osmotins

An increase in endogenous ABA concentration or an application of ABA stimulates adaptation to salinity and promotes the expression of osmotins. In most cases, however, it becomes apparent that osmotin synthesis is not exclusively, but only partly under the control of ABA, and that salt and ABA contribute synergistically to



A



B

Fig. 1.6.16. A Kinetics of ABA accumulation and Em transcript enrichment after treatment of rice suspension culture cells with 400 mM NaCl. The ABA content at time 0 was 0.79 ± 0.27 nmol/g dry weight. B Interaction between externally applied ABA and NaCl in the induction of Em expression in suspension culture cells of rice. The cell cultures were simultaneously inoculated with ABA and NaCl and harvested after 24 h. Em is one of the LEA proteins of rice. (After Bostock and Quatrano 1992)

the expression of osmotin mRNA (Grillo et al. 1995).

Salt is therefore required for the maximum expression of osmotin genes, and the accumulation of osmotins upon salt stress, too, requires a high osmotic potential. Osmotin synthesis evidently does not take place only under the transcriptional control of ABA and salt, but is also under the translational or post-translational control of both or one of these factors (La Rosa et al. 1992). The result is an increase in sensitivity towards ABA due to NaCl (see also Fig. 1.6.16).

Gene fusion products of the osmotin promoter and a reporter gene (GUS) have been used to

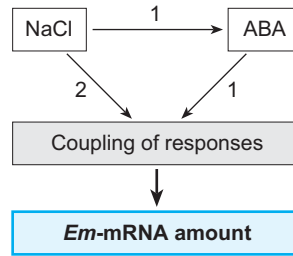


Fig. 1.6.17. Model of the interaction between NaCl and ABA in the induction of Em expression in suspension culture cells of rice. Salt can effect induction of the LEA gene Em via ABA (route 1) or directly, i.e. independently of ABA (route 2). Both routes converge on a common intermediate where they interact and lead to enhanced expression of the mRNA. (Bostock and Quatrano 1992)

study the spatial and temporal expression patterns of osmotins in the plant as well as the sensitivity of the promoter to the various types of stress. The region of the promoter which is responsive to ABA, ethylene, viral infections, salt, drought, UV, wounding, and fungal infections is quite large (~1100 base pairs); the minimum region required for the ABA effect is considerably smaller (the so-called fragment A of base pairs -248 to -108; Liu et al. 1995). The expression of the osmotin gene can be clearly separated from the accumulation of the protein itself. The latter can only be detected upon salt stress or fungal infection.

Corresponding to its stimulation by ABA, the osmotin gene is expressed in all situations in which drought results in an elevated ABA level: During the ripening of pollen grains, during the drying of seed pods, during the senescence of flowers, and in senescing leaves. An accumulation of osmotin does not take place in these cases, however. Osmotin does accumulate though during salt stress, particularly in the elongation zone of the root, in old leaves, in the xylem parenchyma of the shoot, and in the epidermis (Kononowicz et al. 1993).

Salt induces the expression of other protective proteins in addition to osmotins; best known are the LEA proteins and how these work. The expression of these proteins is partly dependent on ABA (see Chap. 1.5.2.2), but exhibits – as is the case with osmotin – at least one additional inducer, namely salt (see Figs. 1.6.16 and 1.6.17).

Induction by salt may be mediated via the “stress hormone” jasmonate in certain cases. Jasmonates induce the expression of many proteins with protective effects, amongst them os-

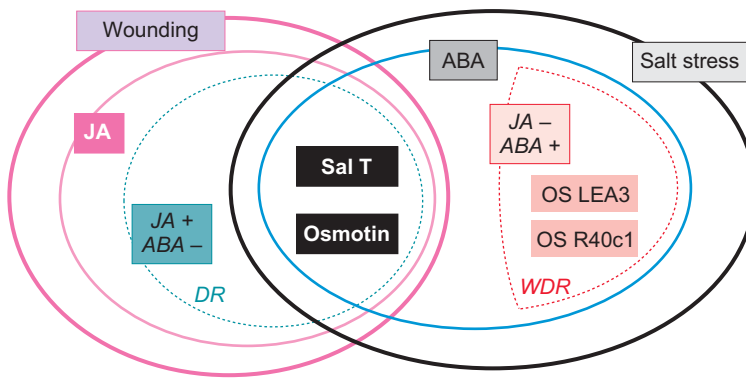


Fig. 1.6.18. Model of the effects of jasmonate and ABA on the expression of genes which are induced by salt stress. ABA, JA Gene expression influenced by ABA or JA or both; JA+/ABA- and JA-/ABA+ antagonistic effects of JA and ABA. *Overlap* Synergistic effects; *WDR* water deficit response; *DR* defence response. *Sal T*, osmotin, *OS LEA3* and *OS R40c1*: genes. (After Moons et al. 1997)

motins and PR proteins. The expression of some of these (osmotins) is induced by both jasmonate and ABA. In this case, various stressors each probably preferentially trigger one of the two signal pathways to a particular extent. Special attention is thereby paid to the interaction of salt stress and stress due to infection or wounding, because it has become apparent that the response to one of these stressors causes a “systemically induced resistance” (immunity) to the other stressors. The next section will explain what this cross protection is due to.

The Function of Osmotins

In contrast to the LEA proteins (see Chap. 1.5.2.5), the function of osmotins in salt stress is unclear. If the conception of an unspecific function as a consequence of the induction pathway is not acceptable (it would be uneconomical in light of the sometimes enormous accumulation of osmotins), the cell biological role of the osmotins must be deduced from their relationship to PR proteins.

Transformation of potato plants with the osmotin gene from tobacco under the control of the strong (CaMV)35S promoter leads to osmotin accumulation and increased resistance to *Phytophthora infestans* (potato blight).

Osmotin inhibits the growth and spore germination of a number of pathogenic fungi such as *Phytophthora*, *Botrytis* and *Helminthosporium* in a manner which is nevertheless species-specific. It depolarises the cell membrane potential of the fungal hyphae by eliminating the pH gradient. This could be brought about by a two-fold mechanism: Thaumatin (see above) exhibits a tertiary structure fixed by eight disulfide bridges, of which the N-terminal domain has similarities to receptor-binding proteins. This highly conserved domain, which is also present

in osmotin, could bind to certain regions of the fungal membrane and integrate its hydrophobic “barrel” of antiparallel β -pleated sheets into this membrane. This “barrel” would then produce a pore (a hole) in the membrane.

PR proteins and chitinases bind preferentially to actin and thus accumulate at the sites at which fungal hyphae penetrate into the cell, where the cytoskeleton is also amassed. The defence enzymes and the poration mechanism put the intruding fungal hyphae under particularly strong attack.

Can this situation be connected with osmotic stress? Pathogen attack destroys the host cell directly or during the course of the hypersensitive reaction (see Chap. 1.10.2), and the enzymes and substrates released damage the neighbouring cells, beginning with the plasma membrane. The breakdown of the selective permeability of this membrane leads to osmotic stress, whereby the toxins of the pathogen intensify the effect. This damage can be recognised macroscopically by the wilting of the infested plant parts and organs.

Fungal attack and osmotic stress are thus causally linked. Both induce not only the expression of the *OSM* gene, but also the accumulation of osmotin. Osmotic stress exerts itself mainly via ABA, pathogenic stress via jasmonate.

Osmotin and LEA proteins, as well as PR proteins, are expressed and accumulated via both pathways, and probably also by means of a third, ABA- and jasmonate-independent route (Fig. 1.6.18). Since osmotins are metabolically very inert, as indicated by the vacuolar inclusion bodies, it is understandable that the component of salt resistance contributed by osmotin is maintained for a long time after a salinity stress. Similarly, pathogen resistance (latent) is also maintained because of the supply of osmotin in the cell. Osmotins thus represent a very interest-

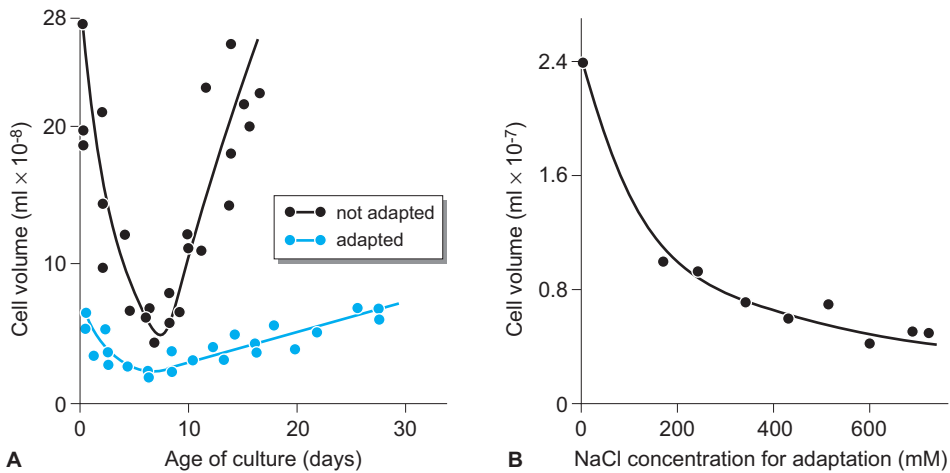


Fig. 1.6.19. Cell growth under salinity stress. **A** Cell volume during the course of a cell culture from the inoculum until into the stationary phase. The adapted tobacco cells grew at 428 mM NaCl in the medium. **B** Dependence of the cell size in the stationary phase on the salt content of the medium. (After Iraki et al. 1989a)

Table 1.6.8. Excretion of cell wall material from tobacco suspension culture cells in the stationary phase. The medium of the non-adapted cells contained no NaCl, that of the NaCl-adapted cells contained 428 mM salt. Drought stress was achieved with 30% polyethylene glycol. Uronic acid is a measure of pectin. (After Iraki et al. 1989b)

Cell type	(mg/25 ml cell culture)			
	Extracellular material (total)	Carbohydrate (total)	Uronic acid	Protein
Not adapted	26.0	18.4	7.2	0.4
Adapted to NaCl	28.0	24.1	1.1	2.8
Adapted to PEG	1.0	0.8	0.1	0.1

ing possibility for the molecular genetic transfer of pathogen and salt resistance on account of their longevity.

The Effects of Salt Stress on Cell Wall Proteins

Salt stress also leads to reactions in the cell wall. The structural proteins in this compartment are proline- and hydroxyproline-rich proteins (so-called extensins), and glycine- and arabinogalactan-rich proteins which are fixed in the cell wall by cross-linkage with one another or with polysaccharides (Showalter 1993). Since salinity-stressed cells are considerably smaller than non-stressed cells (Fig. 1.6.19), it was thought that changes in cell wall proteins could also take place under these conditions. Cells growing under osmotic stress often have considerably higher turgor than cells without salinity stress. Although their cell walls have the same thickness as those of non-stressed cells, they appear to have considerably less tensile strength (Iraki et al. 1989a). This was explained in terms of the walls of the cells adapted to salt containing

much less cellulose and extensin than do those of the non-adapted cells. On the other hand, suspension culture cells adapted to salt excrete significantly more and above all more protein-rich cell wall material into the medium than do non-stressed cells (Table 1.6.8). These data show that salt stress inhibits cell wall metabolism, especially the dynamics of its polysaccharide metabolism (Iraki et al. 1989b).

The synthesis of cell wall-specific proteins is also influenced by stressors other than salt. Certain extensins are formed in greater amounts upon wounding or fungal infection. They become interconnected with one another or with hemicelluloses and pectin ("formation of papillae") under the influence of H₂O₂, an elicitor or high concentrations of GSH, and are thus insolubly deposited within the cell wall.

Salt stress evidently leads to increased synthesis of cell wall material, but not to its cross-linking, for which the so-called oxidative burst is required (Lamb and Dixon 1997). The polymers so formed are thus increasingly excreted into

the medium, especially since cell wall synthesis is inhibited (see above). Another protein secreted into the medium upon salt stress has been identified as chitinase, which is deposited in small pools in both the cell wall and the vacuole in non-stressed cells. Such chitinases are synthesised in increased amounts and secreted during a pathogen attack. The connection between osmotic stress and pathogenic stress can also be seen here.

1.6.3

Avoidance of Salt Stress

Plants growing in salty surroundings (e.g. along sea coasts) often exhibit the phenomenon of salt exclusion, which is interesting in the context of avoiding salt stress. In mangroves, e.g. *Rhizophoria* or *Sonneratia*, the solution in the xylem vessels is very dilute, constituting 0–1% NaCl compared with 3% salt in the environmental medium. Here, the principle of selective Na⁺ exclusion (no or only very low affinity of the cation transporter for Na⁺) appears to be very effectively realised. Ion barriers may occur in the rhizodermis or also further into the root. If such

barriers do not exist, salt is taken up by the plant and distributed via the xylem stream. Both Na⁺ and Cl⁻ are phloem-mobile and are thus usually transported from the leaves back to the shoot and then deposited in the parenchyma there (this happens when the older leaves are not the final site of deposition and are shed after being loaded with salt, as, e.g., in cereals; Colmer et al. 1995). A salt gradient is then formed from the base of the stem to the tip, and from the older to the younger leaves. The meristems, which are not yet connected to the vascular system and in which transport (including that of salts) takes place from cell to cell, are spared the burden of the salt load.

To conclude the chapter on stressor salt, the various aspects that have been discussed are summarised in Fig. 1.6.20.

Summary

1. In contrast to the case with animals, salt (NaCl) plays no or only a subordinate role in the metabolism of plants. Only true salt plants require salt to flourish optimally. A distinction is made between plants which are

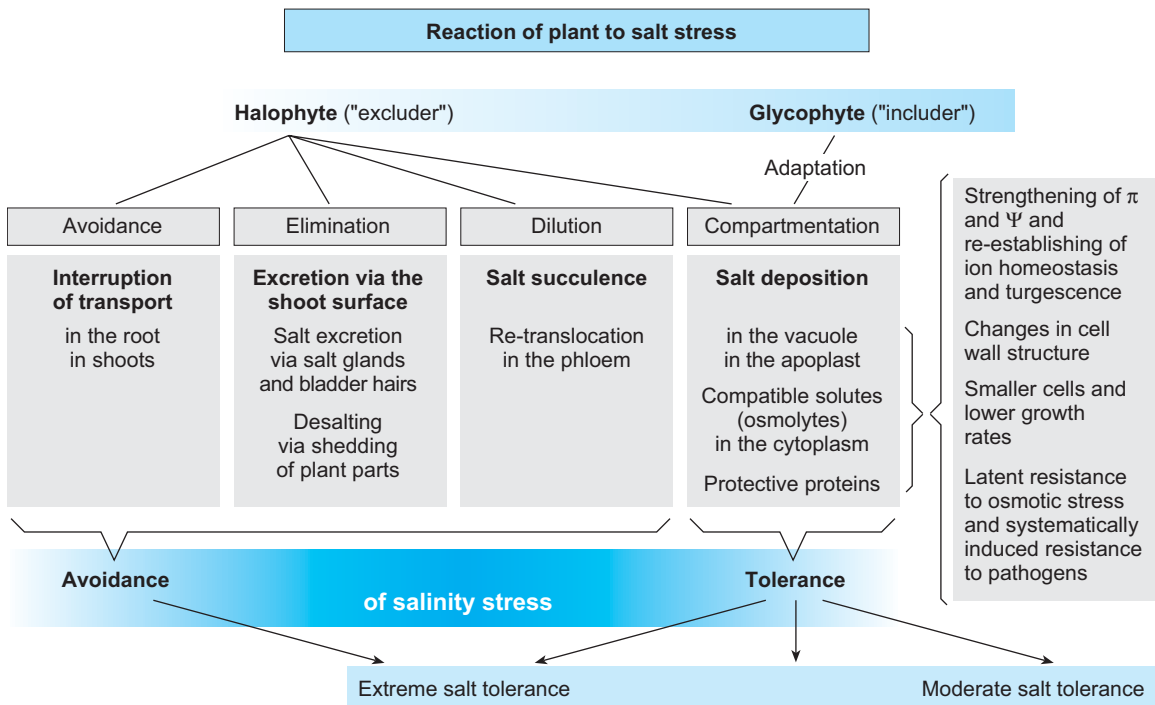


Fig. 1.6.20. Summary of the chapter on salt stress

- not tolerant of salt (glycophytes) and those which are (halophytes).
2. Because of the small diameters of Na^+ and Cl^- ions and the consequent high charge density at their surfaces, both of these components of salt are considered to be aggressive osmolytes. In addition to the so-called salinity stress resulting directly from these ionic properties, the high charge densities of the salt ions also result in the binding and effective withdrawal of water (dehydration stress).
 3. The most important membrane potentials in a functional plant cell are those of the plasmalemma (about 200 mV) and the tonoplast (up to 20 mV). The cytosolic side of the membranes is always the electronegative side. These potentials derive from the activity of ion pumps and channels, and result from the intracellular pools of cations and anions which the pumps and channels maintain in equilibrium. These equilibria (ion homeostasis) are dynamic, and their maintenance is aided by the action of proton-ATPases. This ensures that the pH values of the vacuole (about 5), of the cytoplasm (about 7) and of the apoplast (about 5) remain fairly constant. Non-stressed plant cells contain only very small cytoplasmic and vacuolar pools of Na^+ and Cl^- .
 4. Salt stress leads to an influx of Na^+ and Cl^- and to augmentation of cytoplasmic Ca^{2+} pools. Na^+ and K^+ thereby compete for transport systems, with the result that not only the intracellular Na^+ pools increase in size, but also that the K^+ pool sizes shrink. The attempt by the cell to re-establish the original membrane potentials by increased pumping activity (particularly that of the H^+ pumps) results in the pH of the cytosol being shifted by up to 1 pH unit, which leads to changes in enzyme activities. The elevated calcium level triggers regulatory processes (activation of genes), which may be interpreted as adaptation to high salinity.
 5. Growth by cell division and elongation is particularly affected, as are photosynthetic electron transport (with secondary damage due to ROS) and cell water relations. In particular young tissues often become necrotic.
 6. Adaptive responses of plant cells to salinity stress include measures to re-establish ion homeostasis, to adjust the osmotic potential and to synthesise protective proteins.
 7. How osmotic stress is perceived is still poorly understood (see Chap. 1.1.4). A signal cascade which reacts to the elevated Ca^{2+} level (SOS system) activates a Na^+ - H^+ antiporter in the plasma membrane. Another signal chain, which is also calcium-dependent, leads to synthesis of LEA proteins and of protein kinases. Further signals result from augmentation of the intracellular concentrations of ABA and jasmonate, which induces the expression of numerous proteins.
 8. Among the proteins which are newly synthesised or are synthesised in increasing amounts are those which serve to re-establish an ion homeostasis which exhibits changes in some of the pool sizes while maintaining the original membrane potentials and pH gradients, i.e. Na^+ - H^+ antiporters in both the plasma membrane and the tonoplast membrane. Since these antiporters also require high proton concentrations, the synthesis of H^+ -ATPases is also intensified. The salt tolerance of *Arabidopsis* was considerably increased by over-expression of one of the vacuolar Na^+ - H^+ antiporters.
 9. Halophytes are able to eliminate salt from the cytosol by excreting it from the apoplast onto the leaf surface or by forming large vacuoles in the mesophyll ("salt succulence") or in "bladder hairs". These excretion mechanisms are termed "recretion".
 10. In addition to re-establishing ion homeostasis, increasing the osmotic potential of the cell is an important part of adaptation to salt stress. Halophytes are able to use salt as an osmoticum in the vacuole, whereas glycophytes, which do not (and cannot) produce such high osmotic potentials, usually augment their osmotic potential by means of organic osmolytes. Halophytes, too, must produce such compatible solutes to osmotically stabilise the cytosol, as they, too, must maintain a low salt concentration in this compartment. In addition to their osmotic function, organic osmolytes stabilise and protect biomembranes and additionally also often act as scavengers for ROS.
 11. The most important osmolyte groups with respect to salinity are open-chain and cyclic polyols (sugar alcohols and cyclitols), which are only slowly metabolised and therefore guarantee long-term protection. The slow metabolism of the cyclitols is due to methylation (of *myo*-inositol). Sugar alcohols and

cyclitols are well suited for the transformation of crop plants to increase salt tolerance. Other important osmolytes are the amino acid proline, quaternary ammonium compounds (QACs, e.g. betaine) and tertiary sulfonic acid compounds (TSCs, e.g. 3-dimethyl sulfoniopropionate). They protect above all protein complexes against dissociation caused by salt.

12. In addition to LEA proteins and the proteins which catalyse the biosynthesis of osmolytes, protective proteins are synthesised and accumulated upon salinity stress. It is doubtful as to whether the functions they perform are really specific for salt stress. Amongst these protective proteins are osmotins and osmotin-like proteins, which are now regarded as belonging rather to the pathogen-related proteins, since their synthesis is also induced by pathogens. Osmotins have a strikingly alkaline isoelectric point; they are thus positively charged at the pH values of the cell and can accordingly readily interact with negatively charged membrane proteins. It is assumed, on the basis of their molecular structure, that they penetrate into the plasma membrane of the pathogen and form pores there, which make it easier for the host to combat the pathogen. Their function in relation to salinity stress is less clear. Osmotins, as well as the LEA proteins, are induced by ABA, jasmonate and ethylene and by the stressors which effect the accumulation of these phytohormones. They thus constitute a component of a system that cross-protects against all sorts of possible stressors. Because they are also deposited in vacuolar inclusion bodies, they are thought to provide long-term protection.
13. In addition to the production of the above-mentioned proteins, salt stress also influences cell wall metabolism. The cell walls of salinity-stressed cells contain less cellulose and fewer cell wall proteins (extensins). Salt stress evidently impairs the cross-linking of the extensins to one another and to the carbohydrates of the cell wall.
14. Avoidance of salinity stress: Plants of saline environments, e.g. mangroves, have developed a very effective mechanism for selective cation uptake. They evidently possess potassium transporters with no or only very little affinity for sodium, and are thus able to exclude Na^+ from their tissues. Other halo-

phytes with a less selective K^+ uptake system make use of the fact that Na^+ and Cl^- are phloem-mobile ions which are able to circulate within the plant. They accumulate salt at the base of the stem, while the growing parts of the plant are kept largely salt free.

References

- Apse MP, Aharon CS, Snedden WA, Blumwald E (1999) Salt tolerance conferred by overexpression of a vacuolar Na^+/H^+ -antiport in *Arabidopsis*. *Science* 285:1256–1258
- Barkla BJ, Blumwald E (1991) Identification of a 170-kDa protein associated with the vacuolar Na^+/H^+ -antiport of *Beta vulgaris*. *Proc Natl Acad Sci USA* 88:11177–11181
- Binzel ML, Hess FD, Bressan RA, Hasegawa PM (1988) Intracellular compartmentation of ions in salt-adapted tobacco cells. *Plant Physiol* 86:607–614
- Bohnert HJ, Nelson DE, Jensen RG (1995) Adaptations to environmental stress. *Plant Cell* 7:1099–1111
- Bostock RM, Quatrano RS (1992) Regulation of Em gene expression in rice. *Plant Physiol* 98:1256–1263
- Bressan RA, Hasegawa PM, Pardo JM (1998) Plants use calcium to resolve salt stress. *Trends Plant Sci* 3:411–412
- Colmer TD, Epstein E, Dvorak J (1995) Differential solute regulation in leaf blades of various ages in salt-sensitive wheat and salt-tolerant wheat x *Lophopyrum elongatum* (Host) Love, A. amphiploid. *Plant Physiol* 108:1715–1724
- Crum CP (1993) A lichenologists view of lichen Manna. *Contrib Univ Mich Herbarium* 19:293–306
- de Vos AM, Hatada M, Van del Wel H, Krabbendam H, Peerdeman AF, Kim S-H (1985) Three-dimensional structure of thaumatin I, an intensely sweet protein. *Proc Natl Acad Sci USA* 82:1496–1509
- Delauney AJ, Hu C-AA, Kavi Kishor PB, Verma DPS (1993) Cloning of ornithine δ -aminotransferase cDNA from *Vigna aconitifolia* by trans-complementation in *Escherichia coli* and regulation of proline biosynthesis. *J Biol Chem* 268:18673–18678
- Crillo S, Leone A, Xu Y, Tucci M, Francione R, Hasegawa PM, Monti L, Bressan RA (1995) Control of osmotin gene expression by ABA and osmotic stress in vegetative tissues of wild-type and ABA-deficient mutants of tomato. *Physiol Plant* 93:498–504
- Hanson AD, Rathinasabapathi B, Rivoal J, Burnet M, Dillon MO, Gage DA (1994) Osmoprotective compounds in the Plumbaginaceae: a natural experiment in metabolic engineering of stress tolerance. *Proc Natl Acad Sci USA* 91:306–310
- Hasegawa PM, Bressan RA, Pardo JM (2000a) The dawn of plant salt tolerance genetics. *Trends Plant Sci* 5:317–319
- Hasegawa PM, Bressan RA, Zhu J-K, Bohnert HJ (2000b) Plant cellular and molecular responses to high salinity. *Annu Rev Plant Physiol Plant Mol Biol* 51:463–499
- Hassidim M, Braun Y, Lerner HR, Reinhold L (1990) Na^+/H^+ - and K^+/H^+ -antiport in root membrane vesicles isolated from the halophyte *Atriplex* and the glycophyte cotton. *Plant Physiol* 94:795–801
- Iraki NM, Bressan RA, Hasegawa PM, Carpita NC (1989a) Alteration of the physical and chemical structure of the primary cell wall of growth-limited plant cells adapted to osmotic stress. *Plant Physiol* 91:39–47
- Iraki NM, Bressan RA, Carpita NC (1989b) Extracellular polysaccharides and proteins of tobacco cell cultures and

- changes in composition associated with growth-limiting adaptation to water and saline stress. *Plant Physiol* 91:54–61
- Jin S, Chen CCS, Plant AL (2000) Regulation by ABA of osmotic stress-induced changes in protein synthesis in tomato root. *Plant Cell Environ* 23:51–60
- Katsuhara M, Yazaki Y, Sakano K, Kawasaki T (1997) Intracellular pH and proton-transport in barley root cells under salt stress: in vivo ³¹P-NMR study. *Plant Cell Physiol* 38:155–160
- Kavi Kishor PB, Hong Z, Miao G-H, Hu C-AA, Verma DPS (1995) Overexpression of Δ^1 -pyrrolin-5-carboxylate-synthetase increases proline production and confers osmotic tolerance in transgenic plants. *Plant Physiol* 108:1387–1394
- Kindl H (1994) *Biochemie der Pflanzen*. Springer, Berlin Heidelberg New York, 290 pp
- Kononowicz AK, Ragothama KG, Casas AM, Reuveni M, Watad A-EA, Liu D, Bressan RA, Hasegawa PM (1993) Osmotin: regulation of gene expression and function. In: Close TJ, Bray EA (eds) *Plant responses to cellular dehydration during environmental stress*. *Am Soc Plant Physiol*, Rockville. *Curr Topics Plant Physiol* 10:144–158
- La Rosa PC, Chen Z, Nelson DE, Singh NK, Hasegawa PM, Bressan RA (1992) Osmotin gene expression is posttranscriptionally regulated. *Plant Physiol* 100:409–415
- Lamb C, Dixon RA (1997) The oxidative burst in plant disease resistance. *Annu Rev Plant Physiol Plant Mol Biol* 48:251–275
- Larcher W (1994) *Ökophysiologie der Pflanzen*. UTB Eugen Ulmer, Stuttgart, 394 pp
- Liu D, Narasimhan ML, Xu Y, Ragothama KG, Hasegawa PM, Bressan RA (1995) Fine structure and function of the osmotin promoter. *Plant Mol Biol* 29:1015–1026
- Lüttge U, Kluge M, Bauer G (1994) *Botanik*. VCH, Weinheim, 600 pp
- Marschner H (1986) *Mineral nutrition of higher plants*. Academic Press, London, 527 pp
- McNeil SD, Nuccio ML, Hanson AD (1999) Betaines and related osmoprotectants. Targets for metabolic engineering of stress resistance. *Plant Physiol* 120:945–949
- Moons A, Prinsen E, Bauw G, Van Montagu M (1997) Antagonistic effects of abscisic acid and jasmonates on salt stress-inducible transcripts in rice roots. *Plant Cell* 9:2243–2259
- Nagy Z, Galiba G (1995) Drought and salt tolerance are not necessarily linked: a study on wheat varieties differing in drought tolerance under consecutive water and salinity stress. *J Plant Physiol* 145:168–174
- Nakamura T, Ishitani M, Harinasut P, Nomura M, Takabe T (1996) Distribution of glycinebetaine in old and young leaf blades of salt-stressed barley plants. *Plant Cell Physiol* 37:873–877
- Nelson DE, Rammesmayr G, Bohnert HJ (1998) Regulation of cell-specific inositol metabolism and transport in plant salinity tolerance. *Plant Cell* 10: 753–764
- Niu XM, Bressan RA, Hasegawa PM, Pardo JM (1995) Ion homeostasis in NaCl stress environments. *Plant Physiol* 109:735–742
- Nomura M, Ishitani M, Takahe T, Rai AK, Takabe T (1995) *Synechococcus* sp. PCC7942 transformed with *Escherichia coli* het genes produces glycine betaine from choline and acquires resistance to salt stress. *Plant Physiol* 107:703–708
- Nuccio ML, Russell BL, Nolte KD, Rathinasabapathi B, Gage DA, Hanson AD (1998) The endogenous choline supply limits glycine betaine synthesis in transgenic tobacco expressing choline monoxygenase. *Plant J* 16:487–496
- Papageorgiou GC, Murata N (1995) The unusually strong stabilizing effects of glycine betaine on the structure and function of the oxygen-evolving photosystem II complex. *Photosynth Res* 44:243–252
- Paul MJ, Cockburn W (1989) Pinitol, a compatible solute in *Mesembryanthemum crystallinum* L. *J Exp Bot* 40:1093–1098
- Popp M, Smirnov N (1995) Polyol accumulation and metabolism during water deficit. In: Smirnov N (eds) *Environment and plant metabolism: flexibility and acclimation*. BIOS Scientific Publ, Oxford, pp 199–215
- Rhodes D, Hanson AD (1993) Quaternary ammonium and tertiary sulfonium compounds in higher plants. *Annu Rev Plant Physiol Plant Mol Biol* 44:357–384
- Saneoka H, Nagasaka C, Hahn DT, Yang W-J, Premachandra GS, Joly R, Rhodes D (1995) Salt tolerance of glycinebetaine-deficient and -containing maize lines. *Plant Physiol* 107:631–638
- Schober B, Tschesche H (1978) Unusual solution properties of proline and its interaction with proteins. *Biochim Biophys Acta* 541:270–277
- Shen B, Hohmann S, Jensen RG, Bohnert HJ (1999) Roles of sugar alcohols in osmotic stress adaptation. Replacement of glycerol by mannitol and sorbitol in yeast. *Plant Physiol* 121:45–52
- Sheveleva E, Chmara W, Bohnert HJ, Jensen RG (1997) Increased salt and drought tolerance by D-ononitol production in transgenic *Nicotiana tabacum* L. *Plant Physiol* 115:1211–1219
- Showalter AM (1993) Structure and function of plant cell wall proteins. *Plant Cell* 5:9–23
- Singh NK, Nelson DE, Kuhn D, Hasegawa PM, Bressan RA (1989) Molecular cloning of osmotin and regulation of its expression by ABA and adaptation to low water potential. *Plant Physiol* 90:1096–1101
- Smirnov N, Cumbes QJ (1989) Hydroxyl radical scavenging activity of compatible solutes. *Phytochemistry* 28:1057–1060
- Speer M, Kaiser WM (1991) Ion relations of symplastic and apoplastic space in leaves from *Spinacia oleracea* L. and *Pisum sativum* L. under salinity. *Plant Physiol* 97:990–997
- Tarczynski MC, Jensen R, Bohnert HJ (1993) Stress protection of transgenic tobacco by production of the osmolyte mannitol. *Science* 259:508–510
- Thomas JC, Bohnert HJ (1993) Salt stress perception and plant growth regulators in the halophyte *Mesembryanthemum crystallinum*. *Plant Physiol* 103:1299–1304
- Zelazny AM, Shaish A, Pick U (1995) Plasma membrane sterols are essential for sensing osmotic changes in the halotolerant alga *Dunaliella*. *Plant Physiol* 109:1395–1403
- Zhu B, Chen THH, Li PH (1995) Expression of three osmotin-like protein genes in response to osmotic stress and fungal infection in potato. *Plant Mol Biol* 28:17–26

1.7

Heavy Metals



Lower plants, algae, and especially fungi, are superior to higher plants in coping with heavy metals. In general metals are deposited on surfaces. A particular type of crust formation is the so-called desert varnish that is formed by biological activity. Rock inhabiting algae and fungi solubilise iron and manganese ions from the rocks and deposit them on the surface. The advantage of the crustaceous life form on rocks (mostly dolomite) is a higher CO₂ concentration, and a prolonged water availability after dewfall: Rocks absorb dew by capillary action. This moisture is sufficient for net CO₂ assimilation by endolithic lichens. Cliff drawings, close to Avdat, Negev, showing a rider on an ostrich hunt; ostriches were extinct in the Negev a long time ago.

Recommended Literature

- Abadia J, López-Millán A-F, Rombolà A, Abadia A (2002) Organic acids and Fe deficiency: a review. *Plant Soil* 241:75–86
- Cobbett C, Goldsbrough P (2002) Phytochelatins and metallothioneins: roles in heavy metal detoxification and homeostasis. *Annu Rev Plant Biol* 53:159–182
- Marschner H (1995) Mineral nutrition of higher plants, 2nd edn. Academic Press, San Diego, pp 313–434
- Salt DE, Smith RD, Raskin I (1998) Phytoremediation. *Annu Rev Plant Physiol Plant Mol Biol* 49:643–668
- Schmidt W (2003) Iron solutions: acquisition strategies and signaling pathways in plants. *Trends Plant Sci* 8:188–193
- Stephan UW (2002) Intra- and intercellular iron trafficking and subcellular compartmentation within roots. *Plant Soil* 241:19–25
- Vara Prasad MN, de Oliveira Freitas MH (2003) Metal hyperaccumulation in plants – Biodiversity prospecting for phytoremediation technology. <http://www.ejbiotechnology.info/content/vol6/issue3/>

Heavy metals are metallic elements with a density $\geq 5 \text{ g/cm}^3$, namely the elements Ag, As, Au,

Bi, Cd, Co, Cu, Cr, Fe, Hg, Mn, Mo, Ni, No, Pb, Pt, Sb, Sn, Ti, Tl, U, V, Zn, and Zr. In addition to their high specific weight, most of them can occur in more than one coordination number, i.e. they can become oxidised or reduced. They often occur as metallic components of enzymes which transfer electrons, for example:

- Fe in heme (e.g. in cytochromes) and in S-Fe proteins (e.g. in aconitase),
- Mn in photosynthetic water oxidase, in many dehydrogenases and in superoxide dismutase (SOD),
- Cu in cytochrome oxidase, in plastocyanin, in catalases and in other oxidases,
- Zn is often a component of dehydrogenases, certain species of SOD, of carboanhydrase and of nucleic acid binding proteins (zinc finger),
- Mo occurs in enzymes of N metabolism (e.g. in nitrogenase and nitrate reductase),
- Co in cobalamine (coenzyme B₁₂ which is a derivative of vitamin B₁₂).

This listing is, of course, not exhaustive; nevertheless, it shows the requirement of plants for (some) heavy metals. Related to multiplicity of valences is also the tendency of heavy metals to form chelates, which are important for uptake by plants but also for sequestration in the plant.

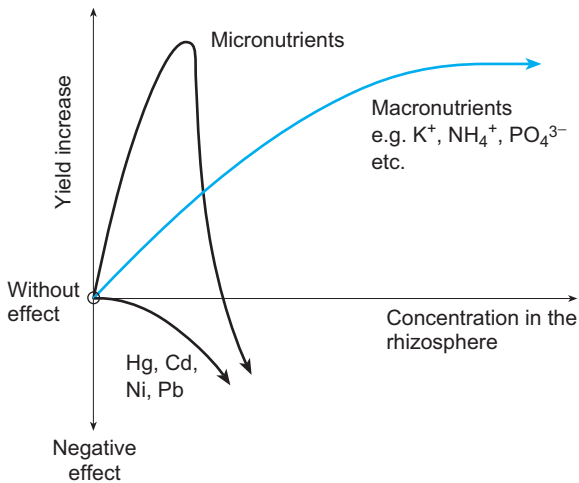


Fig. 1.7.1. Influence of ion availability in the rhizosphere on yield. (After Wallnöfer and Engelhardt 1984)

Some heavy metals are **micronutrients** (Fe, Mn, Zn, Cu, Ni, Mo, Co), others are potent **cell toxins**: Hg, Pb, Cd, Cr and As. However, also micronutrients may become toxic if they accumulate in the organelles of plant cells to higher concentrations. For heavy metals the concentration ranges of deficiency, optimal supply and toxicity are very close together (Fig. 1.7.1 and Table 1.7.1).

While the thresholds of symptoms of heavy metal deficiency are more or less independent of the plant species and within a relatively narrow concentration range, toxicity of heavy metals shows a broad concentration range (Table 1.7.1): Many plants are able to diminish uptake, detoxify or sequester (the so-called **hyperaccumulators**) heavy metal ions and thus avoid metabolic problems. Certain plants growing on soils with a surplus of heavy metals are called **metallophytes**. For example, *Silene vulgaris* is able to tolerate cadmium, cobalt, copper, lead, manganese, nickel and zinc in the substrate, *Festuca ovina*, *Agrostis tenuis* and *Minuartia verna* have ecotypes with similar metal resistance as *Silene vulgaris*, *Viola calaminaria* grows on soils rich in zinc and the fern *Pteris vittata* accumulates arsenic.

Table 1.7.1. Assessment of the microelement concentrations (mg/kg dry matter) in fully developed leaves of agronomical crop plants (Amberger 1988)

Micronutrient	Deficiency	Adequate supply	Toxicity
Mn	<20	20–250	>500
Fe	<50	50–250	(>500)
Zn	<20	20–150	>400
Cu	<40	5–20	>40
B (monocots)	<2	2–5	>20
B (dicots)	<15	15–100	>200

1.7.1

Availability of Heavy Metals

The heavy metal content of soils is usually sufficient for the nutrition of plants, it rather may be too high due to human activities. The total content of heavy metals of a soil is not crucial for the plant (e.g. Fe ca. 10,000 to 50,000 mg/kg, Mn up to 3000 mg/kg, Zn up to 300 mg/kg, Cu up to ca. 50 mg/kg), rather the availability of heavy metal ions is the determining factor. Availability, however, is a question of the solubility of heavy metals as ions or complexes, of the pH and the redox potential of the soil, and of the activity of plant roots and their association with mycorrhizal fungi. Unfavourable constellations of these factors may, at a similar total content, cause heavy metal deficiency or toxicity.

1.7.2

Heavy Metal Deficiency – Example Iron

1.7.2.1

Uptake of Heavy Metals

The effects of heavy metal deficiency on plants will be discussed for iron as an example. Except for poorly aerated mineral soils (gleys and pseudogleys), iron usually occurs in its oxidised, i.e. trivalent, form: goethite (α -FeOOH), haematite (α -Fe₂O₃) and as a lattice element in many minerals. Ferric oxides become insoluble in an alkaline environment and thus **iron deficiency** occurs in alkaline, well-aerated soils. In plants iron deficiency causes **chlorosis** particularly in the intercostal fields of leaves. This phenomenon intensifies at a high supply of phosphate and HCO₃⁻, as insoluble ferric phosphates, hydroxides and (bi)carbonates are formed.

The plant root only takes up the ferrous ion. In the soil, however, the ferric ion is usually

Table 1.7.2. Critical toxicity of manganese ions in shoots of various higher plants. The “critical value” is that concentration at which the plant produces 10% less than its normal biomass (Marschner 1986)

Crop	Mn content (mg/g dry weight)
Maize	200
Soybean	600
Cotton	750
Sweet potato	1380
Sunflower	5300

present and, therefore, iron must be reduced in order to enter the plant (Fig. 1.7.2 A). This is accomplished by the enzyme **chelate reductase**.

Dicots and monocots (except grasses) are capable of increasing their capacity to reduce Fe³⁺ and thus take up iron more efficiently in iron-deficient situations. Chelate reductase is bound to the plasma membrane of the rhizodermis and the surface of this membrane is increased several-fold by formation of cell wall labyrinths of the so-called rhizodermal transfer cells (Fig. 1.7.3).

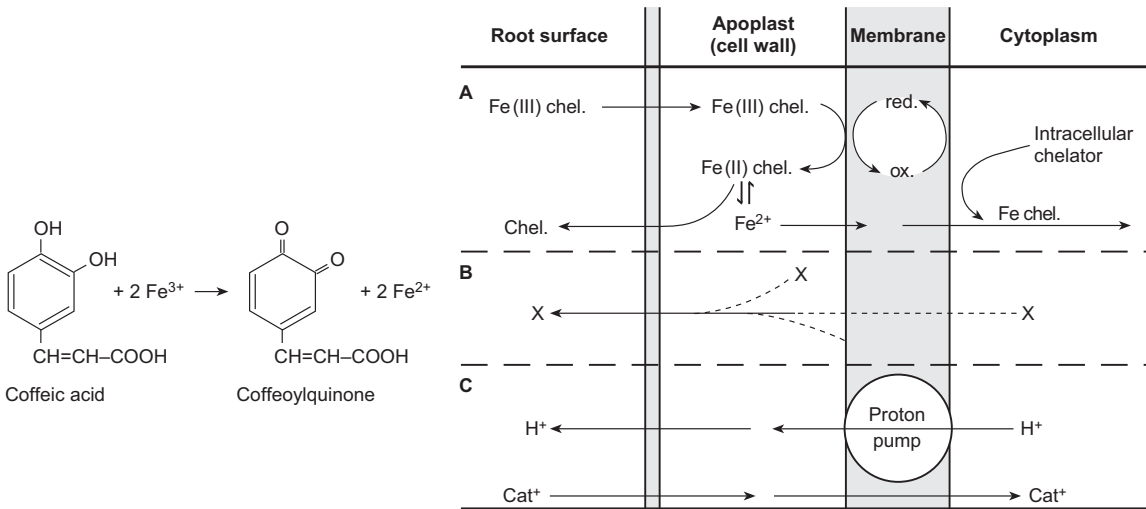


Fig. 1.7.2. Increased uptake of iron by iron “efficient” dicotyledonous plants, upon iron deficiency. **A** Increase in the reductive capacity. **B** Exudation of phenolic compounds. **C** Increase in proton excretion. *Chel* Chelator; *Cat*⁺ cation; *X*, e.g. caffeic acid. (After Marschner 1986)

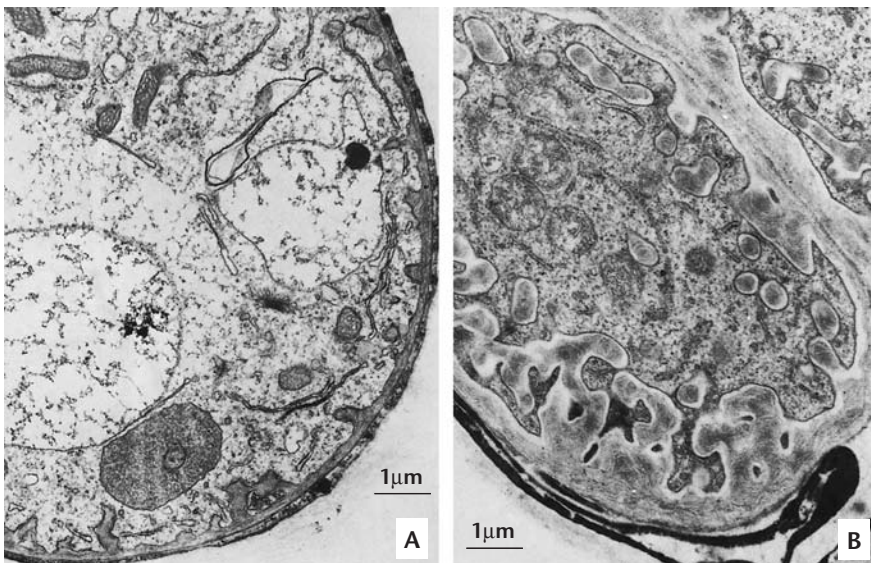


Fig. 1.7.3. Root cells with wall labyrinth (transfer cells). **A** Cross section through a root hair with weakly developed wall labyrinth. **B** Papillate rhizodermal cell (transfer cell) with amply developed labyrinth. (After Kramer et al. 1980)

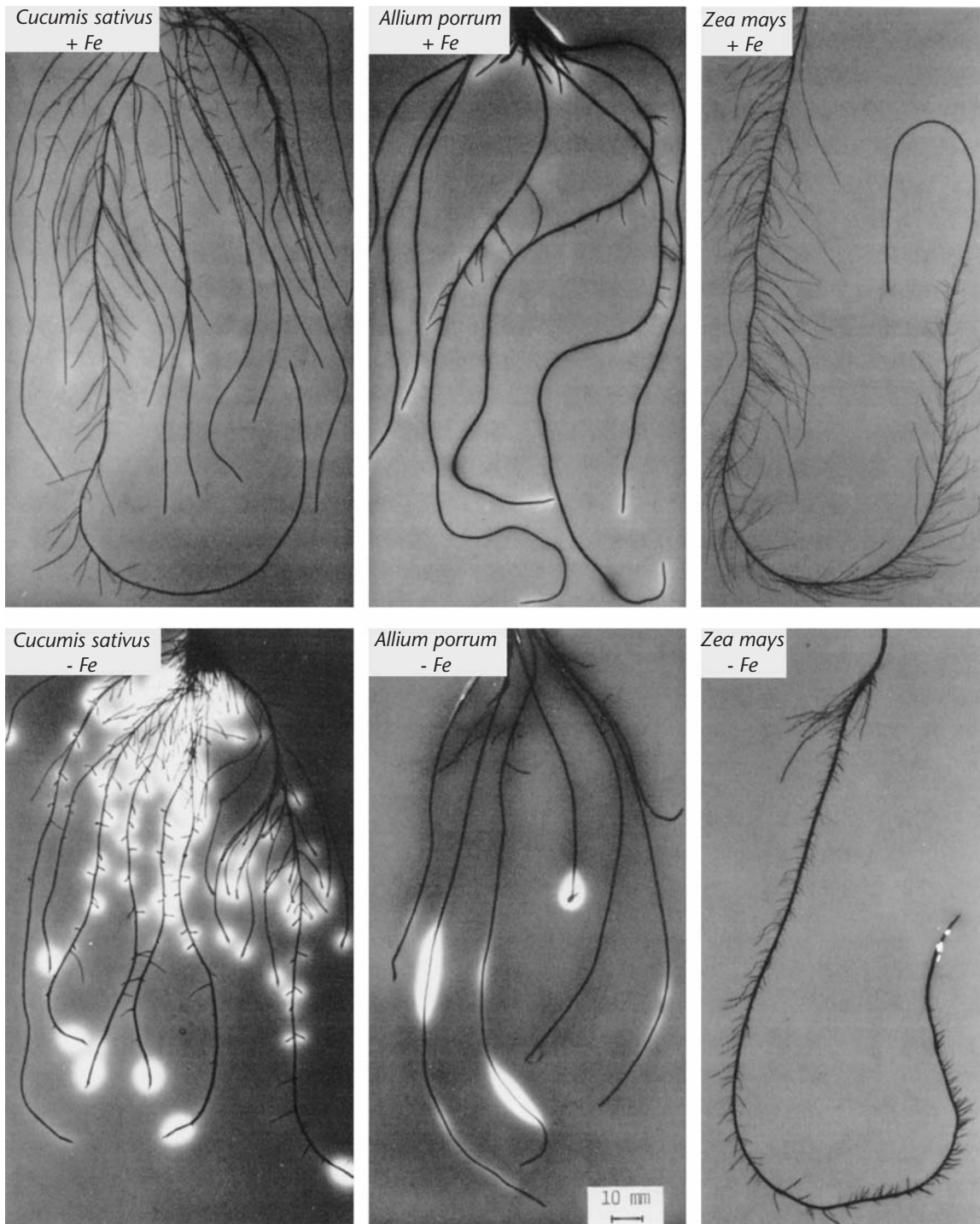


Fig. 1.7.4. Demonstration of proton excretion induced by iron deficiency in roots of different plant species. Roots of intact plants (pre-cultured in ca. $0.1 \mu\text{M}$ FeEDTA) were placed for 2 h in agar medium containing the pH indicator bromocresol (violet at pH 6.0); yellow regions (in the pictures white) show acidification of the agar medium to pH 4.5 and even below. (After Römheld and Kramer 1983)

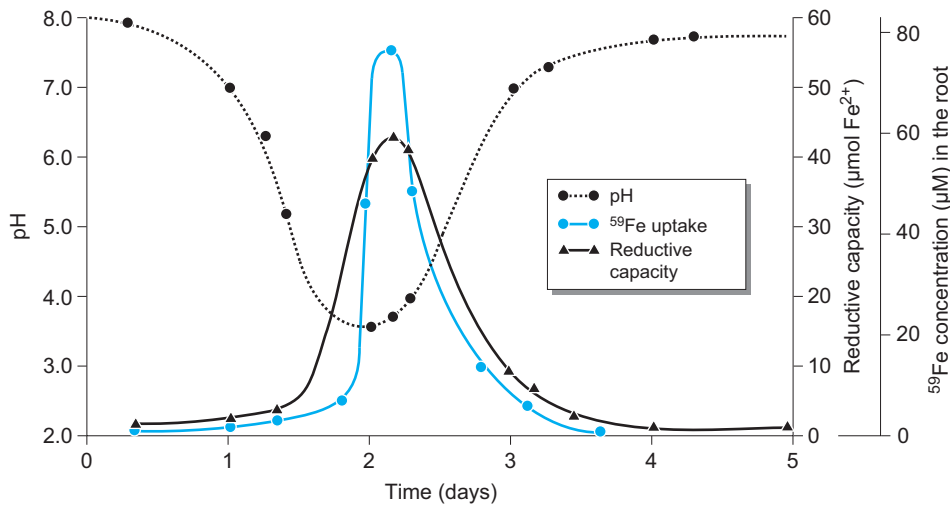


Fig. 1.7.5. Effect of Fe(III) supply on the pH of the medium and on the reductive capacity and uptake of iron, by sunflower, an iron-“efficient” plant. Such a plant, when placed in an Fe(III) solution of neutral pH, becomes iron-deficient within a short time. After only 1 day the plant commences to excrete protons and reducing compounds: the pH of the solution drops and the reductive capacity of the roots increases. With an increased iron(II) uptake the deficiency symptoms disappear and the root system returns to its normal state. The pH of the solution shifts towards the neutral point and the cycle starts again. Iron-“efficient plants” are mainly dicots, whilst many monocots, mostly grasses and cereals, cannot perform such a cycle. (After Amberger 1988)

At the same time, the root exudes large amounts of substances which chelate trivalent iron and thus dissolve ferric ions from the soil-borne stock. Citric and malic acid are common **chelators** exuded from plant roots. Fulvic and humic acids, which originate in the soil, are also chelators for iron ions. In addition, in some cases, phenolic compounds, e.g. caffeic acid, can be involved in formation of soluble complexes, in their chemical transformation and in the reduction of the metal ion (see Fig. 1.7.2B). Upon iron deficiency, root cells form large amounts of such phenolic compounds. Much improvement of low iron availability is achieved by an increase in the rate of proton extrusion by the H⁺-ATPase of the plasma membrane which lowers the pH in the rhizosphere and increases the solubility of ferric ions (Figs. 1.7.2C, 1.7.4 and 1.7.5). All these phenomena, which increase under iron deficiency, are most probably an outcome of the enormous increase in the surface area of the rhizodermal transfer cells. Likewise the rate of root-hair formation from rhizodermal cells increases, which also enhances the absorbing surface area of the roots.

At the outer surface of the plasma membrane, Fe³⁺ ions are released from the chelates and are reduced by a ferric chelate reductase to Fe²⁺ which is taken up by an Fe(II) transporter (Fig. 1.7.2A). In order to protect the intracellular

environment against the reactive species of iron (see below), iron ions are handled again as chelates, e.g. with nicotinamide. From such chelates iron is then incorporated into the target compounds. As soon as the iron supply of the plant normalises and the deficiency symptoms have disappeared, the rate of root growth returns to normal without the special amenities for iron uptake being formed. This status is maintained until iron deficiency comes up again. Cu deficiency also induces plasma membrane Fe-reductase activity (Cohen et al. 1997).

All these processes have been investigated in laboratory experiments with roots lacking any mycorrhizal symbiosis. In nature, however, roots of most plant species are associated with mycorrhizal fungi which can explore smaller soil pores than fine roots and considerably contribute to the supply of the plant with macro- and micronutrients.

Grasses possess a particular chemical mechanism for heavy metal uptake: The roots exude so-called **phytosiderophores** (Greek: *sideros* = iron, *pherein* = carry) into the soil. These compounds are complicated non-proteinogenic amino acids (Fig. 1.7.6A), which solubilise iron from sparingly soluble complexes, and convert it to water-soluble Fe(III)-siderophore complexes from which it is available to plants. Fungi and bacteria also produce siderophores. The latter bind Fe(III) as hydroxamates, whilst plant side-

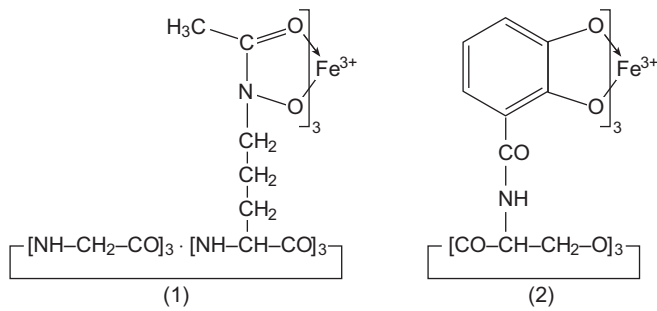
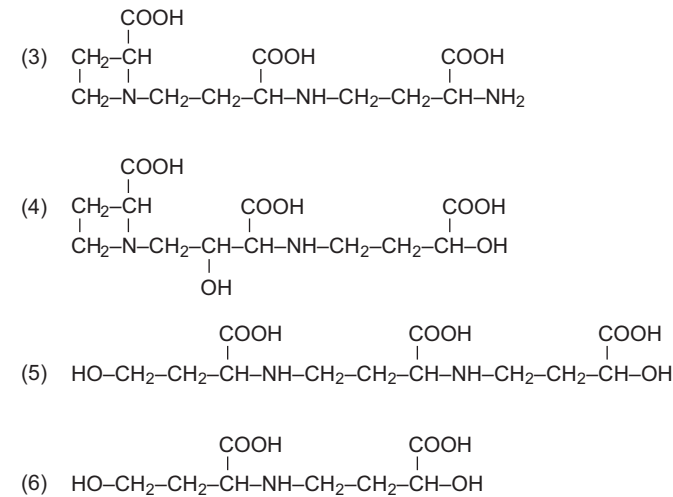
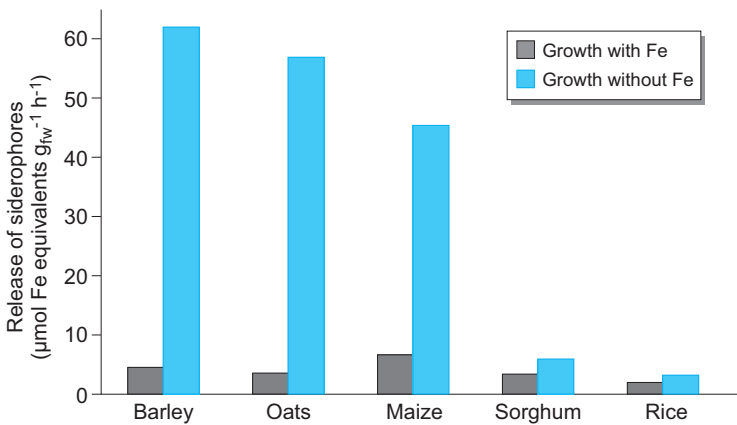


Fig. 1.7.6. A Chemical structures of microbial siderophores (1 and 2) and phytosiderophores (chelators) from higher plants (3–6). 1 Ferrichrome (cyclohexapeptide derivative of hydroxamates); 2 ferrienterobactin (cyclo-tris(*N*-2,3-dihydroxybenzoyl-*L*-serine) derivative of catechols); 3 nicotinamine; 4 muginic acid; 5 avenic acid A; 6 avenic acid B. After Schlee (1992). **B** Release of siderophores by various cereals upon sufficient Fe supply and Fe shortage. (After Mengel 1991)



A



B

Increasing sensitivity to Fe-chlorosis

rophores bind the ferric ion to the carboxy groups. A transporter mediating the uptake of Fe(III)–siderophore complexes has been recently demonstrated in maize. Cleavage of the siderophore complex, by ligand exchange or some other mechanism, occurs within the cell. Formation and exudation of siderophores are dramatically stimulated by iron deficiency (Fig. 1.7.6B).

The siderophore-mediated uptake of heavy metals has been termed “strategy II” in contrast to the uptake by chelate reductase and the ferrous transporter which is known as “strategy I”.

In poorly aerated soils with a negative redox potential, iron usually occurs in its ferrous, easily soluble form. At identical pH, the solubility of Fe(II) oxide/hydroxide is by several orders of

Box 1.7.1 Redox potential of soil

The redox potential of soil results from the ratio of the oxidised to the reduced forms of metals:

$$E = E_0 + \frac{RT}{nF} \ln \frac{a_{\text{ox}}}{a_{\text{red}}} \text{ [V]}$$

$$E = E_0 + \frac{0.059}{n} \log \frac{a_{\text{ox}}}{a_{\text{red}}}$$

where n denotes the number of electrons exchanged between the oxidised and the reduced form, a_{ox} is the activity of the oxidised form, and a_{red} is the activity of the reduced form.

Well-aerated soils have redox potentials of up to +0.8 V and poorly aerated soils within the level of ground water or peat soils of up to -0.35 V.

The **reductive potential** of the soil is characterised by the **pe** value. The **pe** value (analogous to pH) is the negative log of the “concentration of electrons (n)” in the soil:

$$\text{e.g. } pe=2 \quad [e]=10^{-2} \text{ M} \\ pe=-1 \quad [e]=10^1 \text{ M}$$

The conversion factor between E and pe is: $pe = E \text{ (V)} \times 16.9$

The pe values of a paddy rice field are between +4 (surface) and -3 (middle layer).

magnitude greater than that of the corresponding Fe(III) salts. At a soil redox potential of $pe = 1$ the solubility of iron ions is 10^{-5} M, but under aerobic conditions, at $pe = 2-4$, it is 10^{-16} M (for explanation of the pe value, see Box 1.7.1). In soils with a $pe < 1$, iron deficiency usually does not occur in plants. A soil redox potential of ca. +150 mV is required for the reduction of Fe(III) to Fe(II).

1.7.2.2

Physiological Consequences of Iron Shortage

Chlorosis caused by iron shortage shows that the biosynthesis of porphyrines is particularly sensitive to iron deficiency. This not only applies to iron as the central atom of heme, but also to the Mg-protoporphyrin-IX-monomethylester cyclase which forms the isopentanone ring of chlorophyll using oxygen from air. Such a monooxygenase requires a cytochrome P450 as cofactor which contains an iron ion. Thus an impact on chlorophyll synthesis by iron deficiency is conceivable. In addition, many ROS-scavenging enzymes (see Chaps. 1.3.5 and 1.6.2.2), e.g. peroxidases, contain heme and iron shortage limits their synthesis. This leads to an incomplete detoxification of ROS which, in turn, oxidise chlorophyll in a photodynamic, i.e. light-dependent, reaction. A lower rate of chlorophyll biosynthesis, concomitant with an increased rate of oxidative chlorophyll destruction, results in the phenomenon of **Fe chlorosis**. Lower chlorophyll

Table 1.7.3. Effects of iron shortage in tobacco plants: iron limitation is particularly noticeable by reduced chlorophyll synthesis, which leads to chlorosis (bleaching) especially in the intercostal spaces (Marschner 1986)

Availability of iron(III) ions	Pigment concentration (mg/g fresh weight)		Protein content (mg/g fresh weight)	
	Chlorophyll a+b	Carotenoids	Chloroplast	Cytoplasm
Sufficient	0.98	0.45	8.6	12.8
Mild shortage	0.34	0.33	5.0	11.9

concentrations require smaller amounts of chlorophyll-binding proteins. It is therefore not surprising that chloroplasts of iron-deficient plants have significantly less contents of pigments and proteins than those of plants sufficiently supplied with iron (Table 1.7.3).

Physiological iron deficiency may also occur at a good supply of iron ions. At high internal phosphate concentrations, Fe(III) ions are sequestered as phytoferritin in the chloroplasts and are no longer metabolically available.

Phytoferritin is a hollow spheric protein that can store up to 5000 Fe(III) ions as alkaline iron phosphates $[\text{FeO}(\text{OH})]_8[\text{FeO}(\text{H}_2\text{PO}_4)]$ (Casiday and Frey 2000).

The physiologically active form of iron is the Fe(II) ion, as a constituent of various complexes, e.g. in the heme or iron-sulfur proteins; only this form is able to transfer charges.

Many metabolic processes are more or less directly dependent on iron ions but discussion of an impact of iron deficiency on all of them is beyond the scope of this presentation. The reader is referred to textbooks on plant biochemistry, e.g. Buchanan, Gruissem, Jones: *Molecular Biology of Plants* (American Society of Plant Physiologists, 2000, Rockville, MD). Iron is a relatively atoxic heavy metal, required in larger amounts than other heavy metals in cell metabolism (see [Table 1.7.1](#)). However, the uncomplexed Fe^{2+} ion is toxic, as it catalyses Fenton reactions (see [Box 1.3.8](#)), which always result in the formation of ROS. Therefore, deposition of iron as ferritin, upon over-supply of iron, is important as a detoxifying process.

1.7.3

Stress by Heavy Metal Toxicity

Even metabolically essential heavy metal ions, e.g. Cu^{2+} , Mn^{2+} or Zn^{2+} , become toxic at concentrations exceeding the range of trace elements. Heavy metals such as Ag, Au, Cd and Pb which are not natural constituents of cells are toxic even at very low concentrations. However, heavy metal-tolerant plants are able to detoxify also such heavy metals which do not normally occur in a plant. Both phenomena will be discussed in the following section.

1.7.3.1

Copper

Copper belongs to those heavy metals which are essential for organisms, but required in only very small amounts (see [Table 1.7.1](#)). In the soil, Cu occurs almost exclusively as Cu(II), usually adsorbed to iron- and manganese-containing minerals, to soil colloids and as chelate with organic compounds. Copper ions are scarcely mobile in the soil, and because of the strong binding to soil particles copper concentrations in soil solutions are extremely low (ca. 0.01 mg/l). Even in such solutions copper occurs usually as a complex with organic low molecular weight compounds.

The copper content of untreated soils is in the range of 20–50 mg/kg soil, but in vineyards and hop fields, as well as citrus and coffee plantations, the concentration is considerably higher

(>300 mg/kg soil) because of spraying with Cu-containing fungicides and fertilisation with sewage sludge and manure.

Because of the strong adsorption to soil particles, these high concentrations initially remain in the topsoil but ploughing displaces the copper-rich soil into the root region and thus may lead to copper intoxication of the crop (see Section “Copper Toxicity”).

Copper uptake is in part similar to the uptake of iron, and as suggested by a pronounced ion antagonism, plants probably use metal-specific as well as general carriers for copper, iron, manganese and zinc. High affinity Cu uptake is specifically regulated by COPT genes. Amino acids and metallothioneins may be the relevant and often tissue- and age-specific transport metabolites to which Cu ions are bound.

Copper in Plant Metabolism

Relatively high Cu contents are found in carrots, potatoes, buckwheat, and in other soil-borne storage organs, less in above-ground plant organs. Buckwheat is also known as a copper-accumulating species. Obviously, mobility of Cu in plants is fine-tuned by a variety of Cu chaperones delivering Cu to the subcellular sites of demand.

Copper is well known as a component of electron-transporting proteins in photosynthesis (plastocyanin), in the respiratory chain (cytochrome oxidase) and in creating functional ethylene receptors (see [Chap. 1.4](#)). In plastocyanin, copper only mediates electron transfer whereas, in the cytochrome oxidase, copper takes part in electron transfer and, in cooperation with iron, in the binding of O_2 . Oxidases, e.g. ascorbate and amino acid oxidases, peroxidases and phenol oxidases, often contain Cu. Copper proteins, like the above-mentioned cytochrome oxidase, frequently contain a second heavy metal: e.g. the copper-zinc-SOD where both heavy metals are linked by a histidine residue.

Copper Deficiency

Copper-deficient soils are characterised by a low sorptive capacity, such as well-aerated sand, heath (Podsol) and boggy soils. However, because of the higher plants' extremely low requirement for Cu (see [Table 1.7.1](#)), copper deficiency occurs mostly on boggy soils. Most of the typical symptoms of copper deficiency could only be recognised in pot culture experiments. Copper deficiency results in a reduced lignifica-

tion of the cell walls and a clammed sclerenchyma formation. This could be explained by the low contents or activities of phenol oxidases and peroxidases involved in lignin synthesis.

Copper Toxicity

In contrast to copper deficiency, Cu toxicity is widespread, less because of natural cuprous soils but more because of human activities: Rubbish tips, sewage deposits and agricultural areas with recurrent application of copper-containing chemicals, e.g. vineyards and orchards. Toxic copper concentrations give rise to many macroscopically and biochemically recognisable symptoms, which, however, develop after quite different time-spans. Similar to iron deficiency, copper toxicity causes chlorosis, as the Cu ion can readily replace the Fe ion in protein complexes and thus inactivate their enzymatic activities. In addition, Cu acts as a Fenton reagent and catalyses the formation of ROS and their reaction products which primarily attack the unsaturated fatty acids of membrane lipids and thus damage the cell membranes (see [Chap. 1.3.3](#)).

Such damage affects transmembrane ion transport, and in particular disturbs the intracellular K^+ relations which in turn control turgidity of the cell. This results in an inhibition of cell division. One of the fastest effects of toxic copper concentrations is the inhibition of the elongation growth of lateral and subsidiary roots. Instead of a well-structured root system, short, hairy, brown laterals are produced – a phenomenon which may be used to quantify copper damage. Such damage can be evaluated using an EC system (effect concentration: EC_{10} refers to an inhibition of the observed parameter by 10%, EC_{50} indicates 50% inhibition). However, EC and lethal concentration (LC) are not identical. EC measures the current inhibition, LC the irreversible damage. Concentrations which show no recognisable effects are called NOEC (no observable effect concentration).

At the cellular and subcellular level, increased Cu concentrations cause two major effects: removal of functional ions or central atoms from an enzyme, e.g. the replacement of Fe ions in cytochrome, or interference with the Ca^{2+} signalling system of the cell, on the one hand, and formation of cuprous sulfides in cysteine-containing enzymes, an example of which is the inhibition of nitrate reductase.

Substitution of an original metal ion by another excessively supplied heavy metal ion sug-

gests a certain specificity which is probably defined in the protein. For example, ribulose biphosphate carboxylase is much more affected by Mn^{2+} and Ni^{2+} than by Cu^{2+} or Zn^{2+} . On the other hand, Zn^{2+} replaces Mn^{2+} very effectively from the photosynthetic water oxidase. However, these are results of in vitro studies, showing possible reactions, but do not necessarily occur in planta: plants exhibit different ways to intercept heavy metals before their interaction with enzymes. The efficiency of such intercepting mechanisms, amongst other factors, may evoke different sensitivities of various plant species to copper and other heavy metals. It is assumed that the concentration ranges of heavy metal toxicity are shifted in metallophytes to higher concentration by such interception processes.

1.7.3.2 Cadmium

Cadmium is very toxic for any kind of organism. As far as is known, Cd is not a constituent of any metabolically important compound, i.e. there is – in contrast to copper and iron – no useful concentration of this ion in plants. Therefore, Cd is a true xenobiotic. Nevertheless, some plants may contain larger amounts of Cd (up to 100 mg/kg dry weight). Depending on their Cd content, plants are addressed as Cd accumulators or Cd avoiders.

Cd^{2+} accumulates in sewage sludge, waste water and river sediments from where it is taken up by plant roots. Cd can also be taken up from dust on the leaves. Cd^{2+} is readily distributed in the plant via the xylem stream, and then accumulates in all organs of the plant.

Plants are not defenceless towards Cd^{2+} supply by the substrate, as is shown in a comparison of Cd supply and Cd accumulation in leaves of various crop plants ([Table 1.7.4](#)). Beans belong to the excluders, but lettuce accumulates Cd. Thus plants show different sensitivities towards Cd ([Table 1.7.5](#)).

Toxicity of Cadmium

In soils, Cd rarely occurs as the only heavy metal pollutant as it is most frequently accompanied by Zn. Many toxic effects, therefore, result from multiple stresses by heavy metals or from ion replacement: In vitro substitution of Zn by Cd in the enzyme carbonic anhydrase leads to rapid inactivation ([Table 1.7.6](#)). The toxicity of

Table 1.7.4. Cadmium content of plants (mg Cd per kg dry weight) in relation to the cadmium content of the soil (Wallnöfer and Engelhardt 1984)

Plant	Organ	Cd content of the soil (mg Cd per kg soil)			
		1.4 (control)	4	10	30
Green cabbage	Leaves (old)	0.7	9.0	18	36
	Leaves (young)	0.4	2.3	5.6	21
	Shoot	0.5	3.1	4.5	9.6
	Root	0.7	2.3	6.7	8.3
Lettuce	Leaves (old)	1.2	9.6	26	44
	Leaves (young)	0.9	3.8	8.1	18
	Root	0.9	4.2	11	21
Red radish	Leaves	0.9	11	21	49
	Tuber	0.4	3.1	7.4	13
	Root	0.8	5.3	11	34
Leek	Leaves	0.6	3.5	16	28
	Stem	0.5	3.4	3.7	17
	Root	0.7	4.1	9.3	24
Bean	Leaves	0.2	0.4	0.5	0.9
	Seeds	0.2	0.2	0.2	0.2
	Shoot	0.5	0.6	0.9	1.6
	Root	0.9	2.8	8.2	14

Table 1.7.5. Toxicity of Cd for crop plants, measured as Cd content of the leaves that causes 10% reduction of the harvest (Wallnöfer and Engelhardt 1984)

Plant	Cd content of leaves (mg Cd per kg dry weight)
Bean	0.7
Leek	3.0
Green cabbage	> 30
Radish	40
Lettuce	> 40

Table 1.7.6. Loss of carbonic anhydrase enzyme activity (in vitro) after substitution of the original Zn ion in the purified enzyme by another heavy metal ion. The activity of the Zn enzyme is set at 100% (Ernst 1996)

Heavy metal	Activity
Zn	100
Co	55.9
Ni	4.9
Cd	4.2
Mn	3.9
Cu	1.2
Hg	0.05

Cd results from the strength of its links with cysteine residues in proteins.

A generally observed effect of xenobiotic heavy metals is the inhibition of photosynthesis caused by closure of stomata. This phenomenon is particularly pronounced with Cd (Fig. 1.7.7).

Inactivation of metabolically important enzymes results in a stimulation of catabolic reactions comparable to what is known as “wound respiration” (Table 1.7.7). At the subcellular level, swelling of mitochondria, vacuolization, i.e. de-mixing of the plasma, and deposition of Cd-containing granules have been described.

At the whole plant level, strong stress by Cd in addition to the reduced growth produces yellow streaked leaves (Table 1.7.5).

1.7.4

Reaction of Plants to Excessive Supply of Heavy Metals

At the same EC level sensitive as well as tolerant plants to stress by heavy metal generally show similar reactions when exposed to this kind of stress.

The first reaction complex may be considered an avoidance strategy, aiming at immobilisation of the heavy metals outside the protoplasts of root cells in order to prevent physiological effectiveness. Complexing Cu^{2+} ions by root exudates in the soil, but also in the cell wall, on the one hand reduces the supply to the protoplast but, on the other, requires continuous root growth. Depending on the composition of the cell wall and the types and amounts of the exudates, the

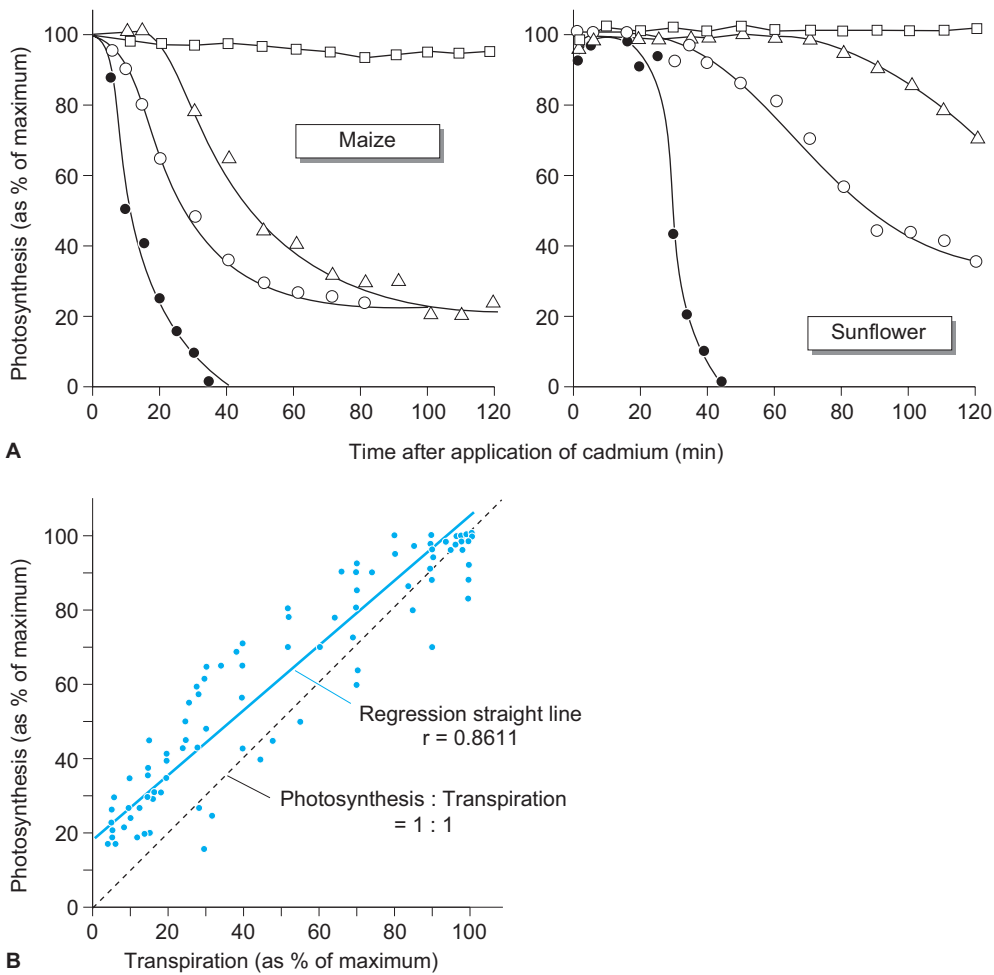


Fig. 1.7.7. Inhibition by cadmium of photosynthesis and transpiration of maize and sunflower. **A** Time kinetics of the influence of various Cd^{2+} concentrations on the rates of photosynthesis. \square =control (27 mM KCl); \triangle =4.5 mM CdCl_2 ; \circ =9 mM CdCl_2 ; \bullet =18 mM CdCl_2 . **B** Relationship between the inhibition of photosynthesis and transpiration by cadmium. The regression line shows a quasi-linear relationship between the two processes. As the regression line does not cross at zero, transpiration, i.e. stomatal conductance, must be inhibited to a greater extent than photosynthesis. This suggests that inhibition of photosynthesis by cadmium principally occurs through closure of stomates. The data points have been produced with both plant species. (After Bazzaz et al. 1974)

Table 1.7.7. Respiration and enzyme activity of leaves from soybean seedlings after 10 days growth at various concentrations of cadmium chloride. The measured activity is normalised to 1 g fresh weight. Respiration as well as activity of catabolic enzymes show a clear "injury effect" (Lee et al. 1976)

Activity	Cd^{2+} concentration (μM)			
	0 (Control)	0.45	0.9	1.35
Respiration ($\mu\text{l O}_2 \times \text{g}^{-1} \times \text{h}^{-1}$)	480	539	784	737
Malate dehydrogenase ($\mu\text{mol NADH} \times \text{g}^{-1} \times \text{h}^{-1}$)	230	250	400	390
RNase ($\mu\text{mol nucleotide} \times \text{g}^{-1} \times \text{h}^{-1}$)	3.0	10.1	6.4	9.8
DNase ($\mu\text{mol nucleotide} \times \text{g}^{-1} \times \text{h}^{-1}$)	1.2	3.6	3.6	4.8
Acid phosphatase ($\mu\text{mol phosphate} \times \text{g}^{-1} \times \text{h}^{-1}$)	190	260	400	410
Peroxidase ($\mu\text{mol H}_2\text{O}_2 \times \text{g}^{-1} \times \text{h}^{-1}$)	880	840	3440	4450

capacity of ion exclusion differs from species to species but less so with respect to the type of the heavy metal.

The second reaction complex is less well known. Competition of heavy metals for uptake has already been mentioned; that between copper and iron would also mean that copper uptake by the carrier is reductive. Apparently, Cu^{2+} can partially displace Ca^{2+} in biomembranes and thus changes the transport properties of the membrane. As far as is known adaptation to stress by excess copper reduces the K^+ efflux from cells. In the cytosol (reaction complex 3) Cu^{2+} is incorporated into the target enzymes or bound to polypeptides, oligopeptides or amino acids for transport into the vacuole and the xylem, respectively.

1.7.4.1 Polypeptides Induced by Heavy Metals

Two types of cysteine-rich peptides are effective in the sequestration of heavy metals in the vacuole: The larger **metallothioneins** (Fig. 1.7.8) and the smaller **phytochelatins** (Box 1.7.2). The role of both types will be discussed with respect to detoxification of elevated concentrations of heavy metals, because both types of polypeptides are synthesised in most plants in correspondence to the severity of heavy metal stress. However, their role in cell biology is still not completely understood.

Metallothioneins

Metallothioneins were originally discovered in microorganisms, animals and fungi, particularly in yeasts, and have recently been demonstrated also in plants; a Cu-binding metallothionein with a molecular mass of 8.5 kDa, the formation

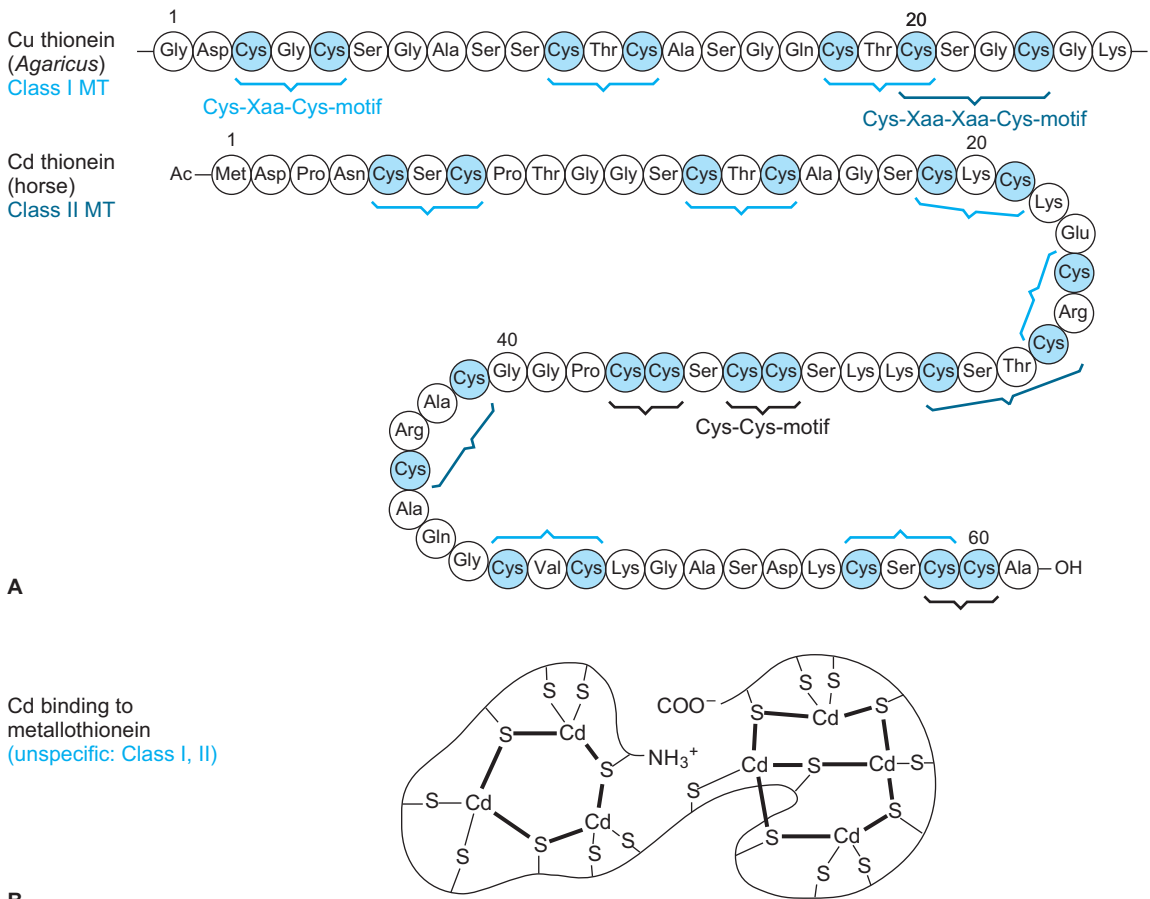
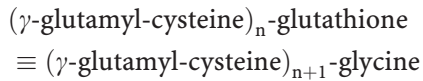


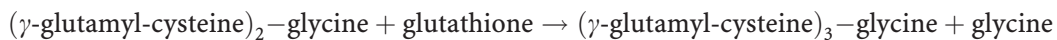
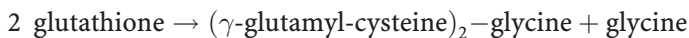
Fig. 1.7.8. A The heavy metal binding motifs of a metallothionein. B Binding of heavy metal ions (cadmium) to a metallothionein. (After Schlee 1992)

Box 1.7.2 Phytochelatins

Phytochelatins are derivatives of the tripeptide γ -Glu-Cys-Gly. This tripeptide is not a protein building block as the “peptide bond” is not between the carboxyl group next to the α -amino group (of Glu) and the amino group of Cys, but between the γ -carboxyl group of Glu, in other words, “at the wrong end of Glu”. Phytochelatins are built along the following principle:

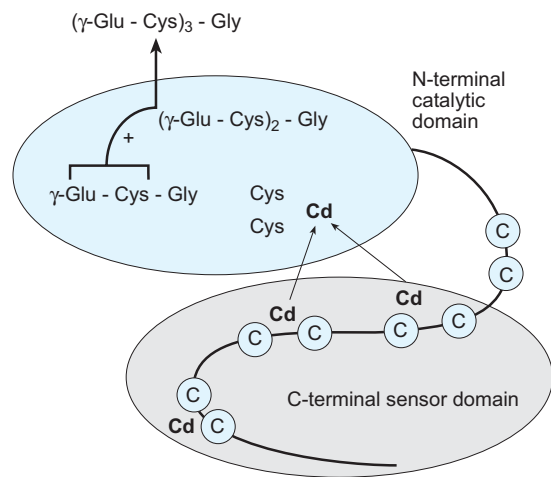


Biosynthesis of these molecules is by dipeptide transfer from glutathione and not en route of a normal polypeptide. The corresponding enzyme is the phytochelatin synthase (γ -glutamyl-cysteine dipeptide transpeptidase) a protein of M_r 4×25 kDa \approx 96 kDa:



and so forth.

Current understanding is that the Cys-rich C-terminal domain is a sensor for heavy metals; the cysteines bind the metal ions and



■ Model of the phytochelatin synthase

concentrate them at the catalytically active N-terminal domain which thereby is activated (see Figure, after Cobbett 1999).

of which is specifically induced by a high supply of copper ions, was found in the roots of the cuprophyte *Silene cucubalus*. This is one of the few instances where heavy metal specificity appears to exist.

Metallothioneins are polypeptides of about 60 amino acids, whose chain is kinked in many places, and whose N- and C-termini are particularly rich in cysteine residues. It is remarkable that they do not contain aromatic amino acids and that the cysteines always appear in the sequence Cys-Xaa-Cys. This motif suggests the formation of metal sulfide clusters (Fig. 1.7.8B).

The two cysteine-rich domains are separated by a cysteine-free central part, the so-called spacer, which comprises about 40 amino acid residues as seen primarily in mammals (Klaassen et al. 1999) and in the metallothionein A from *Pisum sativum*. Such metallothioneins, referred to as class I type, have been found – at least as genes – in pea, maize, barley, wheat and *Mimulus*.

Metallothioneins of the class II type are characterised by slightly different cysteine motifs; in addition to -Cys-Xaa-Cys-, they contain the motifs -Cys-Cys- and -Cys-Xaa-Xaa-Cys- (see Fig. 1.7.8A) as found in fungi, invertebrate animals and plants (soybean, *Ricinus* and *Arabidopsis*; Cobbett and Goldsbrough 2002).

As the genes of these metallothioneins are known (MT genes) analysis of their function can be performed, and the regulatory characteristics of their promoters can be studied using molecular biological methods. The promoters contain at least partly *cis* elements that bind transcription factors responsive to metals, but also ABA-responsive elements. In that respect they correspond to animal representatives whose expression is also regulated by heavy metal stress and internal factors. The spacer apparently gives structure to the cysteine-rich termini. Metallothionein knockout mutants show an increased sensitivity to stress by heavy metals.

This applies also to yeasts, where CUP1_o cells are hypersensitive to copper stress, in contrast to the wild type. In “normal”, i.e. heavy metal sensitive plants, metallothioneins are produced from single copy genes, but the genome of metallophytes contains multiple copies of MT genes. For yeasts, which produce metallothioneins correspondingly to the number of copies of MT genes, a connection between the content of metallothioneins and resistance to heavy metal stress has been shown. Plant MTs are classified into four types according to the arrangement of Cys residues. Type MT1 is expressed more in roots than in leaves, type MT2 primarily in leaves. The expression of MT1 and MT2b is mainly in the phloem and seems to play a major role in Cu homeostasis. MT2a and MT3 are mainly expressed in leaf mesophyll and strongly induced by Cu²⁺ in young leaves, root tips and ripening fleshy fruits. The occurrence of type MT4 seems to be restricted to developing seeds (Guo et al. 2003).

For plants, even though an increased transcription of MT genes has been observed under stress by heavy metals, it is not clear whether the corresponding proteins are formed in amounts sufficient for detoxification. In that context, other interpretations have been put forward:

- a storage function of metallothioneins, as one protein molecule is able to bind several heavy metal ions (see Fig. 1.7.8);
- a role as transporters for the sequestration of heavy metals into the vacuole (see Chap. 1.9.1.1).

Considering induction of metallothionein expression, as well as binding of heavy metal ions as “sulfides”, it appears that metallothioneins are not very substrate-specific. The binding constants for Zn²⁺, Cd²⁺ and Cu²⁺ are not dramatically different, even though Cu²⁺ is usually slightly stronger bound than the others. From that finding a type of cross-protection could be concluded, or, for tolerant species, a type of “cross-tolerance”.

Phytochelatin

The second type of metal-binding peptides, the phytochelatin (sometimes also called metallothioneins class III), differs from metallothioneins in as much as they are not primary gene products, but are produced by enzymatic peptide transfer from tripeptides. Their molecular

masses range from 2–10 kDa. Phytochelatin was discovered in cell cultures of *Datura innoxia* and *Rauvolfia serpentina* as well as in cultures of yeast; recently, they have also been found in cell cultures of tomato, tobacco and other species, usually upon stress by Cd and Cu. Also mosses, ferns and fungi are capable of producing phytochelatin (Grill et al. 1987).

Phytochelatin is derivatives of the tripeptide glutathione with the general formula (γ-Glu-Cys)_n-Gly where n ranges between 2 and 11 (Box 1.7.2).

In phytochelatin of grasses glycine is replaced by serine, and in some members of the Fabaceae by β-alanine (**homophytochelatin**).

Phytochelatin is synthesised by phytochelatin synthase (a dipeptidyltransferase), which is constitutively expressed but is activated by heavy metals with high affinity to SH groups. Mercury, Cd, Cu, and Pb are particularly effective in that respect, while Fe, Mn, Mo, Cr, U and V have no effect on PC synthase expression.

Occurrence of metallothioneins and phytochelatin is not mutually exclusive. Upon heavy metal stress synthesis of both types of polypeptides is intensified. Metallophytes, however, produce significantly less phytochelatin than heavy metal-sensitive plants (Fig. 1.7.9).

This is the reason that heavy metal tolerance of metallophytes cannot be traced back to direct detoxification by phytochelatin. They probably play an important role in the sequestration of heavy metals to the vacuole (see Chap. 1.9.1.1);

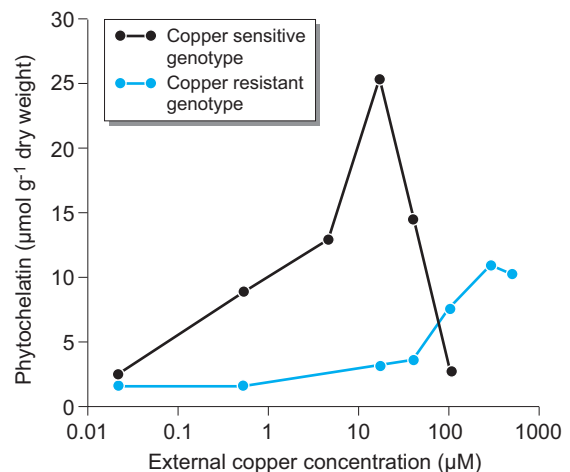


Fig. 1.7.9. Phytochelatin synthesis as related to the copper concentration in the root medium of copper-sensitive and -resistant genotypes of *Silene vulgaris*. (After Ernst 1996)

there, polymers of heavy metal phosphates can be formed, such as polymeric zinc phosphate in *Deschampsia* or *Lemna*.

More or less specific heavy metal binding proteins are usually interpreted as detoxifying elements. However, this would mean that the heavy metal–protein complexes or clusters would accumulate during the lifetime of a plant. This is not the case, although a correlation between the concentration of the heavy metal and that of the thioneins has been shown. However, the concentrations of the thioneins are much too low for such a function (less than 0.1% of dry weight). Rather than for direct detoxification heavy metal binding polypeptides may serve to maintain a heavy metal homeostasis of the tissue. Such a storage function could transiently contribute to a detoxification mechanism (Tomsett and Thurman 1988, but see also Cobbett and Goldsbrough 2002).

Heavy Metal Ion Pumps

Special consideration should be given to the discovery of **heavy metal ion pumps** in the plasma membranes of microorganisms, animals (including man), fungi and of the model plants *Arabidopsis thaliana* (AXA2p; Harper 1997), *Arabidopsis halleri* (Becker et al. 2004) and *Thlaspi caerulescens* (Assunção et al. 2003). Heavy metal pumps in plants belong to different types.

These enzymes are ATP-dependent pumps with a structure similar to that of K^+/Na^+ -ATPases of the plasma membrane which remove heavy metals from the protoplast. Best investigated are the so-called copper ATPases (Solioz and Vulpe 1996). Two of these pumps have been described: CopA accomplishes the import of copper as the Cu^{1+} ion upon copper shortage. CopB functions in export, also of univalent copper. Defects in these copper ATPases lead to diseases in humans (e.g. Menke syndrome). These copper ATPases have certain structural features which are partly unique and partly similar to those of other metal

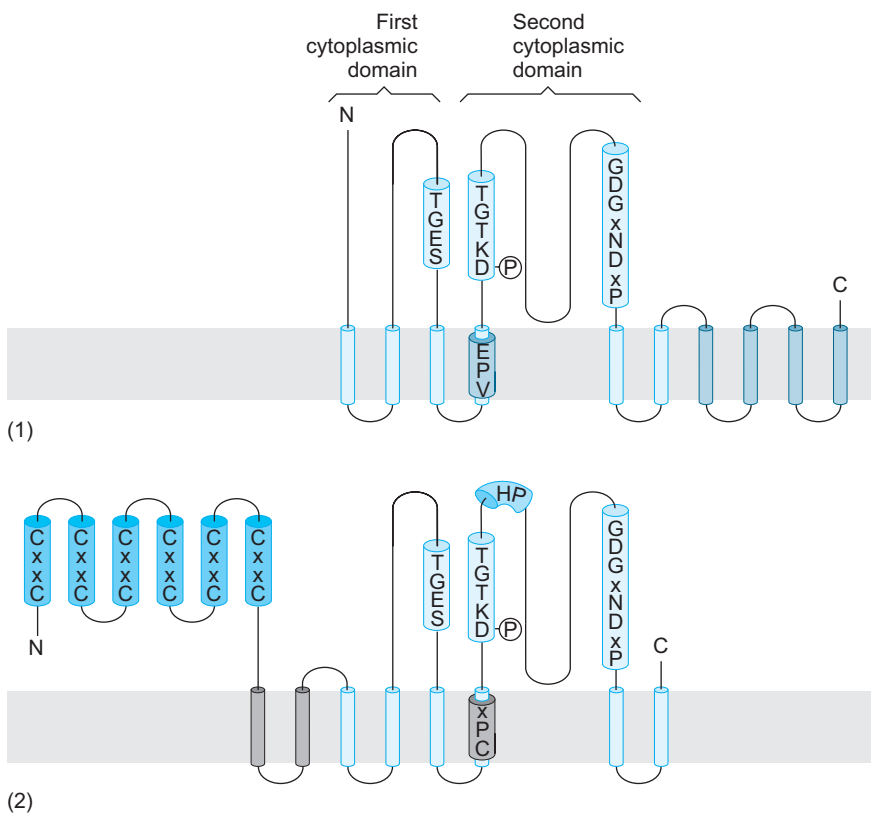


Fig. 1.7.10. Comparison of a Na^+/K^+ -ATPase (1) with a heavy metal ATPase (2). The transmembrane helices and the conserved structural motifs of all P-type ATPases are in light blue. TGES Phosphatase domain; DKTGT aspartate kinase domain; GDGxNDxP ATP-binding domain. The sequences of such ion pumps that do not transport heavy metals are shown in blue-grey. The helices and sequences that only occur in heavy metal ion pumps are grey. The repetitive heavy metal binding domains are in blue. (Solioz and Vulpe 1996)

ion transporting ATPases (Fig. 1.7.10). The partial structures must fit into the transport cycle. All metal-transporting ATPases have in common an aspartate (D) in a very conserved sequence, TGTKD, which is phosphorylated by ATP. The phosphorylating domain is also conserved and is located in the sequence DKTGT. Dephosphorylation of the aspartylphosphates by a domain with phosphatase activity (TGES) forces a conformational change resulting in the transport of one to two metal ions across the plasma membrane. In addition to the structural elements of a Na^+/K^+ -ATPase, the heavy metal ATPases possess an N-terminal extension, consisting of a series of Cys-Xaa-Xaa-Cys elements. In humans there are six repeats, in yeast only two. Further characteristic traits of copper ATPases are a conserved intramembrane motif: CPC, CPH or CPS 9 (so-called CPX motif), a His-Pro dipeptide and a smaller number of integral membrane peptides. The proline residue appears to be an essential part of a Ca^{2+} -binding domain, forming the channel or the transport domain. By the heavy metal binding domain the CPX-ATPases attain a

- certain degree of specificity for heavy metals,
- storage function for cytoplasmic heavy metals (CopA of *Pseudomonas syringae*, e.g. forms a CPX-ATPase, which stoichiometrically binds 11 copper ions).

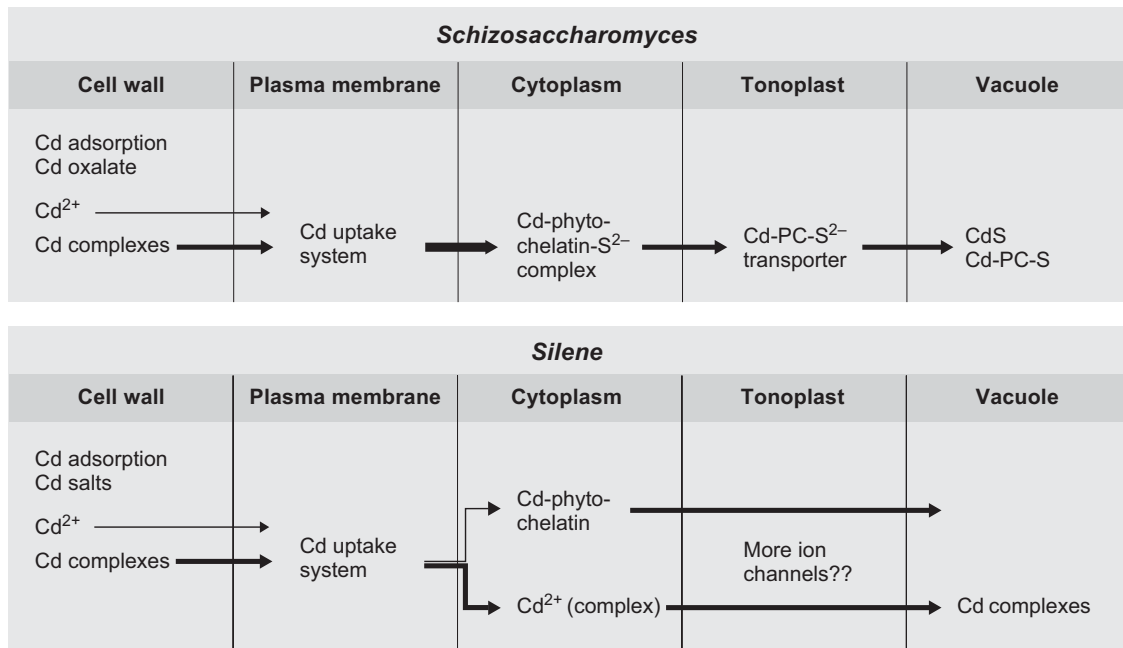
It is to be assumed that the CPX-ATPases, as enzymes of the plasmalemma, play a major role in achieving homeostasis of essential heavy metals. However, this has not yet been shown in physiological experiments. Up- and downregulation of Zn transporters (ZIP family) seems to be responsible for zinc homeostasis in plants.

1.7.4.2

Cellular Response to Heavy Metal Stress: the Example of Cd

It was unclear for a long time whether thioneins or phytochelatins are produced as cellular response to Cd stress. The first Cd-binding polypeptides were found in *Schizosaccharomyces* and called “cadystins” because of the numerous cysteine residues in these compounds. Meanwhile these Cd-binding proteins have been identified as phytochelatins. In addition to the phytochelatins, Cd excretion by an ATP-driven $\text{Cd}^{2+}/2\text{H}^+$ exchange plays a role in Cd tolerance (Fig. 1.7.11).

As in the case of Cu^{2+} , binding of Cd^{2+} to phytochelatins does not serve as a long-term detoxification mechanism, but as short-term storage and probably plays a major role in intracellular Cd^{2+} transport. Mainly phytochelatins of



■ Fig. 1.7.11. Model of cellular and molecular detoxification mechanisms for cadmium in yeast and higher plants. (After Ernst 1996)

the (γ -Glu-Cys)₃-type and (γ -Glu-Cys)₄-Gly have been observed.

1.7.5

Heavy Metal Tolerance

Metallophytes, e.g. cuprophytes, use several strategies to counter the excess of heavy metals. However, they are not forearmed to cope with any concentration of these toxic ions, only the threshold at which damage occurs is higher. In principle, it is not possible to define a particular mechanism by which a plant achieves heavy metal resistance. Rather there is a gradual transition from metal-sensitive to metal-resistant plants, as the cellular responses to that stress are qualitatively similar and only differ quantitatively (Table 1.7.8). Simultaneous stresses from several heavy metals may readily overstretch the capacity even of strongly resistant plants. Such multiple supply often corresponds to real conditions, e.g. on ore outcrops, slag heaps from mines and in sewage sludge. Particularly in the latter, there are in addition to high copper and iron concentrations relatively high concentrations of cadmium or mercury, heavy metals that, in contrast to Cu, Mn and Fe, are true xenobiotics. How do plants cope with an excess supply of such ions?

1.7.6

Heavy Metal Extraction and Soil Decontamination by Plants (Phytomining, Phytoremediation)

Metal tolerance, and in particular heavy metal tolerance, of some plants offers two economically interesting possibilities: **Heavy metal extraction (phytomining)** and **soil decontamination with the help of so-called metal accumulating plants (phytoremediation)**. Plants can exploit substrates the mining of which is technically difficult and therefore unprofitable. Plants may also be used for the extraction of toxic materials, particularly heavy metals, organic pollutants and radionuclides from contaminated soils (soil remediation). For the latter possibility, five different procedures are used (Fig. 1.7.12):

- **phytoextraction:** toxin-accumulating plants extract the pollutant from the soil and accumulate it in the organs to be harvested,
- **rhizofiltration:** plant roots adsorb or take up toxins (particularly heavy metals) from water and sewage,
- **phytodegradation:** Plants and associated microorganisms decompose the pollutant (organic noxes),
- **phytostabilisation:** by synthesising complexes that bind the pollutant or by precipitation plants can decrease the bioavailability of the toxins,
- **phytovolatilisation:** plants detoxify the soil by production of volatile compounds (e.g. selenium).

Table 1.7.8. Heavy metal hyperaccumulating plants. Hyperaccumulating plants are able to accumulate heavy metals from 100 times to 10,000 times (e.g. *Haumaniastrum* for Co) the content of non-accumulating plants. The value of physiological tolerance of most heavy metals is at approx. 0.1% of plant dry matter. Exceptional values are for Zn (up to 1%), for Cd (0.01%) and gold (0.00001%). Surprisingly, some lichens, e.g. *Lecanora vinetorum*, also hyperaccumulate heavy metals (Brooks et al. 1998)

Element	Number of known hyperaccumulators	Examples (species)	Concentration (mg per g dry weight)	Biomass production (t per ha and year)
Ni	300	<i>Berkheya coddii</i>	17	18
Co	26	<i>Haumaniastrum robertii</i>	10.2	4
Cu	24	<i>Haumaniastrum katangense</i>	0.83	5
Se	19	<i>Astragalus pattersoni</i>	6	5
Zn	16	<i>Thlaspi calaminare</i>	10	4
Mn	11	<i>Macadamia neurophylla</i>	55	30
Ta	1	<i>Iberis intermedia</i>	0.3	8
Cd	1	<i>Thlaspi caerulescens</i>	3	4

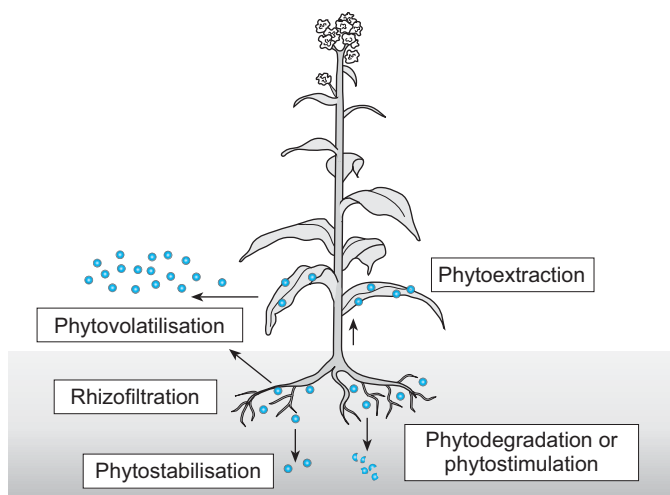


Fig. 1.7.12. The various strategies of phytoremediation. (After Pilon-Smits and Pilon 2000)

1.7.6.1

Phytoremediation

Plants which are able to extract large amounts of heavy metals from soil by accumulating them in an ample biomass even in a short vegetation period are particularly suited for **phytoremediation**. This technique is based on the work of the German botanist, Baumann, who in 1885 discovered accumulation of Zn in the mountain pansy (*Viola lutea* ssp. *calaminaria*), also called the calamine violet, and in an alpine penny-cress (*Thlaspi caerulescens*; Assunção et al. 2003). Two strategies of phytoremediation have been successfully employed: Continuous phytoextraction with hyperaccumulators and chelate-mediated extraction.

For the continuous removal of pollutants **hyperaccumulators** are preferred. Effective hyperaccumulation is obtained with many heavy metals, independent of whether they are metabolically active, or true xenobiotics, such as Cd. Hyperaccumulators may gain a kind of protection against biotic stress such as fungal infection as the pathogen is usually less resistant to intoxication by heavy metals; on the other hand, such protection is physiologically expensive, as it requires biochemical bulwarks mechanisms, e.g. synthesis of metallothioneins and phytochelatins, sequestration mechanisms to the vacuole or cell wall, excretion by salt glands and hydathodes, conversion of toxic amino acids, such as selenocysteine to the volatile methylselenocysteine, or repair after damage.

For **chelate-mediated extraction of pollutants**, annual plants with a high biomass production

are particularly useful, e.g. large grasses, as long as the metal contamination of the soil is low or moderate. These plants that do not belong to the hyperaccumulators are allowed to develop to their full size on the contaminated soil. Heavy metal extraction is then initiated by solubilisation by applying artificial chelators such as EDTA to the soil.

An interesting possibility for **detoxification of mercury** has been described by Meagher (2000). Elemental mercury and mercury ions are released from gold mining, from industrial waste and upon burning of fossil energy carriers and medical wastes. Sulfate-reducing bacteria produce from such mercury-containing waste the extremely poisonous methylmercury ion (MeHg^+), which accumulates in the food chain, and also in aquatic sediments. Gram-negative bacteria possess two enzymes which reduce methylmercury to elemental mercury, which is volatile and much less poisonous (about hundred times) than mercury ions. Organomercury lyase converts methylmercury to Hg^{2+} which by an NADPH-dependent mercurate reductase is reduced to mercury. *Arabidopsis* but also bigger plants, such as tobacco or *Liriodendron*, were transformed with the gene of one of these enzymes and crossed with a partner plant, into which the other gene had been transferred. The plants of the F_1 generation were considerably more resistant to mercury salts in the substrate, from which elemental mercury was evaporated. Transfer and expression of these genes also in aquatic plants are most desirable aims for the decontamination of the wastewaters especially from gold mines. However, phytovolatilisation is

not a solution, but a dilution of the problem, comparable with the construction of high chimneys in central Europe in the 1960s and 1970s to get rid of industrial sulfur dioxide locally, which was then transported predominantly to northern Europe.

Summary

1. About 25% of the heavy metals (Fe, Mn, Cu, Zn, Mo, Co) belong to micronutrients in plant nutrition; the majority of the heavy metals do not have a metabolic function in plants. Nevertheless, they are naturally present in all plants, but often in very low concentrations. They can be classified as xenobiotic heavy metals. Some of the micronutrients occur in several oxidation states and are therefore components of systems that transfer electrons (e.g. Fe in cytochromes). Free heavy metal ions in the reduced form (e.g. Fe^{2+} , Cu^+ , Mn^{2+}) can easily react with oxygen and are therefore toxic Fenton reagents. Mobility of heavy metal ions in the soil and availability to plants depend on the redox potential and pH of the soil. Heavy metal deficiency occurs very rarely, in contrast to metal toxicity which is usually due to human activities. Plants which are capable of accumulating larger amounts of particular heavy metals in their tissues are termed metallophytes.
2. Upon heavy metal shortage, plants increase their capacity for uptake by producing a larger root surface (root hairs, labyrinth in the rhizodermis/transfer cells) and by enhancing secretion of chelators and protons (by plasma membrane H^+ -ATPases) into the substrate, thus increasing the dissolved proportion of heavy metal ions. Because uptake of heavy metal ions frequently requires prior reduction (e.g. $\text{Fe}^{3+} \rightarrow \text{Fe}^{2+}$), the capacity of the plasma-membrane chelate reductase is also increased. Grasses excrete so-called phytosiderophores instead of the chelators into their substrate. Phytosiderophores are non-proteinogenic amino acids which transfer heavy metal ions from insoluble into water-soluble complexes.
3. Heavy metal toxicity also occurs with plant micronutrients if the optimal concentrations are exceeded; of chemically reactive xenobiotic heavy metals already very low concentrations are toxic. Uptake of the latter is via the uptake system for micro- or macronutrients such as Ca. Heavy metal toxicity as well as deficiency result in chloroses which, however, are of different origin in the two cases. Chlorosis from toxicity results from bleaching of the photosynthetic pigments by ROS (heavy metals act as Fenton reagents). Chlorosis from shortage is caused by failing chlorophyll synthesis because of a lack of cofactors (e.g. cytochrome P450). Because heavy metal ions are also part of ROS-scavenging systems, chlorosis from shortage might also be the consequence of a less efficient anti-oxidative system. Apart from oxidative stress caused by heavy metals, they also very effectively replace functional ions from biochemically important complexes and form sulfides with the free sulfhydryl groups of proteins and therefore are toxic, even at very low concentrations. The mobility of heavy metal ions differs in the plant (Cu^{2+} is almost immobile, Fe^{2+} and Cd^{2+} are very mobile).
4. Sensitive and tolerant plants react in a similar way to heavy metal stress. On the one hand, enhanced exudation from the root cells traps heavy metal ions as insoluble complexes in the soil or in the cell wall and, on the other, the concentration of the cytosolic heavy metals is decreased by binding to specific oligo- and polypeptides.
5. Heavy metal binding polypeptides are metallothioneins and phytochelatins. Synthesis of both groups of peptides is enhanced under heavy metal stress. They are rich in cysteine residues by which several up to many heavy metal ions per polypeptide can be fixed. Metallothioneins are gene-encoded proteins with certain repetitive cysteine-containing motifs. The promoters of the MT genes contain elements for metal-responsive transcription factors and frequently also ABA-responsive elements. Metallothioneins are rather unspecific for heavy metals. They are considered as heavy metal storage proteins rather than as means for detoxification. In contrast to thioneins, phytochelatins are not oligo- or polypeptides arising from gene expression. They are synthesised by dipeptide transfer from glutathione. Their general structure is $(\gamma\text{-Glu-Cys})_n\text{-Gly}$, where n ranges from 1 to 11. Glycine can be replaced by serine or β -alanine. They are synthesised by phytochelatin synthase, whose synthesis in turn is induced by the highly toxic heavy metal ions. Phytochela-

tins probably serve to sequester heavy metals to the vacuole and thus, though not representing direct detoxifying compounds, are involved in the relief of heavy metal stress. In the vacuole of some metallophytes polymeric heavy metal phosphates have been demonstrated. Recently, heavy metal pumps have been found in microorganisms, animals and yeast and in *Arabidopsis* as well. These enzymes are ATP-dependent pumps similar to the Na^+/K^+ -ATPases, but with a cysteine-rich N-terminal extension.

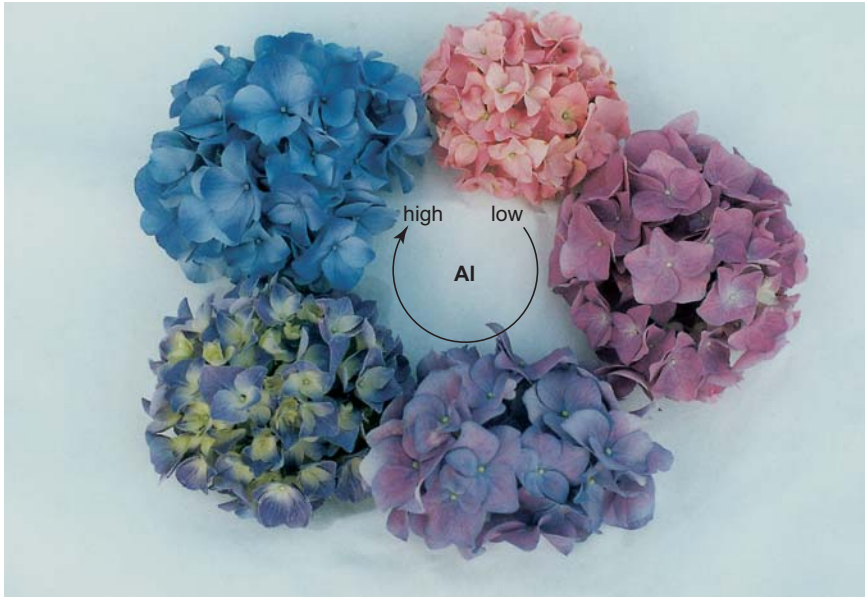
6. Stress by heavy metals evokes multiple responses of plants, which are scarcely element-specific. Differences in tolerance between metallophytes and heavy metal sensitive plants are gradual. Protein denaturing by heavy metal ions can induce heat shock reactions (accumulation of chaperones).
7. Metallophytes can be used for phytomining and for phytoremediation. Phytomining is essentially a question of profitability and is only economically effective for rare heavy metals (Co, Ta, Ni, U). Heavy metal remediation of soils may be carried out by continuous extraction of the toxic compounds with perennial hyperaccumulators or by chelate-mediated removal of materials, using moderately heavy metal tolerant, annual plants with ample biomass production. These grow on the contaminated soils until maturity when the heavy metals are brought into solution by application of chelators. After the uptake of the metal the plants usually rapidly die and are then disposed of.

References

- Amberger A (1988) Pflanzenernährung. UTB Ulmer, Stuttgart, 264 pp
- Assunção AGL, Schat H, Aarts MGM (2003) *Thlaspi caerulescens*, an attractive model species to study heavy metal hyperaccumulation in plants. *New Phytol* 159:351–360
- Bazzaz FA, Rolfe GL, Carlson RW (1974) Effect of Cd on photosynthesis and transpiration of excised leaves of corn and sunflower. *Physiol Plant* 32:373–376
- Becker M, Talke IN, Krall L, Krämer U (2004) Cross-species microarray transcript profiling reveals high constitutive expression of metal homeostasis genes in shoots of the zinc hyperaccumulator *Arabidopsis halleri*. *Plant J* 27:251–268
- Brooks RR, Chambers MF, Nicks LJ, Robinson BH (1998) Phytomining. *Trends Biochem Sci* 3:359–362
- Casiday R, Frey R (2000) Iron use and storage in the body: ferritin and molecular representations: <http://wunmr-wustl.edu/Edu/Dev/Lab/Tutorials/ferritin.htm>
- Cobbett CS (1999) A family of phytochelatin synthase genes from plant, fungal and animal species. *Trends Plant Sci* 4:335–337
- Cobbett C, Goldsbrough P (2002) Phytochelatin and metallothioneins: role in heavy metal detoxification and homeostasis. *Annu Rev Plant Biol* 53:159–182
- Cohen CK, Norvell WA, Kochian LV (1997) Induction of the root cell plasma membrane ferric reductase (an exclusive role for Fe and Cu). *Plant Physiol* 114:1061–1069
- Ernst WHO (1996) Schwermetalle. In: Brunhold C, Rügsegger A, Brändle R (Hrsg) Stress bei Pflanzen. UTB, Bern, pp 191–219
- Grill E, Winnacker EL, Zenk MH (1987) Phytochelatin, a class of heavy-metal-binding peptides from plants, are functionally analogous to metallothioneins. *Proc Natl Acad Sci USA* 84:439–443
- Guo WJ, Bundithya W, Goldsbrough PB (2003) Characterization of the *Arabidopsis* metallothionein gene family: tissue-specific expression and induction during senescence and in response to copper. *New Phytol* 159:369–381
- Klaassen CD, Liu J, Choudhuri S (1999) Metallothionein: an intracellular protein to protect against cadmium toxicity. *Annu Rev Pharmacol Toxicol* 39:267–299
- Kramer D, Römheld V, Landsberg E, Marschner H (1980) Induction of transfer-cell formation by iron deficiency in the root epidermis of *Helianthus annuus* L. *Planta* 147:335–339
- Lee KC, Cunningham BA, Paulsen GM, Liang GH, Moore RB (1976) Effect of cadmium on respiration rate and activities of several enzymes in soybean seedlings. *Physiol Plant* 36:4–6
- Marschner H (1986) Mineral nutrition of higher plants. Academic Press, London, 527 pp
- Meagher RB (2000) Engineered phytoremediation of mercury pollution in soil and water using bacterial genes. In: Terry N, Banuelos G (eds) Phytoremediation of contaminated soil and water. CRC Press, Boca Raton, pp 201–221
- Mengel K (1991) Ernährung und Stoffwechsel der Pflanze. G Fischer, Jena, 466 pp
- Pilon-Smits E, Pilon M (2000) Breeding mercury-breathing plants for environmental cleanup. *Trends Plant Sci* 5:235–236
- Römheld V, Kramer D (1983) Relationship between proton efflux of rhizodermal transfer cells induced by iron deficiency. *Z Pflanzenphysiol* 113:73–83
- Schlee D (1992) Ökologische Biochemie. G Fischer, Jena, 587 pp
- Soligo M, Vulpe C (1996) CPx-type ATPases: a class of P-type ATPases that pump heavy metals. *Trends Biochem Sci* 21:237–241
- Tomsett AB, Thurman DA (1988) Molecular-biology of metal tolerances of plants. *Plant Cell Environ* 11:383–394
- Wallnöfer PR, Engelhardt G (1984) Schadstoffe, die aus dem Boden aufgenommen werden. In: Hock B, Elstner E (Hrsg) Pflanzentoxikologie, Band I. Wissenschaftsverlag, Mannheim

1.8

Aluminium



Aluminium ions form complexes with water-soluble vacuolar pigments. Gardeners use this to great effect in the ornamental plant *Hydrangea* sp., which at different Al^{3+} concentrations changes the colour of its flowers from white through red to deep blue. The colours in *Hydrangea* are the result of aluminium complexes with the anthocyanin delphinidin-3-glucoside and with chlorogenic acid (caffeoylquinic acid). The aluminium concentration in the flowers shown are (from red to blue) 51, 106, 640, 804, and 3959 mg Al^{3+} /kg dry weight. After Ma et al. (2001)

Recommended Literature

- Barceló J, Poschenrieder C (2002) Fast root growth responses, root exudates, and internal detoxification as clues to the mechanisms of aluminium toxicity and resistance: a review. *Environm Experimental Bot* 48:75–92
- Delhaize E, Ryan PR (1995) Aluminum toxicity and tolerance in plants. *Plant Physiol* 107: 315–321
- Kochian LV (1995) Cellular mechanisms of aluminum toxicity and resistance in plants. *Annu Rev Plant Physiol Plant Mol Biol* 46: 237–260
- Kochian LV, Hoekenga OA, Piñeros MA (2004) How do crop plants tolerate acid soils? Mechanisms of aluminum tolerance and phosphorous efficiency. *Annu Rev Plant Biol* 55:459–493
- Macdonald TL, Martin RB (1988) Aluminum ion in biological systems. *Trends Biochem Sci* 13:15–19

Aluminium toxicity is a worldwide problem affecting growth of crop plants and yields on acid soils (see also Chap. 3.5.1 on forest damage): Al is the most frequent metal element in the earth's crust. In acid soils, i.e. at $\text{pH} < 5.5$, the phytotoxic Al^{3+} ion becomes soluble to an extent which inhibits root growth and, as secondary effects, decreases uptake of nutrients and water and thus growth of the plant. In only slightly acidic or neutral soils aluminium forms insoluble oxides or silicates. More than 30% of the (potential) agricultural land has a pH of < 5.5 with aluminium toxicity being a serious problem. The widespread acidic red soils, called oxisols, of the tropics and subtropics are particularly affected. Aluminium toxicity also occurs in temperate climates because of acid rain or mist.

However, there is growing awareness that on acid soils several factors in addition to Al toxicity may limit plant growth, such as high concentrations of iron and manganese ions or deficien-

cy in several essential mineral elements, in particular of phosphorus.

According to present knowledge, aluminium is not a trace element required for the nutrition of plants. Though not belonging to the heavy metals, it is considered a toxin because of its negative effects on plant growth. Nevertheless – as with most xenobiotics – inheritable resistance to Al ions in the root zone occurs, and possibly even tolerance of aluminium ions in the cell. Research into Al toxicity and resistance mechanisms has been made possible by breeding of almost isogenic lines, e.g. of wheat, which differ only in their sensitivity to Al. Because of the multiplicity of secondary effects of Al toxicity, the interpretation of the physiological effects of Al ions is still very controversial. However, methods of analysis have become more sophisticated and hence interpretation is clearing up.

1.8.1

Forms of Aluminium Available to Plants

There are three classes of aluminium ions available to plants: The **mononuclear** forms of Al^{3+} , **polynuclear aluminium**, and **complexed aluminium** (Macdonald and Martin 1988). The latter occurs usually in complexes with low molecular

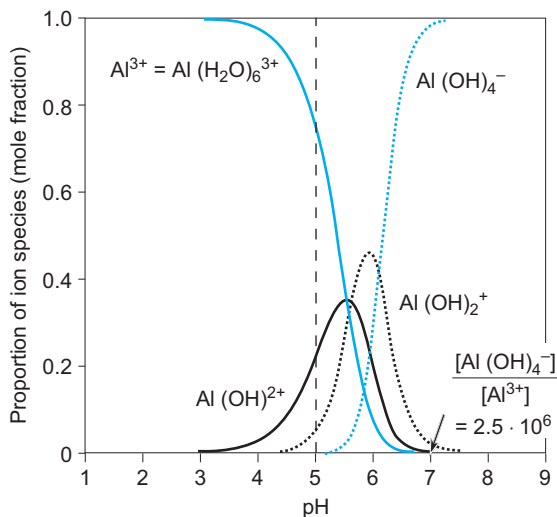


Fig. 1.8.1. Dependence on the pH of the proportion (mole fraction) of soluble, mononuclear aluminium ion species in aqueous solution. At higher concentrations " Al_{13} " = $[\text{AlO}_4\text{Al}_{12}(\text{OH})_{24}(\text{H}_2\text{O})_7]^{7+}$, the triskaidea-aluminium is formed. (After Macdonald and Martin 1988)

weight compounds, but, particularly at neutral pH, macromolecules are also able to bind Al ions.

In acidic solutions ($\text{pH} < 5.0$), mononuclear Al^{3+} occurs as the hexahydrate, $\text{Al}(\text{H}_2\text{O})_6^{3+}$, conventionally called the Al^{3+} ion (Fig. 1.8.1). With increasing pH this hexahydrate is progressively deprotonated producing $\text{Al}(\text{OH})^{2+}$, then $\text{Al}(\text{OH})_2^+$, and, finally, at neutral conditions, the insoluble $\text{Al}(\text{OH})_3$, also called gibbsite, is formed. In an alkaline milieu, the aluminate ion $[\text{Al}(\text{OH})_4]^-$ is produced, which is again soluble, but as an anion has different sites of attack than the cation Al^{3+} .

At higher aluminium concentrations, particularly at neutral conditions, polynuclear forms occur, most frequently the triskaidea-aluminium $[\text{AlO}_4\text{Al}_{12}(\text{OH})_{24}(\text{H}_2\text{O})_7]^{7+}$, the so-called Al_{13} . All positively charged forms are phytotoxic, including Al_{13} . Mononuclear aluminium easily forms complexes with oxygen donor ligands, e.g. carboxyl groups, phosphates (inorganic P_i and polyphosphates) and sulfate.

1.8.2

Aluminium Toxicity

1.8.2.1

Aluminium Uptake

The kinetics of Al^{3+} uptake in wheat roots is biphasic, an initial fast and a subsequent slow phase. The fast phase results from the uptake into the cell wall and in the mucilage (the so-called mucigel) around the root tip. The slow phase represents the uptake into the symplast. Al^{3+} deposited in the cell wall, which either forms precipitates or is adsorbed, can be desorbed and solubilised with citrate. Three hours of exposure of wheat roots to citrate released between 50 and 75% of their Al^{3+} content, whereas in *Arabidopsis* roots only a quarter of the absorbed Al^{3+} could be extracted from the cell wall (Table 1.8.1). Aluminium-resistant cultivars absorb Al^{3+} more slowly and in much smaller quantities than sensitive species. This applies to uptake into the apoplast as well as into the symplast.

Al^{3+} enters the symplast either via cation carriers or by adsorption and endocytosis. In addition, in the acidic apoplast ($\text{pH} \approx 4.5$), aluminium citrate complexes are uncharged and can slowly permeate the plasma membrane.

Since the radius of the Mg^{2+} ion is similar to that of the Al^{3+} ion (Table 1.8.2), it is assumed

Table 1.8.1. Cell-wall-bound Al^{3+} : roots of wild-type and an aluminium-resistant mutant of *Arabidopsis* were incubated for 0 and 3 h, respectively, in 25 μM AlCl_3 solution and subsequently washed for 5 min with either Al-free nutrient solution or (Al-free) nutrient solution containing citrate. The amount of Al^{3+} remaining in the roots was then measured. Somewhat more than 25% of the Al^{3+} absorbed by the roots could be extracted from the cell wall by forming a complex with citrate (Larsen 1998)

Plant	Extraction with water		Extraction with 0.5 mM citrate (pH 4.4)	
	0 h	3 h	0 h	3 h
Treatment		Remaining Al^{3+} [nmol/mg dry weight]		
Wild type	0.2 ± 0.1	42.3 ± 3.4	0.2 ± 0.1	29.3 ± 0.8
Mutant <i>alr-104</i>	0.3 ± 0.1	28.6 ± 1.6	0.4 ± 0.2	31.7 ± 0.9

Table 1.8.2. Toxicity of soluble aluminium ions can be ascribed to the similarity of their ionic radii with those of essential nutrient elements (arrows). Effective ionic radii (in Å) are shown in relation to the coordination number (Maddonald and Martin 1988)

Ion	Coordination number					
	4	5	6	7	8	9
Be^{2+}	0.27		0.45			
Al^{3+}	0.39	↔	0.48	↔	0.54	
Ga^{3+}	0.47	↔	0.55	↔	0.62	
Fe^{3+}	0.49	↔	0.58	↔	0.65	
Mg^{2+}	0.57	↔	0.66	↔	0.72	0.89
Zn^{2+}	0.60	↔	0.68	↔	0.74	0.90
Gd^{3+}			0.94	1.00	1.05	1.11
Ca^{2+}			1.00	1.06	1.12	1.18

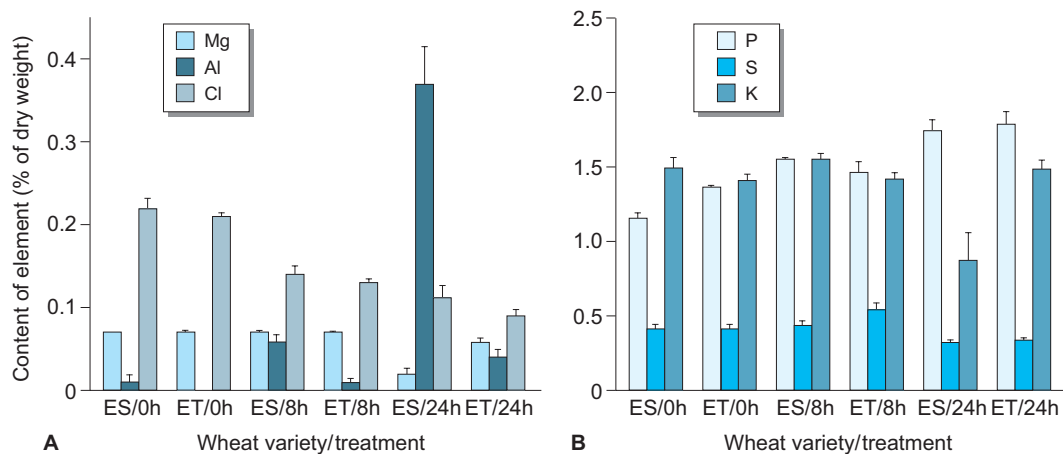


Fig. 1.8.2. Extrusion of ions from the root tips of Al^{3+} -sensitive and -tolerant wheat varieties by incubation of seedlings in 100 μM Al^{3+} solution for 0, 8 and 24 h. **A** Mg^{2+} , Al and Cl^- content of dried root tips. **B** P, S and K^+ content. *ES* Homozygous, sensitive line, *ET* homozygous, tolerant line. (After Delhaize et al. 1993a)

that the latter penetrates through Mg^{2+} channels, which can be seen by the concomitant reduction of Mg^{2+} uptake or by a decreased Mg^{2+} content (Fig. 1.8.2). Because of the similar ionic radius, the Al^{3+} ion might also use the siderophore uptake system for Fe^{3+} , which is well developed in grass roots.

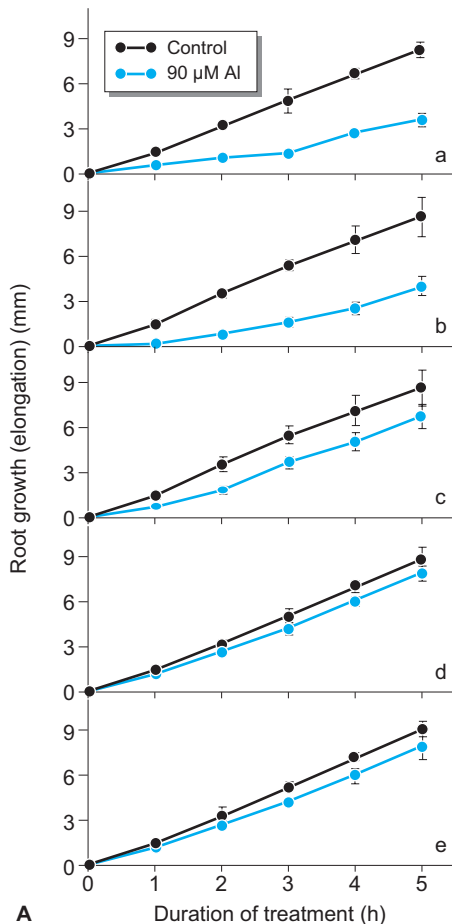
Finally, it cannot be excluded that positively charged Al ions adsorb at the external side of the plasma membrane and reach the cytosol via endocytosis. Al^{3+} does not interact with K^+ channels and, considering the usually high $\text{K}^+/\text{Al}^{3+}$ ratio, has therefore almost no influence on the membrane potential.

1.8.2.2

Phenomena of Aluminium Toxicity

In plants Al^{3+} is not very mobile and, therefore, usually remains in the root, which is therefore the organ where Al toxicity has its biggest impact and where toxic symptoms and resistance mechanisms have primarily been investigated.

The visible effect is a drastic inhibition of the elongation growth of the main and lateral roots, occurring within 1–2 h of exposure. Upon moderate stress elongation growth is resumed later on, but at a significantly lower rate. Therefore, sensitivity to Al^{3+} is highest in the elongation zone (Fig. 1.8.3); Al^{3+} accumulates in that zone and callose forms in response to the stress. In Al-resistant plants these phenomena are less pronounced.



Al^{3+} also inhibits cell division, but with a delay of hours with respect to cell elongation, and therefore inhibition of DNA synthesis cannot be the primary reason for the inhibition of root growth. On the other hand, inhibition of cell division activity is the reason for a long-term inhibition of root growth.

1.8.2.3

Symplastic Aluminium Toxicity

It was previously assumed that Al^{3+} binds to the weakly alkaline phosphate groups of DNA and thus inhibits cell division. However, this interpretation appears more and more unlikely. Likewise the earlier assumption that Al^{3+} predominantly affects the root cap could not be proven. It is

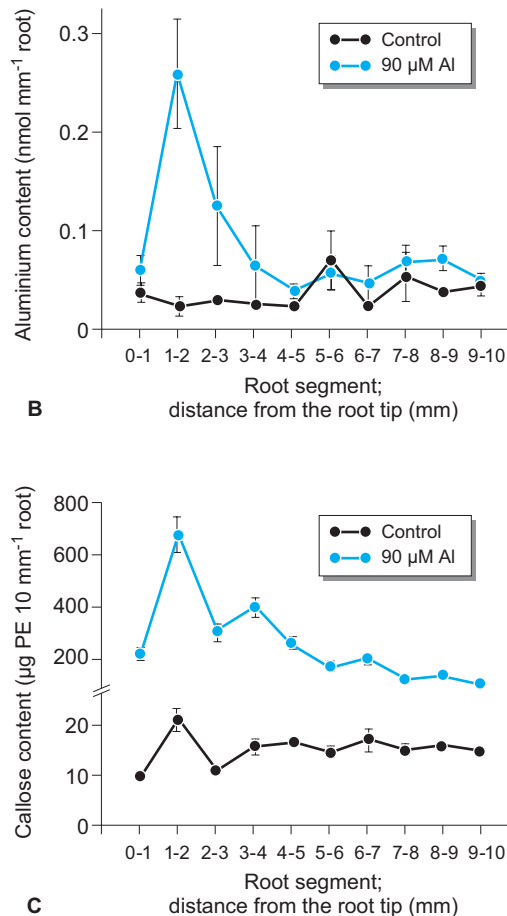


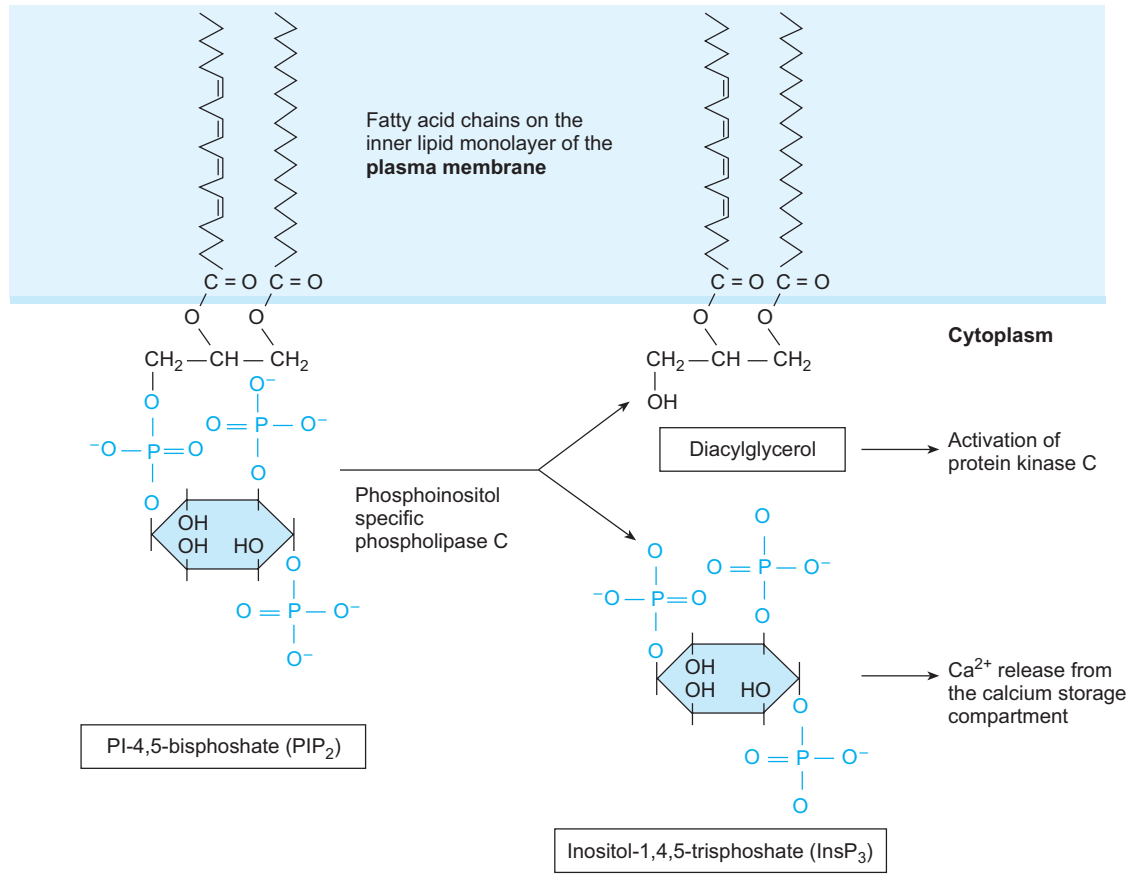
Fig. 1.8.3. **A** Effect of Al^{3+} ions (90 μM) on the elongation growth of individual 1-mm-long sections of an intact maize root. These sections could be selectively exposed to the 90- μM aluminium solution. *a* 0–1 mm; *b* 1–2 mm; *c* 2–3 mm; *d* 3–4 mm; *e* 4–5 mm. The standard deviation refers to five replicates. **B** Aluminium content of the individual segments of the apex of a maize root after 1-h exposure to 90 μM Al^{3+} . **C** Aluminium stress causes deposition of the polyglucan callose [determined with aniline blue, in so-called Pachyman equivalents (PE)] in those zones where aluminium affects root growth. (After Sivagura and Horst 1998)

Box 1.8.1

Role of phospholipase C (PLC) in the intracellular signal network

PLC liberates inositol-1,4,5-trisphosphate (InsP₃) from the membrane lipid inositol-diacylglycerol. InsP₃ controls the cytosolic level of Ca²⁺ which acts as second messenger. The

other component of the PLC reaction, diacylglycerol, autocatalytically activates PLC. InsP₃ is the target of Al³⁺ which in this way interferes with the Ca²⁺ metabolism of the cell.



now thought to interact with the phosphorylated proteins of the cell nucleus. In dicotyledons, Al(OH)²⁺ and Al(OH)₂⁺ have a stronger toxic effect than Al³⁺, in grasses (monocotyledons) Al³⁺ is more toxic. However, the soluble complexes with sulfate, fluoride and with organic acids (chelates) as well as insoluble salts such as Al(OH)₃ or AlPO₄ are not toxic. Because of the similarity of the radii of their ions (Table 1.8.2), Al³⁺ interferes predominantly with the Mg²⁺ and Fe³⁺ metabolism. Increase in Mg²⁺ ion concentration thus counteracts aluminium toxicity. Inhibition of Ca²⁺-dependent reactions was also observed, but this is not yet understood at the molecular level.

The molar fraction of positively charged Al ions depends on the pH of the solution (see Fig. 1.8.1). While an acid pH is common in the apoplast, the cytosol is usually neutral to weakly alkaline (pH >7). In this pH range almost the total aluminium occurs as aluminate and the concentrations of Al³⁺ and its derivatives are in the nanomolar to picomolar range. In addition, several chelating agents in the cytosol are able to decrease the concentration of Al³⁺.

Despite the low concentrations of cytosolic Al³⁺, malfunctions occur, e.g. of reactions which are controlled by Mg²⁺. The Al³⁺ ion replaces Mg²⁺ from the ATP-Mg complex, as the Al-ATP

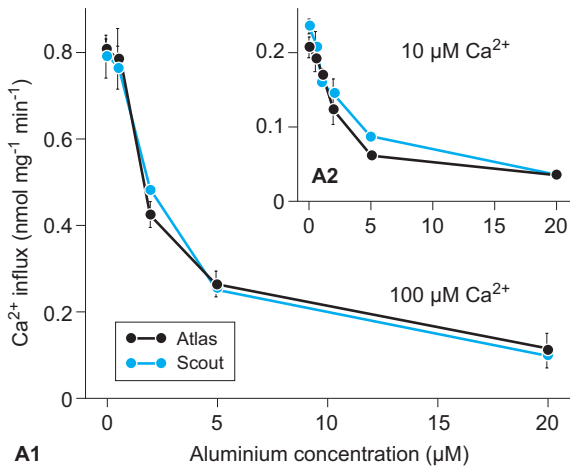


Fig. 1.8.4. Influence of various aluminium concentrations on the voltage-dependent ($E_{\text{membrane}} = -100$ mV) Ca^{2+} uptake by plasma membrane vesicles, isolated from roots of Al-sensitive (Scout 66) and -resistant (Atlas 66) wheat cultivars. **A1** Inhibition of Ca^{2+} uptake at a concentration of $100 \mu\text{M}$ Ca^{2+} in the solution. **A2** Inhibition of Ca^{2+} uptake at a concentration of $10 \mu\text{M}$ Ca^{2+} in the solution. (After Huang et al. 1996)

complex binds 1000 times stronger to hexokinase than does the Mg-ATP complex. In addition, Al^{3+} inhibits Ca^{2+} uptake into the cell by inactivating the voltage-gated Ca^{2+} channel, even though it does not interact with the membrane potential (Fig. 1.8.4). Interference with calcium is also obvious from the derangement of the intracellular signal transduction (Buchanan et al. 2000).

Al^{3+} prevents the signal-induced increase in inositol-1,4,5-trisphosphate (InsP_3) and the subsequent release of Ca^{2+} : Either Al^{3+} binds to the Mg^{2+} -binding site of the G-protein or it reacts directly with phospholipase C; direct binding of Al^{3+} to InsP_3 is, however, not likely (Jones and Kochian 1995) any more than a reaction with calmodulin and an interference with its function in the control of Ca^{2+} metabolism.

Because of the inhibition of root growth, with concomitant thickening of the root tips, it is to be expected that Al^{3+} also reacts with the cytoskeleton, the **microtubules** and **actin filaments**. Biochemical studies have shown that Al^{3+} inhibits the Mg^{2+} -dependent association of the tubulin molecules with the microtubule and the Ca^{2+} -dependent dissociation. As microtubules have a dynamic structure with a growing (+) and a decreasing (-) pole, the interaction of Al^{3+} with microtubules leads to a fixation of the cytoskeleton. In microtubule association, Mg^{2+} binds to the GTP and GDP receptor sites. The

association constant of Al^{3+} with this site is 3×10^7 higher than that of Mg^{2+} and an Al^{3+} activity of 40 nM replaces Mg^{2+} at millimolar concentrations!

When maize roots were treated with $50 \mu\text{M}$ Al^{3+} , microtubules of the outer cortex cells showed fixation in the transverse direction and stabilisation after 1 h simultaneously with the onset of growth inhibition. Al^{3+} requires about 30 min to migrate through the outer three cortex layers.

Three to 6 h after application of Al^{3+} , the microtubules of the inner cortex layer changed their transverse orientation to a random distribution, giving rise to isodiametric cell growth and thus thickening of root tips.

Because of radial expansion, together with the fixation of the cytoskeleton in the external cortex layers, fractures and lesions occur and the outer cell layers peel off. The reorientation of microtubules in the inner cortex is most likely a secondary effect as indicated by the delayed incidence. Microfilaments also show a response to Al^{3+} , but not as strong as that of microtubules (Fig. 1.8.5). Microfilaments of the outer cortical layer reorient from random texture towards a longitudinal direction, whilst the random texture of the inner microfilaments is fixed.

1.8.3

Al^{3+} Resistance

The relative resistance of isogenic lines of plants towards Al^{3+} is usually based on several properties, the genes for which are found in one to several loci. Al resistance is almost always dominant, Al sensitivity on the other hand recessive, and in crossings the F_1 generation is therefore usually Al-resistant.

Resistance may be based on avoidance or tolerance. Avoidance means exclusion of Al^{3+} (Pellet et al. 1997), tolerance chelate formation. Exclusion, too, is mostly achieved via (external) chelates.

1.8.3.1

Al^{3+} Exclusion

Exclusion of the Al^{3+} ion is usually achieved by excretion of chelating acids such as citric, malic or oxalic acid from the root tip (Fig. 1.8.6). By

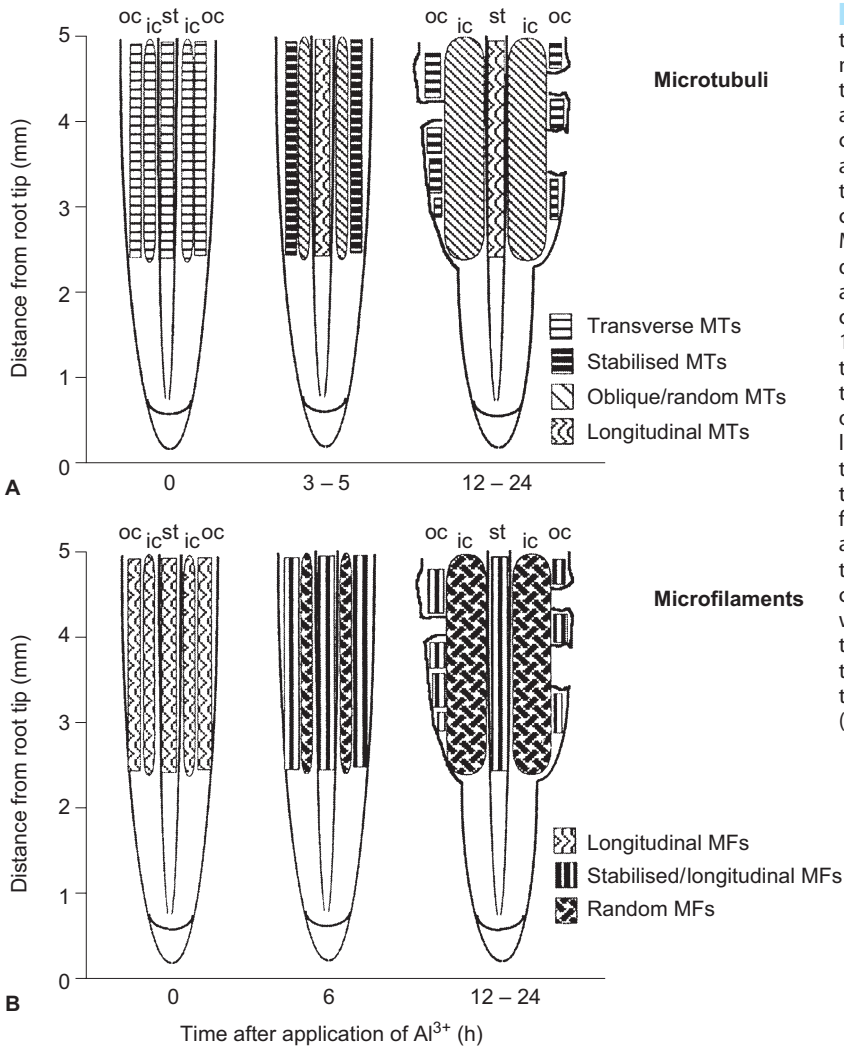


Fig. 1.8.5. Changes in orientation of **A** microtubules (MT) and **B** microfilaments (MF) in the elongation zone of a maize root following application of aluminium (Al³⁺ concentration = 50 µM). **A** One hour after application of Al³⁺, the microtubules in the outer cortex (oc) became fixed in transverse direction. Microtubules with oblique to random texture were produced 3 h after Al³⁺ application in the inner cortical layer (ic inner cortex), and 1 h later in the stele (st). This alteration in the orientation of microtubules may lead to an expansion of cells of the ic and thus to swelling of the root. After 12 h, cells of the oc are deformed and lesions in the outer cell layers result. **B** Microfilaments become stabilised 3 h after Al³⁺ application; random texture and increased clustering of microfilaments in the ic and stele were seen 6 h after Al³⁺ application. Fixation and reorientation of the microfilaments occurred later than that of the microtubules. (After Blancaflor et al. 1998)

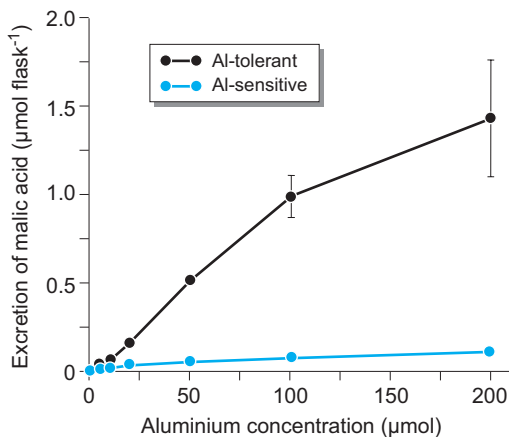


Fig. 1.8.6. Excretion of malic acid by seedling of Al-sensitive and -resistant wheat varieties. Six-day-old seedlings were exposed for 24 h to different concentrations of an Al³⁺ salt solution. (After Delhaize et al. 1993 b)

binding to these acids, the Al³⁺ ion is no longer available to the uptake system.

Malate excretion is a specific reaction to Al³⁺, as it is not triggered by other trivalent cations (La³⁺, Sc³⁺), and also not by Al₁₃. Citric acid chelates strongest, succinic acid weakest (Fig. 1.8.7).

Under aluminium stress, Al³⁺-sensitive cultivars excrete malic acid, too, but much less than tolerant cultivars (see Table 1.8.3). Scavenging of Al³⁺ by excretion of malic acid by Al-sensitive cultivars could be boosted by the addition of malic acid to the nutrient solution (Fig. 1.8.8).

Resistance of wheat is mainly due to excretion of malic acid, whilst maize reacts to Al³⁺ stress by excreting citric acid (Kollmeier et al. 2001). Al³⁺-sensitive and -resistant cultivars of these crops likewise differ mainly in the amount of secreted acid. It is not the acidification of the rhizosphere

Table 1.8.3. Excretion of organic acids by Al-tolerant and -sensitive wheat seedlings after 24-h exposure to Al (5 seedlings each in 20 ml nutrient solution, containing 50 μM Al^{3+}). (After Delhaize et al. 1993 b)

Organic acid	Excreted acid ($\text{nmol seedling}^{-1} \text{h}^{-1}$)			
	Sensitive -Al	sensitive +Al	Tolerant -Al	Tolerant +Al
Malic acid	0.08 ± 0.08	0.33 ± 0.00	< 0.08	3.57 ± 0.08
Succinic acid	0.08 ± 0.08	0.08 ± 0.08	0.08 ± 0.08	0.58 ± 0.08
Citric acid	0.17 ± 0.08	0.08 ± 0.08	0.08 ± 0.00	0.17 ± 0.00

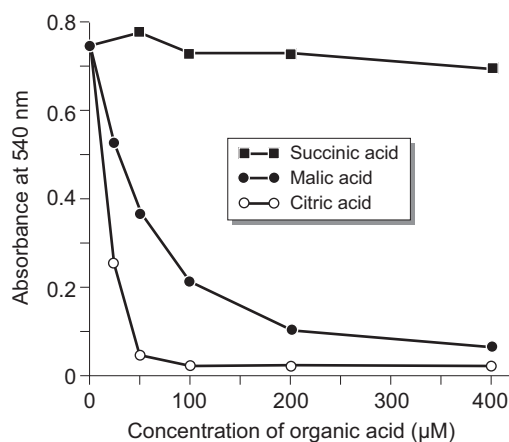


Fig. 1.8.7. Chelation of Al^{3+} by organic acids. Citric, malic and succinic acids were incubated for 1 h with a nutrient solution containing 50 μM Al^{3+} , 3.2 mM Na acetate buffer (pH 4.2) and 250 μM haematoxylin. The formation of Al-haematoxylin complexes was measured by absorption at 540 nm. The reduction of absorption in the presence of organic acids shows that organic acids chelate part of the aluminium which is then no longer available for the formation of a complex with haematoxylin. (After Delhaize et al. 1993 b)

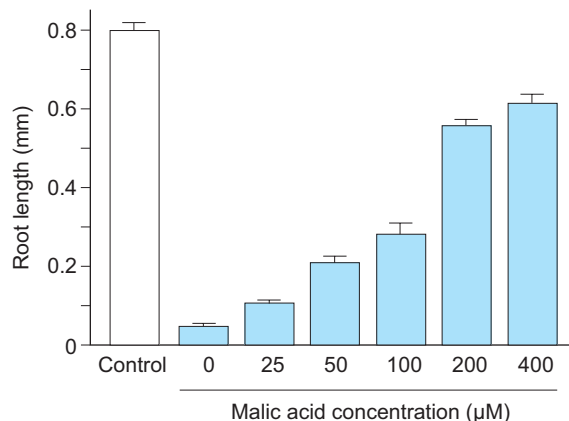


Fig. 1.8.8. Alleviation of the toxic effect of Al^{3+} by malic acid. Al-sensitive seedlings were grown in a nutrient solution containing 50 μM Al^{3+} and various concentrations of malic acid. Control seedlings were grown without aluminium and without malic acid. (After Delhaize 1993 b)

1.8.3.2 Significance of the Apoplast for Al^{3+} Resistance

that finally effects aluminium tolerance, but the complexing of the Al^{3+} ion. Similarly, some Al^{3+} -insensitive species secrete phosphate by their roots, leading to the formation of insoluble AlPO_4 .

Rapid, Al^{3+} -triggered excretion of chelating acids leads to the question how aluminium ions are perceived. Excretion of malic or citric acid can be blocked by inhibitors of anion channels. This, and the fact that malate is a common metabolite of the cytosol, suggest that the primary effect of Al^{3+} is the opening or activation of a malate-transporting channel. But how Al^{3+} gates this channel is still unsolved.

Cell walls, particularly pectin-rich primary cell walls, carry many negative charges which are usually compensated by bivalent ions (Mg^{2+} , Ca^{2+}). It is assumed that Al^{3+} replaces such bivalent ions from their binding sites, and that the cell wall thus acts as an **aluminium trap**. Such binding sites would quickly saturate with Al^{3+} ions, but upon continuous root growth new ion-binding sites originate so that protection of the protoplast by the cell wall does not seem unrealistic. However, so far differences in cell walls of sensitive and resistant cultivars have not been shown.

1.8.3.3 Al^{3+} Exclusion by Alkalinisation of the Rhizosphere

Even slight changes in pH alter the composition pattern of the aluminium ions (see Fig. 1.8.1). It

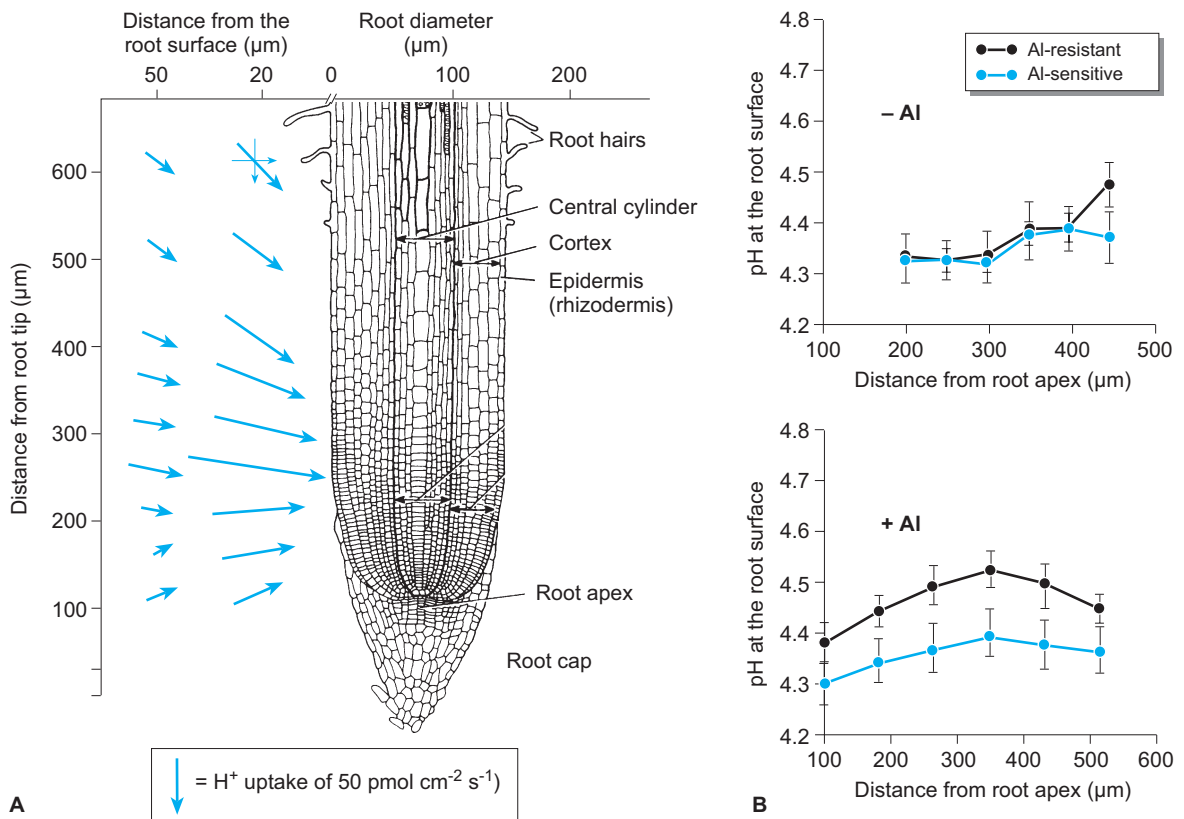


Fig. 1.8.9. A Diagram of the proton uptake by the tip of an *Arabidopsis* root. The length of the arrow indicates the extent of the proton influx. B Influence of aluminium ions on the pH in the rhizoplane ("root surface") of the Al-sensitive wild-type and the Al-resistant mutant *alr-104*. (After Degenhardt et al. 1998)

was therefore assumed that aluminium resistance, based on exclusion, could also be achieved by alkalisation of the rhizosphere. Such a mechanism has been recently shown with Al-resistant *Arabidopsis* plantlets, using a pH microelectrode. This alkalisation is achieved by proton uptake through the root tip leading to a small increase in alkalinity (ca. 0.1 pH units) of the medium at the root surface. Measurements of root growth confirm the significance of the seemingly small pH difference (Fig. 1.8.9). However, such an effect could also result from a reduced H⁺ release from the root. This would then mean that Al³⁺ inhibits the proton pump of the root cell plasma membrane. The slight inhibition of root growth by Al³⁺ at pH 4.5 compared with that at pH 4.4 could also be due to a decrease in the mole fraction of Al³⁺ in favour of Al(OH)²⁺ (see Fig. 1.8.1).

1.8.4

Al³⁺ Tolerance

Aluminium tolerance is imputed to species or cultivars that tolerate an increased intracellular aluminium concentration. Examples are old leaves of tea which accumulate up to 30 g Al per kg dry mass, or hydrangea, whose bracts (sepals) turn blue with the addition of a little Al³⁺ to the irrigation water and whose leaves accumulate up to 3 g Al per kg dry weight (Ma et al. 1997, see also figure introducing Chap. 1.8).

Corresponding to the high content of soluble Al³⁺ in acid soils of the tropics substantial concentrations of Al ions (up to 1 g/kg) occur in wild plants (*Melastoma*, *Vaccinium*) of rain forests. The Al tolerance of these plants could result from an effective sequestration (excretion by the plasma membrane or deposition in the vacuole) or from intracellular detoxification by chelating agents or Al-binding proteins. Buckwheat is an example of an Al-tolerant plant (the

Table 1.8.4. Concentrations of aluminium and oxalic acid in leaves, roots and in the cell sap of buckwheat. Plants were grown in nutrient solution (pH 4.5), which was exchanged every second day by a nutrient solution containing 0.5 mM CaCl₂ and 0 or 50 μM Al. Plants were harvested after 10 days of treatment (after Ma et al. 1998)

Plant organ	Al (mmol/kg fresh weight)	Water content (%)	Cell sap		
			Al (mM)	Al (%) ^a	Oxalic acid (mM)
Leaves					
+Al	2.01	87.5	2.03	88.4	51.08
-Al	0.02	87.4	0.01	-	46.79
Roots					
+Al	3.45	94.7	2.09	57.3	8.80

^a Percent of total aluminium. Rest deposited in cell wall.

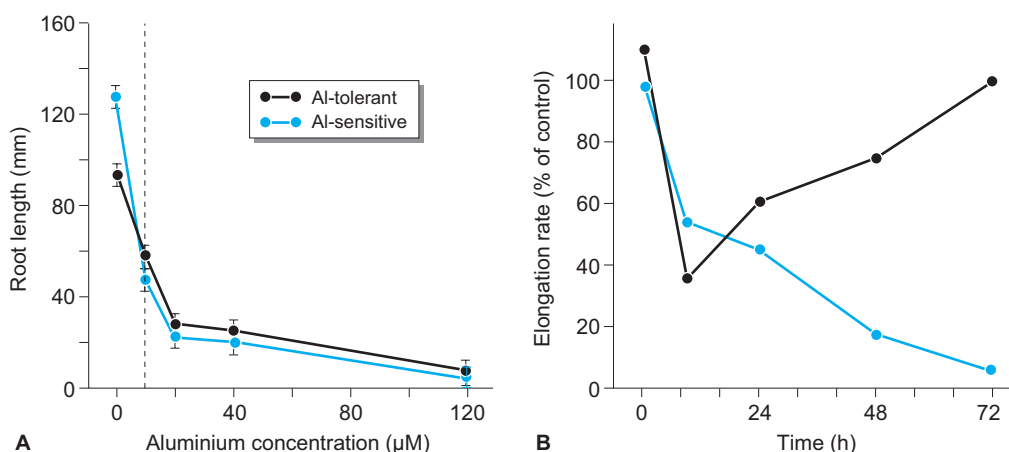


Fig. 1.8.10. A Inhibition of root growth of a sensitive and tolerant bean variety grown for 3 days in an Al³⁺-containing nutrient solution. B Dependence of inhibition on the Al³⁺ concentration is the same in both cultivars. However, the tolerant variety recovers quickly from moderate stress (10 μM Al³⁺), whereas root growth of the sensitive variety remains inhibited. (After Cumming et al. 1992)

cultivar *Jianxi* accumulates up to 0.5 g Al/kg leaf dry weight) which sequesters Al³⁺ from the cytosol into the vacuole where it forms complexes with oxalate (Al³⁺/oxalate=1:3; Table 1.8.4). In addition, Al-stressed, buckwheat roots excrete considerable amounts of oxalic acid, which complexes Al ions immediately in the rhizosphere. Exogenous Al oxalate (1:3 and 1:2) does not inhibit root growth, and thus is not toxic. Apparently, such complexes are so stable that under physiological conditions Al is not released.

In hydrangea the counter ion is citrate instead of oxalate. The corresponding complex contains aluminium and citrate at a ratio of 1:1 and accumulates in the vacuole. In contrast, in tea leaves, the bulk of Al ions seems to be bound to tannins.

The assumption that Al tolerance is inducible arises from experiments in which the initially inhibited root growth recovered completely after

a few days (Fig. 1.8.10), indicating induction and achievement of Al tolerance.

Upon stress by Al, resistant wheat cultivars produced two additional proteins (51 kDa) in the plasmalemma fraction, which occurred only in the root tips and disappeared again when the stress was alleviated. Formation of these proteins was induced most effectively by Al³⁺, to a lesser extent also by Cd²⁺ and Ni²⁺, but not by Cu²⁺, Zn²⁺ or Mn²⁺. In the corresponding Al-sensitive cultivar only traces of these proteins were found under Al stress. One of these proteins could be a metallothionein. Another protein could be related to the production of “defence mucilage” by the outer root cap cells. Strong mucilage formation was observed upon incubation of root tips in solutions of Al salts. After excretion of the mucigel, root growth (of peas) recovered so fast that it was assumed that

the mucilage had adsorbed the aluminium ions and thus detoxified them (Hawes et al. 2000).

These examples show that Al stress may induce a more or less specific protein response, while the physiological role of such proteins still remains to be explained.

Summary

1. Aluminium is the most frequent metallic element in the earth's crust, where it appears in many, usually insoluble compounds and complexes. Three classes of aluminium ions available to plants are distinguished: Mononuclear Al^{3+} , polynuclear Al and complexed Al. At an acid pH (<5) the mononuclear $\text{Al}(\text{H}_2\text{O})^{7+}$ occurs, at neutral pH and at higher Al concentrations polynuclear forms develop, in particular the soluble $[\text{Al}_{13}]^{3+}$. All soluble Al ions are phytotoxic.
2. Aluminium is quickly taken up by adsorption to the cell wall and in the mucigel of the root tip. From there it enters into the cytosol via cation carriers (probably through a Mg^{2+} channel). Endocytotic uptake from the apoplast and, in grasses, uptake by the siderophore system are also discussed. Al^{3+} is almost immobile in the plant; aluminium damage occurs, therefore, predominantly in the roots.
3. Inhibition of root elongation growth by Al^{3+} is particularly striking; upon long-term stress, cell division is also affected. Because of similar ionic radii, Al^{3+} particularly affects Mg^{2+} (e.g. replacing Mg in the Mg-ATP complex) and Fe^{3+} metabolisms, and interferes with the regulation of the cytosolic level of free Ca^{2+} . By these effects and by the inhibition of signal transduction via an increase in inositol-trisphosphate, aluminium causes major changes in the regulation of cellular reactions. In addition, Al^{3+} leads to a reorientation and fixation of the cytoskeleton, resulting in anomalous growth in thickness of root tips and the incidence of numerous lesions.
4. (Relative) aluminium resistance may be based on avoidance or tolerance. Exclusion of aluminium ions (stress avoidance) is usually achieved by excretion of chelating acids (e.g. malic acid) which form aluminium complexes outside the root or the protoplast, thus rendering aluminium ions unavailable for uptake systems. Excretion of such chelators appears to be species-specific and is a typical reaction

to Al^{3+} , but not to other trivalent cations. A pectin-rich cell wall, carrying numerous negatively charged carboxyl groups, may act as aluminium trap, normally displacing the cross-linking cations Mg^{2+} and Ca^{2+} . Al^{3+} in the rhizosphere may also be immobilised or made unavailable for plants by alkalinisation (via proton uptake or reduced proton release).

5. Aluminium-tolerant species are able to accumulate Al^{3+} in high concentrations. The most important mechanisms for this are export into the apoplast or sequestration into the vacuole. At the sites of deposition the aluminium ions must be complexed (e.g. by Al oxalate or with tannins) or fixed to Al-binding proteins to become inactivated.

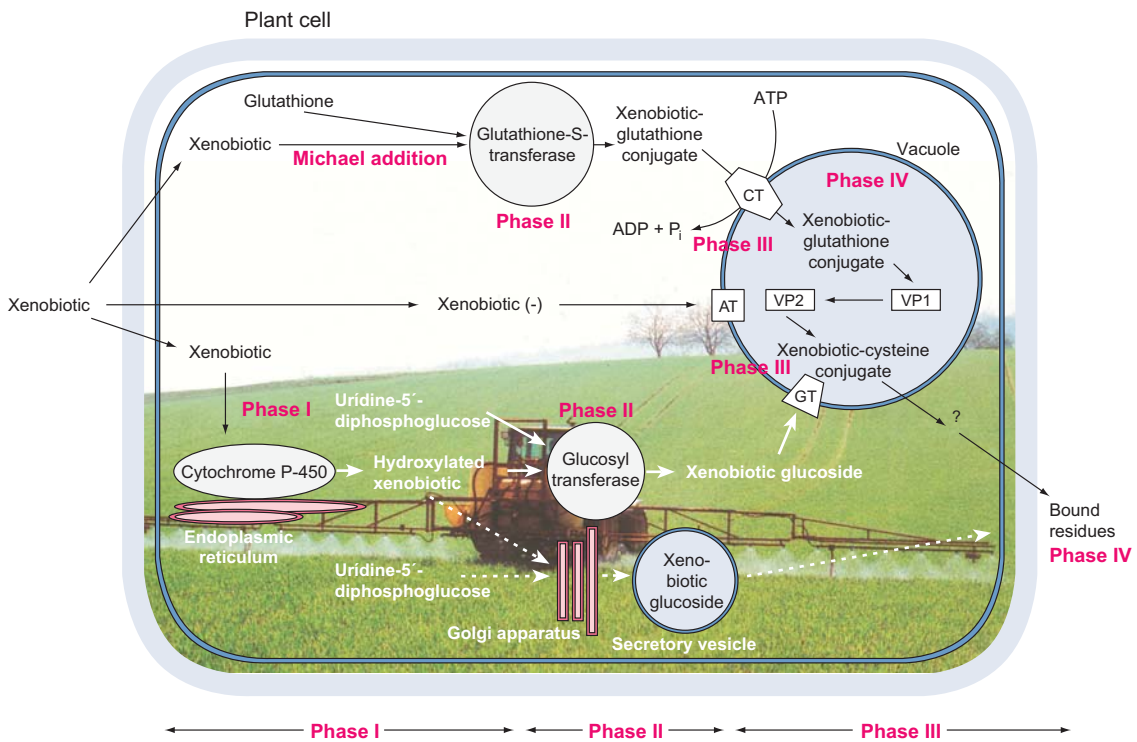
References

- Blancaflor EB, Jones DL, Gilroy S (1998) Alterations in the cytoskeleton accompany aluminum-induced growth inhibition and morphological changes in primary roots of maize. *Plant Physiol* 118:159-172
- Buchanan BB, Gruissem W, Jones RL (2000) Biochemistry and molecular biology of plants. American Society of Plant Physiologists, Rockville, MD, pp 952-963
- Cumming JR, Buckelew-Cumming A, Taylor GJ (1992) Patterns of root respiration associated with the induction of aluminum tolerance in *Phaseolus vulgaris* L. *J Exp Bot* 43:1075-1081
- Degenhardt J, Larsen PB, Howell SH, Kochian LV (1998) Aluminum resistance in the *Arabidopsis* mutant alr-104 is caused by an aluminum-induced increase in rhizosphere pH. *Plant Physiol* 117:19-27
- Delhaize E, Craig S, Beaton CD, Bennet RJ, Jagdish VC, Randall PJ (1993a) Aluminum tolerance in wheat (*Triticum aestivum* L.). *Plant Physiol* 103:685-693
- Delhaize EM, Ryan PR, Randall PJ (1993b) Aluminum tolerance in wheat (*Triticum aestivum* L.). *Plant Physiol* 103:695-702
- Hawes MC, Gunawardena U, Miyasaka S, Zhao XW (2000) The role of root border cells in plant defense. *Trends Plant Sci* 5:128-133
- Huang JW, Pellet DM, Papernik LA, Kochian LV (1996) Aluminum interactions with voltage-dependent calcium transport in plasma membrane vesicles isolated from roots of aluminum-sensitive and -resistant wheat cultivars. *Plant Physiol* 110:561-569
- Jones DL, Kochian LV (1995) Aluminum inhibition of the 1,4,5-trisphosphate signal transduction pathway in wheat roots: a role in aluminum toxicity? *Plant Cell* 7:1913-1922
- Kollmeier M, Dietrich P, Bauer CS, Horst W, Hedrich R (2001) Aluminium activates a citrate-permeable anion channel in the aluminium-sensitive zone of maize root apex. A comparison between aluminium-sensitive and an aluminium-resistant cultivar. *Plant Physiol* 126:397-410
- Larsen PB, Degenhardt J, Tai C-Y, Stenzler LM, Howell SH, Kochian LV (1998) Aluminum-resistant *Arabidopsis* mu-

- tants that exhibit altered patterns of aluminum accumulation and organic acid release from roots. *Plant Physiol* 117:9–18
- Ma JF, Hiradate S, Nomoto K, Iwashita T, Matsumoto H (1997) Internal detoxification mechanism of Al in *Hydrangea*. Identification of Al form in leaves. *Plant Physiol* 113:1033–1039
- Ma JF, Hiradate S, Matsumoto H (1998) High aluminium resistance in buckwheat. II. Oxalic acid detoxifies aluminium internally. *Plant Physiol* 117:753–759
- Ma JF, Ryan PR, Delhaize E (2001) Aluminium tolerance in plants and complexing role of organic acids. *Trends Plant Sci* 6:273–278
- Macdonald TL, Martin RB (1988) Aluminum ion in biological systems. *Trends Biochem Sci* 13:15–19
- Pellet DM, Papernik LA, Jones DL, Darrah PR, Grunes DL, Kochian LV (1997) Involvement of multiple aluminium exclusion mechanisms in aluminium resistance in wheat. *Plant Soil* 192:63–68
- Sivagura M, Horst WJ (1998) The distal part of the transition zone is the most aluminum-sensitive apical root zone of maize. *Plant Physiol* 116:155–163

1.9

Xenobiotics



To detoxify xenobiotics organisms use reactions from their normal metabolism. With a clever combination of such reactions, foreign compounds can be detoxified and then deposited in the vacuole or in the cell wall in a form which is not harmful. Such detoxification passes through a sequence of four phases: Biochemical “opening” of the mostly lipophilic xenobiotic, formation of conjugates, sequestration of the conjugate into the vacuole or the secretory vesicle, and finally deposition in the vacuole or the cell wall via chemical modification of the conjugate (see also Fig. 1.9.5). After Coleman et al. (1997)

Recommended Literature

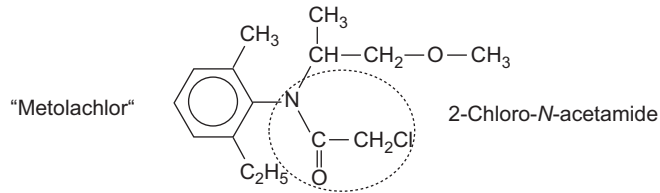
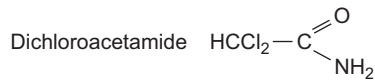
- Darrall NM (1989) The effect of air pollutants on physiological processes in plants. *Plant Cell Environ* 12:1–30
- Edwards R, Dixon DP, Walbot V (2000) Plant glutathione-S-transferases: enzymes with multiple functions in sickness and in health. *Trends Plant Sci* 5:193–198
- Grossmann K (2000) Mode of action of auxin herbicides: a new ending to a long, drawn out story. *Trends Plant Sci* 5:506–508
- Larcher W (2003) *Physiological plant ecology*, 4th edn. Springer Telos, 450 pp
- Marrs K (1996) The function and regulation of glutathione-S-transferases in plants. *Annu Rev Plant Physiol Plant Mol Biol* 47:127–158
- Morgan PB, Bernacchi CJ, Ort DR, Long SP (2004) An in vivo analysis of the effect of season-long open-air elevation of ozone to anticipated 2050 levels on photosynthesis in soybean. *Plant Physiol* 135:2348–2357
- Roberts T (ed) (2000) *Metabolism of agrochemicals in plants*. John Wiley, 300 pp

Box 1.9.1 Safeners and herbicides

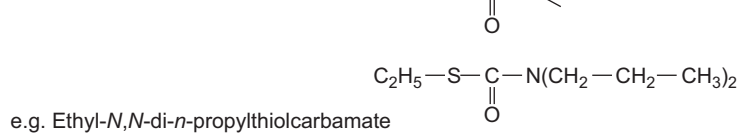
Safeners are non-lethal xenobiotics which protect herbicide-sensitive (crop) plants from the effects of herbicides.

If a plant is pre-treated with a safener, it can be sprayed with the herbicide and the “protected” plant will remain undamaged. In this way the selectivity of a herbicide can be indirectly increased. Safeners elicit a xenobiotic protective response, usually induction of glutathione-S-transferases (see Fig. 1.9.3). With the aid of these enzymes the herbicide is made “harmless”. There are different classes of herbicide for which safeners have been developed. Two of these are

Herbicide group chloroacetamides:



Herbicide group thiolcarbamates:



shown. The corresponding safeners are, e.g., flurazole and dichlorimide.

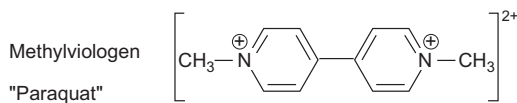
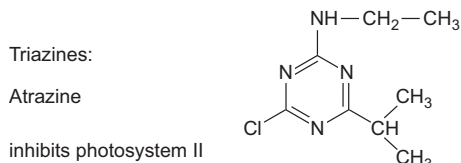
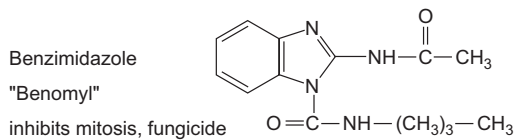
- Sandermann H Jr (1994) Higher plant metabolism of xenobiotics: the “green liver” concept. *Pharmacogenetics* 4:225–241
- Sandermann H (2004) Molecular ecotoxicology of plants. *Trends Plant Sci* 9:406–413
- Sandermann H Jr, Wellburn AR, Heath RL (eds) (1997) *Forest decline and ozone*. *Ecological Studies* 127. Springer, Berlin Heidelberg New York, 400 pp

Xenobiotics are chemicals (or, more generally, a chemical mix) which are not normal components of the organism which is exposed to it. However, xenobiotics are biologically active and may cause, dependent on toxicity and the amount taken up, defence reactions, damage or even death of an organism. With respect to plants, xenobiotics are, in addition to the previously discussed toxic heavy metals and aluminium, mainly pesticides and waste products, which enter soil, water and air – even in countries where waste management and control is well developed. Except for fertilisers, **herbicides** have the greatest share of the agrochemical market amongst all pesticides (insecticides, acaricides, nematocides, fungicides, rodenticides, herbicides) used for plant protection. Herbicides target plant metabolism and are well researched regarding their reactions in plants and in the soil.

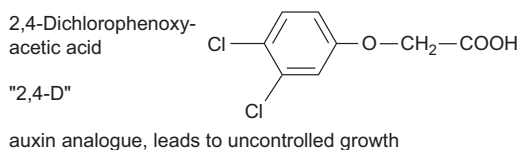
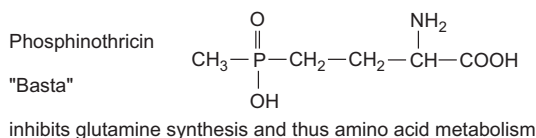
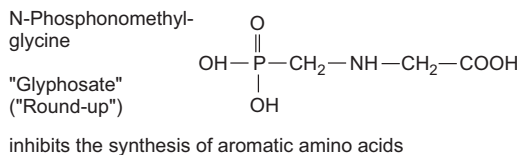
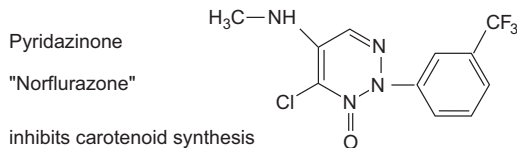
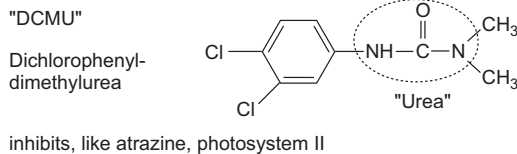
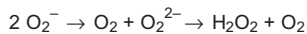
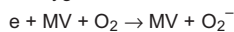
A particular problem of the pesticides is the **selectivity**. Herbicides are supposed to kill off weeds, but crops must be spared. Crops are commonly not able to detoxify herbicides (an exception is maize which detoxifies Atrazine) and therefore a modern trend is towards two-component systems: Herbicide and herbicide safener (antidotes or “immune chemicals”, Box 1.9.1), with the latter activating the defence system of the crop so that it can cope with the herbicide. More difficult is the situation if the pesticide targets processes that are similar in the organisms to be protected and the pest (e.g. the use of fungicides in orchards). In many cases, the different sensitivity of the organisms or different time slots of a targeted process (e.g. mitosis in host and parasite) can be used to achieve some selectivity. Scab, mildew and grey mould (*Botrytis*) develop on mature leaves and fruits, so that toxins inhibiting mitosis, e.g. the fungicide “Benomyl” (a benzimidazole derivative) (Box 1.9.2A), when not applied too early, only affect the parasite and thus render sufficient selectivity. Often the pests and the crop differ naturally in the mode of pesticide uptake or it is possible to formulate (“package”) the chemicals in such a way that differential uptake is achieved. Differences in the structure or the chemistry of the plant surface of weeds and crops, as well as in their morphological charac-

Box 1.9.2 Herbicides

Some of the most important herbicides and their main effects (Fig. A).



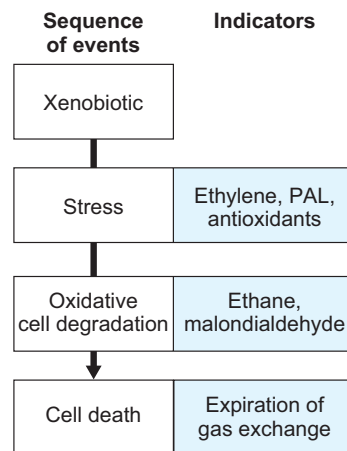
transfers the electrons from ferredoxin (photosystem I) to oxygen:



A

Measurement of herbicide effects

Simple visual and analytical tests are differentiated. As in the assay of frost resistance (Box 1.3.6), a few days are usually required before damage has developed to a stage which allows quantification of yellowing or necroses (Box 1.1.1, Figs. 1–4). Analytical tests are more sensitive; for a first screening for herbicidal effects, algae are most suited, as the herbicide is in close proximity to the cells. In further rounds of screening the individual specific stress reactions can be examined, e.g. induction of PAL as the starting point for the formation of phytoalexins, or the release of ethylene from methionine (Fig. B). A relatively simple method of measuring damage is provided by chlorophyll fluorescence (cf. Box 1.1.1, Fig. 5).



B

Fig. B. Time course of poisoning by a xenobiotic and useful diagnostic parameters. PAL, increase in activity of phenylalanine ammonium lyase. (After Kuhnert 1996)

ters (e.g. leaf-form and orientation in the space), are important in this respect, resulting in differences in uptake.

In crop production, **toxicity** of xenobiotics and of their metabolites for humans and animals as well as the development of resistance of the pest to the pesticide are very important. Resistances develop very quickly if the non-resistant population is completely eradicated. Resistance inheritance is usually recessive. The population quickly loses the dominant targeted gene, if only homozygous recessive organisms propagate.

In the following, the effects of non-metallic xenobiotics on plants and in particular the reactions of plants to these compounds are exemplarily presented. Such reactions may be used for phytoremediation to clean and detoxify air, soil and water, an idea leading to the concept of the “green liver” (Sandermann 1994) in the sense that plants, in analogy to the livers of animals, are able to withdraw toxins (e.g. formaldehyde) from our environment and metabolise them to harmless substances.

The spectrum of xenobiotics is inexhaustible, but in contrast there are only few cellular mechanisms for detoxification. Most xenobiotics are lipophilic, and so diffuse easily into cells. They are also able to accumulate in biomembranes, decreasing their effectiveness and concomitantly the possibility of their metabolism.

1.9.1

Herbicides

Herbicides are the most used pesticides worldwide, constituting 49% of the agrochemical market; they accounted for 68% of total US pesticide sales at approximately US\$ 6 billion.

Herbicides inhibit germination and growth of weeds but their use is only profitable if losses in yield were to exceed 5–10%. In general, a distinction is made between herbicides applied **before sowing** (pre-emergent herbicides) and those applied **after sowing** (post-emergent herbicides). Pre-emergent herbicides are applied directly to the soil, thus being also known as **soil herbicides**; they are designed to interfere with germination or to kill the seedlings. Post-emergent herbicides are sprayed on the standing crop (sometimes sprayed from aeroplanes). They interfere with photosynthesis or growth, and are therefore also called **leaf herbicides**.

1.9.1.1

Modes of Herbicide Action

By inhibiting specific physiological reactions herbicides should kill (Box 1.9.2A) unwanted plants. In the extreme case, when all plants are unwanted, so-called total herbicides are used, which are mostly **inhibitors of the photosynthetic light reactions**. Many **total herbicides** have a very specific effect, e.g. inhibition of plastoquinone reduction by blocking its binding site on photosystem II, e.g. by s-Triazine (s stands for symmetric Triazine), such as Atrazine or by urea derivatives, e.g. DCMU, or by production of ROS in photosystem I (e.g. by methylviologen = Paraquat).

Inhibitors of carotene biosynthesis, such as Norflurazon which inhibits phytoen-desaturase, also increase oxidative stress and thus stop the formation of shading and protective pigments.

Also **N metabolism** is a possible target. The chemical structure of Glyphosate resembles that of phosphoenol pyruvate and therefore this herbicide is bound very effectively by the enolpyruvyl-phosphoshikimate synthase instead of the natural substrate, thus abandoning the synthesis of the aromatic amino acid. Similarly, “Basta” (=phosphinotricin) inhibits synthesis of glutamine which is the starting metabolite for amino acid synthesis in plants.

The herbicides listed above affect photosynthesis, carotenoid and amino acid biosynthesis, but other metabolic activities are also targets of herbicide design to achieve better selectivity and efficiency, e.g. mitochondrial respiration, lipid biosynthesis, nucleic acid synthesis, turnover of the cytoskeleton, phytohormone metabolism and steps in seed germination (pre-emergent herbicides). One of the most frequently used herbicides is 2,4-D, whose molecule is similar to that of the growth hormone auxin, wherefore it is able to disrupt its action.

Even if the principal effects of herbicides are known, e.g. the inhibition of a certain metabolic reaction, in many cases the molecular mechanisms still remain unknown, as the protein structures involved are themselves not known in sufficient detail. Of 2,4-D, e.g., the receptor (probably at the plasma membrane) is still not known. Many herbicides, particularly those affecting photosynthesis and respiration, produce oxygen- and other radicals, lipid peroxides and other particularly reactive substances, of which only the most basic chemistry is known. Fig-

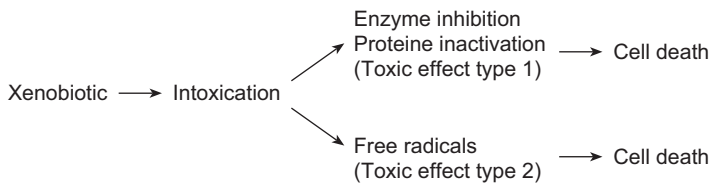


Fig. 1.9.1. Modes of action of total herbicides. In type 1 the toxic effect results from direct interaction of the xenobiotic with a “target” system whose inhibition causes the damage (e.g. inhibition of glutamine synthetase by the phosphino-tricin “Basta”; see Boxes 1.9.2 and 1.9.3). In type 2 mode of action, targets are also hit, but the damage is caused by the reaction of the plant (e.g. by the ROS response of the herbicide “Paraquat”). Likewise, inhibition of the synthesis of protective compounds (e.g. carotenoids by the herbicide “Norflurazon”) leads to a type 2 toxic effect. (After Kuhnert 1996)

Figure 1.9.1 shows an overview of the ways in which herbicides act.

A general principle seems to be that toxicity of a herbicide increases with its electrophilicity, as this determines its ability to react with nucleophilic biological macromolecules such as proteins and nucleic acids. Weakly polarised electrophilic agents react with weak nucleophiles of the cell, and strongly polarised ones with strong nucleophiles.

1.9.1.2 The Four Steps of Xenobiotics Detoxification by Plants

Detoxification of xenobiotics usually requires a reaction sequence which can be separated into four distinct steps (phases). Many pesticides and other xenobiotics are lipophilic compounds which are difficult to attack in the aqueous milieu of the plant cell.

1. Phase I or step I of the detoxification process is therefore the introduction of a hydrophilic group. Oxidation, reduction or hydrolysis is the usual reaction to increase the compound’s water solubility and to start detoxification. Aromatic rings are preferentially oxidised by monooxygenases (mixed function oxygenases; Fig. 1.9.2 A), which contain a cytochrome P450 and require molecular oxygen and a second electron donor. By oxidation electrophilic groups are introduced or created in the molecules which leads to an activation, i.e. increases their toxicity. Seemingly, the system of oxidases, monooxygenases and hydrolases exhibits little substrate specificity, but this is not the case: In *Arabidopsis thaliana* more than 60 genes coding for monooxygenases have been identified! The apparent non-speci-

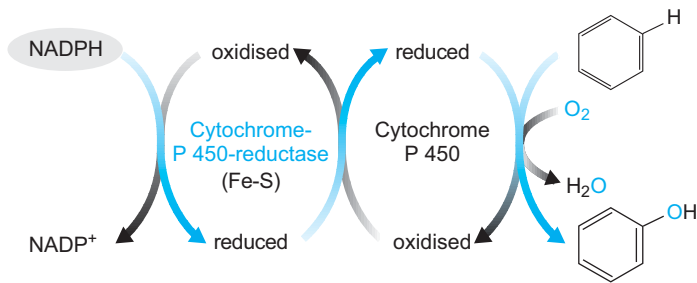
ficity can be explained by the great number of relatively substrate-specific enzymes.

2. In phase II the now more hydrophilic compounds are conjugated, i.e. bound to other hydrophilic molecules. Conjugation is either by glycosylation of the newly formed functional groups or by formation of a thioether (“Michael-addition”; Fig. 1.9.2 B) with glutathione and its homologues (Fig. 1.9.2 C). Glycosylation is catalysed by glucosyl transferases with uridine diphosphate-glucose as the substrate, whereas thioethers are produced by the so-called glutathione-S-transferases (GSTs). The latter group of enzymes can use many natural and artificial compounds as substrates. Amongst these are many herbicides (Atrazine, 2,4-D, Metolachlor), but also typical plant pigments (anthocyanins), growth substances (auxin) or defence substances (salicylic acid; Marrs 1996).

As with the glucosyl transferases the apparent non-specificity of GSTs results from the concomitant presence of a larger number of very specific enzymes. Thus the selectivity of many herbicides is based on the occurrence of certain, substrate-specific GSTs in crop plants and the lack of such (iso-)enzymes in weeds. Also, the effects of “safeners” (antidotes) may be achieved via the induction of a specific GST. However, specificity of conjugation of xenobiotics depends on the specificity of GSTs for natural substrates, e.g. tannins and flavonoids (pigments) or auxins. Usually, safeners effect the induction of such transferases. Infections may also lead to the induction of GSTs. As well as GSTs other transferases are also able to increase the water solubility of xenobiotics by conjugation (Table 1.9.1).

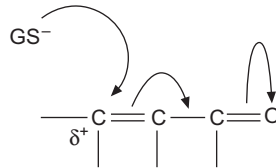
3. In phase III the conjugated product is sequestered, either in the vacuole or in the cell wall,

Introduction of a hydrophilic group into an aromatic ring with the help of a C-450-dependent monooxygenase

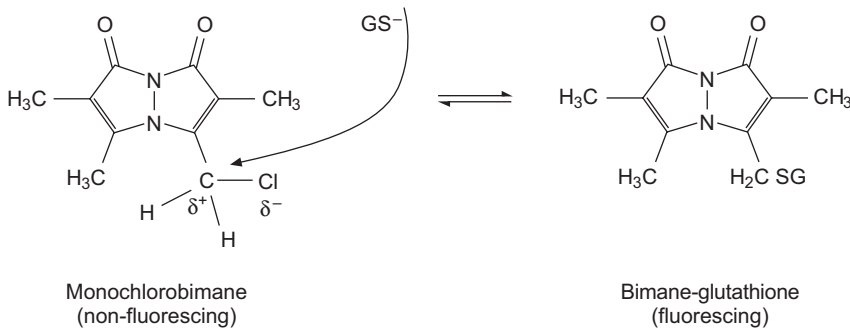


A

(i) "Michael addition" along a polarised double bond in $\alpha\beta$ -unsaturated carbonyl groups

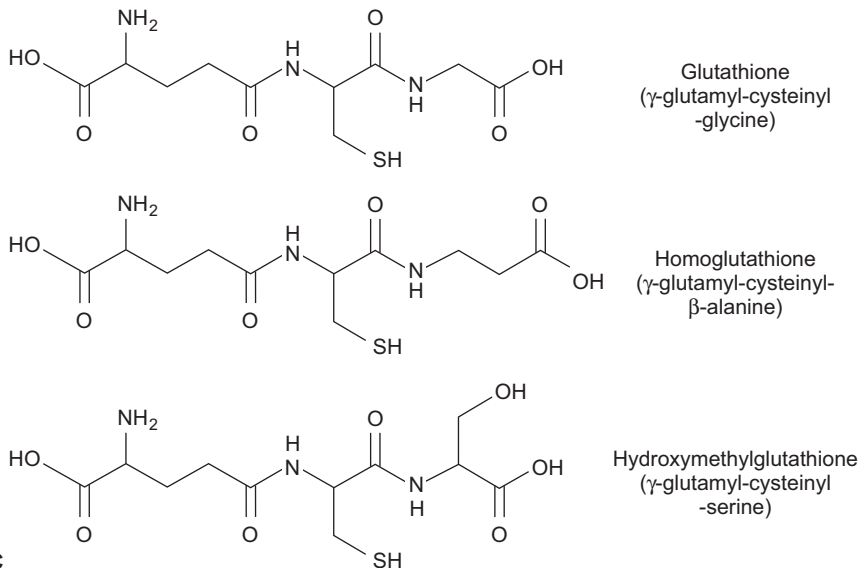


(ii) Nucleophilic replacement of relatively easily cleaved substitutes on saturated carbons



B

Structures of γ -glutamyl-cysteinyl tripeptides



C

Fig. 1.9.2. Biochemistry of detoxification of xenobiotics (A from Lehninger et al. 1994; B, C from Coleman et al. 1997)

Table 1.9.1. Classes of plant enzymes that metabolise xenobiotics and their natural substrates. After Sandermann (1994)

Enzyme class	Xenobiotic substrate	Natural substrate
Cytochrome P450	4-Chloro- <i>N</i> -methylalanine	Cinnamic acid, pterocarpanes
Glutathione-S-transferase	Fluorodifen, alachlor, atrazine	Cinnamic acid
Carboxylesterases	Diethylhexylphthalate	Lipids, acetylcholine
O-Glucosyltransferases	Chlorinated phenols	Flavonoids, coniferylalcohol
O-Malonyltransferases	β -D-Glucosides from pentachlorophenol and from 4-hydroxy-2,5-dichlorophenoxyacetic acid	β -D-Glucosides from flavonoids and isoflavonoids
N-Glucosyltransferases	Chlorinated anilines, metribuzin	Nicotinic acid
N-Malonyltransferases	Chlorinated anilines	1-Aminocyclopropylcarboxylic acid, D-amino acids, anthranilic acid

again by enzymes of the natural secondary metabolism. Key enzymes are the so-called glutathione pumps. Sequestering is required because the GS conjugates can inhibit glutathione-S-transferases as well as glutathione reductases; and, in some cases, they themselves are potent toxins and must, therefore, be removed.

Glutathione Pumps (GS-X Pumps)

GS-X pumps transport the GS conjugates into the vacuole and are, thus, transport proteins of the tonoplast (Rea et al. 1998). They belong to the so-called ABC superfamily, a group of transporters which play an important role in animal, fungal and plant tissues, particularly in connection with secondary metabolism. These proteins have a “Walker” Box A and a “Walker” Box B, which are separated by a characteristic C-motif, hence the term ABC transporter. So far, more than 130 representatives of the superfamily are known, which translocate sugars, peptides, alkaloids, phenolic compounds and inorganic and organic ions.

This superfamily has two large subfamilies, multidrug resistance proteins (MDRs) and multidrug resistance associated proteins (MRPs), the latter being typical of plants. Their assembly is relatively uniform, even if the sequence homologies are, in part, below 40%. It is a large protein with several modular domains, namely one to two membrane-spanning domains (TMDs), two domains forming a nucleotide binding fold (NBF) and the regulatory unit R (Fig. 1.9.3).

These transporters are directly activated by MgATP, resulting in an “active” transport that is not dependent on a H^+ gradient (H^+ -ATPase independent). Even though the mechanism is not fully explained, it is assumed that an intermedi-

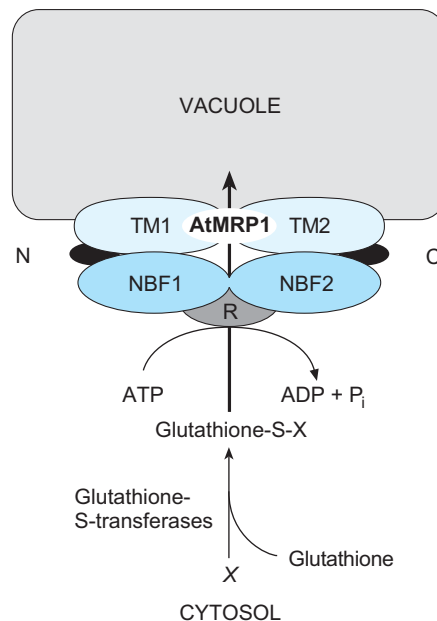
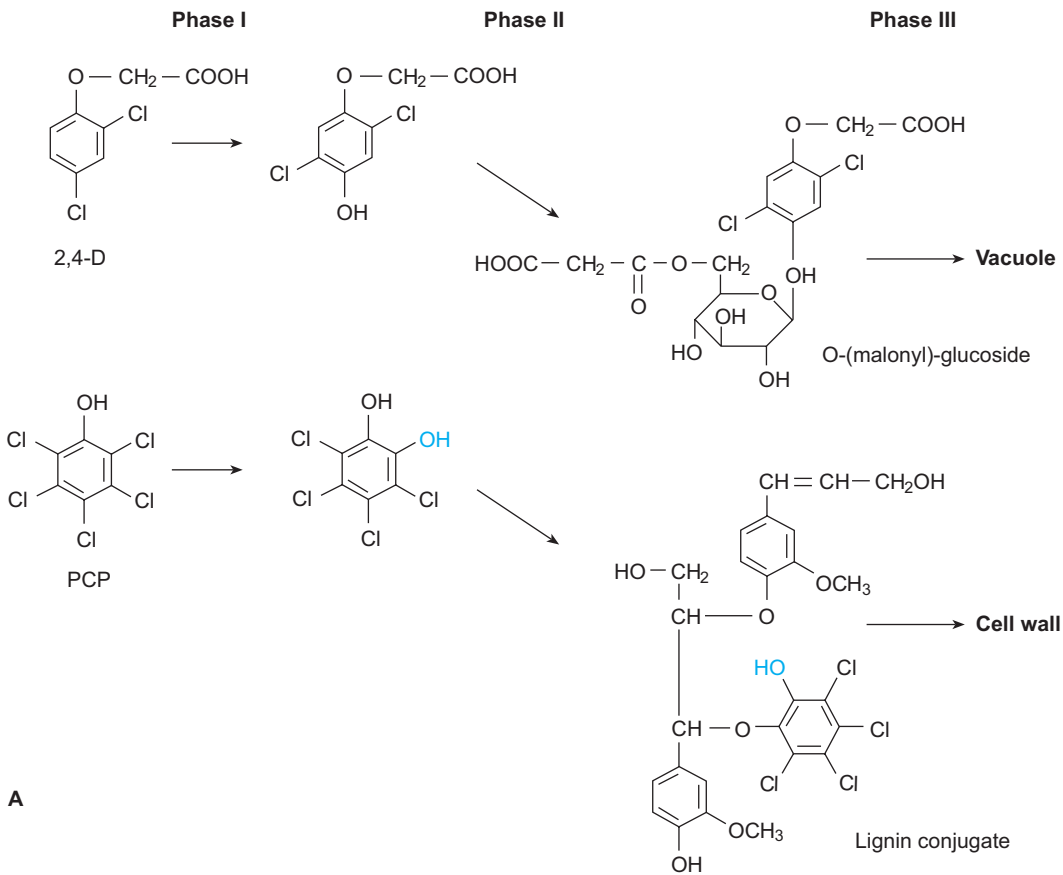
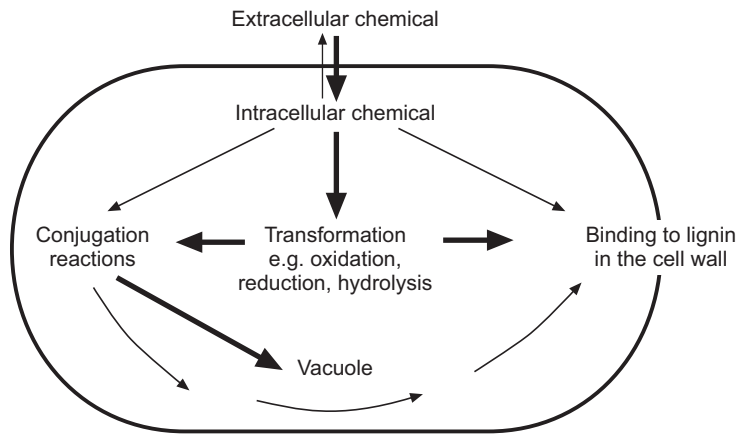


Fig. 1.9.3. Composition and mechanism of a plant ABC transporter from the multidrug resistance associated protein (MRP) family. After the compound X is conjugated with glutathione by a glutathione-S-transferase, it can be transported by the MRP into the vacuole. *N*, N-terminus; *C*, C-terminus; *TM* (1,2) trans-membrane domains; *NBF* (1,2) nucleotide binding pockets; *R* putative regulatory domain. (After Rea et al. 1997)

ary acyl phosphate (perhaps with glutathione) is formed, indicated by the very strong inhibition by vanadate (formation of an acyl vanadate instead of the acyl phosphate). Remarkably, these transporters translocate glutathione conjugates, as well as GSSG (oxidised glutathione), but not reduced glutathione (GSH). So far, three such transporters which differ in substrate specificities have been described from *Arabidopsis thaliana* (*AtMRP*).



A



B

Fig. 1.9.4. Sequestration of xenobiotics, after conjugation, in the cell wall or vacuole. **A** Hydroxylation and conjugation of 2,4-dichlorophenoxyacetic acid and pentachlorophenol. **B** Map of reactions which result in the sequestration of xenobiotics after uptake into the cell. (Sandermann 1994)

Natural Substrates of GS-X Pumps

Of course, organisms did not develop GST-GS-X pumps for xenobiotics. Their natural substrates are nucleophilic substances of secondary metabolism: anthocyanins (flavonoids), auxin, salicylic acid, cinnamic acid, hydroxy fatty acids and degradation products of DNA. The Michaelis

constant of AtMRP 1 and 2 for cyanidin-3-glucoside-GS conjugate (an anthocyanin) is ca. 50 μM and V_{max} is ≈ 5 nmol/mg protein per minute, for example. Similar kinetic data were reported for glucosyl conjugates, e.g. of degradation products of chlorophyll.

4. In **phase IV** the conjugates are immobilised in the vacuole. Conjugates with glutathione are often further metabolised in the vacuole in order to avoid their diffusion back into the cytoplasm. Thus, for example, a carboxypeptidase (exopeptidase) may cleave the glycine residue from glutathione. A vacuolar dipeptidase is able to remove the amino terminal glutamic acid, with the consequent formation of cysteine conjugates. The final fate of these cysteine conjugates is unclear. One possibility would be that they leave the vacuole again via the Golgi system and become irreversibly incorporated into the cell wall as “bound residues” (Fig. 1.9.4).

1.9.1.3 Immunochemicals

Some xenobiotics, e.g. 2,6-dichloroisonicotinic acid and its methyl ester, not only induce the three to four step detoxification system, but also PR proteins (pathogenesis related proteins), e.g. chitinases and β -glucanases (see Chap. 1.10.2.1), serving to combat pathogens (although their mode of action is frequently not known). Such xenobiotics are called **immunochemicals**. They are often formed to such a low extent that detection in cell extracts is hardly possible. When screening for a potential immunogenic effect of a xenobiotic a trick is generally used: Instead of the protein, the activation of the gene encoding for it is examined: Since several of these genes are known, activity of their promoter as induced by a potential immunochemical can be investigated. Fusion of the promoter with a reporter gene – e.g. the GUS-(glucuronidase-)gene of *E. coli* – provides a DNA probe. This probe can then be introduced, via the Agrobacterium system or the particle gun, into the genome of the test plant. After spraying a plant with the potential inducer, induction of the PR promoter by the herbicide can be seen as a stained product from the action of the glucuronidase.

The development of crop plants which respond to immunochemicals is considered as better than development of more herbicides (Box 1.9.3), because immunochemicals do not kill the weed, but rather increase the resistance of the crop. Thus, protective treatment with fungicides and insecticides could be strongly reduced. Treatment with a chemical would, however, still be required, but would induce the nat-

ural defence of the plant in the battle against detrimental organisms.

1.9.2

Gaseous Air Pollutants

The most important gaseous pollutants damaging plants are sulfur dioxide, ozone, nitrogen oxides (NO_x), peroxyacetyl nitrate (PAN), ethylene, and various other substances which are adsorbed on dust particles (Table 1.9.2).

Particularly noxious are the reductive smog (London type) which contains mostly SO_2 , and the oxidative, photochemical smog (Los Angeles type), which is characterised by PAN. The large number of air pollutants cannot be covered here, but it is clear that sulfur dioxide results mainly from burning of S-containing fossil fuels and from smelting of metal sulfide ores. The main component of photochemical, oxidative smogs, PAN, is produced in a complicated chain reaction from nitrogen oxides and unsaturated hydrocarbons during incomplete burning of motor fuels.

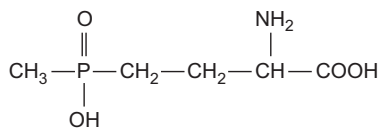
Increasing use of oil and gas as domestic fuels and desulfurisation of industrial emissions have reduced the SO_2 concentration in industrial and heavily polluted areas to less than 10% of that in the immediate post-war years (Fig. 1.9.5). However, concentrations of nitric oxides rose or stagnated in many countries, despite the use of catalytic converters in cars. In addition to industrial and car exhaust gases many other gaseous pollutants accumulate in houses, e.g. formaldehyde (see below).

Of course, such gases are not only problematic to humans, but when present at higher concentrations may also damage plants. Forest decline in recent years (Fig. 1.9.6; see also Chap.

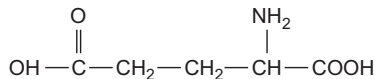
Table 1.9.2. Airborne substances, toxic to plants. From Elstner (1984)

Oxidative smog	NO_2 , PAN, O_3 (Los Angeles type)
Reductive smog	SO_2 (London type)
Acids	HF, H_2SO_3 , H_2SO_4 , HCl
Dusts	Most importantly cement dust and blown soil particles
Phytoeffectors	Ethylene, airborne herbicides and plant protective agents
Allelopathic effectors	(e.g. terpenoids)

Box 1.9.3 Production of herbicide-resistant crop plants



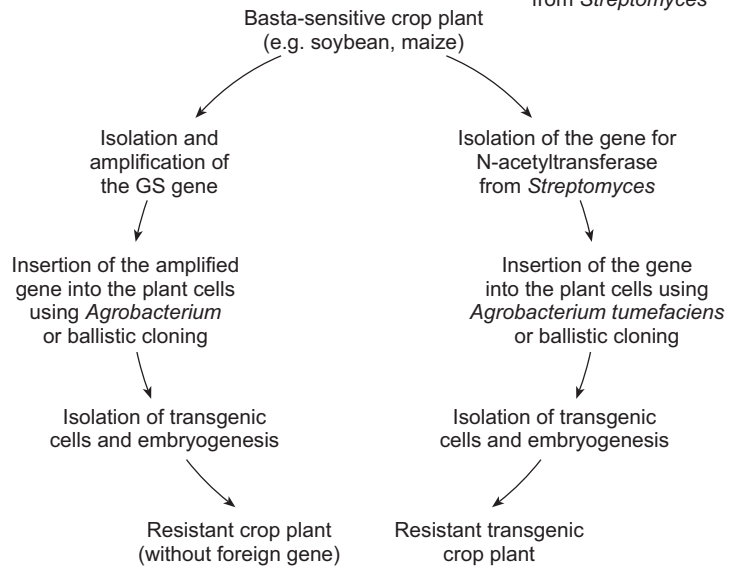
Herbicide:
Phosphinothricin
(trade mark "Basta")



Glutamic acid

Strategy I
Amplification of
its own GS gene

Strategy II
Transformation of
the plant with the
N-acetyltransferase gene
from *Streptomyces*



Due to its similarity with glutamic acid, phosphinothricin ("Basta") inhibits glutamine synthetase. It is inactivated by N-acetylation.

Strategies for the creation of Basta-resistant crops

In principle, there are two strategies to introduce Basta resistance into a plant:

1. Increasing the expression of the plant's own gene that the herbicide targets, i.e. the gene for glutamine synthetase. Thus plants remain undamaged or only slightly damaged at Basta concentrations that kill wild-type plants (strategy I).
2. Introduction of a Basta-inactivating foreign gene, i.e. the gene for N-acetyltransferase from *Streptomyces* (strategy II).

In the first case a non-transgenic plant is produced, whereas in the second the plant is transgenic.

3.5.1 and Fig. 2.3.7F) has been mainly attributed to such atmospheric pollutants.

In the past, trees in the areas of smelting works and power stations fuelled by lignite were damaged lethally by the high SO_2 concentrations (e.g. in the Erzgebirge of Germany). Current regulations on air pollution have resulted in a decrease in the concentrations of these pollutant below the threshold of damage (Fig. 1.9.5). However, this raises the question: "What is the damaging concentration?" In principle, the impact of stress depends on the product of time and concentration of a noxious substance; however, in practice, this

applies only conditionally. For almost all gaseous pollutants exists a range of concentration (below the so-called threshold) where the pollutant does no damage, and may even be useful. Not everything emitted from the exhaust of a motor vehicle is, from the perspective of the plant, a damaging gaseous pollutant – CO_2 and nitric oxides, and to a certain extent even SO_2 , can contribute to the mineral nutrition of plants. In making such a general statement, the different sensitivities of the individual plant species must be considered (Table 1.9.3), which in turn depend on the developmental stage of the plant.

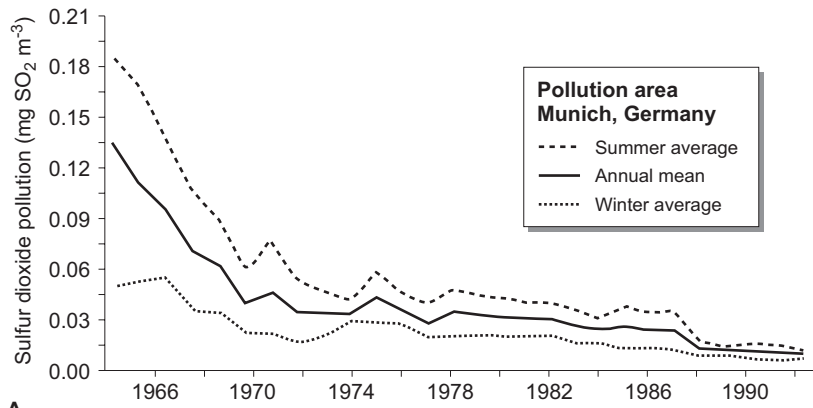
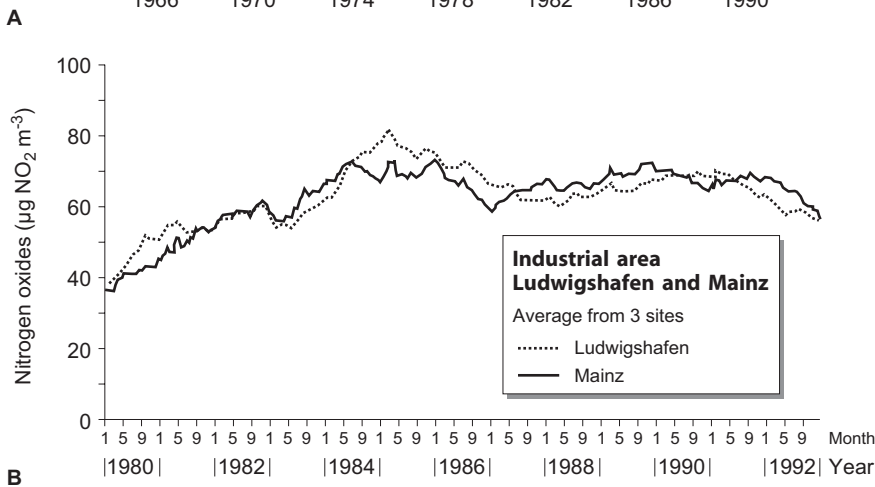


Fig. 1.9.5. Development of the annual, summer, and winter average concentrations of sulfur dioxide (A) and nitrogen dioxide (B) in the past 20 years. (From "Umweltbereich Luft", Folienserie des Fonds der Chemischen Industrie, 1995, Frankfurt)



B



Fig. 1.9.6. Typical symptoms of the "new forest decline": **A** Extreme crown attenuation in spruce. The trees carry leaves of only the most recent years (2–3 years). **B** Yellowing of the current years needles probably resulted from acute magnesium deficiency ("advanced apical yellowing"). Soils are depleted of cations, in particular magnesium, as a consequence of acid deposition ("acid rain"). (Hock and Elstner 1984)

Table 1.9.3. Different sensitivities of plants to SO₂ in the air. Source: VDI-Richtlinie 2310 “Maximale Immissionswerte für SO₂ zum Schutz der Vegetation”

Very sensitive plants	Sensitive plants	Less sensitive plants
Deciduous woody plants		
Walnut (<i>Juglans regia</i>)	Lime (<i>Tilia</i> sp.)	Plane (<i>Platanus</i> sp.), oak (<i>Quercus</i> sp.)
Red current (<i>Ribes rubrum</i>)	Beech (<i>Fagus silvatica</i>)	Poplar (<i>Populus</i> sp.), Sycamore (<i>Acer</i> sp.)
Gooseberry (<i>Ribes uva-crispa</i>)	Hornbeam (<i>Carpinus betulus</i>)	Alder (<i>Alnus</i> sp.), Lilac (<i>Syringa vulgaris</i>)
	Apple (<i>Malus domestica</i>)	Willow (<i>Salix</i> sp.), Robinia (<i>Robinia pseudoacacia</i>)
	Hazelnut (<i>Corylus avellana</i>)	Birch (<i>Betula</i> sp.), cherry and plum (<i>Prunus</i> sp.)
		Grape vine (<i>Vitis vinifera</i>)
		Rhododendron (<i>Rhododendron</i> sp.)
Coniferous trees		
Fir (<i>Abies</i> sp.)	Scots pine (<i>Pinus sylvestris</i>)	Austrian pine (<i>Pinus nigra austriaca</i>)
Spruce (<i>Picea</i> sp.)	Weymouth pine (<i>Pinus strobus</i>)	Western red cedar (<i>Thuja</i> sp.), yew (<i>Taxus baccata</i>)
Douglas fir (<i>Pseudotsuga menziesii</i>)	Larch (<i>Larix</i> sp.)	Juniper (<i>Juniperus</i> sp.)
		Cypress (<i>Chamaecyparis</i> sp.)
Agronomically and horticulturally important plants		
Clover (<i>Trifolium</i> sp.)	Barley (<i>Hordeum vulgare</i>)	Potato (<i>Solanum tuberosum</i>)
Alfalfa (<i>Medicago sativa</i>)	Oats (<i>Avena sativa</i>)	Tomato (<i>Lycopersicon esculentum</i>)
Lupin (<i>Lupinus</i> sp.)	Rye (<i>Secale cereale</i>)	Maize (<i>Zea mays</i>), sugar beet (<i>Beta vulgaris</i> ssp.)
Common vetch (<i>Vicia sativa</i>)	Wheat (<i>Triticum aestivum</i>)	Cabbage (<i>Brassica oleracea</i> ssp.)
Broad bean (<i>Vicia faba</i>)	Lettuce (<i>Lactuca sativa</i>)	Carrot (<i>Daucus carota</i>)
Spinach (<i>Spinacia oleracea</i>)	Beans (<i>Phaseolus</i> sp.)	Strawberry (<i>Fragaria chiloensis</i>)
Pea (<i>Pisum sativum</i>)	Rape (<i>Brassica napus</i>)	Leek (<i>Allium</i> sp.)
Ornamental plants		
Begonia (<i>Begonia</i> sp.)	Dahlia (<i>Dahlia variabilis</i>)	Rose (<i>Rosa</i> sp.), Gladiolus (<i>Gladiolus</i> sp.)
Sweet pea (<i>Lathyrus odorata</i>)	Geranium (<i>Pelargonium zonale</i>)	Tulip (<i>Tulipa gesneriana</i>), iris (<i>Iris</i> sp.)
	Petunia (<i>Petunia hybrida</i>)	Daffodil (<i>Narcissus pseudonarcissus</i>)
	Carnation (<i>Dianthus caryophyllus</i>)	Marguerite (<i>Chrysanthemum leucanthemum</i>)
	Fuchsia (<i>Fuchsia hybrida</i>)	Heather (<i>Calluna vulgaris</i>)

Table 1.9.4. Summary of the stomatal responses to airborne pollutants. (After Darrall 1989)

Pollutant (ppb)	Category of response		
	Low Open or no change	Medium Open, closed or no change	High Closed
SO ₂	< 100	100–950	> 1865
O ₃		≤ 200	> 200
NO ₂	≤ 100	≤ 1000	≥ 2000
NO		≤ 1000	> 1000
HF	≤ 0.6		≥ 14

Only above an appropriate threshold is there usually a range of concentration in which an impact correlates with the product of concentration and exposure time [e.g. for SO₂ short-term (28 h) fumigation with 21 ppm, for long-term exposition (7–50 days) 0.04–0.2 ppm]. At higher concentrations the exposure time is less important, as the concentration alone is responsible for the damage.

In general and for practical reasons, a distinction is made between short-term stress (2–5 h) and chronic stress (7 days, 50–200 days: Fig. 1.9.7). Of course combinations of stresses must be considered in the context of air pollutants, e.g. if gaseous pollutants increase stomata conductance (Table 1.9.4), the danger of desiccation increases substantially. On the other hand, drought stress, and closing of stomates triggered

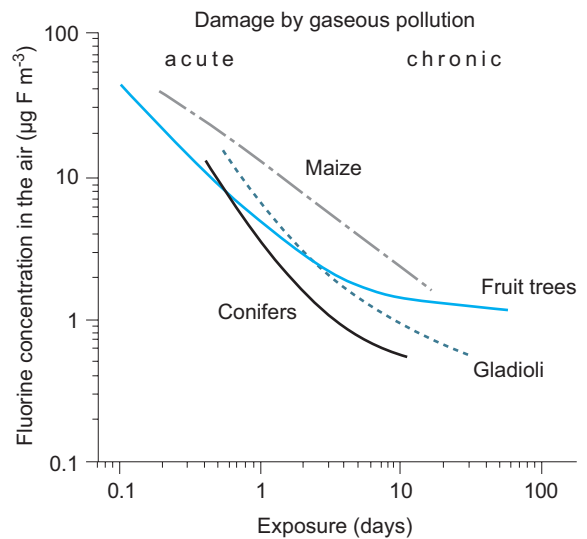
by it, protects against diffusion of gaseous pollutants into a plant.

Many gaseous pollutants are able to enter the leaves by two routes: physically (by diffusion; Fig. 1.9.8 and Table 1.9.5) and/or chemically, e.g. by damaging the cuticle.

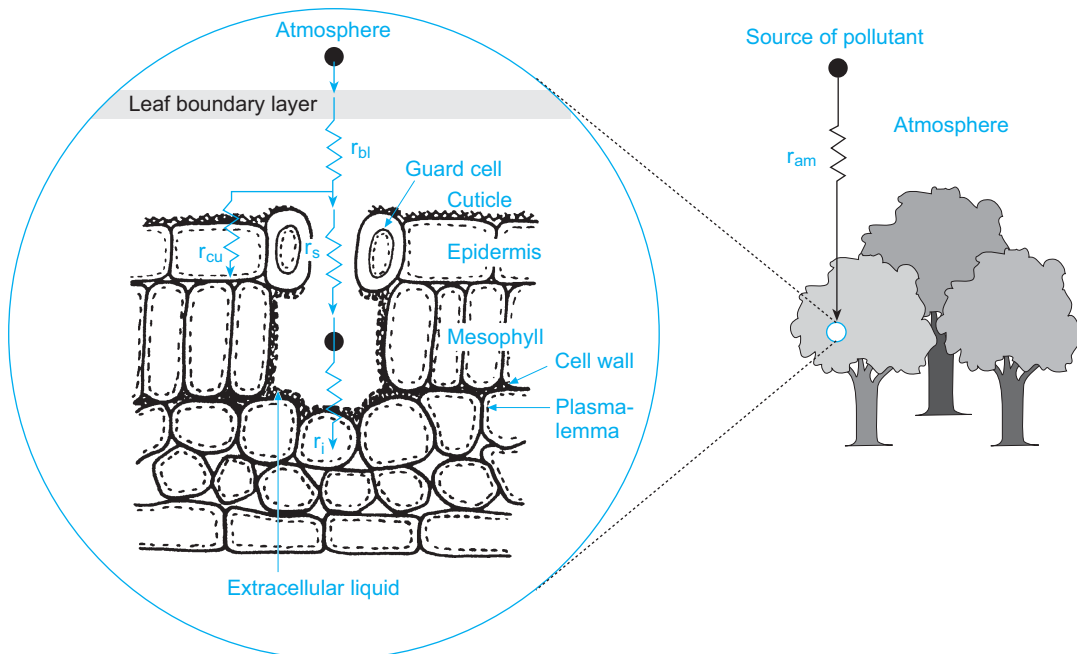
Sulfur dioxide, ozone and formaldehyde will be discussed in the following as examples of pollutants that damage plants.

1.9.2.1 Sulfur Dioxide

SO₂ mainly enters the atmosphere because of human activities and also, to a lesser extent, by natural processes (Box 1.9.4). In the atmosphere SO₂ may be converted, e.g. to sulfurous acid (bisulfite) or sulfuric acid. This chapter will discuss mainly the pollutant SO₂.



■ Fig. 1.9.7. Acute and chronic damage to various plants by fluorine as airborne pollutant. In hours to days the plant reacts with a type of “stress-quantity law” (intensity × duration of exposure). Acute damage is evident by the loss of chlorophyll with subsequent necroses; chronic damage expresses itself through slower growth, alterations in the structure of the wood, and reduction in fertility after a transient flush in fertility. (After Larcher 1994)



■ Fig. 1.9.8. Route of entry of gaseous airborne pollutants into leaves. The entry into leaves requires that pollutants overcome various resistances (r). In the air the rates of transport depend mainly on exogenous factors: Wind, the roughness of the terrain (vegetation), temperature and humidity are major determinants of the rate of dispersal and the fluxes. These factors together are considered to be the “atmospheric resistance” (r_{am}). Further resistance results from the boundary layer on the leaf surface (r_{bl}), from the narrow aperture of the stomates (r_s), and structure and tightness of the cuticle (r_{cu}) and the wall of the mesophyll cells (r_i). Differentiation of these individual resistances is meaningful as their efficacy depends on the nature of the pollutant. In addition, the individual pollutant can influence the opening of the stomates or reduce the density of the cuticle. (Modified after Fuhrer 1996)

Table 1.9.5. Typical range of values for the relative diffusivities of gaseous pollutants (Wesley 1989) and the diffusion resistance (r_c) of leaves to specific gases (Taylor et al. 1988)

Air pollutant (P)	Relative diffusivities ^a (D_{H_2O}/D_P)	Leaf diffusion resistance ($s\text{ cm}^{-1}$)
Ozone, O ₃	1.6	1.4–5
Nitrogen monoxide, NO	1.3	1–10
Nitrogen dioxide, NO ₂	1.6	0.1–0.8
Nitric acid, HNO ₃	1.9	0.2–2
Ammonia, NH ₃	1.0	1.7–5
Peroxyacetylnitrate (PAN)	2.6	1.7–10
Sulfur dioxide, SO ₂	1.9	0.03–0.5
Hydrogen sulfide, H ₂ S	1.4	0.25–0.5

^a Calculated as the square root of the molar mass ratio M_P/M_{H_2O}

SO₂ Uptake into the Plant

Even though the stomatal conductivity for sulfur dioxide is almost the same as for CO₂, SO₂ is able to penetrate the cuticle (with stomata closed) better than oxygen and about 20 times faster than CO₂ (Table 1.9.6). Low external con-

Table 1.9.6. Cuticular and stomatal conductances in a *Citrus* leaf for various gases (including the boundary layer resistance; from Lange et al. 1989)

Gas	Cuticular conductance (cm s^{-1})	Stomatal conductance (cm s^{-1})
SO ₂	2.01×10^{-5}	0.12
O ₂	3.05×10^{-5}	0.18
CO ₂	5.4×10^{-6}	0.14
H ₂ O	1.09×10^{-7}	0.22

centrations of SO₂ lead to turgor loss of the auxiliary cells and to opening of the stomata, high concentrations to closure of stomata. NO₂ permeates easily and quickly through biomembranes whilst hydrogen sulfite or sulfite ions hardly pass through undamaged membranes.

Metabolism of SO₂ in the Plant

SO₂ is a reducing as well as an oxidising agent because of its mid-range redox potential. It reacts easily with many biomolecules (see Box 1.9.4) and thus inhibits many enzymes; it is even mutagenic, as it forms dihydrosulfonates

Box 1.9.4 The air pollutant SO₂

A few interesting facts:

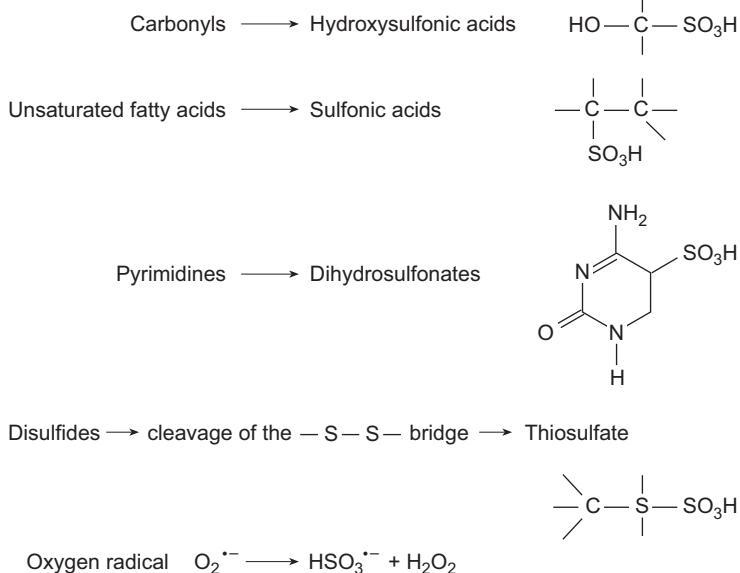
Sulfur dioxide is produced naturally (20 million t/year) and by human activity (150 million t/year). Naturally, sulfur dioxide is produced upon degradation of terrestrial and marine biomass and through volcanic activity.

Clean air contains approx. $1\ \mu\text{g SO}_2/\text{m}^3 = 0.3\ \text{ppb}$ ($1\ \text{ppm} = 2.67\ \text{mg SO}_2/\text{m}^3$), highly contaminated air contains up to $1500\ \mu\text{g SO}_2/\text{m}^3$.

In air, SO₂ gives rise to sulfurous acid:



and OH radicals oxidise this to sulfuric acid:



For plants the strong reducing agent HSO₃⁻ is about 20 times more poisonous than SO₄²⁻.

Sulfurous acid or SO₂ reacts with almost all biomolecules and this is how the sulfonate acids originate.

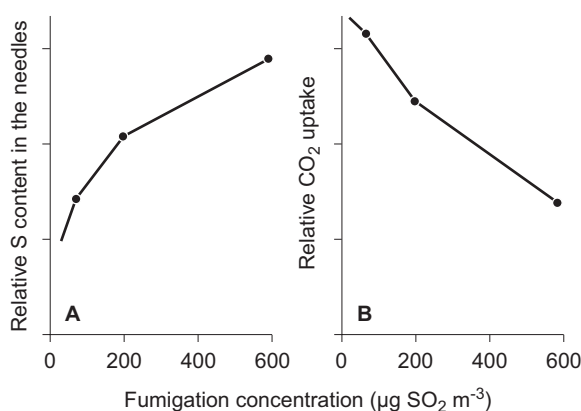
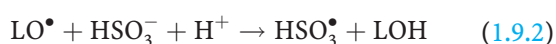
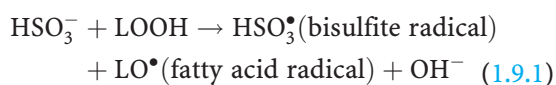


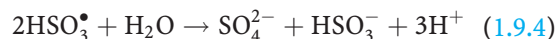
Fig. 1.9.9. Accumulation of sulfur (A) and inhibition of photosynthesis (B) in young spruce trees after 3 months of fumigation with the SO_2 concentrations shown on the abscissa. (After Larcher 1994)

with pyrimidine bases. It can also interfere directly with the plant's CO_2 metabolism by binding, e.g. to ribulosebiphosphate in the RuBP-Rubisco complex, and thus contribute to the well-known inhibition of photosynthesis (Fig. 1.9.9). Inhibition of photosynthesis by SO_2 is not based on a single reaction, but a reaction complex or a syndrome (Darrall 1989). Particularly striking is the bleaching of green tissues caused by SO_2 : originally this was interpreted as an effect of acidity inferred by sulfurous acid, but this probably only applies very rarely, because the required concentration of acid and the required low intracellular pH are usually not reached. Only in a very acidic milieu is the magnesium ion removed from the porphyrin ring of chlorophyll producing the brown pheophytin. It is more likely that SO_2 damage results from oxidation of the unsaturated fatty acids of membrane lipids or from SO_2 addition to unsaturated membrane constituents, thus affecting the chlorophyll-protein complexes to such an extent that chlorophyll is released, or is at least easily available for chemical reactions. In the oxidation of linolenic or linoleic acid, for example, fatty acid hydroperoxides are formed ("LOOH", L=lipid) which trigger a chain reaction producing radicals upon reaction with sulfurous acid:



e.g. hexenal, nonenal as well as ethane (a parameter for monitoring the reaction).

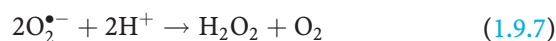
LO^\bullet also oxidises chlorophyll ("bleaching"), aided by the formation of sulfuric acid during the decay of the hydrogen sulfite radical:



as well as by further formation of radicals:



and the formation of the peroxide ion (hydrogen peroxide):



The last reaction is catalysed by the enzyme superoxide dismutase.

In almost all areas with high pollution lower chlorophyll contents are measured, particularly in trees. However, this should not be explained exclusively by chlorophyll oxidation but can often result from magnesium deficiency as a consequence of the acidification of soils by "acid rain" (see Chaps. 2.3 and 3.5.1).

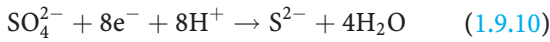
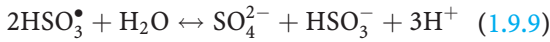
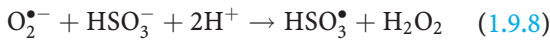
The destruction of membranes does not only pertain to photosynthetic membranes, but may, in principle, be assumed for all cellular membranes. This is indicated by the damage caused to plants by SO_2 concentrations at which no visible symptoms occur.

Part of the SO_2 taken up by the plant is photosynthetically assimilated (reduced) and may thus contribute to the sulfur nutrition. According to the ion trap principle, SO_2 and HSO_3^- accumulate in the alkaline stroma of the chloroplast (Table 1.9.7); however, it must first be oxidised to a sulfate.

Table 1.9.7. Intracellular distribution of HSO_3^- in the individual cell organelles, following the ion trap principle and the proportions of the volumes. (After Pfanz et al. 1987)

Organelle	Chloroplast	Cytosol	Vacuole
pH	8.0	approx. 7.0	approx. 5.0
Percentage distribution of HSO_3^-	96	3	1

The oxidising agent is photosynthetically reduced oxygen, the oxygen anion radical. The reaction occurs via the hydrogen sulfite radical:



After its activation with ATP (to adenosine phosphosulfate, APS) sulfate is reduced to S^{2-} by the well-known assimilatory sulfate reduction pathway. The sulfide ion (S^{2-}) is incorporated into the amino acid cysteine via serine. With protons it may alternatively produce H_2S which is released in considerable amounts into the atmosphere. However, this does not generally exceed 10% of the SO_2 taken up (Rennenberg 1984). Whereas reduction of SO_2 consumes protons, oxidation to sulfate produces sulfuric acid as well as sulfurous acid. If the strain remains below the threshold of damage, these acids may be buffered intracellularly (Lange et al. 1989). Whether proton transport from SO_2 -stressed leaves via sulfate into the roots and finally into the soil can take place needs further clarification. Stress by sulfate to assimilatory organs is not only caused by uptake and conversion of SO_2 . Research on the sulfur relations of spruce (Köstner et al. 1998) showed that uptake of sulfur from the soil may exceed gaseous sulfur uptake by a factor of 4 to 5.

SO₂ Resistance

Beside the different capacity of plants to assimilate SO_2 there is no specific resistance against this pollutant, as it has many effects. Known differences in the sensitivity of various plants and their developmental stages are usually not based on SO_2 -specific interactions or reactions, but on general characteristics of individual plant types, e.g. the higher resistance of C4 plants is based on the fact that SO_2 inhibits PEP-carboxylase less than Rubisco. Other favourable characteristics are frequent renewal of leaves and a greater capacity for buffering or adsorption.

Lichens are an example for a very broad spectrum of SO_2 sensitivity (Box 1.9.5), because they do not possess stomata and are, therefore, more directly and evenly subjected to pollutants in air than higher plants. Because of the close symbiotic interactions between algae and fungi, lichens are particularly delicate and easily disturbed, and they are not able to drop stressed tissues like shedding leaves.

Figure 1.9.10 summarises possible mechanisms for avoidance and tolerance which are used by lichens to cope with air pollution, particularly by SO_2 . However, the role of the typical compounds of lichens, the lichenous acids, in this process is not quite clear. Possibly these acids adsorb some of the gaseous noxes (Box 1.9.6).

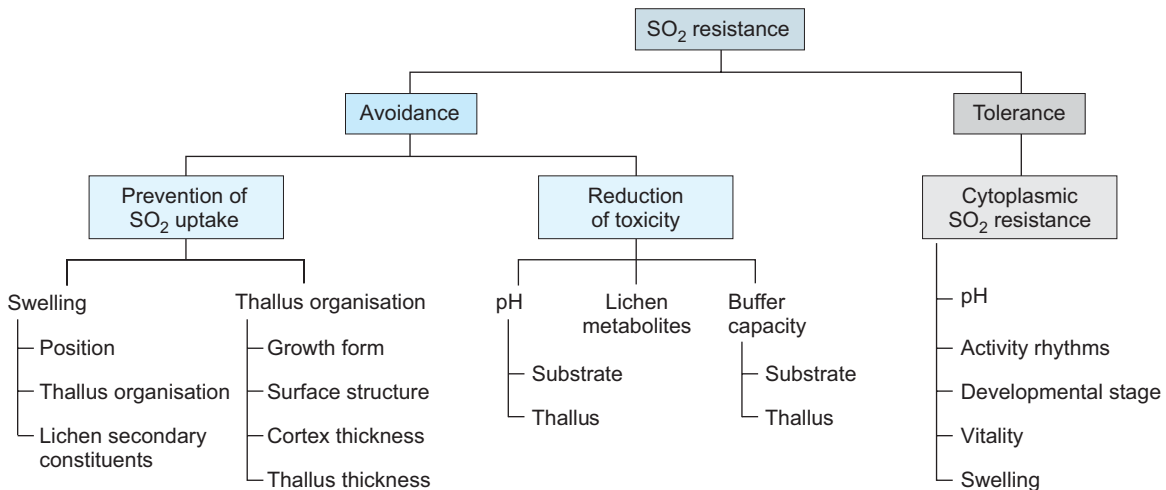


Fig. 1.9.10. The different mechanisms of SO_2 resistance exhibited by lichens; in this case tolerance encompasses also repair. (Türk et al. 1974)

Box 1.9.5 Biomonitoring of air pollutants using lichens

Table 1. Lichen occupation and communities on trees (bark as an organic substrate) and walls, and the influence of SO₂ stress (after Larcher 1994)

Average SO ₂ concentration (µg m ⁻³)	Epiphytic lichens		Epipetric lichens	
	Eutrophic bark	Non-eutrophic substrate	Alkaline substrate	Acid substrate
> 125	<i>Lecanora conizaeoides</i> <i>Lecanora expallens</i>	<i>Lecanora conizaeoides</i> <i>Lepraria incana</i>	<i>Lecanoraia dispersae</i>	<i>Conizaedion</i>
ca. 70	<i>Buellia canescens</i> <i>Physcia adscendens</i>	<i>Hypogymnia physodes</i> <i>Lecidea scalaris</i>		
ca. 60	<i>Buellia canescens</i> <i>Xanthoria parietina</i> <i>Physcia orbicularis</i> <i>Ramalina farinacea</i>	<i>Hypogymnia physodes</i> <i>Evernia prunastri</i>	<i>Xanthorion</i>	<i>Conizaedion</i> <i>Acarospora fuscata</i>
ca. 50	<i>Pertusaria albescens</i> <i>Physiconia pulverulenta</i> <i>Xanthoria polycarpa</i> <i>Lecania cyrtella</i>	<i>Parmelia caperata</i> <i>Graphis elegans</i> <i>Pseudovenia furfuracea</i>		
ca. 40	<i>Physcia aipolia</i> <i>Ramalina fastigiata</i> <i>Candelaria concolor</i>	<i>Parmelia carperata</i> <i>Usnea subfloridana</i> <i>Pertusaria hemisphaerica</i>	<i>Xanthorion</i> (increasing diversity)	<i>Cladonia</i> spp.
< 30	<i>Ramalina calicaris</i> <i>Caloplaca aurantiaca</i>	<i>Lobaria pulmonaria</i> <i>Usnea florida</i> <i>Teloschistes flavicans</i>	Up to 20 species of <i>Xanthoria</i>	Increasing diversity, no <i>Lecanora conizaeoides</i>

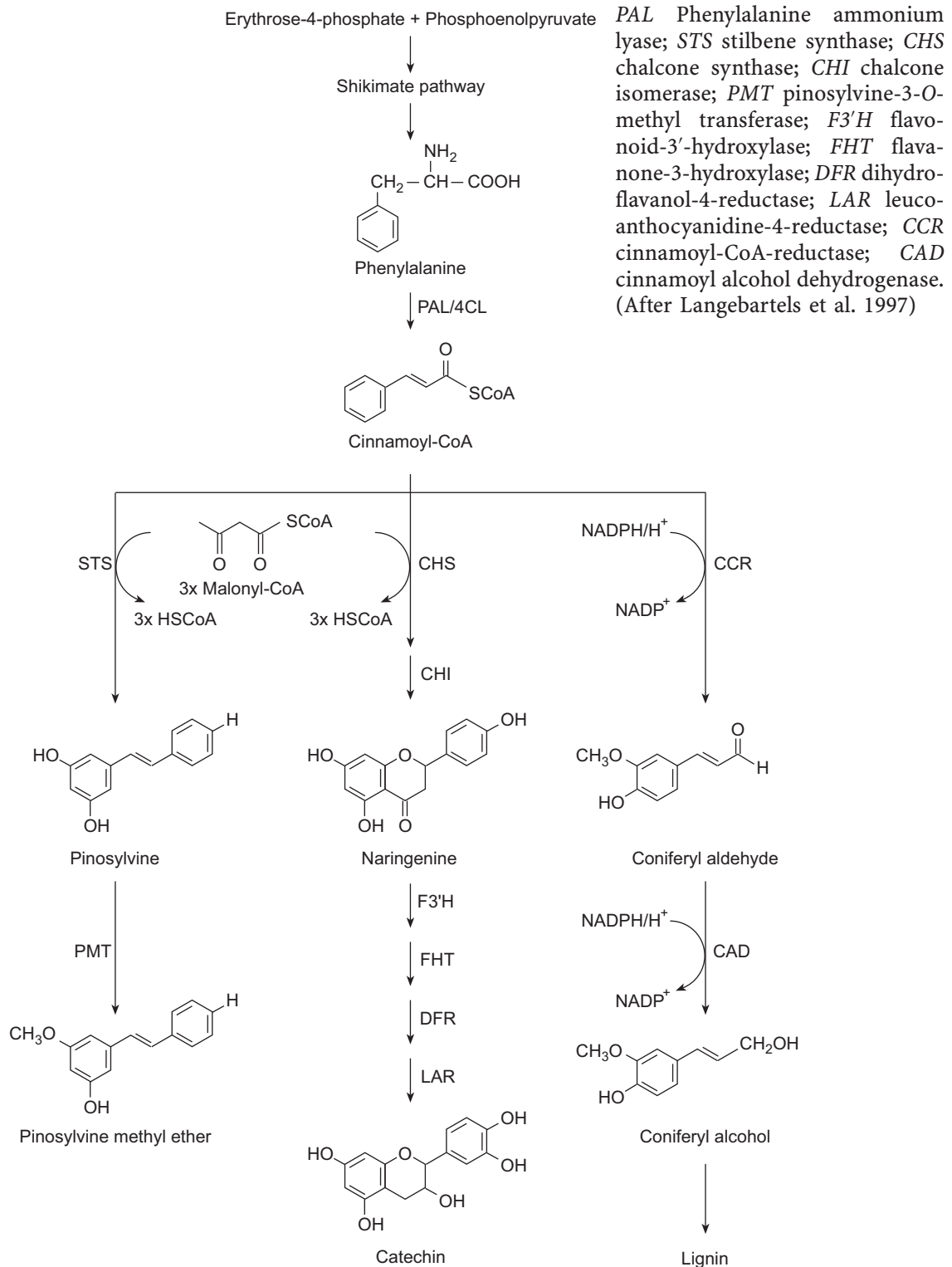
The high sensitivity of many species of lichens to atmospheric pollutants is often used to monitor long-term air pollution, particularly in towns. The presence of lichens can be mapped on areas to be studied, but several precautions must be observed if there is to be value in the results for prediction. For example, only lichen thalli which occupy bark should be used (because basic rocks provide different strengths of buffering capacity); then only those that grow at a particular height and on the side with optimal growth should be counted and their appearance should be rated. In addition, in any one area a number of trees (10–50) should be examined in order to obtain statistically significant data. Of course, only known species of lichens can be used and it is often recommended that only lichen communities should be analysed (Table 1). Even if these include species which are particularly sensitive to air pollutants (e.g. *Xanthoria parietina*, *Grimmia pulvinata* and *Parmelia saxatilis* for SO₂), other pollutants must be taken into consideration. Frequently, in urban areas, dusts containing heavy metals attack lichens more strongly than gaseous pollutants. If these data, particularly the cover abundance, have been recorded, area classification into lichen deserts, struggling zone

and clean air zone can be accomplished using Table 2. For many cities in Europe, such lichen maps already exist. Nevertheless, for long-term biomonitoring, they must be revised from time to time. Short-term biomonitoring can be done with standardised lichen exposure panels. For this the widely distributed and fast growing foliose lichen *Hypogymnia physodes* is used. It is picked with sufficient bark as substrate and is exposed on the panel in ten replicates. These panels are then exposed in the study areas and the state of the thalli is recorded from time to time.

Table 2. Lichen growth in situ as a parameter of lichen zonation (after Seitz 1972)

Cover abundance	Lichen zone
No growth or crustose lichens, maximum 0.5% cover	Lichen desert
Growth only of crustose lichens, foliose lichens absent	Inner struggle zone
Foliose and fruticose lichens 1–25% cover abundance (if >25% cover then partially dying)	Middle struggle zone
Foliose and fruticose lichens 25–50% cover abundance (if 50% then partially clearly dying)	Outer struggle zone
Foliose and fruticose lichens >50% cover abundance, no damage	Clean air zone

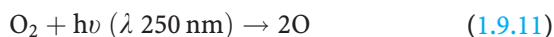
Box 1.9.6 Plant secondary metabolism induced by ozone



1.9.2.2

Ozone

High ozone concentrations occur in the stratosphere and troposphere (Fig. 1.9.11). Ozone is continuously produced in the stratosphere [Eqs. (1.9.11) and (1.9.12)] and degraded again [Eqs. (1.9.13) and (1.9.14)].

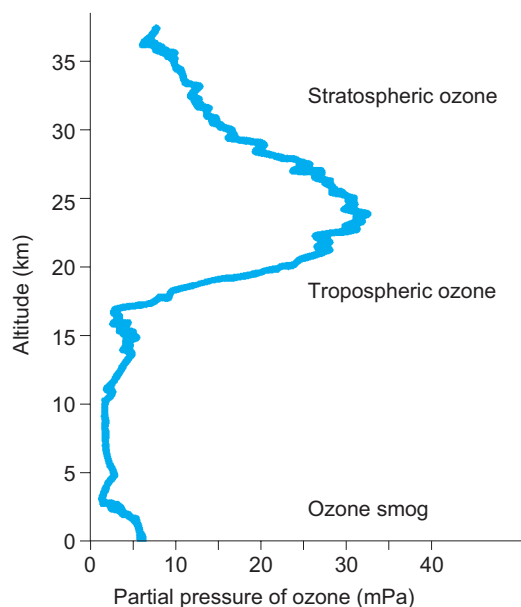


M is a neutral hit-partner taking up the energy of the O=O₂ bond, e.g. N₂, O₂.



Y represents free radicals, e.g. OH, NO, Cl and Br, which are released by photolysis from stable compounds such as water, CFCH or N₂O. In the area of the ozone hole, degradation exceeds formation of ozone (catalysed by Cl⁻, Br⁻ and NO₃ ions). Outside the ozone hole, formation and degradation are balanced. The maximum concentration of ozone in the stratospheric layer is up to 600 μg/m³.

In the lower troposphere (the atmosphere at ground level), ozone is formed at high solar ra-



■ Fig. 1.9.11. Ozone concentrations of the earth's atmosphere. (Häder 1996)

diation in oxidative smog from oxygen and nitric oxide. The ozone concentration in the lower troposphere follows an annual cycle and a diurnal cycle (Fig. 1.9.12). The highest ozone concentrations are reached at high air temperatures and high solar radiation.

Different countries have defined different ozone stresses (concentration × period of exposure) as toxic thresholds: California 400 μg/m³ for 1 h, Federal Republic of Germany 180 μg/m³ for 2 h, Switzerland 120 μg/m³ for 1 h. On sunny days values up to 200–280 μg/m³ can be reached in central Europe (summer smog). Normal average values are 20–60 nl/l. In previous times spas advertised their ozone-containing air and ozone-rich forests, which were considered ideal for recreation in summer. Today, ozone is a toxic trace gas which, in areas with clean air, is held responsible for forest decline. Explanation for the relatively high ozone content in clean air of mountain regions is difficult. It is assumed that monoterpenes, emitted mainly by fir and spruce trees but also by broad-leaved plants during exposure to high radiation, catalyse formation of ozone (Fehsenfeld et al. 1992).

Ozone is, according to its molecular structure



a very strong oxidant with a redox potential of +2.1 V. It reacts easily with unsaturated compounds forming ozonides, peroxides and hydroperoxides. It also oxidises thiols to sulfonic acid or disulfides.

As with other stresses, the critical question also applies to ozone: How much ozone can a plant tolerate? It is easy to subject plants to a high dosage of ozone and to obtain typical damage symptoms (Fig. 1.9.13). In the ample literature on the connection between ozone concentration and forest decline, different thresholds of damage by O₃ are reported depending on the mode of ozone application. One standard is the average concentration of central Europe which is 40 nl/l (40 ppb). Since there is practically no ozone-free natural air, ozone stress is expressed as the concentration above AOT40 (accumulated exposure of ozone above the threshold of 40 nl/l). It could also be expressed directly as concentration. The total dosage is given as SUMO (sum of all hourly mean O₃ concentrations).

In the experiment shown in Fig. 1.9.13 beeches were fumigated from April to October with twice the natural ozone concentrations. The

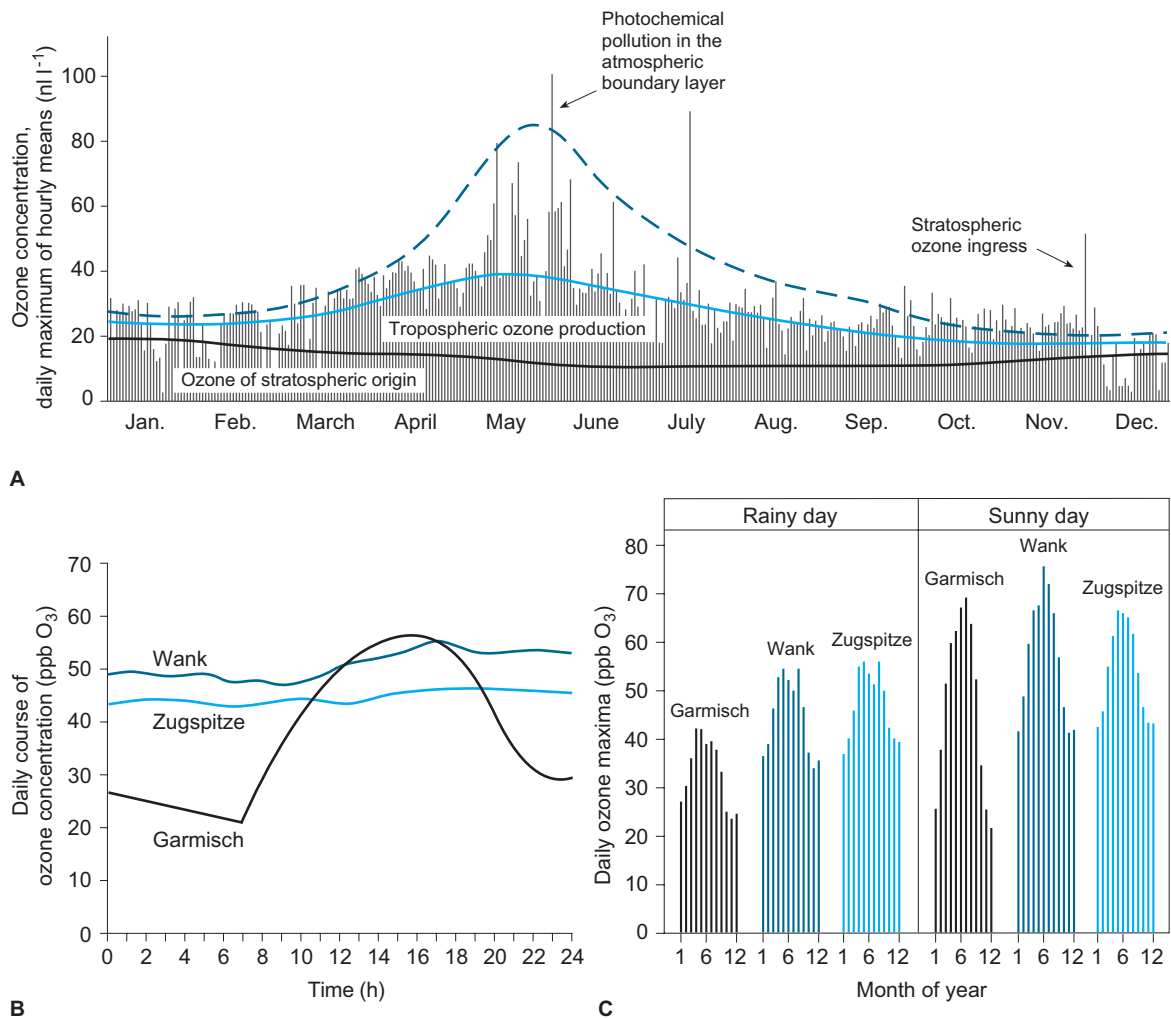


Fig. 1.9.12. Changes in tropospheric ozone concentration in the course of the day and of the year. **A** Proportion of various tropospheric ozone sources in a rural setting. The bars indicate the hourly mean maximum of a day. Tropospheric ozone production increases during the year with its own dynamics and contributes to stratospheric ozone which, however, changes little during the year. Individual peaks can arise from tropospheric pollution events as well as from stratospheric breakthroughs. **B** Daily changes in ozone concentration measured between 15 and 30 March from 1977 to 1980 at Garmisch (740 m), Mount Wank (1780 m), and Mount Zugspitze (2962 m). The peaks of ozone concentration during the day and in the early evening are probably correlated with the rush hour traffic in the city of Garmisch. High above the valley of Garmisch such changes do not appear. The monthly daily maxima of ozone concentrations in these high places are, however, significantly greater than those in the valley (**C**). Gaseous terpenes, produced mainly by coniferous trees, function as catalysts in ozone formation, as can be seen in both the yearly changes and the dependence on solar radiation. RSD Relative sunshine duration. All figures after Stockwell et al. (1997)

photograph was taken by mid-August. Brown spots are visible, some of which have developed into necroses. In Fig. 1.9.14 the development of ozone damage is quantified.

The picture of typically yellow-banded spruce needles was taken in June of the year following fumigation with 80 nl/l ozone from April to October every day for 24 h, and then grown on in the field. Symptoms occurred a year later, but led then to rapid senescence and to premature loss of needles. Generally, plants do not show

any damage symptoms at the ozone concentrations of normal air if they are not exposed to other, additional stress factors. However, upon increased O_3 stress damage occurs very quickly. These findings show that the product of O_3 concentration and time of exposition cannot be used as a measure of ozone stress, as an underlying accumulation of processes exist that leads to a later “memory effect”.

As with other pollutants, ozone tolerance of different plant species varies considerably (Ta-



Fig. 1.9.13. Ozone damage caused by controlled fumigation in beech (A), spruce (B) and pine (C). For explanation, see text. (Sandermann et al. 1997)

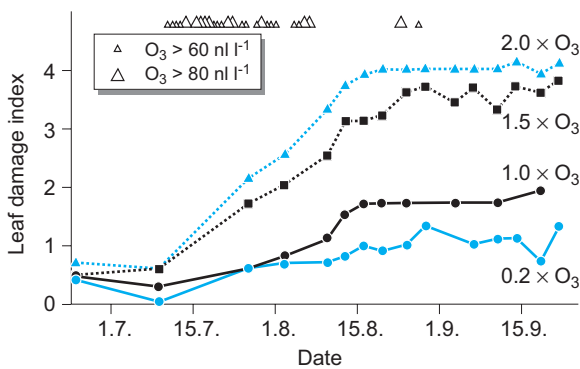


Fig. 1.9.14. Development of visible damage in leaves of 3-year-old beech trees after fumigation with different concentrations of ozone during one growing season. The treatment in the chamber started in April, when the buds opened, and ended in September with leaf fall. Days on which the ambient ozone concentration was above 60 or 80 ppb are indicated by *symbols* at the top of the graph. The symptoms of damage, small brown lesions, are shown in Fig. 1.9.13. The graph shows a rating of the intensity of the lesions. At 0.2 and 1× the natural ozone concentration there was hardly any visible damage. (After Langebartels et al. 1997)

ble 1.9.8). Amongst forest trees, spruce appears as very tolerant, larch and birch more sensitive. However, this interpretation depends on the design of the experiment and on the measured parameters (Matyssek et al. 1977).

Ozone damage has been extensively studied in relation to the new type of forest decline and for crops. After treatment with O₃ plants may become predisposed to subsequent abiotic (e.g.

Table 1.9.8. Sensitivity of various cultivated plants to ozone

Sensitivity (fumigation with O ₂)		
Sensitive (0.1 ppm)	Relatively sensitive (0.2 ppm)	Relatively resistant (0.35 ppm)
Spinach	Onion	Beet
Radish	Wheat	Carrot
Bean	Maize	Strawberry
Potato	Chrysanthemum	Zinnia
Tomato	Begonia	

lack of nutrients, water shortage, high UV-B dosage) and/or biotic stresses (e.g. pathogen attack; Fig. 1.9.15), even if they do not show any direct damage.

Physiological Effects of Ozone Stress

Ozone only enters the leaf through the stomates, as the cuticle is practically impermeable for this molecule. If stomates are closed, e.g. because of drought, damage by ozone of processes taking place in the mesophyll, such as photosynthesis, is small. On the other hand, long-term exposure to ozone reduces stomatal resistance so that drought stress intensifies (Fig. 1.9.16). However, in well-watered plants with open stomates an increased stomatal resistance was observed, i.e. a reduction of conductivity, and CO₂ uptake was reduced. The change in the response can be explained by ozone damage to the guard cells and

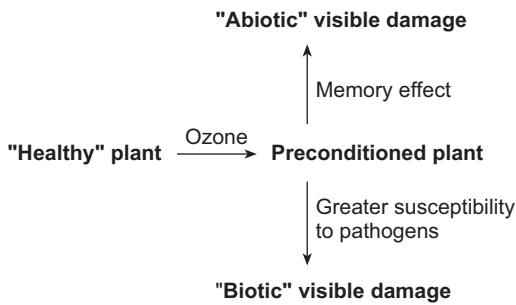


Fig. 1.9.15. Induction of visible ozone damage in conifers. The relatively low ozone concentration (e.g. twice natural background) stimulates the abiotic pathway, which includes the "memory effect" of a previous ozone stress, as described in the text. The biotic pathway includes reactions that also occur upon pathogen attack. This, however, does not occur in an organised mode, i.e. there is no coordinated regulation of gene expression in time and space. From this, decreased resistance (however, in individual cases sometime also increased resistance) to pathogens and other environmental stresses result. (After Langebartels et al. 1997)

their auxiliary cells. Because of the high reactivity of ozone, a steep concentration gradient occurs across the epidermis as O_3 is consumed by oxidation reactions already in the outer cell layer. Model calculations show that the internal ozone concentration in the leaf is almost zero at slightly elevated external ozone concentrations (Laisk et al. 1989). In contrast to oxygen, ozone is hydrophilic and thus reacts mainly with water-soluble or at least hydrated molecules, e.g. with SH-groups of proteins on the outer surfaces of the plasma membrane. Direct and rapid inhibition by ozone was shown by Heath and Taylor (1997) for a K^+ -responsive ATPase of the plasma membrane and a Ca^{2+} transporter. This might explain the changed stomatal responses (see Figs. 1.5.5 and 1.6.2).

The steepness of the concentration gradient of ozone across the epidermis, and the stomatal conductivity for O_3 are factors determining the ozone sensitivity of plants. Spruces have a very low O_3 conductivity and a particularly steep gradient, and are thus relatively insensitive towards ozone. For pines and deciduous trees, it is the other way round.

Influence of Ozone on Primary and Secondary Metabolism

O_3 is a polar molecule and therefore probably does not permeate through the plasma membrane, but produces radicals and signals there and in the cell wall. Increased ozone stress

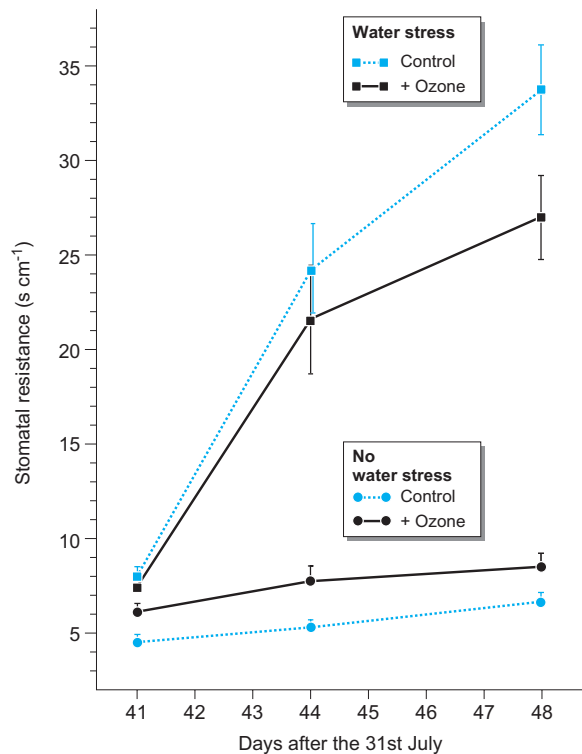


Fig. 1.9.16. Effect of interaction of ozone and drought stress on the stomates (expressed as stomatal resistance) of beech leaves. The drought-induced rise in stomatal resistance is decreased by ozone, i.e. the stomates open. Water loss, and therefore the effect of drought, is enhanced. Ozone treatment was started on day 31 and water supply was stopped on day 39. (After Pearson and Mansfield 1993)

causes several reactions, starting with the destruction of chlorophyll and xanthophyll by radicals. It thus affects photosynthesis, changing allocation of assimilates and causing loss of compartmentation (oxidation of unsaturated membrane lipids). Ozone also reacts with soluble proteins, e.g. Rubisco: Quantity and activity of this enzyme were reduced by 50% in 1-year-old pine needles (*Pinus halepensis*) under O_3 stress. At average light intensities, this did not cause a reduction in the rate of photosynthesis, as Rubisco is usually well in excess. However, in full sun, it became the limiting factor (see Chap. 1.2). This effect is, however, not only attributable to a destruction of Rubisco, but results also from a change in gene expression, because under O_3 stress more PEP-carboxylase is formed (Fontaine et al. 1999).

In the more resistant spruce, moderate O_3 treatment (one to two times ambient O_3 concentration) only causes a predisposition to such

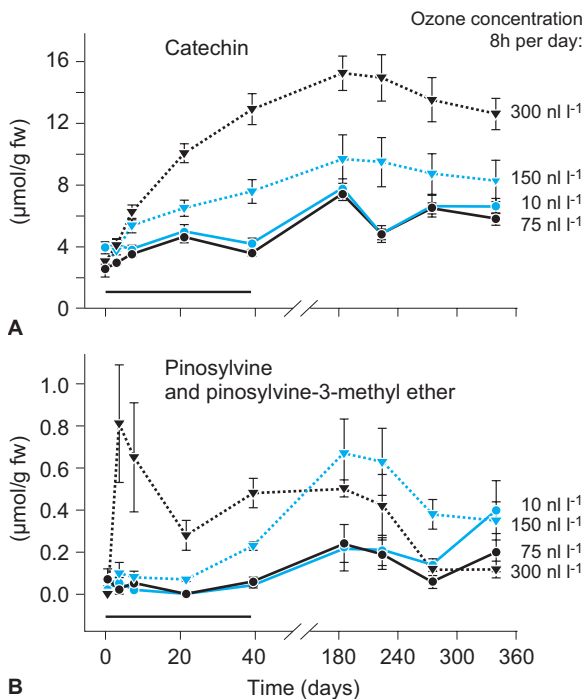


Fig. 1.9.17. Induction of secondary metabolism by ozone stress. One-year-old Scots pine (*Pinus sylvestris*) plants were exposed for 40 days to various ozone concentrations (8 h daily) and afterwards grown under natural conditions until autumn of the following year. **A** The flavane catechin (see [Box 1.9.6](#)), an antioxidant secondary metabolite, accumulated after the termination of ozone treatment and remained high during the following year. The concentration required to induce flavane accumulation was above the naturally occurring concentration but less than double the natural concentration. **B** Stilbenes are inducible phytoalexins (see [Chap. 1.10.2.1](#)) in sap wood and needles, but are constitutive in the heart wood. Their accumulation depends on the time and ozone concentration; incorporation into the cell wall caused a reduction in the soluble stilbene. The memory effect can clearly be seen in the case of stilbenes. (After Langebartels et al. 1997)

symptoms, which are expressed upon Mg or N deficiency.

In contrast to inhibition of primary metabolism, ozone causes a fast activation of secondary metabolism, particularly of the phenylpropane metabolism ([Box 1.2.6](#)). At severe stress when damage becomes visible the antioxidative ascorbate/glutathione system is likewise stimulated. Activation of secondary metabolism always precedes the occurrence of visible damage. This also applies to the apoplastic ascorbate peroxidase, pointing to an apoplastic detoxification system for ozone (and other oxidants).

Activity of some enzymes of flavonoid and stilbene metabolism is increased after O₃ treatment. These are possibly the rate-limiting en-

zymes, because phenolics, particularly stilbenes and flavanes, accumulate as a result of the increased enzyme activities ([Fig. 1.9.17](#)). Both are powerful radical scavengers which polymerise after formation of radicals and whose polymers associate with the cell wall.

The concentration of biogenic amines (see [Box 1.5.6](#)), e.g. tyramine and its conjugates (peptides), with cinnamic acid is also increased. They are particularly potent radical scavengers, almost as effective as the ascorbate system.

At higher doses of O₃ these defence systems are not sufficiently strong, as is shown by increased ethylene formation and premature senescence and shedding of the leaves. Expression of several typical senescence-associated genes was shown in *Arabidopsis* plants after fumigation with ozone, including aminocyclopropane-1-carboxylic acid synthase which is responsible for the production of ethylene (Miller et al. 1999; see also [Box 1.4.3](#)). Critical O₃ stress as indicated by the onset of measurable damage and leading to premature senescence is one and a half to two times ambient ozone for beech during the complete vegetative period.

Ozone and Pathogen-Related Proteins

In addition to enzymes of phenylpropane, glutathione and ascorbate metabolism, and the processes of senescence, the activities of which are stimulated by O₃, further enzymes are known which are not only induced by ozone, but also by pathogen attacks ([Table 1.9.9](#)). They belong to the group of **PR proteins** (pathogenesis-related proteins), e.g. hydrolases which can break down fungal cell walls and usually are expressed in context with a hypersensitive reaction (see [Chap. 1.10.2.1](#)). Expression of some of the ozone-related proteins is also induced by elicitors, i.e. by soluble fragments of plant or fungal cell walls.

An example for the latter is coniferyl alcohol dehydrogenase which is one of the major enzymes in the biosynthesis of lignin. Upon stress by ozone, enhanced lignin formation was observed that is probably similar to **stress lignin** which is also typical of pressure wood and has a different chemical composition to normal lignin.

In total there are specific as well as unspecific biochemical stress responses to ozone which are, of course, related to the oxidising effects of O₃. They may damage the plant or even protect it (cross protection). In many conifers, particularly the ozone-tolerant species, ozone stress

Table 1.9.9. Overview of the induced genes or stimulation of enzyme activity upon ozone stress. (Langebartels et al. 1997)

Enzyme	Tree type	Site of action
Cinnamoyl alcohol dehydrogenase	Spruce, pine	Transcription, enzyme activity
Alcohol dehydrogenase	Spruce	Transcription
Stilbene synthase	Pine	Enzyme activity, transcription
Phenylalanine ammonium lyase	Pine	Enzyme activity
Chalcone synthase	Pine	Enzyme activity
3-Hydroxymethyl-glutaryl-CoA synthase	Pine	Transcription
Extensin	Pine	Transcription
	Spruce	Transcription
	Beech	Enzyme activity
β -1,3-Glucanase	Beech	Enzyme activity
	Spruce	Translation, enzyme activity
Chitinase	Beech	Enzyme activity
	Pine	Translation
Pathogenesis-related proteins 1a, b, c	Spruce	Transcription
Ozone-dependent activities	Spruce	Translation
	Pine	Transcription

first produces a predisposition which either protects the plant (ca. 50% of the investigated cases) or weakens it, especially when secondary stresses come along, e.g. acid fog, drought, attacks by bark beetles or pathogenic fungi (see Fig. 1.9.15).

Considering high ozone concentrations an unnatural stress situation, it cannot be expected that in the course of evolution plants have evolved a “structured defence” system. The plant therefore responds to the multiplicity of impacts by ozone with a complex of more general defence reactions which usually are less specific to the incurred damage.

1.9.2.3

Formaldehyde

Formaldehyde emanates from all kinds of furniture made from chipboard. Glues used in carpets are also often a cause of formaldehyde in dwellings. The permissible indoor concentration of 0.12 mg/m^3 ($=0.1 \text{ }\mu\text{l/l}=0.1 \text{ ppm}$) is frequently considerably exceeded. Particularly high concentrations are usually measured in caravans, where not only the furniture, but also the living area is made of chipboard or lined with it.

Since Calvin’s research in the late 1940s and early 1950s, it is known that formaldehyde is not an intermediary product of photosynthesis, contrary to earlier hypotheses. Nevertheless, the earlier ideas still contain some truth, because

formaldehyde is assimilated by plants in light, being converted to sugar, and other biomolecules, e.g. amino acids. Several **formaldehyde dehydrogenases** have been described. The detoxifying effect of indoor plants on the air in rooms has often been mentioned, without providing ideas on the involved biological mechanisms. Detoxification of air by plants is not only accomplished by enzymatic biochemical reaction, but also by adsorption on the surface of plants and on soil; in addition air pollutants enter the plant tissue via the stomates and, depending on the toxicity of the compound, may cause more or less harm.

The spider plant (*Chlorophytum comosum*) is able to reduce the concentration of formaldehyde in room air from 4–7 μl formaldehyde/l (40–70 times the admissible maximum value) to 0.2 $\mu\text{l/l}$ (=double the admissible concentration)¹ within 5 h. Other plants, e.g. tobacco, are also able to achieve this (Giese et al. 1994).

Spider plants did not show any damage symptoms at 10 $\mu\text{l/l}$ air (=100 times the admissible maximum value) and are more resistant to the pollutant than tobacco which produced strong local necroses; at ten times the admissible concentration tobacco plants developed insignificant symptoms. However, inhibition of growth occurs already at considerably lower concentrations.

¹ Adsorption effects of the surface of the soil are considerable, as a decrease to 3 $\mu\text{l/l}$ was achieved already by unplanted pots.

After 24-h fumigation of *Chlorophytum* with air and ^{14}C -formaldehyde, most of the radioactivity taken up in the plant was in the soluble fraction with about one fifth incorporated in structural substances (lignin). In the soluble fraction ^{14}C -labelled sugars dominated, but the amino acid serine was also strongly labelled, indicating incorporation by serine hydroxymethyl transferase. Phospholipids (phosphatidyl serine) likewise contained significant amounts of ^{14}C .

Enzymatic studies revealed two formaldehyde dehydrogenases. One of these, the more active, was glutathione dependent². Formaldehyde is probably oxidised to formic acid which is then assimilated via C1 metabolism. Detoxification activity was $12.8 \mu\text{g formaldehyde/h} \times \text{g FW}$ and the apparent K_m value was $30 \mu\text{M}$. If these values are extrapolated, a *Chlorophytum* plant would be able, within 6 h, to detoxify a room of 100 m^3 containing twice the admissible maximum value of formaldehyde. However, the reaction of stomates to increasing amounts of formaldehyde in the air has not yet been properly examined. Formaldehyde detoxification is a further example of phytoremediation, supporting the concept of the "green liver" (Sandermann 1994).

Summary

Xenobiotics are foreign substances (with respect to an organism) which have biological activity and, depending on the toxicity and amount taken up, trigger defence reactions, cause damage or even death of the organism. Apart from **toxins** which are unintentionally or unavoidably released into the **environment**, as, for example, air pollutants (also heavy metals and aluminium are occasionally called xenobiotics), xenobiotics are mainly pesticides which on purpose are released in large amounts into the environment. Herbicides are the most important pesticides.

1. **Herbicides** are supposed to have a targeted effect, whereby either individual enzymes or reaction complexes (e.g. photosystem II) are blocked or cell biological damage results from the formation of radicals (total herbicides).

2. Only in very few cases are crop plants able to specifically detoxify particular herbicides. However, with certain substances (herbicide safeners, antidotes or immunochemicals), the endogenous detoxifying potential is stimulated and they become desensitised to the corresponding herbicide. This can also be achieved by genetic engineering.
3. The spectrum of xenobiotics is immense. In contrast, there are relatively few biochemical mechanisms by which plants can detoxify them. In a plant cell detoxification occurs in four steps: Most of the pesticides are lipophilic; detoxification therefore requires prior conversion to a hydrophilic derivative. After uptake into the cell, a hydrophilic group is introduced. This is usually done by monooxygenases or oxidases. The hydrophilic group is then used to form conjugates. Glycosyl transferases or glutathione-S-transferases catalyse the "conjugation" with sugars (usually glucose) and glutathione, respectively. In the third step, the conjugates are sequestered into the vacuole or to the apoplast by glutathione pumps (GS-X pumps). These belong to the family of so-called ABC transporters. Plant ABC transporters are mainly members of the subfamily of multidrug resistance associated proteins (MRPs). Natural substrates of these GS-X pumps are water-soluble secondary plant constituents, deposited in the vacuole, such as flavonoid glycosides, phytohormone conjugates, but also degradation products of DNA and chlorophyll. In the fourth and final step, the sequestered conjugates are modified to detain them in the vacuole, or after translocation by the Golgi covalently incorporate them into the cell wall.
4. In addition to detoxification, pesticides may induce the synthesis of defence proteins, the so-called pathogenesis-related proteins, and thus increase plant resistance to pathogen attack (cross protection). In modern agrochemistry, such xenobiotics are applied under the term **immunochemicals**.
5. **Gaseous xenobiotics** (air pollutants) affect plants by oxidation (oxidising smog, ozone), reduction (reductive SO_2 smog), acidification ("acid rain", hydrofluoric acid), or in other ways (e.g. denaturation of proteins by formaldehyde, or by a phytohormonal effect, e.g. ethylene). Below the damage threshold SO_2 and NO_x may even act as sources of sulfur or nitrogen (sulfate or nitrate) for plant nutri-

² The GSH-dependent formaldehyde dehydrogenase shows sequential similarities with alcohol dehydrogenase. It is assumed that the latter developed phylogenetically from the former, as formaldehyde probably is one of the components of the early atmosphere of the earth (Fliegmann and Sandermann 1997).

- tion. In this case the oxidant is usually photosynthetically reduced oxygen ($O_2^{\bullet-}$).
6. Above the threshold of damage the "law of stress quantity" applies, i.e. the strain or damage corresponds to the product of stress intensity and duration of exposure. Differentiation between a short-time stress peak and chronic, i.e. long-term, stress is also useful.
 7. Air pollutants are taken up by plant tissues through stomates or directly through the cuticle and epidermis. Both paths undergo pollutant-specific modification: Opening of stomates may be increased or reduced by air pollutants; and the cuticle may become more permeable due to damage (etching), e.g. by hydrofluoric acid.
 8. **Sulfur dioxide** has a mid-range redox potential and therefore affects a wide range of reactions in plant cells. The well-known inhibition of photosynthesis is not an outcome of a single reaction, but results from a reaction complex. The visible phenomenon is bleaching of chlorophyll-containing plant parts, which is due to the oxidation of unsaturated membrane lipids rather than to the acidity of SO_2 or sulfurous acid. Damage of chlorophyll-binding proteins results in the release of chlorophyll which is then accessible to photooxidation. If the damage continues, necroses form and leaves or needles die.
 9. Bleaching of leaves ("yellow tips") may also indicate magnesium deficiency. Acid deposition ("acid rain") causes increased leaching of cations, in particular of magnesium, from the soil into the groundwater and as a consequence a shortage of these cations in the plant tissue.
 10. Because of the large range of biological reactions in which sulfur dioxide can become involved plants have not developed any specific resistance against this pollutant. Different sensitivities of individual plant species are based on individual features, e.g. increased capabilities of buffering or adsorption.
 11. Lichens are particularly sensitive to SO_2 and other gaseous noxes, because their thalli do not possess stomates and because of the susceptibility of their inherent symbiotic interactions. They are thus very suitable for long-term monitoring of air pollution.
 12. **Ozone** is continuously formed in the stratosphere, but is also found in the lower troposphere in oxidative smog, where it is produced in the reaction of nitric oxides with oxygen but also in forests by reaction of gaseous terpenes with oxygen upon intense irradiation. Therefore, the ozone content of the troposphere varies during the day and with the seasons. Naturally occurring ozone concentrations do not cause any visible damage to plants.
 13. Ozone is taken up into the plant through stomates, as the cuticle is impermeable to it.
 14. Ozone is a strong oxidant and thus reacts predominantly with SH-containing proteins and with oxidisable structural elements of the cell. It is consumed already in the outer cell layers of plant tissues, e.g. of leaves, where only traces of ozone reach the mesophyll. Potassium and calcium transporters in the guard cells and their auxiliary cells are inactivated by ozone, which explains the reduced reaction of stomates to drought. Ozone damage is therefore often coupled with damage caused by drought. Ozone is a polar molecule and since it hardly permeates biomembranes, membrane-bound components are mainly damaged. At higher concentrations pigments contained in the membrane system of plastids are destroyed by oxidation.
 15. Fumigation with ozone leads to rapid activation of secondary metabolism by enzyme induction, as well as by activation of certain enzymes. Good examples are phenylpropane, flavonoid and ascorbate metabolism.
 16. The so-called memory effect of ozone can be shown by the increased content of secondary metabolites also in such plant parts which develop after the termination of the stressful treatment. Because of the memory effect the "law of stress quantity" does not apply to ozone damage. As many of these secondary plant constituents are radical scavengers, their accumulation provides chemical protection.
 17. In addition to enzymes of secondary metabolism, ozone also induces the formation of so-called pathogenesis-related proteins.
 18. Formaldehyde is released particularly from modern furnishings (chipboard furniture, carpet floors). Many plants are able to assimilate formaldehyde and thereby detoxify it. Formaldehyde dehydrogenase is the key enzyme of formaldehyde assimilation; after oxidation to formate it enters the plant's C1 metabolism. Depending on the plant species,

further metabolism usually leads to carbohydrates or amino acids.

19. The spider plant (*Chlorophytum comosum*) and tobacco are particularly efficient assimilators of formaldehyde. These plants are able to reduce the concentration of formaldehyde in the air of a room from values many times above the admissible concentration to admissible values within a few hours.
20. Formaldehyde detoxification is a further example of phytoremediation, thus providing a good example of the concept of the "green liver".

References

- Coleman JOD, Blake-Kalff MMA, Davies TGE (1997) Detoxification of xenobiotics by plants: chemical modification and vacuolar compartmentation. *Trends Plant Sci* 2:144–151
- Darrall NM (1989) The effect of air pollutants on physiological processes in plants. *Plant Cell Environ* 12:1–30
- Elstner EF (1984) Schadstoffe, die über die Luft zugeführt werden. In: Hock B, Elstner ET (eds) *Pflanzentoxikologie*. BI Wissenschaftsverlag, Mannheim, pp 67–94
- Fehsenfeld F, Calvert J, Fall R, Goldan P, Guenther AB, Hewitt CN, Lamb B, Shaw L, Trainer M, Wetsberg H, Zimmerman P (1992) Emission of volatile organic compounds from vegetation and the implications for atmospheric chemistry. *Global Biogeochem Cycles* 6:389–430
- Fliegmann J, Sandermann H Jr (1997) Maize glutathione-dependent formaldehyde dehydrogenase cDNA: a novel plant gene of detoxification. *Plant Mol Biol* 34:843–854
- Fontaine V, Pelloux J, Podor M, Afif D, Gerant D, Crieu P, Dizengremel P (1999) Carbon fixation in *Pinus halepensis* submitted to ozone. Opposite response of ribulose-1,5-bisphosphate carboxylase/oxygenase and phosphoenolpyruvate carboxylase. *Physiol Plant* 105:187–192
- Fuhrer J (1996) Gasförmige Luftschadstoffe. In: Brunold C, Rügsegger A, Brändle R (eds) *Stress bei Pflanzen*. UTB Haupt, Bern, pp 221–246
- Giese M, Bauer-Doranth U, Langebartels C, Sandermann H Jr (1994) Detoxification of formaldehyde by the spider plant (*Chlorophytum comosum* L.) and by soybean (*Glycine max* L.) cell-suspension cultures. *Plant Physiol* 104:1301–1309
- Häder D-P (1996) UV-Belastung und Ozonproblematik. *Biologie Unserer Zeit* 26:206–208
- Heath RI, Taylor GE Jr (1997) Physiological process and plant response to ozone exposure. *Ecological Studies* 127. Springer, Berlin Heidelberg New York, pp 317–368
- Hock B, Elstner EF (1984) *Pflanzentoxikologie*. BI Wissenschaftsverlag, Mannheim, 346 pp
- Köstner B, Schupp R, Schulze E-D, Rennenberg H (1998) Organic and inorganic sulfur transport in the xylem sap and the sulfur budget of *Picea abies* trees. *Tree Physiol* 48:1–9
- Kuhnert KJ (1996) Xenobiotika. In: Brunold C, Rügsegger A, Brändle R (eds) *Stress bei Pflanzen*. UTB Haupt, Bern, pp 247–261
- Laisk A, Kull O, Moldau H (1989) Ozone concentration in leaf intercellular air space is close to zero. *Plant Physiol* 90:1163–1167
- Lange OL, Heber U, Schulze E-D, Ziegler H (1989) Atmospheric pollutants and plant metabolism. *Ecological Studies* 77. Springer, Berlin Heidelberg New York, pp 238–273
- Langebartels C, Ernst D, Heller W, Lütz C, Payer H-D, Sandermann H Jr (1997) Ozone responses of trees: results from controlled chamber exposures at the GSF phytotron. *Ecological Studies* 127. Springer, Berlin Heidelberg New York, pp 163–200
- Larcher W (1994) *Ökophysiologie der Pflanzen*. UTB Eugen Ulmer, Stuttgart, 394 pp
- Lehninger AL, Nelson DL, Cox MM (1994) *Prinzipien der Biochemie* (Tschesche H ed). Spektrum Akademischer Verlag, Heidelberg, 1223 pp
- Marrs K (1996) The function and regulation of glutathione-S-transferases in plants. *Annu Rev Plant Physiol Plant Mol Biol* 47:127–158
- Matyssek R, Havranek WM, Wieser G, Innes JL (1997) Ozone and the forests in Austria and Switzerland. *Ecological Studies* 127. Springer, Berlin Heidelberg New York, pp 95–134
- Miller JD, Arteca RN, Pell EJ (1999) Senescence-associated gene expression during ozone-induced leaf senescence in *Arabidopsis*. *Plant Physiol* 120:1015–1023
- Pearson M, Mansfield TA (1993) Interacting effects of ozone and water stress on the stomatal resistance of Beech (*Fagus sylvatica* L.). *New Phytol* 123:351–358
- Pfanz H, Martinoia E, Lange OL, Heber U (1987) Flux of SO₂ into leaf cells and cellular acidification by SO₂. *Plant Physiol* 85:928–933
- Rea PA, Lu Y-P, Li Z-S (1997) Detoxification of xenobiotics revisited. *Trends Plant Sci* 2:290–291
- Rea PA, Li Z-S, Lu Y-P, Drozdowicz YM (1998) From vacuolar GS-X pumps to multispecific ABC transporters. *Annu Rev Plant Physiol Plant Mol Biol* 49:727–760
- Rennenberg H (1984) The fate of excess sulfur in higher plants. *Annu Rev Plant Physiol* 35:121–153
- Sandermann H, Wellburn AR, Heath RL (1997) Appendix. *Ecological Studies* 127. Springer, Berlin Heidelberg New York, 397 pp
- Sandermann H Jr (1994) Higher plant metabolism of xenobiotics: The "green liver" concept. *Pharmacogenetics* 4:225–241
- Schlee D (1992) *Ökologische Biochemie*. G Fischer, Jena Stuttgart, 587 pp
- Seitz W (1972) Flechtenwuchs und Luftverunreinigung im Großraum Saarbrücken. *Ber Deutsch Bot Ges* 85:239–247
- Stockwell WR, Kramm G, Scheel H-E, Mohnen VA, Seiler W (1997) Ozone formation, destruction and exposure in Europe and the United States. *Ecological Studies* 127. Springer, Berlin Heidelberg New York, pp 1–38
- Taylor GE Jr, Hanson PJ, Baldocchi DD (1988) Pollutant deposition to individual leaves and plant canopies: sites of regulation and relationship to injury. In: Heck WW, Taylor OC, Tingey DT (eds) *Assessment of crop loss from air pollution*. Elsevier Appl Science, London, pp 227–257
- Türk R, Wirth V, Lange OL (1974) CO₂-Gaswechsel-Untersuchungen zur SO₂-Resistenz von Flechten. *Oecologia* 15:33–64
- Wesely ML (1989) Parameterization of surface resistances to gaseous dry deposition in regional-scale numerical models. *Atmos Environ* 23:1293–1304

1.10

Biotic Stress: Herbivory, Infection, Allelopathy



A leaf of the broad-leaved dock (*Rumex obtusifolius*) that has been perforated by leaf beetles (*Chrysomelidae*) and their larvae. Further clutches of eggs are on the leaf lamina. In the right margin of the picture, two spots with red edges, which show the accumulation of anthocyanin, indicate a hypersensitive reaction. This is probably due to an additional pathogen attack. Picture E. Beck

Recommended Literature

- Baldwin IT (2001) Update on *Nicotiana attenuata*: an ecologically motivated analysis of plant-herbivore interactions in native tobacco. *Plant Physiol* 127:1449–1458
- Dudareva N, Pichersky E, Gershenzon J (2004) Biochemistry of plant volatiles. *Plant Physiol* 135:1893–1902
- Kessler A, Baldwin IT (2002) Plant responses to insect herbivory. The emerging molecular analysis. *Annu Rev Plant Biol* 53:275–298
- Memelink J, Verpoorte R, Kijne JW (2001) ORCAnization of jasmonate-responsive gene expression in alkaloid metabolism. *Trends Plant Sci* 6:212–219

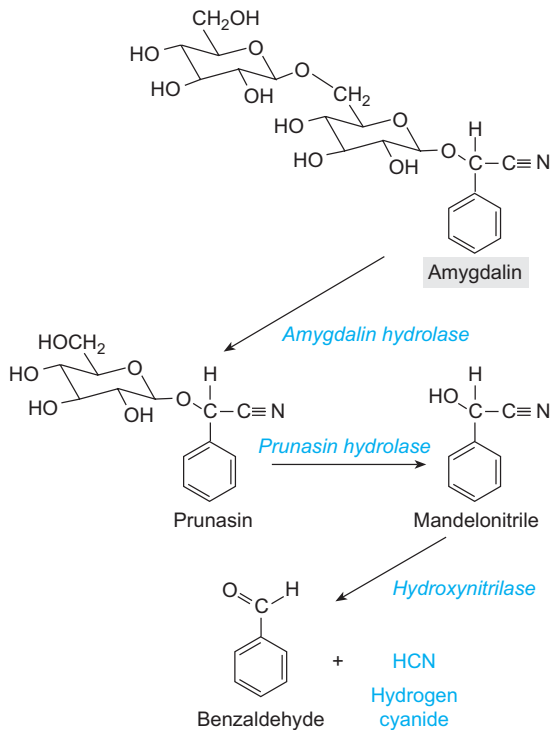
1.10.1

Herbivory

Herbivory is predominantly selective, as long as there is no extreme lack of fodder – almost as if animals had distributed the menu amongst themselves! However, there are many plants that are practically never touched or only attacked by very special herbivores, so-called **poisonous plants**. These plants are protected by **secondary plant metabolites**, which are constitutively formed (so-called anticipators) and accumulated in the vacuoles or cell walls during the life of the plant. Examples are alkaloids (more than 6000 known compounds), terpenoids (more than 5000 substances), steroids (e.g. saponin, bitter-

Box 1.10.1

Biological activities of secondary plant constituents on herbivorous animals

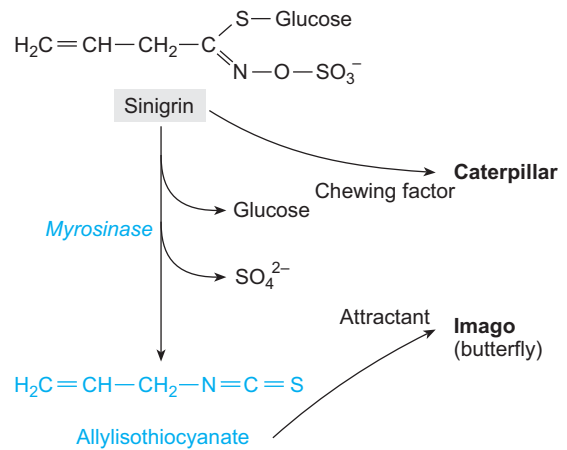


■ Fig. 1. Release of hydrogen cyanide from amygdalin

Secondary plant metabolites as potential toxins: Release of hydrogen cyanide from seeds of many Rosaceae. Amygdalin occurs in many seeds (embryos) of stone- and pome-fruit plants. On imbibition of the seeds or after wounding, the glucosidases amygdalin hydrolase and prunasin hydrolase become active, followed by the hydroxynitrilases, which finally lead to the release of hydrogen cyanide (Fig. 1).

ing agents, heart-active glycosides), phenolic compounds (e.g. tannins), cyanogenic compounds and mustard oil glycosides (which are hydrolysed upon damage of the cells releasing HCN or mustard oils), and many more.

However, these defence compounds do not provide complete protection, particularly regarding phytophagous insects. Even many vertebrates are able to detoxify such compounds, for example, by converting cyanide ions from cyanogenic glycosides into the non-poisonous thio-



■ Fig. 2. Release of allyl mustard oil from sinigrin

Defence compounds as attractants (Fig. 2). When cabbage leaves are damaged, sinigrin, a mustard oil glucoside, is released from the vacuole and simultaneously a thioglucosidase ("myrosinase") is released from the lytic compartment (Golgi vesicles, etc.). Removal of glucose by myrosinase results in a reactive intermediate, which, on hydrolysis of the sulfate residue, is converted into volatile allyl isothiocyanate (allyl mustard oil). This compound, which has a pungent flavour to humans, is extremely toxic to many insects. For the large cabbage white butterfly (*Pieris brassicae*), the allyl mustard oil is, however, an attractant which stimulates the female butterfly to oviposition. For the caterpillars, which hatch from the eggs, sinigrin and its derivatives are feeding stimulants (after Heß 1999).

cyanate by the liver enzyme rhodanese. Some phytophagous insects detoxify the cyanide ion by binding it with β -cyanoalanine synthase to serine or cysteine. Other phytophages take up such toxins with their food, for example, the butterflies of the genus *Zygaena* accumulate the cyanogenic glycosides linamarin and lotaustralin from the birds-foot trefoil (*Lotus corniculatus*) and protect themselves against their enemies by releasing hydrogen cyanide. Hymenopteran and dipteran insects, on the other hand, when para-

sitising these phytophages, are able to detoxify HCN with rhodanese. During the course of evolution, phytophagous insects not only adapted to the chemical defence of plants, they also evolved mechanisms to use volatile plant defence compounds as signals to find food. The mustard oils produced by various cabbage species (*Brassica* spp.) prevent many species of insects from feeding on cabbage leaves, but they also serve as a signal for the female butterflies of the genus *Pieris* (cabbage white butterfly) to oviposition. The larvae of these butterflies are specialised for cabbages and have thus found their food niche by overcoming the deterrent effect of mustard oils.

The broad field of interaction between herbivores and their host plants and their chemical defences is inexhaustible and can only be briefly discussed with a few examples within the frame of this book.

In addition to the above-mentioned constitutive defence by plant toxins, there is also an **induced defence reaction** probably for all (higher) plants against herbivores. If a plant is mechanically wounded by feeding or being trodden on, tissues are damaged including – in most cases – the long-distance transport pathways, xylem and phloem. As a consequence, a cascade of hydraulic, electric and biochemical reactions is induced which finally leads to induction of gene expression. Wounding, for instance, induces gene expression which results in closure of the wound by formation of a callus. It also induces the synthesis of defence proteins like proteinase inhibitors (PIN), proteins directed against the activity of insect proteinases. The responses are induced **locally** (at the site of wounding) as well as **systemically** (at sites not wounded, demanding spreading of signal(s) throughout the plant). The signal transduction chain from wounding to the new expression of genes has been studied intensively, but is still far from being completely understood.

1.10.1.1

Signal Transduction Chain

When the xylem of a transpiring plant is wounded, the strength of the suction in the xylem is changed as air enters the xylem at the damaged site. A decrease in the strength of tension results in a “positive” pressure wave. Step increases in pressure experimentally applied to

tomato leaves (Fig. 1.10.1) or roots (Fig. 1.10.2) lead to:

- a depolarisation wave across the plant (Figs. 1.10.1 and 1.10.2), which has established an electrical potential difference between root (soil) and tip;
- a transient stimulation of petiole growth (Fig. 1.10.1).

The depolarisation propagates slowly in the apical direction, the extent corresponding to the intensity of the pressure wave.

The hydraulic pressure wave signals to the unwounded part of the plant that wounding (of the xylem) has occurred. These signals are changed into electrical signals probably by mechano-sensitive ion pumps or ion channels appearing somewhat later than the hydraulic signals. The strength of the signal decreases with increasing distance from the wounded site. Hydraulic and electric signals are one of the earliest components of the signal transduction chain inducing systemic reactions, but their connection to the biochemical events is not yet resolved.

As a systemic response in leaf 4 after wounding of leaf 1 (Fig. 1.10.1), an increase in the mRNA of proteinase inhibitors (*Pin1* and *Pin2*) and of calmodulin, which plays an important role in the Ca^{2+} -mediated signal transduction chain, was found. On the other hand, total protein synthesis was decreased in the non-wounded leaf indicated by the dissociation of (cytoplasmic) polysomes.

The induced expression of the proteinase inhibitors has been used to find further components of the signal transduction chain. In tomato, an 18 amino acid oligopeptide, called systemin, was detected after wounding. It is able to induce proteinase inhibitors when supplied to young tomato plants via the petiole. Systemin was found to be translocated in the phloem and was suspected to be the signal for the induction of **systemic defence reactions** (hence its name). It is proteolytically cleaved from a 200 amino acid precursor protein, called prosystemin, when leaves are damaged. Systemin leads to an alkalinization of the medium, when applied to a cell suspension culture of tomato (Fig. 1.10.4), and to the activation of a MAP kinase. The effect of systemin is transmitted by its binding to a plasma membrane bound receptor. This 160 kDa protein has an extracellular receptor domain and a cytoplasmic kinase domain characteristic

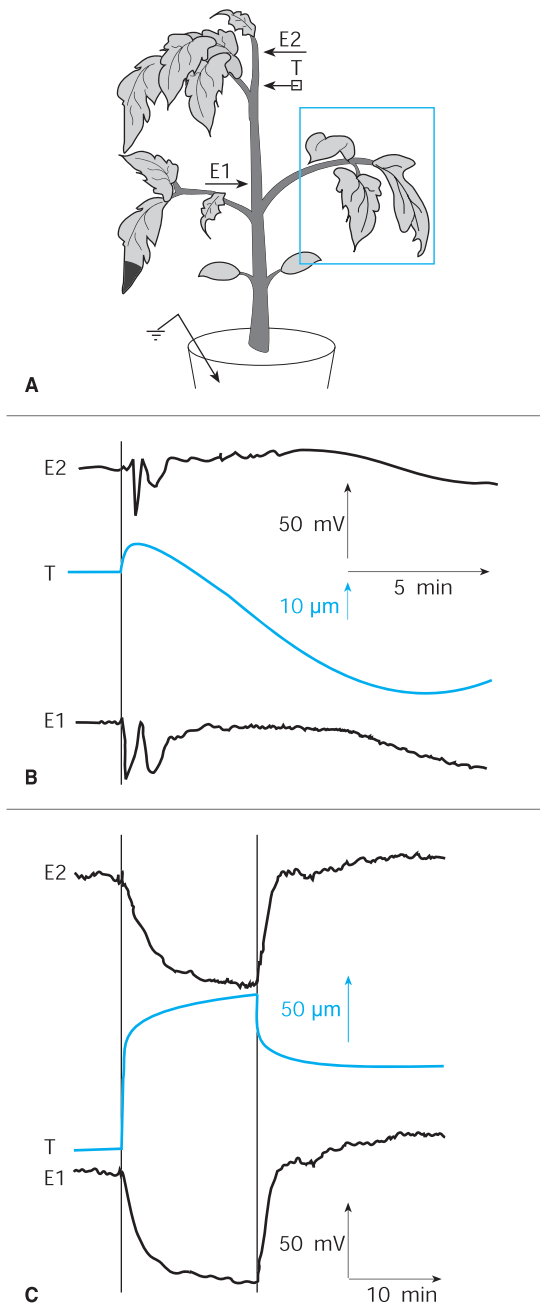


Fig. 1.10.1 Wound reactions of tomato plants. **A** Test plant with the experimental setup. The pot of the plant is contained in a temperature-controlled water bath in which a reference electrode is placed. *E1* and *E2* indicate the positions of the measuring electrodes. *T* is a position sensing transducer that allows automatic measurements of elongation. In the first experiment, the oldest leaf (leaf 1) below *E1* was damaged with a lighted match (*blackened area*) for 3 s. In the second experiment, leaf 2 was placed in the chamber of a pressure bomb (*blue line*) and subjected to a pressure of 0.3 Mpa for 15 min. **B** Changes in the total electrical potential of the plant and the length of the petiole of leaf 4 (*T*) after damaging the tip of leaf 1. Two waves of depolarisation pass through the plant after wounding for 3 s. Immediately after wounding, the petiole of leaf 4 extends by ca. 10 μm but then contracts by at least 50 μm in the next few minutes. This contraction relaxes again during the next 30 min. **C** Correlation of pressure-induced changes in electrical potential and the change in petiole length. Leaf 2 (see **A**) was subjected for 15 min (between the two vertical lines) to a pressure of 3 bar (0.3 MPa) in a pressure chamber. Changes in electrical potential and petiole length proceed in the opposite direction compared to the wounding experiment. (Stanković and Davies 1998)

for proteins involved in the transduction of external signals.

Another component in the jigsaw puzzle of the signal transduction chain after tissue damage is the small, but significant, transient rise of free fatty acids in the tissue, mainly resulting from the release of linoleic acid (C18:2) and linolenic acid (C18:3; Fig. 1.10.3). The rise precedes the induction of *Pin1* and *Pin2* expression. It is assumed that the release of free fatty acids is based on the transient activation of a lipase, which cleaves predominantly glycolipids

from chloroplastic membranes. Whether the MAP kinase, activated by systemin, is involved in the activation of the lipase has not been established. There are indications that abscisic acid (ABA) could be a further signal in the transduction chain.

The release of linoleic and linolenic acids from biomembranes may also be induced in a different way, either by direct mechanical damage to the membrane, or by high temperature or UV radiation, and by so-called **elicitors** – degradation products (oligosaccharides) of cell wall

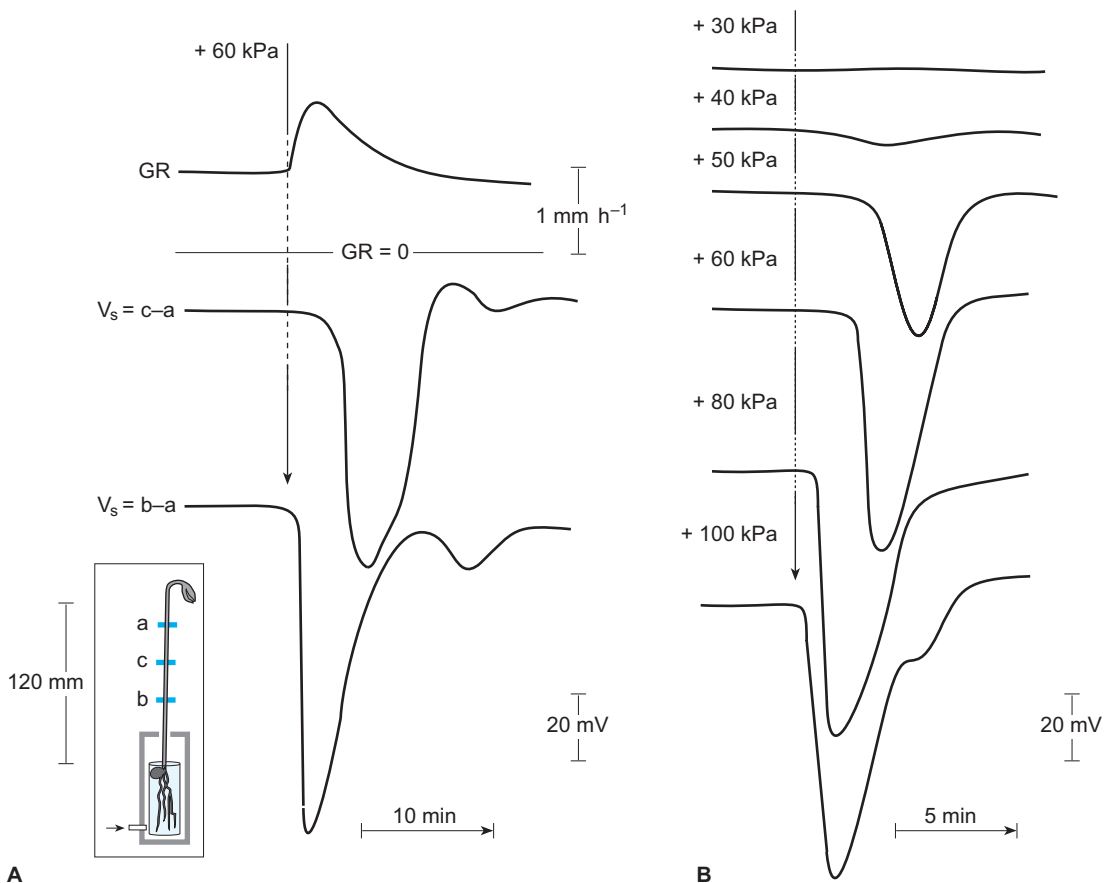


Fig. 1.10.2. Production of an electrical signal as a consequence of an increase in pressure in pea epicotyls. **A** Below left, experimental setup. Dark-grown, etiolated pea seedlings were used. The roots and the basal 10 mm of the epicotyl were incubated in tap water in a small tube and enclosed in a root pressure chamber. At the time point indicated in the diagram by the vertical arrow, the pressure in the chamber was increased by 60 kPa. The propagation of the depolarisation signal of the surface potential from b to c is shown in the dynamics b-a and c-a; in c-a a small hyperpolarisation can be seen before the potential returns to its original level. The growth rate (GR) increases immediately after the increase in pressure, showing that the pressure wave reached the tip of the shoot in only a few seconds. a, b, c Positions of the surface electrodes; Vs surface potentials, GR growth rate. **B** Effect of increasing pressure on the extent and the lag phase of the depolarisation (voltage change) at point c. Below a threshold value of 30 kPa there is no change in potential. Above a pressure of 60 kPa, the extent of the depolarisation hardly alters any longer; however, the response at higher pressures is significantly faster than at lower pressures, which indicates a relatively slow propagation of the potential wave from the base to the apex. (Stahlberg and Cosgrove 1997)

carbohydrates formed during pathogen attack, for example, by a fungus (see Chap. 1.10.2).

This induction, however, which is not via systemin, is effective only locally, i.e. directly at the site of damage. In contrast, induction via systemin is systemic because this peptide can be distributed throughout the plant via the phloem (Fig. 1.10.5). In the signal chain from the first bite into the xylem, via the release of the polyunsaturated fatty acids (PUFA) to the synthesis of the proteinase inhibitors *Pin 1* and *Pin 2*, the immediate inducer for the proteinase inhibitors still requires mentioning. This inducer, **jasmonate**, is synthesised in several steps from the

three-fold unsaturated linolenic acid released by the activity of the lipase. The first reaction is catalysed by **lipoxygenase (LOX)**, which not only initiates the synthesis of jasmonate, but is also responsible for the formation of radicals and reactive derivatives from the PUFAs.

Lipoxygenase produces hydroperoxides from PUFAs, which then react further in multiple enzyme-catalysed and non-enzymatic steps (Box 1.10.2). The sequence of reactions leading to the synthesis of jasmonic acid starts with the formation of an allene epoxide, which is then converted to the cyclic 12-oxophytodienoic acid (12-OPDA). From 12-OPDA three acetate resi-

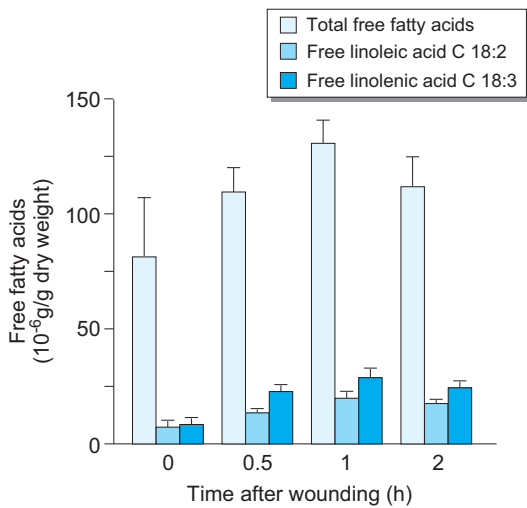


Fig. 1.10.3. Release of fatty acids in tomato leaves after mechanical damage. Only 30 min after a small mechanical damage, the concentrations of free fatty acids rise, compared to an untreated control (time 0). About 85% of the rise is due to the release of linoleic (C18:2) and linolenic (C18:3) acids. Free linolenic acid is the starting point for the synthesis of jasmonate. (After Conconi et al. 1996)

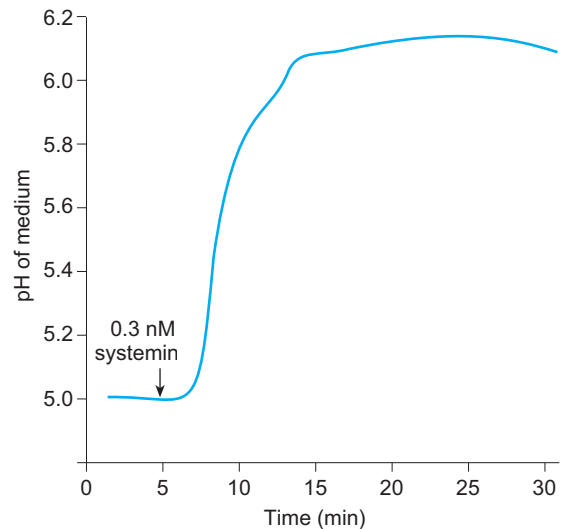


Fig. 1.10.4. Increase in pH of the medium of a cell suspension of wild tomato (*Lycopersicon peruvianum*) after addition of systemin. (Meindl et al. 1998)

dues are removed by β -oxidation, leading to the (+)-7-*iso*-jasmonate, which can be quickly transformed into the stable (-)-jasmonate. This can be conjugated in many ways, for example, by esterification, glycosylation and amidation. These conjugates as well as the derivatives of jasmonate, shown in Fig. 1.10.6, exhibit biological activity which is species-specific in some cases.

Jasmonate is ubiquitous in the plant kingdom, prevailing in young, i.e. meristematic, tissues. The methyl ester of jasmonate is volatile and has been identified as the fragrant constituent of the essential oil from jasmin flowers (hence the term). Free jasmonic acid was first isolated in large quantities from the culture filtrate of fungal cultures.

1.10.1.2

Proteins Induced by Jasmonate (JIPs)

As with many phytohormones, **jasmonate** exhibits pleiotropic effects. It is regarded as a typical stress hormone and, in this context, as a hormone triggering senescence (leaf yellowing). Correspondingly, it acts synergistically with ABA and ethylene (see Chap. 1.6.2).

According to its pleiotropic effects, jasmonate induces the expression of several very different proteins and enzymes which are called **jasmonate-induced proteins (JIPs)**. Table 1.10.1 gives a survey of the most important JIPs. For many of them, however, the biological functions have not yet been elucidated.

Table 1.10.1. Reactions which are induced by stress and/or during developmental phases in which jasmonate is involved. ABA Abscisic acid; ACC aminocyclopropanecarboxylate oxidase; Et ethylene; JA jasmonic acid; JIPs jasmonate-induced proteins; S systemin; SA salicylic acid. (After Wasternack and Parthier 1997)

Process	Signal(s)	Protein(s)/reaction	Gene sequence known
Wounding	S, JA, ABA, Et	Proteinase inhibitors	Yes
Pathogen attack	JA, SA	Thionins, "pathogenesis-related proteins"	Yes
Elicitor (fungal) application	JA, Et	Phytoalexin-producing enzymes	Yes
Contact	JA	Tendrill movement	No
Drought stress	ABA, JA	Dehydrins, JIPs	Yes
Osmotic stress	ABA, JA	JIPs	Yes
Salt stress	ABA, JA, Et	Osmotin	Yes
Nitrogen storage	JA	N-storage proteins in vegetative tissues	Yes
Fruit ripening	JA, Et	ACC oxidase	No
Senescence	JA, Et	Lipoxygenase, JIPs	Yes
Stabilisation of the cell wall	JA	Hydroxyproline- and glycine-rich proteins	Yes

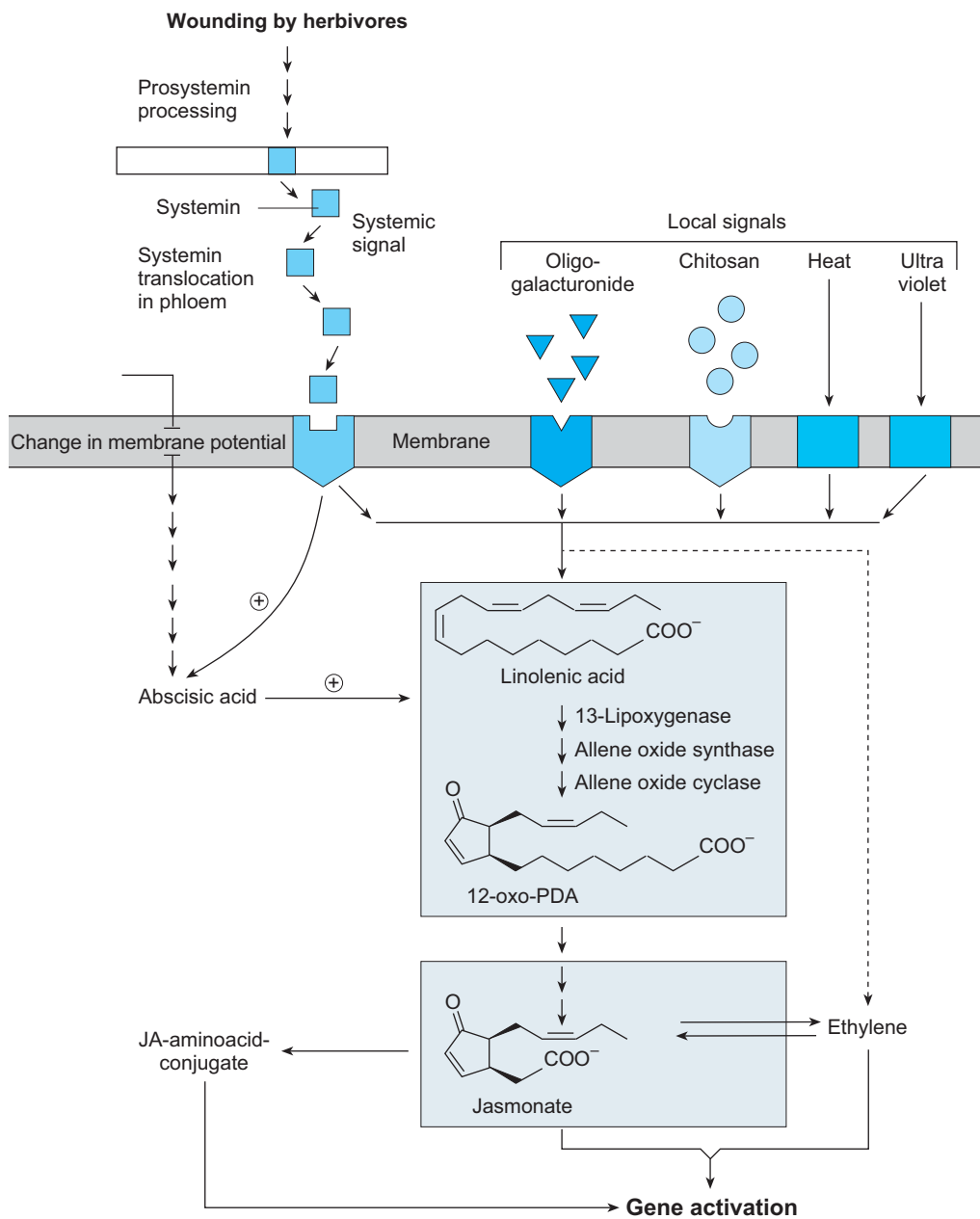
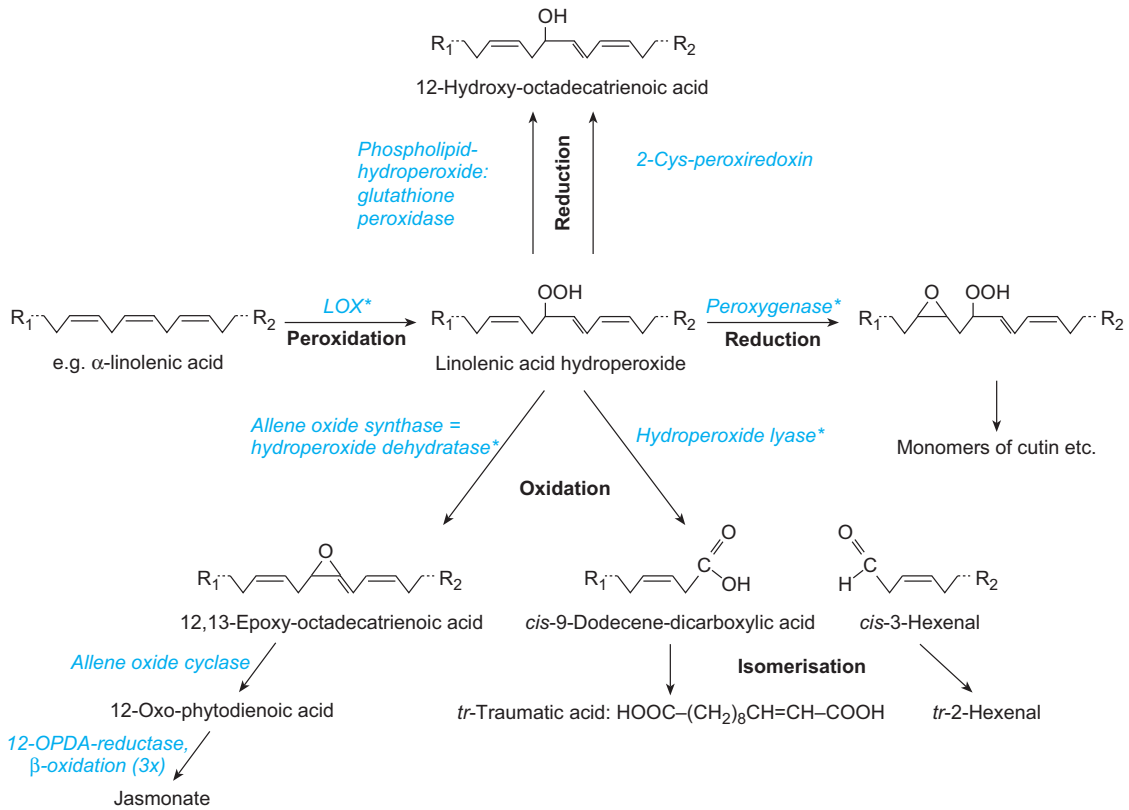


Fig. 1.10.5. Induction of systemic defence. After wounding, the signal peptide systemin is released from the precursor protein prosystemin. Systemin is distributed throughout the whole plant via the phloem. After interaction of systemin with its receptor and/or by influence of other exogenous factors, linolenic acid is released from the plasma membrane. Linolenic acid is the starting point of the so-called octadecanoid pathway, which finally leads to the synthesis of jasmonate. The phytohormone ABA may modulate the activity of this pathway. Jasmonate in turn induces the expression of defence genes, often in combined action with ethylene. (After Wasternack and Parthier 1997)

Box 1.10.2

Metabolism (detoxification) of alkyl hydroperoxides in plants using the example of α -linolenic acid

The formation of jasmonate is a response to stress: As soon as a biomembrane is damaged or deformed linolenic acid is released from phospholipids. Lipoxygenase is constitutively present and active, so that the chain of reactions starting from linolenic acid hydroperoxide is initiated immediately. As indicated in the figure, jasmonate is only one of the many possible products, depending on whether the linolenic acid hydroperoxide is metabolised by a dehydratase, lyase, peroxygenase or peroxidase (as, e.g., 2-cys-peroxiredoxin).

Of special quantitative importance are allene oxide synthase and hydroperoxide lyase reactions. The former reaction finally leads to jasmonate. In the lyase reaction, linolenic acid hydroperoxide (or also the 12,13-epoxyoctadecatrienoic acid) is cleaved, resulting in the production of reactive, unsaturated aldehydes: Hexenal and nonenal that in turn can be reduced to their respective alcohols hexanol and nonenol. The strong smell of freshly cut

grass (not that of hay) is largely due to these compounds.

The unsaturated aldehydes themselves (e.g. 2-*trans*-hexenal) have strong bactericide, fungicide and insecticide effects, and so are potent defence compounds. In the hydroperoxide lyase reaction, *cis*-9-dodecenedicarboxylic acid (*cis*-9-oxo-dodecadienic acid) is formed in addition to *cis*-3-hexenal. Both compounds are transformed to the corresponding *trans* compounds with shifting of the double bond (leading to 12-oxododec-10-eneic acid, known as traumatin, and *trans*-2-hexenal). Traumatin, like jasmonate, has a phytohormonal effect. It functions as a wound hormone that stimulates cell division in the cells adjacent to the damaged site (together with other hormones) and so induces callus formation around the wound (after Creelman and Mullet 1997; Baier and Dietz 1999; Feussner et al. 2001).

* reactions that can also occur non-enzymatically, then, however, not stereospecifically.

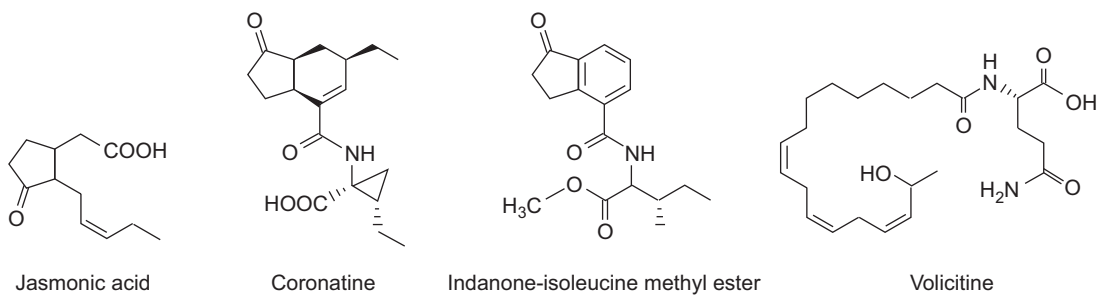


Fig. 1.10.6. Structure of jasmonic acid and jasmonic acid like compounds or derivatives. In certain plants, these induce the same effects as jasmonate. (After Mitchell-Olds et al. 1998)

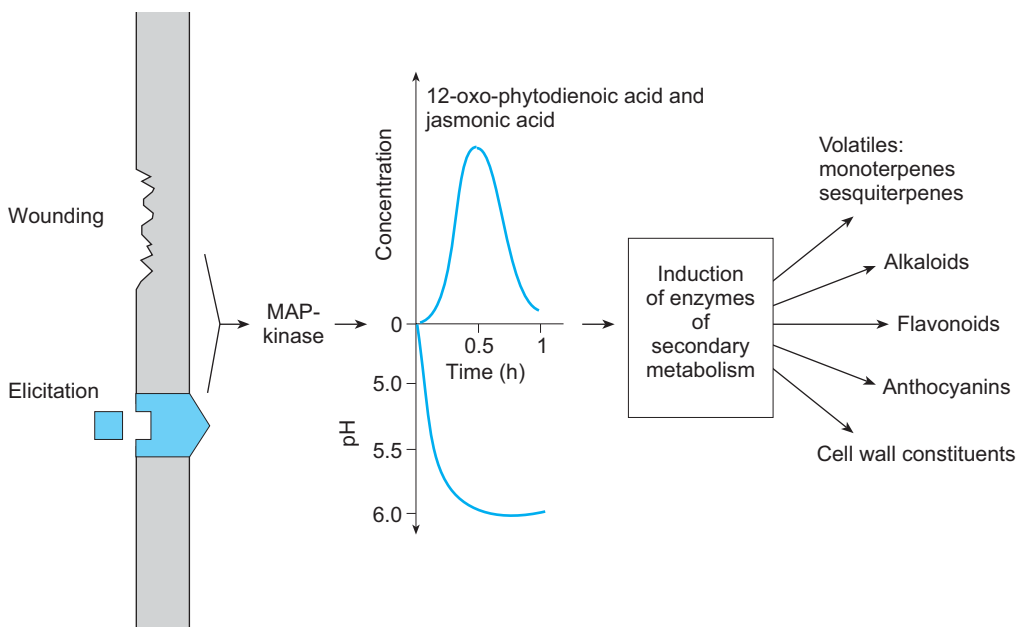


Fig. 1.10.7. Induction of secondary plant metabolites by jasmonic acid. Wounding and elicitation lead to an increase in the external pH, to a transient rise in 12-OPDA and jasmonate within the cells, and to the expression of genes encoding enzymes involved in secondary metabolism. Volatile compounds act as signals (e.g. for insects), alkaloids and phytoalexins are defence compounds and the flavonoids protect against light and UV radiation. Re-enforcement of the cell wall by cross-linking also prevents pathogen attack. (After Wasternack and Parthier 1997)

In addition to the induction of *Pin* genes, jasmonate induces particularly the expression of genes whose products serve in some way or the other in defence against stress: PR proteins (pathogenesis-related proteins), phytoalexin-synthesising enzymes, dehydrins and osmotin, as well as genes which are also induced by ABA or ethylene. A possible signal transduction chain leading to these products is shown in Fig. 1.10.7. As can be seen, the concentration of jasmonate (and 12-OPDA) rises only transiently; defence, however, is permanent as a result of the induced synthesis of biologically active proteins. Since these proteins (enzymes) are now also synthe-

sised in plant parts which are not wounded or even not existent at the time of wounding, the systemic reaction (with respect to pathogen attack) is also called **immunisation** of plants.

The biochemistry of activation of a jasmonate-responsive promoter of JIPs is still relatively unknown. Promoters of *Pin 2* and *LOX 1* are best analysed. A palindromic element (TGACG) was found in the promoter of *LOX 1* which is essential for inducibility by jasmonate. This sequence is known as the *cis* element of transcription factors possessing a bZIP element (see Chap. 1.5.2.2; Rouster et al. 1997).

Table 1.10.2. Influence of the type of leaf damage on the pattern of enzymes involved in protection against damage (after Stout et al. 1994)

Type of damage	Protein pattern			
	Polyphenol oxidase	Peroxidase	Lipoxygenase	Protease-inhibitor
Caterpillar feeding	+	-	+	+ ^a
Feeding by leaf miners	-	+ ^b	-	-
Tapping by mites	-	+	+	-
Submerged in soap solution	-	+	+	-
Mechanical damage	+	-	-	+

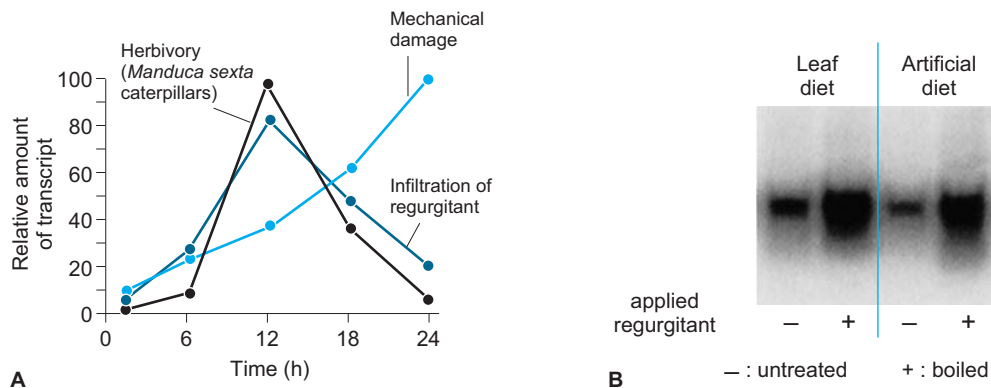
^a Statistically significant in two of three replicates.^b Significant effect in one of three replicates.

Fig. 1.10.8. **A** Different rates of accumulation of mRNA of *Pin 2* in potato leaves mechanically damaged or fed on by caterpillars, or supplied with regurgitant of the caterpillar via the petiole. **B** Proof that the inducer for the *Pin 2* transcription originates from the regurgitant of the caterpillar and not from the damaged leaves: the regurgitant of two differently fed caterpillars were applied to potato leaves, which were then analysed for the induction of *Pin2* mRNA. Caterpillars were fed on potato leaves (left) or on a pulp of filter paper soaked in a 1% sucrose solution (right). Both diets led to the same induction of *Pin2* mRNA. Shown are the Northern blots probed with a *Pin 2*-specific probe (after Korth and Dixon 1997). The chemical compounds in the regurgitant of *Manduca sexta* that cause this specific response have been identified. They are conjugates of fatty acids (e.g. linolenic acid, linoleic acid, oleic acid, palmitic acid) of membrane lipids with various amino acids. (Baldwin 2001)

Plants distinguish between purely mechanical wounding and wounding by phytophagous insects: Depending on the type of damage, typical patterns of enzymes involved in the defence response are induced (Table 1.10.2). The effects of a caterpillar (*Manduca sexta*) feeding on potato leaves have been extensively studied. Around the damaged site, mRNA of *Pin 2* and 3-hydroxy-3-methyl-glutaryl-CoA-reductase (HMGR) accumulate, as after mechanical wounding, but the accumulation is much faster and, as could be shown, in principle, not dependent on the stimulus by mechanical damage. If diluted regurgitant of the caterpillar is applied to the petioles of potato leaves, the transcripts of *Pin 2* and the *HMGR* gene accumulate in a similar way as after true herbivory. With purely mechanical wounding a similar concentration of mRNAs is achieved, however, only several hours

later (Fig. 1.10.8). The regurgitant of the caterpillars stimulates the expression of *Pin 2*, even after they were feeding on a mixture of filter paper and sucrose, but no leaves. It must, therefore, be concluded that the stimulating agent is produced by the caterpillar and not taken up in the food (Fig. 1.10.8B). In the caterpillar of *Manduca sexta* feeding on potato leaves, this stimulating agent is a conjugate of fatty acids and amino acids.

There must be substances in the regurgitant of insects which act as elicitors and induce transcription. The chemical nature of these “elicitors” is not yet known in many cases. Freezing and thawing the mandible juice and heating to 100°C increase the inducing efficiency enormously. It is therefore concluded that the elicitor is not an enzyme. Obviously, different insects have different elicitors, as can be realised by the

specific protein patterns induced by the different insects (Table 1.10.2).

1.10.1.3 Secondary Metabolism Induced by Jasmonate

Proteins often induced by jasmonate are Pin 2 and HMGR. The effect of Pin 2 as proteinase inhibitor has been mentioned above, but what is the significance of HMGR? It is a pace-maker enzyme of terpenoid biosynthesis. It has been shown that a few hours after insect feeding, volatile terpenoids are newly synthesised and released in large amounts.

The release of terpenoid compounds is modulated in a diurnal cycle, as their synthesis is connected to the photosynthetic metabolism of the chloroplast. Under strong illumination and high temperatures, higher plants divert a considerable amount of freshly assimilated carbon to terpenoid metabolism and secrete, as volatile compounds, isoprene and other low molecular weight terpenoids in considerable quantities during the day (Sharkey 1996). Damage, particularly insect damage, appears to considerably stimulate the sequestration of newly assimilated carbon into these compounds. In addition,

HMGR, the pace-maker enzyme of their biosynthesis, is induced by the wounding (slowly) and by feeding (quickly). This explains the increased secretion of terpenoids after feeding and wounding during the day. Terpenoids are also stored in glandular hairs, and it is therefore possible that they are released during the night, following damage.

In many plants, in addition to terpenoids, secondary plant metabolites are formed under the influence of jasmonate also by other biosynthetic pathways, for example, the alkaloid nicotine in tobacco species, which is highly toxic not only for warm-blooded animals, but also for many invertebrates. Such secondary metabolites can be substantial sinks for carbon and nitrogen.

Beside the secondary metabolites mentioned above, other volatile compounds are released after wounding or feeding; they are formed during peroxidation of linolenic acid liberated from membrane lipids (Fig. 1.10.9). During mechanical damage, various hexenals and their reaction products, hexenols, are formed which produce the typical smell of freshly cut grass (see Box 1.10.2). Damage by insect feeding, on the other hand, produces only hexenyl acetate, which was not found upon mechanical damage.

Shortly after feeding ended, the rapid formation of these compounds ceases. This is of eco-

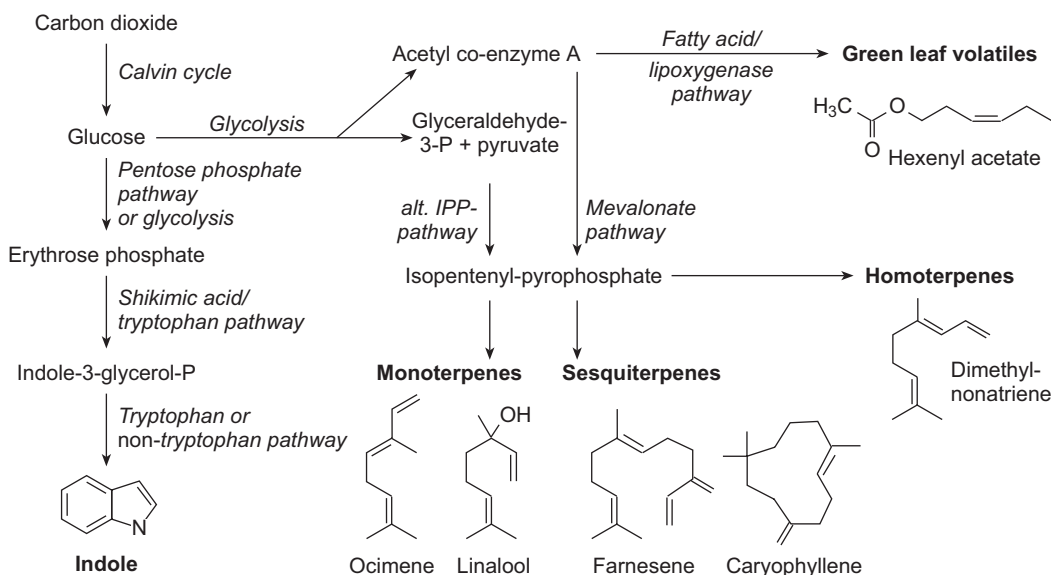


Fig. 1.10.9. Biosynthetic pathways of secondary plant metabolites leading to volatile compounds. Indole can be synthesised via two mechanisms: either as an intermediate during tryptophan synthesis or by a tryptophan-independent path (Frey et al. 1997). Terpenoids may be synthesised via the alt-IPP path [the alternative desoxy-xylulose-5-phosphate (DOXP) pathway] by which isopentenyl pyrophosphate is synthesised in the chloroplast. For further information on the lipoxygenase pathway, see Box 1.10.2. (After Paré and Tumlinson 1999)

nomical importance with regard to the production of secondary plant metabolites, because more carbohydrates (and nitrogen) are then available for growth. In an interesting experiment, the cost-benefit relation of jasmonate-induced defence was analysed (Baldwin 1998). Seed production of the annual *Nicotiana attenuata* was measured after some plants had been treated with methyl jasmonate to induce the defence reactions while others were left untreated. Both “populations” were then exposed to different intensities of herbivory by the natural spectrum of herbivores and phytophagous insects. Under herbivory pressure the (previously) induced plants produced significantly more seeds than the non-induced “unprotected” control plants. With little or no herbivory, however, the non-induced plants were superior. In nature, herbivory is the normal case, and therefore species capable of jasmonate-induced defence are favoured by selection.

Jasmonate plays the role of transmitter not only in the signal cascade after wounding, but also after infestation by pathogens. The reaction to both stimuli may be very different, not only regarding the metabolic end products: If the signal cascade is triggered by a fungal elicitor and if arachidonic acid instead of, or in addition to, linolenic acid is released, a different isozyme of the HMGR is induced, compared to the reaction in which jasmonate is the elicitor (“*hmg1*” vs. “*hmg2*”). The biological sense behind this differentiation is still unknown.

A jasmonate-independent signal pathway was identified, beside the jasmonate-dependent transduction of the wound signal (Titarenko et al. 1997). However, the jasmonate-independent signal pathway does not lead to a systemic induction, but only to a local induction of defensive genes as in the previously discussed system-independent signal pathway. This path is shown in Fig. 1.10.5 by the broken arrow.

It is interesting that the isoprenoids which are released function as **kairomones**¹ and particularly attract parasitoids, which then parasitise phytophages. Ichneumon wasps are especially attracted by the volatile terpenoids (Paré and Tumlinson 1999; Kessler and Baldwin 2001). Isoprenoids thus serve as signals with very high specificity regarding the host plant of the phy-

tophage, but the signal does not give much information about the type of phytophage. This is understandable, as the signal originates from the plant and not from the phytophage. It might be a kind of co-evolution that the inducible signals are produced almost exclusively during the day, when parasitoids are active. Induction of HMGR can thus be interpreted as an active defence strategy of plants against herbivory.

1.10.2

Pathogen Attack and Defence

Recommended Literature

- Durrant WE, Dong X (2004) Systemic acquired resistance. *Annu Rev Phytopathol* 42:185–209
- Hammond-Kosack K, Jones JDG (2000) Responses to plant pathogens. In: Buchanan BB, Gruissem W, Jones RL (eds) *Biochemistry and molecular biology of plants*. American Society of Plant Physiologists, Rockville, MD, pp 1102–1156
- Heil M, Baldwin IT (2002) Fitness costs of induced resistance: emerging experimental support for a slippery concept. *Trends Plant Sci* 7:61–67

In addition to phytophagous insects, plants may also suffer from infestation by pathogens like viruses, bacteria and fungi. **Pathogens** often cause considerable damage to the high-yielding cultivars of our crop plants and therefore their interaction with the host plant has been the topic of extensive research in the scientific area of **phytopathology**. Within the scope of this book, the reaction spectrum of plants to pathogen attacks can only be described in a cursory fashion.

We distinguish between **compatible** and **incompatible interactions**. In compatible interactions host and pathogen “get along with each other”, i.e. infestation is strong, the pathogen is virulent and the plant is susceptible. In incompatible interactions, the infested plant can cope with the attack of pathogens by establishing defence reactions, i.e. it is resistant and the pathogens are called avirulent. In compatible interactions, pathogens are able to circumvent, inactivate or tolerate the plant defences. Generally, however, the resistance of plants to the broad

¹ Kairomones are (usually) volatile signal compounds, which are useful for the detecting organism: attractants, repellents (escape), stimulants, warning signals.

spectrum of potential, more or less omnipresent pathogens, is very high.

Fungi and bacteria proliferate and expand within the extracellular space of the plant, therefore cell walls are one of the preformed barriers these pathogens have to overcome. Often cell walls are very difficult to penetrate because of coating with or insertion of cutin, or because of lignification.

1.10.2.1 Infection by Fungi

A fungal infection starts from a spore adhering to the cuticle by an adhesion pad on the surface of a plant. A germ tube develops from the spore and an **appressorium** is formed (see Fig. 1.10.12). Within this appressorium a high pressure is built up exerting a mechanical force and with the additional help of cutinases, cellulases and pectinases the fungus enzymatically disrupts cuticle and cell wall, without damaging the plant plasma membrane. Primary hyphae expand in the extracellular space and haustoria are formed. Haustoria are nutrient-absorbing cells which invade plant cells by infolding the plant plasma membrane. The plant cell therefore remains intact, but their nutrients are consumed

serving to support growth of the fungus. Other fungi start infection of a plant similarly as described, but instead of forming haustoria they invade the plant cell with secondary hyphae destroying the plant's plasma membrane. The plant cells die and the fungi live from the contents of dead plant cells.

Without appropriate plant defence, fungi overgrow the plant tissue and their virulence is often increased by formation of exo- or zoospores.

1.10.2.2 Induced Defence

Resistant plants are able to prevent proliferation and expansion of pathogens. They do so by induction of defence responses which include (see Fig. 1.10.10)

- stiffening of their cell walls by synthesis of callose, a β -1,3-glucan, synthesis of hydroxyproline-rich glycoproteins, which cross-link cell wall components, and increased lignification (see Fig. 1.10.12, formation of a papilla),
- synthesis of so-called **PR proteins** (pathogenesis-related proteins), some of which are chitinases and glucanases which hydrolyse fungal and bacterial cell walls, others have anti-oxidative capacities,

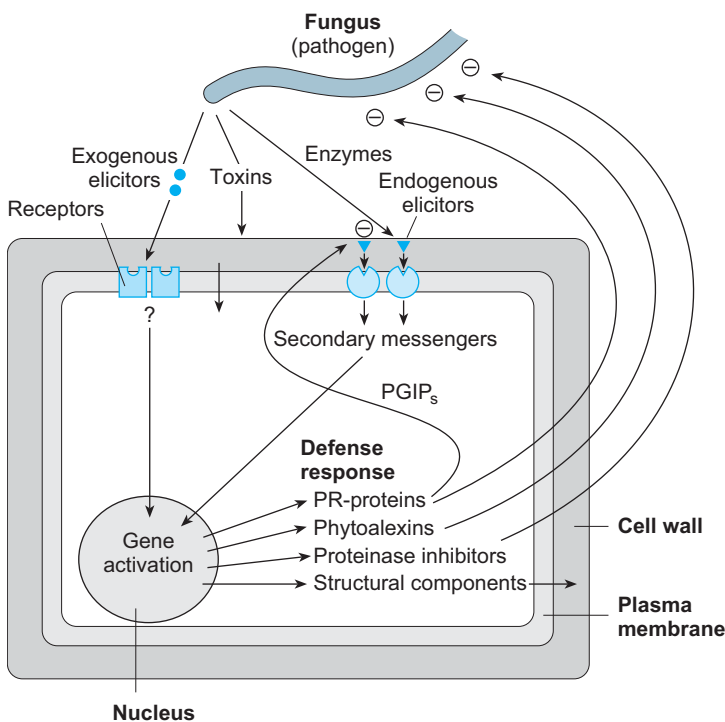
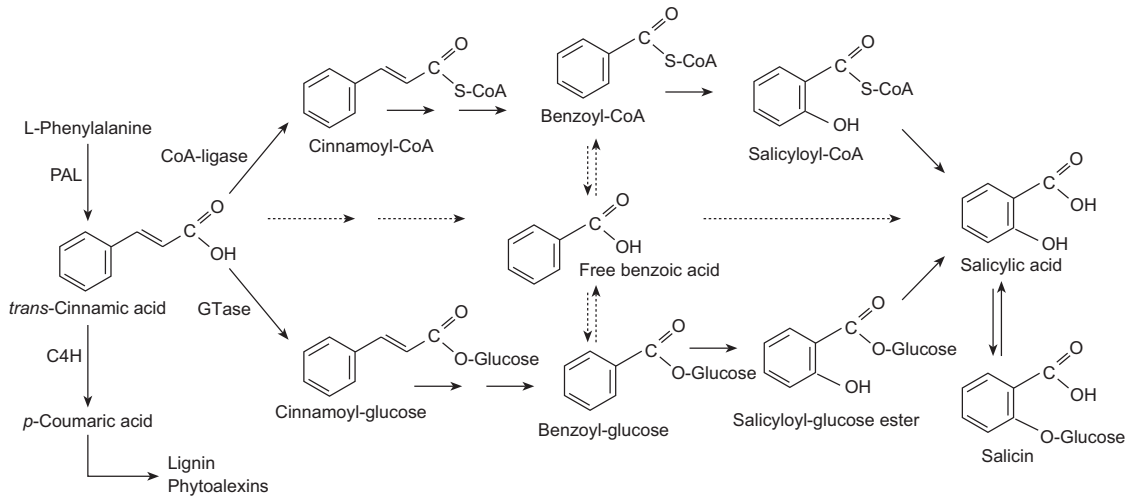


Fig. 1.10.10. Model of the interaction between pathogen and host in the hypersensitive reaction. The fungus releases cell wall lysing enzymes and elicitors from its hyphae, and in some cases also toxins. Via a signal cascade, the fungal elicitors, and the elicitors produced by hydrolysis of the plant cell wall, induce the expression of genes in the nucleus, which are involved in the synthesis of defensive enzymes that either directly attack the fungus (for instance PR proteins) or produce defensive compounds (phytoalexins and enzyme inhibitors). The polygalacturonase inhibitor (PGIP) highlighted in the model prevents degradation of oligogalacturonides, products of the action of a fungal polygalacturonase, which act as elicitors and thus increase the defence reaction. While the defence reactions are induced in cells surrounding the infection site during the hypersensitive response, the infected cell itself is "sacrificed" by programmed cell death. (After Heß 1999)

Box 1.10.3 Salicylic acid

Salicylic acid can be produced via several biosynthetic pathways, either via cinnamic acid coenzyme A thioester or via cinnamic acid glucose ester. Free benzoic acid is probably only a by-product. The storage form of sal-

icylic acid is the glucoside salicin. *C4H* Cinnamate-4-hydroxylase; *PAL* phenylalanine ammonia lyase; *GTase* glucosyl-transferase (after Chong et al. 2001).



- synthesis of **phytoalexins** (Greek *alekein* = “to fend off”), a diverse group of low molecular weight secondary metabolites, predominantly compounds of the classes isoprenoids, flavonoids and stilbenes, which exert an antibiotic effect against a broad spectrum of fungi and bacteria.

The defence responses are induced in cells surrounding the infested cell. One mediator of the induction of PR proteins is salicylic acid² (see Box 1.10.3 and Table 1.10.1). In resistant plants, the infested cell itself often dies by programmed cell death, the final result of the so-called **hypersensitive response (HR)**. During an HR, reactive oxygen species (“ROS”, see Chap. 1.3.5.3) are produced, leading to an **oxidative burst** (Lamb and Dixon 1997). ROS are toxic for the pathogen

² Acetylsalicylic acid, aspirin, is the most produced medicine worldwide. It is better tolerated by humans than free salicylic acid, the actual agent. This substance from the bark of the willow tree (*Salix*) was used in ancient times in western Europe and by North American Indians to relieve pain and fever. In plants, it increases resistance against pathogens, and is also used as a spray to prevent mildew. Many amateur gardeners water their plants from time-to-time with aspirin solutions.

and the host and, therefore, synthesis of antioxidants in cells around the infection site is plausible.

Why are the defence responses induced during incompatible but not during compatible interactions? In an incompatible interaction, signals are transmitted between pathogen and host, which trigger the defence responses. The basis of this “signal transmittance” is a certain genetic background of both partners. Plants contain **R genes (resistance genes)**, while pathogens contain **avr genes (avirulence genes)** or **vir genes (virulence genes)**. For an interaction to be incompatible, host and pathogen must have corresponding R and avr genes (Hammond-Kosack and Jones 2000; Staskawicz 2001). The products of R genes are often integral plasma membrane proteins which function as receptors. Binding of a proper elicitor to the receptor then induces – via a signal transduction chain (similar as during herbivory) – the defence responses. The products of avr genes may be the elicitors per se or, in most cases, avr genes encode proteins which are involved in the synthesis of elicitors.

Upon a fungal infestation, elicitors are often degradation products of cell walls, either of plant or fungal origin. They are very specific oligosac-

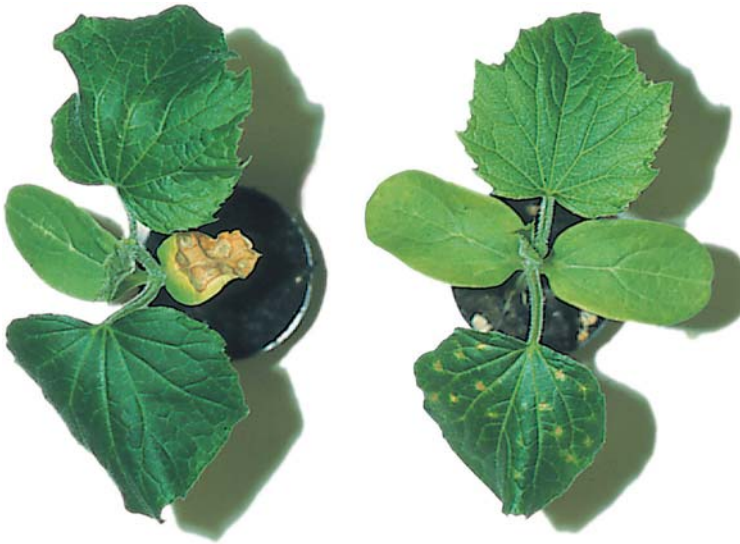


Fig. 1.10.11. Systemic acquired resistance of cucumber plants to the Anthracnose fungus *Colletotrichum lagenarium*. One cotyledon of the plant on the left was infected with spores of the fungus. Obviously, it is suffering severely from necrosis. The plant on the right was left untreated. One week later, 20 drops of a spore suspension were placed on a main leaf of both plants. The leaf of the plant on the left remained fully healthy as it had become resistant. The leaf of the plant on the right, which experienced no “immunisation”, exhibited necrotic areas at the positions of every drop of spore suspension. (Conrath and Kauss 2000)

charides. In one case, this elicitor is produced by the combined action of a fungal polygalacturonase (hydrolysing pectin of the plant cell wall) and a polygalacturonase inhibitor protein (PGIP), which is synthesised by the plant after infection, leading to oligogalacturonides of the appropriate length to function as elicitor (see Fig. 1.10.10). This is probably the result of a co-evolution between a former virulent fungus and a susceptible plant cultivar. Elicitors may also be secreted glycoproteins which bind to plant receptors. Regarding bacteria, *avr*-gene products are proteins which often are transferred into the plant's cytoplasm interacting with intracellular receptor proteins which “guard” the defence response. In the presence of a corresponding *avr*-gene product, the defence responses are induced.

The difference between resistant and susceptible plants is not that susceptible plants were unable to produce PR proteins or phytoalexins, but that their production is not triggered or not triggered in time because a proper signal (from the pathogen) or a proper receptor (in the plant) is missing.

1.10.2.3

Systemic Acquired Resistance

The hypersensitive response often includes the establishment of a systemic acquired resistance (SAR) against pathogens. SAR is reminiscent of the systemic defence against phytophagous insects. It means that the defence response (mainly synthesis of PR proteins) is induced in non-in-

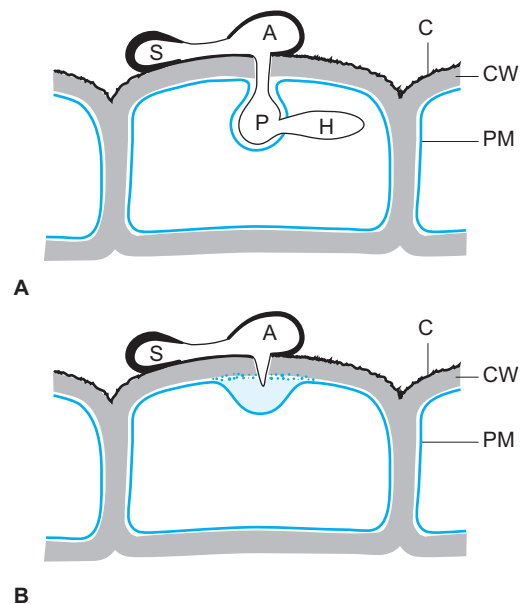


Fig. 1.10.12. Compatible (A) and incompatible (B) interactions during infestation by a fungus. **A** A germinating spore (S) develops a germ tube from which an appressorium (A) is formed. Within the appressorium a high pressure is built up and by secretion of cell wall lysing enzymes a primary hypha (P) is growing through the cuticle (C) and cell wall (CW). Later secondary hyphae (H) enter the cell by destroying the plasma membrane (PM). **B** Defence against a fungal infestation in a (systemically) resistant plant. The fungus is unable to penetrate the outer wall of the epidermal cell, as a papillose wall thickening develops under the appressorium. This papilla is also “impregnated” with a strong layer of lignin. (After Conrath and Kauss 2000)

fested plant organs remote from the infection site (Fig. 1.10.11). When pathogens later try to infect these plant organs they fail because of the defence mechanisms already preformed (Fig. 1.10.12). As during the local defence response, salicylic acid is part of the signal transduction chain leading to the expression of PR proteins in the non-infested tissue. Interestingly, the SAR is directed against a broad spectrum of pathogens, not only against the pathogen of the primary infection.

Establishment of a SAR requires a mobile signal probably moving in the phloem. Salicylic acid has been found to be translocated in the phloem, but despite this fact and though it is necessary for the induction of PR-protein synthesis in the remote site, it does not seem to be the mobile signal responsible for SAR induction. This still remains elusive.

1.10.3

Allelopathy

Many interactions between plants and herbivores and plants and pathogens are known. Less well known is that plants affect the growth of other plants. Such a phenomenon, **allelopathy** (Greek *allos*, “another”; *pathos*, “suffering”), cannot always be unequivocally demonstrated, and was often said to be responsible for reduced plant growth without good evidence for such an interpretation.

The classical example for allelopathy is the inhibitory effect on germination by leaves of the walnut trees (*Juglans regia*, *J. nigra*). The inhibition is caused by juglone (1-hydroxynaphthalene), which is formed from 5-glucosyl-1,4,5-trihydroxynaphthalene under the influence of bacteria. Another classical example is the inhibition of grasses in the garigue of southern California, in the presence of the shrubs *Salvia leucophylla* and *Artemisia californica*. They produce a broad spectrum of possibly toxic, volatile terpenoids which impair growth of grasses. However, recently, doubts have been expressed about this interpretation; it is now thought that rabbits shelter under the bushes and graze the grasses causing their low biomass production. In most cases known, compounds which act allelopathically are phenolics which are metabolised by soil microorganisms and are thus “activated”.

A good example of intraspecific allelopathy is shown by several representatives of the genus

Kalanchoë, where root exudates from the mother plant inhibit growth of the daughter plants which are formed at the edge of the leaf (Fig. 1.10.13). The main components of the root exudate (in decreasing amounts) are gallic acid, caffeic acid, *p*-hydroxybenzoic acid, protocatechuic acid and *p*-coumaric acid, again all phenolic substances (Bär et al. 2000).

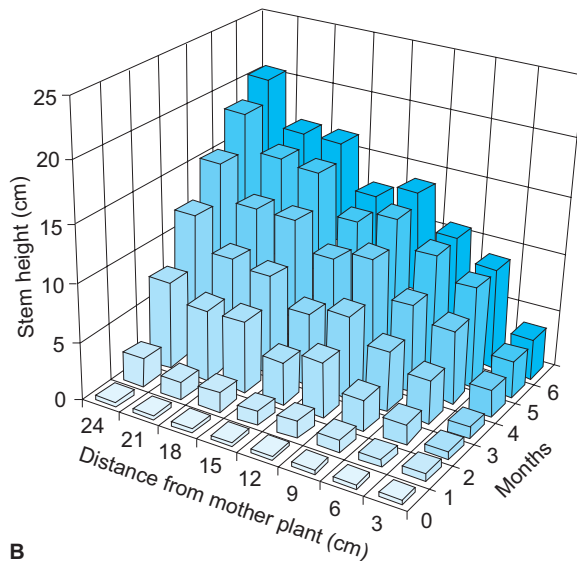
It is not yet known how these phenolic compounds affect growth of competitors; inhibition of germination often plays an important role.

Summary

1. Poisonous plant compounds, which are constitutively formed and are usually products of secondary metabolism, protect plants from **herbivory**, however, never completely. Some phytophagous insects take up such compounds while feeding on plants and accumulate them to protect themselves from their enemies. During the course of evolution, however, counteractions developed again. Volatile secondary plant metabolites often act as messengers which either frighten off or entice.
2. In addition to the constitutively expressed defence system of plants, reactions are also induced after **wounding** or infestation by pathogens. These reactions are triggered by pressure waves in the case of wounding, and by elicitors in the case of pathogen infestation.
3. If a plant is wounded, the vascular bundles are almost always affected. If air enters into the xylem, which is under negative pressure, a positive pressure wave is triggered across the whole plant. A depolarisation wave, decreasing with increasing distance from the damaged site, follows the change of pressure. The depolarisation wave activates intracellular signal chains, initially the formation of systemin from prosystemin, followed by activation of a lipase which releases linolenic acid from biomembranes. The free linolenic acid undergoes many metabolic reactions, initiated by lipoxygenase. One of the products is jasmonate, a stress hormone, but traumatin, a wound stress hormone, which activates cell division in the damaged tissue, may also be produced.
4. Jasmonate, like many phytohormones, has pleiotropic effects; it induces the expression of various genes, which, insofar as they are known, encode proteins serving to counteract stress. These genes are active even in those



Fig. 1.10.13. Intraspecific allelopathy in *Kalanchoë daigremontiana*. **A** Same age daughter plantlets were placed in a sand soil at regular intervals from the mother plant. After 150 days the height of the daughter plants clearly shows the inhibitory effect of the mother plant on their growth. **B** Quantification shows that the inhibition of the young plants depends on the distance from the mother plant. (After Bär et al. 2000)



B

parts of the plant that have not been exposed to stress or develop after the stress. Because of this systemic reaction, this phenomenon is also called “immunisation”.

- Plants distinguish in their reaction between simple mechanical wounding and damage because of herbivory. In damage caused by herbivory, the regurgitant of phytophagous insects or their larvae is very important. This digestive fluid contains fatty acids conjugated to amino acids as elicitors. Synthesis of proteinase inhibitors, as well as synthesis of volatile signal compounds of the group of terpenes, is predominantly induced. Additionally, non-volatile defensive substances are formed after induction by jasmonate, e.g. the alkaloid

nicotine, which is toxic for many insects and warm-blooded animals.

- In addition to the transduction of the wound signal by jasmonates, there is also a jasmonate-independent path which activates the defence reactions.
- Compatible and incompatible reactions are distinguished in **pathogen attacks**. In compatible reactions, there is a strong infestation, whilst the incompatible reactions indicate resistance. Resistance may be constitutive, directly acquired or acquired by “immunisation”, the so-called systemic acquired resistance. Salicylic acid derived from phenolic metabolism is the signal substance inducing the defence system in infected or in non-infected plant parts.

8. The most frequently occurring form of an incompatible reaction is the "hypersensitive response": In addition to the synthesis of PR proteins (pathogenesis-related proteins, mainly lytic enzymes) and low molecular weight antibiotically active phytoalexins, the hypersensitive response comprises the programmed cell death of the infected cell, thereby depriving the pathogen from its resources. The hypersensitive reaction can be recognised by small, well-defined lesions.
9. Hypersensitive reactions are triggered by so-called elicitors, which may be derived from the pathogen, but also from the plant cell wall attacked by the pathogen. They bind specifically to the receptors which are encoded by R(esistance) genes. The specificity of elicitors is based on the avr genes (avirulence genes) of the pathogen.
10. Inhibition of growth and development of plants by neighbouring plants is called **allelopathy**, if it is based on excretion of incompatible chemical substances and not on simple competition. Classical examples are inhibition of germination and growth caused by rotting leaves of walnut trees, and the inhibition of growth of grasses by volatile compounds from Lamiaceae and Asteraceae.

Intraspecific allelopathy is demonstrated by *Kalanchoe daigremontiana*, where the mother plant inhibits growth of plantlets developing at the edges of its leaves by secretion of a broad spectrum of phenolic compounds from the roots.

References

- Baier M, Dietz K-J (1999) Alkyl hydroperoxide reductases: the way out of the oxidative breakdown of lipids in chloroplasts. *Trends Plant Sci* 4:166–168
- Baldwin IT (1998) Jasmonate-induced responses are costly but benefit plants under attack in native populations. *Proc Natl Acad Sci USA* 95:8113–8118
- Bär W, Pfeifer P, Dettner K (2000) Biochemische Interaktionen zwischen *Kalanchoe*-Pflanzen. *Biol Unserer Zeit* 30:228–234
- Chong J, Pierrel M-A, Atanassova R, Werck-Reichhart D, Fritig B, Saindrenan P (2001) Free and conjugated benzoic acid in tobacco plants and cell cultures. Induced accumulation upon elicitation of defense responses and role as salicylic acid precursors. *Plant Physiol* 125:318–328
- Conconi A, Miquel M, Browse JA, Ryan CA (1996) Intracellular levels of free linolenic and linoleic acids increase in tomato leaves in response to wounding. *Plant Physiol* 111:797–803
- Conrath U, Kauss H (2000) Systemisch erworbene Resistenz – Das „Immunsystem“ der Pflanze. *Biologie unserer Zeit* 30:202–208
- Creelman RA, Mullet JE (1997) Biosynthesis and action of jasmonates in plants. *Annu Rev Plant Physiol Plant Mol Biol* 48:355–381
- Feussner I, Kühn H, Wasternack C (2001) Lipoxygenase-dependent degradation of storage lipids. *Trends Plant Sci* 6:268–273
- Frey M, Chomet P, Glawischnig E, Stetter C, Grun S, Winklmair A, Eisenreich W, Bacher A, Meeley RB, Briggs SP, Simcox K, Gierl A (1997) Analysis of a chemical plant defense mechanism in grasses. *Science* 227:696–699
- Heß D (1999) Pflanzenphysiologie: molekulare und biochemische Grundlagen von Stoffwechsel und Entwicklung der Pflanzen. UTB Ulmer Stuttgart, 608 pp
- Kessler A, Baldwin IT (2001) Defensive function of herbivore-induced plant volatile emissions in nature. *Science* 291:2141–2144
- Korth KL, Dixon RA (1997) Evidence for chewing insect-specific molecular events distinct from a general wound response in leaves. *Plant Physiol* 115:1299–1305
- Lamb C, Dixon RA (1997) The oxidative burst in plant disease resistance. *Annu Rev Plant Physiol Plant Mol Biol* 48:251–276
- Meindl T, Boller T, Felix G (1998) The plant wound hormone systemin binds with the N-terminal part to its receptor but needs the C-terminal part to activate it. *Plant Cell* 10:1561–1570
- Mitchell-Olds T, Gershenzon J, Baldwin IT, Boland W (1998) Chemical ecology in the molecular era. *Trends Plant Sci* 3:362–365
- Paré PW, Tumlinson JH (1999) Plant volatiles as a defense against insect herbivores. *Plant Physiol* 121:325–331
- Rouster J, Leah R, Mundy J, Cameron-Mills V (1997) Identification of a methyl-jasmonate responsive region in the promoter of a lipoxygenase gene expressed in barley grain. *Plant J* 11:513–523
- Sharkey TD (1996) Emission of low molecular mass hydrocarbons from plants. *Trends Plant Sci* 3:78–82
- Stahlberg R, Cosgrove DJ (1997) The propagation of slow wave potentials in pea epicotyls. *Plant Physiol* 113:209–217
- Stanković B, Davies E (1998) The wound response in tomato involves rapid growth and electrical responses, systemically up-regulated transcription of proteinase inhibitor and calmodulin and down-regulated translation. *Plant Cell Physiol* 39:268–274
- Staskawicz BJ (2001) Genetics of plant-pathogen interactions specifying plant disease resistance. *Plant Physiol* 125:73–76
- Stout MJ, Workman J, Duffey SS (1994) Differential induction of tomato foliar proteins by arthropod herbivores. *J Chem Ecol* 20:2575–2594
- Titarenko E, Rojo E, León J, Sánchez-Serrano JJ (1997) Jasmonic acid-dependent and -independent signaling pathways control wound-induced gene activation in *Arabidopsis thaliana*. *Plant Physiol* 115: 817–826
- Wasternack C, Parthier B (1997) Jasmonate-signalled plant gene expression. *Trends Plant Sci* 2:302–307

Autecology: Whole Plant Ecology



Cocos nucifera, the coconut palm, a pan-tropical tree with nuts that are capable of floating, has long been used by man for a wide variety of purposes. The trunk is useful as timber for building, the leaves for roof material, the fluid endosperm is vitamin-rich coconut milk, and the hard endosperm is fat-containing copra, whilst the air-containing mesocarp is coconut fibre. Worldwide the production of copra is 4–5 million tonnes. Coconuts may form the pioneer tree vegetation along tropical coasts, especially on coral atolls where it is saline and periodically arid with high incident radiation. A “desert” area at the Atlantic coast, Punta Cahuita, Costa Rica. Photograph E.-D. Schulze

Autecology considers conditions and responses of individual plant species within their habitat. During the course of evolution, plants have occupied every terrestrial habitat with conditions ranging from tropical climates to eternal ice, from moors to deserts, and extremely saline habitats to those where one or other of the ions required for nutrition limits growth. These different environmental conditions require various **adaptations** of plants, but this does not necessarily imply that the individual plant itself adapts to specific conditions. It is much more the case that in a population mutations occur which are possibly not even visible externally and which are not disadvantageous under the prevailing conditions of competition and stress by the habitat. If conditions change, for example, the climate, or supply of nutrients or greater competition, then individual plants with certain advantageous traits are able to compete better and have a better chance of survival to enlarge the area which they occupy. This process is called **pre-adaptation**. Traits that are “advantageous” for certain habitats develop before the actual change of growth conditions and are the precondition for the settlement of new habitats (see Chaps. 4.1 and 4.2).

The subject of autecology is the result of these processes, i.e. to discover which characteristics make it possible for individual plants to flourish under certain conditions. The number of possible responses to the environment is wide and ranges from biochemical through cellular to morphological changes. Plants occur in a wide

variety of forms, from giant trees which are hundreds of years old in boreal or tropical forests with a life cycle from germination to formation of seeds in centuries, to annual species of arid regions which form seed in a few days. Thus the characteristics with which a plant responds to the environment are its structure and its life span, as well as its physiological responses to stress. Thus autecology becomes **whole plant ecology**, considering the reactions at the level of individual organs (e.g. height of shoot, size of leaf, depth of root) or relationships between organs (e.g. distribution of resources between shoot and root, regulation of the coordination of shoot and root). Ecology of individual plants provides the connection between stress physiology and environmental conditions.

Whole plant ecology can be divided in various ways; here we consider the classical approach of “balance” or relations. At a particular site the individual plant needs to regulate various components and balance them, particularly:

- Thermal balance: certain extreme temperatures must not be exceeded;
- Water balance: active life requires that cells maintain a high water content;
- Nutrient balance: growth is possible only with the supply of essential nutrient elements;
- Carbon balance: life requires energy to supply existing organs and resources for further growth and reproduction.

2.1

Thermal Balance of Plants



Formation of ice on the branches of beech. Formation of ice crystals is due to freezing of super-cooled water from clouds onto the surface of the vegetation. The “ice beard” grows against the direction of the wind (hoar frost) and can reach such a volume that the crown of the tree may break (ice damage). In contrast to this, rime is composed of ice crystals which are formed from vapour. Solling IBP Beech-area B1. Photograph E.-D. Schulze

Recommended Literature

The most comprehensive book on whole plant ecology was by Lange, Nobel, Osmond and Ziegler in the *Encyclopaedia of Plant Physiology*, Part *Physiological Plant Ecology*, vols. 12A–D (Springer, 1982). Despite being published 20 years ago it is still a landmark in providing understanding of whole plant ecology. The textbook by W. Larcher *Ecophysiology of Plants* (Springer 4th ed. 2003) and Lambers and Chapin: *Plant Physiological Ecology* (Springer, 1998) are recommended for further reading.

The thermal relations of plants deal with the balance of radiation energy. Only slightly more than 1% of the incident solar energy is used for photosynthetic metabolism. The remainder of the energy (about $700\text{--}1000\text{ W m}^{-2}$ at full sun light near the ground) has to be released again because the plant is fixed at the site and absorbs short-wave radiation dependent on its **albedo** (reflectivity). The energy balance can only be regulated by release of heat to the surrounding air (**sensible heat**) or by evaporation of water (**latent heat**). The flow of heat into the soil is too slow to regulate the thermal balance in a leaf or plant organ, with rapidly changing incident radiation. The **temperature of organs** (particu-

larly of leaves and flowers) or the **temperature of surfaces** (stems, flowers) results from the energy balance. The temperature must be kept within certain physiological limits, to avoid damage, and energy balance must be regulated by the plant in such a way that damaging temperatures do not occur, even for short periods. Moreover, the temperature should rather be within the range of the physiological optimum of metabolic processes, which could be above or below the general temperature of the habitat. Plants are able to influence their organ temperatures over a wide range. For example, in the inflorescences of the Araceae, temperatures of ca. 17 K greater than the ambient air are produced via cyanide-resistant electron transport in respiration in order to entice pollinators. In arid climates leaf temperatures may be ca. 17 K below the ambient temperature because of evaporation, thus avoiding heat damage. The temperature of the plant thus is a result of the energy balance and is connected within a certain range to edaphic and climatic conditions.

In the following, the atmosphere and air layers near the ground will be considered as part of the habitat followed by the analysis of the energy balance of a leaf and its effects on plant responses. Ecophysiological responses of plants at extreme temperatures were discussed in Chapter 1.3.

Box 2.1.1 Atmospheric composition

Chemical composition of the lower atmosphere

78% N₂, 21% O₂, 0.6–4% H₂O, 0.03% CO₂, noble and trace gases of natural and anthropogenic origin.

Water vapour pressure: The maximum amount of water vapour that can be held by the atmosphere is termed saturation pressure (e_o), and which depends on temperature and pressure. The pressure of the atmosphere without water vapour, P_a , is derived from the measured pressure of the atmosphere, P , and the actual vapour pressure, e ($P_a = P - e$). At a constant air pressure the vapour pressure rises exponentially with a linear increase in temperature. For exact data on the composition of air, see List (1971).

Note: humid air is lighter than dry air, determined by the relationship between the molecular weights of H₂O and N₂, which is 0.62 (18/36). Hence, humid air in the lower atmosphere rises until it condenses on cooling, and forms fog or clouds. For the same reason, condensation forms on the ceilings of humid rooms or on the lids of Petri dishes.

The atmosphere is only rarely saturated with water vapour. The actual vapour pressure of the atmosphere (e) is generally lower than the saturation value (e_o). There are a number of terms that are used to describe the humidity of air (Fig. 2.1.1):

- **absolute vapour pressure:** $c_w = (2.17/T) e$, unit: $g\ m^{-3}$ (Note: volume of air is temperature and pressure dependent);
- **relative humidity:** $H = e/e_o$, unit % (Note: at constant vapour pressure this is dependent on T);
- **water vapour saturation deficit of the atmosphere:** $D_a = (e_o - e)/P_a$, unit $Pa\ Pa^{-1}$ (often shortened to VPD: vapour pressure deficit). Note: the value is independent of temperature and pressure;
- **water vapour saturation deficit between leaf and atmosphere:** $D_l = (e_{oL} - e)/P_a$, where e_{oL} is the vapour pressure deficit at leaf temperature and e the actual vapour pressure in the atmosphere; this term is important as it is the driving force for transpiration in plants (used to be abbreviated as WD: water vapour deficit);
- **dew point temperature °C:** T_d for $e = e_o$ (temperature, t , below which condensation temperature is reached and therefore condensation follows);
- **wet bulb temperature T_w :** This unit is used to measure the actual vapour pressure (psychrometer)

$$e = e_o(T_w) - \gamma(T_a - T_w)$$

where γ , the psychrometric constant, is $66.1\ Pa\ K^{-1}$ for a ventilated thermometer at 100 kPa air pressure and 20 °C.

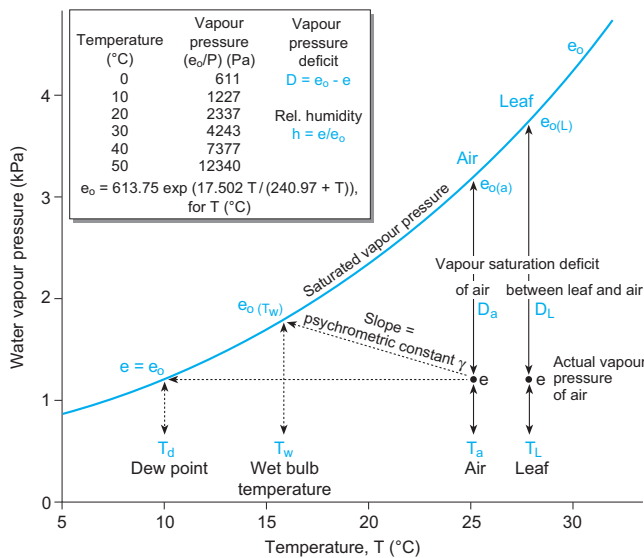


Fig. 2.1.1. Dependence of saturated vapour pressure, e_o , on temperature, T , and the graphical explanation of the various terms needed to define vapour pressure. T_a Air temperature; T_l leaf temperature; T_w wet bulb temperature; T_d dew point temperature; γ the psychrometric constant; e actual vapour pressure of the atmosphere; D_a saturation deficit of air; $e_{o(a)}$ saturation vapour pressure at leaf temperature, where e_o is calculated from $e_o = 613.75 \exp(17.502 T / (240.97 + T))$, with T in °C

2.1.1

The Atmosphere as Habitat

The thermal balance of plants is closely connected to the chemical composition of and the physical transport processes in the atmosphere, which are part of the discipline of meteorology (textbooks: Lutgens and Tarbuck 2000; Wallace and Hobbs 1977). Variations in solar energy balance are responsible for the climatic conditions in the boundary layer near the ground, compared to the free atmosphere. Gregor Kraus (1911) was the first scientist to describe this phenomenon quantitatively on limestone sites near Würzburg, Germany, and thus founded a new discipline of micrometeorology (textbook: Jones 1994).

Water vapour, CO₂ and O₂ are the most important gases for the plant, independent of several other trace gases (ozone, nitric oxide, ammonia, methane and others) which influence the plant (see Chap. 1.9). Here, we discuss the energy balance in the context of water vapour and CO₂ in the atmosphere. Both gases are important for the existence and growth of plants.

Through the formation of clouds, **water vapour** influences

- absorption and reflection in the atmosphere and thus the solar radiation reaching the earth's surface;
- evaporation from the earth's surface as being dependent on the saturation deficit and on the plant cover;
- density of the atmosphere and the transport processes in it (formation of clouds) via the temperature dependence of saturation, which is the basis for precipitation.

Carbon dioxide influences

- the thermal balance of the lower atmosphere by absorption and radiation of long-wave radiation;
- photosynthesis, as it is the substrate for the process.

The interaction between the optical characteristics of the atmosphere and its constituent gases is explained in Fig. 2.1.2 A (Mitchell 1989; IPCC 1996). The solar radiation entering the earth's atmosphere occurs in the short-wave range at about 6000 K with maximum radiation at about 0.6 μm wavelength (visible light). Mean radiant energy at the upper limit of the atmosphere is 1370 W m⁻² (**solar constant**, measured in the

stratosphere). Because the earth is not flat, but a sphere, the mean radiation flux during the day, averaged over the illuminated hemisphere, is about 340 W m⁻² (WBGU 1997). This radiation is balanced by the long-wave radiation (**thermal radiation**, I₁), which by itself is a balance between thermal radiation of the atmosphere and thermal radiation from the stratosphere which operates at a temperature of 255 K. Long-wave radiation follows the **Stefan-Boltzman** law:

$$I_1 = \sigma T^4, \quad (2.1.2)$$

where $\sigma = 5.67 \times 10^{-8}$ (W m⁻² K⁻⁴), the Stefan-Boltzman constant, and T the temperature in Kelvin. Without an atmosphere, there would be no re-radiation from the atmosphere and thus the average temperature on earth would be -18 °C.

Atmospheric gases, particularly water vapour and CO₂, have the effect that part of the incoming solar radiation in the short-wave and near-IR range is absorbed and reflected (Fig. 2.1.2 B). In the atmosphere the short-wave solar radiation (UV radiation) is absorbed particularly by ozone. H₂O and CO₂ absorb in the near-IR, thus limiting the incoming radiation to a narrow **radiation window** with a maximum in the visible range. The incoming energy is balanced by emission of long-wave IR from the earth's surface; this is limited by water vapour and CO₂. There is only a narrow **emission window** between 8 and 14 μm wavelength in which the earth's surface absorbs or emits heat.

Reflection and absorption processes are additive in determining the **energy balance** of the earth (Fig. 2.1.2 C; Mitchell 1989). Short-wave radiation is absorbed in the molecules of the atmosphere and clouds and reflected. Some of the short-wave radiation is reflected from the earth's surface, dependent on the type of vegetation cover.

The thermal balance is determined by the sum of processes of reflection and absorption (Table 2.1.1). A distinction is made between the **radiation balance** and the **energy balance**. The radiation balance comprises the sum of short- and long-wave radiation fluxes and their reflection whilst the energy balance of radiation is the sum of all thermal fluxes and incorporates thermal transport, latent heat of evaporation and the fluxes of heat into the soil. The radiation balance is normally not at equilibrium (i.e. it differs from zero), but the energy balance must be zero as the sum of all processes.

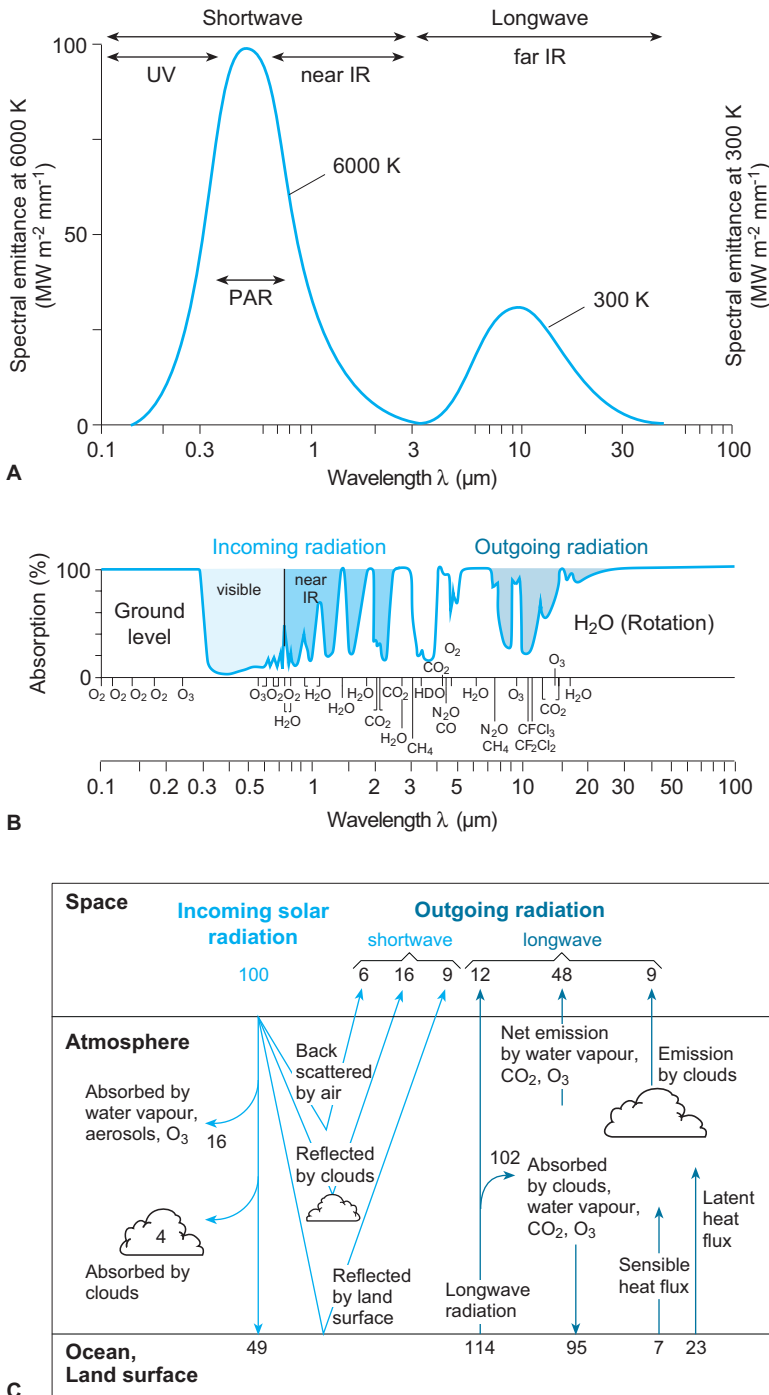


Fig. 2.1.2. Energy distribution and the incident radiation balance of the earth. **A** Spectral distribution of short wavelength incident solar radiation and the long wavelength heat radiation of the earth. **B** The spectral absorption of incident radiation by gases in the atmosphere. Note that ozone absorbs short wavelength radiation and CO₂ absorbs in the long wavelength range. In addition CO, N₂O and fluorochlorocarbons absorb incident radiation. **C** The transformation of incident radiation to heat radiation in the atmosphere. The percentages given are for the average global solar incident radiation of 342 W m⁻². (After Mitchell 1989; WBGU 1997)

Table 2.1.1. Energy balance^a of the earth

Atmospheric radiation balance		Turnover (W m ⁻²)	Relative contribution (%)
Incident solar radiation (short-wave)	I_{sA}	+342	100
- reflection (short-wave)	$\rho_{sA}I_{sA}$	-106	-31
- of radiation	(-75 = 22%)		
- of aerosols and clouds	(-31 = 9%)		
- of the soil (= net radiation)			
- heat radiation	$\epsilon_{IA} I_{IA}$	-236	-69
- of gases in the atmosphere	(-164 = 48%)		
- of clouds	(-31 = 9%)		
- of the soil to space	(-41 = 12%)		
Atmospheric radiation balance in the upper atmosphere	Q_{nA}	0	0
Radiation balance at the ground surface			
Incident solar radiation (short-wave)	I_{sA}	+342	100
- reflection (short-wave)	$\rho_{sA}I_{sA}$	-106	-31
- of aerosols and clouds	(-75 = 22%)		
- of soil	(-31 = 9%)		
- absorption in the atmosphere		-68	-20
Short-wave radiation input to the ground surface		+168	+49
Long-wave radiation			
- heat loss by the ground surface	$\epsilon_{IB}I_{IB}$	-390	-114
- heat re-radiation by clouds	$\epsilon_{IA}I_{IA}$	+325	+95
Radiation balance of the ground surface	Q_{nB}	+103	+30
Energy losses of soils			
- conductance of sensible heat into the soil	H	-24	-7
- energy loss by vaporisation	λE	-79	-23
Energy balance of soil		0	0

^a The energy conversion with reflection, absorption and long wavelength emission occurs in the atmosphere and at the ground surface. The solar constant (1370 W m⁻²) is the amount of energy that arrives at a surface above the atmosphere vertical to the incident radiation from the sun. In contrast, the solar energy arriving at the earth's surface (342 W m⁻²) is the average amount of energy falling on the half of the earth facing the sun. The parameters are equivalent to the transport equations given in the text

Generally, the net **radiation balance** of the earth (R_n ; n=net) may be expressed in the following equation:

Radiation balance of the upper atmosphere (R_{nA})

$$R_{nA} = I_{sA} - \rho_{sA}I_{sA} - \epsilon_{IA}I_{IA} \quad (2.1.2)$$

radiation balance = incoming solar radiation - reflection - long-wave outgoing radiation

R_{nA} is the balance of radiation fluxes at the upper boundary of the atmosphere, I_{sA} the short-wave incoming solar radiation at the upper boundary of the atmosphere, ρ_{sA} the ability of the atmosphere (clouds, gases) and soil to reflect incoming solar radiation, ϵ_{sA} is the ability of the atmosphere to emit long-wave radiation

and I_{IA} the long-wave emission of the atmosphere (clouds, gases) and soil.

The radiation balance near the soil may be expressed analogously. The radiation balance at the earth's ground surface (R_{nG}) is the sum of short-wave incoming and outgoing solar radiation.

$$R_{nG} = I_{sG} - \rho_{sA}I_{sG} + I_{IA} - \epsilon_{IG}I_{IG} \quad (2.1.3)$$

radiation balance = incoming short-wave radiation - reflection + incoming long-wave radiation - long-wave emission

The incoming short-wave radiation I_{sG} is called solar radiation. $I_{sG} - \rho_{sA}I_{sG}$ denotes the short-wave radiation balance measured by a radiometer with a glass dome and $I_{IA} - \epsilon_{IG}I_{IG}$ is

the long-wave radiation balance measured by a radiometer with selenium glass. The radiation balance is measured with a radiometer with a polyethylene dome which transmits IR radiation.

In contrast to the radiation balance, the energy balance includes further thermal fluxes and thus the balance is in equilibrium.

$$\Phi_{nG} = R_{nG} - H - \lambda E - B - S - M = 0 \quad (2.1.4)$$

energy balance = radiation balance - sensible heat flux - latent heat flux - soil heat flux - storage - metabolism = 0

Φ_{nG} is the net energy flux at the soil surface and R_{nG} the radiation balance near the soil. The sensible heat flux, H , is proportional to the specific heat capacity of air ($c_p = 1012 \text{ J kg}^{-1} \text{ K}^{-1}$) and the temperature difference between soil and atmosphere ΔT . ρ is the density of air:

1.1884 kg m^{-3} at 20°C and 1000 hPa air pressure. H is dependent on the coupling of the exchange from surface to atmosphere. This coupling is expressed by the boundary resistance, r_b :

$$H = (\rho c_p \Delta T) / r_b \quad (2.1.5)$$

In Eq. (2.1.4) λE is the latent heat flux, whereby λ expresses the energy required for evaporation of water (2.454 MJ kg^{-1} at 20°C) and E the evaporation (kg m^{-2}).

Long-wave radiation follows the Stefan-Boltzmann law in all cases [see Eq. (2.1.1)].

The annual incoming short-wave solar radiation (solar radiation, Fig. 2.1.3) is unevenly distributed over the earth's surface. Because there are fewer clouds over dry areas of the earth, net radiation is lowest and decreases in polar regions to about 40% and in the tropics to 70% of the radiation in dry areas. The global distribution of radiation reflects the global temperature and in particular low temperatures and frosts.

Only 12% of the outgoing radiation from the earth's surface reaches the universe directly and without change by interaction with gases or clouds in the atmosphere (see Fig. 2.1.2). The effect of trace gases on climate is based on their effect on the outgoing radiation from the earth. This effect is often called the **greenhouse effect**. As window glass is more permeable to short-wave radiation than to long-wave radiation, short-wave radiation passes through the window glass without resistance and is absorbed by the surfaces of the room. Long-wave radiation is emitted at the temperature of the room, but cannot pass the glass. It is thus "trapped" in the

room – as a consequence, the temperature in the greenhouse increases as energy enters, but does not exit. Trace gases in the earth's atmosphere are analogous to the window pane, with water vapour, CO_2 , methane and other trace gases (comparable to the quality of the glass) absorbing long-wave radiation and this influences the temperature of the atmosphere and thus a very large increase in these gases **influences the climate** (Stott et al. 2001). This outgoing window through which long-wave energy is emitted is made even smaller by ozone and anthropogenic **chlorofluorocarbons** (CFCs). These trace gases absorb exactly in the long-wave length and so are in the maximum range of outgoing radiation and are thus significantly more effective than trace gases such as CO_2 , methane and nitrous oxide gas (N_2O), which only decrease the outgoing radiation at the edge of the absorption spectrum (i.e. make the atmosphere more impermeable for long-wave heat radiation; via the "greenhouse effect").

The course of **changes in temperature and CO_2 concentration** during the last ice ages is surprisingly similar (Fig. 2.1.4) pointing to a causal connection. The earth, during its history, has always been subjected to considerable oscillation in temperature and CO_2 , as shown in Fig. 2.1.4A. However, organisms usually had to cope with lower temperatures than those of the present day. Most plant species developed before the climatic changes in the Tertiary, and yet were able to survive these changes. Figure 2.1.4B shows the changes in the CO_2 concentration in the last 1000 years. From the course of the curves over this period it becomes clear that early tree felling by humans in central Europe (first to third period of deforestation: 800–1300, see Chap. 4.1) did not change the CO_2 concentration of the atmosphere because the release of CO_2 occurred in a predominantly undisturbed environment which assimilated the CO_2 again. CO_2 concentration has only increased since the eighteenth century, initially slowly but exponentially since the middle of the twentieth century. Pre-industrial CO_2 concentrations are assumed to be 280 ppm. Currently, the increase is 1.5 ppm/year . The CO_2 concentration and the temperatures have reached values never before reached in the recent history of earth. Global effects are discussed in Chapter 5.

The significance of increased trace gas concentrations for the climate can be seen for an event in the earth's history (Norris and Röhl 1999). The boundary between Palaeocene and Eocene

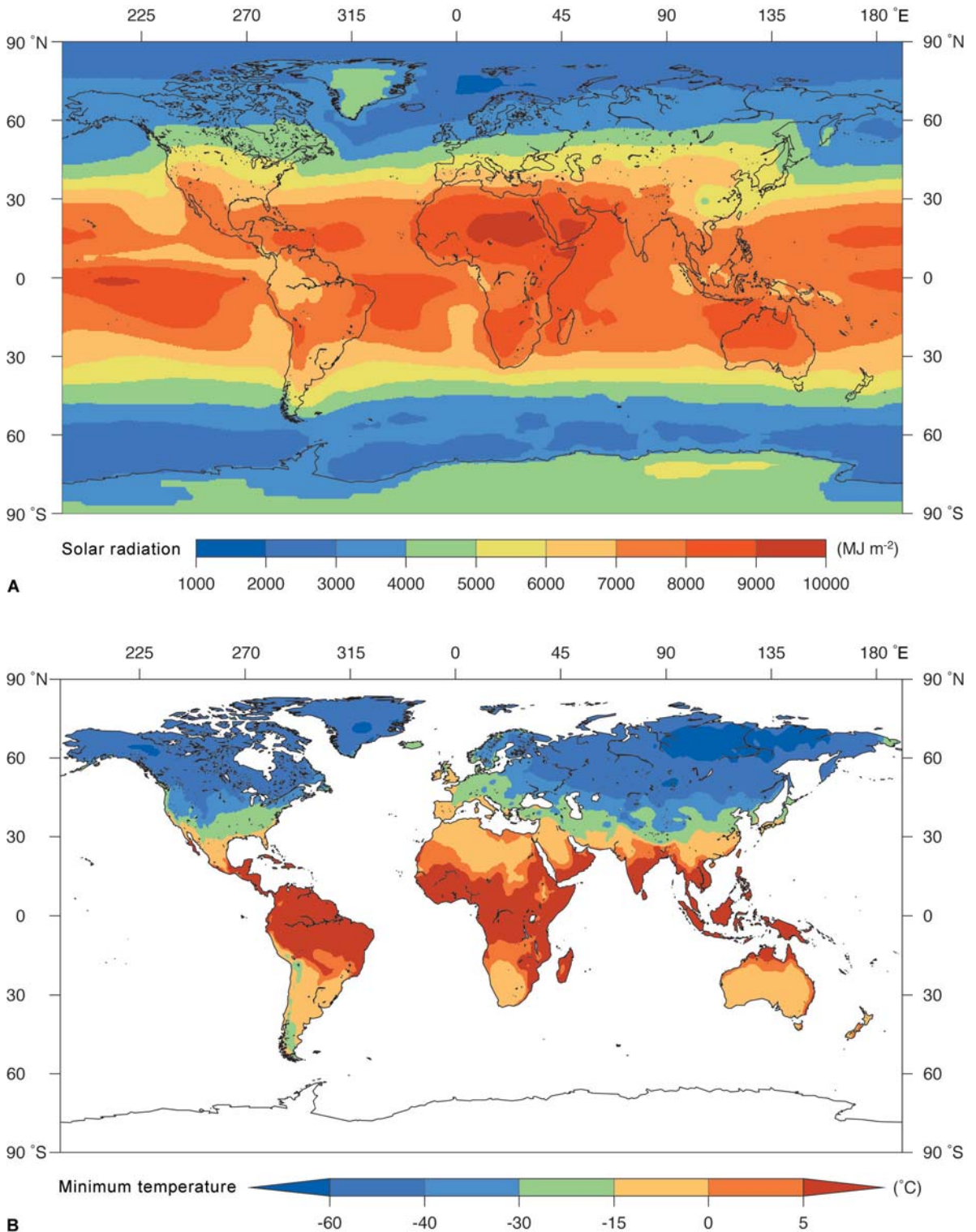


Fig. 2.1.3. A Global distribution of solar radiation (short wavelength incident radiation of the sun at the earth's surface); B global distribution of frosts (drawn by J. Kaplan; A, after http://daac.gsfc.nasa/CAMPAIGN_DOCS/FTP_SITE/INST_DIS/readmew/sre rad.html; Bishop and Rossow 1991)

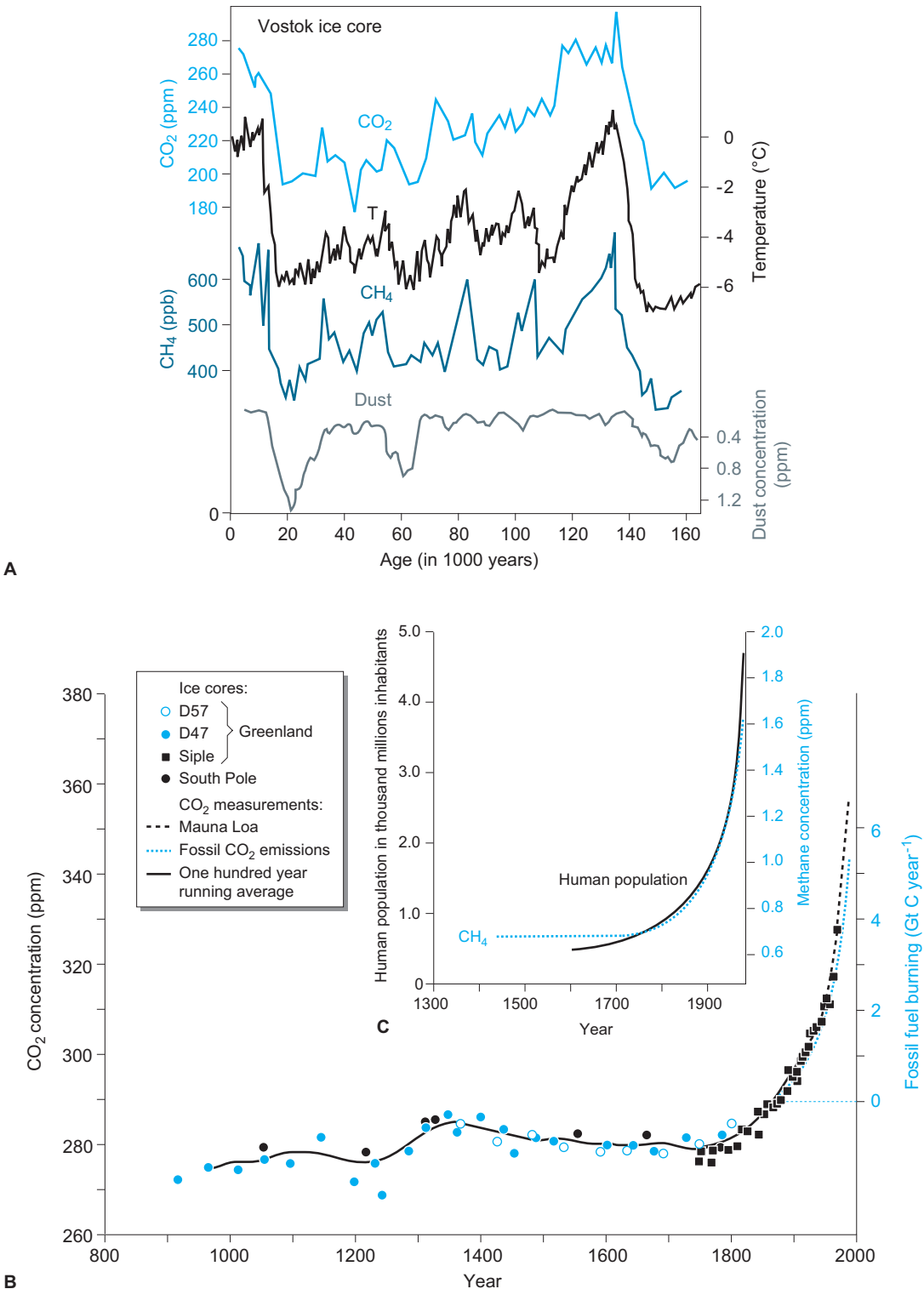


Fig. 2.1.4. A Changes in temperature and CO₂, methane and dust concentration in the last 160,000 years. B CO₂ concentration over the last 1000 years and the consumption of fossil fuels since 1850. The CO₂ concentration was determined from ice cores. Direct measurements of CO₂ concentration have been made on Mount Mauna Loa in Hawaii since 1960. C Change in methane concentration in the atmosphere since 1400 and the increase in the world population since approximately 1600 (WBGU 1997)

(55 million years ago) is characterised by a transient increase of 5–7 K in the mean global temperature. It has been shown that this increase in temperature was triggered by a landslide on the continental shelf of the Atlantic releasing 1000–2000 Gt carbon as methane from **methane hydrate**. This release is similar to the current release of CO₂ from fossil fuels (6 Gt/year × 100 years corresponds to 600 Gt). This event in the earth's history may be used as a model to evaluate the consequences of the present human activity.

It cannot be concluded from the parallel course of CO₂ and temperature curves that CO₂ alone causes the climate change (see, e.g., Veizer et al. 2000). There are various factors which increase the **trend of climatic change** or decrease it. These are in particular (Mitchell 1989; IPCC 1996):

- Position of the earth relative to the sun (Milankovitch effect),
- Changes in outgoing radiation from vegetation and snow whilst cooling,
- Changes in absorption of glaciers with increasing dust cover,
- Repeated release of methane hydrates from ocean sediments,
- Complex interactions of various trace gases from aerosols, which may have an increasing as well as decreasing effect (IPCC 1996).

2.1.2

Climate of Air Near the Ground

2.1.2.1

Daily Changes of Temperature Near the Ground

The **climate of the air near the ground** is regulated by the same processes as the climate in the atmosphere. However, bigger extremes occur due to the exchange of energy and are modified by the type of soil and the vegetation (Fig. 2.1.5). This is shown clearly by the **course of temperatures during one day** (Walter 1960; Gates 1965). We shall first consider an area without vegetation, vertical to the incoming radiation source, and then modifications resulting from different inclinations, exposure and, most of all, vegetation cover.

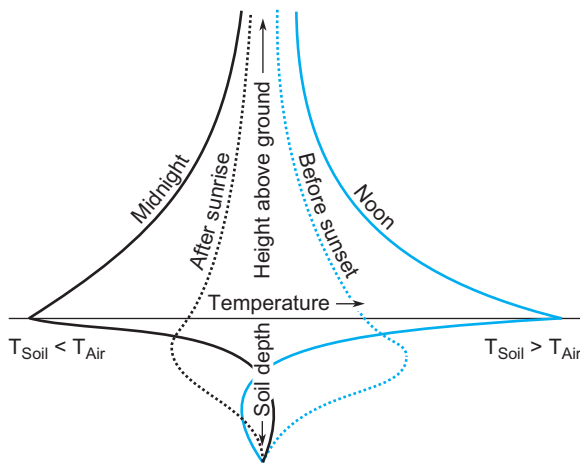
Midnight

The long-wave radiation balance with high outgoing radiation and low incoming radiation substantially cools the earth's surface; the negative radiation balance is partially compensated by heat conduction from the soil, and by the low heat exchange (convection) with the air layers near the soil surface. Formation of dew and hoar frost may compensate this effect due to heat released in condensation and freezing. On a cloud-free night, temperatures may fall more than 10 K below the temperature of the atmo-

Box 2.1.2

Summary: The earth's temperature

- The **temperature** of the earth is an equilibrium between short wavelength incident radiation and long wavelength emissions.
- The **incident** radiation reaching the earth's surface is in a narrow "incident radiation window" in the visible light range. The incident radiation is reduced as the cloud cover increases (low clouds with higher reflective properties) and with the amount of aerosols in the atmosphere. Aerosols can be of natural as well as anthropogenic origin.
- **Emissions** result from a relatively narrow "emission window", in which water vapour has the lowest emission minimum. The emission window is getting increasingly narrower because of the increase in natural as well as anthropogenic trace gases, especially chlorofluorocarbons, ozone, methane, nitrogen dioxide and CO₂. The earth's temperature rose due to a release of trace gases between the Palaeozonic and Eocene periods.
- The **temperature of the earth** results from a balance between the energy flows. It is difficult to predict the temperature and climate, as the slightest imbalance in opposing heat flows has considerable effects on the temperature, as long wavelength radiation emission is proportional to the fourth power of the temperature (Stefan-Boltzman law).



■ **Fig. 2.1.5.** Above- and below-ground diurnal temperature profile. (After Gates 1965)

sphere 2 m above ground. In the soil, the temperature increases with increasing depth, reaching a maximum which depends on the heat gain of the previous day and at greater depth corresponds to the mean temperature of the season.

Sunrise

Incoming solar radiation compensates for long-wave outgoing radiation of the soil. Because of the net heat loss to the atmosphere at night and the heat transfer to the soil, soil temperatures during the morning initially decrease with depth before they rise to the mean temperature of the season.

Midday

Temperatures may rise to 20 K above the atmospheric temperature as measured 2 m above ground, dependent on incoming radiation. Heat transfer is via convection (heating of the atmosphere) and heat conductance into the soil, where the temperature decreases with depth and still shows a minimum dependent on the previous night, before reaching the mean temperature of the season at greater depth.

Sunset

Surface temperature decreases with the incoming radiation, but the temperature within the soil still rises, due to the heat wave reaching the soil because of the heat flow during midday.

2.1.2.2

Modification of Environmental Radiation and Temperature by Abiotic Factors

Daily variation of temperature at the soil surface and average annual temperatures are affected by the soil conditions and its exposure (see also Chap. 4.3).

- **Heat conductivity and heat storage in soil:** Dry soils have a very low heat conductivity and warm substantially at the surface during the day due to incoming short-wave solar energy, and cool greatly during the night, as the incoming radiation is balanced by the outgoing long-wave radiation from the soil. Also in dry soils heat exchange is limited to a small volume. On limestone near Würzburg in the Federal Republic of Germany, maximum surface temperatures of 60 °C have been measured (Krause 1911). In contrast, moist soils have a high heat conductivity and heat capacity and thus a lower daily amplitude of temperature. Because of the higher evaporation on moist soils, their annual average temperatures are lower than those of dry soils.
- **Optical characteristics of surfaces:** Absorption of incoming radiation is increased on black surfaces of rock or humus; reflection is increased on white mineral soils and with snow cover. With black organic cover soil surface temperatures of more than 50 °C can be reached even in alpine climates. On organic soil exposed to the sun, the temperature tolerance of seedlings is often exceeded (e.g. beech seedlings “fall over”).
- **Exposure and slopes:** In the northern hemisphere, northern slopes receive less radiation than southern slopes, i.e. they do not warm up at midday so much (Fig. 2.1.6 A). Southern slopes receive radiation maxima according to the latitude of the site. Slopes cool less during the night than the bottom of the valley, because cold air is heavier than warm air and flows downhill into the valley. The radiation balance between a slope and the atmosphere is also more favourable during the night than the lowlands, as radiation input from neighbouring slopes positively influences the radiation balance. This is the reason that vines at their northern growth limit are planted on south-facing slopes. The climatic differences between north- and south-facing slopes in the northern and southern temperate climates

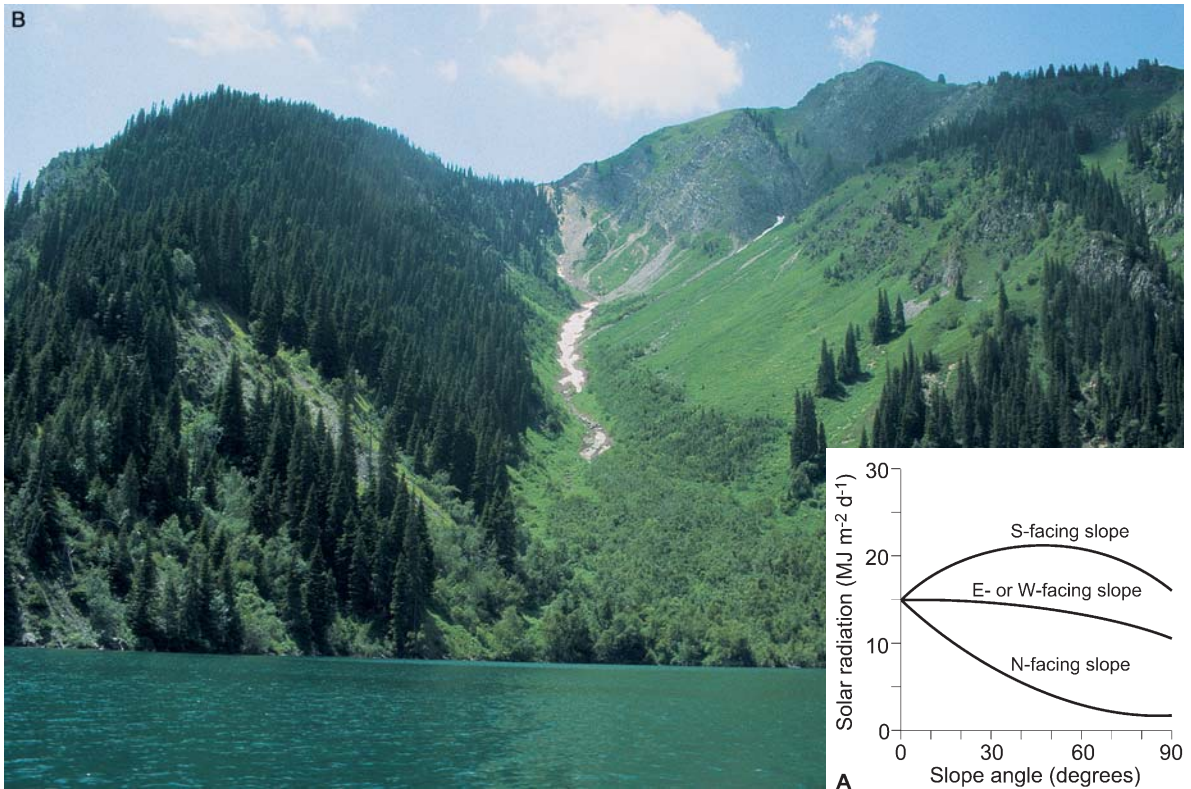


Fig. 2.1.6. A Influence of the orientation of a slope on the potential incident radiation (excluding clouds) at 55° latitude (after Jones 1994). B Sub-alpine vegetation (2500–3000 m NN) in the northernly Fergana mountain range (41°N in Sari Chilek, Kirgistan) with a natural differentiation of the vegetation on the north- and south-facing slopes: *Picea schrenkiana* of the northern slope, meadows on the south slope. The shrub vegetation (*Rosa*, *Lonicera*, *Berberis*) of the valley are a consequence of the increased snow and soil moisture. (Photo E.-D. Schulze)

may be as large so as to cause differences in the vegetation (Fig. 2.1.6B).

- **Depth and moisture of soil:** Temperatures within the soil are much more stable than at the surface, i.e. they do not vary as much. Depending on their moisture content, which determines the heat capacity, there is a clear temporal shift in changes in soil temperatures compared to air temperatures, with soils cooler than the air during spring and early summer and warmer in autumn and early winter.

2.1.2.3

Modification of Radiation and Temperature by Biotic Factors

Radiation climate and temperature at the soil surface are particularly affected by vegetation cover:

- **Reflection:** The composition of the vegetation determines its reflection characteristics. The reflection coefficient varies between 30%, e.g. for

birch forests, and 15% for conifers. The low reflection of conifer forests affects the climate at the limit of boreal forests; more radiant energy is absorbed, and thus more energy kept as heat in the stand, than on forest-free areas. The occurrence of evergreen conifers may, thus, cause a shift in the conifer tree limit to the north; the effect is compensated by the shading of roots by the evergreen canopy, which delays thawing in spring and thus shortens the growing season.

- **Radiation absorption:** The largest part of the incoming radiation is absorbed in the canopy, independent of the height of vegetation (Fig. 2.1.7 A). The radiation balance depends on the leaf area and leaf orientation. The leaf area is quantified by the **leaf area index (LAI)**, defined as the sum of the projected leaf surface per soil area. With the idealised assumption of a statistically random distribution of leaves in the canopy, the decrease of radiation (extinction) follows the Lambert-Beer law of absorption:

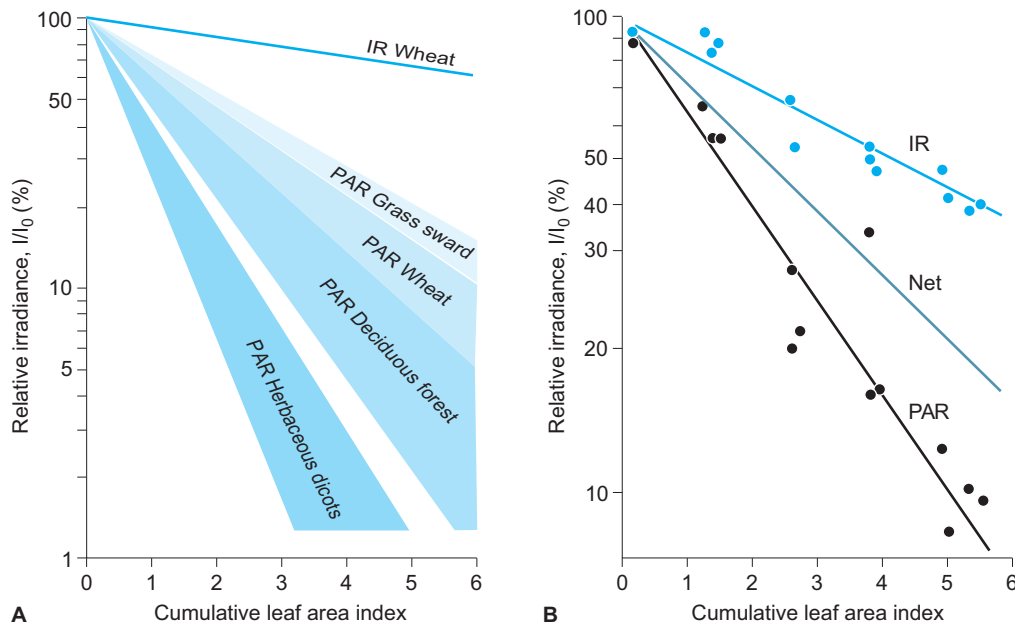


Fig. 2.1.7. A Reduction of photosynthetically active radiation (PAR) with increasing leaf area index for dicotyledonous shrubby plants (horizontal leaf position, extinction coefficient $k=0.7$), deciduous forests, wheat field and grass meadows (vertical leaf position, extinction coefficient $k<0.5$; after Larcher 1994). B Relative reduction of the light intensity of infrared light (IR), net radiation balance (net) and the photosynthetically active radiation (PAR: 400–700 nm) with the leaf area index. (Jones 1994)

$$I = I_0 e^{-kLAI}, \tag{2.1.6}$$

where I is the radiation flux at a defined site in the vegetation, I_0 is the incoming radiation above the canopy, LAI is the leaf area index above the measuring point, and k is the extinction coefficient [and corresponds thus to the absorption $(1-\epsilon)$ in the radiation balance, Eq. (2.1.2)], k varies between 0.5 for vertical leaves (e.g. grasses) and 0.7 for horizontal leaves (e.g. clover). Several species (particularly legumes) are able to move their leaves and thus the LAI is actively and variably regulated (see also Fig. 2.1.13). The “clumped” distribution of needles in conifers results in decreased absorption of light with depth in the canopy, and thus to an increased LAI (see Fig. 2.1.8).

The **extinction** of the visible, short-wave light in the canopy (which depends on the LAI) is faster than extinction of the long-wave energy flux (Fig. 2.1.7B; Jones 1994). Thus long wave radiation (heat) penetrates deeper into the vegetation than the photosynthetically active photon flux. Vegetation is only able to increase the leaf area until all visible light is absorbed, i.e. the maximum LAI is deter-

mined by the incoming radiation (available light) and the angle of the leaf. However, even with complete absorption of visible light, still a part of the IR radiation reaches the soil.

- **Climate within the vegetation:** With changes of radiation in the canopy (Fig. 2.1.8; Monteith 1973) not only the temperature, but all other meteorological factors change, particularly the saturation deficit and the turbulence. Because of mixing in the atmosphere within the canopy, temperature extremes are less than on a vegetation-free soil surface, during the day as well as at night. The gradient in the stand depends on the roughness of its surface. In coniferous forests absorption of light is less steep (related to the height of the canopy) than in cereal crops. Consequently, wind penetrates deeper into the canopy of conifers; temperatures and vapour pressures are more uniform during the day in a coniferous forest than in a cereal field. Because of the difference in coupling to the atmosphere, only in the cereal canopy is there a significant decrease in CO_2 concentration. During the night the gradients of temperature, humidity and CO_2 are reversed. Differences depend mainly on the roughness of the surface and thus on coupling to the atmosphere (see

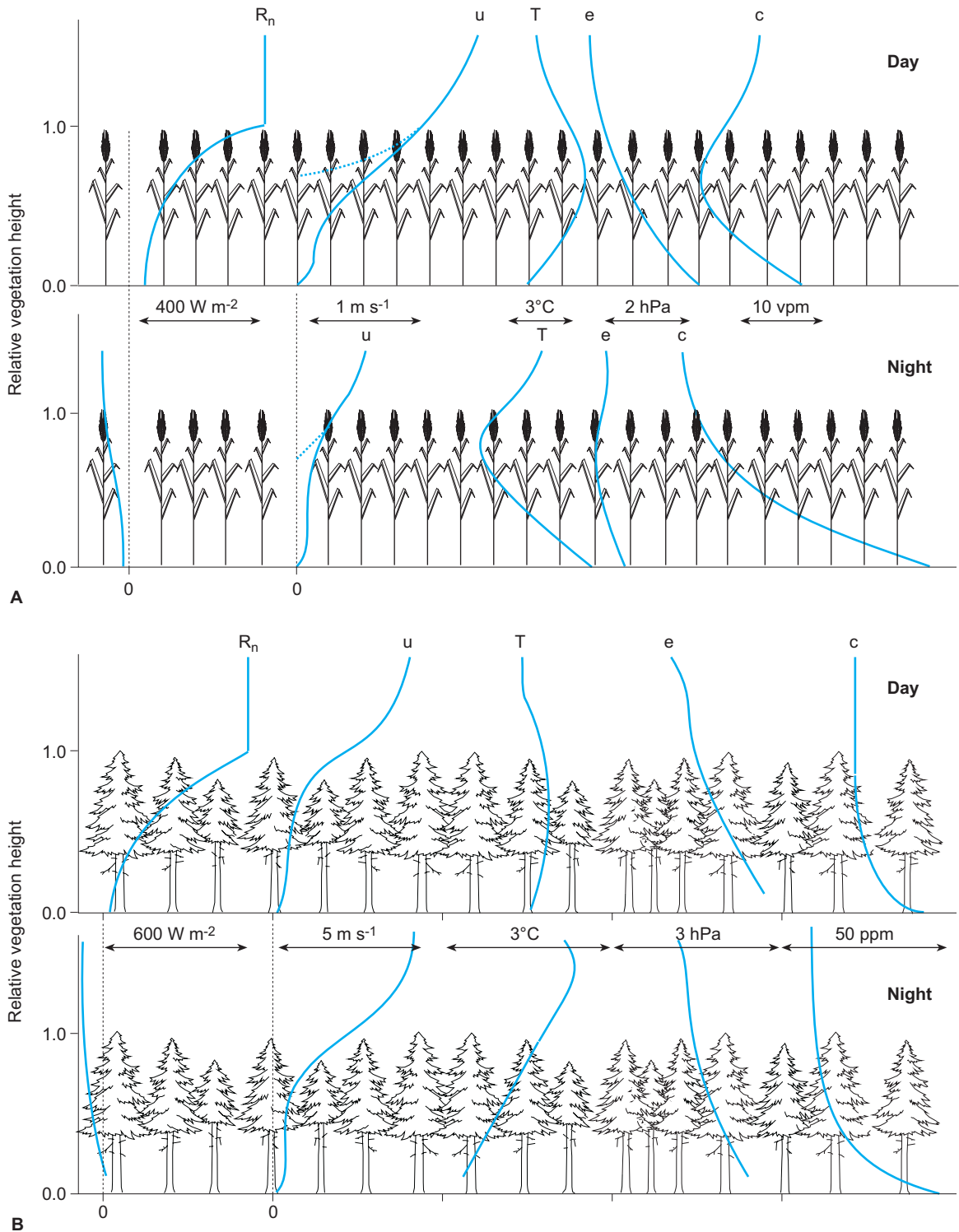


Fig. 2.1.8. Energy transformation changes the meteorological parameters during the day and night in (A) a wheat field and (B) a coniferous forest. R_n Radiation balance; u wind speed; T air temperature; e vapour pressure; c CO_2 concentration. During the day, absorbed radiation leads to a rise in temperature and an increase in vapour pressure. The CO_2 concentration is minimal at the height of the assimilating layer of leaves. The wind speed is reduced. During the night, there is a net loss of energy. This leads to the minimum temperature at leaf height. The CO_2 concentration is maximal at the soil surface. Due to the lower surface roughness, the gradient in wheat fields is more marked than in a forest. From the rise in the profile, the energy and mass balance can be calculated (wheat: after Monteith 1973; spruce: compiled by C. Rebmann)

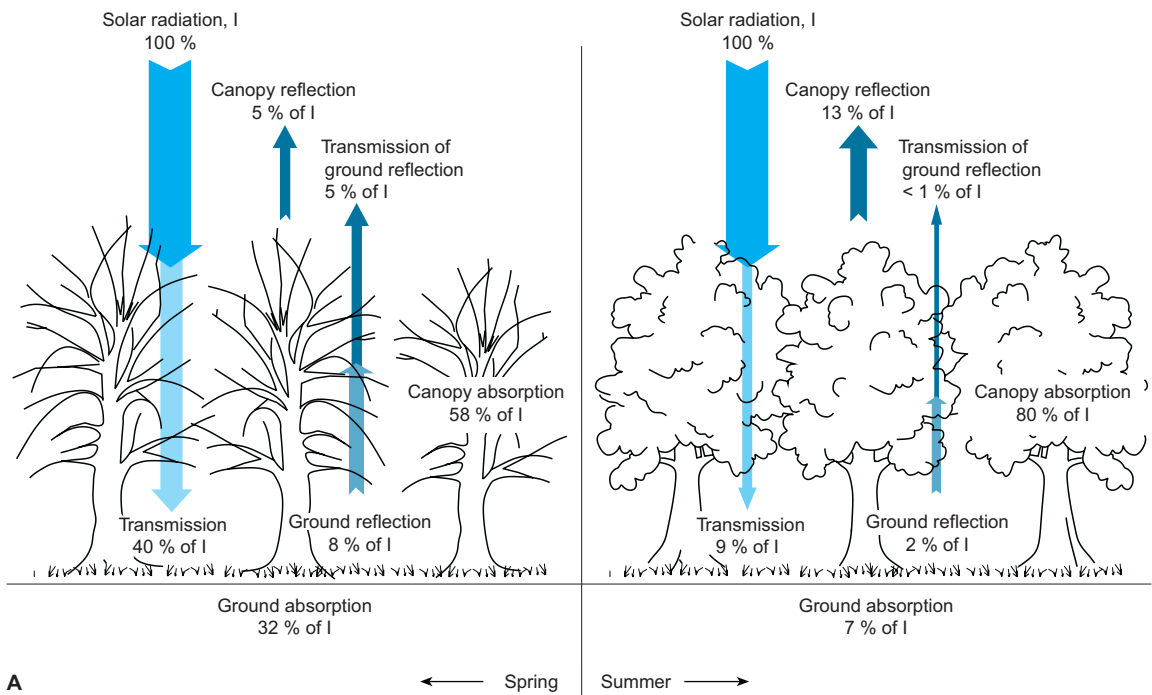


Fig. 2.1.9. **A** Radiation balance of a beech forest in spring and summer. About 40% of the incident radiation reaches the forest floor in spring. About one-third of the incident radiation is absorbed by the litter layer; this leads to a marked rise in temperature in the litter layer and thereby activating the spring geophytes. In summer the leaf canopy absorbs about 80% of the incident radiation and less than 10% reaches the forest floor. Thus the litter layer remains cool and damp (after Schulze 1982). **B** Picture showing the spring geophytes in a deciduous forest, with *Anemone nemorosa*. Picture taken close to Schweinfurt, Lower Franconia, Germany. (Photo E.-D. Schulze)

Box 2.1.3

Summary: Climate close to the ground

- Close to the ground conditions are different to those measured 2 m above the earth's surface, the meteorological climate (-10 to $+20^{\circ}\text{C}$).
- The climate in the vegetation canopy is different to that at ground level (turbulence, radiation balance).
- Vegetation, through the leaf area index (LAI) regulates the amount of incident radiation it absorbs dependent on the available visible light [$\text{LAI} = f(Q)$], leaf position and, in exceptional cases, on leaf movement (*Oxalis*, Leguminosae).
- LAI changes with season and determines the type of vegetation on the forest floor.

Chap. 2.2.4.1). In the shadow within a forest the daily fluctuations in soil temperature are thus less marked. On a cloud-free summer day the difference in temperature between an open area and inside a forest corresponds to the decrease in temperature resulting from a difference in altitude of 1000 m (see Chap. 4.3).

- **Leaf shedding:** In deciduous temperate forests there is substantial change in the surfaces receiving light energy over the year (Fig. 2.1.9 A). Before the emergence of leaves, 40% of radiation reaches the ground, with the outgoing radiation during the night being decreased because of the canopy of branches. Thus the organic layer on the ground warms up very quickly and the **spring geophytes** (Fig. 2.1.9 B; *Anemone*, *Corydalis*, *Primula* and others) develop faster than the leaves of the trees. With the emergence of leaves, 90% of the energy is intercepted in the canopy. Thus the floor of the forest remains relatively cool. The light received is not sufficient for herbaceous plants with horizontal leaves. Shade-tolerant grasses which can use diffuse indirect light, or species able to **move leaves** (*Oxalis*, see also Chap. 1.2.1), develop. Many plants in the herbaceous layer of forests rely on sun flecks resulting from gaps in the canopy (Pearcy and Pfitsch 1994). In evergreen coniferous forests the short seasonal "window", in which the sun's rays reach the floor of the deciduous forests, is missing. In evergreen forests geophytes have little opportunity to grow. Shade in the forest also delays melting of snow on the floor, and thus the beginning of the growing season, with negative effects on the water balance (see Chap. 1.3.6.10, freezing drought). Slow warming of the floor in coniferous forests may offset the positive effects on the energy balance in the canopy (high absorption of radiation); in Siberia deciduous larch forms the boreal forest limit.

2.1.3

Energy Balance of Leaves

The **energy balance of a leaf** is discussed here as an example, as it represents any organ or surface of a plant. The thermodynamic laws applicable to a leaf are basically the same as described for the atmosphere. However, additional parameters need to be considered for a leaf, namely exchange resulting from reflection of short- and long-wave light at the upper and lower side of the leaf and outgoing re-radiation from the soil to the leaf (Fig. 2.1.10; Jones 1994).

In as far as I_s represents the radiation flux to a surface at right angles to the incoming radiation and I_L the net radiation flux to a surface oriented in any direction, then

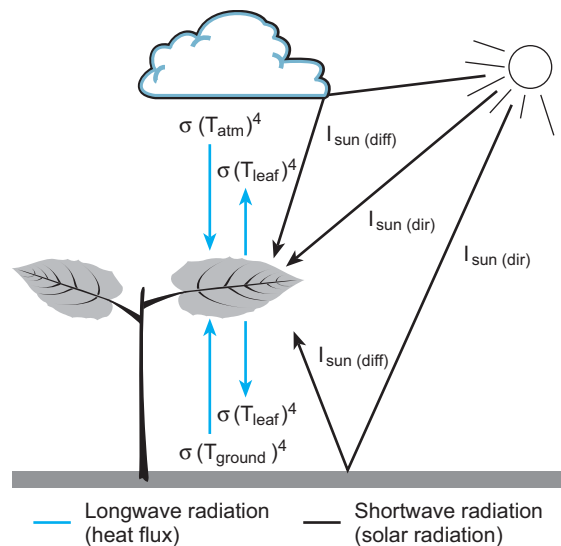


Fig. 2.1.10. Radiation balance of a leaf. I_s Radiation from the sun as direct and diffuse radiation; $\sigma(T_{\text{atm}})^4$ heat radiation of the atmosphere; $\sigma(T_l)^4$ heat radiation of the upper surface of the leaf; $\sigma(T_B)^4$ heat radiation from the soil (from Jones 1994)

$$I_L = \sin\beta I_s, \quad (2.1.7)$$

where β the angle between solar ray and object (i.e. the equation describes the energy gain on slopes, see also Fig. 2.1.6). Neglecting possible outgoing heat and storage, the following equation describes the energy gain of a leaf from absorption of short-wave radiation or from IR radiation out from the upper and lower surfaces, from the sensible and latent heat transport, and from metabolism:

$$\Phi_{\text{nleaf}} = I_L + \rho_{\text{SB}} I_L a_L + \sigma(T_{\text{atm}})^4 + \sigma(T_{\text{leaf}})^4 - 2\sigma(T_{\text{leaf}})^4 - H - \lambda E - M = 0 \quad (2.1.8)$$

Energy balance = short- and long-wave absorption - heat loss - sensible and latent heat transport - metabolism = 0

Symbols and indices are explained in Eqs. (2.1.1)–(2.1.3). The **sensible heat flux** for a leaf is:

$$H = \frac{c_p(T_{\text{leaf}} - T_{\text{atm}})}{r_b} \quad (2.1.9)$$

whereby the **boundary layer resistance**, r_b , is proportional to the length of the leaf (l) and inversely proportional to wind speed (u):

$$r_b = \sqrt{\frac{l}{u}}. \quad (2.1.10)$$

Neglecting the boundary layer of the leaf, the **latent heat flux** is proportional to the vapour pressure deficit between leaf and atmosphere (D_L) and to the **stomatal conductance** (g_s):

$$\lambda E = D_L g_s, \quad (2.1.11)$$

and g_s is dependent on D_L . So far, this relation may only be shown as a physiologically regulated, empirical function:

$$g_s = f(D_L) = \frac{1}{1 + \frac{D_L}{D_{L1/2}}} \quad (2.1.12)$$

where $D_{L1/2}$ corresponds to the vapour pressure deficit at which the stomata are half closed; g_s is measured in ventilated cuvettes. The conductivity of a non-ventilated leaf depends on the boundary layer [Eq. (2.1.8)] and is lower than g_s .

The equations for the leaf energy balance show that **leaf temperature**, although measur-

able, cannot be directly calculated (perhaps it may be interpolated as part of the energy balance), as temperature depends both on the laws of physics relating to the energy balance as well as a physiological reaction. Plants have many possibilities of regulating leaf temperature to avoid extremes and to keep it in the optimal range for physiological activity (see Chap. 1.3.2). These possibilities are:

- Short-term (modulated) responses: change of leaf position, and regulation of stomata, and thus cooling by transpiration;
- Modified responses: changes in leaf size (e.g. slitting of banana leaves with high irradiation) and LAI;
- Evolutionary (genotypic) responses: changes in the reflective characteristics of the leaf, e.g. hairs and pigment composition.

2.1.4

Adaptation to Temperature Extremes

The **limit of resistance** of plants and the maximum and minimum temperatures measured in their organs under natural conditions are generally very different (see Chap. 1.3.1). This distance from normal conditions to the limit of resistance is required, as temperatures in the organs depend on the incident radiation and may fluctuate very quickly. Threshold values for changes in metabolism (see Chap. 1.3.4) and the resistance limits should not be exceeded, even for a short time. Seedlings and organs close to the soil are particularly vulnerable to extreme temperatures. The sequence of life forms according to Raunkiaer (trees, shrubs, herbaceous plants, annuals and geophytes), with dominance of trees in the tropical regions and herbaceous plants in the temperate and cold regions of the earth, can nevertheless not be interpreted as adaptation to temperature. There are many different conditions promoting or suppressing growth of trees. The coldest place on earth (-70°C : Oimikon, eastern Siberia) is dominated by extensive forests of Siberian larch, and also in hot climates trees grow if water is available (e.g. palm trees in an oasis). The tree limit in alpine and boreal regions is caused by other factors (growing season, frost drought, anaerobic conditions in the moors of the tundra, fire). In

well-drained sites in Siberia (Chertskii) forests extend almost up to the Arctic Ocean.

There are very few examples of the limitation of **habit for plants** by temperature. One example for the distribution limits is beech (*Fagus sylvatica*). At the eastern borders it is the resistance of buds to the winter cold. The northern and western limits are caused by late frosts, whilst the southern limit is due to drought. Obviously the adaptation to – or avoidance of – extremely low temperatures is not as easy as avoidance of high temperatures, but “death from cold” may often not be differentiated from “death from drought” under field conditions (see Chap. 1.5 and Chap. 2.2).

There are many possible ways for adaptation, but more for adaptation to high temperatures than to low. In the following some examples are given which are representative for many other species and situations.

2.1.4.1

Adaptation to High Temperatures

High temperatures combined with drought lead to many adaptations at the level of the leaf,

spanning from molecular reactions (Chap. 1.3.4) to morphological changes:

- **Changes of leaf surface** (wax, hair): the genus *Encelia* comprises several species characterised by variable density of epidermal hair (Fig. 2.1.11; Jones 1994). These hairs reflect the incoming energy to different degrees (Ehleringer 1980).
- **Change in leaf size** (Fig. 2.1.12): with high solar radiation smaller leaves (microphyllly) are usually formed. In response to radiation stress the same plant may produce small sun leaves and large shade leaves (Smith 1978). A famous exception to this rule is *Welwitschia mirabilis* of the Namib Desert, which forms very large leaves that may be up to 3 m long and 1 m wide, despite the high incoming radiation. Here, the leaf temperature is regulated by convection and long-wave radiation from the cooler soil (Schulze et al. 1980).
- **Changes in leaf angle** (Fig. 2.1.13): for some plant species, particularly in the Leguminosae, the movement of the leaf plays an important role, by either moving the leaf blade towards the sun to obtain maximum photon flux, or away from the incoming radiation to minimise absorption. Classical examples are the

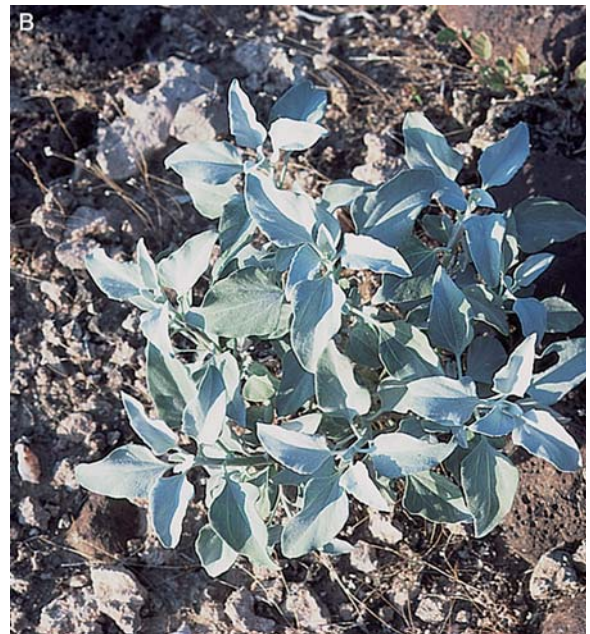
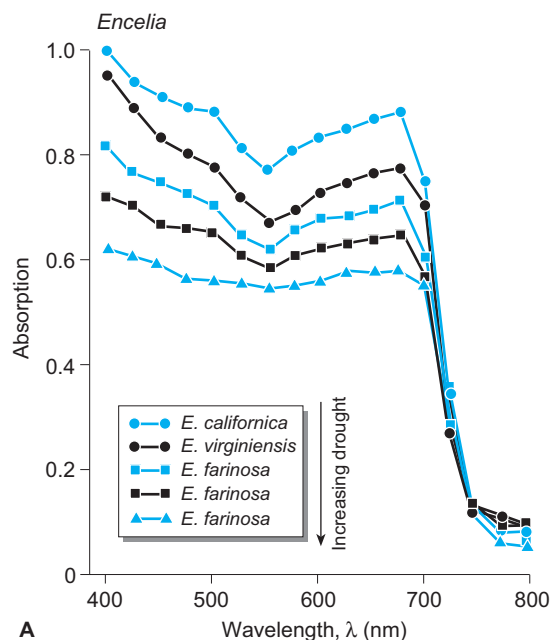


Fig. 2.1.11. **A** Effect of leaf hairs on radiation absorption of plants of five species of genus *Encelia*. With increasing amount of hairs on the surface, leaves absorb less and less radiation in the visible range. Whilst green *Encelia californica* occurs in coastal regions or where there is a good water supply, *E. farinosa* with white leaves grows on dry slopes and in the Sonora Desert (after Ehleringer, 1980). **B** *Encelia farinosa* in the Sonora Desert, south Nevada. (Photo E.-D. Schulze)

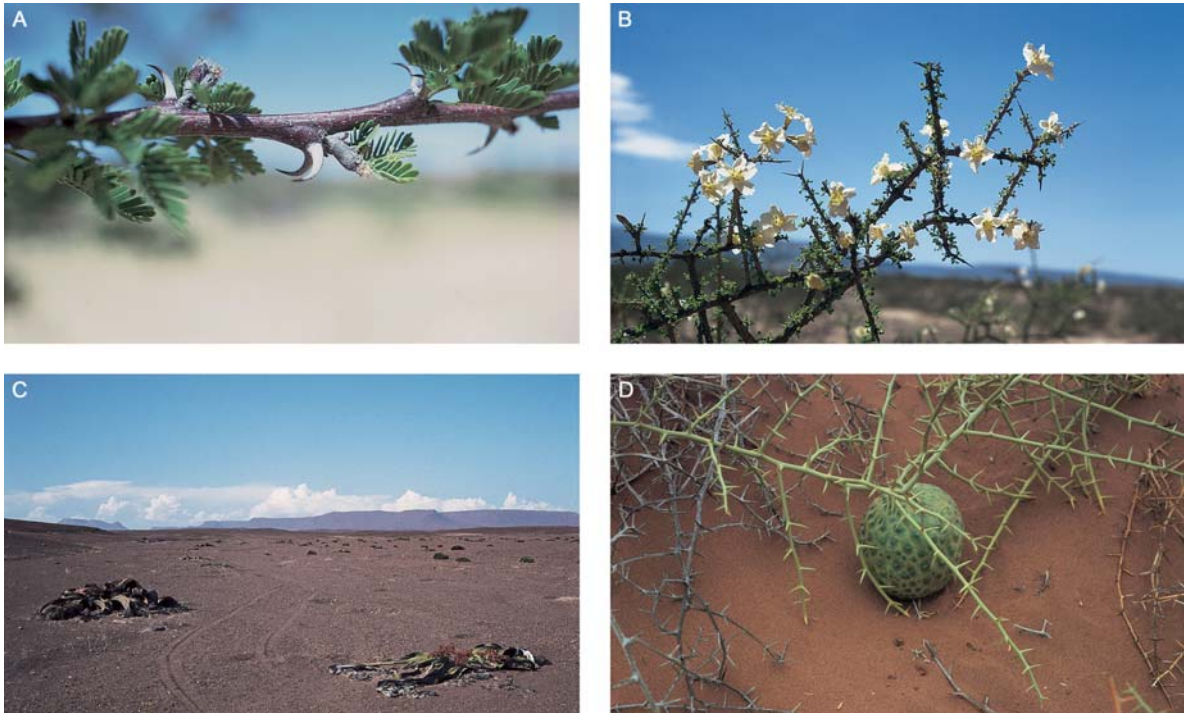


Fig. 2.1.12. Leaf morphology of plants growing in the Namib Desert: **A** pinnate leaves: *Acacia detinens*, Mimosaceae; **B** with small leaves: *Boscia foetida*, Capparaceae; **C** with large leaves: *Welwitschia mirabilis*, Welwitschiaceae; **D** photosynthetically active shoots: *Acanthosicyos horrida*, Cucurbitaceae. (Photo E.-D. Schulze)

cow pea (*Vigna unguiculata*) and the forage plant *Macroptilium purpureum*. They turn their leaves to the sun or away from it depending on water supply. In extreme cases they turn their leaves so that the plant does not create a shadow (Shakel and Hall 1979). This leaf movement changes the leaf temperature and thus the vapour pressure gradient between leaf and surrounding atmosphere. This in turn affects transpiration [Eq. (2.1.11)] and thus the water relations of the plant (see Chap. 2.2). However, even without leaf movement, the leaf angle is an important factor in the energy balance of vegetation. The hanging leaves of *Eucalyptus* are well known and the reason why eucalypt forests create hardly any shadow.

- **Changes of transpiration** (Fig. 2.1.14; Larcher 1994). *Citrullus colocynthis* is a type of pumpkin which grows near the ground in desert regions of North Africa (Lange 1959). The intact leaf transpires heavily and may have a temperature of about 40°C when the surrounding temperature of the air layer near the ground is about 53°C. This is the greatest

transpirational cooling which has been measured in the field. If the leaf is cut off, and thus prevented from transpiring, its temperature rises to more than 60°C and thus exceeds the upper limit for temperature tolerance which is around 46°C.

- **Shading:** In a free-standing tree, branches and leaves protect the stem from direct radiation. This applies particularly to subtropical dry regions, where, for example, in *Acacia*, the broad canopy shades the **base of the stem** (Fig. 2.1.15). Alternatively, there is also **antenna growth** where shoots extend as far as possible from the hot air layer near the ground. However, in this case, the hypocotyl requires protection from radiation. Even in a temperate forest, in gaps within the forest or at the edges of the forests (particularly if the forest is economically used), high temperatures may occur around stems causing damage (sun burn on beech). In contrast to the positive effects of having leaves or needles, shading may also be of disadvantage in boreal and alpine climates (see also Fig. 2.1.9).

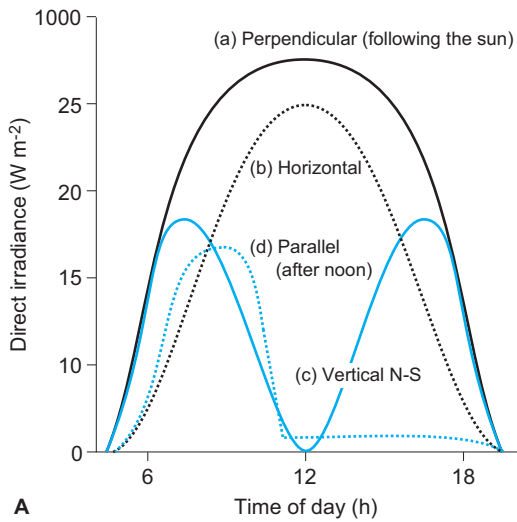


Fig. 2.1.13. A Daily movement of a leaf with changes in the incident radiation (calculated for 50°N): *a* vertical to the incident radiation and tracking the sun during the day (e.g. beans), *b* horizontal position (e.g. clover), *c* constant vertical position to the south or to the north (e.g. *Lactuca seriola*), *d* parallel to the incident radiation in the later afternoon (*Vigna unguiculata*: from Jones 1994; *Vigna*: from Shakel and Hall 1979). **B** *Macroptilium purpureum* (Leguminosae), a cultivar of Australian pastures, in time of good water availability with leaves that follow the sun. **C** During drought with leaves that are parallel to the sun and have no shadow. Experimental farm Narryen, Queensland, Australia. (Photo E.-D. Schulze)

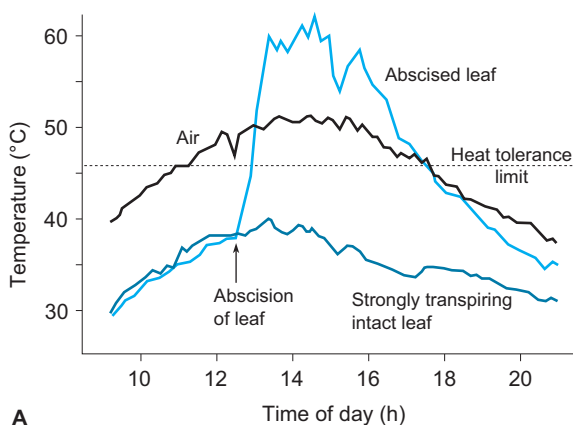


Fig. 2.1.14. A Changes over 24 h in leaf temperature of *Citrullus colocynthis* in North Africa (Lange 1959). In natural conditions a strongly transpiring leaf has a temperature about 12 K below that of air temperature. Cut the leaf off, and the temperature rises 10 K above air temperature due to the loss of the cooling effect of transpiration. The limit of heat tolerance for *Citrullus* is about 46°C, so the cooling effect of transpiration prevents death by overheating. **B** Wild *Citrullus colocynthis*, Omaruru, Namibia. It can be clearly seen that the edges of the feathery leaves roll up at midday and also positions themselves facing the sun and so minimise the incident radiation absorbed, i.e. they have no shadow. (Photo E.-D. Schulze)



Fig. 2.1.15. Shading of the trunk by the umbrella-like crown of *Acacia reficiens*. The protection of the base of the trunk is a common phenomenon in subtropical savannahs. Light sensitive, shrubby dicotyledonous plants colonise the shade surrounding the trunk, whereas the shrub-free area is colonised by C4 grasses with vertical leaves. (Photo: E.-D. Schulze)

2.1.4.2

Adaptation to Low Temperatures

There are few mechanisms to protect plants against lower temperatures and radiative cooling and thus against cooling below ambient. Therefore, molecular adaptations are particularly important (see Chap. 1.3.5):

- **Rosette plants** in Alpine climates use the warming of the soil below the rosette and the more favourable conditions on slopes. Similarly, cushion plants and so-called thorny cushions provide their own internal climates, temperature and humidity, because they minimise the surface area, and thus outgoing radiation, due to their spherical form. Branches emerging from the surface experience less favourable conditions and thus stop growth [explanation in Chap. 2.2.4 with Eq. (2.2.25)].

This leads often to thorny, short shoots at the surface.

- **Leaf inclination:** The angle of the leaf (or the angle of the bud) determines the long-wave radiation balance, particularly during the night.
- **Bud scales** are a morphological adaptation for changing the radiation balance. They raise the surface from which energy is re-radiated, away from the bud meristem and thus protect it, because of their low heat and water vapour conductances, not only against cold, but also against drying out (see Chap. 1.5). In addition the bud is round and not a flat surface, thus minimizing the surface of main heat loss to the atmosphere.
- **Heat storage:** In tropical alpine regions, the length of night frosts is limited and the days are warm. Species of *Lobelia* have a large storage of free water and this provides sufficient heat capacity so that the growing point does not freeze (see Chap. 1.3.6.7).

2.1.4.3

Summary of Plant Reactions to Temperature

- Plants exploit many possible ways to avoid heat stress (leaf position, size, surface area, transpiration, insulation).
- Plants have limited ways of avoiding cold stress (position of leaf, insulation, heat storage and heat conductance).
- Structural modifications and regulation of stomata are usually sufficient to keep the temperature of the plant within the physiologically acceptable range and away from damaging temperatures by latent heat loss.

Box 2.1.4

Summary: Leaf temperature

The following factors are important in regulation of leaf temperature:

- **Leaf position** (direction of organs as energy-absorbing and energy-emitting surfaces) and leaf area index (shading);
- **Size of organs** (avoidance of laminar boundary layer and regulation of the sensible heat flux);
- **Insulation** (bud scales, bark);
- **Evaporation** (regulation of the latent heat flux);
- **Heat dissipation** and storage of heat have in particular climatic conditions an additional function (afro-alpine rosette plants, cacti);
- Warming by increased **respiration** is important only under particular conditions (flower spathes of Araceae), but may generally be neglected.

- There are very few documented examples of limitation of plant geographical distribution based only on temperature. The critical period is mostly germination.
- Although global vegetative models use, to a large extent, temperature as the factor determining plant distribution, other factors (salt stress, drought and fire, length of vegetative periods, imbalance between temperature in the soil and in the atmosphere, drought because of freezing) limit distribution to a much larger extent than just temperature.

References

- Bishop JKB, Rossow WB (1991) Spatial and temporal variability of global surface solar irradiance. *J Geophys Res* 96:16839–16858
- Ehleringer JR (1980) Leaf morphology and reflectance in relation to water and temperature stress. In: Turner NC, Kramer PJ (eds) *Adaptations of plants to water and high temperature stress*. Wiley, New York, pp 295–308
- Gates DM (1965) *Energy exchange in the biosphere*. Harper and Row, New York, pp 151
- IPCC – Intergovernmental Panel on Climate Change (1996) *Climate change 1995: the science of climate change*. Cambridge University Press, Cambridge New York, 572 pp
- Jones HG (1994) *Plants and microclimate; a quantitative approach to environmental plant physiology*. Cambridge University Press, Cambridge, 428 pp
- Kraus G (1911) *Boden und Klima auf kleinstem Raum; Versuch einer exakten Behandlung des Standortes auf dem Wellenkalk*. Gustav Fischer, Jena, 184 pp
- Lange OL (1959) Untersuchungen über den Wärmehaushalt und Hitzeresistenz mauretanischer Wüsten- und Savannenpflanzen. *Flora* 147:595–651
- Larcher W (2003) *Ecophysiology of plants*. 4th ed. Springer Berlin Heidelberg New York, 433pp
- List RJ (1971) *Smithsonian meteorological tables*. Smithsonian Institution Press, Washington, DC, 527 pp
- Lutgens FK, Tarbuck EJ (2000) *The atmosphere: An introduction to meteorology*. 8th ed. Prentice Hall. Upper Saddle River, NJ, 484 pp
- Mitchell JFB (1989) The greenhouse effect and climate change. *Rev Geophys* 27:115–139
- Monteith JL (1973) *Principles of environmental physics*. Edward Arnold, London, 441 pp
- Norris DR, Rohl U (1999) Carbon cycling and chronology of climate warming during the Palaeocene/Eocene transition. *Nature* 401:775–778
- Pearcy RW, Pfitsch WA (1994) The consequences of sunflecks for photosynthesis and growth of forest understorey plants. *Ecological Studies* 100. Springer, Berlin Heidelberg New York, pp 343–360
- Schulze E-D (1982) Plant life forms and their carbon, water and nutrient relations. *Encycl Plant Physiol* 128:616–676
- Schulze E-D, Eller BM, Thomas DA, Willert DJ von, Brinckmann E (1980) Leaf temperatures and energy balance of *Welwitschia mirabilis* in its natural habitat. *Oecologia* 44:258–262
- Shakel KA, Hall AE (1979) Reversible leaflet movements in relation to drought adaptation in cowpea, *Vigna unguiculata* (L.) Walp. *Aust J Plant Physiol* 6:265–276
- Smith WK (1978) Temperatures in desert plants: another perspective on the ability of leaf size. *Science* 201:614–616
- Stott PA, Tett SFB, Jones GS (2001) External control of 20th century temperature by natural and anthropogenic forcings. *Science* 290:2133–2137
- Veizer J, Gooderis Y, Francois LM (2000) Evidence for decoupling of atmospheric CO₂ and global climate during the phanerozoic. *Nature* 408:689–701
- Wallace JM, Hobbs PV (1977) *Atmospheric science: An introductory survey*. Academic Press, San Diego, 467 pp
- Walter H (1960) *Grundlagen der Pflanzenverbreitung. Teil I Standortlehre*. Ulmer, Stuttgart, 566 pp
- WBGU (1997) *World in transition. Ways towards sustainable management of freshwater resources*. Springer, Berlin Heidelberg New York, 392 pp

2.2

Water Relations of Plants



“Funnel” oases near El Qued, Algeria, northern Sahara: About 10 m of sand is removed in bags on donkeys. The limestone crust of an additional 10 m is broken and removed to reach a layer of loose material in which fresh water is found at a depth of about 4–6 m. On the sandy material typical oasis plants (date palms, pomegranates) and vegetables are grown; water is supplied by wells. The funnel is protected from refilling with sand by a series of concentric circles of dry leaves of date palms which are placed on the perimeter. These trap sand that is blown inwards from the desert. The outer ring is visible on the photograph. The oasis has a total diameter of approx. 1 km. Thus, the donkey moved about 7 million m³ per garden. Despite the rings of date leaves, permanent removal of sand that is blown in by wind is still necessary (Photo E.-D. Schulze)

Recommended Literature

The classical textbook on water relations of plants is by Slatyer (1967). Lange et al. (1982) devoted one volume of the *Encyclopaedia of Plant Physiology* to “water”. Noble (1991) treats the physical-chemical basis of water transport. Kramer and Boyer (1995) is a comprehensive treatment of the water relations of plants and soils.

2.2.1

Water as an Environmental Factor

2.2.1.1

Water Consumption and Plant Production: Comparison of Plant Types with Differing Water Economy

Life on earth developed in water and despite evolution over many millions of years, today as then, all living processes with their underlying biochemical reactions are only possible in the aqueous milieu (see also Chap. 1.5). Most land plants in their active state do not tolerate any drying out. This is illustrated by the **water content**: In the active state the protoplasm of most

leaves and fruits contains 0.85–0.90 g H₂O g⁻¹ FW (fresh weight). The water content of wood decreases to about 0.50 g H₂O g⁻¹ FW because of the high percentage of dead water-conducting tissue in the xylem. Lowest values are reached in ripe seeds: 0.05–0.15 g H₂O g⁻¹ FW.

Land plants must keep the water content of cells close to or fully saturated in relatively dry air, and still maintain exchange of CO₂ with the air in order to photosynthesise. Life outside water brings benefits as well as dangers for plants for the following reasons:

The **diffusion coefficient** of CO₂ in air is about $0.14 \times 10^{-4} \text{ m}^2 \text{ s}^{-1}$ and decreases in water to $0.16 \times 10^{-8} \text{ m}^2 \text{ s}^{-1}$. Thus, CO₂ diffuses in air 10,000 times faster than in water (Sestak et al. 1971). However, it must be considered that the CO₂ concentration in the Lower Devonian, the period of first settlement of plants on land, was significantly higher (ca. 4000 ppm) than today (ca. 370 ppm).

During the evolution of plants, no membrane was “invented” which is permeable to CO₂ but remains impermeable to H₂O vapour. Even in the future, there will not be a type of “GoreTex” for CO₂ because the molecular weight of CO₂ is larger than that of H₂O (44/18). Of course, it was the availability of CO₂ in the atmosphere that provided the incentive for plants to adapt

Table 2.2.1. Water use and resources acquisition (CO₂ in plants and O₂ in animals) at 20 °C and 50% relative humidity and taking into account the diffusability of gases which depends on their molecular weight. A human with a body temperature of 36.6 °C acts as an example for the animal kingdom

	Plants		Human	
	CO ₂	H ₂ O	CO ₂	H ₂ O
Concentration (ppm)				
– in the atmosphere	350	12 000	210 000	12 000
– in the mesophyll or in breathed air	250	24 000	160 000	62 000
Gradient	100	12 000	50 000	50 000
Relationship between H ₂ O/CO ₂ or H ₂ O/O ₂	192		13	

from life in water (algae) to life on land. However, in order to use this advantage, mechanisms had to be developed to regulate the water relations of land plants.

Water relations are more important for land plants than for animals because of the **chemical constitution of air**: as plants photosynthesise, a CO₂ gradient of the magnitude of 100 ppm (Table 2.2.1) develops between the atmosphere and the mesophyll. At the same time, there is a gradient of water vapour of about 12,000 ppm between the water-saturated mesophyll cell walls and the ambient air. CO₂ diffuses 1.6 times slower than H₂O vapour; the rate is related to the square root of the molecular weights (CO₂ 44, H₂O 18 and $\sqrt{44/18}=1.6$). Thus a mole of CO₂ taken up loses the plant almost 200 mol H₂O ($12,000 \times 1.6/100=192$) and so the **water consumption** of plants is very high, relative to the photosynthetic gain.

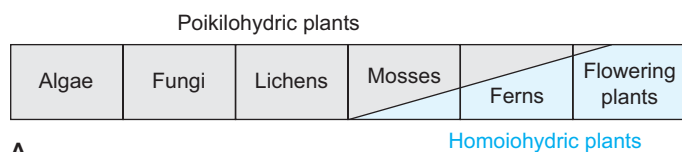
For **mammals** (warm-blooded with a body temperature of 37 °C) it is quite different: With 210,000 ppm O₂ in the atmosphere and 160,000 ppm O₂ in the breath the O₂ gradient is 50,000 ppm and the air breathed out is water-saturated. Thus there is under the same conditions for humans as well as for plants a water vapour gradient to the atmosphere of 50,000 ppm. However, a warm-blooded animal loses only about 1 mol H₂O per mole of O₂ taken up. The water loss related to O₂ uptake for cold-blooded animals is even lower (about 0.2), i.e. water use related to O₂ gain is comparatively low.

As the loss of water from plants is so rapid, it is usually not cost-effective to have **water storage** (see also Chap. 1.5.1). A sunflower leaf loses in a day about ten times its own weight of water and a forest tree loses about 100–1000 l water, more than is available in the stem of a 25-m-high spruce. This means that the costs of providing organs for water from storage sufficient

to safeguard the supply in arid regions over days or months would be unprofitably large. There are some species of cacti, euphorbias and mesembryanthemums which live transiently on water stored in cell vacuoles (e.g. *Oppophyllum* or *Prenia*); but their biomass production is very low. Even the baobab tree (*Adansonia digitata*) is hardly able to use the water stored in the stem (Schulze et al. 1998b), as the wooden structure is so rigid that it is not able to shrink: The function of the thickened stems of baobab trees is probably to store carbohydrates and amino acids. For 25-m-high spruce trees the available water storage in the stem is only sufficient to maintain transpiration in the humid morning hours for about 2 h (Schulze et al. 1985).

During the evolution of plants, two strategies of water use developed in plants (Fig. 2.2.1):

1. **Desiccation tolerant, poikilohydric** (variable water content) organisms respond similarly to purely physical systems which absorb water and swell to an extent depending on the humidity in the air. When dry plants are exposed to moisture from rain, dew, or high humidity, they become fully active. They dry out with decreasing humidity and lack of water and become dormant during that time. In this cycle of adjustment, there is an optimum water status. If the organism (e.g. a lichen) is too wet, diffusion of CO₂ from the atmosphere is restricted and the rate of photosynthesis decreases with high water contents (see Fig. 2.4.13). Metabolism is restricted to the period when only the tissue and not the intercellular spaces is water-saturated. The most important representatives of this type of water use are algae, lichens and mosses (Fig. 2.2.1A). They are not differentiated into organs for absorption or structures that prevent loss of water. Amongst flowering plants,



A



Fig. 2.2.1. A Schematic presentation of the occurrence of desiccation-tolerant (poikilohydric) and non-desiccation-tolerant (homoiohydric) plant types. B Lichen growth dominated by *Teloschistes* sp. with almost no higher plants in the coastal region of the fog desert of Namibia

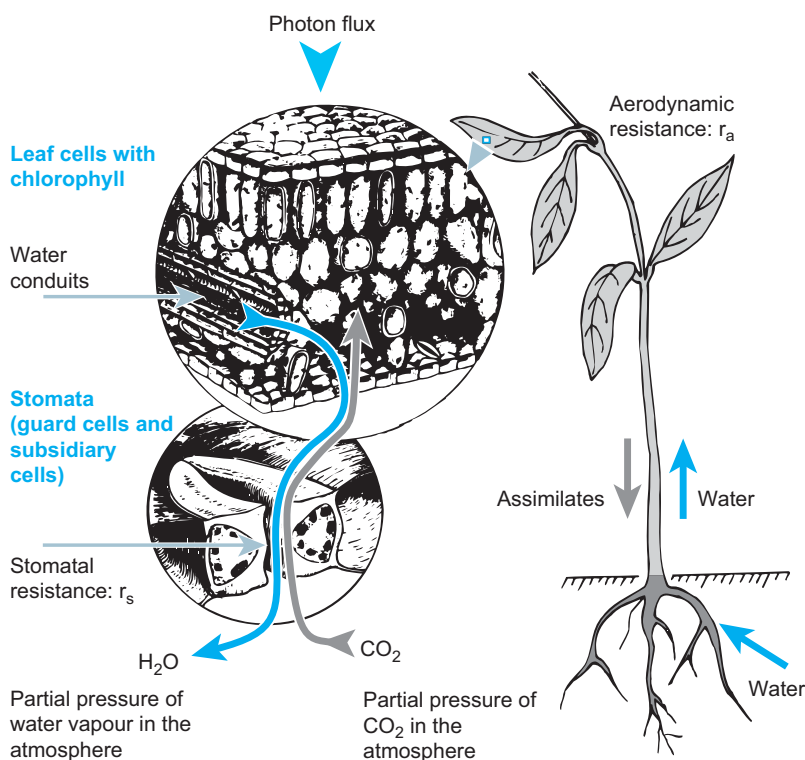


Fig. 2.2.2. The flow of water and assimilates in cormophytes. Vascular plants are specialised by organs for CO_2 , water and nutrient uptake. These are connected via the stem which conducts the water and assimilate flows. In the stem water and assimilates are transported by mass flow, in the leaf there is a phase transition from liquid water to water vapour. At the same time, CO_2 is assimilated into soluble organic substances. Diffusion between the inside of the leaf and the atmosphere is controlled by the stomata. (Evenari et al. 1982; WBGU 1998)

there are also a few species which may be capable of desiccation, e.g. *Myrothamnus flabelliformis* from the Namib Desert (Ziegler and Vieweg 1970; Bewley and Krockho 1982). These species, however, differ from the lower plants in that they may dry out, but are not activated by dew and high humidity as their cuticle prevents water uptake via the shoot. In these species activation is solely by water uptake through roots.

2. Non-desiccation tolerant, homoiohydric plants (high water content). These cormophytes are able to maintain living tissue in the state of a high water content independent

of dry conditions in the surrounding atmosphere. There is a division of labour between organs (Fig. 2.2.2) which are specialised in uptake of water (roots), transport of water (xylem in the trunk or stem), and organs from which water evaporates simultaneously with absorption and assimilation of CO_2 (leaves, phyllodes, phylloclades). Homoiohydric plants have large vacuoles in their cells, functioning, amongst other things, as buffers for the cellular water supply and thus stabilise the cell and plant water balance (Chap. 1.5). The leaf surface is covered with a cuticle, practically impermeable to CO_2 and H_2O . The

leaf is connected to the free atmosphere only by stomata whose aperture can be regulated. By forming cuticles and stomata, the plant's ability to absorb water vapour from the air in above-ground organs is lost, as is the ability to desiccate and to be rehydrated. However, one developmental stage of intensive dehydration of cells remains also in these homoiohydric plants – the seed.

The expansion of plants into terrestrial habitats, even under extreme edaphic and climatic conditions, was only possible because of the division of labour between organs and by stabilising the cellular water relations through the formation of vacuoles. However, because of their cuticle, higher plants have lost the ability to utilise dew and water vapour from air at high humidity. Where such conditions exist, e.g. in the fog desert of the Namib (no precipitation except dew), higher plants are inferior to lower plants (Fig. 2.2.1 B).

In the following, we will deal predominantly with homoiohydric plants, as they form the largest part of the terrestrial flora and possess control mechanisms beyond stress physiological adaptations. Chapter 1.5 considered the biochemical basis for the plant's response to lack of water.

2.2.1.2

Availability of Water on Earth

The hydrological balance of different parts of the earth's surface provides the overall conditions for plant growth (Ward and Robinson

1990). Disregarding changes of water storage in the soil, the water balance consists of precipitation (P), evaporation (E) and river discharge (F), which is fed by surface runoff and seepage.

$$P - E - F = 0 \quad (2.2.1)$$

The global distribution of precipitation is determined by the position of the sun and the global circulation of air masses; the result is high precipitation in the tropics, a minimum of precipitation around the tropics and increased precipitation in the temperate latitudes, also determined by distance from the oceans (**oceanity**) and the size of the continents (**continentality**). The gulf stream also provides favourable conditions for the eastern part of the Americas, as well as for Europe. In the higher latitudes of the Arctic and Antarctic precipitation decreases again.

Surface evaporation (E_G), where there is sufficient moisture, depends primarily on the available energy (I_G) at the ground surface (Philip 1957).

$$\lambda E_G = \varepsilon I_G / (\varepsilon + 1) \quad (2.2.2)$$

where λ is the latent heat of evaporation of water (2.454 J kg^{-1} at 20°C) and ε the change in amount of water vapour relative to the heat content in water vapour saturated air at air temperature (1.27 at 10°C). With drying of the ground surface an additional boundary layer resistance must be considered (see Chap. 2.2.7). If the ground surface is covered by plants, free evaporation only occurs after precipitation, when the so-called **intercepted water** (the

Box 2.2.1

Summary: Water use and productivity of plants with different types of water economy

- The **chemical composition of the atmosphere** is the reason that animals living on land have more favourable water use during oxygen exchange in respiration than do plants during CO_2 exchange in photosynthesis.
- **Water storage** to support transpiration is uneconomic in the longer term. Therefore, water storage is part of the survival strategies of only a few specialists.
- **Desiccation tolerant and non-tolerant plants** represent different strategies to cope with dry atmospheres, with poikilohydric plants gaining competitive advantage in conditions where dew fall is frequent. (There are many lichens in the Namib Desert but few in the Sahara.)

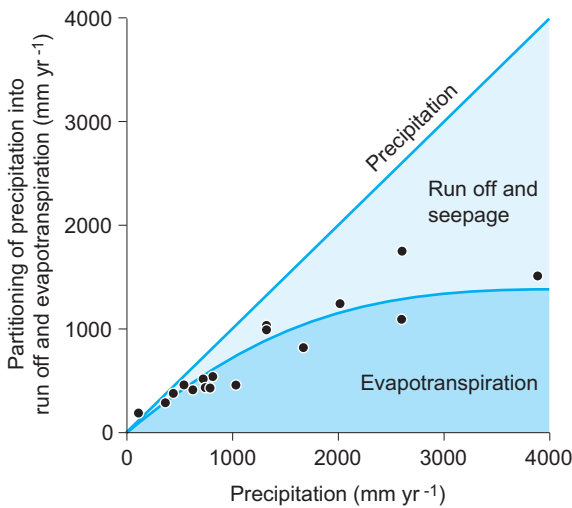


Fig. 2.2.3. The relationship between run-off and evaporation of precipitation (after Schulze and Heinmann 1998). Evaporation reaches a maximum that depends on the incident radiation. Thus the proportion of water that runs off or penetrates into the soil increases with increasing rainfall

amount of precipitation captured in the canopy and not reaching the ground) evaporates. In spring, before plant cover is achieved, arable fields lose water as if it was an open wet surface until the top soil layer dries off. The rate of evaporation decreases as the crop grows (Greenwood et al. 1992). **Transpiration** describes the amount of evaporation lost from the plant, and it is thus subject to physiological control. However, evaporation from the ground also occurs in a closed stand, dependent on the leaf area index (Schulze et al. 1995). The sum of free evaporation and transpiration is called **evapotranspiration**. The global distribution of evapotranspiration shows a maximum in the tropical regions and roughly follows the distribution of precipitation. However, evapotranspiration is additionally influenced by available solar radiation and

mean wind speed (see Chap. 2.2.7). Evapotranspiration decreases with decreasing available solar energy in the higher latitudes (north and south). In humid climates about 30% of the precipitation evaporates and 70% is lost in **surface runoff and seepage**.

From the water balance and the temperature, **climate zones** were defined by Köppen (1923), who, however, oriented his climate types also in relation to vegetation maps (e.g. those of Grisebach 1872).

Considering the dependence of evapotranspiration on precipitation, Fig. 2.2.3 shows that evapotranspiration does not increase without limits, but follows a saturation curve, with **discharge** making up a larger proportion of the total precipitation as precipitation increases. Even under extremely low precipitation vegetation does not consume the total amount of precipitation, as in arid climates precipitation occurs as heavy rainstorms, with massive runoff. This water is thus not available for plants at the site of rainfall, but may merely serve plant growth somewhere downhill or reach the ocean.

2.2.1.3

Transport of Water Between Soil and Atmosphere

In soils and plants, water is not freely available but bound to molecules or surfaces to a greater or lesser extent. The following distinctions are made:

- **Constituent water:** this water is formed into organic molecules as H^+ or OH^- .
- **Hydration water:** the layer of water molecules that is arranged as dipoles around ions is called hydration water. The strength of the binding increases with the charge and de-

Box 2.2.2

Summary: Water availability

- Precipitation, evaporation and run off determine **the water balance**.
- Water loss includes **evaporation**, which is determined by the chemico-physical conditions in the atmosphere and **transpiration** from plants, which is regulated by physiological processes. Evaporation and transpiration are combined in the term **evapotranspiration**.
- Evaporation from the earth's surface depends primarily on available radiation.
- Global temperature distribution and hydrological balance determine **climatic regions** and thus the distribution of vegetation on earth.

creases with radius of the hydrated ion. Thus Na^+ has a larger hydration shell than K^+ (Lüttge 1973). There are hydration shells for all polar groups in organic molecules. Five to 10% of the total water in a leaf is thereby not freely available.

- **Capillary water:** in cell walls, as well as in the fine pores, water is subject to capillary forces. The rise of the water column in a capillary (h , measured in m) is, as a first approximation, inversely proportional to the radius (r) of the capillary, because the water mass and the gravitational force effecting it ($\pi h \rho g$) must be balanced against the cohesive force produced by the surface tension ($2\pi r \sigma_w$). Neglecting the contact angle a ($\cos a = 1$), the following applies (Nobel 1991, p. 55)

$$\pi h \rho g = 2\pi r \sigma_w \quad (2.2.3)$$

where h is the height in m to which the water column rises, ρ is the density of water (998 kg m^{-3} at 20°C), g the acceleration of the earth (9.8 m s^{-2}), r is the radius of the capillary (m), and σ_w the surface tension of water (0.0728 N m^{-1} at 20°C).

Thus the pressure in a capillary, the so-called **capillary force** is:

$$P = h \rho g = 2\sigma/r (\text{Nm}^{-2}) \quad (2.2.4)$$

and the height of the meniscus is calculated as:

$$h = 2\sigma_w / (r \rho g); h = (1.5 \times 10^{-5} / r) \quad (2.2.5)$$

In a clean (lipid-free) glass capillary $3 \mu\text{m}$ in diameter ($1.5 \mu\text{m}$ radius), water rises to 10 m. In a xylem vessel of $30 \mu\text{m}$, typical for tracheids of conifers, water rises by capillarity by only 1 m and in the $300 \mu\text{m}$ trachea of deciduous trees the water rises only 0.1 m via capillarity. This means that the capillary force is not sufficient to lift water into the canopy of trees and thus does not provide the lifting power required for flow of water (see Chap. 2.2.2).

- **Storage water:** this water is osmotically bound, e.g. in the vacuole (see also Chap. 1.5). The osmotic value (Π , measured as MPa) depends on the number of particles per mole (n), the concentration (c_n), the gas constant R ($8.3144 \text{ Pa m}^3 \text{ mol}^{-1} \text{ K}^{-1}$) and the temperature (T in K):

$$\Pi = n c_n R T = 2.27 c_n \quad (2.2.6)$$

Π of a 1 molar solution of an undissociated solute at 0°C is 2.27 MPa and at 20°C 2.43 MPa.

The osmotic value is generally expressed as pressure, in MPa, based on an experiment which also demonstrates the phenomenon of osmosis: A closed chamber is divided into two compartments by a semipermeable membrane which allows passage of water molecules but it is impermeable for ions. One compartment of the chamber is filled with distilled water, the other with a salt solution. To balance the difference in concentration of both solutions only free water is able to flow into the chamber with the salt solution, so building up a hydrostatic pressure there (i.e. the level of water rises in comparison to the free water in the neighbouring part of the chamber). The height of the water column corresponds to the osmotic value, which is therefore called the **osmotic pressure**.

The flow of liquid between soil, plant and atmosphere is based on several forces. In order to describe the flow between the very heterogeneous compartments of the environment it is necessary to quantify the availability of water uniformly. This is possible by the definition of a common force for water transport, the **water potential**, Ψ (see also Chap. 1.5):

$$\Psi = (\mu_w - \mu_o) / V_w = (V_w / V_w^o) \Pi \quad (2.2.7)$$

where μ_w is the chemical potential in the system (J mol^{-1}) and μ_o is the chemical potential of a reference system, i.e. of pure liquid water at a given temperature and at normal pressure (atmospheric pressure). By dividing the difference in the chemical potentials ($\mu_w - \mu_o$) by the molar volume of liquid water (V_w) the water potential is defined in units of pressure. Thus, the water potential describes the driving force for water movement in a practical way because pressures can be easily measured. V_w is slightly dependent on temperature and pressure, but this is normally neglected. V_w^o expresses the molar volume of pure water.

In the gaseous phase the water potential is proportional to the relative humidity:

$$\Psi = RT \ln(e/e_o) / V_w \quad (2.2.8)$$

where e/e_o expresses the vapour pressure of bound water (e.g. in solution or solid material)

relative to that of free water, and thus corresponds to the relative humidity. The right side of Eq. (2.2.5) is also called **water activity**, describing, e.g., the degree of swelling of colloids and thus characterises the conditions for life of microorganisms or poikilohydric plants. As the chemical potential of bound water, μ_w is lower than that of free water, μ_o (energy has to be added to change, e.g. bound water in a salt solution into the state of free water), the water potential has a negative sign. Water movement occurs from sites with high potential to sites with low potential.

Water potential describes

- the state of water of plants or particles, and
- the driving force for the movement of water.

Using water potential it is possible to describe water in single-phase systems (e.g. in a plant) as well as in phase transitions (e.g. evaporation of a leaf; see Chap. 1.5, Fig. 1.5.1). In a cell with good water supply, the osmotic pressure is compensated by the counter pressure of the cell wall, the turgor pressure, P_c , the water potential is zero. With decreasing water content the turgor pressure sinks, the osmotic pressure rises because of the increasing concentration of the residual solution in the cell and the difference, $\Pi - P$, corresponds to the water potential, Ψ , which becomes increasingly more negative. Thus, in a tissue, water flows, e.g., from the cell wall into this cell. If desiccation of the cell continues and water potential becomes equal to the osmotic pressure ($\Pi = -\Psi$), then plasmolysis starts.

The water balance of the cell is given by the equation:

$$\Psi = P_c - \Pi - \tau + \rho gh \quad (2.2.9)$$

where τ represents the binding force in the membrane-free matrix of the cell wall (the so-called **matrix potential**, see Chap. 2.2.2.1 and Chap. 1.5) and ρgh the water pressure, with ρ the density of water, g the gravitational force (9.807 m s^{-2} at 45° latitude) and h the height of the meniscus [m; see Eq. (2.2.4)].

Equation (2.2.9) shows that water potential is dependent on osmotic pressure, the chemical binding of water, and surface properties and on gravity, particularly important for tall trees. The matrix potential is an analogous value to Π , but in this case the value is dependent on surface forces and not on the number of particles in the solution. In the literature, the osmotic pressure is often also called osmotic potential and the

numerical value is given as a negative number. It is basically only a different formulation of the same process. We use the term osmotic pressure because it creates a positive pressure.

If the water potential between plant, soil and air is balanced, there is no evaporation. In nature this state occurs particularly in the early morning, before dawn. Therefore, the **early morning water potential**, Ψ_{predawn} , in a plant is used to characterise the water conditions of the soil in the zone from which the roots gain their water. With transpiration, a gradient in water potential develops between soil and atmosphere, which may be up to 100 MPa.

In the continuum of water transport between soil and atmosphere, water follows the potential gradient (from high to lower potential, i.e. to increasingly more negative values), whereby the flow rate is limited by resistances which are dependent on the characteristics of the soil and the types of tissue. In addition there is a phase transition in the leaf from the liquid to the vapour phase, with the rate of diffusion in the vapour phase determined by the water vapour pressure of the atmosphere (e/e_o). In the **soil-plant-atmosphere continuum** (SPAC), the highest water potential gradient is between the surfaces of the cell walls in the mesophyll of leaves where water evaporates and the external air, because the hydraulic resistance is highest there.

2.2.2

Water Transport in the Plant

2.2.2.1

Water Uptake

Precipitation seeps through the soil profile into the groundwater. Only the water stored in pores is retained in the soil. Amount and rate of water movement in the soil are dependent on the type of soil, the size of pores and the water saturation. The **field capacity** describes the content of water which is retained against gravity, i.e. it is the amount of water that does not drip out of a flower pot after watering. However, this water is only partially available for plants, because a proportion is firmly bound as hydration water or capillary water. The amount of bound water depends on the **matrix potential** (Ψ_m) of the soil [see Eq. (2.2.9)] and, neglecting the influence of the angle at the wall of the capillary, is deter-

Box 2.2.3 Summary: Water as an environmental factor

- Water in soils and tissues is not freely available, but bound by chemical, capillary and osmotic forces (**matrix and osmotic components of water potential**).
- **Water potential** describes the state of water in homogeneous and heterogeneous systems. It is a measure of the energy which must be expended to convert bound water to the state of free water. Water flows from a compartment with higher to one of lower water potential.
- Cells regulate their water status by altering the **osmotic potential** (see Chap. 1.5.2.6) and thus maintain positive **turgor**.
- In plants, the greatest change in potential occurs between the mesophyll and atmosphere (**stomatal conductance**, see Chap. 2.2.3) and the most important regulation of plant water status occurs there, regulating water loss.

mined by the surface tension of water ($\sigma = 7.28 \times 10^{-3} \text{ N m}^{-1}$) and the radius of the soil capillaries [m ; see Eq. (2.2.4)],

$$\Psi_m = -2\sigma/r; \tau = 2\sigma/r \quad (2.2.10)$$

with the unit $\text{N/m}^2 = \text{Pa}$.

In pores of 5 nm, which occur in the cell walls of higher plants, the matrix potential reaches 3.0 MPa and decreases in vessels with a radius of 500 μm (xylem vessels of ring-porous woods) to only 30 Pa (Table 2.2.2).

Figure 2.2.4 A (Slatyer 1967; Larcher 1994) shows the relation between the water potential and the water content of sandy and loamy soils. Certain threshold values were defined for the characterisation of soils:

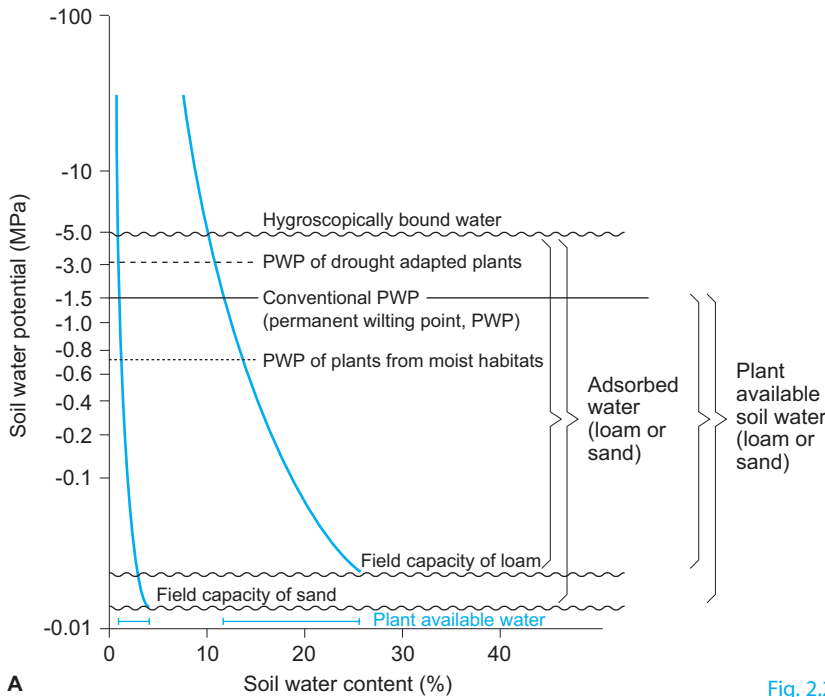
Table 2.2.2. The relationship between water potential and relative humidity calculated using Eq. (2.2.5). The relationship is measurable, if, in a closed vessel, air is allowed to equilibrate with solutions of different osmotic potentials and the relative humidity is measured (in this case $-\Psi = \pi$). The values show what relative humidity must be reached in order to support a particular living process. For example, moulds can already establish themselves if the relative humidity in their environment is $>70\%$

Relative humidity (%)	Water potential (MPa)	Condition in soil or plant
100	0	Field capacity of soil
99	-1.35	Approaching permanent wilting point in soil
98	-2.72	Strong water stress in a plant
90	-14.1	Lowest measured Ψ in a desert plants
80	-30.1	Activation of photosynthesis in lichens
70	-48.1	Activation of respiration in moulds
50	-93.3	Ambient air in an office

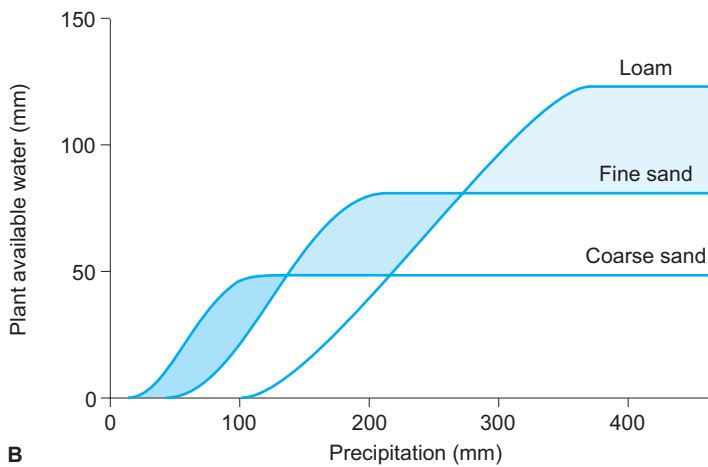
- **Hygroscopically bound water** is defined as that water that is bound by forces $>5 \text{ MPa}$;
- The **permanent wilting point** is defined as the water status when water is bound by 1.5 MPa. This is the water potential at which a sunflower plant is no longer able to replace the water lost through transpiration from the water in the soil and thus wilts. Depending on the adaptation of plants to dry habitats the permanent wilting point may be at values between 0.7 and 3 MPa;
- **Field capacity** is defined as water bound at 0.05 MPa. At this point water can no longer be retained by soil particles against gravity and therefore drains out of the soil.

The amount of water in the soil that is available for plants corresponds to the water content between field capacity and wilting point. Loam and clay soils differ not only in the amount of available water (for loam with 0.2 g g^{-1} almost ten times higher than in sandy soils), but also in the amount of water which is not available for plants in dry soils; this has consequences for the availability of water to plants with decreasing precipitation (Fig. 2.2.4 B). In areas with high precipitation, sandy soils are drier habitats than clay soils, because sandy soils retain less water. With less precipitation the limit at which water can no longer be taken up by the plant, because of the capillary and matrix forces are reached sooner in clay soils than in sandy soils. In arid regions sandy soils are therefore “moister” for plants than clay soils. This is modified in nature by the frequency of precipitation.

The transport of water in the soil to the root occurs along the potential gradient, whereby the rate of flux in the soil is determined by the hy-



A Soil water content (%)



B Precipitation (mm)



C

Fig. 2.2.4. A The change in water potential in a sandy and a loamy soil with increasing water content. Depending on texture the water potential at field capacity is -0.05 MPa (sand) and -0.015 MPa (loam). Convention sets the permanent wilting point of agricultural systems at -1.5 MPa. Plants that live in wet or dry conditions may have wilting points at -0.7 MPa and -3 MPa, respectively, but the additional available water resulting from a shift in the wilting point is small. The limit of hygroscopically bound water is set as -5 MPa. The difference between field capacity and hygroscopically bound water is the exchangeable water, only a proportion of which is available for the plant (from Larcher 1976). **B** Change in the amount of water available to a plant with increasing rainfall on a loam and sandy soil. In arid areas sandy soils contain more water that is available to a plant than a loam soil as the water is not so strongly held by capillarity in sand as it is on loam. In contrast, in areas of high rainfall, the amount of water that can be stored by a sandy soil is less than a loamy soil. The shaded areas indicate the rainfall conditions that are most suitable for plants for that soil type (from Walter 1960). **C** The distribution of vegetation in the Namib Desert with *Acacia karroo*, *Aristida sabulicola* and *Acacia ciliata* growing on the sand dunes (high water availability and low salt) and vegetation-free areas on the plain, where loam and clay soils have low water availability and higher salt concentration. Asab, Namibia. (Photo E.-D. Schulze)

draulic conductivity, which depends on the water content of the soil. In dry soils the limiting factor is the conductivity of the unsaturated soil where water moves in the vapour phase. In contrast, in saturated moist soils, the limiting step for water uptake is the conductivity of roots (the latter is usually the case in temperate climate zones). Depending on texture and saturation of the soil, roots must grow towards the water or “wait” until the water flows from the soil to the root. This determines the surface area of roots required to provide leaves with water.

Water transport in soils is differentiated into saturated (water content above field capacity) and unsaturated states (water content below field capacity). According to Darcy’s law (1856), based on studies of water pressure in the wells of Dijon, the rate of flux (v) in saturated soils is proportional to the hydraulic gradient (dh/dx : change in height per change in the length of the flow path, which corresponds to the potential gradient) and the **saturated conductivity** of the soil (k_s),

$$v = -k_s(dh/dx) \quad (2.2.11)$$

where k_s depends on the particle size. In stony soils k_s is $>0.001 \text{ m s}^{-1}$, in sandy soils $>10^{-5} \text{ m s}^{-1}$, in silty soils $<10^{-7} \text{ m s}^{-1}$ and in clayey soils $<10^{-9} \text{ m s}^{-1}$.

In unsaturated soils, the rate of flux is much smaller than in saturated soils; it depends on the **unsaturated conductivity**, k_θ , which decreases with soil water content, θ , and is determined by the potential gradient, $\Delta\Psi$, over the distance, x .

$$v = k_\theta(\Delta\Psi/\Delta x) \quad (2.2.12)$$

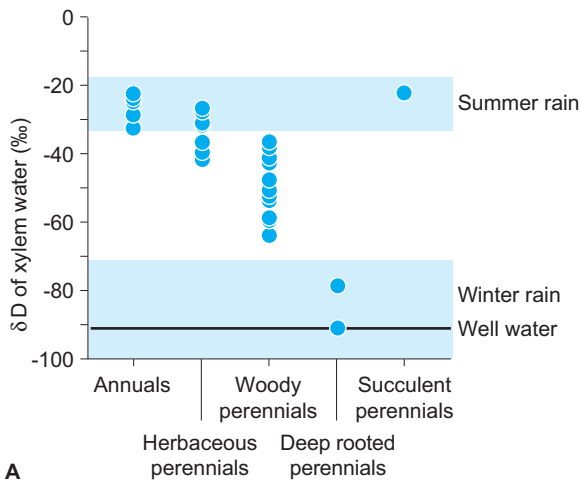
This equation is analogous to Eq. (2.2.11), but for unsaturated soils the water potential is the driving force. The values for k_θ in silty soils is between 10^{-13} (saturated soils) and $10^{-17} \text{ cm s}^{-1} \text{ Pa}^{-1}$ in the range of the wilting point. Soils are not homogeneous, but structured in horizons and differentiated within the horizons in more or less dense aggregates. Thus the hydraulic conductivity of soil crumbs in close proximity may decrease over a very short distance with the soil water content (Horn 1994). Also, within a soil profile, water is available to very different degrees.

It is not surprising that plants develop many different forms of **root systems**, considering the

heterogeneity of water status and flow in soils and the modifications which depend on soil texture. Grasses develop a particularly dense adventitious root system near the soil surface. Dicotyledons, in contrast, form a less extensive root system, but penetrate the ground much deeper with their very large primary root. In horizons where nutrients and water are easier available they are also able to form secondary roots.

The soil layer from which a plant gains its transpiration water may be determined with stable isotopes of hydrogen, D=**deuterium**, and oxygen, ^{18}O . The isotope relation of H/D (the δD value) and of $^{16}\text{O}/^{18}\text{O}$ (the $\delta^{18}\text{O}$ value) increases with the temperature of precipitation (**hydraulic water line**; Dawson 1993), i.e. winter rains have a different isotopic signal than summer rains. In addition, the heavier isotope accumulates at the soil surface, as water molecules with the heavier isotope evaporate slower than molecules with the lighter isotope. Measuring the isotope rates in xylem water and in soil water provides information on the horizons from which certain species get their water.

It is, of course, easier to establish the origin of transpiration water with reference to the soil depth in regions with seasonal rainfall at different temperatures. An example is given in Fig. 2.2.5 A for the Colorado Desert in the southwestern USA (Ehlinger 1994). Summer and winter rains show very different δD values and groundwater is even more depleted of deuterium than winter rain. Various plant species use water sources from different depths. In this subtropical “warm” desert (Fig. 2.2.5 B), annuals and succulents use summer rains, which reach the Sonora Desert as sporadic subtropical fronts (Note: in Mediterranean winter rain regions annuals use mainly winter rains). In contrast to the summer annuals, deeper rooting perennials (usually evergreen herbaceous plants and shrubs) utilise the water of winter rains or groundwater. In between these two contrasting types there is a group of moderately deep-rooting perennial plants which use the water as it percolates through the soil profile. At times between these periods of oversupply of water there are longer dry periods where these plants lose their leaves, i.e. they are deciduous. In the ecological literature, a distinction is made between **arido-active** plants which keep their photosynthetically active leaves during the dry period, and **arido-passive** plants which either shed their leaves or minimise metabolism. Figure 2.2.5 shows that there are many



A

Fig. 2.2.5. A Deuterium isotopic ratio in water from xylem of different types of plants growing in the Sonora Desert, compared with the deuterium ratio in summer and winter rainfall, as well as in ground water (after Ehleringer et al. 1994a,b). The δD value is calculated from D/H of the sample in comparison with a standard $[(D/H)_{\text{sample}} / (D/H)_{\text{standard}} - 1] \times 1000$, where water from deep oceans is used as the standard (SMOW=standard mean ocean water). In the case of the Sonoran Desert, annuals use the summer rain water almost exclusively, which has a high δD value dependent on the temperature. In contrast, deep-rooted perennials almost exclusively use water from winter rainfall with a low δD value due to the lower temperatures. The δD value of water from the xylem of plants shows from which soil level they obtain the water. **B** Vegetation in the Sonoran Desert close to Oatmans, South Nevada, with summer annual plants *Pectis papposa* (Asteridae, C4 plants), perennial woody plants, *Ambrosia dumosa* (Asteridae, C3 plant) and perennial deep-rooted *Larrea tridentata* (Zygophyllaceae). (Photo E.-D. Schulze)



B

transitions which make such a classification (as appears so often in the older ecological literature) unsuitable. The differentiation of species according to their source of water not only applies to the Colorado Desert, but also to other dry regions, e.g. the temperate semi-deserts in Argentina (Schulze et al. 1996c).

Water uptake from the soil into a plant occurs at a zone behind the apex of root tips where root hairs develop and the root cortex is not yet suberised (Steudle 1994). In addition, water is taken up at meristematic regions of the side roots. Above the meristematic region, roots are differentiated (Fig. 2.2.6) into an epidermis, in many species a suberised layer called the exodermis, followed by the root cortex, the heavily suberised endodermis (Casparian bands) and the central

cylinder (stele) with the xylem vessels and the phloem. Within the root cylinder, water follows (as a first approximation) the water potential gradients from the soil to the xylem, but it may follow several pathways (Fig. 2.2.6B). In the region of the root cortex: (a) water may flow in the cell wall (**apoplast**), (b) move from cell to cell via the plasmodesmata (**symplast**), or (c) across the cells (**transcellular path**). At the endodermis (and probably also at the exodermis) water must be moved through the cell. Unsuberised transmission cells exist in this region. **Water transport in the root** may be explained by a model with a series of parallel resistances connected at regular intervals by serial resistors. The hydraulic conductivity in each cell layer is the conductivity of a non-cylindrical tissue (L_{p_z}).

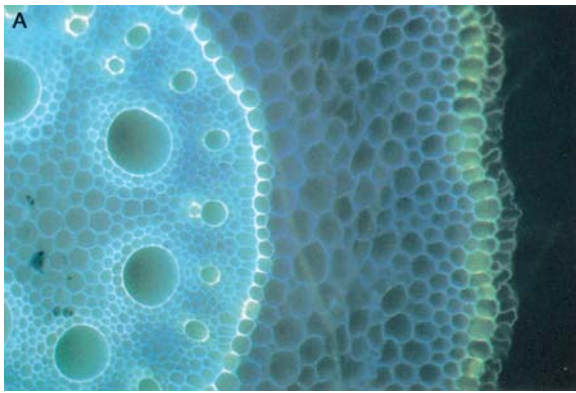
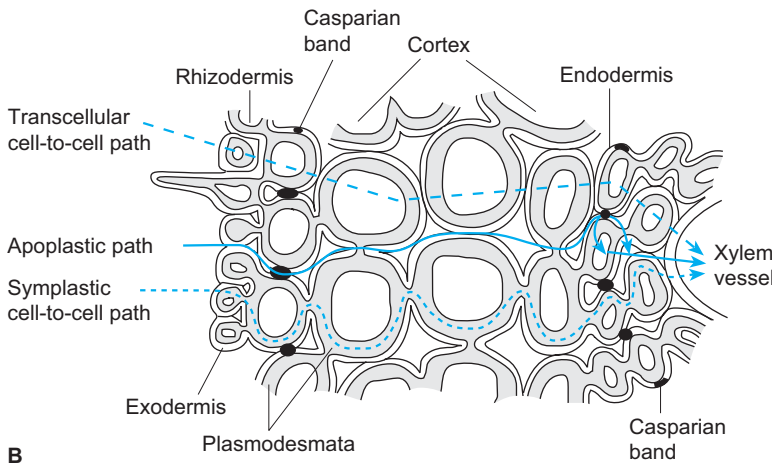


Fig. 2.2.6. A Cross section through a maize root in which the lignin and lipids in the exodermis and endodermis are stained with berberin sulfate. B Schematic cross section of a root showing routes of water and nutrient transport. The suberised Casparian bands appear as black dots in this cross section, showing their position in the cell wall. Blue arrows mark clearly different paths that water can take. (After Steudle 1994)



$$Lp_z = \gamma_c \frac{Lp_c}{2} + \gamma_{cw} \frac{Lp_{cw} \Delta x}{\Delta x d} \quad (2.2.13)$$

where Lp_z is the conductivity of a cell in $m s^{-1} MPa^{-1}$. Lp_c describes the conductivity of cell membranes, where the factor 2 considers the fact that two membranes per cell must be crossed. Lp_{cw} is the conductivity of the cell wall, γ_c and γ_{cw} the amount of cytosol and cell wall at the cross section in the direction of the flux ($\gamma_{cw} + \gamma_c = 1$), Δx the width of a cell layer and d is the thickness of the tissue. This shows that the relevant fluxes may be differently distributed according to the structure of the root cortex. The distribution of pore size in the cell wall and the size of the hydrated ions determine the conductivity. Pores in the intermicella space are about 1 nm; the space between the cellulose fibrils is about 10 nm. In comparison, a water molecule is about 0.3 nm, Na ions with their hydrated shell reach 0.5–0.7 nm, K ions 0.4–0.5 nm and a glucose molecule is about 0.75 nm (Lüttge 1973). Even though the cross section available for apoplastic transport is much smaller than

that for cellular components, measurements of the components have shown that the apoplastic transport dominates when the flux is hydraulic (transpiration suction) and does not follow the osmotic gradient. If the apoplastic transport path is effectively interrupted (strong suberisation of roots), the cellular component dominates (Michael et al. 1997). The flow of water through the cell membrane in the cellular transport path is actively regulated by **aquaporins** (proteins, which transport water through the otherwise hydrophobic cell membrane: water channels; Tyerman et al. 1999; see Chap. 1.5.2). In strongly differentiated regions of roots and less differentiated regions, water may be taken up in parallel; water flow is also possible in the suberised regions of the root, namely in places where side roots are formed, in the edge between the main and the side root meristematic tissues are retained. The root is thus not a uniform surface vis-à-vis the soil, but a very differentiated region of uptake, called by Steudle and Peterson (1998) a **compound membrane**. Water uptake supports the water status of the plant (Ψ_{shoot}) which,

however, depends not only on water uptake – the input –, but also on transpiration – the output –; both are separately regulated but tuned to each other by hormonal and pressure signals.

It has been known for more than 60 years that the **hydraulic resistance** of the root, and thus the water uptake, is variable. In contrast to the shoot and its regulation of water loss via stomata (see Chap. 2.2.3), the regulation of the water uptake is also via the hydraulic architecture of the roots and, because of technical limitations, this is much less studied than the hydraulic architecture of the shoot. Also, processes in the root are not obvious. Regulation appears as a purely physical adaptation to water uptake as well as by metabolic regulation.

The differentiation in root anatomy is, from an ecological point of view, an adaptation of plants to the conditions of water flow between soil and root and the associated flow of nutrients. The process of **water uptake** normally does not limit the supply of water to the plant in moist soils. The water potential in the shoot is, of course, also determined by the transpiration and may fall below a critical value for metabolic processes in the leaf even at wet sites. In moist soils the water potential in the xylem sinks with the amount of water that is transported through the system (Fig. 2.2.7, curve A). In dry soils, corresponding to the low flux and the very low conductivity in the unsaturated soil, a dry zone may develop around the surface of the root, i.e. further supply from the soil may, in this case, be the limiting factor for the flow of water (Michael et al. 1999). This state would be visible in the leaf by a strong reduction of water potential in the xylem without an associated increase in the flux through the vessels (Fig. 2.2.7, curve B). A corresponding turgor loss is expected to occur in the root tip under such conditions, leading to the production of the stress hormone ABA (see Chap. 1.5.2.2). Conversely, there are situations where changes in water transport occur without changes in water potential (Fig. 1.1.7, curve C). This observation is described by the transport model in Fig. 2.2.6. Here, the water potential gradient between soil and xylem reaches a magnitude which allows a flux via additional surfaces, i.e. other roots or root regions which were not participating in water uptake because the potential gradient was too low.

The sites for water uptake also harbour a danger, in as far as the plant is not able to totally seal itself against the soil. The unprotected

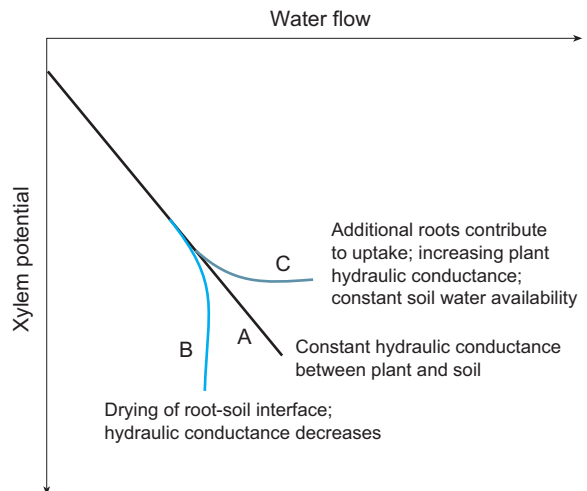


Fig. 2.2.7. Schematic diagram of the change in xylem water potential with the increased water flow, when: (A) the hydraulic conductance is constant, (B) the hydraulic conductance falls when the interface between root and soil dries out, and (C) additional roots contribute to the transport as the soil dries

regions include particularly the meristematic regions of root tips and the axial meristems of side roots. The transmission cells in the endodermis and exodermis are also able to transport water in both directions, i.e. roots are not only able to take up water from the soil, but may lose water to the soil. This is in fact an important ecological process and occurs particularly at times of low transpiration. It is termed **hydraulic lift**, where water is taken up from wet soil in deep horizons, lifted by a water potential gradient to the upper soil horizon, where it is released into the dry soil. Water release of plants to the soil was first observed in dry climates (Richards and Caldwell 1987), but it is also important in temperate climates. For *Acer saccharum* it was observed (Dawson 1993) that the isotopic composition of soil water in the region of the canopy does not correspond to the rain water, but to the much deeper ground water (Fig. 2.2.8). The further the distance from the root regions of the tree, the more similar is the isotopic composition of the xylem water of the herbaceous vegetation to that of the precipitated water. Obviously, during the night, larger amounts of water are transported by tree roots from the moist soil in the proximity of the water table into the dryer upper layer of soil. The isotopic label of the water of the top soil changes correspondingly. The water is utilised during the day not only by the tree, but also by the vegetation

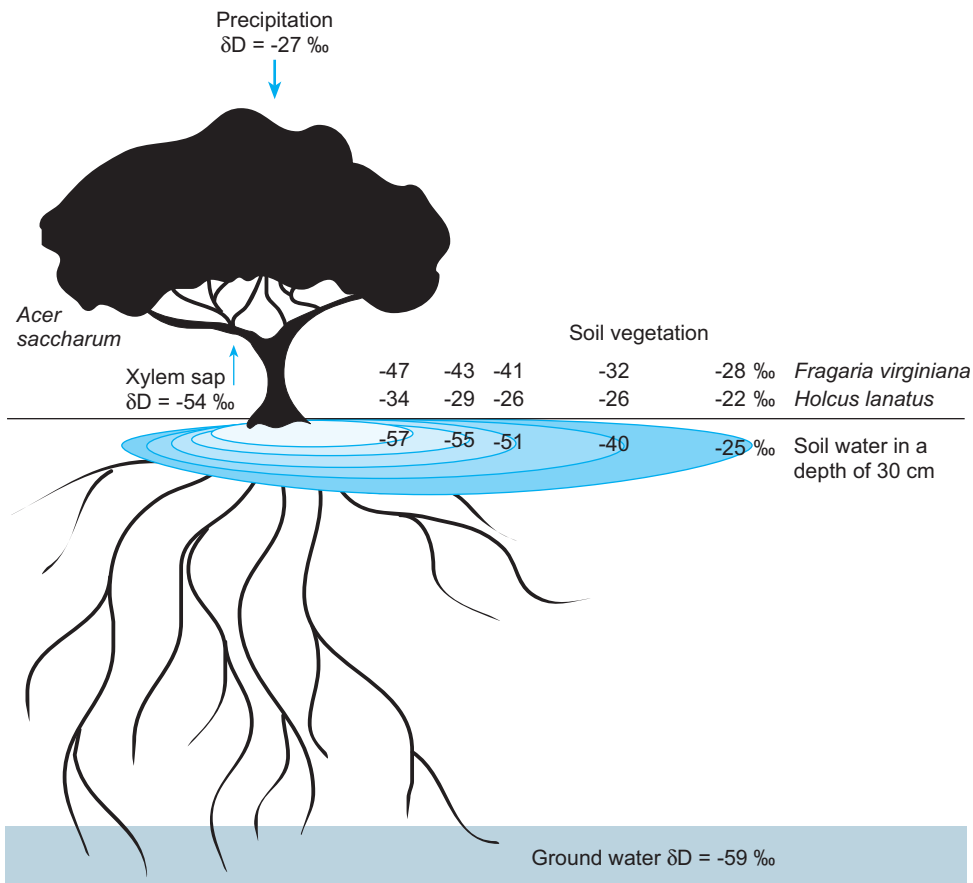
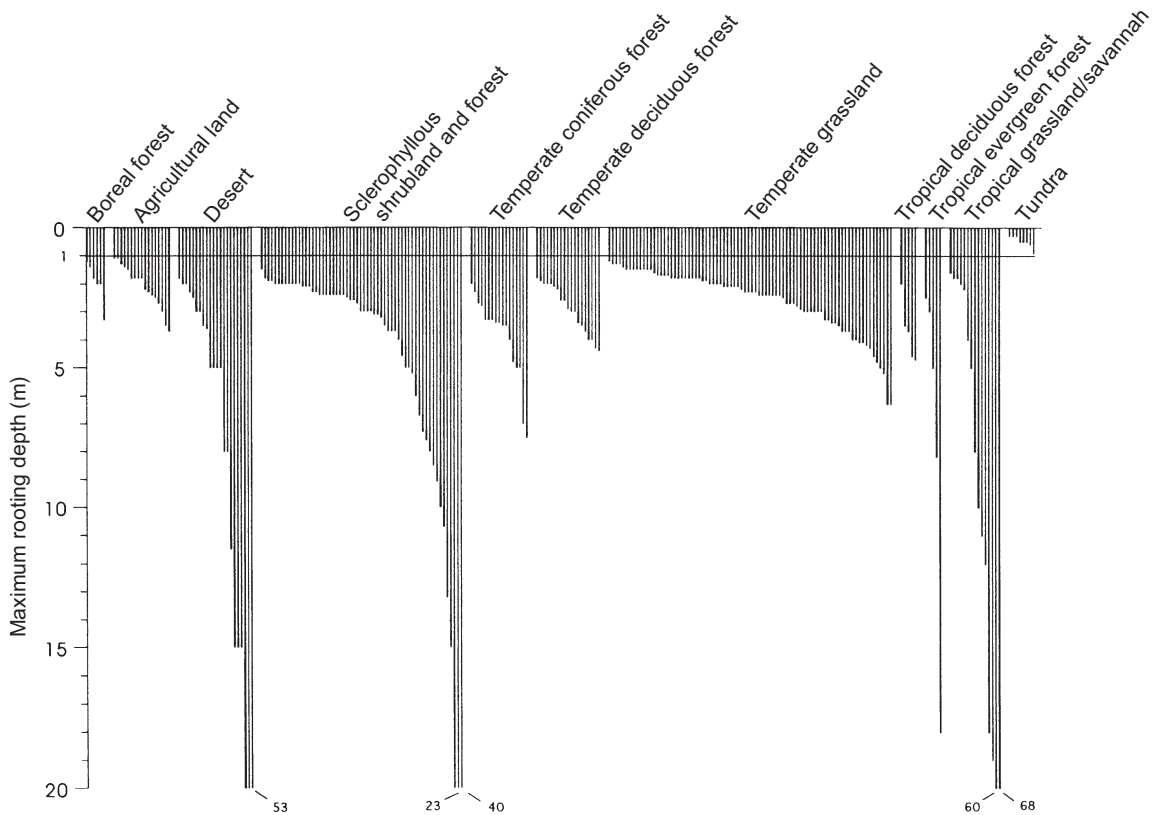


Fig. 2.2.8. Isotopic relationship of deuterium (δD) at different soil depths and in plants as a marker of the source of the water. The δD value is calculated from the D/H ratios of the sample in comparison with a standard $[(D/H)_{\text{sample}}/(D/H)_{\text{standard}} - 1] \times 1000$, where water from deep oceans is used as the standard (SMOW = standard mean ocean water). The δD value in vegetation is between the high value in rainfall and a significantly lower δD value in the ground water. The lower δD value in the xylem water shows that *Acer saccharum* derives its water from the ground water. The soil water (0–30 cm deep) shows a gradient in δD value from the low value near the trunk to a high δD value away from the trunk. The water with the lowest δD value can only have come from ground water that is transported by the roots and is released into the soil, during the so-called hydraulic lift. The vegetation reacts differently to the water availability depending on how deep roots penetrate. Where *Fragaria virginiana* is able to use the “lifted” water, roots of *Holcus lanatus* do not go that deep. (After Dawson 1993)

covering the ground in the shade of this tree (water parasitism). In this example, one-third to two-thirds of the water in the xylem of this ground flora stems from the hydraulic lift. This example may explain the often luxurious vegetation of herbaceous species in the shadow of trees in semi-arid regions.

The reverse process, **inverse hydraulic lift** (Schulze et al. 1998a; Burgess et al. 2001), is ecologically just as important as the hydraulic lift. In arid regions the lower soil layers are very rarely moistened as precipitation is only sufficient to wet the upper soil layers to field capacity. The “wave of water” produced in the soil by rain fall only penetrates a few meters, e.g. in sandy soil the water is retained in the upper ho-

rizons. Lower soil layers remain permanently dry unless there is groundwater. Nevertheless, roots are able to penetrate such dry soil to considerable depths (Fig. 2.2.9; Canadell et al. 1996). Plants in deserts and savannahs attain maximum **root depths** of more than 50 m. The absolute record of observed root depth is 68 m in the Kalahari, where the groundwater is more than 100 m deep covered by dry sand to which roots are able to penetrate. Roots up to 100 m deep have not yet been found because wells have only been plated by a wall to 70 m. Penetration of roots into such deep, dry soil layers is only possible by transport of water from the moist top soil, i.e. the root must maintain the rhizosphere in the vicinity of the root moisture in order to sur-



A



B

Fig. 2.2.9. A Maximum observed root depth of different types of vegetation. Each line represents a single measurement of a particular plant species. The numbers show the maximum depths that are beyond the y scale (from Canadell et al. 1996). The deepest known root depth was measured in the Kalahari Desert from *Acacia erioloba* when bore holes were sunk. B *Acacia erioloba* savannah with perennial C4 grasses *Aristida* and *Stipagrostis* (see Schulz et al. 1996a). Kalahari Desert north of Uppington, South Africa. (Photo E.-D. Schulze)

vive and grow in such an environment. Without additional transport of water, the root tip, which is not protected by a cuticle, would desiccate in the dry soil. Inverse water transport was demonstrated with water labelled with deuterium, which was transported by plants from the watered horizon near the surface into the lower dry layers of soil (Schulze et al. 1998 a). Hydraulic conductivity is very important for the effectiveness of such processes, and this depends on the anatomy (see above) as well as on the nature and magnitude of the participating forces. Both processes contribute to a water redistribution in soils.

2.2.2.2

Water Transport in the Xylem

Water transport in the xylem follows the water potential gradient between root and leaf; the conductivity of the xylem is relatively high. The question of the physical conditions in a capillary with negative pressure of more than 10 MPa has been a topic of research for many years. Böhm (1893) was probably the first to postulate that the cohesion between water molecules is sufficient to achieve a continuous water column in the xylem vessels under tension (cohesion theory). With the measurement of negative pressures of more than 1 MPa in xylem vessels (Wei et al. 1999) and the observation that the tension changes with the flux through the xylem vessels, the cohesion theory has also been proven experimentally.

The **rate of flux** (flux density) in a xylem vessel, J_x , is described by the Hagen-Poiseuille law for laminar flows, and depends on the radius, r , of the xylem vessel, the viscosity of the liquid ($\eta = 10^{-3}$ Pa s for water) and the hydrostatic gradient, dP/dx :

$$J_x = (r^2/8\eta)(dP/dx)(m s^{-1}) \quad (2.2.14)$$

The volume flow is in the direction of the decreasing hydrostatic gradient. The flow must be sufficiently slow so that the conditions of laminar flow (in contrast to turbulent flow) are maintained, to avoid rupture of the water columns. This applies at the flow rates occurring in the xylem, as the pore radii (pits) in cell walls are significantly smaller than those in typical xylem vessels (cell wall: $d = 5$ nm; xylem vessel: $r = 10\text{--}500$ μm). Thus the potential gradient required to transport a certain volume flow (e.g. 1 mm s^{-1}) across the cell wall is very high, about 3×10^5 MPa m^{-1} , according to Eq. (2.2.14) (Nobel 1991). This shows that a particularly large decrease in pressure is to be expected at the evaporation surfaces in the mesophyll and that the enormous forces required to move the water through the cell wall lead to a relatively slow movement of water in the xylem (see Table 2.2.3).

In plants, the volume flux, I_x , in the xylem under a pressure gradient is determined by the area of the cross section per vessel, and the number of xylem vessels, n , per organ:

$$I_x = \frac{\pi r^4 \Delta P}{8\eta \Delta x} n = Lp_x \Delta P \quad (2.2.15)$$

where I_x is measured in $(m^4 Pa)/(s Pa m) = (m^3 s^{-1})$ and Lp_x corresponds to the hydraulic conductivity in the xylem ($m^4 s^{-1} Pa^{-1}$). The axial hydraulic conductivity is related to a 1 m length of xylem and thus has different dimensions to Lp of the membrane.

According to Eq. (2.2.15), a plant has many possible ways to change the flux in the xylem and thus the water potential gradient (Gartner 1995):

- **Radius of vessels:** The radius varies between 500 μm in lianas, ca. 100 μm in ring-porous woody plants (e.g. oak), and 10–40 μm in the tracheids of conifers; a larger radius allows a

Table 2.2.3. Specific conductance, maximum speed of sap flow through the xylem, vessel radius and length, and maximum capillarity of vessels from different types of plants. (Zimmermann 1983; Carlquist 1991; Nobel 1991)

Plant type	Specific conductance for water ($m s^{-1} MPa^{-1}$)	Maximum rate ($m h^{-1}$)	Vessel diameter (μm)	Vessel length (m)	Capillarity (kPa)
Conifers	$5\text{--}10 \times 10^4$	1–2	10–40	0.002–0.005	29–7
Diffuse porous angiosperms	$5\text{--}50 \times 10^4$	1–6	5–150	1–2	58–1.0
Ring porous angiosperms	$50\text{--}300 \times 10^4$	4–44	10–600	10	29–0.5
Herbaceous plants	$30\text{--}60 \times 10^4$	10–60	10–500	1–2	29–0.6
Lianas	$300\text{--}500 \times 10^4$	150	600	ca. 10	0.5

considerably higher volume flux. However, there is the basic danger that the cohesive force, which determines the continuity of the water column, is exceeded. However, this is not sufficient for **cavitation**. Apparently, cavitation is caused by “air seeding”, which is the entry of small air bubbles via the pitted cells in the wall (Tyree 1997; Steudle 2000, 2001). During the breakage of the water column, the flux in the vessel is interrupted, i.e. it no longer participates in the water transport. In wood, pits close this vessel off and the water transport is laterally redirected (Grace 1993). Under normal conditions, such a vessel may be filled with water again (Sperry et al. 1987; Gartner 1995), but it may also occur that the xylem of complete organs (leaves or branches) cavitate and that these parts of the plant dry out. As the volume flow is determined by meteorological conditions in the atmosphere and by stomatal aperture, the water potential gradient in the xylem is a consequence and not a cause of the volume flow. Nevertheless, stomatal conductivity in plants is tuned to the hydraulic conductivity of the stem (see, e.g., Hubbard et al. 2001). Particular hydraulic conditions occur in **grasses**, where nodes provide special barriers (Martre et al. 2001).

With a constant volume flow, the gradient of water potential decreases with increasing radius of the vessels. This means that the advantage of wide vessels for rapid transport of large amounts of water is counteracted by the increased risk of **cavitation** (Tyree and Sperry 1989). The forces of cohesion, maintaining a continuous column of water in the xylem, decrease with increasing radius of the xylem vessels [Eq. (2.2.14)] from about 1500 Pa in tracheids of conifers ($r=10\ \mu\text{m}$) to about 60 Pa in tracheids of ring-porous woods ($r=500\ \mu\text{m}$; see Table 2.2.3), but other processes participate in cavitation (see above: **air seeding**). The process of interruption of the water column is often also called **embolism**. The term embolism could imply that the space created is a vacuum, but this is not the case. The space is filled with water vapour and hence the term cavitation is much more appropriate.

- **Number of conducting elements:** The number of conducting elements is regulated in woody plants by the annual increase of new elements as well as by the transition of old elements from sapwood to heartwood (Fukuda 1997). The conducting sapwood area is thus very

variable and depends on the size of the conduction elements as well as on conditions in the habitat. Thus ring-porous woody plants have only a few actively conducting annual rings, whilst in conifers the conducting elements remain active for decades.

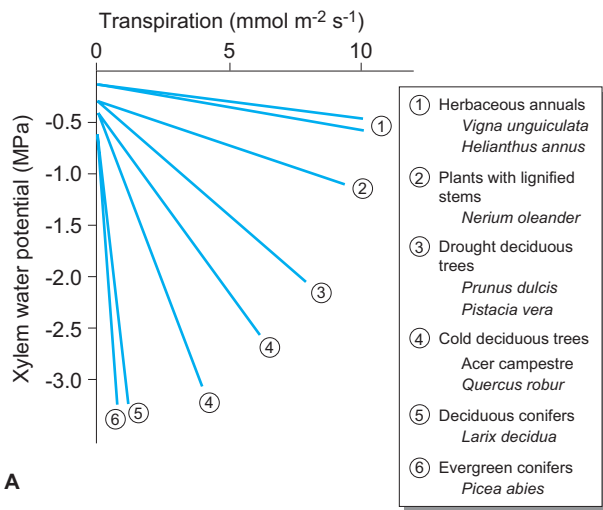
- **Differentiation of the shoot:** Generally, the diameter of vessels is smaller in peripheral organs, particularly in the petiole. Thus the decrease in potential in the xylem of the stem is small and increases with the water transport into the leaf. Thus the risk of cavitation is located into the peripheral organs (Zimmermann 1983).

Despite the manifold possibilities of regulation, there are basic differences in water transport between different groups of species (Table 2.2.3).

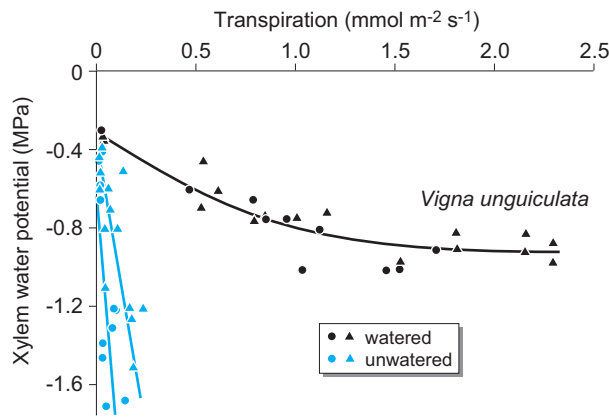
In a tropical **liana** the soil water taken up by the root reaches the transpiring leaf in less than 1 h. This applies also to **ring-porous woody plants** and dicotyledenous **herbaceous plants**. In contrast, it takes 2–3 months for the water taken up by the roots to reach the tip of a 100-m-high *Sequoia gigantea*, because of the low rate of flux in **conifer wood** composed of tracheids.

At constant **hydraulic conductivity**, the water potential in the leaf changes linearly with transpiration. This can be used to demonstrate structural differences in the stem between species (Fig. 2.2.10 A; Schulze and Chapin 1987). Plants with lower conductivity have lower rates of transpiration and more negative water potentials. In contrast, plants with high conductivity also have rapid rates of transpiration; however, the water potential does not decrease to the same extent. In these species, the risk of cavitation is particularly great leading to a substantial change in conductivity when the soil dries out (Fig. 2.2.10 B; Schulze and Hall 1982). In these cases, the water transport in moist soils takes place via vessels with large lumen and in dry soils water transport is restricted to vessels with narrow lumen. Regulation of water flux via structural characteristics of the shoot is thus possible and dependent, to some degree, on the conditions under which a species grows.

Risk of **cavitation** occurring with the increased size of xylem vessels, and thus the increased mass flow, is shown in Fig. 2.2.11 A for *Ceratonia siliqua* (Lo Gullo and Salleo 1991). With the increasing water potential gradient apparently cavitation occurs first in vessels with a large lumen, whilst the water column in vessels



A



B

Fig. 2.2.10. Relationship between the water potential in the xylem and the transpiration rate for **A** different plant functional types (Schulze and Chapin 1987) and **B** the crop plant *Vigna unguiculata* in drying soil (Schulze and Hall 1982). The increasing transpiration rate causes a lowering of the water potential. The slope of the graph is a measure of the hydraulic conductance of the plant–soil system. Circles and triangles show the two groups of plants measured (see also Fig. 2.2.7)

with a small lumen remains intact, even at high water tension. Obviously, the structure of the conducting tissue is a limiting factor, and thus determines the risk of cavitation at high transport rates of water into the shoot (Grace 1993). However, the plant is not unprotected in face of this danger. With increasing drought water transport in soil and root changes, but stomata will restrict also the water flow (see Chap. 2.2.3) and the relation of leaf area to xylem conducting area is eventually decreased by shedding of leaves. The importance of leaf area in regulating the water flow in stems has been demonstrated for *Artemisia tridentata*, a shrub of the prairies of North America (Kolb and Sperry 1999) shows the close relationship between leaf area and early morning water potential as a measure of the water supply from the soil. The decreased leaf area with soil drying limits transpiration to such an extent that the critical flux rate, at

which cavitation of vessels would be expected, is not reached. Fertilisation increases the risk of early cavitation more than watering because it results in wider vessels (Ewers et al. 2000).

Obviously, species “adapted” to a habitat have generally developed mechanisms to avoid lethal stress situations. Other species would not flourish in these habitats or would restrict their growth and reproductive phase to a short period in which this critical situation does not occur. For example, the Mediterranean *Bromus* species are a successful invasive species in North American prairies and Australian semi-deserts where the vegetative growth is restricted to the period with sufficient water supply, but they gain this water at the cost of the water supply to indigenous perennial dwarf shrubs, particularly *Artemisia tridentata* and *Atriplex* species (West and Young 2000; see Chap. 3.1).

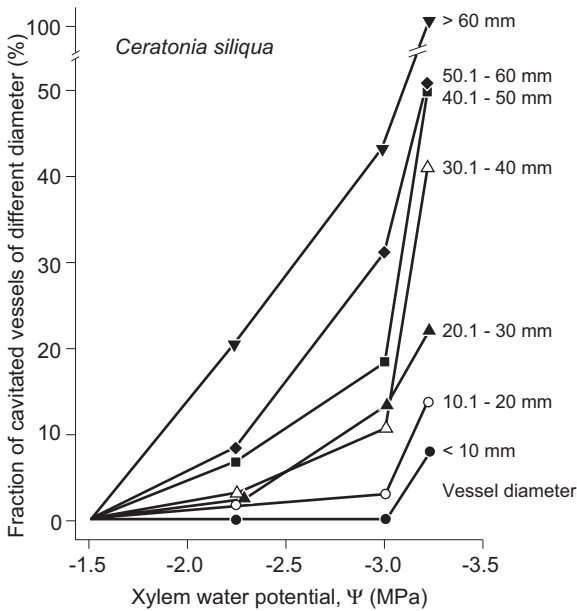


Fig. 2.2.11. Dependence of cavitation in xylem vessels of different size on the water potential in the xylem as the soil dried over several days. At a water potential of approximately -3.3 MPa all large vessels of *Ceratonia siliqua* ($>60 \mu\text{m}$), but only 10% of the small vessels ($<10 \mu\text{m}$), are cavitated

Another pointer to the limiting role of the **xylem structure** for water transport is given by the measurement of water flow in the xylem of pines of different ages in the continental climate

of central Siberia (Fig. 2.2.12; Zimmermann et al. 2000). In pines, the xylem flow increases linearly with the sapwood area. The greatest sapwood area is achieved at the age of 60 years. At this age the growth of trees is relatively high and the formation of heartwood has not yet started. For very old pines the sapwood area decreases and thus the flow of water. Sapwood area results from growth of annual tree rings and hardwood formation.

2.2.2.3 Water Transport in the Phloem

The importance of water transport in the xylem and the danger of cavitation for the functioning of the whole plant are fully appreciated only when considering also the flow of material in the phloem (**phloem transport**). In vascular bundles of plants, almost all neighbouring cells transport larger amounts of water in the opposite direction, in the xylem from root to shoot, in the phloem from shoot to root. Water transport occurs

- in the xylem along a water potential gradient
- in the phloem along an osmotic pressure gradient (pressure gradient hypothesis; Fig. 2.2.13).

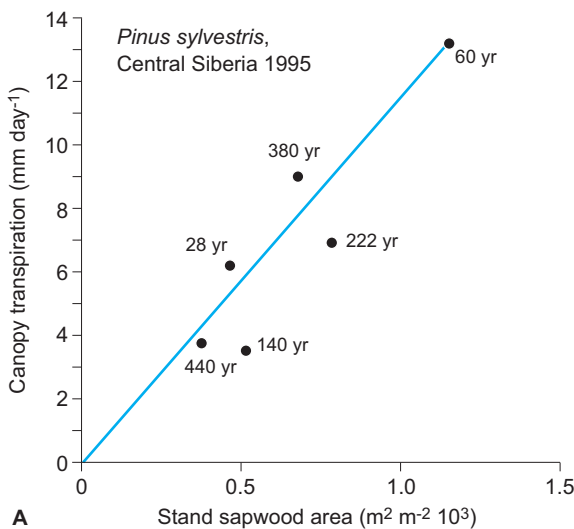


Fig. 2.2.12. A Relationship between canopy transpiration of the stand and the sapwood area of the stand. The rate of water flow rises linearly with the sapwood area: Note that it is not the youngest nor the oldest and largest trees which have the highest transpiration rates, but the 60-year-old pole stand. The small area of sapwood in the oldest stand is caused mainly by the low tree density in older stands (after Zimmermann et al. 2000). **B** *Pinus sylvestris* woods on Pleistocene sand dunes in central Siberia, 60°N on the west bank of the Jennessy. Here, cohorts of even-age trees establish after fire (see Wirth et al. 1999). The vegetation of the forest floor is *Cladonia* sp. (Photo E.-D. Schulze)

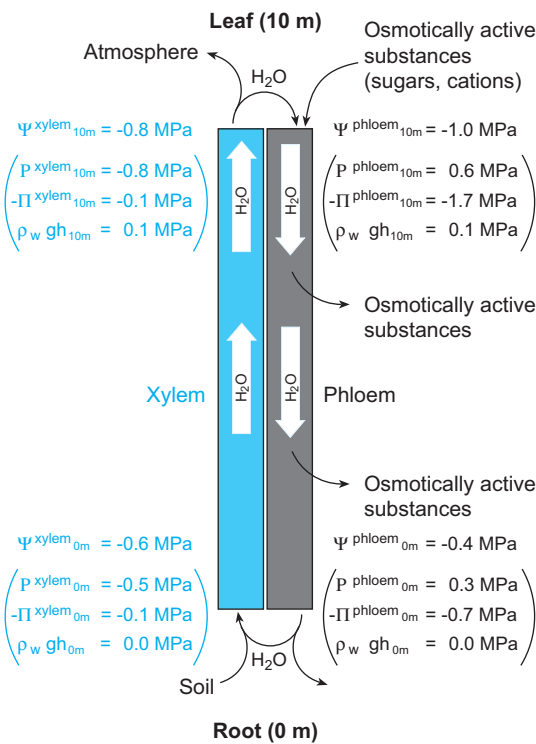


Fig. 2.2.13. The internal water cycle of a plant is due to the gradient of water potential, Ψ , which develops as a result of transpiration. In the phloem, the mass flow gradient is a result of the turgor (P), caused by loading and unloading of osmolytes (sugars and cations) in the phloem, and hence the osmotic pressure (Π) changes. In trees there is the additional hydrostatic pressure ($\rho_w gh$) to be taken into account, where ρ_w is the density of water, g is gravity, and H is tree height

Different gradients are maintained as follows: In moist soils the water potential of roots is similar to that of the soil ($\Psi_{root}=0$). With the uptake of cations the osmotic pressure increases to about 0.1 MPa. Water transport starts because of the decrease of water potential in the leaf ($\Psi_{leaf}=-1.5$ MPa) as a consequence of evaporation and is dependent on the vapour pressure of the external air (e) and the net radiation (R_n). In the leaf, a smaller part of this water mass is redirected into the phloem where, because of the additional loading of the sieve cells with cations and sugars, an osmotic value of 2.0 MPa at a water potential of -1.5 MPa, and a turgor pressure of 0.5 MPa develops. This turgor pushes the phloem water from the leaf to the root. As the tissues along the sieve tubes remove sugar, the hydrostatic pressure decreases with decreasing osmotic value. This pressure-dependent transport occurs contrary to the longitudinal gradient of water potential between shoot and root. In

the root the phloem water partially re-enters the xylem. This internal circulation of water occurs even if the plant grows under extremely moist, i.e. the water potential gradient=0 (Tanner and Beevers 1990), and under very dry conditions. This transport would only be interrupted if the complete xylem were not functioning due to cavitation during drying. In this case the survival of the plant would no longer be possible. Consequently,

- all species with large xylem vessels also make small xylem vessels so that re-direction of water flows is possible should cavitation occur;
- special closing structures (pits) ensure that the damage is limited, i.e. that cavitation does not continue in the stem.

In the case of drying out, not only the water potential changes but also the osmotic pressure so that the pressure gradient in the phloem is maintained (Schulze 1993).

2.2.3

Regulation of Stomata

Evaporation of water from plants (**transpiration**) takes place at the surfaces of cell walls lining the intercellular spaces, from where the water vapour, as a consequence of the vapour pressure gradient, reaches the external air by diffusion via the stomata. **Stomata** are the regulatory valves limiting diffusion. These valves are regulated by processes in the leaf, as well as by processes in the roots, and by conditions in the environment (see Fig. 2.2.1).

Guard cells of stomata are structured in pairs which only grow together at the ends (Fig. 2.2.14; Meidner and Mansfield 1968). The middle part, which is not fused, forms an aperture. This opens to a varying extent because the expansion of the cell with increasing turgor is radially restricted due to the orientation of the micelles in the cell wall. Thus the cell volume changes mainly by longitudinal expansion, and, together with the counter pressure of the surrounding epidermal cells, both cells form an opening of different widths (aperture). The **number of stomata** per unit epidermal area and the size of the aperture are, to a large degree, species and site specific (Meidner and Mansfield 1968). Thus the number of stomata (mm^{-2} leaf

Box 2.2.4 Summary: Water transport

- **Availability of water** depends on the soil texture. This determines the amount of bound water and conductance of water in the soil.
- Plants exploit water with the formation of **roots of very different anatomy** and morphology.
- Water flux in roots depends on external conditions, as well as on root structure both in the symplast and the apoplast. **Water uptake** is not constrained to the root tips, it can also occur in areas of lateral roots where there is meristematic tissue.
- Limited **water transport** in the soil can lead to deficits in the rhizosphere. Roots can transfer water to the soil if part of the root system is in soil horizons with higher water potential; this leads to the phenomenon of **hydraulic and inverse hydraulic lift** which re-distribute water in the profile.
- With **water transport** in the xylem, the flow of water increases with increasing size of vessels but at the same time the risk of cavitation increases.
- Water transport and the risk of **cavitation** are determined by alterations in xylem radius, the number of vessels involved in transport and the differentiation of vessel size in the shoot.
- **Conductance of the xylem** is smallest in conifers, and increases progressively in diffuse and ring porous woods, herbaceous plants and lianas.
- The maximum longitudinal water flow is limited by cavitation in vessels and is primarily dependent on the cross-sectional area of the stem occupied by functional **xylem area** (=cumulative cross-sectional area of xylem to stem cross section).
- Xylem transport occurs along a **water potential gradient** and is dependent on the vapour pressure deficit of the air.
- **Phloem transport** occurs along a gradient of osmotic pressure which depends on the loading and unloading of sugars.
- **Circulation of water within the plant** between phloem and xylem is important for plant survival, i.e. it is maintained even under unfavourable environmental conditions. Regulation depends on xylem flux, and is achieved by stomatal closure, leaf abscission and partial senescence (crown drying in oak). Regulation of phloem transport occurs through the osmotic pressure.

area) varies between 30 (*Triticum*, *Larix*) to more than 5000 (*Impatiens*). The **size of stomata** varies between $77 \times 42 \mu\text{m}$ (*Phyllitis*, *Tradescantia*) to $25 \times 18 \mu\text{m}$ (e.g. *Tilia*). The opening mechanism is based on a physiologically regulated change of turgor, where K^+ ions from the neighbouring cells (the so-called subsidiary cells) and the cell wall are taken up. This ion uptake occurs in exchange with H^+ ions, where the protons are released from malate, and this acid metabolism is connected with the degradation of starch. The movement of the stomatal aperture is unsymmetrical, i.e. closing occurs much faster (1–10 min) than opening (30–60 min; Lange et al. 1971).

Measurement of the **apertures of stomata** is possible with a microscope (Kappen et al. 1994), even though for many plant species the aperture is covered by protrusions of the cuticle or by waxy scales. In the field, these investigations are very difficult because of disturbance of the leaf and of the climatic conditions around it. There-

fore, rather than carrying out direct observations, analogous to Ohm's law a resistance (R_L) or a conductance (g_L) are calculated from the transpiration stream (E_L) and the gradient in the vapour pressure between leaf and air (D_L) when the subscript L refers to the leaf as a whole:

$$g_L = \frac{E_L}{D_L} = \frac{1}{R_L} \quad (2.2.16)$$

with the dimension ($\text{mol m}^{-2} \text{s}^{-1}$), conductivity has the same dimension as transpiration. At 15°C , conductivity of $1 \text{ mol m}^{-2} \text{s}^{-1}$ corresponds to a conductivity of 4.24 m s^{-1} (3.83 m s^{-1} at 45°C). This scheme neglects cuticular transpiration, which is very low for most plants. In general conductivity is used as the standard, as it changes in proportion to the flux:

$$E_L = D_L \times g_L \quad (2.2.17)$$

Stomatal aperture is **regulated** directly by environmental conditions related to climatic fac-

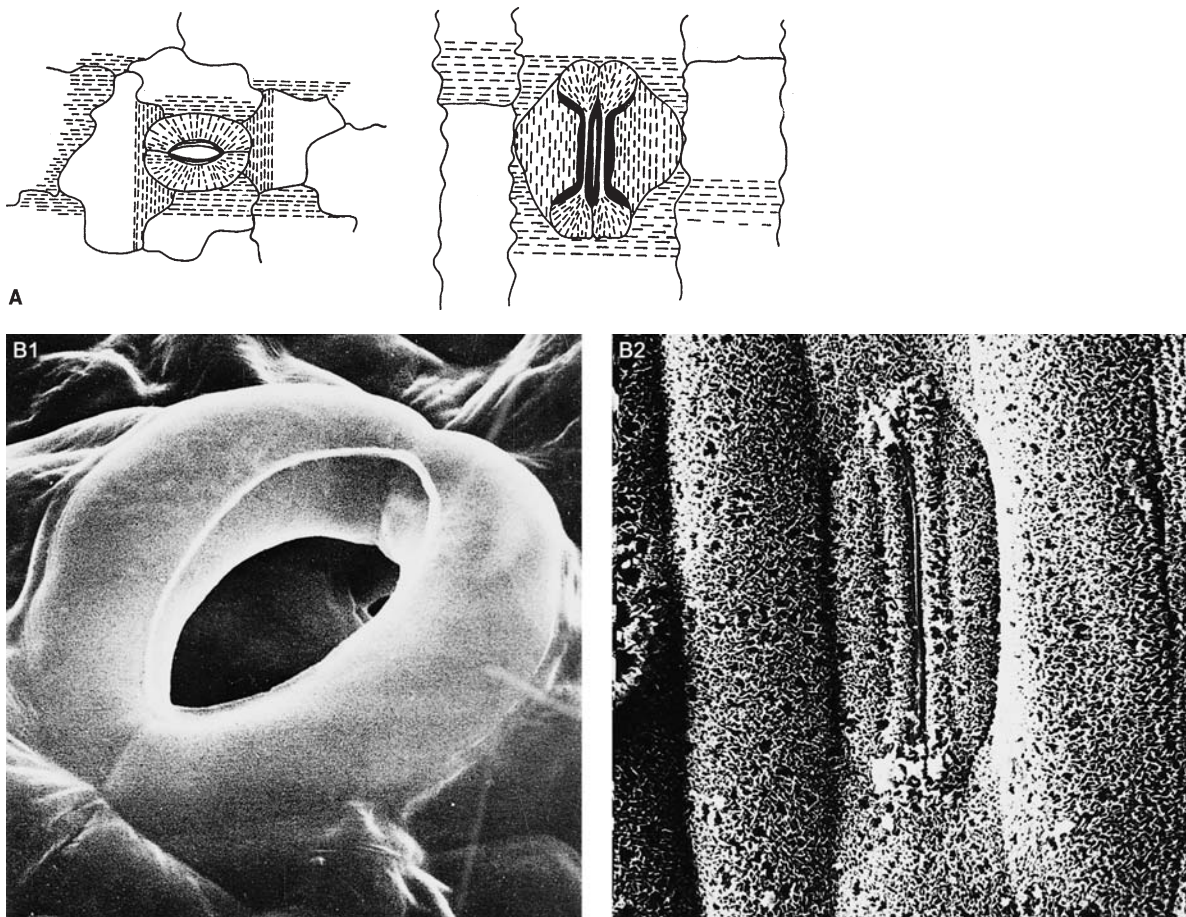


Fig. 2.2.14. A Schematic structure of the cell wall of guard cells of dicotyledonous (*left*) and monocotyledonous plants (*right*). Micelles in the cell wall (*hatched lines*) are arranged so that the expansion of the cell with increasing turgor can only take place perpendicular to their orientation (from Meidner and Mansfield 1968). B Scanning electron micrograph of a guard cell of grape vine (B1) and of wheat (B2; Troughton and Donaldson 1972)

tors (so-called **feed-forward regulation**) and indirectly by processes in the mesophyll (so-called **feed-back regulation**). Feed-back regulation is determined by water status and the carbohydrate balance. [Figure 2.2.15](#) illustrates the different reactions, which are often independent, and which play a role in the regulation of stomata.

2.2.3.1

Non-reversible Response of Stomata to Factors Within the Plant

Non-reversible responses are those connected to the development of leaves, and are only changed by the development of new leaves or shedding of old ones.

Photosynthetic Capacity

Maximum opening of stomata correlates with the capacity for photosynthesis of leaves and is determined by the nitrogen supply and the specific leaf area (leaf area/leaf weight) which depends on species. The responses of stomata which are related to photosynthetic activity apply to all forms of plants, but these are characterised by different specific leaf areas (Reich et al. 1997). From the relation between conductance and leaf nitrogen concentration, global maps of maximum stomatal conductance are produced from which also maximum rates of CO₂ assimilation may be derived (see [Fig. 2.4.6C](#)). Such maps are important means of verifying coupled global climate models, in which the influence of vegetation is considered. Maximum conductivity is shown, as sufficient knowledge is available about the responses of stomatas

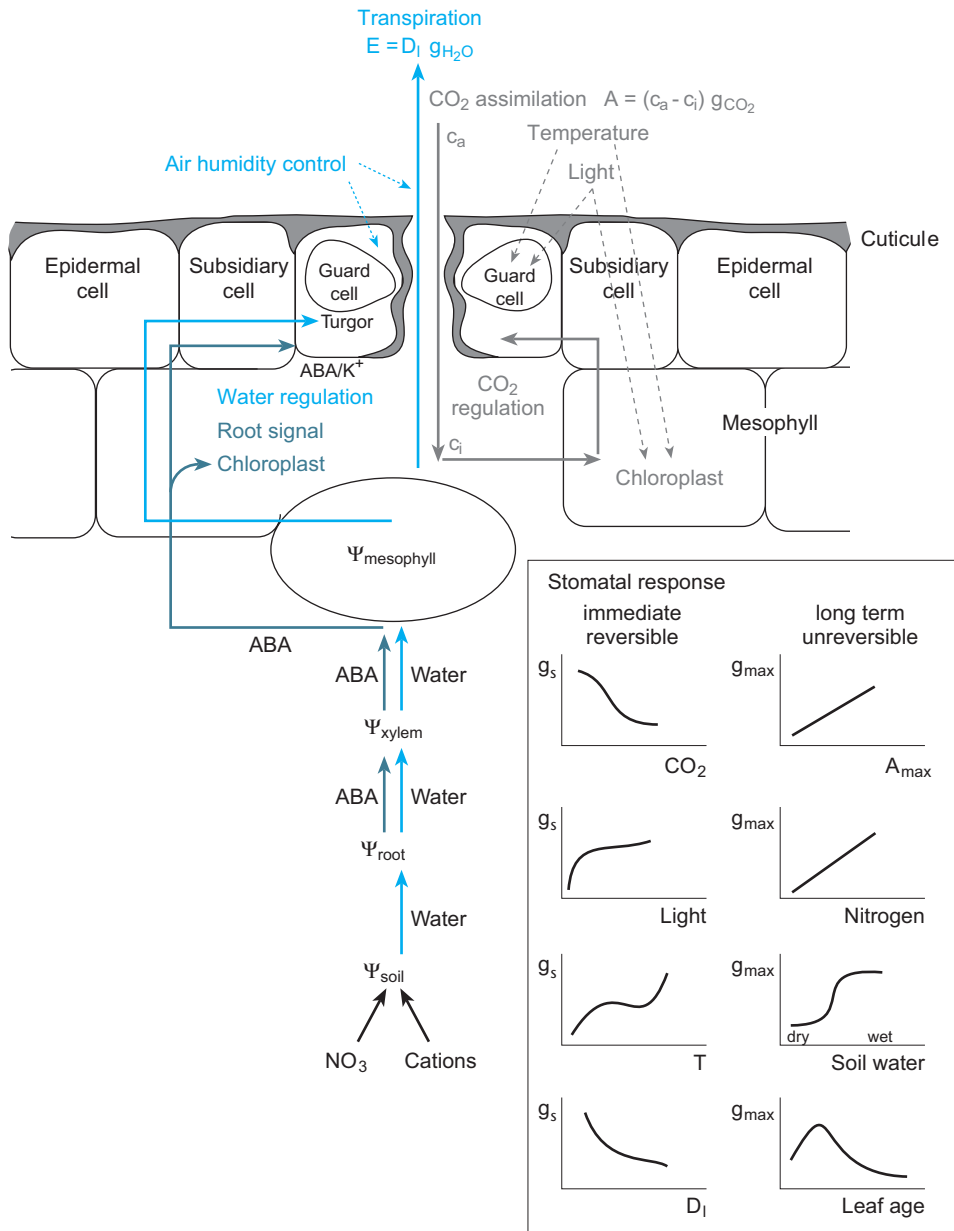


Fig. 2.2.15. Diagram of the factors and control systems which determine conductance of stomata. *ABA* Abscisic acid; Ψ water potential; E transpiration; D_l water vapour pressure deficit between leaf and air; c_a atmospheric CO₂ concentration; c_i CO₂ concentration in the mesophyll; g_s variable stomatal conductance; g_{H_2O} stomatal conductance for H₂O; g_{CO_2} stomatal conductance for CO₂; g_{max} maximum stomatal aperture, a measure of long-term irreversible responses to stress. **Box 2.2.5**, important responses of stomata to environmental conditions and those in the plant

to environmental factors and these may thus be calculated in a model. It has not been possible to calculate the capacity of plants for stomatal opening, which has only been established empirically; it is functionally correlated with the specific leaf area and the nitrogen content of leaves, pointing to the important role of photosynthesis and CO₂ in the regulation of stomatal behaviour.

Water Status

The availability of water in the soil is globally the most important environmental factor limiting stomatal conductance. During soil drying abscisic acid (ABA) is formed in the root tips (see also Chap. 1.5.2.2), and this is the basis for the regulation of stomatal conductance. ABA reaches the leaf via the water stream in the xylem and closes the potassium channels which

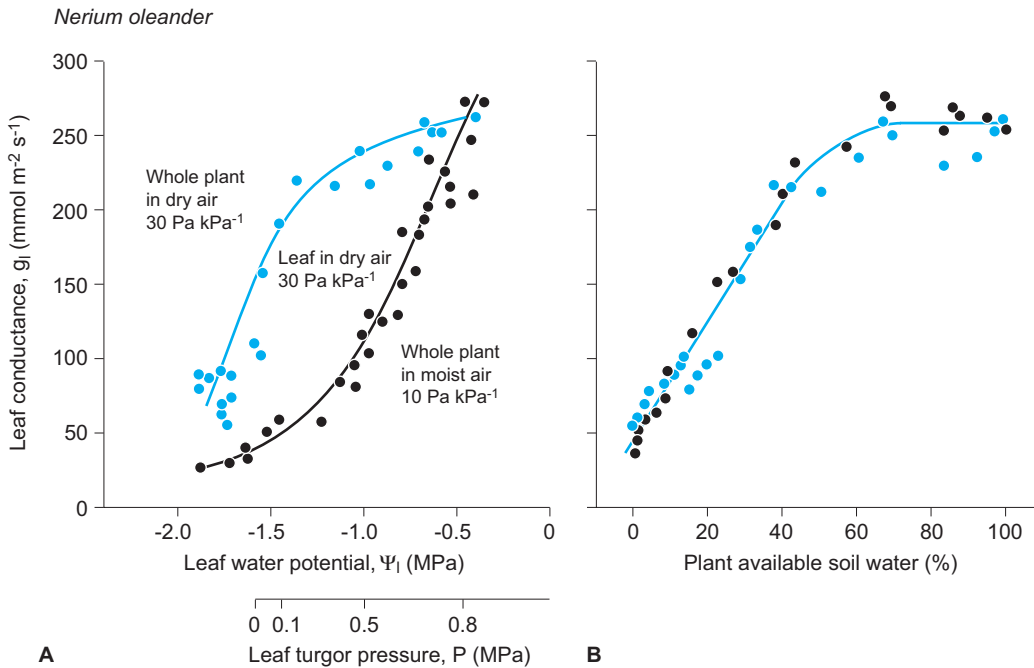


Fig. 2.2.16. A Relationship between conductance of the leaf and water potential in the xylem in *Nerium oleander* with increasing soil drying. The gradient of water vapour pressure between the leaf, on which the stomatal conductance was measured, and of the air around the leaf was constant (10 Pa kPa^{-1}) but the plant itself was either in moist (*black symbols*) or dry (*blue symbols*) air. The stomata close (decreasing conductance) as the soil dries, but the humidity of the air around the whole plant alters the leaf water potential almost 1 MPa in dry compared with moist air, although the measured leaf was under constant conditions. B Leaf conductance in the same experiment, but related to soil water content (after Schulze 1986). This experiment shows that the stomata do not respond to xylem water potential but to soil water content

regulate the turgor pressure of guard cells. This is called a **root signal**, as part of the **root-shoot communication** occurring in dry soils via the production of ABA (Schröder et al. 2001). Stomata close with increasing ABA concentration in the xylem stream. This reaction is modulated by the high pH in chloroplasts, which are a strong sink for ABA. Apparently, the pH value in the cell wall determines whether ABA is immobilised in the mesophyll and metabolised, or whether it reaches the epidermis. Here also a steady state is achieved, determined by the breakdown of ABA in light and by the transport of ABA in the phloem. With ample water supply, and good nutrition, roots produce another plant hormone, cytokinin, which opens stomata, in contrast to ABA (see also Chap. 1.5, Stress physiology).

It has often been observed that stomata close with decreasing **water potential** in the leaf.

However, this correlation does not describe the basic mechanism, as the leaf water potential depends on the rate of transpiration, as well as on the state of water in the soil and the supply of water (Fig. 2.2.16). Stomatal conductance increases with the availability of water in the soil and decreases when the soil dries out (Fig. 2.2.16A; Schulze 1994). Parallel to transpiration and water supply, the leaf water potential changes as well. Thus, the effects of the influence of water availability in the soil are masked (Fig. 2.2.16B). The effect of the root signal can be verified by compensating the matrix potential of the drying soil by a hydrostatic pressure applied to the soil. Thus the effect of soil drying may be observed on fully turgid plants. In this case stomatal closure is also dependent on the **soil water content** (Schulze 1994). However, this does not mean that stomata do not also react to the turgor in the leaf (see below).

2.2.3.2

Reversible Responses of Stomata to Factors Within Leaves

Carbon Dioxide

Stomata react to the gradient of CO₂ concentration between the external air and the intercellular spaces of leaves. In a classical experiment, Raschke (1972) was able to open stomata by decreasing CO₂ concentration in the external air and then close them by increasing it.

Water Status of the Epidermis

With decreasing turgor in the epidermis the aperture of stomata decreases (Nonami et al. 1990). In contrast to the reaction of the leaf to changes in root water potential this is a cellular imbalance in the epidermal turgor as dependent on transpiration (Schulze 1993).

2.2.3.3

Reversible Responses to Climatic Factors

Light

Stomata open with increasing light intensity. They are activated by a blue light receptor (Zeiger et al. 1987). Thus stomatal conductance in the morning increases earlier than photosynthesis, which is only activated when the sun has risen further and with a larger proportion of red light. Therefore, stomata open wide and do not limit the flow of CO₂ during the early morning when the humidity is high.

Temperature

At low temperatures (freezing point) stomata are

closed and open as temperature increases. This opening is exponential at temperatures above 40 °C, so leaf temperature decreases below that of the air because of the strong transpirational cooling (Raschke 1979).

Humidity

Stomata close with increasing vapour pressure deficit between leaf and air, and this can also be observed on isolated epidermis (Lange et al. 1971); where closing is faster than opening (Fig. 2.2.17 A). This response can be so strong that transpiration decreases despite an increasing water vapour gradient between leaf and air (Fig. 2.2.17 B; Schulze et al. 1972). It is still unclear how stomata “measure” humidity. Research on *Tradescantia* suggests that stomata react to local water deficits in the epidermis caused by transpiration from the stomata themselves and not from water loss of the epidermis (Nonami et al. 1990) and this depends on the time constants of water flows.

In high trees the reaction to local deficits probably plays an important role in the regulation of stomata during the course of the day. In the canopy of a forest, turbulence of air movement occurs with fast exchanges of air packages with different humidity (see Chap. 2.2.7). This correlates with fast changes in the xylem flow. Neighbouring trees, exposed to the same air masses, show synchronous changes in xylem flow (Hollinger et al. 1994). Stomatal closure is induced (Köstner et al. 1992) by short-term change in transpiration and the associated change of the water state of the epidermis. As closure is faster in dry air than is opening in moist air, a continuous decrease in stomatal conductance is the consequence. Under ambient

Box 2.2.5

Summary: Stomatal regulation

- Stomata are the most important valves by which plants can regulate transpiration in an otherwise physically determined process. Stomatal aperture is referred to as “conductance” in analogy to Ohms law.
- Stomata respond to the physiological activity of leaves measured as **photosynthesis**. Stomata determine the maximum conductance which is related to the specific leaf area for different types of plants.
- Stomata respond to **root** signals, during drought (abscisic acid, ABA) and also under favourable conditions of water and nutrition (cytokinin, CK).
- Stomata respond to conditions within the leaf, particularly CO₂ within the mesophyll, which in turn depends on photosynthesis and on the **water status** of the epidermis.
- Stomata respond to environmental factors, particularly **light**, **temperature** and **atmospheric humidity**.

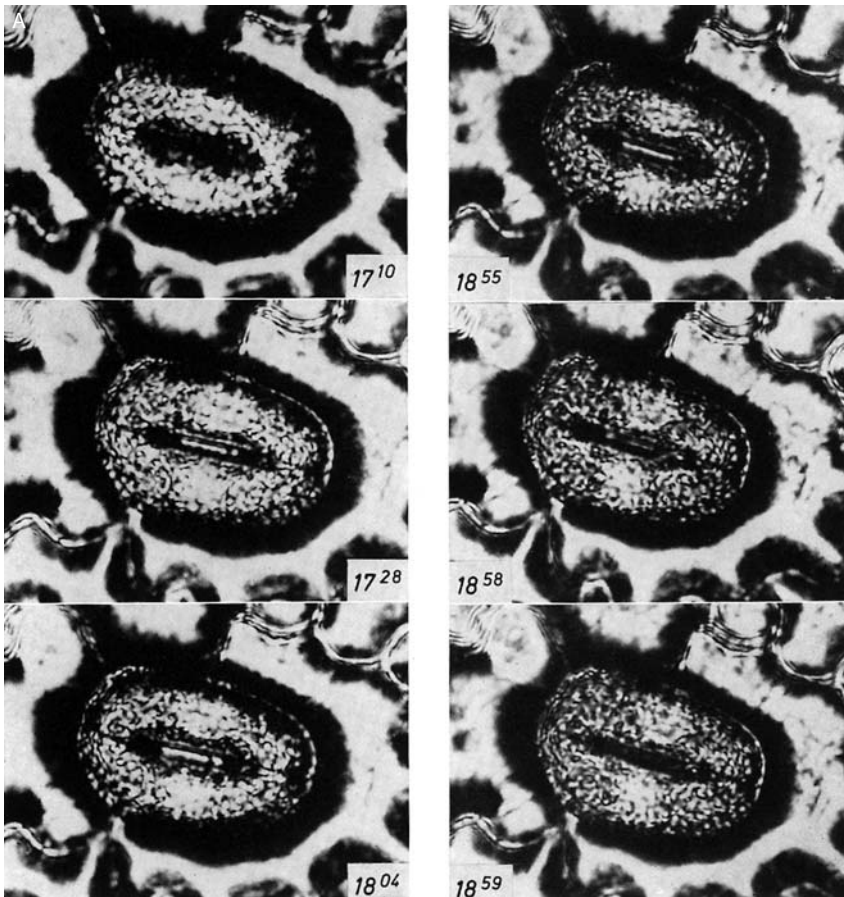
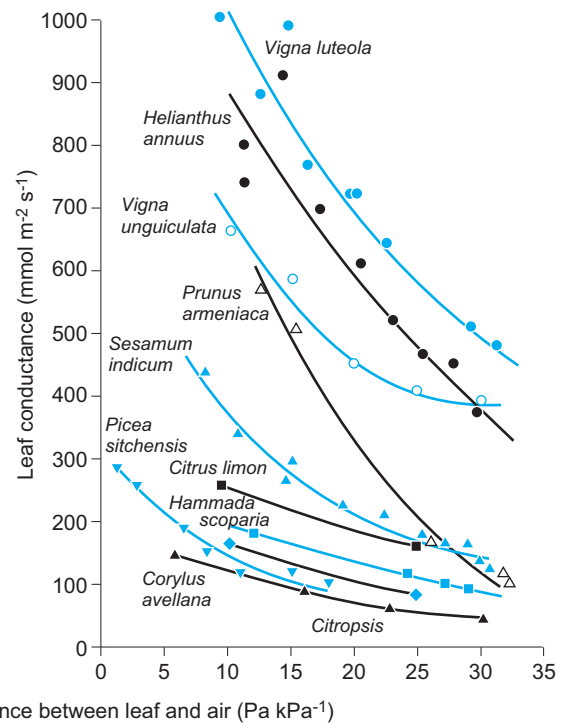
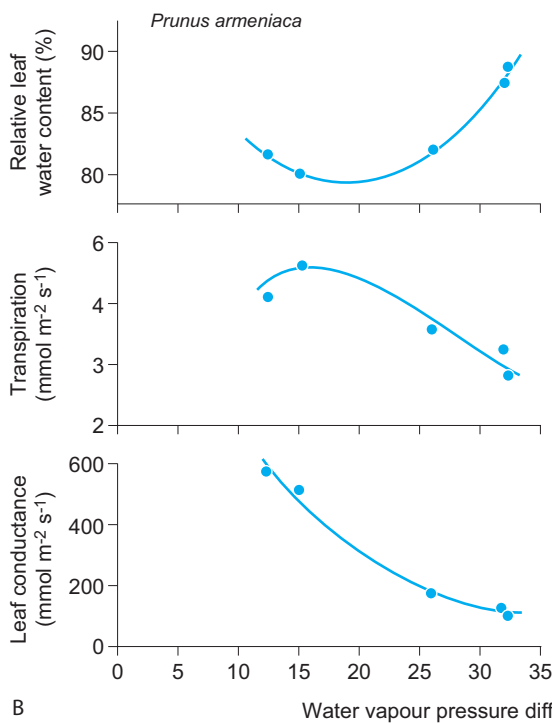


Fig. 2.2.17. A Stomata in isolated epidermis of *Polypodium vulgare*. The lower surface of the epidermis was in contact with water. Only a small air bubble simulated the substomatal air space. On the upper surface dry or moist air was blown over the stomata with a capillary. The experiment started with closed stomata in dry air. Changing to moist air induced slow stomatal opening in 54 min. With constant moist conditions the stomata stayed open but with application with dry air closed within 4 min (Lange et al. 1971). **B** Response of leaf conductance, transpiration and water content of a leaf of *Prunus armeniaca* to dry air. Stomata closed, transpiration decreased and leaf water content increased. **C** Responses of different types of plant to dry air. (Schulze and Hall 1982)



conditions, this observation shows clearly that the water status affects stomata in many more ways than can be seen from experiments in the laboratory.

2.2.4

Transpiration of Leaves and Canopies

2.2.4.1

Coupling of Water and Heat Balance

Transpiration of leaves and vegetation surfaces is only partially regulated by stomata (Schulze et al. 1996b). Stomata are the most important site where individual plants limit the flow of water physiologically but there are other structural possibilities by which plants influence transpiration. These are in particular:

- roughness of the surface of the vegetation;
- leaf area; and
- inclination of leaves.

Because of the physical laws of evaporation, transpiration is primarily dependent on climatic factors, particularly on the available radiation energy and the saturation deficit of air. At a given water supply, transpiration and not stomatal conductance ultimately determines survival of plants. Transpiration is, at the level of whole plants in their natural environments, governed by **turbulence**, the effects of which are hard to assess ecologically. Those interested in mathematics should read the works of Raupach and Finnigan (1988) with the remarkable title “Single-layer models of evaporation from plant canopies are incorrect but useful, whereas, multi-layer models are correct but useless”. Here we restrict our considerations to the “large leaf model” which assumes that the total surface of a plant behaves as a single leaf, even if sub-divided. The so-called **Pennman-Monteith equation** (Monteith 1965; the derivation of the equation is also explained by Jones 1994) describes **evaporation as energy turnover** (λE , W m^{-2} ; see Chap. 2.1). Evaporation depends on net radiation, R_n , and the water vapour gradient between leaf and air, D (Pa), as well as the conductance of the canopy for water vapour, G_w (mm s^{-1}), and for sensible heat, G_H (mm s^{-1}):

$$\lambda E = \frac{sR_n + \rho c_p G_H D}{s + \gamma(1 + G_H/G_w)} \quad (2.2.18)$$

latent heat flux = (radiation + sensible heat flux) / (relation of conductance of sensible and latent heat).

The coefficient s (Pa K^{-1}) describes the change in saturation vapour pressure D with temperature, ρ is the density of air (1.204 kg m^{-3}), c_p the specific heat capacity of air ($1012 \text{ J kg}^{-1} \text{ K}^{-1}$) and γ (Pa K^{-1}) the psychrometric constant (66.1 Pa K^{-1} ; see Chap. 2.1.1).

The equation combines the turn-over of **latent** (λE) and **sensible heat** ($= \rho c_p G_H D$) with radiation, because, ultimately, the turnover of water from the plant depends on the energy that is available. Under the conditions of simultaneous transport of heat and water vapour, i.e. completely turbulent transport conditions in the boundary layer, G_a and G_s are resistors in series and thus are replaceable by the frequently used terms **boundary layer conductance** (G_a , where a represents the atmosphere) and the **surface conductance** of the canopy (G_s , the **surface conductance**). For $G_H/G_w = (1 + G_a/G_s)$, Eq. (2.2.18) is expressed in the more frequently used form

$$\lambda E = \frac{sR_n + \rho c_p G_a D}{s + \gamma(1 + G_a/G_s)} \quad (2.2.19)$$

It should be noted that G_s is not equal to the stomatal conductance g_s , as the surface of the vegetation also contains the evaporation from the soil (Fig. 2.2.18; Schulze et al. 1994). G_a is composed of the immediate boundary layer of the leaf and the boundary layer of the vegetation, which is the zone in which the horizontal wind speed is influenced by the vegetation (see Fig. 2.1.9).

If the flow is not described as a function of conductance but as a function of the resistance (R), then $R_s = 1/G_s$

$$R_s = \frac{1}{G_s} = \frac{\rho c_p D}{\gamma \lambda E} + \frac{1}{\gamma G_a} \left[\frac{sR_n}{\lambda E} - (s + \gamma) \right] \quad (2.2.20)$$

Equations (2.2.18)–(2.2.20) show:

- Saving water leads to increased heat flux, dependent on the temperature difference between the exchanging surface and the air and thus to increased leaf temperature and also to greater vapour pressure deficit between the leaf and its environment (see Chap. 2.2.1).

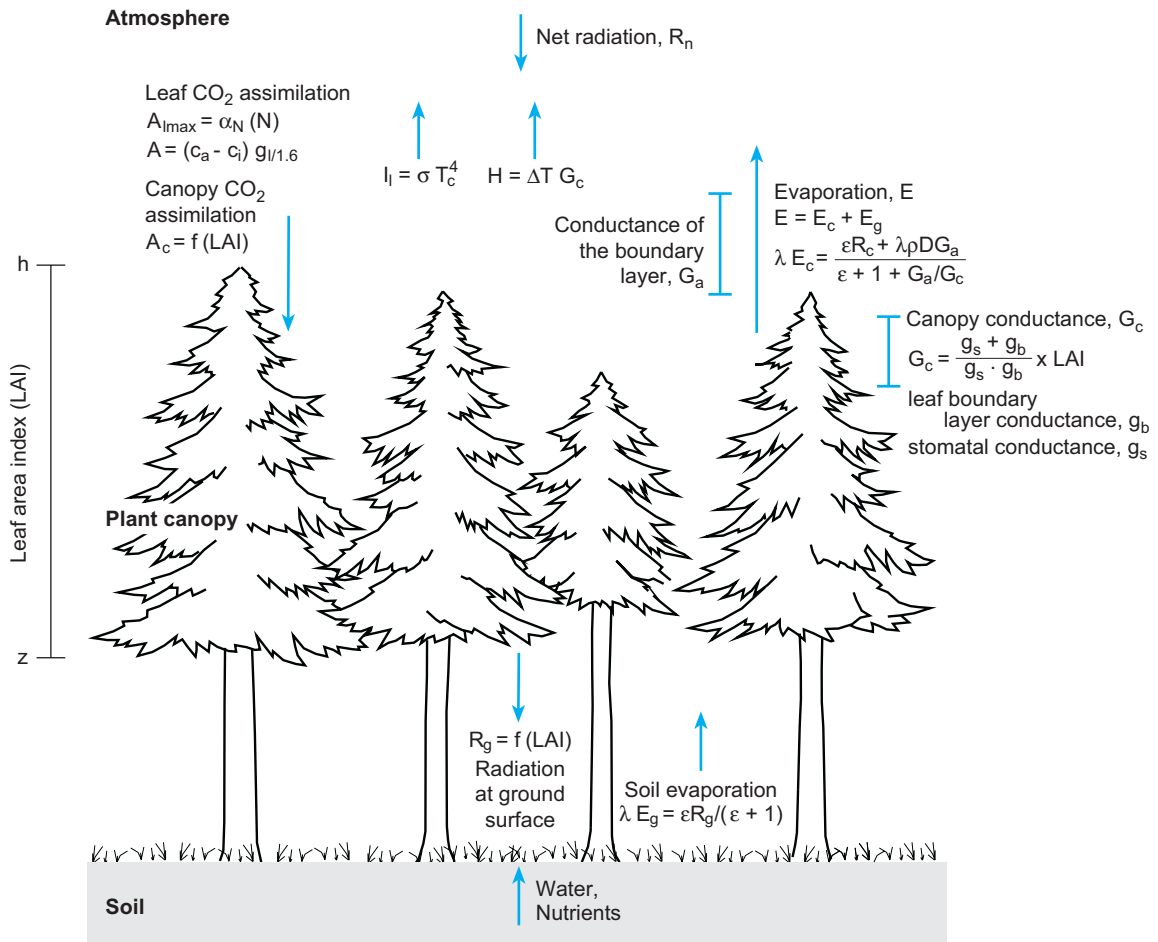


Fig. 2.2.18. Representation of water and CO₂ fluxes in a plant stand. The determining abiotic factors are net radiation, and the water and nutrient supply from the soil. The radiation intensity (and the leaf angle) determines the leaf area index (LAI). Carbon dioxide assimilation is determined by the capacity of the leaf (CO₂ gradient: c_a-c_i), stomatal conductance, g_s, nitrogen nutrition and the LAI. In a dense plant stand most of the incident radiation is intercepted before reaching the soil surface. Evaporation takes place against the CO₂ influx. Evaporation consists of water loss from soil (E_g) in equilibrium with radiation at the forest floor and transpiration from the canopy (E_c). Both evaporative fluxes are limited by a number of conductances: soil and plant water loss are dependent on the surface roughness of the whole stand (G_a). G_a describes the turbulence above the canopy where wind speed decreases by contact with the vegetation (2–5 m above the vegetation). The canopy conductance (G_c) is determined by the conductance in the boundary layer around the leaf g_b and the stomatal conductance g_s, with the total conductance dependent on LAI. The surface conductance G_s is the sum of G_a and G_c. Not all of the energy is used as latent heat of evaporation and the energy balance is achieved by alterations in surface temperature (T_c) and the emission of long-wave, infrared radiation dependent on it, and on the sensible heat flux (H) (see Chap. 2.1) ε corresponds to s in Eq. (2.2.18). (After Schulze et al. 1995)

This compensates the effect of stomatal closure on transpiration.

- The plant may change its form or growth. If the conductance of the boundary layer G_a is very large, there is a tight coupling with the temperature of the environment, for example, in trees. Water consumption then depends on the conductance of the surface G_s. In contrast, G_a may become very small, e.g. in a meadow, with a consequent increase in surface temperature because turbulent exchange with the

surrounding air layers is limited. In this case, water loss is less dependent on G_s than on radiation and plants could, under certain conditions, maintain open stomata and assimilate CO₂ with little water loss. Differences shown in Fig. 2.1.9 (Chap. 2.1.2.3) between a crop of cereals and a forest are mainly a consequence of the differences in G_a.

- It should be noted that the term $[1/\gamma G_a [(sR_n/\lambda E) - (s + \gamma)]]$ is not taken into account in ventilated cuvettes in physiological experiments,

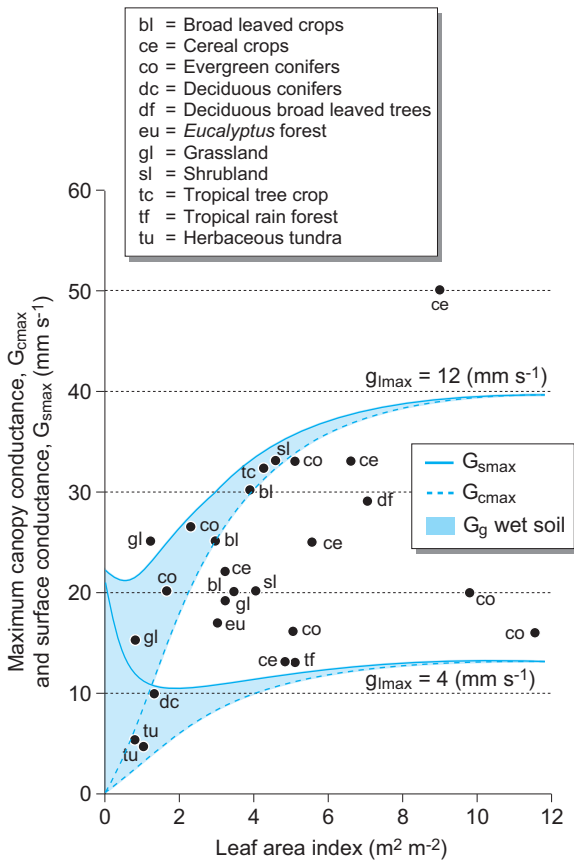


Fig. 2.2.19. Relationship between maximum canopy conductance (G_c =vegetation) and surface conductance (G_s =soil and vegetation) and their relation to leaf area index. The *continuous line* shows the conductance of the surface, the *hatched line* conductance of the vegetation, the *zone between the lines* shows the conductance of moist soil, G_g . (After Kelliher et al. 1995)

as G_a becomes very large in this case. Such experiments provide information on stomata, but not about transpiration which occurs under field conditions.

- The significance of evaporation from the soil surface becomes obvious if the maximum conductance of the canopy, as the component of the surface conductance that is regulated by the plant, is plotted against the leaf area index (LAI; Fig. 2.2.19). Canopy and surface conductances are affected by the maximum stomatal conductance, i.e. dependent on the coupling with the atmosphere, different rates of water turnover are reached. Canopy conductance increases with LAI and becomes saturated at LAI=5. In contrast, surface conductance behaves somewhat differently. With decreasing LAI, free evaporation from the soil surface becomes important. With LAI=2 con-

ductance of the soil is as large as that from plants, as long as the soil surface is wet. For LAI<1 surface conductance increases again, i.e. sparse vegetation cover protects the soil from loss of water, but the component regulated by the plant is very small. In this case “water saving” by plants does not affect the water loss from the site, because the water balance is determined by evaporation from the soil (Greenwood et al. 1992). In Fig. 2.2.19 data from measured plant stands are included. It becomes obvious that the maximum stomatal conductance of the plant cover of the earth is between 4 and 12 mm s^{-1} . Whilst herbaceous vegetation is characterised by a high LAI and high canopy conductance, forests and shrubs have a low LAI and low conductance. The reason for this difference is the coupling of the vegetative types to the atmosphere. The high conductance does not mean that herbaceous vegetation transpires more than forest stands.

2.2.4.2 “Imposed” and “Equilibrium” Evaporation

Two limiting cases are distinguished with regards to the relative significance of stomatal conductance versus the conductance of the boundary layer (Jarvis and McNaughton 1986):

1. Therefore,

$$G_a \gg G_s : \lambda E \rightarrow (\rho c_p / \gamma) D G_s \tag{2.2.21}$$

In this case, transpiration depends on the saturation deficit of air and on stomatal opening. This would be the case in the rough canopy of a forest. For constant stomatal width, transpiration is “forced or imposed” by the saturation deficit of the air. This is called **imposed evaporation** (E_{imp}).

2. Thus,

$$G_a \ll G_s : \lambda E \rightarrow (s / (s + \gamma)) R_n \tag{2.2.22}$$

In this case, transpiration is in equilibrium with the available net incoming radiation, and is thus independent of stomatal conductance, an example is an even lawn. Stomata may be opened wide, but the vegetation loses little water, even if the free atmosphere is dry. This may be observed in long lasting dew, for ex-

Box 2.2.6**Summary: Measurement of transpiration of leaves, of single plants and plant canopies**

Measurement in leaves (see Sestak et al. 1971; Pearcy et al. 1991):

- **Porometer:** this is a vessel onto which a leaf is pressed or into which a leaf is sealed. The changes in air humidity and CO₂ concentration are measured and from this a flux is calculated. **Advantage:** simple to use. **Disadvantage:** the response of the plant, i.e. the change in stomatal conductance and not the transpiration rate is actually measured under artificial conditions.
- **Cuvettes:** these are controlled chambers in which all or part of a leaf is enclosed. The temperature and the humidity can be controlled so that it is possible to determine the plant's responses to specific conditions. **Advantage:** experiments are possible in the field. **Disadvantage:** complicated machinery. The measured transpiration rate does not correspond to the transpiration rate under undisturbed conditions.

Measurement on single plants (see Pearcy et al. 1991):

- **Xylem flux:** the water in the xylem is heated at a point and the distribution of temperature in the stem is measured. There are different approaches, either the temperature dissipation is held constant and the current is regulated (Cermak method) or the energy input is held constant and the change in temperature is measured (Granier method). **Advantage:** it allows measurement of the natural rate of transpiration of the plant. **Disadvantage:** the method is best suited for trees, small shoots are difficult to measure: extrapolation

to the whole vegetation surface is difficult.

Measurements of canopies (see Aubinet et al. 2000):

- **Eddy correlation method:** Turbulence over the surface of vegetation is determined from the vertical profile of wind speed. The size of the air parcels that enter or leave the vegetation is then determined by combining wind profiles with measurements of temperature and humidity. From knowledge of the chemical composition of the air packages (concentration of gases, e.g. CO₂) the water and CO₂ fluxes may be assessed over a large area of vegetation (1–4 km²). **Advantage:** integrated measurement of fluxes for whole ecosystems. **Disadvantage:** can only be used under particular topographical conditions (small slope, homogeneous canopy and unstable layers).

Measurements at landscape scales (see Lloyd et al. 2001):

- **CBL-balancing** (CBL=convective boundary layer): The lower layer of the atmosphere may be used as a cuvette, i.e. during the day changes in concentration in gases in this zone may be measured from an aeroplane and knowledge of the flux balances with the environment and the troposphere can be obtained at landscape scale from 50–100 km². **Advantage:** quantification of flux balances from varied landscapes. **Disadvantages:** technically and meteorologically demanding and limited to particular meteorological conditions.

ample, in the shadow of woods. It is called **equilibrium evaporation** (E_{eq}). In this case, the transport of water vapour from the boundary layer away from the plant is not taking place and evaporation will saturate the non-turbulent air space immediately. Water vapour transport to the atmosphere is only possible if the temperature of the surface rises as a consequence of radiation.

Under natural conditions both limiting cases occur but usually a mixture of transpiration imposed by saturation deficit and in equilibrium with radiation occurs.

$$\lambda E = \Omega \lambda E_{eq} + (1 - \Omega) \lambda E_{imp}, \quad (2.2.23)$$

where Ω is the **decoupling factor** which quantifies the connection of the vegetation to the at-

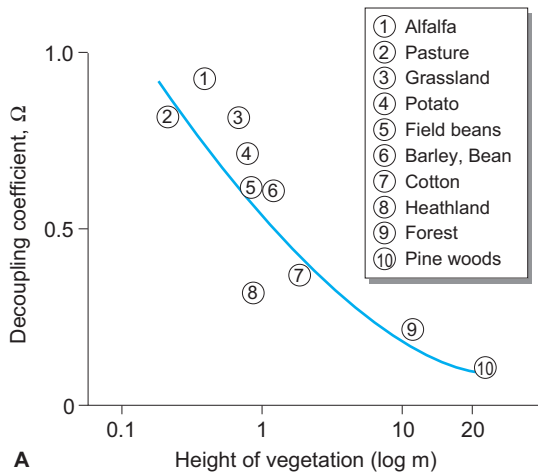


Fig. 2.2.20. **A** Dependence of the uncoupling factor Ω on the height of the vegetation as a measure of the roughness of the surface (after Kelliher et al. 1995). **B** In boreal forest the ratio of latent to sensible heat flux is affected by the form of tree canopy. *Picea obovata* x *excelsa* (narrow crown) is more densely covered with needles and therefore warms more than *Picea excelsa* (broad crown) or *Betula pubescens*. The thick ground vegetation with *Vaccinium myrtillus* does not have a very rough surface and thus warms more strongly. Gutulia, central Norway (Photo E.-D. Schulze). **C** Canopy of a *Eucalyptus marginata* stand with an average height of 100 m in south-western Australia. *Eucalyptus marginata* reaches a height of 140 m. In contrast to boreal forests, the leaf surface is almost uniformly distributed in the canopy, although *Eucalyptus* forms leaf bundles at the ends of braches. Picture taken from the "Glocester tree" near Pemperton. (Photo E.-D. Schulze)



mosphere, λE_{eq} is the equilibrium evaporation and λE_{imp} the imposed evaporation [see Eqs. (2.2.21) and (2.2.22)].

$$\Omega = 1 / (1 + (\gamma/s + \gamma)(R_s/R_a)) \quad (2.2.24)$$

at 10°C , $(\gamma/s + \gamma) = 0.44$.

The sensitivity with which transpiration reacts to changes of stomata, $(dE/E)/(dG_s/G_s)$, is directly determined by Ω :

$$(dE/E)/(dG_s/G_s) = (1 - \Omega) \quad (2.2.25)$$

The above-mentioned relations are very important in the regulation of water loss from plant

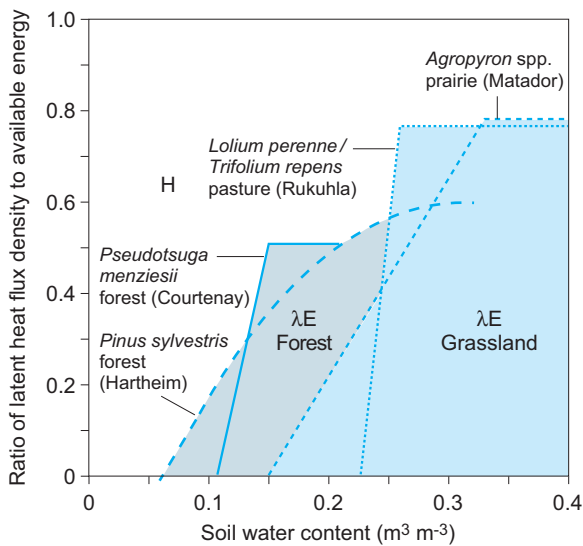


Fig. 2.2.21. Relation between energy exchange of different types of vegetation and soil water content (after Kelliher et al. 1993). The figure shows that the tree vegetation with deeper penetrating roots only limits transpiration at low water contents in the upper soil, in contrast to grasslands. Forest vegetation *Pinus sylvestris* at Hartheim, Germany; *Pseudotsuga menziesii* in Kourtenay, USA. *Agropyron* grassland in Matador, USA; *Lolium/Trifolium* grassland: Rukuhla, New Zealand

canopies. Under certain conditions the characteristics of the vegetation are more important than stomatal regulation. A branch standing out

from a “wind swept” canopy of a forest near the coast experiences different evaporative conditions to other leaves protected by the canopy.

The **decoupling factor** Ω decreases with increasing height of vegetation (Fig. 2.2.20). However, this does not explain how and to what extent transpiration takes place, because, at constant Ω , transpiration is dependent on radiation and saturation deficit.

For many types of vegetation the **maximum rate of transpiration** decreases with the height of vegetation (i.e. the stomatal component increasingly regulates the water loss in the stand as well; Kelliher et al. 1993). The faster evaporation for low vegetation is not caused by the regulation of stomata, but because the relative amount of evaporation from the soil increases and becomes more important. In the canopy of the forest it is also possible for individual trees or species to influence, within certain limits, coupling to the atmosphere. This is, for example, the case in very dense canopies of boreal spruces and pines which form, considered as the surface of the forest, a very rough canopy (G_a is very large), but individual trees carry a very dense branch and needle cover (clumped distribution of leaf area; G_a very small). Thus, in the region near the stem, equilibrium evaporation dominates and a differential temperature climate may be formed in the canopy.

Box 2.2.7

Summary: Transpiration of plant canopies

- Factors controlling **transpiration** are net radiation, water vapour deficit in the air, aerodynamics of the boundary layer above the canopy and stomata. The relative influence of these factors depends on the structure of the vegetation cover, especially the roughness of the surface. This is largely dependent on the types of plants that are growing (trees, shrubs and grasses).
- Plants regulate water losses primarily through their **form**. At the same time, the form of a plant is dependent on its environment. Most noteworthy features are the height to which the plants grow and the number of leaves.
- At low LAI the proportion of water evaporated from the soil surface increases so that a “water saving” through the abscission of leaves does not lead, necessarily, to a reduction in the amount of water lost by the ecosystem.
- For vegetation with smooth surfaces the transpiration rate is primarily dependent on the net radiation (**steady-state evaporation**) and is mostly independent of the stomata.
- In vegetation with rough surfaces the transpiration rate is primarily dependent on the saturation deficit of air. In this case control of transpiration can occur through stomata. The **uncoupling factor** describes the relative effects of the stomata on the total transpiration of the plant and soil system.
- Plants have a further method of controlling their water balance, by having different root structures (**rooting depth**).

The response of stomata to humidity was observed to be independent of the forms of different herbaceous and woody species, e.g. in low rosette plants and trees. According to Eq. (2.2.20), and (2.2.24), this response is ecologically mainly important for trees, where an effective limitation of transpiration by closure of stomata during the course of the day has been observed (e.g. for *Nothofagus fusca* in New Zealand; Köstner et al. 1992).

Considering water relations of plants from the view of the atmosphere “clouds” the fact that plants have a further, important structural way of regulating their water relations, that is a regulation by **rooting depth**. The available amount of water is an important component in the water balance and differs greatly for different types of plants. Figure 2.2.21 gives an example of the behaviour of different grasslands with drying soils showing the proportion of evaporation which is determined by latent and sensible heat flows. It becomes obvious that agronomically used grassland with good water status turns over 80% of the available energy as latent energy (transpiration) but limits transpiration very early (in this case because of drought). In the prairie with good water supply, a similarly high turnover of latent energy occurs, but this vegetation starts to regulate water loss earlier and maintains a favourable water balance for longer. In contrast, conifer stands have a significantly lower turnover of latent energy, even if much water is available in the soil; they limit transpiration significantly later than grasslands, mainly because of their deeper roots.

References

- Aubinet M, Grelle A, Ibrom A, Rannik U, Moncrieff J, Foken T, Kowalski AS, Martin P, Berbigier P, Bernhofer C, Clement R, Elbers I, Cranier A, Gruenwald T, Morgenstern K, Pilegaard K, Rebmann C, Snijders W, Valentini R, Vesala T (2000) Estimates of the annual net carbon and water exchange of European forests: The EUROFLUX methodology. *Adv Ecol Res* 30:113–175
- Bewley JD, Krochko JE (1982) Desiccation tolerance. *Encycl Plant Physiol NS* 12B:325–378
- Böhm J (1893) Capillarität und Saftsteigen. *Ber Dtsch Bot Ges* 11:203–212
- Burgess SSO, Adams MA, Turner NC, White DA, Ong CK (2001) Tree roots: conduits for deep recharge of soil water. *Oecologia* 126:158–165
- Canadell J, Jackson RB, Ehleringer JR, Mooney HA, Sala OE, Schulze E-D (1996) Maximum rooting depth of vegetation types at the global scale. *Oecologia* 108:583–595
- Carlquist S (1991) Anatomy of vine and liana stems: a review and synthesis. In: Putz FE, Mooney HA (eds) *The biology of vines*. Cambridge University Press, Cambridge, pp 53–71
- Darcy H (1856) *Las Fontains Publiques de La Villa Dijon*. Dalmont, Paris
- Dawson TE (1993) Water sources as determined from xylem-water isotopic composition: perspectives on plant competition, distribution, and water relations. In: Ehleringer JR, Hall AE, Farquhar GD (eds) *Stable isotopes and plant carbon-water relations*. Academic Press, San Diego, pp 465–498
- Ehleringer JR (1994a) Variation in gas exchange characteristics among desert plants. In: Schulze E-D, Caldwell MM (eds) *Ecophysiology of photosynthesis*. Ecological Studies 100. Springer, Berlin Heidelberg New York, pp 361–392
- Ehleringer JR (1994b) Carbon and water relations in desert plants: an isotopic perspective. In: Ehleringer JR, Hall AE, Farquhar GD (eds) *Stable isotopes and plant carbon-water relations*. Academic Press, San Diego, pp 155–172
- Evenari M, Shanan L, Tadmor N (1982) *The Negev; the challenge of a desert*. Harvard University Press, Cambridge, 437 pp
- Ewers BE, Oren R, Sperry JS (2000) Influence of nutrients versus water supply on hydraulic architecture and water balance in *Pinus taeda*. *Plant Cell Environ* 23:1055–1066
- Fukuda H (1997) Tracheary element differentiation. *Plant Cell* 9:1147–1156
- Gartner BL (1995) *Plant stems: physiology and functional morphology*. Academic Press, San Diego, 439 pp
- Grace J (1993) Consequences of xylem cavitation for plant water deficits. In: Smith JAC, Griffiths H (eds) *Water deficits*. Bios Scientific Publishers, Oxford, pp 109–128
- Greenwood EAN, Turner NC, Schulze E-D, Waton GD, Venn NR (1992) Groundwater management through increased water use by lupine crops. *J Hydrol* 134:1–11
- Griesebach A (1872) *Die Vegetation der Erde nach ihrer klimatischen Anordnung*. Wilhelm Engelmann, Leipzig, 709 pp
- Hollinger DY, Kelliher FM, Schulze E-D, Köstner BM (1994) Coupling of tree transpiration to atmospheric turbulence. *Nature* 371:60–62
- Horn R (1994) The effect of aggregation of soils on water, gas and heat transport. In: Schulze E-D (eds) *Flux control in biological systems*. Academic Press, San Diego, pp 335–361
- Hubbard RM, Ryan MG, Stiller V, Sperry JS (2001) Stomatal conductance and photosynthesis vary linearly with plant hydraulic conductance in ponderosa pine. *Plant Cell Environ* 24:113–122
- Jarvis PG, McNaughton KG (1986) Stomatal control of transpiration: scaling from leaf to region. *Adv Ecol Res* 15:1–15
- Jones HG (1994) *Plant and microclimate; a quantitative approach to environmental plant physiology*. Cambridge University Press, Cambridge, 428 pp
- Kappen L, Schulz G, Vanselow R (1994) Direct observations of stomatal movements. *Ecological Studies* 100. Springer, Berlin Heidelberg New York, pp 231–246
- Kelliher FM, Leuning R, Schulze E-D (1993) Evaporation and canopy characteristics of coniferous forests and grasslands. *Agric For Met* 62:53–73
- Kelliher FM, Lenning H, Raupach M, Schulze E-D (1995) Maximum conductance for evaporation of global vegetation types. *Agric For Met* 73:1–16

- Kolb KL, Sperry JS (1999) Transport constraints on water use by the Great Basin shrub *Artemisia tridentata*. *Plant Cell Environ* 22:925–935
- Köppen W (1923) *Die Klimate der Erde*. Walter de Gruyter, Berlin, 369 pp
- Köstner BMM, Schulze E-D, Kelliher FM, Hollinger DY, Byers JN, Hunt JE, McSeveny TM, Meserth R, Weir PL (1992) Transpiration and canopy conductance in a pristine broad-leaf forest of *Nothofagus*: an analysis of xylem sap flow and eddy correlation measurements. *Oecologia* 92:236–241
- Kramer PJ, Boyer JS (1995) *Water relations of plants and soils*. Academic Press, London, 495 pp
- Lange OL, Lösch R, Schulze E-D, Kappen L (1971) Responses of stomata to changes in humidity. *Planta* 100:76–86
- Lange OL, Nobel PS, Osmond CB, Ziegler H (1982) *Physiological plant ecology II: water relations and carbon assimilation*. Encyclopaedia of plant physiology, vol 12B. Springer, Berlin Heidelberg New York, 747 pp
- Larcher W (1976) *Ökophysiologie der Pflanzen*. UTB 232, Ulmer, Stuttgart, 399 pp
- Larcher W (1994) *Ökophysiologie der Pflanzen*. UTB, Ulmer, Stuttgart, 394 pp
- Lloyd J, Francey RJ, Sogachev A, Byers JN, Mollicone D, Raupach MR, Kelliher FM, Rebmann C, Arneth A, Valentini R, Wong SC, Schulze E-D (2001) Vertical profiles, boundary layer budgets and regional flux estimates for CO₂, its ¹³C/¹²C ratio, and for water vapour above a forest/bog mosaic in central Siberia. *Global Biogeochem Cycles* 15:267–284
- Lo Gullo MA, Salleo S (1991) Three different methods for measuring xylem cavitation and embolism: a comparison. *Ann Bot* 67:417–424
- Lüttge U (1973) *Stofftransport der Pflanzen*. Heidelberger Taschenbücher 125. Springer, Berlin Heidelberg New York, 280 pp
- Martre P, Cochart H, Durand JL (2001) Hydraulic architecture and water flow in growing grass tillers (*Festuca arundinacea* Schreb.). *Plant Cell Environ* 24:65–76
- Meidner H, Mansfield TA (1968) *Physiology of stomata*. McGraw-Hill, London, 179 pp
- Michael W, Schultz A, Meshcheryakov AB, Ehwald R (1997) Apoplasmatic and protoplasmatic water transport through the parenchyma of a potato storage organ. *Plant Physiol* 115:1089–1099
- Michael W, Cholodova VP, Ehwald R (1999) Gas and liquids in intercellular spaces of maize roots. *Ann Bot* 84:665–673
- Monteith JL (1965) Evaporation and environment. *Symp Soc Exp Biol* 19:205–234
- Nobel PS (1991) *Physicochemical and environmental plant physiology*. Academic Press, San Diego, 635 pp
- Nonami H, Schulze E-D, Ziegler H (1990) Mechanisms of stomatal movement in response to air humidity, irradiance and xylem water potential. *Planta* 183:57–64
- Pearcy RW, Ehleringer J, Mooney HA, Rundel PW (1991) *Plant physiological ecology: field methods and instrumentation*. Chapman and Hall, London, 457 pp
- Philip JR (1957) Evaporation, and moisture and heat fields in the soil. *J Meteorol* 14:354–366
- Raschke K (1972) Saturation kinetics of the velocity of stomatal closing response to CO₂. *Plant Physiol* 49:229–234
- Raschke K (1979) Movements of stomata. In: Haupt W, Feinleib RE (eds) *Physiology of movements*. Springer, Berlin Heidelberg New York, pp 383–440
- Raupach MR, Finnigan JJ (1988) Single-layer models of evaporation from plant canopies are incorrect but useful, whereas multilayer models are correct but useless. *Aust J Plant Physiol* 15:705–716
- Reich PB, Walters MB, Eldsworth DS (1997) From tropics to tundra: global convergence in plant functioning. *Proc Natl Acad Sci USA* 94:13730–13734
- Richards JH, Caldwell MM (1987) Hydraulic lift: substantial nocturnal water transport between soil layers by *Artemisia tridentata* roots. *Oecologia* 73:486–489
- Schröder JI, Kwak JM, Allen GJ (2001) Guard cell abscisic acid signalling and engineering drought hardness in plants. *Nature* 410:327–330
- Schulze E-D (1986) Carbon dioxide and water vapor exchange in response to drought in the atmosphere and in the soil. *Annu Rev Plant Physiol* 37:247–274
- Schulze E-D (1993) Soil water deficits and atmospheric humidity as environmental signals. In: Smith JAC, Griffiths H (eds) *Water deficits*. Bios Scientific Publishers, Oxford, pp 129–145
- Schulze E-D (1994) The regulation of plant transpiration: interactions of feedforward, feedback, and futile cycles. In: Schulze E-D (eds) *Flux control in biological systems*. Academic Press, San Diego, pp 203–236
- Schulze E-D, Chapin FS III (1987) Plant specialization to environments of different resource availability. *Ecological Studies* 61. Springer, Berlin Heidelberg New York, pp 120–148
- Schulze E-D, Hall AE (1982) Stomatal response, water loss and CO₂ assimilation rates of plants in contrasting environments. *Encycl Plant Physiol* 12B:181–230
- Schulze E-D, Heinmann M (1998) Carbon and water exchange of terrestrial systems. In: Galloway J, Mellilo J (eds) *Asian change in the context of global climate change*. Cambridge University Press, Cambridge. IGBP Publ Ser 3:145–161
- Schulze E-D, Lange OL, Buschbom U, Kappen L, Evenari M (1972) Stomatal responses to changes in humidity in plants growing in the desert. *Planta* 108:259–270
- Schulze E-D, Cermak J, Matussek R, Penka M, Zimmermann R, Vasicek, Gries W, Kucera J (1985) Canopy transpiration and water fluxes in the xylem of the trunk of Larix and Picea trees – a comparison of xylem flow, pyrometer and cuvette measurements. *Oecologia* 66:475–483
- Schulze E-D, Kelliher FM, Körner C, Lloyd J, Leuning R (1994) Relationships among maximum stomatal conductance, carbon assimilation rate, and plant nitrogen nutrition: a global ecology scaling exercise. *Annu Rev Ecol Syst* 25:629–660
- Schulze E-D, Leuning R, Kelliher FM (1995) Environmental regulation of surface conductance for evaporation from vegetation. *Vegetatio* 121:79–87
- Schulze E-D, Ellis R, Schulze W, Trimborn P, Ziegler H (1996a) Diversity, metabolic types and $\delta^{13}\text{C}$ carbon isotope ratios in the grass flora of Namibia in relation to growth form, precipitation and habitat conditions. *Oecologia* 106:352–36
- Schulze E-D, Kelliher FM, Körner C, Lloyd J, Hollinger DY, Vygodskaya NN (1996b) The role of vegetation in controlling carbon dioxide and water exchange between land surface and the atmosphere. In: Walker B, Steffen W (eds) *Global change and terrestrial ecosystems*. IGBP Book Series 2. Cambridge University Press, Cambridge, pp 77–92
- Schulze E-D, Mooney HA, Sala OE, Jobbagy E, Buchmann N, Bauer G, Canadell J, Jackson RB, Loreti J, Oesterheld M, Ehleringer JR (1996c) Rooting depth, water availability, and vegetation cover along an aridity gradient in Patagonia. *Oecologia* 108:503–511

- Schulze E-D, Caldwell MM, Canadell J, Mooney HA, Jackson RB, Parson D, Scholes R, Sala O, Trimborn P (1998a) Downward flux of water through roots (i.e. inverse hydraulic lift) in dry Kalahari sands. *Oecologia* 115:460–462
- Schulze E-D, Williams RJ, Farquhar GD, Schulze W, Langridge J, Miller JM, Walker BK (1998b) Carbon and nitrogen isotope discrimination and nitrogen nutrition of trees along a rainfall gradient in northern Australia. *Aust J Plant Physiol* 25:413–425
- Sestak Z, Catsky J, Jarvis PG (1971) Plant photosynthetic production. Manual of methods. Dr W Junk NV Publishers, Den Haag, 818 pp
- Slatyer RO (1967) Plant-water relationships. Academic Press, London, 366 pp
- Sperry JS (1995) Limitations on stem water transport and their consequences. In: Gartner BL (eds) Plant stems: physiology and functional morphology. Academic Press, San Diego, pp 105–124
- Sperry JS, Holbrook NM, Zimmermann MH, Tyree MT (1987) Spring filling of xylem vessels in wild grapevine. *Plant Physiol* 83:414–417
- Stedle E (1994) The regulation of plant water at the cell, tissue, and organ level: role of active processes and of compartmentation. In: Schulze E-D (eds) Flux control in biological systems. Academic Press, San Diego, pp 237–302
- Stedle E (2000) Water uptake by roots: effects of water deficits. *J Exp Bot* 1531–1542
- Stedle E (2001) The cohesion-tension mechanism and the acquisition of water by plant roots. *Annu Rev Plant Physiol Plant Mol Biol* 847–875
- Stedle E, Peterson CA (1998) How does water get through roots? *J Exp Bot* 49:775–788
- Tanner W, Beevers H (1990) Does transpiration have essential function in long-distance ion transport in plants? *Plant Cell Environ* 13:745–750
- Troughton J, Donaldson LA (1972) Probing plant structures. Chapman and Hall, London, 85 pp
- Tyerman SD, Bohnert HJ, Maurel C, Stedle E, Smith JA (1999) Plant aquaporins: their molecular biology, biophysics and significance for plant water relations. *J Exp Bot* 50:1055–1072
- Tyree MT (1997) The cohesion-tension theory of sap ascent. Current controversies. *J Exp Bot* 48:1753–1765
- Tyree MT, Sperry JS (1989) Vulnerability of xylem to cavitation and embolism. *Annu Rev Plant Physiol Plant Mol Biol* 40:19–38
- Walter H (1960) Grundlagen der Pflanzenverbreitung. Teil I: Standortlehre. Eugen Ulmer, Stuttgart, 566 pp
- Ward RC, Robinson M (1990) Principles of hydrology. McGraw Hill, Berkshire, 365 pp
- WBGU (1998) World in transition: ways towards sustainable management of freshwater resources. Springer, Berlin Heidelberg New York, 392 pp
- Wei C, Stedle E, Tyree MT (1999) Water ascent in plants: do ongoing controversies have a sound basis? *Plant Sci* 4:372–373
- West NE, Young JA (2000) Intermountain valleys and lower mountain slopes. In: Barbour MG, Billings WD (eds) North American terrestrial vegetation. Cambridge University Press, Cambridge, pp 255–284
- Wirth C, Schulze E-D, Schulze W, von Stürzner-Karbe D, Ziegler W, Milukova I, Sogachev A, Varlagin A, Panfyorov M, Grigoriev S, Kusnetzova W, Siry M, Harges G, Zimmermann R, Vygodskaya NN (1999) Aboveground biomass and structure of pristine Siberian Scots pine forests as controlled by competition and fire. *Oecologia* 121:66–80
- Zeiger E, Lino M, Shimazaki KI, Ogawa T (1987) The blue light response of stomata: mechanisms and function. In: Zeiger E, Farquhar GD, Cowan IR (eds) Stomatal function. Stanford University Press, Stanford, pp 209–228
- Ziegler H, Vieweg GH (1970) Poikilohydre Spermatophyta. In: Walter H, Kreeb K (eds) Die Hydratation und Hydratur des Protoplasmas der Pflanzen und ihre ökophysiologische Bedeutung. Springer, Berlin Heidelberg New York, pp 95–108
- Zimmermann MH (1983) Xylem structure and the ascent of sap. Springer, Berlin Heidelberg New York, 325 pp
- Zimmermann R, Schulze E-D, Wirth C, Schulze EF, McDonald KC, Vygodskaya NN, Ziegler W (2000) Canopy transpiration in a chronosequence of central Siberian pine forests. *Global Change Biol* 6:25–37

2.3

Nutrient Relations of Plants



Magnesium deficiency in spruce. With insufficient Mg available in the soil the young needles obtain their Mg by retranslocation from the old needles via the phloem, and so the old needles become golden yellow at the time of bud break of new growth in spring. This process is exacerbated by an excess of nitrogen, especially when nitrogen is absorbed into the above-ground biomass directly from the atmosphere, bypassing the roots and hence not being regulated. The above-ground N uptake occurs from gases (NO_x , NH_3) via the stomata, or as ions (NH_4^+ , NO_3^-) via the young bark or needles. The exacerbation of Mg deficiency by nitrogen input is because N has a much larger influence on growth than does Mg. However, the amount of Mg required for growth is larger than the Mg availability, and therefore an excess of N results in Mg deficiency. This phenomenon became well known in the 1980s as the "mountain yellowing" syndrome of forest decline. Fichtelgebirge, Upper Warmensteinach, Germany. Photo E.-D. Schulze

Recommended Literature

The classical textbook on plant nutrition is by Epstein (1972). The most comprehensive book on this topic was written by Marschner (1995) and for soil science refer to Brady and Weil (1999).

2.3.1

Availability of Soil Nutrients and Ion Uptake

2.3.1.1

Plant Nutrients

Plants require for their metabolism and growth many elements or their ions which are primarily taken up from the soil. These materials are released into the soil either by weathering from the original rocks, and are then freely available, or from organic substances which are decom-

posed and “mineralised” (i.e. the elements are released from the dead organic material) and are thus available to plants.

Plants take up required nutrients selectively and usually in the form of ions, from the liquid phase in the soil (soil solution). Proof that plants contain inorganic elements is shown by incineration.

After burning the organic material, non-combustible minerals remain in the **ash**, but C, H, N and O can only be identified as gases. For most plants the ash content is 3–8% of dry weight; in halophytic plants the ash content rises to 20% and in lichens may reach 30% due to mineral depositions on the hyphae. The concentration of individual elements in plants spans about six orders of magnitude (Table 2.3.1).

Macro-elements and **trace elements** are essential for the life of plants. Transitions between macro and trace elements are gradual. Macro-elements participate directly in the metabolism (N, S, P) or indirectly support metabolism (K), and there are transitions to trace elements (Ca, Mg). Trace elements are also termed micro-nutrients and are often heavy metals which are directly required for enzyme reactions (Chap. 1.7). **Facultative elements** are only required in some plant groups (Si for grasses). Iodine and vanadium are not mentioned here, as they are only essential for lower plants (Marschner 1995).

Concentration and consumption of nutrient elements are often expressed in units of mass (gram). However, physiological turnover and physicochemical effects of these elements are

■ **Table 2.3.1.** Typical concentration of nutrients in plant tissues. (Marschner 1995)

	Element	Average concentration ($\mu\text{mol g}^{-1}$)
Macroelements	N	1000
	K	250
	Ca	125
	Mg	80
	P	60
	S	30
Trace elements	Cl	3
	B	2
	Fe	2
	Mn	1
	Zn	0.3
	Cu	0.1
	Mo	0.001
Facultative elements	Si	11000
	Na	200
	Co	0.1

usually not measured as mass, but by the number of required molecules; therefore, mole is a better unit than gram.

The following chapter deals with the essential macro nutrients. Heavy metals as trace elements were considered in Chapter 1.7. NaCl is not essential for plants (only under certain conditions does it stimulate growth), and was considered under salt stress in Chapter 1.6.

2.3.1.2

Availability of Nutrients in Soil

Nutrients are available in the soil in different forms (Scheffer/Schachtschabel 1998).

Primary Minerals

Minerals, for example, quartz, feldspar and mica, are created during the formation of rocks by crystallisation from the molten magma (intrusive and igneous rocks) or by re-crystallisation under conditions of high pressures and temperatures (metamorphic rocks) in the upper crust of the earth. Depending on the chemical composition of the magma (acid to alkaline), and the temperature and pressure in the molten material, rocks of different mineral composition are formed (Fig. 2.3.1 C). The largest proportion of primary minerals in the earth's crust is represented by **silicates**, made of silicium-oxygen tetrahedra and with many different crystal structures. Different forms of silicates are distinguished (see Table 2.3.1). In many silicates some of the Si^{4+} ions are replaced by Al^{3+} . Silicates build Si-Si chains similar to C. Thus silicates are to a variable degree negatively charged, allowing positively charged ions (cations) such as K^+ , Na^+ and Ca^{2+} to neutralise the charge and become inserted into the crystal structure. Weathering, particularly by hydrolysis, releases these cations from the mineral matrix and they then become available to plants. With the exchange of base cations against H^+ the crystal structure loses its geometry and falls apart.

Weathering of silicates depends on various factors, the degree of reduction of their crystal structure, replacement of Si by Al, the actual cation content and the proportion of elements (Fe) that may be oxidised yielding a series of increasing stability to weathering (olivine \rightarrow augite \rightarrow tourmaline \rightarrow feldspar \rightarrow quartz).

The composition of primary minerals determines the weathering of rocks, and thus the

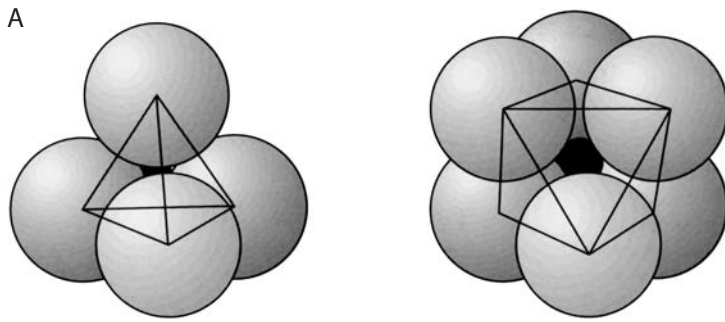
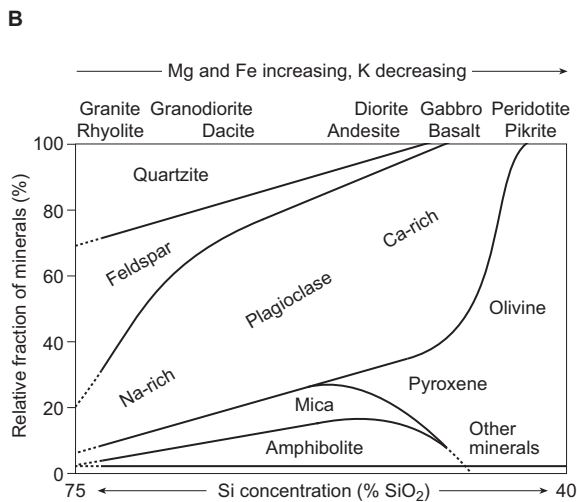
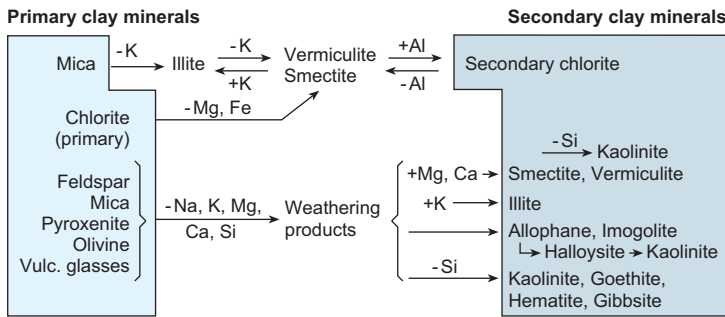


Fig. 2.3.1. A Spatial structure of a Si-tetrahedron (left) and an Al-octahedron (right). B The conversion of primary minerals into secondary clay minerals. C Composition of important rocks with respect to their base and Si content. (Scheffer-Schachtschabel 1998)



C

availability of alkaline compounds. Basalt, for example, is much more alkaline than granite, i.e. contains more potassium, calcium and magnesium.

Secondary Minerals

From the primary intrusive and igneous rocks as well as from metamorphic rocks (e.g. slate), secondary sediments are formed during the course of weathering and erosion, and are deposited and solidified. Depending on the original rock and its “weathering history”, **sedimentary rocks** have different cation contents. Clay-rich soils possess a greater capacity for exchange of cations than sandy soils, not only be-

cause of their much larger surface area for ion exchange, but also because of the greater number of covalent bonds. Secondary minerals include those in sedimentary rocks; for example, in limestone, there are aluminium oxide, iron oxide, manganese (hydr)oxide. Clay minerals are particularly important components of soils which are formed as new products of the Si-Al minerals during the course of weathering from silicates. According to the climatic conditions when the clay minerals were formed, these could be layer lattices in which the cations are imbedded more or less tightly between the layers of Si-tetrahedra and Al-octahedra. These cations can be reversibly exchanged against H⁺ without

Box 2.3.1 The mineral composition of rocks

Rocks

Rocks are mixtures of different minerals, and are classified according to their chemical composition and how they were formed. Distinction is made between magmatite formed from the cooling of molten magma in the earth's crust (intrusive rock) or on the earth's surface (igneous rocks) and sedimentary rocks originating from deposition of weathered loose material or chemical degradation products by sedimentation and subsequently hardened, and metamorphic rocks formed by the partial re-melting and recrystallisation of magmatite and sedimentary rocks.

Primary Silicates

The basic building blocks of the silicates are Si-tetrahedra and Al-octahedra (Fig. 2.3.1A). The original minerals are found in the igneous and intrusive rocks which are distinguished primarily by their Si and cation contents (Fig. 2.3.1C).

Clay Minerals

Weathering produces clay minerals either directly from mica and chlorite or they are newly formed from individual degradation products of silicate weathering. In this case Si-tetrahedra and Al-octahedra are released. They bind to secondary phyllosilicates formed by alternate layers of Si-tetrahedra and Al-octahedra which are linked by covalent bonds (Fig. 2.3.1B). Clay minerals are differentiated by the structure of the layers and the cations which lie between the layers (Fig. 2.3.1C).

- Two-layered minerals
1 Si-tetrahedral + 1 Al-octahedral layer: kaolinite, serpentinite, no cations in the intermediate layers.
- Three-layered minerals
1 Si-tetrahedral + 1 Al-octahedral + 1 Si-tetrahedral layer: illite, chlorite, vermiculite, montmorillonite: cations occur in the inter-

mediate layers, and these cations can be reversibly exchanged against hydrogen ions.

The clay minerals allophane and imogolite are exceptions which occur exclusively in soils derived from volcanic activity. They are spherical or tubular and in acid soils can adsorb anions, e.g. phosphate, so tightly that they are no longer available to plants (phosphate fixation).

Oxides and Hydroxides

In parallel to the breakdown of the Si-tetrahedra during silicate weathering, oxidation of metals also occurs, particularly that of Fe^{2+} to Fe^{3+} or Fe-hydroxide, which is linked to changes in solubility and spatial structure. Such oxidation of metals contributes considerably to the breakdown of the primary crystal structure. The most important oxides and hydroxides are those of Fe, Mn and Al: dependent on climatic conditions, these form different types of secondary minerals which are often responsible for the characteristic colours of soils. Tropical soils are often bright red as a consequence of hematite ($\alpha\text{-Fe}_2\text{O}_3$), whilst the yellow-brown colour of many soils of the temperate zone is caused by goethite ($\alpha\text{-FeOOH}$).

Sedimentary Rocks

Sedimentary rocks are the consequence of transport and the following compaction of the products of primary rocks. They differ mainly in Si and Ca content. A distinction is drawn between rocks and loose sediments, which are characterised by decreasing Si content:

- Rocks: sandstone (70% Si), greywacke (67% Si), slate (59% Si), limestone (8% Si);
- Loose sediments: drifting sands (97% Si), loess (72% Si), marl (64% Si).

Box 2.3.1 The mineral composition of rocks (continued)

Table. Tetrahedra structures of primary silicates

Nesosilicates SiO_4^{4-}	4 free charges/tetrahedron	Tetrahedra are cation saturated	Olivine $(\text{Mg, Fe})_2[\text{SiO}_4]$
Sorosilicates $\text{Si}_2\text{O}_7^{6-}$	3 free charges/tetrahedron	Few tetrahedra covalently bound	Diopside $(\text{Ca, Mg})[\text{Si}_2\text{O}_3]$
Inosilicates SiO_3^{2-}	2 free charges/tetrahedron	Tetrahedra form a chain	Augite $(\text{Ca, Mg, Fe, Al, Na})[\text{SiO}_3]_n$
Cyclosilicates $[\text{Si}_2\text{O}_6]^{1.5-}$	1.5 free charges/tetrahedron	Tetrahedral chains form ribbons	Hornblende amphibole $(\text{Na, K, Ca, Mg, Fe, Al})(\text{OH}_4) [\text{Al}_{2-4}\text{Si}_{14-12}\text{O}_{44}]$ Tourmaline $\text{NaMg}_3\text{Al}_6[(\text{OH})_{1+3} \cdot (\text{BO})_3 \cdot [\text{Si}_6\text{O}_{18}]$
Phyllosilicates $\text{Si}_2\text{O}_5^{2-}$	1 free charge/tetrahedron	Tetrahedra form layers	Muscovite $(\text{KAl}_2)(\text{OH}_2)[\text{Si}_3\text{AlO}_{10}]$ Biotite $\text{K}(\text{Mg, Fe, Mn})_3(\text{OH, F})_2 [\text{AlSi}_3\text{O}_{10}]$
Tectosilicates SiO_2	No free charges 1 free charge with Al replacing SiO_2		quartz SiO_2 Feldspar orthoclase $\text{K}[\text{AlSi}_3\text{O}_8]$ Anorthite $\text{Ca}[\text{Al}_2\text{Si}_2\text{O}_8]$

destruction of the Si-crystal structure. The so-called **cation exchange capacity** (CEC) is large in clay minerals which swell (e.g. montmorillonite, 70–130 mval/100 g) and small in non-swelling clay minerals (e.g. kaolinite, 3–15 mval/100 g).

The chemical composition of the original rock or of the deposited sediments (e.g. loess soils) determines, ultimately, the availability of water and nutrients (**fertility of soil**) and thus the type of vegetation. Plant cover may increase the CEC of soils by a factor of 10 (1–3 mol equivalents kg^{-1}) by converting organic matter and increasing the retention capacity of organic residues which are difficult to degrade (humus), but even then the chemical composition of the original rock determines the form of humus and thus the availability of nutrients in the soil: Raw, acidic humus and alkaline humus only have potential CECs of 2 and 3 mol equivalents kg^{-1} respectively (Mitscherlich 1975). This means that the availability of cations in the soil, and thus of nutrients, affects ecosystem processes right up to the carbon metabolism.

As soils developed from abiotic and biotic processes, it is not surprising that the soil map of the earth reflects, in principle, the distribution of different types of vegetation on earth (Fig. 2.3.3).

2.3.1.3

General Aspects of Plant Nutrient Balance

Nutrient Supply and Cellular Ion Transport

In mineral soils, chemically characterised by the content of alkaline cations (**base saturation**: e.g. K, Mg and Ca) and physically determined by the texture (**particle size distribution**), roots also act as ion **exchangers**. Whilst cations in the soil are in equilibrium between the exchanger (clay minerals, oxides, humus) and the free soil solution, roots cause chemical imbalances because of their active transport processes, and ability to take up cations against the concentration gradient. This process may also occur selectively for certain cations. In exchange against cations from the soil, the root releases H^+ and HCO_3^- and organic acids to the soil, which are derived from the carbon cycle. A consequence of the uptake of alkaline cations in exchange with protons is an acidification of soils (Ulrich 1987). In the case of vegetation that is not managed or harvested by man, these minerals are returned in the dead biomass to the soil as litter. In agriculture, cations are removed from the soil by harvesting, grazing or use of litter and the chemical conditions in the soil change (**acidification of soil water, podsolisation**) if the depletion exceeds the re-supply by weathering. Deposition into the soil of strong acids from the atmo-

Box 2.3.2 Ion-exchange capacity of soils

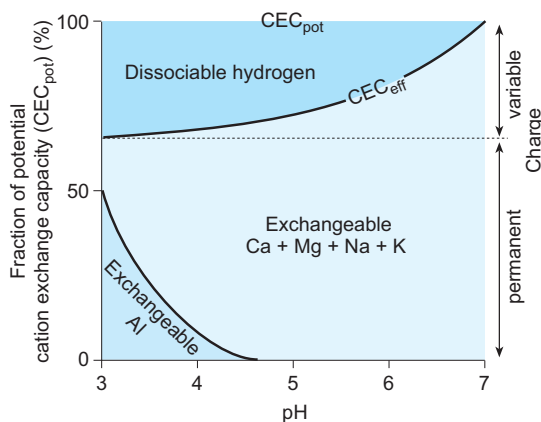


Fig. 2.3.2. Dependence of the effective cation-exchange capacity (CEC_{eff}) pH on a soil with 20–30% clay content and 2–3% humic content. The potential cation-exchange capacity (CEC_{pot}) includes, in addition to the basic cations, the dissociable protons (from Scheffer-Schachtschabel 1998)

Soils

Soils are the product of weathering and transportation of the original materials of the earth's continental land surface by physical and chemical processes and biological agents. They are mixed to different extents with the dead organic matter, the humus.

Cation-Exchange Capacity (CEC)

The CEC is an important measure of the cation availability in soil, giving the number (in moles) of cations which can be adsorbed by a defined quantity of soil (mval/100 g or $mmol_{equiv}/kg$). The magnitude of the CEC depends on the number of available exchange sites of clay minerals, humus and (hydr)oxides. The carboxyl, carbonyl and enol groups can only absorb cations when deprotonated (variable charge) and this depends on the pH. In contrast, a proportion of the exchange sites

in the crystal structure of clay minerals occurs by replacement of Si^{4+} by cations of lower valency (e.g. Al) which is independent of soil pH (permanent charge). Distinction is drawn between the **potential CEC** which includes all exchangeable cations (protons, Al and basic cations, measured at pH 8, for example) and the **effective CEC** which is the exchangeable basic cations and Al at soil pH (Fig. 2.3.2). In addition to the CEC, the anion-exchange capacity (AEC) is important.

According to their clay and humus contents, soils are distinguished by their potential CEC ($mmol$ cation equivalents kg^{-1}):

- arable fields: marshland (370), pelosol (220), black earth (180), para brown earth (170),
- forest: brown earth (600), pseudogley (184), podsol (40).

sphere due to air pollution (SO_4^{2-} , NO_3^-) has a similar effect as harvesting of plant material. Fertilisation and liming of soils balance the loss of cations caused by harvesting or leaching.

Uptake of cations and anions into the plant occurs via the same mechanisms (transporters, ion channels, see Box 2.3.3). There is a specific interaction between cations and anions; in the presence of Cl^- , for example, the uptake of K^+ decreases (see Marschner 1995).

Ion Uptake by Roots

Roots take up ions primarily at the root tip. In addition they may be taken up or lost via leaves

and shoots; this plays an important role in the uptake of air pollutants (Harrison et al. 2000). Along the root tip the uptake of nutrients is not distributed equally (Fig. 2.3.4), as transport depends on ion radius and chemical composition, and occurs either in the cell wall, the **apoplast**, or in the cytosol, the **symplast** (see Chap. 2.2.2). Transport of Ca, Al and heavy metals is mostly through the apoplast, whilst transport of P, K, N and Mg occurs mostly in the symplast. Water transport occurs over a wider area of the root than the active ion transport, but decreases when secondary root cortex is developed. It also decreases towards the root tip because of the

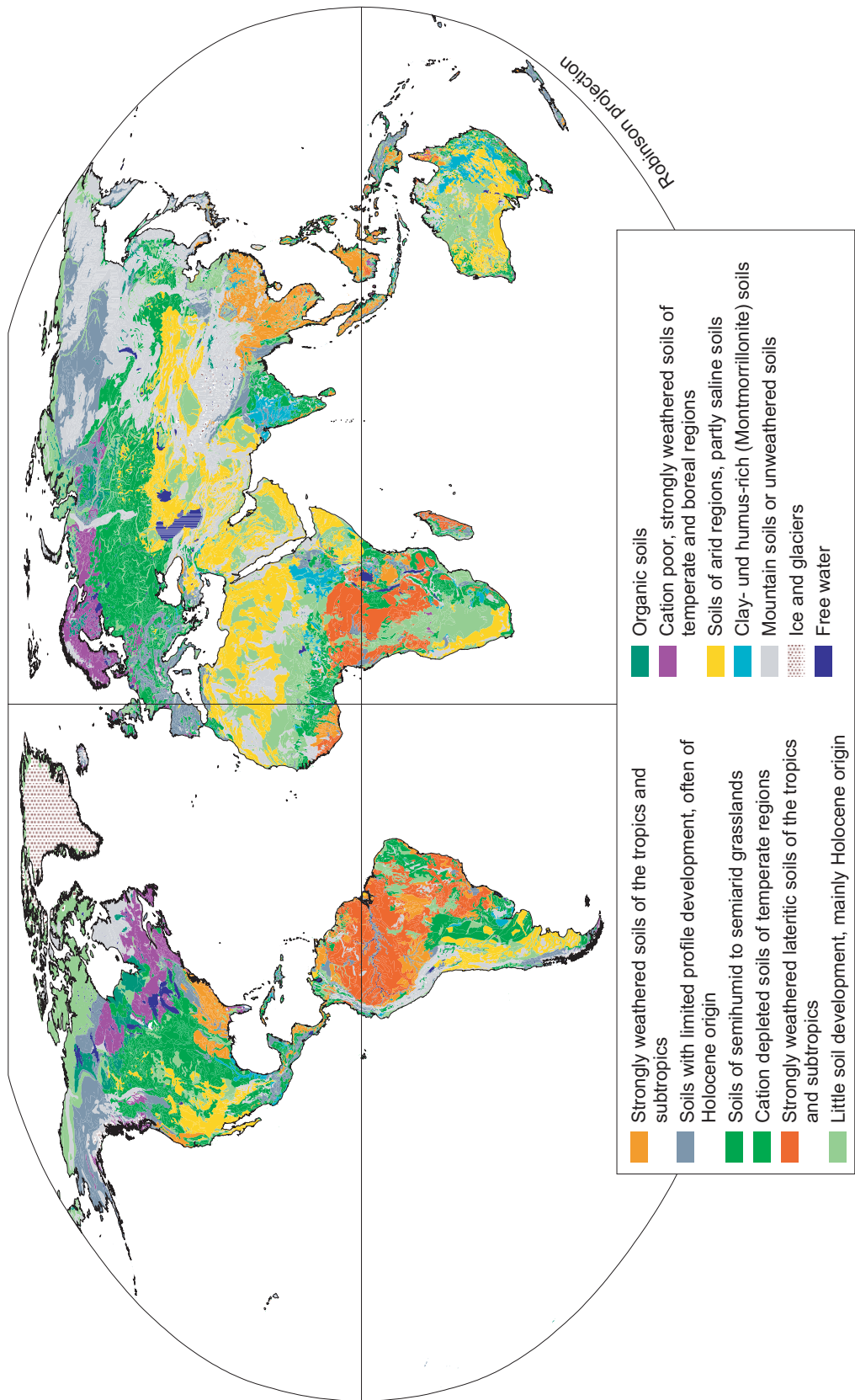


Fig. 2.3.3. Global distribution of the most important soil types. (Compiled by G. Guggenberger)

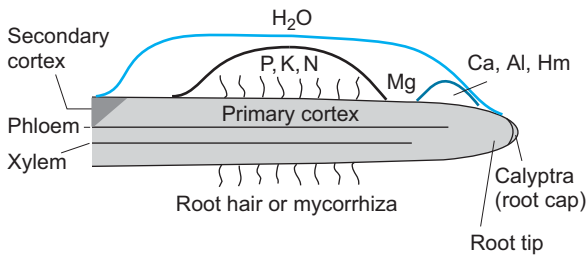


Fig. 2.3.4. Schematic representation of the uptake of nutrients along a root tip. *Hm* Heavy metal

denser cell packing and the thinner cell wall. Phloem reaches further into the root tip, i.e. it is differentiated earlier than xylem.

Ion Transport and Distribution

Plants require and consume nutrients for (see also Chap. 1.7):

- growth (e.g. Mg, Ca in the cell wall)
- catalysis (e.g. Fe in ferredoxin)
- transport of electrons (heavy metals)
- passive accumulation (heavy metals)
- storage and reserve (e.g. N, P).

Nutrient transport in plants and their distribution to sites of uptake, storage and consumption occurs via xylem and phloem (see Chap. 2.2.2.3), with very different amounts transported in both pathways so the concentration in them differs (Table 2.3.2). It is obvious that in

Table 2.3.2. Concentration of substances in the xylem and phloem of *Nicotiana glauca* (Schurr and Schulze 1995). The concentrations do not say anything about the amount transported. The flow in the phloem is slower than that in the xylem. Organic acids were not measured

	Phloem ($\mu\text{g ml}^{-1}$)	Xylem ($\mu\text{g ml}^{-1}$)
pH	7.8–8.0	5.6–5.9
Sucrose	170–196	1.1–1.2
Amino substances	10808	283
Potassium	3673	204
Phosphorus	435	68
Chlorine	486	64
Sulfur	139	43
Magnesium	104	34
Sodium	116	46
Calcium	83	189
Ammonium	45	10
Zinc	16	2
Iron	9	0.6
Copper	1	0.1
Manganese	0.9	0.2
Nitrate	<1	70

the phloem not only large amounts of sucrose but also amino acids are transported, and that this transport is connected with that of several cations (particularly K^+ ; Herdel et al. 2001).

Figure 2.3.5 shows the multiple interactions between **nutrient uptake** and various organs of plants, using the example of nitrate and its turnover (Marschner 1995). Clearly, transport and retention of a nutrient do not occur independently of other nutrients and are almost always

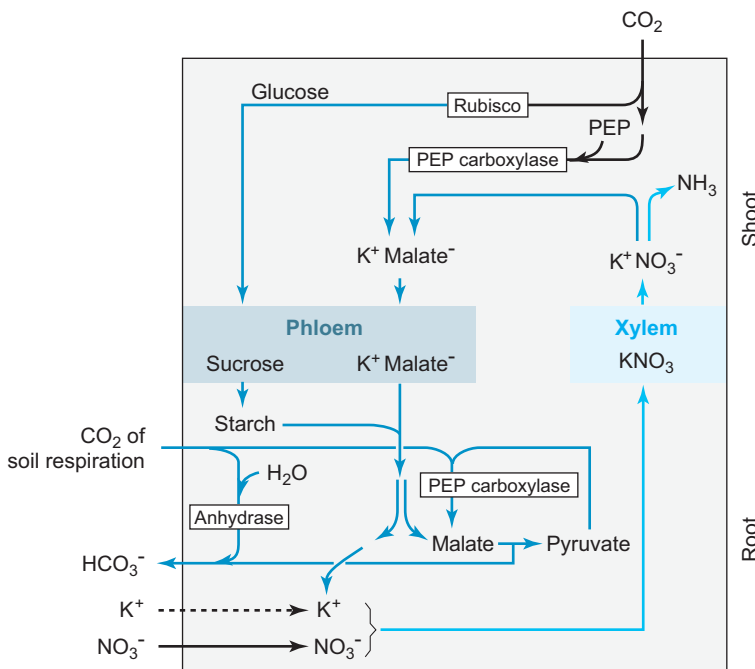


Fig. 2.3.5. Cycling of potassium and the uptake of nitrate in the xylem and phloem. In the phloem K is the counter-ion for transport of malate and sugars. In the root K is released from the phloem and transported into the xylem, where it is the counter-ion for nitrate. Nitrate uptake occurs both by co-transportation with potassium from soil solution, and by an exchange with HCO_3^- . (After Marschner 1995)

Box 2.3.3 Ion uptake (see Marschner 1995)

The following processes lead to the uptake of ions by plants:

- **diffusion:** anion gradient leads to passive transport (example: A1),
- **uniport:** H^+ gradient leads to passive transport via ion channels (K),
- **symport:** H^+ is transported back with anions (Cl, SO_4^{2-}),
- **antiport:** H^+ efflux causes a cation influx (K^+ , Ca^{2+} , NH_4^+).

In a plant cell, ion exchange occurs not only on the outer membrane surface, but also at the membranes of plastids and vacuoles. Thus chloroplasts have a characteristically large Mg concentration and mitochondria a large Ca concentration. The vacuole serves as an ion-exchange reservoir. The pH of the cytosol is stabilised by the continuous exchange of cations and/or anions (pH stabilisation mechanism, pH stat). In this, K^+ has a particular part to play in the exchange and regulation of H^+ and thus regulates cellular proton concentration and proton gradients (see also Chap. 1.6.2).

Ion uptake occurs generally through ion channels; these are proteins that span the lipid layers and have an internal passage through which ions can be selectively transported. The selectivity is largely due to the radius of the ion (i.e. K ions pass also through a Ca channel) and amino acids lining the pore that forms the channel. As this is an active, metabolically controlled process, ion uptake is

- **oxygen-dependent;**
- **inhibited by mercury,** if the ion channels are lined with S-containing amino acids;
- **temperature-dependent:** rising exponentially, with an optimum generally at $30^\circ C$;
- **suited to the external concentration,** i.e. there are ion uptake systems that are most efficient at high or low external ion concentration transporters with a small efficiency for substrate ions can also have a function as sensors (W. Schulze et al. 2000);
- **competition in the presence of other ions:** e.g. the uptake of magnesium falls in the presence of K^+ or Ca^{2+} .

coupled to the transport of organic substances. The initiation of nitrate uptake starts with CO_2 assimilation in the leaf by the enzyme phosphoenolpyruvate-(PEP)-carboxylase, which carboxylates pyruvate to malate. This anion is transported with K^+ via the phloem to the root and there it is decarboxylated to pyruvate and HCO_3^- . This bicarbonate anion is excreted and exchanged with nitrate. Uptake of K^+ occurs simultaneously. Nitrate is transported, together with K^+ as cation, via the xylem into the shoot. With the reduction of nitrate, K^+ is released again and balances the malate transport in the phloem. Simultaneously with K^+ uptake the phloem is also loaded with sucrose (Marschner 1995). Independent of this cycle of potassium, malate may also be formed in the root from starch or via assimilation of CO_2 by PEP-carboxylase. Anhydrases also form HCO_3^- which is used to take up nitrate by antiport (Moroney et al. 2001). As the plant requires more N than K, the soil is also made more alkaline by the nitrate uptake through the exchange with HCO_3^- .

With respect to the **use of nutrients** the following distinctions are made:

- elements transformed in metabolism. They change the level of reduction. N and S belong to this group
- elements which cannot be metabolised but support metabolism. These are:
- freely moving cations (K, Ca, Mg) and anions (PO_4^-) which store energy by polymerisation
- heavy metals with catalytic functions which are bound firmly to proteins and act chemically because of changes in their oxidation state (Fe, Mn, Cu and others).

Analysis of the nutrient balance of the plant shows that a large part of nutrients is continuously exchanged in the plant, i.e. circulated between root and shoot. This applies particularly for individual organs with only a limited **span of life**. Root tips and leaves are periodically or continuously formed anew, utilised transiently and afterwards shed. Obviously, leaves are fixed-term "machines". Old leaves are shed, a re-

response to decreasing physiological activity. At the same time formation and shedding of leaves are mechanisms for adaptation of the whole plant to changing environmental conditions (particularly light). Leaf shedding often serves other functions, e.g. detoxification following excessive salt uptake.

The expanding leaf is first a sink for carbohydrates and nutrients, but trace elements are required for the activation of enzymes earlier than macro nutrients. Organic substances are required for the structure of the leaf. In the young state leaves are thus a carbohydrate sink (see Chap. 2.4.3.6), i.e. “sink leaves” import carbohydrates for their growth. The leaf becomes a “source leaf” only after the development of about a third of the leaf area, exporting carbohydrates for maintenance or growth at other sites. Even before full development of the leaf’s area, its capacity for photosynthesis decreases and finally it becomes unproductive. This process of **leaf ageing** is modified by environmental conditions including nutrition. In contrast to ageing, **senescence** is a genetically regulated process of the fully differentiated cell (Guarente and Kenyon 2000; Thomas et al. 2000). Ageing and senescence finally lead to shedding of leaves, however, before this part of the invested resources of nutrients is remobilised and transported back into the plant. Thus the leaf is a “throughput system” for nutrients, highly adaptable to environmental conditions and the internal requirements of the plant for nutrients. The turnover rate of nutrients in plants may change suddenly depending on the ontogeny of the whole plant, particularly during the change from vegetative to reproductive growth.

2.3.1.4

Nutrient Deficiency and Excess

Nutrient deficiency and excess lead to **plant diseases**, recognisable by typical changes in colour of needles or leaves, and these are important indicators for the diagnosis of nutrient-dependent effects. They are:

- colour changes (browning and yellowing = chlorosis);
 - progression of damage on the individual leaf (e.g. dryness starting from the tip);
 - progression along the branch (damage starts in old organs);
 - presence of pests, as lack of nutrients may be the cause or consequence of biotic stress [e.g. by honey fungus (*Armillaria* spp.) attack];
 - nutrient analyses are required to confirm the findings;
 - tolerance towards deficiency and excess, and development of symptoms, vary with genotype and are species-specific.
- Figure 2.3.6 shows some important nutrient-dependent plant diseases of spruce needles and oak leaves as examples. Regarding SO_2^- and ozone damage, see also Chapter 1.9. The development of symptoms by nutrient deficiency or excess is more marked in evergreen than in deciduous species:
- **nitrogen deficiency:** evenly distributed chlorosis on the whole tree and for all needle ages; small needles, compressed sprouting, growth inhibition. Usually not limited to individual trees. On moor and heathland soils. Possibilities of misidentification: honey fungus (*Armillaria* spp.), but here individual trees or younger needles are turning yellow.
 - **manganese deficiency:** light yellow chlorosis of younger needles, starting in the lower canopy, particularly on limestone. Mn is not phloem-mobile, i.e. requirements for growth are only by root uptake, the influx in xylem water. Therefore, with increasing age, symptoms disappear.
 - **iron deficiency:** whitish-yellow chlorosis of the youngest needles. Considerable deficiency causing needle tips to brown and die on limestone. Similar to Mn deficiency.
 - **potassium deficiency:** pale yellow to violet brown (reddish) colouration starting from needle tips, but at first predominantly on older needles, which are shed prematurely and lead to light canopies. K is phloem-mobile and is thus first re-transported to the youngest organs. K deficiency increases sensitivity to frost. Misidentification: Mg deficiency, but in this case the colouration is more intensely yellow, rarely red.
 - **magnesium deficiency:** light yellow to golden yellow chlorosis, starting in older needles from the tip. Shaded branches and the underside of needles are less decolourised. Mg is phloem-mobile and therefore remobilised from old to young needles. Occurs on silicate soils.
 - **air pollution (SO_2) damage:** gold-brown to reddish-brown colouration, starting from the



Fig. 2.3.6. Typical nutrient deficiency and damage due to over-availability of nutrients. **A** Nitrogen deficiency, **B** manganese deficiency, **C** iron deficiency, **D** potassium deficiency, **E** magnesium deficiency, **F** SO_2 damage, **G** NaCl damage, **H** mild phosphate deficiency, **I** severe phosphate deficiency. (Hartmann et al. 1988)

Box 2.3.4**Summary: plant nutrients**

- **Macronutrients** are C, O, H, N, S, P, K, Mg, Ca, Fe;
- **availability** of nutrients is variable and dependent on the original rocks (this determines the texture and the chemical composition), climate (which controls weathering), vegetation (which selectively removes or returns certain elements), and the management of nutrient supply;
- nutrient **uptake** by plants occurs mainly via the roots. Uptake may also occur via shoots (leaves and bark), which is important for aerial pollutants (see Chap. 2.3.2.2);
- dependent on the availability of nutrients or biotic pests, specific **deficiency diseases** may occur, that are recognised by specific symptoms in leaves.

needle tip. Necrotic flecks or bands in the middle part of the needle. Buds often die off. Misidentification: damage from road salt, herbicides (see Chap. 1.9).

- **Road salt damage:** needles of the previous year's growth dark copper-brown in spring, falling in early summer. Buds often fall. Damage along the edge of roads. Misidentification: frost-drought (but here needles light red-brown) or sulfur dioxide.
- **phosphorous deficiency:** starting with dark, blue-green colour (increased formation of chlorophyll), later violet red to copper brown, yellow colouration (anthocyanin), in parts spotty, starting from the edge of the leaf. Misidentification: K deficiency, drought, salt, but then without the violet-red colour.

2.3.2

Nitrogen Nutrition

2.3.2.1

Nitrogen in Plant Metabolism

Nitrogen is the nutrient required in the largest quantity, after carbohydrates, but the huge amount of N_2 in the earth's atmosphere is not directly available to plants.

Plants require nitrogen for:

- amino acids (free amino acids, proteins)
- nucleic acid (DNA)
- heterocyclic and azo-compounds (e.g. pyrrole ring).

The gas N_2 is very inert and thus not directly usable. Nitrogen can only be used in its reduced or oxidised form (NH_4^+ or NO_3^-) or in the organ-

ic form ($-NH_2$). Industrially reduced nitrogen for fertilisers is synthesised by the Haber-Bosch process from N_2 and H_2 at high temperatures and high pressures. In nature the transformation of gaseous N_2 into nitrogen available for plants occurs either in the atmosphere through lightning ($10\text{--}40 \text{ mol N m}^{-2} \text{ year}^{-1}$) or in the soil by nitrogen-fixing bacteria.

The process of N_2 **fixation** occurs catalytically under anaerobic conditions in root nodules of legumes, for example, or in free-living cyanobacteria (blue green algae; see Marschner 1995). In the primary succession from open soil to a vegetation with a closed nitrogen cycle, there is a stage in where N_2 -fixing organisms dominate (see Chap. 3; Fig. 3.2.9). Because of the high-energy requirement for N_2 reduction (and the requirement for P associated with it), these organisms are unable to compete in the later stages of succession, where more nitrogen is available in the oxidised and reduced forms (Read 1993). The nitrogen cycle and the conversion of organic nitrogen to reduced nitrogen are discussed in Chapter 3.3.3. Here we concentrate on N uptake and the turnover in plants.

2.3.2.2

Nitrogen Uptake and Nutrition

Plants gain nitrogen

- from litter and soil solution as
 - amino acids
 - ammonium cation
 - nitrate anion
- from the atmosphere as
 - NH_3 , NO or NO_2 gas
 - ammonium cation
 - nitrate anion.

Box 2.3.5 Interactions between nitrogen and carbon metabolism

N and C metabolism are closely intertwined. It starts with photosystem I (PSI) when a surplus of electrons to ferredoxin not only reduces NADP to NADPH, which is used for CO₂ assimilation, but is also used for nitrate and sulfate reduction (Fig. 2.3.7A). This is important in the N and S cycles (see Chap. 2.3.2.2 and 2.3.3.2).

The main processes involved in the interaction between N and C cycles are (Fig. 2.3.7B):

- production of carbohydrates for root maintenance and growth;
- production of C skeletons for N assimilation;

- influence of N-nutrition on protein metabolism;
- influence of nitrate on the phytohormone balance (especially cytokinin);
- feedback coupling of protein availability and phytohormones on photosynthesis (30% of the N content of a leaf is in the CO₂-fixing enzyme Rubisco; see Chap. 2.3.2.3) and growth (principally of leaves);
- regulation of C-allocation by metabolites of the C cycle and nitrate;
- development is limited by self-shading.

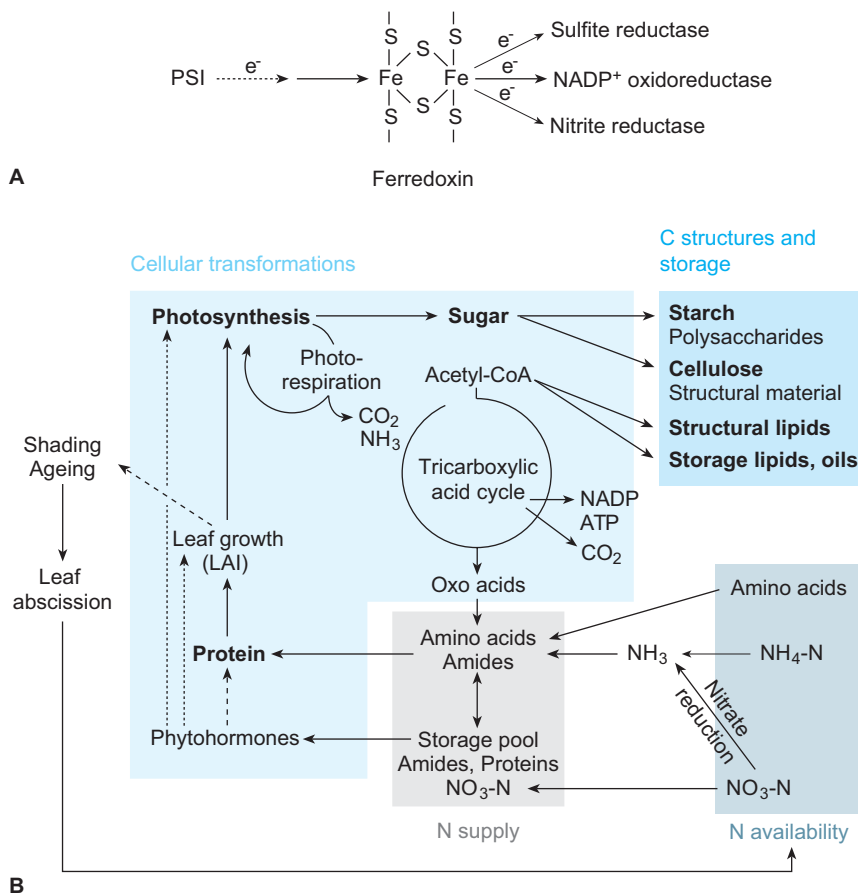


Fig. 2.3.7. **A** Coupling of electron transport from photosystem I (PSI) to sulfite, nitrite, and NADP reduction via ferredoxin. **B** Diagram of the coupling of C and N metabolism in a plant. For a detailed description, see text. (After Marschner 1995)

Amino Acid Uptake and Nutrition

Amino acids are available from N_2 fixation by nitrogen-fixing bacteria, via the direct degradation of litter or from the soil solution (Wallenda et al. 2000). It is known from laboratory experiments that roots are able to take up a broad spectrum of amino acids.

Nutrition with amino acids is very important, particularly in boreal forests, where ammonium- and nitrite-fixing bacteria in the soil are probably not active because of the acute N deficiency (Persson et al. 2000). In these conditions amino acid uptake via mycorrhiza supplies the plant with almost all of its nitrogen requirements. These organisms are able to excrete a protease and thereby break down proteins and use the resulting amino acids directly from the litter (Näsholm et al. 1998; Wallenda 2000). It has been shown (Nordin et al. 2001) that the uptake of amino acids also takes place in the presence of ammonium and nitrate ions and may reach the same level as on poor sites; only the relative contribution to the N requirement is lower, as additional ammonium and nitrate are available and utilised at N-rich sites. At N-deficient sites, plants are adapted to different forms of N nutrition (Schulze et al. 1994; Michelsen et al. 1996).

Ammonium Uptake and Nutrition

Ammonium is taken up directly in the area of the root hair or via mycorrhiza. NH_4^+ would be toxic as an ion, because its ionic radius and strength are very similar to that of K^+ , so it could enter the cell instead of K^+ , leading to interference with the pH regulation of the cell membrane. Therefore, NH_4^+ taken up by the root is not stored but converted immediately into amino acids via the GOGAT (glutamine-oxoglutarate-amino-transferase) enzyme system. In this process, NH_4^+ is bound to α -ketoglutarate using $NADPH+H^+$. The primary amino acids glutamine and glutamate are formed, which donate the NH_2 group to other organic molecules by transamination and thereby regenerate α -ketoglutarate. GOGAT is the enzyme system which also traps free NH_4^+ ions in all other plant organs.

Ammonium uptake (Fig. 2.3.8; Marschner 1995) occurs generally as antiport to protons released in the assimilation of NH_4^+ to $-NH_2$. The protons are excreted via the root; uptake of ammonium thus leads to acidification of the soil. For NH_4^+ assimilation in the root, organic molecules are required to provide the C-skeletons;

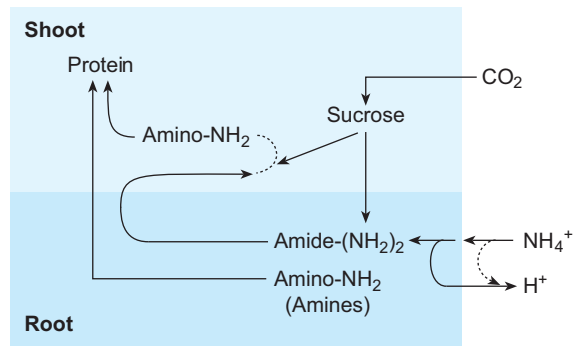


Fig. 2.3.8. Exchange and transport processes in the uptake of ammonium. Protons are released to neutralise ionic charges when NH_4^+ is taken up, i.e. the soil pH decreases (see Fig. 2.3.9B). Ammonium is immediately assimilated into amino acids in the roots; for this C skeletons have to be transported from the shoot to the root. Ammonium-fed seedlings are deficient in soluble carbohydrates, as the C skeletons are used for assimilation of NH_4^+ in the roots and are thus not available for growth. Detoxification of ammonium leads to a surplus of amino acids, which are not used for protein synthesis, as the assimilates in the roots are required for the assimilation of ammonium ions. (After Marschner 1995)

they are derived from sucrose produced in the leaf and transported, via the phloem, into the root. Because free amino acids act as an osmoticum and could interfere with the metabolism, amino acids and amides are transported via the xylem into the leaf and incorporated into proteins.

Ammonium nutrition is important particularly in acidic soils where nitrification is inhibited and particular cation deficiencies (e.g. Mg, K) may be triggered or increased because of ionic interactions of Mg and NH_4^+ .

Nitrate Uptake and Nutrition

Nitrate is taken up by the same area of the root as cations. Some mycorrhiza species also take up nitrate. It is not possible to use nitrate directly in the metabolism, it must first be reduced to $-NH_2$. Nitrate uptake (Fig. 2.3.9; Marschner 1995) occurs either together with cations or in exchange with OH^- . As the requirement for N is larger than that for alkaline cations, the symport with cations is not unlimited. In this case nitrate uptake takes place in exchange with HCO_3^- leading to increased soil pH. Conversely, with nitrate deficiency in the soil, nitrate is missing as anion in the uptake of cations resulting in the uptake of Cl^- and SO_4^{2-} and leading to disturbances in the later metabolism.

Box 2.3.6

Summary: ammonium nutrition

Ammonium nutrition has the following physiological, structural and ecological consequences:

- Supplying only ammonium ions leads to **carbohydrate deficiency**, as C skeletons are largely required for the assimilation and detoxification of ammonium in the root;
- Ammonium nutrition leads to **cation deficiency** (especially Mg deficiency), as the uptake of ammonium results in competitive inhibition of the uptake of other cations;
- In ammonium nutrition Cl^- and SO_4^{2-} are the available ions in the soil which are also taken up by symport, acting as counterions to balance charges. Cl^- can become toxic. SO_4^{2-} can react with other essential cations, especially Ca^{2+} , leading to the formation of the insoluble calcium sulfate and therefore enhancing cation deficiency;
- In the case of ammonium, an excess of **free amino acids** (diamines, e.g. putrescine) occurs. The formation of storage proteins would result in smaller ratio of N to C and therefore an increase in the C deficiency. Formation of amino acids leads to changes in leaf structure; they have a higher water content (as a result of the osmotic effects of amino acids) and lower dry weight per area, making the leaves more susceptible to environmental stress (e.g. temperature and pests and diseases);
- Higher concentration of amino acids leads to a greater **susceptibility of the plant to plant diseases** and pests. Especially damaging are pests that “suck” phloem sap (aphids);
- In the soil (or nutrient solution), feeding ammonium leads to a **reduction in pH**. Ammonium is stored in the soil as an exchangeable ion. This leads to the release of basic cations and heavy metals that are toxic to plant roots (see Chaps. 1.7 and 1.8). Cations are washed out of the soil horizon. Initially, when plants are placed in an ammonium-rich environment, there is an improvement in cation availability (Kreutzer and Göttlein 1991). The high binding affinity of ammonium is used in soil science to determine the cation-exchange capacity (CEC, determination of the exchangeable basic cations by washing with NH_4Cl);
- Ammonium nutrition can, with high cell pH, lead to the release of NH_3 into the atmosphere, as almost half the ammonium at pH 7.2 (cytosolic pH) is already dissociated, i.e. in neutral conditions, half is already present as NH_3 . Ammonia (NH_3) is poisonous to cells.

Physiologically, nitrate is not toxic and thus may be stored in the root or shoot. Nitrate storage in the leaf has a regulatory (signal) effect on C allocation (shoot–root growth) of plants (Scheible et al. 1997; Klein et al. 2000). Large nitrate concentration in the leaf stimulates shoot growth and inhibits root growth by regulating the sugar transport to the root whereas in the soil it stimulates root growth.

Generally, nitrate transport is via the xylem into the storage parenchyma of the stem, or into the leaf where nitrate is initially stored together with cations in the vacuole. This increases the osmotic concentration and the water content of leaves (e.g. with “crunchy” nitrate-fertilised vegetables). If required, nitrate may be transported back from the vacuole into the cytosol. This occurs in exchange with organic acids formed via PEP-carboxylase in the leaf. For some plant spe-

cies, oxalic acid is transported in exchange for nitrate into the vacuole. With a large Ca supply this leads, in the vacuole, to the formation of Ca oxalate which is difficult to dissolve (rhabdites, giving the typical taste of rhubarb and banana peel). Nitrate is reduced to nitrite in the cytosol. In the chloroplast, nitrite is reduced to NH_4^+ , which is immediately assimilated by the GOGAT system. The turnover rate of nitrite reductase is faster than that of nitrate reductase, as nitrite is toxic to the cell. Some of the cations taken up with nitrate are transported back into the phloem, particularly K^+ is relocated into the root, accompanied by associated organic acids. These acids are decarboxylated in the root (e.g. malate) and thus support nitrate uptake.

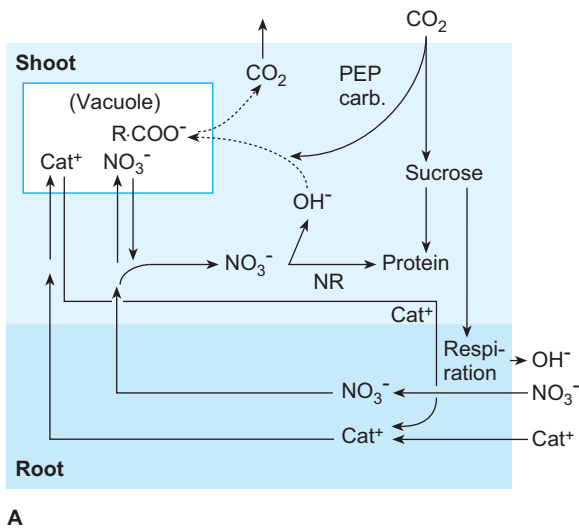
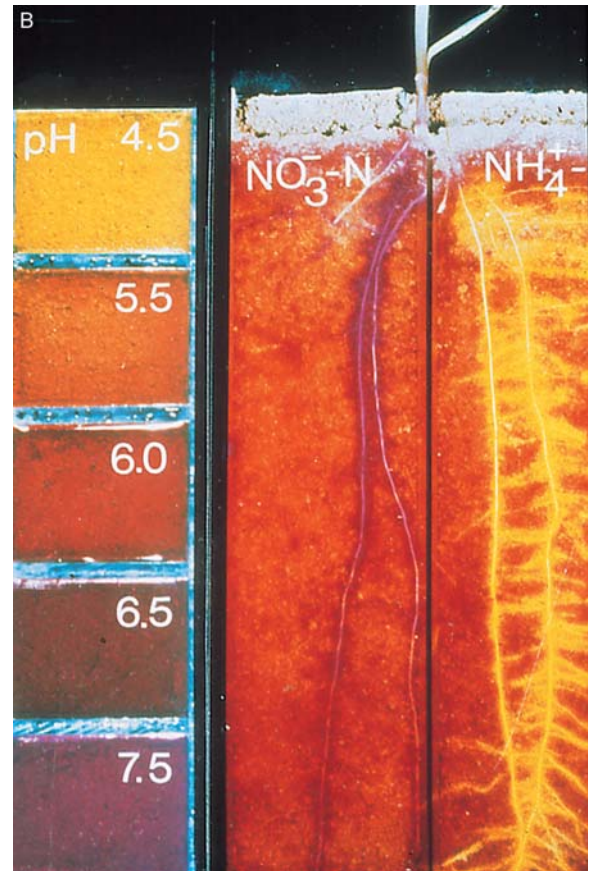


Fig. 2.3.9. A Exchange and transport processes involved in the uptake of nitrate. To balance the charges, OH^- ions are released into the soil, i.e. the soil pH rises. Nitrate can be stored in the vacuole until reduction (Marschner 1995). B Changes in soil pH after nitrate or ammonium uptake. Roots of plants were divided between two compartments: in one the N source was nitrate and in the other ammonium. The yellow colouration shows the fall in pH in the proximity of the root during ammonium uptake. The red colour shows nitrate uptake and the corresponding pH rise. (Photo E. George)



Ammonium Nitrate Nutrition

It becomes clear, from the specific effects of ammonium and nitrate uptake, particularly with respect to the cation uptake, that the uptake of **ammonium nitrate** is most favourable for nutrition. Nutrition with ammonium nitrate

- maintains the **balance of anions and cations** in the plant and in the soil
- **decouples the uptake of cations and anions** from the N nutrition (the N requirement is larger than the requirement for cations)
- **maintains the C/N balance.** The relation of nitrate and free amino acids (in the case of ammonium nutrition) to starch is a sensitive indicator of the state of nutrition in the leaf (Fig. 2.3.10B). Large nitrate and amino acid concentrations are always connected and indicate too much fertilisation, whilst substantial starch concentrations always correlate with small nitrate and amino acid concentrations and thus indicate N deficiency. Maximum growth rates are achieved under conditions where the nitrate and starch concentration safeguards the supply for growth during the

night, as growth and thus the N and C requirement continue during the night, but N and C assimilation requires light.

Nitrogen Input from the Atmosphere

Nitrogen-containing **air pollutants** are taken up as gas (NH_3 , NO , NO_2) by the plant via the stomata. NH_3 is more soluble than NO , which in turn is more soluble than NO_2 . In the leaf all gases are immediately assimilated to amino acids. Not only gases, but also ions dissolved in rainwater and fog reach the inside of the bark via the medullary rays (Klemm 1989). Dust particles containing Mn on the cortex and cuticle of needles may oxidise gaseous NH_3 and SO_2 to ammonium sulfate in a surface reaction and thus increase N deposits. Uptake of nitrogen from the atmosphere contributes significantly to the N balance for growth in the canopy of trees (20–40% of the N requirements; Harrison et al. 2000).

There is a basic difference between the N uptake via the shoot or the root. Uptake of nitrogen via the root is metabolically regulated, i.e.

Box 2.3.7 Summary: nitrate supply

Nitrate nutrition has the following physiological and ecological effects:

- **Increase in pH in the soil near roots** (Fig. 2.3.9). Nitrate is very mobile and is almost not bound in the soil, so that it is easily leached out and takes with it a corresponding number of basic cations. These are replaced with H^+ on the ion-exchange surfaces and thus, **in the long-term, nitrate leaching leads to soil acidification** (clover and lupins in agriculture). In acidic soils, Al^{3+} (and other heavy metals) can act as cations, and these are also leached into the groundwater; this is not only damaging for the roots but adversely affects the quality of the ground water. Especially in soils with high microbial nitrification and low nitrate uptake rates (e.g. cultivation of spruce on Ca-rich soils), this has a significant effect on the nutrient balance of the ecosystem;
- Occurrence of an equilibrium between cation and anion uptake **without the accumulation of Cl^- or SO_4^{2-}** ;
- **Increasing the leaf water content** during storage in the vacuole and formation of Ca-oxalate-rhaphides;
- **Better quantum yields** due to the use of excess electrons from PSI (photosystem I) for nitrate reduction;
- **Re-routing of carbohydrate flows** in the plant. Nitrate is not just a substrate supply-

ing N, but has additional specific “signal effects” in shoot-root communication and allocation of carbohydrates (Scheible et al. 1997). A higher nitrate concentration in the leaf stimulates shoot growth and inhibits root growth by controlling sugar transport into the roots. High nitrate concentrations in the soil stimulate root growth;

- Nitrate has a specific “**signal-effect in germination**”. This is marked in ruderal plants where the presence of nitrate in the soil solution enhances germination;
- **Decoupling of N uptake and N usage**, as nitrate is stored in the vacuole. In contrast to ammonium, nitrate does not damage membranes. Decoupling of uptake and use is significant for growth, for example, in annual plants (cereals) where availability of nitrate is large at the beginning of the growth period and decreases with growth. The consumption of nitrate from the internal store supports seeds maturation. However, even very large nitrate concentrations are not sufficient to maintain long-term growth. A nitrate concentration of 15 mg g^{-1} in leaf cells of *Raphanus sativus* is sufficient to maintain a high growth rate for only 1 day. Then the growth rate drops exponentially. Depending on growth rate, the nitrate pool is used up in 4–10 days (Fig. 2.3.10 A).

the plant takes up nitrogen according to its requirements (or until enough is stored). In contrast to this, the plant has no “defence” mechanisms against uptake of NO_x , NH_3 , or NH_4^+ via the shoot. In addition, uptake via the shoot occurs in exchange with cations (K, Mg), i.e. is coupled with a loss of cations. Nitrogen nutrition from air pollutants thus may lead to an imbalance in cations, particularly if cation uptake is limited.

2.3.2.3

Nitrogen Requirements for Growth

Nitrogen nutrition is not only important for plants growing under natural conditions, but also for crops. Here requirements and responses of woody plants are different to those of herbaceous plants; not only the growth form, but also the season determines the requirements for N.

Nitrogen Supply and Growth

Growth is linearly dependent on N supply over a wide range. With ample N this response becomes saturated, but many other environmental factors determine at which nitrogen supply satu-

Box 2.3.7 Summary: nitrate supply (continued)

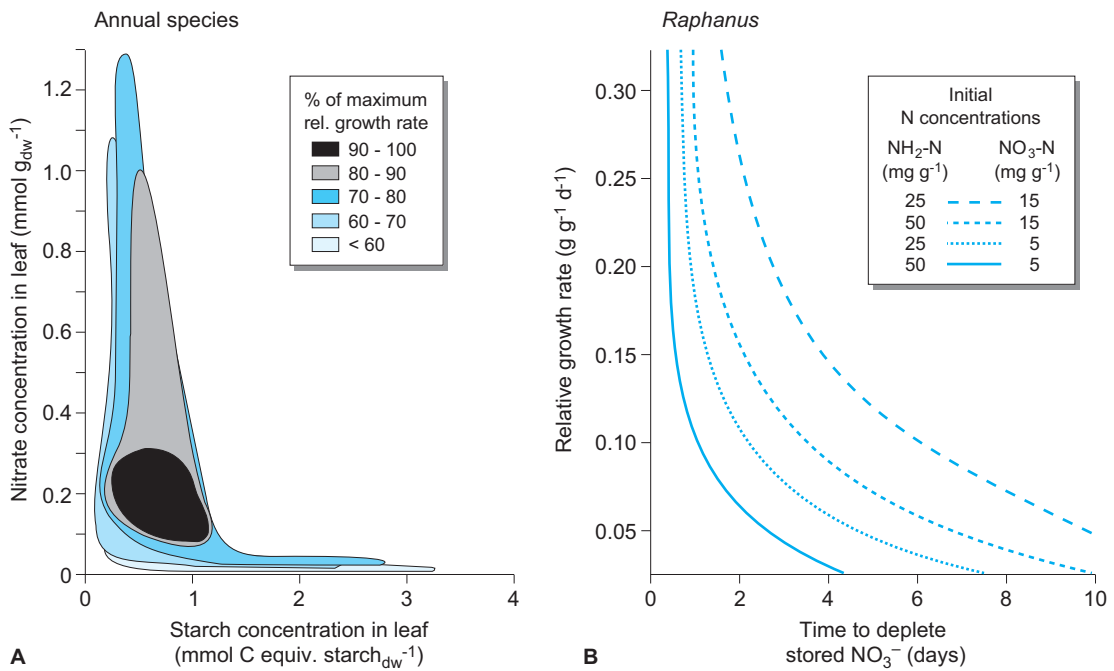


Fig. 2.3.10. A Relative growth rate (RGR, shown as isohypses) in relation to the nitrate and the starch concentration in the leaf. Highest growth rates are in the lower concentrations of the two substances. Starch accumulation is thus an indicator of N deficiency, nitrate accumulation an indicator of C deficiency. B Consumption of nitrate reserves of plants grown with different nutrient conditions, following a sudden decrease in the N availability. Even in plants well supplied with nutrients and with a large nitrate concentration, the supply of nitrate from within the plants lasts only a few days due to their high growth rate. (After Stitt and Schulze 1994)

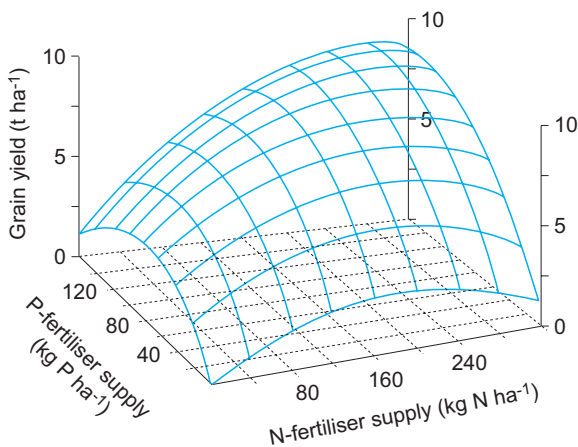


Fig. 2.3.11. Change in the grain yield of maize with different N and P fertilisation. At a high P availability (140 kg P ha^{-1}), 300 kg N ha^{-1} can lead to a high yield. If only 40 kg P ha^{-1} are available then adding only 160 kg N ha^{-1} leads to loss of yield. (Schopfer and Brennicke 1999)

ration is reached (Fig. 2.3.11). With “optimal” supply of other nutrient elements, saturation occurs for agricultural crops at about $200 \text{ kg N ha}^{-1} \text{ a}^{-1}$. Higher rates of fertilisation yield a small increase of grain, with the benefits of a marginally greater yield determined by the

prices of cereals and fertiliser. At the same time, high rates of fertiliser affect the environment by nitrate leaching to ground water. In contrast to the high capacity for N utilisation of crops, consumption by trees is much smaller. If mineralisation exceeds N deposition of about 100 kg N

$\text{ha}^{-1} \text{a}^{-1}$, beeches and spruce are no longer able to use the available N. This is mainly because the N requirement for production of wood is much less than that for non-lignified tissues. Less than 10% of the nitrogen taken up is used for growth of a tree trunk (Nadelhoffer et al. 1999). This does not take into consideration that 90% of the nitrogen taken up and invested in leaf and branch growth creates the preconditions for the growth of wood by building up the photosynthetic apparatus. However, the biomass of leaves in the canopy may not be increased indefinitely. Maximum leaf area index (LAI) is dependent on the light supply and on structural characteristics such as leaf inclination and leaf clustering (see Chap. 2.1.2.3).

Utilisation of Ammonium and Nitrate

Herbaceous species are better equipped to utilise nitrate than woody species, for many reasons. Herbaceous species usually have smaller dry weights and greater water content per leaf area (Schulze et al. 1994) and are better able to store nitrates because of their larger vacuoles. Because of greater N concentration in the mesophyll (and thus concentration of the CO_2 -reducing enzyme Rubisco), herbaceous plants usually have faster rates of photosynthesis and thus an increased capacity for nitrate reduction than woody plants (see Fig. 2.3.7 in Box 2.3.5). A further basic difference is the association of roots of herbaceous plants with VA (vesicular arbuscular) **mycorrhiza** and ectomycorrhiza in woody plants. VAM are able to utilise mineralised P and ectomycorrhiza (Smith and Read 1997) are able to gain amino acids from litter; thus they bypass mineralisation (Wallenda et al. 1999). Ectomycorrhiza are also able to take up ammonium in acid soils, as they precipitate the Al with phosphate. There are also mycorrhiza which reduce nitrate (Wallenda et al. 1999). The distinction, whether plants utilise nitrate, ammonium or amino acids, is partly possible via stable isotopes (Hobbie et al. 2000). The N requirement for growth (C/N relation) of fungi is higher than the N requirement of trees, as the cell wall of fungi consists of chitin (50 mg N g^{-1} dry matter for fungi and 1 mg N g^{-1} dry matter for wood). However, there are exceptions: Ash uses large amounts of nitrate but does not possess any mycorrhiza. In trees the nitrate is reduced in mycorrhiza or roots, so that nitrate can no longer be detected in the xylem water.

Stress Tolerance with Nitrogen Deficiency

In ecology a theory has developed that species with a high material turnover are stress-sensitive and those with a low turnover are stress-tolerant (Orians and Solbrig 1977; see Fig. 2.4.5). This could, however, not be shown for N supply and its interaction with growth (Fichtner and Schulze 1992). Species adapted to high N supply, e.g. *Galeopsis tetrahit* (common hemp-nettle, Labiatae on eutrophicated sites), reduce growth with reduced supply as do species adapted to N-poor sites, e.g. *Teesdalia nudicaulis* (shepherd's cress, Cruciferae, on sandy lawns). The important difference between the two species is that *Teesdalia* flowers at low N supply, but not *Galeopsis* (see also Chap. 2.4.5).

2.3.2.4

Nitrogen Storage

In all natural systems nitrogen is a limiting nutrient. It is therefore to be expected that storage of the nitrogen takes place in different organs and at different times. Nitrogen is stored in various forms:

- as **organic nitrogen** in the vacuole, only in the form of nitrate and together with cations. This storage bridges the changing requirements during the day-night rhythm of growth as well as changing seasonal nitrogen supply.
- as **organically bound nitrogen**. Stored in the form of amino acids, lipids and proteins. Most of these substances have further functions, i.e. storage is a by-product of metabolism, and of imbalance in production and consumption of certain materials.
- as **amino acids**. They serve as storage and transport form for N. Amino acids have an osmotic function and therefore particularly those with several $-\text{NH}_2$ or $-\text{NH}$ groups are stored [glutamine (2N/4C), asparagine (2N/4C), arginine (4N/6C), allantoin (4N/4C)]. Storage is short-term to seasonal and occurs in the phloem–xylem cycle or in the vacuoles of the storage parenchyma of stems. Some of the amino acids not only have a storage function, but also protect against frost and salt in winter (proline, Chaps. 1.3.6 and 1.6.2.3). The storage amino acids play an important ecological role in sprouting and growth of young leaves in spring. About 60% of the N content of a beech leaf originates from storage in the

Box 2.3.8 Insectivorous plants

“Carnivorous” or **insectivorous** plant species are found in areas which are particularly deficient in nutrients. They have adapted by changing their leaves in various ways to organs which act as traps and are suitable for trapping insects and at the same time excrete proteases and chitinases that digest them (Fig. 2.3.12 A). They are differentiated into:

- spring traps (e.g. *Dionaea*);
- pitfall traps (e.g. *Nepenthes*);
- sticky traps (e.g. *Drosera*);
- suction traps (e.g. *Utricularia*).

These types have evolved in very different taxonomic groups (Fig. 2.3.12 B). Often the same trap types occur in geographically and taxonomically distinct regions (pitfall traps in *Nepenthes*: Indonesian islands; *Sarracenia*: eastern USA, *Darlingtonia*: western USA; *Cephalotus*: SW Australia).

The effectiveness of insect capture can be measured using stable ^{15}N isotopes, as insects have a higher ^{15}N value, depending on their trophic level, than soil N (Table 2.3.3; Schulze et al. 1991; W. Schulze et al. 1997).

Roridula gorgonias (South Africa) is a special case as it does not excrete proteases. The sticky leaves catch insects, but they are harvested by bugs (Hemiptera) which are adapted to life on the sticky trap and move slowly and carefully. The excrement of the bugs is used by the *Roridula* as N source (Ellis and Midgley 1996).

Nepenthes takes nitrogen from the trapped insects in the form of ammonium which is absorbed via glands (W. Schulze et al. 1997) where amino acids are formed before transport to the bundle sheath. There polypeptides are formed (a N concentration mechanism), and then loaded into the phloem. In young *Nepenthes* shoots 100% of the N content originates from trapped insects. In Venus flytraps (*Dionaea*) survival depends on the seedlings being able to trap insects (W. Schulze et al. 2001). Only after a significant catch can the larger spring traps develop that are suited to catch larger insects; only the rosette is capable of flowering.

Table 2.3.3. The contribution of insects N to the N nutrition of insectivorous plants. (W. Schulze et al. 2001)

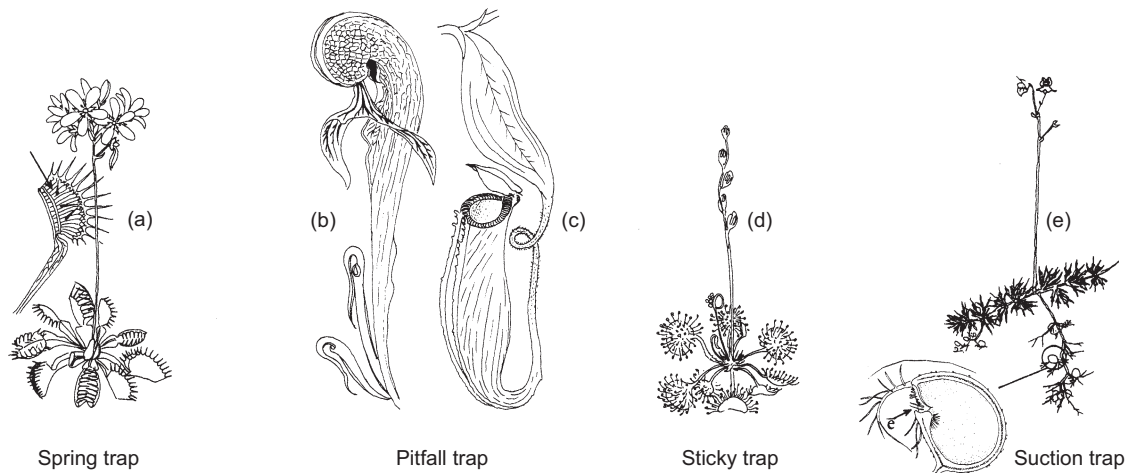
Trap type	Genus	Growth form	Proportion of insect in plant N (%)
Sticky trap	<i>Drosera</i>	Rosette	20 (e.g. <i>D. erythrorhiza</i> , Western Australia)
		Climber	53 (e.g. <i>D. macrantha</i> , Western Australia)
		Upright, low	48 (e.g. <i>D. stolonifera</i> , Western Australia)
		Upright, high	54, (e.g. <i>D. gigantea</i> , Western Australia)
		Shrub	70
Pitfall trap	<i>Roridula</i>	Rosette	26
	<i>Cephalotus</i>	Climber	62 (100% in buds)
	<i>Darlingtonia</i>	Rhizome	76
	<i>Heliophora</i>	Rhizome	79
	<i>Brocchinia</i>	Erect rosette	59
Spring trap	<i>Dionaea</i>	Rosette	80

stem. In the xylem of spruce, amino acid concentrations are greater than 100 mmol/l (Kummetz 1996) during the emergence of new needles.

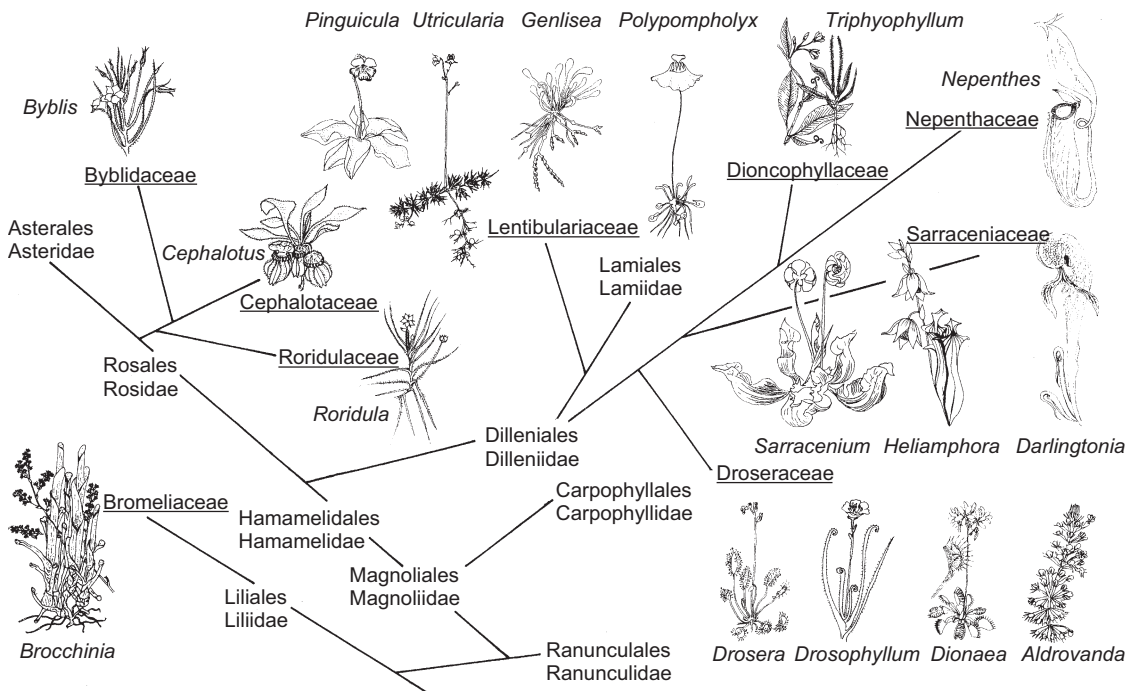
- as **polypeptides and proteins**. They are formed when the osmotic activity of amino acids may interfere with metabolism, for example, during the loading of phloem the number of molecules must be decreased and N must be concentrated

in a few molecules (Schulze et al. 1999). Important storage proteins, e.g. prolamine, glutelin, and albumin, accumulate in seeds but these proteins are also some of the proteins required in metabolism and have additional storage and protective functions. The CO_2 -reducing enzyme Rubisco (ribulose-bis-phosphate-carboxylase/oxygenase) forms about 30% of the N content of a leaf. Only a proportion of this pro-

Box 2.3.8 Insectivorous plants (continued)



A



B

Fig. 2.3.12. A Different forms of leaf used to capture insects. Spring traps: *Dionaea muscipula*, pit-fall trap: *Darlingtonia californica* and *Nepenthes* spp., sticky traps: *Drosera* spp., suction traps: *Utricularia* spp. B Distribution of insectivorous plants in angiosperms. (From W. Schulze 1991)

tein is normally active, the excess serving to safeguard the photosynthetic apparatus at high photon flux, or a proportion may be degraded during N deficiency and used for growth (Stitt and Schulze 1994). Before leaves are shed, part

of this nitrogen is degraded and the amino acids re-translocated back to the plant. This remobilisation of nitrogen from leaves comprises about 20% of the leaf N (Chapin and Kedrovski 1983; Koch et al. 1988).

- as **glucosides**. These plant poisons serve as protection against herbivory and may be transported to sites of growth or metabolised, serving as N storage.

2.3.2.5

Signs of N Deficiency and N Excess

N deficiency and N excess are shown by the following characteristics:

- **N deficiency:** Yellowing, reduction of growth of shoots and leaves, high dry weight/leaf area, starch accumulation, premature ageing and shedding of leaves. Note: Yellowing of leaves is not very specific and is often also caused by deficiency of other nutrients and degradation of chlorophyll. The nitrogen cation imbalance determines deficiency and excess.
- **N excess:** High chlorophyll contents, high water content, low dry weight/area (shade leaf type), nitrate and amino acid storage, long internodes.

Because of the rapid and substantial alterations in N supply with changing conditions in time and location it is very time- and resource-consuming to quantify the N supply. In contrast to nitrate, which is not bound to a soil exchanger and can thus be measured in soil solution, quantifying the exchangeable ammonium in litter is difficult. Ellenberg (1986) suggested, in order to characterise the supply of nitrogen at a particular site, that it would be possible to derive the supply from different sources from the species distribution, i.e. each species is classified by a relative scale, with a range of 1–5 to 1–9 of the so-called **indicator values** (Box 2.3.9). Conversely, it is possible to draw conclusions about the occurrence of a species from the supply of resources. However, this is only possible within the original areas where the plant occurred, as the interaction with other species changes the occurrence and thus the indicator value of a particular species (see Chap. 4).

Box 2.3.9 Indicator plants

Indicator plants are defined as follows (see also Chap. 4.3.3.4):

- About 2000 vascular plants in central Europe occur with varying frequency in different habitats and are classified into particular classes and locations. This classification is also applied to mosses and lichens;
- The classification is based on three climatic factors (light, temperature, continentality) and four soil factors (N availability, soil pH, soil water content and salinity). A classification of species in relation to P-supply is being developed;
- Class values are the so-called indicator values and should allow a general characterisation of a site, without additional analysis in a laboratory;
- The classes rise from 1 (small) to 9 (large);
- Indicator values are not a measured value only, but based on expert knowledge. They are extrapolated from the normal behaviour of a species in its natural environment, i.e. they do not characterise the physiologi-

cal requirements but the ecological niches that they occupy. Thus they apply only in areas where the initial floristic analysis was performed.

As **nitrogen indicator** they serve in the following way:

- N1: species that only occur in nitrogen-poor environments, e.g. *Trifolium arvense*, *Erophila verna*, *Calluna vulgaris*;
- N2 and N3 species which occur more often in N-poor than on N-rich locations e.g. *Medicago sativa*, *Equisetum arvense*;
- N4 and N5 types of species, occurring in moderate to rich locations but only infrequently on N-poor locations, e.g. *Ribes nigrum*, *Primula vulgaris*;
- N6 and N7 species only flourish on N-rich locations, e.g. *Chenopodium album*;
- N8 species are special N indicators, e.g. *Mercurialis annua*, *Urtica urens*, *Epilobium angustifolium*, *Ballota nigra*;
- N9 species occurring in extremely high N-rich locations, e.g. *Chenopodium bonus-henricus*, *Lamium album*, *Sambucus nigra*.

Box 2.3.10**Summary: nitrogen**

The nitrogen economy can be summarised as follows:

- **Nitrogen** is second only to carbon in importance for plant life. Under natural conditions, most plants are subject to nitrogen deficiency;
- **N uptake** occurs from the soil or from the air as ammonium, nitrate, amino acids, or as gaseous NH_3 or NO_x . A number of specialised plants can, together with symbiotic microorganisms, form nodules; these microorganisms assimilate N_2 from the air and change it into ammonia;
- **Ammonia and ammonium** ions are toxic for cells and are rapidly assimilated into amino acids. Ammonium uptake leads to acidification of the soil, C imbalance and cation deficiency.
- The uptake of **nitrate** is coupled with cation uptake in most cases. This leads to increasing pH (alkalinisation) in the soil; where nitrate is in excess there is long-term acidification of the soil due to cation leaching, as nitrate cannot be stored in the soil;
- **Indicator plants** allow an assessment of the average N availability of sites;
- **Nitrogen deficiency** leads to specialised adaptations of plants to capture mainly insects and use them as N sources. Nitrogen deficiency can be beneficial in environments which are cation deficient, as the requirement for cations is reduced. With poor N availability there are no signs of cation deficiency syndrome (e.g. in boreal forests).

2.3.3**Sulfur Nutrition****2.3.3.1****Sulfur in Plant Metabolism**

Sulfur is a macro-nutrient element which can be metabolised and is available:

- in oxidised form as
 - **SO_4^{2-} ion**: sulfolipid (ester binding of SO_4 to a sugar lipid); occurs in all membranes
 - **-S-S or -S-O group**, occurs in species-specific secondary metabolites, e.g. alliin in *Allium*, isothiocyanate R-N-C-S in Brassicaceae. These substances serve as S storage and protection against herbivory.
- in reduced form as **-SH groups**
 - in **amino acids** (cysteine, cystine, methionine)
 - as **co-enzyme** (acetyl-S-enzyme protein: acetyl-CoA)
 - as non-peptide unit making a functional protein (**prosthetic group**): ferredoxin, thiamine, biotin
 - in **proteins to form the tertiary structure**
 - in **cellular redox systems for regulation of pH** ($\text{R1-SH} + \text{R2-SH} \rightarrow \text{R1-S-S-R2} + \text{H}_2$), particularly with participation of glutathione

- in proteins to **bind heavy metals** (heavy metal resistance; see Chap. 1.7). In particular, cysteine participates in many ion channels and is thus sensitive to heavy metal binding
- glutathione cycle to **detoxify radicals**.

Sulfur Metabolism

Sulfate is activated by ATP (Fig. 2.3.13) and adenosine phosphatesulfate (APS) is formed. This substance is transformed, either by formation of phosphoadenine-phosphosulfate (PAPS) into the sulfate ester metabolism to give, for example, sulfolipids, or serves as a substrate for sulfur reduction, with the reduced sulfur deposited as thiol groups in C-skeletons (usually an amino acid, e.g. glutathione) synthesised via a sulfotransferase. The S-reduction occurs in the chloroplast, where ferredoxin transfers the electrons to oxidised sulfur. The SH-group is transferred to acetylserine which is split into acetate and cysteine. Cysteine is the starting point for the formation of all organic molecules with an SH-group, and thus makes plants sensitive to heavy metals (see also Chap. 1.9).

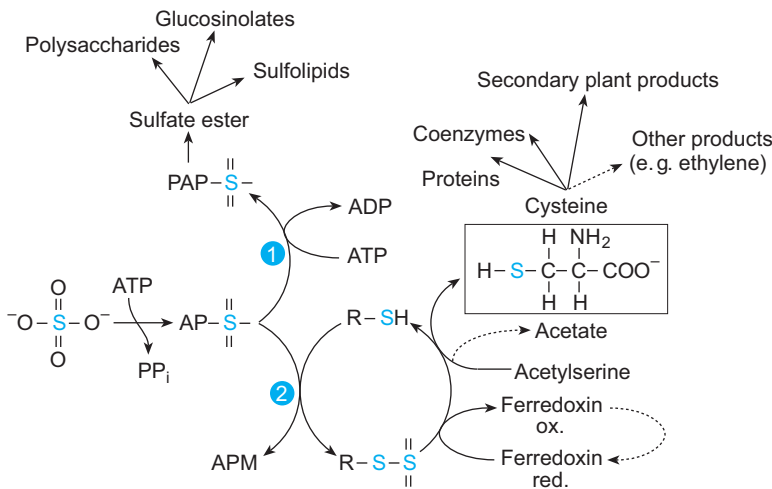


Fig. 2.3.13. Schematic representation of the assimilation of sulfur into various plant metabolites. *ATP* Adenosine triphosphate; *PAPS* phosphoadenosine phosphosulfate; *APS* adenosine phosphosulfate; *APM* adenosine phosphomalate; 1 sulfate esterase; 2 sulfite reductase. (After Marschner 1995)

2.3.3.2 Sulfur Uptake and Plant Requirements

Sulfur is taken up as SO_4^{2-} anion in symport with cations. Sulfate is the most important additional anion, next to nitrate, in plant nutrition. Reduction of the sulfate anion to -SH occurs in the chloroplast, via sulfite utilising the electron flow from PS I (see Fig. 2.3.7). With calcium, sulfate forms salts (gypsum) which are difficult to dissolve so it cannot be stored in its inorganic form in the vacuole, but sulfate is bound to organic molecules.

Generally, the requirement for N also regulates the demand for S, as the N/S ratio of proteins is approximately constant (10:1). Only in some plant families does the S requirement increase due to secondary metabolism. This applies particularly to Cruciferae, where mustard oil (glucosinolates) provides protection against herbivory, but also serves as S deposition. Rape belongs to those plants able to grow well with very high S-supply. As a part of the mustard oil is volatile, these plants are also able to remove S via stomata. The S-requirement is also large in Leguminosae, particularly because of the S-containing storage proteins in seeds.

Sulfur is not only taken up via the roots but also via the shoot. This applies particularly to SO_2 , which enters the intercellular spaces together with CO_2 (the chemistry of SO_2 turnover is explained in Chapter 1.9.2.1). SO_2 is soluble in the cell wall with formation of the toxic sulfite anion which follows the pH gradient reaching the chloroplast where it is assimilated. In general, SO_2 is oxidised to SO_4^{2-} by heavy metals in

the cuticle and in the cell wall, particularly by Mn which is assimilated in the mesophyll in the same way as sulfate is taken up by the roots. Part of the sulfate reacts in the cell wall with Ca and forms gypsum. Photosynthesis of damaged and undamaged spruce needles is not dependent on their S content, even at very large S contents (Lange et al. 1989). Obviously, the toxic sulfite formed from SO_2 is immediately reduced and sequestered in amino acids. In addition, the mass balance shows that most of the sulfur in a needle does not originate from SO_2 , but from the uptake of **sulfate** from the soil solution (Köstner et al. 1998): 97% of S in the xylem was transported in the form of sulfate taken up by roots (Table 2.3.4). Only 15% of the S available in a tree originates from above-ground uptake. This demonstrates that the **forest damage** observed in the 1980s was not classical damage from smoke- SO_2 , but indirectly caused by sulfate input and acidification of soils (Schulze et al. 1989; Ulrich 1995). Sulfate stress in the canopy, by uptake from the soil, is about a third greater

Table 2.3.4. Transport of S in the xylem of trees and from the atmosphere in healthy and damaged spruce forests (Köstner et al. 1998); given in mmol m^{-2} soil year $^{-1}$

	Healthy stand	Damaged stand
Transport in xylem		
Sulfate	25.9	34.7
Glutathione	0.52	0.47
Cysteine	0.14	0.14
Methionine	0.3	0.3
Uptake of SO_2	7.4	7.6
Total S load for the canopy	34.26	43.21

Box 2.3.11**Summary: sulfur balance**

- **Sulfur** is required in the plant in the oxidised form (sulfate ester) as well as in the reduced form (-SH-groups of amino acids);
- **Sulfate reduction** occurs in chloroplasts;
- Even with high anthropogenic S-input, uptake occurs predominantly in the form of sulfate via the roots;
- Requirement for S is very different for various plant species. Cruciferae have particularly high requirements.

in damaged than in undamaged stands (concerning damage to forests, see Chaps. 1.9.2 and 3.5.1).

2.3.3.3**Indicators of Sulfur Deficiency and Excess**

- **Deficiency:** symptoms are similar to S deficiency (chlorosis), accumulation of non-S-containing amino acids (arginine, aspartate), inhibition of protein synthesis.
- **excess:** high SO₂ stress leads to the well-known pollution (smog) damage. Lichens are particularly sensitive. The damage is caused by the formation of sulfite and accumulation in the chloroplast. The threshold for SO₂ damage is 5 µg m⁻³ as average concentration in the air.

2.3.4**Phosphate Nutrition****2.3.4.1****Phosphorus in Plant Metabolism**

Phosphorus is the central element in the **energy metabolism** of all living organisms; in this process, storage and transfer of chemical energy by formation and degradation of polyphosphate esters with adenosine take place. Phosphorus is not reduced, in contrast to nitrogen and sulfur, but remains in the highest oxidation state and is esterified in this form. It is taken up as H₂PO₄⁻. In the cell phosphorus is available in this form (P_i) and binds as PO₄³⁺ to carbohydrates forming simple phosphate esters (C-O-P, e.g. in sugar phosphate) or forming energy-rich pyrophosphate (P-P bonds) or diester bridges between carbohydrate groups (C-P-C).

Structural functions: P participates in the formation of

- RNA as a bridge between the ribose-N bases
- phospholipids of membranes.

Metabolic functions:

- **energy storage and transfer** by polyphosphate esters with adenosine. Di- and triesters are the actual energy storage in the cell (adenosine monophosphate, AMP; adenosine diphosphate, ADP; adenosine triphosphate, ATP)
- **energising of binding sites** for metabolic turnover. Sugar phosphates (e.g. fructose-1,6-diphosphate) play a decisive role in the regulation of sugar metabolism and triosephosphates are an important transport metabolite between chloroplast and cytosol (Stitt 1994).

2.3.4.2**Phosphate Uptake and Plant Requirements**

In many habitats, phosphate is a limiting factor for plants because of its low solubility in alkaline conditions (Ca phosphates, apatite) and acidic conditions (Al phosphates, goethite). In the sea, phosphorus accumulates in the trophic levels. Sea birds bring this phosphorus to land: Bird excrement (guano) as the primary source for P fertiliser (for discussion of import nutrients from the sea to islands, see Erskine et al. 1998). Phosphate does not dissolve easily in soils and leaching hardly occurs, in contrast to nitrate which dissolves easily. Root hairs provide good contact with soil particles and the phosphate is dissolved because root hairs secrete protons and organic acids. Mycorrhiza play an important role in dissolving phosphate from minerals and are additionally very important in primary phosphate uptake. After the uptake of phosphoric acid this is directly bound to organic molecules and thus “protected” from transport back into

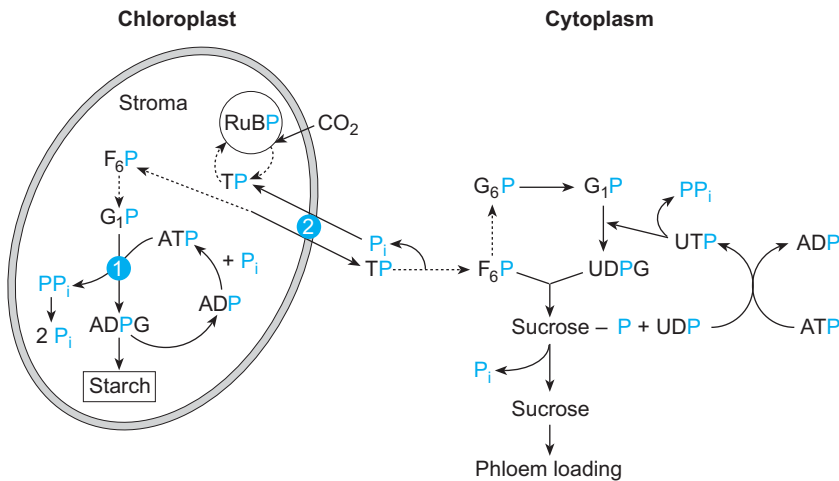


Fig. 2.3.14. The involvement of phosphate in the synthesis of starch and sucrose, and regulation of metabolism by phosphate: ADP-glucose-pyrophosphorylase regulates starch synthesis: inhibition by P_i and stimulation by PGA (1). Phosphate translocation regulates the export of photosynthetically produced substrates from the chloroplast: stimulation by P_i and TP (triosephosphate) (2). F_6P Fructose-6-phosphate; G_6P glucose-6-phosphate. (After Marschner 1995)

Box 2.3.12 Summary: phosphate balance

- Phosphate serves as the carrier of chemical energy in the plant;
- Phosphate is not reduced in plants, but used in polyphosphate esters.

the soil solution. Despite this, transport in the xylem is as P_i .

P_i occurs in the cell as substrate, as well as product, in all activations and enzyme reactions with ATP and ADP and simultaneously regulates many enzyme reactions. Because of this important physiological activity, the concentration of P_i in the cytosol is regulated in a very narrow range, 4–6 mmol l⁻¹, the vacuole serves as storage site. The relative concentration of P_i in the cytosol and chloroplasts regulates (together with the concentration of sucrose in the cytosol) the formation of starch in the chloroplast (Fig. 2.3.14).

Phosphate is stored in plants in the form of polyphosphates or as sugar esters; in **phytate** up to six phosphate molecules may be deposited on one sugar (myoinositol). This form of storage is very important in seeds.

2.3.4.3 Indicators of Phosphorus Deficiency and Excess

- **Deficiency:** interference in reproductive processes (delay in flowering), reduced longitudinal growth, dwarfing, smaller leaves because

of reduced cell growth, increased root growth, dark green colouration of leaves and reddish colouring of needles with chlorosis and premature ageing.

- **excess:** does not occur naturally because phosphate is not easily dissolved and may be regulated by polyphosphate formation.

2.3.5

Nutrition with Alkaline Cations

The alkaline cations potassium, magnesium and calcium are essential macro nutrients which are not metabolised, but are essential to provide the correct environment for particular reactions, to regulate pH and in regulation of cellular water relations.

2.3.5.1 Magnesium

Function

Similar to other alkaline cations, magnesium is not metabolised and it is therefore difficult to determine its actual function.

Structural function of Mg:

- in the structure of chlorophyll (central atom of four pyrrole rings)
- in the cross-connections of cellulose fibrils in the cell wall

Metabolic functions of Mg:

- stabilising enzymes, predominantly during the turnover of phosphates (nitrogenase, ATPase, phosphorylase, and others). In these processes Mg binds to phosphate and, because of allosteric interactions, binding between substrate and phosphate becomes possible
- stabilising energy-rich bonds, e.g. phytate as phosphate storage
- Mg regulates the proton gradient in the stroma of chloroplasts in ATP synthesis and thus determines the pH in the chloroplast (pH 7.6 in the dark and 8 with illumination)
- osmoregulation and pH regulation in the cell, as antagonist to Ca and K.

Uptake and Requirement

In the soil magnesium is bound to the substrate predominantly as an exchangeable cation. Mg is a component of primary and secondary minerals (serpentine) from which it is released by weathering. The uptake of magnesium is particularly antagonistically influenced by ammonium. The most important antagonist for Mg is Ca, but also NH_4^+ , K, Mn and even H^+ influence the uptake of Mg.

In the plant magnesium is transported in the xylem and phloem and the ion is stored in chloroplasts. Remobilisation from ageing leaves occurs.

Deficiency and Excess

With Mg deficiency and excess the following symptoms occur:

- **Mg deficiency:** yellowing of older leaves, yellow tips and early shedding of needles, chlorosis because of inadequate chlorophyll synthesis, starch accumulation because of the effect on phosphate metabolism, water relations affected because of poor osmoregulation, dwarf growth.
- **Mg excess:** on Mg-rich substrates (serpentine) because of interactions with other nutrients. Water stress may lead to increased concentrations of Mg.

2.3.5.2

Calcium

Function

Structural function of Ca:

- stabilising cell wall together with Mg
- Metabolic functions of Ca:
- Ca^{2+} is toxic and only transported in the cytosol as bound proteins
 - interaction with phytohormones (IAA) in elongation of cells (calmodulin)
 - interactions with ABA
 - activator of membrane-bound enzymes (amylase) and ATPases of ion channels
 - osmoregulation (shrinking)
 - Ca functions in the mitochondria, in contrast to Mg which regulates the proton gradient predominantly in chloroplasts.

Uptake and Requirement

Ca occurs in the soil solution as Ca^{2+} ; a distinction must be made for “Ca-rich” and “Ca-poor” soils. Calcium-rich soils are predominantly found on limestone. The pH of these soils with almost unlimited CaCO_3 is stabilised by the dissolution of CaCO_3 at about pH 7. In Ca-poor soils, CaCO_3 is quickly consumed because it dissolves easily and is not stable against weathering, so that the dissolved Ca^{2+} is only bound to the ion exchangers of the soil after the dissolution of the carbonate. The pH of Ca-poor soils is usually around pH 5, but may sink on acidic rocks (shales containing pyrite) to 3.5. Below a pH of 5.5 the chemistry of the soil is increasingly determined by aluminium. Ca uptake at the root is antagonistically influenced by other cations, particularly Al. If Al instead of Ca is incorporated into the cell wall, elongation growth is inhibited.

Ca uptake occurs in symport with anions, particularly nitrate, and in acidic soils with sulfate and occurs predominantly at the root tip, where the endodermis is not yet formed, as transport into the xylem via the cell wall is possible there. Ca is transported in the xylem, but is absent from the phloem where, because of the high pH, Ca would react with phosphate forming insoluble apatite. Thus Ca is transported in the phloem only in bound form (Ca protein binding, e.g. calmodulin). Ca is stored in cell walls and vacuoles together with malate, where Ca-oxalate, Ca-sulfate or Ca-carbonate may be formed by precipitation. High Ca concentrations also occur in the endoplasmic reticulum.

Box 2.3.13

Mg deficiency in combination with forest die-back

Mg deficiency was found to be particularly prominent in combination with forest die-back, the so-called “mountain yellowing”, diagnosed as magnesium deficiency (Zech and Popp 1983). Lange et al. (1989) showed in a simple and impressive experiment that mountain yellowing was not caused by air-borne pollutants (SO₂, ozone; Fig. 2.3.15): On spruce twigs with yellowed needles buds were left either intact or they were removed so that no further growth could occur. On twigs on the opposite side of the same branch it was observed later that only the needles on twigs with buds yellowed. In contrast needles on the shoots without buds were green. The experiment showed that magnesium availability from the xylem was sufficient to fulfil the requirement of a non-growing shoot but was inadequate to supply growing shoots. From this

the question arose as to what factors control growth. Oren and Schulze (1989) were able to show that there is an interaction with the N supply, the unregulated uptake of nitrogen having a particular growth effect on the canopy. Uptake leads not only to dis-equilibrium between N supply and cation uptake, but also has the effect of causing cation loss during the uptake of ammonium ions (Klemm 1989). The low supply of magnesium which trees take up from the soil is further reduced by an antagonism to ammonium, the main nitrogen form in sulfate-contaminated soils (Kaupenjohann et al. 1989). The high ammonium concentration of the soil solution leads to an exchange of ammonium against Al³⁺ on the clay particles, and to Al contamination of the soil water, which may lead to root damage (Ulrich 1995).

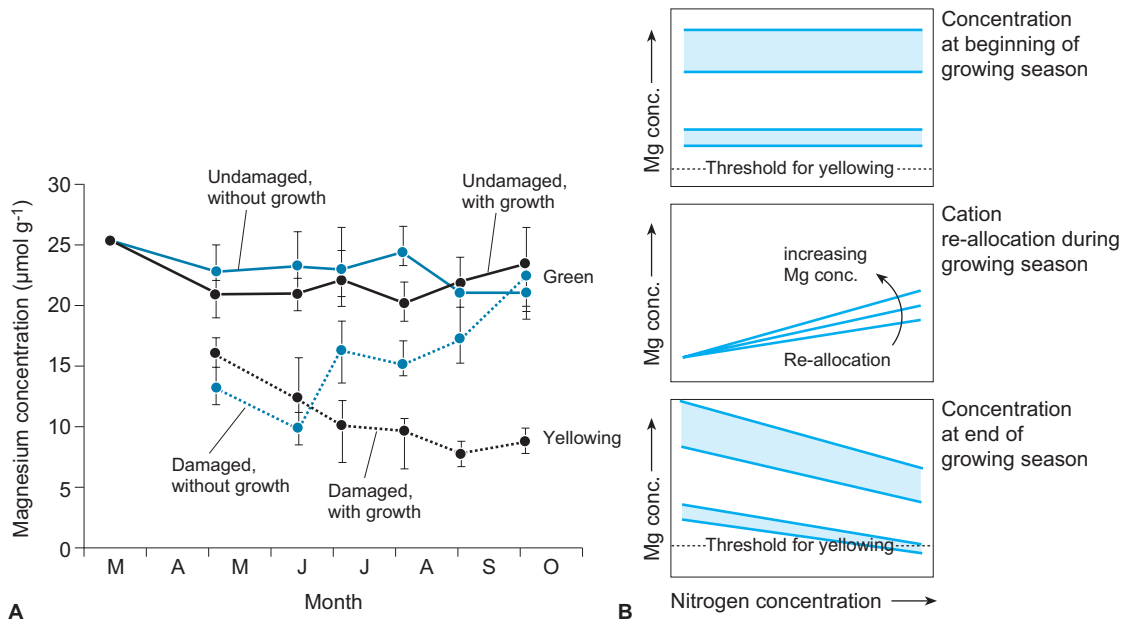


Fig. 2.3.15. A The yearly change (x-axis) in magnesium concentration of spruce twigs, that prior to treatment had Mg deficiency symptoms, compared with healthy green twigs. In the damaged and undamaged twigs, buds were either removed and thus growth was halted, or buds were maintained unchanged. Damaged side shoots without buds showed an increase in the Mg concentration during the year and were green at the end of the growing season. This experiment was decisive in showing that yellowing of spruce on silicate soils was not a direct consequence of SO₂ but of the interaction between growth and Mg supply. The Mg deficiency is also clearly visible on the spruce canopy on the title page to [Chapter 2.3](#). Changes in magnesium concentration with N concentration in twigs of spruce before emergence (*top picture*), translocation of Mg from old to new needles (*centre picture*), and after emergence of young needles (*bottom picture*). The change is shown in twigs with high and low Mg supply. Only high N availability and low Mg supply crosses the threshold that leads to yellowing. (After Oren and Schulze 1989)

Box 2.3.14**Indicator plants for soil conditions
(for lime and silica indicating plants, see Chap. 4.2.3)**

The reaction number is a qualitative indicator of soil pH:

- R1+R2: strong acid indicators, never occur on slightly acidic to alkaline soils, e.g. *Scleranthus annuus*, *Rumex acetosella*, *Spergula vernalis*;
- R3+R4: acid indicators, mainly on acidic soils, but also occupy soils of neutral pH, e.g. *Raphanus raphanistrum*, *Stachys arvensis*, *Anthemis arvensis*;
- R5+R6: moderate acid indicators, seldom occur on strongly acidic or on neutral to alkaline soils, e.g. *Sinapis arvensis*, *Veronica persica*, *Fumaria officinalis*;
- R7+R8: weak acidic to weak basic indicators, never occur on strongly acid soils, e.g. *Aconitum napellus*, *Arctium lappa*, *Corydalis cava*;
- R9: base and lime indicators, only occur on chalky soils, e.g. *Delphinium consolida*, *Adonis aestivalis*.

Ca reaches the leaf in the xylem stream, but may only be transported out via the phloem if bound to proteins, resulting in an excess of Ca in the leaf and accumulation over time. This becomes obvious from the Ca content of leaves which rises with age and is particularly striking in conifers with needles of different age (Oren et al. 1988).

The function of Ca as stabiliser of the primary wall, by binding to pectin, becomes important in elongation growth which essentially depends on the presence of Ca. However, Ca has further functions in growth ranging from the formation of callose to the secretion of the calyptra and the regulation of geotropism. By forming bridges between phosphate and carboxyl groups of phospholipids, Ca maintains the membrane structure.

Deficiency and Excess

Ca deficiency and excess lead to the following reactions:

- **Ca deficiency:** disturbed growth by inhibition of cell division, desiccation of tips and buds, death of root tips and chlorosis of needle tips. Ca deficiency is possible during ripening of fruits and in organs which grow fast but transpire little (bulbs, tubers, tap roots, etc.), as Ca is not transported in the phloem. In fruits, Ca deficiency leads to increased susceptibility to fungal attack.
- **Ca excess:** occurrence of Ca-oxalate, Ca-sulfate and Ca-carbonate. Grasses generally require less Ca than dicotyledons. Low Ca requirements and adverse reactions to high Ca supply also occur in “calcifuge” plants which

are not able to maintain compartmentation of large amounts of Ca (see Chap. 3.5.3).

2.3.5.3**Potassium****Function**

Potassium is the most required nutrient in plants (2–5% dry weight) after nitrogen.

Structural functions (no direct involvement in chemical reactions):

- pH regulation
- enzyme activation by changing the conformation of proteins (ATPase)
- influencing protein synthesis (translation, synthesis of RuBP-carboxylase)
- osmoregulation and elongation growth of cells, interacting with IAA and GA
- tropism and movement (stomata regulation)
- phloem transport.

These metabolic functions of potassium cannot be replaced by Na (the most important cation in animals) and NaCl leads to salt stress in plants (Chap. 1.6); however, the osmotic function of K may be replaced by Na, Mg and Ca. The K concentration is high in the cytosol and low in the apoplast (except in movements and tropism: osmotically regulated movement, e.g. of stomata). Transport through the membrane is via K channels.

Besides the general physiological importance of potassium in enzyme activation and protein synthesis it is particularly important in the following processes:

Box 2.3.15

Mistletoes as nutrient parasites

Mistletoes are heterotrophic phloem parasites (leaves without chlorophyll) as well as autotrophic xylem parasites (with green leaves). Xylem parasites have been known for their medicinal use since Hippocrates' time, and not just since Asterix and Getafix. Their alkaloids and lectins (carbohydrate-binding proteins) have major pharmaceutical relevance in the treatment of tumours (Luther and Becker 1987).

Mistletoes are of botanical interest (Calder and Bernhardt 1983) as they have a high potassium concentration in their leaves (40 mg g^{-1}). In hyperparasitic plants (mistletoe growing on mistletoe) an additional accumulation of K and other cations may occur ($157 \text{ mg g}^{-1} \text{ Na}$ in arid locations; Ehleringer and Schulze 1985) because the mistletoe takes up the xylem water with the cations which accumulate in the shoot, as there is no connec-

tion and re-circulation to the host's phloem. This accumulation of salt can lead to leaf damage and abscission.

In mistletoe it is particularly significant that despite the high, almost toxic, ion concentrations they maintain higher transpiration rates than the host (Ehleringer et al. 1985). Thus, mistletoes are not only significant sinks for cations but they are also water parasites. Under field conditions it is particularly interesting that even at high ion concentration and even under arid conditions mistletoes do not control transpiration but apparently metabolise the ABA entering them in the xylem water. The controlling factor is their nitrogen requirement. Schulze et al. (1984) showed that N requirement is the limiting factor for mistletoes and a high water requirement is needed to provide the N as mistletoes are characterised by substantial seed production. If mistletoe grows on a N_2 -fixing plant, then transpiration rate is often not so large as on host plants that do not fix N_2 (Marshall et al. 1994). As trees predominantly transport amino acids in the xylem, their mistletoes gain additional carbon skeletons, i.e. they are not only cation, nitrogen, and water parasites, but also C parasites; 15% of the carbon for an "autotrophic" mistletoe originates from the host (Marshall et al. 1994). Photosynthesis is generally lower in the mistletoe than the host plant.

An unusual botanical feature of Australian mistletoes (Fig. 2.3.16) is that their leaves mimic the shape and form of the host so closely that it is difficult to explain except by horizontal gene transfer (Calder and Bernhardt 1983).

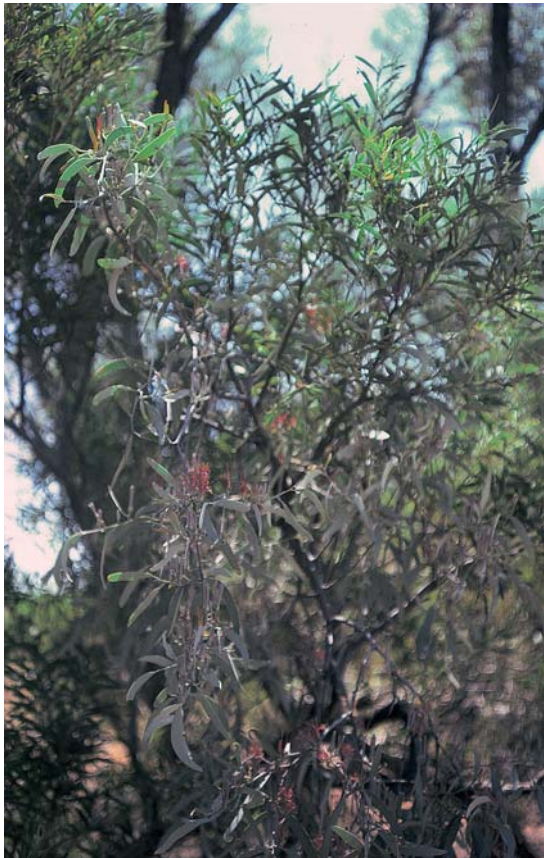


Fig. 2.3.16. Leaf mimicry of Australian mistletoe (see Calder and Bernhardt 1983). *Acacia cambagei* with *Amyema maidenii*. (Photo E.-D. Schulze)

Table 2.3.5. Characteristic features of mistletoe. After Ehleringer and Schulze 1985 (1); Marshall et al. 1994 (2)

	Mistletoe	Host	Source
K concentration (mg g^{-1})	28	11	(1)
P concentration (mg g^{-1})	2	1	(1)
N concentration (mg g^{-1})	28	25	(1)
	10	11	(2)
Transpiration ($\text{mmol m}^{-2} \text{ s}^{-1}$)	4	2	(2)
CO_2 assimilation ($\mu\text{mol m}^{-2} \text{ s}^{-1}$)	4	5	(2)

Box 2.3.16**Summary: cations**

Cation nutrition is summarised as follows:

- Basic cations are not metabolised, but they are important in a number of enzymatic reactions and in some cases form the reaction centres of enzymes (Mg in chlorophyll);
- Requirement for K is higher than for Ca and Mg;
- K regulates osmotic concentrations and pH of the cell;
- Mg is involved in chlorophyll functions and in the transfer of phosphate from ATP to organic molecules;
- Ca acts as an osmotic dehydrating ion and as a signal in cell metabolism (calmodulin).

- **regulation of photosynthesis** (photophosphorylation) and drought resistance. K regulates the osmotic potential during drought and maintains growth with decreasing water potential (Fisher and Turner 1978). The effect of K on osmoregulation also explains its importance in frost resistance.
- **regulation of movements:** The function of stomata (see Chap. 2.2.3) is based on oxygen requiring respiratory metabolism, with starch degraded to malate which is then transported into vacuoles and increases their ion content. Simultaneously, malate is decarboxylated in the mitochondria and the ATP produced is available for proton efflux. The HCO_3^- formed is used again in the degradation of starch. The proton efflux results in an influx of K from the apoplast via the antiport. Some of the protons are regained because of the influx of Cl^- . Potassium and chloride are transported into the vacuole, where they balance the ratio of anions/cations to malate. Thus the osmotic potential in the vacuole increases, with a consequential influx of water – and the stomata open. The effect of the stress hormone abscisic acid (ABA) in the regulation of stomata is to close the K channels (Schulze 1994) and thus to stop the movement of K^+ .
- **phloem transport:** potassium is the most important cation regulating the pH in the phloem and sucrose loading.
- **regulation of fruit and tuber (potato) ripening** occurs because of the effect of K on the cation/anion balance and on sugar/starch metabolism.

Uptake and Requirement

Potassium occurs predominantly in silicate rocks and becomes reversibly bound to exchangers in the soil, particularly to clay minerals. Because of its ionic radius potassium fits optimally into the intermediate layers of clayey minerals and is therefore preferentially accumulated there (specific adsorption). In some soils, accumulation of K^+ in clay minerals which are able to swell results in contraction of these clays which thus “fix” K^+ so strongly that it is no longer available for plants. The ionic radius and physical characteristics of K^+ are similar to ammonium, so that these two ions are easily interchangeable. Excess of ammonium leads to exchange of K (and other anions) and if these cations are leached this stimulates acidification of soils. K and ammonium are both used to determine the cation concentration of the exchanger.

Deficiency and Excess

With K deficiency and excess the following symptoms occur:

In this reaction ABA has a signal effect on Ca channels, thus increasing the cytosolic Ca concentration which again affects the K and anion channels of the plasmalemma. K uptake is inhibited and thus stomata are not able to open (Schroeter et al. 2001). Closure of stomata is affected by malate and an efflux of K. A corresponding mechanism affects other movements, e.g. of leaves of *Mimosa pudica* and *Dionaea muscipula* on touching, and the orientation of legumes to the sun.

- **K deficiency:** reduced growth and increased remobilisation from ageing organs, disturbed water relations (drying of tips), wilting appearance particularly at the edge of older leaves, yellowing and early shedding of needles.
- **K excess:** with K excess (e.g. on granite containing muscovite), Ca and Mg uptake are competitively influenced, thus increasing Mg deficiency at these sites.

References

- Brady NC, Weil RR (1999) The nature and properties of soils, 12th edn. Prentice Hall, Upper Saddle River, New Jersey, 881 pp
- Calder M, Bernhardt P (1983) The biology of mistletoes. Academic Press, Sydney, 348 pp
- Chapin FS III, Kedrovski RA (1983) Seasonal changes in nitrogen and phosphorous fractions and autumn retranslocation in evergreen and deciduous taiga trees. *Ecology* 64:376–391
- Ehleringer JR, Schulze E-D (1985) Mineral concentrations in an autoparasitic *Phoradendron californicum* growing on a parasitic *P. californicum* and its host, *Cercidium floridum*. *Am J Bot* 72:568–571
- Ehleringer JR, Schulze E-D, Ziegler H, Lange OL, Farquhar GD, Cowan IR (1985) Xylem tapping mistletoes: primarily water or nutrient parasites? *Science* 227:1479–1481
- Ellenberg H (1986) Vegetation Mitteleuropas mit den Alpen. Eugen Ulmer Verlag, Stuttgart, 943 pp
- Ellis AG, Midgley JJ (1996) A new plant-animal mutualism involving a plant with sticky leaves and a resident hemipteran insect. *Oecologia* 106:478–481
- Epstein E (1972) Mineral nutrition of plants: principles and perspectives. Wiley, New York, 412 pp
- Erskine PD, Bergstrom DM, Schmidt S, Stewart GR, Tweedie CE, Shaw JD (1998) Subarctic Macquarie Island – a model ecosystem for studying animal-derived nitrogen sources using ^{15}N natural abundance. *Oecologia* 117:187–193
- Fichtner K, Schulze E-D (1992) The effect of nitrogen nutrition on growth and biomass partitioning of annuals originating from habitats of different nitrogen availability. *Oecologia* 92:236–241
- Fisher RA, Turner NC (1978) Plant productivity in arid and semiarid zones. *Annu Rev Plant Physiol* 29:277–317
- Guaente L, Kenyon C (2000) Genetic pathways that regulate ageing in model organisms. *Nature* 408:255–262
- Harrison AF, Schulze E-D, Gebauer G, Bruckner B (2000) Canopy uptake and utilization of atmospheric pollutant nitrogen. In: Schulze E-D (ed) Carbon and nitrogen cycling in European forest ecosystems. *Ecological Studies* 142. Springer, Berlin Heidelberg New York, pp 171–188
- Hartmann G, Nienhaus F, Butin H (1988) Farbatlas Waldschaden; Diagnose von Baumkrankheiten. Eugen Ulmer Verlag, Stuttgart, 256 pp
- Herdel K, Schmidt P, Feil R, Mohr A, Schurr U (2001) Dynamics of concentrations and nutrient fluxes in the xylem of *Rhizinus communis* – diurnal course, impact of nutrient availability and nutrient uptake. *Plant Cell Environ* 24:41–52
- Hobbie EA, Macko SA, Williams M (2000) Correlation between foliar $\delta^{15}\text{N}$ and nitrogen concentrations may indicate plant-mycorrhizal interactions. *Oecologia* 122:273–283
- Kaupenjohann M, Zech W, Hantschel B, Horn R (1989) Mineral nutrition of forest trees: a regional survey. *Ecological Studies* 77. Springer, Berlin Heidelberg New York, pp 282–296
- Klein D, Morcuende R, Stitt M, Krapp A (2000) Regulation of nitrite reductase expression in leaves by nitrate and nitrogen metabolism is completely overridden when sugars fall below a critical level. *Plant Cell Environ* 8:863–872
- Klemm O (1989) Leaching and uptake of ions through above ground Norway spruce tree parts. *Ecological Studies* 77. Springer, Berlin Heidelberg New York, pp 210–237
- Koch LW, Schulze E-D, Percival F, Mooney HA, Chu C (1988) The nitrogen balance of *Paphanus sativus* × *raphanistrum* plants. Growth, nitrogen redistribution and photosynthesis under NO_3 -deprivation. *Plant Cell Environ* 11:755–767
- Köstner B, Schupp R, Schulze E-D, Rennenberg H (1998) Organic and inorganic sulfur transport in the xylem sap and the sulfur budget of *Picea abies* trees. *Tree Physiol* 18:1–9
- Kreutzer K, Göttlein A (1991) Ökosystemforschung Högwald; Beiträge zur Auswirkung von saurer Beregnung und Kalkung in einem Fichtenbestand. Beihefte zum Forstwissenschaftlichen Zentralblatt 39:1–261
- Kummetz E (1996) Die Wurzelentwicklung der Fichte (*Picea abies* (L.) Karst.): Untersuchungen zum C- und N-Haushalt unterschiedlich alter Bestände. Staatsexamensarbeit, Bayreuth
- Lange OL, Heber U, Schulze E-D, Ziegler H (1989) Atmospheric pollutants and plant metabolism. *Ecological Studies* 77. Springer, Berlin Heidelberg New York, pp 238–269
- Lange OL, Weikert RM, Wedler M, Gebel J, Heber U (1989) Photosynthese und Nährstoffversorgung von Fichten aus einem Waldschadensgebiet auf basenarmem Untergrund. *Allg Forstzeitschr* 3:54
- Luther P, Becker H (1987) Die Mistel; Botanik, Lectine, medizinische Anwendung. Springer, Berlin Heidelberg New York, 188 pp
- Marschall JD, Ehleringer JR, Schulze E-D, Farquhar GD (1994) Carbon isotope composition, gas exchange and heterotrophy in Australian mistletoes. *Funct Ecol* 8:465–487
- Marschner H (1995) Mineral nutrition of higher plants. Academic Press, London, 889 pp
- Michelsen AM, Schmidt IK, Jonasson S, Quarmby C, Sleep D (1996) Leaf ^{15}N abundance of subarctic plants provides field evidence that ericoid, ectomycorrhizal and non- and arbuscular mycorrhizal species access different sources of nitrogen. *Oecologia* 105:53–56
- Mitscherlich G (1975) Waldwachstum und Umwelt, Bd. 3. Sauerlanders, Frankfurt, 352 pp
- Moroney JV, Bartlett SG, Samuelsson G (2001) Carbonic anhydrase in plants and algae. *Plant Cell Environ* 24:141–154
- Nadelhoffer KJ, Emmett BA, Gunderson P, Kjõnaas OJ, Koopmans CJ, Schleppi P, Tietema A, Wright RF (1999) Nitrogen deposition makes minor contribution to carbon sequestration in temperate forests. *Nature* 398:145–147
- Nåsholm T, Ekblad A, Nordin A, Giesler R, Högberg M, Högberg P (1998) Boreal forest plants take up organic nitrogen. *Nature* 392:914–916
- Nordin A, Högberg P, Nåsholm T (2001) Soil N from and plant N uptake along a boreal forest productivity gradient. *Oecologia* 129:125–132
- Oren R, Schulze E-D (1989) Nutritional disharmony and forest decline: a conceptual model. *Ecological Studies* 77. Springer, Berlin Heidelberg New York, pp 425–443
- Oren R, Werk KS, Schulze ED, Meyer J, Schneider BU, Schraml P (1988) Performance of two *Picea abies* (L.) Karst. stands at different stages of decline. VI. Nutrient concentrations. *Oecologia* 77:25–37
- Orians GH, Solbrig OT (1977) A cost-income model of leaves and roofs with special reference to arid and semi-arid areas. *Am Nat* 111:677–690
- Persson T, Rudebeck A, Jussy JH, Colin-Belgrand M, Priemé A, Dambrine E, Karlsson PS, Sjöberg RM (2000) Soil nitrogen turnover – mineralisation, nitrification and denitrification in European forest soils. *Ecological Studies* 142. Springer, Berlin Heidelberg New York, pp 297–331

- Read DJ (1993) Plant-microbe mutualism and community structure. Ecological Studies 99. Springer, Berlin Heidelberg New York, pp 181–210
- Scheffer/Schachtschabel (1998) Lehrbuch der Bodenkunde, Ferdinand Enke Verlag, Stuttgart, 284 pp
- Scheible WR, Gonz ales-Fontes A, Lauerer M, M uller-R ober B, Caboche M, Stitt M (1997) Nitrate acts as a signal to induce organic acid metabolism and repress starch metabolism in tobacco. Plant Cell Environ 9:783–798
- Scheible WR, Lauerer M, Schulze E-D, Caboche M, Stitt M (1997) Accumulation of nitrate in the shoot acts as signal to regulate shoot-root allocation in tobacco. Plant J 11:671–691
- Schopfer P, Brennicke A (1999) Pflanzenphysiologie. Springer, Berlin Heidelberg New York, 695 pp
- Schroeter JI, Kwak JM, Allen GJ (2001) Guard cell abscisic acid signalling and engineering drought hardiness in plants. Nature 410:327–330
- Schulze E-D (1994) The regulation of plant transpiration: interactions of feedforward, feedback, and futile cycles. In: Schulze E-D (ed) Flux control in biological systems. Academic Press, San Diego, pp 203–236
- Schulze E-D, Turner NC, Glatzel G (1984) Carbon, water, and nutrient relations of two mistletoes and their hosts: a hypothesis. Plant Cell Environ 7:293–299
- Schulze E-D, Lange OL, Oren R (1989) Forest decline and air pollution: a study of spruce on acid soils. Ecological Studies 77. Springer, Berlin Heidelberg New York, 475 pp
- Schulze E-D, Gebauer G, Schulze W, Pate JS (1991) The utilization of nitrogen from insect capture by different growth forms of *Drosera* from southwest Australia. Oecologia 87:240–246
- Schulze E-D, Kelliher FM, K rner C, Lloyd J, Leuning R (1994) Relationships among maximum stomatal conductance, ecosystem surface conductance, carbon assimilation and plant nitrogen nutrition: a global ecology scaling exercise. Anti Rev Ecol Syst 25:629–660
- Schulze W (1991) Versuche mit insektenfangenden Pflanzen. Biol Unserer Zeit 21:307–312
- Schulze W, Schulze E-D, Pate JS, Gillison AN (1997) The nitrogen supply from soils and insects during growth of pitcher plants *Nepenthes mirabilis*, *Cephalotus follicularis* and *Darlingtonia californica*. Oecologia 112: 464–471
- Schulze W, Frommer WB, Ward JM (1999) Transporters for ammonium, amino acids and peptides are expressed in pitchers of the carnivorous plant *Nepenthes*. Plant J 17:637–646
- Schulze W, Weise A, Frommer WB, Ward JM (2000) Function of the cytosolic N-terminus of sucrose transporter AtSUT2 in substrate affinity. FEBS Lett 485:189–194
- Schulze W, Schulze E-D, Schulze I, Oren R (2001) Quantification of insect nitrogen utilization by the Venus fly trap *Dionaea muscipula* catching prey with highly variable isotope signatures. Exp Bot 1041–1049
- Schurr U, Schulze E-D (1995) The concentrations of xylem sap constituents in root exudate, and in sap from intact, transpiring castor bean plants (*Ricinus communis*). Plant Cell Environ 18:409–420
- Smith SE, Read DJ (1997) Mycorrhizal symbiosis. Academic Press, San Diego, 605 pp
- Stitt M (1994) Flux control at the level of the pathway: studies with mutants and transgenic plants having decreased activity of enzymes involved in photosynthetic partitioning. In: Schulze E-D (ed) Flux control in biological systems. Academic Press, San Diego, pp 13–36
- Stitt M, Schulze E-D (1994) Plant growth, storage, and resource allocation: from flux control in a metabolic chain to the whole plant level. In: Schulze E-D (ed) Flux control in biological systems. Academic Press, San Diego, pp 57–118
- Thomas H, Thomas HM, Ougham H (2000) Annuality, perenniality and cell death. J Exp Bot 51:1781–1788
- Ulrich B (1987) Stability, elasticity, and resilience of terrestrial ecosystems with respect to matter balance. Ecological Studies 61. Springer, Berlin Heidelberg New York, pp 11–49
- Ulrich B (1995) The history and possible causes of forest decline in central Europe, with particular attention to the German situation. Envir Rev 3:262–276
- Wallenda T, Stober C, H gbom L, Schinkel H, George E, H gberg P, Read DJ (2000) Nitrogen up-take processes in roots and mycorrhizas. Ecological Studies 142. Springer, Berlin Heidelberg New York, pp 122–143
- Zech W, Popp E (1983) Magnesiummangel, einer der Gr nde f r das Fichten- und Tannensterben in NO-Bayern. Forstwiss Zentralbl 102:50–55

2.4

Carbon Relations



Nothofagus fusca in a temperate deciduous forest of New Zealand. Beech forests of New Zealand occur mainly on the South Island and form approximately 36 m high mixed stands of the "red beech" *Nothofagus fusca* and the "silver beech" *Nothofagus menziesii*. The stands grow with about 2000 mm rainfall and average yearly temperature of 9.4°C, and are often very dense >1000 trunks per ha and 67 m² ha⁻¹ basal area, attaining a biomass of >300 t ha. The distribution of trees per hectare is characterised by about 20 very large trees, 300–400 years old, with a diameter at breast height of >5 m. Leaf area index reaches 7. Measurements of the carbon balance of this ecosystem of natural beech forests showed, for the first time, that in an undisturbed primeval forest there is no steady-state carbon balance. The forests are carbon sinks, i.e. they accumulate carbon over thousands of years in the humus layer (Hollinger et al. 1994). Photo E.-D. Schulze

Photosynthesis is not only the basis for growth of individual plants, but also the most important process providing energy in ecosystems. Considered from an ecological point of view, the biochemical process of CO₂ fixation is only a part of the carbon balance. The balance of photosynthesis and respiration and the response of the net process to climatic and edaphic factors is decisive for understanding growth of individual plants as well as for the ecosystem carbon cycle. In addition, it is essential to consider the way by which plants, through their structure and phenology, regulate their carbon balance and thus keep their position during competition with other species. Therefore, the carbon relations involve the broad spectrum from the biochemical reactions of CO₂ reduction to competition in a plant stand.

The following chapter considers the carbon relations of individual plants and of different types of plants. Chapter 3.3.2 considers C turnover in ecosystems. In Chapter 4.3 the phenomenon of competition and in Chapter 5.2 the effects of climate change for the global carbon balance are discussed.

2.4.1

Net Photosynthesis: Physiological and Physical Basis

2.4.1.1

Photosynthesis as a Diffusion Process

Net photosynthesis, also called CO₂ assimilation (A), is the difference between biochemical CO₂

fixation (P) and respiration (R_L), which takes place in the leaf simultaneously:

$$A = P - R_L \quad (2.4.1)$$

Respiration consists of a number of partial processes:

- **respiration in mitochondria of heterotrophic cells (R_{het})**, which do not possess chloroplasts, but are indispensable for the function of the leaf (conducting tissues, epidermis);
- **respiration in mitochondria of photosynthetically active cells (R_{mit})** which depends on ATP concentration in the cytosol and thus on photosynthesis;
- **light-induced respiration (photorespiration, R_{phot})**.

$$R_L = R_{het} + R_{mit} + R_{phot} \quad (2.4.2)$$

Because it is difficult to quantify these partial processes in an illuminated leaf, net photosynthesis is used in ecology as the standard for assessments of the plant carbon balance (Fig. 2.4.1) and it is usually measured as the net CO_2 exchange. Only the net exchange can be measured in the field. Basically, it should also be possible to measure the O_2 exchange. However, this is much more difficult because of the higher background concentration of O_2 in the atmosphere. However, measurement of O_2 becomes much more important globally (see Chap. 5).

CO_2 assimilation is a **diffusion process**, i.e. CO_2 from the atmosphere diffuses into the leaf as the CO_2 concentration in the intercellular

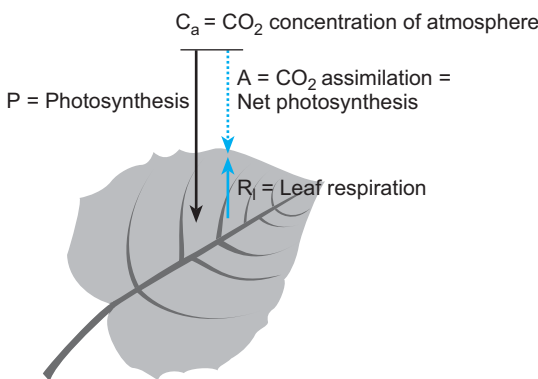


Fig. 2.4.1. Schematic presentation of CO_2 fluxes of a leaf. The flux of CO_2 into a leaf corresponds to the rate of photosynthesis minus respiration occurring at the same time. The net influx is known as net photosynthesis or CO_2 assimilation

spaces of the mesophyll is smaller than in the external air. The following equation applies to the transport via stomata:

$$A = (C_a - C_i)g_s \quad (2.4.3)$$

where C_a is the CO_2 concentration in the atmosphere, C_i the CO_2 concentration in the mesophyll and g_s the **stomatal conductance**. It is the same conductance which regulates the water vapour flux (see Chap. 2.2.3), but the conductance of stomata for CO_2 is lower by a factor of 1.6, corresponding to the higher molecular weight of CO_2 as compared with H_2O ($g_{\text{CO}_2}/g_{\text{H}_2\text{O}} = 1.605$; Jarvis 1971).

It would appear reasonable to also express the movement of CO_2 between C_i and the chloroplast as a diffusion process. However, as already noted, respiratory processes occur in the leaf [Eq. (2.4.1)], and also the transport of CO_2 in the cell wall occurs not only in the dissolved form, but also partially as HCO_3^- . Because of the respiratory processes taking place in different tissues, a CO_2 concentration, the **compensation point (Γ)**, is reached with decreasing CO_2 concentration, where CO_2 assimilation and respiration are balanced. Therefore, the following analogue equation applies:

$$A = (C_i - \Gamma)g_m \quad (2.4.4)$$

where g_m is the conductance of the mesophyll and represents all leaf-internal transport processes. If the CO_2 concentration in the atmosphere is decreased experimentally below the compensation point, increased or decreased CO_2 release may occur, depending on the experimental conditions. Under such conditions the photosystems may be irreversibly damaged (Schäfer 1994; see also Chap. 1.2.1).

The response of CO_2 assimilation to the CO_2 concentration in the atmosphere describes the physiological state of photosynthesis in the leaf and is called a response curve (Fig. 2.4.2) with three important ranges:

- a linear range above the compensation point: In this range CO_2 assimilation is limited by the **activation of RuBP-carboxylase** by the substrate CO_2 (Farquhar and von Caemmerer 1982; Lange et al. 1987). The increase ($\Delta A/\Delta c$) describes the efficiency of RuBP-carboxylase. According to Eq. (2.4.4), $g_m = A/(C_i - \Gamma)$;
- a saturation range at high CO_2 concentration: With increasing supply of CO_2 , RuBP-carb-

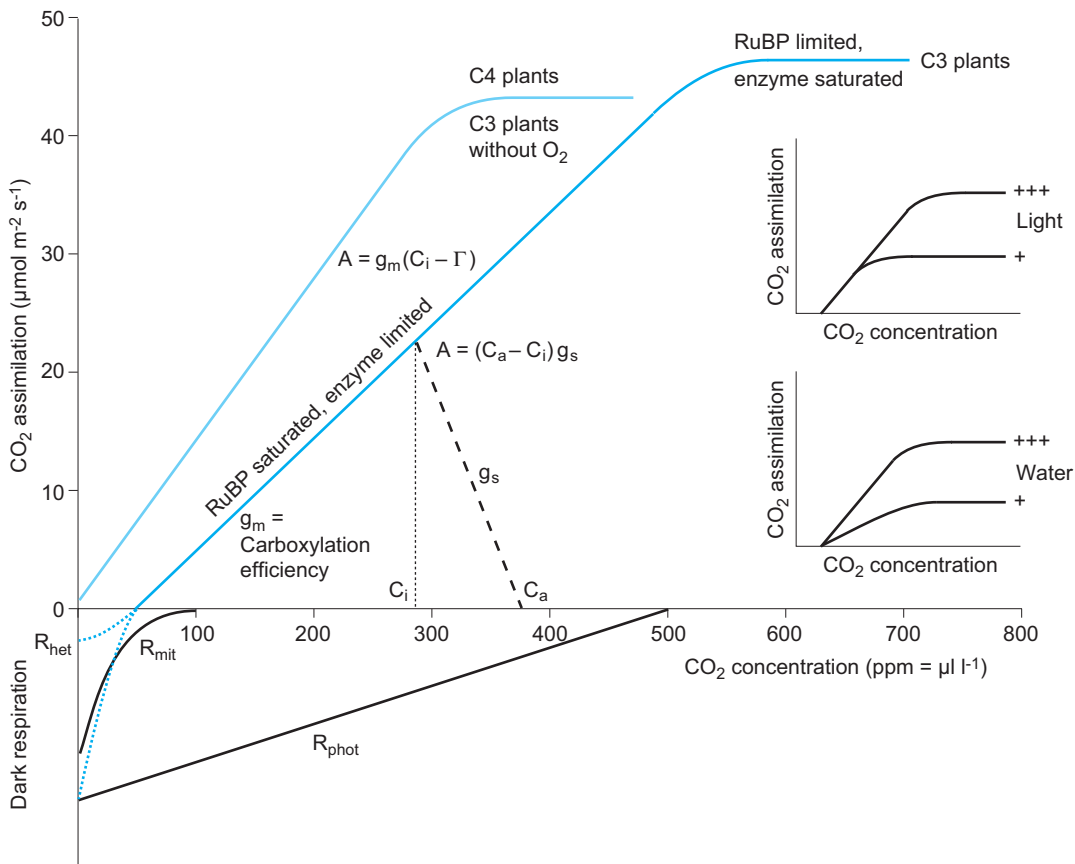


Fig. 2.4.2. Diagram of the dependence of CO_2 gas exchange on the CO_2 concentration in the air. The y-axis shows positive values as CO_2 assimilation and the negative values as respiration. The linear part of the curve shows enzyme limitation, the flat part shows saturation because of substrate limitation. The *inserts* show that change in light only affects the saturated region, whereas drought operates via enzyme limitation. For explanation, see text

oxylase is fully activated, but CO_2 assimilation is limited by the **supply of the substrate ribulose-1,5-bis-P (RuBP)**, to which the carbon of CO_2 is bound. In this range the turnover rate of RuBP-carboxylase is saturated and it cannot use the supplied CO_2 . Because of the limited capacity of the Calvin cycle, CO_2 assimilation finally reaches a maximum rate at which it is CO_2 saturated;

- the range below the compensation point: In CO_2 -free air with 20% O_2 the **oxygenase function of RuBP-carboxylase/oxygenase** is fully activated, i.e. light-induced respiration (R_{phot}) reaches its highest value. At the same time, dependent on ATP consumption in the cytosol, mitochondrial dark respiration (R_{mit}) is activated. R_{mit} decreases with increasing rates of photosynthesis as ATP is also formed in photosynthesis and is probably reduced under conditions of assimilation above the compensation point (Loreto et al. 2001). With de-

creasing CO_2 , the R_{mit} approaches asymptotically the rate of respiration of chlorophyll-free heterotrophic leaf cells (R_{het}). Light-induced respiration (R_{phot}) decreases dependent on the CO_2/O_2 ratio and is very low at CO_2 saturation.

Whilst these processes of photosynthesis and respiration occur in an intact leaf, CO_2 supply to the mesophyll is limited by the diffusion resistance of stomata. Analogous to a current/voltage diagram, CO_2 concentration decreases down the diffusion path from ambient air to the intercellular spaces of the mesophyll (see Fig. 2.4.2). Starting from the ambient CO_2 concentration, the CO_2 influx into the mesophyll increases with decreasing concentration in the intercellular spaces (C_i). Plotting C_a against C_i results in a straight line corresponding to the increase in stomatal conductance. According to Eq. (2.4.3), $g_s = A/(C_a - C_i)$. Thus stomata regulate the CO_2

flux, so that the concentration of CO₂ in the mesophyll is lower than in the ambient air (C_a), and lies between Γ and C_a . On average, $C_i/C_a = 0.7-0.8$.

The response of photosynthesis to CO₂ concentration may also be expressed as a function of consumption (Raschke 1979). Stomatal conductance (**function of supply**) and efficiency of carboxylase (**function of consumption**) decrease the CO₂ concentration in the mesophyll.

$$A = (C_a - C_i)g_s = (C_i - \Gamma)g_m \quad (2.4.5)$$

Therefore

$$(C_i - C_a)/(C_i - \Gamma) = g_m/g_s \quad (2.4.6)$$

The CO₂ gradient across the stomata (from the atmosphere to the intercellular spaces), Δc , is proportional to the ratio of A to g_s :

$$\Delta c = C_a - C_i = A/g_s \quad (2.4.7)$$

Stomatal closure means reduced conductance of g_s , leading to a decrease in the **supply function** of Fig. 2.4.2, and at constant photosynthetic capacity (**consumption function**) to a decrease in C_i . Removing the epidermis experimentally would bypass the influence of stomata, and enable CO₂ assimilation to be measured at C_a and thus determine the RuBP-carboxylase activity. In this case, the measured rate (A_{C_a}) would reach the RuBP limiting range (Farquhar and von Caemmerer 1982).

A decrease in light intensity has its primary effect on the chloroplast which results in decreased CO₂ assimilation and to a decrease in the saturated rate of photosynthesis at the same CO₂ concentration, despite constant carboxylase activity. There need not necessarily be an effect on C_i . In contrast, water stress or N deficiency causes reduced efficiency of carboxylase, i.e. at constant stomatal conductance C_i increases. CO₂ assimilation (consumption function) increases more slowly and reaches saturation earlier than in plants with sufficient water supply or N nutrition.

Efficiency of CO₂ fixation may be evaluated by the number of CO₂ molecules diffusing through the stomata and exchanging oxygen with the cell water and diffusing back into the atmosphere, as they are not assimilated by photosynthesis. Of 1000 CO₂ molecules entering the leaf only one is reduced, the others diffuse out to the atmosphere (Lloyd et al. 1996). This

process can be shown by the ¹⁸O content in CO₂. At the evaporating surfaces in the mesophyll cells ¹⁸O is enriched in the cell wall water (Roden and Ehleringer 1999). This H₂¹⁸O exchanges oxygen with the oxygen of CO₂, as a consequence of gaseous CO₂ dissolving in the cell wall water and then reacting with the dissociated ¹⁸OH⁻ ions to give HC¹⁸OO⁻. In this process O atoms are "exchanged" so that the CO₂ diffusing from the leaf back to the atmosphere contains a new ¹⁸O atom as a label showing the significance of the physical process of diffusion in CO₂ uptake: It is possible to increase CO₂ assimilation by increased CO₂ concentration, but large amounts of CO₂ apparently diffuse back into the atmosphere without being used for photosynthesis by the plant because Rubisco is limiting. In this context, turnover of CO₂ by anhydrase plays an additional important role (Gillon and Yakir 2001).

2.4.1.2

C3, C4 and CAM Metabolism

During evolution in the plant kingdom, certain species developed which overcame these physical limitations of CO₂ uptake under conditions of H₂O loss. A distinction is made in photosynthesis between the **light reactions** of photosystems I and II, which supply energy (ATP) and reduction equivalents (NADP) and **dark reactions** of CO₂ assimilation. With regard to these photosystems, land plants evolved from green algae and the photosystems are not very different, but there are considerable differences in the way CO₂ is fixed (see Chap. 1.2). The following distinctions are made:

C3 Plants

CO₂ assimilation occurs by RuBP-carboxylase, with phosphoglyceric acid (PGA), a three-carbon molecule, the first product detected experimentally. C3 plants also undergo a oxygenase reaction (see Chap. 1.2) in which O₂ forms phosphoglycolate with RuBP; during turnover of the pathway of light-induced (photo)respiration, several amino acids (glutamate, glycine, serine, alanine) are metabolised and CO₂, as well as NH₃, are released (ammonia is generally reassimilated). Coupling of the oxygenase reaction to amino acid metabolism involves losses in the C balance, but for the N balance it is a very important metabolic pathway. This photosynthetic

type is found in about 95% of all plant species. They are adapted to average temperatures (20–30°C), and include trees and shrubs as well as herbaceous plants and grasses of temperate, boreal and humid tropical regions.

C4 Plants

CO₂ fixation in these plants occurs by a PEP-carboxylase (see Fig. 2.4.3) which binds CO₂ to phosphoenol pyruvate and a C4 organic acid malate or aspartate is formed via oxaloacetate. These organic acids are transported into the mesophyll cells surrounding the bundle sheath. The organic acids are decarboxylated and the CO₂ released is assimilated as in the C3 metabolic pathway. The advantage of this pathway for CO₂ fixation is that PEP-carboxylase has a higher affinity for CO₂ than RuBP-carboxylase; it has no oxygenase function, and additionally also uses HCO₃⁻ (Chap. 1.5.3.1). Thus the plant is able to refix the respiratory CO₂ which is produced by the light-induced respiration, and dark respiration from mitochondria of the vascular bundles. The compensation point for C4 plants is thus almost zero. In addition, several malate-forming mesophyll cells per bundle sheath cell form organic acids (Fig. 2.4.3 A). Therefore, after decarboxylation, there is an increased CO₂ concentration of about 1000 ppm in the bundle sheath which is in the saturation range of C3 photosynthesis. Thus C4 metabolism is a mechanism to concentrate CO₂. Based on the type of organic acids formed, the structure of the bundle sheath, and the location of chloroplasts in the bundle sheath, different C4 metabolic types are differentiated (Hattersley 1992). C4 plants form about 1–2% of the plant species occurring in tropical arid regions with temperatures above 30°C during the day. The crop plants *Sorghum* and maize are C4 plants. Because of their efficient photosynthetic pathway, C4 plants can grow particularly rapidly with favourable temperature, water and nutrient supply. The highest rates of assimilation of an ecosystem were measured on *Echinochloa polystachya* meadows in tropical swamps (Morison et al. 2000). Some algae have a corresponding CO₂ concentration mechanism, using HCO₃⁻ (Raven 1994).

From anatomical and physiological characteristics, different forms of C4 metabolism are described as follows (see Fig. 2.4.3):

- anatomically: species with or without **Kranz structure** (K = Kranz; n-K + non-Kranz spe-

cies); the term “Kranz” structure was coined by Volken (1887) in his famous flora of the Egyptian desert

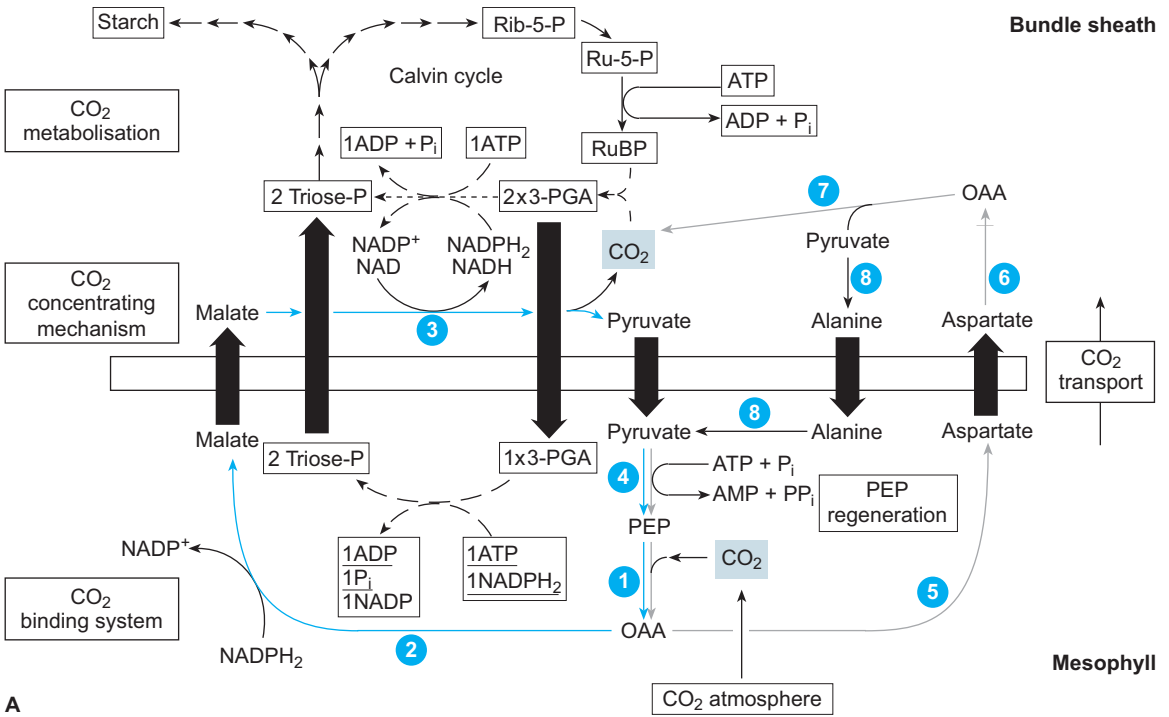
- physiologically:
 - according to the transport metabolite: **malate** (MS) or **pyruvate** (PS) species;
 - according to the enzyme system: **malate enzyme** (ME) or **PEP carboxykinase** (PCK) type;
 - according to the proton acceptor: **NADP⁺**- or **NAD⁺**-dependent malate reduction (in the chloroplast or cytosol, respectively).

The anatomy and site of malate reduction determine whether CO₂ diffuses back out of the bundle sheath. The NADP-ME-type achieves the highest rate of photosynthesis (Hattersley 1992; Schulze et al. 1996). The variety of expression of C4 metabolism points to a polyphyletic evolution, even within grasses (Clayton 1981).

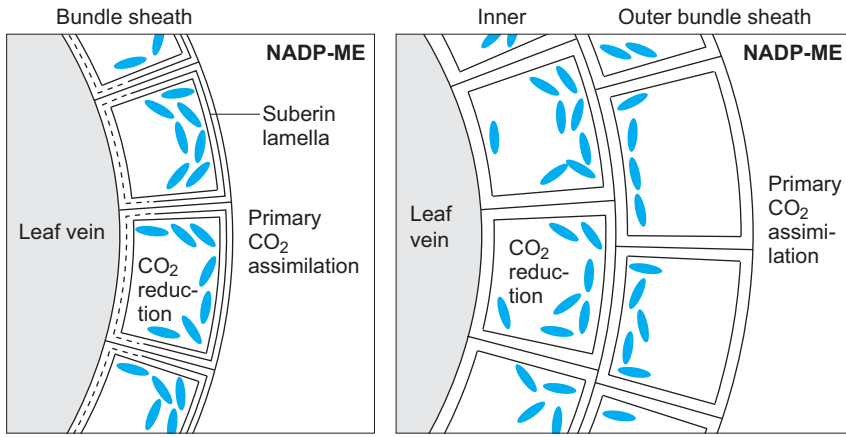
CAM (Crassulacean Acid Metabolism) Plants (see Chap. 1.5.3)

The famous German poet Goethe (1749–1832), who also wrote many articles on natural sciences, cultivated the Crassulacean plant *Kalanchoe pinnata* (previously called *Bryophyllum calycinum*) because this plant grew well even in dry conditions in houses. However, it was the Englishman Heyne who grew *Bryophyllum* as suggested by Goethe, and who discovered in 1815 the acid metabolism in these plants by eating them in the morning and evening. The leaves tasted sour in the morning and sweet in the evening. The acid metabolism is similar to C4 metabolism. The formation of malate is not spatially divided between mesophyll and bundle sheath, but acid formation is temporally restricted to the night and then it is decarboxylated during the day (Lüttge et al. 1988). Storage of the acids formed via PEP-carboxylase occurs in the vacuole, and thus limits the C balance and also the assimilate production. This metabolic pathway is expressed in succulents (plants with high water content/dry weight or high water content/volume) of desert regions of the earth, and in epiphytes of tropical vegetation (see Fig. 2.4.4). The CAM pathway enables plants to avoid transpiration losses as CO₂ assimilation takes place during the night, when irradiation is absent and humidity is high. Thus, the PEP-carboxylase of most CAM plants is adapted to low

The term ‘Kranz’ is used in English, meaning wreath.

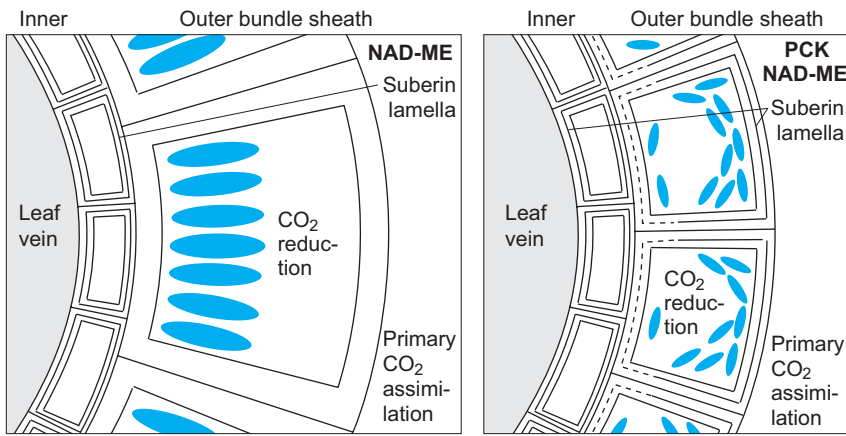


A



a

b



c

d

B

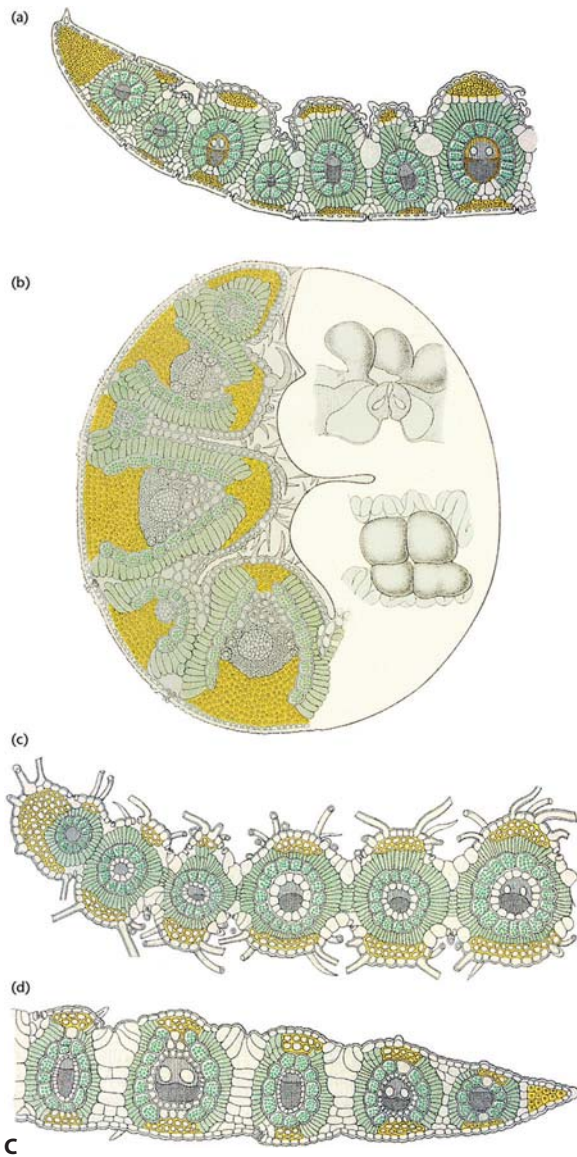


Fig. 2.4.3. A CO_2 assimilation in C4 plants with malate- and aspartate-forming types in the mesophyll and decarboxylation in the bundle sheaths. The distinction between malate- and aspartate-forming types is made according to the organic acid which is initially formed and then transported between the mesophyll and the bundle sheath. Also a distinction is made between NADP and NAD forms of C4 metabolism according to the site at which decarboxylation takes place. In the NADP type CO_2 is released in the chloroplasts, whereas in contrast in the NAD type decarboxylation occurs in the cytosol of the bundle sheath cells. *Rib-5P* Ribose-5-phosphate; *Ru-5P* ribulose-5-phosphate; *RuBP* ribulose-1,5-bisphosphate; *3-PGA* 3-phosphoglyceric acid; *ATP* adenosine triphosphate; *ADP* adenosine diphosphate; *AMP* adenosine monophosphate; *PEP* phosphoenol pyruvate; *OAA* oxalacetate. Enzymes indicated: 1 PEP-carboxylase; 2 NADP⁺-dependent malate dehydrogenase; 3 malic enzyme; 4 pyruvate-phosphate-dikinase; 5, 6 oxalacetate-aspartate-transaminase; 7 oxalacetate decarboxylating enzyme; 8 pyruvate-alanine-transaminase (from Strasburger 1999). **B** Schematic of bundle sheath in **a** typical NADP-ME species (ME=malic enzyme), in which the chloroplasts are oriented on the outer side of the bundle sheath cells, **b** the genus *Aristida*, which is characterised by two bundle sheath cells and chloroplasts which are positioned on the wall between the bundle sheaths, **c** typical NAD-ME species with large chloroplasts on the mesophyll cell walls close to the vascular bundle and formation of a suberin lamella between the outer and inner bundle sheaths, and **d** typical PCK species with the formation of a suberin lamella as in the NAD species, but with orientation of the chloroplasts close to the mesophyll cells (after Hattersley 1992). **C** Leaves with C4 metabolism are obvious from the "Kranz" form of the bundle sheath cells. **a** *Andropogon*: NADP species, **b** *Aristida*: NADP species, **c** *Danthonia forskalii*: NAD-ME species, **d** *Eragrostis*: PCK species. Flora of the Egyptian-Arabian desert (Volkens 1887). Volkens coined the phrase "Kranz" type for the assimilatory cells. The relation between CO_2 -assimilating cells and photosynthetically active Kranz cells is clearly seen (3:1) as the anatomical basis of the CO_2 -concentrating mechanisms in C4 plants

temperatures which occur, for example, in cool coastal deserts, in Chile, Namibia, and Baja California. However, C3 metabolism of CAM plants takes place at high temperatures during the day. Rates of C fixation are limited by the capacity of the vacuole to store malate.

It becomes obvious from the geographic and taxonomic distribution of C4 and CAM species that these are relatively recent developments in evolution, taking place simultaneously in various parts of the earth, in different, unrelated plant species and as a response to changing climatic conditions (Fig. 2.4.4).

2.4.1.3

Photosynthesis Models and Calculation of $^{13}\text{C}/^{12}\text{C}$ Rates (contribution by A. Arneith)

The processes taking place during CO_2 fixation in leaves of C3 plants were described mathematically by Farquhar et al. (1980). This **photosynthesis model** is based on biochemical processes and the interactions of three metabolic pathways:

- photosynthetic C reduction;
- photorespiratory oxidation;
- gain in chemical energy (reduction equivalents, ATP) by photosynthesis.

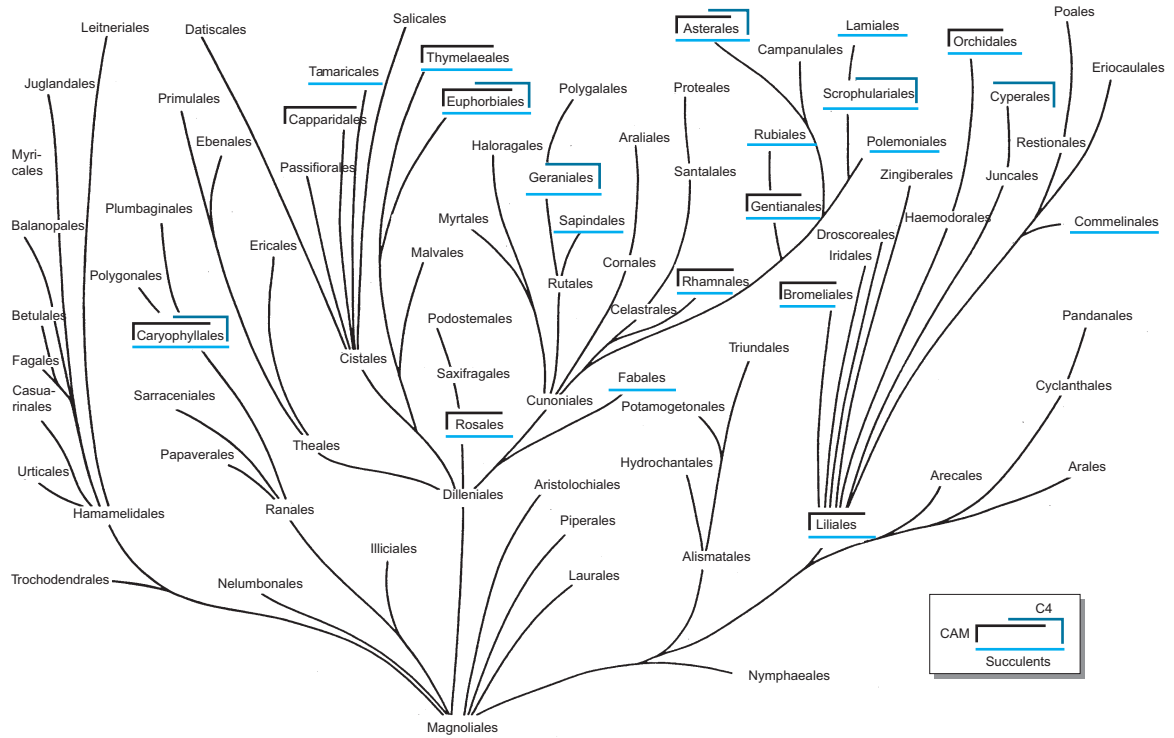


Fig. 2.4.4. The phylogenetic tree of higher plants at the category of Orders showing the distribution of succulents with C3 metabolism and of CAM and C4 plants. It can be seen that certain leaf types are in one taxonomic “guild”, whereas in some orders all three types occur. (Evans 1972)

The model is based on the kinetics of carboxylation, specifically on the carboxylase-oxygenase reactions of Rubisco in the chloroplast. The model also combines Rubisco kinetics with the stoichiometry of electron transport and the requirement for NADPH. In the following only some of the most important points are summarised. The derivation of the model is explained in Farquhar et al. (1980), Farquhar and von Caemmerer (1982) and Farquhar and Lloyd (1993).

The rate of CO₂ assimilation may be described as the minimum of two dependent processes, Rubisco limitation (A_v) or RuBP regeneration (A_j), which in turn is limited by the electron transport.

$$A = \min\{A_j, A_v\} \tag{2.4.8}$$

1. Rubisco-Limited or RuBP-Saturated Rate A_v

Because of photosynthetic C reduction and photorespiration, the rate of CO₂ assimilation in the stroma of the chloroplast may be described as:

$$A_v = V_c(1 - 0.5V_o/V_c) - R_{mit} \tag{2.4.9}$$

where V_c is the rate of RuBP carboxylation, V_o the rate of RuBP oxygenation and R_{mit} the rate of mitochondrial respiration in light. This equation takes into account that photorespiratory oxidation loses 0.5 mol CO₂ per mol oxygenation and thus the rate of net C fixation is decreased. V_c and V_o may be described mathematically by the maximum rates of the enzyme system (V_{cmax}, V_{omax}), which are limited by the presence of O₂ or CO₂, respectively, as follows:

$$V_c = V_{cmax}pC_c / [pC_c + K_c(1 + pO/K_o)] \tag{2.4.10a}$$

and

$$V_o = V_{omax}pO / [pO + K_o(1 + pC_c/K_c)] \tag{2.4.10b}$$

where K_c and K_o are the Michaelis-Menten constants for the carboxylation and oxygenation, respectively, and pO and pC_c are the partial pressures of oxygen and CO₂ in the chloroplast, respectively.

The ratio of the activities (φ) of the oxygenation and carboxylation of Rubisco is:

$$\varphi = V_o/V_c = V_{\text{omax}}K_c pO / (V_{\text{omax}}K_o pC_c) \quad (2.4.11) \quad A_j = J/4(pC_c - \Gamma^*) / (pC_c + 2\Gamma^*) - R_d \quad (2.4.15)$$

and this is reduced at $R_d=0$ to:

$$\varphi = 2\Gamma^* / pC_c \quad (2.4.12)$$

where Γ^* is the photosynthetic compensation point in the absence of mitochondrial respiration and R_d the dark respiration.

These general biochemical equations may be used to calculate the **Rubisco limiting rate of CO₂ assimilation**, A_v , as follows:

$$A_v = V_c(1 - \Gamma^* / pC_c) - R_d \quad (2.4.13a)$$

$$A_v = V_{\text{cmax}} \left[\frac{(pC_c - \Gamma^*)}{(pC_c + K_c(1 + pO/K_o))} \right] - R_d \quad (2.4.13b)$$

K_c , K_o and Γ^* are temperature-dependent values (Harley et al. 1986; Kirschbaum and Farquhar 1984; von Caemmerer et al. 1994). At 20°C the numerical value of $K_c=30.2$ Pa (CO₂), $K_o=25.6$ kPa (O₂) and $\Gamma^*=3.46$ Pa. V_{cmax} is not only dependent on temperature, but also on the type of plant, the state of nutrition and the light conditions.

2. RuBP Regeneration Dependent and Electron Transport Limiting Rate A_j

A continuous rate of CO₂ reduction or oxygenation activity requires continuous and equal rate of RuBP supply. RuBP is regenerated via the pentose phosphate cycle or the photorespiratory C-oxidation cycle. Both processes consume ATP and NADPH and there is a very complex stoichiometry, i.e. PGA (phosphoglycerate) production, the rate of NADPH and ATP consumption, and the number of electrons required to produce the redox equivalents and ATP. This is in turn dependent on the linear rate of electron transport through PS I and PS II as well as on cyclic electron transport. The sum of these processes is:

$$J' = J / (4.5 + 10.5\Gamma^* / pC_c) \quad (2.4.14)$$

where J' is the maximum carboxylation rate maintaining the potential rate of electron transport and J is the potential rate of linear electron transport. It follows that the **Rubisco limiting rate of CO₂ assimilation**, A_j , is:

where J is the rate of electron transport. J increases hyperbolically with light (Q):

$$J = (Q + J_{\text{max}} - \text{SQRT}\{(Q + J_{\text{max}})^2 - 4\theta Q J_{\text{max}}\}) / (2\theta) \quad (2.4.16)$$

where θ describes the curvature of the hyperbolic function. V_{cmax} depends, as with J_{max} , on temperature and other growth conditions. In practice the temperature dependence of V_{cmax} and J_{max} is experimentally determined from a regression of the dependence of photosynthesis on conductance, measured experimentally under the climatic conditions of interest.

3. Supply of CO₂ Through Stomata

The relationships described above may only be applied if the supply of CO₂ to the chloroplast (C_c) is known. The CO₂ supply in the leaf is a **diffusion process**, limited by stomatal conductance (g). Equation (2.4.8) may also be expressed as **diffusion-limited CO₂ assimilation**, A

$$A = g(pC_a - pC_c) / P \quad (2.4.17)$$

where pC_a is the CO₂ partial pressure in the air which surrounds the leaf and P is the air pressure. It should be noted that the CO₂ concentration at the leaf surface also depends on the boundary layer conditions (Chap. 2.2.4).

The calculation of photosynthesis from the model requires simultaneous solution of Eqs. (2.4.8) and (2.4.17). Unfortunately, there is no biochemically based model for stomatal responses corresponding to carboxylation. To solve Eqs. (2.4.8) and (2.4.17) a set of equations is produced which determines the reaction of stomata empirically and this is coupled to the photosynthesis model. In this model g is a function of air humidity, temperature, light, soil water, atmospheric CO₂ and other growth factors, insofar as they influence stomata (Jarvis 1976; Leuning 1995; Lloyd et al. 1995b; Arneth et al. 2002).

Although the original equations by Farquhar et al. (1980) were based solely on cellular processes, this model may also be applied to whole leaves, whole plants and whole ecosystems

(Lloyd et al. 1995 a; Leuning et al. 1998; Arneth et al. 1999; de Pury and Farquhar 1999). Depending on the question, the successful use of the model requires not only information on V_{\max} and J_{\max} , but also knowledge about the state of nutrition and water supply from the soil.

4. $^{13}\text{C}/^{12}\text{C}$ Discrimination

The photosynthesis model developed by Farquhar et al. (1980) may also be used to model discrimination against ^{13}C in photosynthesis. The most important processes contributing to discrimination against ^{13}C compared to ^{12}C in leaves are the different rates of diffusion of $^{12}\text{CO}_2$ and $^{13}\text{CO}_2$ and the fractionation related to the carboxylation by Rubisco. According to Farquhar et al. (1989) the **carbon isotope rate** (R_p) is determined by:

$$R_p = {}^{13}\text{A}/{}^{12}\text{A} \quad (2.4.18)$$

where ${}^{13}\text{A}$ and ${}^{12}\text{A}$ are the rates of assimilation of $^{13}\text{CO}_2$ and $^{12}\text{CO}_2$. According to the definition the isotopic effect of carboxylation (1+b) is

$$R_i/R_p = 1 + b \quad (2.4.19)$$

where R_i is the isotope ratio of the intercellular CO_2 and b is the net fractionation during carboxylation which is primarily determined by Rubisco (27‰) in the case of C3 plants (for C4 plants see below).

R_i may be calculated from Eq. (2.4.17), as the kinetic isotope effect for diffusion corresponds to the ratio of the diffusivities of $^{12}\text{CO}_2$ and $^{13}\text{CO}_2$ in air:

$${}^{13}\text{A} = g(R_a pC_a - R_i pC_c) / [(1 + a)P]$$

where, corresponding to Eq. (2.4.19), $1 + a = g/{}^{13}\text{A}$ and a describe the fractionation by diffusion in air (4.4‰).

These equations may be combined and expressed as:

$$a = 1 + \Delta = \frac{R_a}{R_p} = (1 + a) \frac{pC_a - pC_c}{pC_a} + (1 + b) \frac{pC_c}{pC_a}$$

and

$$\Delta = a \frac{pC_a - pC_c}{pC_a} + b \frac{pC_c}{pC_a} = a + (b - a) \frac{pC_c}{pC_a} \quad (2.4.20)$$

The above equations for the **discrimination coefficient** Δ only apply to C3 plants. Discrimination in C4 plants is much more complicated because of the higher affinity of PEP-carboxylase for CO_2 and also the transformation of CO_2 into HCO_3^- needs to be considered. In the equilibrium there is more ^{13}C in HCO_3^- . Even though the effective discrimination of PEP-carboxylase is about -5.7‰, a certain proportion of the CO_2 (ϕ) is lost by back diffusion and the permeability of bundle sheath cells. This contributes to the discrimination by Rubisco in bundle sheath cells. The total effect of **discrimination in C4 plants** is as follows:

$$\Delta = a + (b_4 + b\phi - a) pC_c/pC_a \quad (2.4.21)$$

The numeric value of $(b_4 + b\phi)$ is smaller than that of b. This value may be positive, zero or negative, depending on the permeability, ϕ . In C4 plants, Δ may therefore depend positively, be independent, or depend negatively on pC_c/pC_a .

The equations shown here may be used to interpret measured $^{13}\text{C}/^{12}\text{C}$ ratios in plant materials, with respect to the effects of particular climatic and growth conditions. For example, from the measurements of $^{13}\text{C}/^{12}\text{C}$ in plant dry matter a time-integrated value of pC_c/pC_a may be calculated [Eq. (2.4.20 a,b)]. Alternatively, pC_c/pC_a may be calculated from the climatic conditions, the capacity of photosynthesis and electron transport [Eqs. (2.4.8) to (2.4.18)]. By comparing the calculated and measured values in annual rings of wood the long-term effect of increased CO_2 concentration on stomatal conductance may be deduced (Arneth et al. 2002).

Box 2.4.1 Summary: Photosynthesis

- **Net photosynthesis** is the balance between the rate of CO₂ fixation in the chloroplasts and the simultaneous respiration occurring in the leaf (light-induced respiration) and mitochondrial respiration of both photosynthetic and non-photosynthetic cells.
- **CO₂ concentration within the mesophyll, C_i**, indicates the balance between CO₂-requiring processes and the supply of CO₂ via the stomata. The ratio C_i/C_a depends on the plant type and growth conditions and lies between 0.7 and 0.8. C_i is a sensitive indicator of both changes in stomatal conductance, as well as of changes in the physiological capacity of the enzymes involved.
- For the purposes of carbon balance CO₂ **assimilation** can be described as a **diffusion process**:
- Plants have different ways of fixing CO₂:
 - **C3 plants** (95% of plant species) form a C3 compound (PGA) as the first product of CO₂ assimilation. The CO₂-compensation point in these species is determined by the photorespiration. The temperature optimum lies between 20 and 30 °C.
 - **C4 plants** (ca. 2% of plant species) form organic acids, with four-carbon skeletons, from the reaction of CO₂ with PEP catalysed by PEP-carboxylase. The C4 acids are decarboxylated in the bundle sheath. The CO₂ released is then reduced by the C3 pathway. The advantage of the C4 pathway is in the very large concentration of CO₂ (1000 ppm) in the bundle sheath cells and also in refixation of respired CO₂. C4 plants can maintain smaller stomatal aperture at the same rate of photosynthesis as C3 plants. C4 plants are adapted to the arid sub-tropics with temperatures above 30 °C. Maize is a cultivated C4 plant.
 - **CAM plants** (ca. 3% of plant species) resemble C4 plants biochemically; however, CO₂ fixation and assimilation are not separated spatially as in C4 plants but are separated temporarily into CO₂ uptake at night, when acids are formed and stored in the vacuole, and CO₂ release and assimilation during the day in mesophyll cells. Nocturnal CO₂ uptake results in a very low water use. CAM plants are generally adapted to low night temperatures and high day temperatures. Their assimilate production is limited by the capacity of vacuoles to store acids.
 - **Mathematical models** have been developed to describe the processes of photosynthesis on the basis of the biochemistry of RuBP-carboxylase enzyme activity and RuBP regeneration. Combined with measurements of isotope discrimination between ¹³C and ¹²C they can reconstruct the climatic conditions in the habitat during growth.

2.4.2

Specific Leaf Area, Nitrogen Content and Photosynthetic Capacity

2.4.2.1

Specific Leaf Area

Specific leaf area characterises the relation of projected leaf area to leaf weight (m² kg⁻¹) and it is a sensitive indicator of several ecological processes and adaptations. The specific leaf area of organs for assimilation differs by a factor of 5. Annual crop plants reach 23.6 m² kg⁻¹ leaf area in contrast to 4.1 m² kg⁻¹ in evergreen conifers. These differences are:

- determined by **evolution**, i.e. in competition with other species; during the course of evolution plants developed ever greater leaf areas per unit of invested dry mass, thus increasing light capture, and supplied these thin leaves with optimal amounts of N (high N concentrations);
 - **adaptively** determined, i.e. the habitat, particularly the water and nitrogen supply together with changes in light conditions, result in modifications to the specific leaf area.
- The specific leaf area has several ecologically important consequences and effects:
- **elasticity** of leaves and their ability to endure drought and other stress situation; this is not

to say that ecological factors determine the structure of the leaf or whether species with certain leaf structures occupy a specific site,

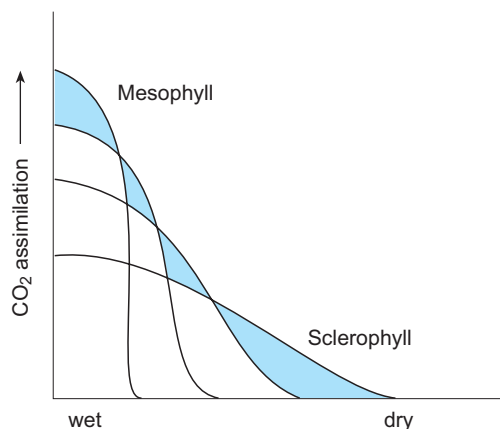
- packaging density (**concentrations**) of nutrients, particularly nitrogen (38.4 mg N g^{-1} in crop plants and 11 mg N g^{-1} in conifers);
- relation of assimilating cells to transpiring surface (**A/E relation**).

In general, species with high specific leaf area show a higher metabolic activity than species with lower specific leaf area. Therefore, there is differentiation of vegetation on the earth: Species with high specific leaf areas are opportunists (ruderal plants), settling in new sites and those with a large supply of resources. In contrast, plants with small specific leaf area occupy less favourable sites. Both groups occupy their respective site, not because they would not grow on other more or less favourable sites (exceptions are stress-tolerant species: e.g. obligate halophytes), but because they are generally “pushed out” from sites outside their niche by competition. Other mechanisms, e.g. shade tolerance and germination, result in plants which reproduce less effectively (see Chap. 4.3).

Orians and Solbrig (1977) formalised this observation in a **cost-benefit analysis** of the adaptation of plant to a gradient of increasing drought (Fig. 2.4.5). The model starts with the assumption that all species are able to live at a well-watered site. Species which assimilate large quantities of CO_2 are less stress tolerant, i.e.

they have a large leaf area per dry weight and are thus sensitive to being dried out. In those plants, CO_2 assimilation decreases with very little soil drying. In contrast, species with low rates of CO_2 assimilation usually possess leaves with a smaller leaf area per dry weight and are thus able to endure drought stress to a greater degree. However, under optimal conditions, these species do not achieve such large rates of CO_2 assimilation as the less stress-tolerant species, but are still able to assimilate CO_2 when stress-intolerant species can no longer photosynthesise.

Obviously, **specific leaf area** is an important parameter in response to favourable and unfavourable conditions, as well as a constitutive characteristic of species (herbaceous annuals in comparison to conifers), which plays a large role in determining the rate of CO_2 assimilation. The relation between specific leaf area ($\text{m}^2 \text{ kg}^{-1}$) and nutrient (nitrogen) concentration in the leaf is linear (Fig. 2.4.6 A; Schulze et al. 1994). Simultaneously, there is a close relationship between CO_2 assimilation and N concentration (Fig. 2.4.6 B) where, corresponding to the model of Orians and Solbrig (1977), species with large maximum rate of CO_2 assimilation react more sensitively towards N deficiency than species with less photosynthetic capacity. Obviously, the investment to overcome N deficiency (high dry weight per leaf area) reduces physiological efficiency.



■ **Fig. 2.4.5.** The dependence of CO_2 assimilation on soil water content for different functional plant types that are sensitive or resistant to drying. Sensitive types have a much higher rate of CO_2 assimilation than resistant types when water is abundant. Sensitive types reduce CO_2 exchange early as the soil dries, so that under this condition resistant types dominate. (After Orians and Solbrig 1977)

2.4.2.2

Maximum Rates of CO_2 Assimilation

Loss of water, as well as uptake of CO_2 , occurs via stomata and thus there is a physical connection between the stomatal conductance and the rate of photosynthesis (see Chap. 2.2.3). It is therefore not surprising that **maximum CO_2 assimilation** of a vegetative cover (A_{max}) is linearly correlated with the maximum conductance of the surface for transport of water vapour (Fig. 2.4.6 C). This function is important for global models of carbon budgets because it allows an estimate of the maximum turnover of CO_2 and water vapour. There is no corresponding correlation between E_{max} (maximum transpiration) and A_{max} (maximum assimilation), because transpiration depends on very variable meteorological conditions (water vapour saturation deficit, irradiation; see Chap. 2.2.4), whilst

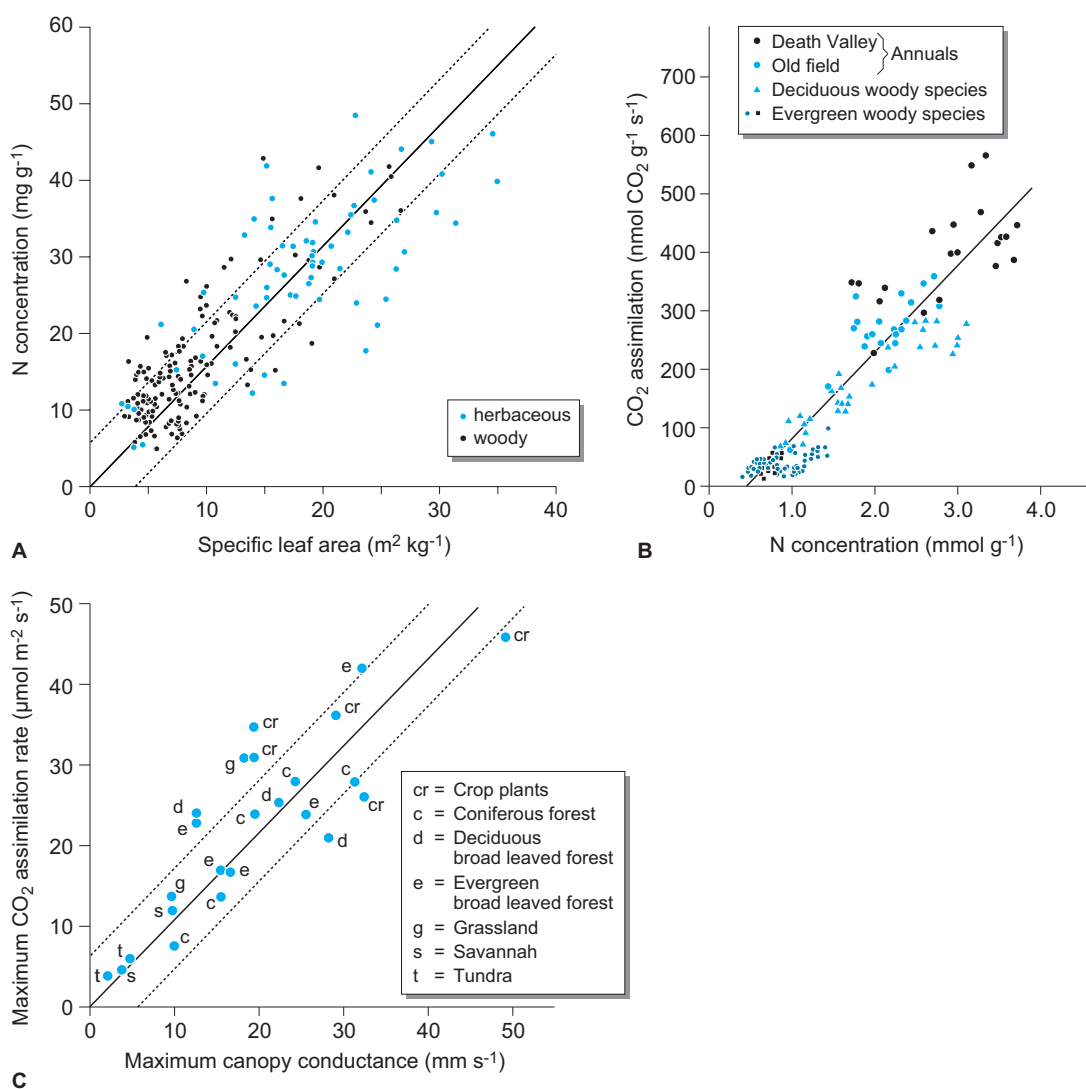


Fig. 2.4.6. **A** Correlation of N concentration (mg g^{-1}) in a leaf with specific leaf area ($\text{m}^2 \text{kg}^{-1}$) for herbaceous and woody species from all climatic regions of the earth (Schulze et al. 1994). **B** Relations between maximum rate of CO_2 assimilation and N concentration in the leaf (Field and Mooney 1986). **C** Relation between maximum CO_2 assimilation (A_{max}) and maximum conductance of a leaf surface. Data represent, in this case, measurements of single experimental plots in different vegetation zones of the globe. Lowest values occur in the tundra, highest values in a wheat field. The second highest value is in a tree plantation of *Hevea brasiliensis*. (Schulze et al. 1994)

the maximum rate of photosynthesis is determined by the CO_2 concentration in the atmosphere, which is relatively constant in the short term. Maximum rates of CO_2 assimilation are very different for different types of vegetation. Ultimately, such a classification is artificial, because there are many intermediates regarding nitrogen concentration and rates of assimilation of the leaf, even within one type of vegetation. Considering the known dependence of CO_2 assimilation on climatic and environmental factors, it is possible to estimate the actual rate of CO_2 assimilation using maximum rates of CO_2 assimilation.

The close relationship between leaf morphology, nutrient supply and physiological activity shows a broad continuum. Nevertheless, for large ranges, it may be generally stated that species with structures to protect assimilatory organs against site-specific stresses are successful in extreme sites and that are poor in resources. As a consequence, metabolic activity decreases (measured at rate per leaf area). Ultimately, the economic principle of **diminishing returns** applies to the occupation of extreme sites.

From the relation between leaf morphology, nutrition and CO_2 assimilation, independent of

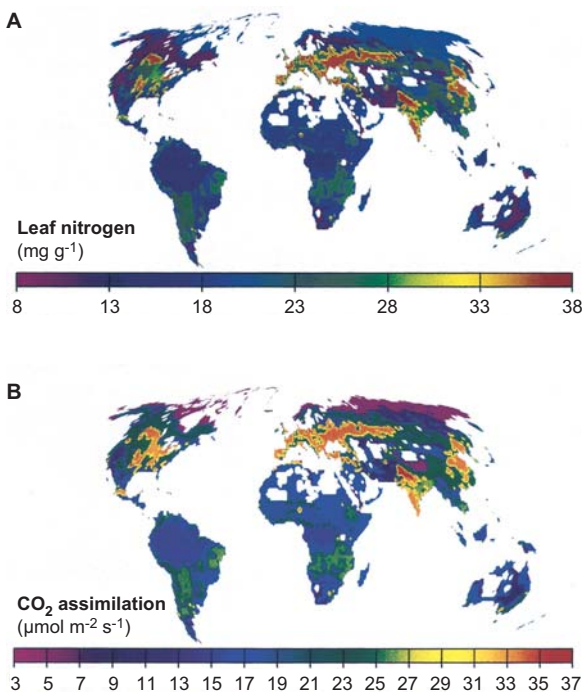


Fig. 2.4.7. A Global distribution of N nutrition measured as leaf N concentration and B global distribution of maximum CO_2 assimilation. The maps are based on correlations given in Fig. 2.4.6 and the global distribution of vegetation types. The original parameter on which the maps are based is the specific leaf area; from this the N concentration is calculated as the basis for calculating A_{max}

the type of plant and measurement conditions at the site, photosynthetic capacity may be plotted globally, as only the specific leaf area and the N supply are required values (Fig. 2.4.7). In contrast to other values, such as stomatal conductance or C assimilation, these two values are easily determined. Agriculturally used areas of the earth, in North America, Europe, India and East Asia, are striking by their high N concentration. Other parts of the continents are characterised by N deficiency. Thus the photosynthetic capacity on earth correlates with potentially maximum rates in agricultural areas and low rates in other regions.

The physiological differentiation between C3, C4 and CAM plants becomes less important in the global perspective of CO_2 assimilation. In addition, Gifford (1974) demonstrated that the differences between C3 and C4 photosynthesis, which are very marked in the chloroplast, disappear progressively if the whole plant or the complete stand is considered. However, despite this reservation, the physiology of the C3 and C4 pathway is very important, considered from a historic perspective of the development of the earth as well as for the present day when considering the geographic distribution of species (Ehleringer and Cerling 2001; see Chap. 2.4.4).

Box 2.4.2

Summary: Interactions between specific leaf area, nitrogen supply and photosynthesis

- The **specific leaf area** is an important measure of the photosynthetic activity of a leaf. In the course of evolution, plants developed leaves with an increasingly large area per unit of dry matter, enabling greater light interception. However, this is tightly related to increased transpiration and thus demanded the adaptation of the whole organism in terms of transport tissues and roots (see Chap. 2.4.4). There is a continuum of leaf forms ranging from herbaceous dicotyledons with high specific leaf area at one extreme to conifer needles or the phylloides of Australian *Acacia* species with low specific leaf area at the other.
- In leaves the **nitrogen concentration** correlates with the specific leaf area and the rate of net photosynthesis, allowing CO_2 assimilation on a global scale to be modelled based on specific leaf area and N concentration.
- In many cases, greater **physiological activity** is correlated with smaller tolerance to stress, with stress-tolerant species having limited physiological activity. Specific leaf area, N concentration and maximum CO_2 assimilation rate determine very largely the distribution of particular leaf forms and plant species on earth.

2.4.3

Response of Photosynthesis to Environmental Factors

Different conditions determine to what extent A_{\max} may actually be used as **mean rate of CO₂ assimilation**. These factors are:

- **climatic factors:** primarily available light which varies by two orders of magnitude (0.5 mol photons $\text{m}^{-2} \text{day}^{-1}$ on the soil of a tropical forest and 50 mol photons $\text{m}^{-2} \text{day}^{-1}$ in a tropical grassland), and temperature and humidity;
- **edaphic factors:** primarily nutrition and availability of water (without transpiration there is no assimilation);
- **time-dependent factors:** particularly the duration of the growing season and the age of the leaf.

Climatic factors affect the short-term, usually reversible, responses as well as long-term, non-reversible changes, whilst edaphic factors are only long term and irreversible. The following considers how CO₂ assimilation depends on these conditions. Initially, change is considered with all other conditions remaining optimal and constant. In the natural environment there are, of course, different interactions between the conditions and these will be discussed later.

2.4.3.1

Light Environment

Photosynthesis increases with increasing irradiation. This is shown in Fig. 2.4.8 A, where CO₂ assimilation is a positive value and respiration negative. With increasing irradiation, dark respiration of mitochondria decreases and light-induced respiration increases. As light increases, a compensation point is reached at which CO₂ exchange is zero and above which net CO₂ uptake takes place eventually becoming saturated with increasing light. The immediate, short-term response of photosynthesis to the changing light is generally reversible.

In contrast to these short-term and reversible responses to radiation is adaptation involving structural modifications to the leaf (Chap. 1.2.1.1). **Sun and shade leaves** represent the extreme responses to light; however, there are many intermediate stages. Leaves of shade plants

adapted to low light conditions usually have a large leaf area per leaf weight and a lower compensation point than those species adapted to high light intensities (Fig. 2.4.8 B). A shade leaf is damaged in strong light, shed and replaced by a new leaf adapted to the new light conditions. This may be observed in house plants, when they are put in the open air in spring. Some, but not all, plants are able to adapt to light conditions (Fig. 2.4.8 C, D). For obligate shade plants light dependence of photosynthesis does not change, even if the plant is grown at a sunny site. Specific adaptation to light may also be observed between different populations of a species. In Fig. 2.4.8 C, D clones of *Solidago* which originate from sunny and shady sites are shown. Increased photosynthesis with full light utilisation only occurs in the “sun clone”.

There are two ecologically important situations in which adaptation to light is required: At extremely shady sites where **sun flecks** only allow a short time to assimilate CO₂ and in dry areas of the earth where plants close their stomata because of lack of water. Plants at shady sites (e.g. in the herbaceous layer of a forest) receive during the day, and also with the season, often very high light intensities for short periods of time, so-called sun flecks (Fig. 2.4.9; Pearcy and Pfitsch 1994). Photosynthesis of these plants responds to these sun flecks with higher rates than would be expected from the light response curve, as the acceptor for CO₂ is not limiting whilst the carboxylase may be fully activated. In addition, the pools of ATP and NADP formed during the sun fleck may be still utilised for CO₂ fixation after the light has faded so that dark fixation of CO₂ continues at low light intensity. As a result, a short light fleck causes a longer period of CO₂ uptake. Using stable isotopes ($\delta^{13}\text{C}$) it was shown that about 50% of the dry matter production of these plants was assimilated in the extremely short periods of sun flecks.

In dry areas of the earth plants have about 50 mol photons $\text{m}^{-2} \text{day}^{-1}$ to process without sufficient water to open the stomata. Thus a situation arises in the leaf in which PS I and PS II are not able to release electrons to NADPH because no CO₂ enters the stomata and thus CO₂, the substrate for reduction, is inadequate. The CO₂ concentration in the mesophyll is around the compensation point. The consequences of such a “bombardment” with photons are (see Chap. 1.2):

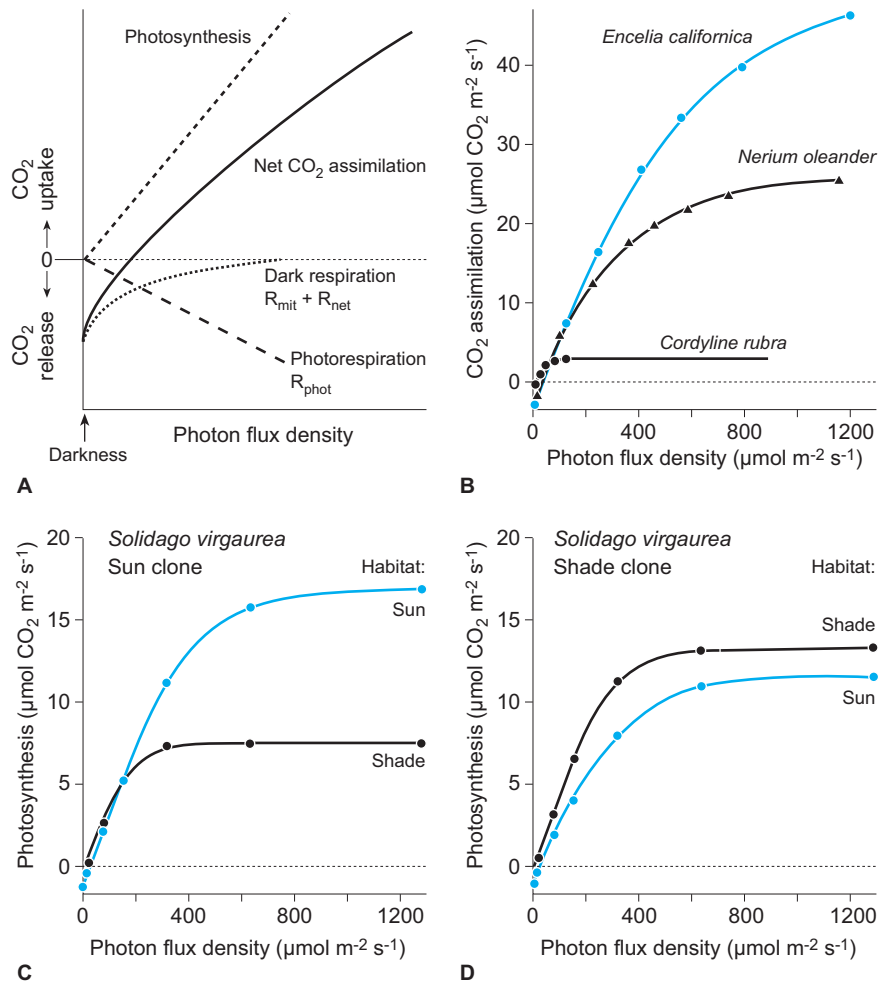


Fig. 2.4.8. A Dependence of CO₂ gas exchange on the light intensity, measured as quantum flux ($\mu\text{mol photons m}^{-2} \text{s}^{-1}$). The y-axis corresponds to a positive value of CO₂ assimilation and a negative value for respiration. The figure shows the processes which occur in the region below light saturation (after Larcher 1994). B Dependence of CO₂ gas exchange on quantum fluxes of species differently adapted to shade. C Change in light-dependent photosynthesis with adaptation to the light climate in *Solidago virgaurea*. Clones that were pre-adapted to full light adapt their rate to the location (i.e. shade) compared with D clones that are adapted to the shaded location and do not change the rate of CO₂ assimilation. (Björkman 1981)

- increased **fluorescence** (Björkman and Demmig-Adams 1994);
- increased **release of heat** (Björkman and Demmig-Adams 1994); or
- damage in PS II at the D1 protein (**photoinhibition**) with subsequent yellowing (Schäfer 1994).

2.4.3.2 Temperature

Starting from temperatures below 0°C where photosynthesis as well as respiration are at a complete standstill, respiration of leaf cells is

generally activated earlier than photosynthesis with increasing temperatures. At low temperatures a range exists at which only respiration is measurable. Photosynthesis starts around -5°C (Fig. 2.4.10A), reaches an optimum and decreases at high temperatures. In contrast, respiration increases exponentially over a wide range of temperatures and is only inhibited at very high temperatures. Net photosynthesis as the balance between these two processes shows an optimum shifted to slightly lower temperatures than the physiological process of photosynthesis. The interaction between respiration and photosynthesis is particularly obvious considering the common effect of light and temperature: At low

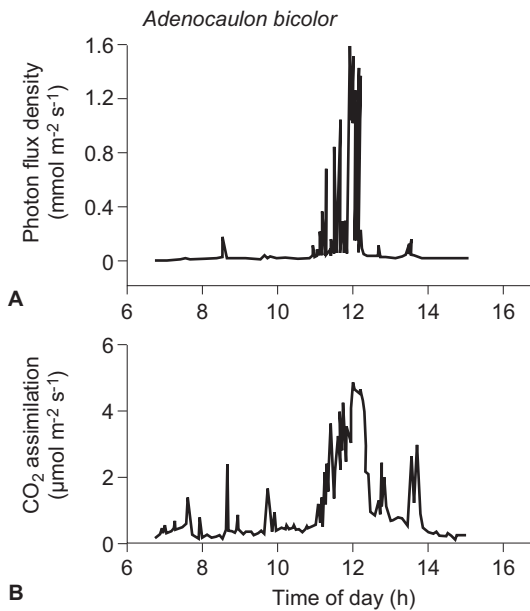


Fig. 2.4.9. **A** Change with time of a light fleck in a shaded habitat and **B** delay in CO_2 fixation in *Adenocaulon bicolor*. The period of CO_2 uptake is longer than the duration of the light fleck, i.e. reduction equivalents are stored and, after the light fleck has passed, these are used in dark reactions for CO_2 reduction. (Percy and Pfitsch 1994)

light intensities the temperature optimum is shifted to lower temperatures (Fig. 2.4.10 B) with the consequence that plants are able to operate at low light intensity during the cool hours of the morning as well as in the optimum range of their potential net photosynthesis during mid-day, at high temperatures and full light.

The **temperature optimum** of net photosynthesis is not at all constant, for example, it changes with season (Lange et al. 1975 a). Similarly, the size of plant leaves is “adapted” to the radiation conditions so that the temperature (see Chap. 2.1) remains in the physiologically optimum range.

Even though plants operate most of the day in the photosynthetically optimum range there are two critical ranges of temperature in photosynthesis (see also Chap. 1.3):

- Low temperature is not a factor damaging photosynthesis, but frost together with high light intensities leads to photoinhibition. This effect was first observed in Alpine sites, which is not surprising as the CO_2 concentration decreases with increasing height and thus increases the imbalance between light flux and

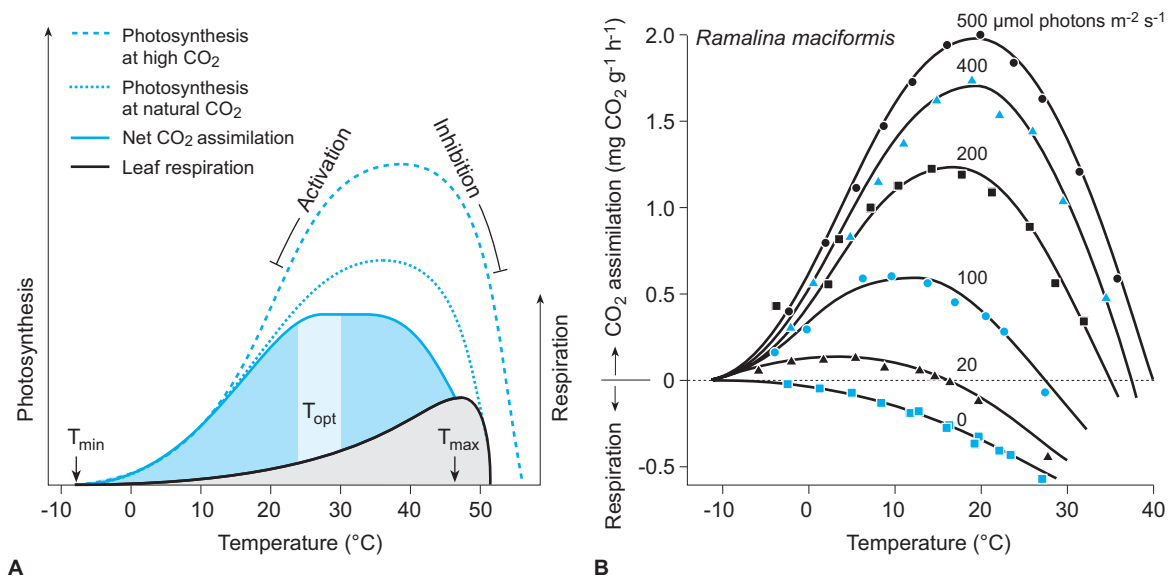


Fig. 2.4.10. **A** Schematic presentation of the dependence of photosynthesis, respiration and net CO_2 gas exchange on temperature. Activation of photosynthesis leads to an exponential increase in CO_2 uptake. Increasing temperature also increasingly inhibits photosynthesis. Interaction between activation and inhibition leads to an apparent optimum of CO_2 uptake that finally leads to a lower CO_2 uptake at high temperatures. The rate of net assimilation at increased temperature is balanced in part by the exponential rise in respiration. The temperature optimum for respiration is higher than that of photosynthesis (after Larcher 1994). **B** Interaction between light and temperature on photosynthesis (positive value on the y-axis) and respiration (negative value on the y-axis) leads to a decrease in the optimal temperature range at lower light intensities, i.e. for the lichen *Ramalina maciformis* cool mornings with low light are as much “optimum” as are high temperatures at full light. (Lange et al. 1977)

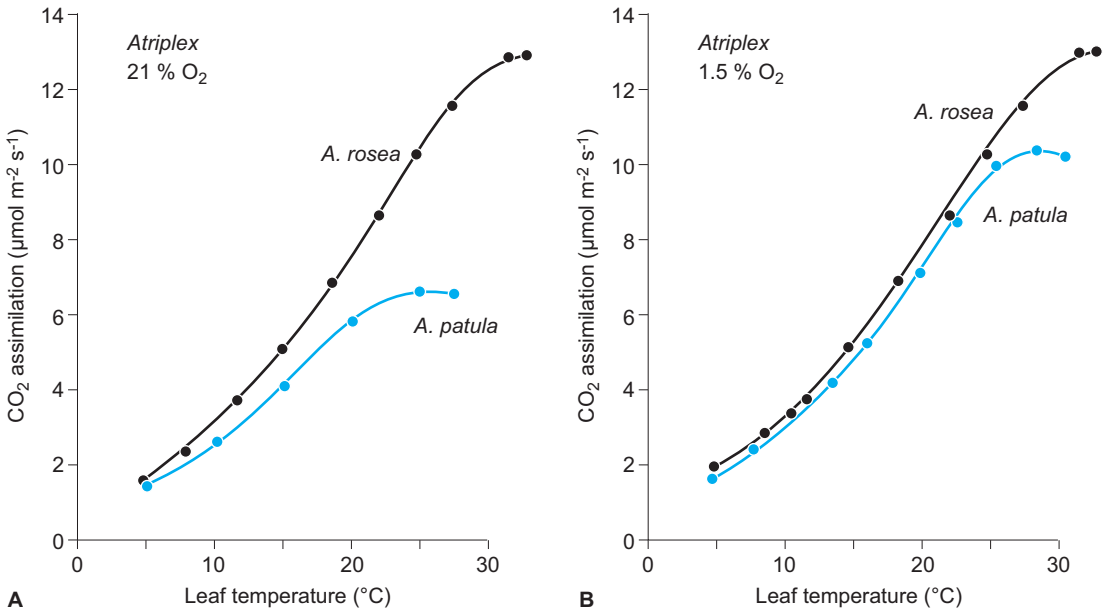


Fig. 2.4.11. **A** Temperature dependence of CO₂ assimilation of the C₄ plant *Atriplex rosea* and the C₃ plant *Atriplex patula* showing clearly differences in maximum rate of CO₂ uptake and in the temperature optimum. **B** The same experimental conditions as in **A** but 1.5% O₂ and not 21% O₂ in the surrounding air. CO₂ uptake of C₃ plants changes so that it is like the C₄ plants. Investigation at low partial pressure of O₂ demonstrates experimentally the existence and importance of light-induced respiration on CO₂ assimilation. (Björkman 1971)

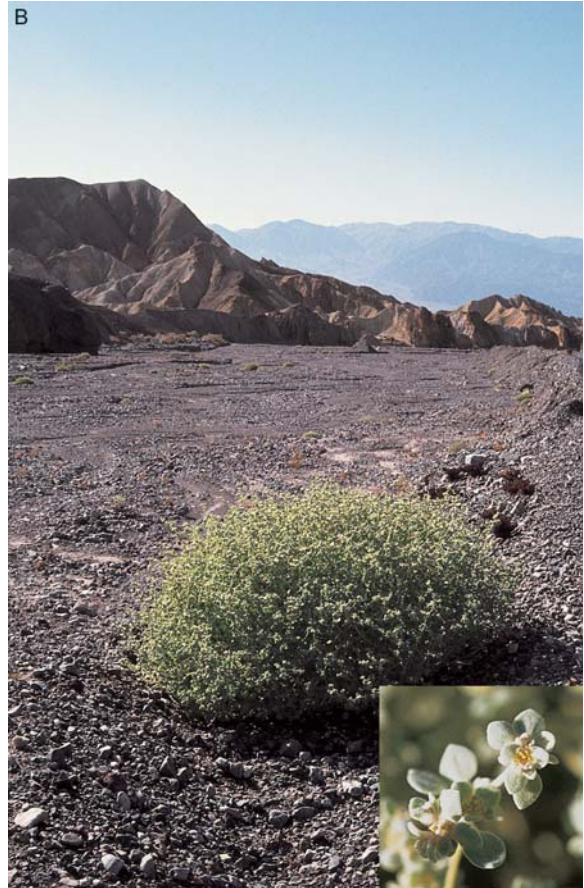
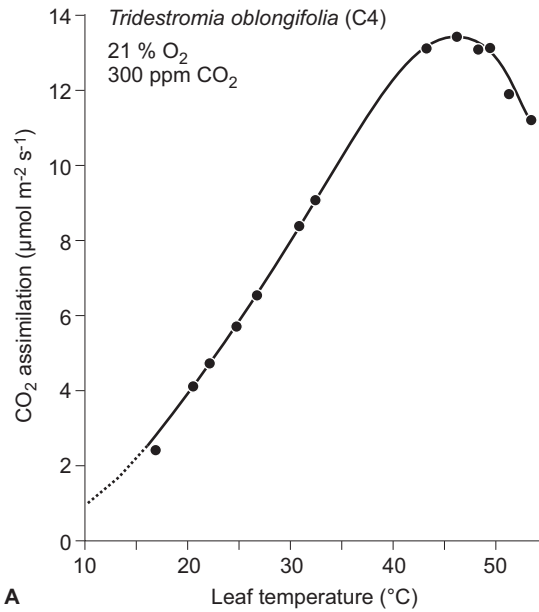


Fig. 2.4.12. **A** Temperature dependence of CO₂ assimilation of *Tridestromia oblongifolia*, Amaranthaceae, in Death Valley, California. This plant reaches a maximum rate of CO₂ assimilation at 48°C. **B** *Tridestromia oblongifolia* grows in Death Valley as a summer annual in erosion gullies in which rainwater gathers and then percolates into the soil. (Photo E.-D. Schulze)

C fixation. After several frosts net photosynthesis decreases and then recovers slowly, but does not reach the values as during the summer.

- High temperatures affect opening of stomata and result in a disproportional increase in transpiration (Lange 1959); thus a leaf is more likely to dry out completely than to be damaged by heat.

C4 plants have a higher temperature optimum of photosynthesis than C3 plants, because the PEP-carboxylase of C4 plants has its optimum at high temperatures and is thus able to reassimilate respiratory CO₂. This effect may also be achieved by exposing C3 plants to an atmosphere with little O₂ and thus reduce the oxygenase function of RuBP-carboxylase (Fig. 2.4.11). The highest temperatures at which higher plants reach optimum rates of photosynthesis were observed on *Tidestromia oblongifolia* at 46°C in Death Valley, California (Fig. 2.4.12).

2.4.3.3 Humidity

Net photosynthesis decreases with **stomatal closure** induced by low humidity; however, it has often been observed that CO₂ assimilation does not decrease in proportion to stomatal conductance. It is difficult to explain this, because direct effects of humidity on photosynthesis have also been described (Mott and Parkhurst 1991). Obviously, stomata do not close synchronously, so that some areas between the veins still have open stomata whilst others are closed. Thus, there is a higher CO₂ influx to some small areas, but a lower influx into other areas of the leaf; consequently, the calculated average CO₂ concentration in the mesophyll remains constant, even though the total conductance of the leaf is decreased. The temperature distribution (Jones 1999) shows that a leaf is not a homogeneous area and so the heterogeneity, so-called **patchiness of the leaf**, contributes to a partial decoupling of the flux of CO₂ and water vapour for the whole leaf (Mott et al. 1993).

2.4.3.4 Nutrition

CO₂ assimilation and stomatal conductance change in proportion to the **nutrition** of the leaf. This not only applies to changes in N nutrition (see Chap. 2.4.5), but also to phosphorus (P). C4 plants, despite a generally lower N concentration, have a potentially higher rate of assimilation than C3 plants, as in C4 plants RuBP-carboxylase is concentrated in the bundle sheath. Under natural conditions the higher photosynthetic capacity is not used, but rather a lower stomatal conductance is reached resulting in lower evaporation but similar assimilation as in C3 plants. Therefore, saving water appears more important than maximising photosynthesis. This leads to a decrease of RuBP-carboxylase and of the N concentration compared with C3 plants (see Penning de Vries and Djitéye 1982) with consequences for assimilate production and for distribution of plants exhibiting the two types of photosynthesis (see Chap. 2.4.4).

2.4.3.5 Water

The response of CO₂ assimilation to water stress is easier to study on plants without an epidermis, such as **lichens**, as here stomatal effects do not occur. When dry lichens are moistened, only respiration becomes measurable at a water content (per dry weight) of 20% (Fig. 2.4.13). With increasing water content respiration and photosynthesis increase. The maximum CO₂ assimilation is reached at a water content of 80%. The equilibrium humidity for activation of gas exchange thus corresponds to an air humidity of 80% and a water potential of -30 MPa. This water potential is much lower than ever measured for higher plants (-11 MPa; Kappen et al. 1972).

Obviously, photosynthesis starts at a range which is normally not reached in intact leaves. However, photosynthesis responds to changes in **turgor** (Kaiser 1982). As the changes in cell volume and thus in turgor depend on the rigidity of the cell wall ($\epsilon = \Delta P / \Delta V$), plants with a large leaf area per dry weight, the so-called mesophytes, are more sensitive towards drying out of the soil than plants with smaller leaf area per dry weight (so-called sclerophytes; Fig. 2.4.5).

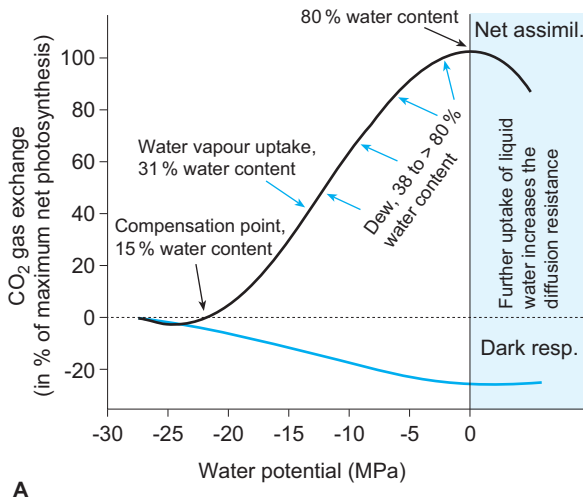


Fig. 2.4.13. A Dependence of CO_2 gas exchange (NP: net photosynthesis) on net water potential of the thallus of the lichen *Ramalina maciformis* in the Negev Desert (temperature 15°C , saturating light). On the y-axis are the positive values of CO_2 assimilation and the negative values of respiration. For an ecologically relevant conditions, the water content of the thallus is presented in percent of its dry weight. The black arrows indicate the maximum water contents (given as percent of the dry weight of the thallus), which were measured after dew fall or with increased air humidity in the field (Lange 1965). At low water potential initially respiration is activated followed by photosynthesis. This leads to a water compensation point for CO_2 assimilation that is considerably lower than the water potential so far measured in leaves of higher plants. Note: There are types of plants that have even lower water compensation points: An extreme plant is *Dendrographa minor* (California) with activation of photosynthesis at -38 MPa. *Dendrographa* attains 50% of its net photosynthesis at -18 MPa (Lange 1988). There are also types that are not able to photosynthesise at low water potential. Thus cyanolichens (with cyanobacteria as symbionts rather than green algae) require fluid water (in contrast to water vapour) in order to activate photosynthesis. High water content (right of vertical line, which occurs after rain) increases the diffusion resistance to CO_2 in many lichens to an extent that CO_2 assimilation decreases and in extreme circumstances reaches the compensation point. B *Ramalina maciformis* on flint in Avdat, Negev, Israel. (Photo E.-D. Schulze)

Under field conditions changes in the photosynthetic activity (this comprises not only photosynthesis) are best correlated with the **pre-dawn water potential** (Ψ_{predawn}) which indicates the water status of the soil. Photosynthesis decreases with Ψ_{predawn} as the soil dries, closely related to a simultaneous increase in the xylem sap of abscisic acid formed in the roots (see Chap. 1.5.2 and Chap. 2.2).

2.4.3.6

Age of Leaves and Growing Season

During the course of their development from emergence to shedding, leaves undergo an ontogenetic change in activity (see also Chap. 2.3.3). Three phases are distinguished: leaves which are still developing and have formed less than about 30% of the leaf area are carbohydrate sinks. They are often called **sink leaves** as they consume more carbohydrates than they produce photosynthetically. In the next stage, fully grown leaves are **source leaves**, which produce an ex-

cess of carbohydrates and export these, via the phloem, for the consumption at other sites. In the **ageing phase**, leaves yellow and there is degradation of structures, providing an additional source of carbohydrates and amino acids for the rest of the plant. Photosynthesis need not necessarily change synchronously with the carbon export, and may reach its highest rates before the leaf is even fully expanded, i.e. the leaf starts to age with its expansion. In many herbaceous plants, new leaves are permanently formed and shed. They age according to a genetic programme of senescence (see also Fig. 2.3.6).

Some examples explain the processes during leaf development:

- **herbaceous species:** in herbaceous species, maximum rate of CO_2 assimilation is reached before complete leaf expansion (Fig. 2.4.14) and decreases continuously after complete expansion of the leaf until the leaf is shed. In the meantime the next leaf is developed, which reaches higher rates, but ages according to the same pattern (Woodward 1976).

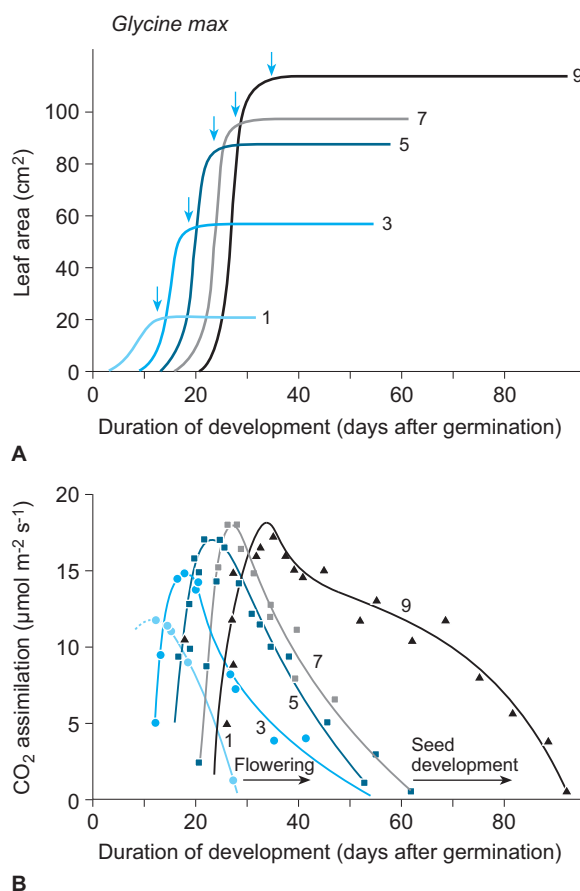


Fig. 2.4.14. **A** Development of leaf area and **B** associated changes in photosynthesis in leaves of different age *Glycine max*. The figure shows that the leaf starts to age before it has fully developed its leaf area. (Woodward 1976)

- **deciduous trees: beeches in Solling.** Sun leaves of beech emerge very quickly in May and reach maximum activity in mid-June (Fig. 2.4.15). As early as the beginning of August ageing starts, with decreasing rates of CO₂ assimilation, and leaves are shed at the beginning of October. On the same tree, development of shade leaves is significantly slower. Maximum CO₂ assimilation is only reached in August. Ageing then occurs much faster and leaf shedding is only slightly delayed compared to that of sun leaves.
- **coniferous trees: spruce in Solling.** Development of evergreen needles of spruce is very different (Fig. 2.14.16). Needles emerge later than leaves of beech, maximum rates decrease only slightly in autumn and the activity of needles remains constant in the following year. Ageing starts only after 3–5 years.

2.4.3.7

Optimisation of CO₂ Assimilation Relative to Water Use

CO₂ assimilation is obviously a variable process and may fluctuate considerably, depending on climate and soil as well as differences between species. As long as the climatic conditions at the site are favourable for growth the process is primarily determined by soil fertility. As soon as conditions become more extreme, colder as well as drier, there are several options in the plant kingdom for coping when these conditions exist. This is shown by an example from the Negev Desert (Fig. 2.4.17; Schulze and Hall 1982): At the same site lichens, CAM, C3 and C4 plants flourish next to each other. During the course of the day, they behave differently regarding their CO₂ assimilation, transpiration and stomatal conductance. Lichens do not regulate water relations and therefore their CO₂ assimilation is restricted to a few hours in the morning after the falling of dew. Their material production is minimal but despite this lichens belong to the most successful organisms in this desert. They settle on each stone and form extensive crusts on the loess soil. The CAM plant *Opuntia* occurs in the Negev as an introduced plant, but *Caraluma negvensis* is an autochthonous CAM plant which behaves similarly (Lange et al. 1975 b). CAM plants assimilate during the night and also under good conditions during the day. Transpiration is substantially lower at night than for other species during the day. Despite the favourable relation of assimilation to transpiration, CAM plants in the Negev are rather rare, probably because of climatic conditions in the late Holocene. C3 and C4 plants respond similarly. Both attain similar rates of photosynthesis on dry soils; the rate decreases with soil drying. In summer both species have a **daily course of two peaks** in CO₂ uptake, with a “**midday depression**” caused by dry air. It is to be expected that the transpiration of C3 plants is slightly higher than that of C4 plants related to the significantly lower stomatal conductance of C4 plants. The potential advantage of a high assimilation capacity is not used by C4 plants in nature, but rather is used to avoid water stress. Despite this, C4 plants do not settle in extremely dry sites in the Negev, but in the more favourable valley floors which also have higher salt levels. This does not mean that C3 plants suffer maximum water stress at the dry sites. They regulate their water

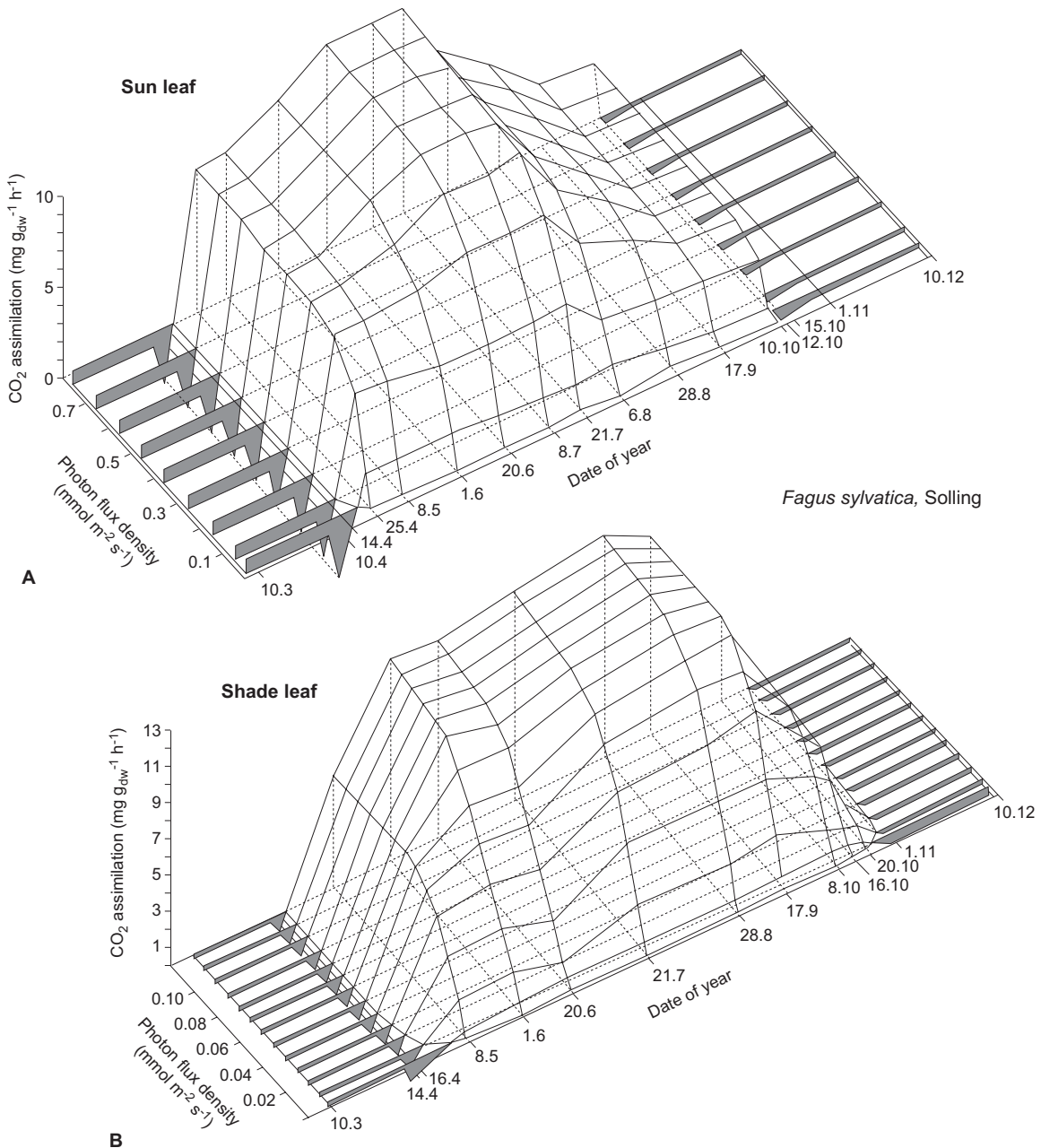


Fig. 2.4.15. Light dependence of CO₂ assimilation related to leaf weight in **A** sun and **B** shade leaves of beech, throughout the year. Only in spring do buds show respiration, which however rises sharply with bud break. With leaf emergence CO₂ is assimilated. Also, in autumn, only respiration is measured in buds. Sun leaves develop faster, but age faster than shade leaves. In sun leaves full development takes almost 2 months (until mid-June), they are fully active for only 1 month and start to yellow in August. (Schulze 1970)

relations and physiological activity by leaf shedding, so that at the end of the dry period the water conditions of a dry slope are more favourable than for C4 plants in the valley floors (Kapfen et al. 1976).

With such a range of reactions the question remains whether there is a basic principle for

the regulation of physiological activity. As the coupling of CO₂ assimilation to the atmosphere occurs via stomata and as a consequence water is lost, regulation balancing both processes might be feasible. It is striking that maximum photosynthetic rates are only rarely attained at most sites. Most of the time plants operate, in

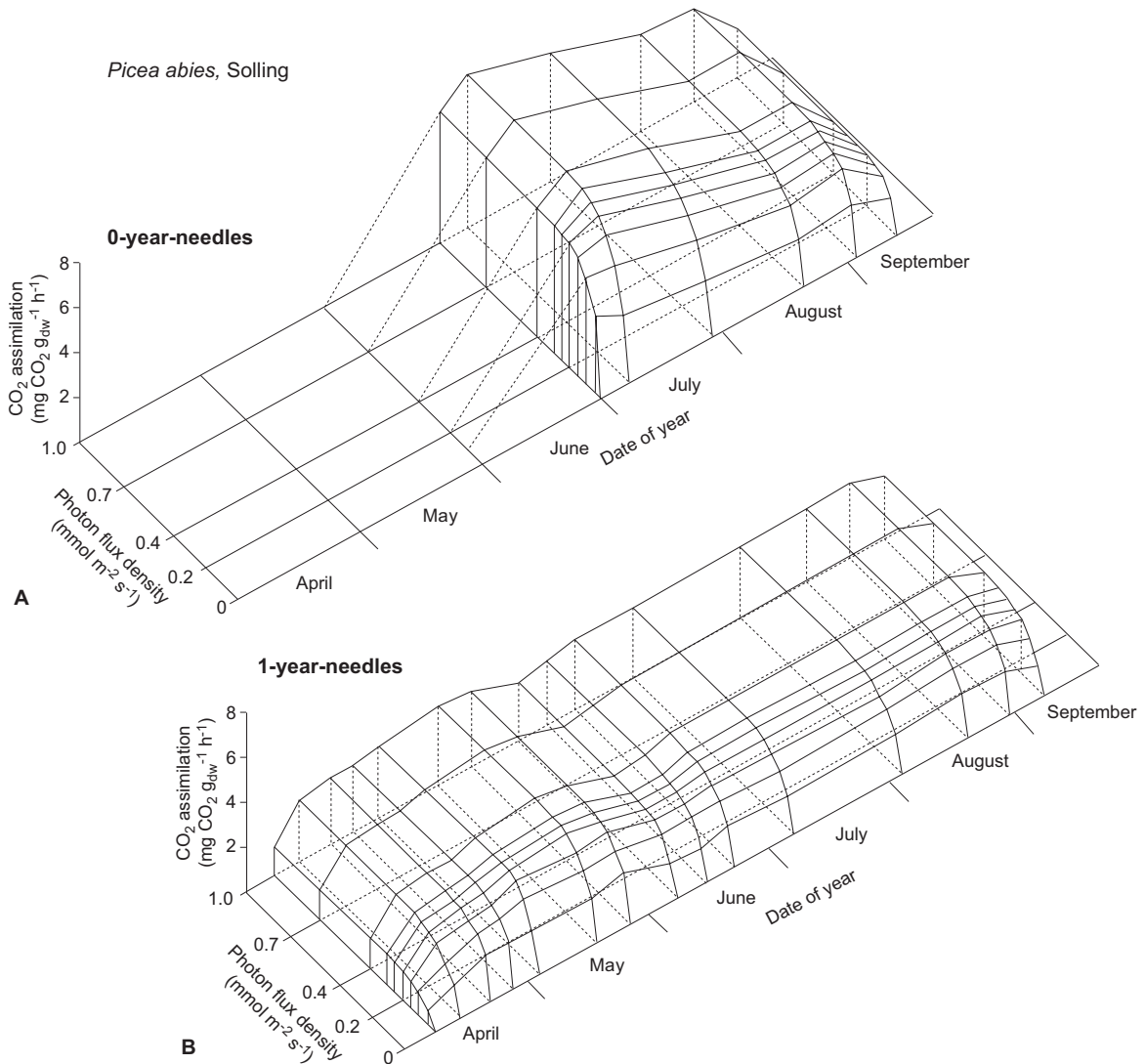


Fig. 2.4.16. Light dependence of CO₂ assimilation based on leaf weight in **A** current year and **B** 1-year-old spruce needles throughout the year. Young needles develop later in the year than leaves of beech (see Fig. 2.4.15). Development requires about 5 weeks before they reach the highest rates of CO₂ assimilation. With the reinforcement of the cell wall which continues until the autumn of the current year the rate of CO₂ uptake per dry weight decreases. In contrast the rate of CO₂ assimilation in the 1-year-old needles is lower than in current year's needles, but is constant for about 5 months. Ageing occurs after 3–5 years. (Fuchs et al. 1977)

temperate woodlands as well as in desert regions, at an **average rate of assimilation** that is about 50% of the maximum rate, and this also applies to stomatal conductance. In temperate climates the actual rate of CO₂ assimilation is reduced by light, in arid climates by light and air humidity.

Photosynthesis depends on the physiological activity of Rubisco and the CO₂ concentrations in mesophyll and atmosphere but is also regulated by stomata and energy balance. It is basically not possible to write a simple equation for

the relation between climate and assimilation, as the Penmann-Monteith equation does for the dependence of evaporation on stomatal changes ($\delta E/\delta g$; see Chap. 2.2). It is not possible to express the dependence of assimilation on C_i and the dependence of transpiration (E) on the vapour pressure deficit of air and by solving the energy balance, as the CO₂ flux (in contrast to E) not only depends on external factors, but also on the leaf's internal physiological regulators. Cowan and Farquhar (1977) simplified the problem by assuming that photosynthetic activity re-

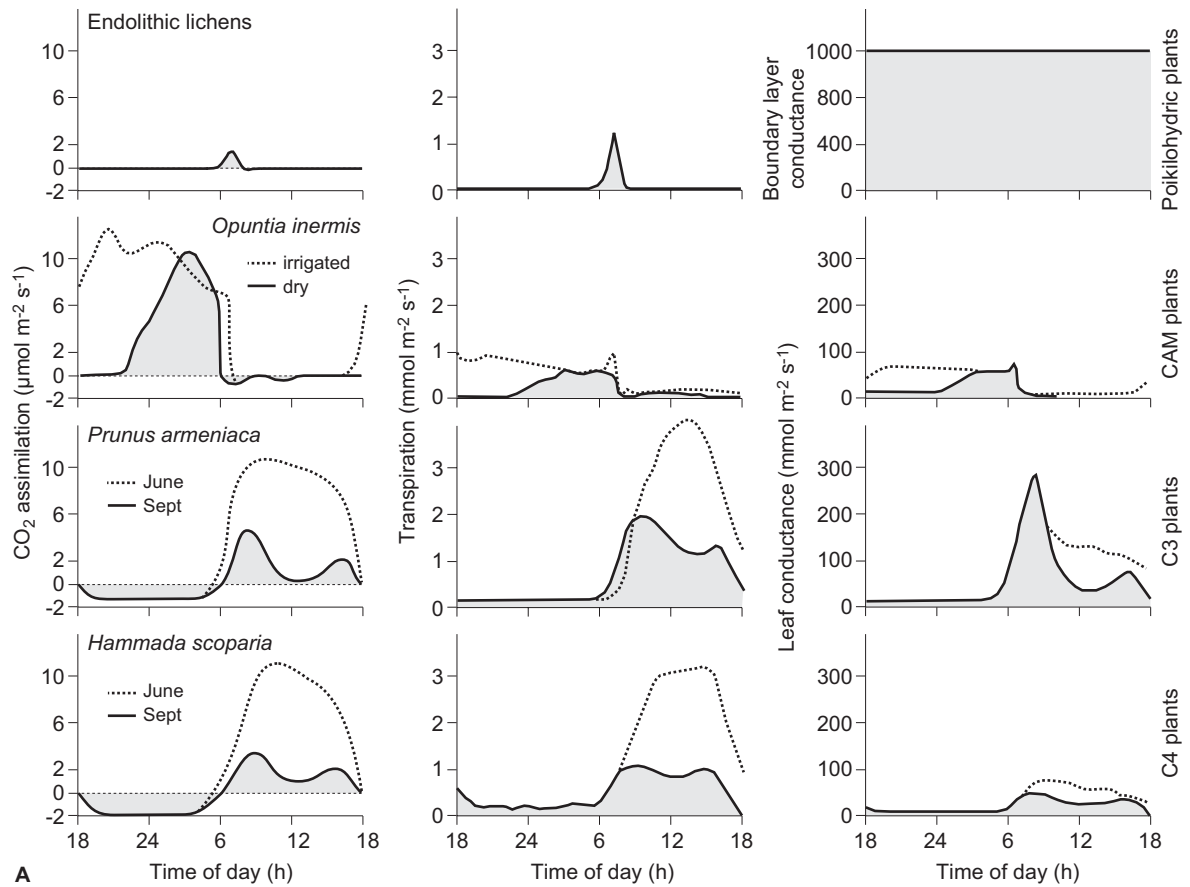


Fig. 2.4.17. A Daily changes in CO₂ exchange (CO₂ assimilation positive values; respiration negative values), evaporation and leaf conductance in various plant types in the Negev Desert: endolithic lichens, CAM plants: *Opuntia inermis*; C3 plants: *Prunus armeniaca*; C4 plants: *Hammada scoparia* (Schulze 1982). **B** The Negev Desert: slopes occupied by dwarf bushes (*Artemisia*, *Zygophyllum*, *Reaumuria*), stones are covered with endolithic lichens, in the stone's shade *Caraluma negevensis*, a CAM succulent, may be found. In the valley remains of terracing from Nabatean farmers, currently used by Bedouins for wheat growing, otherwise covered by the C4 plant *Hammada scoparia*. (Photo E.-D. Schulze)

mains constant. They came to the conclusion that there should be a balance between the response of assimilation ($\delta A/\delta g$) and transpiration ($\delta E/\delta g$) resulting from the change in stomata. Neglecting the energy balance and possible changes of photosynthetic capacity they conclude that “**optimal**” regulation occurs when

$$(\delta A/\delta E) = \lambda \quad (2.4.22)$$

where λ is a species-specific parameter which is constant, at least over the course of a day.

The limits of this interpretation are at the next higher organisational level, the vegetation. What use is it to an individual plant to behave optimally, when the saved water remains in the soil and either seeps further into the soil profile or evaporates from the crust or is used by its neighbours? In “non-cooperative behaviour” of neighbours (i.e. with excessive use of resources by neighbours) the individual which is acting optimally might lose, because the “neighbourly squanderer” has used almost all the water, if the saved resource is required to maintain life of the “optimiser” during drought conditions. This is exactly what is observed under arid conditions as diversity of species and structures: The equalisation of **opportunistic (non-optimised)** and **conservative (optimised) behaviour** in assimilation and use of water. Opportunistic behaviour is usually coupled to the ability of vegetation to complete development quickly (annuals), whilst conservative behaviour is coupled with slow development of vegetation and storage of resources over several growing seasons (**perennials**); an example of this type of behaviour is discussed in Chapter 3.2.5.3: Invasion of *Bromus* into the *Artemisia* steppe of North America. However, here, as so often in nature, there are many transitions which do not fall within such simple classifications.

2.4.3.8

Geological and Recent Distribution of C3, C4 and CAM Plants

Based on the physiological characteristics of C3 and C4 plants there is differentiation of these two photosynthetic types in the earth’s vegetation. Because of their high-temperature optima for photosynthesis and the ability to use high light intensities, C4 plants, particularly perennials, are more prevalent than C3 plants in subtropical savannahs and grasslands with summer

rains (Fig. 2.4.18 A). In contrast, the main distribution area of C3 grasses (often annuals) is in the winter cold steppes (Fig. 2.4.18 B). As the dependence on temperature and light is affected by CO₂ concentration in the atmosphere, the balance in the distribution of the two physiological types is not fixed.

The distribution of CAM plants in comparison to C4 plants is botanically very interesting, but is of rather secondary importance regarding the C cycle of the earth. Succulents are mainly distributed in **coastal deserts with cool nights** (South Africa with Namibia, Chile, Baja California, Tenerife; Fig. 2.4.18 C). The PEP-carboxylase of these coastal succulents is adapted to low night temperatures. Independent of this, CAM plants can also be found in warm, humid, moist rain forests. These include epiphytic orchids and some tree species of the genus *Clusia* (Clusiaceae; Lüttge 1999). The PEP-carboxylase of these genera is adapted, like C4 plants, to high temperatures, showing that the distribution pattern of CAM succulents with their major distribution in cold coastal deserts does not depend on the temperature response of PEP-carboxylase but is probably caused by competition, i.e. succulents grow too slowly in order to compete in the tropics and in the tropical grasslands the humidity at night is too low, so that stomata open during the night would also lose too much water.

Ehleringer et al. (1997) showed, based on the CO₂, light and temperature dependence of photosynthesis during the night, that C3 plants are competitively superior to C4 plants at increasing CO₂ concentrations and as climates become warmer (Fig. 2.4.19 A, B). At the time of the biggest freeze in the **glacial period**, the atmospheric CO₂ concentration was at about 200 ppm; in this CO₂ climate C4 plants were superior to C3 plants even at temperatures of 10 °C during the growing season. It is assumed that with increasing CO₂ concentrations C4 plants will be out-competed and have to move into climates with higher temperatures. For current temperature and CO₂ distributions on earth, C3 plants dominate at latitudes greater than 45° north and south (Fig. 2.4.19 B).

This observation is strengthened by the N requirement, which is higher for C3 than for C4 plants (Fig. 2.4.19 D). Under drier conditions, the N concentration in leaves is high due to the activation of nitrification in the soil after rain. Also, growth of plants is limited by drought and N concentration thus increases. In addition,

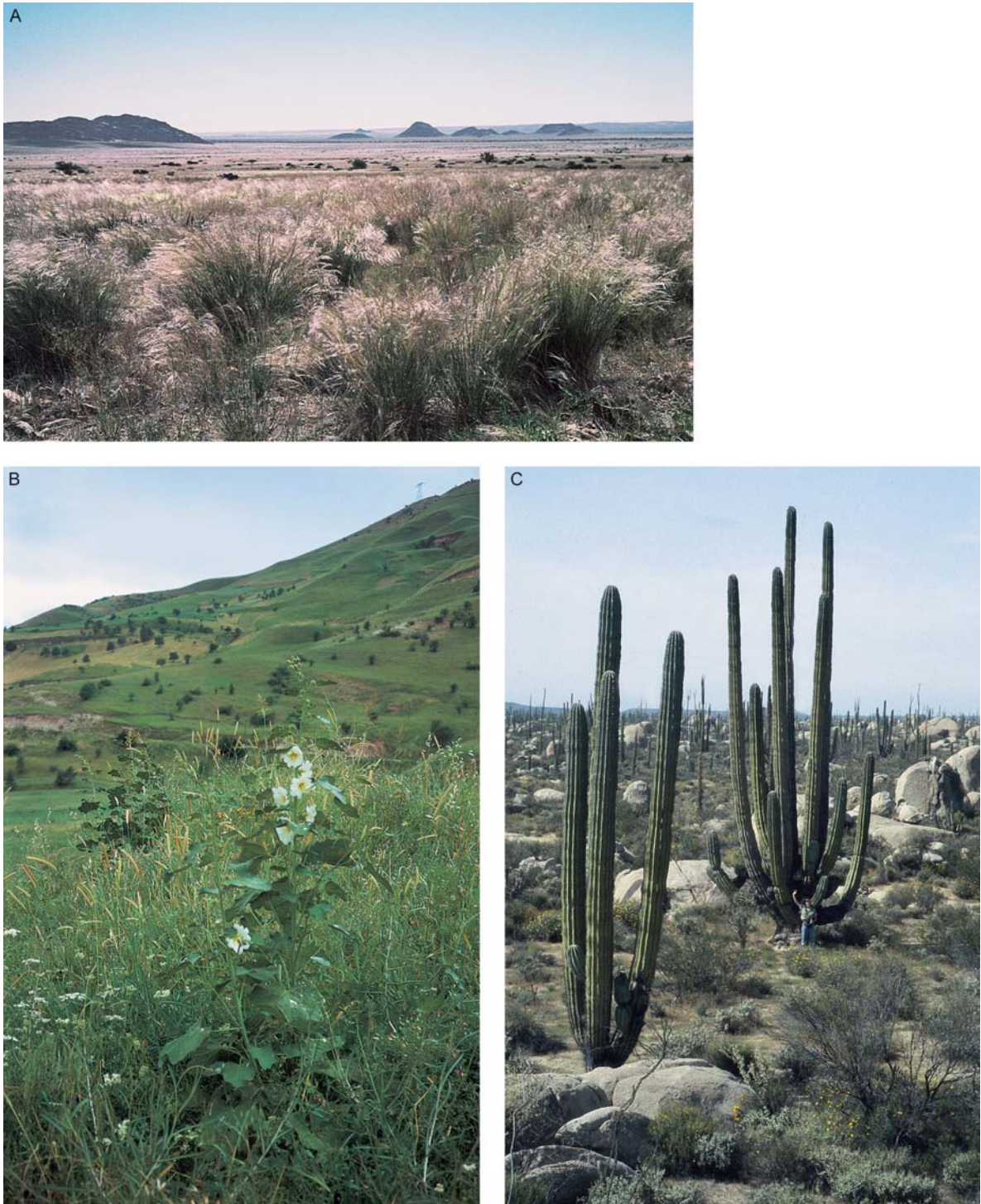


Fig. 2.4.18. **A** View of a tropical grassland in Namibia at about 200 mm rainfall of summer rains, i.e. water is available at high temperatures. Thus perennial C4 grasses and single succulents of the order Euphorbia are typical. **B** View of a continental steppe in Khazacstan. Note: Water is available after snowmelt at low temperature followed by summer drought. The vegetation is characterised by annual and perennial C3 grasses and shrubs (e.g. *Altaea*), a higher proportion of annuals and Leguminosae (e.g. *Astragalus*) and single shrubs (*Crataegus*). **C** View of succulent desert in Baja-California, Mexico, with *Pachycereus pringlei* as dominating cactus species. In the undergrowth are shrubs of *Larrea tridentata*, *Encelia* and *Ambrosia*, amongst others. (Photo E.-D. Schulze)

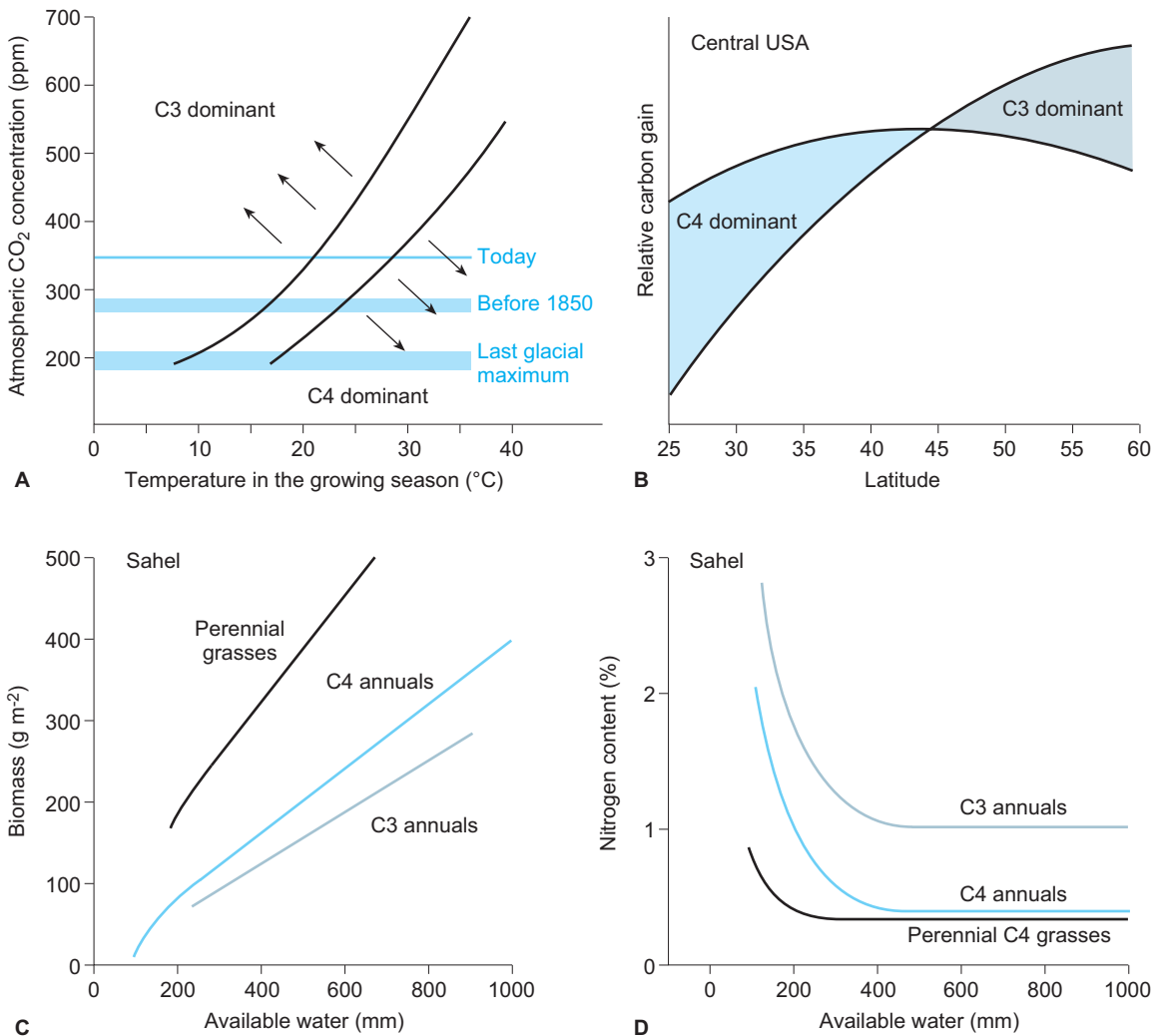


Fig. 2.4.19. **A** Distribution of C3 and C4 species in relation to temperature in the growing season and atmospheric CO₂ concentration. The blue lines indicate the shift of the temperature-CO₂ regime since glaciation. **B** Relative carbon gain of C3 and C4 species in relation to latitude at present CO₂ concentration (after Ehleringer et al. 1997). Changes in **C** biomass and **D** nitrogen concentration of C3 and C4 plants with water availability from rainfall in the Sahel. C4 plants have a lower N concentration than C3 plants and, therefore, are less suitable for grazing. (Penning de Vries and Djitéye 1982)

nitrification in the soil is more drought resistant than the growth of plants. Nitrogen concentration decreases with increasing precipitation and increasing plant production. In subtropical arid climates, annual plants with C4 metabolism are not in any way superior to C3 plants, rather they are inferior, whilst with high precipitation C4 perennial grasses dominate over C3 grasses. This has consequences for the use of land. The **Bedouin** move their herds to grazing sites with annuals which also have high N concentration, whilst with higher precipitation settled people pursue agriculture with C4 grasses which were perennials in their original forms (Penning de Vries and Djitéye 1982; MacFadden and Cerling 1996).

2.4.4

Growth and Storage

2.4.4.1

Introduction to the Carbon Balance

Ultimately, photosynthesis serves the plant to produce biomass and seeds. Assimilate production supplies the material for a continuous increase in the size of the plant body, which is important in competition with other plants and for storage of resources which are required for flowering and production of fruit.

Box 2.4.3

**Summary:
Responses of photosynthesis to environmental factors**

- Photosynthesis changes reversibly with **weather conditions**: light, temperature and atmospheric humidity. Strong light may lead to irreversible damage (photoinhibition) whereas low light leads to decreased CO₂ assimilation. On average a leaf functions at about 50% of its maximal CO₂ assimilation rate (A_{\max}).
- Photosynthesis in the long term is adapted to the **light environment** and the level of **nutrition**.
- Photosynthesis of higher plants responds irreversibly to **water stress**. Lichens in contrast respond reversibly to desiccation.
- Leaves respond to environmental conditions by modifying the **ageing process** which is species-specific.
- There is a tendency towards **optimisation** of CO₂ assimilation and transpiration, although “the optimal” response (water saving) may be disadvantageous in a plant community, as an unused resource in the soil becomes available for neighbouring plants or tillers.
- **C3, CAM and C4 plants** occupy niches which depend on the geological and more recent conditions of atmospheric CO₂ concentration and temperature in the growing season. C4 plants dominate at low CO₂ concentrations under high temperatures whereas in contrast C3 plants dominate at low temperatures. However, with high CO₂ concentrations, C3 plants can also dominate at high temperatures. This trend is strengthened by nutrition. Perennial C4 grasses have smaller N concentration in their leaves than C3 plants and are thus, in subtropical climates and also with limited nutrition, superior to C3 plants.

Table 2.4.1. Estimated annual balances of a beech forest (Schulze 1970; Scarascia et al. 1999), spruce forest (Fuchs et al. 1977; Scarascia-Mugnozza et al. 2000) and a barley crop (Biscoe et al. 1975; Jones 1994) in t C ha⁻¹ year⁻¹

	Beech	Spruce	Barley
A_{\max} (mg CO ₂ g ⁻¹ h ⁻¹)	10	5	20
GPP (t C ha ⁻¹ year ⁻¹)	8.6 (100%)	14.9 (100%)	8.3 (100%)
Respiration	2.4 (28%)	7.8 (52%)	1.7 (20%)
Leaf	1.3	6.4	1.5
Shoot	0.4	1.0	0.0
Stem and root	0.7	0.4	0.2
Litter	3.2 (37%)	2.9 (20%)	6.6 (80%)
Leaves	1.8	1.2	4.4
Fine roots	1.4	1.7	2.2
Growth	3.0 (35%)	4.2 (28%)	0.0
Large roots	0.4	0.7	0.0
Branches	1.4	1.5	0.0
Trunk	1.3	2.0	0.0

For biomass production additional energy is required for catabolic processes. This is independent of the energy required to maintain the existing biomass. In both cases, this energy is made available by the consumption of carbohydrates. **Net primary production (NPP)** results from the **net photosynthesis (A)** and the **respiration of the autotrophic whole plant (R_a)**; res-

piration without light; see [Chap. 2.4.1](#)). Net photosynthesis (A) is often also called **gross primary production (GPP)**:

$$\text{NPP} = A - R_a \quad (2.4.23)$$

The **material balance** of the plant indicates the magnitude of these processes.

Table 2.4.1 shows that barley with the highest photosynthetic rates (A_{max}) does not have the highest C gain (GPP). Spruce has a C gain which is about 80% higher than that of barley with about 25% of the photosynthetic rate. Reasons for this difference are that spruce has double the leaf mass of barley and the growing season is three times longer than that of barley. The deciduous beech is between these extremes. Costs for evergreen needle cover are paid, in spruce, by a significantly higher respiration. On the other hand, spruce invests less carbon in the growth of branches than beech, therefore the stem growth of spruce is almost a third higher than that of beech. For both tree species the harvested growth in stems is only a smaller fraction of the C gain (beech 15%, spruce 13%). Grain yield for barley would be comparable to the growth of stems and with a harvest index (grain yield/above ground biomass) of 0.4 about 1.8 t C/ha. This is about 20% of net photosynthesis and thus significantly higher than in trees.

The example shows that many factors determine NPP and that the plant kingdom has many ways of regulating biomass production. These are, amongst others:

- C balance over a growing season (mean rate of net photosynthesis*mean leaf area*length of the growing season; Schulze 1982);
- distribution of assimilates to different organs (Stitt and Schulze 1994);
- respiration in existing and growing biomass (Merino et al. 1982);
- storage (Chapin et al. 1990).

2.4.4.2 Respiration

Respiration of mitochondria is obviously an important component in reducing the C gain. The amount of C required for the synthesis of certain products is very different and may differ by two orders of magnitude according to the product (Penning de Vries 1975, 1983; Table 2.4.2).

It is possible to calculate C requirements of growing organs from their synthetic products, but the requirement of existing organs is not quantified by this. McCree (1983; Amthor 1989) suggested the following terms to divide these two functions of respiration:

- **growth respiration, R_g** (respiration serving growth); and

Table 2.4.2. Respiratory requirement for a plant to synthesise substrates required for growth, and for respiration of organs. (After Penning de Vries 1975)

		Respiratory CO ₂ requirement mg CO ₂ g ⁻¹
Substrate	Organic acids	11
	Carbohydrates	170
	Proteins	544
	Lipids	1720
Plant organ	Leaves	333
	Stems	278
	Wood	426
	Rice grain	186
	Beans	420

- **maintenance respiration, R_m** (respiration for maintenance of organs).

Dark respiration (respiration of autotrophic plants), R_d (mg CO₂ plant⁻¹ time⁻¹), of a plant with weight W consists of the maintenance respiration (mg CO₂ plant⁻¹ time⁻¹) and the growth respiration (mg CO₂ plant⁻¹ time⁻¹)

$$R_d = R_m + R_g \times dW/dt \tag{2.4.24}$$

Dividing by the weight yields the respiration rates per unit weight

$$R_d/W = R_m/W + R_g \times dW/dt \times 1/W \tag{2.4.25}$$

where $dW/dt \times 1/W$ is the so-called **relative growth rate (RGR)**. If the dark respiration, R_d is plotted as a function of RGR, for short periods

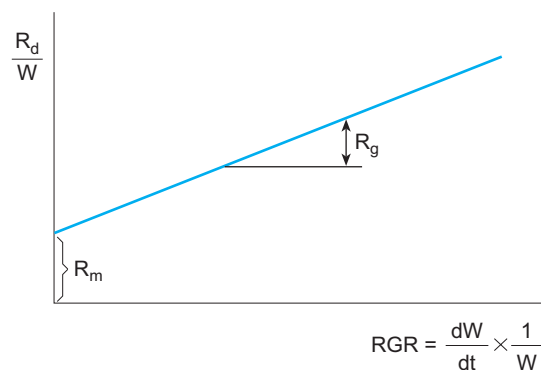


Fig. 2.4.20. Visual presentation of the definitions of growth-induced respiration (R_g) and maintenance respiration (R_m). If dark respiration (R_d per unit weight) is measured in relation to the relative growth rate (RGR =increase in weight per unit total weight of the plant), then the slope of the curve is a measure of growth-induced respiration and the intercept on the y-axis is a measure of maintenance respiration

of time a straight line should emerge, the slope corresponds to the growth respiration and intersection with the y -axis, R_m (Fig. 2.4.20). The relation between R_m and R_g depends on the time in which individual organs are photosynthetically active. In herbaceous plants the root respire for 24 h, whilst the shoot shows net respiration only during the night. In woody plants branches and sapwood respire corresponding to the amount of living cells for 24 h.

Research into respiration has been neglected compared with research on photosynthesis, so that there are still many uncertainties about the conditions relating acclimatisation and adaptation to resources (Amthor 1989).

2.4.4.3 Growth

Growth of plants and the processes of accumulation can only be shown as a mathematical model as there is no satisfactory physiological model explaining the regulation of C distribution to various organs and gain in mass (Fig. 2.4.21). CO_2 assimilation depends on the CO_2 gradient, the stomatal conductance and the leaf area. Assimilates formed produce an assimilate pool as intermediary storage from which the distribution to growth of green and other organs takes place. In both cases growth is added to the existing biomass. Particularly in leaves self-shading may occur and old leaves are shed (see Chap. 2.4.5.3: *Urtica*). Turnover in the root region is similar.

Growth of leaves has a positive feed-back on CO_2 assimilation, which produces additional re-

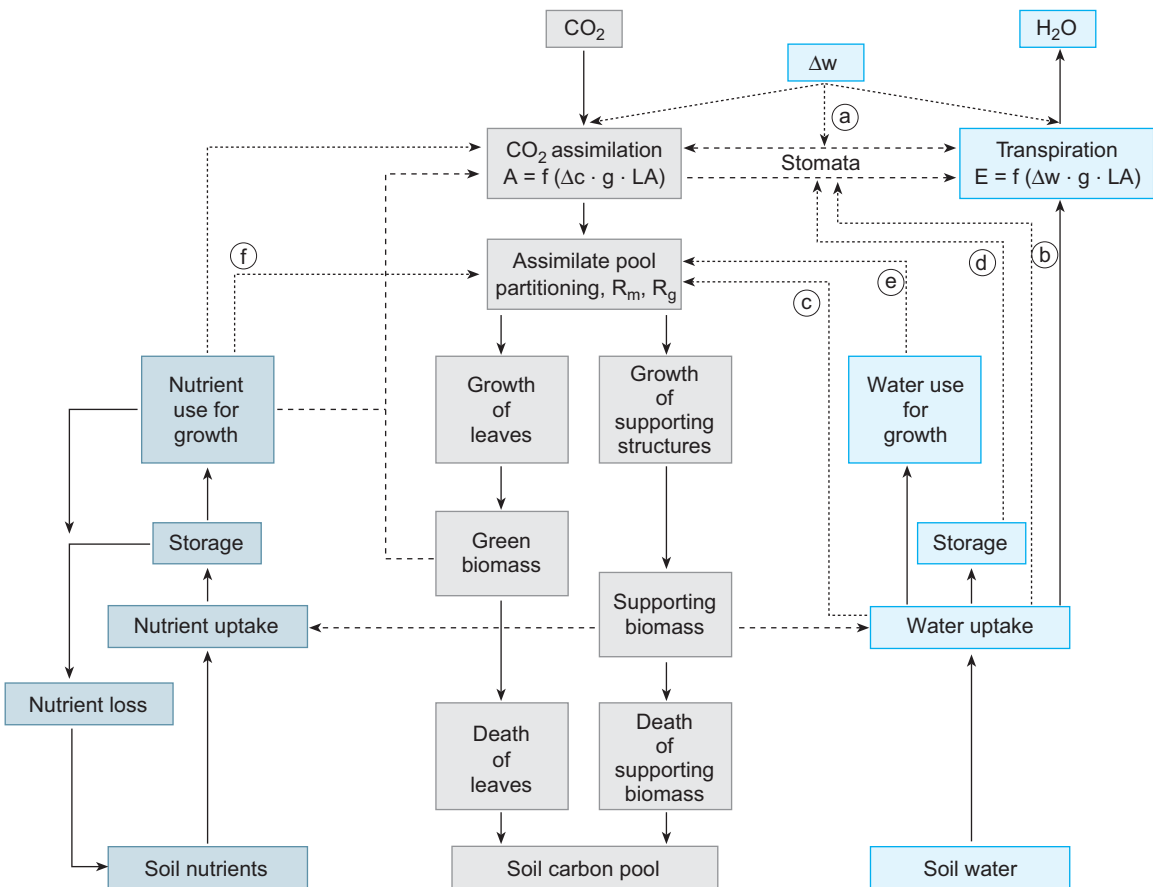


Fig. 2.4.21. Schematic model of internal carbon, water and nutrient pools and fluxes within the plant for shoots and roots (*continuous line*), as well as the important feed-back (*broken line*) and regulation between C, N and water balance. Regulating factors are (a) the effects of climatic factors, (b), (c), (d), and (e) regulation of stomata and carbon partitioning by the water balance, and (f) regulation of assimilation and C partitioning by the nutrient balance. (Schulze and Chapin 1987)

quirements for nutrients and water. Growth of non-green organs has a negative feed-back on CO₂ assimilation, but stimulates the uptake of nutrients and water. Regulation of assimilate distribution and rates of senescence determines the balance between assimilating and respiring organs, where the latter are responsible for the uptake of nutrients and water. A special situation occurs in woody plants, because the biomass which dies remains in the stem (**heartwood**) and only a small ring of vessels (**sapwood**) is metabolically active. Thus the heartwood does not respire, but serves to increase the vegetative structure and is thus very important in competition with other species.

There are several other regulatory mechanisms for the “**communication**” of shoot and root. The carbohydrate supply gives, of course, the decisive signal for the growth of root and stem. Roots regulate, via cytokinin, the shoot with respect to CO₂ assimilation as well as the distribution of assimilates. The supply of nutrients, particularly nitrate (Scheible et al. 1997), and the availability of carbohydrates (W. Schulze et al. 1991) may also act as signals regulating carbon allocation.

Of course, gain of resources and consumption of resources need not always take place synchronously. This applies particularly to the uptake of

nutrients and CO₂ assimilation. If plants were only to take up nutrients synchronously with their consumption, neighbouring plants would have the possibility to gain these resources if they are available in the soil (see Chap. 2.4.3.7). At the same time, light must be controlled to maintain the existing photosynthetic apparatus, when little carbohydrate is necessary (e.g. in drought periods) as without the transfer of electrons to carbon, nitrogen or sulfur the chlorophyll is damaged by irradiation. Therefore, the assimilate and nutrient pool is very important as a “**store**” from which various requirements of the plant are covered.

2.4.4.4 Storage and Feed-Back

Plants use resources for **growth**, **defence** against herbivores and **reserves**, and they **accumulate** these passively if the gain of resources is greater than their consumption. Only part of these resources may be recovered and only this is considered a “**store**” (Fig. 2.4.22). Subdivision into accumulation and formation of reserves is difficult. **Formation of reserves** is the process in which stored products at the time of their production by metabolism compete with growth processes.

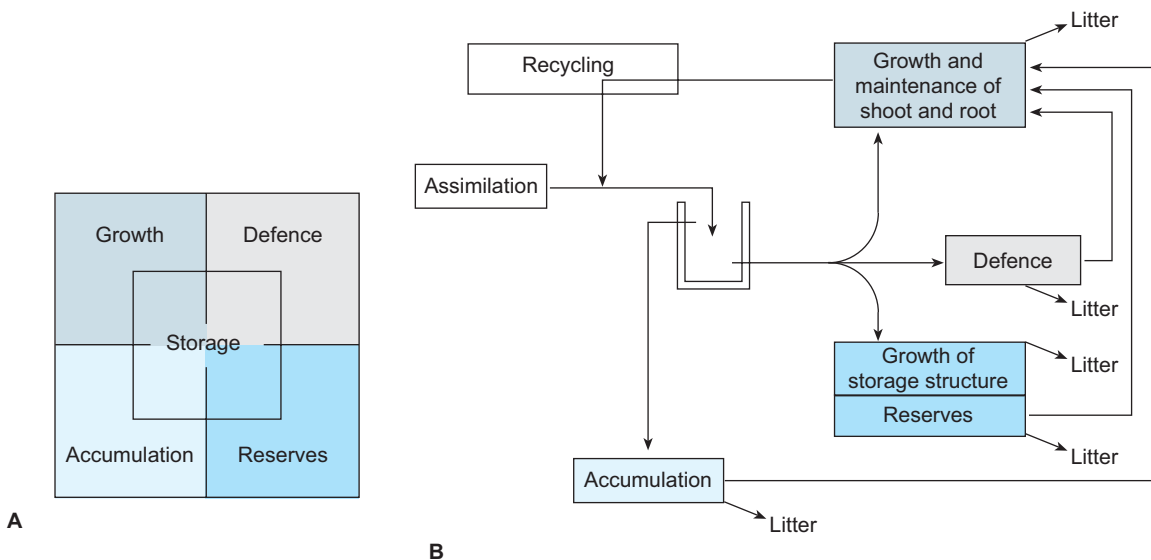


Fig. 2.4.22. A Schematic presentation of the partitioning of carbon in a plant for particular functions: growth, defence, formation and accumulation of reserves. Only part of this C can be reallocated and is thus a “store”. B Flux of carbon assimilates from CO₂ assimilation to growth and the reutilisation of C with death of plant parts (e.g. leaf fall). Accumulation occurs when C production (assimilation plus reallocation) exceeds immediate requirements. Formation of reserves occurs when the conditions for formation of storage products (e.g. starch) competes with growth processes. Short-term assimilate pools, which act as physiological control, are shown as a “well”. (Chapin et al. 1990)

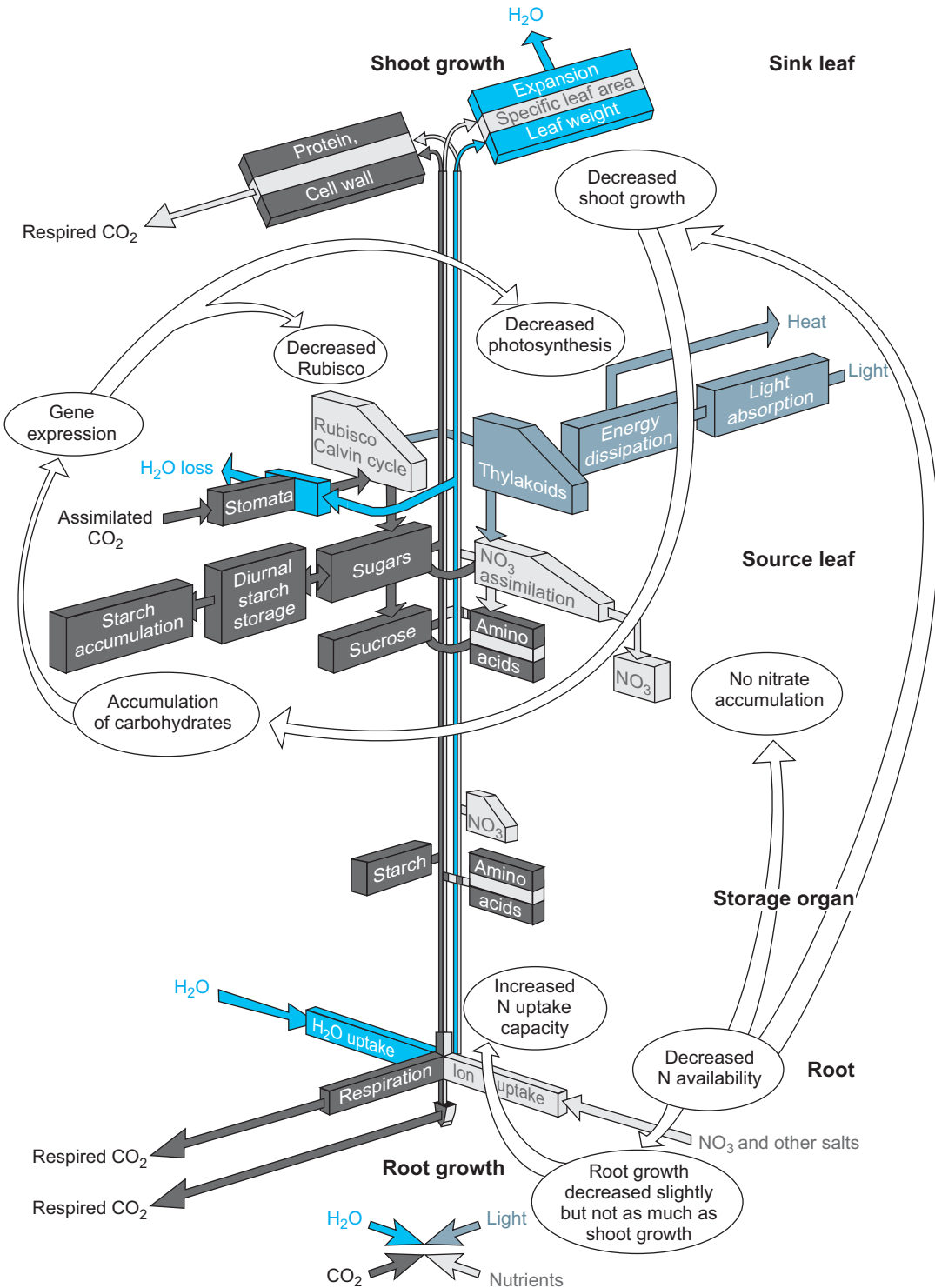


Fig. 2.4.23. A conceptual model to show the sequence of changes in metabolism resulting from changes in resource availability, e.g. nutrient deficiency results in reduction of growth in sink organs. Consequently, carbohydrates accumulate in source leaves. This causes Rubisco and light-harvesting systems to decrease (yellowing of old leaves with N deficiency). Thus nitrogen becomes initially available again for growth. (After Stitt and Schulze 1994)

Box 2.4.4 Summary: Growth

- **Carbon balance** of a plant is substantially determined by morphological characteristics and the longevity of the assimilatory organs (e.g. beech, spruce, barley).
- **Respiration** plays an important regulatory role. Distinction is drawn between the function of respiration in “maintenance respiration” and “respiration required for growth”.
- **Increased growth (net primary production)** is only possible when the material produced exceeds that required for maintenance of existing organs. In the extreme case plants grow towards the light even at the cost of maintenance of existing organs, which therefore die off. This strategy is particularly seen in trees with formation of heartwood, an important step towards the reduction of maintenance respiration. Sapwood, which respire, is converted into heartwood, which does not respire, but still supports the plant individual through its woody structure.
- Resource gain and consumption of C and N do not proceed synchronously so **storage** of resources is an important component of all growth processes. Distinction is drawn between passive accumulation of substances (resource acquisition > consumption: nitrate in leaves) and formation of reserves (reserve formation competes with growth: starch in potato).

In contrast, **accumulation** is a process in which the acquisition of resources exceeds consumption by growth at the time of production.

In Fig. 2.4.21 it becomes clear that the C, N, water and energy balances in the plant interact and that the various material fluxes are interconnected. It is not only the distribution of resources to shoot and root, but also distribution between various plant parts in which growth, CO₂ assimilation or storage take place. To understand the interaction between these plant parts and their function, a model with several levels is required (Fig. 2.4.23) allowing feed-back signals between them to be considered. Excess of carbohydrates not only affects stimulation of “sink” activity in shoot and root, but also stimulates nitrate reduction and leads to degradation of photosynthetic activity to produce organic nitrogen. Conversely, lack of nitrogen leads to reduced growth and thus to accumulation of carbohydrates and a reduction in photosynthetic capacity. The ecological consequences of storage in different types of plants are discussed in Chapter 2.4.5 and Chapter 4.3.

2.4.5

C and N Balance in Different Types of Plants

Plant species differ by more than one order of magnitude regarding the relation between green organs for assimilation (leaves, needles, phylloclades, phylloclades) and non-green biomass. In tropical rain forests only 2% of the biomass is leaves, in a meadow more than 50% (Table 2.4.3). Nevertheless, the material gain per year in the tropical forest is not different to that in tropical grasslands and even higher than in temperate grasslands. The average monthly NPP calculated over a year is very similar (Fig. 2.4.24), showing that there are structural elements which not only differentiate the plant kingdom, but which also act compensatorily regarding biomass production.

The analysis of plant structures in botany which is independent from the taxonomic description of a species leads to the term **life-form**. The definition of the life-form has two

Box 2.4.5 Plant life forms

In plant ecology different forms are distinguished according to:

- **Raunkiaer:** trees, shrubs, perennial herbs, annuals, geophytes;
- **Grime:** r-strategies, k-strategies, stress-tolerant species;
- **Monsi:** annuals vs. perennials, herbaceous vs. woody, evergreen vs. deciduous.

Table 2.4.3. Change in biomass and net primary production in various types of global vegetation and the percentage distribution of biomass in leaves, above-ground organs and roots. (Schulze 1982)

Vegetation types	Biomass (kg m ⁻²)	Primary production (kg m ⁻²)	Mass of green material (photosynthetically active organs) (%)	Only respiring organs (%)	
				Above-ground woody material	Roots and under-ground shoots
Evergreen trees of tropical and sub-tropical forests	41–65	6–17	ca. 2%	80–90% ^a	10–20% ^a
Deciduous trees of temperate zones	18–60	0.4–2.5	1–2%	ca. 80% ^a	ca. 20% ^a
Evergreen trees in taiga and mountain forests	20–90	0.2–1.5	4–5%	ca. 75% ^a	ca. 20% ^a
Dwarf trees of the forest margins	5–10	0.1–0.5	ca. 25%	ca. 30% ^a	ca. 45% ^a
Ericaceous dwarf shrubs of heaths and tundra	1–6	0.1–0.5	10–20%	ca. 20% ^a	60–70% ^a
Meadow plants	–	0.1–1.3	ca. 50%	–	ca. 50%
Alpine grass lands	0.1–3	0.1–1	ca. 30%	–	ca. 70%
Steppe plants					
Wet years	–	0.1–1	ca. 30%	–	ca. 70%
Dry years	0.3–3	–	ca. 10%	–	ca. 90%
Plants at high altitude	0.1–4	0.1–0.5	10–20%	–	80–90%

^a A large part of the mass is dead supporting material

goals. Geographers and botanists visiting “foreign” countries wanted to describe a taxonomically foreign vegetation figuratively. They also wanted to analyse those strategies with which plants survived in their environment (Box 2.4.5). The term life-form has been extended by the term “functional groups”, which not only comprise structural characteristics, but also physiological characteristics (C3/C4 plants, N₂ fixers, deep roots and many others; see Chap. 4.3).

To understand the distribution of resources in plants, the scheme by Monsi (1960) has proved particularly useful. The most important forms will be explained in the following based on their C flux (see Fig. 2.4.21).

2.4.5.1 Annual Species

Annual species are described by the following characteristics:

- They have a short life cycle (2–3 weeks from germination to formation of seeds in *Linaria haelva*, Scrophulariaceae).

- All tissues are physiologically active (lignification is exceptional: *Helianthus annuus*, Compositae).
- The shoot/root relation is shifted towards the shoot (strong feed-back coupling of leaf formation to the production process), hardly any subterranean storage organs (except after breeding for cultivation: radishes = *Raphanus sativus*, Cruciferae).
- High yield of seeds after a very short developmental phase. The harvest index (yield/above-ground biomass) may reach up to 60% (rice: *Oryza sativa*, Gramineae).

Within a very short time, multiplication of individuals in the population occurs as the number of seeds is larger than the number of parents. Thus annuals colonise wastelands very effectively (r-strategy according to Grime). With limited area there is soon intensive competition between individual plants, as the leaf area index (LAI) remains constant.

Crop plants are the most important representatives of annuals. In wheat (Fig. 2.4.25), particularly in older varieties, even the number of shoots increases after germination, as several

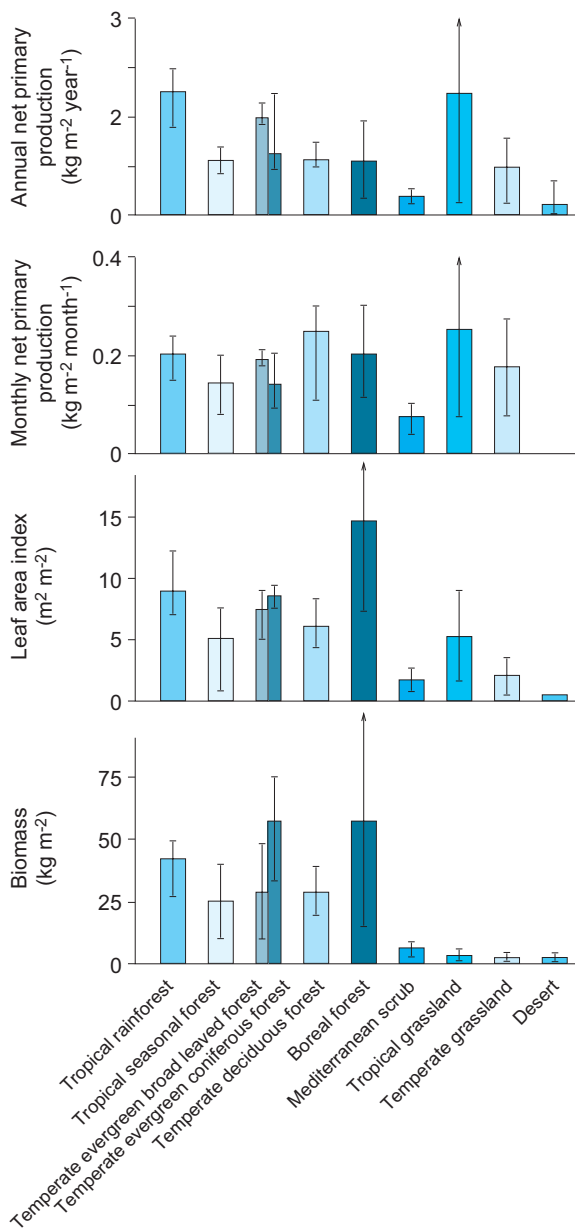


Fig. 2.4.24. Biomass, annual net primary production (NPP_a), leaf area index and monthly net primary production of different types of vegetation in different parts of the globe. Despite large differences in biomass and NPP_a the monthly rate of NPP is very similar, i.e. differences in NPP_a are mainly caused by differences in the duration of the growing season. (Schulze 1982)

flowering shoots form from the basal rosette. After about 40 days this leads to competition between shoots, and self-thinning (Chap. 3.2.1), with some of the resources stored in the dying shoots relocated into the remaining plant. One could consider the formation of such shoots as a strategy to occupy space and to store resources

from the soil temporarily. Only after stabilisation of the number of shoots and the development of a closed leaf cover with constant LAI, does the biomass of the remaining shoot increase. Growth of new roots and leaves stops with formation of the ear. At the end of the life cycle, all resources which can be relocated are deposited into the developing grains. Filling of grain with carbohydrates is supported by awns, which do not possess functional stomata and thus can supply carbohydrates for the final ripening of seeds even at the beginning of drought. The physiological achievement of these plants is enormous, if one considers that in a very short time (1–2 weeks) 60% of the above-ground dry weight is relocated from senescing leaves and stalks to grains in a regulated manner. The relation of grain yield/biomass (the so-called **harvest index**) in high-yielding crops is 0.5 (wheat) to 0.6 (rice) and is thus significantly higher than for natural annuals (0.3) on average.

Regarding the distribution of assimilates, annuals are the plant group with a very high relocation in the direction of the leaf from the time of germination. This is possible because these plants have a very effective transport system for water and an effective root system to take up nutrients. Most herbaceous species have VAM mycorrhiza which are very effective in making phosphorus available from the soil (see Chap. 2.3.2.3).

Comparing annuals which are native to soils with different fertility, it may be shown that all species hardly differ regarding the vegetative phase with low N supply (Fig. 2.4.26; Fichtner and Schulze 1992). Growth rates of species adapted to nutrient-rich sites are faster, particularly with greater supply of resources. As shown in Chapter 2.3.2.3, the main difference between species is that only those species which are adapted to the lower N supply flower (*Teesdalia nudicaulis*, *Filago vulgaris*) at low N supply. Species of nutrient-rich sites lack **flowering induction** at nutrient-poor sites and remain vegetative (*Galeopsis tetrahit*, *Urtica urens*), and die.

In natural vegetation annuals are particularly successful on sites with a periodically abundant supply of resources (deserts, flooded meadows). Limits of the distribution of annuals are determined by the length of the growing season; therefore, they are missing in boreal climates. There are various adaptations to increase the duration of vegetative growth. This applies particularly to **winter annuals** (e.g. *Gallium apar-*

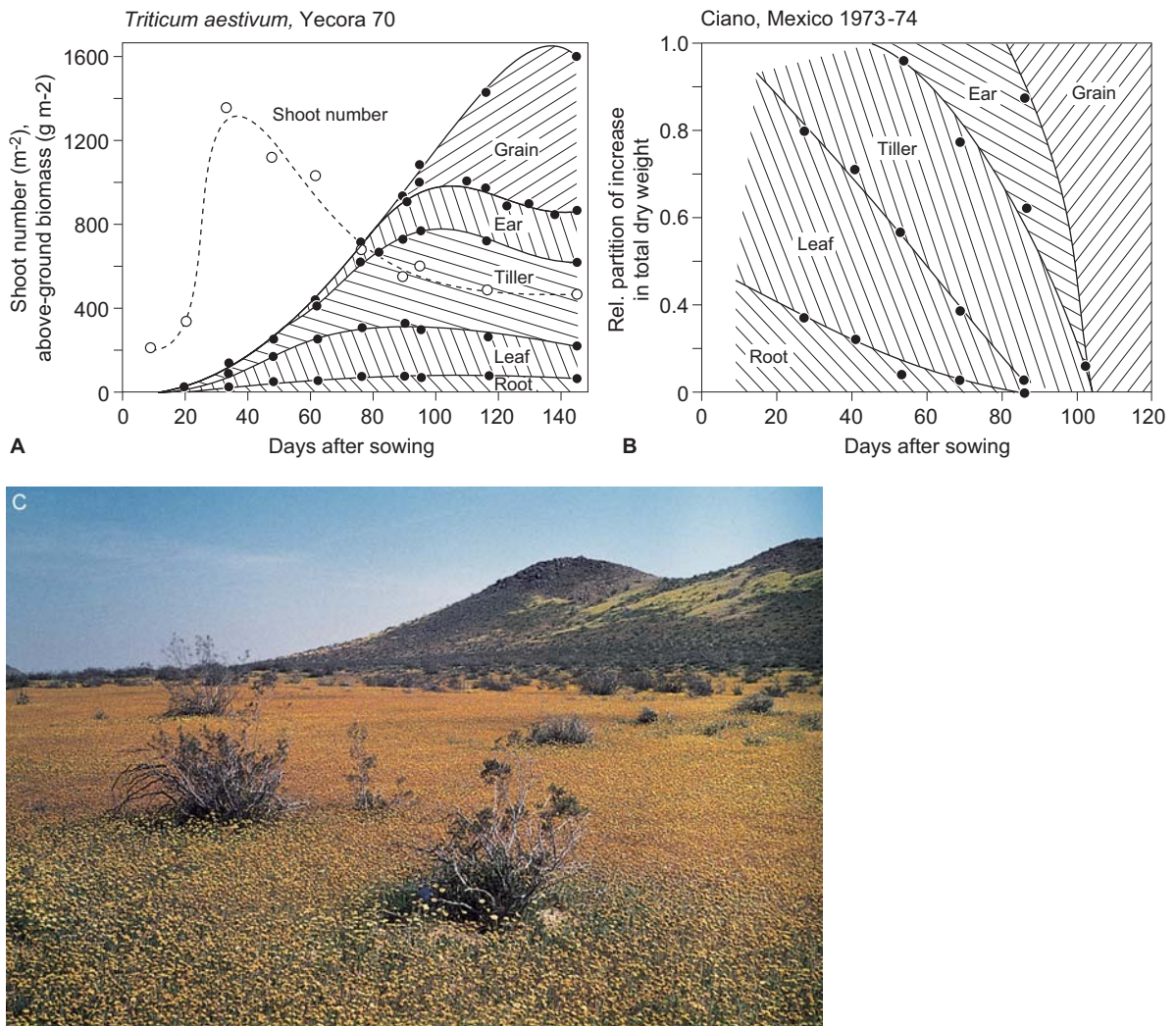
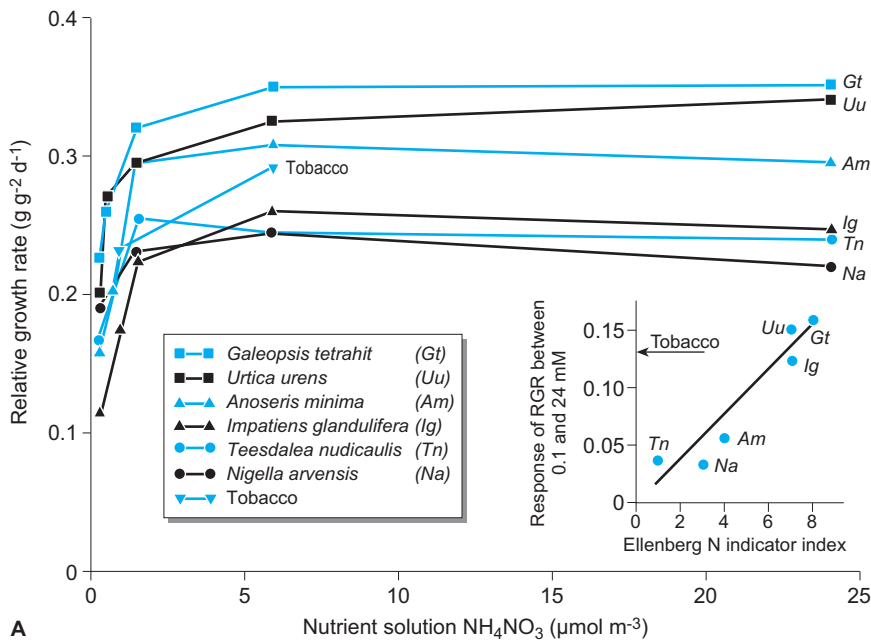


Fig. 2.4.25. **A** Changes with time in above-ground biomass and numbers of shoots from germination to harvest in wheat. Figures show the cumulative biomass of individual organs. The *hatched areas* show the biomass per organ. **B** Relative distribution of growth into roots, leaves, stems, ears, and grain. The figure shows accumulated growth in the individual organs (Schulze 1982). **C** Flowering of the winter annual *Coriopsis biglowii* in the Mohavi Desert which is dominated in the dry season by the perennial shrub *Larria tridentata*. (Photo E.-D. Schulze)

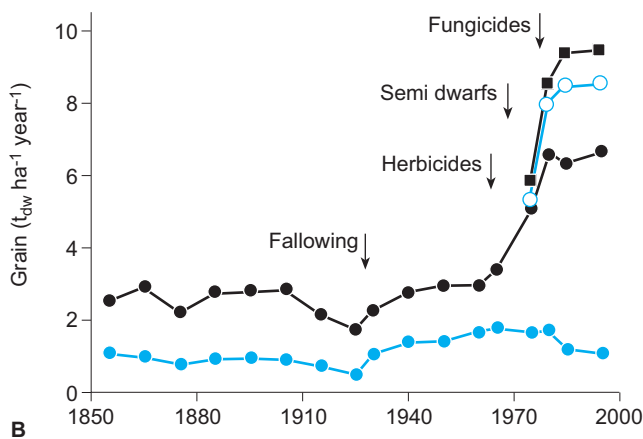
ine) which germinate in autumn and flower the next year. For these plants, as for all winter plants including winter wheat, there is the danger of dying because of frost drought. A lengthening of the growing period to extend flowering occurs in the facultative biennial species (e.g. *Daucus carota*) and the true **biennials** (e.g. *Arctium tomentosum*).

With annuals, for example, it is possible to use a model to study the structural characteristic of a productive **crop plant**. This is independent of the potential physiological change possible through gene modifications (Mifflin 2000). The structural characteristics include:

- **One stalk per rosette:** Formation of fewer stalks, as the distance between seeds when sowing the crop should regulate competition, and the supply of resources should be controlled by fertiliser and herbicides.
- **Length of stem:** Stems with ca. 3 leaves are needed. It has been shown that the uppermost leaf (flag leaf in cereals) is essentially responsible for grain filling. The lower leaves supply stem and root. A tall stem is an advantage in competition with other species. However, this is an unnecessary C sink if weeds are eradicated with herbicides. A short stem also stands better when carrying a large ear.



A



B

Fig. 2.4.26. A Alterations in biomass of native annuals in relation to the nitrogen concentration of the nutrient solution. As it is a physiological laboratory experiment tobacco is also used as a test plant. Tobacco has a particular function in ecophysiological laboratory studies, as it can be genetically transformed and single parameters which influence growth can be regulated genetically. It is clear that some annuals of the native flora have faster growth rates than tobacco. The insert shows that the relative growth rate correlates with the Ellenberg indicator values for nitrogen (Fichtner and Schulze 1992; for tobacco studies, see Stitt and Schulze 1994). B Influence of particular crop management procedures on grain yield of wheat in the long-term experiment at Rothamsted. (After Mifflin 2000)

- **Many seeds per stem:** The yield of grain is proportional to the number of seeds and less to the weight per grain. An additional seed is thus a better C sink than a larger grain, which is important for the relocation of material during seed ripening.
- **Position of the leaf:** Erect leaves determine, at constant irradiation, the maximum leaf area index regulating the C balance.
- **Depth of root:** Deeper reaching, thin roots to increase root volume and exploit resources to as great a depth as possible. This is important for water relations at the time of seed ripening.
- **Awns:** Awns were bred out of crop plants because of the unpleasant characteristics during threshing. With machine threshing the awn gains new significance as security at the time of seed ripening. *Triticale* [crossing of *Triticum* (wheat) with *Secale* (rye)] is one of the very productive modern cereals with very long awns.

- **Control of diseases and competition:** Yields of cereals increased after regulation of nutrition by (1) use of herbicides, (2) change of crops, (3) introduction of dwarf varieties, and (4) use of fungicides (Miflin 2000; Fig. 2.4.26B).

2.4.5.2 Biennial Species

Biennial species have a transitional position between annual and perennial herbaceous species. They occur in the succession only for a short period between ruderal plants and the perennial vegetation (Fig. 2.4.27; Heilmeyer et al. 1997).

Biennials are characterised by:

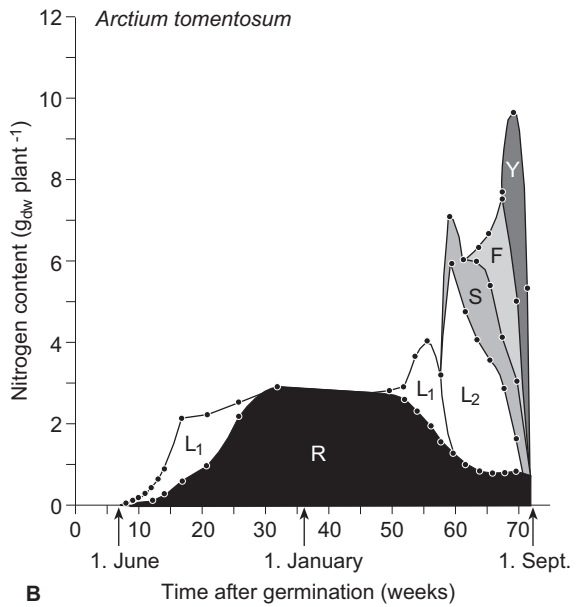
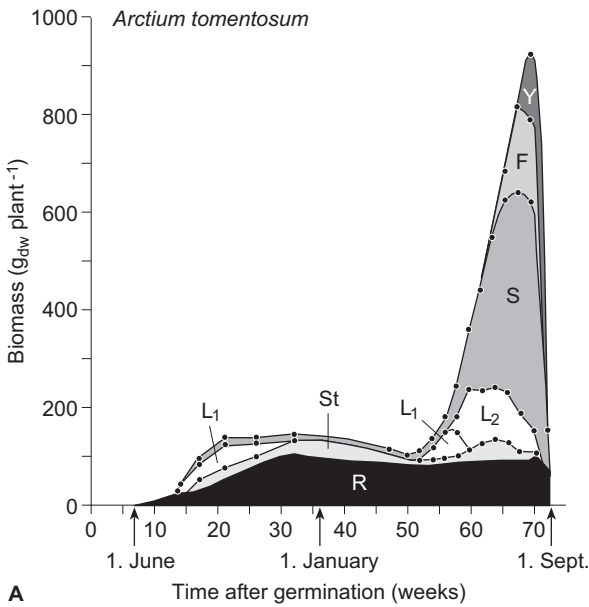


Fig. 2.4.27. Changes with time in **A** dry mass and **B** amount of N in different organs of *Arctium tomentosum* during the 2 years of growth from germination until death after seed production. Development of the storage roots (*R*) is particularly noteworthy for it supports early leaf emergence from the rosette in the second year. The large biomass production of *Arctium* in its second year is mainly due to the “exploitation” of the habitat due to its rosette leaves (*L*₁) in its first year and the basal rosette in the second (*L*₁ and *L*₂), which makes possible the harvest of nitrogen from an area of about 1 m². This nitrogen gain permits growth of large flowering shoots (*S*) and of the leaves on the shoot (*F*) which assimilate CO₂ after *L*₁ and *L*₂ die. All resources are finally transferred to the fruits (*Y*). During flowering, when the rosette and the stem leaves are already dying, the plant receives some 15% of its total N from the root. Exploitation by the basal rosette of the area in which the plant grows is so complete and long-lasting that the seeds of this species can establish themselves in the area without significant competition from other competing species. Thus the biannual *Arctium* occupies an area for many years (Heilmeyer et al. 1986). **C** *Arctium lappa* in a ruderal situation in competition with couch grass and thistles. Campus of the University of Bayreuth. (Photo E.-D. Schulze)

- Behaviour analogous to annuals in the first year, but the formation of a storage organ (often the hypocotyl) occurs very early and is genetically fixed. This storage organ is formed during growth (formation of reserve) or is filled with resources only after the termination of growth (accumulation);
- Storage of amino acids predominantly, sometimes lipids;
- Early emergence in the following year because of the stored N products at a time when the root is not yet active;
- Formation of the basal rosette which reduces competition with other species dependent on the size of leaves, and which also enables exploitation of a larger area and also volume of soil, increasing availability of resources, in particular N and water;
- Formation of a flowering shoot in the second year, supplied with nitrogen by the dying leaves of the basal rosette;
- Relocation of all resources to the seed during a period of 1–2 weeks with an harvest index corresponding to that of annuals.

Biennials are, because of the formation of the basal rosette, often very successful in out-competing other species even in the long term. After flowering many seeds drop at the site where the basal rosette of the mother plants died. Seeds germinate and, because of the enormous inter-species competition, only a few are left at the end of the new growing season and then flower again. Thus large-leaved biennials are able to occupy habitats for decades.

Biennial species occur in a very wide range of sites. At nutrient-poor sites these are often biennial legumes able to fix N₂ (*Melilotus officinalis*), at nutrient-rich sites it is usually species with large leaves. Species from nutrient-poor sites often have many small seeds, those from nutrient-rich sites few large seeds.

Biennials are a suitable object to consider strategies and transitions between storage and accumulation. In *Arctium*, formation of the storage organ and filling occur after the development of the leaf so that the store accumulates excess products. In contrast, for *Dipsacus sylvestris* or *Daucus carota*, the development of the store occurs at the same time as the development of the leaf, so that storage competes with growth (Steinlein et al. 1993).

2.4.5.3

Perennial Herbaceous Species

Perennial herbaceous species behave similarly to annuals after germination, forming storage organs, creeping shoots, tubers and other vegetative organs, which may also serve for vegetative multiplication, but do not enter the reproductive phase. Thus perennial species have the following characteristics:

- Individual plants live for many years.
- Storage of C and N dominates before reproduction.
- Reserve material allows plants to start early and maintain a long period of growth.
- Many species are able to die back to very few vegetative apices and emerge or re-grow.

In contrast to annuals where the increase in the population is most important, in perennial species, it is maintenance and growth of the individual plant. Seed production is delayed to a time with good resources and storage.

In **grasses**, carbohydrate transport occurs in the phloem of a rhizome predominantly in the direction of the vegetative apex which is younger than the producing leaf and thus enhances the sink (see Chap. 2.3.1.3). Transport into older organs is very small. Thus older shoots are more of an “insurance” for situations where the young shoot is damaged. In this case older shoots re-grow.

Different **storage** products may accumulate at different times in the same shoot during the season (Fig. 2.4.28). Thus, in summer, nettles store starch, which is required in autumn to produce new runners after the death of the above-ground shoots. Starch is also used for the reduction of nitrate, which is available in the soil in autumn and taken up. Storage of amino acids thus occurs in autumn and winter and is the basis for early emergence in spring. Young leaves are very quickly self-sufficient with respect to carbon. In herbaceous perennial plants there is, similar to the situation in a wheat field, very early strong competition between shoots. The LAI remains constant and individual shoots compete by the continuous formation of new leaves with the old leaves dying simultaneously. Thus, *Urtica dioica* leaves are exchanged about four times during the growing period (see also Chap. 2.4.4.3). Formation of below-ground rhizomes also shows many forms in nettles. On nutrient-poor sites, rhizomes, which may be up to 3 years old,

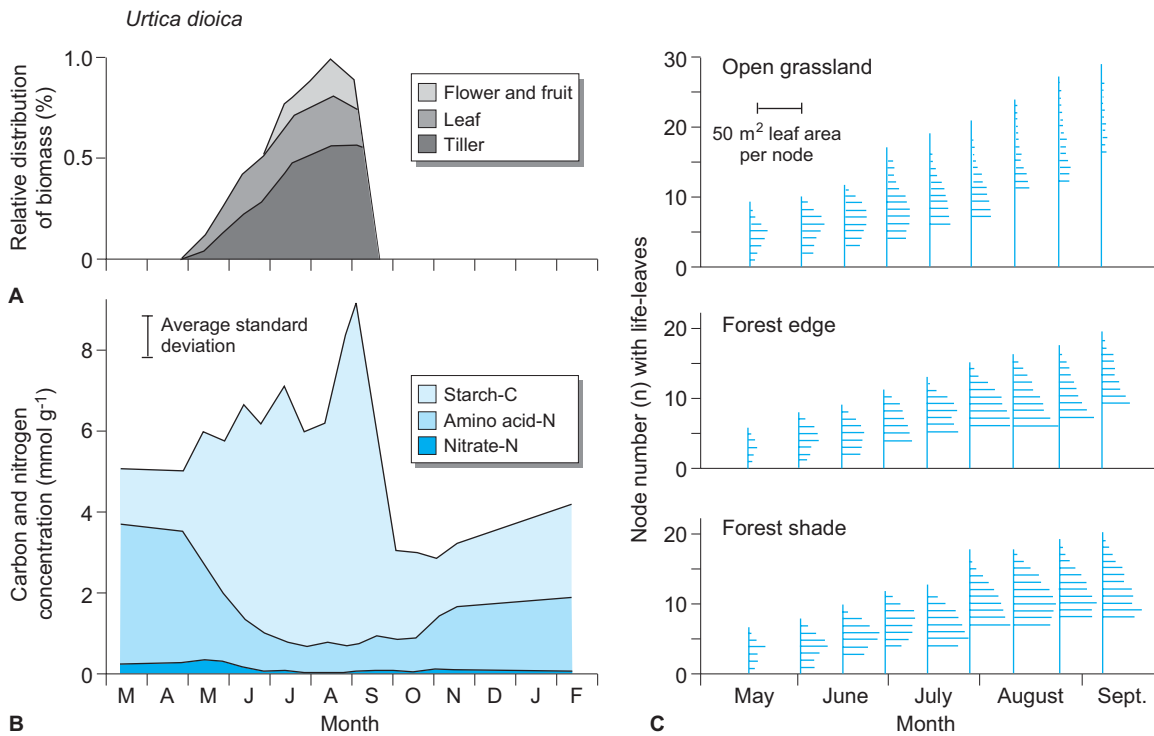


Fig. 2.4.28. Annual progression of **A** growth in biomass and **B** changes in storage products starch, amino acids and nitrate in the rhizome of the stinging nettle, *Urtica dioica*. It is interesting that rhizomes of nettles function in summer as a starch store and in winter as an N store for amino acids. **C** Schematic of leaf development in *Urtica*. Height of stems and size of leaves are shown. With growth of stems, new leaves are formed at their tips, and at the same time leaves at the base of the stem die, so the number of leaves per stem remains constant. In shaded areas fewer but larger leaves are formed. In open areas there are more leaves of smaller area. In this way, more stems per unit area can exist in brightly illuminated locations. (Stitt and Schulze 1994)

meander through the soil and new shoots are formed at their tip; eventually, the end of the rhizome dies off. On nutrient-rich sites, rhizomes (more than 12 years old) are formed which are probably only destroyed by burrowing animals. On dry sites taproots with secondary growth in thickness are formed, supplying a whole cohort of shoots with short rhizomes with water. Therefore, it is not surprising that it is very difficult to eradicate a bed of nettles (*Urtica dioica*) or ground elder (*Aegopodium podagraria*) in a garden. Couch grass (*Agropyron repens*) is an example of a successful perennial rhizomatous weed in crops.

Perennial herbaceous species are successful where there are **continuously poor growing conditions** for growth. They occupy shady forest floors, salty sites, dry sites and cold habitats. It is these plants that occur at greatest elevation in Alpine regions (*Stellaria decumbens* in the Himalayas above 6000 m) and go furthest north in the Arctic (*Saxifrage oppositifolia*, 83' north). *Allocasia macrocarpa* is the species in which the

lowest light saturation of photosynthesis was measured ($80 \mu\text{mol m}^{-2} \text{s}^{-1}$ photons). Some perennial herbaceous species only flower once and require several years to store sufficient resources for flowering. These “monocarpic” species not only include *Agava*, but also bamboo species and tropical alpine giant rosette plants (*Lobelia*, *Senecio*; see Chap. 1.3.6.7).

For herbaceous perennial species there is a **maximum size** of the vegetative body, when respiration in non-photosynthetically active organs consumes the C gained by leaves. Bananas have to be cut back to maintain the development of flowers and fruits. Old shrubs do not develop flower panicles. Some species cope with this limitation of structure by secondary lignification of the shoot (e.g. sunflower). Secondary thickening is rather rare in perennial herbaceous species, but does occur, for example, in the root of nettles. Many herbaceous temperate species have close relatives in the woody flora of tropical regions.

The fact that a balance of resources between respiring and assimilating biomass occurs in

perennial herbaceous species becomes particularly obvious in grasses where maximum production is reached with **grazing or mowing**. Grasses are predestined for such a use as they are able to regenerate new leaves quickly after herbivory, because of the intercalary growth of the leaf sheath. Grasses of the “old world” are better adapted to grazing than those of the “new world”. The typical cluster grass of the American Prairie, the genus *Bouteloua*, was completely eradicated after introduction of horses, as *Bouteloua* does not root firmly enough in the soils and the clumps were ripped out by horses.

2.4.5.4

Woody Plants

Woody plants, **trees and shrubs**, are always perennial. They often flower and fruit only after decades. They differ from herbaceous species particularly by the fact that the growth of the woody body is balanced by the transition of living **sapwood** into dead **heartwood**. This does not have to occur synchronously, but is influenced by environmental conditions and species-specific characteristics. In the whole plant the capacity of the xylem determines the leaf area, and the leaf area in turn determines growth and area of sapwood. This was shown in the “**pipe model**” (Shinozaki et al. 1964), starting from a balance of growth processes in the stem, branches and leaves which is regulated by the conductive area of the xylem. The ring-porous oak only has three to five functioning annual rings in contrast to spruce which has over 30, as spruce wood consists of tracheids with low hydraulic conductance and little medullary ray parenchyma. It is important for the C balance that the respiring woody body remains constant, independent of growth and changes with the leaf mass (see also Chap. 2.2.2.2). Using dead, that is non-respiring biomass (heartwood), as the supporting apparatus, the functional limitation of the **size of the vegetative body** no longer applies, removing the limitation to growth in plants that do not lignify. However, even in trees there is a functional maximum size. This is achieved in the tallest trees on earth (*Eucalyptus marginata*, South West Australia; 140 m) and probably the thickest trees (*Agatis australis*, New Zealand, 7 m diameter, 50 m height; Fig. 2.4.29 A) or in trees with the greatest volume (*Sequoia gigantea*, California, General Sherman tree, 96 m height, 6 m di-

ameter at the root, volume 5500 m³). The maximum size at which respiration of non-green parts is in balance with assimilation of green parts is not only achieved in large trees, but also in shrubs. For *Calluna*, for example, flowering depends on grazing which regulates the ratio of green to non-green biomass. For ungrazed plants the non-green biomass increases, the amount of shoots remains constant and the investment in flowers decreases with age. Similar effects have been shown for fruiting trees (apple), which need to be “cut back” in order to increase the yield of fruits.

Storage of carbohydrates and nitrogen-containing substances is also very important in trees. Leaf emergence and early tree ring growth occur from the mobilisation of amino acids and carbohydrates from the woody parenchyma. In spruce, N concentration in the sap water increases to >5 mM in spring. Bottle trees (e.g. *Adansonia digitata*; separating pages to Chap. 1.6) do not store water, but carbohydrates and amino acids for dry periods (Schulze et al. 1998). In vegetation which regenerates by fire (Mediterranean vegetation), there are so-called **seeders**, fruits of which open only with fire allowing seeds to fall into the fresh ash and germinate. These species do not have storage parenchyma in roots and the starch concentration in the root is small (1.9±0.5 mg starch per g dry weight of root). This contrasts to so-called **sprouters** which emerge after the fire from the root (Fig. 2.4.29 B); these have 14.1 g starch per dry weight root (Bell et al. 1996). Obviously, in cold winter climates, most N is stored (as the soil is still cold at the time of emergence), whilst in fire climates predominantly carbohydrates are stored, as the ash contains sufficient nutrients for the new vegetation.

A particularly impressive C economy exists in trees which become very old; *Pinus aristata* is the **longest living** tree species (Fig. 2.4.29 C, D; disregarding species with runners) with more than 4000 years. This species occurs in the high Alpine dry regions of Nevada. In this climate, wood is only slowly degraded and conditions allow only very slow growth. Most of its cambium dies within a 1000 years. Only a small strip of the living bast remains, keeping the ratio of green biomass to respiring biomass almost constant. Trees grow like a board, 1–2 m wide and only 10–15 cm thick. Without external interference (lightning, storms) these trees may potentially live forever (LaMarche et al. 1984; Fritts et al. 1991).



Fig. 2.4.29. **A** Barrel-like trees: *Agatis australis*, Kauri, in the subtropical forest of New Zealand's North Island. The base of the stem is branchless and may achieve 45 m in height with 6–7 m diameter. Dimensions become clear with Waltraud Schulze climbing a liana. **B** *Eucalyptus pauciflora* as an example of sprouting plants, i.e. tree species which re-generate from hypocotyl buds after fire. **C** *Pinus arsitata* in the Snake Mountains of Nevada at 3500 m above sea level; an example of extreme longevity. Trunks may be more than 4000 years old, resulting from death of the cambium which, except for a narrow strip, grows in balance with the resource supply from the shoot. Thus an equilibrium is achieved between assimilation and respiration and between shoot and root. The trunk grows only in width on the side with the living cambium, i.e. the trunk develops in the shape of a plank over a long period. A trunk in broad aspect with E.-D. Schulze and **D** side aspect, with Valmore LaMarche in the picture



E Aerial roots of *Ficus*, growing through the canopy of a rain forest in Costa Rica. **F** After reaching the ground with its aerial root and thus securing water, *Ficus* enmeshes the host with a root net, Lamington, Queensland, and thus kills the host. **G** *Ficus superba* with stilt roots which grow from the canopy to the soil, supporting the canopy and supplying it with water and nutrients, Yakushima, Japan. **H** Central hole in the trunk of a *Ficus*, showing the position of the original host. (Photos E.-D. Schulze)

Amongst the many life-forms termed “tree” (Vareschi 1980) are **figs**, which are masters in carbohydrate economy. They germinate as epiphytes in the canopy of the rain forest and grow with a large aerial root through the canopy (Fig. 2.4.29 C, F). As soon as the roots have reached the soil and thus water, they enclose the host with a mesh of roots. The host dies as its phloem transport is interrupted by strangulation from the fig, which then uses nutrients released from the decomposing wood of the host. In the end only a chimney-like structure remains of the host (Fig. 2.4.29 H). The fig then increases in size by forming new aerial stilt-like supporting roots and conquers a new habitat for the tree. *Ficus benegalensis* (Fig. 2.4.29 G) produces many hundreds of stilt roots covering an area of >20 ha, under which “an army of 20,000 men could camp in the shade”, according to Warburg (1913). Similar areas are covered by *Populus deltoides*, with underground runners, in the southern boreal forests of Canada.

Trees and **shrubs** are distinguished from each other by height (greater or less than 2 m, respectively, according to Ellenberg (1978), or greater or less than 5 m according to the FAO (2000), and are functionally distinguished by the different arrangement of regenerating buds (Fig. 2.4.30). In trees there is an apical dominance, also called **acrotony** (e.g. in spruce) in which the terminal bud remains. The term **amphitony** is used if the terminal bud remains, but only one of the lateral buds develops (*Fagus*). In some trees the terminal bud dies off and the next bud at the upper side of twigs takes the lead, which is called **hypotony**, e.g. in *Acer* or *Thilia*. Some deciduous trees have acrotonic growth in the juvenile period and hypotonous growth when older (*Acer pseudoplatanus*). In contrast, shrubs have renewal buds predominantly in the lower region of branches (hazel, **basitonic dominance**) or on the underside of branches, also called **epitonic growth** (e.g. *Rosa*, *Rubus*). Obviously, there are many transitions between these extremes, but it is usually possible to determine the tree form from the dominance of bud development along the main axis of the stem and along the branches. Thus, true trees are **monopodial** (one stem) while shrubs and tree-like shrubs are mostly **sympodial** (many stems). These different types of growth determine competition and succession in hedgerows (Küppers 1989).

In woody plants the shoot-root communication depends on the species and is tuned so that

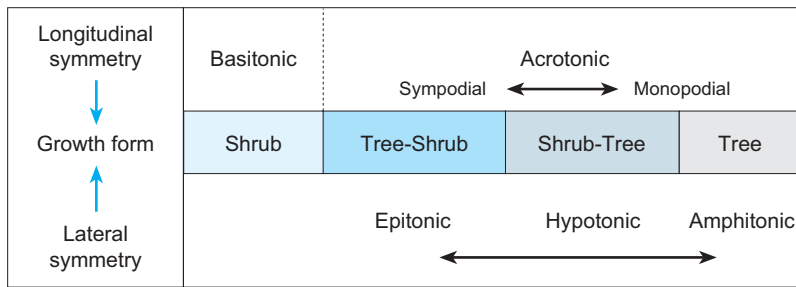
shoot and root growth are tightly correlated (Fig. 2.4.31; Heilmeyer et al. 1997) – even if, under extreme stress conditions, very different tree sizes are reached. For the almond, *Prunus dulcis*, there is tight correlation between root and shoot biomass as well as between leaf area and length of fine roots. Such regulation is also observed in basitonic shrubs. Evenari et al. (1982) called the phenomenon of a root-shoot regulation “**survival through dieback**” which is common in arid regions. In a dry year part of the shrub dies back and only a few shoots survive which are in balance with the root.

In addition to the regulation of the respiring mass of their woody body, trees have another means of regulation, **the life span of assimilatory organs**. Distinction is made between:




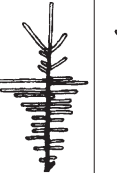
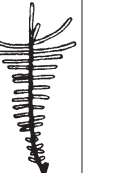
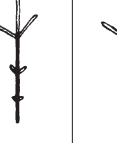

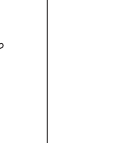







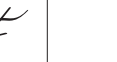
- **deciduous** species (trees of temperate forests and rain-green savannahs) with seasonal changes in leaves;
- **semi-evergreen** species with a life span of assimilatory organs of about 12–14 months, when the old leaves are shed with the emergence of new leaves (*Eucalyptus* and many tropical species);
- **evergreen** species with a life span of their assimilation organs of up to 35 years (*Pinus aristata*, California).

Deciduous and evergreen assimilatory organs show functional differences:

- **Evergreen** species have a larger dry weight per area because they usually are forced to survive very unfavourable conditions (cold, drought).
- A smaller rate of CO₂ assimilation in evergreen species than in deciduous species correlates with the larger dry weight per area. Short-lived leaves have a greater CO₂ gain per time than long-lived leaves, which experience so-called “diminishing returns” (smaller returns per unit of investment with time). This investment should be compared with a possible maximisation of physiological activity with lower investment in protecting cell walls.
- Evergreen species are able to use intermittently favourable weather conditions to assimilate (spruce is able to assimilate CO₂ on warm days during the European winter). Assimilation starts earlier in spring than for deciduous species and lasts longer in autumn. For deciduous species the growing season is often limited by early or late frosts.



A

	<i>Rubus</i>	<i>Rosa</i>	<i>Ribes</i>	<i>Prunus</i>	<i>Crataegus</i>	<i>Cornus</i>	<i>Acer</i>	<i>Fagus</i>
Branching pattern	Sympodial	Sympodial	Sympodial	Sympodial	Sympodial	Monopodial	Monopodial	Monopodial
Longitudinal symmetry	 Basitonic	 Basitonic	 Weakly basitonic	 Mesotonic acrotonic	 Mesotonic acrotonic	 Mesotonic acrotonic	 Mesotonic acrotonic	 Mesotonic acrotonic
Lateral symmetry	 Strongly epitonic	 Strongly epitonic	 Strongly epitonic	 Weakly epitonic	 Epitonic and hypotonic	 Weakly epitonic	 Strongly hypotonic	 Amphitonic
				<i>Prunus spinosa</i>	<i>Crataegus macrocarpa</i>		<i>Acer campestre</i>	<i>Fagus sylvatica</i>
Volume gain per dry-matter investment of single twigs ($\text{m}^3 \text{kg}^{-1}$)				0.038	0.078		0.134	0.549

B



C

Fig. 2.4.30. **A** Definitions of terms in dominance of buds in vertical (main stem) and horizontal (branches) axes of a woody plant. Shoot dominance ultimately determines the growth forms of woody plants. **B** Schematic of the important features of symmetry in native woody plants in a hedge (Troll 1939; Küppers 1985; Schulze et al. 1987) and quantification of the competitiveness of selective species based on the volume of the living space occupied per unit of dry mass and per unit photosynthetic carbon acquisition of the leaves. Species in the later succession have a greater capacity to exploit the space and also a larger assimilate acquisition per unit of invested twig mass. **C** Hedge landscape on limestone near Stadtsteinach, Upper Franconia, Germany. The hedge shows a typical succession from the edge to the centre with *Prunus spinosa* as the woody pioneer plant at the edge followed by *Rubus* and *Rosa* species. Then *Crataegus* and finally *Rhamnus cathartica* and *Acer campestre* follow. (Photo E.-D. Schulze)

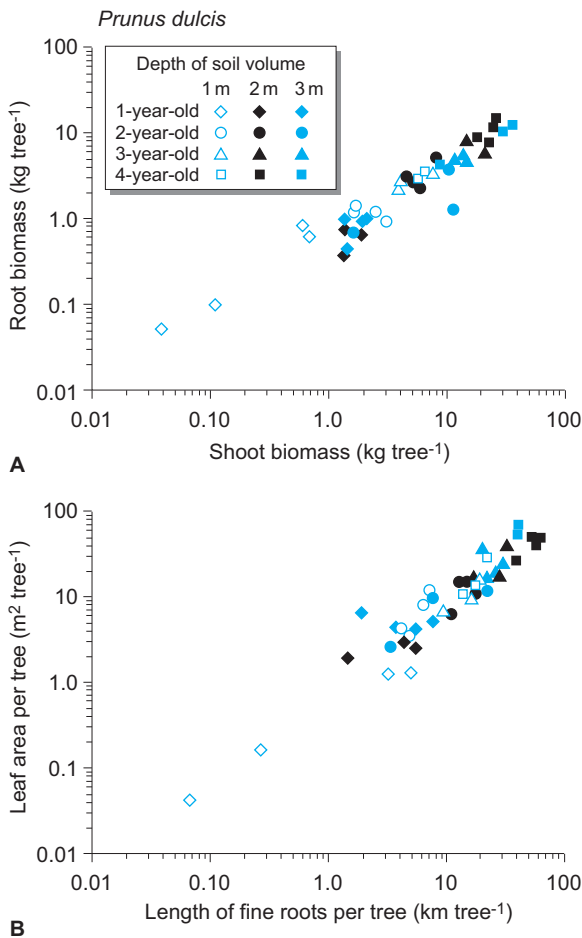


Fig. 2.4.31. Correlation between **A** root and shoot biomass and **B** leaf area and length of fine roots in *Prunus dulcis*. Plants were grown at the Avdat research station in the Negev Desert, in containers 3 m in diameter and 1, 2, or 3 m deep. Plants were watered only once in spring and had to regulate shoot and root growth in relation to the water stored in the soil. The strong correlation between shoot and root is independent of the absolute water supply and the size of the plant, the allometry between shoot and root is constant. Environmental factors determine the capacity for growth in this woody plant but not the partitioning of material. The plant is a grafted cultivated plant in which shoot and root have their own genetic programme, so the equilibrium is regulated by resource distribution within the plant (Heilmeier et al. 1997). **C** View of experiments on almonds at the runoff farm, Avdat. (Evenari et al. 1982)

- **Deciduous species** must form their assimilation organs again each year, which leads to substantial consumption of carbohydrate reserves. Evergreen species in contrast are able to put up with a greater respiration of needles as they do not have the enormous demand for resources required to completely build up the assimilating biomass. The material balance of both leaf types is surprisingly similar (see Table 2.4.1) and the amount of usable wood mass depends again on the distribution to stem and branches which depends on the species. The allocation scheme of C distribution is genetically fixed. Thus material gain is dependent on the environment, but the shoot-root relations remain almost constant (Heilmeier 1997).
- Deciduous growth requires a high nutrient uptake at the time of emergence. Thus deciduous species are more frequently found on nutrient-rich soils than evergreen species.

It becomes obvious that there are several advantages and disadvantages of evergreen and deciduous assimilatory organs and it is, therefore, not surprising that in many plant communities both leaf types (deciduous and evergreen) exist side by side. Analysing advantages and disadvantages of both types shows:

- All factors (**shade, cold**) that reduce the **C gain** of the plant (**assimilation × leaf area**) lead to longer life of the assimilatory organs. Plants with high respiratory rates and low C gain must minimise investment into new assimilatory organs in order to safeguard the supply to the respiring organs. The plant manages this only by prolonging the life span of assimilatory organs. For example, the boreal pine forest succeeds temperate deciduous forest in Alpine regions as well as at higher latitudes where the growing period becomes shorter. With increased supply of nutrients,

Box 2.4.6

Summary: The carbon balance

- **CO₂ assimilation**, also termed **net photosynthesis**, is the balance between photosynthetic CO₂ fixation and respiration of a leaf. It is an important quantity in considering the ecological carbon balance. It depends on climatic factors (light, temperature, atmospheric humidity) and also on factors within the plant (nutrition, water status, age). The physical process of CO₂ diffusion into the leaf is regulated by the stomatal aperture. Linear relationships occur, over a wide range, between the nitrogen content of leaves and specific leaf area and between nitrogen content and net photosynthesis, as well as between CO₂ exchange and conductance of leaves and of canopies.
- **Plant growth** is determined by the CO₂ assimilation balanced against respiration of all non-assimilating parts of the plant. Distinction is drawn between growth respiration (energy from respiration which is required for growth) and maintenance respiration (energy from respiration used for maintenance of the existing living organism). The balance between assimilation and respiration is called net primary production. Plant species are distinguished particularly by the way in which accumulated assimilates are distributed to shoots and roots and how parts of the plant die (i.e. require no further energy from maintenance respiration) or maintain their structure (heartwood formation). The carbon economy is further determined by the turnover of the leaf cover; a functional distinction is drawn between annual species, biannual species, herbaceous perennials, evergreen and deciduous woody forms.
- The **vegetation** of the earth and the invasion of different habitats by species are explicable on the basis of resource use, particularly of water and nutrients (see Chap. 4).

e.g. after a fire, these unfavourable climatic conditions are compensated, so that succession may occur at first via deciduous birch or poplar. In the central Asian continental climate, the evergreen boreal forest is replaced by deciduous larch forest where investment in needles is particularly low (Schulze et al. 1995). This species is, therefore, able to utilise the warm continental summer better than evergreen species in oceanic climates. Additionally, in the continental climate with extremely cold winters, the investment in protection of evergreen needles increases and a bud is less endangered than a fully developed assimilatory organ. Obviously, the functional causes of the change from evergreen to deciduous boreal conifers are diverse. Larch is dominant in Asiatic but not in the North American boreal forests. The difference between continents is the reaction to dryer periods in summer in continental Asia and compared to the high temperatures in the Siberian summer that do not limit photosynthesis, i.e. deciduous leaves are an advantage. In the Siberian winter, on the other hand, temperatures are so cold (-50 to -70 °C) that damage

to evergreen needles is possible; this would greatly affect the C balance. In East Siberia the evergreen *Picea obovata* still occurs on riverbanks so that drought and related fires are probably also deciding factors responsible for the dominance of larch.

- **Nutrient deficiency** leads to reduced photosynthesis, and higher investment in roots is required. This leads generally to evergreen growth (example: tropical evergreen forests, Australian sclerophyll woodlands).
- **Lack of water** stimulates evergreen growth (Mediterranean sclerophyll woodlands) where in the winter rain regions occasional rains are also possible in summer (thunder storms) and thus the evergreens are able to bridge the short dry periods (deep roots). In Southern California and Mexico there are shrubs, the so-called ombrophytes (genus *Fouquieria*), whose leaves emerge after each precipitation many times per year but are only active for a few days. As these plants are not able to store water, the duration of the drought period determines which species occur. Even in the Mediterranean vegetation there are deciduous species at particularly dry sites. The subtro-

pical savannah is a further example of the change from evergreen tropical to deciduous vegetation. However, drought, together with nutrient deficiency, can again be of advantage for evergreen species which often do not form leaves but phylodes or phyloclades, similarly to, for example, *Acacia* in Australia. Very long drought periods are thus of advantage to evergreen species, often together with reduction of leaves and formation of assimilating shoots (Chenopodiaceae in North Africa).

References

- Amthor JS (1989) Respiration and crop productivity. Springer, Berlin Heidelberg New York, 215 pp
- Arneth A, Kelliher FM, McSeveny TM, Byers JN (1999) Assessment of annual carbon dioxide exchange in a water-stressed *Pinus radiata* plantation: an analysis based on eddy covariance measurements and an integrated biophysical model. *Global Change Biol* 5:531–545
- Arneth A, Lloyd J, Santrucova H, et al (2002) Response of central Siberian Scots pine to soil water deficit and long-term trends in atmospheric CO₂ concentration. *Global Biogeochem Cycles* 16:5–13
- Bell TL, Pate JS, Dixon KW (1996) Relationship between fire response, morphology, root anatomy and starch distribution in south-west Australian Euphorbiaceae. *Ann Bot* 77:357–364
- Biscoe PV, Scott RK, Monteith JL (1975) Barley and its environment. III. Carbon budget of the stand. *J Appl Ecol* 12:269–293
- Björkman O (1971) Comparative photosynthetic CO₂ exchange in higher plants. In: Hatch MD, Osmond CB, Slatyer RO (eds) *Photosynthesis and photorespiration*. Wiley, New York, pp 18–34
- Björkman O (1981) Responses to different quantum flux densities. *Encycl Plant Physiol* 12A:57–108
- Björkman O, Demmig-Adams B (1994) Regulation of photosynthetic light energy capture, conversion, and dissipation in leaves of higher plants. *Ecological Studies* 100. Springer, Berlin Heidelberg New York, pp 17–70
- Chapin FS III, Schulze ED, Mooney HA (1990) The ecology and economics of storage in plants. *Annu Rev Ecol Syst* 21:423–447
- Clayton WD (1981) Evolution and distribution of grasses. *Ann Mo Bot Gard* 68:5–14
- Cowan IR, Farquhar GD (1977) Stomatal function in relation to leaf metabolism and environment. In: Jennings JR (eds) *Interaction of activity in the higher plant*. Cambridge University Press, Cambridge, pp 471–505
- dePury DGG, Farquhar GD (1999) A commentary on the use of a sun/shade model to scale from the leaf to a canopy. *Agric For Met* 95:257–260
- Ehleringer JR, Cerling TE (2001) Photosynthetic pathways and climate. In: Schulze E-D, Heimann M, Harrison S, Holland E, Lloyd J, Prentice C, Schimel D (eds) *Global biogeochemical cycles in the climate system*. Academic Press, San Diego, 350 pp
- Ehleringer JR, Cerling TE, Helliker BR (1997) C₄ photosynthesis, atmospheric CO₂, and climate. *Oecologia* 112:385–399
- Ellenberg H (1978) *Vegetation Mitteleuropas mit den Alpen*. Ulmer, Stuttgart, 981 pp
- Evans LT (1972) Evolutionary, adaptive and environmental aspects of the photosynthetic pathway. In: Hatch MD, Osmond CB, Slatyer RO (eds) *Photosynthesis and photorespiration*. Wiley, New York, pp 130–137
- Evenari M, Shanan L, Tadmor N (1982) *The Negev; the challenge of a desert*. Harvard University Press, Cambridge, 437 pp
- FAO (2000) *Forest resources of Europe, CIS, North America, Australia, Japan and New Zealand*. Main report. United Nations, New York, Geneva, 445 pp
- Farquhar G, Lloyd J (1993) Carbon and oxygen isotope effects in the exchange of carbon dioxide between terrestrial plants and the atmosphere. In: Ehleringer JR, Hall AE, Farquhar GD (eds) *Stable isotopes and plant carbon-water relations*. Academic Press, San Diego, pp 47–70
- Farquhar GD, von Caemmerer S (1982) Modelling of photosynthetic response to environment. *Encycl Plant Physiol* 12B:549–587
- Farquhar GD, Ehleringer JR, Hubick KT (1989) Carbon isotope discrimination and photosynthesis. *Annu Rev Plant Physiol Plant Mol Biol* 40:503–537
- Farquhar GD, von Caemmerer S, Berry JA (1980) A biochemical model of photosynthetic CO₂ assimilation in leaves of C₃ species. *Planta* 149:78–90
- Fichtner K, Schulze E-D (1992) The effect of nitrogen nutrition on growth and biomass partitioning of annual plants originating from habitats of different nitrogen availability. *Oecologia* 92:236–241
- Field C, Mooney HA (1986) The photosynthesis-nitrogen relationship in wild plants. In: Givnish TJ (ed) *On the economy of plant form and function*. Cambridge University Press, Cambridge, pp 25–56
- Fritts HC, Vaganov EA, Sviderskaya IV, Shashkin AV (1991) Climatic variation and tree-ring structure in conifers: empirical and mechanistic models of tree-ring width, number of cells, cell size, cell-wall thickness and wood density. *Climate Res* 1:97–116
- Fuchs M, Schulze E-D, Fuchs MI (1977) Spatial distribution of photosynthetic capacity and performance in a mountain spruce forest of northern Germany. II. Climatic control of carbon dioxide uptake. *Oecologia* 29:329–340
- Gifford RM (1974) A comparison of potential photosynthesis, productivity and yield of plant species with differing photosynthetic metabolism. *Aust J Plant Physiol* 1:107–117
- Gillon J, Yakir D (2001) Influence of carbonic anhydrase activity in terrestrial vegetation on the ¹⁸O content of atmospheric CO₂. *Science* 291:2584–2587
- Harley PC, Tenhunen JD, Lange OL (1986) Use of an analytical model to study limitations on net photosynthesis in *Arbutus unedo* under field conditions. *Oecologia* 70:393–401
- Hattersley PW (1992) C₄ photosynthetic pathway variation in grasses (Poaceae): its significance for arid and semi-arid lands. In: Chapman G (ed) *Desertified grasslands: their biology and management*. Academic Press, London, pp 181–212
- Heilmeyer H, Schulze E-D, Whale DM (1986) Carbon and nitrogen partitioning in the biennial macrocarp *Arctium tomentosum* Mill. *Oecologia* 70:466–474
- Heilmeyer H, Erhart M, Schulze E-D (1997) Biomass allocation and water use under arid conditions. In: Bazzaz F, Grace J (eds) *Plant resource allocation*. Academic Press, San Diego, pp 93–112
- Hollinger DY, Kelliher FM, Byers JN, Hunt JE, McSeveny TM, Weir PL (1994) Carbon dioxide exchange between

- an undisturbed old-growth temperate forest and the atmosphere. *Ecology* 75:134–150
- Jarvis PG (1971) The estimation of resistances to carbon dioxide transfer. In: Sestak Z, Catsky J, Jarvis PG (eds) *Plant photosynthetic production: manual of methods*. Junk, Den Haag, pp 566–631
- Jarvis PG (1976) The interpretation of the variations in leaf water potential and stomatal conductance found in canopies in the field. *Philos Trans R Soc Lond B* 273:593–610
- Jones HG (1994) *Plants and microclimate*, 2nd edn. Cambridge University Press, Cambridge, 428 pp
- Jones HG (1999) Use of thermography for quantitative studies of spacial and temporal variation of stomatal conductance over leaf surfaces. *Plant Cell Environ* 22:1043–1055
- Kaiser WM (1982) Correlation between changes in photosynthetic activity and changes in total protoplast volume in leaf tissue from hygro-, meso- and xerophytes under osmotic stress. *Planta* 154:538–545
- Kappen L, Lange OL, Schulze E-D, Evenari M, Buschbom U (1976) Distributional pattern of water relations of *Hammada scoparia* (Pomel) Iljin in a desert environment. *Oecologia* 23:323–334
- Kappen L, Lange OL, Schulze E-D, Evenari M, Buschbom U (1972) Extreme water stress and photosynthetic activity of the desert plant *Artemisia herba-alba*, Asso. *Oecologia* 10:177–182
- Kirschbaum MUF, Farquhar GD (1984) Temperature dependence of whole-leaf photosynthesis in *Eucalyptus pauciflora* Sieb. Ex Spreng. *Aust J Plant Physiol* 11:519–538
- Küppers M (1985) Carbon relations and competition between woody species in a central European hedgerow. IV. Growth form and partitioning. *Oecologia* 66:343–352
- Küppers M (1989) Ecological significance of aboveground architectural patterns in woody plants: a question of cost-benefit relationships. *Trends Ecol Evol* 4:375–379
- LaMarche VC Jr, Graybill DA, Fritts HC, Rose MR (1984) Increasing atmospheric carbon dioxide: tree ring evidence for growth enhancement in natural vegetation. *Science* 252:1019–1021
- Lange OL (1959) Untersuchungen über den Wärmehaushalt und die Hitzeresistenz mauretanischer Wüsten- und Savannenpflanzen. *Flora* 147:595–651
- Lange OL (1965) Experimentell-ökologische Untersuchungen an Flechten der Negev-Wüste. I. CO₂-Gaswechsel von *Ramalina maciformis* (Del.) Bory unter kontrollierten Bedingungen im Laboratorium. *Flora* 158:324–359
- Lange OL (1988) Ecophysiology of photosynthesis: performance of poikilohydric lichens and homoiohydric Mediterranean sclerophylls. The seventh Tansley lecture. *J Ecol* 76:914–937
- Lange OL, Schulze E-D, Evenari M, Kappen L, Buschbom U (1975a) The temperature-related capacity of plants under desert conditions. II. Possible controlling mechanisms for the seasonal changes of the photosynthetic response to temperature. *Oecologia* 18:45–53
- Lange OL, Schulze E-D, Kappen L, Evenari M, Buschbom U (1975b) CO₂-exchange patterns under natural conditions of *Caraluma negevensis*, a CAM plant of the Negev Desert. *Photosynthetica* 9:318–326
- Lange OL, Geiger IL, Schulze E-D (1977) Ecophysiological investigations on lichens of the Negev Desert. V. A model to simulate net photosynthesis and respiration of *Ramalina maciformis*. *Oecologia* 28:247–259
- Lange OL, Beyschlag W, Tenhunen JD (1987) Control of leaf carbon assimilation – input of chemical energy into ecosystems. *Ecological Studies* 61. Springer, Berlin Heidelberg New York, pp 148–163
- Larcher W (1994) *Ökophysiologie der Pflanzen*. UTB, Eugen Ulmer, Stuttgart, 394 pp
- Leuning R (1995) A critical appraisal of a combined stomatal-photosynthesis model for C₃ plants. *Plant Cell Environ* 18:339–355
- Leuning R, Dunin FX, Wang YP (1998) A two-leaf model for canopy conductance, photosynthesis and partitioning of available energy. II. Comparison with measurements. *Agric Fort Met* 91:113–125
- Lloyd J, et al (1995a) A simple calibrated model of Amazon rainforest productivity based on leaf biochemical properties. *Plant Cell Environ* 18:1129–1145
- Lloyd J, et al. (1995b) Measuring and modelling whole-tree gas exchange. *Aust J Plant Physiol* 22:987–1000
- Lloyd J, Kruijt B, Hollinger DY, Grace J, Francey RJ, Wong SC, Kelliher FM, Miranda AC, Fraquhar GD, Gash JHC, Vygodskaya NN, Wright IR, Miranda HS, Schulze ED (1996) Vegetation effects on the isotopic composition of atmospheric CO₂ at local and regional scales: theoretical aspects and a comparison between rain forest in Amazonia and a boreal forest in Siberia. *Aust J Plant Physiol* 23:377–399
- Loreto F, Velikova V, Di Marco G (2001) Respiration in the light measured by ¹²CO₂ emission in ¹³CO₂ atmosphere in maize leaves. *Aust J Plant Physiol* 28:1103–1108
- Lüttge U (1999) One morphotype, three physiotypes: sympatric species of *Clusia* with obligate C₃ photosynthesis, obligate CAM and C₃-CAM intermediate behaviour. *Plant Biol* 1:138–148
- Lüttge U, Kluge M, Bauer G (1988) *Botanik*. VCH, Weinheim, 577 pp
- MacFadden BJ, Cerling TE (1996) Mammalian herbivore communities, ancient feeding ecology and carbon isotopes: a 10-million-year sequence from the Neogene of Florida. *J Vertebrate Paleontol* 16:103–115
- McCree KJ (1983) Carbon balance as a function of plant size in *Sorghum* plants. *Crop Sci* 20:82–93
- Merino J, Field C, Mooney HA (1982) Construction and maintenance costs of Mediterranean-climate evergreen and deciduous leaves. I. Growth and CO₂ exchange analysis. *Oecologia* 53:208–213
- Mifflin B (2000) Crop improvement in the 21st century. *J Exp Bot* 51:1–8
- Monsi M (1960) Dry-matter reproduction in plants. I. Schemata of dry-matter reproduction. *Bot Mag* 73:82–90
- Morison JIL, Piedade MTF, Müller E, Long SP, Junk WJ, Jones MB (2000) Very high productivity of the C₄ aquatic grass *Echinochloa polystachia* in the Amazon floodplain confirmed by net ecosystem flux measurements. *Oecologia* 125:400–411
- Mott KA, Gordon ZG, Berry JA (1993) Asymmetric stomatal closure for the two surfaces of *Xanthium strumarium* L. leaves at low humidity. *Plant Cell Environ* 16:25–34
- Mott KA, Parkhurst DF (1991) Stomatal response to humidity in air and helox. *Plant Cell Environ* 14:509–515
- Orians GH, Solbrig OT (1977) A cost-income model of leaves and roots with special reference to arid and semi-arid areas. *Am Nat* 111:677–690
- Pearcy RW, Pfitsch WA (1994) The consequences of sunflecks for photosynthesis and growth of forest understory plants. *Ecological Studies* 100. Springer, Berlin Heidelberg New York, pp 343–357
- Penning de Vries FWT (1975) Use of assimilates in higher plants. In: Cooper JP (ed) *JGP 3: photosynthesis and productivity in different environments*. Cambridge University Press, Cambridge, pp 459–480
- Penning de Vries FWT (1983) Modelling of growth and productivity. *Encycl Plant Physiol* 12D:117–150

- Penning de Vries FWT, Djitéye MA (1982) La productivité des pataurages Sahéliens: Une étude des sols, des végétations et de l'exposition de cette ressource naturelle. PU-DOC, Wageningen, 52 pp
- Penning de Vries FWT, van Laar HH, Chardon MC (1983) Bioenergetics of growth of seeds, fruits, and storage organs. In: Potential productivity of field crops under different environments. International Rice Institute, Los Banos, Philippines, pp 37–59
- Raschke K (1979) Movements of stomata. *Encycl Plant Physiol* 7:383–441
- Raven JA (1994) Photosynthesis in aquatic plants. *Ecological Studies* 100. Springer, Berlin Heidelberg New York, pp 299–318
- Roden JS, Ehleringer JR (1999) Observations of hydrogen and oxygen isotopes in leaf water confirm the Craig-Gordon model under wide-ranging conditions. *Plant Physiol* 12:1165–1173
- Scarascia-Mugnozza G, Bauer GA, Persson H, Mateucci G, Marci A (2000) Tree biomass, growth and nitrogen pools. *Ecological Studies* 142. Springer, Berlin Heidelberg New York, pp 49–62
- Schäfer C (1994) Controlling the effects of excessive light energy fluxes: dissipative mechanisms, repair processes, and long-term acclimation. In: Schulze E-D (ed) Flux control in biological systems. Academic Press, San Diego, pp 37–56
- Scheible WR, Gonzáles-Fortes A, Lauerer M, Müller-Röber B, Caboche M, Stitt M (1997) Nitrate acts as a signal to induce organic acid metabolism and repress starch metabolism in tobacco. *Plant Cell* 9:783–798
- Schulze E-D (1970) Der CO₂-Gaswechsel der Buche (*Fagus sylvatica* L.) in Abhängigkeit von den Klimafaktoren im Freiland. *Flora* 159:177–232
- Schulze E-D (1982) Plant life forms and their carbon water and nutrient relations. *Encycl Plant Physiol* 12B:616–676
- Schulze E-D, Chapin FS III (1987) Plant specialization to environments of different resource availability. *Ecological Studies* 61. Springer, Berlin Heidelberg New York, pp 120–148
- Schulze E-D, Hall AL (1982) Stomatal responses, water loss and CO₂ assimilation rates of plants in contrasting environments. *Encycl Plant Physiol* 1213:181–230
- Schulze E-D, Küppers M, Matyssek R (1987) The role of carbon balance and branching pattern in the growth of woody species. In: Givnish TJ (ed) On the economy of the plant form and function. Cambridge University Press, Cambridge, pp 585–602
- Schulze W, Stitt M, Schulze E-D, Neuhaus HE, Fichtner K (1991) A quantification of the significance of assimilatory starch for growth of *Arabidopsis thaliana* L. Heynh. *Plant Physiol* 95:890–895
- Schulze E-D, Kelliher FM, Körner C, Lloyd J, Lenning P (1994) Relationships among maximum stomatal conductance, ecosystem surface conductance, carbon assimilation and plant nitrogen nutrition: a global ecology scaling exercise. *Annu Rev Ecol Syst* 25:629–660
- Schulze E-D, Schulze W, Kelliher FM, Vygodskaya NN, Ziegler W, Kobak KI, Koch H, Arneth A, Ksnetsova WA, Sogachev A, Issajev A, Bauer G, Hollinger DY (1995) Above ground biomass and nitrogen nutrition in a chronosequence of pristine Dahurian *Larix* stands in eastern Siberia. *Can J For Res* 25:943–960
- Schulze E-D, Ellis R, Trmborn P, Ziegler H (1996) Diversity, metabolic types and $\delta^{13}\text{C}$ carbon isotope ratios in the grass flora of Namibia in relation to growth form, precipitation and habitat conditions. *Oecologia* 106:352–369
- Schulze E-D, Williams RJ, Farquhar GD, Schulze W, Langridge J, Miller JM, Walker BH (1998) Carbon and nitrogen isotope discrimination and nitrogen nutrition of trees along a rainfall gradient in northern Australia. *Aust J Plant Physiol* 25:413–425
- Shinozaki K, Yoda K, Hozumi K, Kira T (1964) A quantitative analysis of plant form – the pipe model theory. II. Further evidence of the theory and its application in forest ecology. *Jpn J Ecol* 14:133–139
- Steinlein T, Heilmeyer H, Schulze E-D (1993) Nitrogen and carbohydrate storage in biennials originating from habitats of different resource availability. *Oecologia* 93:374–382
- Stitt M, Schulze E-D (1994) Plant growth, storage, and resource allocation: from flux control in a metabolic chain to the whole plant level. In: Schulze E-D (ed) Flux control in biological systems. Academic Press, San Diego, pp 57–118
- Strasburger E (1999) *Lehrbuch der Botanik*. G. Fischer, Stuttgart, 1161 pp
- Tjoelker MG, Oleksyn J, Reich PB (2001) Modelling respiration of vegetation: evidence for a general temperature-dependent Q₁₀. *Global Change Biol* 7:223–230
- Troll W (1939) *Vergleichende Morphologie der Höheren Pflanzen*. Bd. 1: Vegetationsorgane. Verlag Gebrüder Bornträger, Berlin, 2005 pp
- Vareschi V (1980) *Vegetationsökologie der Tropen*. Ulmer, Stuttgart, 293 pp
- Volkens G (1887) *Die Flora der ägyptisch-arabischen Wüste auf Grundlage anatomisch-physiologischer Forschung*. Gebrüder Bornträger, Berlin, 151 pp
- Von Caemmerer S, Evans JR, Hudson GS, Andrews TJ (1994) The kinetics of ribulose-1,5-bisphosphate carboxylase/oxygenase in vivo interfered from measurements of photosynthesis in leaves of transgenic tobacco. *Planta* 195:88–97
- Warburg O (1913) *Die Pflanzenwelt*, Bd 1. Bibliographisches Institut, Leipzig Wien
- West NE, Young JA (2000) Intermountain valleys and lower mountain slopes. In: Barbour MG, Billings WD (eds) *North American terrestrial vegetation*. Cambridge University Press, Cambridge, pp 255–284
- Woodward GR (1976) Photosynthesis and expansion of leaves of soybean grown in two environments. *Photosynthetica* 10:274–279

Ecology of Ecosystems



Ecosystems are networks between organisms and interactions between organisms and their environment on limited space. The space limitation which determines the intensity of these interactions between organisms and environment is determined by the available area of ground. A cross-section through an ecosystem already shows the levels where these interactions are most intense. At the one end this is the leaf canopy where different plant life forms (trees, shrubs, herbs) compete for light by outshading the neighbors. At the other end intense competition exists in the soil where roots compete for water and nutrients. In the organic layer litter fall, decomposition and nutrient uptake interact chemically in such a way that organic acids are lost. This causes leaching of cations and results eventually in podsolization, which may make the area uninhabitable for some species. Only some species can penetrate into the resource rich deeper soil layers.

3.1

The Ecosystem Concept



Experimental stand of beech trees “B1” in Solling. The experimental site was important in the International Biological Program (IBP). It was the first time that all the fluxes in a terrestrial forest ecosystem were investigated. Methods developed in the years 1965–1975 at this site served as a model for the global work of the IBP (Ellenberg 1971; Ellenberg et al. 1986). Photo E.-D. Schulze

Recommended Literature

To understand the processes taking place in the ecosystem the following literature is recommended:

- Brady and Weil: Elements of the nature and properties of soil, 2nd edn. Prentice-Hall, Englewood Cliffs, New Jersey, 2004
- Schlesinger: Biogeochemistry. Academic Press, London, 1997
- Schulze: Flux control in biological systems. Academic Press, San Diego, 1994
- Schulze: Carbon and nitrogen cycling in European forest ecosystems. Ecol Studies vol 142. Springer, Berlin Heidelberg New York, 2000.

In previous chapters the focus was on the responses of cellular processes (Chap. 1: Stress physiology) and the use of resources by individual plants (Chap. 2: Whole plant ecology). In the following, these responses will be related to conditions where plants:

- do not grow on their own but form stands, i.e. they compete with individual plants of the same species (perhaps even of the same rhizome) or with other species,
- are subject to use by other organisms (herbivory, pathogens),

- rely on resources and conditions which arise from the activity of other species. This concerns particularly feedback supply of nutrients by microorganisms from dead organic matter into forms which can be used by plants.

The botanical analysis of these diverse interactions deals with the temporal and spatial dynamics of vegetation (history of vegetation, distribution of plant species, competition and succession). This will be discussed in Chapter 4: Synecology. However, there are also processes dealing with the turnover and the distribution of resources at certain sites. This “ecosystem aspect” will be discussed in this chapter.

By moving from the level of the individual plant to the level of material turnover at a site, the following conditions are changed:

- the reference system, and
- the availability of resources.

Reference system: Turnover no longer depends on the concentration (g g^{-1} or mol g^{-1}) of material in certain organs or individual plants, but on the use of the habitat where the ground surface area is the only constant reference ($\text{g m}^{-2}_{\text{ground}}$ or $\text{mol m}^{-2}_{\text{ground}}$) based on which air and ground surface area may be used by different organisms. The density of individuals and

the biodiversity are just as important and variable parameters in considering turnover per ground surface area as is turnover in different partial systems which relate to the ground area and are interconnected. These partial systems range from the living plant cover, via litter, to soil organisms. They may be individually or as a whole connected laterally with neighbouring systems.

Availability of resources: New system characteristics become important with the focus on the ground area of the stand. The plant does not exist on its own and independently in the space, but is incorporated into a complicated structure where the resources are also turned over by neighbours and made available, within limits, by soil organisms. The limitations of space also limit the use of external resources (light, water, CO₂).

3.1.1

What Is an Ecosystem?

The understanding that, at the level of the vegetation, additional higher order parameters were determined by the system itself led to the introduction of the term “ecosystem”. Tansley (1935) realised, in his definition of the term, that it is not a description of a symbiosis or parts of a super-organism, but the interaction of plants and animals with the physical-chemical environment. Because of the importance of the basic concepts describing the development of the term “ecosystem”, the original text is cited here:

I have already given my reasons for rejecting the term “complex organism” and “biotic community”. Clements’ earlier term “biome” for the whole complex of organisms inhabiting a given region is unobjectable, and for some purposes convenient. But the more fundamental conception is, as it seems to me, the whole system (in some sense of physics), including not only the organism complex, but also the whole complex of physical factors forming what we call the environment of the biome – the habitat factors in the widest sense. Though the organisms may claim our prime interest, when we are trying to think fundamentally, we cannot separate them from their special environment, with which they form one physical system.

It is the systems so formed which, from the point of view of the ecologist, are the basic units

of nature on the face of the earth. Our natural human prejudices force us to consider organisms (in the sense of biologists) as the most important part of these systems, but certainly the inorganic “factors” are also part – there could be no system without them, and there is constant interchange of the most various kinds within each system, not only between the organisms but between the organic and inorganic. These ecosystems, as we may call them, are of the most various kinds and size. They form one category of the multitudinous physical systems of the universe, which range from the universe as a whole down to the atom.

Ecosystems Are Thus Networks of Interrelations Between Organisms and Their Environment in a Defined Space

In this definition (1) boundaries of ecosystems and (2) their compartmentalisation remain unresolved. It is not resolved (3) whether new system characteristics occur which concern the system as a whole. Occasionally, ecosystems are defined as networks of interrelations without reference to space. In these cases, too, the interaction between organisms becomes only critical within the limitation of space.

3.1.2

Boundaries of Ecosystems

The size of an ecosystem is not pre-defined. The region should be uniform regarding the biogeochemical turnover, and contain all fluxes above and below the ground area under consideration. Likens (1992) considers river catchment areas as basic units for ecosystems within regional spaces, as material balance may only be completely quantified within such region. However, a river catchment area is subdivided into regions near brooks and those away from them and have, per ground area, very different turnover if peaty river valleys and dry woodlands are considered, for example. Considerable turnover occurs also in the flowing water itself, so that the balance of regions away from the flowing water appears almost impossible. River catchment areas integrate very heterogeneous parts of the region and would thus to be too wide a demarcation to be valid as a basic unit of ecosystems. The opposite extreme would be to consider a rotting tree in a forest as an ecosystem.

The limits of an ecosystem must, clearly, extend so far that the essential parts of material turnover per ground area (e.g. carbon assimilation, nitrogen mineralisation, formation of ground water, etc.) are taken into account quantitatively. A rotting tree trunk is, considered from this point of view, only a partial system within a forest. Only the total turnover describes the characteristics and limits of, for example, a forest ecosystem. This is independent of the fact that some organisms (migrating birds) also have influence beyond these limits or that partial areas of the system possess their own dynamics.

3.1.3

Compartmentalisation

The division of ecosystems into different compartments depends on the question posed. The following divisions appear, amongst others, sensible:

- Above-ground and below-ground compartments: This division separates autotrophic and heterotrophic processes. In addition, it is possible to subdivide into soil horizons, and stems, branches and leaves. This classification describes material fluxes and separates the ecosystem regarding atmosphere and ground-water.
- Trophic level: Producers, consumers and decomposers describe energy flux.
- Functional groups: Groups of species which behave similarly regarding certain characteristics are often considered together (e.g. nitrogen-fixing plants, insects sucking phloem, parasites, and many others). They may reflect important interfaces within the trophic level.
- Structural characteristics: The structure of vegetation is particularly important in the coupling of exchanges of vegetation with the atmosphere. The division into trees, shrubs and herbaceous plants is important here.

3.1.4

System Characteristics

The network of interrelations is complex, i.e. it is determined by a multitude of factors and interactions. They are far away from an equilib-

rium and undetermined, i.e. there is no goal for certain dynamic change. Ecosystems behave linearly only within a short time span. Because there are no closed systems, there are always irregularities. Thus ecosystems may “break down” and make space available for new compositions of species. Open systems may be disturbed externally, particularly by anthropogenic and climatic influences.

In ecosystems, several new system characteristics occur, whereby all transitions to whole plant ecology are transient. This applies particularly to the structure (e.g. roughness of surface, climate of the stand, spatial compartmentalisation) already discussed in Chapters 2.1, 2.2 and 2.3. New characteristics occur regarding the use of resources at the level of the ecosystem, and regarding the interaction of specific functions of many species (**biodiversity**). From the point of view of the individual plant, the most important system characteristic is that there are neighbours, which, in contrast to the very variable physical-chemical environment, possess a multitude of options and thus codetermine the success or failure of an individual or a species. Because of the interaction between organisms the following system characteristics are particularly important:

- **Material balance:** This concerns all organisms of the ecosystem. Compared to whole plant ecology, material pools and material fluxes and the resulting ecosystem balance become increasingly important when studying ecosystems. Even in the future it will hardly be possible to trace and measure all processes. Thus the balance of material fluxes consisting of input and output remains as the most important quantitative characteristic at the scale of a stand. Similarly to whole plant ecology, the following quantities are observed:
 - amount of material (pool size; g m^{-2}),
 - material flux ($\text{g m}^{-2} \text{ time}^{-1}$),
 - material balance, and here particularly loss and gain,
 - mechanisms regulating the size of the flux: regulation by substrate = **feed-forward**, regulation by products = **feed-back**, branching, modulation, Co-limitation (see also Chaps. 1 and 2),
 - in addition to material fluxes, there are also “information fluxes”, i.e. material fluxes are started (e.g. pollination), without the amount becoming visible in the material fluxes.

- **Differentiation between species and individual plants:** Ultimately, it is individual plants that successfully dominate or die within an ecosystem. Depending on neighbouring individuals, differences occur between the course of growth of different plants in an ecosystem, even in clonal monocultures. In addition, individual species have different direct or indirect effects on the whole system (so-called keystone species). Behaviour under conditions of competition is difficult to predict, as slight differences between species may have far-reaching cumulative consequences.
- **Time scale:** Accumulation and consumption of resources change basic life conditions in the long term. Often seconds are sufficient to assess physiological reactions. Material balance is often determined on a yearly basis. However, if it concerns conditions at a site, then dependent on losses and gains, centuries or millennia are appropriate time scales (Chadwick et al. 1999; see Fig. 3.5.1).
- **Random events and interference:** Survival of individual plants in an ecosystem is not only determined by physiological characteristics of the species, but often also randomly by who the neighbour is (see also Chap. 4.1.4). The chance whether, in a microspatial mosaic of environmental conditions, a plant germinates or grows next to a less competitive neighbour

may determine the success or failure of a species. The constitution of vegetation is decided during the seedling phase. With longer time scales individual processes, so-called interference, also become more important; storm damage, breakage caused by snow, drought, fire or economic measures of human beings may drastically change ecosystems within minutes. Material pools that accumulated over millennia may degrade within a very short time.

References

- Chadwick OA, Derry LA, Vitousek PM, Huebert BJ, Hedin LO (1999) Changing resources of nutrients during four million years of ecosystem development. *Nature* 397:491–497
- Ellenberg H (1971) Integrated experimental ecology. Methods and results of ecosystem research in the German Solling project. *Ecological Studies*, Vol 2. Springer, Berlin Heidelberg New York, 214 pp
- Ellenberg H, Mayer R, Schauer mann J (1986) Ökosystemforschung; Ergebnisse des Sollingprojektes 1966–1986. Eugen Ulmer Verlag, 597 pp
- Likens GE (1992) Some applications of the ecosystem approach to environmental problems and resource management. In: Teller A, Mathy P, Jeffers JNR (eds) Responses of forest ecosystems to environmental changes. Elsevier Applied Science, London, pp 16–30
- Tansley AG (1935) The use and abuse of vegetational concepts and terms. *Ecology* 42:237–245

3.2

Processes in Stands and Ecosystems



Self-thinning of a *Pinus contorta* forest in the Canadian Rocky Mountains. *Pinus contorta* has cones that only open after heating in fire, enabling the species to rejuvenate itself after a fire which kills the crowns of older trees. This results in a thick carpet of young trees that compete with each other, the weaker ones die and so the forest is thinned. The picture shows a large amount of dead wood, i.e. a large number of fallen dead trees and also a number of severely bent trees that are too weak to survive the snowfall in winter in this area. Self-thinning of growing trees is clearly visible. Thinning continues also in mature forests, unless other factors such as fires on the forest floor decrease the number of trees per area below a size-dependent maximum density. Alberta, Jaspers National Park, Canada. Photo E.-D. Schulze

3.2.1

Self-Thinning

Light is used in a stand according to Beer's extinction law, so that light in the stand of vegetation decreases exponentially (see Chap. 2.1.2). The upper limit for light capture by a stand is determined by the flux of radiation and the maximum leaf area index (LAI_{max}), which in turn is determined by the inclination and position of the leaf (horizontal, vertical, clumped; see Chap. 2.1.2.3). The consequence of this upper limit is that individual plants, living on a

given ground area, must share this maximum possible leaf area. The leaf area may occupy different layers of the vegetation. Based on Reineke (1933), Yoda et al. (1963) further formalised this relation and expressed the biomass per individual plant (W) as a function of density of individual plants (n), where c is a proportionality factor, depending on light and nutrient supply:

$$W = cn^{-3/2} \quad (3.2.1)$$

The equation states that in a closed, growing stand where the biomass per individual plant in-

creases, the number of individual plants per area must necessarily decrease. Fewer but larger individual plants survive at the cost of smaller individuals, which die. This process is called **self-thinning** of stands, where the factor $-3/2$ is called the self-thinning constant. The coefficient may be explained by the spatial expansion of mass (exponent 3) and the expansion of the projected area of an individual plant (exponent 2; Osawa and Allen 1993).

As the biomass per area (B) corresponds to the product of ($W \times n$), the self-thinning of stands result, according to Westoby (1984), from the multiplication of Eq. (3.2.1) by the factor n :

$$B = cn^{-1/2} \quad (3.2.2)$$

Taking the logarithm of this equation yields the linear equation:

$$\log B = \log c - \frac{1}{2} \log n \quad (3.2.3)$$

The equation shows that the maximum biomass which may be achieved on an area depends, for a particular species, on the number of individual plants. The slope of the line (-0.5) applies to a broad range of growth forms (herbaceous plants, shrubs, trees) in as far as these are kept in comparable conditions, in monoculture, and the maximum leaf area is reached dependent on the available light. The parameter c gives the productivity, which is determined by many factors such as site conditions and growth characteristics of the species. From the equation it follows that in a closed stand some of the individual plants must die when the critical limit of the leaf area is reached and if the biomass of the stand is to increase. The maximum achievable biomass depends essentially on the growth form of the dominant plant species (trees, herbaceous plants, position of the leaf and form of the canopy) and the available radiation.

An example of the process of self-thinning is shown in Fig. 3.2.1 A (Stitt and Schulze 1994). In a growing stand of nettles, the stems belong physiologically to the same organism, because of rhizomes. Initially, many individual plants may coexist, as long as their leaf biomass fills the growth space vertically and horizontally (Fig. 3.2.1 A, arrow 1). After that, the process of self-thinning starts, i.e. the biomass of the stand increases with the simultaneous decrease in the number of individual plants (Fig. 3.2.1 A, arrow

2). With the onset of flowering, the biomass of stems increases further with constant number of individual plants, but the flower stalks do not increase leaf area (Fig. 3.2.1 A, arrow 3). Biomass production is different between sites due to different light availability.

Deviations from the linear trend may occur under natural conditions predominantly in forests:

- **Decline of old growth forests:** Stem density decreases in old growth forest to an extent that it can no longer be compensated by the remaining trees. Individual trees die because of statistical events, e.g. lightning, storms or diseases, and the growth of the remaining stand, depending on species, results in a canopy that is no longer closed. With the opening of the canopy, external influences (e.g. wind) become more important and thus the number of individual plants is then further reduced. Gaps emerge which are used by other species or individuals of the same species and ultimately leads to the rejuvenation of the stand or a change in the vegetation (see Chap. 4.1.5.3). In plant ecology, this phase in the development of a stand is often called “the phase of stand collapse”. This term does not describe the causes of the collapse, i.e. that self-thinning and stochastic events reduced the number of individual plants and that the remaining stand is no longer able to close the canopy.
- **Availability of nutrients and water:** The theory of self-thinning is based on the assumption that light is the exclusive limiting factor. However, there are other limiting factors, e.g. nutrients which determine the density of the stand; in this case, competition takes place in the ground and not in the canopy. This may be observed very clearly in forests where a large part of the nutrients available in the ecosystem is bound in the existing biomass. With increasing total biomass of the stand, and because of the limited weathering of primary minerals, increasingly less nutrient is available (Schulze 1995), leading to a change in growth form and composition of participating species.
- **Use of light:** The form of the forest canopy changes with age thus causing self-thinning, which is flatter or steeper than the -0.5 slope discussed earlier. Thus, e.g., the canopy of pines changes from a form of a pointed cone

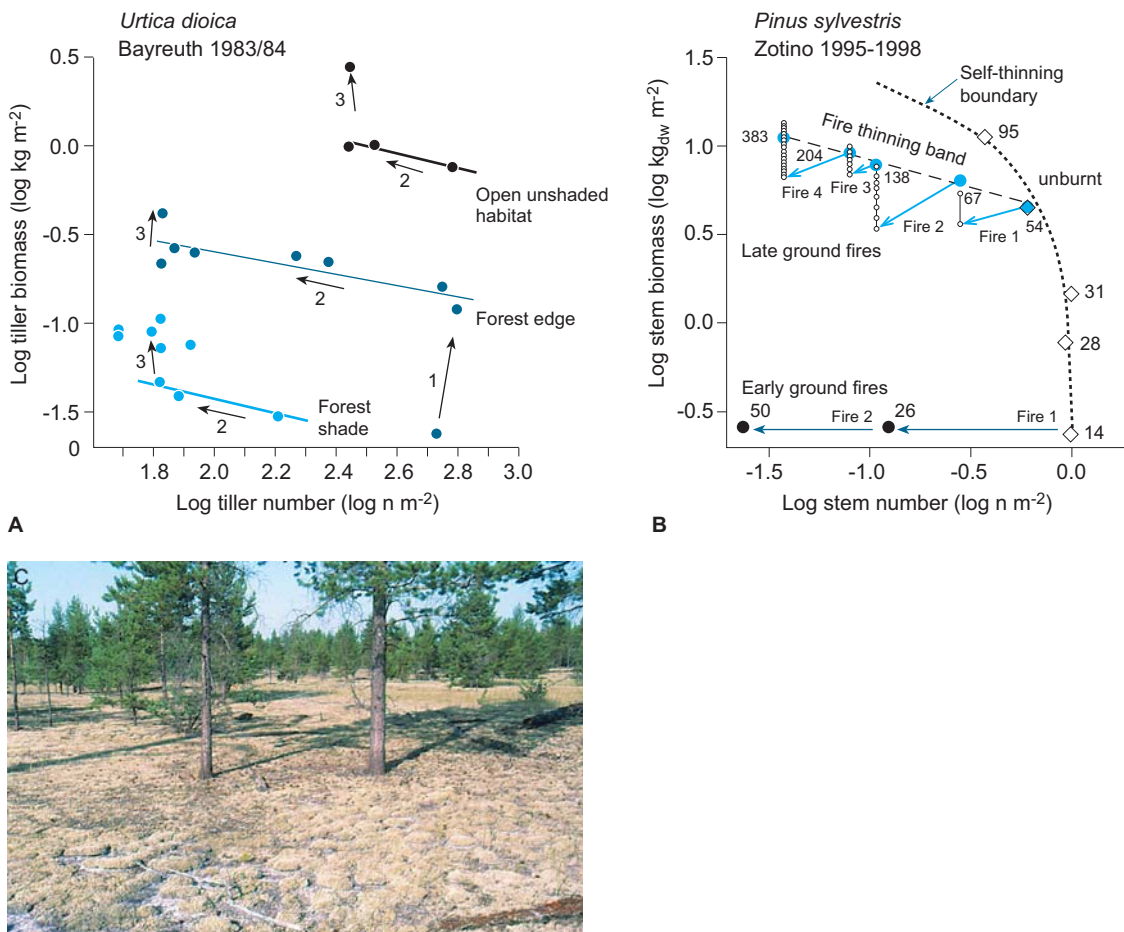


Fig. 3.2.1. **A** Self-thinning of *Urtica dioica* stands in the shadow of a riverine forest, a forest margin, and at a site with full sunlight. Production differs depending on the available light. *Arrow 1* shows the development when the canopy is not fully closed, *arrow 2* shows self-thinning when the canopy is closed, and *arrow 3* shows flowering, when shoot biomass increases whilst leaf biomass decreases (Stitt and Schulze 1994). **B** Self-thinning of *Pinus sylvestris* in Siberia after regeneration following a crown fire. Each large symbol represents a different forest stand. The *numbers* give the age of the stand. *Dotted line* Self-thinning without the influence of fire. Self-thinning usually occurs after the canopy closes, when the trees are approximately 54 years old. Late ground fires (i.e. the first fire occurred when the trees were 50 years old) resulted in a reduction in biomass and in the number of trunks. After this first ground fire it takes about 10 years until the same production is reached as pre-fire at higher stand density. However, before reaching the self-thinning line stands usually experience a repeated ground fire that continues to decrease the number of trees and the biomass. With increasing age of trees the regeneration phase takes longer (*small open circles* show the increase in biomass within 10 years). With early ground fires in young stands (<50 years), the number of trunks may be reduced considerably. Stands may become so open that a compensation of biomass at the stand level by increases from the remaining trees is no longer possible. In these stands the biomass remains low. The smaller number of tree individuals prevents new ground fires, as there is not much burnable biomass (Wirth et al. 1999). **C** View of a park-like landscape with 60-year-old pines in central Siberia after an early intensive fire. The vegetation on the forest floor is formed by a close cover of *Cladonia* species which suppress germination of pine seeds. Such areas remain in this state over centuries and are marked in maps as “forest free” sites. (Photo E.-D. Schulze)

in the juvenile phase (many individual plants fit into a space), to a wide-spreading, flat crown (fewer individual plants fit into a space than would have done if the juvenile form were kept the same into old age).

- **External disturbances:** There are many external disturbances affecting the number of individual plants in a stand (lightning, wind and

snow breakages) which will be discussed in detail in [Chapter 3.2.5](#). In many ecosystems, fire has a large effect on the number of individual plants in a stand, independent of the supply of nutrients. Self-thinning in Siberian pine (*Pinus sylvestris*) forests depends on the frequency of fires, as well as on the rate of growth ([Fig. 3.2.1B](#); Wirth et al. 1999). Siber-

ian pine forests are rejuvenated by so-called canopy fires which destroy the stand. Very densely growing, young stands of the same age develop (see also Fig. 3.2.1), which are also selectively very prone to fires. A fire in a juvenile stand causes a reduction in the number of individual plants and the biomass decreases (Fig. 3.2.1B, fire 1). It takes several decades until the remaining stand accumulates biomass again until a stage is reached where self-thinning starts again. This regeneration would be possible, but, because of the climate, it is more probable that repeated soil fires occur (Fig. 3.2.1B, fires 2–4), again reducing the number of individual plants and thus reducing the biomass. The result is a thinning line, caused by fire, which probably keeps the biomass per area almost constant. Lacking competitive pressure the pine canopy changes; it no longer grows in height, but in width, thus strengthening the trend that biomass no longer increases despite decreasing number of stems.

Fires in a young stand could also prevent formation of a completely closed canopy. Park-like stands develop with low growing individual stems (Fig. 3.2.1C). Biomass in the Siberian pine forest is thus determined by fire in juvenile stands and the resulting number of individual trees.

- **Economic use:** In agriculture as well as in forestry, death of individual plants which are not harvested is uneconomic. Additionally, the economic aim, namely to attain a certain size of tree within a reasonable time span, may only be achieved if the individual trees do not compete for light. In cultivated forests the density of the stand is regulated by man through thinning. In agriculture, crop density is similarly regulated by the number of seeds sown. Here, the relation between biomass and number of individual plants (regulated by cultivation) is similar to that in natural, nutrient-poor systems which is below that of potential self-thinning.

Strictly speaking, the law of self-thinning only applies to monocultures of the same age. But the same principles apply (proportionality of canopy area to the volume of the canopy) even in mixed stands of different ages where several vegetative layers share the same habitat. In these cases the thinning curve is steeper, because in biodiverse

stands there is a complementary use of niches involving many factors, such as rooting depths, form of canopy, growth of vegetation. Therefore, diverse stands may have a higher productivity than monocultures, often termed over-yielding (Hector et al. 1999).

The asymmetric competition for light, i.e. the fact that taller individual plants harvest a larger proportion of the “light” resource compared with shorter plants, differentiates the stand from juvenile stands with many small and shorter individual plants (distribution shifted to the left or right). With the onset of self-thinning the stand develops normally again, as mainly smaller individual plants die because of competition. If the stand is very uniform in its size distribution (e.g. pine stands after fires), it may happen that growth stops until differentiation starts because of external influences (storm, snow).

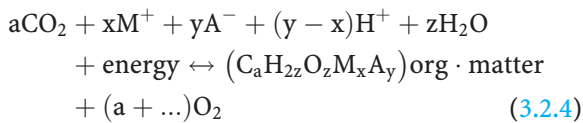
3.2.2

Reversible and Irreversible Site Changes Related to Resource Exploitation

3.2.2.1

Material Fluxes Accompanying Plant Growth

Growth of plant stands not only depends on assimilation of CO₂ and the availability of water, but also on the turnover of nutrients (see Chap. 2.4.3.7). Water as well as CO₂ may be regarded in ecosystems as renewable resources from an indefinitely large atmospheric pool. This is different for nutrients. Ecology has the task of establishing the flux balances of carbon, water and nutrient elements. Generally, nutrients are released during decomposition of litter or weathering of primary minerals, and they are then reversibly stored by the soil exchanger or in soil organic substance. The ash content of biomass shows the amount of nutrients taken up by plants from soil. If the organic mass is not harvested, but remains as dead biomass (litter) and is degraded again, then these cations are returned to the soil (see Chap. 3.3: material cycles). Ulrich (1987) has formalised the connection between availability of CO₂, water and ions, and their incorporation into organic substances, in an equation of material balance for organic matter in ecosystems:



where M^+ and A^- are the consumption of cations and anions and the coefficients a , x , y and z are the amount of molar ratio in the soil solution. To maintain large production in managed systems, according to Eq. (3.2.4) the loss of cations due to harvesting must be replaced by fertilisation.

3.2.2.2

Immobilisation of Nutrients and Nutrient Imbalances

In a balanced system, synthesis of material and mineralisation of material would occur simultaneously and balance. This equilibrium does not occur in the real world, as there are considerable shifts in time between consumption and feed-back of resources, described by the mean residence time in the appropriate compartment. Leaves, e.g., are synthesised within 1 year, but the litter is decomposed over many years, i.e. nutrients bound in leaves will, on average, only be available for further growth after 2–8 years (Persson et al. 2000). The mean residence time of these nutrients in the foliage is thus 2–8 years. In wood, nutrient may be bound in the plant body for more than 100 years. The decomposition of a tree trunk takes decades, even centuries, and thus the delay between uptake of resources and making the same resource available again takes a lot longer for wood than for leafy litter.

The accumulation of litter in the form of raw humus is a sign that the shedding of leaves or needles exceeds the capacity of soil organisms to decompose the litter, and that fast decomposition is hindered by substances which are difficult to metabolise or by unfavourable climates. Raw humus is only decomposed when the tree stand becomes lighter (e.g. by tree fall or wind damage) and thus the supply of litter decreases and also the open stand provides better conditions for mineralisation (higher soil temperature and moisture, change of soil organisms). However, the turnover of raw humus into highly decomposed forms of humus (mull, moder) is not continuous but depends on the chemistry of the original substance, as intermediary products are

formed which may be decomposed at different speeds or accumulated. A distinction is made between rapidly and slowly decomposed soil carbon although these terms are not well defined [<30 years: recent soil carbon; 30–100 years: intermediary soil carbon; 100 to >1000 years: black carbon (charcoal, soot); >1000 years: “recalcitrant” humus (Townsend et al. 1995; Schlesinger 1997; Schulze et al. 2000)].

The delay between use and feed-back of nutrients leads, even in a year, to imbalances between, e.g., nitrification in autumn and nitrate uptake in summer.

Loss of Resources

Chemical conditions in the soil are primarily dependent on the constitution of the original bed rock (see Chap. 2.3). However, these conditions are changed as a consequence of the mobilisation and consumption of cations by plants and by the inevitable loss of cations through leaching into lower soil layers or into the groundwater. Seasonality of plant growth and formation of new organic compounds in the course of decomposition of inorganic matter (humic acids) lead to relocation of ions and to changes in soil chemistry (Kaiser and Guggenberger 2000). The temporal shift between formation and consumption of nitrate shows, again, that loss of nutrients occurs even in natural ecosystems. As nitrate in the soil is not bound to minerals it may be leached into the groundwater as acid anions, taking along cations. Nitrate is also formed in autumn when most plants stop growing; nitrate and cation losses thus occur particularly during winter. In summer, however, the nitrogen requirement of vegetation exceeds supply from the soil. This asynchronous pattern of supply and demand leads, in the end, to changes in conditions in the habitat with local over-exploitation (loss of cations in the upper mineral layer = podsolisation and acidification of soils, see Chap. 2.3.1) or to accumulation of intermediary products, in as far as degradation is impeded by decreasing pH (e.g. raw humus).

Chemical conditions in the soil are particularly changed by strong acids (SO_4^{2-} , NO_3^-) from anthropogenic emissions and the subsequent relocation of cations. In particular, the deposition of acids (Fig. 3.2.2 A) in the uppermost horizon of mineral soils leads to a large decrease in pH and finally to release of Al ions. An acidification horizon is formed which may affect the complete zone of weathering. In this case, pH in-

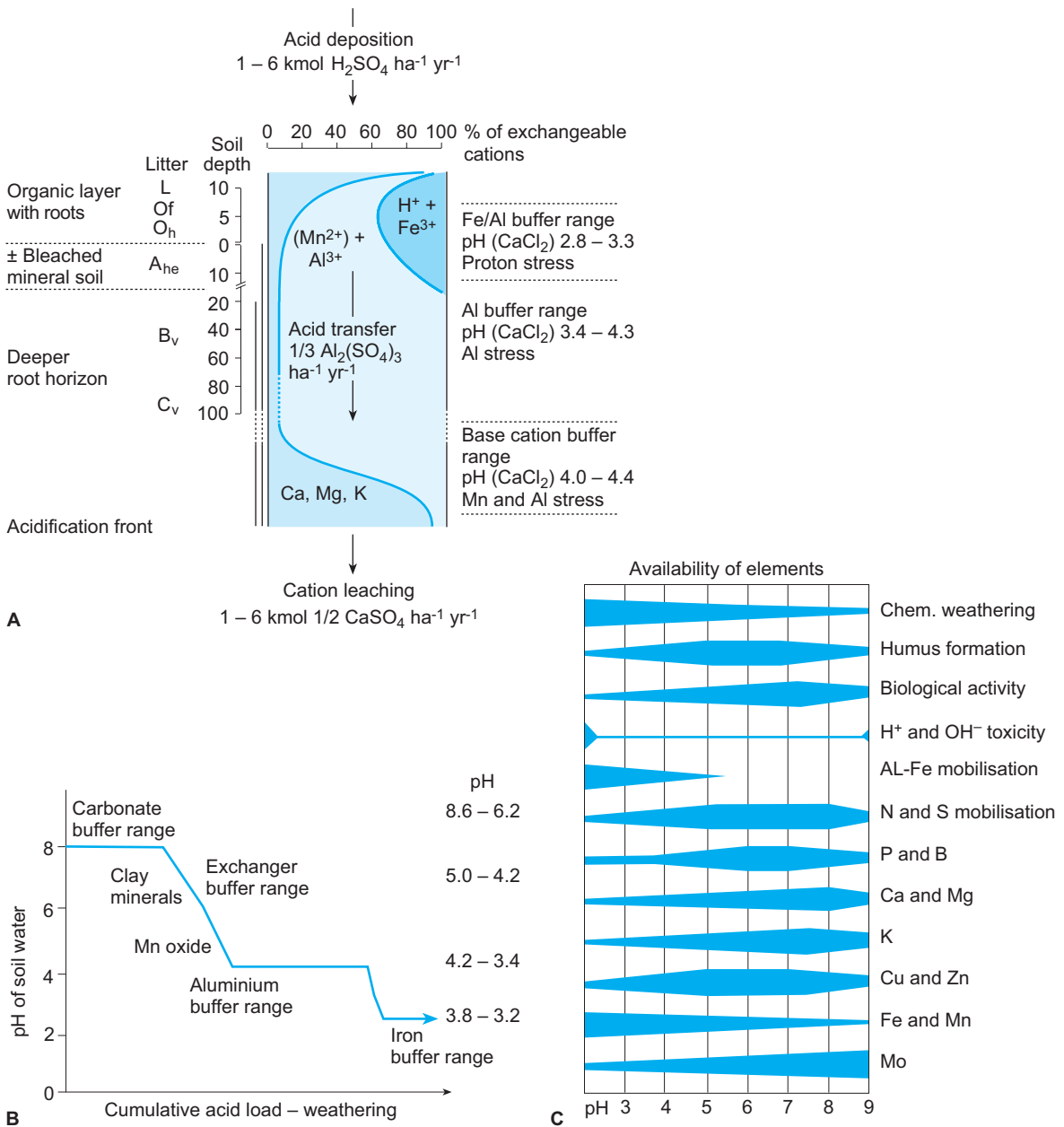
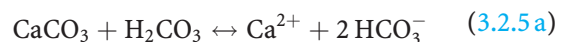


Fig. 3.2.2. A Depth of acidification with acid rain (FBW 1989; Last and Watling 1991) showing that when strong acids are deposited, horizons from A- to the upper C-horizon can be acidified, without becoming visible as soil horizon. The base saturation rises in the lower C-horizons. Due to cation uptake by roots and shedding of needles the organic matter on the forest floor also becomes more alkaline. B Changes in pH of the soil solution with continuing weathering as a consequence of the cumulative proton stress, i.e. acid deposition (after Schulze and Ulrich 1991). C Availability of nutrients dependent on the pH of the soil solution. (Larcher 1994)

creases only near the original bed rock. Stronger alkaline saturation and higher pH also occur in the deposited humus, as cations from roots from lower soil layers are taken up into the plant and reach the organic deposits via the litter.

The rate of soil acidification depends on the mineral constitution of the bed rock and the cu-

mulative acid stress (Fig. 3.2.2B). On limestone soils with high CaCO₃ the imbalance of cations triggered by fixation of cations in organic matter or by relocation of cations is, at first, balanced by weathering of carbonate.



where



The released Ca ions occupy the charges that become free on the soil exchangers (see Chap. 2.3.1). With the loss of organic matter, e.g. by harvesting and leaching of cations from the clay minerals and humus complexes, CaCO_3 is continually consumed. Over a long period, the soil pH decreases and a reversible exchange of cations occurs with clay minerals and humus. With continuing loss of cations and H^+ -buffering by metal oxides and hydroxides, a pH-dependent increase in the availability of certain metal ions occurs. Thus Mn becomes mobile at a pH between 5 and 4.2. At a pH of 4.2, the soil reaches another stable buffer system as with the availability of lime, but in this case the pH is buffered by Al hydroxides (see Chap. 1.8); Fe buffers below pH 3.8. The availability of ions is very variable during the course of this process and each element is specifically dependent on the pH of the soil solution (Fig. 3.2.2 C; Larcher 1994).

The chemical changes in the soil are reversible, i.e. by fertilisation or liming, provided that the clay minerals are not restructured. As soon as the crystalline structure of silicates and clay minerals is changed (e.g. by dissolving the Al lattice as a replacement of alkaline cations by protons, Chap. 2.1), a reverse into the original state is no longer possible, not even by supplying cations (liming of forests; see Chap. 3.5.1).

3.2.3

Complexity and Non-linear Behaviour

Ecosystems are by definition complex structures, which are far removed from equilibrium and therefore change dynamically. From the multitude of processes related to this complexity, some processes are listed in the following which, even at the level of the ecosystem, occur non-linearly and irregularly without the sole regulation by the individual plant. It becomes obvious that most ecosystem processes become saturated with increasing intensity of a regulating variable or decreased again. Only very few processes, above all the dependence of respiration on temperature, continue to increase over a broad range.

- **Photosynthesis, respiration:** Photosynthesis follows a saturation function which on the whole is regulated by the availability of light and CO_2 . Nutrient supply determines the level at which saturation occurs (see Chap. 2.4.1). In contrast, respiration of non-photosynthetic organs, and soil respiration of heterotrophic soil organisms, increases exponentially with temperature (Lloyd and Taylor 1994). Thus the reaction of ecosystems to the increase in global temperatures is very dependent on respiration.
- **Sensible and latent heat:** The turnover of sensible and latent heat depends most of all on solar radiation and the water supply (see Chap. 3.2.4). Latent and sensible heat fluxes increase initially in proportion. In a climate with high precipitation and moderately high solar radiation (Fichtelgebirge in Germany, Fig. 3.2.3 A), relatively low irradiation limits the transport of sensible heat and advectively transported dry air masses are important which mainly affect evapotranspiration from wet surfaces. The light limitation of turnover becomes obvious in assimilation (Fig. 3.2.3 B) which also reaches an upper limit, although evaporation still increases. A different scenario occurs in the continental climate of Siberia (Fig. 3.2.3 C, D) where evaporation and sensible heat flux are coupled over a wide range and evaporation reaches the upper limit sooner than the sensible heat flux. Assimilation and evaporation are coupled closely to each other at low rates over a very wide range.
- **Formation of biomass:** Formation of biomass in a stand is similar to the saturation function for an individual plant. After exponential growth up to stand closure the phase of self-thinning follows and, with age, biomass of the stand is limited by plant density (Fig. 3.2.4 A; Schulze et al. 1999). The maximum attainable biomass depends on climate, structure of trees and nutrient supply. Climate conditions lead to regional differentiation. The yield of forests in southern Germany is higher than in northern Germany because of the more favourable climatic conditions there. In managed forests, the biomass (and thus the competition between trees) is additionally regulated by thinning (Fig. 3.2.4 B; Kramer 1988).

The saturation function applies to all forms of vegetation (Schulze 1982), even for herbac-

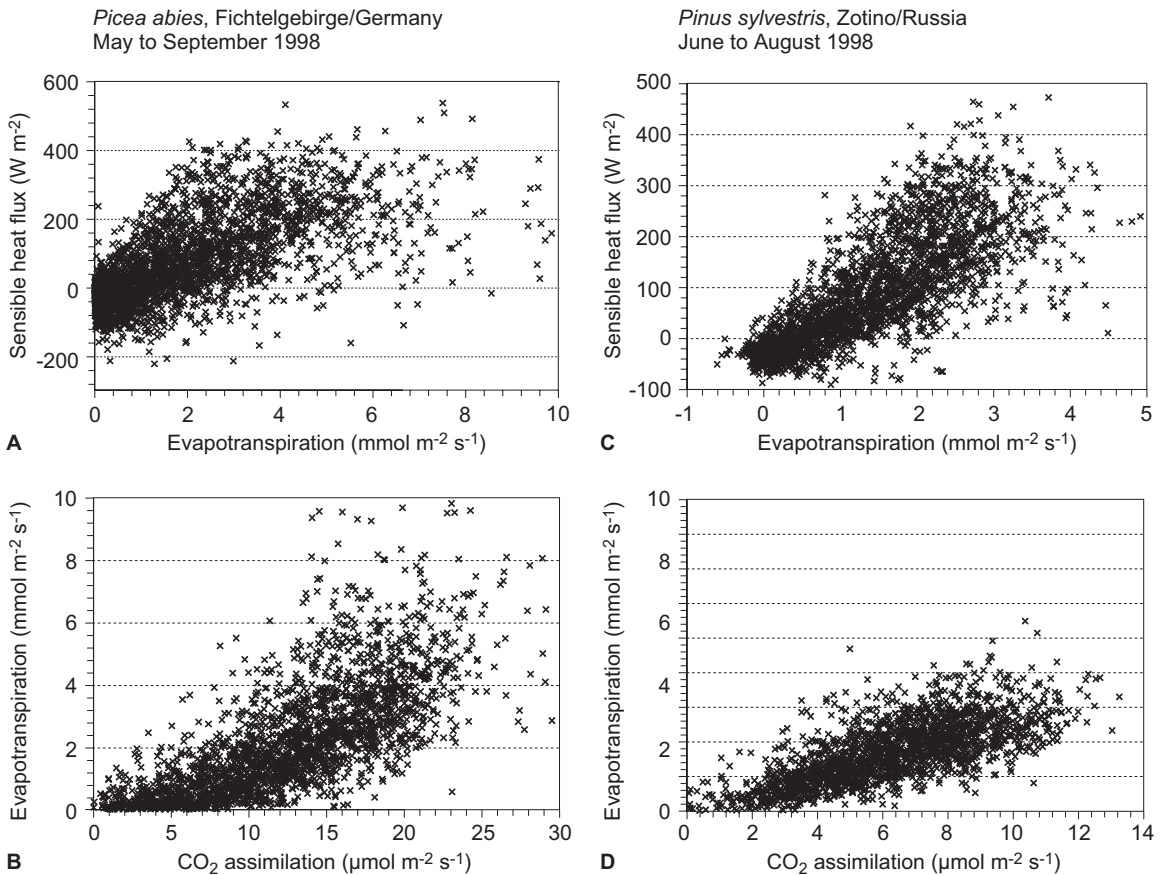


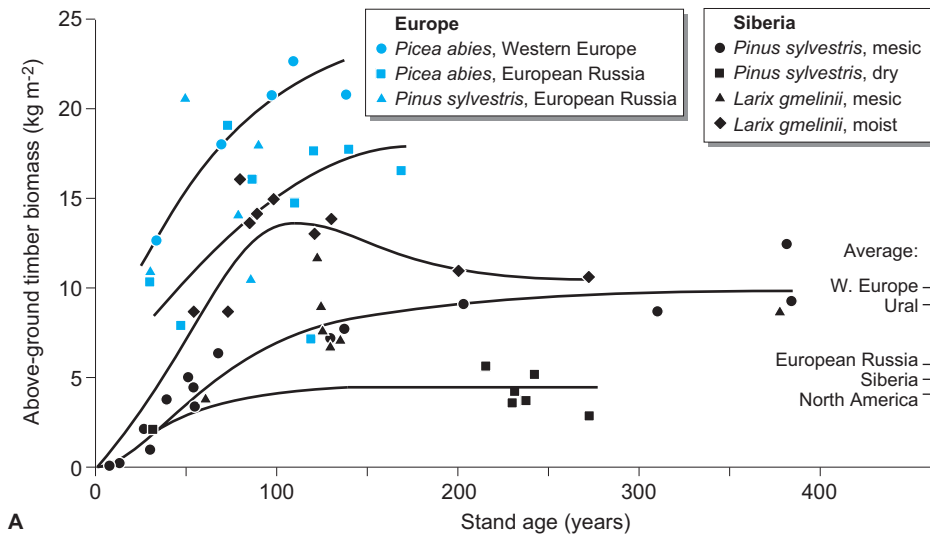
Fig. 3.2.3. A,C Changes in evaporation and latent heat transport and B,D changes in evaporation and assimilation in spruce trees in the Fichtelgebirge, Germany (A,B) and pine forests in Siberia (C,D). It is obvious in temperate climates that there is not a linear relationship, i.e. the evaporation rises with constant sensible heat transport or constant assimilation. In a continental climate the flows are much smaller, with the linear part of the graph representing spruce trees (*Picea abies*: C. Rebmann, unpubl., *Pinus sylvestris*: A. Knohl, unpubl.)

eous plant stands. Mowing of meadows occurs at a time before the biomass reaches the plateau of saturation.

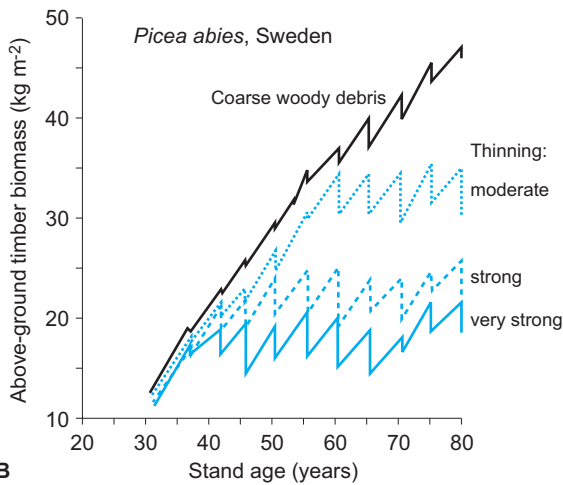
Particular irregularities in biomass accumulation are observed in annual field crops caused by the change from vegetative to reproductive growth (flowering and fruiting). After a certain period (**determinate species**) or after storage or availability of certain resources (**non-determinate species**) flowering occurs, leading to fruiting and finally to death of plants.

- **Harvesting** of field crops leads, in summer, to a substantial change in water, heat and nutrient balances of fields, shown here as an example of the complexity of interactions at the

next higher level, the landscape. Under certain conditions, harvesting may even affect the weather. If the sensible heat flux of the harvested areas increases and evaporation on neighbouring forest areas is high, convective thunderstorms occur. Because of the convective transport of air masses from the ground into the higher atmosphere volatile organic compounds rise into the troposphere and affect the chemical conditions in the atmosphere and the NO-ozon cycle. Thus oxidation of NO to NO₃⁻ occurs and thus deposition of nitrogenous compounds from the atmosphere.



A



B

Fig. 3.2.4. A Increase in biomass with age of trees in managed spruce forests in Germany compared with unmanaged forests of spruce, pine and larch in eastern Europe and Siberia (Schulze et al. 1999). It is shown that even unmanaged forests reach a maximum biomass, but that this is not an equilibrium between assimilation and respiration. It is the result of stresses (fire, wind). B Influence of forest management showing the effect of thinning on the development of a stand of spruce in southern Sweden. The “zig-zags” in the development of the stand are due to the removal of biomass in forest management and the subsequent recovery of the stand. (After Kramer 1988)

3.2.4

Number of Species and Habitat Partitioning

3.2.4.1

Rank Dominance and Keystone Species

In the so-called rank dominance distribution one parameter, characterising the presence of a species (number of individual plants, biomass, ground cover per species), is plotted with decreasing proportion of that parameter as shown by the different species of that community (Sala

et al. 1996). In many vegetation types a few species, often only one species, comprise the largest fraction of individuals, biomass and canopy cover. Other species obtain a lesser fraction.

Increase or decrease of plant species, or the presence of certain functional types, may have very different, usually non-linear effects on ecosystem processes. Generally, productivity increases with biodiversity because of the better temporal and spatial use of the site (Hector et al. 1999). With the loss of plant species different developments are possible (Sala et al. 1996). There are species which achieve the highest biomass in monocultures (Fig. 3.2.5 A). Removing such spe-

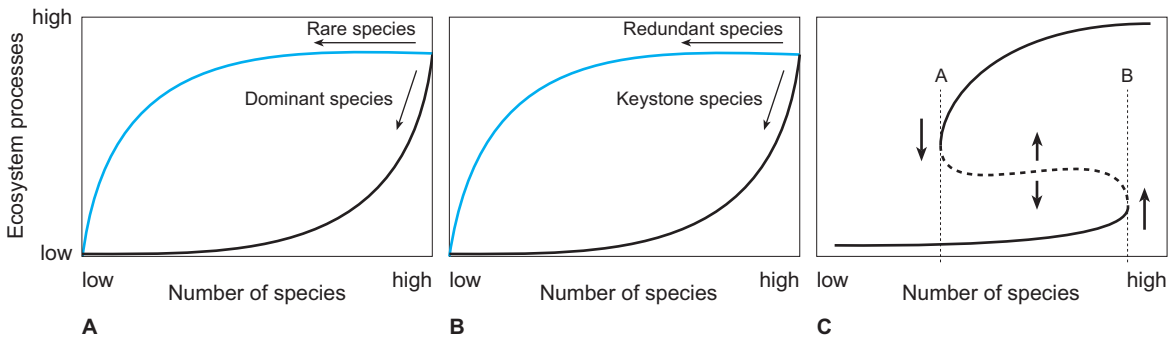


Fig. 3.2.5. The effect of dominance by a single type of organism on ecosystem processes. **A** Removal of a dominant species by a stress has a greater impact than the loss of a rare species. **B** If a keystone species dies out then the ecosystem is affected more than expected from the comparatively small proportion of biomass that was removed by extinction of the keystone species. The effect is much greater than for species whose function can be replaced (redundant species). **C** Depending on the structure (plant life form) of the predominant vegetation, there are various stable states that the ecosystem can develop with increasing or decreasing biodiversity. The *dotted line* shows alternative states that an ecosystem under moderate stress could return to. Points A and B are threshold values at which the system changes from one state to another. (Sala et al. 1996; WBGU 1998)

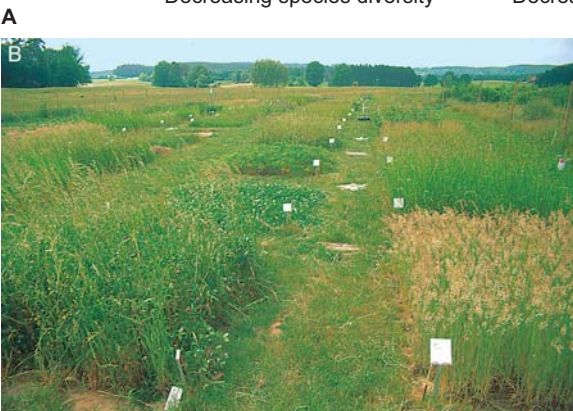
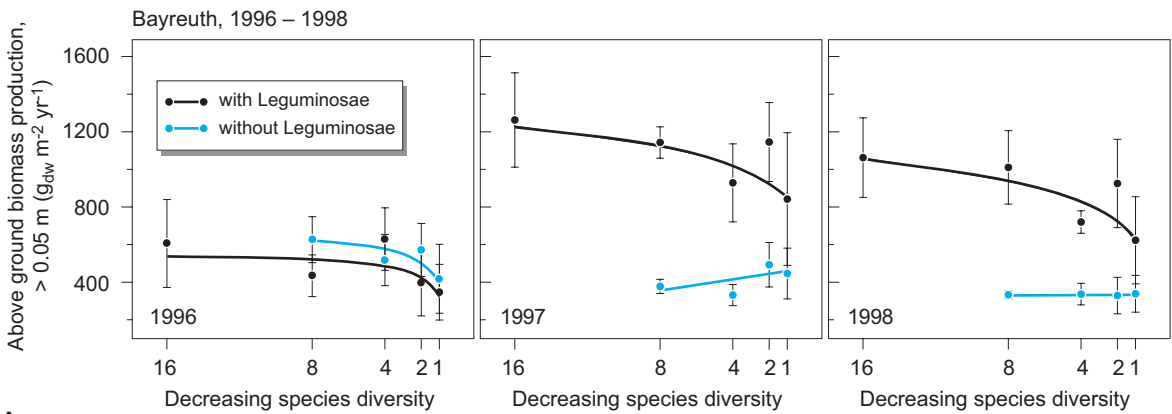


Fig. 3.2.6. **A** Changes in above-ground biomass production in experimental fields with differing diversities, with and without leguminous plants. The fields were planted in 1996 and mown twice a year. In 1998, productivity of plots containing legumes was significantly higher than those without. In contrast, the productivity of plots without legumes decreased after five mowings (Scherer-Lorenzen 1999). **B** Plots of the biodiversity experiment in Bayreuth. (Photo E.-D. Schulze)

cies results, even in mixed stands, in massive losses of yield. There are also minor species which appear to be redundant (Fig. 3.2.5B) with little influence on the immediate ecosystem processes (e.g. orchids in a meadow). The absence of these plants hardly affects the biomass production of the stand. If the loss of biodiversity is associated

with a change of life form (see Chap. 2.4.5), very different yield levels may be reached by the same numbers of species according to the presence of a specific life form at the site (Fig. 3.2.5C). The system may, with a loss of a species, jump from one level to another with consequences for all processes in the ecosystem.

There are deviations from this general observation. It may happen that one of the introduced species has a much greater effect on the ecosystem than would have been assumed based on its fractional share of resources. Such species are called **keystone species** (Bond 1994). An example of such keystone species are nitrogen fixers in a meadow (Fig. 3.2.6A). In an experiment in which meadow communities of differing diversity were sown (Fig. 3.2.6B), an increase in above-ground biomass occurred with increasing number of species. This effect was, however, only observed if Leguminosae (particularly *Trifolium rubrum*) were included in the stand. In the first year after sowing, there were still sufficient nutrients available in the soil and the effects were not seen. With increasing depletion of the soil because of the loss of nutrients through harvesting, the effect of Leguminosae became stronger in the following years (Scherer-Lorenzen 1999). Keystone species are often animals, which affect vegetation composition although this may not be obvious (see, e.g., Ernest and Brown 2001).

3.2.4.2

Distribution of Above- and Below-Ground Biomass in a Habitat

Exploitation of the habitat between different species and individual plants affects above as well as below-ground parameters (Fig. 3.2.7A,B). Competition is usually asymmetric, i.e. large individuals use a much larger proportion of available resources. Above ground the inclination of leaves is important. Tall, growing shrubs with horizontal leaves may dominate a stand, because they effectively shade competitors (*Petasites*, *Urtica*; see Chap. 2.4.5.3). Below-ground competition operates mainly via the formation of root biomass, and particularly via the renewal of root tips (Fig. 3.2.7B). This is shown clearly in a comparison of fertilised (i.e. nutrient-rich) and unfertilised (nutrient-poor) meadows in central Europe. Forty to 50 species grow in nutrient-poor meadows, both dicotyledonous and monocotyledonous species, but with a greater variety of the former than the latter in the canopy (Fig. 3.2.7C). Light penetrates through the low vegetation cover and reaches the vegetation layer just above the ground where the largest proportion of leaf area is located, and where low growing rosette plants still find conditions enabling

them to survive. In the unfertilised meadow about 75% of the biomass is in roots. Comparing this with a well-fertilised meadow, then the number of species decreases to 10 or 20 species, with new species invading. The remaining species have higher stems and may form a closed canopy at considerable height above the soil surface (Fig. 3.2.7D). At first, grasses dominate. With further eutrophication and availability of nutrients, dicotyledonous species which grow even taller become dominant. The large leaf area index (LAI) near the ground in Fig. 3.2.7A originates from the lower leaves of these tall, growing species during early development of the vegetation, but these lower leaves will die off with further growth of the stand. Because of the dense and high canopy little light penetrates to the ground and thus low growing species are excluded with time. Tall growth is stimulated by only investing 30% of the biomass into roots. The example shows that the reduction of root competition changes the competition for light, regulated predominately by the height of the vegetation.

3.2.4.3

Mycorrhizae

Assessment of ecosystems is made more complicated by the association of plants with mycorrhizae, where only some are species specific. Herbaceous species and grasses are generally associated with vesicular-arbuscular (VA) mycorrhizae, whilst woody plants are associated with ectomycorrhizae. There are several ecologically significant differences between these two types. VA mycorrhizae are able to use nutrients from the soil (particularly P) whilst ectomycorrhizae are able to use organic and inorganic nitrogen (ammonium, nitrate). In the uptake of organic compounds by ectomycorrhizae, the use of amino acids from falling litter is particularly important (Wallenda et al. 2000; Nordin et al. 2001). With a change in the type of external N supply, e.g. from amino acids to ammonium or nitrate, the occurrence of ectomycorrhizal species may change.

3.2.4.3.1

Vesicular-Arbuscular Mycorrhizae

The same VA mycorrhiza (i.e. the same mycelium) connects several plant species. It could almost be assumed that individual plants and species in a

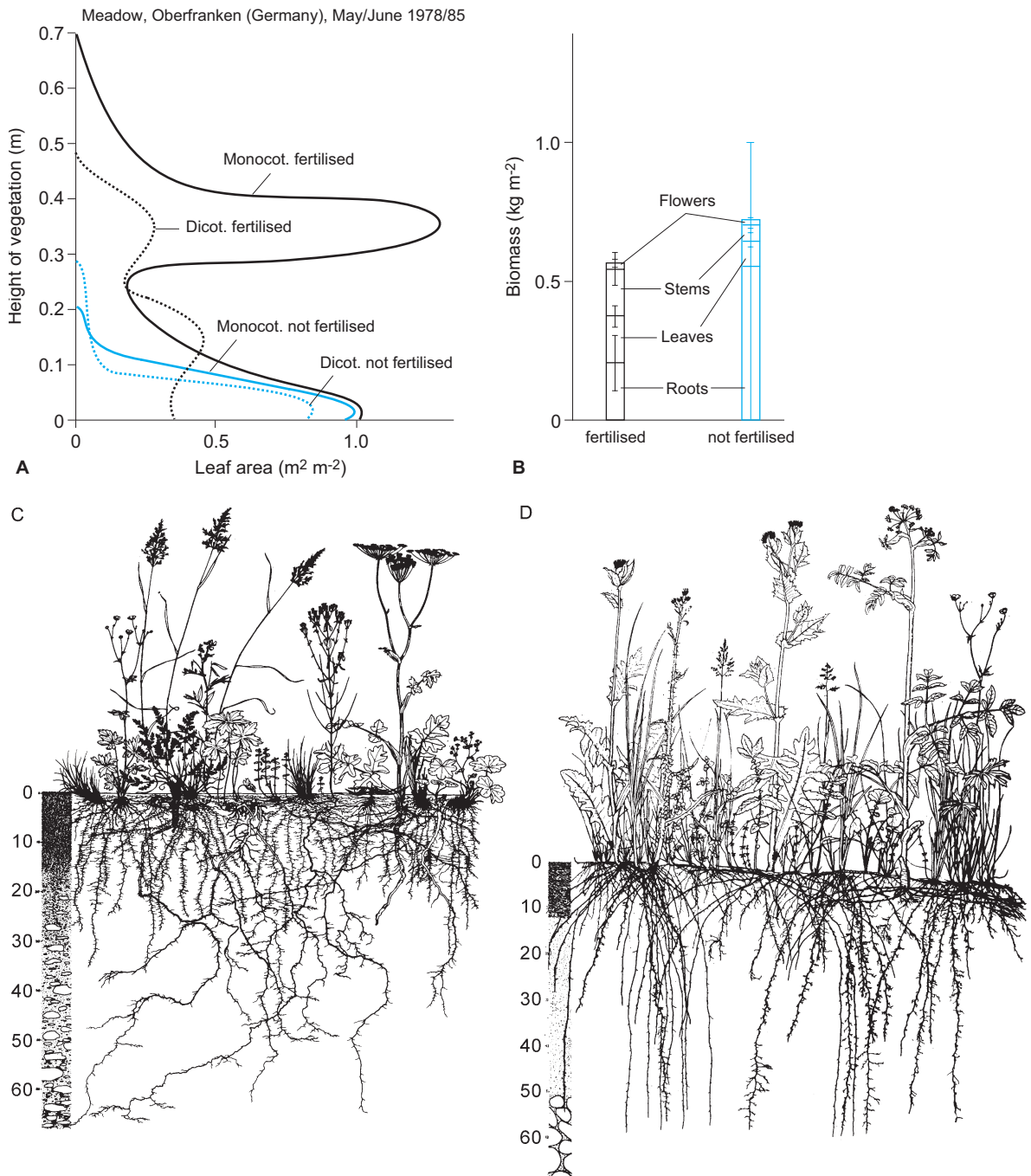


Fig. 3.2.7. **A** Change in leaf area with height of vegetation and **B** distribution of flowers, stems, leaves and roots in fertilised and unfertilised meadows. It is clear that only in fertilised meadows is a greater leaf area formed at greater height above the soil surface. In contrast, in unfertilised fields, most leaves are near the soil surface. Unfertilised plants invest up to two to three times the amount of biomass in the growth of the roots compared with their fertilised counterparts. **C** Nutrient-poor yellow oat meadow has a 70-cm-deep root system. Plants from left to right are: *Nardus stricta*, *Ranunculus acris*, *Meum athamanticum*, *Trisetum flavescens* (three stalks), *Lathyrus linifolius*, *Trollius europaeus*, *Hypericum maculatum*, *Festuca rubra*, *Hypericum perforatum*, *Heracleum sphondyleum*, *Alchemilla vulgaris*. **D** Nutrient-rich thistle meadow with roots that go down to 60 cm only. Plants from left to right: *Cirsium oleraceum*, *Carex acutiformis*, *Cirsium palustre*, *Lotus uliginosus*, *Holcus lanatus*, *Galium palustre*, *Filipendula ulmaria*, *C.o.*, *H.i.*, *C.a.*, *Geum rivale*, *Angelica sylvestris*, *Ranunculus acris*, *Poa trivialis*. (After Hundt 1958, 1962)

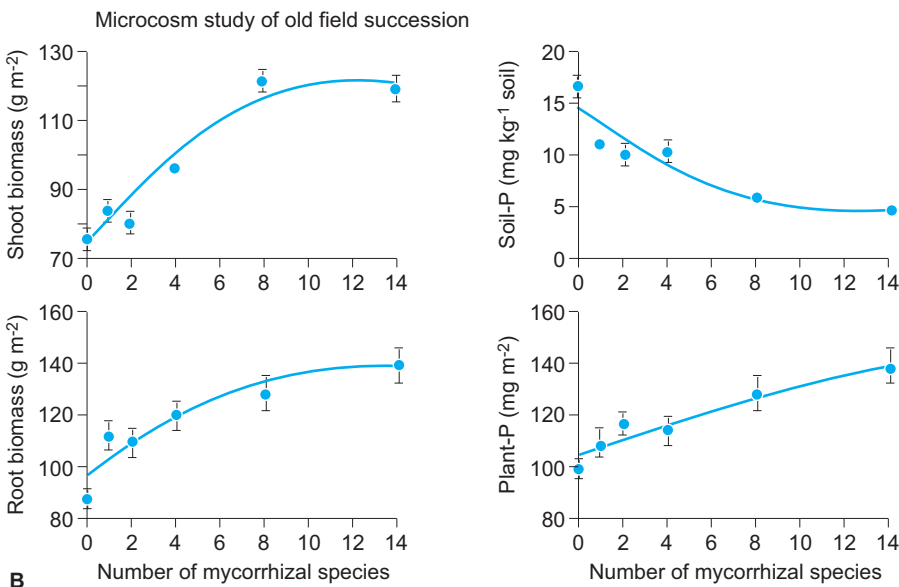
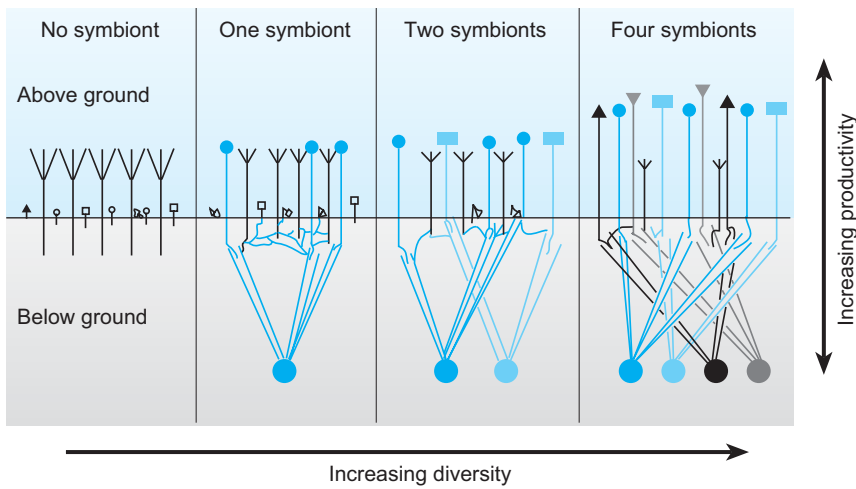


Fig. 3.2.8. A Schematic presentation of the interactions between various plant types in a meadow with one or more types of VA mycorrhizae (Read 1994). B Changes in shoot and root biomass and changes in concentration of available phosphate in the plant related to the number of types of VA mycorrhizal fungi. (After van der Heijden et al. 1998)

Table 3.2.1. Transfer of ¹⁴C-labelled assimilates to neighbouring plants by VA mycorrhizae. Donor plant: *Festuca ovina*, not VAM inoculated: *Rumex acetosa*. (Grime et al. 1987; Smith and Read 1997)

	Activity of ¹⁴ C in the shoots (decays min ⁻¹)
<i>Festuca ovina</i>	9276 (donor)
<i>Briza media</i>	14002
<i>Poa pratensis</i>	6241
<i>Plantago lanceolata</i>	18764
<i>Hieracium pilosella</i>	60716
<i>Centaurea nigra</i>	45081
<i>Leontodon hispidus</i>	15363
<i>Scabiosa columbaria</i>	23912
<i>Centaureum erythraea</i>	4213
<i>Rumex acetosa</i>	494 (not inoculated)

meadow are the assimilatory organs of a large VAM growing under ground (Fig. 3.2.8A). This has consequences for the assimilate and nutrient supply of individual plants, e.g. because transport between species and individual plants is possible and has, in fact, been demonstrated (Table 3.2.1). If photosynthetically produced assimilates of the grass *Festuca ovina* are labelled with ¹⁴C, transfer takes place of labelled sugars from the labelled plant to other plants which did not receive ¹⁴CO₂ (in Table 3.2.1 predominantly *Hieracium pilosella*). It is even possible that ¹⁴C accumulates in the receiver plant. Species unconnected to VAM do not show the ¹⁴C signal (*Rumex acetosa*).

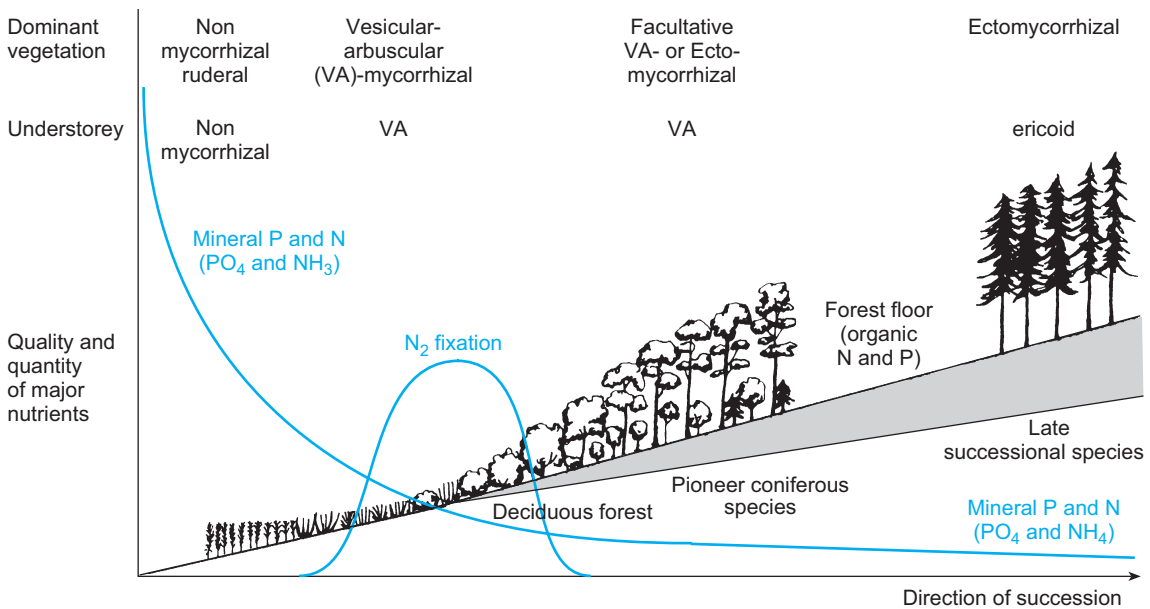


Fig. 3.2.9. Changes in mineralisation and availability of organic forms of N and P, which cause a change in the vegetation and their associated types of mycorrhizae in a succession starting with mineral soil and ending in a late successional species. Early ruderal types are not infected with mycorrhizal fungi. VA mycorrhizae occur mainly in perennial herbaceous plants. With increasing development of the site and reduction in available P supply, nitrogen-fixing plants and woody shrubs invade. With the woody plants a further reduction in P and N availability in the soil follows, resulting in the formation of a litter layer that can be colonised by ectomycorrhizal fungi at this stage. N and P are stored predominantly in the organic layer. (Read 1994)

Ectomycorrhizae

In contrast to herbaceous species, woody plants are not connected with each other via their own ectomycorrhiza and the same root may be occupied by several individuals of different ectomycorrhizal species but ectomycorrhizae do not connect between roots or species. This does not exclude that a species of mycorrhiza is not species-specific regarding the host, and uses different resources (Wallenda et al. 2000).

The number of fruiting mycorrhizal species decreases with external input of ammonium and nitrate. With small N influx about 18 fungal species were found in the spruce forests of northern Sweden, but only 7 species with large N input in the Fichtelgebirge in Germany. At the same time 15 species of northern Sweden have a narrow range of distribution (regional endemic species) but only one species was regional in the Fichtelgebirge. In contrast, the number of ubiquitous species increases from one in northern Sweden to six in the Fichtelgebirge (Taylor et al. 2000).

Distribution of Mycorrhizae

The well-known succession from annual plants which are able to distribute quickly on nutrient-rich mineral soils, to woody plants, is related to a substrate-specific progression in the mycorrhizal occupation (Fig. 3.2.9). The content of mineral N and P in the soil decreases quickly with establishment of vegetation. With increasing N deficiency (at a still large P supply) perennial herbaceous plants and N₂-fixing species follow. The first woody species establish with increasing organic layer. Then, with decreasing nutrient supply, deciduous shrubs are replaced by evergreen conifers. This sequence is accompanied by mycorrhizal succession. Herbaceous plants are settled by VAM, which are particularly able to release P from the soil. With the establishment of woody plants and increasing organic matter on the soil, ectomycorrhizae follow, which are able to remobilise N and P from the increasing organic mass. Finally, with very low N and cation supply, ericoid mycorrhizae follow (Read 1994).

3.2.5

Disturbances

The idea that ecosystems are in equilibrium with their environment (Gleason 1926) has been proven incorrect – short-term variability of climate and the occurrence of small or large spatial “catastrophes” cause continuous change in the biogeochemical conditions and turnover of the participating species. Disturbances affect individuals, species, as populations, ecosystems and aspects of the material balance, up to the existence of the affected organism or system. Disturbances affect processes in:

- Individual plants: transient damage (late frosts), weakening by parasites, failing reproduction because of weather, death by wind-fall.
- Populations: changes in the structure of populations and gene pools by reduction of the number of individual plants, extinction by events occurring over large areas (volcanic eruption).
- Ecosystems: creeping or spontaneous losses due to fire or leaching, changes in the species composition.

Disturbances are thus events changing the continuous material turnover suddenly and in unexpected directions. At the level of the ecosystem, it is important whether the system loses resources or whether these resources are only moved around within the system and relocated. This is well shown by the carbon balance, where the following conditions are distinguished (Fig. 3.2.10; Schulze et al. 1999):

1. Factors exerting a continuous “stress” (weather, CO₂),
2. Factors interrupting the turnover of C, but the organic matter and resources bound in them remain in the ecosystem (twig and leaf fall due to wind, insect frass),
3. Factors removing organic matter and resources from the system (fire, harvest).

These disturbances may lead to changes in the assembly of species and this may cause new patterns of material turnover in an ecosystem.

3.2.5.1

Continuous Stress and Disturbances Where the Organic Matter Remains in the Ecosystem

Disturbance from continuous changes of the carbon balance are caused by changing **weather**. There are years with large and small carbon gain and rates of material turnover. In the long term, permanent but changing **conditions of growth** (e.g. increase in CO₂ concentration in the atmosphere, N-deposition, global climate change) disturb the balance of resources. Thus, continuously increasing CO₂ concentrations at first affect growth of plants by increasing their resource requirements and only secondarily, with a delay of about 30 years, through enhanced decomposition processes in the soil (Melillo et al. 1996). This delay is caused by the intermediate storage of assimilates in biomass (e.g. wood) and the slow transition of decomposition of organic matter along the chain of organisms participating in the decomposition process (see Chap. 3.3.2). Thus there is accumulation of intermediate products in the ecosystem, which are

Ecosystem disturbances		
Continuous forcing of the C and N cycles by changes in:	Disruption of the C and N cycles but maintenance of organic matter in the ecosystem:	Losses of C and N bypassing heterotrophic processes:
<ul style="list-style-type: none"> – Temperature – CO₂ – Radiation (aerosols) – Precipitation 	<ul style="list-style-type: none"> – Diseases, Herbivores – Windthrow 	<ul style="list-style-type: none"> – Harvest, Grazing – Fire

■ **Fig. 3.2.10.** Classification of ecosystem disturbances according to their effect on the C and N budgets of ecosystems. With respect to C, it is important to know whether C remains on the site, if carbon is added to the soil, or if the biomass is removed (in the case of fire or harvesting). Removal of biomass also means that nutrients are removed. (Schulze et al. 1999)

not stable (e.g. raw humus), but will probably be decomposed later.

These continuously changing parameters and their influences are thus different from disturbances, which interrupt the synthesis or decomposition of matter. In this category belong “catastrophes” such as wind damage, snow damage or being eaten and damaged by insects, and also smaller disturbances such as by moles or wild boar. These disturbances change mainly the aggregate structure of the soil or directly accelerate decomposition of soil organic matter. This type of disturbance may lead to temporary accumulation of organic matter in certain compartments (e.g. raw humus) and re-allocation of resources. However, they generally do not change the ecosystem, only if certain pathogens stop the regeneration of dominating species, as happens in Australia where *Phytophthora* causes the death of Proteaceae and of some eucalypt species.

3.2.5.2

Disturbances by Export of Organic Matter from Ecosystems

Disturbances in which biomass and nutrients have been removed from the ecosystem (**export of resources**) have rather different impacts than disturbances where resources remain in the ecosystem. Loss of organic matter occurs particularly by grazing, harvesting and fire. In all three processes biomass is lost or exported from the ecosystem and degraded somewhere else, e.g. in human-dominated systems, in sewage works or by burning of rubbish. Heterotrophic organisms in the ecosystem in which the organic matter was produced no longer participate in decomposition.

In **harvesting** and **grazing**, organic matter as well as the cations bound in it are removed from the ecosystem. As roots normally remain in the ecosystem heterotrophic organisms are at first stimulated, but later soil C is decomposed. Loss of nutrients by harvesting leads quickly to degradation of the total system, if nutrients are not re-supplied by fertilisation. The influence of two mowings per year in a newly planted meadow is measurable even 3 years later (see Fig. 3.2.6; Scherer-Lorenzen 1999).

Historically, litter raking in forests was an important harvest when the newly fallen leaves were collected and used during the winter as bedding for animals in stables and taken to the

fields in spring as fertiliser. As leaves and needles have considerably higher cation contents than wood, this form of forest use drastically decreased soil fertility and led to relocation of cations from forests to fields over large areas of land. The effect of this use is still visible after decades as particularly weakly developed humus layers in the affected forests (see Schulze 2000, site at Aubure in France).

A particular type of disturbance is **fire**, because a large part of the standing biomass over large areas may be destroyed. At sites where fires occur regularly, vegetation has adapted to fires. Of course, the intensity of the fire depends on the available biomass. Therefore, rare fires, in which the biomass accumulated in the long interval between the fires is consumed, have more drastic effects than frequent and thus less intense fires (Fig. 3.2.11 A,B). During savannah fires, temperatures at ground level usually remain below 100°C and 10 cm deep into the ground 40°C is rarely reached. The reason for this is the very short duration (only minutes) of the fire at the same site because of the limiting biomass. The renewal buds (of grasses) below ground are not affected and the seeds below ground (“seed bank”) are hardly damaged, and these may germinate and produce seedlings very quickly. Luxuriant growth of herbaceous species is often a consequence of surface fires, as many minerals become available in the ash (Fig. 3.2.11 C). Also, seeds of many plants, particularly those that survive frequent fires, receive a germination stimulus from the cold smoke (Dixon et al. 1995; Roche et al. 1998). Even in woody plants with relatively little biomass usually only the outer layer of the shoot turns to charcoal so that a regeneration of the shoot from living tissues at the base of the stem is possible. The Australian grass tree even contains a resin which is difficult to burn and protects the stem from fire. For many plants a sub-lethal fire acts as a stimulus to flowering. In other plants, the so-called **pyrophyte** fruits open only after a fire (Fig. 3.2.11 D).

Besides these positive stimulations of ecosystem processes, **fire** takes carbon and nitrogen from the system in the form of different gaseous oxidation products, although base cations remain in the ash in the ecosystem. Part of the remaining organic bound nitrogen is transformed into ammonium and nitrate. Thus young plants and surviving rhizomes have better conditions for growth initially than before the fire, which



Fig. 3.2.11. A,B Fire vegetation on Mount Kilimanjaro (Shira Plateau). A *Erica arborea* as stunted vegetation that regenerates from charred branches. On average there is a fire every 3–5 years. B Charred *Erica arborea* at a site with less frequent fires. The bifurcated twigs show that the plant had survived at least one fire, between the last and the most recent fire a substantial trunk has developed, and the intensity of the fire was therefore high. Both pictures were taken 2 years after the fire. Rejuvenation of the bushes had occurred with bushy growth on the frequently burnt site where little biomass had accumulated between fires. In contrast, growth from the charred thick trunk was comparatively sparse. In the foreground, *Helichrysum splendidum*, a typical fire indicator (Photo E. Beck). C Vigorous germination of *Festuca obturbans* and *Kniphofia thomsonii* after an intense fire in the alpine zone of Mount Kilimanjaro. In the foreground charred twigs of *Erica arborea* and *E. trimeria* (Photo E. Beck). D Fruits of the Australian *Hakea* (Proteaceae) open only after a fire. (Photo E. Beck)

is, therefore, used worldwide as an agricultural measure in grasslands and savannahs to activate new growth. With fires the soil is supplied with carbon that is difficult to degrade (charcoal and soot). In the long term fire leads to a reduction of soil fertility, particularly the N supply.

In boreal coniferous forests, the fire sequence determines the amount of carbon which may be stored in the soil (Fig. 3.2.12). Calculated over a period of 6000 years (since the end of the Ice Age) the frequently burnt *Pinus banksiana* only contains half as much C in the soil than the less frequently burnt *Picea mariana* and these amounts are significantly lower than in very rarely burnt blanket bog where, independent of the fire frequency, the high water table conserves the carbon in the soil; this ecosystem indicates the potential to accumulate litter. In all cases a saturation curve occurs, i.e. there is a balance

between the synthesis of organic matter in the soil and the consumption by fire, which is determined not only by respiration or burning, but also by the high frequency of fires and by the reduced productivity of the vegetation (Harden et al. 2000).

3.2.5.3

Effects of Changes in Species Composition

Disturbances not only change the immediate material fluxes, but also affect the composition of species within the system. Areas suitable for growth are opened, which were previously occupied by other species now weakened by the disturbance or killed. The remaining, surviving organisms may spread or new species enter. The greatest number of species is found with average

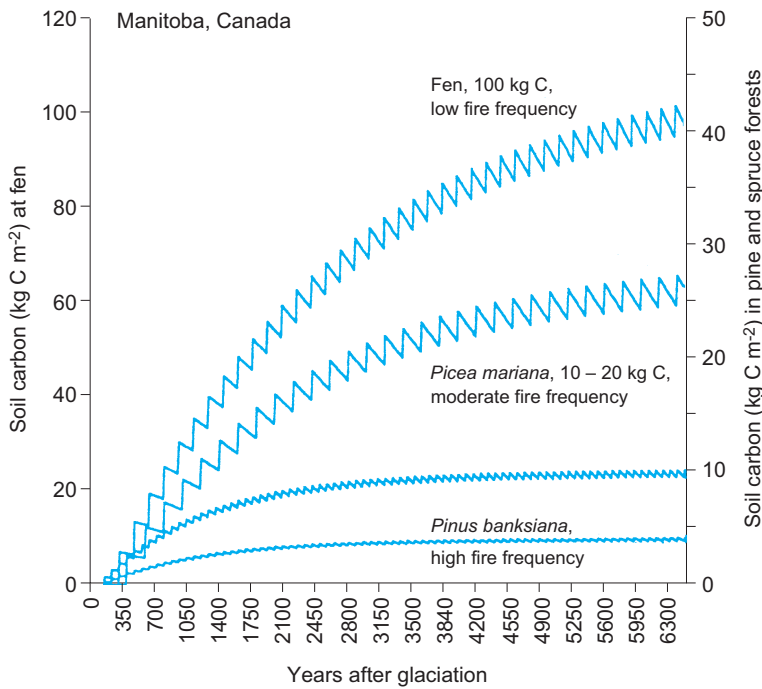


Fig. 3.2.12. Changes in soil carbon in a sedge bog with low frequency of fires and in *Picea mariana* and *Pinus banksiana* stands exhibiting increasing frequency. The zig-zags on the curves show the frequency at which fires occur. The figure illustrates the cumulative amount of C that is removed from these ecosystems directly or indirectly by fires. (Harden et al. 2000)

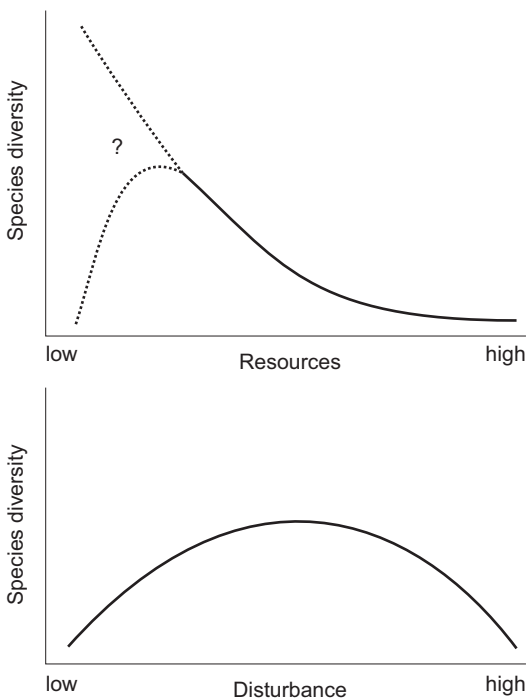


Fig. 3.2.13. Schematic presentation of the relationship between species diversity and resource availability, and between species diversity and habitat disturbance. Species diversity reaches a maximum at average ecosystem disturbance. (Hobbie et al. 1994)

disturbance intensities (*intermediate disturbance hypothesis*; Fig. 3.2.13; Hobbie et al. 1994; see also Chap. 4.2). If the frequency of disturbance increases, only a few specialists remain. The number of species also decreases in the absence of external disturbance. Either only a few very competitive species dominate or there is competition for other resources, and thus biodiversity increases further (see also Fig. 3.2.5).

Two examples demonstrate this effect:

- 1. Invasion and water use:** For individual plants the limitation of water use was discussed in the context of adaptation to stress and optimisation of water use (see Chap. 2.4), but at the level of a plant stand the situation is different. If a plant “saves water”, this may have the consequence that another species or individual plants of the same species uses this water. Opportunists which do not save water have an advantage, insofar as they manage to sustain the species, e.g. by early seed production. The “saver of water” could dry out under these conditions. This occurs particularly at sites where new species invade existing vegetation (invasion, Fig. 3.2.14). Invasion of Mediterranean *Bromus* species into the North American *Artemisia tridentata* prairie led to a marked reduction of *Artemesia* (West and Young 2000). *Bromus* species use the water supply without limitation at the beginning of

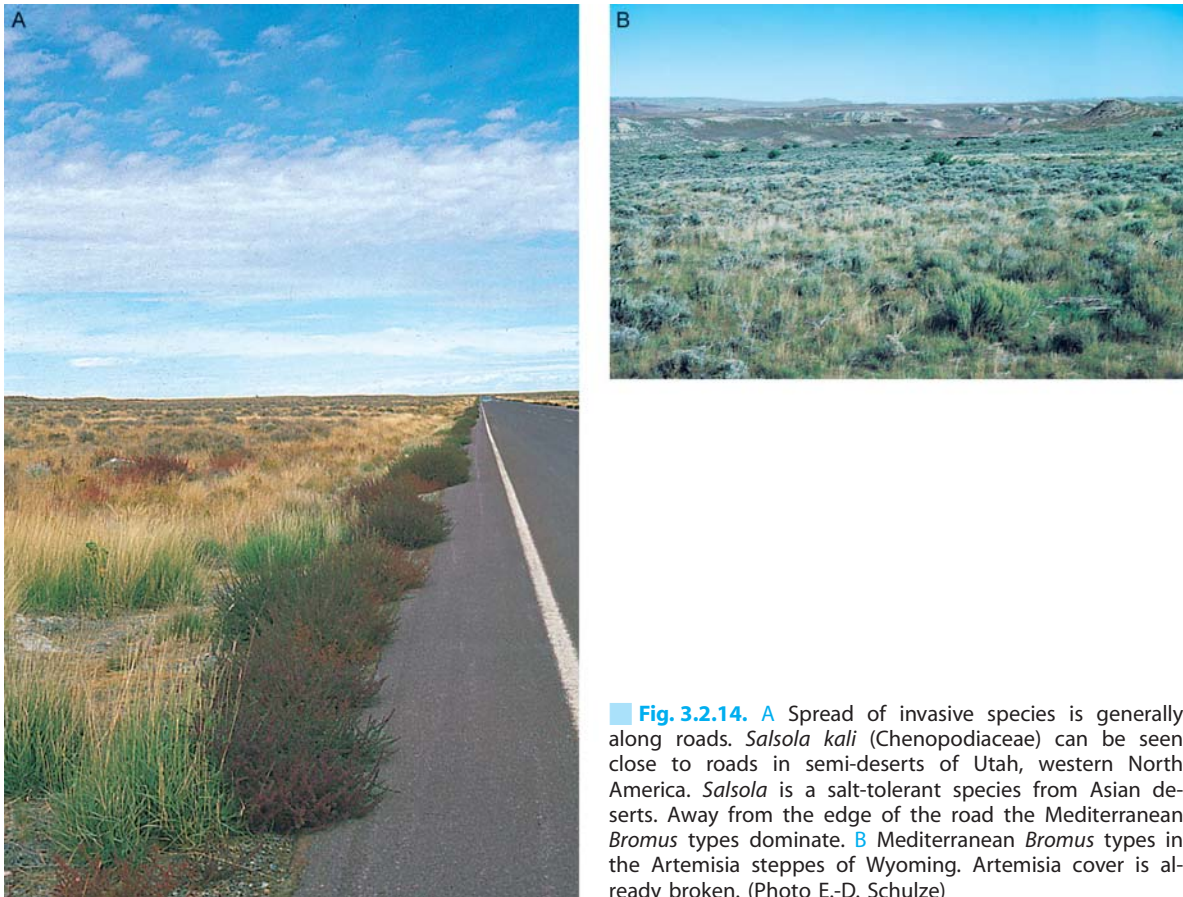


Fig. 3.2.14. A Spread of invasive species is generally along roads. *Salsola kali* (Chenopodiaceae) can be seen close to roads in semi-deserts of Utah, western North America. *Salsola* is a salt-tolerant species from Asian deserts. Away from the edge of the road the Mediterranean *Bromus* types dominate. B Mediterranean *Bromus* types in the Artemisia steppes of Wyoming. Artemisia cover is already broken. (Photo E.-D. Schulze)

the growing season because they are annual species which form their seeds before the drought starts and then die. The high water use of *Bromus* means that the perennial *Artemisia*, which must survive the dry period, does not have enough water later. *Artemisia* dies, often without forming seeds and without having the ability to regenerate as fast as *Bromus*; also, seedlings of *Artemisia* are not able to compete with *Bromus*. The effect of differential water use is enhanced by fire. Dry stalks of *Bromus* increase the frequency of fire, whereby *Artemisia* is not fire-tolerant. Grazing also plays a role as *Artemisia* is very sensitive to mechanical disturbance from trampling by animals which is not the case for *Bromus*.

2. **Grazing:** Disturbances causing a change in the assembly of the vegetation are particularly caused by **grazing**. Grazing animals have par-

ticular effects because they selectively eat species which may be destroyed if they are not adapted to grazing pressure. *Bouteloua* cluster grasses in North America are not adapted to grazing by horses, as they remove the whole clump and pull the roots out of the soil, so the plant dies off. Similarly, grasses from Australia, with auxiliary buds high on the stem, are adapted to kangaroos but not to grazing by cows or sheep; kangaroos pick individual leaves from shoots, whilst cows and sheep bite the above-ground shoots completely off and thus stop re-sprouting of the plant. In both cases, grazing with European domestic animals caused far-reaching changes in the flora. Additionally, there are indirect disturbances, e.g. trampling by animals compacts the soils and there is relocation of resources with the deposition of faeces, e.g. in cow pats, or places where animals congregate.

Box 3.2.1 Summary: Characteristics of ecosystems

- Ecosystems are complex webs between organisms and their environment on a defined and limited area of ground, whereby the assimilation of material by plants and its degradation by soil microorganisms plays an essential role.
 - When considering an ecosystem, flows and balances of material and energy must be considered per unit area. The distribution of material between individuals of a single species or between different species is important. The mass balance quantifies the over-use of substances or their accumulation.
 - The partitioning of a habitat by individuals of a species follows the laws of self-thinning. When partitioning of a habitat between different species occurs then host-parasite interactions and mycorrhizae become important. In the case of managed land, man controls the density.
 - Availability of resources (especially water and nutrients) determines the turnover rates of an ecosystem. In this case the cycling and the losses of nutrients are a major factor. The uptake of nutrients by plants and their remineralisation usually do not occur simultaneously, hence in natural ecosystems carbon is accumulated and losses of nitrogen and cations may occur.
 - Biomass harvesting is an important factor in removing resources from an ecosystem.
- These must be replaced by fertiliser or liming to avoid degradation of the site.
- Ecosystems are characterised by non-linear processes. These include saturation of the production of organic matter with increasing biomass, exponential increase of respiration with temperature, exponential demand for resources, threshold values in buffering of soils and changes in turnover with the composition of species.
 - Biodiversity decreases with increasing resource availability. It is more difficult to predict what happens to biodiversity when resources are scarce. In this case, either the number of species may increase or only few species gain dominance. This depends on what is limiting (nitrogen, water or cations).
 - Disturbances often lead to an initial increase in diversity, but beyond a certain optimum the number of species falls, depending on the strength of the disturbance.
 - Ecosystems are generally not at equilibrium with respect to the various processes of accumulation and decomposition. Disturbances constantly change the dynamics. Disturbances can be factors such as the seasonal change in the weather, long-term changes in climate, catastrophic events that result in resources being either added (dust storms) or removed (fire, harvest, grazing) from the system.

References

- Bond WJ (1994) Keystone species. *Ecol Studies* 99:237–254
- Dixon KW, Roche S, Pate JS (1995) The promotive effect of smoke derived from burnt native vegetation on seed germination of western Australian plants. *Oecologia* 101: 185–192
- Ernest SKM, Brown JH (2001) Delayed compensation for missing keystone species by colonization. *Science* 292: 101–103
- FBW Forschungsbeirat Waldschäden/Luftverunreinigungen (1989) Dritter Bericht an die Bundesregierung. Forschungszentrum, Karlsruhe, 611 pp
- Gleason HA (1926) The individualistic concept of the plant association. *Bull Torrey Bot Club* 53:7–26
- Grime JP, Mackey JML, Hillier SH, Read DJ (1987) Floristic diversity in a model system using experimental microcosms. *Nature* 328:420–422
- Harden JW, Trumbore SE, Stocks BJ, Hirsch A, Cower ST, O'Neill KP, Kasischke ES (2000) The role of fire in the boreal carbon budget. *Global Change Biol* 6:174–184
- Hector A, Schmid B, Beierkuhnlein C, Caldeira MC, Diemer M, Dimitrakopoulos PC, Finn JA, Freitas H, Giller PS, Good J, Harris R, Högberg P, Kuss-Danell K, Joshi J, Jumpponen A, Körner C, Leadley PW, Loreau M, Minns A, Mulder CPH, O'Donovan G, Otway SJ, Pereira JS, Prinz A, Read DJ, Scherer-Lorenzen M, Schulze E-D, Siemann D, Spehn EM, Terry AC, Troumbis AY, Woodward FI, Yachi S, Lawton JH (1999) Plant diversity and productivity experiments in European grasslands. *Science* 286:1123–1127
- Hobbie SE, Jensen DB, Chapin ES III (1994) Resource supply and disturbance as control over present and future plant diversity. *Ecological studies*, vol 99. Springer, Berlin Heidelberg New York, pp 385–408
- Hundt R (1958) Beiträge zur Wiesenvegetation Mitteleuropas. I. Die Auenwiesen an der Elbe, Saale und Mulde. *Nova Acta Leopoldina NF* 20:135

- Hundt R (1962) Die Bergwiesen des Harzes, Thüringer Waldes und Erzgebirges. Habilitationsschrift Halle/Saale, 250 pp
- Kaiser K, Guggenberger G (2000) The role of DOM-sorption to mineral surfaces in the preservation of organic matter in soils. *Org Geochem* 31:711–725
- Kramer H (1988) Waldwachstumslehre. Parey, Hamburg, 374 pp
- Larcher W (1994) Ökophysiologie der Pflanzen. Ulmer, Stuttgart, 394 pp
- Last FT, Watling R (1991) Acid deposition, its nature and impacts. *Proc R Soc Edinb, Section B*, 97, 343 pp
- Lloyd J, Taylor JA (1994) On the temperature dependence of soil respiration. *Funct Ecol* 8:315–323
- Mellilo JM, Prentice IC, Farquhar GD, Schulze E-D, Sala OE (1996) Terrestrial biotic responses to environmental change and feedbacks to climate. *Climate Change 1995 – The science of climate change WG I*. Cambridge University Press, Cambridge, pp 445–482
- Nordin A, Högberg P, Näsholm T (2001) Soil N availability and plant N uptake along a boreal forest productivity gradient. *Oecologia* 129:125–132
- Osawa A, Allen RB (1993) Allometric theory explains self-thinning relationship of mountain beech and red pine. *Ecology* 74:1020–1032
- Persson T, Rudebeck A, Jussy JH, Clin-Belgrand M, Prieme A, Dambrine E, Karlsson PS, Sjöberg M (2000) Soil nitrogen turnover – mineralisation, nitrification and denitrification in European forest stands. *Ecological studies*, vol 142. Springer, Berlin Heidelberg New York, pp 297–331
- Read D (1994) Plant-microbe mutualism and community structure. In: Schulze E-D, Mooney HA (eds) *Biodiversity and ecosystem functions*. *Ecological studies*, vol 99. Springer, Berlin Heidelberg New York, pp 181–210
- Reineke LH (1933) Perfecting a stand-density index for even-aged forests. *I. Agric Res* 46:627–638
- Roche S, Dixon KW, Pate JS (1998) For everything a season – smoke-induced seed germination and seedling recruitment in a western Australian *Banksia* woodland. *Aust J Ecol* 23:111–120
- Sala OE, Lauenroth WK, McNaughton SJ, Rusch G, Zhang X (1996) Biodiversity and ecosystem functioning in grasslands. In: Mooney HA, Cushman JH, Medina E, Sala OE, Schulze E-D (eds) *Functional role of biodiversity: a global perspective*. *SCOPE* 55:129–150
- Scherer-Lorenzen M (1999) Effects of plant diversity on ecosystem processes in experimental grassland communities. *Bayreuther Forum Ökol* 75:193
- Schlesinger WH (1997) Biogeochemistry; an analysis of global change. Academic Press, San Diego, 588 pp
- Schulze E-D (1982) Plant life forms and their carbon, water and nutrient relations. *Encycl Plant Physiol New Ser* 12B:615–676
- Schulze E-D (1995) Flux control at the ecosystem level. *Trends Ecol Evol* 10:40–43
- Schulze E-D (2000) Carbon and nutrient cycling in European forest ecosystems. *Ecological studies*, vol 142. Springer, Berlin Heidelberg New York, 498 pp
- Schulze E-D, Ulrich B (1991) Acid rain – a large-scale, unwanted experiment in forest ecosystems. *SCOPE* 45:89–106
- Schulze E-D, Lloyd J, Kelliher FM, Wirth C, Rebmann C, Lühker B, Mund M, Knohl A, Milyokova IM, Schulze W, Ziegler W, Varlagin A, Sogachev AF, Valentini R, Dore S, Grigoriev S, Kolle O, Panforyov MI, Tchebakova N, Vygodskaya NN (1999) Productivity of forests in the Euro-siberian boreal region and their potential to act as a carbon sink – a synthesis. *Global Change Biol* 5:703–722
- Schulze E-D, Högberg P, van Oene H, Persson T, Harrison AF, Read D, Kjöllér A, Matteucci G (2000) Interactions between the carbon and nitrogen cycle and the role of biodiversity: a synopsis of a study along a north-south transect through Europe. *Ecological studies*, vol 142. Springer, Berlin Heidelberg New York, pp 468–492
- Smith SE, Read DJ (1997) Mycorrhizal symbiosis. Academic Press, London, 605 pp
- Stitt M, Schulze E-D (1994) Plant growth, storage, and resource allocation: from flux control in a metabolic chain to the whole plant level. In: Schulze E-D (ed) *Flux control in biological systems*. Academic Press, San Diego, pp 57–118
- Taylor AFS, Martin F, Read DJ (2000) Fungal diversity in ecomycorrhizal communities of Norway spruce (*Picea abies*) and beech (*Fagus sylvatica*) along north-south transects in Europe. *Ecological studies*, vol 142. Springer, Berlin Heidelberg New York, pp 343–365
- Townsend AR, Vitousek PM, Trumbore SE (1995) Soil organic matter dynamics along gradients in temperature and land use on the island of Hawaii. *Ecology* 76:721–733
- Ulrich B (1987) Stability, elasticity, and resilience of terrestrial ecosystems with respect to matter balance. *Ecological studies*, vol 61. Springer, Berlin Heidelberg New York, pp 11–49
- van der Heijden MAG, Klironomos JN, Ursic M, Moutoglis P, Streitwolf-Engel R, Boller T, Wiemke A, Sanders IR (1998) Mycorrhizal fungal diversity determines plant biodiversity, ecosystem variability and productivity. *Nature* 396:69–71
- Wallenda T, Stober C, Högberg L, Schinkel H, George E, Högberg P, Read DJ (2000) Nitrogen uptake processes in roots and mycorrhizae. *Ecological studies*, vol 142. Springer, Berlin Heidelberg New York, pp 122–143
- WBGU (1998) Welt im Wandel: Strategien zur Bewältigung globaler Umweltrisiken. Wissenschaftlicher Beirat der Bundesregierung Globale Umweltveränderungen. Jahrestgutachten 1998. Springer, Berlin Heidelberg New York, 383 pp
- West NE, Young JA (2000) Intermountain valleys and lower mountain slopes. In: Barbour MG, Billings WD (eds) *North American terrestrial vegetation*. Cambridge University Press, Cambridge, pp 255–284
- Westoby M (1984) The self-thinning rule. *Adv Biol Res* 14:167–225
- Wirth C, Schulze E-D, Schulze W, von Stünzner-Karbe D, Ziegler W, Miljukova IM, Sogachev A, Varlagin A, Panforyov M, Grigoriev S, Kusnetzova W, Siry M, Harges G, Zimmermann R, Vygodskaya NN (1999) Above-ground biomass and structure of pristine Siberian Scots pine forests as controlled by competition and fire. *Oecologia* 121:66–80
- Yoda K, Kira T, Ogawa H, Hozumi H (1963) Self-thinning in overcrowded pure stands under cultivated and natural conditions. I. *Inst Polytech Osaka City Univ Ser D* 14:107–129

3.3

The Biogeochemical Cycles



The study of biogeochemical cycles in ecosystems requires not only extensive observations (see introductory page to [Chap. 3](#)), but also experiments outside the laboratory (see Mooney et al. 1991). Technical requirements for such sites in the field are demanding. An example is the “Shelter” experiment in a forested watershed conducted by the EU project “Exman”. The canopy was separated from the roots by a roof. Rainwater was collected from this cover and pollutants (sulfur and nitrogen deposition) were removed. The purified rainwater was then returned to the soil. Thus it was possible to separate the effects of pollutants on the crown of the trees from the effects of acid deposition on the roots. As it is not possible to derive statistically significant information from one plot, the experiment was repeated at five sites within the EU. Gorsjön, southern Sweden. Photos E.-D. Schulze

The interactions between autotrophic and heterotrophic organisms of an ecosystem have been combined in the biogeochemical cycles, where the coupling between the trophic levels only occurs by making substrates available. In each ecosystem many alternative paths exist for the synthesis and decomposition of materials. Physicochemical conditions and composition of species in the ecosystem often decide which path is used preferentially within the nutrient network. Feedback effects of organisms on the physicochemical boundary conditions occur mainly via weathering and loss of minerals as well as the heat and water balances (for change of optical characteristics and surface roughness, see Chaps. 2.1 and 2.2).

According to the extent of exchange of substances with the environment, i.e. material leaves the ecosystem or is re-cycled into the ecosystem, a distinction is made between open and closed cycles. Transitions are possible and, indeed, under natural conditions, transitions are the rule rather than the exception.

Open cycles occur

- with water: the requirement for water is so large that storage is not possible;
- with carbon: as plants obtain CO_2 from the free atmosphere and CO_2 is released back to the atmosphere through the respiration of autotrophic and heterotrophic organisms; transfer of organic carbon from heterotrophic

to autotrophic species can be neglected (amino acids);

- in managed systems (grazing, agriculture and forestry): Wherever material is taken out of the ecosystem and perhaps other materials (fertilisation) are added, the biogeochemical cycles are open;
- in ecosystems subjected to high input of S and N from the atmosphere; intermediate storage in the system may occur (e.g. for N) which, in the first instance, accelerates turnover within the ecosystem. Release of these elements to the atmosphere or to groundwater may occur later or be started earlier by external disturbances.

Closed cycles are found under favourable conditions

- for nitrogen, e.g. when the external supply of N and denitrification are low compared with the internal turnover in the ecosystem;
- for cations and phosphate, although losses of these elements through leaching cannot be excluded. The balance between weathering of primary minerals and leaching determines the succession of the ecosystem.

The ideal view of closed material cycles has not been achieved, even in ecosystems undisturbed by man (Chadwick et al. 1999; see Fig. 3.5.1). In the following, the turnover of water and the **carbon** and **nitrogen** cycles are discussed in more detail.

3.3.1

Water Turnover

Water flows through ecosystems and it is stored only to a small degree (see Chap. 2.2), i.e. it would be more correct to speak of a hydrological balance rather than of a water cycle. The ecosystem gains water as precipitation (rain, snow, dew = total precipitation). The structure of the vegetation may increase the water input, e.g. by “combing out” of clouds via increased surface area onto which fog droplets settle. An example is the laurel forests in Tenerife which are, to a large extent, dependent on water harvested from clouds. Ecosystems lose water to the atmosphere because of the free evaporation from the wet surfaces, and by transpiration and by seepage into the groundwater. The hydrological

balance is positive if excess water seeps below the root horizon into deeper soil layers and negative if precipitation is completely used by evapotranspiration or if transpiration is fed by supplies which do not originate from immediate precipitation (advective groundwater, melting permafrost, capillary rise of water from deeper horizons). According to the amount of precipitation, the hydrological balances are variable, but, on average, about 50–60% is used by plants. This applies in all climatic regions irrespective of their different conditions (see Fig. 2.2.3 in Chap. 2.2).

As transpiration and CO₂ assimilation are coupled via stomata (see also Fig. 3.2.5), the hydrological balance controls, to a first approximation, vegetation growth, the so-called net primary production (NPP, see Chap. 3.3.2, Fig. 3.3.9). This is particularly important for agriculture in dry areas (DeWitt 1978; Fischer and Turner 1978).

$$\text{NPP} = m\Sigma E / \Sigma E_0 \quad (3.3.1)$$

where ΣE is the sum of transpiration integrated over the period of the NPP measurement and ΣE_0 is the sum of daily evaporation from an area of free water. The equation is analogous to Eq. (2.4.7) in Chapter 2.4, describing the diffusion of CO₂ across the stomata ($A = \Delta c g$ and $\Delta c = A/g$, where $g = E/D$), because ΣE is the sum of the water consumption by transpiration and ΣE_0 is proportional to the mean saturation deficit of air (D). The coefficient m is thus a parameter analogous to the mean internal mesophyll CO₂ concentration (Schulze 1982). This coefficient varies for C₃ plants between 10 and 14 g dry matter per m² and reaches 21–23 g m² in C₄ plants. Assuming that the transpiration corresponds to the hydrological balance (precipitation minus seepage), it is then possible to use this equation for a rough estimate of yield from precipitation. For particular crops, e.g. for cereal grain, a ratio of grain yield to biomass, i.e. the harvest index, must be considered. Generally, it is 0.5 for high-yielding varieties (Fischer and Turner 1978). If in a sub-arid region 200 mm precipitation is available for the growth of plants, then about 2400 g dry matter harvest m⁻² biomass production are to be expected. For a harvest index of 0.5, this results in a grain yield of 1.2 t grain ha⁻¹.

Independent of the fact that yields may be calculated from Eq. (3.3.1) as first approximation, there are several restrictions. Particularly

the distribution of precipitation is a constraint in arid areas. For example, many light rains may “imply” a large amount of precipitation; however, most of this water would evaporate immediately from the moist ground and thus not be available for the plant. This shows that the hydrological balance is the important parameter and not precipitation. The distribution of precipitation is particularly important in planning sowing and harvesting in short and long rainy seasons.

3.3.2

Carbon Turnover

3.3.2.1

Carbon Turnover in Ecosystems

The term carbon cycle is often used for ecosystems. This is incorrect, as it does not take into account that CO₂ from the free atmosphere used in photosynthesis mainly. Only a small amount originates from respiration at the same site. Atmospheric turbulence leads to a rapid mixing in the atmosphere. Thus the CO₂ which is assimilated enters the ecosystem by advection via the atmospheric transport of air masses and is lost again in the same way (see Chap. 2.1).

The plant cover assimilates CO₂ from the atmosphere by photosynthesis (Fig. 3.3.1). The sugars synthesised are either used immediately for growth, to form or maintain existing structures, or are stored in the form of starch (e.g. see Chap. 2.4). The sum of photosynthetic C bound over a certain period (e.g. 1 year) is called **gross primary production (GPP)** neglecting light-induced respiration (photorespiration, see Loreto et al. 1999).

About 50% of the photosynthetically assimilated carbon is consumed by the plant itself for maintenance and synthesis of biomass. The balance of assimilation and respiration of plants is called **net primary production (NPP)**. A distinction is drawn between the more frequently measured **above-ground primary production (ANPP)** and the **below-ground primary production (BNPP)** because it is easier to measure ANPP. Depending on the organisation of individual plant structures, there are allometric relations between ANPP and BNPP (for trees, on average, BNPP/NPP=0.3). Quantitative assessments of plant biomass on earth and of NPP were made in the 1960s, within the International Biological Programme (IBP). These data are still the basis for many model calculations, but there are still, according to the subject area, many different interpretations about the “productivity” of plants. For the farmer it is the grain yield, for the forester the increase in stem growth and wood volume, for the biologist the total increase including fruit and fine roots. There is no direct connection between biomass and NPP. Biomass formed by NPP remains for very different periods in the organism or in the stand, thus leading to different values of biomass (see Table 3.3.1). For **annual species** the total biomass, except seeds, dies off at the end of the growing season and is again supplied to the heterotrophic organisms in the soil as litter. Disregarding rhizomes, bulbs or corms which are permanent organs in **perennial herbaceous plants**, almost all the total biomass resulting from the NPP also dies and becomes litter. In woody plants about 50% of the NPP is wood. In the lignified organs, part of the sapwood is changed to dead heartwood, depending on the C assimilated, and this is converted into litter with a long delay, because the heartwood forms the tree’s structure (see Chap. 2.4.5.4). Even for trees about 50% of the NPP reaches the soil each year

lated carbon is consumed by the plant itself for maintenance and synthesis of biomass. The balance of assimilation and respiration of plants is called **net primary production (NPP)**. A distinction is drawn between the more frequently measured **above-ground primary production (ANPP)** and the **below-ground primary production (BNPP)** because it is easier to measure ANPP. Depending on the organisation of individual plant structures, there are allometric relations between ANPP and BNPP (for trees, on average, BNPP/NPP=0.3). Quantitative assessments of plant biomass on earth and of NPP were made in the 1960s, within the International Biological Programme (IBP). These data are still the basis for many model calculations, but there are still, according to the subject area, many different interpretations about the “productivity” of plants. For the farmer it is the grain yield, for the forester the increase in stem growth and wood volume, for the biologist the total increase including fruit and fine roots. There is no direct connection between biomass and NPP. Biomass formed by NPP remains for very different periods in the organism or in the stand, thus leading to different values of biomass (see Table 3.3.1). For **annual species** the total biomass, except seeds, dies off at the end of the growing season and is again supplied to the heterotrophic organisms in the soil as litter. Disregarding rhizomes, bulbs or corms which are permanent organs in **perennial herbaceous plants**, almost all the total biomass resulting from the NPP also dies and becomes litter. In woody plants about 50% of the NPP is wood. In the lignified organs, part of the sapwood is changed to dead heartwood, depending on the C assimilated, and this is converted into litter with a long delay, because the heartwood forms the tree’s structure (see Chap. 2.4.5.4). Even for trees about 50% of the NPP reaches the soil each year

Box 3.3.1 The water cycle

- Ecosystems have no water cycle, but a hydrological balance between precipitation (dew, rainfall and snow) and evaporation plus transpiration, deep percolation and runoff. The hydrological balance is controlled, in physiological terms, by responses of stomata, the optical properties determining the absorption of incident radiation and the roughness of the surfaces (see also Chaps. 2.1.2.2 and 2.2.4).
- Net primary production increases in proportion to transpiration and decreases with increasing potential evaporation ($NPP = m E/E_0$). The proportionality factor m is 10–14 g dry mass in C3 plants and 21–23 g dry mass m^{-2} in C4 plants.

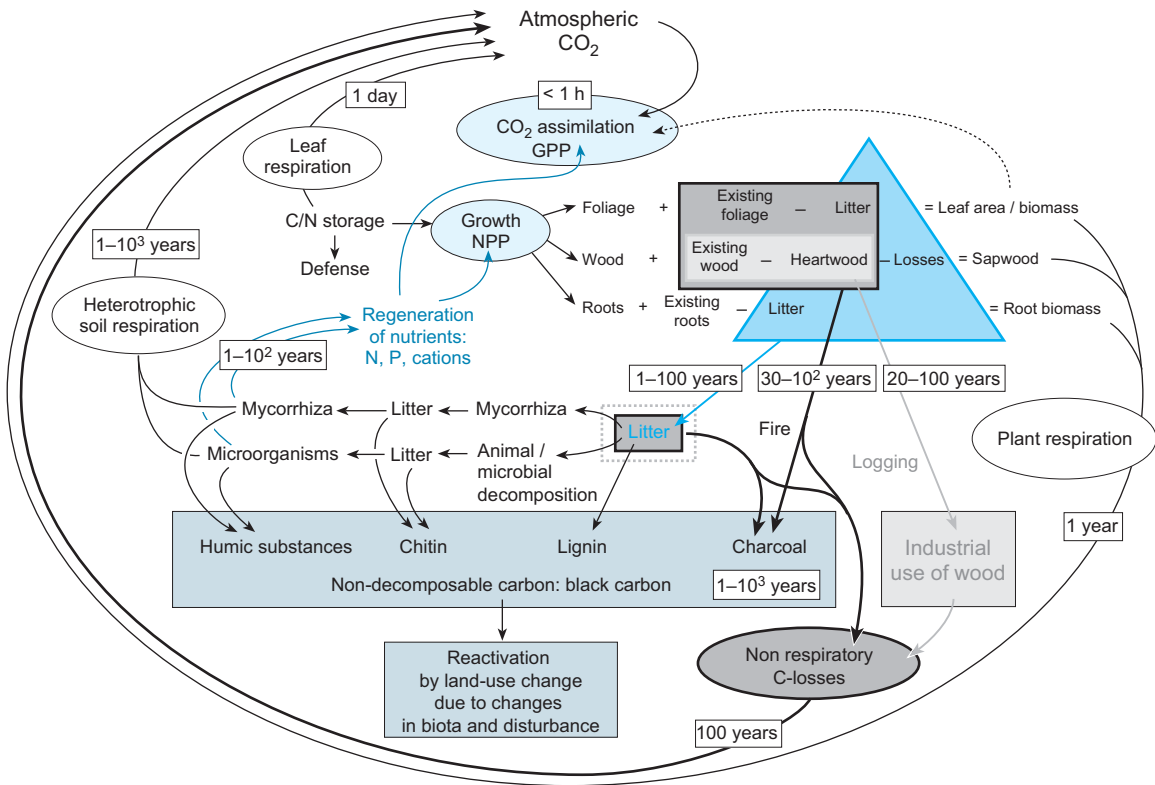


Fig. 3.3.1. Turnover of carbon in ecosystems (Schulze 2000 a). Turnover begins with photosynthetic assimilation of CO₂ by the plant. Products are distributed to leaves, shoots and roots and, in the case of trees, to heartwood. Maintenance and growth of biomass require energy that may be measured as respiration. However, a large part of the biomass is wood which no longer respire. The autotrophic vegetation is linked to the soil by leaf litter and mycorrhizae. Additional losses result from harvests and fires. Organic substances that occur in the soil are turned over and are decomposed by various organisms and eventually are released as CO₂ by respiration (in the process of mineralisation). In ecosystems only black carbon remains in the ecosystem for a very long period of time

as leaf, twig and root litter. For herbaceous species this litter production corresponds to the NPP (see also Fig. 2.4.20 in Chap. 2.4).

The problem in determining NPP is mainly the difficulty in assessing the turnover of fine roots (<2 mm diameter) because this part of growth is almost impossible to measure. In the tropics the determination of NPP of epiphytes is

an additional problem. For temperate forests the **mean life span of fine roots** is about 0.5 to 2 years, i.e. fine roots are turned over about once or twice a year, and are continuously replaced by new fine roots (Stober et al. 2000). The turnover in grasses is much greater with sufficient water supply, i.e. the life span of fine roots is shorter. The proportion of fine roots as

Table 3.3.1. Biomass, net primary production (NPP), and litter production in different vegetation types of the earth. (Schulze 1982; Schlesinger 1997; Schachtschabel et al. 1998)

Ecosystem	Biomass (kg C m ⁻²)	NPP (kg C m ⁻² a ⁻¹)	Leaf litter (kg C m ⁻² a ⁻¹)
Tropical rainforest	20–32	3–10	0.5–1.4
Temperate deciduous forest	5–30	0.2–1.2	0.1–0.6
Temperate coniferous forest	15–75	0.4–1.3	0.1–0.6
Boreal coniferous forest	8–10	0.3–0.4	0.1–0.5
Savannah	1–2	0.4–0.6	0.1–0.4
Grassland	0.2–2.2	0.1–1.0	<0.1–1.0
Agricultural land	0.5	0.3–0.5	0.1–0.2
Desert	0.2–3	<0.1–0.5	<0.1–0.2
Tundra	0.1–2	<0.1–0.2	<0.1

Table 3.3.2. The biomass of fine roots (<2 mm diameter) and leaves in different vegetation types of the earth. (Schulze 1982; Jackson et al. 1997)

Vegetation type	Roots Total (kg m ⁻²)	Fine roots			Leaves or needles	
		Mass (kg m ⁻²)	Length (kg m ⁻²)	Root surface index (m ² m ⁻²)	Mass (kg m ⁻²)	Leaf surface index (m ² m ⁻²)
Tropical rain forest	4.88	0.57	4.1	7.4	2.5	11
Temperate coniferous forest	4.40	0.82	6.1	11.0	1.3	9
Temperate deciduous forest	4.14	0.78	5.4	9.8	0.4	7
Boreal forest	2.92	0.60	2.6	4.6	1.8	11
Shrub vegetation	4.82	0.52	8.4	11.6	0.4	8
Savannah	1.40	0.99	60.4	42.5	0.9	3
Temperate grassland	1.56	1.51	112.0	79.1	0.6	3
Tundra	1.25	0.96	4.1	7.4	0.4	2
Desert	4.13	0.27	4.0	5.5	0.1	<1
Average	3.28	0.78				

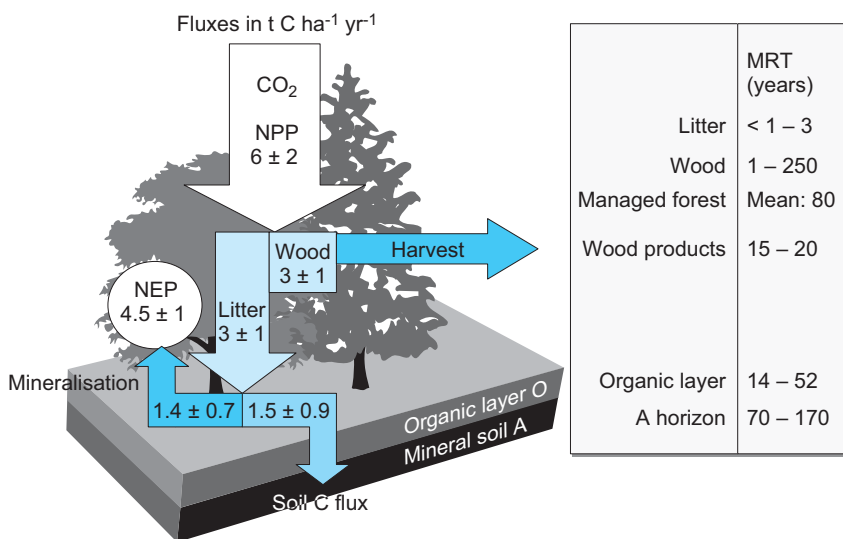


Fig. 3.3.2. The flow of carbon in a forest ecosystem and the mean residence time (MRT) of litter, wood and wood products in a managed forest. The figure shows that almost half the net primary production is in litter and the other half in accumulated wood. Of the leaf litter, half remains in the soil as organic substances with an MRT of >100 years. (After Schulze 2000a)

part of biomass is, on average, 28% (Table 3.3.2). Fine roots in forests reach a total length of 2–8 km m⁻² and a projected area of 4–11 m² m⁻², corresponding in magnitude to the leaf area index. In grasslands the length of fine roots (>100 km m⁻²) is a factor of ten greater than in forests. The NPP of fine roots probably corresponds to the turnover of leaves (Schulze 2000b).

Ultimately, in natural ecosystems, all plant parts reach the ground in the form of litter and are decomposed and mineralised. We distinguish between **decomposition**, which describes the breakdown of organic substances into subunits and its re-assembly into new organic molecules, and **mineralisation**, where the organic substances are oxidised to CO₂ or to methane. Large differences occur in how long individual

organs remain on the plant or in the soil. An example of an European forest ecosystem is given in Fig. 3.3.2, with synthesis and decomposition of fine roots occurring in the same year, but leaves and needles having a life span of 1–10 years (*Pinus aristata* 30 years) and decomposition takes another 1–20 years. Wood remains on the plant >100 years (oldest living trees 4000 years: *Pinus aristata*, Fig. 2.4.29, Chap. 2.4) and the decomposition of wood takes, in general, 50 to >100 years. These periods are comparable to the average life span of woody materials, corresponding to the 15–25 years for the turnover of litter. It is also important that the mean retention of C in the organic layer of soils is of the same magnitude as that in forest biomass.

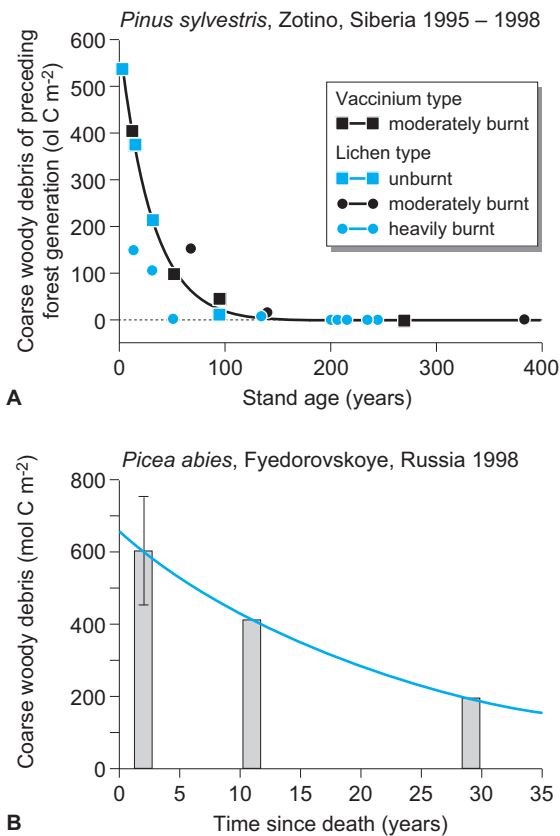


Fig. 3.3.3. A Degradation of dead wood after a fire in a Siberian pine forest. The mean residence time is only about 40 years, despite the cold climate. This is because of the repeated fires at ground level. As these fires only char the outside of the wood (see Fig. 3.3.8C), single dead trunks can be traced back 400 years (Wirth et al. 2002). B Dead-wood after wind falls in a natural forest reserve in European Russia. The mean residence time in the east European climate is about 15 years. (Knohl et al. 2002)

Degradation of wood has mainly been studied in boreal coniferous forests (Fig. 3.3.3A; Wirth et al. 2002). Trunks killed by fire are degraded with a half-life of 25 years. Decomposition is finished after about 120 years with part of the dead wood being burnt because of periodic ground fires. In this case, decomposition becomes accelerated compared to microbial decomposition (Fig. 3.3.3B). Because of unfavourable mineral composition ($<0.01 \text{ mol N g}^{-1}$ dry matter) microbial decomposition of wood is slower than that of litter (leaves and fine roots).

Imbalances between litter fall and decomposition may lead to accumulation of organic matter (raw humus), which may be decomposed at other times in the development of the stand. A balance between supply of organic matter and decomposition can only be expected seldomly

because both processes depend on different conditions. Imbalances occur particularly under the following conditions:

- Bogs: C decomposition is limited because of anaerobic conditions and low pH.
- Forests: C decomposition is limited by unfavourable mineral conditions and by acidification of the soil (accumulation of raw humus). The formation of heartwood is also a type of “litter production”. In this case decomposition is delayed by decades. Another form of stabilisation of C is the binding of soluble organic carbon to heavy metals. This process is particularly important in tropical soils, where organic substances would otherwise be quickly decomposed and are only immobilised by such reactions.
- Meadows: C decomposition is delayed by binding of organic substance to clay minerals, occurring after passing through the intestines of earth worms (stable clay humus complexes). Despite this, the amount of C in the long-term grassland experiments at Rothamsted did not increase.
- Arable fields: Soil organisms are C limited, as the above-ground organic material is removed during harvesting. After the change from forests or natural grasslands to arable fields, degradation of organic carbon in the soil takes place. Carbon content is additionally affected by mechanical working of soils. This was shown particularly impressively for prairie soils in North America, following agricultural use; during a period of about 50 years, 50% of the carbon in the soil was lost (see Chap. 3.5; Matson et al. 1997). With changing agricultural practices (e.g. shallower ploughing or zero tillage) this carbon started to accumulate again (Post and Kwon 2000; Smith et al. 2000).

3.3.2.2 Heterotrophic Decomposition of Soil Organic Matter

A multitude of organisms (fungi, bacteria), specialised in certain partial processes, degrade organic substances in soil. The activity of heterotrophic soil organisms is C limited, in contrast to plants where production is limited by nutrients. However, several organic substances in the soil “resist” decomposition to different degrees.

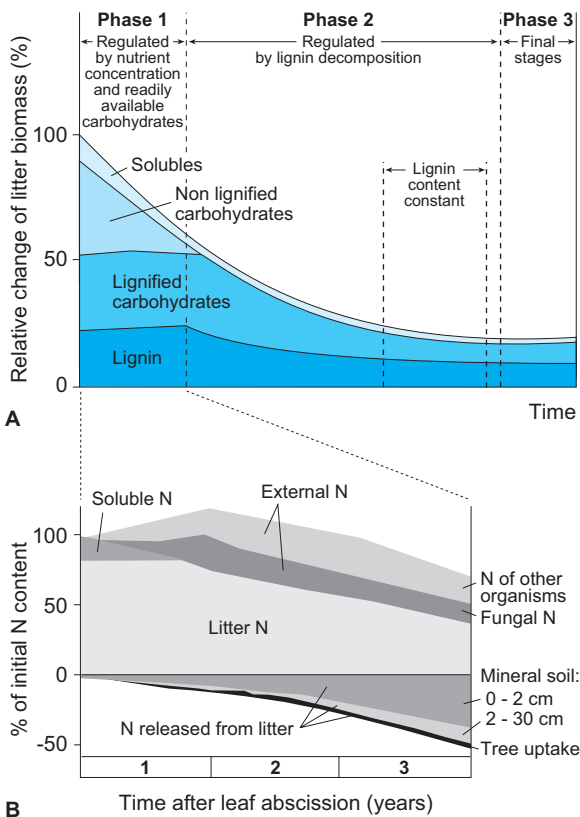


Fig. 3.3.4. **A** Degradation of leaf litter from beech over time. Initially, the easily available carbohydrates were consumed. Then lignin decomposition started with the breakdown of lignified carbohydrates rather than lignin itself. At the end about 20% of the leaf litter remained (after Berg and Matzner 1996). **B** Parallel with the decomposition of dry matter, decomposition of the N-containing substances followed. The N content of the leaf litter increased initially with colonisation by microorganisms, but then decomposition of compounds containing organic N occurred with transport to the mineral soil. After 3 years 60% of the N was decomposed. (After Cotrufo et al. 2000)

Decomposition occurs in several steps, with the dynamics for nitrogen (Fig. 3.3.4 B) being different to that of carbon (Fig. 3.3.4 A). In a newly fallen leaf, the N content rises initially as microorganisms and fungi settle on the dead leaf (for beech this takes about 1 year). At the same time the C content of the leaf decreases because of the use of easily decomposed C compounds (sugar, hemicellulose, cellulose). Finally, N-containing substances are decomposed and the N content of the leaf decreases as organisms retreat from the leaf (for beech after about 3 years). At this time the leaf has lost about 60% of its mass. Further decomposition is much slower. Lignin is now decomposed by fungi, but for this process an additional carbon source is required (Gleix-

ner et al. 2001). The temporal course of litter decomposition is the most important basis for modelling carbon turnover in the soil (Gholz et al. 2000).

Figure 3.3.4 shows that models of litter decomposition based on a change of total biomass describe global turnover rates sufficiently well for many purposes, but not well enough to enhance our understanding of long-term storage of C in soils where decomposition rates depend on the substance (Gleixner et al. 2001):

Cellulose forms most of the dry matter of plant biomass (15–40% of dry weight). Cellulose is synthesised from glucose units, whilst hemicellulose (10–43% of dry weight) is formed from hexoses and pentoses. Cellulose and hemicellulose are directly used by microorganisms as energy sources and to form their body substance. In these organisms a resynthesis of carbohydrates and new cell wall material (e.g. chitin) may occur. Particularly the newly formed microbial polysaccharides (bacterial slime) bind to clay and silt fractions in the soil and this stabilises these substances against further decomposition. The large amounts of carbohydrates, which are also found in deeper layers of soils, originate from the microbial biomass and their metabolic products. Thus, carbohydrates circulate in the soil between microbial populations and are thus only relatively slowly mineralised to CO_2 .

Lignin forms about 25–40% of the dry matter of plants. These are high molecular mass, three-dimensionally structured compounds of phenylpropane units which enclose cellulose fibrils and stabilise and protect them from decomposition. Conifers form lignin from coniferyl alcohol and deciduous trees use both coniferyl and sinapyl alcohols. Grasses also use coumaryl alcohol. The monomers are linked by C–C- and C–O-bonds. Lignin-degrading organisms are not able to grow on lignin being the only carbon source. Degradation occurs by laccase-forming fungi (white rots), which break bonds in the side chains and the aromatic rings by forming oxygen radicals (Fig. 3.3.5; Zech and Kögel-Knabner 1994). In the first step C–O-bonds (ether bonds) are broken, followed by degradation of C–C-carbohydrate chains. It is unlikely that the OH groups of the cyclic bonds are broken, because it would be difficult in biological decomposition to disrupt the hydrophobic benzene ring. Residual polymers, which are water soluble, remain and are relocated into deeper soil layers (**DOC = dissolved organic carbon**) or the chemically modi-

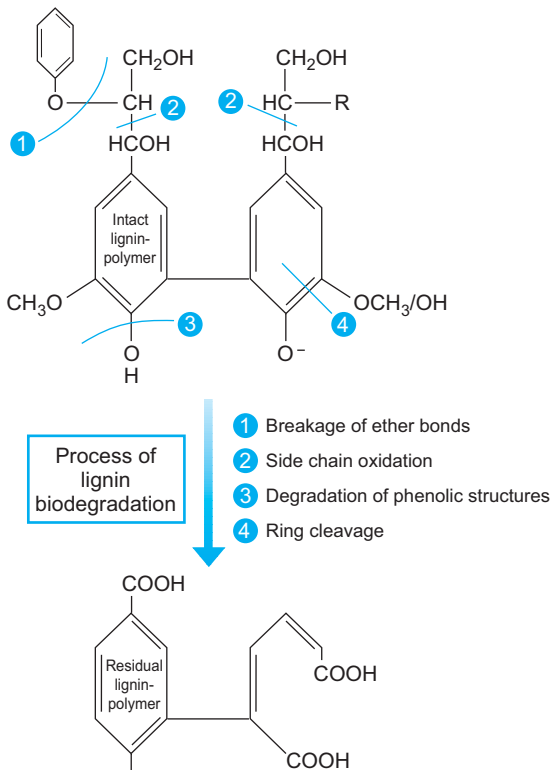


Fig. 3.3.5. Schematic presentation of the decomposition of lignin. The first step is breakage of the ether bonds, then oxidation of the side chains and, finally, opening of the double bond of the benzene ring, as long as the molecule is still hydrophilic. (Zech and Kögel-Knabner 1994)

fied lignin fractions react, forming new polymers, the humic substances.

Waxes and lipids are long-chain hydrocarbons which form only 1–10% of plant dry matter but they are the most difficult material to decompose, as short-chain lipids are formed in the reaction which may be toxic to microbial metabolism. However, long-chain lipids are decomp-

osable, e.g. by methanogenic bacteria living under anaerobic conditions in small spaces in soil aggregates, and convert alkanes into acetate and then into methane (Fig. 3.3.6; Parkes 1999; Krüger et al. 2000).

At the end of this material degradation, substances remain which are either derived from plant metabolism or are newly synthesised by microbial metabolism. This means that degradation of plant substances consists of a series of several cycles (Fig. 3.3.7):

- conversion of polymers into monomers;
- cleavage of heterocyclic compounds via the side chains;
- uptake and incorporation of plant material into microbial biomass (recycling of carbohydrates, amino acids, pyridine);
- degradation of carbohydrates or terminal groups (e.g. R-COOH or R-CH₂) to CO₂ or CH₄;
- binding of polar groups to clay minerals. This last step is the actual stabilisation (protection from further degradation) of the organic substance in soil. Thus the clay content determines the ability of soils to store C (Bird et al. 2001);
- even if plant substances can no longer be produced in the original form (e.g. lignin) it does not mean that the substance has been mineralised to CO₂, but rather that some parts of the molecules (e.g. benzene) can remain for a long time in the soil, whilst other molecular parts (pyridine, amino acids) are passed on from generation to generation and from organism to organism;
- binding to clay minerals occurs via an ester or ether bond, hydrogen bridges or in the form of ionic interactions.

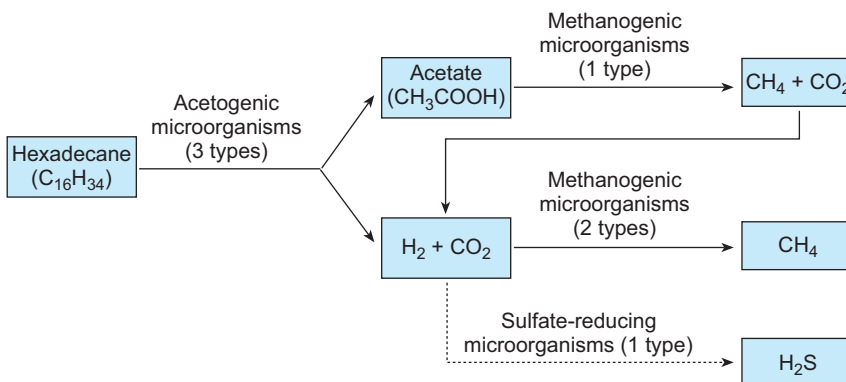


Fig. 3.3.6. Schematic representation of the degradation of long-chain carbohydrates

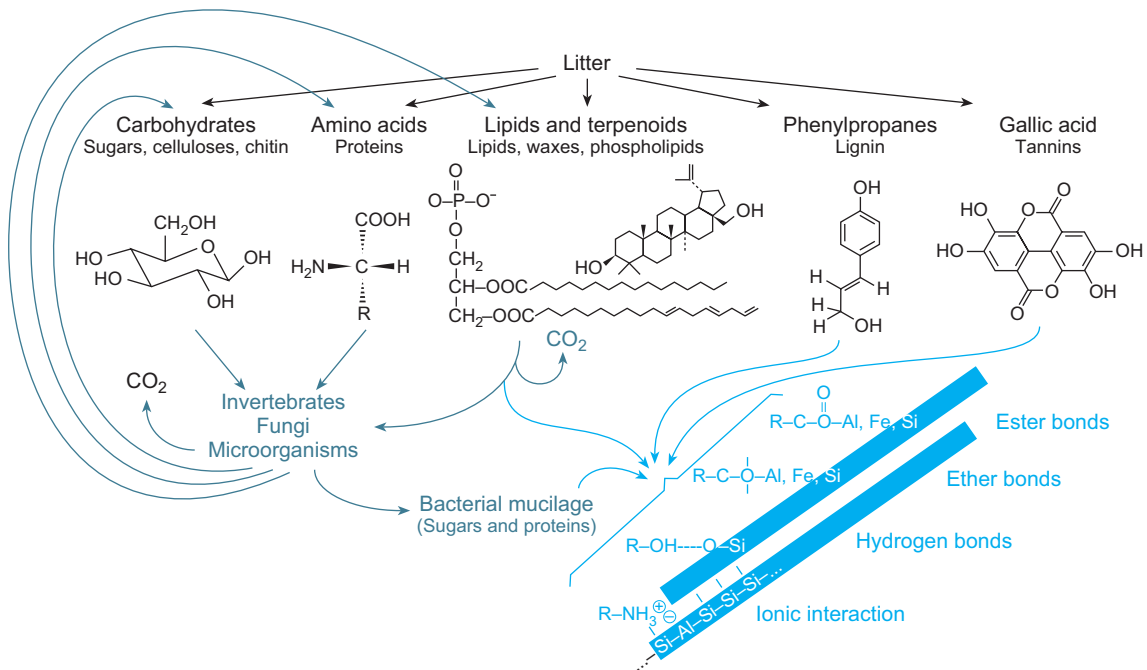


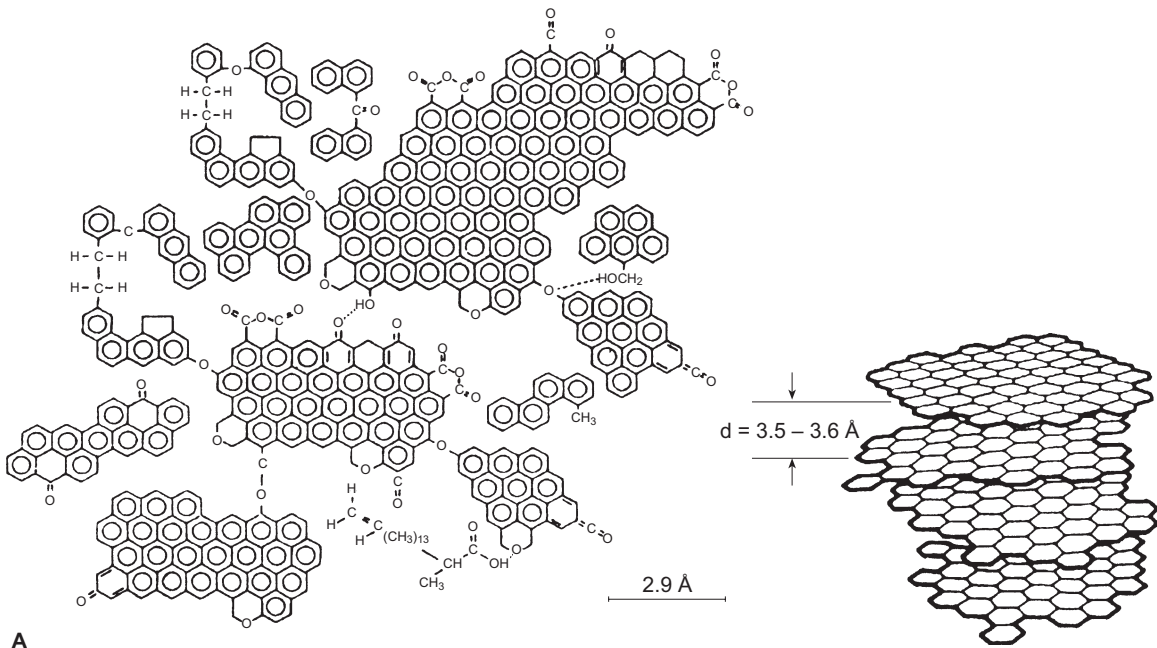
Fig. 3.3.7. Schematic representation of microbial recycling of plant substances from leaf litter and the formation of decomposition products, which bind to clay minerals. The figure shows a number of substances, such as carbohydrates, that remain a long time in the cycle and are passed from one generation of microorganisms to the next. Only a proportion is mineralised to the level of CO₂. Stabilisation of organic carbon is only through binding with clay minerals or heavy metals. (After Schulze 2000 a)

In the soil profile, related to the soil C in the respective horizon, a relative accumulation of aromatic structures (e.g. aryl-C from the degradation of lignin) and of long-chain carbohydrates (lipids: alkyl-C) occurs, but there is a relative decrease in polysaccharides (O-alkyl-C), because of the decomposition processes.

Changes in the chemical composition of litter observed with increased atmospheric CO₂ are not sufficient to change the general trend of litter decomposition (Norby et al. 2001).

The remaining organic substances form new polymers which are called **humus**, which not necessarily consist only of recalcitrant organic substances, but may also contain molecules which are easy to decompose (e.g. sugars), but these are protected by clay minerals from further decomposition (Torn et al. 1997). Under changing conditions, when other organisms occur or when mechanical treatment of soils destroys the aggregated structure, these semi-stable compounds are again subjected to further decomposition. In general, decomposition results in a decrease in the O/C and H/C ratios, i.e. the proportion of cyclic aromatics increases (Haumeier and Zech 1995).

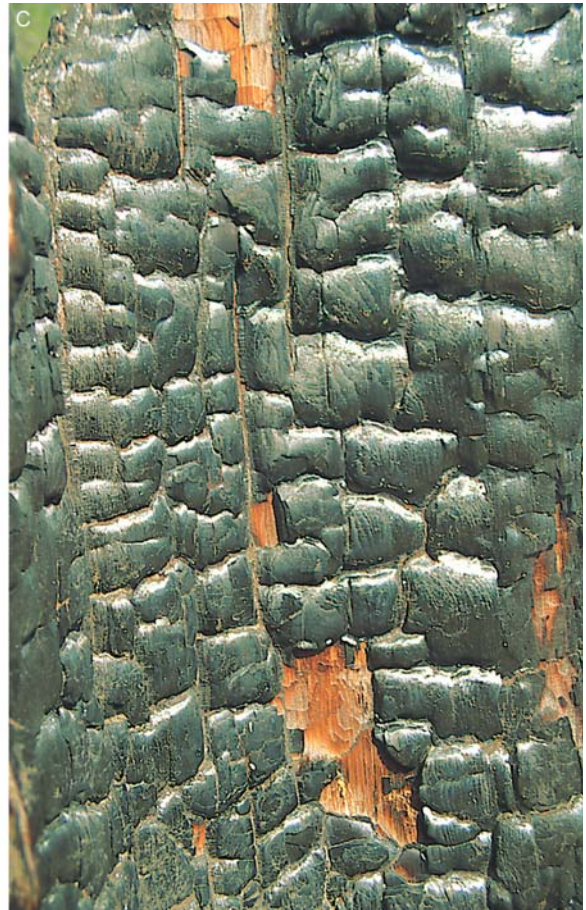
Charcoal (black carbon): There is a further path forming the so-called recalcitrant carbon which is difficult to degrade, that is by fire. When charcoal or soot is produced, recrystallisation of carbon takes place, forming polyaromatics with a structure similar to graphite (Fig. 3.3.8 A; Gleixner et al. 2001). These structures are almost inert to microbial decomposition. The residues of the carbonisation process are called **black carbon**. However, in forest fires, only a small proportion of the biomass is burned or changed into charcoal (Fig. 3.3.8 B). The largest proportion of the biomass is dead, unburned wood, where a charcoal cover protects the inner wood from decomposition (Fig. 3.3.8 C). It has been shown that the colour of black soils (chernozem) in steppes is based on soot and charcoal residues and is not just a product of humus formation (Schmidt et al. 1999). However, black carbon is not accumulated in savannahs despite frequent fires because charcoal burns again in the next fire. Also, the life span even of black carbon is not indefinite. It may be oxidised by strong acids and alkalis.



A



B



C

Fig. 3.3.8. A The putative structure of black carbon. In charcoal and soot there is a recrystallisation of cyclic hydrocarbon molecules to a condensed lattice of benzene rings (Gleixner et al. 2001). B Residue of a burnt tree trunk from the previous generation of trees in a pine forest in central Siberia. C Surface of a burnt tree trunk. It is clear that only the surface of the stem is charred, i.e. little charcoal is formed during a fire. The wood structure of a large proportion of the stem remains intact. During death of roots, resins are over-produced, impregnating the core of the trunk and protecting it against microbial decomposition. (Photo E.-D. Schulze)

3.3.2.3

Ecosystem and Biome Productivity

The sum of assimilatory and respiratory processes in carbon balance is called **net ecosystem productivity (NEP)**.

$$\text{NEP} = \text{GPP} - R_a - R_h = \text{NPP} - R_h \quad (3.3.2)$$

where R_a is the respiration of autotrophic plants and R_h the respiration of heterotrophic organisms (Fig. 3.3.9; Schulze and Heimann 1998; Schulze et al. 2000).

The NEP gives no information where the accumulated C is deposited. This could take place with low R_a in the biomass (increase of stems and heartwood in a forest) and with limited R_h in the soil as humus. Thus, NEP should not be equated with formation of humus only. Whether NEP is accumulated temporarily at the level of the stand, or as undecomposed carbon in soils waiting to be transferred into the chain of heterotrophic organisms at a later date (for trees > 100 years), can only be established after observation over longer periods or at a regional scale.

Figure 3.3.10 (Rebmann 2001) shows net ecosystem carbon fluxes as measured by a micro-

meteorological approach (eddy covariance method, see Chap. 2.2, Box 2.2.6), as an example. Photosynthetic activity during summer is clearly detectable. It balances and exceeds respiration during the night from mid-March until September. Also in winter there are times when net CO_2 assimilation is greater than respiration of spruce. Respiration of the ecosystem is significantly higher in summer than in winter. Under certain conditions (low irradiation) the forests may also be at the compensation point in summer. This stand assimilated, over the whole year, a total of $13.8 \text{ t C ha}^{-1} \text{ year}^{-1}$ (GPP). Of this, $13 \text{ t C ha}^{-1} \text{ year}^{-1}$ was lost through respiration of biomass and soil. In the end NEP was only $0.8 \text{ t C ha}^{-1} \text{ year}^{-1}$, which was deposited mainly in wood, as a consequence of growth. The balance may also become negative, i.e. losses exceed the gain from assimilation. As the wood is harvested in managed forests the amount of C is only transiently available in the ecosystem and thus the balance of this stand in the ecosystem is negative.

In addition to heterotrophic degradation, natural and anthropogenic exports of C occur mainly by **harvesting** (of agricultural crops or wood or animals) and **fire**. Including non-respi-

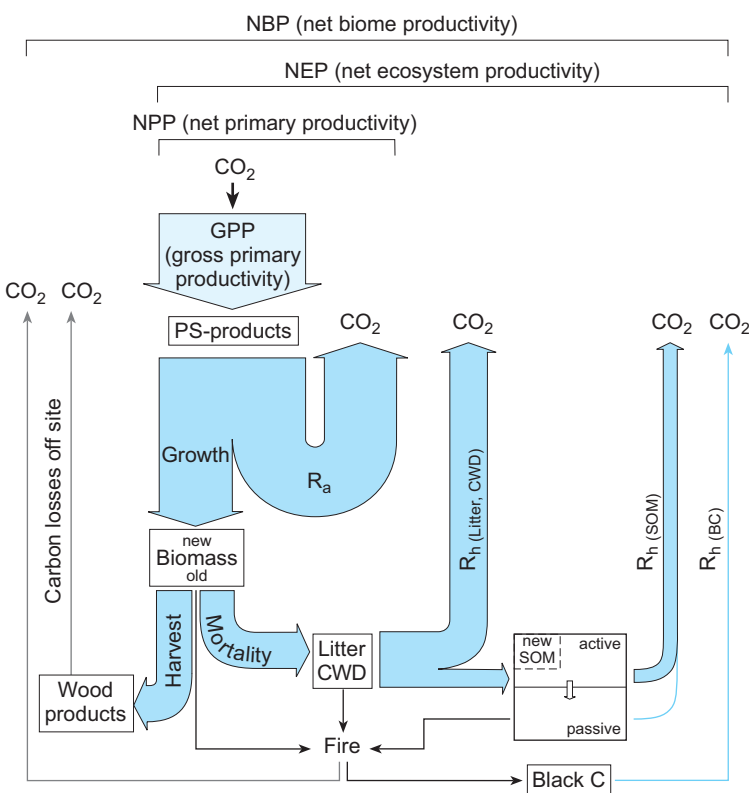


Fig. 3.3.9. Definitions of the term “productivity” in the carbon cycle (Schulze et al. 2000a). The initial process is the gross primary production (GPP), which corresponds to photosynthesis. Growth and maintenance requires about 50% of the assimilates for the energy requirement of the plant. Biomass is formed that appears as growth (net primary production, NPP). A proportion of this annual increase in biomass is returned to the soil as litter (leaves, roots, flowers) and, of this, a proportion returns to the atmosphere due to soil respiration. The “net ecosystem productivity” (NEP) is the balance between assimilation and total respiration. Independent of soil respiration are processes that remove C from the system without appearing in the respiration term. Examples are harvesting by man, grazing and fire. The balance of all these C turnovers is called “net biome productivity” (NBP). CWD Coarse woody debris; SOM soil organic matter; BC black carbon; R_h heterotrophic respiration; R_a respiration of autotrophic plants

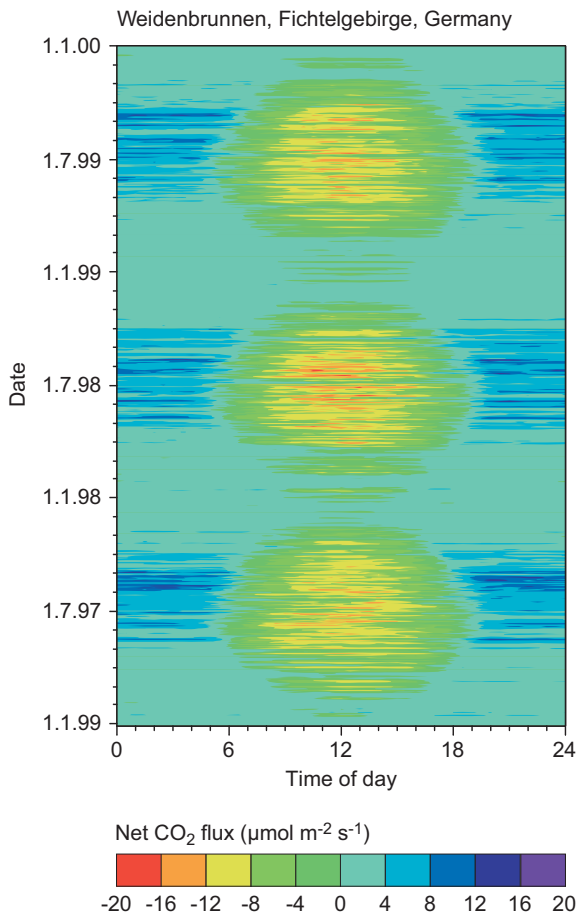


Fig. 3.3.10. Annual and daily changes of net ecosystem CO₂ exchange in a spruce forest in the Fichtelgebirge (Germany). In three subsequent years, CO₂ assimilation can be seen during the day in summer, which is higher than respiration at night. In autumn and winter, only respiration is measurable, with the exception of a few days when net CO₂ assimilation occurs also in winter. (Rebmann 2001)

ratory losses results in the so-called **net biome productivity** (NBP; see Fig. 3.3.9; Schulze and Heimann 1998):

$$\text{NBP} = \text{NEP} - \text{“non-respiratory” C losses} \quad (3.3.3)$$

Determining NEP by eddy covariance evaluates the net balance without considering from which of the many sources, e.g. from plants or carbon stored in different soil horizons, the respiratory CO₂ is derived. To interpret data from Table 3.3.3 the **mean residence time** (duration) of carbon in the potential source must be known (Harrison et al. 2000; Persson et al. 2000). The mean residence time of carbon in the soil (Fig. 3.3.2) increases from 1 to 8 years in litter to 4 to 50 years in the organic layer and reaches

Table 3.3.3. Mean residence time of soil carbon and carbon sequestration and decomposition in the soil of European deciduous and coniferous forests (Schulze et al. 2000a). The mean residence time of carbon in biomass is shown in Fig. 3.3.2

	Deciduous forests	Coniferous forests
Mean residence time (years)		
Litter	7	8
Organic layer	47	51
Mineral soil 0–10 cm	121	126
Mineral soil 10–20 cm	178	195
Net primary production (g C m ⁻² a ⁻¹)	600	630
Litter production (g C m ⁻² a ⁻¹)	310	260
Mineralisation (g C m ⁻² a ⁻¹)	130	150
Net ecosystem productivity (g C m ⁻² a ⁻¹)	470	480
Increase in soil C (g C m ⁻² a ⁻¹)	180	110
Proportion of the degradation in		
20 years (%)	54	46
20–100 years (%)	35	39
> 100 years (%)	11	15

>100 years in the mineral soil. Thus almost 50% of the carbon supplied to the soil by litter is decomposed in less than 20 years, 30–40% remains less than 100 years and only 10–15% is transformed into substances that are difficult to decompose and which accumulate in the soil where they remain more than 100 years, or these substances are so valuable for heterotrophic organisms (essential amino acids, pyridine, and others) that they are passed on between generations. The maximum age of carbon in the soil is around 3000–6000 years (Schlesinger 1990; Schachtschabel et al. 1998; Schulze et al. 1999). Only if soil horizons are buried, i.e. cut off from microbial decomposition, greater ages are attained in fossilised horizons.

A qualitative understanding of how carbon is transformed in the soil is possible, particularly by using mathematical models. An example is the CENTURY model (Parton et al. 1988), which shows the transformation and its dependence on availability of resources – C, N, P and S (Fig. 3.3.11 A). The model shows that, at all stages in decomposition, carbon is returned to microbial biomass. The proportion of carbon ending up in recalcitrant form is less than 1% of GPP. The turnover of carbon in microbial biomass means

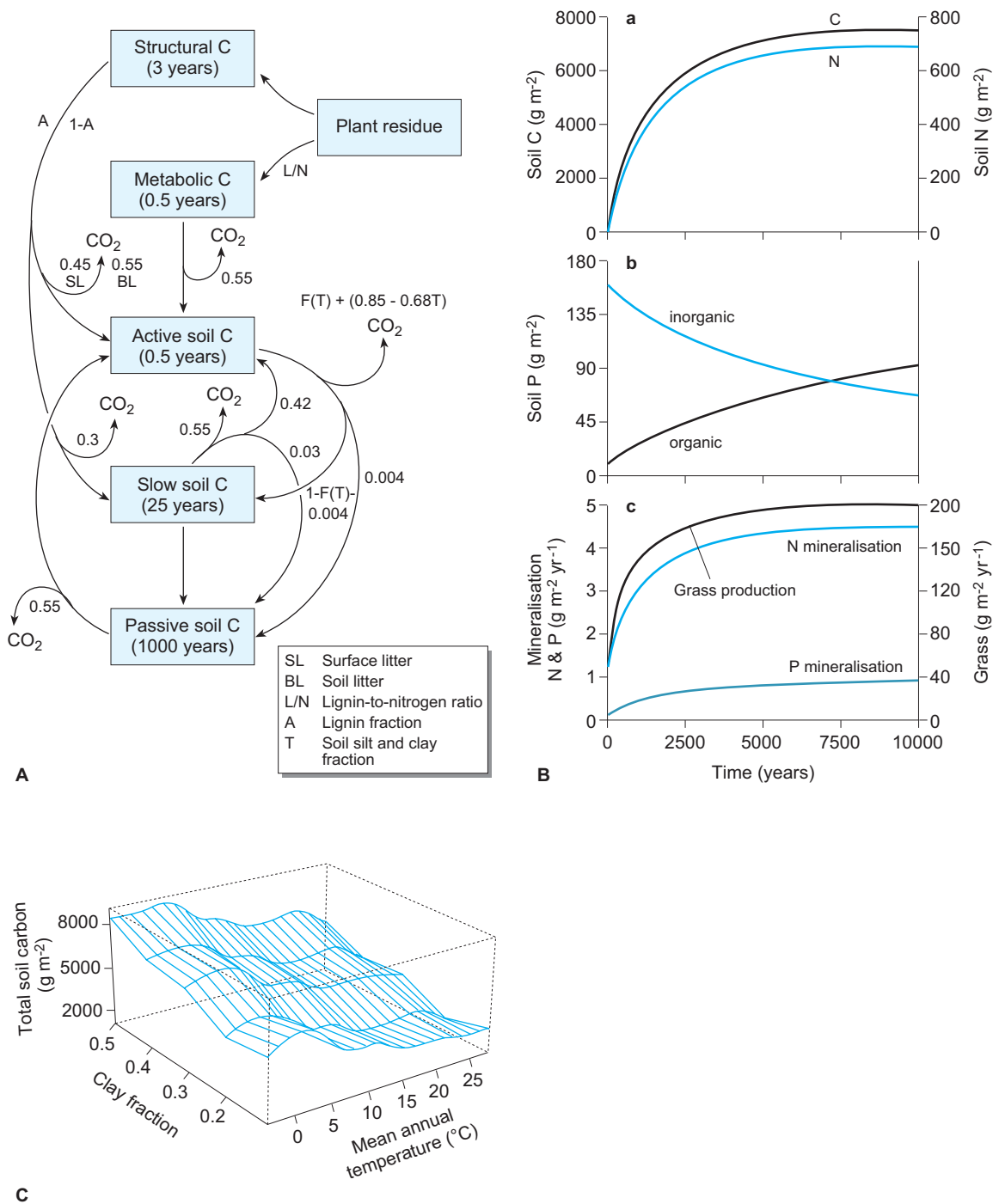


Fig. 3.3.11. **A** Flow chart of the CENTURY model to calculate the N and C turnover in an ecosystem using a grassland as an example. **B** Simulated changes in C, N and P content of various compartments. The model shows the magnitude of recycled substances in an ecosystem and also indicates the long-term accumulation of C and N in soil (Parton et al. 1988). **C** Dependence of soil carbon on ambient temperature and clay content of the soil. Adsorption of organic molecules to clay particles is a significant process that stabilises the soil carbon, thus the accumulation of carbon in a soil rises with increasing clay content. As the activity of soil microorganisms depends on the temperature, C accumulation in soil falls with mean annual temperature. (Schimel et al. 1994)

Box 3.3.2 Carbon turnover

- Carbon turnover in an ecosystem is not a cycle but an open exchange with the atmosphere. Ecosystem balance is determined from assimilation and respiratory processes in plants and soil. Fire and harvesting also determine the C turnover.
- Distinction is made between photosynthetic CO₂ fixation, identified as gross primary production (GPP), the growth of all plant organs, or net primary production (NPP), the net ecosystem productivity (NEP), the balance between assimilation and all respiratory processes, and the net biome productivity (NBP) that also takes into account non-respiratory carbon losses, from processes such as fire, harvesting and grazing.
- Litter couples plant productivity to heterotrophic processes in soil. It is only with great difficulty that the turnover rates of fine roots (<2 mm diameter) can be measured. Fine roots are about 28% of the total root mass and are assumed to turn over in woody plants about once a year, which is comparable to the turnover of leaves. Fine roots may attain 4 km m⁻² of soil surface area in tropical forests and up to 120 km m⁻² in grasslands. The projected area of fine roots is about that of the leaf area index.
- Litter degradation takes about 1–20 years for leaves and needles and up to 100 years for wood. Degradation can be significantly reduced by various local factors such as anaerobic conditions in moors, clay content (which leads to the formation of clay humic complexes) and low pH. Litter degradation is dependent on the chemical composition of the biomass with proteins, amino acids, cellulose and hemicelluloses directly degraded by – and incorporated into – microbes, i.e. they disappear rapidly from litter, whereas lignin and lipids are only slowly degraded and in the case of lignin are degraded without a gain in energy for the organisms (fungi with laccase activity).
- Plant polymers are degraded into monomers, and in part are recycled into microbial biomass (amino acids and pyridine) and are passed from generation to generation and from species to species (recycling).
- During the course of decomposition, organic substances decrease the O/C and H/C ratios, i.e. the proportion of cyclic aromatic substances increases.
- Fire releases CO₂ but also creates charcoal and crystalline carbon which due to the graphite-like structure are difficult to degrade. Black earth soils are enriched with such forms of black carbon.
- In European woodlands, about 46% of the litter is decomposed in 20 years, 39% in 100 years and only 15% remains after 100 years.
- Mathematical models of litter decomposition show the constant recycling of soil carbon, even for substances that are difficult to degrade in the microbial C cycle. This leads to an upper threshold of C storage in the ecosystem, determined by the clay content, duration and environmental temperature. Only about 1% of the assimilated C is held as recalcitrant carbon in the soil.

that the ecosystem reaches, in the long term, a constant value of soil carbon, specific to the system, but dependent mainly on the clay content of the soil (Fig. 3.3.11 B) and the mean annual temperature (Fig. 3.3.11 C; Lloyd and Taylor 1994; Schimel et al. 1994; Bird et al. 2001).

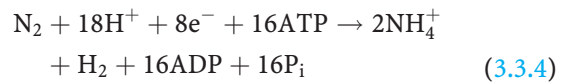
3.3.3

Nitrogen Cycle

Transformation of nitrogen in natural, anthropogenically undisturbed ecosystems (if they still exist) probably corresponds most closely to what is generally called a metabolic cycle (Fig. 3.3.12; Schulze 2000 a). Elemental nitrogen does not occur in nature and most nitrogen is found in the atmosphere as N₂ gas which cannot be directly

used by higher plants unless they are in symbiosis with microorganisms. In the ecosystem, nitrogen occurs in inorganic oxidised and in reduced forms (nitrate and ammonium) or with C in organic compounds, particularly as amino (C-NH₂) or amide (C-N-C) groups, and so the C and N cycles are tightly coupled. In the following, “N” cycle refers not to N₂, but to mole equivalents of N in different oxidised or reduced forms.

The nitrogen cycle is characterised by continuous change in the oxidation number of N (Fig. 3.3.13A; Gottschalk 1986; Meyer 1993). Electrons are first derived from degradation of organic substances and used to reduce N₂ to NH₃ (N₂ fixation).



The change in N₂ gas into organic compounds is achieved by N₂-fixing bacteria which occur either as free-living cyanobacteria, or as bacteria in nodules of Leguminosae or as symbionts with fungi (lichens) or higher plants [alders, cycads plants (Fig. 3.3.13B–D); *Gunnera*, etc.]. The chemical reaction requires 960 kJ mol⁻¹. At the reduction state of NH₄⁺, nitrogen may be transformed in many metabolic processes without changing the reduction state. Only during the transformation of organic substances in the soil are electrons removed from nitrogen via binding to oxygen. A veritable “zoo” of very different soil bacteria is involved to handle the electron. Distinction is made between the following reactions.

Type	Electron donor	Electron acceptor	C source biomass
Chemoorganoheterotrophs	OS	O ₂ , NO ₃ ⁻ , SO ₄ ²⁻ , OS, Me(ox)	OS
Chemolithotrophs	H ₂ , CO, H ₂ S, Me(red); NH ₃ , NO ₂ ⁻	O ₂ , NO ₃ ⁻ , CO ₂	CO ₂
Photolithoheterotrophs	H ₂ O, H ₂ S, S ⁰ , H ₂	CO ₂	CO ₂
Photoorganoheterotrophs	OS	OS	OS

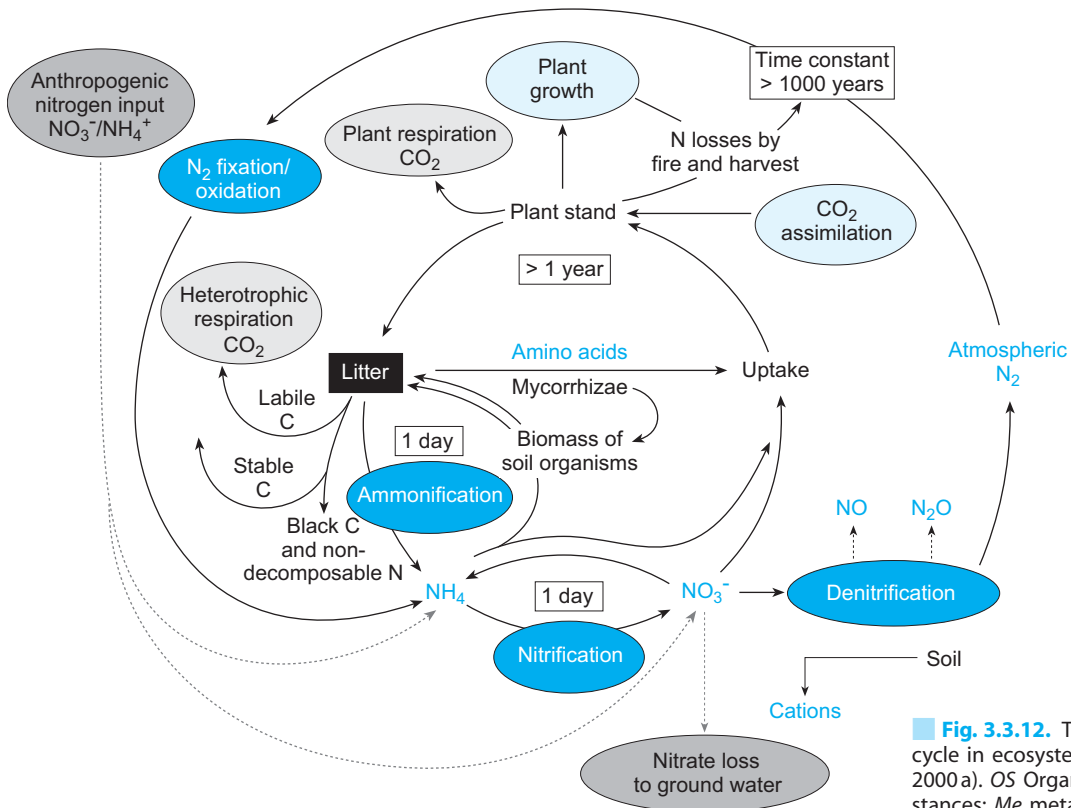


Fig. 3.3.12. The nitrogen cycle in ecosystems (Schulze 2000 a). OS Organic substances; Me metals

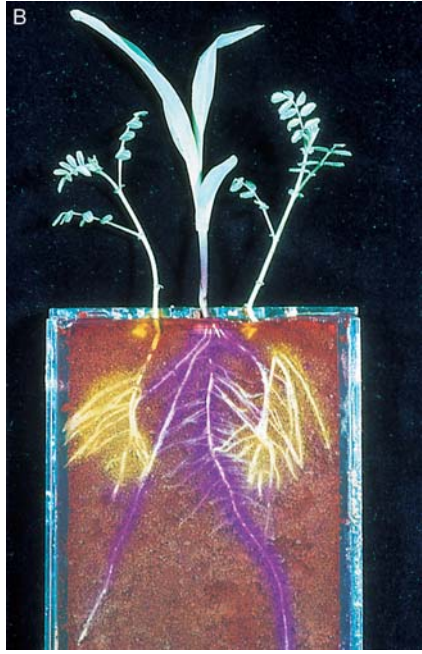
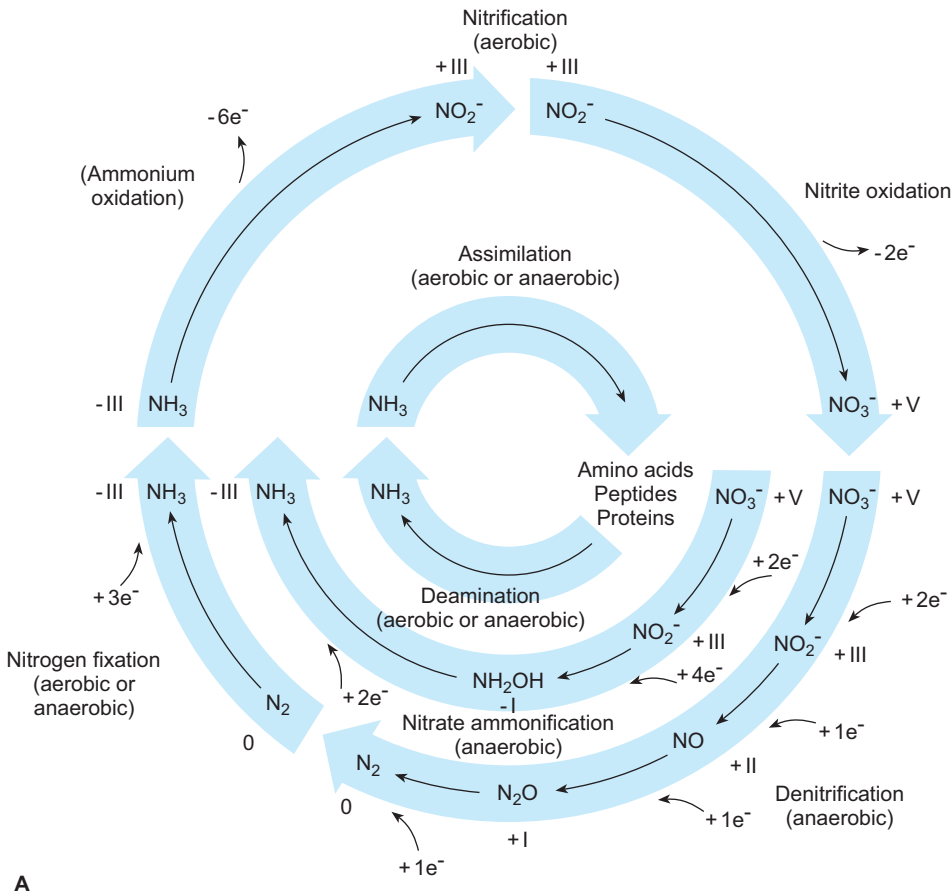


Fig. 3.3.13. A Functional groups of microorganisms in the biogeochemical nitrogen cycle. Blue arrows indicate reactions that occur within a single organism. Small black arrows are intermediate products. The figure also shows the oxidation state and the uptake or loss of electrons (after Meyer 1993). B Soil acidification as a result of N₂ fixation: During reduction of N₂ protons are released, which leads to acidification in many soil types. In the figure the lowering of pH in the soil close to the pea root is negated by the maize root that raises the pH by absorbing nitrate. A few N₂-fixing species are able to oxidise H⁺ to H₂ and thus avoid acidification (Photo: E. George).

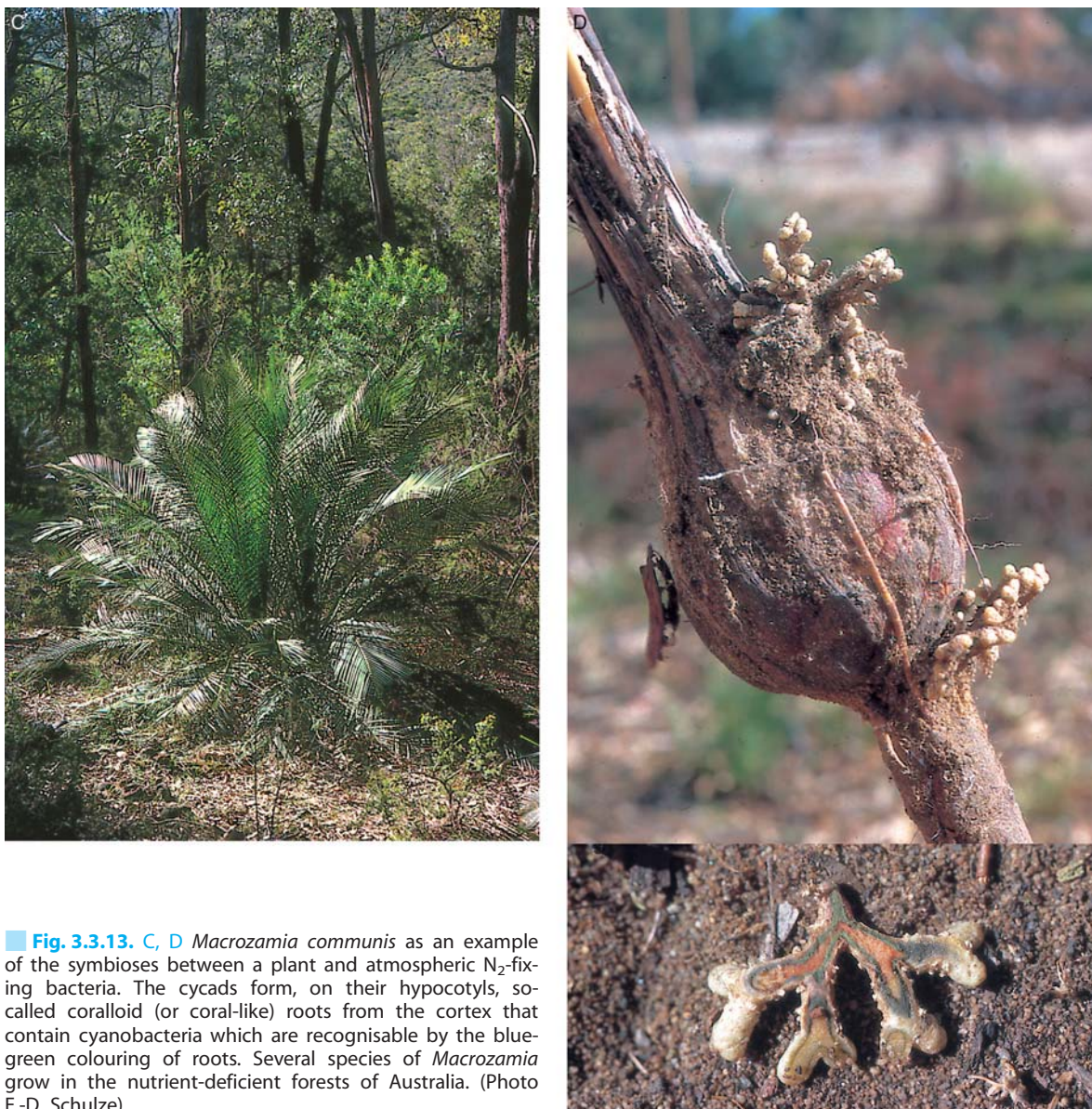
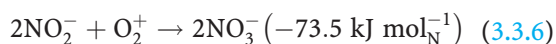
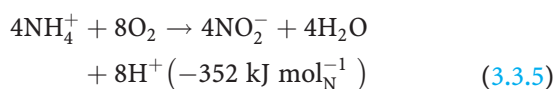


Fig. 3.3.13. C, D *Macrozamia communis* as an example of the symbioses between a plant and atmospheric N_2 -fixing bacteria. The cycads form, on their hypocotyls, so-called coralloid (or coral-like) roots from the cortex that contain cyanobacteria which are recognisable by the blue-green colouring of roots. Several species of *Macrozamia* grow in the nutrient-deficient forests of Australia. (Photo E.-D. Schulze)

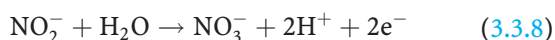
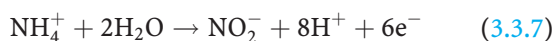
Transformation of NH_4^+ into oxidised nitrogen occurs by the following reactions:



A total of $425.5 \text{ kJ mol}_N^{-1}$ is released in the reaction, and is used by the autotrophic soil bacteria of the genus *Nitrosomas* (nitrification) and *Nitrobacter* (formation of nitrate) as an energy source to form ATP. The reaction is complicated, as during the formation of nitrite the oxygen

used as electron acceptor comes not from O_2 but from water. Nitrate oxidase, a molybdo-protein at the inner side of the cell membrane, transfers the electron to a cytochrome c at the outer surface of the membrane, which in turn transfers two electrons to a further cytochrome on the inner side of the membrane. This cytochrome transfers the electron to O_2 and thus produces a proton gradient which provides the energy for formation of ATP. In addition, electrons from cytochrome c are transferred to NAD^+ and thus reduction equivalents are formed (Gottschalk 1986).

Chemolithotrophic bacteria are also able to perform the following reactions:



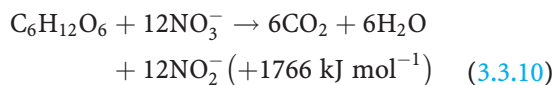
where the electrons are used for reduction of NAD^+ .

Plants are able to reduce NO_3^- back to NH_3

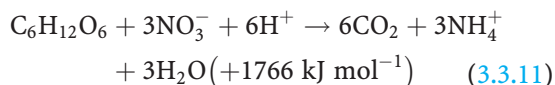


in this case electrons are made available from photosynthesis (see Chap. 2.3).

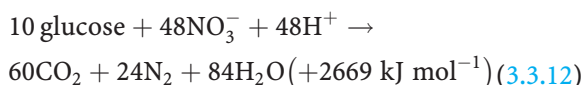
In another cycle, microorganisms are able to use the oxidised NO_3^- as an electron acceptor, thus gaining the oxygen required for oxidation of other substrates (**anaerobic nitrate ammonification**, also called **nitrate respiration**), where NO_3^- returns to the reduction state of NO_2^- using glucose.



or NO_3^- is transformed directly into NH_4^+



Independent of these reactions, nitrate may be degraded under anaerobic conditions to molecular N_2 (**denitrification**). Nitrate serves as electron acceptor and the oxygen released is used to oxidise organic substrates. The total energy gain by reduction of nitrate to N_2 is 561 kJ per mol electron acceptor, and is thus greater than by anaerobic respiration (475 kJ mol⁻¹ O₂). In the conversion of ammonium to nitrate and in denitrification, losses of intermediate products, particularly NO_2 , NO and N_2O as gases, are possible: these affect the radiation budget of the earth (see Chap. 2.1). The total balance of denitrification is:



where this reaction may take place in the same organisms as well as via a chain of organisms.

In ecosystems, nitrogen is not only made available to plants from N_2 by bacteria, but there are additional supplies from the atmosphere, where N_2 is oxidised by lightning or fire, for ex-

Table 3.3.4. The N balance in a spruce forest in Solling, Germany. (Horn et al. 1989)

Net requirement (mmol m ⁻² a ⁻¹)	Availability (mmol m ⁻² a ⁻¹)	
Needles	257	Uptake via the shoot
Branches/twigs	84	$\text{NH}_3 + \text{NO}_x$
Trunks	177	$\text{NH}_4 + \text{NO}_3$
		Uptake via the root
Roots	609 ^a	$\text{NH}_4 + \text{NO}_3$
Total	1127	Total
		1127

^a Requirement for roots includes turnover for fine roots and therefore is not easily quantifiable.

ample. Anthropogenically produced oxidised nitrogen (NO_x) originates from burning processes, and reduced nitrogen (NH_3) from domestic animals, sewage systems or industrial production of ammonium. The N deposition in ecosystems from such sources is <5 kg N ha⁻¹ a⁻¹. In industrially and agriculturally stressed ecosystems the N deposition is 20 to >100 kg N ha⁻¹ a⁻¹ (Schulze and Ulrich 1991).

In ecosystems, N consumption in different plants and their compartments is of interest, but the amount of N available in the ecosystem is particularly important (Table 3.3.4). Part of the requirement is provided by relocation of amino acids prior to leaf shedding. The N content of litter varies between 5 and 10 mg g⁻¹ dry matter in needles and leaves and 1 to 5 mg g⁻¹ dry matter in wood. About 3 t dry matter ha⁻¹ of litter reaches the soil in a beech forest and so the total input of reduced N is 15–30 kg N ha⁻¹. This does not cover the measured N requirements for the system. About one-third of the N supply in Germany is obtained via above-ground organs from air pollutants.

The geographic distribution of N supply is variable with respect to both the chemical species as well as the amount. With low supply (N deficiency) and acid soils, fungi are the dominating organisms in the soil (Chap. 3.2.4.3; Smith and Read 1997). They make organic nitrogen available via a protease which is particularly active at low pH, i.e. fungi acidify the substrate by releasing protons and thus directly take up organic nitrogen from litter. Fungi have generally a higher N requirement than plants, as in several species their cell wall is formed from glucosamine (chitin) and thus require a large amount of N to form the structure of their own biomass. Fungi also require carbohydrates which

they obtain as mycorrhizae either directly from plants or from saprophytes living on organic substances from the decomposition of dead material in the litter. Mycorrhizal fungi supply amino acids derived from protein degradation to the plant, in counter exchange with carbohydrates. In boreal coniferous forests this “short circuited” cycle of nitrogen, bypassing mineralisation by microbes, is so effective that no free nitrate or ammonium may be found in the soil (Wallenda et al. 2000). Despite the dominance of fungi in the degradation of organic substances and in the uptake of N in boreal forests, there are ammonium-forming and nitrifying bacteria as shown by the presence of spores becoming active after long incubation times (Persson et al. 2000).

With fungal degradation of lignin, DOC (**dis-solved organic carbon**) is released and percolates with cations through the soil profile (Chap. 3.2.2.3), and thus advances soil acidification and provides environmental conditions for the acid proteases of fungi. Ammonium and nitrate only occur in soil solutions of boreal climates if the supply of calcium, and thus soil pH, increases (Nordin et al. 2001). Bacteria are more effective than fungi at high pH. Ectomycorrhizal species using amino acids change into ectomycorrhizae

which take up inorganic nitrogen. Thus, in boreal climate with low pH, amino acids – and in temperature and warm climates with higher pH nitrate and ammonium – can be detected in the soil solution as the main N products of decomposition (see Fig. 3.3.12; Schulze et al. 2000).

In an ecosystem, oxidation and reduction of nitrogen compounds not only takes place in different horizons but also in the same soil horizon, as inside soil crumbs (aggregates) oxygen-free zones may be formed (Horn 1994).

If there is an excess of ammonium or nitrate, i.e. if external supply or formation in the ecosystem exceeds consumption (e.g. by seasonal variation of growth), this has particular consequences for the ecosystem (Chap. 3.2.2.3). **Ammonium excess** effects release of cations, particularly K and Al from clay minerals (see Chap. 2.3). In contrast to the almost immobile ammonium ion, nitrate is not bound to the soil exchanger and remains mobile in the soil solution. Nitrate excess thus leads to **nitrate leaching** into the groundwater. This loss of anions is coupled to an equimolar loss of cations. Deposition of N from air pollutants generally accelerates N transformation and leads to increased nitrate loss, even without interaction with organisms in the ecosystem (Durka et al. 1994).

Box 3.3.3 The N cycle

The N cycle

- Turnover of N is almost a closed system cycle.
- Nitrogen as organically bound amino N and as inorganic forms ammonia and nitrate undergoes cyclic transformation. Conversion of ammonium into nitrate and from nitrate into ammonium is controlled by microbial processes which are dependent on the redox potential. Soil chemical conditions determine if organic nitrogen, ammonium or nitrate are the dominant forms in the N turnover.
- Ecosystems gain nitrogen through nitrogen fixation by symbiotic, and by free-living N₂-fixing organisms (cyanobacteria, actinomycetes).
- Nitrogen is also gained from the atmosphere through oxidation of N₂ by lightning strikes and from natural and anthropogenic burning processes. Reduced nitrogen comes from sewage works and animal husbandry. The N gained from the atmosphere is mainly from anthropogenic sources and it can be greater than that gained from the natural mineralisation of N from organic substances.
- Anaerobic conditions lead to conversion of nitrate to ammonia, or to denitrification, which releases NO₂, NO and N₂O which are or which can be transformed into greenhouse gases that affect climate.
- Nitrogen losses not only occur via denitrification, but also through leaching of nitrate. Nitrate, in contrast to ammonia, is not bound to soil exchangers. Leaching of nitrate (and other strong acids, i.e. sulfate) also leads to equivalent cation loss.

3.3.4

Cation Turnover

The importance of cation (K, Mg, Ca) supply in ecosystems was apparent already in the N cycle. Cation supply occurs primarily from the chemical weathering of primary minerals (Chap. 2.3.1) or dust particles entering the ecosystem from the atmosphere. Examples of input of dust are the formation of loess in the post-glacial period (Schachtschabel et al. 1998), the supply of dust from the Sahara to the Amazon delta (Lloyd et al. 2001), and buffering of sulfur-containing emissions by industrial dusts in the 1960s which delayed acidification of soils, as the ionic charge of deposited material was neutral.

Cations are taken up by the roots. The return of cations into the soil is not only via litter, but also through leaching from the canopy. Canopy leaching is a consequence of ammonium uptake from air pollution and a consequence of buffering during the input of protons (leaching).

In soils, accumulation of cations in the organic deposits (see Fig. 3.2.4) and a dense root network in the organic layer enable direct re-supply of cations from litter into plants, particularly in nutrient-limited conditions. Cations are also released from the organic matrix and transported together with organic acids (**dissolved organic carbon**, DOC; see Chap. 2.3). Cation uptake by roots and cation losses caused by leaching of DOC decrease the concentration of cations in the soil solution of the upper layers and bleached horizons are formed, especially in nutrient-poor soils (eluvial E horizons) if the losses exceed weathering. Alkaline saturation increases only in deeper soil layers (B and C horizons; see also Chap. 3.2.2.3).

The turnover, i.e. the cycle from the uptake to the release, is very different for individual elements. In a spruce stand on granite (Horn et al. 1989) the calcium turnover is twice that of potassium, and exceeds that of magnesium five-fold. As leaching into the groundwater occurs for all elements at about the same magnitude, different amounts of Ca, K and Mg must be supplied by weathering of primary minerals in the soil profile (Table 3.3.5). Since weathering of granite is slow, this leads to decreased soil pH and to long-term forest damage particularly on acidic rocks (see Chap. 3.5.1).

Leaching of cations from an ecosystem into the groundwater and lateral transport into other ecosystems may have far-reaching consequences for nitrogen cycles of “supplier” and “receiver” systems. Two interactions are possible occur (Fig. 3.3.14): (1) Nitrate (or sulfate) is leached and carries cations down the slope leading to an increased total turnover; this is the “classic” assumption. (2) DOC is leached and cations accumulate in the groundwater. As DOC is microbologically mineralised during transport there is secondary cation accumulation down the slope. Thus the conditions for nitrification improve along the transport path. Local nitrification and absence of nitrate leaching improve biomass production and thus the material cycles. The transport of DOC appears to dominate in the boreal climate (Högberg 2001) on acid substrates (granite), effecting relocation of cations, e.g. on a slope (Guggenberger and Zech 1993; Kaiser and Guggenberger 2000).

Table 3.3.5. Cation flows in a spruce forest ($\text{mmol m}^{-2} \text{a}^{-1}$)

	Calcium	Potassium	Magnesium
Soil balance			
Atmospheric input	25	19	10
Leaching from canopy	10	25	1
Weathering	79	52	36
Release from litter	189	54	29
Leaching into groundwater	-45	-21	-33
Available in soil	258	129	43
Plant balance			
Plant uptake	258	129	43
Incorporation into wood	59	50	13
Leaching from canopy	10	25	1
Litter	189	54	29

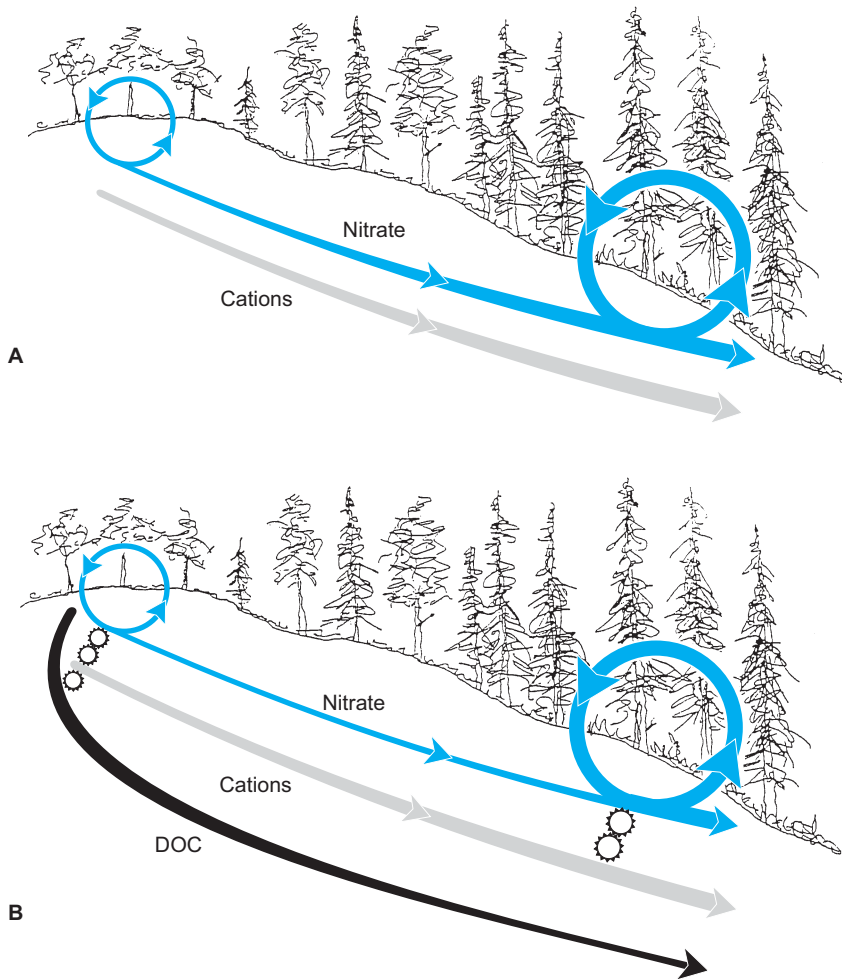


Fig. 3.3.14. Schematic representation of nitrate and cation fluxes down a slope resulting from the groundwater runoff in a boreal forest of Scandinavia. **A** High nitrate leaching and associated cation loss and **B** low nitrate loss and large cation loss in association with DOC. It can be shown that cation transport associated with DOC in natural systems contributes significantly to the low availability of cations on slopes. Thus, **(B)** is the dominant process. (After Högberg 2001)

Box 3.3.4 The cation cycle

The cation cycle

- Cycling of cations is not a completely closed cycle in natural ecosystems. Especially dissolved organic carbon (DOC) and strong acids which are produced anthropogenically displace cations within the soil horizons or this leads to loss of cations to the groundwater.
- Cation losses lead to acidification of soils, when the losses are not compensated by weathering of primary minerals or by import of dust, or by liming operations.
- In an ecosystem, the turnover of Ca is larger than that of K, and both exceed that of Mg.
- Base saturation determines the type and availability of the various N types (amino acids, ammonium, nitrate).
- Lateral transport of cations, together with the transport of DOC, explains the differentiation of soil chemical characteristics and of vegetation even along short hydrological gradients.

References

- Berg B, Matzner E (1996) Effect of N deposition on decomposition of Plant litter and soil organic matter in forest systems. *Environ Rev* 5:1–25
- Bird M, Santrůcková H, Lloyd J, Veenendaal E (2001) The global soil organic carbon pool. In: Schulze E-D, Holland E, Harrison S, Lloyd J, Prentice C, Schimel D (eds) *Global biogeochemical cycles in the climate system*. Academic Press, San Diego, pp 185–199
- Chadwick OA, Derry LA, Vitousek PM, Huebert BJ, Hedin LO (1999) Changing resources of nutrients during four million years of ecosystem development. *Nature* 397:491–497
- Cotrufo MF, Miller M, Zeller B (2000) Litter decomposition. *Ecological studies*, vol 142. Springer, Berlin Heidelberg New York, pp 276–296
- DeWitt CT (1978) Simulation of assimilation and transpiration of crops. PUDOC, Wageningen, 141 pp
- Durka W, Schulze E-D, Gebauer G, Vorkelius S (1994) Effects of forest decline on uptake and leaching of deposited nitrate determined from ^{15}N and ^{18}Q measurements. *Nature* 372:765–767
- Fischer RA, Turner NC (1978) Plant productivity in the arid and semiarid zones. *Annu Rev Plant Physiol* 29:277–317
- Gholz HL, Wedin DA, Smitherman SM, Harmon ME, Parton WJ (2000) Long-term dynamics of pine and hardwood litter in contrasting environments: towards a global model of decomposition. *Global Change Biol* 6:751–766
- Gleixner G, Czimczik CJ, Kramer C, Lühker B, Schmidt MWI (2001) Turnover and stability of soil organic matter. In: Schulze E-D, Holland E, Harrison S, Lloyd J, Prentice C, Schimel D (eds) *Global biogeochemical cycles in the climate system*. Academic Press, San Diego, pp 201–215
- Gottschalk G (1986) *Bacterial metabolism*. Springer, Berlin Heidelberg New York, 358 pp
- Guggenberger G, Zech W (1993) Dissolved organic carbon control in acid forest soils of the Fichtelgebirge (Germany) as revealed by distribution pattern and structural analysis. *Geoderma* 59:109–129
- Harrison AF, Harkness DD, Rowland AP, Carnett JS, Bacon PJ (2000) Annual carbon and nitrogen fluxes in soils along the European forest transect, determined using ^{14}C -bomb. *Ecological studies*, vol 142. Springer, Berlin Heidelberg New York, pp 171–188
- Haumeier L, Zech W (1995) Black carbon – possible source of highly aromatic components of soil humic acids. *Org Geochem* 23:191–196
- Högberg P (2001) Interactions between hilltops hydrochemistry, nitrogen dynamics and plants in Fennoscannian boreal forest. In: Schulze E-D, Holland E, Harrison S, Lloyd J, Prentice C, Schimel D (eds) *Global biogeochemical cycles in the climate system*. Academic Press, San Diego, pp 227–233
- Horn R (1994) The effect of aggregation of soils on water, gas, and heat transport. In: Schulze E-D (ed) *Flux control in biological systems*. Academic Press, San Diego, pp 335–364
- Horn R, Schulze E-D, Hantschel R (1989) Nutrient balance and element cycling in healthy and declining Norway spruce stands. *Ecological studies*, vol 77. Springer, Berlin Heidelberg New York, pp 444–458
- Jackson RB, Mooney HA, Schulze E-D (1997) A global budget for fine root biomass, surface area and nutrient contents. *Proc Natl Acad Sci USA* 94:7362–7366
- Kaiser K, Guggenberger G (2000) The role of DOM-sorption to mineral surfaces in the preservation of organic matter in soils. *Org Geochem* 31:711–725
- Knohl A, Kolle O, Minajeva T, Milyukova IM, Vygodskaya NN, Foken T, Schulze E-D (2002) Carbon exchange of a Russian boreal forest after disturbance by wind throw. *Global Change Biol* 8:231–246
- Krüger M, Frenzel P, Conrad R (2000) Microbial processes influencing methane emission from rice fields. *Global Change Biol* 7:49–64
- Lloyd J, Taylor JA (1994) On the temperature dependence of soil respiration. *Funct Ecol* 8:315–323
- Lloyd J, Bird MI, Veenendaal E, Kruijt B (2001) Should phosphorous availability be constraining moist tropical forest response to increasing CO_2 concentrations? In: Schulze E-D, Holland E, Harrison S, Lloyd J, Prentice C, Schimel D (eds) *Global biogeochemical cycles in the climate system*. Academic Press, San Diego, pp 96–114
- Matson PA, Parton WJ, Power AG, Swift MJ (1997) Agricultural intensification and ecosystem properties. *Science* 277:504–509
- Meyer O (1993) Functional groups of microorganisms. *Ecological studies*, vol 99. Springer, Berlin Heidelberg New York, pp 67–96
- Mooney HA, Medina E, Schindler DW, Schulze E-D, Walker BH (1991) *Ecosystem Experiments*. SCOPE 45. Wiley, Chichester, 268 pp
- Norby RJ, Cotrufo MF, Ineson P, O'Neill EG, Canadell JG (2001) Elevated CO_2 , litter chemistry, and decomposition. *Oecologia* 127:153–165
- Nordin A, Högberg P, Näsholm T (2001) Soil N availability and plant N uptake along a boreal forest productivity gradient. *Oecologia* 129:125–132
- Parkes J (1999) Cracking anaerobic bacteria. *Nature* 401:217–218
- Parton WJ, Stewart JWB, Cole CV (1988) Dynamics of C, N, P and S in grassland soils: a model. *Biogeochemistry* 5:109–131
- Persson T, Rudebeck A, Jussy JH, Clin-Belgrand M, Prieme A, Dambrine E, Karlsson PS, Sjöberg M (2000) Soil nitrogen turnover – mineralisation, nitrification and denitrification in European forest stands. *Ecological studies*, vol 142. Springer, Berlin Heidelberg New York, pp 297–331
- Post WM, Kwon KC (2000) Soil carbon sequestration and land-use change: processes and potential. *Global Change Biol* 6:317–329
- Rebmann C (2001) Carbon dioxide and water exchange of a German *Picea abies* forest. Dissertation, University of Bayreuth, Germany
- Schachtschabel P, Blume HP, Brümmer G, Hartge KH, Schwertmann U (1998) *Lehrbuch der Bodenkunde*. Enke, Stuttgart, 494 pp
- Schimel DS, Braswell BH, Holland EA, McKeown R, Ojima DS, Painter TH, Parton WJ, Townsend AR (1994) Climatic, edaphic, and biotic controls over storage and turnover of carbon in soils. *Global Biogeochem Cycles* 8:279–293
- Schlesinger WH (1990) Evidence from chronosequence studies for a low carbon storage potential of soils. *Nature* 348:232–239
- Schlesinger WH (1997) *Biogeochemistry; an analysis of global change*. Academic Press, San Diego, 588 pp
- Schmidt MWI, Skjemstad JO, Gehrt E, Kögel-Knabner I (1999) Charred organic carbon in German chemozemic soils. *Eur J Soil Sci* 50:351–365

- Schulze E-D (1982) Plant life forms and their carbon, water and nutrient relations. *Encycl Plant Physiol New Ser* 12B:615–676
- Schulze E-D (2000 a) Carbon and nutrient cycling in European forest ecosystems. *Ecological studies*, vol 142. Springer, Berlin Heidelberg New York, 498 pp
- Schulze E-D (2000b) Der Einfluss des Menschen auf die biogeochemischen Kreisläufe der Erde. *MPG Jahrbuch* 2000
- Schulze E-D, Heimann M (1998) Global carbon and water exchange of terrestrial systems. *IGBP Book Ser* 3:145–161
- Schulze E-D, Ulrich B (1991) Acid rain – a large-scale, unwanted experiment in forest ecosystems. *SCOPE* 45:89–106
- Schulze E-D, Lloyd J, Kelliher FM, Wirth C, Rebmann C, Lühker B, Mund M, Knohl A, Milyokova IM, Schulze W, Ziegler W, Varlagin A, Sogachev AF, Valentini R, Dore S, Grigoriev S, Kolle O, Panfyorov MI, Tchebakova N, Vygodskaya NN (1999) Productivity of forests in the Euro-siberian boreal region and their potential to act as a carbon sink – a synthesis. *Global Change Biol* 5:703–722
- Schulze E-D, Högberg P, van Oene H, Persson T, Harrison AF, Read D, Kjöllér A, Matteucci G (2000) Interactions between the carbon- and nitrogen cycle and the role of biodiversity: a synopsis of a study along a north-south transect through Europe. *Ecological studies*, vol 142. Springer, Berlin Heidelberg New York, pp 468–492
- Smith DE, Read DJ (1997) *Mycorrhizal symbiosis*. Academic Press, London, 605 pp
- Smith WN, Desjardins R, Patterey E (2000) The net fluxes of carbon from agricultural soils in Canada 1970–2010. *Global Change Biol* 6:557–568
- Stober C, George E, Persson H (2000) Root growth and response to nitrogen. *Ecological studies*, vol 142. Springer, Berlin Heidelberg New York, pp 99–121
- Torn MS, Trumbore DE, Chadwick OA, Vitousek PM, Hendricks DM (1997) Mineral control of soil carbon storage and turnover. *Nature* 389:170–173
- Wallenda T, Stober C, Högbom L, Schinkel H, George E, Högberg P, Read DJ (2000) Nitrogen uptake processes in roots and mycorrhizae. *Ecological studies*, vol 142. Springer, Berlin Heidelberg New York, pp 122–143
- Wirth C, Schulze E-D, Lühker B, Grigoriev S, Siry M, Hades G, Ziegler W, Backor M, Bauer G, Vygodskaya NN (2002) Fire and site type effects on the long-term carbon balance in pristine Siberian Scots pine forest. *Plant Soil* 142:61–63
- Zech W, Kögel-Knabner I (1994) Patterns and regulation of organic matter transformation in soils: litter decomposition and humification. In: Schulze E-D (ed) *Flux control in biological systems*. Academic Press, San Diego, pp 303–334

3.4

Biodiversity and Ecosystem Processes



Temperate rainforest of New Zealand's South Island. This is a highly diverse Tertiary relict forest with *Weinmannia*, *Metrosideros*, *Nothofagus*, *Dacrydium* (Gymnospermae), *Dicksonia* (tree ferns) and a large number of epiphytic mosses, genera common right around the Antarctic. Fjordland, New Zealand. Photo E.-D. Schulze

In the past, ecosystem processes and vegetation dynamics were considered and discussed separately. A relatively new branch of research in ecosystems is trying to find the relationship between biodiversity and processes in ecosystems. This will be considered in the following section, whilst basic considerations of biodiversity will be discussed in Chapter 4.

It is difficult to prove a coupling between biodiversity and ecosystem processes, at the level of the ecosystem, as diversity and historic land use correlate positively as well as negatively. If it is the task to identify the specific influence of di-

versity, then it is not sufficient to just compare sites with different diversity (e.g. an orchid-rich hornbeam forest and a species-poor spruce forest). The biogeochemical cycles in natural or managed ecosystems (Chap. 3.2.5.4) are influenced by many uncontrollable factors, such as history, which makes specific experimental investigations necessary.

When dealing with biodiversity and ecosystem processes, it is necessary to distinguish between ecosystem functioning in response to changes in biodiversity, where “functioning” addresses the internal regulation of ecosystems,

which ecosystem “goods and services” describes the human needs and expectations to be delivered by ecosystems. This anthropocentric attitude should be assessed critically, as criteria change with time and conditions. For humans, “ecosystem services” include most importantly:

- production of biomass,
- supply of drinking water,
- material degradation, decomposition and mineralisation,
- filtering of air,
- recreation.

Key questions are (GBA 1995; IPCC 1996):

1. Are many species required to achieve certain functions of the ecosystem?
2. If not all species are required, which species are redundant?

The discussion of these difficult questions could perhaps be initiated by asking: How many or how few species are required for a functioning ecosystem? The answer is “5” (Woodward 1994). For millions of years, completely self-sufficient and stable ecosystems consisting of one fungus, one cyanobacterium, one alga, one lichen and one non-photosynthetically active bacterium (material degradation) have existed in the Antarctic. In the Antarctic as a whole, there are about six species of lichens, each forming a stable community. Woodward (1994) also showed that the diversity of microbial forms increased with the diversity of the constituents of the litter, and that the diversity of plant families increased with the minimum temperature. This means that only very few organisms are required under certain (simple or extreme) conditions, but more and more species are required with increasing complexity of living conditions and substrates, in order to balance the requirements for resources with a corresponding supply of resources (for synecological links, see Chap. 4.3).

Functional links cannot be tested with existing ecosystems, as historical development and processes in an ecosystem cannot be distinguished from each other. It is therefore necessary to test these links experimentally and the following examples may demonstrate how difficult it is to establish the link between processes in ecosystems and biodiversity experimentally:

1. In Costa Rica, Ewel et al. (1991) planted stands of different diversity (1–130 species). After 5 years most processes showed a saturation

function with fewer than 10 species, i.e. the other 100 species were superfluous for production and soil processes (C storage, availability of nutrients, etc.).

2. Tilman and Downing (1994) designed a biodiversity experiment in the North American prairie to assess the effect of N input. In a dry year experimental areas reacted differently to drought, depending on the diversity. Monocultures were more sensitive than species-rich stands. However, the effect only occurred if the ecosystem reached less than ca. ten species. The interpretation of this experiment was criticised, as the experiment was not designed to test drought, but N tolerance. Monocultures were N-indicator plants which were also very sensitive to drought. If the monocultures had been drought-resistant prairie species, the result would have been different (Huston 1994). In this case, it would be expected that also stands with <10 species would have been drought-resistant.
3. Tilman et al. (1996) observed in the same experiment in the prairie of North America that nitrate loss from experimental fields decreased linearly with increasing biodiversity and fell to very small values with about eight species. This interpretation was also not conclusive, as the decrease in nitrate loss correlated with the increase in total biomass of the experimental fields and not only with the number of species.
4. Naeem et al. (1994) designed artificial ecosystems with plants, herbivores and destruents in climate chambers and found that species-rich ecosystems had greater productivity than species-poor stands. This experiment can also be questioned, as the species-rich stands contained plants that grew taller than those with fewer species and the result may thus correlate with the dominant growth form.
5. Lawton (1994) designed and carried out a diversity experiment in eight European countries, from northern Sweden to Greece, using experience from the preceding experiments to avoid mistakes in the selection of the experimental design. The mixture of species was therefore randomly selected from an inventory of species occurring in a grassland community around the experiment area. Each diversity level (1, 2, 4, 8 and 16 species) was sown with different combinations of individual species, to be able to distinguish the pure diversity effect from the influence of individual

species. On average, across all experimental fields, productivity increased linearly with diversity up to 16 species (Hector et al. 1999). However, in this experiment, too, there are different possible interpretations. The behaviour was not uniform in all countries. In England, Greece and Ireland there was no difference, whilst in Germany, Switzerland and Sweden the effect was proportionally much larger. In addition, it was shown that some monocultures were just as productive as mixed cultures, but not all species were tested as monocultures. Thus the possibility remains that with increasing number of species some additional, highly productive, species entered the mixture, i.e. the result may not be based on complementarity of different species, but may be the result of a selection effect.

In this experiment, the number of species and also the effects of “functional groups” (N_2 fixers, grasses and dicotyledonous herbaceous plants) were considered. The presence of N_2 fixers is more important for productivity than the influence of biodiversity (see Fig. 3.2.7; Scherer-Lorenzen 1999). In this case it was just a single species, *Trifolium rubrum*, which increased productivity, i.e. it was a **keystone species**. Also changes in further ecosystem processes correlated with change of productivity. Nitrate losses were reduced with diversity, independent of vegetation cover. Also, the rate of litter degradation increased with diversity.

Experience shows that more than one species (genotype) is required to maintain the productivity of a plant community in the long term and regionally. Obviously, maximum production of a plant community is also possible with just one individual species (agriculture) but human care is required (Fig. 3.4.1; Heywood and Watson 1995). However, even in agriculture, it is known that it is risky to only work with one species or genotype (see Chap. 2.4.5.1). In as far as different edaphic conditions apply, several species or crop plants are required to achieve maximum yields. Furthermore, weather conditions vary from year to year, so that in some succession stages different resources are available and thus different species are more suitable for planting, and further diversity is required for future maintenance and breeding. Thus the necessary number of species required to maintain the level of productivity in a region increases far beyond “one”.

Considering the links between biomass and biodiversity in different climates (Fig. 3.4.2; Tilman and Pacala 1993), it is striking that biomass increases with biodiversity initially. At a certain point, which appears to be specific to the biome, the curve changes, i.e. highest rates of productivity are measured in stands with few species. This is particularly striking in temperate herbaceous communities whereas, in Mediterranean grasslands, it is less obvious, where about 40 species participate for greatest productivity. It should also be taken into account, considering Fig. 3.4.2, that in a region these stands of different productivity represent also differences in conditions of the site and in the history of the stands. Thus it is not an experimental comparison, but observations in a certain natural region. The figure shows that a repeat of Lawton’s experiment on a nutrient-rich substrate might come to a different result.

Spatial and temporal variation of climatic and edaphic conditions requires division of the space amongst several specialised species or genotypes in order to fully use the resources. Evolution did not lead to the formation of “super organisms” (this would be a solution of the optimisation hypothesis), but formed a large spectrum of species differing in the requirements for certain environmental conditions and specialised for par-

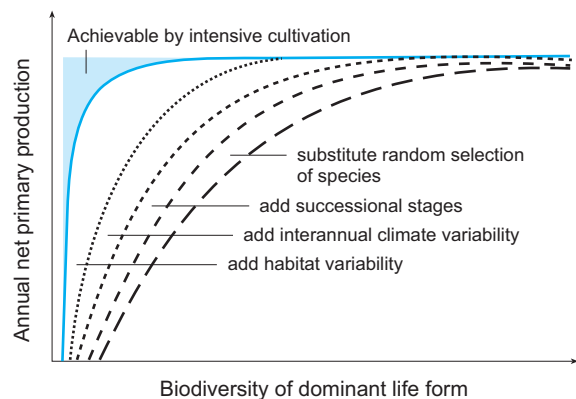


Fig. 3.4.1. Conceptual scheme of the dependence of net primary production (NPP) on the diversity of plant species or genotypes of the dominant forms. With intensive agriculture, monocultures attain the same NPP as mixed cultures. When considering the variability of habitat and climate, the stage in the succession and the substitution of susceptible species that occur not only in a small area but also on the landscape scale, more than one species is necessary (Heywood and Watson 1995). The region between the two curves shows the range of additional types required in order to compensate. The exact value is, naturally, dependent on many factors

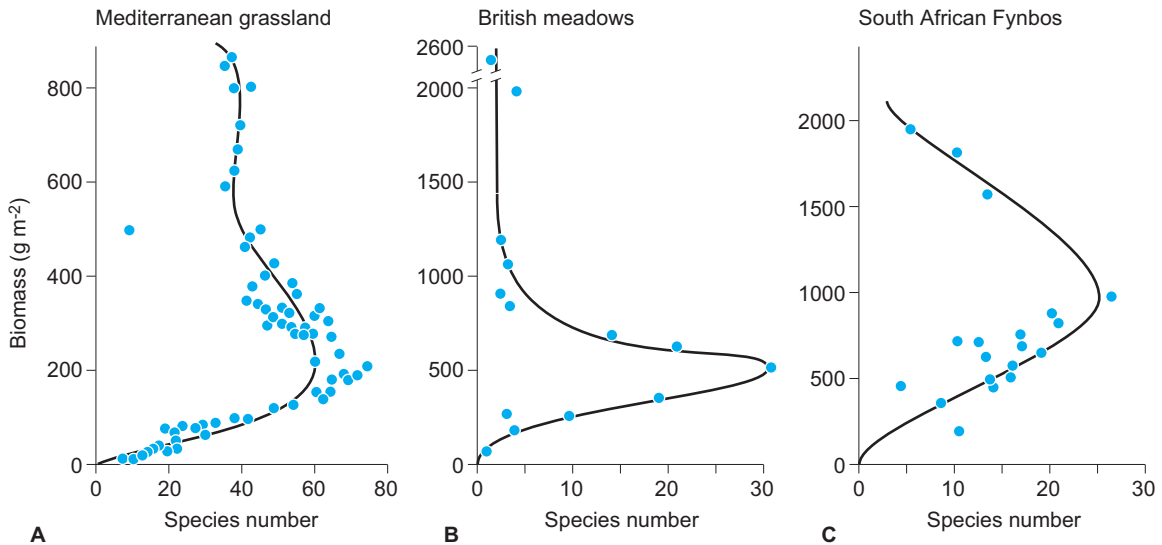


Fig. 3.4.2. Dependence of changes in biomass on diversity of forms of plant growth in **A** Mediterranean grasslands, **B** meadows in the British Isles, and **C** South African scrubland. It is possible to see that in all vegetation types the productivity rises initially with diversity, but then decreases, i.e. the highest biomass production is achieved in species-poor areas. This figure is only partly comparable with Fig. 3.4.1, as this is not an experiment but based on observations of vegetation at different sites that have different uses, fertility and water availability. (Tilman and Pacala 1993)

Box 3.4.1 Biodiversity and ecosystem function

- There are many indicators that diversity of plant types is required in order to maintain the biogeochemical cycles of an ecosystem in the long term. To prove that processes such as productivity rise with increasing diversity (shown for up to 16 species) is extraordinarily difficult, and has not yet been conclusively established. Current knowledge indicates that substantial diversity of the vegetation cover on the landscape scale is required in order to maintain the diversity of a site, and to be able to withstand the long-term risks from climate change.
- In most cases in which diversity had a significant effect on ecosystem processes, effects of specific types have been seen. Integration of species into functional groups to assess an ecosystem is only possible in part.

ticular processes. The question whether it is possible to narrow down biodiversity to functional groups thus becomes dubious (Smith et al. 1997), as an increasing functional specialisation will ultimately only be supplied by species. On the basis of certain physiologically regulated processes (assimilation, storage, shoot/root allocation, life span, and many more), Kleidon and Mooney (2000) modelled the most important features of global distribution of biodiversity.

References

- Ewel JJ, Mazzarino MJ, Berish CW (1991) Tropical fertility changes under monocultures and successional communities of different structure. *Ecol Appl* 1:289–302
- GBA (1996) Global biodiversity assessment. Cambridge University Press, Cambridge, 1140 pp
- Hector A, Schmid B, Beierkuhnlein C, Caldeira MC, Diemer M, Dimitrakopoulos PG, Finn JA, Freitas H, Giller PS, Good J, Harris R, Högberg P, Kuss-Danell K, Joshi J, Jumpponen A, Körner C, Leadley PW, Loreau M, Minns A, Mulder CPH, O'Donovan G, Otway SJ, Pereira JS, Prinz A, Read DJ, Scherer-Lorenzen M, Schulze E-D, Siemann D, Spehn EM, Terry AC, Troumbis AY, Woodward FI, Yachi S, Lawton JH (1999) Plant diversity and productivity experiments in European grasslands. *Science* 286:1123–1127

- Heywood VH, Watson RT (eds) (1995) Global biodiversity assessment. Cambridge University Press, Cambridge, 1140 pp
- Huston MA (1994) Hidden treatments in ecological experiments: re-evaluating ecosystem function of biodiversity. *Oecologia* 110:449–460
- IPCC (1996) Climate change 1995. Second assessment report. Cambridge University Press, Cambridge
- Kleidon A, Mooney HA (2000) A global distribution of biodiversity inferred from climatic constraints: results from a process-based modelling study. *Global Change Biol* 6:507–524
- Lawton JH (1994) What do species do in ecosystems. *Oikos* 71:367–374
- Naeem S, Thompson LJ, Lawler SP, Lawton JH, Woodfin RM (1994) Declining biodiversity can alter the performance of ecosystems. *Nature* 368:734–737
- Scherer-Lorenzen M (1999) Effects of plant diversity on ecosystem processes in experimental grassland communities. *Bayreuther Forum Ökol* 75:193
- Smith TM, Shuargt HH, Woodward FI (1997) Plant functional types. IGBP Book Series, vol 1. Cambridge University Press, Cambridge, 369 pp
- Tilman D, Downing JA (1994) Biodiversity and stability in grasslands. *Nature* 367:363–365
- Tilman U, Wedin D, Knops J (1996) Productivity and sustainability influenced by biodiversity in grassland ecosystems. *Nature* 379:718–720
- Tilman U, Pacala S (1993) The maintenance of species richness in plant communities. In: Ricklefs RE, Schluter D (eds) *Species diversity in ecological communities*. University of Chicago Press, Chicago, pp 13–25
- Woodward FI (1994) How many species are required for a functional ecosystem? *Ecological studies*, vol 99. Springer, Berlin Heidelberg New York, pp 271–292

3.5

Case Studies at the Scale of Ecosystems



Forest damage at Nussard, Fichtelgebirge, Germany, in September 1989. In 1983, Zech and Pop diagnosed at this location, for the first time, Mg deficiency in young trees which was previously unknown in this area. During the next 10 years, the visible signs of Mg deficiency developed throughout the Fichtelgebirge. Mg deficiency does not necessarily lead to death of trees, but causes yellowing and early needle loss; combined with frost and drought it causes damage leading to thinning of crowns. With the death of a few individual trees the remaining trees have a better Mg supply. Thus, in the short term, the remaining trees recover but may die later. Thus, slowly, the stand of trees dies from stress, i.e. each year a few trees fall, so that in the end the stand has only a few trees which succumb to external factors. Bark beetles increased the rate of tree death as they attacked the relatively healthy trees rather than those suffering severe Mg stress. At the end of the 1980s, about 10,000 ha was affected in the Fichtelgebirge. Increased tree removal and liming helped to regenerate these forests; this occurred during the time when less SO_2 and SO_4^{2-} was released due to changes in the law regulating combustion of coal. Critics doubted that forest dieback had anything to do with the amount of pollution in the atmosphere or that the trees were dying as a result of SO_2 and SO_4^{2-} . Rather they considered that it was due to complex forest "diseases" primarily related to factors in the soil that weakened the plant. The only way to confirm the cause would be to subject forest areas again to pollution, equivalent to values in the 1970s. The scientific investigations stimulated the "Advisory Council of the Federal Republic of Germany on Forest Decline" (Forschungsbeirat Waldschäden der Bundesregierung) in 1986 to conclude that, in all the different forms of forest dieback that were studied, air pollution played a significant role. Photo E.-D. Schulze

It is possible to demonstrate processes and interactions of organisms at the scale of the ecosystem in various ways (Mooney et al. 1991). These are:

- observation of natural catastrophes (El Niño);
- observation of the consequences of human intervention (clearing of forests, acid rain);
- experiments with radioactive labelled materials (e.g. release of ^{14}C from atomic bomb tests);
- ecosystem experiments (fumigation with CO_2 , SO_2 or O_3).

These "experiments" allow observations over areas differing in size (even globally) of the effects of climate change or of interference on ecosystems, or determination of the transport of particular substances in ecosystems. This is particularly important as scientifically planned experiments in ecosystems are not acceptable to the public or they are not practicable.

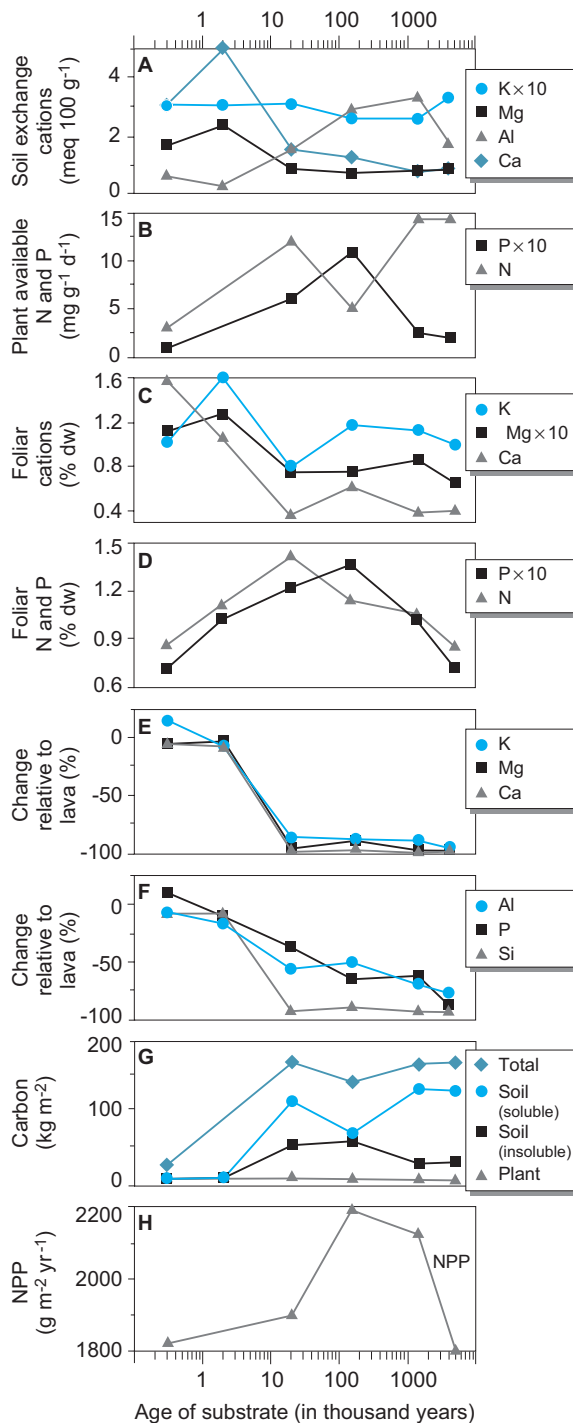


Fig. 3.5.1. Changes in concentrations of Ca, Mg, N and P in lava, the soil derived from the weathered lava and in leaves following weathering of lava over the past 400,000 years on Hawaii. The associated changes in soil acidification and biomass production are also shown. (Chadwick et al. 1999)

From some of these observations and experiments at different scales, conclusions may be drawn about the causes and effects. From the many available case studies, three examples will be used to show how very complex the links are.

3.5.1

Soil Acidification and Forest Damage

Ecosystems do not seem to be able to avoid loss of cations. Even in natural ecosystems, without management and with a high density of roots, organic acids (DOC) are released which causes relocation of cations into deeper layers. In these, microorganisms metabolise the organic substances, leading to secondary accumulation of cations (see Fig. 3.3.14). This process is known from the boreal zone as podsolisation (Schachtschabel et al. 1998; Brady and Weil 2004) and occurred in Scandinavia, for example, during the first settlement after the land rose and was evident even after only 400 years (Starr 1991). It is often assumed that other vegetation, particularly in the tropics, is so well adapted to the poor nutrient conditions that cation losses can be ignored. However, Chadwick et al. (1999) have shown that the same processes occur also in tropical climates. Similar cation losses to those in boreal zones were shown for vegetation on lava flows of different ages (Fig. 3.5.1; Chadwick et al. 1999). As soon as the first critical step of weathering is finished (after 10,000 years), the system stabilises at a smaller mineral concentration. It has not been explained whether this is, in fact, a state of equilibrium or a consequence of disturbances occurring stochastically.

Natural processes causing cation loss may be accelerated by strong acids, particularly if they form acid anions which then enter the groundwater. To these acid anions belong not only sulfate, but also chloride and nitrate, insofar as they are not used in lower soil layers and thus enter the groundwater. Strong acids do not occur in excess under natural, anthropogenically unaffected conditions. Since industrialisation, ecosystems have been increasingly stressed by these acids (Schulze 1989). Deposition of acids in Europe over a period of about 30 years has caused acidification of soils (Fig. 3.5.2) with base saturation in all soil horizons decreasing from 10 to 50% at the start of the period to 5% on average a few decades later (Ulrich 1987).

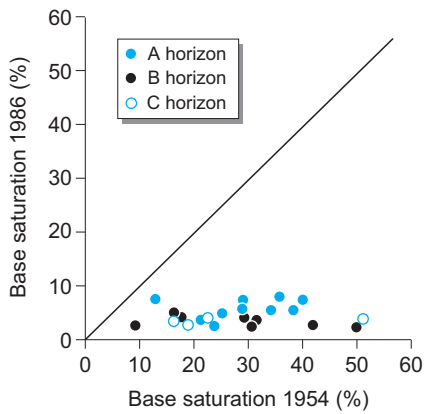


Fig. 3.5.2. Changes in the cation-exchange capacity of beech forests over 30 years on loess covering red sandstone in Niedersachsen, Germany (Hildebrand, pers. comm.; FBW 1989)

Forest vegetation should be adapted to soil acidification, as under natural conditions trees occupy sites across a very wide range of soil acidity (Ellenberg 1978). The phenomenon of “new-type forest damage” [Forschungsbeirat Waldschäden 1989 (*Advisory Council of the Federal Republic of Germany on Forest Decline*)] started a controversy about whether:

- the observed loss of needles and discolouration was natural and would have occurred without the input of acids;
- the damage was triggered by organisms (plant pathogens);
- the damage was a direct response to pollutants;
- or a consequence of acidification of soils.

Schulze and Lange (1990) showed that the different paths leading to damage need not be exclusive, but become effective at different times during the course of the disease (Fig. 3.5.3).

Air pollutants are involved in each of these pathways of decline. The combination of soil acidification, N-dependent growth and ozone together with interaction of insect pests caused damage across Europe (Last and Watling 1991). The photographs at the beginning of [Chapter 3.5](#) give an impression of the situation in forests in high elevations in the Fichtelgebirge, Germany, in 1989. However, after decreased SO_2 deposition and additional measures in forest management (liming, substantial clearing), the damaged areas were re-forested. Forest damage to spruce stands is, meanwhile, slightly decreasing but damage to deciduous trees is still increasing [see Waldscha-

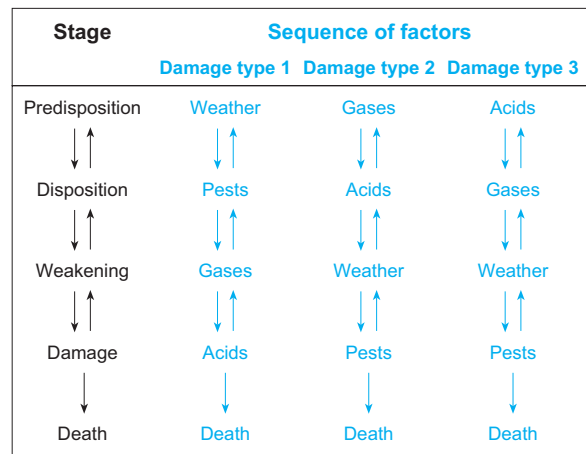


Fig. 3.5.3. Schematic representation of the course of a disease as infection initiated by a combination of factors, using the example of forest decline. (Schulze and Lange 1990)

denbericht 2003 (Report on Forest Damage 2003)].

It was necessary to initially examine the range of possible factors in order to identify the main causes:

- Primary pathogens could not be demonstrated, but there are several parasites and pathogens (bark beetles, stem rot) which attack weakened trees and, ultimately, cause their death.
- During the last century, high concentrations of pollutant gases in emissions from industries caused damage but the more recent damage symptoms were different. These new damage symptoms were related to tropospheric ozone, but the effect of ozone was shown to be very complicated. Plants react to it with changes in stomatal opening (see Chap. 1.9). Needles fumigated with ozone in one year only show increased sensitivity to ozone in the following year, and, only then, were they finally damaged.
- Acidification of soils causes root damage, particularly with release of Al. However, individual tree species react differently to Al; some of the Al reacts with phosphate in the mycorrhiza and is thus immobilised (Kottke and Oberwinkler 1986). Thus, soil acidification alone could not explain the observed damage.
- One type of forest damage, characterised by yellowing of needles caused by magnesium deficiency, could be explained as a consequence of pollutants at the ecosystem scale

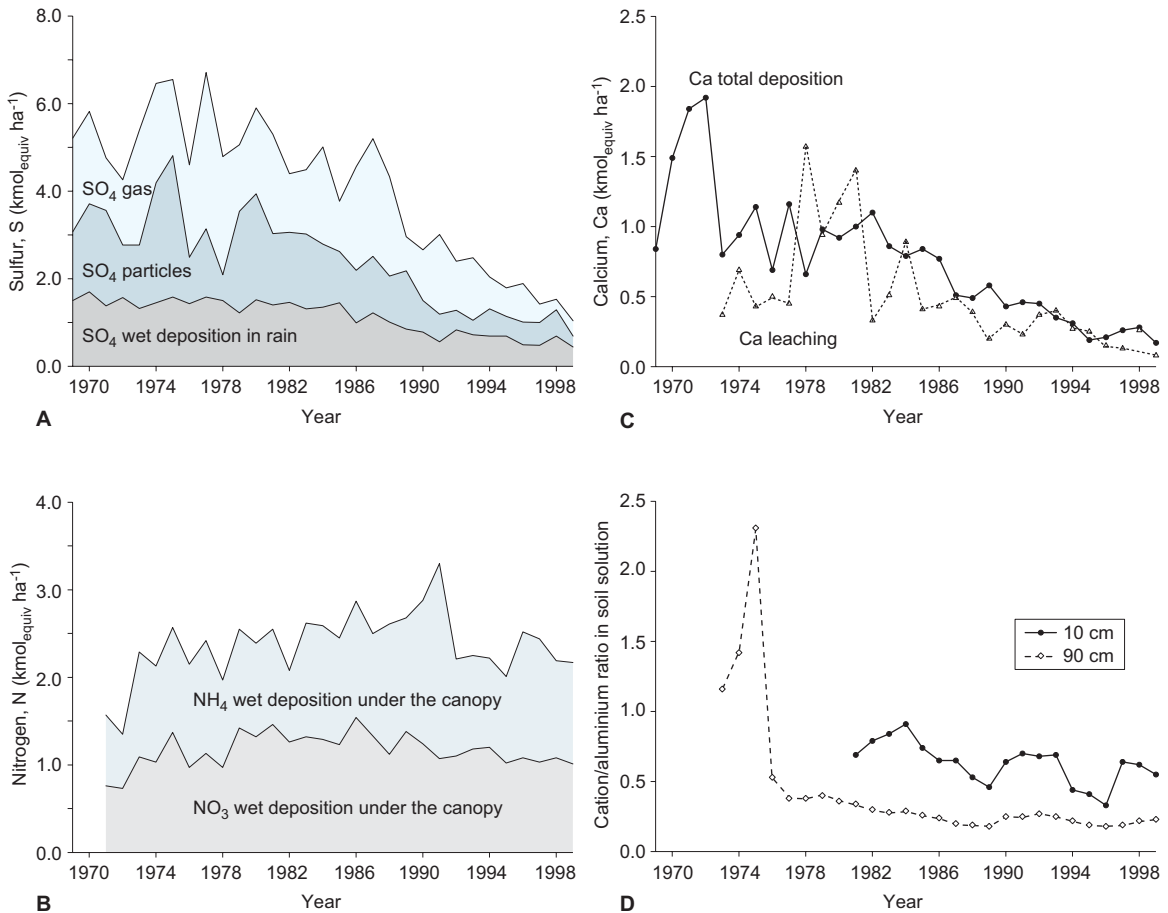
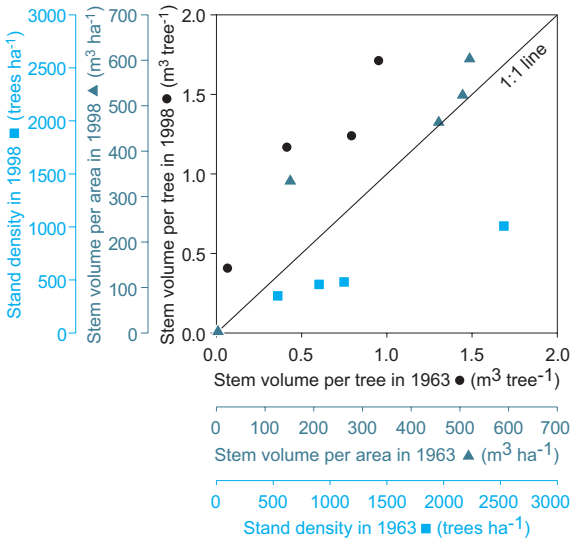


Fig. 3.5.4. Changes with time in deposition of **A** sulfur, **B** nitrogen, and **C** deposition of Ca, and leaching of Ca in the groundwater in a forest ecosystem in Solling, Germany (after Ulrich 1994). Deposition of Ca in dust fell at the beginning of the 1970s; S deposition remained high till the 1980s. Calcium leaching into the groundwater decreased with reduction in S deposition and therefore contributed significantly to the regeneration of forest ecosystems. **D** Changes with time of the base cations (K, Mg, Ca) to Al ratios in the soil solution. In the 1970s, the cation/Al ratio was >1 due to mobilisation of cations by acid rain. After about 1976, cations were exhausted up to a depth of 90 cm in a soil. The soil was then buffered by Al. Due to cation transport from roots at deeper layers to leaves, followed by leaf fall, the cation/Al ratio increased in the upper surface layer but, despite the small increase, there is still a tendency of a decrease (data: Lower Saxony Forest Institute)

(Schulze 1989). Soil acidification strongly reduced the availability of magnesium (and calcium). This is not only caused by the reduced base saturation of the soil exchanger occurring simultaneously with acidification, but also by competitive inhibition of Mg uptake by ammonium. In addition to ammonification, ammonium in the soil originates from atmospheric deposition, particularly from animal husbandry. Ammonium causes release of Mg from the exchangers in the soil and stimulates release of Al. Finally, Lange et al. (1989) proved, in a very elegant experiment, that the interaction with growth causes the deficiency. Buds were removed from opposite

lateral twigs on some spruce twigs or not removed on opposite twigs along the same branch. Only on that side with twigs of the branch where buds were not removed and where growth occurred was the damage observed (see Chap. 2.3). Obviously, growth of trees is significantly regulated by the N supply (Oren and Schulze 1989). Thus the uptake by the canopy of N from air-borne pollutants (in rain and dew) becomes particularly important, because this additional N supply is not balanced by cation uptake, but leads to increased growth and the observed yellowing. In the case of cation deficiency, growth is not regulated by availability of the limiting nutri-

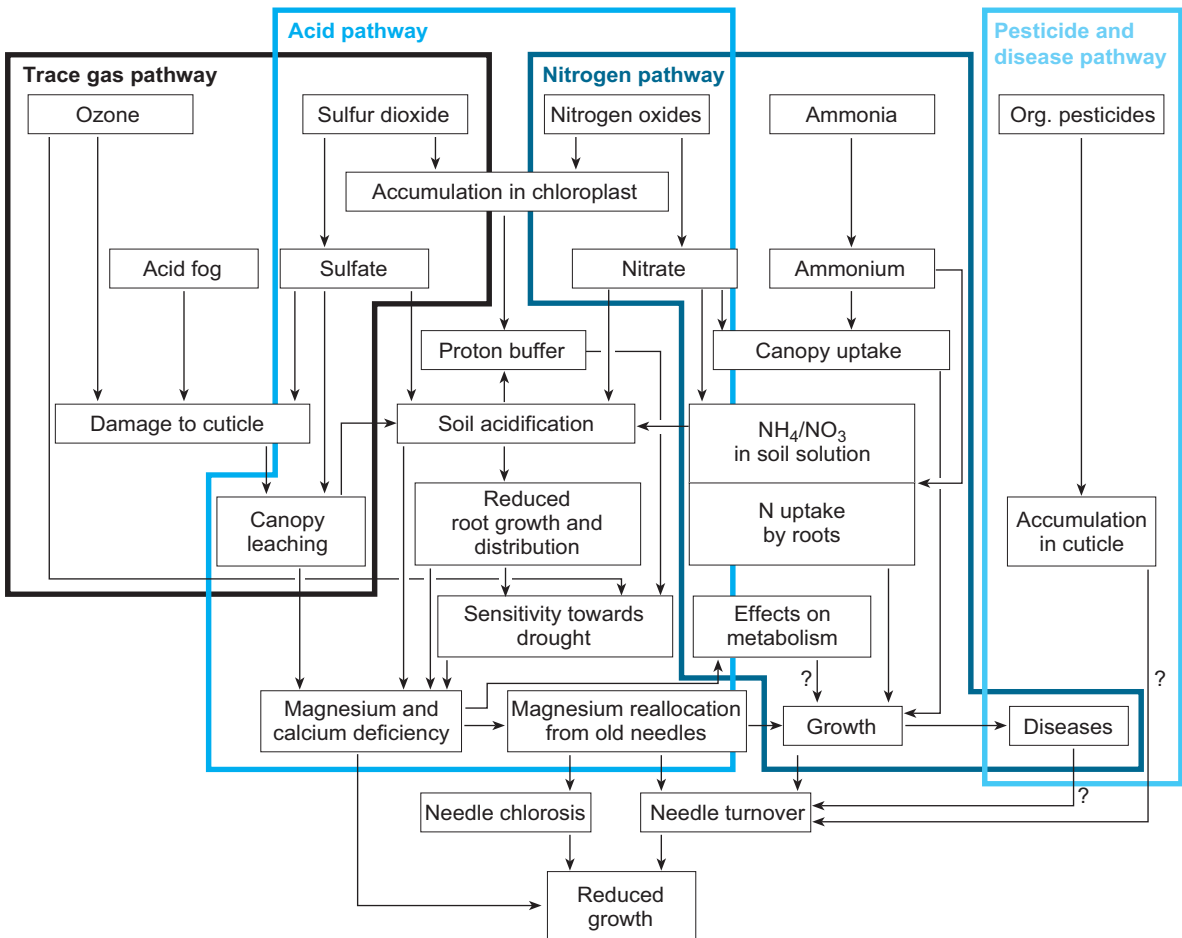


■ Fig. 3.5.5. The effects of management on forests. The figure shows that logging in the 1980s left free-standing single trees. With less S pollution and greater N the remaining individual trees grew faster. Despite fewer trunks and a smaller leaf area, the volume of growth per stand remained the same. (Mund et al., 2002)

ent (Marschner 1994). Some nutrients (particularly nitrogen) participate more in the growth process than others.

The model of a nitrogen-cation interaction with limited cation supply resulting from soil acidification observed in forest decline could also be related to other observed cation deficiencies, particularly K deficiency on bogs, Mn and Fe deficiency on limestone, and the rarer Ca deficiency.

With the decrease in SO₂ deposition resulting from regulations controlling emissions from large electric power plants, input of sulfur sank and thus the rate of soil acidification also (Fig. 3.5.4; Ulrich 1994). With reduced S and N input, loss of Ca decreased. This together with so-called compensation liming, which was supposed to balance the acid input, has resulted in partial recovery of soils with respect to base saturation.



■ Fig. 3.5.6. Schematic representation of the processes that lead to forest decline. (After Schulze and Lange 1990)

Heavy clearing reduced the density of trees in declining forests of the Fichtelgebirge (Germany) far below the recommended values of yield tables (Fig. 3.5.5). Thus, the cation supply per tree increased and, together with the high N deposition and with the higher light availability, growth of individual trees improved. Despite the reduced density of stands wood growth per area was eventually maintained.

Reducing the sulfur stress does not solve the problem of forest damage, as there is obviously more than one path of damage and complicated interactions occur between pollutants and organisms (Fig. 3.5.6; Schulze 1989). With the shift from S to N deposition other types of damage occurred, particularly to deciduous trees where insect damage increased. Tropospheric ozone concentrations are still damaging, particularly for herbaceous plants with high stomatal conductance (FBW 1989).

3.5.2

Effect of Deciduous and Coniferous Forests on Processes in Ecosystems

Forest damage started discussions in public and in forest science whether management of stands as monocultures, usually dominated by spruce, is sustainable, i.e. whether or not this management affects the productivity of a site with a turnover time of about 100 years over several generations, and whether the change from deciduous forests to coniferous forests, which was enforced by man, increased the damage observed, and whether reverting from coniferous forests to deciduous forests would avoid such damage in future.

Deciduous and coniferous forests differ with respect to several parameters, including:

- Differences in radiation and heat balance (Chap. 2.1; Schulze 1982);
- Differences in water relations (Chap. 2.2; Schulze 1982);
- Differences in growth (Chap. 2.4; Schulze 1982);
- Differences in the formation of humus (Mitscherlich 1975).

Heat Balance

Seasonal shedding of leaves in deciduous forests results in the energy exchanging surface being

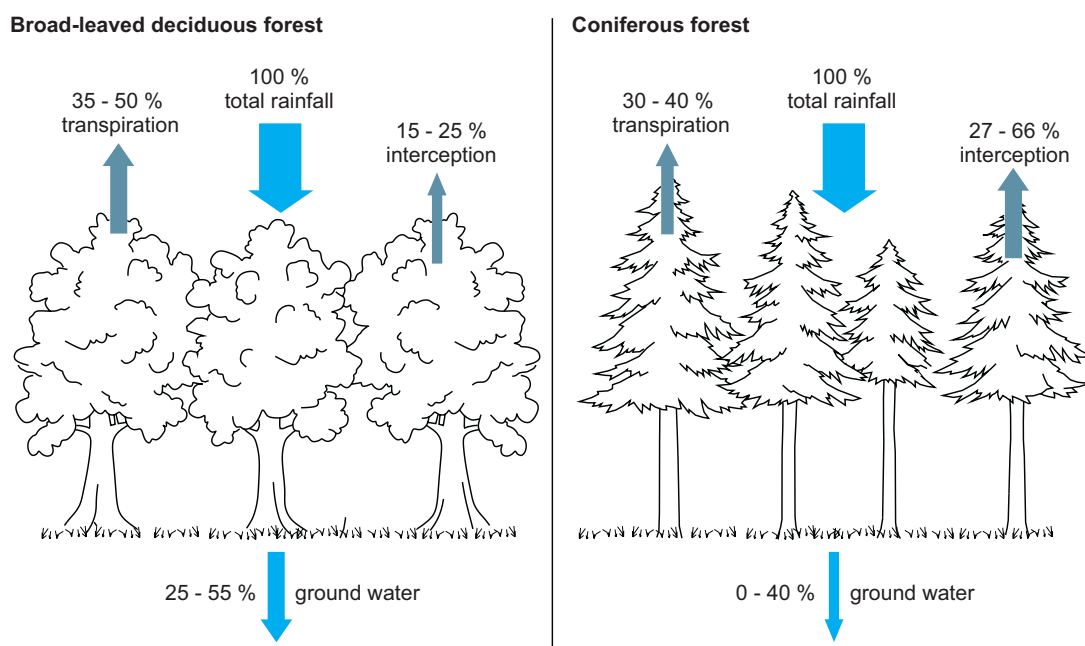
near the ground in winter and spring, but high in the canopy in summer (as with spruce; see Chap. 2.1, Fig. 2.1.9). Prior to leaf emergence in spring, temperatures in the litter rise rapidly and reach values far above the freezing point. This leads to activation of the species-rich ground vegetation (spring geophytes), which are important not only regarding the diversity of forests, but also for the storage of nutrients in the ecosystem because these herbaceous plants utilise nitrate that is formed in spring when tree roots are still inactive. In coniferous forests the permanent needle cover prevents light penetrating to the ground. Lack of light prevents the development of the spring flora. The soil remains cold, thus slowing down decomposition of litter. During the summer months, the climate for both types of trees is similar.

Water Relations

The greater needle and branch area of conifers compared with deciduous trees increases interception of precipitation by coniferous forests (Fig. 3.5.7; Schulze 1982). Transpiration for beech and spruce is approximately the same. Obviously, the increased needle area balances decreased stomatal conductance of conifers. It is the lower interception which leads to ca. 20% higher flow of water to the groundwater in deciduous forests than in coniferous forests. This is particularly important for the ecosystem service to supply water for human consumption. Areas acting as sources for water are therefore presently re-forested with deciduous forests or with herbaceous shrubs.

Carbon Balance

Conifers grow faster than deciduous trees in temperate climates because they start to assimilate earlier in the year and continue longer. This difference, however, is counterbalanced by the higher assimilation rates of deciduous trees. Conifers have an important additional advantage because only a fraction of their assimilating organs is exchanged every year, whilst deciduous trees renew the complete leaf mass. Also, in spruce, the ratio of twigs to stem mass is lower than for beech or oak (see Chap. 2.4.5.1). Thus, more assimilates remain for building stem wood. The increase in spruce is on average $10 \text{ m}^3 \text{ a}^{-1}$ compared with $5 \text{ m}^3 \text{ a}^{-1}$ for deciduous trees (Kramer 1988).



■ **Fig. 3.5.7.** Comparison of the hydrological balance of deciduous and coniferous forests (after Schulze 1982). Coniferous forests are drier than deciduous forests because of the increased evaporation from their wetter surfaces which depends on leaf area index

Nutrient Balance

Beech and spruce differ in their ability to utilise nitrate (Bauer et al. 2000). Coniferous trees have only a low nitrate reductase activity and thus take up ammonium predominantly, leading to nitrate leaching and increasing acidification in coniferous forests. Deciduous trees together with the more vigorous ground vegetation take up nitrate predominantly, so nitrate leaching is very low.

Formation of Humus

Underneath deciduous trees, the formation of raw humus is less than under coniferous trees, as the litter is more alkaline and richer in nutrients than in coniferous forests. The community of humus-decomposing organisms in the soil is thus more active and includes more species. The lower proportion of resins and other secondary metabolites makes decomposition easier, although deciduous trees as well as conifers contain specific materials that slow down decomposition (tannins in oaks, terpenes in conifers). Underneath deciduous forests, depending on cation availability, leaf mull or moder is formed with a larger cation-exchange capacity than in raw humus of conifers.

All these differences might be arguments for changing monocultures of spruce back into deciduous forests. However, at the moment (year

2004), deciduous forests are damaged more than coniferous forests by atmospheric pollutants.

Differences between deciduous and coniferous forests were studied on a transect between northern Sweden and central Italy, where conditions of the field sites were kept as constant as possible, i.e. beech and spruce grew on acid substrates in neighbouring stands (Schulze 2000). There were no conclusive differences in mineralisation and other soil parameters between deciduous and coniferous forests (Fig. 3.5.8; Schulze et al. 2000 a, b). Apparently, some of the differences which we have discussed so far were related to the fact that conifers, either planted or in natural stands, grow on sites which are more acid and nutrient poorer than sites on which deciduous trees grow. If conifers and deciduous trees grow on the same site under the same conditions, differences between tree types are lost.

Data from the European Transect show important features of ecosystems, particularly that production of litter increases with the supply of nutrients from mineralisation and deposition. In contrast, mineralisation compared with the supply of litter is too slow, i.e. the decomposition of litter over a larger area is disturbed. The imbalance increases with N deposition. This means that forest ecosystems in Europe accumulate carbon in the soil and this accumulation increases

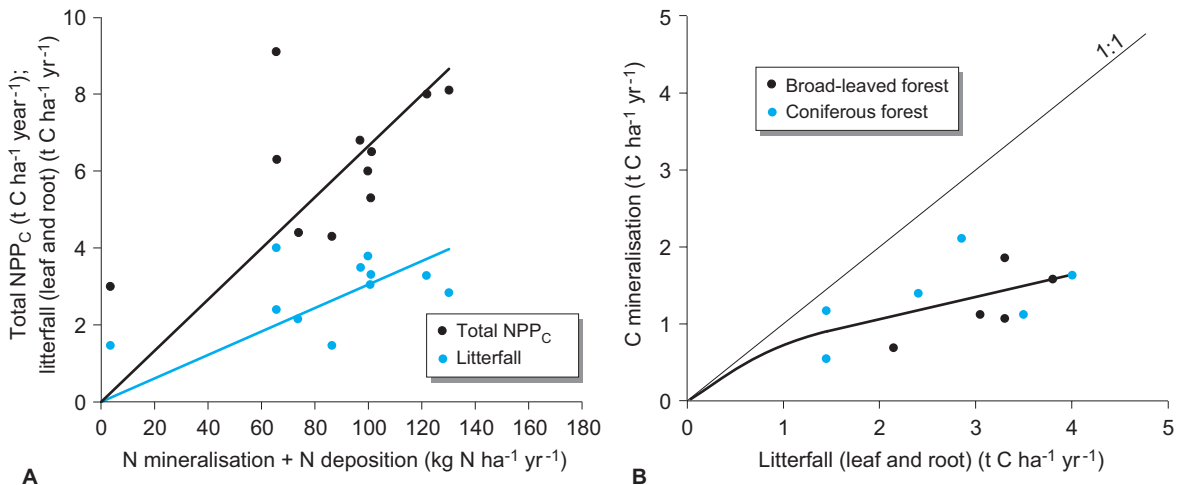


Fig. 3.5.8. The relationship between **A** growth (total NPP and litter) and N availability and **B** C mineralisation and litter availability in various deciduous and coniferous forests in Europe (Schulze et al. 2000 a). It can be seen that growth is generally related to N availability. Saturation of growth with N availability is not noticeable. In contrast, mineralisation does not follow the availability of litter, i.e. at present there is an accumulation of C in the organic layer over large areas of Europe. It is still unclear which factors are controlling this imbalance between availability and use in soil

with N deposition. There are indications that this type of accumulation could provide easily decomposable carbon, i.e. forests could change into important carbon sources with climate change.

3.5.3

Plants of Limestone and Siliceous Rocks

It has been observed since a long time that the flora on limestone differs from that on siliceous rock. The change in flora is particularly obvious in the Alps, where so-called vicarious species, e.g. *Rhododendron hirsutum*, occurs on limestone, whereas *R. ferrugineum* is found on siliceous rocks. In general terms, differences in geology are related to differences in flora (Fig. 3.5.9). The question as to which factors cause these changes in flora can only be answered at the level of the ecosystem. Similarly to the change in the substrate, the following ecological conditions of the site alter:

- limestone sites are usually drier than siliceous sites, as the water from precipitation seeps rapidly into deep soil layers.
- limestone sites are warmer than siliceous sites because of the lower soil water content.
- limestone sites have a different soil chemistry than siliceous sites (limestone: deficient in Fe,



Fig. 3.5.9. View of a limestone ecosystem with dry meadow and deciduous forest supporting a large biodiversity (in the foreground), and a poor diversity of species in a coniferous forest on siliceous rocks (background) near the Franconian fault line close to the village of Zeyern (Upper Franconia, Germany). (Photo E.-D. Schulze)

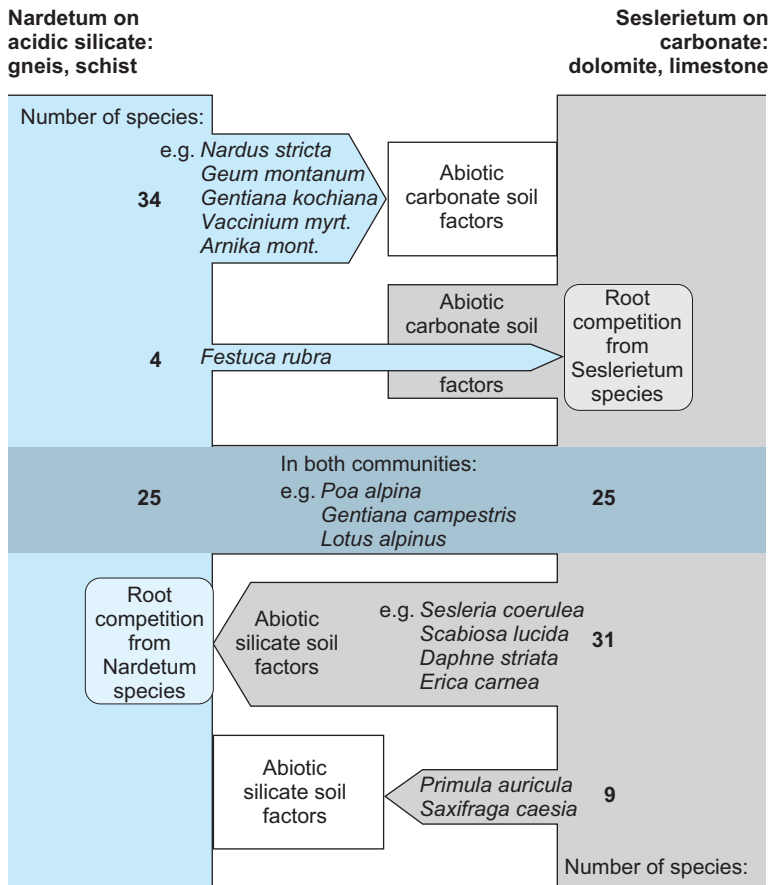


Fig. 3.5.10. Relationship between lime and silica vegetation of two alpine plant ecosystems, mat grass (*Nardus stricta*) and blue Sesleria (*Sesleria caerulea*). The number of species unable to invade the other's root space, either because of root competition or other abiotic factors, is shown. (Gigon 1987)

Box 3.5.1 Study of ecosystems

What can be learned from studies of ecosystems?

- Only at the scale of ecosystems can observations such as “forest decline” or long-term effects of management be understood.
- Forest decline is an excellent example of the interaction between soil and vegetation. Damage indicated by yellowing of foliage is a consequence of the stimulation of growth through N deposition and, at the same time, a decreased availability of cations in the soil due to acidification. Knowing this sequence of causal effects, remediation is possible.
- Deciduous and coniferous forests have different impacts on almost all ecosystem processes. Nevertheless, the turnovers in soils are quite similar and are more controlled by the soil chemical parameters of the base rock rather than by the tree cover.
- Differences between vegetation, such as they occur on chalky or silicate soils, can be seen clearly. They are controlled by a number of complex factors and not by a single parameter. Soil chemical and physical factors (dryness, warmth, availability of ions) and biological factors (such as competition), combined, lead to species that grow on chalk being unable to invade silica sites, and vice versa.

no Al; siliceous: deficient in Mo and alkaline cations but excess of Al).

- on limestone sites litter decomposition leads to mulch (mull) as the dominating form of humus, while siliceous sites are characterised by raw humus or moder.
- N mineralisation on limestone sites leads to nitrate as the dominating N form, whereas on siliceous sites it is ammonium.

The multitude of factors effecting a site show that there is not one single factor which explains the simple observation of a difference in vegetation. According to Gigon (1987), most siliceous plants do not grow on limestone because of the soil chemistry (Fig. 3.5.10). Conversely, competition in the root regions stops migration of limestone species onto siliceous sites, although they could grow there if there is no competition. Whilst 34 species of the mat grass meadows (Nardetum) are not able to colonise blue grass meadows (Seslerietum) because of abiotic factors, it is mainly competition by roots of the mat grass species that stops invasion by blue-grass species. Abiotic factors, on the other hand, only affect nine species.

References

- Bauer GA, Persson H, Persson T, Mund M, Hein M, Kummert E, Matteucci G, van Oene H, Scarascia-Mugnozza G, Schulze E-D (2000) Linking plant nutrition and ecosystem processes. *Ecological studies*, vol 142. Springer, Berlin Heidelberg New York, pp 63–98
- Brady N, Weil R (2004) *Elements of the nature and properties of soil*, 2nd edn. Prentice-Hall, Englewood Cliffs
- Chadwick OA, Derry LA, Vitousek PM, Huebert BJ, Hedin LO (1999) Changing resources of nutrients during four million years of ecosystem development. *Nature* 397:491–497
- Ellenberg H (1978) *Vegetation Mitteleuropas mit den Alpen*. Ulmer, Stuttgart, 981 pp
- Forschungsbeirat Waldschäden/Luftverunreinigungen FBW (1989) *Dritter Bericht an die Bundesregierung*. Forschungszentrum Karlsruhe, 611 pp
- Gigon A (1987) A hierarchic approach in causal ecosystem analysis. The calcifuge-calcicole problem in alpine grasslands. *Ecological studies*, vol 61. Springer, Berlin Heidelberg New York, pp 228–244
- Kottke I, Oberwinkler F (1986) Mycorrhiza of forest trees – structure and function. *Trees* 1:1–24
- Kramer H (1988) *Waldwachstumslehre*. Parey, Hamburg, 374 pp
- Lange OL, Weikert RM, Wedler M, Gebel J, Heber U (1989) Photosynthese und Nährstoffversorgung von Fichten aus einem Waldschadensgebiet auf basenarmem Untergrund. *Allg Forstz* 3:54–63
- Last FT, Watling R (1991) Acid deposition, its nature and impacts. *Proc R Soc Edinb Sect 8*, 97:343 pp
- Marschner H (1994) *Mineral nutrition of higher plants*. Academic Press, London, 889 pp
- Mitscherlich G (1975) *Wald, Wachstum und Umwelt*, 3. Bd: Boden, Luft und Produktion. Sauerländers Verlag, Frankfurt, 351 pp
- Mooney HA, Medina E, Schindler DW, Schulze E-D, Walker BH (1991) Ecosystem experiments. *SCOPE* 45:268 pp
- Mund M, Kummert E, Hein M, Bauer GA, Schulze E-D (2002) Growth and carbon stocks of a spruce forest chronosequence in central Europe. *Forest Ecology and Management* 171:275–296
- Oren R, Schulze E-D (1989) Nutritional disharmony and forest decline: a conceptual model. *Ecological studies*, vol 77. Springer, Berlin Heidelberg New York, pp 425–443
- Schachtschabel P, Blume HP, Brümmer G, Hartge KH, Schwertmann U (1998) *Lehrbuch der Bodenkunde*. Enke, Stuttgart, 494 pp
- Schulze E-D (1982) Plant life forms and their carbon, water and nutrient relations. *Encycl Plant Physiol New Ser* 128:615–676
- Schulze E-D (1989) Air pollution and forest decline in a spruce (*Picea abies*) forest. *Science* 244:776–783
- Schulze E-D (2000) Carbon and nutrient cycling in European forest ecosystems. *Ecological studies*, vol 142. Springer, Berlin Heidelberg New York, 498 pp
- Schulze E-D, Heinmann M, Wirth C (2000a) Managing forests after Kyoto. *Science* 289:2058–2059
- Schulze E-D, Högberg P, van Oene H, Persson T, Harrison AF, Read D, Kjöllér A, Matteucci G (2000b) Interactions between the carbon and nitrogen cycle and the role of biodiversity: a synopsis of a study along a north-south transect through Europe. *Ecological studies*, vol 142. Springer, Berlin Heidelberg New York, pp 468–492
- Schulze E-D, Lange OL (1990) Die Wirkungen von Luftverunreinigungen auf Waldökosysteme. *Chem Unserer Zeit* 24:117–130
- Starr MR (1991) Soil formation and fertility along a 5000 year chronosequence. *Geol Surv Finland, Spec Pap* 9:99–104
- Ulrich B (1987) Stability, elasticity, and resilience of terrestrial ecosystems with respect to matter balance. *Ecological studies*, vol 61. Springer, Berlin Heidelberg New York, pp 11–49
- Ulrich B (1994) Nutrient and acid-base budget of central European forest ecosystems. In: *Effects of acid rain on forest processes*. Wiley-Liss, Chichester, pp 1–50
- Waldschadensbericht 2003 Bundesministerium für Verbraucherschutz, Ernährung und Landwirtschaft: “Bericht über den Zustand des Waldes 2003 – Ergebnisse des förstlichen Umweltmonitorings”, Bonn

Syndynamics, Synchorology, Synecology



Small scale vegetation mosaic in the Afro-Alpine region of the Bale mountains (south-east Ethiopia) 3400 m above sea level with shrubby communities (*Erica arborea*), dwarf shrubby vegetation (different species of *Alchemilla* and *Helichrysum*) and individual giant lobelias (*Lobelia rhynchopetalum*) on the dry rocky slopes and also in the grassland communities and marshy depressions at the moist foot of the slopes. Photo K. Müller-Hohenstein

In this chapter a new level of organisation is discussed. Consideration of plant ecology, and thus the many aspects between autecology and research into ecosystems, necessarily requires **progression from the laboratory to natural conditions**. Subsequent to the study of individual plants or plant species under controlled conditions with predominantly experimental treatment, in this chapter, we build on the previous analysis of ecological systems (Chap. 3), which recognise the **spatial distribution and communities of plants**, including the description and understanding of the relative success of the individual plant (or species) in complex communities.

This goal is linked to synecological questions which have been formulated following the laws of Thienemann. Summarising for plants these state that no plant can exist on its own, only in **communities (biogeocenes)** in interactions comprising living plants and animals. These communities develop with a limited number of plant species and individuals in a limited space in certain temporal rhythms. It is assumed that it is possible to distinguish between **plant communities (phytocoenoses)**.

With the increasing complexity of processes to be considered comes a decreasing ability to make prognoses about development. Synecology is a science of observation, rather than experimentation, mainly because of the spatial as well as the temporal dimensions of the areas of distribution, and of processes to be considered. Synecological experiments are carried out by nature itself, including all anthropogenic influences, which increase the complexity considerably. The task is to recognise patterns in the experimental structure and to describe them, as well as to define the limiting conditions. However, the goal of synecology extends beyond mere description. Comparable to experiments under controlled conditions, explanations are sought; however, quantitative measurements are much more difficult to obtain. Thus, quantitative measurements slip into the background, whilst qualitative assessment gains importance.

In analysing ecosystems (Chap. 3), it became obvious that two aspects are connected with the

step into field, conditions which so far have only been marginally addressed. Communities – and of course also plant communities – develop during the course of time and may display directed or cyclic dynamics. Their history and rhythms of development must be known in order to understand their actual structure. Here, the influences of human settlement and management are particularly important. **Historical-genetic aspects** of plant communities are discussed in **Chapter 4.1 as syndynamics**. During their development over time, plants and plant communities conquered habitats and expanded into available space. The **basis of the spatial distribution** of plant communities is discussed in **Chapter 4.2 as synchorology**. In **Chapter 4.3, synecology and biotic interactions** between plants and animals are considered on the basis of syndynamics and synchorology.

Because of the complexity, it is not possible to comprehensively describe synecology, only a selection of generalised knowledge of temporal dynamics and stability, of spatial expansion and diversity, as well as of competition and coexistence is presented.

As further literature the textbooks by

- Begon M, Harper JL, Townsend C (1999) Ecology, 3rd ed. Blackwell, Oxford
- Begon M, Mortimer M, Thompson D (1996) Population ecology. A unified study of animals and plants, 3rd ed. Blackwell, Oxford
- Chapin SF III, Matson PA, Mooney HA (2002) Principles of terrestrial ecosystem ecology. Springer, New York
- Crawley MJ (1997) Plant ecology, 2nd ed. Blackwell, Oxford
- Krebs JR, Davies NB (1997) Behavioural Ecology. An evolutionary approach, 4th ed. Blackwell, Oxford
- Odum EP (1971) Fundamentals of ecology, 3rd ed. Saunders, Philadelphia
- Remmert H (1980) Ecology: a textbook. Springer, Berlin Heidelberg New York

are recommended.

4.1

Historic-Genetic Development of Phytocenoses and Their Dynamics



The species-rich segetal flora in an annual crop of lentils and in a perennial crop of olive trees demonstrates the typical anthropogenic replacement of communities in an area of the European Mediterranean region which is still little influenced by herbicides. Photo K. Müller-Hohenstein

Recommended Literature

To understand the development of the plant cover on earth and provide detailed explanations on individual temporal periods, as well as on the general basic aspects of vegetation dynamics, the following books are recommended in addition to those mentioned at the beginning of [Chapter 4](#):

- Burrows CJ (1990) Processes of vegetation change. Unwin, London
- Ellenberg H (1988) Vegetation ecology of central Europe, 4th ed. Cambridge Univ Press, Cambridge
- Graham LA (1993) Origin of land plants. Wiley, New York
- Lovett Doust J, Lovett Doust L (eds) (1988) Plant reproductive ecology. Patterns and strategies. Oxford Univ Press, Oxford
- Solomon AM, Shugart HH (eds) (1993) Vegetation dynamics and global change. Chapman & Hall, New York London

- Sukopp H, Hejny S (eds) (1990) Urban ecology. SPB Acad Publ, The Hague
- Thompson JN (1995) The coevolutionary process. Univ of Chicago Press, Chicago

Recent ecological interactions between living organisms and their environment are the basis of the present structure and distribution of vegetation. Thus, present-day conditions can only be understood on the basis of abiotic and biotic interactions, i.e. ecologically. However, the existence of species and communities may only be explained historically on the basis of knowledge of evolution and distribution.

Three important geological events have contributed significantly to the formation of present-day patterns of distribution:

- continuous migration of the continents in relation to the poles ([Fig. 4.1.1](#), see also [Table 4.1.1](#)). According to measurements of palaeomagnetism, the magnetic North Pole in the Cambrium was in the Pacific, not far from

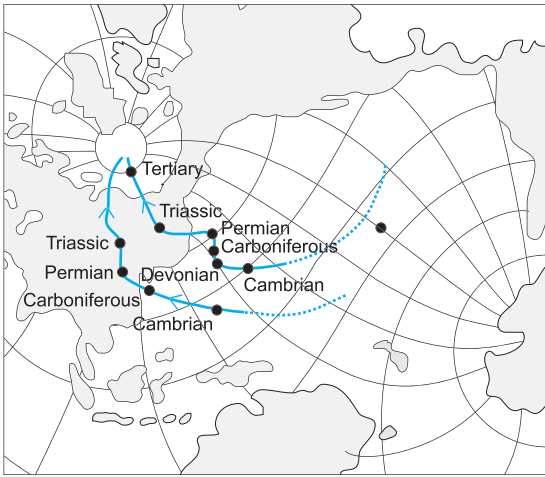


Fig. 4.1.1. Changes in the position of the magnetic North Pole during geological time (determined from palaeomagnetic measurements of North American (upper curve) and British (lower curve) rocks. (Kreeb 1983)

the Japanese island group, but in the Trias it was in north-east Asia.

- formation of continents arising from the **permanent changes in position of parts of the earth's crust** (Fig. 4.1.2). Despite controversy (plate tectonics) the theory of continental shift formulated by Wegener is valid and confirmed in its basic features.
- **solar effects** (different radiation conditions) arising from the composition of the atmosphere, and from the changing distances between earth and sun.

These events are linked to two influences directly affecting plants and their evolution. Firstly, climatic conditions have changed drastically, and secondly the possibility for expansion of plants by the opening or closing of land bridges or by the rise of mountain barriers was limited or enhanced. In this context events related to catastrophic **asteroid impacts** which greatly reduced biodiversity at the end of the Permian (Barbault and Sastrapradja 1995) and the Mesozoic should be mentioned.

In the recent past, the development of vegetation has been changed worldwide to a much greater extent and within a much shorter time span by the continuously growing **influence of human settlement and land use**. This shows clearly that palae-ecological links and historical development must be known to understand the present-day vegetation and its structure, composition and spatial distribution.

In the following, older periods of the history of life on earth, including selected aspects of the phylogeny and the coevolution of organisms (eophyticum, palaeophyticum, mesophyticum), will only be briefly outlined. The neophyticum will be discussed in more detail with two of its most important periods:

1. Late and postglacial development of vegetation. The links between climate and vegetation in the most recent geological past will be central.
2. Direct and indirect influence of humans on plant cover. These influences dominate partic-

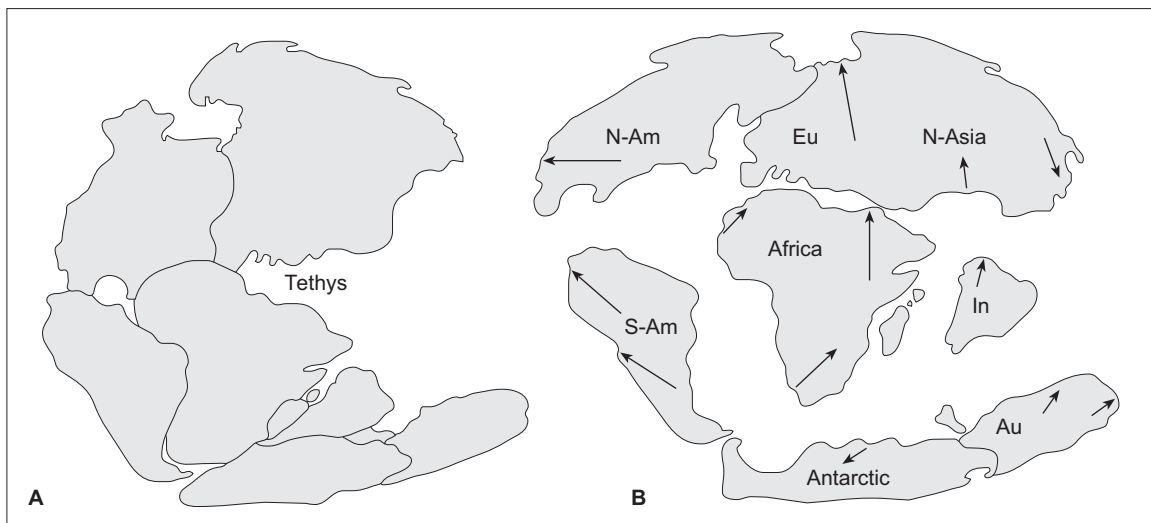


Fig. 4.1.2. Stages in development of the present distribution of the continents. **A** Joined landmass of Pangaea in the Triassic. **B** Distribution of continents at the end of the Cretaceous. (After Bick 1993)

Table 4.1.1. The putative evolution of life forms and ecosystems during the history of the earth. (After Kreeb 1983)

	Time in millions of years	Geological formation	Plant	Animal	Ecosystem type
Neophyticum (Angiosperm time)	0	Present	Agricultural techniques	<i>Homo faber</i>	Anthropogenic ecosystem disruption
	0.005	Holocene	Cultivated plants	Domestication of animals	Anthropogenic changes in ecosystems
	0.5	Pleistocene		<i>Homo sapiens</i>	All land ecosystems, deserts, halophytic communities, cold areas
	30	Tertiary	Deciduous trees	Freshwater fish, humanisation	
	95	Cretaceous	Angiosperms		
Mesophyticum (Gymnosperm time)	150	Jurassic	Pine trees, first flowering and seed plants	Early birds	Plant adaptation to different climate zones
	200	Triassic		Dinosaurs, early mammals	
Palaeophyticum (Pteridophyte time)	230	Permian			Species diversity decreases slightly
	280	Carboniferous	First tree-like ferns: Lycopods Calamites	Reptiles and dinosaurs	Swamp forests (dry land not colonised)
	340	Devonian	Horsetails Ferns	Lung fish, amphibians, insects	First highly developed land ecosystems in moist places
	450	Silurian	First land plants: early ferns	First vertebrates	Simple ecosystems without consumers on land near coasts
Eophyticum (algal time)	500	Cambrian	Algae	All animal types except vertebrates	Higher developed aquatic ecosystems
	2000	Algoncium	Photosynthesis, respiration using oxygen		(Oxygen atmosphere) simple aquatic ecosystems
	3000	Archaean	First chemosynthetically active organisms		(Anaerobic aquatic ecosystems?) thermophilic organisms
	4000	Early ocean/early atmosphere	Start of biological evolution: first cells		(Oxygen-free environment) (Salt-free ocean?)

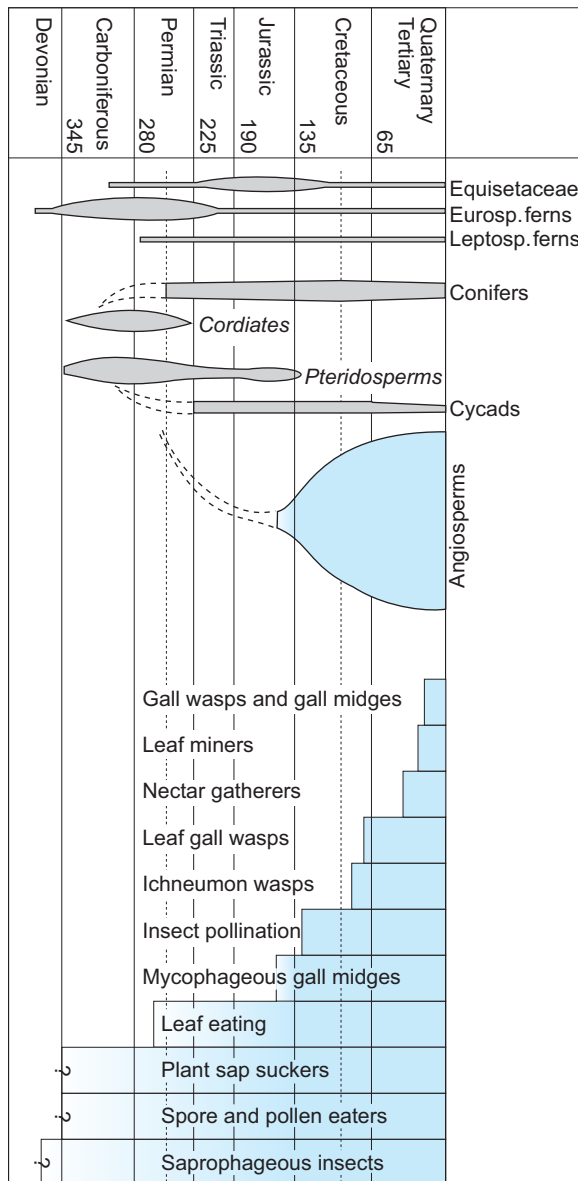
ularly in old, cultural landscapes developed by man and in regions of intensive agriculture and forestry.

The main focus of the following subchapters is Europe. More recent developments in other continents will be mentioned briefly. Problems of global change will be discussed comprehensively in Chapter 5.

4.1.1

History of Vegetation to the End of the Tertiary

In the **Precambrium** two large separate landmasses (first continents) had formed, each near the poles: in the northern hemisphere **Laurasia**, in the southern hemisphere **Gondwana** (Table 4.1.1). These two landmasses merged over time forming one large landmass, the **Pangaea**,



■ Fig. 4.1.3. Age and development of important groups of vascular plants, and of phyto- and entomophagous insects, as well as evidence of pollination and herbivory. (After Zwölfer 1978)

which remained until the Palaeozoic (about 220 million years ago; see Fig. 4.1.1) with changing positions towards poles and equator.

Traces of life and the first single-cell prokaryotes (bacteria, cyanobacteria) existed for about 3 billion years in an oxygen-poor atmosphere. Eukaryotes and multicellular forms could only develop with increasing oxygen content. This period, extending into the **Silurian** (about 400 million years ago), is called the **eophytic** (proterophytic) or the algal period.

The most important developmental step occurred with the settling of the land at the change from the eophytic to the **palaeophytic** during the Silurian period. The first land plants possessed cells with large vacuoles, already had stomata and had developed supporting tissues. These autotrophic producers lived together with fungi and bacteria as decomposers and formed the first bioscenoses.

Evolution of animal and plant species and communities progressed in parallel (see Table 4.1.1 and Fig. 4.1.3). Psilophytes (archetypal ferns) are regarded as precursors of the Pteridophyta (ferns and their allies), to which Filicinae (ferns proper), Equisitinae (horsetails) and Lycopodiinae (club mosses) belong. At that time Bryophyta (mosses) split off and remained at this developmental stage, but the other groups in the warm and humid climate of the **Carboniferous** formed luxurious forests with tree-like horsetails, club mosses and Cordiates, which later became extinct, on the swampy and boggy sites. Analyses of deposits of bituminous coal allow exact reconstruction of this very structured vegetation, including indications of symbiotic interactions (mycorrhiza) and the animal kingdom linked to it.

At the transition from the Carboniferous to the **Permian** climatic conditions became dryer. Many species did not survive and many land plants were unable to adapt their water relations. Thus the transition from the palaeophytic to the mesophytic is characterised by a decrease in species diversity. At the beginning of the **Triassic**, the Tethys Ocean separated off the eastern part of Pangaea (Fig. 4.1.2). During the **Jurassic**, the North Atlantic developed, and during the Cretaceous period the South Atlantic formed; in the early **Tertiary** the Antarctic and Australia separated. The continents moved into their present position only in the **Pliocene**.

Up to the **Cretaceous** period the flora was very similar worldwide. The oceans forming between the drifting continents were no obstacles to the exchange of flora. The history of vegetation up to the **mesophytic** is also called the period of the gymnosperms. After the extinction of the larger club mosses and horsetails, gymnosperms gained space, particularly conifers and the Ginkgoaceae. The only present-day representative of the Ginkgoaceae is *Ginkgo biloba*, regarded as a “living fossil”. In the northern regions the first representatives of the Pinaceae and the genus *Juniperus* have been found. Cu-

pressaceae, as well as the genus *Araucaria*, which today is limited to the tropics of the southern hemisphere, occurred worldwide.

The boundary between the Jurassic and Cretaceous periods also divides the mesophytic from the neophytic and the period of gymnosperms from that of the angiosperms. The first angiosperms occurred at the end of the Jurassic period. In a relatively short period, 25 million years of the Cretaceous period, flowering plants developed very rapidly and suppressed many of the gymnosperms which had dominated until then. Almost at a stroke all main angiosperm groups developed; all available sites which could be occupied were filled with adapted species and the intercontinental flora exchange was still not too difficult. A much stronger floristic separation occurred during the upper Cretaceous period. The so-called **plant kingdoms** developed and – corresponding to the slightly earlier division in the south – distinction is made between the three floristic realms in the southern hemisphere (**Antarctic, Australis and Capensis**), two tropical equatorial floristic realms (**Neotropics and Palaotropics**) and only one northern hemisphere floristic realm (**Holoarctic**).

Zwölfer (1978) has given an overview of the geological occurrence of vascular plants as well as phytophagous and entomophagous insects, and thus of the development of communities. There is proof that pollen and dead plant material were eaten as early as the Devonian period and in the Permian leaves were consumed. In the Triassic period insect pollination of flowers occurred and there were entomophagous parasites (ichneumon wasps) and plant galls. From the Tertiary period onwards all present-day phytophages are represented: herbivores, nectar collectors, leaf miners, gall flies and gall gnats. [Figure 4.1.3](#) shows that development of phytophagous and entomophagous forms is geologically fairly recent and occurred at the same time as the development of angiosperms.

Mutual adaptations of floristic and faunistic partners is a consequence of the **selection pressure** linked to this development. Plants developed thorns, spines or chemical defence substances, animals responded with adaptive changes to their mouth parts or resistance against plant toxins. Some flowering plants were, however, particularly successful as they were able to protect themselves against herbivory; e.g. gentians (defence by indoalkaloids) or deadly nightshades (defence by tropanalkaloids). Dur-

ing this evolution, some insects used secondary plant metabolites for their own defence, e.g. against entomophagous enemies.

The most important groups of flowering plants were present at the beginning of the Tertiary period and, therefore, the period of the history of vegetation from then to the present day is called the **neophytic** or angiosperm period. Amongst the flowering plants, specialists adjusted to stress environments such as deserts and saline soils developed. Along with the formation of mountain ranges, in the northern hemisphere, including the central Asiatic and European Mediterranean mountains, young mountain floras developed (**oreophytes**, closely related to flora in plains). Often individual altitudinal steps are characterised by vicarious species and genera.

Holoartic flora has been found in Palaeozoic to Eocene lignite deposits in Spitzbergen, where not only remains of plants (e.g. *Acer*, *Betula*, *Fagus*, *Quercus*, *Salix*, *Tilia*, *Pinus* and *Picea*) growing today in central Europe under conditions of a temperate climate were found, but also those which now grow only in humid, subtropical conditions (e.g. *Taxodium*, *Magnolia*, *Liriodendron*), as well as species which survived in Ice Age refuges in North America and east Asia. Comparable plants (e.g. *Aesculus*, *Castanea*, *Plantanus*, *Vitis*) found in Greenland represent the so-called **arcto-tertiary flora**, the basis of the Holoarctic flora.

From the Eocene flora from southern England and the “flora from the Geiseltal” near Merseburg, Germany, plant lists were compiled containing families of plants (e.g. species of Annonaceae, Pandanaceae, Sterculiaceae) which now occur in seasonally moist tropical regions. At that time the vegetation in Europe was similar to that in mountain regions of Southeast Asia. Europe only took its current position during the Tertiary, evidenced by fossiles from the early Tertiary (Miocene and Pliocene).

In plant remains of **Pliocene** in central Europe, tropical species could no longer be found, but representatives of present-day genera (*Fagus*, *Quercus*, *Salix*, *Fraxinus*, *Populus*, *Pinus*), and also species of genera which are at present extinct in this region (*Liriodendron*, *Sequoia*). Comparable fossiles from north-east Asia and North America indicate **worldwide progressive cooling**. In Europe, climate and vegetation zones shifted to the south. The west-east extension of the Alps and the Mediterranean made it difficult

for species adapted to a warm climate to survive; some got extinct, others were pushed into limited regions. The relative uniformity of the Pliocene flora in the Holoarctic was lost. Large distribution areas were separated into several spatially limited regions, the so-called **large Tertiary disjunctions** (e.g. *Sequoia* and *Metasequoia*, Magnoliaceae). For some species, e.g. of the genera *Styrax*, *Plantanus*, *Melia* and *Castanea*, the moist warm sites in the eastern Black Sea region (Colchis) became important refuges.

Development of Mediterranean sclerophyllic vegetation and the recent steppe, semi-desert and savannah flora is also often connected to the general cooling of global climate in the Tertiary period. Cooling in the Pliocene may be regarded as a precursor of the multiple quaternary climate changes in the most recent neophytic,

with lasting influence on the central European and American flora.

4.1.2

Change of Climate and Vegetation in the Pleistocene

The change from cold to warm periods is very important in central Europe. Temperatures continued to decrease in the Pleistocene and this decrease lasted about 2 million years, with periodically changing cold and warm periods up to present. Average annual temperatures decreased in central Europe by at least 8 and as much as 12°C below present-day temperatures. In tropical regions they probably fell only about 6°C.

Table 4.1.2. Vegetation and climatic elements of late- and postglacial time. Columns for time, pollination zone I–XII (from Overbeck 1975), vegetation period, climate history and prehistory of man. (Walter and Straka 1970)

1000	XII	Forest plantations						
		Beech		Post-interglacial period (sub-Atlanticum) (relatively cool and moist)			Historical period	
0	XI						Iron Age	
		Beech – oak		Late interglacial period (sub-boreal) (warm and dry)			Bronze Age	
-1000	X							
-2000								
	IX	Mixed oak forest (oak, elm, lime, ash)					Late	
-3000				Middle interglacial period (Atlanticum) (warm and moist, climate optimum)		Postglacial	Middle	Neolithic
-4000	VIII							
-5000							Early	
-6000								
	VII	Hazel		Early interglacial (boreal) (warm and dry)				Mesolithic
-7000	VI	Hazel–pine						
-8000	V	Birch–pine		Pre-interglacial (increasing temperatures)				
	IV	Tree-poor tundra		Late sub-arctic period (return of cold)				
-9000								
	III	Birch–pine		Middle sub-arctic period (Alleröd) (temporarily warmer)		Late Ice Age		
-10000								
	II	Tree-poor tundra		Early sub-arctic period				Palaeolithic
-11000	I	Treeless tundra		Late arctic period (cold)				
-12000						Main glaciation		

Climatic variations in the Holocene are usually explained by periodic changes of solar radiation caused by alterations in the orbit of the rotational axis of the earth (Milankovitch theory, see also Chap. 5).

Direct and indirect consequences of **Quaternary climate variations** may be summarised as follows: On both hemispheres, starting from the polar regions, enormous inland ice masses up to 3000 m thick developed, reaching e.g. in Germany to some mountain ridges such as the Harz and the Weserbergland. Enormous glaciers also covered higher mountain ranges and during the maximum of the Alpine ice cover only few peaks rose on top of the ice cover (Nunataker). The glaciers extended far north into the foothills of mountainous regions, so that the ice-free space between the Alpine and Polar ice caps was in Europe hardly more than 300 km wide. However, at the same time, sea level sank to about 200 m below the present level (eustatic changes) so that movement of plants in the cold period became easier between landmasses currently separated by shelf oceans.

For Europe six cold periods are recognised with intermittent warm periods and short-term climate changes; the interstadial (e.g. Paudorf-Arcy) or deviations (e.g. Alleröd) are proven, whereby the terms for glacial advances are taken from the appropriate regional ice cap positions (Table 4.1.2). For a long time it was assumed that cold periods at higher latitudes corresponded to pluvial periods in dry regions at lower latitudes, but even here there are different opinions (Pachur 1987). In this context, terms are used for the **cold periods** which apply to the European glaciation of mountainous regions:

- **Biber and Danube ice age** in the early Pleistocene about 1 million years ago;
- **Günz and Mindel ice age** in the middle Pleistocene, about 250,000 years ago;
- **Riss ice age** about 230,000 to 120,000 years before the present;
- **Würm glaciation** (about 90,000 to 10,000 years before the present) in the late Pleistocene.

The increasing extinction of warmth-requiring tropical and subtropical species becomes obvious from Fig. 4.1.4, as well as the alternating dominance of woody species in the warm periods and herbaceous species and grasses in cold periods. Trees in particular disappeared locally or survived unfavourable periods in **refuges** of

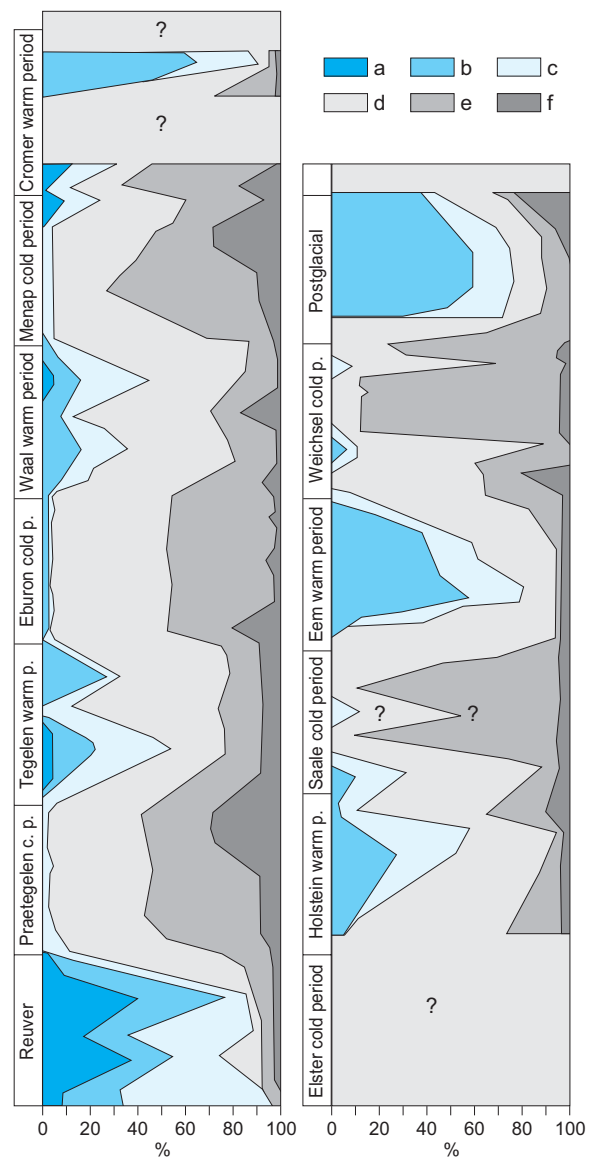


Fig. 4.1.4. Development of the vegetation in ice-free central Europe during the Quaternary. Simplified pollen diagram from the end of the Tertiary to the postglacial period with the percentage of *a* tree species of the Tertiary (e.g. of the genera *Sequoia*, *Taxodium*, *Liquidambar*); *b* thermophilic tree species (e.g. of the genera *Quercus*, *Castanea*, *Corylus*); *c* woody species of moist to wet sites (e.g. of the genera *Alnus*, *Carya*, *Vitis*); *d* conifers of different genera; *e* Ericales; *f* grasses and herbs. (After Frenzel 1968, from Strasburger and Sitte 1998)

southern latitudes. As herbaceous plants, grasses and low-growing dwarf shrubs expand faster because of their shorter time of regeneration, there are far fewer losses of such species than of trees. In North America no mountain barriers blocked the way for warmth-loving plants that wanted to move south. According to Ellenberg (1978), a

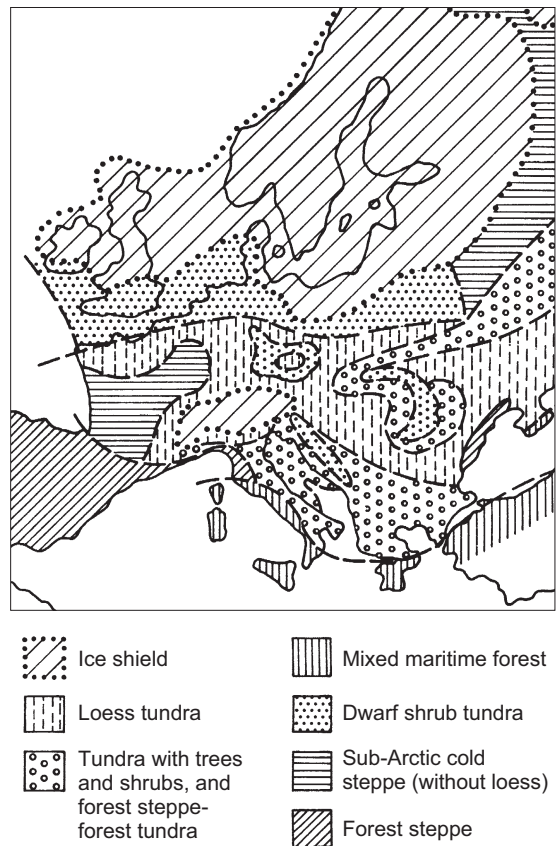
comparison of North America and Europe shows about the same number of herbaceous species and grasses, but the ratio of herbaceous species and trees is 124 to 53, respectively.

Some thermophilic species were able to occupy refuges and survived to the present, but their original closed area was separated into several **disjunct areas**. A **disjunct distribution** is shown by *Rhododendron ponticum* with present-day occurrence in southwest Spain, in the Pontic region and in the Lebanon, or by cedars, with some species in the North African mountains, in the Taurus and in Lebanon. Present-day growth areas of **arcto-tertiary relics** played an important role as refuges for forests during cold periods.

During cold periods, only very few species successfully remained in mountains, surrounded by glaciers, on the Nunatakers rising out of the ice. These are mainly mosses and lichens but also some high Alpine flowering plants. The area expansion of some species towards the south, beyond the equator, is also attributed to the changed climate during cold periods. There are several migratory paths – the East African rift valley, the American Cordilleras and the bridge southeast Asia – New Guinea – Australia, where these plants found places to grow and even today they occur in **bipolar distribution regions**. Examples are the genera *Carex*, *Erica*, *Epilobium* and *Empetrum*.

Frenzel's map (1968) of the vegetation in Europe during the peak of the Würm glaciation (Fig. 4.1.5) shows the shift of vegetation zones towards the south, compared to the present day. Island-like remains of oceanic summer green Mediterranean deciduous mixed forests occurred on Mediterranean islands. The Mediterranean sclerophyllic vegetation was limited to the present arid area of North Africa. Large parts of the Iberian and Balkan peninsulas were covered by forest steppes. The regions of central Europe between the edges of the ice sheet were almost tree free.

The vegetation of tundras and cold steppes of that time was reconstructed from plant remains deposited in lakes. The indicator plant of this flora is the arctic alpine *Dryas octopetala* which is now found on the species-rich grassland that occurs on limestone with a very shallow soil. This plant occurs together with species which occupy similar sites, e.g. *Polygonum viviparum*, *Silene acaulis*, *Oxyria digyna*, *Tofieldia calyculata*, as well as numerous mosses and dwarf and espalier shrubs such as *Loiseleuria procumbens*,



■ Fig. 4.1.5. Distribution of vegetation types in Europe during the time of maximal glaciation in the Würm glacial period. (After Frenzel 1968, from Kreeb 1983)

Salix herbacea, *Empetrum nigrum* and *Betula nana*. At locations further away from the edges of the ice sheets in eastern Europe, under continental climatic conditions, the cold steppe expanded with a rich herbaceous flora with *Artemisia*, *Centaurea*, *Ephedra* and *Chenopodium* species as well as numerous Cyperaceae and Poaceae of the genera *Stipa*, *Festuca*, *Poa* and *Agropyron*.

During the warm periods, separated by cold periods, an **interglacial vegetation** developed, similar to the postglacial vegetation discussed in Chapter 4.1.3. In the interglacial period a mixed forest of lime trees, elms, alder, oak and hornbeam established. This forest developed gradually from a forest in which spruce and birch dominated, and which again dominated before the onset of the Würm glaciation.

4.1.3

Late and Postglacial Climate and Vegetation History

The discussion of the history of vegetation so far has shown two points:

- the enormous development of species taking place dependent on astronomical, tectonic and climatic events as well as on the communities in biosceneses.
- a distinct spatial separation of the large parts of the earth's crust occurred. The formation of young mountains is almost finished. Now developments over smaller areas are started in which regional floristic, and environmental characteristics of the site play a decisive role.

The history of climate and vegetation during the Holocene in Europe has long been documented in its basic features, particularly because the availability of new methods such as **pollen analysis** and **radiocarbon dating** provided supplementary research tools. Almost all plant species found have survived to the present day.

A noticeable warming of the climate occurred about 20,000 years ago, with the retreat of glaciers into the mountains and to the north allowing warmth-demanding plants, particularly trees, to move back into the area of central Europe occupied by dwarf shrub communities and cold steppes. This did not occur continuously or from the same refuges. Climatic variations also occurred in the late and postglacial periods. They can be easily observed from the position

of the timber line in the last 20,000 years, which was probably about 1200 m or even 1600 m lower in the Apennine in the last cold period compared with the present. The course of the line shows that a rapid increase in the **Alleröd period** in the middle-late glacial was abruptly interrupted before the timber line reached its present position. This happened in the postglacial **boreal**. In the following **Atlantic period** about 6000 years ago the timberline in the Alps was about 400 m higher than today. The situation in the mountains of central Germany was similar and in Scandinavia the timberline was lower. However the forest area extended far into the present-day tundras (Fig. 4.1.6).

The movement of the most important tree species back to the earlier positions was reconstructed by comparison of pollen profiles, so-called **iso-pollen maps**, and occurred in different ways and at different periods, where the requirements of species for the site, the speed of migration and the position of the cold period refuges are important.

Spruce came from an easterly direction, following the "northern path" from the Urals, south of the present-day northern coasts and along northern borders of the central European mountain chain and the northern borders of the Alps. Figure 4.1.7 shows the temporal sequence of the expansion of spruce along the edges of the Alps. Fir trees, and also almost all deciduous trees (beech), originated from the Mediterranean areas and reached central Europe via the Burgundian Gate or the Pannonian Basin.

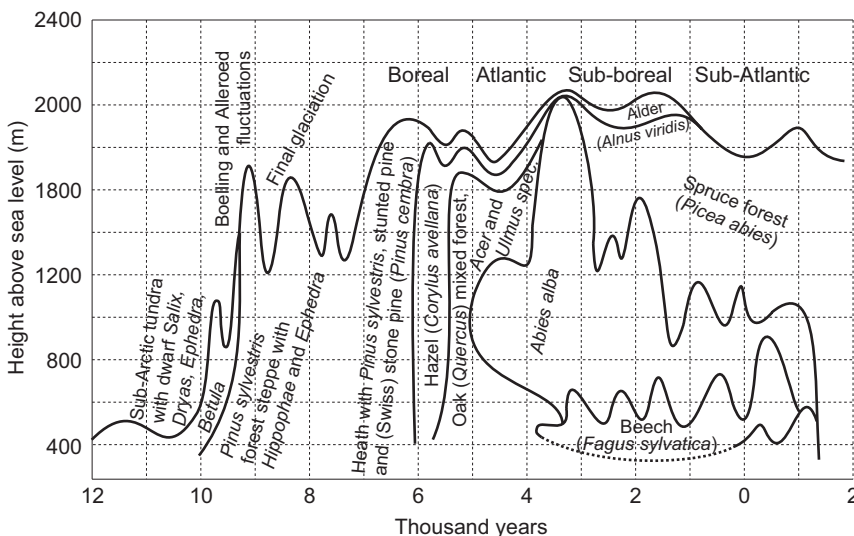


Fig. 4.1.6. Development of altitudinal zones of vegetation in the northern Swiss Alps since the maximum of the Würm glaciation. (Strasburger and Sitte 1998)

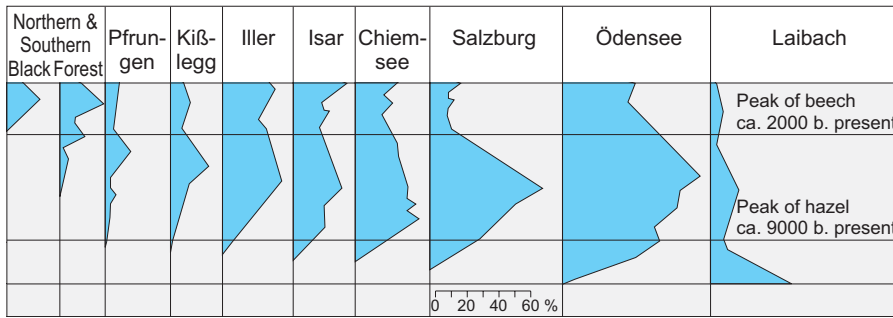


Fig. 4.1.7. Migration of spruce (*Picea abies*) in postglacial times along the margins of the Alps. (After Walter 1986)

Data from pollen analyses, based on the evaluation and comparison of many pollen diagrams, allows the late and postglacial history of vegetation to be divided into several sections (Figs. 4.1.8 and 4.1.9A,B).

In the **oldest tundra period**, also called the Dryas period after the indicator species *Dryas octopetala*, a continental steppe vegetation predominated with scattered tree-free tundra islands. In the following warmer **Alleröd** epoch, sparse spruce and birch forests and willow shrubs were able to exist, but these species receded again about 1000 years later. The steppes advanced from the east under the still extremely

continental conditions. Only in the early **warm period** (preboreal and boreal) was the temperate forest able to extend again because conditions were no longer so cold in winter; birch was replaced by hazel and other deciduous trees (first oak and elm, followed by lime and ash). Man in the middle Stone Age about 8000 years ago was surrounded by species rich forest communities dominantly hazel. Residues of tundra occupied the increasingly melting edges of the ice sheet, and steppes were pushed towards the southeast.

The warmest climatic conditions, and the corresponding development of vegetation, were experienced by Neolithic Man in the **middle warm**

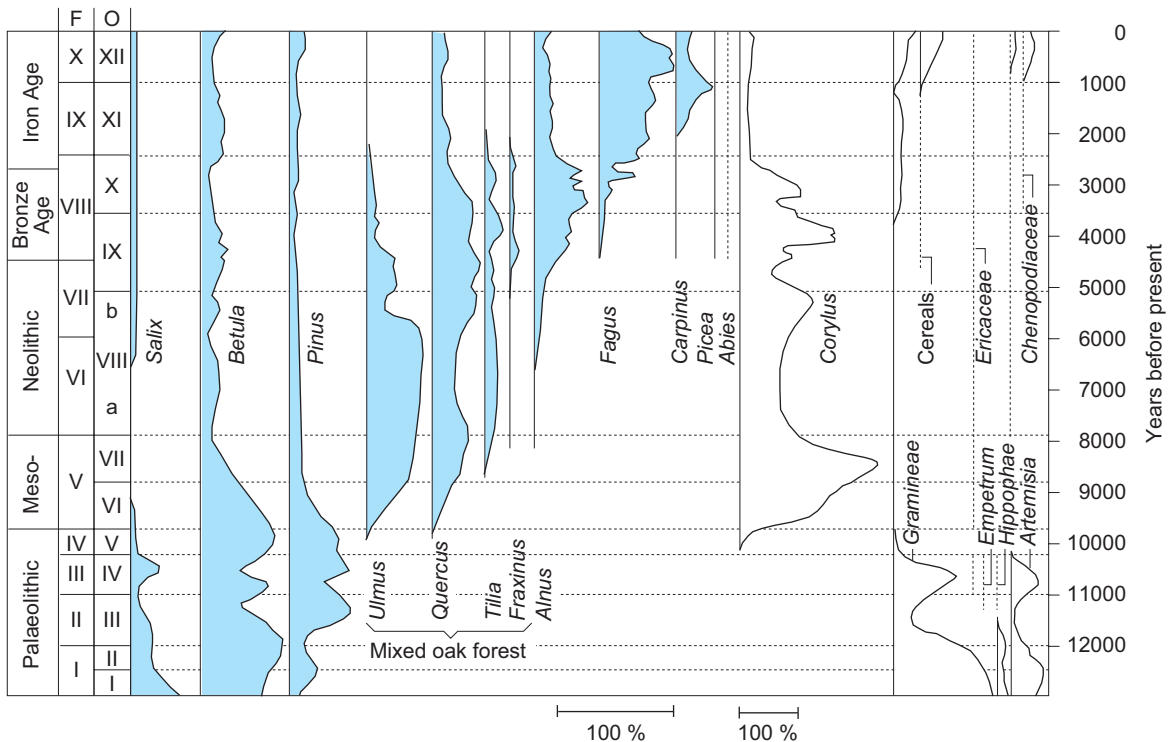


Fig. 4.1.8. Pollen diagram from the Luttersee (Göttingen, northern Germany, 160 m above sea level, a.s.l.), with pollen zones according to Firbas (F) and Overbeck (O) (after Walter 1986). Scale: sum of tree pollen 100%, without hazel (*Corylus*)



Fig. 4.1.9. A Part of the almost natural “Pillermoor” (1600 m a.s.l.) which is a protected area in the lower Pitztal (Tyrol) and B part of the same raised bog where peat was removed more than 30 years before. Pollen analysis from this bog shows the postglacial development of vegetation of the montane region in the Tyrol. (Photos K. Müller-Hohenstein)

period (Atlantic period) about 6000 to 7000 years ago. In northern Europe, mean annual temperatures, with oceanic conditions during this time of the “climatic optimum”, were 2–3 °C higher than present temperatures. Mixed oak forests with deciduous trees requiring good climatic and edaphic conditions and few beech trees were dominant. In the montane areas, fir dominated in the western Alps, spruce in the eastern Alps and pines in the eastern part of central Europe on nutrient-poor sites. Only on particularly dry sites did steppe vegetation still occur with thermophilic species.

Glacial relicts from the cold periods are still maintained in present-day vegetation as islands, e.g. *Betula nana* in the foothills of the Alps or *Aster alpinus* and *Pulsatilla alpina* in the Harz mountains in Germany in tree-free, particularly cold sites (edges of bogs); similarly, species from the warmest periods were also able to hold their own. These **xerotherm relicts**, submediterranean species (*Quercus pubescens*, *Helianthemum nummularium*) or types from the south Siberian and Pontic area (*Stipa div. spec.*, *Adonis vernalis*, *Linum flavum*) were able to survive after the onset of cooling in the subboreal forest, on sites hostile to growth of trees (extremely shallow sites exposed to the south) and were able to expand again onto anthropogenic tree-free areas (meadows on soils derived from limestone that are

shallow, where the site is dry and comparatively warm, but nevertheless rich in species).

Beech only became dominant in the forests of central Europe in the **late warm period** and took over the role of hornbeam which dominated in the interglacial period and was now predominant further to the east. Beech forms, together with spruce and fir, the montane forests up to the montane belt. Even though beech has only been dominating the forests of central Europe for 30 to 50 tree generations, distinct forest communities were formed everywhere until humans intervened (Ellenberg 1978).

Species which required higher temperatures for their development migrated back into warmer parts and outcompeted the cold period vegetation, except for a few relict species. Their expansion partly followed the edges of the ice sheet and thus many closed areas became divided and **disjunctions** were formed. Some are concentrated on the southern European mountains (e.g. species of the genera *Primula*, *Saxifraga*, *Gentiana*), others form the arcto-alpine disjunctions with interspersed occurrence on the highest parts of the mountains of central Germany (e.g. *Nigritella nigra coll.*, *Gnaphalium supinum*). Disjunctly distributed, also including the North American region, are *Betula nana*, *Salix herbacea*, *Dryas octopetala* and the circumpolar *Loiseleuria procumbens* and *Eriophorum scheuchzeri*.



Only in recent decades precise dates of the history and climate of the African dry areas have been collected (Pachur 1987). According to these findings, the long-established views of a synchronous sequence of cold and warm periods in moderate latitudes and humid (pluvial) and dry periods in present dry areas must be corrected. During the last cold period (evidence for a period of ca. 20,000 years before the present day), an even shift to the south must be assumed. The Sahara could have been “green” and rain forest regions became narrower, at least from the north (Lauer and Frankenberg 1979). Mountains in the Sahara possessed a strongly Mediterranean vegetation similar to that in the later humid period during the climate optimum. Pachur (1987) speaks of a semiarid climate in the east African region.

During the climate optimum, with semiarid conditions and summer rain in the south and winter rain in the north, the Sahara was reduced to a small region from both sides. Neumann (1988) assumes on the basis of charcoal analyses that the Sahelian vegetation with species such as *Balanites aegyptiaca*, *Acacia albida* and *Cadaba farinosa* established up to 600 km further north in sparse dry woodlands. The southwest shift of Mediterranean influences is regarded as far smaller. After the moister conditions around 8000 years ago, Neolithic Man in the Sahara experienced increasing drought from 5000 years ago until now (Fig. 4.1.10 A–C). The tropical savannah reached its actual position again 3300 years ago. The rock relief of “crying cows” of Terarart in front of a former drinking place near Djanet in southern Algeria is taken as a symbol of this drying. For the Sahara, even today, two relatively stable and interchanging vegetational states are assumed, a “green” Sahara and a “red” Sahara, which is bare of vegetation (Claussen 2001).

Quaternary climate change was also effective in the tropics of South America. In areas near the equator the forest line fell in the high glacial period and rose again in the postglacial optimum. At the edges of the tropics a horizontal shift of vegetation limits occurred (Lauer 1986).

Fig. 4.1.10. A, B and C Rock paintings and engravings indicate that there were once more humid climatic conditions in the central Saharan mountains. Pictures of hunters (A) and large grazing herds (B) near Sefar (Tassili), southern Algeria, are nearly 8000 years old. The “crying cows from Terarart” (C) near Djanet are about 5000 years old and indicate the gradual increase in aridity. (Photos K. Müller-Hohenstein)

In the tropical lowlands of South America the expanded moist forests shrank in the high glacial period and allowed a stronger floral and faunal exchange between the dry area taxa than was previously possible. Moist forest areas became more isolated. After the favourable conditions of the climate optimum the timber line fell again, however very quickly because of human influence. Small *Polylepis* stands are witness to this; today they are found far above the actual tree limit. In lowlands, moist forests expanded initially. The long uninterrupted period of development assumed in the history of rain forests cannot be confirmed for the Neotropis. Because of increasing drought in the late Holocene and again through human intervention, areas of most forests have decreased considerably.

4.1.4

Changes in Vegetation Because of Human Influence

Present-day global distribution of vegetation can only be understood by considering human influences affecting the plant cover for thousands of years. Nowadays, in central Europe, no plant communities exist which are not influenced by humans. It would potentially be possible to have forests everywhere, except for a few sites above the timberline in high mountains, on coasts or in extremely moist areas. The present vegetation is the result of a long interaction between the requirements of humans in different cultural situations and resources which offered natural landscapes (Deil 1997).

4.1.4.1

Forms of Human Influence on Vegetation

Human activity has always had effects on vegetation, as humans are directly or indirectly dependent on plants for nutrition, energy and raw materials. This influence was fairly small initially and was restricted to the search for food. Over time the influence increased with the increase in population and changing technologies (Ellenberg 1996). The mosaic of anthropogenic plant communities became more colourful, corresponding to the **type, duration, intensity and extent of human influence**. Gathering, hunting,

wood cutting, grazing and clearing led to specific **replacement communities** (Müller-Hohenstein 1973). Soon coppiced forests, managed meadows and other, previously unknown, vegetational units arose (Box 4.1.1).

The human influence on forests was initially fairly small, but extended over large areas. With increasing industrialisation and with the formation of urban settlements, industrial areas, and refuse dumps, human influence on small areas became more intense (Sukopp and Wittig 1998). Since industrialisation not only the influence of supplying resources, but also of management of anthropogenic waste products has become increasingly noticeable. Whilst once the working of the soil or watering and draining changed sites locally, it is now also pollutants and the effects of fertilisation that have increased man's effect on vegetation.

For the vegetation of our arable landscapes not only ecophysiological rules of regulation by temperature, light, water, and nutrients apply, but also effects of pollutants, pesticides and fertilisers must be considered.

4.1.4.2

From the Neolithic to Mass Migration

For a long time the **effect of prehistoric man** on the cover of vegetation was underestimated. Too much trust was put in the reports of Roman writers describing Germania as an impenetrable forest area. Today it is possible to prove human activity for the periods in which, during post-glacial times, the edges of the ice sheet retreated and woodland species immigrated. These activities were at first restricted to **hunting and gathering of fruits**. The transition to agriculture occurred in Europe only during the Neolithic about 5000 years ago, a transition that is decisive for the dynamics of vegetation.

Wissmann (1957) regards the area around the Gulf of Bengal and the northern savannah landscapes of India as the oldest centres of **agriculture**. At first rural cultures with agriculture and animal husbandry extended slowly, via Iran, into Mesopotamia, for a long time thought to be the cradle of agriculture, where technical progress was made with irrigation. From this region of the "fertile crescent" agriculture and animal husbandry reached central Europe via the Mediterranean region. The important steps in cultural development away from pure gathering to using

Box 4.1.1

Typical methods of forest and agricultural management

Forestry

Coppice (Niederwald): In the Middle Ages, such forests were used to obtain oak bark for tanning and firewood (see Fig. 4.1.12D). The whole forest was used in 30-year cycles and regenerated from the coppiced trees (coppicing). Thus species that could regenerate were selected for (e.g. hazel, oak, hornbeam). Today, in many developing countries, afforestation (e.g. with *Eucalyptus* species) is used as coppiced forest.

Mittelwald: A form of management in the Middle Ages (Fig. 4.1.12C) in combination with agriculture. Few tree individuals (mainly oak) were grown to supply timber for construction and more tree individuals being used as coppice for firewood in a 30-year cycle. Valuable oak for veneers comes today often from these forests (still widely distributed in France). Earlier in these forests births and marriages were celebrated by planting 5–10 year old trees grown from seed. Thus an open canopy of unequally aged canopy trees was maintained and a sustainable supply of timber for use in construction was ensured.

Hochwald: This consists of trees which had grown from seed (in contrast to regrowth from coppiced trees in low forest; Fig. 4.1.12B). The stand of trees was completely managed. Use was by (1) **clear felling**: All trees on an area were felled at the same time, (2) **partial felling (umbrella felling)**: Some of the trees remained, as protection and for seed production, distributed uniformly over the area. Regeneration then occurred “under an umbrella”. The use of the protective trees then proceeded either after successful regeneration (beech) or after twice the normal cycle of use (pine, oak). Thus some of the trees were twice as old as the average age of the stand. For oak, which becomes most valuable after more than 300 years, the space between the trunks was filled with some tree generations of beech in order to minimise growth of shoots from dormant buds. (3) **Selective thinning and shelter wood selection**: Such thinning resulted in production of stands which were not of uniform age; only some of the trees were removed according to their size

and usefulness and the distribution of the diameters of the trunks left standing remained constant. Regeneration in selectively thinned forests took place where the individual trees were removed. In sheltered woods regeneration occurred on areas where groups of trees had been harvested. Because of the difference in light and size of the regeneration area a species-rich and multi-storey, economically but sustainable exploited forest cover resulted.

ARD: Afforestation, reforestation and deforestation attained particular significance in the Kyoto Protocol (see Chap. 5). **Deforestation** refers to changing forest into other forms of land use (e.g. roads), **reforestation** is establishment of forests on areas which had been forests earlier (e.g. planting of forests on valley meadows), **afforestation** means establishment of forests on land which had not been forested earlier (e.g. forests on moorlands). **Revegetation** is the re-establishment of forests on areas which had been free of vegetation (e.g. slag heaps). **Degradation** is use of wood in excess of growth, that is the number of individual trees clearly falls below the limit set by self-thinning and density of the stand which would have occurred with maximal growth. The current definition of a forest (10–30% cover, 2–4 m high) allows degradation to these limiting values before **conversion** (e.g. from primary to secondary forest or to plantations). **Harvests** are currently classified not as emissions in the calculations, as it is linked to regeneration of stands in normal forest management.

Agriculture

Economically productive grasslands: This term refers to areas of grass, used for production of hay or for grazing. In Germany these grasslands occur mainly on heavier (clay) soils which are difficult to plough in spring, or on areas where the growing period for cereals is too short (mountain meadows). The species richness of such grasslands depends strongly on the intensity with which they are used (number of mowings, fertilisation, etc.; Ellenberg 1996).

Box 4.1.1 Typical methods of forest and agricultural management (continued)

Arable farming: Distinction is made (Swift and Anderson 1993) according to:

- **Type of soil manipulation:** ploughing, disc harrowing. With the latter a breakdown of organic matter in soil is reduced. With low tillage, seed is sown in the furrows made by the disc harrow. This method decreases the compaction of soils and leads to deeper rooting, which may increase yields in semi-arid regions. With zero tillage there is no soil manipulation.
- **Type of crop: root crops** (potatoes, beet) and **cereals**. Earlier agriculture employed intensive soil manipulation (“Hackfrucht” in German=crops that required hoeing, e.g. potatoes) and thinning after sowing as a means of controlling weeds and crop density. Today, hoeing is no longer essential as weeds are controlled chemically with herbicides and the number of plants is regulated by machine. In cereal cultivation distinction is drawn between **winter cereals** which are sown in autumn (e.g. winter wheat) and **spring cereals** (barley, rye, oats and spring wheat) which are sown in spring. Spring cereals have smaller yields but avoid the risk of frost damage in winter. Particular types of crops are those grown for **oil seed** (rape: sown in autumn, sunflower; sown in spring) and **maize**, sown in late spring after frost in May because this C4 plant requires warm temperatures for growth. Cultivation of oil seeds and maize in central Europe has increased in importance considerably in the last decades.

Rain-fed agriculture occurs in dry areas (Fig. 4.1.24B): In the first year fields are ploughed but not sown (fallow land). Precipitation is stored in the soil after rain and the soil surface is often harrowed in order to decrease evaporation from the soil and the capillary rise of water from deep in the soil to the surface. In the second year the field is

sown, so the crop benefits from the 2 years of stored rainfall available.

Shifting cultivation: This type of agriculture is dominant in tropical regions (Fig. 4.1.28 A–C): smaller areas of forest are cleared and burnt in order to make nutrients available for the cultivation, e.g. of rice, manioc, banana, etc., for a number of years.

After a period of time, the nutrient availability is exhausted by the continuous harvesting and the area is abandoned and a new area is cleared for use. Depending on the duration of this cycle, secondary forests can establish on the abandoned areas. With very rapid rotation, degradation occurs because the fallow period is inadequate for the accumulation of nutrients in soils and vegetation. A number of crops (e.g. pepper) require intensive poisoning of the soil in order to control root pests and diseases so that any succession on the fallow areas is prevented. Frequent rotations prevent establishment of forests. Grass species (e.g. *Imperata cylindrica*) invade; these are not eaten by animals because of their large Si content and must be controlled by fire. Consequently, there is a transition from species-rich forest to monotonous grasslands (see also Fig. 4.1.34).

Agroforestry (predominantly in the tropics) describes economic use in which forest regeneration and timber production (for fodder and fire wood, respectively) are linked with field crop production in space and time. There is also another meaning of agroforestry, with mixed cultivation in which the growth of woody plants for firewood and fodder and short-term crops occurs only within the limits of the field or land owned by the farmer.

Multiple cropping (mainly in the moist tropics and oases of the Sahara): in this case (Fig. 4.1.35 B) there is a permanent layer of fruit trees (mango, coconut) above useful shrubs (herbs, banana) which in turn cover herbaceous crops (ginger, taro, manioc).

many techniques to grow crops were taken far away from Europe.

Neolithic agriculture in southern-central Europe started about 7000 years ago, but in the northern region only about 5500 years ago mainly in areas where it was possible because of climatic and edaphic characteristics (dry warm, nutrient-poor sites) as present in sparse mixed oak forests. Areas were cleared without particular tools by fire, particularly in river valleys and on the fertile loess soils bordering the central European mountain regions. These enormous loess deposits also occurred in the Rhine, Moselle and Nahe Valleys and the dry inner Alpine valleys.

Gradmann (1933) was the first to point to the close relation between vegetation, occupation and development of managed landscapes in his “**Steppenheidtheorie**” (**steppe heathland theory**). He assumed that thermophilic, often xerophytic, species of Mediterranean origin indicated the preferred early sites of settlement. Ellenberg (1954) argued against this theory, because the typical “steppe heathland species” were missing in the North. Rather Ellenberg developed the “**Waldweidetheorie**” (**forest grazing theory**) according to which Neolithic man had to win his agricultural land from sparse, easily clearable forest where forest grazing made regeneration difficult and attributes the formation of such xerothermic vegetational units to zoonchoric expansion. Today, it is assumed that plant communities limited to these dry warm sites are relicts from the postglacial period (Pott 1996). Pontic-Pannonic as well as Mediterranean geoelements were able to penetrate to central and north Europe via the open spaces at that time. With the change from Mesolithic to Neolithic non-tree pollen increased, including pollen of light-demanding species, such as cereals, and of segetal and ruderal species such as *Centaurea cyanus*, *Vicia cracca*, *Plantago lanceolata* and *Artemisia vulgaris*.

The type of land use in the Neolithic is described as „**unregulated forest-field management**“; after clearing, agriculture was practised for a few years then the area was left fallow for a long period. Regulated rotation with sowing, grazing and use of wood in certain restricted periods on an area was only developed in the Bronze and Iron Ages (about 1700 b.c.), when sickles and iron ploughs replaced the old wooden hook plough. In Germany the “**Hauberge**” in the Siegerland and the “**Birkenberge**” in the

Bavarian Forest are relicts of land use by such a **rotation**.

Crops grown were wheat, emmer, einkorn and spelt. Regionally, buckwheat was important and later barley and rye. Grazing in the forest with cattle and pigs played always a role and the use of wood for building and burning also influenced forests. The first “**Niederwälder**” (**coppiced forests**) were developed in the Bronze Age. Wood was used for charcoal kilns and smelting of iron ore, as well as oak coppicing, long before the birth of Christ. Hedges developed along the rows of collected stones (Reif 1987). Species-rich edges of forests, nutrient-poor meadows and dwarf shrub heathland were to expand while regeneration of grazed forest areas was endangered. Very early forest degradation occurred and scrub with species possessing defensive thorns developed. Many deciduous trees were lopped to provide animal fodder for the winter.

Thus, natural vegetation was not only considerably changed on arable fields and replaced by crop plants and their accompanying vegetation, but also changed in structure and species composition and in large areas around settlements by grazing, trampling, tree felling and other uses of trees and other vegetation for fodder. Major effects, such as soil erosion, cannot be excluded.

4.1.4.3

Medieval Forest Clearing

The period between the end of the period of mass human **migration** (about 600 A.D.) and the beginning of modern times (since 1500) is characterised in central Europe by several **periods of clearing** and may be called the time of pre-industrial extensive management.

The German terms “**Niederwälder**”, “**Hochwälder**” and “**Mittelwälder**” are used to describe types of forest management. “**Niederwälder**” are forests where the trees are harvested (after approx. 30 years in Germany, Eucalyptus in Morocco every 12 years) and then they regrow from the still existing (and producing) roots. This is only possible for broadleaved trees. This special management was widespread in central Europe and in the Mediterranean. Common species for this type were oak, beech, and hornbeam. “**Hochwälder**” are forests where the trees are planted and harvested as single trees (mainly for timber) after 100 or more years. These trees may be conifers. After harvesting, they must be replanted. “**Mittelwälder**” are a mixture of both types of management, which can still be found in France today. Here, the “**Niederwald**” part is used today for firewood and the “**Hochwald**” for timber.

After forests expanded during the period of mass migration, systematic clearing of forests started in the early Middle Ages (900 A.D.) caused by population pressure. The clearing was by both the secular and religious bodies which owned the land, in southern Germany particularly the Franconian kings and monasteries. The aim was to gain new areas for agriculture, whilst forests were degraded by grazing animals and also by the increased requirement for wood. Wood was the only energy source before the opening of coal deposits, and was used in small smelters and by blacksmithies as well as for salt making and glass production domestically.

In central Europe the first major clearing period was from the sixth to the ninth century. During this time, most forests were cleared, even those not suitable for agriculture and also sometimes the protected forest reserves for hunting. Most forests were used for **forest grazing**. The old settlement areas, with village names ending in *-ingen*, *-heim*, *-hausen*, were founded at that time. In the second clearing period from the eleventh to the thirteenth century the area of the central European mountains was included in the land acquisition. Many village names of this younger settlement period end in *-ried*, *-reuth*, *-rode*, and *-schlag*.

The **relation of forest to open land** at the end of this period was about 70:30, despite Neolithic and Roman settlements, but in the thirteenth century it was reversed and had thus reached a state that applies to many landscapes in central Europe even today. Almost natural forests only existed in locations unfavourable for agriculture. Towards the end of the Middle Ages periods of social breakdown led to a slight increase in forest areas (Ellenberg 1996). The first forest regulations of the sixteenth century introduced protection for and limitation on uses. Regionally, as early as the twelfth century, grazing of goats in forests was forbidden, as they eat woody species.

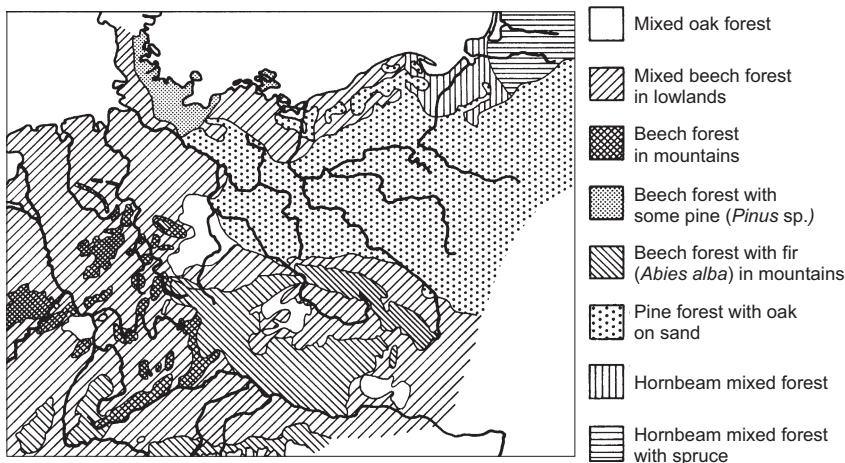
Forest areas had not only decreased drastically, but the remaining forests were structurally and floristically changed. To safeguard the energy requirements and to consciously save areas of forests for grazing, coppiced forests (which had existed in the Iron Age) were managed. Oak and hornbeam were particularly suited to this kind of forest management, as they regenerate easily. Oak, beech and hazel and their fruits were not only important animal fodder, but also part of human nutrition and were cultivated in open forests, so shade-demanding woody species

decreased. Oaks were grown not only for acorns (animal feed), but also for their bark which was used for tanning, and large, emergent trees were retained in “**Mittelwälder**” as the timber, that was required for construction. Such “**Mittelwälder**” and coppices still survive regionally in some parts of central Europe (oak forests in France and Lower Franconia) where they are managed today to produce valuable timber.

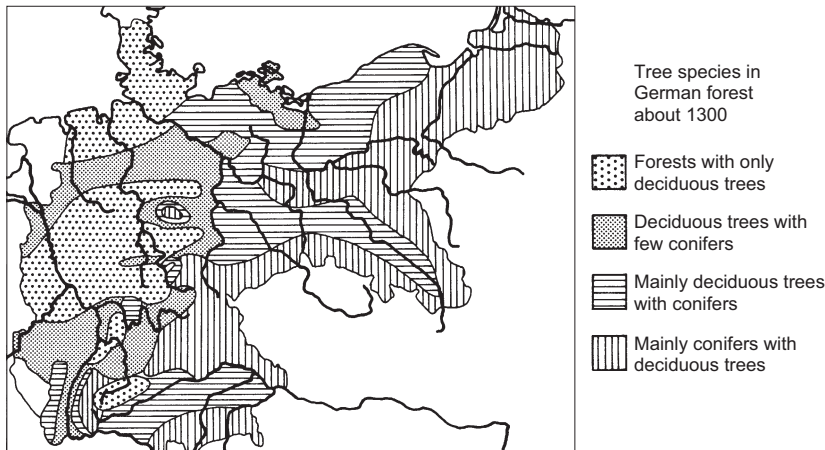
Different forms of management of the remaining forests have not contributed to the loss of species; on the contrary, opened up tall forests allowed several light-demanding herbaceous plants and grasses to establish. Losses of species occurred with the heavy grazing and when the surface litter of forests was used. Over centuries the latter caused loss of cations from forests and increased cation supply to the fields via manure from stables. Thus the use of litter substantially contributed to soil acidification and to loss of nutrients from forests, and to the large differences in fertility between forests and arable land which can still be seen (see Chap. 2.3). Excessive use of forests on sandy soils caused the formation of heathland in northern Europe. Erosion by wind and water endangered many areas. In many chronicles scarcity of wood is described, which led to the **use of peat from bogs**. Regulations to protect forests were not always followed. Early attempts were made to reforest land, e.g. in 1368, these attempts were recorded for the forest “Nürnberger Reichswald”. This was the beginning of the change from deciduous forests to coniferous forests in modern times (Fig. 4.1.11). Large areas of mixed forests were retained until the nineteenth century because of the many possible uses, but were also degraded. With the industrialisation reforestation started with spruce and pine on the degraded areas and this trend has increased to meet requirements for building wood and commercial timber.

In Fig. 4.1.12 A–D characteristic forms of forest management are shown.

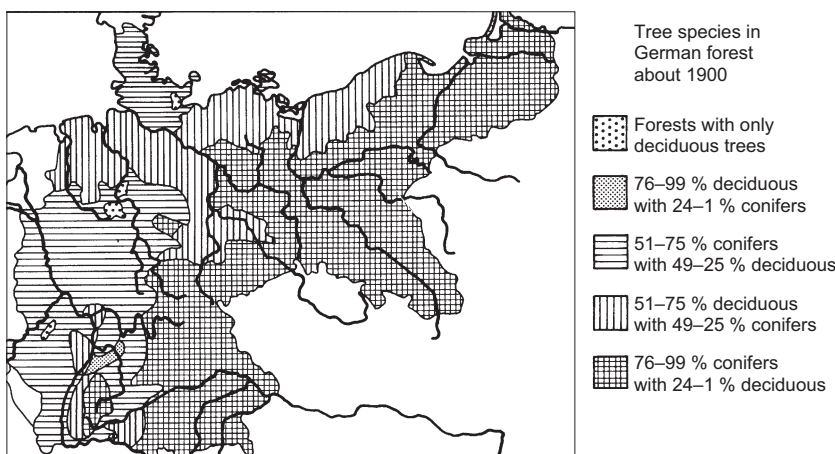
Ellenberg (1996) regards grazing in forests worldwide as the anthropogenic factor which influenced vegetation the most. Individual steps of degradation from a natural forest to wasteland are shown in Fig. 4.1.13. The increasing level of grazing had two consequences. Independent of the original stage, the number and type of grazing animals and the characteristics of the site, many **plant communities dominated by herbs and grasses** developed. Moist meadows, nutrient-deficient meadows, hay meadows and pas-



A



B



C

Fig. 4.1.11. Development of forests in central Europe from **A** after the warm period about 2000 b.p. (after Firbas 1949–1952) through **B** the Middle Ages, until **C** the nineteenth century. (After Hausrath, from Kreeb 1983)

tures with grasses able to regenerate rapidly expanded and excluded woody species. Fewer animals and occasional burning stimulated some herbaceous species whilst others disappeared. Erosion and continuous nutrient depletion led to degradation of meadows. More animals led to an increase of weeds (e.g. thistles, nettles) in the

pastures and those plants sensitive to trampling disappeared. Poisonous species and those protected against being eaten became dominant. Animals contributed to the expansion of shrubs such as *Prunus spinosa*, *Juniperus communis* and *Rubus* species, dwarf shrubs such as *Ononis spinosa* and various broom species, herbaceous spe-



Fig. 4.1.12. Important man-made forest types in central Europe and North Africa. **A** Almost naturally mixed forests (*Quercus faginea*, *Q. rotundifolia*, *Cedrus atlantica*) with trees of all age classes in the central Atlas Mountains (Morocco). **B** Beech forest close to Bayreuth (Bavaria). Trees are either clear felled or the largest trees selectively removed. **C** Oak forest (*Quercus robur*, *Q. pubescens*) in Burgundy. The best stems for timber are only felled after 100 or more years, the rest for firewood every 30 years. **D** A *Eucalyptus* coppice in northern Morocco, cut 2 years before with new shoots forming which will be harvested after 12–15 years. (Photos K. Müller-Hohenstein)

cies such as *Ranunculus acris*, *Taraxacum officinale*, *Salvia pratensis* or *Nardus stricta*, a grass which indicates heavy grazing. Farmers also regulated time and frequency of mowing, and the periods of grazing and the number of animals and thereby the species composition of permanently used grasslands. Meadows for mowing increased as animals were kept in stables and forest litter was substituted by hay. A particular feature of

the vegetation is the large number of nitrophilic species in areas where many animals were kept.

Previously unknown plant communities also developed with agriculture. During the Middle Ages the permanent cultivation of rye without crop rotation led together with the growth of other cereals and buckwheat and with the input of organic material obtained from soils removed from forests and finally the slash and burn man-

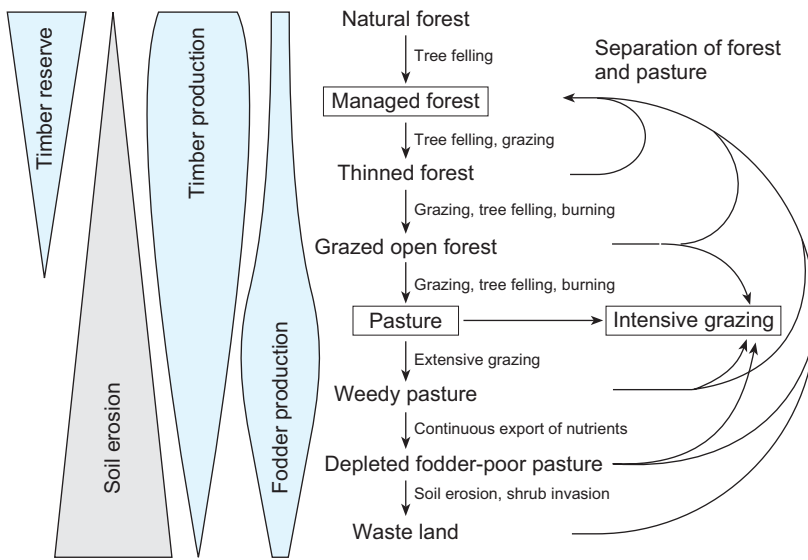


Fig. 4.1.13. Human influences on the vegetation of central Europe, including harvested timber and fodder yields as well as estimates of timber reserves and soil erosion. (Ellenberg 1996)

agement (Hüppe 1989) to the “three-field” crop rotation. The succession was winter cereals (sowing in autumn), summer cereals (sowing in spring) and usually a compulsory grazing fallow period which was supposed to balance the nutrient loss by input of manure as fertiliser. Because of this change in cropping, different weeds devel-

oped in pastures and meadows and arable fields (Burrichter et al. 1993). Weeds on arable fields – e.g. *Adonis aestivalis*, *Falcaria vulgaris*, *Caucalis platycarpus* – originated predominantly from the grass steppes of southeastern Europe and were quickly dispersed by grazing animals (epi- and endozoochoric). Others grew naturally in river

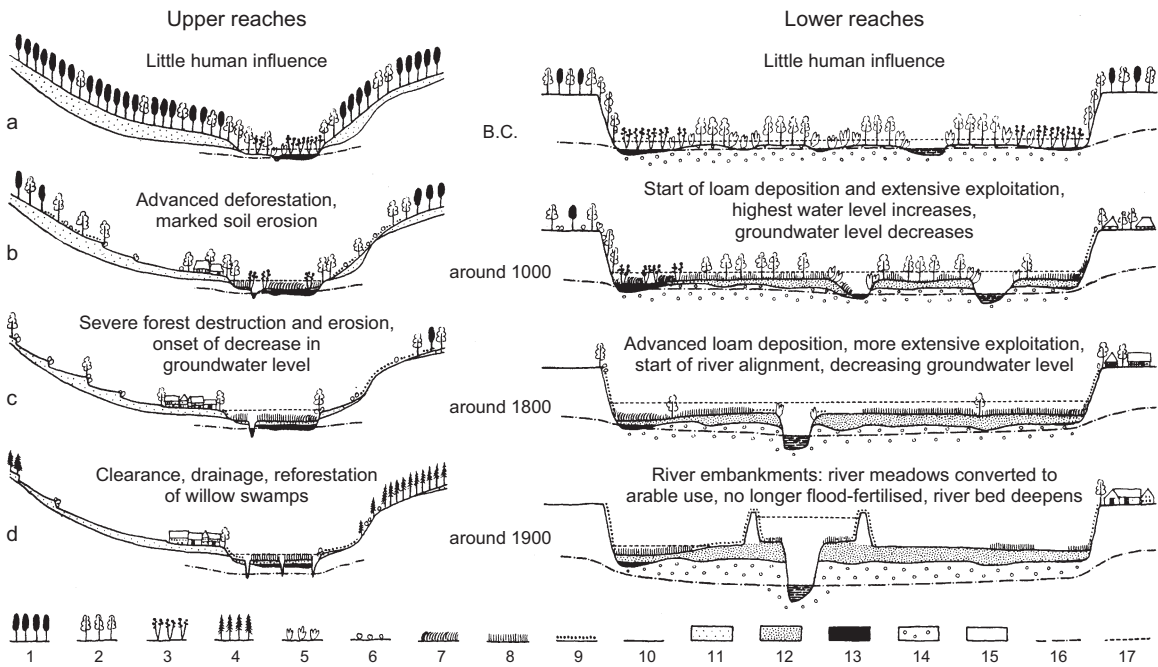


Fig. 4.1.14. Development of a central European river valley landscape in the upper and lower reaches of the river with increasing deforestation, drainage, erosion and deposition of loam in flood meadows (from Ellenberg 1996). 1 Beech forest; 2 oaks and other mixed deciduous forests; 3 alder swamp; 4 conifer reforestation; 5 willow scrub; 6 other scrub; 7 wet grassland; 8 moist grassland; 9 dry grassland; 10 arable fields; 11 loess soils; 12 meadow loam; 13 moorland; 14 gravel; 15 other soil types; 16 mean groundwater level; 17 highest water level

valleys, e.g. *Stellaria media*, *Poa annua*, *Vicia* and *Trifolium* species. The first communities of weeds on arable land still contained many perennial species, because of the fallow period, and the relative rare disruption from ploughing the soil.

Today, it can be assumed that the highest diversity (number of species per region) in central Europe occurred at the end of the Middle Ages because of the activities of man, and this diversity did not only concern plant species but also plant communities and their habitats. Ellenberg (1954) drew characteristic profiles for the valley landscapes in central Europe and thus showed the most important processes and their consequences (Fig. 4.1.14): the valleys were important in their differentiation over small areas and in their significance for the expansion of economic innovation as well as for the dispersal of plants.

The increase in richness of the flora was only possible because of the disturbance of natural sites and the creation of new sites, by the accumulation as well as depletion of nutrient elements, by the microclimatic differences between forest and field, and by watering and drainage (Ellenberg 1996). New, open sites favoured the expansion of short-lived species with broad amplitude in their demands for sites. In the **agricultural landscape of the Middle Ages** an extremely varied mosaic of plant communities de-

veloped very quickly a diversity, which has been lost again, or is very much endangered with the subsequent mechanisation in agriculture. Species which have become naturalised (**archaeophytes and neophytes**), as well as those that have become extinct, were summarised by Scherer-Lorenzen et al. (2002; Fig. 4.1.15). The **peak of floristic diversity** is confirmed for the middle of the nineteenth century, and the consequent decrease is evident.

4.1.4.4

Development of Vegetation in Modern Times

The beginning of the industrial age is linked with new anthropogenic influences on the plant cover. At the onset of industrialisation most remaining forests in central Europe had already been thinned and degraded: at times soil was very eroded, depleted of nutrients and in the upper layers acidified. However, it was not so much the conditions of forests which led to changes, but rather the new energy source available as coal. The very tight linkage between use of wood and charcoal as well as mining and industry no longer existed, and many traditional minor activities of forestry were no longer practised. However, the population grew and with it the extension of towns and industry and so the demand for wood for construction and commercial timber, as well as for cellulose and paper.

The **“new forest management”** started with plantations of **conifers** on degraded forest areas and abandoned fields. Experiments with exotic trees such as Douglas fir were successful and larch was planted beyond its natural boundaries. Coppiced and medium-height forests slowly changed to **tall forests**. Various forms of forest management were tried, e.g. clear cutting, shelterwood-compartment systems and shelterwood-selection systems (see **Box 4.1.1**). The aim was to produce commercial timber as quickly and as frequently, but as sustainably, as possible.

The success of managed forests (e.g. thinning) had many reasons, e.g. forests were no longer used for grazing, pruning, and sod-cutting was no longer practised and less litter was used. New food crops (amongst them potato) were planted and the yield per cropping area increased because of fertiliser applications. The most important change in forests was, however, the change from the once dominant deciduous trees to coniferous trees which triggered its own

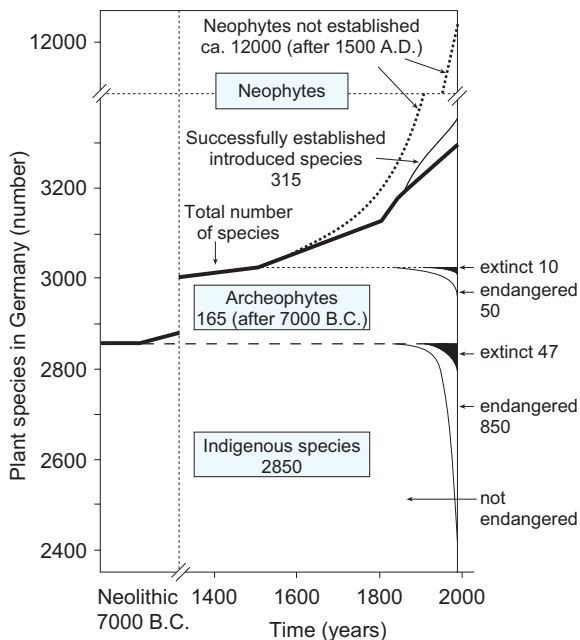


Fig. 4.1.15. Increase and decrease in plant species in central Europe since Neolithic times. (Scherer-Lorenzen et al. 2000)

vegetation dynamics. All coniferous species, particularly pine and spruce, are relatively undemanding and can be sown without problem. Only later they were planted. They grow rapidly, so that very much shorter turnover times may be planned. Conversion particularly affected deciduous trees on good soils and the fast change and the extent of the change from predominantly deciduous forests to coniferous forests are shown for the last centuries by maps from the German forests (Fig. 4.1.11).

Reforestation with only conifers is problematic, for different reasons. Measurements showed soil erosion to be very much higher under spruce forests than under mixed deciduous forests. According to Remmert (1964) reforestation with mixed forests on *Empetrum* heaths of the primarily forest-free island Amrun caused a decline in the wood mouse population and an increase in voles, which disturbed large areas of the island and are thought to have been partly responsible for the failure of dykes during the storm tide of 1962. Such examples show that the change of species may have consequences for the site and the whole biocenose. According to Goudie (1994), twice as many bird species and numbers of birds lived in deciduous forests than in coniferous forests. Research on bird populations in south Chilean deciduous forests and spruce forests gave even more pronounced differences (Finckh 1995).

The **separation of forest and grazing** was very important for the development of vegetation in open spaces. To protect forest and arable land from animals, fences were put around many grazing areas. In early summer with an excess of food, animals picked only the tastiest species. Areas of rank growth – eutrophicated areas because of excrement – developed and gave grazing areas a characteristic pattern. Damage followed from trampling and erosion by too many animals.

Using mineral fertilisers and new varieties of crops, yields increased. Soils of low fertility giving crops of low yield were fertilised and sown with grass (“**Vergrünlandung**”) so the ratio of arable to pasture land shifted. Meadows were mowed, often several times per year, to provide enough fodder for stable animals. Cereal fields were also used for grazing after the harvest (stubble fields) and this influenced the segetal flora. The once characteristic migratory sheep herds disappeared from many regions because wool became uneconomic, due to cheap imports. Many nutrient-poor meadows were invaded by

scrub, and sites for thermophilic and xerophilic species became rarer. This example shows how new trade patterns and inclusion into the global market affected the development of vegetation.

In agriculture, the **improved three-field crop rotation** was increasingly used. The fallow was abandoned and replaced by root crops, particularly potato. Also, since the middle of the nineteenth century, mineral N and P fertiliser had become available and differences in the fertility of fields could be equilibrated. The **diversity of sites was decreased** which also reduced the floristic diversity. Because of fewer fallow fields, and the increasing use of **fertilisers** and **herbicides** and **modern agricultural techniques**, many perennial species of the segetal flora disappeared, e.g. bulbous geophytes like *Tulipa sylvestris*, *Muscari* and *Allium* species. Other perennial species, e.g. *Cirsium arvense* and *Convolvulus arvensis*, with rhizomes which regenerate strongly, expanded. Bogs and wetlands shrank. Bogs and marshes were used for agriculture and grazing, particularly in northern Europe because of the newly developed management of raised bogs (without burning, with sand mixtures). Many marshes, bogs and river forests, e.g. in the southern Upper Rhine Valley, were drained and changed to meadows or pastures.

Currently, intensive land use with fertilisation, ploughing, drainage and the use of herbicides has thus led to drastic losses of diversity in the landscape and plant communities in all regions of Europe. The colourful mosaic of a rural landscape developed for extensive use since the Middle Ages has only been sustained in some remote areas. Even there, it is endangered by increasing eutrophication.

4.1.4.5

Current Trends in the Development of Vegetation

The current influences affecting habitats and the vegetation developed over such a short time span during the last decades have no parallel in the past with respect to intensity and consequences. The goal of intensifying and increasing production in agriculture is continuing. With increasingly fewer small subsistence farms it is no longer necessary to combine arable crops with animal husbandry. The **balance of forest, grazing land and arable land** once required in the rural landscape has been lost. Several special

crops are no longer cultivated (flax, linseed or dyer's woad). Areas with marginal yields (site conditions as well as economically) are no longer cropped, so-called **social fallow lands** developed because of changes in working practices and changing job opportunities.

Farming became increasingly intensive with planting of specialised crops. **Highly technical cropping practices on large areas** were promoted after the **redistribution of farmland**; in Europe, fields were traditionally small and these were enlarged in the redistribution (Schreiber 1995). The important aim of this was to provide the best, most economic conditions for use of machinery, so field size had to be increased. Edges of fields, hedges, terraces and marginal biotopes, all with important interconnecting functions, were drastically reduced and differences in sites were equilibrated by drainage and fertilisation. Small biotopes disappeared and wet and moist meadows, mat-grass (*Nadus stricta*) and nutrient-deficient meadows were changed to **uniform, intensively farmed agricultural land**.

Schreiber (1995) demonstrated how various central European grassland communities, which had developed up to the middle of the nine-

teenth century, were changed by new agricultural practices into intensive grassland (Fig. 4.1.16). Even in the 1940s only 2% of the meadows in the Allgäu (southern Germany) were cut three times or more; today 95% are cut four times or more. At the same time there was a reduction in species from 75 to 20 per ha (Abt 1990), a consequence that can be seen in all forms of intensive agriculture including animal husbandry and grazing.

Plants associated with cultivated pastures, meadows and fields are now cosmopolitan and persistent "resistant weeds" (e.g. *Galium aparine*). Intensively used pastures and meadows were also sown with a smaller range of highly productive varieties, because of the EU-wide unification of the seed trade, so species and genotypes no longer correspond to the original types of meadows. Ellenberg (1996) describes this type of meadow as the "most boring plant community type" for anyone interested in vegetation.

The redistribution of land was only one precondition for the development of modern agriculture. More important was the policy of permanent subsidies, requiring high application of fertilisers, frequently accompanied by run-off

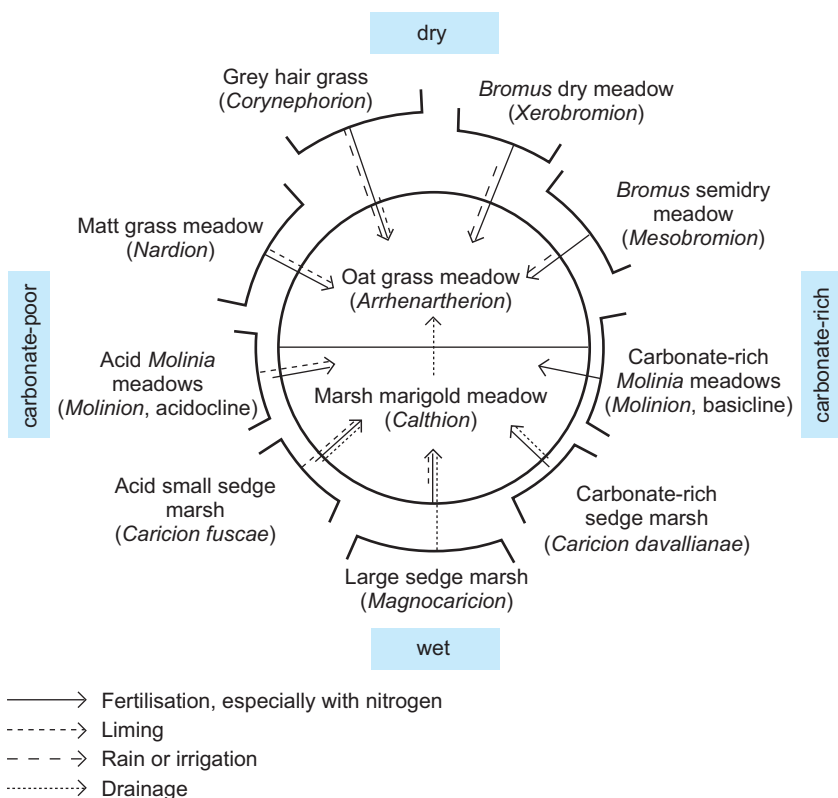


Fig. 4.1.16. Characteristics of habitats of different herbaceous plant communities. (After Schreiber 1995)

and percolation into surrounding waters and their eutrophication. Application of pesticides accelerated planting of crops without the need for rotation. **Liquid manure** created by **intensive rearing of animals** stimulated **planting of maize**, which tolerates large amounts of liquid manure. The formation of a “liquid manure flora” consisting of meadow chervil, chickweed and several types of daisies is often observed.

Tractors and machines in agriculture become increasingly heavier and cause **soil compaction** and **problems in soil water relations**. Soil organisms suffer, particularly the macrofauna with Lumbricides. However, yields are still increasing, because modern plant-breeding programmes continuously provide new **varieties with increased yield potential**. Varieties have to be continuously improved, as they become resistant towards xenobiotica which also require continuous change. An unwanted “co-evolution” takes place. The WBGU (2000) risk assessment points to the dangers posed by crops modified genetically for herbicide and virus resistance, if such transgenic crop plants become wild or cross with indigenous species.

Intensive agricultural practices result in fewer and fewer species in the associated flora, which are often resistant to pesticides and herbicides. Therefore, **measures for the protection** of the segetal flora are required. Various attempts have been made: mixed cropping, intercropping, management of strips at the edge of fields. Within the framework of the subsidised **field margin programme** emphasis is put on increasing local alpha diversity and the promotion of useful non-cropping species. Heitzmann-Hofmann (1993) shows, using examples from Switzerland, that in the medium term succession in the sense of **biotope management** may be possible so that stable communities can be developed.

These attempts are not always successful. Under present-day climatic conditions it should be possible to regenerate raised bogs. However, atypical plants and animals have to be excluded and those species typical of raised bogs must be reintroduced when the area becomes wet again. Success is questionable, as, with the present annual N influx of between 20 and 100 kg/ha in central Europe, the required oligotrophic conditions may no longer be achieved. It is, therefore, very important to maintain all those raised bog areas that are left, even if degraded.

Thus, the present-day agricultural landscape is characterised not only by mechanisation, spe-

cialisation and high production, but also by homogenisation and contamination. In the agricultural landscape there is, on the one hand, a growing uniformity and depletion of differences within one site, but in other places new sites are created with new vegetation units, e.g. developed by canalisation of rivers, building of new infrastructure, mining and slag heaps. River valleys play an important role in the mosaic of our landscapes, because they are refuges for endangered species and transit spaces for invading species, and, because of the high morpho- and hydrodynamic characteristics of regions near rivers, they become growing sites for many specialists (Müller 1995).

The use of land for settlement and industrial sites has grown enormously. Habitats and communities, which are without parallel in the natural landscape, are investigated in **urban ecology**. [Figure 4.1.17](#) gives an overview of the changes to sites, vegetation and fauna in such areas. Urban areas are basically warm islands where warmth- and light-demanding species find a refuge, but they need to be relatively insensitive to mechanical disturbance and pollutants. Such urbanophilic species are, e.g., *Amaranthus albus*, *Chenopodium botrys*, *Poa compressa* and *Silene vulgaris*. These plants characterise the warm, dry sites in towns polluted by heavy metals.

The **urban flora** is fairly diverse and develops many rather constant plant communities, because of the new non-natural sites and because of the ruderal species settling here. According to Wittig and Diesing (1989), urban plant communities may be associated with various types of structures within towns (e.g. dense block buildings, semidetached or town houses, open spaces, areas around stations, etc.). **Lichen flora** in towns is particularly well known; epiphytic lichens are often taken as the standard for assessment of SO₂ pollution and evaluated regarding their **toxi-tolerance**. [Figure 4.1.18](#) shows an example of the zonation of lichens in the region around Frankfurt at a time of high SO₂ pollution. With the reduction of SO₂ emissions, lichen establishment in urban conurbations has increased again.

New characteristic plant communities are also found in villages. Wittkamp et al. (1995) compared the vegetation of northern Bavarian and southern Thuringian villages on both sides of the former border between western and eastern parts of Germany and found that variation of use is linked to variation in vegetation, e.g. the

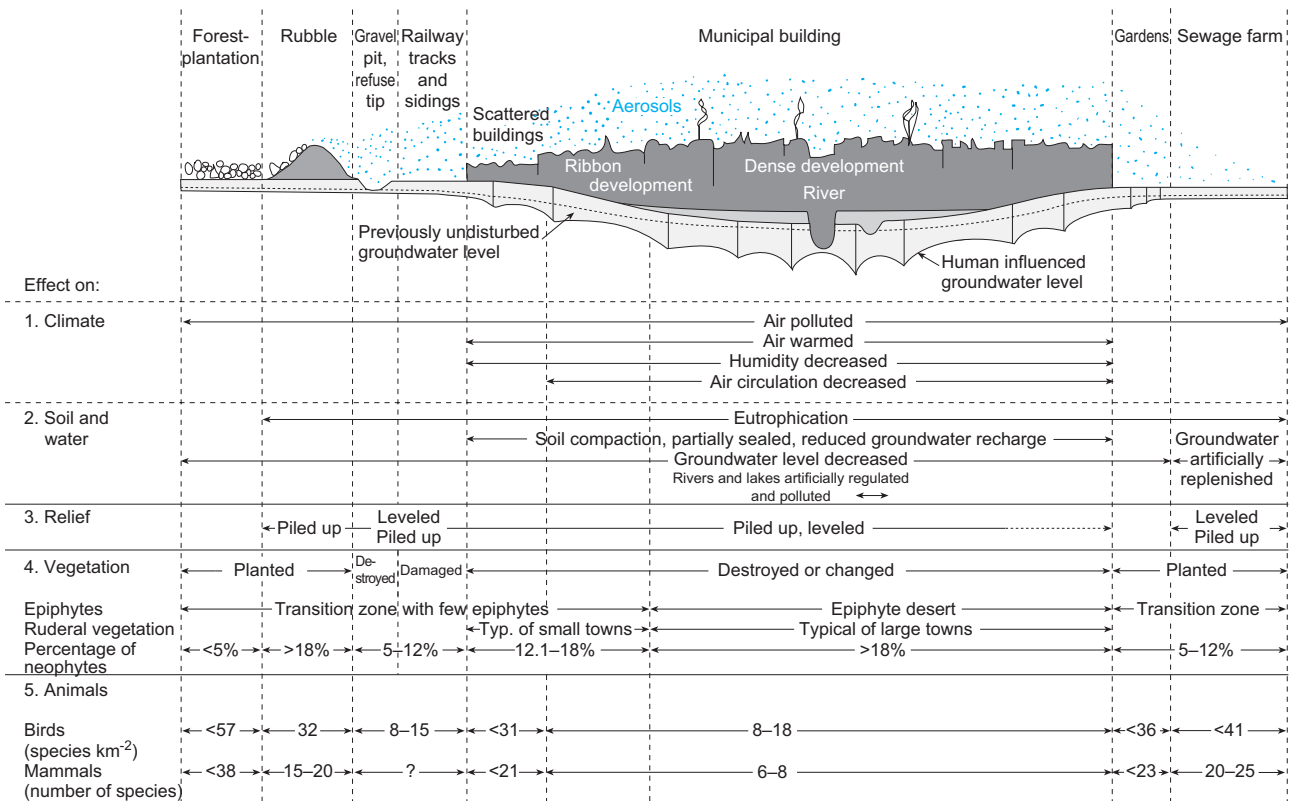


Fig. 4.1.17. Ecological organisation of a large town, stressing interactions between human influences and abiotic and biotic conditions in this ecosystem. (After Sukopp 1990, from Sukopp and Wittig 1998)

species-rich gardens in Thuringia (former East Germany) had almost no parallel to those in northern Franconia (part of Bavaria, former West Germany). The comparison also showed that social structure and economic activity influenced vegetation. Differences in vegetation caused by the site are of secondary importance compared with differences as a consequence of usage. Deil (1995) used the example of landscapes north and south of the Strait of Gibraltar to determine how much agro-political measures, culture-specific characteristics and the economic activity influence the vegetation of large areas, and whether this influence is stronger than the site conditions. With almost identical natural initial conditions, a completely different inventory of communities developed with the intensive, market-orientated land use of Spain compared with the subsistence-orientated land use of Morocco with traditional, almost non-mechanised forms of agriculture.

A particular inventory of species also occurs at the edges of roads. Schmidt (1989) gives an overview of the **ruderal vegetation** of the motor-

way network in North Rhine-Westphalia. Direct (exhaust fumes) and indirect (gritting with salt) effects of traffic influence the differentiation of these sites. Basic composition of vegetation on road verges is relatively unspecialised as specialists in the fauna and flora have hardly any chance of survival. The refuge and interconnected effects of road verges should not be overrated. The negative effects of separating and fragmenting areas of distribution are ecologically more significant.

Recent influence of man on vegetation in central Europe is well documented by the **new type of forest decline** (see Chap. 3.5.1). Damage to trees and complete forest areas by smoke and other pollutants from industry has been reported since the beginning of the industrial age. It was also known that rejuvenation of forests in central Europe had become more difficult for several reasons, amongst them occupation of soils of old forest stands by grasses from grazing by animals, damage by pests, attacks by fungi or other pathogens, climatic abnormalities (breakage because of storms or snow, fire, frost peri-

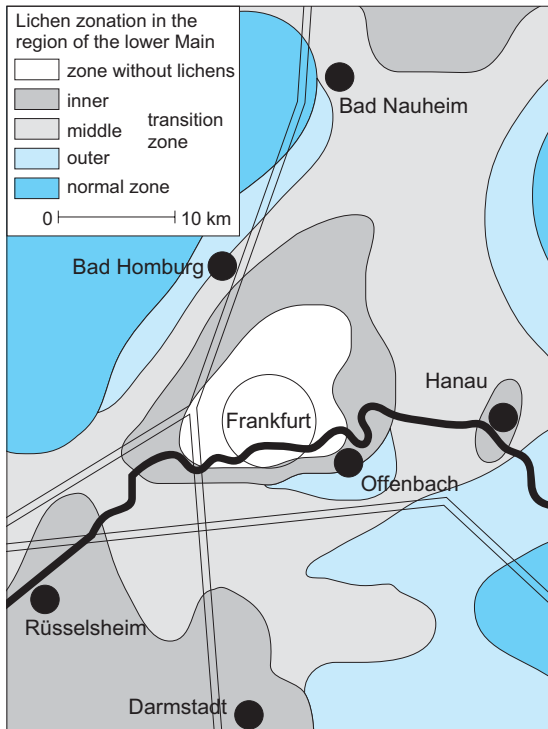


Fig. 4.1.18. Zonation of lichens in and around Frankfurt. (After Steubing 1978, from Sukopp and Wittig 1998)

ods, dry years) and most of all from acidification of the upper soil layer. It is now reasonably certain that the soils of many semi-natural woodlands and managed forests were depleted because of litter removal, erosion and monoculture practices over centuries. Therefore, forests are particularly susceptible to stresses mentioned.

The “new forest decline” affecting complete forest ecosystems has only been observed since about 30 years. Since the 1970s, damage over large areas in fir and spruce forests have become obvious, but these areas were far away from heavy industry. Damage was attributed to the influx of strong acid from the atmosphere via long-distance transport in the form of acid rain. The discussion in Chapter 3.5.1 shows that, ultimately, nutrient deficiencies and imbalances in ion compositions cause the decline of forests. Nevertheless research into forest damage also showed that forests are able, to a large extent, to recover.

Altering nitrogen influx causes changes in the flora which are thus an indicator for increased N (Fig. 4.1.19). With repeated evaluation of forest vegetation, a shift in the mean nitrogen indicator values (mN) in the direction of higher N-

indicators took place. This was independent of the closed canopy of stands, as the indicator values for light (mL) showed. Thus, the change in vegetation is caused by alteration of the conditions of the site related to N deposition independent of management.

Stress by pollutants is associated with a CO₂ increase in the atmosphere as discussed in the context of climate change. Carbon dioxide is a plant nutrient and an increase in it may lead to higher rates and greater total production. Plants are able to compensate for part of the emission of fossil fuels (see Chap. 5). Globally, one could also envisage a shift of biomes (Melillo et al. 1996).

From the analysis of the recent history of vegetation it has become clear that if the present-day vegetation is to be understood “it is not sufficient to know the current management methods in forests and fields. At least with respect to

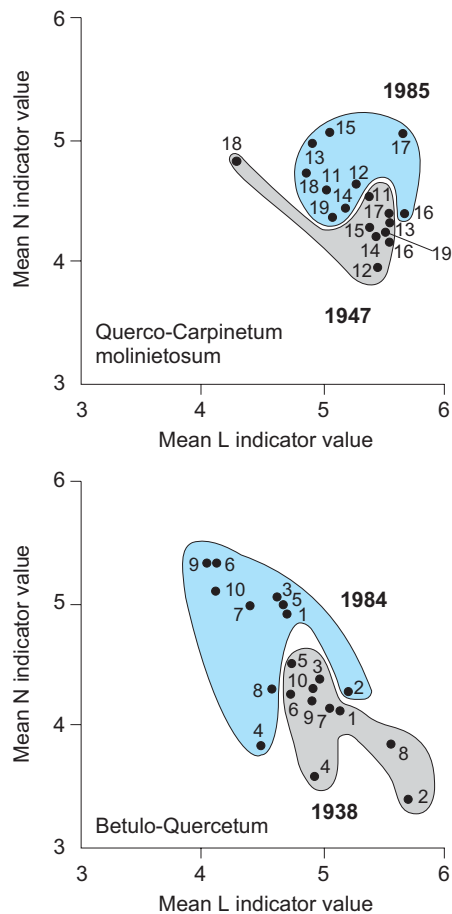


Fig. 4.1.19. Changes of the mean N (nitrogen) and L (light) values in mixed deciduous forests in Switzerland during the course of 38 or 46 years. (After Kuhn 1993, from Ellenberg 1996)

forests and heathlands, but also to many green grassland areas and bogs, it is necessary to always keep in mind earlier management methods and their effects” (Ellenberg 1996).

4.1.4.6

Attempts to Classify and Evaluate Anthropogenic Influences and Their Consequences for Vegetation

Processes and results of human influence on the plant cover, its expansion and retreat, increase and decrease of plant species and vegetation units have also been considered with the view to objectively report, **classify** and **evaluate** the changes.

Jäger (1977) made the initial attempt to classify anthropogenic effects on vegetation, and made three categories:

- **original** (natural) **vegetation** (in the sub-Atlantic period, as perhaps shown on the map by Firbas in Fig. 4.1.11);
- **actual** (recent) **vegetation** under present-day conditions of site and use;
- **potential natural vegetation** (pnV), a term introduced by Tüxen (1956), describing the vegetation which would occur under the present conditions of the site (without further changes).

Natural vegetation no longer exists in central Europe, so pnV is very important in considering the protection of nature and in spatial planning, but the actual vegetation and its sites are at the centre of discussions.

Evaluating anthropogenic influences is essentially a balance between gain (introduction, immigration, naturalisation) and losses (extinction, exclusion) of species. Compared with natural vegetation, **gains** as well as **losses** mean damage to the “natural” state. An approach is to characterise and typify anthropogenic vegetation by defining the “**level of naturalness**”. Several proposals have been made to scale naturalness. **Syn-anthropic successors** are the “winners”. They are subdivided in many ways (Schröder 1969) and consist of apophytes (indigenous species on anthropogenic sites) and anthropochors (non-indigenous species with expansion dependent on man). The term **hemerochors** is also used for those species whose expansion is dependent on man. Plants may be hemerophilic, requiring cul-

tivation, or hemerophobic. Human influence on ecosystems is called hemeroby.

Another subdivision of **anthropochors** was given by Sukopp (1972), based on Schröder, but occasionally using slightly different terminology. Sukopp used three criteria:

1. **Based on the time of immigration** (see Fig. 4.1.15): Archaeophytes (old adventives) immigrating in prehistoric times are divided from neophytes (new adventives) which only came in historical times.
2. **According to the method of immigration**, i.e. the type of human interaction in immigration. These are **ergasiophytes** (intentionally introduced species, e.g. crop plants and their forms that grow wild, ornamental plants and also examples from botanical gardens) as well as **xenophytes** (unintentionally introduced species, e.g. weeds accompanying imported seeds, plants from bird food). Occasionally, an added difference is drawn between these and akulotophytes, plants only able to invade after humans provide suitable sites.
3. **According to the degree of naturalisation**, how well they establish permanently at the new site.

The latter group is subdivided into five additional groups, in some cases based on several causes:

- **idiochorophytes** (indigenous species which existed prior to anthropogenic influences);
- **agriophytes** (new indigenous species, nowadays competitive without human activity);
- **epecophytes** (species dependent on cultivation which disappear as soon as the crop is no longer planted);
- **ephemerophytes** (unpersistent, ephemeral species, which disappear quickly);
- **ergasiophytes** (cultivated species which must be protected from competition).

This division is not always adhered to by different authors (Jäger 1988). Ultimately, only three criteria are important: the time of naturalisation, the type of naturalisation and the length of naturalisation.

The term **neophyte** will be discussed in more detail here. These new indigenous species with a firm place in the present day pnV are also called agriophytes by Sukopp (1972). A plant must be introduced or imported, establish after reaching its new sites and be naturalised and establish permanently without direct help by humans, and finally expand. The hypothetical number of

Table 4.1.3. Characteristics of successful neophytes. (After Sukopp 1987; Jaeger 1988; Di Castri 1990; Roy 1990, from Sukopp and Wittig 1998)

<p>1. Related to reproduction and biology of distribution Early capacity to reproduce (rapid flowering after the vegetative phase=short juvenile period) Single parent reproduction Self-compatibility; probable, although not obligatory self-pollination or apomictic If cross-pollinated then unspecific pollinator or wind Seed production under a wide range of environmental conditions and continuous high reproductive capacity (production of many propagules) Particularly large seed production under favourable conditions Very resistant and long-lived seed [capacity to build up seed (diaspore) bank] Fruit and seed morphology suitable for extensive distribution by wind and animals including man Unspecialised seedling and developmental processes; therefore, wide ecological potential Discontinuous germination by induced dormancy Rapid seedling growth</p>
<p>2. Related to vegetative growth and phenology Rapid growth as a consequence of fast exploitation of resources (large photosynthesis and respiration capacity) Often able to exploit large N supply Very flexible distribution of assimilates If perennial, marked vegetative reproduction, able to regenerate from lower nodes and roots Generally short and simple growth cycle Frequently photoperiodic: day length neutral Dormancy</p>
<p>3. Genetic characteristics Large genetic variability Polyploidy; hybrids Very flexible genetic system; thus alterations of recombination rates possible Frequently phylogenetically young group</p>
<p>4. Population dynamics and ecological characteristics Generalists: broad climatic and edaphic range Large acclimation potential; often phenotypically plastic=increases ecological potential Rapid population increase due to high growth rates and early, as well as large, reproductive capacity r Strategy Very competitive through particular features such as rosette form, parasitic growth, allelopathy or fast and vigorous growth</p>

Table 4.1.4. Classification of vegetation dependent on the degree of human influence. (After Dierschke 1984)

Bernátsky (1905)	Tüxen (1958)	Falinski (1969)	Ellenberg (1963)	Seibert (1980)	Dierschke (1984)	Sukopp (1969, 1972)		
Not influenced Original structure	Mature community	Autogenic	Original	Determined by nature	Undisturbed Natural	Natural	Natural to almost natural	Ahemerob
Influenced			Natural		Almost natural Relatively natural		Almost natural	Oligohemerob
Modified structure Plantations	1. stage 2. stage 3. stage 4. stage	Anthropogenic	Half-natural Pro-synanthropic Eu-synanthropic	Determined by cultivation	Relatively unnatural Distant from nature Unnatural Artificial	Artificial	Half-natural unnatural Artificial	Mesohemerob Beta-Euhemerob Alpha- Polyhemerob

species that are successful in this sequence decreases with each new step. Plants must possess the characteristics listed in Table 4.1.3 in order to be successful.

The classification of vegetation according to the “degree of naturalness” has also differed. The most important differences are compared by Dierschke (1984; Table 4.1.4). It is now assumed that the proportion of agriophytes in vegetational units correlates with the degree of human influence. Therefore, it is possible to determine, quantitatively, the degree of human influence (**degree of hemeroby**) in a unit of vegetation by the proportion of agriophytes and neophytes and the loss of indigenous species (Table 4.1.5).

Bornkamm (1980) uses the classification by Sukopp (1972) for planning of land use. The proportion of neophytes increases with the loss of indigenous species (Fig. 4.1.20). He also reconstructed the distribution of land with the same degree of hemeroby for two Bavarian villages during the course of historical development and was able to demonstrate the increasing human influence (Fig. 4.1.21).

Recently, the consequences of gain and loss of species on the indigenous vegetation have been discussed. The loss of barriers to distribution leads to **mixing of the flora** and fauna from various bioareas. Elton (1958) regards this as a decisive, recent change in the biosphere. Two marked historical epochs must be distinguished: the time after the discovery of America up to the sixteenth century with increasing possibilities for travel between continents, and the time from the nineteenth century when new anthro-

Table 4.1.5. Proportion of neophytes and loss of native species related to the degree of human interference (hemeroby). (After Sukopp 1972)

	Proportion of neophytes	Loss of native vascular plant species (per 1000 km ²)
Ahemerob	0%	0%
Oligohemerob	< 5%	< 1%
Mesohemerob	5–12%	1–5%
Euhemerob	13–20%	> 6%
Polyhemerob	21–(80)%	?
Metahemerob	> 80%	?

pogenic sites opened up for the establishment of plants.

Lohmeier and Sukopp (1992) analysed the consequences of introduced foreign plants on the actual vegetation and present ecosystems in Europe, and Jäger (1988) gave percentage and absolute figures of synanthropic species worldwide (Fig. 4.1.22). In industrial countries about 100 species per 100,000 km² are naturalised, but there are exceptions such as the 800 species in Japan, where three floral regions meet. Lövei (1997) has shown (Table 4.1.6) that the proportion of **synanthropic species** has increased since the research by Jäger. Sukopp (1972) assumed fewer than 1% of introduced plants, but, according to Lövei (1997), this has increased to 6%. Sukopp (1972) considered that 54% of naturalised species in Germany originate from Europe itself and west Asia, 30% from areas with moderate climates in North America, 9% from central and east Asia. From these values of distribu-

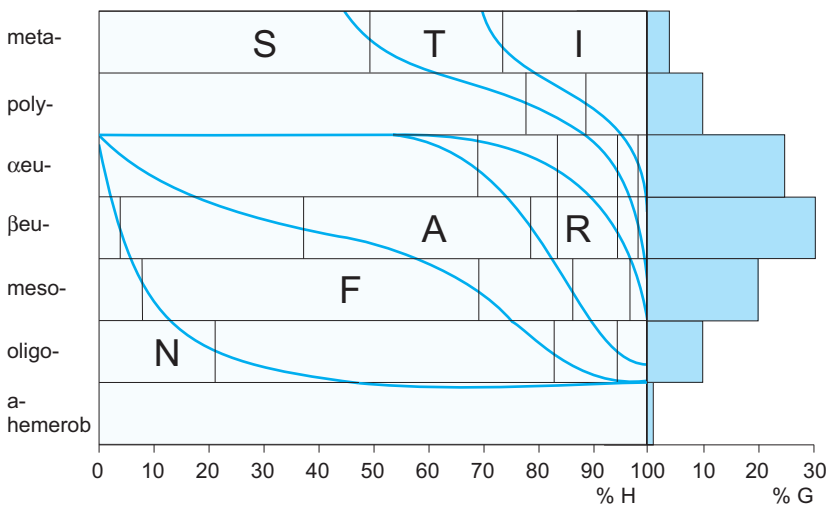


Fig. 4.1.20. Schematic relationship between type of land use and classification of human influence, also called hemeroby (after Bornkamm 1980). % H Proportion of total land surface under particular types of human influence (hemeroby); % G proportion of a particular hemeroby class in the total landscape area. Surface use: I industry; V transport; S settlement; E recreation; L agriculture and gardens; F forestry; N nature reserves (see also Table 4.1.5)

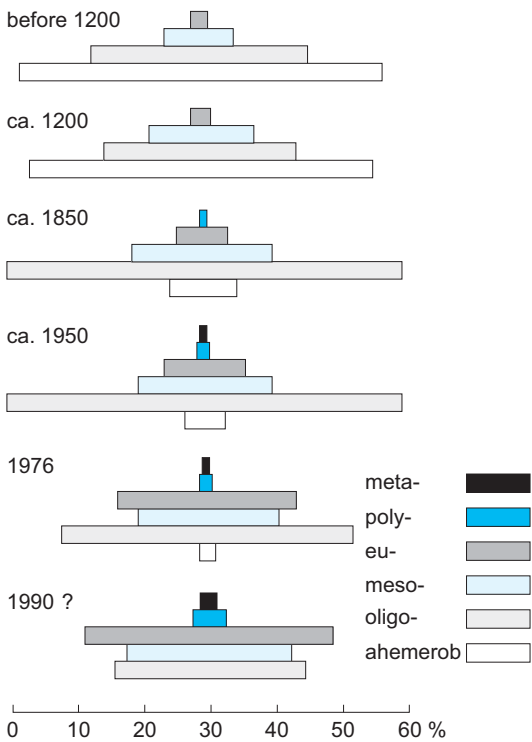


Fig. 4.1.21. Distribution of areas with the same type of human influence (hemeroby value) during the historical development of two villages, Kochel am See and Schlehdorf, in Bavaria, Germany (see also Table 4.1.5)

Table 4.1.6. The contribution of non-indigenous species to the flora of different regions. After Lövei (1997)

Region	Number of species		Percent of non-indigenous species
	Indigenous	Non-indigenous	
Russian Arctic	1403	104	6.9
Europe	11820	721	5.7
USA	17300	2100	10.8
South Africa	20573	824	3.9
Australia	15638	1952	11.1
Ontario	2056	805	28.1
New York State	1940	1083	35.8
Perth region (Australia)	1510	547	26.6
British Isles	1255	945	43.0
Hawaii	1143	891	43.8
New Zealand	2449	1623	39.9

tion, it may be considered that these species behaved in their naturalisation in central Europe according to the “law of relative constant sites” (Walter 1960): “If the climate changes in a certain direction within the area of a species, this species will change its biotope in order to compensate the climatic change”. There is also a

trend to include areas nearer the poles and/or oceans. As a cultivated landscape possesses a varied site mosaic, the probability of species meeting and hybridising is larger. Particularly crossing with sympatric families is eased. Thus several families developed quickly and became species-rich, e.g. the *Oenothera* species, after their introduction into central Europe.

Agriophytes are plants introduced for economic reasons which established in natural habitats (*Robinia pseudoacacia*, *Junglans regia*, *Prunus serotina*, *Castanea sativa*, *Helianthus tuberosus*, *Isatis tinctoria*), ornamental plants (*Centranthus ruber*, *Cymbalaria muralis*, *Heraclium mantegazzianum*, *Impatiens glandulifera*, *Tulipa sylvestris*, *Reynoutria japonica*, *Laburnum anagyroides*), species originating from botanical gardens (*Impatiens parviflora*, *Galinsoga parviflora*, *Elodea canadensis*), and also species which were consciously planted in natural areas (*Lupinus* div. spec.). Merkel and Walter (1982) listed more than 70 such species for Upper Franconia alone.

Agriophytes were not able to establish everywhere. They are particularly numerous on sites disturbed by man, in towns and industrial areas. Only few species established in woodland regions. Examples in forests are the wild cherry (*Prunus serotina*) which was originally introduced to accelerate the accumulation of humus, but impedes natural rejuvenation. The aggressive robinea (*Robinia pseudoacacia*) which fixes nitrogen and as a consequence of the nitrogen accumulation leads to an increase of nitrophilic species. The tree of heaven (*Ailanthus altissima*) which invades in warmth-demanding forest communities; and the small balsam (*Impatiens parviflora*) which is becoming more frequent in the undergrowth of beech forests are additional examples.

Along the coasts the cord-grass (*Spartina anglica*), planted at one time to gain land, has widely replaced glasswort (*Salicornia europaea*) and Sea Poa (*Puccinellia maritima*), and has thus become an unwanted invader. This applies also to the Canadian pond weed (*Elodea canadensis*), but in many waters it has been decreased again due to increasing eutrophication of waterways.

Areas around river banks provide particularly favourable conditions for immigration and expansion of agriophytes (see Chap. 4.1.4.3), as new open spaces always develop, due to the natural dynamics of water flow, and because there

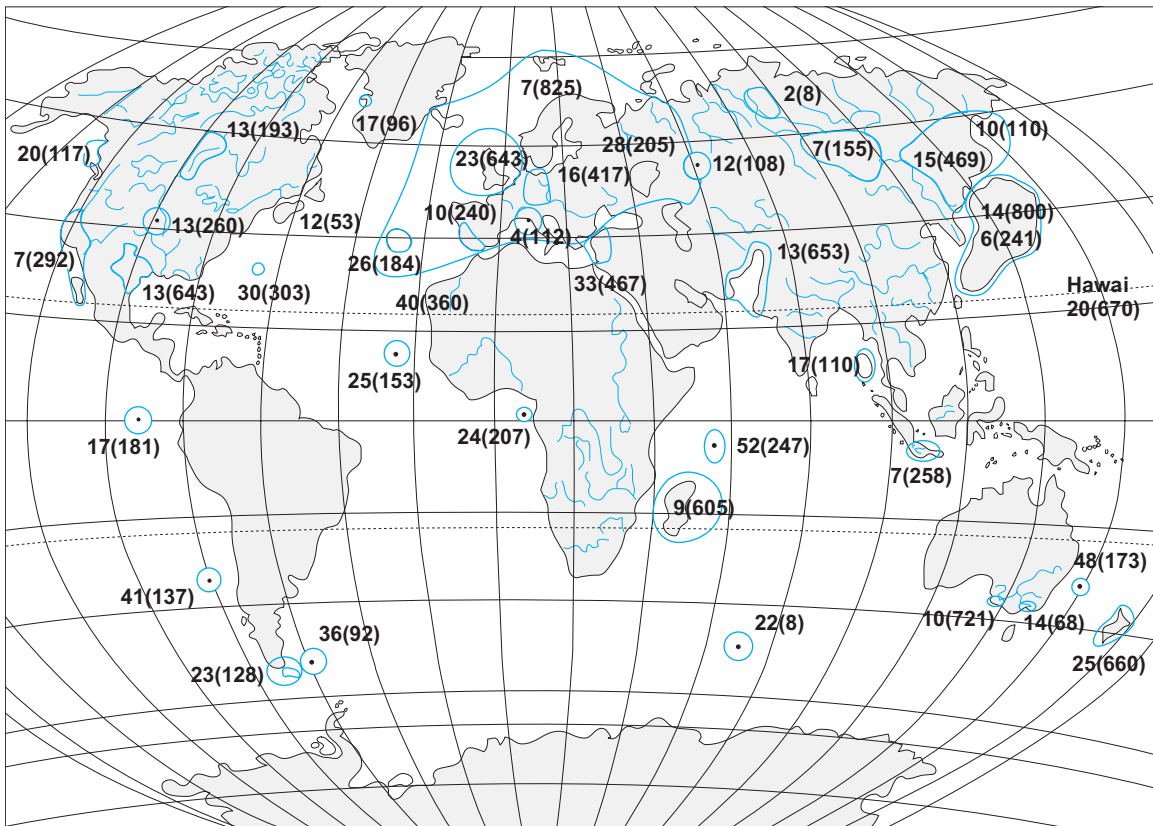


Fig. 4.1.22. The proportion, in percent, and absolute numbers (in parentheses) of vascular plant species which are always associated with human activity (synanthropic agri- and epecopytes). (After Jäger 1988)

are few competitors for immigrants. Schwabe and Kratochwil (1991) described nicheing of some species and the associated consequences. They distinguish between five “functional types”:

1. Species with relatively low cover and good adaptation with respect to existing vegetation as well as enrichment of the nectar supply for insects, e.g. *Mimulus guttatus*, *Aster lanceolatus* and *A. tradescantii*.
2. Species with a tendency for further expansion and suppression of other species, e.g. the golden-rod (*Solidago canadensis* and *S. gigantea*), which flower late and thus provide good food for many diptera and butterflies.
3. Species covering large areas of the site and exclude competitors by shading: *Impatiens glandulifera* belongs to this type.
4. The giant hogweed (*Heracleum mantegazzianum*) is put into its own, fourth group as it may act as biologically enriching, but brings danger for human health (eczema follow skin contact).

5. Species which dominate quickly and vigorously exclude indigenous species. Amongst those are the rhizome-forming knot grass species (*Reynoutria japonica*=*Polygonum cuspidatum* and *R. sacchalinense*=*P. sacchalinense*).

The “gain” of agriophytes may be linked to considerable disadvantages for indigenous species, perhaps even extinction. Plant communities change their floristic compositions and structure, uniform stands or stands with only a few species arise, instead of the diversity and multitude of structures of the original plant communities. Managed forests, intensive greenland, persistent ruderal fields and nitrophilic riverbank communities are part of this. The replacement of near-natural communities by those distinct from the original vegetation is linked with a change in site conditions, such as nutrients, moisture and humus in the soil and/or microclimatic conditions.

Most agriophytes are not grazed, or are accepted only by a few polyphagous indigenous

insects as a source of food. In Great Britain fewer than 10 species of insects were counted on introduced trees, e.g. robinia, whilst on indigenous oak trees more than 300 species occurred (Lohmeier and Sukopp 1992). On the other hand, robinia may be regarded as important for foraging bees. More mono- and oligophageous insect species were found on indigenous *Impatiens* species than on introduced species. By excluding indigenous flowering plants, species relying on specific food sources, so-called stenophageous animals, are lost.

Are neophytes a danger to nature? The number of alien species in central Europe exceeds the extinct species, according to Böcker et al. (1995; see Fig. 4.1.15). At present, about 5–25% of the flora in central Europe may be anthropochor, in towns about 50% is reached. There is evidence for the decrease in indigenous species because of the advance of neophytes. Two species with a particularly high invasion potential, *Solidago canadensis* in Berlin and *Tribulus terrestris* in the east African savannahs, were analysed in 1991 by Cornelius using a key-lock model to explain their invasion of niches. Particularly if – as in these cases – demands on resources, tolerance to climate stress and strategies of adaptation to competition and regeneration (key traits) agree with the climatic conditions and the adaptation to disturbance and succession (lock), then settling in is easy and this endangers the existing mosaic of species and communities.

At present, neophytes are not regarded as a danger in Europe, apart from a few special cases. They are hardly responsible for the present loss of species. However, these losses have only been documented since the beginning of the twentieth century. According to Jäger (1988), in Europe, in areas of up to 1000 km², a loss of between 6 and 27% (maximum) of the original species was estimated. Within the urban area of Frankfurt/Main with a size of 195 km² about 17% of the original species disappeared. For areas of 30,000 km² a loss of about 5% is assumed. In the USA with 7.8 million km² a loss of 0.5% is estimated. Comparing data before and after 1950 in the flora of the Netherlands, species such as *Salvinia natans*, *Verbena officinalis*, *Eriophorum latifolium*, *Hammarbya paludosa*, *Narthecium ossifragum* and *Pinguicula vulgaris* have disappeared in more than 80% of locations where they were previously established. Particularly species with limited competitive ability are affected.

4.1.4.7

Anthropogenic Influences on Vegetation Outside Central Europe

Human influences have changed the natural vegetation in all climatic regions and biomes. There are specific developments connected to the natural basis of plant growth as well as specific human influences. Examples have been chosen from three biomes showing the spectrum of possible consequences: the **Mediterranean region**, the **dry regions of Africa** (keyword “desertification”) and the **humid tropics of Africa** (keyword “destruction of tropical forest”).

Mediterranean Region

Plants in the Mediterranean region are particularly stressed because of the **dry periods in summer**, which may be of different length, but are always significant. The **influence of fire** must also be considered, an influence which has increased by human intervention. Tree species of Mediterranean forests in the lower and upper mountain zones, listed in the scheme of altitudinal zones in Fig. 4.1.23, are thus almost all drought resistant and stimulated rather than damaged by fire.

Land use affecting large areas started in the western Mediterranean region (bays of Alicante and Catalonia) in the early Neolithic about 7000 years ago (Badal et al. 1994; Riera-Mora and Esteban-Amat 1994). The evergreen oak forests (*Quercus rotundifolia*) near the coast was intermixed with deciduous oaks (*Quercus faginea*, *Q. pubescens*) was thinned and shrubs which demanded more light (heliophilic shrubs) occupied the area. Typical Mediterranean shrub communities, the **macchie**, developed. Inland areas remained untouched for a long time, disregarding the first transhumance, e.g. shepherds moving in the hot, dry summers from the plain into the mountains near the coast, and establishing a “vertical” migratory pattern of grazing management. The farms on the coastal plain, with favourable soils and availability of water, e.g. the Spanish “huertas”, were the first areas with intensive agricultural crops. Evidence of crop plants introduced from the Mediterranean into North Africa demonstrates the development of an increasingly richer flora in the agriculturally managed landscapes (Le Floch et al. 1990). In the Palaeolithic period barley (*Hordeum vulgare*) was evident, in the Neolithic period wheat (*Triticum* spp.) emerged as well as fruit trees (*Phoe-*

semihumid-humid zonation sequence		Altitudinal zone	semiarid-arid zonation sequence	
Reforestation with	Natural vegetation		Natural vegetation	Reforestation with
	Mountain grassland and dwarf shrub communities	subalpine/alpine (oro-mediterranean)	Mountain steppes, dwarf shrub communities and thorny cushion plants	
<i>Pinus silvestris</i>	Mountain forests with <i>Fagus sylvatica</i> <i>Abies alba</i> <i>Pinus silvestris</i> <i>Pinus uncinata</i>	montane (montane-mediterranean)	Mountain forests with <i>Cedrus atlantica</i> <i>Cedrus libani</i> <i>Abies pinsapo</i> <i>Abies cilicica</i> , <i>Pinus nigra</i>	<i>Pinus nigra</i> <i>Populus</i> div. spp.
<i>Pinus radiata</i> <i>Pinus pinaster</i> <i>Eucalyptus</i> div. spp. <i>Populus</i> div. spp.	Deciduous forests with <i>Quercus cerris</i> <i>Quercus pubescens</i> <i>Quercus faginea</i> <i>Carpinus orientalis</i>	submontane (sub-mediterranean, supra-mediterranean)	Evergreen and deciduous forests with <i>Quercus boissieri</i> <i>Quercus pubescens</i> <i>Quercus coccifera</i> <i>Quercus ilex</i> , <i>Pinus brutia</i>	<i>Pinus pinaster</i> <i>Eucalyptus</i> div. spp.
<i>Pinus radiata</i> <i>Pinus halepensis</i> <i>Eucalyptus</i> div. spp.	Evergreen forests with <i>Quercus ilex</i> <i>Quercus suber</i> <i>Pinus pinea</i> <i>Pinus pinaster</i>	basal/foothills (eu-mediterranean)	Evergreen forests with <i>Tetraclinis articulata</i> <i>Juniperus phoenicea</i> <i>Pinus halepensis</i>	<i>Pinus halepensis</i> <i>Eucalyptus</i> div. spp. <i>Tamarix</i> div. spp.

Fig. 4.1.23. The altitudinal zones of dominant tree species of natural vegetation and the most important exotic tree species used in reforestation in the Mediterranean region. (After Müller-Hohenstein 1991)

nix dactylifera, *Ziziphus* spp., *Lawsonia inermis*), and Fabaceae (*Lens culinaris*, *Pisum sativum*, *Vicia faba*).

The Phoenecians brought olives, vine, pomegranates and figs and the Romans introduced garlic, onions, apples and pears. During the Arab period the number of species from central and east Asia increased, e.g. citrus, mulberry and carob trees, hemp and sugar cane. Species from the New World followed after the discovery of America. During that time those plants now regarded as characteristic of the region reached the Mediterranean basin: agave, opuntia as well as maize, tobacco and tomato. In the nineteenth century many ornamental plants were added. Economic reasons resulted in the successful introduction of acacia and eucalyptus. About 200 exotic species are today naturalised in North Africa, corresponding to 4% of the total flora (Le Floch et al. 1990). Many species were introduced unintentionally, along with the crop plants, and became established. The number of those species originating from the New World is considerable, amongst them so-called aggressive invaders which established particularly on ruderal sites (species of the genera *Amaranthus*, *Cuscuta* and *Coryza*, as well as *Heliotropium curassavicum*, *Solanum eleagnifolium*, *Xanthium spinosum*). The three last mentioned, as well as

some shrubs (*Ricinus communis* and *Nicotiana glauca*), are expanding rapidly in North Africa at the moment.

In the **segetal flora**, on the other hand, indigenous species found new niches. The ca. 50 species on fields and fallow land include *Ammi majus*, and *A. visnaga*, *Anagallis arvensis* and *A. foemina*, *Echium italicum*, *Ridolfia segetum*, *Sinapis arvensis*, *Calendula arvensis*, *Cirsium arvense*, as well as *Carduncellus*, *Convolvulus*, *Cyperus* and *Diploaxis* species. The number of sometimes thorny weeds on pastures is just as high (*Astragalus armatus*, *Atractylis serratuloides*, *Calycotome villosa*, *Scolymus hispanicus* and *S. grandiflorum*), and also partly poisonous or at least non-edible species (*Asphodelus fistulosus*, *A. macrocarpus*, *A. tenuifolius*, *Haloxylon scoparium*, *Hertia cheirifolia*, *Peganum harmala*, *Solanum nigrum*, *Stipagrostis pungens* and *S. capensis*). Among the nutrient indicators (nitrophils) are, e.g., *Aizoon* and *Mesembryanthemum* species, *Calendula arvensis*, *Chenopodium murale*, *Hyoscyamus albus* and *H. niger*, *Malva parviflora* and *Withania somnifera* (Le Floch et al. 1990).

For the Mediterranean regions the same applies as for central Europe: Naturalisation, expansion and disappearance of individual species is closely connected to agricultural practices.

Deil (1997) showed for the areas bordering the Strait of Gibraltar, how, to a high degree of certainty, vegetational landscapes may be read as history books, and how historic and actual forms of use show religious regulation, as well as subsistence-orientated management of the indigenous population, or the market-oriented management of colonial times. Thus, even today, it is possible to demonstrate, from the spectrum of different species, an Islamic cemetery from the time before the reconquista, just as it is possible to show the different use of herbicides and mechanical control of weeds in the fields of southern Spain or northern Morocco.

The recent **history of forests in the Mediterranean regions** is determined by man and will be discussed in more detail, particularly as it is possible to explain essential problems of site conditions. During the Greek colonisation of Dalmatia from the eighth century B.C., forests were cleared. The Italian peninsula was predominantly deforested during Roman times, the Iberian peninsula mostly from the 6th century B.C. onwards. Consequences for vegetation and site have often been shown (Müller-Hohenstein 1973; Finckh and Deil 1989). Forest degradation often starts with structural changes (age structure, density of stand and closure of canopy); the grazing in forests leads to invasion of ruderal

species, decline of rejuvenation and therefore to thinner stands.

At first forests on more favourable sites were **cleared**. Arable fields extended with not very productive dry land agriculture. Clearing occurred also, often supported by fires, to gain grazing areas. Le Houerou (1992) showed how and for what reasons Mediterranean dwarf shrub communities (**macchie** with various regionally different terms such as **garrigue**, **tomillares**, **phrygana**, **matorral**) and pastures differing in their floristic compositions are anthropogenically determined (see [Box 4.1.2](#)).

Clearing was not only an intervention with irreversible consequences for vegetation, but particularly because of soil erosion down to the bed rock and resulted in sedimentation in valleys. At present, floods signal the considerable changes in water relations. The view that degradation has had negative economic consequences, and also the acute lack of wood for the last 50 years, has led to increased reforestation, at first in southern European regions and later in north African countries. Any trend to establish nearly natural economic forests is, however, hardly recognisable. **Exotic, fast-growing types of trees** are chosen for reforestation, in part pine species, but predominantly eucalyptus species. [Figure 4.1.23](#) shows the most important forest spe-

Box 4.1.2

Fire and grazing influenced types of forest degradation in the Mediterranean region (after Le Houerou 1992)

Many studies have been made of the sequence of woodland degradation by regular burning and/or grazing in the Mediterranean region. Braun-Blanquet (1928) developed the first scheme. Le Houerou has distinguished between two series, one in the semihumid southern European Mediterranean, called the “*Quercus ilex* series”, and another for the semi-arid north African Mediterranean region called the “*Pinus halepensis* series”.

Quercus rotundifolia (= *Qu. ilex*) oak forest when burnt is transformed into cork oak (*Quercus suber*) dominated forest, but only on silicate soils. With further burning numerous, mainly evergreen shrubs form the vegetation (e.g. *Erica arborea*, *Calycotome villosa*, *Myrtus communis*) followed by rock roses (*Cistus*

crispus, *C. ladaniferus*, *C. monspeliensis*). The final stage of this fire-determined development is a scrub vegetation with dwarf shrubs and geophytes (e.g. *Helianthemum guttatum*, *H. tuberaria*, *Urginea maritima*).

The sequence in dryer and more heavily grazed regions of the north African Mediterranean starts with Aleppo pine forest (with *Pinus halepensis*, *Juniperus phoenicea*) which is degraded by fire and grazing initially into a “garrigue” with rock roses and dwarf shrubs (*Rosmarinus officinalis*, *Lavandula stoechas*, *Cistus libanotis*). Finally, grasses of the dry steppes (*Stipa tenacissima*, *Lygeum spartum*) become dominant. The final stage of the degradation is pasture with weeds (e.g. *Pegamum harmala*, *Noaea mucronata*).

cies for individual altitudinal zones used presently for reforestation.

Where the reforestation was successful, “forest” areas were increased, but also caused uniformity. The hoped-for economic yields have not always materialised, and no positive effects on water relations and formation of soil have so far been found. The negative side effects on the fauna and organic substances in the soil, attacks by

pests and fires, etc., known from monocultures, are deplorable. With the rich Mediterranean variety of different woody species, the preferential use of exotic species would not have been required. One could have limited those for protective reforestation, e.g. on areas where a rapid protection from further erosion was required. In the long term economic success could have been sought in indigenous species (production reforestation).



Fig. 4.1.24. Typical types of agricultural land use in countries around the Mediterranean. **A** Subsistence farming on a small area with mixed crops and many cultivated plant species (Central Atlas, Morocco). **B** Grain crops and fodder plants for the national market on large-scale farms with high input of agrochemicals and machinery (Tuscan Hills, Italy). **C** Mixed agroforestry with grain crops for the growers' consumption, and cork (*Quercus suber*) for the national market (Extremadura, Spain). **D** Unregulated, excessive grazing with severely degraded forests and soil erosion (Central Atlas, Morocco). (Photos K. Müller-Hohenstein)

In south European countries, the pressure on using wood from forests is also declining and recovery in the sclerophyllic and deciduous species can be observed. In north African countries, however, the pressure on the last near-natural remnants of forests is growing. It is feared that shortly the last cedar will be cut, and only sparse woods with particularly drought-resistant species, such as *Pinus halepensis* and *Tetraclinis articulata*, will remain locally.

Also, in the European/North African-Mediterranean region, it is obvious that subsistence-oriented land management in small family units coincides with a greater diversity of landscape and vegetation. Modern market-oriented management is always linked with a loss of diversity at all levels. In the recent past an agro-sylvo-pastoral balance was recommended; however, without developing precise ideas of it. Typical forms of the Mediterranean land use are shown in Fig. 4.1.24 A–D.

Desertification on the Edges of the Sahara

The term **desertification**, coined by Aubréville (1949), has been used at least since the many years of drought in the Sahel at the end of the 1970s to describe environmental problems in dry areas. However, it is not always used with the same meaning. Today it is obvious that this term **not only** describes **climatic stress** in long-lasting drought periods, but also complex interactions **which include particularly human interventions** on vegetation and landscape. In the context of ecosystems in dry areas, and of the often-quoted **man-made deserts**, it should be stressed that, although often described as unusual, extended dry periods are a characteristic feature of dry (desert) areas. It is not only the small amount of available water after precipitation together with high temperatures, but also the temporal, episodic and spatial distribution of this precipitation which cannot be anticipated.

In the Saharan region dry periods lasting several years have always occurred, as shown by reports in historical sources, and the interpretation of old lake sediments (Nicholson 1978). The recent dry period in the Sahel had such catastrophic consequences because it was preceded by a relatively moist period, and the population (which had meanwhile grown considerably) was not prepared for this in its land use. Better medical supplies and technical innovations (deep wells to tap fossil water) improved grazing conditions and the

number of animals increased continuously (Müller-Hohenstein 1993). Recent meteorological data indicate large regional differences in the amount of precipitation, but a general trend of increasing drought is hardly visible.

It is incorrect to regard, in this context, ecosystems of dry areas as particularly labile systems. These ecosystems are adapted to extreme climatic variability. Autochthonous plants and animals are able to adapt in many ways, and thus are able to survive under such conditions. The human population in dry areas also knows how to maintain supplies and is prepared for variations in yield (Ibrahim 1988).

Figure 4.1.25 shows a “**schematic of desertification**” with the most important causes and the consequent land degradation, in dry regions. It is important to consider the discrepancy between growth of population and – despite all technological progress – the limited availability of renewable resources as well as the substitution of traditional forms of management (nomadic life style) by modern forms of grazing and agriculture on dry fields. In the last 100 years, the human population around the Sahara has grown fivefold (Goudie 1994). Today examples of poorly adapted agriculture can be found in all areas near deserts, e.g. agriculture in northeastern Syria or eastern Jordan, with precipitation below 200 mm/year, or growing animal fodder using fossil water from more than 1000 m deep in Algerian oases, or supplying drinking water for animals in the Sahelian Ferlo, where vegetation thus degrades even further.

Human influence on the vegetation in dry areas is not so much linked to the introduction of species foreign to the flora of the region, more to the disturbance of sites and the original plant cover. Thus woody plants have disappeared in many regions because of the increased requirement for energy. The naturally sparse, so-called **contracted vegetation** (Walter 1973) is damaged by overgrazing, shown by the decrease in cover and primary production, and a shift of the floristic constitution. Good fodder plants become locally extinct in dry areas and toxic or thorny species invade. Ultimately, loss of species is to be expected. Local changes resulting from the increased loss of vegetation are seen in **remobilisation of dunes** and increased number of **dust storms**. Also water relations of areas are affected by modern irrigation installations which result in **salinisation of soils** and an increase in halophytes (Fig. 4.1.26).

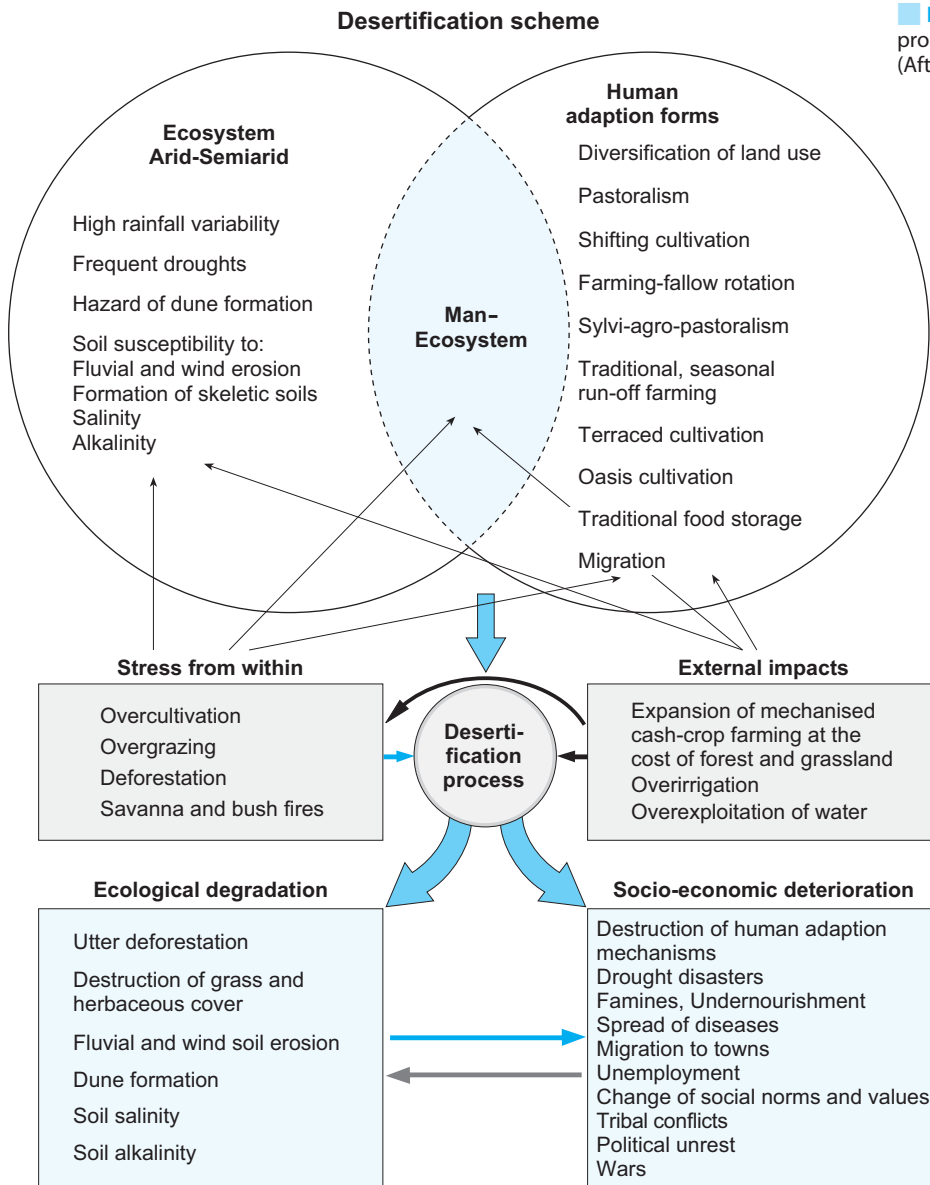


Fig. 4.1.25. Scheme of the process of desertification. (After Ibrahim 1988)

Without doubt, the recent deficiency of precipitation has worsened degradation, locally and regionally. The desert area has probably grown by 15% in the last 100 years; between 1958 and 1975 the Sahara is believed to have extended 100 km to the north and to the south (Lamprey 1975). However, such growth of the desert is also questioned; Hellden (1991) interpreted satellite pictures and was able to show a close relationship between precipitation and the vegetation, but could not find evidence for expansion of desert areas. Questions remain: are the observed changes permanent degradation and do the processes shown lead to irreversible condi-

tions, or is regeneration possible? The latter is understood as the sum of processes in an ecosystem, by which lost elements may be regained and thus re-establish themselves equivalent to their original situation. This question cannot be answered yet, as there are many positive and negative interactions between climatic events, the development of vegetation and sites, all of which are inadequately known. However, in all dry areas of the Old World, there are examples of a rapid recovery of vegetation after precipitation. Obviously, **the ability to regenerate in dry regions** depends on the variability of precipitation and the linked natural stresses, and has

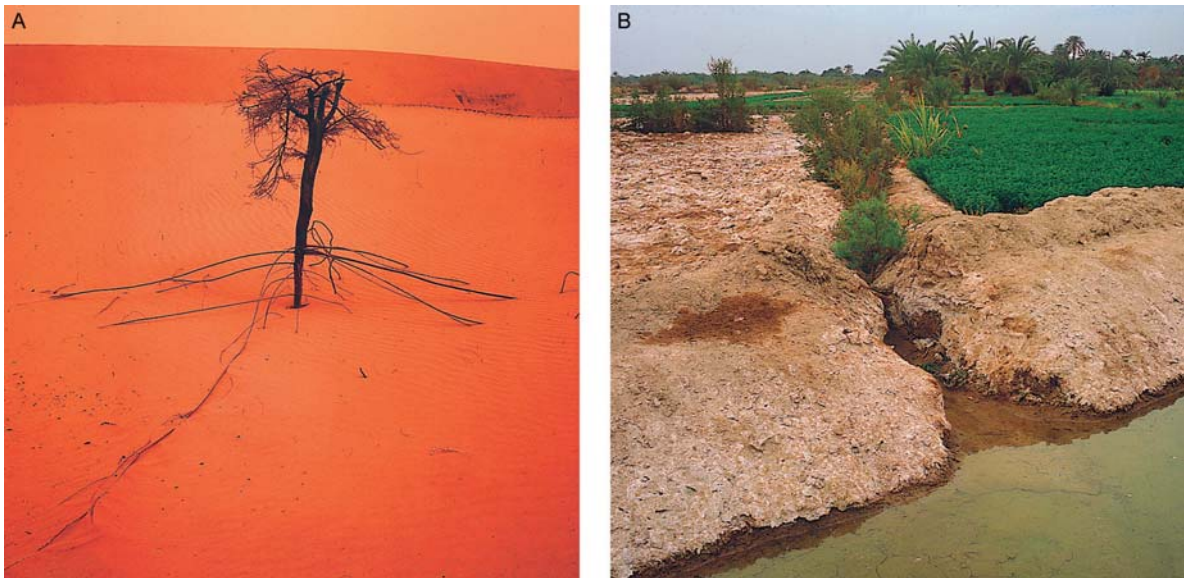


Fig. 4.1.26. Desertification is obvious in areas where people apply inappropriate forms of exploitation. **A** A single tree (*Commiphora africana*) in the southern Sahel of Mauritania is witness to former removal of dry forests, which disappeared because of excessive grazing and movement of sand dunes. **B** Incorrect irrigation with water of high salt content and inadequate drainage has caused salinisation in oases which had functioned for centuries with traditional cultivation (Dakhla Oasis, New Valley, Egypt). (Photos K. Müller-Hohenstein)

probably been underestimated. However, despite this, man may be causing the changes in dry areas, via global climate changes resulting from alterations to the albedo and the increasing dust load in the atmosphere, as well as to changes in soil moisture.

Destruction of Tropical Forests

Destruction of tropical forests has been discussed in public even more than the problem of desertification. Not the climatic but the edaphic preconditions, particularly the availability of nutrients, are the limiting factor. It has long been known that soils weather intensively and **nutrients are leached out** in uniformly high temperatures and with continuous moisture. Although litter production as well as decomposition is rapid reserves, e.g. in the form of humus, are available. Even fertilisation in the two-layered clay mineral soils is not sustainable, because they are weak exchangers. Weischet spoke as early as 1977 of a “disadvantaged tropics”. The system can only remain functional if the **short-circuited nutrient cycle** is maintained, perhaps with the help of mycorrhizae or fine roots. The export of organic substances by harvesting results in far-reaching consequences. Exceptions exist only where primary cations are released because of the geological-mineralogical condi-

tions, e.g. in some regions on Java and Sulawesi (east Asia) where, with young, relatively nutrient-rich volcanic soils, permanent rice crops can be grown.

Clearing and land use have taken place in tropical rain forests for thousands of years, in India more than 9000 years ago, in Africa only 3000 years ago. The consequences of these early influences are considered to be small. Intervention over large areas began with colonial times. Of the ca. 1.5 million described animal and plant species of the permanently moist tropics – in total about 30–50 million (Furley 1993) – many thousands had probably become extinct before they could be scientifically classified. In contrast to temperate forests, “modern” forestry methods have very negative effects in the tropics, as perhaps only one single tree trunk is used per hectare and many neighbouring trees are destroyed. Even the mangrove stands in tropical coastlands are not protected for **wood management**. Sites of these unique plant communities are used in east Asia, as well as Equador, for **breeding and cultivation of prawns**.

Not only the management of forests leads to loss of species. Settlers followed the woodcutters and limited the development of secondary forests. Governments of several rain forest states saw the forests as a “valve” for the growing pop-

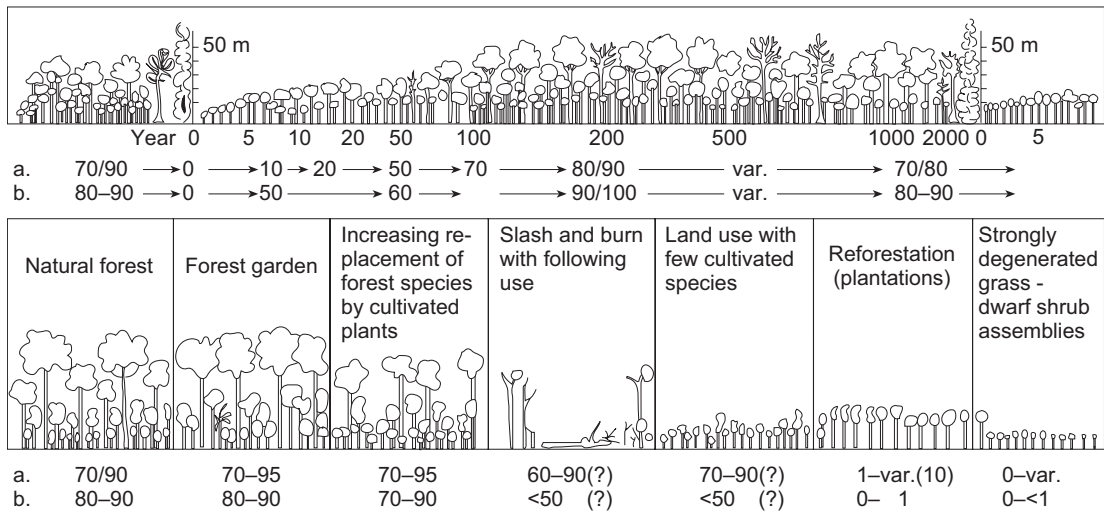


Fig. 4.1.27. Diversity of trees in undisturbed and disturbed tropical rainforests (*top* natural succession, *bottom* following increasing intensity of land use): *a* species richness as % of the maximum attainable species number and *b* evenness as % of the maximum attainable species number. (After Bruenig 1991)

ulation pressure. Thus, state subsidies were used to clear enormous areas for “ranching” establishments during the inland colonisation of Brazil (Kohlhepp 1991). At that time grass seed was sown from planes, but subsequent grazing was mostly given up after a few years as **replacement communities with hard grasses** (sclerophyllic grasses, e.g. *Imperata cylindrica*, and others) developed which were not suitable species for animal fodder. The practice of **shifting cultivation with slash and burn** used commonly in all moist, tropical areas was previously regarded as damaging. Today this form of land use is regarded as less damaging, particularly if fallow periods last long enough. However, almost all-over the tropical regions the fallow periods were shortened because of pressure from fast-growing populations. Regeneration, particularly of mycorrhizae, is no longer guaranteed. Bruenig (1991) compared the consequences of mild intervention with “modern” intervention and assessed the consequences with the help of two profiles (Fig. 4.1.27). In Fig. 4.1.28A–C typical phases of the development of land use from the natural forest to unproductive fallow areas are shown.

Worrying numbers showing the loss of tropical moist forests have been published. The FAO documents a faster rate of decrease in rain forests from the 1980s onwards and estimates for the year 1991 alone indicate a loss of 2% of tropical forest area. Klötzli (1993) quotes 0.3 million ha/year, Bruenig (1991) calculated

more than 7 million ha/year. Even if starting from the assumption of a relatively low β -diversity (differences of diversity between different sites), these area losses affect complete plant communities with highly endemic species, and particularly the specialists amongst plants and animals. Genetic material for breeding, species for medical use, food and various commodities are lost (WBGU 2000). Erosion on the cleared areas increases manifold, **changes in water relations** occur. There are local climatic changes at the micro- and mesoscale range. Because of the increased atmospheric CO_2 content global **climate change** is expected, with increased greenhouse effect with rising temperature and changed precipitation (IPCC-WGI 2001).

Linked to the destruction of tropical rain forests, the establishment of more protected areas than so far established has been demanded. However, many millions of people live in these areas, so concepts for sustainable management must be developed. It is often overlooked that such concepts already exist, and that there are examples of sustainable land use. The earlier hunters and gatherers, and the first settled agriculturists, independent of each other, developed well-adapted forms of land use in most tropical regions. Low population density allowed long fallow periods. The population was less mobile, stimulating a closed cover of several “storeys” from different crop plants. The original land use simulated (intuitively?) the structure and biodiversity of a natural rainforest with useful plants.

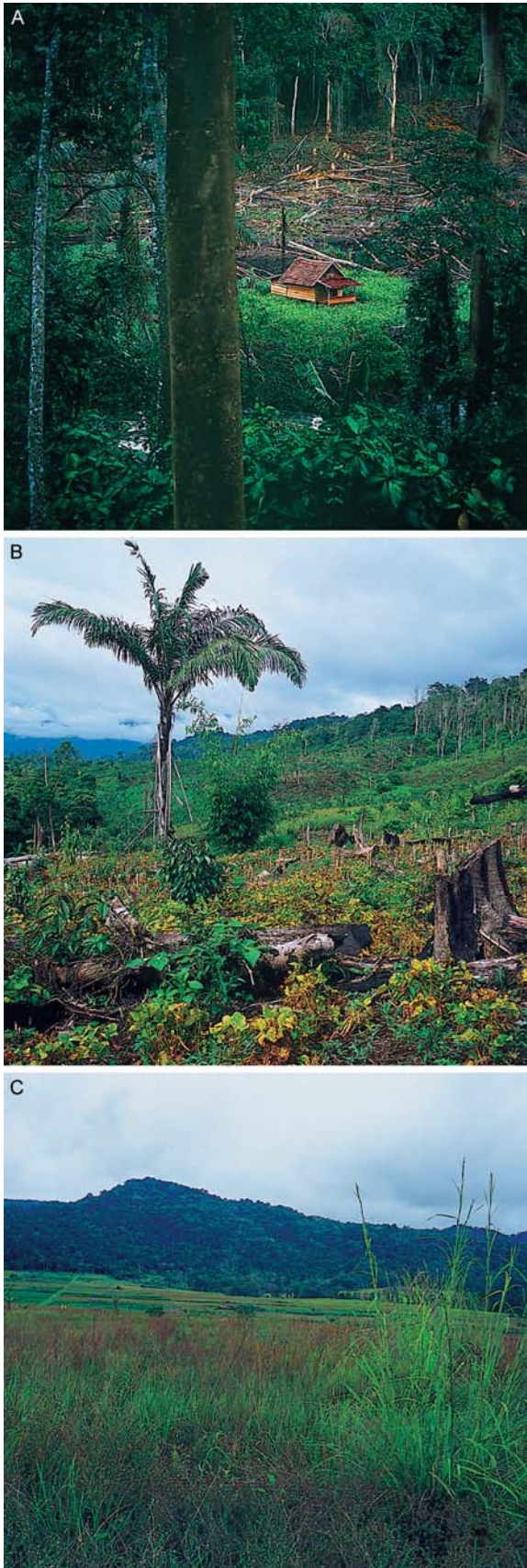


Figure 4.1.29 A–C shows forms of sustainable land use in the permanent rain forest, and in the seasonally moist rain forests of the tropics.

Wood extraction by foresters cannot be sustainable in the continuously moist tropical rain forests because of the imbalanced nutrient supply. Integrated forms of use, with crop plants adapted to – and supplementing – the conditions (e.g. supply with nutrients and water) and affecting the site (e.g. creation of particular microclimatic conditions) must be developed or taken over from indigenous populations. However, in doing this, the expectations of high yields often linked to land use in the tropics must be revised. Sustainability must be considered more than mere technologies and rates of production; the ultimate aim is maintenance of the cultural heritage in particular environments. Some elements of sustainable use are generally valid. These are **agroforestry**, **mixed cropping**, **mulching**, **biological pest control**, etc. (Furley 1993).

Examples of recent attempts to protect the environment exist but almost everywhere a creeping loss of protected areas can be observed. Many questions are also open about the scientific basis for nature protection in the tropics. It is, for example, assumed that a suitable number of individual plants, able to reproduce, must be available to maintain a species. Assuming this number to be 500, this would require, in the rain forest ecosystem, probably several 100 ha per species. This does not (only) concern the protection of species, but the protection of plant communities in an area. Little is known about the protection of communities in environments, about the minimum size of such spaces required and the bordering buffer zones. The borders of national parks and biosphere reserves were

Fig. 4.1.28. The three photographs show the typical processes and sequences in exploitation of tropical rainforest (example from central Sulawesi, Indonesia). **A** Uncontrolled clearing (slash and burn) of primary forest, done often by groups of people without knowledge of methods appropriate for the environment. **B** Agricultural use of the cleared forests for only a few years (without fertiliser application) until the fertility of the land is exhausted by the cultivated plants grown to fulfil the people's needs. **C** The unproductive area is abandoned and quickly invaded by alang-alang grass (*Imperata cylindrica*) and bracken (*Pteridium aquilinum*). (Photos K. Müller-Hohenstein)

usually roughly estimated, even if not determined according to political and economic criteria. These are important tasks for ecology which is concerned with the protection of tropical ecosystems.

4.1.5

Basis of General Vegetation Dynamics

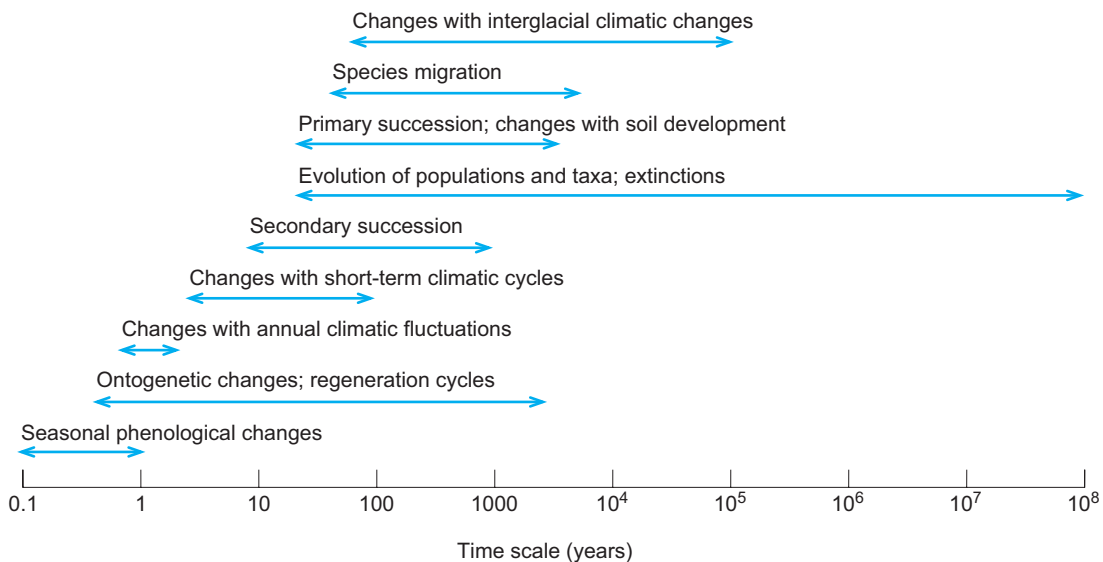
Vegetational units are permanently subjected to changes in space and time. Each recording of vegetation is only a momentary event in a complex dynamic process. The temporal dynamics in the structure of species in space, and the corresponding changing patterns, are closely linked to the different demands of species, to their life cycle, mechanisms for reproduction and response to competitive pressures, and to the available resources, in the community of species. To understand the dynamics of vegetation, a knowledge of stress situations and responses to stress is important.

Vegetation dynamics aims to record and to explain similarities of vegetation patterns and processes with time and then to derive characteristics or typical responses and models. The causes of processes taking place may be found in disturbances of very different kinds and they are particularly important.

Discussions of vegetation dynamics are made difficult by a confusing multitude of terms, which is caused by insufficient consideration of **spatial and temporal scales**. Vegetation dynamics on a few square centimetres of bare rock must be described differently to that of square kilometres of large forests. For boreal coniferous forests a different terminology should probably



Fig. 4.1.29. In the humid as well as in seasonally moist tropical regions, types of sustainable agricultural land use have been developed on all continents. **A** "Continuous" rice cultivation in south-east Asia, often combined with cultivation of different palm trees (Sulawesi, Indonesia). **B** In almost all tropical regions, small home gardens are multi-storied with different layers of cultivated plants, which 'copies' the species-rich tropical forests, e.g. trees such as oil palm (*Elaeis guineensis*), cashew nut (*Anacardium occidentale*) and banana (*Musa paradisiaca*) and annual vegetables below (Guinea-Bissau). **C** Sophisticated irrigation schemes on widespread terrace complexes have been in use for many centuries for cultivation of annual crops such as sorghum (*Sorghum bicolor*) and perennial shrubs such as coffee (*Coffea arabica*) and qat (*Catha edulis*) in the Yemen Arab Republic. (Photos K. Müller-Hohenstein)



■ Fig. 4.1.30. Time scales for the dynamic changes in vegetation. (After Miles 1987)

be used to that for tropical rain forests. Temporal differences are probably even more important, reaching from the course of a day to centuries (Fig. 4.1.30). Ecology of vegetation must deal with extreme complexity, in the temporal sequence and the close spatial arrangement of species, populations and vegetation units.

4.1.5.1 Aspects of Daily and Seasonal Vegetation Dynamics

Plants need to adapt to changing daily and seasonal conditions in their habitat, particularly periodic changes of radiation, day length and temperatures, as well as the amount and distribution of precipitation (see Chap. 2.1). The **short-term dynamics** of plants and vegetational units is considered by the discipline of **phenology**, defined as the science of seasonal sequences of life cycles of plants and plant communities. Visible changes in the life cycle of plants are recorded and stages of development defined, and attempts made to explain these by changes with time and biotic and abiotic factors in the habitat. Not only typical sequences are of interest, but also differences in weather conditions from year to year which affect the time of flowering, conditions for germination, the amount of material production and its distribution and formation of fruit and seeds, as well as the start and duration of individual phenological stages.

Phenological characteristics have been known for a long time, because they are easy to observe. In the **daily rhythm** leaves and petals move, e.g. to protect against excessive radiation, or to capture the highest possible amount of radiation. The production of odorous substances, the secretion of nectar or the supply of pollen by flowers may be coupled with the active phases of animal partners and change during the day. This is regulated by population processes in the vegetation at a microscale as well as by the daily change of light and dark periods.

Different aspects of flowering, harvesting or colouration of leaves are basic observations in phenology. The regulation of these processes is by **photoperiodic responses** and light quality. Further important factors are temperature extremes and temperature sums or even human intervention. Examples for the spatial heterogeneity are the mosaic of vegetation on snow patches or the use of light by spring geophytes in nemoral deciduous forests (Fig. 4.1.31), or the **flowering aspects** of economically exploited meadows and pastures. Particularly important for economically useful plants, and thus of interest to many researchers, are the factors delaying growth of species at temperature limits during the course of the year. Plants may require particular temperatures in order to germinate (**stratification**) or for flower induction (**vernalisation**). Annual, biannual and perennial species behave differently, making the derivation of general rules difficult.

Box 4.1.3 Methods in phenology

Phenological studies focus on the appearance of plants during their development throughout the year and describe them quantitatively and qualitatively. The characteristics include floral development (reproduction) and leaves (vegetative growth). In spring observations are made weekly, and later at two or more week intervals. The number of flowers and the frequency of flowering (the proportion of flowering individuals in the total population of the species), number of shoots, leaves and fruits as well as the degree of cover are counted or measured.

Dierschke (1994) provides an example of such analysis in deciduous trees in nemoral forests, and reproductive stages in phenology.

- Vegetative phenological stages
 0. buds completely closed
 1. buds with green tips
 2. green leaf emergence
 3. leaves 25% unfolded
 4. leaves 50% unfolded
 5. leaves 75% unfolded
 6. leaves fully expanded
 7. first leaves yellowing
 8. leaves 50% turned colour
 9. leaves 75% turned colour
 10. leaves <75% turned colour
 11. bare

- Reproductive phenological stages
0. without flower buds
 1. flower buds recognisable
 2. flower buds swollen
 3. shortly before flowering
 4. start of flowering
 5. up to 25% flowers mature
 6. up to 50% flowers mature
 7. full flowering
 8. flowering decreasing
 9. flowering ceased
 10. fruiting
 11. fruit dispersal

Comparable scales have been developed for herbs, grasses and cryptogams. For general phenological examination, in which the whole plant stand or vegetation unit is considered, permanent areas are marked and regularly observed. This may include all, or only selected, species in vegetative and reproductive

stages of development (phenophases). In addition, environmental data are recorded, particularly those related to weather conditions as in other analysis of plant communities. The data is categorised by the start of flowering or the length of flowering period.

Subdivisions of the different phases in the development during the year into phenophases are based on phenological plant types. They have the same developmental rhythm, which appears in comparable leaf characteristics, time of flowering and duration of the growing season. Applicability of these types is limited to particular regions because individual species behave differently in different communities. Phenophases are initiated by, for example, initiation of flowering of particular plant species. Examples are flowering of *Taraxacum officinale* or seed production of *Stipa* sp. Leaf unfolding, leaf colouration and leaf fall are also important.

In phenophase diagrams, representatives of important phenological plant types are used to present phenology during the course of the year (Fig. 4.1.33). Dierschke (1989) has shown that quantitative-synthetic phenological spectra provide a precise understanding of the floristic structural features of vegetation and also allow floral and distribution aspects of biology to be understood in their interactions, thus providing the basis for the study of biocenotic relationships. **Phenological maps** are widely used to show spatial differentiation, e.g. of the start of spring (e.g. based on the initiation of flowering of apple or lilac). The selected plant species used for this must fulfil two conditions. First, they must be frequent, and widely distributed; second, they must be clearly distinguishable and have easily assessable phenological characteristics. In mesoclimatic regions trees are generally selected. Herbs represent the climate near the ground. Phenological maps, which now are made from aerial photographs, show differences within small areas such as towns and their suburbs. In agriculture, phenological characteristics are used to establish maps of growth climates and temperature ranges to assess the potential use or the probability of damage to particular types of crops.

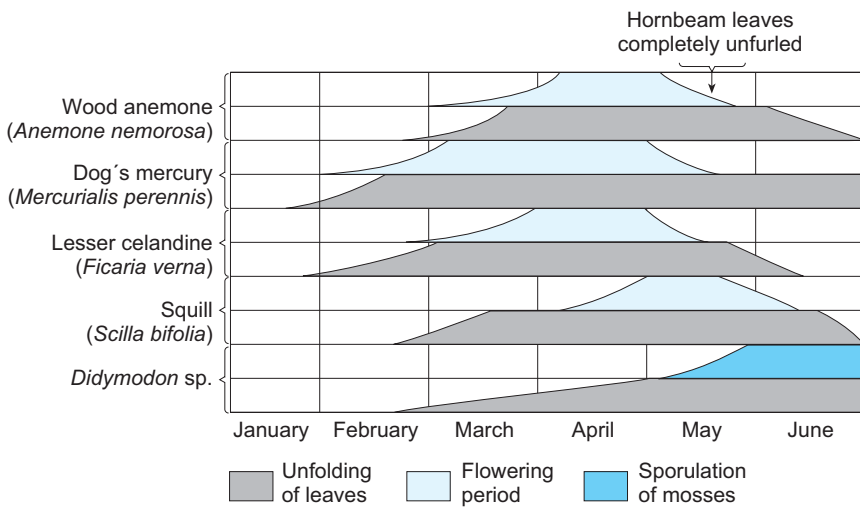


Fig. 4.1.31. Period of flowering for geophytes during spring in a hornbeam (*Carpinus betulus*) forest. (After Schmidt 1969)

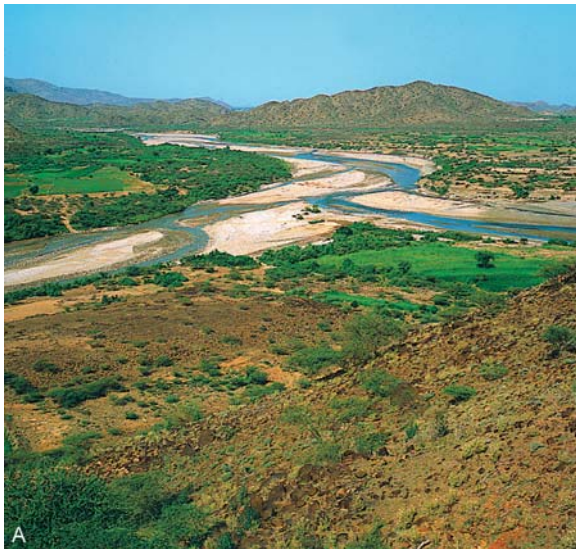
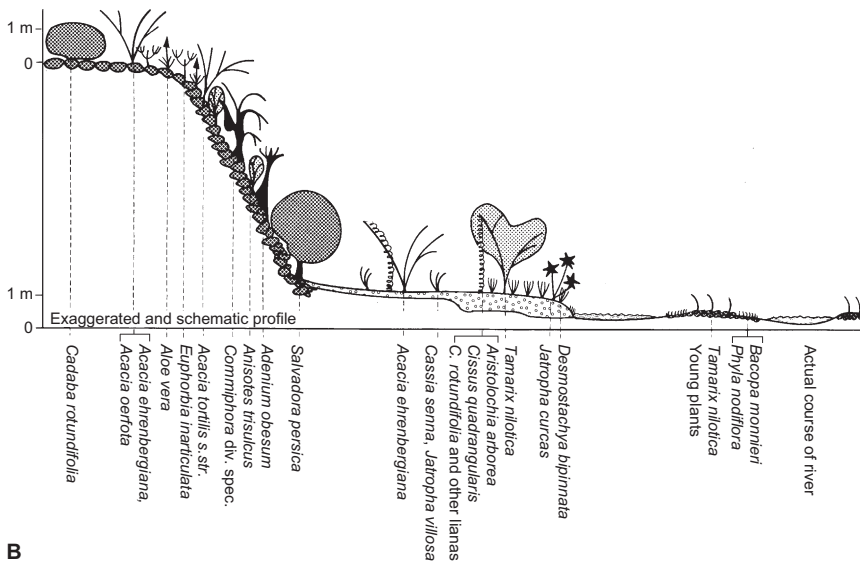


Fig. 4.1.32. Zonation of plant communities on the sides of large wadis in North Yemen (Yemen Arab Republic), determined by runoff. **A** Wadi Mawr in the Tihama mountains with highly variable water discharge during the year (Photo K. Müller-Hohenstein). **B** Exaggerated and schematic profile from the bed of the wadi to the lower terraces to the top of the wadi bank. Only therophytes such as *Bacopa monnieri* and *Phyla nodiflora* are able to colonise the frequently moving gravel banks. In the more strongly consolidated regions of the banks, grasses with particular root systems (rhizomes) such as *Desmostachya bipinnata* and very elastic woody species, such as *Tamarix nilotica*, are able to survive episodic flooding. The resulting changes in vegetation are relatively rapid and aperiodic. (After Deil and Müller-Hohenstein 1985)



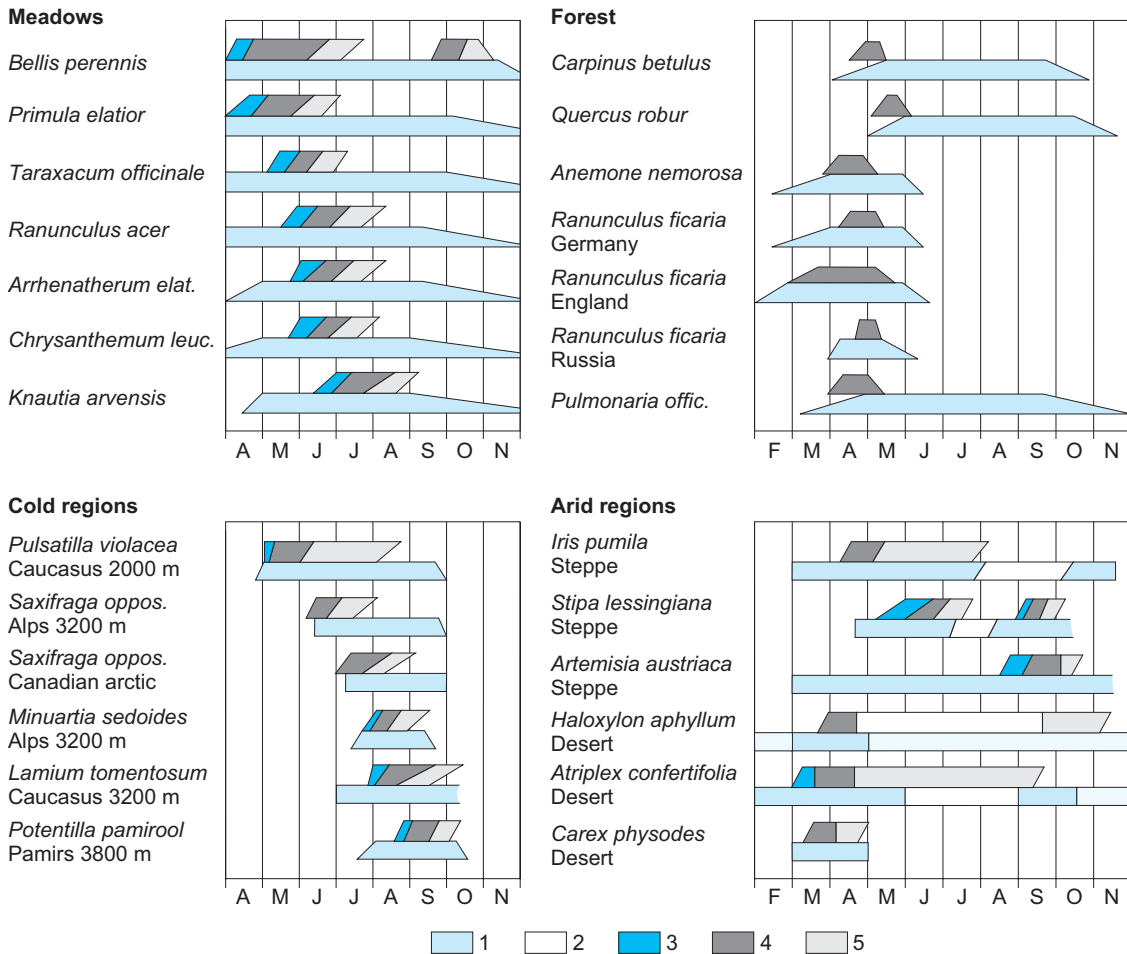


Fig. 4.1.33. Vegetative period (phenological phases) for meadow plants (oat grass – *Arrhenatherum* – in Poland), for trees and herbs in a mixed oak forest in northern Germany (with comparison of *Ranunculus ficaria* to those in Russia and England), and also for plant species from cold regions (high mountains, arctic regions) and from semiarid and arid regions (steppe, deserts). After Larcher (1994). 1 Time required for complete leaf cover; 2 death due to drought; 3 flower buds visible; 4 flowering period; 5 fruit ripening and seed dispersal

There are also short-term periodic or episodic events which cannot be explained by the usual phenological characteristics, but determine the dynamics of these communities decisively. These include regularly occurring floods in river basins, requiring particular adaptations to the extreme water supply, and problems of root respiration and perhaps mechanical disturbance (Fig. 4.1.32 A, B). Another example is the stress caused by avalanches, with the subsequent characteristic vegetation patterns in the Alpine belt. Regularly repeated human influences are important, e.g. mowing once or twice a year and grazing with different numbers or species of animals.

Other growth processes also occur in phases, e.g. of shoots or roots, but this may not always be visible (Fig. 4.1.34).

Phases of activity and dormancy are characteristic for all regions with a seasonal climate. A distinction is made between phases or periods of stronger activity of vegetative and reproductive growth. Occasionally, several vegetative **pulses of growth** occur; for example, in late summer some tree species rapidly form very distinct new shoots. Seasons may be determined by temperature or from water supply. In the latter case, seasonally changing water supply is the most important regulatory factor for short-term dynamics of vegetation. Even under Mediterranean conditions, for example, summer annuals of temperate zones are replaced by winter annuals, flowering periods shift into autumn. In the tropics with seasonal precipitation the flowering phase is induced by the onset of the rains.

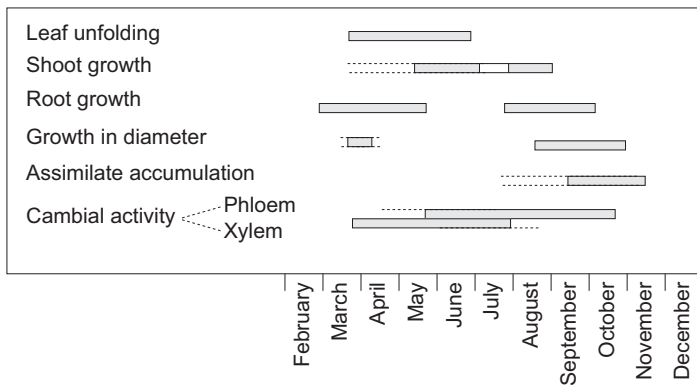


Fig. 4.1.34. Growth periods and storage of assimilates by trees in temperate zones during the year. (After Larcher 1994)

In woody species, two types have evolved. “Late flowering” plants flower only after the development of leaves or after shedding of leaves at the end of the rainy season, whilst “early flowering” plants start to flower before the emergence of leaves, i.e. before the rainy season begins. For both types biological processes ensure pollination and distribution, i.e. the simultaneous occurrence of pollinators or seasonal periods with regular winds. In extremely dry regions, where therophytes dominate, definite flowering periods no longer occur, because of the high variability of precipitation in time and space. But after rain the “flowering desert” quickly develops. Many annuals of dry areas may finish their life cycle within a few weeks (Fig. 4.1.35).

Because of the usually favourable conditions of temperature and moisture in the moist tropics, plants often grow continuously. Nevertheless, irregular bursts of growth may be observed, with differences in the trunks even for an individual plant. However, definite flower periods or other phenological phases can hardly be established. Some individuals flower and carry ripe fruits at the same time. Occasionally, slight periodicity may be observed, which is triggered by very slight changes in temperature or endogenously. It is remarkable that several species of plants only flower very episodically, sometimes only after several decades.

Timing and duration of individual phenological phases within the year is very closely correlated with the sequence of weather during the year. These short-term dynamics, occurring year by year, but not necessarily cyclic, are often termed **fluctuation**. Changes are registered at the level of individual plants. The most important expression of fluctuation is the change of dominance of the participating species. They

may deviate from the hypothetical average sequence, mostly determined by environmental stress. A return to the previous state is possible and thus this differs from succession. In open fields it is not easy to distinguish between fluctuation and succession, as both overlap and influence each other.

Fluctuations in dry regions with fairly high variations in precipitation are particularly striking. **Annuals in deserts** may fail for many years, but after precipitation, they determine the aspect. The biblical seven fat and seven lean years



Fig. 4.1.35. After one of the rare rainfall events in extreme deserts, the “flowering desert” (Arabic, *acheb*) quickly develops. Such an unpredictable change in vegetation is called a fluctuation and is a plant community composed only of therophytes. This example is from the Arabian Desert (United Arab Emirates) and contains *Silene villosa*, *Senecio glaucus* and *Plantago amplexicaulis*. (Photo K. Müller-Hohenstein)

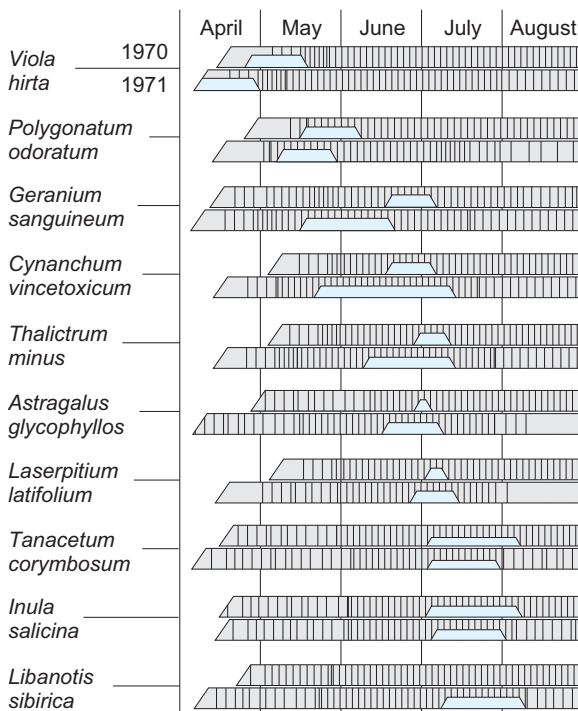


Fig. 4.1.36. A 2-year phenological spectrum for some species bordering a forest. After Dierschke (1994). The small trapezoidal area shows the flowering period

point towards fluctuations and their significance in dryland agriculture. In mountains of moderate latitude, simple or complex snow patch communities are formed depending on the time scale and thus document fluctuations. Figure 4.1.36 shows the phenological spectrum of species of woodland edges for two different annual sequences, documenting the extent of such fluctuations.

Fluctuations may also occur because of a massive attack by herbivores. Genetically determined fluctuations are, for example, the so-called mast years with production of many fruits. Ultimately, fluctuations are often the result of human intervention, e.g. changing the rotation in grazing management or changing crops in agriculture. Rabotnov (1974) gives a classification of fluctuations according to their cause and progression.

Evaluations of synecological and biocenological links are only emerging, e.g. of the temporal niches of flowering species in plant communities, of the synchronisation of insects and animals which eat and distribute pollen, fruits and seeds. This would not only make pollen calendars available for those with allergies, but also

help those protecting nature, i.e. by providing dates for mowing, for extensive maintenance, or as a control for the success of different types of land use.

4.1.5.2

Aspects of Long-Term Vegetation Dynamics

Medium- and long-term changes of the plant cover over several decades and up to millennia are analysed as **research of successions**. Until a few decades ago, the empirical data were easy to grasp and from them principles and models were derived. However, from the beginning, there was controversy in the scientific discussions between those with holistic and those with reductionist approaches. There were those who always wanted to consider the complete ecosystem, and those who did not believe that this was possible and therefore concentrated on individual functions and processes in those systems. Both approaches had the same aim in trying to recognise the causes of vegetation dynamics, to explain the resulting effects and, if possible, to predict them. Recently, new theories have been added, not always based on broad empirical information. There is still belief that there are **basic rules of dynamic sequences**, but many processes are now seen as stochastic. It is generally accepted that it is necessary to consider spatial and temporal scales in greater detail.

Beginnings of Succession Research

Systematic scientific research into vegetation dynamics started relatively recently and is connected with the names of the geographer Cowles, the ecologists Clements and Gleason and the botanist Gams. Clements (1916) is regarded as the founder of the discipline of succession, starting from the idea that only undemanding species grow first on bare substrates. With time they influence each other and also the conditions at the site. The latter leads to a succession by different communities which are adapted to the changing conditions. Clear temporal periods are recognisable until the development of a uniform, final community, the so-called **climax community**, representing a relative equilibrium. Small fluctuations are possible but not a reversal of the clearly directed processes leading to this climax community.

In his later work, Clements assumed three succession sequences. One of these sequences

has its origin in a fresh water basin. During the processes of receding water and emerging land in temperate latitudes, deciduous forests develop as a climax via a boggy and pre-forest stage (**hydroseries**). Another sequence starts from saline substrate (**haloseries**), a third on bare rock (**xeroseries**), but all end in the same deciduous forest climax. Changes in the site always originate from plants themselves, they cause changes. Also, in a large area with the same climatic conditions, the same final community will always emerge (**monoclimax**).

This concept was well received, because of the belief that all vegetation units fitted into this concept, but there were critics who could not empirically confirm this theory. The reason for the discrepancy was that Clements concentrated on the dynamics of undisturbed vegetation (**primary succession**) and interferences of any kind, and developments arising from them (**secondary succession**), were disregarded.

Clement's theory, which regarded plant communities as organisms, was soon challenged and rejected by Gleason (1926), who stressed that there was also an individualistic type of vegetation dynamics without clear steps and without formation of the different vegetation units. Gleason started from the assumption that changes of species at a site depended on the species composition and the influx of diaspores to that site.

Following this controversy two important movements become clear, which set the tone of succession research to this day:

- relatively general interpretation of the broad spectrum of dynamic events in ecosystems; and
- recognition of the enormous complexity of conditions and attempts to clarify individual aspects.

Even if the concepts of Clements and Gleason are no longer accepted in their pure form, it is still to the credit of the first researchers of succession that they introduced the principle of dynamics into an ecological analysis which had been rather static before.

Definition of Successions

Vegetation dynamics is the **change of structure and species constitution** in vegetation units in **space and time**. Short-term, daily and seasonal changes are included. All forms may be described by the term "**patch dynamics**" (Pickett and White 1985).

Successions are medium- to long-term dynamic processes in a **directed, temporal sequence** of species communities in an ecosystem. It is often stressed that these sequences are irreversible and – within limits – predictable. This sequence may be triggered by endogenous or exogenous processes, e.g. an explosion in the propagation of individual species or anomalous weather conditions. During succession, self-organisation in the ecosystem (on the precondition that there is no disturbance) increases and a balance between primary production and mineralisation develops. Odum (1980) lists a total of 24 different ecosystem characteristics able to change during the succession sequence. He regarded the development as a well-ordered process, resulting from changes caused by the vegetation and ultimately leading to a stable ecosystem, where maximum functional interconnections are achieved. The hypothetical final state is understood as a complex community of organisms with complex links and interactions, in which the equilibrium once achieved may, of course, change again.

However, successions are often also understood as stochastic processes, basically because the seed input in a biocenose at a site is random; the same applies also to the germination rates or the availability of necessary safe sites and, of course, the occurrence of disturbance – their type, intensity and degree – which are generally not predictable.

Based on Dierschke (1994), here succession is understood as a long-term, directed change in the composition of vegetation and its structure at a site. Main features are the changes in quantitative and qualitative characteristics of a stand (abundance and combinations of species). The result is a more or less controlled sequence of different plant communities, depending on the conditions of sites and how they change.

Succession Types

Succession may be considered over large or small areas, or as fast or slow changes. It may be directed or cyclic, and may be affected by endogenous or exogenous processes which many differ in type, intensity, duration or extent. It is important to consider the geographic location within different climatic zones of the region, whether development occurs on newly formed soils, or on those previously colonised and still established. Finally, participating plant species differ in their ability to win space and, in their

Box 4.1.4

Methods for studying succession

Research into succession has followed two complementary paths. In one the development of the vegetation with time is studied on a particular site with experimental treatments. The other is an older approach in which the composition of vegetation is related to changes over time (false time series, **location for time**). An example which is often given is the littoral zone of a lake which in its spatial development may be seen as an ecological series but in its temporal processes on the same site may be interpreted as succession.

Indicator plants, age structure and diversity of stands or analysis of seed banks often help to establish the temporal sequence of particular developmental stages. Indicators from outside the vegetation being studied are often used, such as analysis of the differences in soil profiles or historical records from archives on land-use registries and account books of farms which often have data about fertilisation or use of herbicides at particular times. An example of a derived succession is that of different types of plants in abandoned vineyards (Fig. 4.1.37). There are numerous important studies from areas covered with volcanic lava flows of different ages which can be dated accurately (see Chap. 3.5.1).

There are problems in drawing conclusions from spatial associations about temporal succession. Therefore, more direct methods of understanding succession have been established and are increasingly used. Spatially

limited units of vegetation are established and in regular sequence evaluated individually (**biomonitoring**). This long-term observation on **permanent plots** provides detailed analysis about population dynamics as the vegetation changes. Evaluation of aerial photographs and repeated satellite data promise much, although current technical methods still allow speculation. Only a few parameters can be measured. The scale is not sufficient for observation of individuals, although it is suitable for comparison of the average state of stands, and structural aspects of the plant cover are most obvious whilst inventories of species are not comparable. Experimental studies of succession, for example of economic use, are carried out on comparable areas using a range of treatments (e.g. different fertiliser applications, mowing regimes, single or multiple soil tillage, fencing and exclusion of grazing or other sorts of herbivory) and the effects on the vegetation during the following period are measured. Particular attention is paid to experiments relating to the problems of biodiversity and to competition within and between species. Also these questions are linked to succession in stands (EU project *Biodepth*; Hector et al. 1999). Biomonitoring is used in analysis of succession for regulation and manipulation of measures in nature conservation in order to show trends in development of the vegetation.

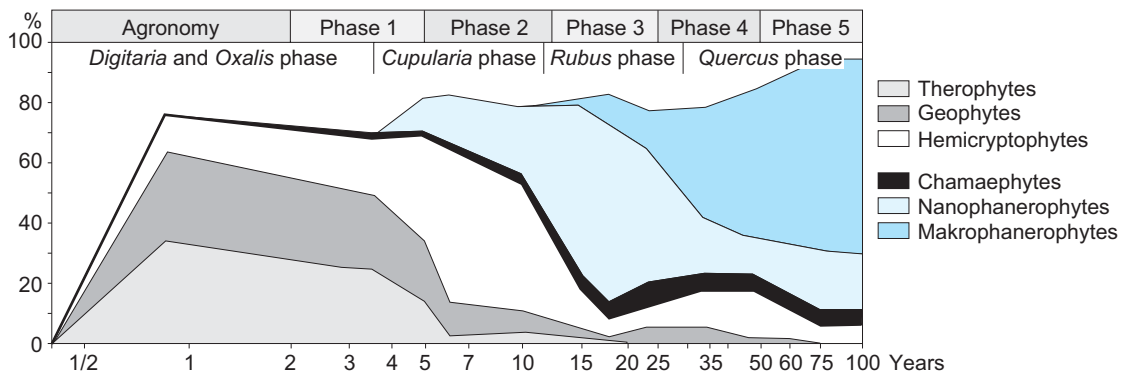


Fig. 4.1.37. Succession on Italian fallow vineyards, based on life forms. (After Richter 1989, from Dierschke 1994)

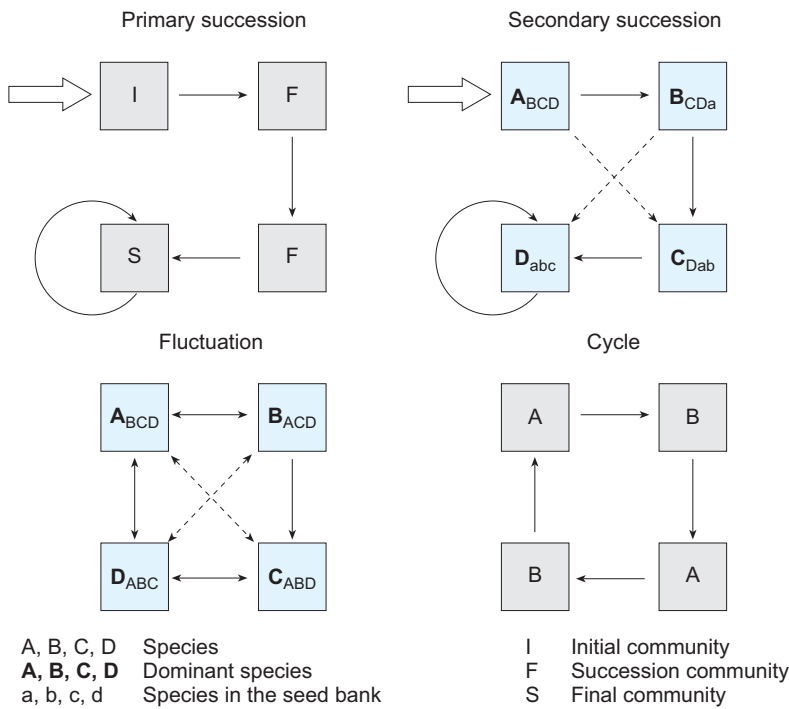


Fig. 4.1.38. Types of directed and cyclic vegetation dynamics. (After Jochimsen 1993)

life cycles, their demands on the site, the qualities for competition and strategies. Dynamic processes are triggered if net production and mineralisation in an ecosystem are not balanced. In this case it is possible, for example, to accumulate organic matter (formation of bogs, **autotrophic succession**) or the organic matter is consumed (use of humus by agricultural systems, **heterotrophic succession**).

Considering these aspects, many succession types on different spatial and temporal scales have been described. Van der Maarel (1996) attempted to show the spatial and temporal rela-

tions and how they are related and differ (Table 4.1.7).

Succession dynamics are visible by the loss of species and life forms possibly replaced by others. Often only short-term changes in abundance or dominance of species within a vegetation unit are noticeable. On this basis, it is hardly possible to determine a certain type of succession.

Figure 4.1.38 shows successional types schematically. These are the most important examples of progressive and regressive, directed as well as cyclic vegetation dynamics.

Table 4.1.7. Relationships between spatial and temporal dimensions in the changes in vegetation. (After van der Maarel 1996)

	Individual	Patch	Population	Community	Landscape	Region
Fluctuation	×	×	×			
Gap dynamics	×	×	×			
Patch dynamics	×	×	×			
Cyclic succession		×	×	×		
Regeneration succession		×	×	×		
Secondary succession		×	×	×	×	
Primary succession			×	×	×	
Secular succession				×	×	×

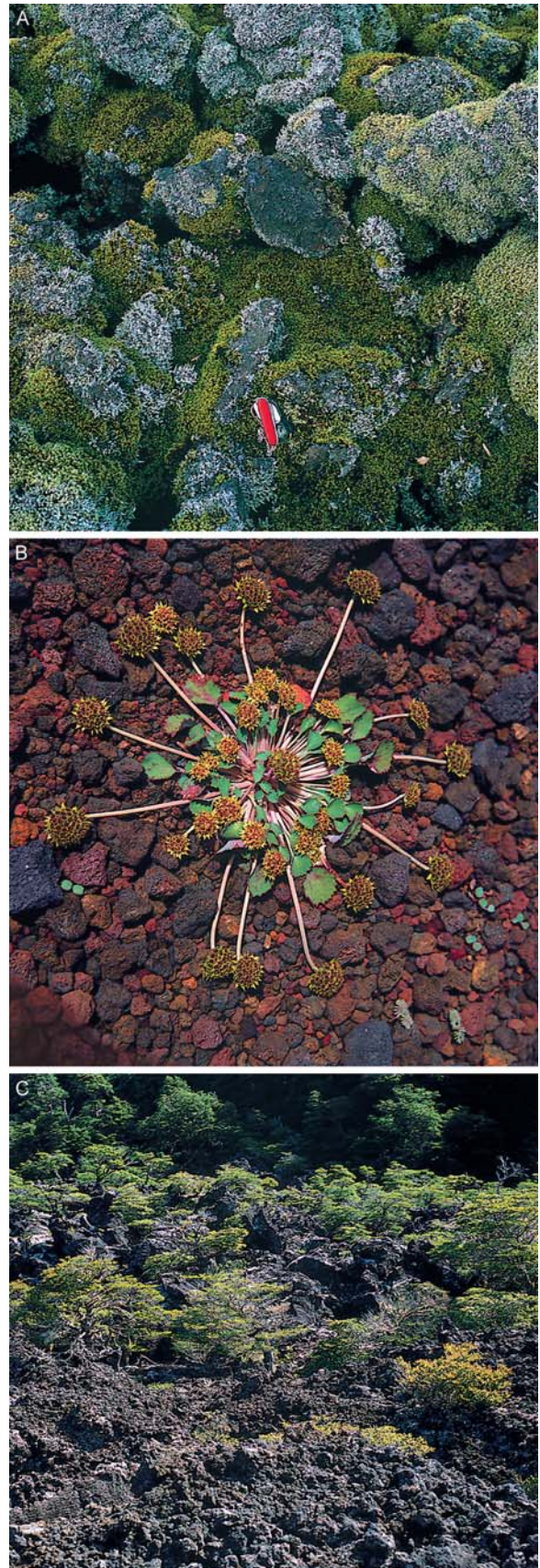
The terms in the table header refer to spatial dimensions. A patch is a small homogeneous area (ecotope), a gap a small open space in the forest

Primary Successions

Primary successions are very important for understanding processes of vegetation dynamics, but in reality they are rarely observed. There are two reasons for this: they only occur slowly over decades and centuries, and one of the main prerequisites for this type of succession is missing – a completely bare abiotic substrate where such a directed development may start. Knowledge of individual stages of the sequence of primary succession is mainly from newly formed sites, for example, after volcanic eruptions (island of Surtsey near Iceland, in 1963), or in newly developed coastal regions or at the feet of melting glaciers (Fig. 4.1.39 A–C). Anthropogenic sites, such as rubble heaps, quarries, etc., may be regarded as starting points of primary succession. Despite the differences in sites, uniform trends and basic patterns may be derived from such situations (see also Chap. 3, Fig. 3.2.14).

Only very few plants are able to cope with the extreme conditions of a site during the initial phases. On rocks, cryptogamic communities develop first, perhaps lithophilic lichens, then fruticose lichens, mosses and ferns. In unfavourable exposed positions, e.g. on steep rock walls or on mobile debris, the development does not go beyond this phase (permanent pioneer communities). Usually, the pioneer communities, which themselves depend on the input of propagules from the surrounding areas, change the site over the course of time because of soil formation. Herbaceous pioneers occurring in such a site are many Leguminosae, leading to accumulation of nitrogen. Later pioneer plants change the microclimate of their habitat. If flowering plants have not established during the first phase of succession, they will now follow. These are predominantly heliophilic, epigeaic germinating therophytes or, where the climatic conditions do not allow such establishment, undemanding herbaceous hemicryptophytes and chamaephytes, e.g. on the moraine of the Aletsch glacier (Fig. 4.1.40).

Fig. 4.1.39. Three photographs showing stages of primary succession. **A** On fresh volcanic lava dense moss and lichen communities have developed after 8 years. **B** Only specialists among the vascular plants (e.g. *Pozoa volcanica*, Apiaceae) establish quickly on the almost unweathered rocks almost without soil. **C** Only after several decades do the first trees (*Nothofagus obliqua*, *N. dombeyi*) form an open woody vegetation. Photos were taken on sites of different ages on the volcano Llama in southern Chile. (Photos K. Müller-Hohenstein)



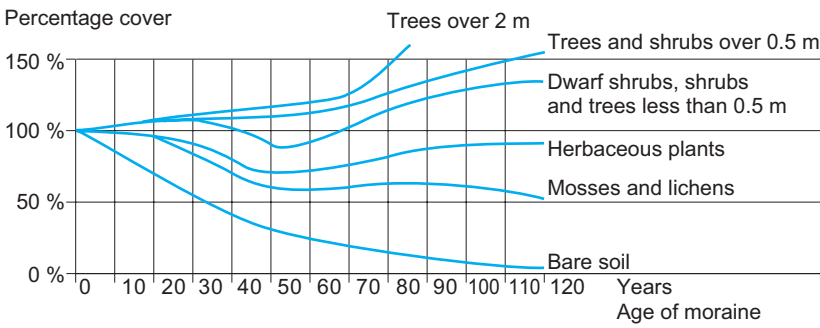


Fig. 4.1.40. Succession on moraines of the Aletsch glacier (Switzerland). (After Klötzli 1993)

Pioneers are slowly excluded. More demanding species gain space. If this change takes place solely because of the changes in the vegetation itself it is called **autogenic succession**. If other causes are more important – e.g. natural climate change or lower groundwater table caused by human extraction of water – this is called **allogenic succession**. If successions proceed under steady external conditions, there are further stages, after the pioneer stage, where competing species occur, which are superior to the pioneer species in vegetative and reproductive growth. These species grow taller, despite lower rates of

growth, because of their longer life span (occurrence and increase of phanerophytes), they are more shade tolerant but often have less effective mechanisms for distribution, despite their more effective occupation of space in the long term. Trees are superior to shrubs, **forming polycormones** (see Chap. 2.4, Fig. 2.4.30), which enable them to dominate for a certain time. In the final phase of such development, trees dominate (see Chap. 3; Fig. 3.2.14). This type of primary succession is understood to be progressive, as the diversity increases at the level of the species as well as with regard to their structure.

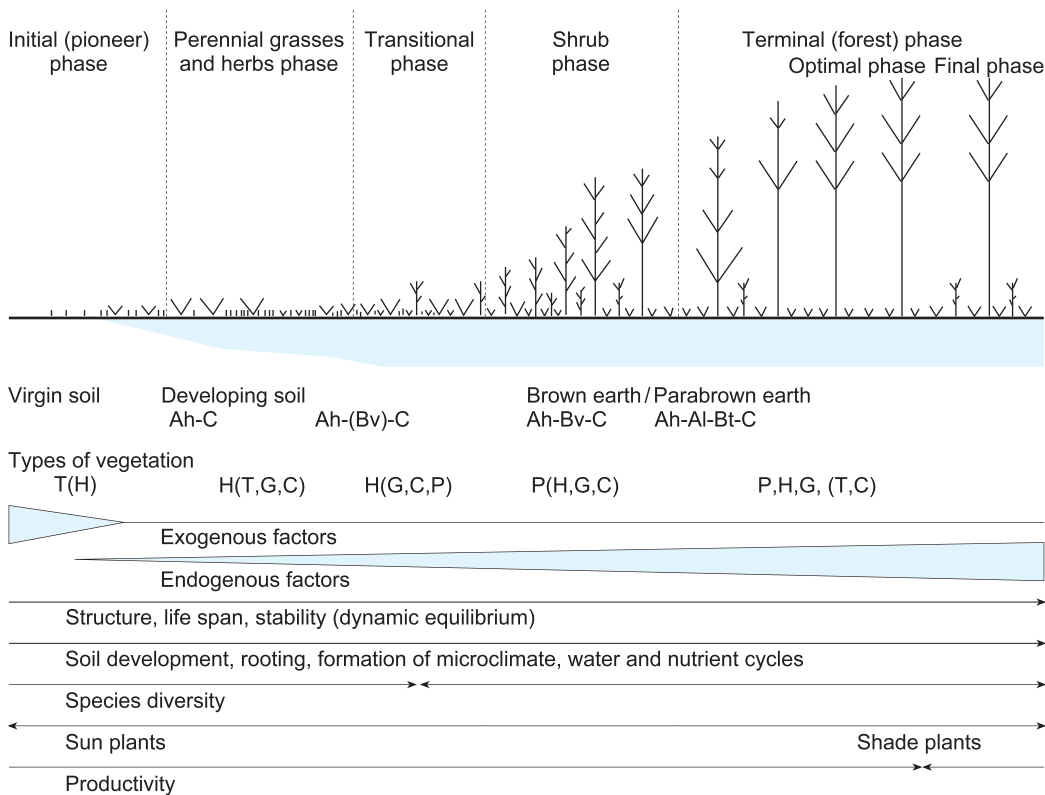


Fig. 4.1.41. Main characteristics of the progress of primary succession (on silicate rock and under subatlantic climatic conditions). (Dierschke 1994)

Dierschke (1994) tried to summarise common themes and dynamic trends, despite the apparent individuality of responses (Fig. 4.1.41). At the beginning of primary succession, chaotic interactions dominate, which cannot be predicted, as input and establishment of propagules are, to a high degree, stochastic. Widely distributed therophytes dominate. Between the development of vegetation and changes in the site feed-back mechanisms occur (Table 4.1.8). This means that plants themselves contribute, to a considerable degree, to creating environmental conditions for their species. The dominance of exogenous factors is only slowly substituted by endogenous factors, and is accompanied by a change of species and life forms. In the labile pioneer stages, intra- and interspecific competition is not very

important, but in the later stages competition plays a decisive role in the development of communities (see Chap. 3.2.1) which are more and more resistant to external disturbance, and, from the point of view of the plant community, is termed an increasingly saturated community.

Primary succession occurs faster under warm, humid climate conditions than under cold or dry conditions; deep soils are more favourable than bare rock. However, it is most important that development is not affected by disturbance, which can now only be very rarely excluded. Thus primary successions are particularly important for understanding of secondary successions which determine the actual vegetation dynamics in our environment.

Table 4.1.8. Environmental changes during succession. After Klötzli (1993)

1. Species structure	First rapid, then stepwise change
Species composition	Increasing, often early in secondary succession
Number of autotrophic species (autotrophic diversity)	Increasing, until late in secondary succession
Number of heterotrophic species (heterotrophic diversity)	Initially increasing, then stable or again decreasing
Species diversity	Initially broad then narrow
Niche specialists	Initially small then large
Size of organism	Initially brief and simple, then long and complex
Life cycle	Initially r-selection then K-selective
Selection pressure	Initially quantitative then qualitative
Type of production	
2. Nutrient cycles	
Cycles	Initially open then closed
Nutrient exchange	Initially rapid then slow
Role of organic debris (detritus)	Initially unimportant then very important
3. Organic structure	
Total biomass	Initially small then large
Stratification	Initially one layer then multiple
Inorganic nutrients	Initially in soil then in biomass
Recalcitrant organic material (e.g. humus)	Initially little then much
Biochemical diversity (e.g. pigments)	Initially low then high (increasing accumulation of toxins!)
Chlorophyll amount	Initially small then large (in secondary succession little difference!)
4. Energy flow	
Relation to the food chain	Initially simple (food chain) then complex (food web)
Gross primary production	During early phase of primary succession increasing (only limited or no increase in secondary succession)
Net primary production	Continuously decreasing
Total respiration	Continuously increasing
Primary production per unit respiration	Initially primary production greater than equal to respiration (steady-state condition)
Primary production per unit biomass	Initially large then small
Biomass per unit of energy	Initially small then large; therefore, minimal use of energy per unit of biomass
5. Homeostasis (ecological steady state, result of irreversible processes)	
Internal symbiosis	Initially not developed then developed
Nutrient storage	Initially small then large
Stability (resistance to disturbance)	Initially small then large
Entropy (increasing entropy)	Initially large (small) then small (constant)
Information	Initially small then large

Secondary Successions

Primary successions may develop into secondary successions because of disturbance (see also Chap. 3.2.5). There is a multitude of different types of **disturbance** which affect the sequence of vegetation so various secondary successions occur (Fig. 4.1.42 A,B).

Succession sequence may be classified into three types, according to the responses to disturbance (regarding the material balance of the ecosystem, see Chap. 3.2.5):

- Disturbance may interrupt the dynamics and the vegetation may thus remain at a certain stage (permanent communities).
- Changes occurring without clear direction within vegetation, e.g. because of long-term fluctuations in the water level.
- Influences mentioned can lead to faster or slower, and also irreversible, alterations. Such processes result in a reverse response of the direction of changes which is termed as regressive succession or also regression or retrogression. These include successions which occur as a consequence of over-exploitation or selective use of forests and pastures.

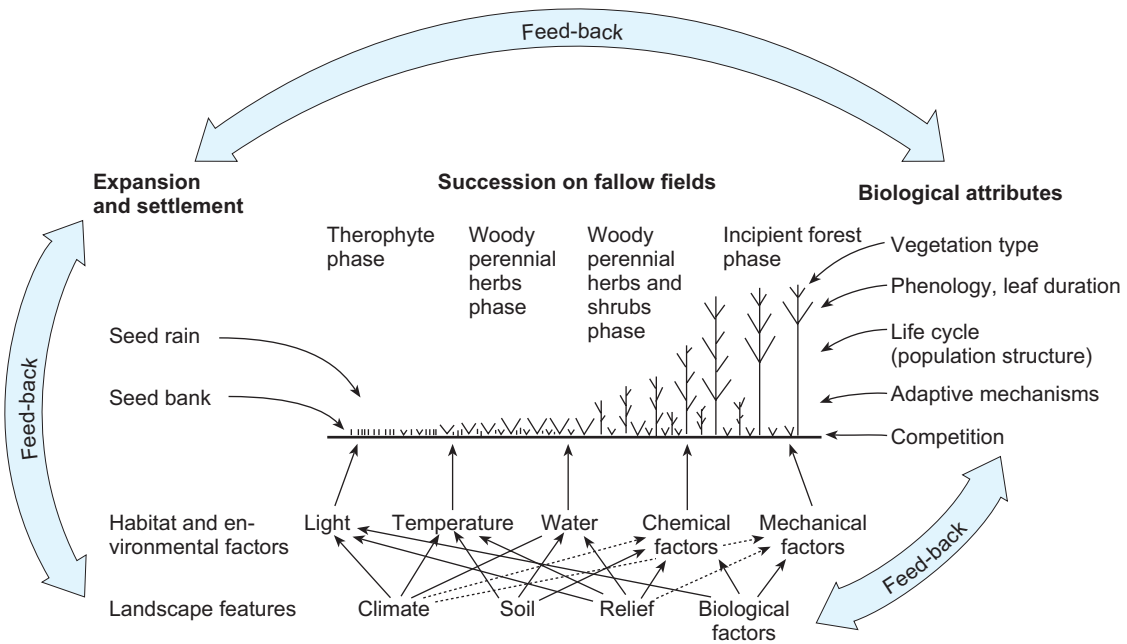
The most important secondary successions are those which aim to achieve the previous state after disturbance. These progressive sec-

ondary successions hardly differ in their development from primary successions. Here, too, the changes in direction lead to a more complex form of organisation in the plant community. However, secondary successions have a different initial stage. Their dynamic changes start from an already settled substrate and may build on an existing seed bank. This means that secondary successions progress faster than primary successions; right from the start there is competition for space and resources and only species able to compete are able to invade.

In central Europe numerous studies were made on secondary succession on fallow land and meadows. Schmidt (1993) describes succession over 25 years on (previously sterilised) fallow fields. After only 2 years occupation by therophytes, persistent herbaceous plants established until the eighth year, after which hemi-cryptophytes and shrubs occurred up to the twentieth year. Finally, successions continued with pioneer forest, or a pre-forest stage. These phases were initially limited by nutrients and light. Even if individual phases develop relatively regularly it is difficult to analyse this development and to determine the decisive factors determining the succession because of the many factors influencing and feeding back into the process (Fig. 4.1.43).



Fig. 4.1.42. Secondary successions develop after disturbances, which may be natural, e.g. in **A** when accumulated dead wood results from volcanic activity and subsequent fire in a forest community (in lower mountain forests on the Lanin volcano in southern Chile). However, **B** the disturbances can also be man-made, e.g. forests cleared by fire for range lands, not for timber, in southern Chile near Aisen. (Photos K. Müller-Hohenstein)



■ Fig. 4.1.43. Successions on fallowed agricultural fields: influencing factors and interrelations. (Schmidt 1993)

Secondary succession on fallow pasture is difficult because of the existing dense grassland community. Schreiber (1995) shows, from observations over 20 years, that establishment of woody plants occurs in several ways. Occasionally, well-known basic processes in the succession of different types of plants from annuals to woody species occur. However, pastures, initially relatively homogeneous, often show formation of dominance patterns with few species that cover the area well after just a few years. With good nutrient supply herbaceous plants dominate because biomass is not removed (autotrophication), but with poor nutrient supply grasses dominate. The temporal sequence of individual stages differs considerably. On some areas, 10–15 m high pre-forest vegetation occurs; on other potential forest sites neither trees nor shrubs grow. The difference in appearance and establishment of woody plants does not fit any succession model so far described; a prediction on changes of life forms and species is not yet possible, even if occasionally such phases in vegetation dynamics may be clearly seen.

Secondary successions not only develop on fallow or abandoned land, but also in plant communities affected by disturbance such as from fire or avalanches. Here processes directed towards a re-establishment of the original status

occur and fit into a **cyclic regeneration scheme**. Examples originate from managed forests where man is the driving force of such cycles. Pignatti and Pignatti (1984) analysed such regeneration cycles for Mediterranean forests (Fig. 4.1.44) and showed two variants – one for regeneration after clearing, and one, more regressive, succession after several fires. After clearing various weeds appear which are excluded by oaks. Repeated fires lead to a permanent stage, with regeneration occurring – if at all – only after a long period.

A special case of secondary succession is the polycormophyte succession. Vegetative side shoots of plants form shoot colonies, able to expand in closely covered herbaceous plant communities faster than via seeds. This type of succession usually starts with a pioneer woody species with defence against herbivores, e.g. *Prunus spinosa*. Such plants are able to survive over large areas for decades. Finally, higher growing unprotected shrubs and trees establish in the centres of such areas, so that forest islands and, ultimately, closed forest areas may form (Hard 1975). This development may be interpreted as an autogeneous type of succession, regulated by the vegetation itself. Study of this form of succession allows strategies of competition in woody species to be recognised (Fig. 4.1.45).

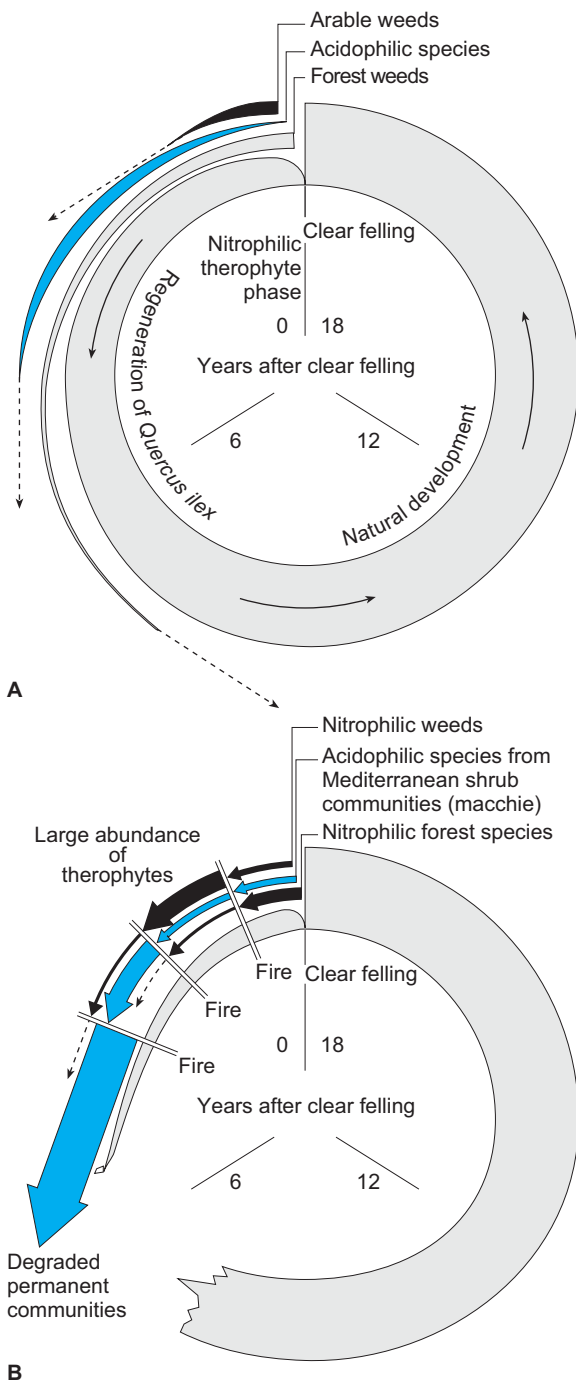


Fig. 4.1.44. Succession in a Mediterranean oak forest. **A** Cycles following clear felling. **B** Regression after multiple fires. (After Pignatti and Pignatti 1984, from Dierschke 1994)

The concept of successions as a directed, more or less deterministic process, and therefore also predictable, must be corrected according to empirical results obtained in recent decades.

These changes over time are very complex, there are many variables influencing development, e.g. site, biological reproduction, space and time. Particularly important is the type, intensity and duration of disturbance. All these factors make it difficult to regulate and predict successions.

Cyclic Vegetation Dynamics

Cyclic processes in the development of vegetation are also important, in addition to the directed – progressive or regressive – dynamic processes. Glavac (1996) interprets the final phase of secondary succession as a sort of self-preservation cycle. In a cyclic succession, different ages of plants enter and replace each other in the same vegetational community. Structural changes with the same or different species at one site are important. Remmert (1985) in particular – stimulated by ideas on cyclic successions from Aubréville (1949) – built on this interpretation and confirmed it theoretically, as well as practically. Further concepts about **cyclic vegetation dynamics** originated from Watt (1947) who introduced the term “gaps” into the discussion, i.e. sites where these processes take place. In each case an important observation was that the climax stage (mature stage) does not extend over enormous areas in natural forests, but that various phases of development are spread like a mosaic over the whole area. Displaced phases occur side by side, in small areas at all stages. For central European forest areas three phases are distinguished:

- an optimal phase corresponding to a forest of uniform age with few species; a closed stand with little undergrowth;
- ageing and decaying phases when the tree layer is disrupted over large areas and species requiring light and nutrient are able to invade;
- a rejuvenating and juvenile phase, with young plants of the same or different tree species, with the previous phases occurring again. Often light-demanding trees invade first, followed by shade-tolerant trees.

As explained in Chapter 3.2.1 these phases may be regarded as a continuous process of **self-thinning**.

Figure 4.1.46 shows schematically the cyclic dynamics for a tropical rain forest. The size of the pieces of the mosaic differs, depending on the diversity of species. In nemoral deciduous forests an average size of 1–2 ha is assumed, in

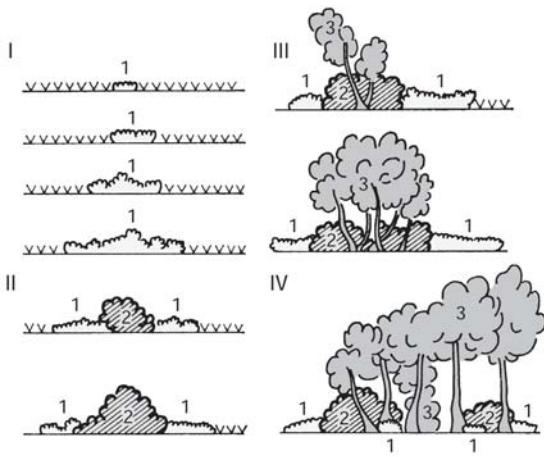


Fig. 4.1.45. Polycormophyte succession of woody species in grassland: 1 with establishment of low-growing woody species; 2 followed by tall-growing woody species; 3 with woody, tall trees. (After Hard 1975, from Dierschke 1994)

boreal forests the pieces of the mosaic are several square kilometres because of fires; in contrast, in tropical rain forests they are hardly ever larger than 100 m² (treefall gaps). The duration of cycles also differs. For the well-analysed forests of the boreal zone several centuries are assumed, in the North American sequoia forests

cycles last several thousands of years. Processes of vegetation dynamics similar to mosaic cycles have also been described for North Atlantic heath and bog complexes. For tropical communities (rain forests, savannahs, mangroves, coral reefs) this type of change occurs over time. This does not mean that the cycles must always be uniform. Certain phases may be left out.

Disturbance is again seen as the driving force for cyclic vegetation dynamics. The life span of “key organisms” is important, and competition following the death of key organisms for light and nutrients. Mechanical influences (wind breakage, fire) play an important role. Changed conditions in the site result from disturbance. Species which are able to obtain the necessary resources from the site after the disturbances can establish and their regeneration strategy enables them to start a new cycle.

Constant conditions are not to be expected in an **pristine forest**, it is a **mosaic of asynchronous phases of cyclic vegetation dynamics**. During the individual phases, structural characteristics of forests as well as the diversity change. This means that large sections of a forest contain all phases and possess normal population distribution of the dominant species. As a consequence, all phases in such vegetation dynamics

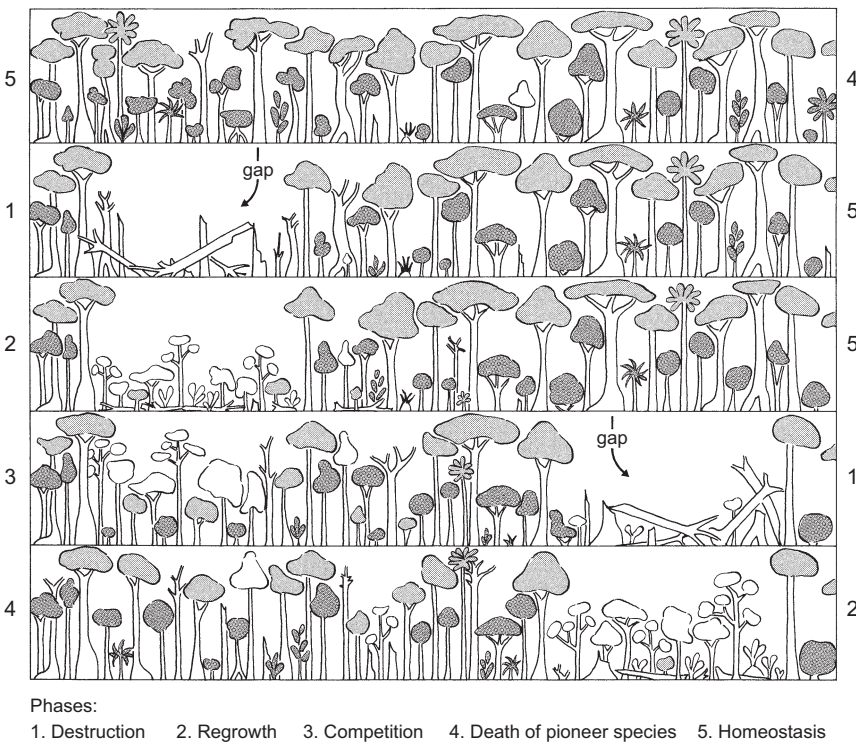
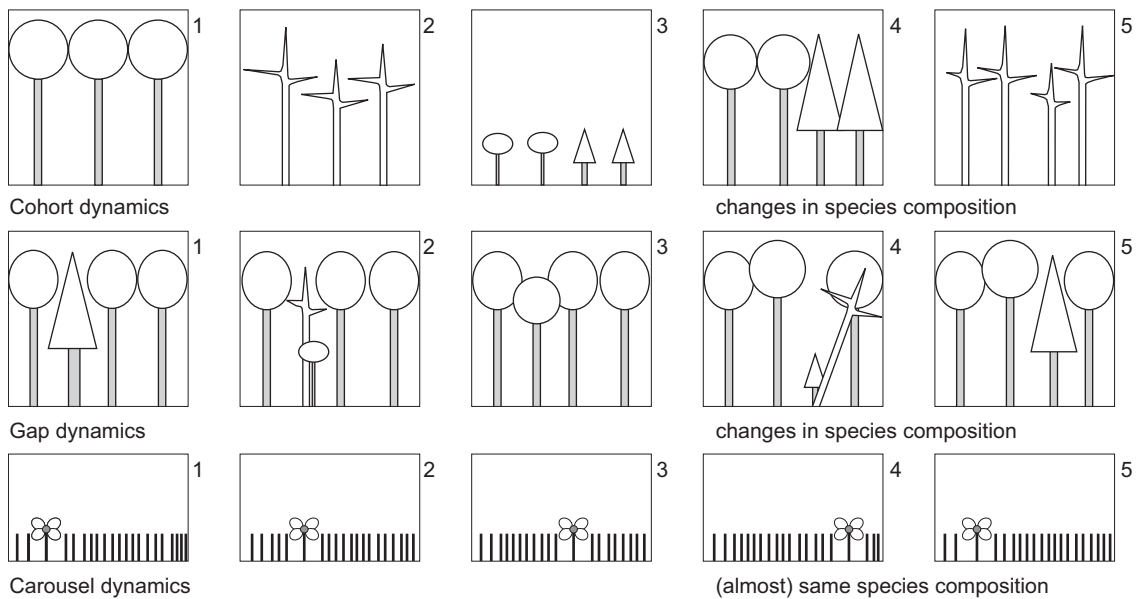


Fig. 4.1.46. Mosaic cycle in a tropical rainforest. From Richter (1997). *Open tree crown Pioneer species; thick tree crown canopy species; medium tree crown shade-tolerant species*



■ Fig. 4.1.47. Developmental phases of different types of plants during the changes in vegetation. (After Richter 1997)

must be regarded as a (dynamic) ecosystem with all biotic partners and the also changing abiotic conditions, as occurs in **sigma sociology** (Schwabe 1991). The term climax is also regarded in this mosaic concept as the sum of different stages of the affected system over a large area (Jax 1994).

Today, further types of cyclic vegetation dynamics are distinguished, based on questions of scale and preferential occurrence in different biomes. Formation of mosaics over large areas in Hawaii as a consequence of “**death of cohorts**” is described by Müller-Dombois (1995). Demographically unfavourable situations caused and maintained by fire and storm damage are the driving force. In this context, the endogenous mass-dying of bamboo-like grasses in all tropical regions should also be included; so far this has not been convincingly explained.

In “**cohort dynamics**”, as in the mosaic cycle, the species composition may change. However, in the “**carousel dynamics**”, the pattern formation in grasslands, occurring over small areas, is not included according to Van der Maarel and Sykes (1993). The basic idea of this change over time is that species are able to recycle in the short term and on smallest areas. A “**regeneration gap**” is sufficient free space for seeds and establishment of germinating plants. These spaces become available through endogenous death of individual plants, and are conquered in

a sort of “**guerrilla strategy**” or even according to the lottery principle of species in the community in which all have occupied the same regeneration niche. As these species are short lived, the carousel model describes vegetation dynamics at the smallest space and of the shortest duration. Populations of a species are always available, but are very mobile. The species composition remains constant. Figure 4.1.47 compares different spatial and temporal scales of cohort, gap and carousel dynamics schematically.

Aspects of Applied Succession Research

The dynamic nature of plant communities has often been recognised via bio-indicators. It is assumed that the response of a plant community to disturbance is specific, and perhaps quantifiable. The vitality of species of the plant community and shifts in the species spectrum are measured. Knowledge about the formation of plant communities and their regulation is gained by empirical findings of many succession studies. For instance pioneer plants with uniform seeds are selected for greening of open spaces, or to stabilise open slopes after road building (Fig. 4.1.48 A, B). It was believed, in many cases, that vegetation dynamics could be predicted.

Today, we know about asynchronous vegetation cycles and have doubts about the term “**ecological equilibrium**” and therefore realise the limits to practical application of current knowl-



Fig. 4.1.48. Pioneer plant species are able to start the succession on areas which require protection, such as those subject to erosion. *Pennisetum setaceum* (A) is a tussock grass with extensive roots which is suitable for stabilisation of steep slopes (mountains in Yemen Arab Republic). B As part of a project to protect against severe degradation of vegetation and soils in the Central Atlas Mountains (Morocco), a mixture of suitable plant species, such as dwarf and brush-wood scrubs, dwarf palms and *Opuntia* cactus, was used to achieve the initial stages in regeneration of the area. (Photos K. Müller-Hohenstein)

edge of vegetation dynamics. Measures for maintenance also need to be rethought, as well as minimum spatial dimensions of protected areas or the concepts of a biotope (Baierlein 1991). Without question, current knowledge of vegetation dynamics helps in the selection of replacement areas, where neighbouring areas have been lost because of disturbance and new communities are to develop (Beierkuhnlein 1998).

Biomonitoring was developed in order to understand syndynamic processes, to indicate damaging influences so that they could be quickly counteracted. Examples are air pollution, as well as eutrophication of water. Vegetation changes resulting from interventions at certain sites have also been recorded with biomonitoring. Knowledge of vegetation dynamics is important for cultivation and maintenance of plant communities, formed during the development of our landscape,

which might get lost without traditional forms of management. Grasslands without any fertilisation on not very fertile soils and grasslands on very shallow dry soils are examples of this.

Human influences may also degrade the vegetation and this can also be monitored. Multiple scales on hemeroby of spaces for vegetation have been devised (see Chap. 4.1.4.6). Red List species, loss of species, proportion of therophytes and neophytes are important values for structuring vegetation units according to the degree of human intervention. Ultimately, knowledge about vegetation dynamics is applied in attempts to improve areas to be used for agriculture or forestry and to control such attempts. Thus, for example, application of Ca-containing fertilisers in order to combat acidification of soils in forests and the effects of herbicide application in vineyards were assessed in this way.

4.1.5.3

Vegetation Dynamics and Strategy Models

Plants grow faster or slower, are able to tolerate more or less shade or are distributed near or far away from the mother plant. Such characteristics, acquired during the course of evolution, enable the plant to gain ground from competitors and to become established, and are often summarised by the term “strategy”. It is defined as the sum of genetically fixed physiological and morphological adaptations required to conquer a habitat and to persist with optimal use of resources (Dierschke 1994). Individual plants and populations are also classified using strategic aspects as plant functional types.

McCook (1994) showed, with five examples, how two different plant species with different characteristics may behave in competition (Fig. 4.1.49). The following basic variants are possible: One species loses out to the other at different rates, both species achieve a similar distribution, or both species become dominant at different times.

All strategy models are based on such assumed forms of behaviour, and differ only in the way they are interpreted. External influences are not considered (e.g. climate change, herbivory, mechanisms of distribution). As overlapping anthropogenic interference is also excluded, the knowledge gained is relatively limited. Other models originate from functional characteristics of the whole ecosystem and ask which of these have changed over time and how. These models usually generalise too much and the results are only roughly valid. Some models are only descriptive, others try to make predictions or attempt to explain current dynamic processes. However, no model provides a comprehensive explanation for the empirical findings from the field.

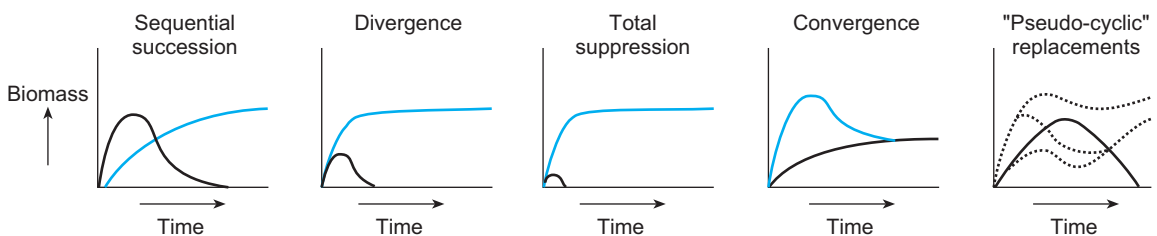
Initial Floristic Composition

The model based on Egler (1954) of initial floristic composition (IFC) is still used to describe the sequence of successions, because it represents sequences which are physiognomically recognisable. According to this model the complete set of species is present from the beginning and a sequence of succession takes place with only a few of these species – according to their special characteristics – becoming dominant. Figure 4.1.50 shows the course of growth for six species from germination via establishment of seedlings, through the vegetative and finally to reproductive growth phases. Species 1 to 4 are relatively short-lived therophytes to short-lived woody species, and species 5 and 6 are long-lived and shade tolerant. When the latter species are fully developed, the short-lived species are no longer able to maintain themselves and die off.

IFC is accepted as a **descriptive model** of primary as well as of secondary successions. As Egler stressed, there are no generally valid succession sequences because of external disturbance and the stress situations caused by them. Egler introduced the concept of **gradual change** as the centre point and prefers the term development of vegetation to that of succession. The great limitation of such a model is the exclusion of the propagule influx.

K and r Strategies

MacArthur and Wilson (1967) developed a model of r and K selection, within the framework of their work on island biogeography (see Chap. 4.2.3.1) which is used by botanists and zoologists to stress particularly contrasted behaviour of species. K means here “maximum population size” and r is the “rate of reproduction”. When classifying species in one or other group the type of reproduction is critical.



■ **Fig. 4.1.49.** Possible behaviour of two species during the course of succession. (After Huston and Smith 1987, from McCook 1994)

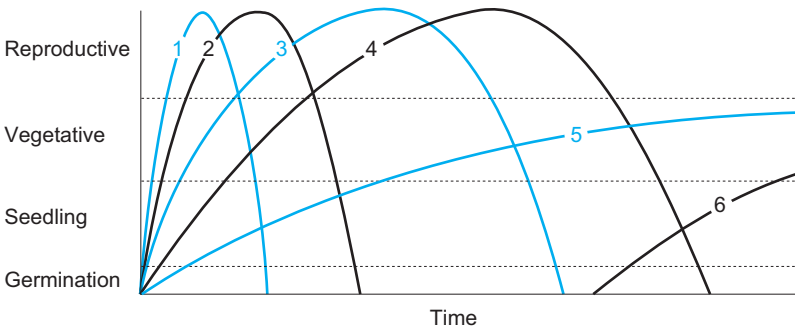


Fig. 4.1.50. Schematic of the initial floristic composition model of succession (the curves show the behaviour of six species). (After Finegan 1984)

r strategists form many, very small seeds representing a high proportion of their phytomass, have an efficient mechanism for distribution, grow fast without high rates of biomass accumulation, tolerate long periods of seed dormancy and can be activated very quickly. They are **short-lived opportunists**, able to establish faster in their environment than shade-tolerant species, but they are inferior to K strategists in their biotic environment.

K strategists are **long-lived**, slow growing and accumulate large amounts of biomass over time. For this reason, and because they are shade tolerant, they are able to gain ground in competition with the r strategists. They need to invest less in their reproduction and have only a few, large seeds which are not necessarily formed in each growing season (most years). However, they need to form metabolites for defense to protect long-lived leaves and other organs from herbivory. It therefore follows that r strategists

determine the early and early K strategists the late stages of succession. On fallow land, for example, annual and biennial species are replaced over time by shrubs and finally trees.

The classification of species into only two groups has often been criticised. The characteristics mentioned above are accepted as decisive, but a continuum is seen between the extreme positions of r and K strategists. **Figure 4.1.51** shows this continuum and also indicates that not only habitats are modified by r strategists which are disturbed in the short term, but also that they do not allow stress-free growth of the long-term established K strategists. With the requirement for **stress tolerance**, a **further strategy type** is indicated.

Strategy Types of Grime (C-S-R Model)

Grime (1974, 1979) and Grime et al. (1988) worked out one of the most well-known models of vegetation dynamics: The **triangle model of ecological primary strategies**. Stress tolerance, adaptation to unfavourable conditions and reaction to disturbance missing in the r/K strategy model were regarded as particularly important and therefore expanded. Three strategy types were introduced:

- **Competitor strategist (C):** Long-lived, competitive species on favourable sites without limitation of resources and almost stress free. They use resources particularly well, often possess storage organs and show considerable plasticity in root and shoot formation, continuously produce leaves which only live for a short time, and have low seed production. These are perennial herbs, shrubs and trees, hardly adapted to negative environmental influences as this is not required. They form medium to late succession stages.
- **Stress-tolerant strategist (S):** Species adapted to unfavourable sites with poor availability of

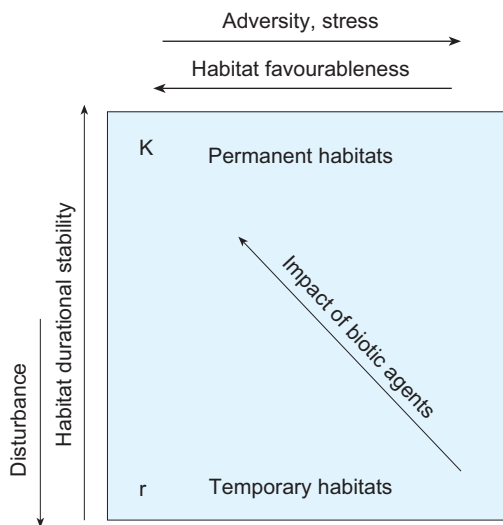


Fig. 4.1.51. Model of K- and r-selection considering the effects of stress. (After Southwood 1977, from Brown 1985)

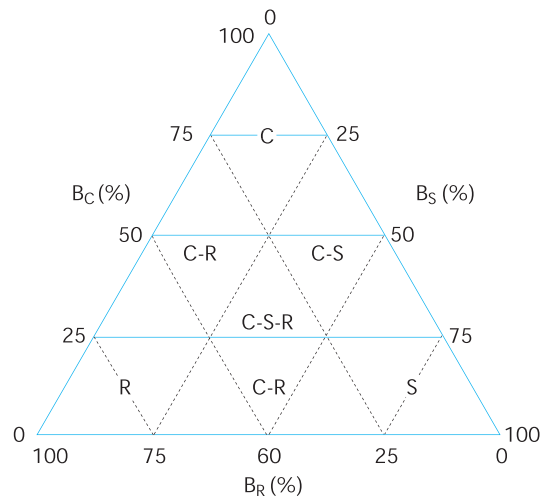
resources (inadequate light, drought, nutrient deficiency, frequent frosts, etc.). They are long-lived, but with low productive and reproductive rates and switch to sites with little competition (e.g. nutrient-poor grassland, saline sites). Extremely stress-tolerant species are lichens on cold and dry sites.

- **Ruderal strategists (R):** Short-lived, usually herbaceous species with fast growth rates and high seed production, usually self-pollinated with rapid seed ripening and distribution, disturbance-tolerant opportunists and pioneers but weak competitors. Therefore, they grow on sites with frequent, natural disturbance, such as rubble heaps and mechanically disturbed river banks.

However, it is difficult to classify many plant types in only one of these three extremes. Transitions can be observed frequently – plants with characteristics of several strategy types in different combinations. Thus, for example, on favourable sites where competitor strategists should dominate, C-R transition forms are found, if the favourable conditions are temporarily disturbed, for example, by mowing on agricultural meadows. Stress-tolerant competitor strategists (C-S) are long-lived species, e.g. many tree species of nemoral forests, adapted to non-optimum sites. Stress-tolerant ruderal strategists (S-R) grow on unfavourable sites which are often disturbed. Excluded is also an intermediary type (C-S-R) species combining several strategies, and often also in temporal sequence (e.g. many grasses).

Grime (1988) attributed life forms to some of his strategy types, and included them in areas of his “strategic triangle”; he also indicated these strategy types as succession sequences (Fig. 4.1.52) and suggested different possible rates of production. On productive sites development proceeded from ruderals via competitively strong types to those plants with competitive stress strategies. This applies in central Europe, e.g. to beech forests on limestone. On less productive sites, the final stage is determined by stress-tolerant species. The more productive the interactions at the site, the higher the proportion of competitively strong species in the middle succession period. The intensity of competition increases with increasing productivity at the site; however, Tilman (1990) contradicts this conclusion.

The universally valid system of classification which Grime tried to establish with his C-S-R



■ **Fig. 4.1.52.** C-S-R diagram of the different types of strategy according to Grime. C competitor species; S stress-tolerant species; R ruderal and intermediate types with the relative importance of competition (B_C), stress (B_S) and disturbance (B_R). (After Grime et al. 1988)

system was immediately criticised, because such a classification into individual types of strategy is not random, but is also not possible unequivocally. This makes quantitative evaluation difficult. Stress tolerance and ability to compete are often seen as two aspects of the same mechanism. Ultimately, in addition to genetically fixed characteristics of plants, those acquired are also important. They are not considered in this concept. Nevertheless, it cannot be left out of the discussion on vegetation dynamics because it started a controversy and provoked further models.

Resource Ratio Model of Tilman

All plant species are limited in their distribution by resources, which are difficult to acquire, but required for survival. If one species is successful in competition for such a **limiting resource**, it usually loses out in competition for another. This is the basic premise of Tilman (1990). He assumes further that the most important limiting resources in terrestrial habitats are either in the soil (and there usually nitrogen supply), or light. If these resources are limited they stress plants. These resources often behave inversely, i.e. with low nitrogen supply there are usually favourable light conditions, and commonly at sites with favourable conditions for plant nutrition, light is not easily available. Gradients between those two extremes lead to succession stages where plants replace each other according

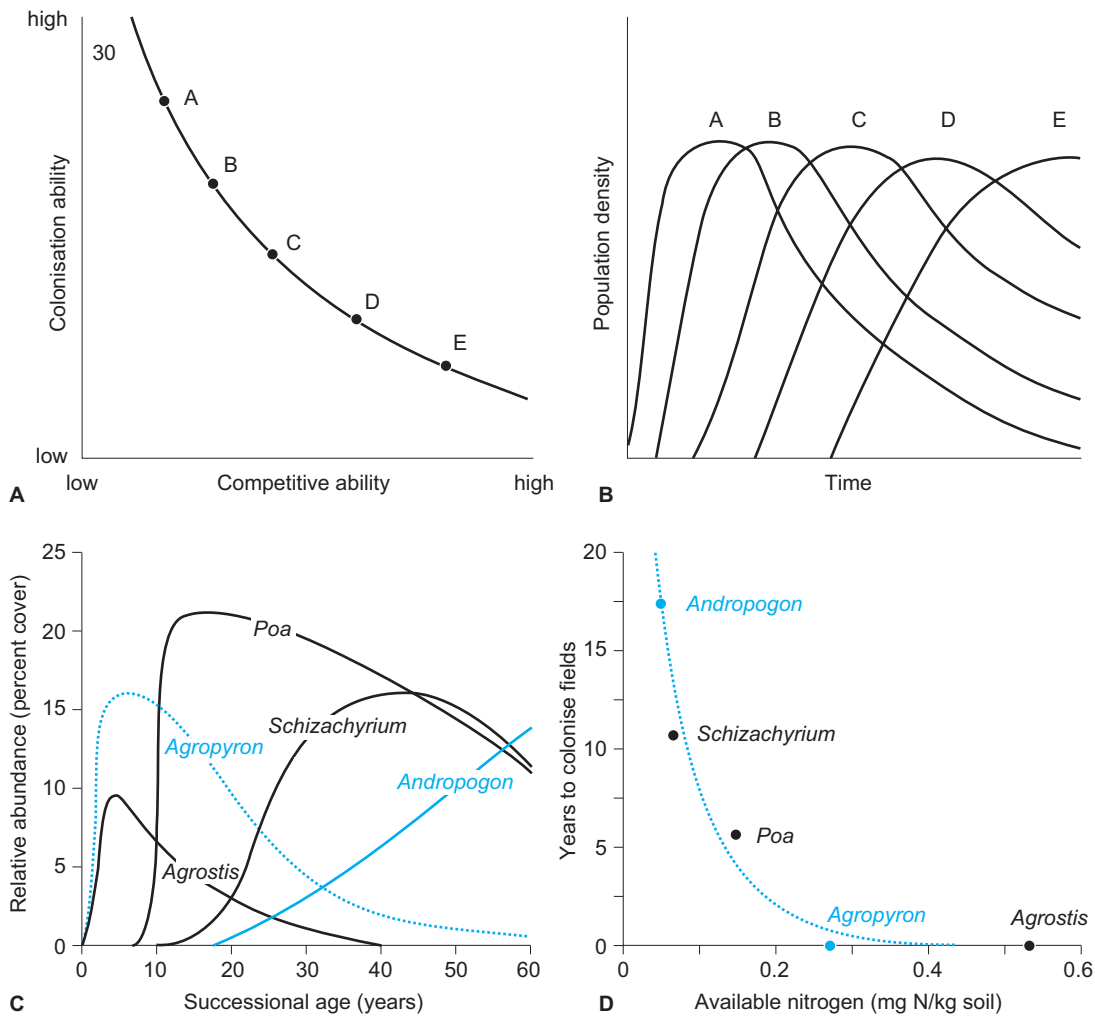


Fig. 4.1.53. Relationship between competition and colonisation ability. After Tilman (1990). **A** Hypothetical relation for five species (A–E). **B** Changes in the species A–E over time, based on their characteristics. **C** Observed changes in succession of five grass species (Tilman 1988). **D** Observed relationship between the time required for colonisation and competitive ability (expressed as available N) for the five grasses. (Tilman and Wedin 1991)

to their demands and their specific competitiveness. Each species grows fastest and reproduces best with the resources to which it is best adapted and where it, therefore, wins in competition. Sufficient root biomass is very important for obtaining sufficient nutrients, but also sufficient above-ground biomass is essential for light capture.

This explains not only the early and late stages of primary succession, but also secondary succession on nutrient-poor substrates. In primary succession, species able to cope with a poor nitrogen demand exclude those that require nitrogen. With time the nutrient situation improves because of mineralisation and nitrogen influx. Now species able to cope with less light are competitively

stronger. This hypothesis is the basis of the **resource ratio model** or the **nutrient-light relation model**. Simpler than this model are the ideas of the nutrient colonisation and light colonisation models. The former again applies to nutrient-limited habitats. Colonisers producing many seeds which they are able to distribute quickly are initially successful. However, they are weak in the competition for nutrients. Species that invest quickly in their root system are successful and therefore win the competition for nutrients. The corresponding situation applies to nutrient-rich habitats for light as the limiting factor. In Fig. 4.1.53, Tilman shows these interactions for five grass species demonstrating their ability for competition and colonisation.

From these models, consequences for biodiversity within areas may be derived. The more heterogeneous a space to be colonised – particularly regarding its natural features (nutrients, light, water etc.) and the natural and anthropogenic interference – the more species are able to grow there. It follows that with increasing heterogeneity not only biodiversity increases but, in the habitat, average required resources are available. Questions of dynamics and diversity are most closely linked according to Tilman's interpretation.

Tilman's ideas were not without controversy. He argued, for example at the species level, that in nature it is individual plants which compete with each other. It is suggested that he neglected dynamic processes in favour of assuming states of equilibrium. It is also difficult to imagine that species able to minimise their requirements would ultimately push out all other species. Despite this, the ideas of Tilman have led to the most widely accepted models of vegetation dynamics.

Facilitation – Tolerance – Inhibition – Models by Connell and Slatyer

Competition for resources at the site which may change in type and amount over time and disturbance of all kinds are also regarded by Connell and Slatyer (1977) as the driving forces of vegetation dynamics. They also stress the question of scale and thus suggest that certain forms of vegetation dynamics are only relevant at certain scales.

Three models, **succession pathways**, are considered by Connell and Slatyer to be at the centre (see [Box 4.1.6](#)):

- **Facilitation model:** Facilitation is understood as promotion or enabling, starting from the assumption that the first colonisers change the site conditions over the course of time autogeneously in such a way (change in substrate, formation of humus, etc.) that colonisation of more demanding species is stimulated. This is usually linked to displacement of the first colonisers as they are unable to cope with the competition of the newcomers.
- **Tolerance model:** Late succession species are neither stimulated nor inhibited. However, they are only able to establish if previously established individuals “make room”. The species now present compete and behave similarly to the resource ratio model of Tilman.

Species able to use resources most efficiently succeed.

- **Inhibition model:** Earlier colonists suppress or inhibit subsequent invaders. These are only able to establish if the stand is disturbed or short-term space becomes available because of death of individuals, but not because of their competitive strength.

All three models have been tested in field experiments. The facilitation model may be observed in primary successions, where pioneer species prepare the substrate, as well as after disturbance, because the succession is thrown back into an earlier phase. Both other model versions were tested in later, species-rich succession stages. The final steady-state stage is regarded as relatively stable, but cyclic dynamics are not excluded.

Connell and Slatyer also consider the question of stability (see [Chap. 4.1.6](#)) and regard succession as a balancing reaction of a “stable” system, which has been badly disturbed. Spatial and temporal extent of the disturbance as well as their type and intensity are decisive for the initial stage of following new successions. Connell and Slatyer conceded that their models, too, did not explain vegetation dynamics sufficiently. Exogenous influences, heterogeneity in small spaces as well as influences by faunistic partners are not included. There is a need to further differentiate between the three pathways formulated here because there are differences between facultative and obligate stimulation, between partial and exclusive inhibition, etc. Ultimately, species of early succession may stimulate as well as inhibit for subsequent colonisers (McCook 1994).

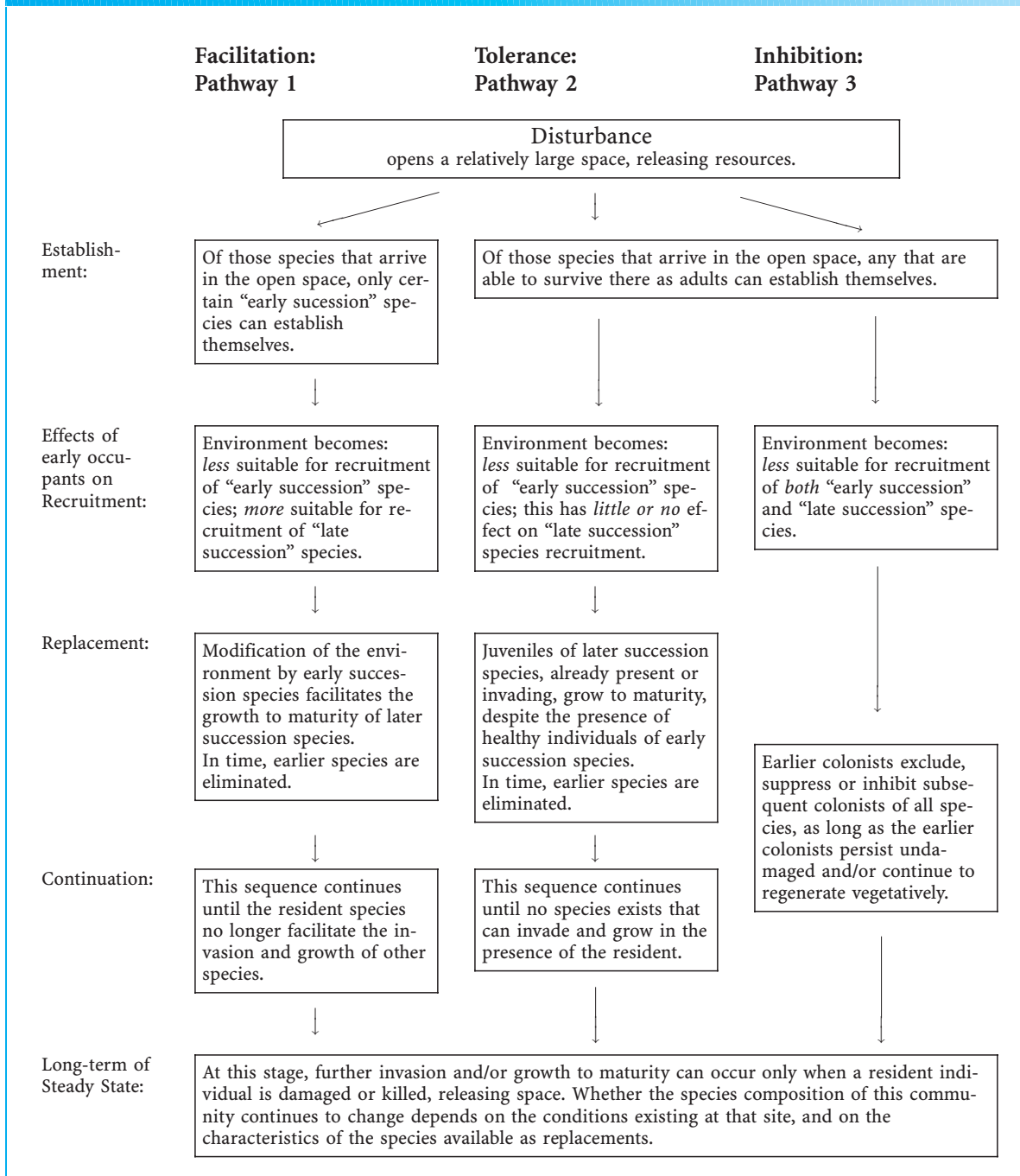
4.1.5.4

Vegetation Dynamics and Influence of Animals

At any time of a succession two important influences by animals must be taken into account. The spectrum of species may be changed by herbivory, or at least the conditions for competition are changed. This is rarely fully taken into account, as **herbivores** often eat seeds and seedlings and the extent of such disturbance is very difficult to evaluate. Often it is a matter of speculation, how the vegetation would have developed without herbivores. However, **animals** are also **vectors for propagules** and thus for the dis-

Box 4.1.6

Three "succession pathways" after Connell and Slatyer (1977) from McCook (1994)



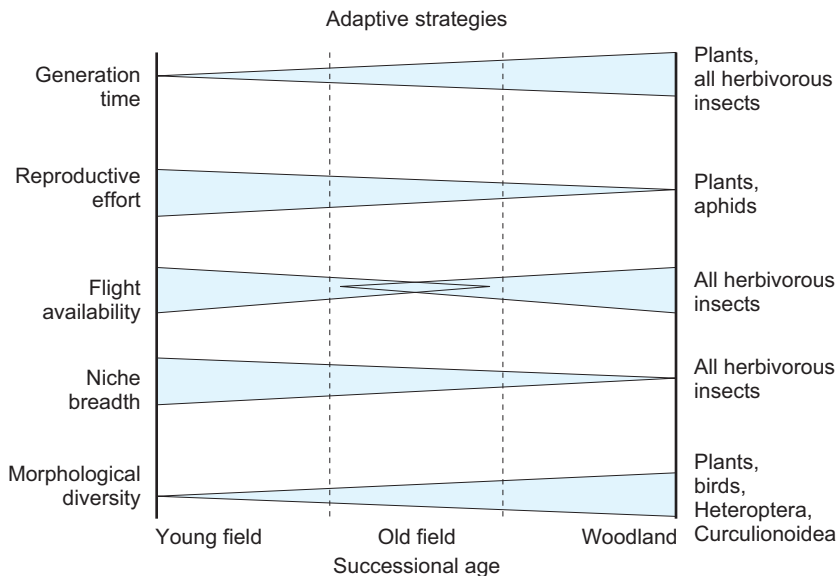


Fig. 4.1.54. Adaptive strategies of plants and animals during secondary succession. (After various sources from Brown and Southwood 1987)

tribution of species, and they participate decisively in the formation of spatial patterns and the composition of vegetation units. In addition, animals change the site by their excrement (e.g. resting sites) and by their mechanical activities and soil disturbance.

There is much evidence that animals, too, exhibit a distinct dynamics. In the initial stages of succession, herbivores dominate with 93% of all insect species during older stages this proportion decreases to 51%, and in forests it is only 44%. During the initial stages, sap-sucking phytophages make up half of that population, later only a quarter. Macroinvertebrates and predators associated with them increase with the age of the succession. Brown and Southwood (1987) tried to derive from these observations basic adaptation strategies for plants and animals during succession (Fig. 4.1.54). They concluded that faunistic partners in the early stages of succession usually are opportunists (*r* strategists) investing in their reproduction. Many insects are able to fly, promising fast colonisation. Phytophages are generalists with only simple nutrition chains. In the middle stage, secondary consumers are also represented amongst the animals, particularly insectivores. Nutrient chains and the complete structural organisation of the habitat become more complex. Litter may be colonised. Many insects no longer have wings, invertebrates are uniformly distributed. The enormous structural diversity of vegetation in the mature phase means a large number of niches for specialists. Morphological (and trophical) di-

versity in invertebrates (particularly insects) and vertebrates (particularly birds) is high and *K* strategists dominate even for animals.

Some models formulated for vegetation dynamics may also be transferred to animals or were originally developed for them (*K* and *r* strategists), an important aspect for understanding dynamics and biocenoses.

4.1.5.5

Future Aspects for the Understanding of Vegetation Dynamics

Concepts of vegetation dynamics incorporated into the enormous complexity of ecosystems should be supplemented, e.g. those concerning **convergence and divergence** in the development of successions (Leps and Rejmanek 1991), the **continuum concept** by Austin (1985) or the discussion of **chaos theory and non-linear systems** (Stone and Ezrati 1996). These models, as well as those with partially overlapping concepts covered previously, show that it is not possible to describe vegetation dynamics (and even less so dynamics of communities or ecosystems) with “one simple formula”. Complex processes and pattern of such a dynamics may only be generalised or modelled to a certain extent. Descriptive models of the sequence of individual species are accepted, but explain little. There is also little emphasis of the fact that a species behaves differently in its juvenile stage than in its older stages. As summarised by Bazzaz (1990): “De-

spite much progress in modelling succession, the tension between simplicity of models for prediction and complexity to include all relevant parameters remains unsolved.”

A path towards better understanding of processes and mechanisms of vegetation dynamics could be the integration of previous information from experimental concepts. Note should be taken of different spatial and temporal scales and integration and organisational levels of plants – individual, species, population, community. Empirical results of long-term studies should be used for verification. The results by Schreiber (1995) on very detailed succession studies over more than 20 years (on fallow land) do not fit into any succession model. This means that succession can hardly be predicted, and planning based on such predictions is risky.

4.1.6

Stability of Plant Communities

The topics of succession and cyclic vegetation dynamics touch questions of “stability” of plant communities and whole ecosystems as well as the concept of **ecological balance**. There is still much controversy surrounding this complex topic, particularly the broad spectrum of the understanding of what stability is and of the characteristics required for stability (Grimm et al. 1992). Temporal and spatial scales are not considered sufficiently, stability is related to momentary conditions, years extended to centuries, the phytocenoses considered extrapolate from only a few square centimetres up to many square kilometres. In all cases the stability-instability is linked to disturbance and stress.

Stability is often discussed together with **diversity** and **complexity** (Pimm 1984; see also Chap. 4.2.4). For a long time it was believed that high diversity would bring high stability, and should be regarded as the basic precondition for stability. Meanwhile, results have been obtained for the other extreme, namely high stability with low diversity. It appears plausible that species-rich and niche-rich biocenoses are particularly stable, because they are able to better balance the loss of a species, because their functions may be taken over by another species. However, it is very difficult to recreate very disturbed cycles.

4.1.6.1

Breadth of the Terms “Ecological Stability” and “Ecological Equilibrium”

The many definitions of ecological stability point to special, as well as many common, aspects. Generally, these definitions are linked to the idea of a system able to maintain its structures and functions in the long term. Sizes of populations of species may fluctuate around a mean value and the range is understood as ecological equilibrium. Changes of species are possible to a limited extent, but not that of life forms or functional groups. However, it is actually the latter that provide functional relations, the many different niches and feed-back mechanisms in a system. Theoretically, **stability** may be defined as the **sum of all system connections**.

Stability is a dynamic concept, despite all continuity in the face of changing environmental conditions, as the stability of processes is included. Stable systems react to disturbance and return to the initial stage by (self) regulation. Ecological stability includes cyclic changes, but not successions. A labile system is not able to balance changing external influences. Ultimately, stability may not be equated with constancy, as the latter excludes any change.

According to Schaefer (1992), four **basic types of stability** may be distinguished which could be applied to phytocenoses:

- **constancy** (the system is not disturbed and does not change from within);
- **cyclicity** (the system changes from within, but returns to the initial stage);
- **resistance** (the system is disturbed, but does not change);
- **resilience** (the system changes with disturbance, but returns to the initial stage).

These interpretations of stability consider the stress concept and were developed again by Pimm (1984) and Gigon (1984). Whilst stability is often taken as the basic precondition for the functioning of systems, occasionally stability is considered irrelevant (as not existing in any form), because no such order is recognisable in ecosystems (chaos theory).

Closely linked to ecological stability is **ecological balance**, which does not describe constant relations, but a dynamic system. According to Bick (1993) this implies two aspects. One of these is the export and import of nutrients and

water, and the formation and degradation of organic substances in an ecosystem (**equilibrium**). In agriculture the attempt is made to recreate this balance after harvesting by fertilisation. The others are biocenotic equilibria, species-to-species relations, and those of plants to herbivores or of partners in symbiosis. The (self) regulation of ecosystems is regarded as the most important factor for the maintenance of such dynamic equilibria.

4.1.6.2

Stress, Disturbance and Ecological Stability

Disturbance is not necessarily negative for the stability of ecosystems or communities and it can be essential for the maintenance of a dynamic balance. Thus a boreal larch forest would develop into quite a different system without the regular influence of fires. Influences which only transiently cause deviations from the system are called “**strain**”, those that actually change are “**stress**”. The same interfering factors may thus have different consequences for a system. Ultimately, disturbances have different spatial dimensions (Fig. 4.1.55).

Disturbance and strain are generally seen as influences which indicate a “situation deviating from the norm” and which lead to stress situations (Guderian and Braun 1993). To what extent the system can cope with the strain depends on the type, the intensity of the disturbance, the duration and the extent (see Fig. 4.1.55). However, the stability of a system is based on its sensitivity towards disturbance and its characteristics for regeneration after a disturbance. It may be particularly resistant or able to quickly re-

turn to the initial state (i.e. before the disturbance). If a system is able to cope with disturbance it is called **resilient**.

Disturbance may be inherent in the system, come randomly from outside, or may happen endogenously or exogenously, the latter caused naturally or anthropogenically. The failure for several years of precipitation in desert regions is an internal disturbance to the system, as is the regulation of population density based on predator-prey relationships, or on the dynamics of avalanches or earth flow of montane ecosystems. It is often difficult to distinguish which disturbance is caused by endogenous biological disturbances and which are caused by environmental influences.

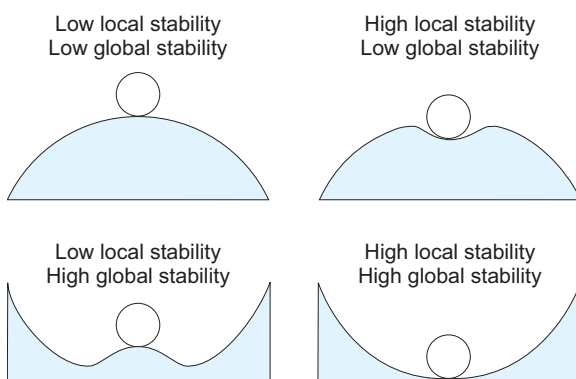
Walker (1989) summarised natural disturbance in an hierarchical order. Different spatial as well as temporal scales are taken into account. The scale extends from disturbances by continental drift with a scale of millions of square kilometres and years, to climate change and fluctuations which may only affect one climatic subzone and for a few thousand years, to damage by spring tides, late frosts or extreme herbivory effecting a few hectares over a very short time span.

4.1.6.3

Pimm and Gigon’s Concepts of Ecological Stability

Pimm (1984) attempted to provide a common basis for further understanding of ecological processes by clear differentiation of complexity and stability contrasted with interpretation of ecological stability. For the complexity in a system he regards **the number of species, connectance and interaction strength** and the **evenness of species distribution** as the most important characteristics. This leads to five different terms currently used in discussion on stability.

- Stability, in its narrower definition, implies that all system elements affected by a disturbance return to the original balanced state (an ecological balance).
- Stability is related to the period required until the original state is re-established. This shows the resilience of the system.
- Persistence is the third term, also connected to time. The deviation of the period which passes before individual elements of the sys-



■ Fig. 4.1.55. Relations between different spatial scales (local, global) and stability. (Begon et al. 1999)

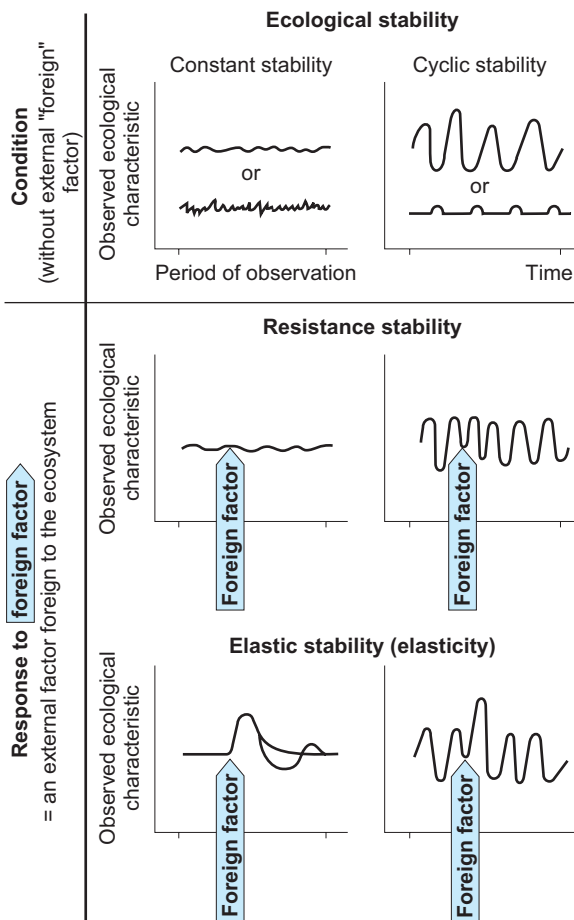


Fig. 4.1.56. Basic types of ecological stability, according to the dynamics of chosen characteristics and to the presence or absence of external factors. (Gigon 1984)

tem are permanently changed by the disturbance is measured.

- Resistance, as the fourth term, expresses the extent of change of a system element after disturbance.
- Variability of the system must be considered. This includes the variance of population density and abundance over time, measured as deviation of mean densities.

Pimm (1984) explains that it is very important to include temporal and spatial scales in all discussion of ecological stability.

Gigon (1984) also starts from this basis and suggests from this that ecological stability should not only be related to considerations of balance. Other stabilising mechanisms have more influence, such as inertia, buffer effects, the replacement principle and risk distribution in an ecosystem. Important characteristics are

the basic dynamic behaviour of ecosystems and the availability (or lack) of disturbance. He also states much more clearly than before that imbalances and instabilities in nature are just as decisive for evolution as balance and stability.

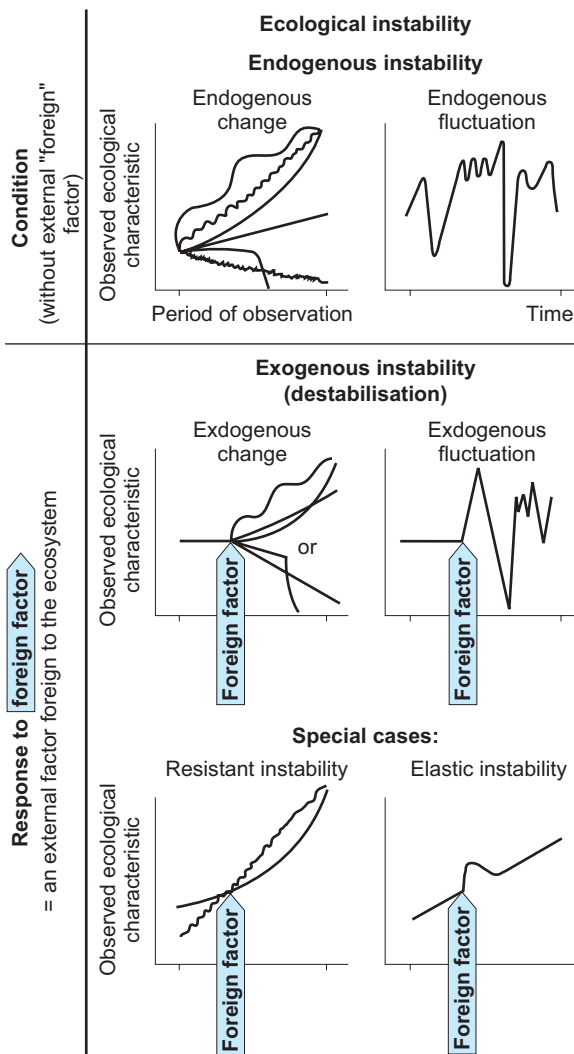
Gigon thus differentiates:

- **ecological stability**, which includes the immutability of a system or its ability to achieve the initial position again after a disturbance;
- **ecological instability**, where changes after a disturbance cannot be reversed;
- **ecological lability** which is a transient phase with a strong disposition to change by disturbance.

Forms of ecological stability may be described as constancy, if no actual changes take place (except the change of individual plants) or as resistance, if disturbance is buffered (Fig. 4.1.56). In these cases, the affected systems remain almost unchanged. Other forms where a major dynamic is apparent, but still the initial position is reached, may be called cyclic with regular fluctuations and regeneration cycles, or as resilient, if regeneration takes place after irregularly occurring disturbance.

Forms of instability (Fig. 4.1.57) lead to changes: these may be triggered endogenously (e.g. in autogenic successions) or exogenously (because of the effects of disturbance) or on the other hand cause either endogenous or exogenous fluctuations (e.g. mass reproduction of insects or fluctuations of yield in agriculture because of pathogen attack).

Forms of stability and instability sketched here may occur in the same system. An individual tree behaves differently to a complete forest; a locally destructive fire may be necessary for the maintenance of the system over a large area. With this interpretation a clear, practically oriented concept is provided, which may, in many cases, serve as an ordering scheme. Only few cases do not fit into this concept because of insufficient observations or insufficient knowledge of the interfering factors. It must be stressed that no value judgement is implied by this scheme. A stable system will possibly be judged differently by a farmer than by an environmentalist, by a skier differently to a hunter. **Evaluation of stability**, oriented on standards and models, must include a **practice oriented synecology**.



■ **Fig. 4.1.57.** Basic types of ecological instability, according to the dynamic of chosen characteristics and to the presence or absence of external foreign factors. (Gigon 1984)

References

- Abt K (1990) Auswirkungen des Agrarstrukturwandels auf Streuwiesen und zweischürige Futterwiesen im württembergischen Allgäu. *Verh Ges Ökol* 19/2:434–441
- Aubréville A (1949) *Climats, forêts et désertification de l'Afrique tropicale*. Soc Ed maritimes et coloniales, Paris
- Austin MP (1985) Continuum concept, ordination methods and niche theory. *Ann Rev Ecol Syst* 16:39–61
- Badal E, Bernabeu J, Vernet JL (1994) Vegetation changes and human action from the Neolithic to the Bronze Age (7000–4000 bp) in Alicante, Spain, based on charcoal analysis. *Veget Hist Archeobot* 3:155–166
- Baierlein F (1991) Biotopverbundsysteme und das Mosaik-Zyklus-Konzept. *Laufener Seminararbeiten* 5/91:45–51
- Barbault R, Sastrapradja SD (1995) Generation, maintenance and loss of biodiversity. In: Heywood VH, Watson RI (eds) *Global biodiversity assessment*. Cambridge University Press, Cambridge, pp 193–274

- Bazzaz FA (1990) Plant-plant interactions in successional environment. In: Grace JB, Tilman D (eds) *Perspectives on plant competition*. Academic Press, San Diego, pp 239–263
- Beierkuhnlein C (1998) Biodiversität und Raum. *Die Erde* 128:81–101
- Begon M, Harper JL, Townsend C (1999) *Ecology*, 3rd edn. Blackwell, Oxford
- Bick H (1993) *Ökologie*. Fischer, Stuttgart
- Böcker R, Gebhardt H, Konold W, Schmidt-Fischer S (1995) Neophyten – Gefahr für die Natur? Zusammenfassende Betrachtung und Ausblick. In: Böcker R, Gebhardt H, Konold W, Schmidt-Fischer S (Hrsg) *Gebietsfremde Pflanzenarten. Auswirkungen auf einheimische Arten, Lebensgemeinschaften und Biotope. Kontrollmöglichkeiten und Management*. Ecomed, Landsberg, pp 209–215
- Bornkamm R (1980) Hemerobie und Landschaftsplanung. *Landschaft und Stadt* 12:49–55
- Braun-Blanquet J (1928) *Pflanzensoziologie, Grundzüge der Vegetationskunde*. Springer, Berlin Heidelberg New York
- Brown VK (1985) Insect herbivores and plant succession. *Oikos* 44/1:17–22
- Brown VK, Southwood TRE (1987) Secondary succession: patterns and strategies. In: Gray AJ, Crawley MJ, Edwards PJ (eds) *Colonisation, succession and stability*. Blackwell, Oxford, pp 315–337
- Bruenig EF (1991) Functions of the tropical rainforest in the local and global context. *Gießener Beitr Entwicklungsforsch Reihe* 1(19):1–13
- Burrlicher E, Hüppe J, Pott R (1993) Agrarwirtschaftlich bedingte Vegetationsbereicherung und -verarmung in historischer Sicht. *Phytocoenologia* 23:427–447
- Claussen M (2001) Biogeographical feedbacks and the dynamics of climate. In: Schulze ED (ed) *Global biogeochemical cycles in the climate system*. Academic Press, San Diego
- Clements FE (1916) *Plant succession: an analysis of the development of vegetation*. Carnegie Institute, Washington
- Connell JH, Slatyer RO (1977) Mechanisms of succession in natural communities and their role in community stability and organisation. *Am Nat* 111:1119–1144
- Cornelius R (1991) Populationsbiologische Grundlagen des speziellen Artenschutzes. *Verh Ges Ökol* 20:905–916
- Deil U (1995) Vegetation und rezenter Landschaftswandel im Campo de Gibraltar (Südwestspanien) und im Tangerois (Nordwestmarokko). *Geoökodynamik* 16:109–136
- Deil U (1997) Zur geobotanischen Kennzeichnung von Kulturlandschaften – Vergleichende Untersuchungen in Südspanien und Nordmarokko. *Erdwissenschaftliche Forschung* 36, Wiesbaden Stuttgart
- Deil U, Müller-Hohenstein K (1986) Beiträge zur Vegetation des Jemen. I. Pflanzengesellschaften und Ökotoptgefüge der Gebirgstihamah am Beispiel des Beckens von At Tur (J.A.R.). *Phytocoenologia* 13:1–102
- Di Castri F (1990) Biological invasions in Europe and the Mediterranean basin. Kluwer, Dordrecht
- Dierschke H (1984) Natürlichkeitsgrade von Pflanzengesellschaften unter besonderer Berücksichtigung der Vegetation Mitteleuropas. *Phytocoenologia* 12:173–184
- Dierschke H (1989) Kleinräumige Vegetationsstruktur und phänologischer Rhythmus eines Kalk-Buchenwaldes. *Verh Ges Ökol* 17:131–144
- Dierschke H (1994) *Pflanzensoziologie. Grundlagen und Methoden*. Ulmer, Stuttgart
- Egler FE (1954) Vegetation science concepts I. Initial floristic composition, a factor in old-field vegetation development. *Vegetatio* 4:412–417
- Ellenberg H (1954) Zur Entwicklung der Vegetationssystematik in Mitteleuropa. *Angew Pflanzensoziol* 1:133–143

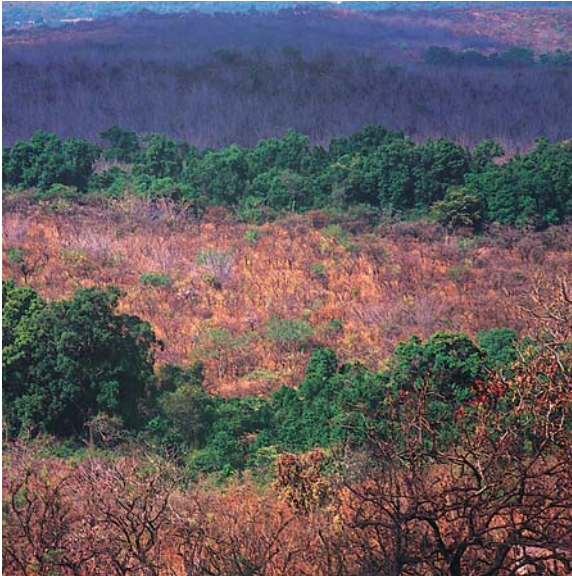
- Ellenberg H (1978) Wege der Geobotanik zum Verständnis der Pflanzendecke. In: Lauer W, Klink HJ (Hrsg) Pflanzengeographie. Wege der Forschung Bd 130, Wissenschaftliche Buchgesellschaft, Darmstadt, pp 40–65
- Ellenberg H (1996) Die Vegetation Mitteleuropas mit den Alpen. Ulmer, Stuttgart
- Elton CS (1958) The ecology of invasion by animals and plants. Methuen, London
- Finckh M (1995) Die Wälder des Villarrica-Nationalparks (Südkile) – Lebensgemeinschaften als Grundlage für ein Schutzkonzept. Diss Bot 259:1–181 Berlin Stuttgart
- Finckh M, Deil U (1989) Approches de l'étude de la dégradation des forêts du Jebel Bougriy (Moyen Atlas Central). RGM 13/1:55–69
- Finegan B (1984) Forest succession. Nature 312:109–114
- Firbas F (1949–1952) Waldgeschichte Mitteleuropas. 3 Bd. Fischer, Jena
- Frenzel B (1968) Grundzüge der pleistozänen Vegetationsgeschichte Nord-Eurasiens. Erdwissenschaftliche Forsch 1:1–326
- Furley PA (1993) Tropical moist forests: transformation or conservation. In: Roberts N (ed) The changing global environment. Blackwell, Oxford, pp 309–331
- Gigon A (1984) Typologie und Erfassung der ökologischen Stabilität und Instabilität mit Beispielen aus Gebirgsökosystemen. Verh Ges Ökol 12:13–30
- Glavac V (1996) Vegetationsökologie. Grundfragen, Aufgaben, Methoden. Fischer, Jena
- Gleason HA (1926) The individualistic concept of the plant association. Bull Torrey Bot Club 53:7–26
- Goudie A (1994) Mensch und Umwelt. Spektrum, Heidelberg
- Gradmann R (1933) Die Steppenheide Stuttgart. Dtsch Lehrerver Naturkd 98–128
- Grime JP (1974) Vegetation classification by reference to strategies. Nature 250:26–31
- Grime JP (1979) Plant strategies and vegetation processes. Wiley, Chichester
- Grime JP, Hodgson JP, Hunt R (1988) Comparative plant ecology. Unwin, London
- Grimm V, Schmidt E, Wissel C (1992) On the application of stability concepts in ecology. Ecol Modell 63:143–161
- Guderian R, Braun H (1993) Belastbarkeit von Ökosystemen. In: Kuttler W (Hrsg) Handbuch zur Ökologie. Analytica, Berlin, pp 55–60
- Hard G (1975) Vegetationsdynamik und Verwaltungsprozesse auf den Brachflächen Mitteleuropas. Die Erde 4:243–276
- Hector A, Schmid B, Beierkuhnlein C, Caldeira MC, Diemer M, Dimitrakopoulos PG, Finn J, Freitas H, Giller PS, Good J, Harris R, Höglberg P, Huss-Danell K, Joshi J, Jumpponen A, Körner C, Leadley PW, Loreau M, Minns A, Mulder CPU, O'Donovan G, Otway SJ, Pereira JS, Prinz A, Read DJ, Scherer-Lorenzen M, Schulze ED, Siamantziouras ASD, Spehn E, Terry AC, Troumbis AY, Woodward FI, Yachi S, Lawton JH (1999) Plant diversity and productivity experiments in European grasslands. Science 286:1123–1127
- Heitzmann-Hofmann A (1993) Einsaat und Sukzession ausgewählter, nützlingsfördernder Pflanzenarten in Ackerandstreifen. Verh Ges Ökol 22:66–72
- Hellden U (1991) Desertification – time for an assessment? Ambio 20:372–383
- Hüppe J (1989) Die Genese moderner Agrarlandschaften in vegetationsgeschichtlicher Sicht. Verh Ges Ökol 19:424–432
- Ibrahim FN (1988) Ecological imbalance in the Republic of the Sudan – with reference to desertification in Darfur. Bayreuther Geowissenschaftliche Arbeiten 6
- IPCC-WGI (2001) Climate change 2001, the science of climate change. Contribution of working group I to the 3rd assessment report of the intergovernmental panel on climate change. Cambridge University Press, Cambridge
- Jäger EJ (1977) Veränderungen des Artenbestandes von Floren unter dem Einfluß des Menschen. Biol Rundsch 15/5:287–300
- Jäger EJ (1988) Möglichkeiten der Prognose synanthroper Pflanzenausbreitung. Flora 180:101–131
- Jax K (1994) Mosaik-Zyklus und patch-dynamics: Synonyme oder verschiedene Konzepte? Eine Einladung zur Diskussion. Z Ökol Natursch 3:107–112
- Jochimsen ME (1993) Sukzession. In: Kuttler W (Hrsg) Handbuch zur Ökologie. Analytica, Berlin, pp 418–424
- Klötzli F (1993) Ökosysteme, 3. Aufl. Fischer, Stuttgart
- Kohlhepp G (1991) Ursachen und aktuelle Situation der Vernichtung tropischer Regenwälder im brasilianischen Amazonien. Kieler Geogr Schr 73:87–110
- Kreeb KH (1983) Vegetationskunde. Ulmer, Stuttgart
- Lamprey HF (1975) Report on the desert encroachment reconnaissance in northern Sudan. 21 October to 10 November 1975, UNESCO/UNEP
- Larcher W (1994) Ökologie der Pflanzen. Ulmer, Stuttgart
- Lauer W (1986) Die Vegetationszonierung der Neotropis und ihr Wandel seit der Eiszeit. Ber Dtsch Bot Ges 99:211–235
- Lauer W, Frankenberg P (1979) Der Jahresgang der Trockengrenzen in Afrika. Erdkunde 33/4:249–257
- Le Floch E, Le Houerou HN, Mathez J (1990) History and patterns of plant invasion in northern Africa. In: Di Castri F, Hansen AJ, Debussche M (eds) Biological invasion and the Mediterranean basin. Kluwer, Dordrecht, pp 105–133
- Le Houerou HN (1992) Climatic change and desertization. Impact Sci Soc 42:183–201
- Leps J, Rejmanek M (1991) Convergence or divergence: what should we expect from vegetation succession? Oikos 62/2:261–264
- Lohmeier W, Sukopp H (1992) Agriophyten in der Vegetation Mitteleuropas. Schriftenr Vegetationskde 25, 185 pp
- Lövei GL (1997) Global change through invasion. Nature 388:627–628
- MacArthur RH, Wilson EO (1967) Biogeographie von Inseln. Wissenschaftliche Taschenbücher, Goldmann, München
- McCook LJ (1994) Understanding ecological community succession. Vegetatio 110:115–147
- Melillo JM, Prentice IC, Farquahr GD, Schulze ED, Sala OE (1996) Terrestrial biotic responses to environmental change and feedbacks to climate. In: IPCC-WGI, 2nd Assessment report. Cambridge University Press, Cambridge, pp 445–482
- Merkel J, Walter E (1982) Rote Liste seltener und bedrohter Farn- und Blütenpflanzen in Oberfranken. Regierung von Oberfranken, Bayreuth
- Miles J (1987) Vegetation succession: past and present perceptions. In: Gray AJ, Crawley MJ (eds) Colonisation, succession and stability. Blackwell Scientific, Oxford
- Müller N (1995) Zum Einfluß des Menschen auf Flora und Vegetation von Flußauen. Schriftenr Vegetationskde 27:289–298
- Müller-Dombois D (1995) Biological diversity and disturbance regimes in island ecosystems. In: Vitousek PM, Loope LL, Andersen H (eds) Islands. Springer, Berlin Heidelberg New York, pp 163–175

- Müller-Hohenstein K (1973) Die anthropogene Beeinflussung der Wälder im westlichen Mittelmeerraum unter besonderer Berücksichtigung der Aufforstungen. *Erdkunde* 27:55–68
- Müller-Hohenstein K (1991) Der Mittelmeerraum. Ein vegetationsgeographischer Überblick. *Geogr Rundsch* 43/7–8: 409–411
- Müller-Hohenstein K (1993) Auf dem Weg zu einem neuen Verständnis von Desertifikation – Überlegungen aus der Sicht einer praxisorientierten Geobotanik. *Phytocoenologia* 23:499–518
- Neumann K (1988) Die Bedeutung der Holzkohlenuntersuchungen für die Vegetationsgeschichte der Sahara – das Beispiel Fachi/Niger. *Würzb Geogr Arb* 69:71–85
- Nicholson SE (1978) Climatic variations in the Sahel and other African regions during the past five centuries. *J Arid Environ* 1:3–24
- Odum EP (1980) *Grundlagen der Ökologie*. Bd 1. Thieme, Stuttgart
- Pachur HJ (1987) Gerinnenetze, Seen und Ergs der östlichen Sahara als Indikatoren quartärer Formungsdynamik. *Verh Dtsch Geographentages* 45:167–173
- Overbeck F (1975) Botanisch-geologische Moorkunde unter besonderer Berücksichtigung der Moore Nordwestdeutschlands als Quellen zur Vegetations-, Klima- und Siedlungsgeschichte. Wacholtz, Neumünster
- Pickett STA, White PS (1985) *The ecology of natural disturbance and patch dynamics*. Academic Press, New York
- Pignatti E, Pignatti S (1984) Sekundäre Vegetation und floristische Vielfalt im Mittelmeerraum. *Phytocoenologia* 12:351–358
- Pimm SL (1984) The complexity and stability of ecosystems. *Nature* 307:321–326
- Pott R (1996) Die Entwicklungsgeschichte und Verbreitung xerothermer Vegetationseinheiten in Mitteleuropa unter dem Einfluß des Menschen. *Tuexenia* 16:337–369
- Rabotnov TA (1974) Differences between fluctuations and successions. In: Knapp R (ed) *Vegetation dynamics*. Handbook of vegetation science 8. Junk, The Hague, pp 19–24
- Reif A (1987) Vegetation der Heckensäume des hinteren und südlichen Bayerischen Waldes. *Hoppea, Denkschriften der Regensburger Bot Ges* 45:277–343
- Remmert H (1964) Änderungen der Landschaft und ihre ökologischen Folgen, dargestellt am Beispiel der Insel Amrum. *Veröffentl Inst Meeresforsch Bremerhaven* 9:100–108
- Remmert H (1985) Was geschieht im Klimax-Stadium? Ökologisches Gleichgewicht aus desynchronen Cyclen. *Naturwissenschaft* 10:505–511
- Remmert H (ed) (1991) *The mosaic-cycle concept of ecosystems*. Springer, Berlin Heidelberg New York
- Remmert H (1992) *Ökologie*, 5. Aufl. Springer, Berlin Heidelberg New York
- Richter M (1997) *Allgemeine Pflanzengeographie*. Teubner, Stuttgart
- Riera-Mora S, Esteban-Amat A (1994) Vegetation history and human activity during the last 6000 years on the central Catalan coast (northeastern Iberian peninsula). *Veget Hist Archeobot* 3:7–23
- Schaefer M (1992) *Ökologie*. Fischer, Jena
- Scherer-Lorenzen M, Elend A, Nöllert S, Schulze E-D (2000) Plant invasions in Germany – general aspects and impact of nitrogen deposition. In: Mooney HA, Hobbs RJ (eds) *Invasive species in a changing world*. Island Press, Washington, pp 351–368
- Schmidt G (1969) *Vegetationsgeographie auf ökologisch-soziologischer Grundlage*. Teubner, Leipzig
- Schmidt W (1989) Struktur und Funktion von Straßenränder in der Agrarlandschaft. *Verh Ges Ökol* 19:566–591
- Schmidt W (1993) Sukzession und Sukzessionslenkung auf Brachäckern – neue Ergebnisse aus einem Dauerflächenversuch. *Scripta Geobot* 20:65–104
- Schreiber KF (1995) Renaturierung von Grünland – Erfahrungen aus langjährigen Untersuchungen und Managementmaßnahmen. *Ber Tüxen-Ges* 7:111–139
- Schröder FG (1969) Zur Klassifizierung der Anthropochoren. *Vegetatio* 16:225–238
- Schwabe A (1991) Perspectives of vegetation complex research and bibliographic review of vegetation complexes in vegetation science and landscape ecology. *Exzerpta Bot* 28:223–243
- Schwabe A, Kratochwil A (1991) Gewässer-begleitende Neophyten und ihre Beurteilung aus Naturschutz-Sicht unter besonderer Berücksichtigung Südwestdeutschlands. *NNA-Berichte* 411:14–27
- Stone L, Ezrati I (1996) Chaos, cycles and spatio-temporal dynamics in plant ecology. *J Ecol* 84:279–291
- Strasburger E, Sitte P (1998) *Lehrbuch der Botanik für Hochschulen*. Fischer, Stuttgart
- Sukopp H (1972) Wandel von Flora und Vegetation in Mitteleuropa unter dem Einfluß des Menschen. *Ber Landwirtschaft* 50:112–139
- Sukopp H, Wittig R (eds) (1998) *Stadtökologie*, 2nd edn. Gustav Fischer, Stuttgart
- Swift MJ, Anderson JM (1993) Biodiversity and ecosystem function in agricultural systems. *Ecological studies*, vol 99. Springer, Berlin Heidelberg New York, pp 15–41
- Tilman D (1988) *Plant strategies and the dynamic and structure of plant communities*. Princeton University Press, Princeton
- Tilman D (1990) Constraints and tradeoffs: towards a predictive theory of competition and succession. *Oikos* 58:3–15
- Tilman D, Wedin D (1991) Oscillation and chaos in the dynamics of a perennial grass. *Nature* 353:653–655
- Tüxen R (1956) Die heutige potentielle natürliche Vegetation als Gegenstand der Vegetationskartierung. *Angew Pflanzensoziol* 13:5–42
- van der Maarel E (1996) Pattern and process in the plant community: fifty years after AS Watt. *J Veg Sci* 7
- van der Maarel E, Sykes MT (1993) Small scale species turnover in a limestone grassland: the carousel model and some comments on the niche concept. *J Veg Sci* 4:179–188
- Walker D (1989) Diversity and stability. In: Chervett JH (ed) *Ecological concepts*. University Press, Oxford, pp 115–145
- Walter H (1960) *Grundlagen der Pflanzenverbreitung*. I. Teil: Standortslehre, 2. Aufl. Stuttgart
- Walter H (1973) *Die Vegetation der Erde*. I. Die tropischen und subtropischen Zonen, 3. Aufl. Fischer, Jena
- Walter H (1986) *Allgemeine Geobotanik*. Ulmer, Stuttgart
- Walter H, Straka H (1970) *Arealkunde (Floristisch-historische Geobotanik)*, 2. Aufl. Ulmer, Stuttgart
- Watt AS (1947) Pattern and process in the plant community. *J Ecol* 35:1–22
- Weisheit W (1977) Das ökologische Handicap der Tropen in der Wirtschafts- und Kulturentwicklung. In: 41. Deutscher Geographentag Mainz. *Tagungsbericht und wissenschaftliche Abhandlung*, pp 25–41
- Wissenschaftlicher Beirat der Bundesregierung Globale Umweltveränderungen (WBGU) (2000) *Welt im Wandel: Erhaltung und nachhaltige Nutzung der Biosphäre*. Springer, Berlin Heidelberg New York

- Wissmann H von (1957) Ursprungsherde und Ausbreitungswege von Pflanzen- und Tierzucht und ihre Abhängigkeit von der Klimageschichte. *Erdkunde* 11:175–193
- Wittig R, Diesing D (1989) Beziehungen zwischen Stadtstruktur und Stadtvegetation in Düsseldorf. *Braun-Blanquetia* 3:99–105
- Wittkamp J, Deil U, Beierkuhnlein C (1995) Sozialstruktur und Dorfvegetation – im Vergleich von Dörfern beiderseits der ehemaligen innerdeutschen Grenze. *Die Erde* 126:107–126
- Zwölfer H (1978) Mechanismen und Ergebnisse der Co-Evolution von phytophagen und entomophagen Insekten und höheren Pflanzen. *Sonderb Naturwiss Ver Hamburg* 2:7–50

4.2

Synchorology: Basis of Spatial Distribution of Plants



Vegetation mosaic of evergreen gallery riverine forest and dry woodlands of deciduous species in higher elevations in seasonally moist, tropical, western Ethiopia.
Photo K. Müller-Hohenstein.

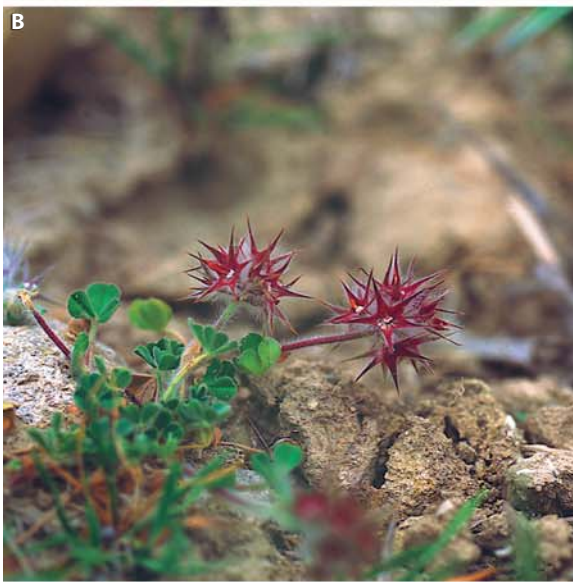
Recommended Literature

In addition to the literature listed in [Chapter 4.1](#) the following literature on the spatial context is recommended:

- Brown JH, Lomolin MV (1998) *Biogeography*. Sinauer Associates, Sunderland
- Brown GB, Gibson AC (1983) *Biogeography*. Mosby, St. Louis
- Forman RTT (1995) *Land mosaics. The ecology of landscapes and regions*. Cambridge Univ Press, Cambridge
- Hengeveld R (1990) *Dynamic Biogeography*. Cambridge Univ Press, Cambridge
- Hubbell SP (2001) *The unified neutral theory of diversity and biogeography*. Princeton Univ Press, Princeton
- Remmert H (ed) (1991) *The mosaic-cycle concept of ecosystems*. Ecol Stud 85, Springer, Berlin
- Rosenzweig ML (1995) *Species diversity in space and time*. Cambridge Univ Press, Cambridge
- Richardson D.M., Pysek P., Rejmanek M., Barbour M.G., Panetta F.D., West C.J. (2000) Naturalisation and invasion of alien plants: concepts and definitions. *Divers Distrib* 6:93–107
- Williamson M., Fitter A. (1996) The characteristics of successful invaders. *Biol Conserv* 78:163–170

For literature in English with all the terms concerning introduced plant species (invasive plants, aliens, neophytes):

The previous chapter showed how plants and plant communities develop over time and their dynamics in the short and long term. These dynamics lead to patterns of distribution at the landscape level. It is the task of **synchorology** to recognise such distribution patterns, describe them and explain their actual spatial distribu-



tion. After the temporal aspects of synchorology, it is now the spatial aspects that are of central focus. Both aspects are prerequisites for understanding synecological connections, which will be discussed in [Chapter 4.3](#).

The following chapter deals first with the basis for distribution ecology (“Arealkunde”, part of plant geography), later questions of species-area relations are discussed with particular emphasis on island biogeography. The synchorological part of [Chapter 4](#) closes with the topic of biodiversity which cannot be discussed meaningfully without reference to space.

4.2.1

Dispersal of Plants

The life cycle of usually sessile plants also includes a mobile phase. In this phase generative **propagules** (spores, seeds, fruits, syncarps or even complete plants carrying seeds) as well as vegetative propagules (bulbs, shoots, runners, adventitious buds, parts of rhizomes, clonal growth, etc.; [Fig. 4.2.1 A](#)) are transported over different distances, on their own or with the help of abiotic or biotic factors. The aim of this process is to find a site for the establishment of the propagule, a so-called **safe site**. Germination and further survival should be guaranteed there.

One of the limits of dispersal are physical barriers. Too great a difference in the relief, or extended oceans, cannot be bridged. Other limits are the demands of species on their environment (**ecological demands**) and the supply of resources at the site. However, man has taken away some of the barriers and is, at the moment, a particularly important **vector** for plant distribution by deliberately and knowingly or unknowingly transporting propagules beyond

Fig. 4.2.1. Plants have developed many different methods of effective dispersal. **A** *Aeloropus littoralis* is a salt-tolerant coastal grass which spreads by vegetative runners (blastochory) as here in south-western Arabia. **B** Self-dispersal (autochory) in *Trifolium stellatum* takes a special form (herpochory) with awns on the fruit having hygroscopic characteristics which enable the seed to move over short distances. **C** A special form of secondary animal dispersal (zoochory) is provided by coprochory. Dung beetles (many types of scarabs) collect the droppings of animals (e.g. cattle) and form it into balls. The dung contains seeds that are then buried just below the soil surface, where they may have a chance to germinate. (Photos K. Müller-Hohenstein)

natural distribution barriers, and ensuring suitable growing sites.

Propagules are also **functional units** adapted to transport by wind, water and animals, or with their own means of distribution. Such adaptation includes, e.g., morphological structures on seeds, such as barbs which cling to coats or feathers. Seeds with tissues containing air may float and those with wings are carried by the wind. Nutritious, fleshy fruits entice animals.

4.2.1.1

Vectors of Propagule Transport

The great number of different means of transport for propagules requires a structured overview of the vectors and mechanisms. Three large groups are distinguished:

- **autochory**, where the plant itself carries out the dispersal of its propagules,
- **allochory**, where the plant exploits different means of transport (**vectors**),
- **atelochoy**, where dispersal is inhibited (Table 4.2.1).

Autochory

Plants have evolved many mechanisms which ensure distribution in different ways. In the simplest form of autochory, **barochory**, propagules are transported via gravity without special aids, a method that may only result in distribution over a wider area on steep slopes. Usually, the highest density of seeds is reached near the mother plant (seed shade). In contrast, with **blastochory**, propagules only find suitable growing sites by growth processes, e.g. via scions (vegetative shoots) or pedicels as in *Cymbalaria muralis*. In **herpochory** propagules move themselves short distances, e.g. the awns of *Trifolium stellatum* have hygroscopic characteristics, and twist with changes in humidity, dispersing the propagules (Fig. 4.2.1 B).

Special forms of autochory are summarised under the term **ballochory**, where propagules are propelled by a single impulse from the

Table 4.2.1. Distribution syndrome. Collected from Müller-Schneider (1977), Lindacher (1995), Frey and Lösch (1998)

Autochory (self dispersal)	Barochory (transport via gravity) Blastochory (dispersal via runners) Herpochory (transport via active creeping) Ballochory (self seeder) <ul style="list-style-type: none"> – Zooballochory (impetus provided by animals) – Anemoballochory (impetus provided by wind) – Hydroballochory (impetus provided by water) – Autoballochory (propulsion mechanisms based on sap pressure or drying)
Allochory (dispersal via a vector)	Anemochory (transport via wind) <ul style="list-style-type: none"> – Chamaechory (transport close to the soil because of large size and soil adherence to animals, etc.) – Meteochoy (transport in air for small seeds) – Boleochory (transport started by wind, further dispersal assured by other mechanisms) Hydrochory (transport in water) <ul style="list-style-type: none"> – Nautochory (transport by movement in the sea) – Bythisochory (drifting in flowing water) – Ombrochory (transport via rain drops) Zoochory (dispersal via animals), further differentiation by animal types, e.g.: <ul style="list-style-type: none"> – Ornithochory, myrmecochoy, etc. – Epichory (transport by attachment of propagules to animals) – Endochory (transport of propagules during passage through the gut) – Stomatochory (transport in the mouth) – Dysochory (transport of accidentally ingested propagules) Hemerochoy (dispersal by man) <ul style="list-style-type: none"> – Ethelochory (deliberate dispersal) – Speirochory (dispersal due to accidental dispersal with seeds) – Agochory (unintentional dispersal)
Atelochoy (transport and dispersal are not impeded)	

mother plant. This may be triggered by animals, wind or even a raindrop. In **autoballochory** even such impulses are not required and the pressure is produced via differences in turgour (*Ecbalium elaterium*) or drying fruits or seed cases (*Bauhinia purpurea*, broom species). Seeds can be thrown over considerable distances, often several metres.

Allochory

Anemochory

Wind is a very important vector for allochoric seed transport. Even propagules blown by wind across the ground surface possess morphological adaptations. Such **chamaechory** is frequent in dry regions where there are rarely impediments to such transport. More important, however, is transport by air currents (**meteochoy**). Small, light propagules which do not settle easily are transported in vertical – as well as horizontal – air streams across large distances, e.g. seeds of orchids or spores of cryptogams (so-called dust-fliers). **Balloon fliers** (*Astragalus spinosus*) possess special morphological adaptations, as do **seeds or fruits with parachutes** (*Taraxacum officinale*) and **wings** (*Acer* and *Fraxinus* species). Wind also triggers seed transport in plants which scatter seeds, e.g. the scatter mechanisms of *Papaver* species (**boleochory**).

Hydrochory

Transport in, and with the help of, water is important for many plant species. Some propagules are able to float because of special tissues or large intercellular spaces, have a low specific weight and an external cover which is difficult to wet (*Nymphaea* and *Nuphar* species). Coconuts, as well as seeds and seedlings of mangrove species, are even able to stay in salt water for long periods without damage. Seed dispersion in salt water and stagnant water is called **nautochory**; that in flowing water is called **bythisochory**. In flowing water seeds are transported by floating, and often drift over large distances. Small distances are often achieved by the impact of raindrops (**ombrochory**, e.g. *Anastatica hierochuntica* in dry regions). It is important that seeds in water do not germinate prematurely because of continuously moist conditions.

Zoochory

The most important and ecologically most complex forms of allochoric distribution have devel-

oped in **zoochory**. Close interrelations between some plant and animal species point towards a long co-evolutionary development. This applies particularly to **endochory**, where propagules are taken up by the animal and pass through the intestines. During this time (retention time) they are transported by the animal. Most such seeds have a relatively hard shell and do not get damaged during passage through the gut, nor is it necessary for germination. However, after excretion, seeds are provided with very good starting conditions for germination in the nutrient-rich excrement. Some of the propagules are taken up randomly, particularly by large herbivorous mammals.

In addition to endochory, there are many other ways in which seeds are distributed by animals: Birds and bats, as well as ants, are specifically attracted; plants invest in nutrient-rich fruits and attract attention by striking colours or strong smells. Ants are particularly well known for their distribution processes (**myrmecochoy**, however, this is a form of epichory, see below) and so are birds (**ornithochory**). The former carry seeds possessing lipid-rich elaiosomes (e.g. *Corydalis cava*) but the seeds remain untouched. This form of distribution is also called **synchrony**. Birds react first and foremost to colours and are able to distinguish ripe seeds from unripe seeds.

In **dysochory** propagules are eaten and sometimes damaged. Such propagules, which are often starch-rich, are collected and accumulated as reserves (e.g. seeds of *Pinus cembra* collected by a bird, *Nucifraga caryocatactes*), but some propagules still have a chance of surviving because not all hiding places are found again and some seeds are lost during transport. Some propagules are taken, together with the fruit pulp, into the mouth and spit out again (**stomatochoy**) by many species of monkeys.

Propagules and their fruit pulp or endosperm are not always used as food. These means of attraction are often not developed at all, but still seeds or whole fruiting bodies are transported by animals. Propagules often possess glue-like excretions, glandular hair, barbs with awns and other outgrowths formed from the pericarp. Therefore, they are easily attached to fur and feathers and are transported until they fall off or are stripped off by animals during grooming and preening. In this form of transport, **epichory**, animals distributing the seeds are not rewarded by food or energy and the plant invests less. In endochory close interaction exists be-

Table 4.2.2. Relationship between propagules and dispersal by vertebrates. (Howe and Westley 1986, with additions)

Animal/animal group	Propagule colour	Propagule smell	Propagule form	Use to animals
Mammals in herds	Brown	Little smell	Thick husked nuts, do not burst open	Seeds
Birds in flocks	Green, brown	Without	Seeds without wings and small nuts	Seeds
Frugivor mammals in trees	Yellow, green, white, orange, brown	Aromatic	Seeds often with arils, whole fruits, burst open	Arils, pulp rich in proteins and sugars
Bats	Green, white, light yellow	Aromatic, musty	Diverse, often pendent fruit	Lipid- and starch-rich fruits
Ground living and frugivorous mammals	Green, brown	Without	Hard, over 50 mm long fruits, do not burst open	Lipid-rich fruits
Frugivorous birds (obligate)	Black, blue, red, green	Without	Big seeds with arils, whole seeds often burst open	Lipid- and protein-rich fruit flesh
Frugivorous birds (facultative)	Black, blue, red, white	Without	Small seeds with arils, berries and stone fruits	Mostly carbohydrate-rich fruit
Furry or feathery	Insignificant	Without	Sticky and barbed hooks	None

tween plant and animals and distribution is regulated, sometimes even targeted. Epichory, in contrast, is often random. Some of the close links between characteristics of propagules and the animals distributing them are summarised in [Table 4.2.2](#) (Howe and Westley 1986).

Hemerochory

Man plays an increasingly important role in the recent history of plant distribution. In this particular allochoric form, **hemerochory** or **anthropochory**, any distances may be covered and all geographical and ecological barriers overcome. In **ethelochory**, plants are purposefully moved to different regions, e.g. to provide food or ornament. If distribution occurs unintentionally along with other propagules (e.g. weed seeds in seeds of cereal crops), this is called **spirochory** or in the case of random distribution **agochory**.

Atelochory

The most important methods of distribution, **autochory** and **allochory**, are contrasted with **atelochory** (also called **achory**). This is a special form of distribution, as it is prevented. The consequence of this evolutionary development is that reproduction takes place at the site where the mother plant grows, which is favourable to the species. Examples are *Arachis hypogaea* or *Trifolium subterraneum*. After pollination pedicel and ovary penetrate into the ground.

Heterosporry is widely used by therophytes in arid regions as the chance for survival are particularly good at sites where the mother plant is

able to form fruits. Only some of the propagules are distributed to “conquer” new growing sites (Evenari et al. 1982).

4.2.1.2

Effectiveness of Mechanisms for Seed Dispersal

The dispersal of propagules is successful if they reach a site which allows germination and growth of a new plant. It is also important for survival of a species to exploit suitable growing sites further from the mother plant and to establish there, thus increasing the area of distribution, and the population's chances of survival. To a large degree this depends on the available mechanisms for dispersal and their effectiveness regarding a targeted (suitable site for growth) and broad (gain space) transport of propagules. However, such “targets” are not achieved by any of the forms of dispersal and therefore different vectors have proved particularly useful in certain regions. With the “choice” of vector, different strategies are developed during evolution in which safe sites and territorial expansion are balanced.

Howe and Smallwood (1982) studied seed dispersal in temperate forests in North America, as well as in neo- and palaeotropic forests. The data show that most trees are morphologically adapted to zoochory in the humid tropics as well as in the tropics with rainy and dry seasons. In temperate forests this also applies to

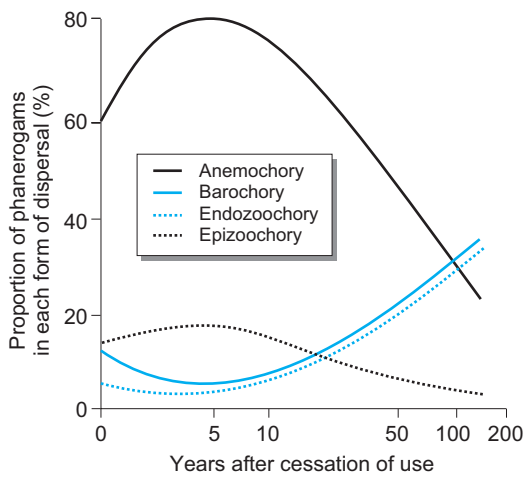


Fig. 4.2.2. Relative frequency of four dispersal mechanisms in phanerogamic flora of fallow fields close to Montpellier (France) at different times after their abandonment. (After Lepart and Escarre 1983)

shrubs, but trees are predominantly anemochoric. This change in the form of dispersal is explained by regular winds occurring in temperate latitudes, but many attempts to explain linkage of certain species with certain vectors have so far not been successful. In dry areas, where obstacles hardly limit distribution by wind, anemochory predominates, but there are no recognisable trends that would indicate that autochoric forms are linked to particular biomes. In these forms, in addition to “primary” dispersal, “secondary” dispersal by a particular vector becomes important (Chambers 1994). Propagules reaching the ground by gravity (barochoric) or excreted by animals (endochoric) may drift in the wind or water, or be taken up by other animals. Engel (2000) reports this for dung beetles which take seeds from elephants’ dung and transport them over short distances before burying them and thus acting as a secondary vector; he called this **coprochory** (Fig. 4.2.1 C). The importance of “secondary” distribution is often underestimated. The example of dung beetles shows that the most favourable micro-growth sites are often only found in the second transport phase. The spatial and temporal component is also important. A major vector in one year need not be so important in another when conditions have changed. Lepart and Escarre (1983; Fig. 4.2.2) showed how the proportion of the four mechanisms for seed dispersal changes in a fallow field. During the first years, anemochoric species establish predominantly via long-dis-

tance transport, but barochoric and endozoochoric species become more important after the first two decades and finally, after a century, replace anemochoric species as the most important species.

Plants species often do not use one form of seed dispersal only. Different forms may supplement each other to better safeguard dispersal. Particularly under unfavourable external conditions, e.g. a short vegetation period in high mountains or long dry periods, reproductive dispersal is combined with vegetative propagation. Some plant species form different forms of propagules (**heterospory**) increasing their chances of dispersal.

Several hypotheses and models have been developed to explain the link between certain plant species and their chosen vector. The **low investment model**, for example, is based on the view that plants that produce many small seeds are linked to vectors for long-distance dispersal (anemochory, epichory). Thus they are able to disperse over large areas in a very short time; however, the fate of seeds distributed in such a way is fairly uncertain. According to the **high investment model**, some plants only form very few seeds but these are large and well equipped with energy and nutrients and are thus very attractive to birds and bats. They are only distributed over short distances, but usually find relatively safe conditions for germination. In zoochory both strategies are used, epichory (with low investment) and endochory (with high investment). The **directed dispersal hypothesis** of Howe and Smallwood (1982), of targeted, relatively safe dispersal, also corresponds to the high investment model. This contrasts with the **colonisation hypothesis** where opportunists exploit opportunities for rapid dispersal over large areas. The premise for the **escape hypothesis** is that the chances for establishment and germination depend on low density and therefore the proximity of the mother plant must be avoided.

There are very few empirical results confirming particular hypotheses. It is certain that many plants do not use only one vector, but possess morphological and other adaptations to exploit several vectors. Such **polychory** improves the chances of dispersal considerably.

The efficiency of seed dispersal has qualitative and quantitative aspects. The quality of a seed may decide whether or not a bird accepts it, how the seed is treated by the bird so that it is transported, and if what remains is able to ger-

Table 4.2.3. Factors affecting efficiency of dispersal. (After Schupp 1993)

- I. Quantity of seed dispersal**
- A. *Number of visitors*
1. Density of dispersal agent
 2. Type of nutrition
 3. Reliability of the visit
- B. *Number of seeds dispersed per visit*
1. Number of seeds touched per visit
 2. Probability of dispersal of a seed touched
- II. Quality of seed dispersal**
- A. *Quality of treatment*
1. Seeds are transported intact or broken
 2. Change in germination rate
- B. *Quality of seed deposition*
1. Transport type
 - a. Targeted choice of habitat
 - b. Targeted transport
 2. Deposition type
 - a. Proportion of deposited seeds
 - b. Mixing of different seeds

minate. Of quantitative importance are the number of seeds and the number of visits of the distributor to the plant. Schupp (1993) tried to develop a hierarchical classification of the most important components for efficient seed dispersal (Table 4.2.3). The density of dispersal, as well as the type of seed treatment (intact or damaged), and patterns of dispersal (targeted or ran-

dom dispersal) are particularly important (see also Box 4.2.1).

4.2.1.3 Propagule Bank and Establishment of Germination

Seed dispersal is only successful if the transported propagules germinate at a potential site or are in the propagule bank (**seed bank**) in the ground.

Many propagules have a rest period before germination. This may have several reasons. Germination-inhibiting substances may prevent further development at first: sometimes temperatures must fall below a certain minimum value (**vernalisation**) before the seedling can develop. Such rest periods are called **dormancy** and may be determined genetically or by external conditions, e.g. if the position of seed is too deep in the soil and can only germinate after disturbance when it gets enough light as with many segetal species.

The period of **dormancy** is different for individual types of propagules even under the same conditions. In tropical rainforests, shade trees germinate immediately if they are in a suitable

Box 4.2.1 Hypotheses on the effectiveness of dispersal mechanisms

In their mobile phase, plants move themselves (self-dispersal or autochory) by means of propagules (diaspores, e.g. spores, seeds, fruits, corms and runners); the most important form of autochory is barochory with the propagules falling under gravity and therefore not moving very far laterally. Alternatively, propagules are moved by various vectors (allochory), the most important of which are wind, water and animals and – particularly more recently – man. The propagules reach a location with favourable conditions allowing survival and establishment (safe site), and leading to further growth: this depends on the environment and specific requirements of the species and the physical parameters that hinder or aid dispersal.

Various hypotheses describe how effective the dispersal mechanisms are. The directed dispersal hypothesis – considers a mechanism where the propagules are specifically targeted,

taken and dispersed (i.e. by animals). The colonisation hypothesis, in contrast, considers that opportunists use wind and water primarily as vectors. The first hypothesis is a high-investment model, suggesting that many resources are invested in the propagule as “rewards” for the dispersal vector (i.e. nectar for humming birds, fruits for bats). In low-investment models which apply to many opportunists, little is invested in the individual seeds. Here, dispersal and chance colonisation are based on the large number of seeds produced.

Distribution of propagules is successful when germination and growth of young plants are successful that finally produce seeds of their own. This does not have to happen directly after dispersal. Many propagules remain dormant in the soil for long periods and then are able to germinate under favourable growth conditions.

growing site. Seeds of light-requiring trees remain dormant until favourable conditions occur and then germinate, e.g. after a fallen tree opens a gap in the canopy, a so-called **tree fall gap**. In dry regions with very variable wet periods, species differ considerably in dormancy, even within one species. Generally, it may be assumed that dormancy of propagules serves to tune germination to growth conditions, in order to bridge a cold winter or a dry season.

The stock of all dispersal units in the soil is called the **propagule bank** (**seed bank** or **seed potential**). Seeds may remain viable for several years, in some cases even centuries, until more favourable conditions for development occur. This propagule bank is usually in the uppermost 10 cm of soil. Temporary propagule banks with accumulation of seeds which will germinate in the short term (next year) are distinguished from permanent banks. The latter are particularly important for the regeneration of plant communities. With propagules in temporary banks having only limited ability to germinate – as for the tropical shade trees mentioned above – regeneration of forests after severe interference is unlikely. This also applies, for example, to rainforests in southern Chile outside the tropics. A few years after clearing of the almost natural stands and reforestations of the area with *Pinus radiata* the local seed banks contained hardly any propagules of indigenous species (Scherer, unpubl. data). This underlines the importance of propagule banks for the protection of species and biotopes.

The phase of **seedling establishment** is particularly sensitive in the life cycle of plants. Pathogens, herbivores and competitors, but also climatic abnormalities, may lead to large losses. Ryser (1993) found in germination experiments that some seedlings require the protection of neighbouring species (e.g. *Arabis hirsuta*, *Primula verde*), but for others germination is reduced by neighbouring species (*Platago lanceolata*, *Sanguisorba minor*). A third group of species was able to germinate under all experimental conditions (e.g. *Medicago lupulina*). Large, time-dependent fluctuations were also observed. Espigares and Peco (1993) found close relations between rates of germination and interannual fluctuations of climatic conditions, particularly of temperatures. Most species germinated more successfully at higher temperatures, others germinated better at lower temperatures (e.g. different species of *Trifolium*).

It is still not possible to satisfactorily explain dormancy and germination in detail. Even if edaphic and climatic conditions at the growing site satisfy the demands of the dispersed species, if pollinators are present, and if the species is able to stand its ground against competitors and protect itself against pathogens, its permanent establishment is only safeguarded by a permanent input of propagules in addition to its own propagule production.

4.2.2

Basis of Spatial Distribution (Phytogeography, "Arealkunde")

A consequence of dispersal of propagules across short distances is that as many potential growing sites as possible are occupied near the mother plant, whereas long-distance dispersal leads to spatial gain. The result of **dispersal of propagules (active process)** is permanent establishment in a site, the **distribution (passive state)** of plant species into new sites. A growing site which can be limited geographically is called an **area**, i.e. spatial distribution.

It is the aim of the science of **spatial distribution** of plants to describe the pattern of forms of areas as they are today, and in the past, and to explain them. The two main goals are: to recognise types and characteristic patterns of distribution (dispersal) and to describe their organisation (Meusel et al. 1965, 1978; Merxmüller 1952, 1953, 1954) and to attempt to explain the development of patterns of distribution (Walter and Straka 1970). A comparative assessment of geographical areas leads to characterisation of **floristic elements** and **area types** and to a hierarchical and spatial classification based on the scientific understanding. Thus studies of areas are the basis of any further understanding of vegetation distribution.

4.2.2.1

Interpretation of Area of Distribution

There are various ways to map areas. Frequently, only the borders of areas in which the species occur are drawn, however, providing no information on the distribution and abundance of species within the area. This is avoided by **dot**

maps which contain each sighting, however often, of the expected distribution rather than the real, observed distribution. Information on geographical areas is usually presented in **grid maps**. However, these maps only show a section of the area, with the distribution of the species (without, however, the frequency). Such maps were provided by Haeupler and Schönfelder (1988) for the Federal Republic of Germany (following the indispensable classical presentation by Meusel et al. in outline maps). These distribution maps show, for example, the mesoclimatic differentiation of areas often better than those based on meteorological data. Such maps are indispensable for formulating basic questions on taxonomy and vegetation, as well as for applied tasks, e.g. nature protection.

The expansion and form of areas depend on historical as well as ecological factors, that is the ecological demands of species and their competitiveness, as well as the potential supply of resources at the growing site, plus the competitiveness of other species. Attempts have frequently been made to explain limits of distribution by limiting conditions at the site using isotherms. However, these attempts should be viewed critically. Plants hardly react to average climatic values; furthermore, conditions at a site are so complex that it is not possible to assess individual factors and then identify the decisive one. Limiting conditions for plants in large areas are very different. Beech (see Chap. 2.1), at its eastern limits, suffers from low precipitation during the year, but is particularly damaged by cold winters (limit of resistance of buds -30°C). In the south, beech is limited by summer droughts and in the north by prolonged winters

and late frosts. However, in the north west of the British Isles, beech has probably not reached all potential growing sites since the end of glaciation. The complexity of limiting factors at a site may also be shown by the course of the **tree limit** for **olive trees** in the Mediterranean region (Fig. 4.2.3). In higher mountainous regions longer-lasting frosts occur and limit the short growing season, in southern Europe the early summer is too moist, making pollination and fruit setting difficult, but, in North Africa, towards the south, increasing drought limits its distribution. **Walter's law of the relative constancy of habitat** (see Chap. 4.1.6) should be applied to understand the occurrence of plants. *Quercus pubescens*, for example, indicates in its southern distribution moist, early outposts of Mediterranean habitats, but in the north, in the upper Rhine valley, it is found only on the warmest and driest, south-facing slopes.

It is often forgotten that the expansion of areas is subject to change, which may be climatic. The postglacial, warmer climate caused large-scale **shifts in areas**, making it possible to gain information on the rate of species migration. These species came from their refugia to occupy their present areas. For the most important central European tree species, expansion at a rate of some 100 m/year is calculated, rather a large rate, considering that many tree species only form fruits after several years. Climatic change and growing competition, particularly human influences, may also lead to **areas shrinking**. Thus, dynamics of areas can mean them contracting, expanding or shifting, with the consequence that making an inventory of species for a region is never finished. In addition, neophytes and synanthropic species

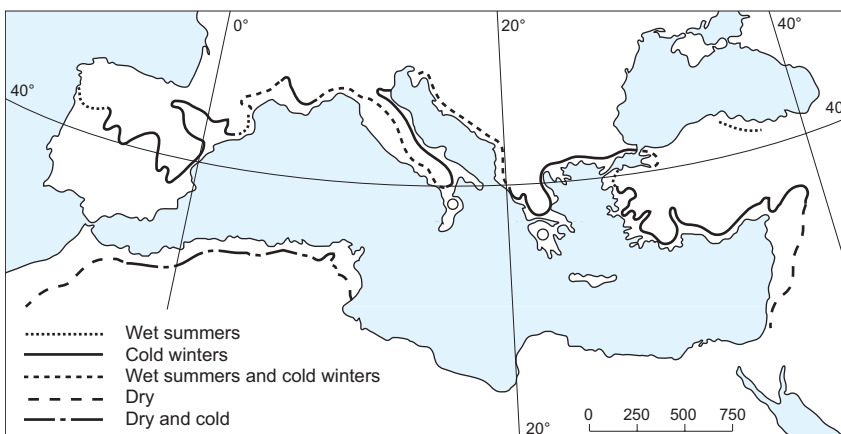


Fig. 4.2.3. Limit of the distribution of olive trees (*Olea europaea*) in the Mediterranean area and the most important climatic factors determining it. (After Birot 1964, modified from Müller-Hohenstein 1981)

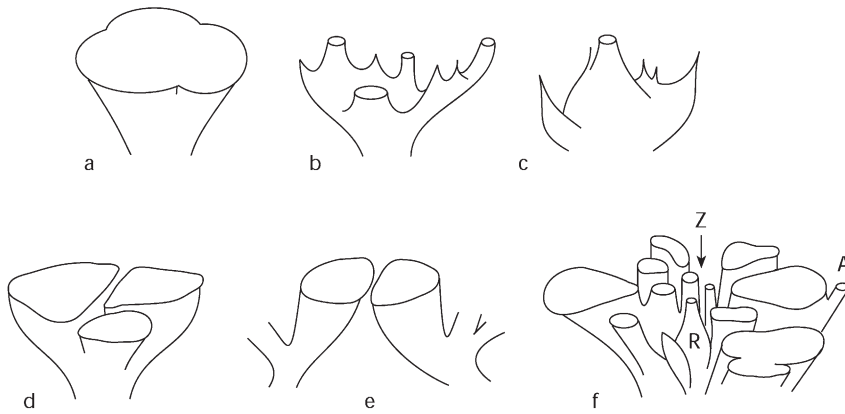


Fig. 4.2.4. Possible means by which plants exploit space over a period of time (time axis vertical, space axis horizontal, cut surfaces show the current situation) (Strasburger 1998). **a** Area expansion; **b** death of populations and shrinkage to disjunct areas; **c** as in **b** with development of relict palaeoendemic areas; **d** allopatric differentiation of three vicarious related groups; **e** pseudovicarious species, living in ecologically or geographically similar conditions; **f** a distribution of closely related species with a centre of diversity (Z), relict endemics (R) and neoendemic species (A). There are no fixed relationships between the age of the species, diversity of the group or size of the area

make this task even more difficult and, strictly speaking, **potential and actual areas** should be considered separately. The potential area comprises all suitable growing sites, whereas actual real area is usually much smaller and is determined by limits of the site and geographical barriers, conditions of competition and migrational behaviour of species. Figure 4.2.4 shows schematically how differently the space-time formation of areas may occur. Areas may grow or shrink; they can also divide (**disjunction**) or form species by allopatric differentiation.

4.2.2.2

Characterisation of Areas

Areas are divided according to (1) their size, (2) form and (3) geographical location. Differentiation into mainly **cosmopolitan** and **endemic** species is based on the size of areas. The former occur in large areas, extending beyond continents, over large climate regions. Cosmopolitans have very effective dispersal mechanisms, are strongly competitive and are old species, phylogenetically speaking. Bracken (*Pteridium aquilinum*) and the annual meadow grass (*Poa annua*) are the most quoted examples. Cosmopolitans are differentiated from **ubiquists** in that they are not able to grow on all sites.

Endemics are, in contrast to cosmopolitans, only found in small areas, e.g. in isolated mountain regions or on islands, strictly speaking also on 'inland islands'. Two variants exist.

Phylogenetically old species, which once were widely distributed, were pushed back to smaller areas by increasing competition. These species are called **palaeo-endemics** or **relict-endemics**. Giant redwood trees (*Sequoia gigantea* and *Metasequoia*) or the southwest African gymnosperm *Welwitschia mirabilis*, as well as the eastern Asian *Ginkgo biloba*, are examples. In contrast to palaeoendemics are **neoendemics**, phylogenetically younger species which have not been able to establish in potential areas because of time limitation, or which are restricted to smaller areas because of insurmountable barriers to their expansion. Data from Frey and Lösch (1998) for selected island groups show that the distance of the island to the mainland and the

Table 4.2.4. Proportion of endemics in the flora of different islands and island groups. (After Frey and Lösch 1998)

Island/island group	Endemics in %	Distance to the nearest mainland (in km)
Fernando Po	12.0	100
Canary Islands	53.5	170
Sao Tomé	19.4	250
Cape Verde Islands	15.0	500
Juan Fernandez	66.7	750
Madeira	10.5	970
Galapagos	40.9	1120
Azoren	36.0	1460
St. Helena	88.9	1920
Hawaii	94.4	4400
Marquesas	52.3	6000

duration of isolation are reflected in the proportion of endemics in the flora (Table 4.2.4).

Areas are also differentiated by their form, particularly whether they are closed areas, i.e. the species is established in a single, clearly delimited space, or whether the area consists of several partial areas and is thus **disjunct** (see Chap. 4.1.2). In closed areas, gaps between individual growing sites are so small that they may be bridged easily and quickly by transport of propagules or pollen. In disjunct areas this is no longer possible. It may be assumed that polyphyletic origin of the same species does not occur and therefore other explanations for the genesis of disjunctive areas must be found. One explanation might be an extremely rare distribution event, e.g. by migrating birds, or atmospheric anomalies. In many cases, however, it is known that present disjunct areas were once closed and were either separated by tectonic events (e.g. continental drift), formation of mountains, or climatic changes (e.g. change in cold and warm periods). For the latter there are many examples with Arcto-Alpine species (e.g. *Draba aizoides*).

With the separation of once closed areas, so-called **vicarious areas** may develop. In the partial areas, the populations of once uniform species developed further in different ways. This would be called **geographical vicariance** with examples of the genera *Kleinia* and *Aeonium* (Fig. 4.2.5). The **centres of diversity** of these species in southern and eastern tropical Africa as well as in Macronesia and Cap Verde were

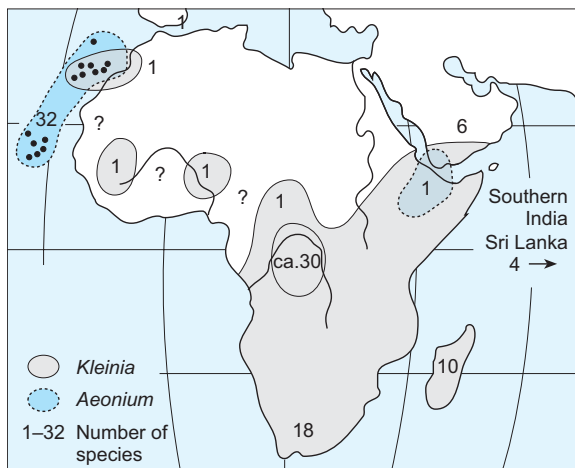


Fig. 4.2.5. Vicariance of the two genera *Kleinia* and *Aeonium*. (After Deil and Müller-Hohenstein 1984, from Richter 1997)

separated by the north African dry regions. If subspecies or other species of a genus are established in the same space at different sites, this is called **ecological vicariance**; examples are the two alpine rhododendrons, *Rhododendron hirsutum* and *R. ferrugineum*, respectively, on limestone and silicate rocks.

If many related species are distributed closely together, it may be concluded that they have developed within the same space and that the area is a **centre of diversity** (genetic centre, central zone of related groups) or at least a **maintenance centre** of this genus. Plant breeders aim to find such centres for economically important plants, as they hope to find important gene reserves.

4.2.2.3

Area Types – Floristic Elements – Geoelements

Areas of similar basic structures, size and geographical positions are called **area types**, which are somewhat abstract units. Various species do not occupy absolutely identical areas, but all species of the same area type are considered to be **geoelements** if spatial aspects are more important, and **floristic elements** if floristic aspects are considered. Nevertheless, these terms may be regarded as synonyms. At times **geoelements** (the same phylogenetic origin of a species group) and **chronoelements** (the same period of development of a species group) are used (Frey and Lösch 1998).

The spatial distribution of area types is clearly seen in climatic characteristics: (1) zonal temperature dependence with latitude, (2) distribution shown in the duration of the growing season with height above sea level, (3) distribution according to the influence of oceanic or continental climates which affect temperature ranges. Floristic types of Europe are included in this three-dimensional presentation of area types (Meusel et al. 1965). Groups of geoelement for Europe are shown on a map designed by Walter (1986; Fig. 4.2.6). The following abbreviations are generally used for the zonal sequence from north to south:

- arct = arctic
- bor = boreal
- cen = central European, also temp for temperate or nem for nemoral
- med = Mediterranean

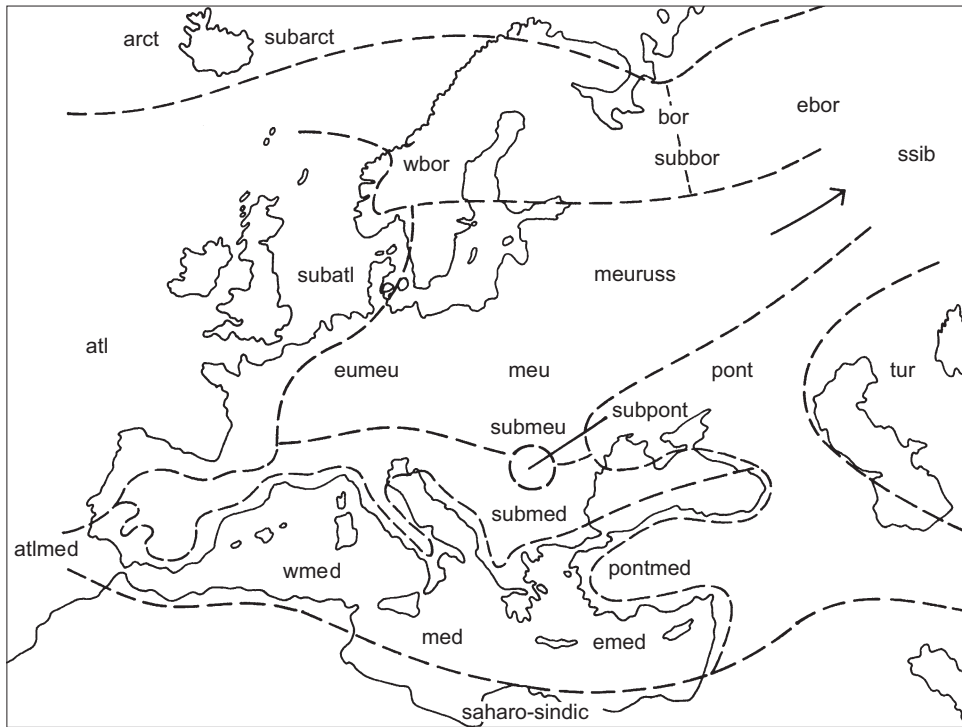


Fig. 4.2.6. Classification of geoelements (similar area types) of central Europe. (From Kreeb 1983)

These can be subdivided, e.g. arctic into sub-arctic, mediterranean to sub-mediterranean, etc. It is important for further subdivision that clearly defined floristic contrasts exist between the observed areas.

For changes in altitude the following terms are used:

- plan (planar belt of lowlands)
- coll (colline belt)
- mont (montane belt)
- subalp (subalpine belt to the timberline)
- alp (alpine belt)
- niv (nival belt)

For the west–east change the following terms are used:

- atl (atlantic)
- cen (central European)
- ssib (southern Siberian)

Here, too, intermediate steps are often used. Meusel et al. (1965) suggested that the terms continental and oceanic be used as classifications. Examples for geoelements influencing central Europe are shown in Table 4.2.5.

Vegetation may also be regarded as the combination of species for a certain area distribution or type. Causes of boundaries between area types are only poorly understood but the evaluation and interpretation of regional floras using **area type spectra** are based on the ecological characteristics of species. Filzer (1963) provided

Table 4.2.5. Examples of types of central European geoelements and neighbouring geoelements

Central European (eu-mi):	<i>Fagus sylvatica, Quercus petraea, Hedera helix</i>
Sub-arctic (subarct):	<i>Betula nana, Salix herbacea, Rubus chamaemorus</i>
Boreal (bor):	<i>Picea abies, Larix decidua, Ledum palustre</i>
Atlantic (atl):	<i>Erica tetralix, E. cinerea, Sarothamnus scoparius, Ilex aquifolium</i>
Central Russian (mi-ru):	<i>Carpinus betulus, Quercus robur, Alnus glutinosa, Melampyrum nemorosum</i>
Sub-Mediterranean (submed):	<i>Acer monspessulanum, Quercus pubescens, Sorbus terminalia, Bromus erectus</i>
Mediterranean (med):	<i>Quercus rotundifolia, Arbutus unedo, A. andrachne</i>
Pontic (pont):	<i>Adonis vernalis, Anemone sylvestris, Stipa pennata, St. capillata</i>
South-Siberian (ssib):	<i>Daphne mezereum, Betula verrucosa, Astragalus danicus</i>
Arctic-alpine (arct-alp):	<i>Loiseleuria procumbens, Poa alpina, Arctostaphylos alpinus</i>

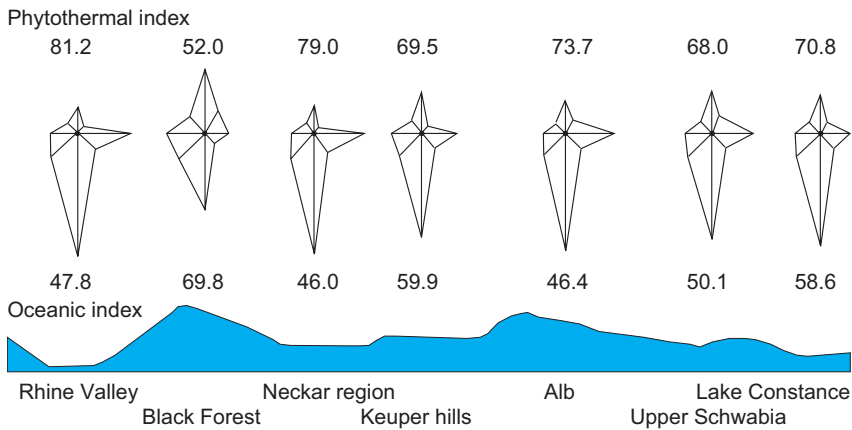


Fig. 4.2.7. Spectrum of area types in landscapes on a transect from the upper Rhine valley to Lake Constance. (After Filzer 1963, from Reichelt and Wilmanns 1973)

such an evaluation for a region of southern Germany and thus differentiated oceanic and continental influences, as well as thermally favoured areas (Fig. 4.2.7). Similarly, Frankenberg (1978) analysed floristic gradients in North Africa. Müller-Hohenstein (1988) characterised vegetation units on the Arabian peninsula using an area typological approach, which was used to interpret the views of climatologists and plant geographers concerning the boundaries between tropics and subtropics, and the palaeotropics and holarctic (Fig. 4.2.8). The figure shows these different interpretations. The area analysis showed that the north-eastern Arabian coastal regions may not be classified as tropical.

4.2.2.4 Plant Kingdoms

Area types and the corresponding geoelements are the basis of a hierarchical division of the earth according to floral relationships. At the highest level of this hierarchy are the six **plant kingdoms**. This division is made on the best possible homogeneity of such plant kingdoms and the greatest contrast between neighbouring units. The differentiation is mainly based on the geographical positions in which these species have developed for different periods in isolation. The early separation of the southern continents with the corresponding formation of three plant

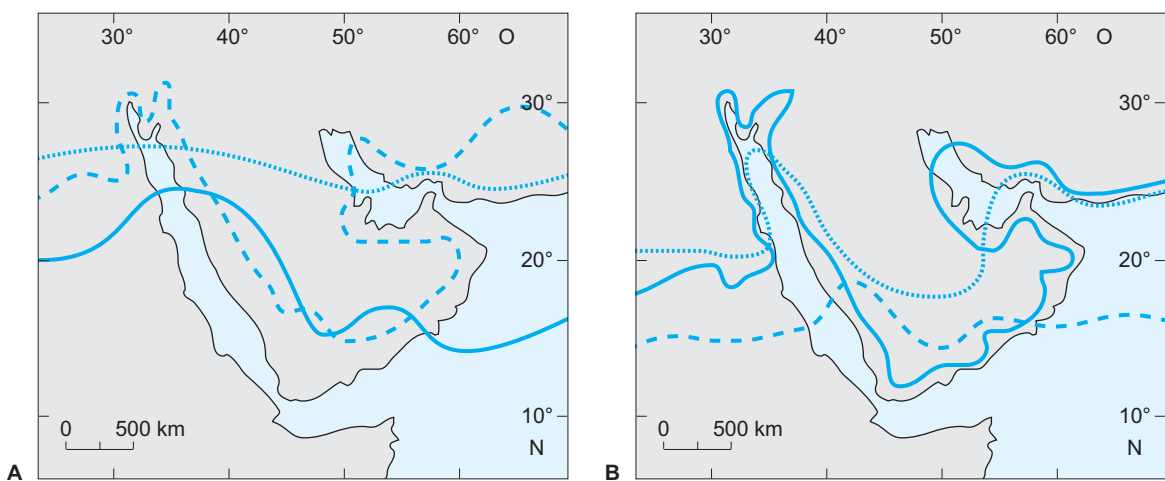
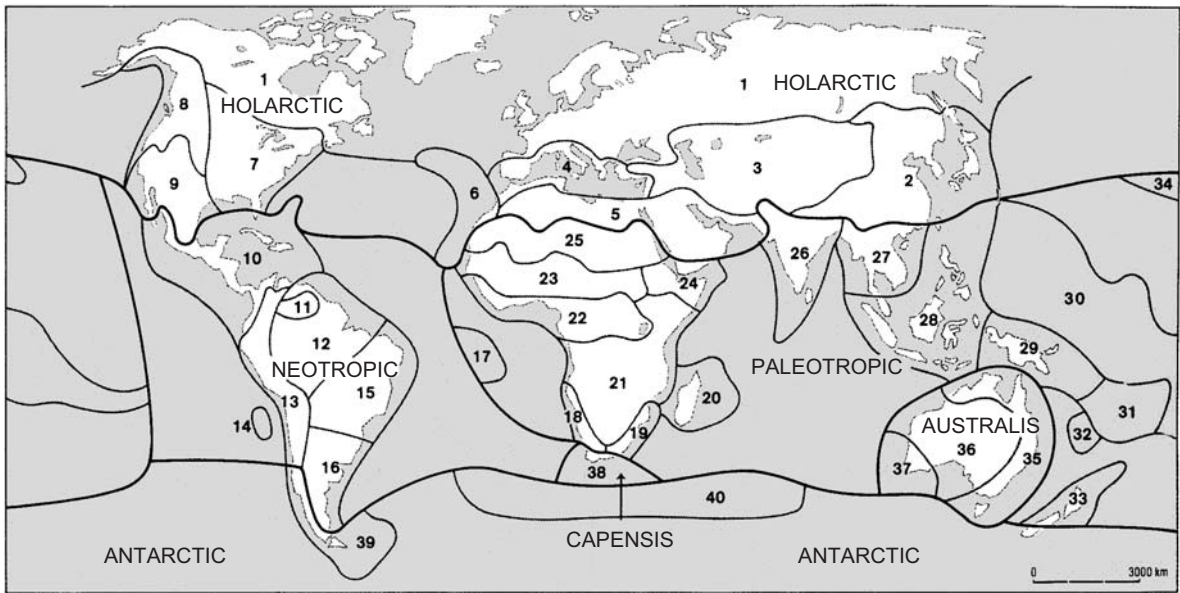


Fig. 4.2.8. A Position of the boundaries between the Holarctic and the Palaeotropic plant kingdoms on the Arabian Peninsula according to Diels (1908, *dotted line*), Al Hubaishi and Müller-Hohenstein (1984, *continuous line*) and Kürschner (1986, *broken line*). B Boundaries between the subtropics and tropics on the Arabian Peninsula according to Troll and Paffen (1964, *dotted line*), von Wissmann (1962, *continuous line*), from Blüthgen (1964), and Creutzburg and Habbe (1964, *broken line*), from Blüthgen (1964)



Plant kingdom: Holarctic (can be divided into Palearctic and Nearctic)

Floral regions:

- | | | |
|-----------------|-------------------------|---------------------------|
| 1 Circumboreal | 4 Mediterranean | 7 North American-Atlantic |
| 2 East Asian | 5 North Saharan-Arabian | 8 Rocky Mountains region |
| 3 Irano-Turanic | 6 Macaronesian | 9 Madric |

Plant kingdom: Neotropic

Floral regions:

- | | | |
|--------------|---------------------------|--------------------------------|
| 10 Caribbean | 13 Andean region | 16 Argentinian-East Patagonian |
| 11 Guyanese | 14 Juan-Fernandez islands | |
| 12 Amazonian | 15 Brazilian | |

Plant kingdom: Paleotropic (can be divided into African, Indomalaysian and Polynesian regions)

Floral regions:

- | | | |
|-----------------------------------|----------------------|----------------------|
| 17 Acension Island and St. Helena | 23 Sudano-Sahelian | 29 Papua-New Guinean |
| 18 Karoo-Namibian | 24 Eritreo-Jemenitic | 30 Polynesian |
| 19 Zulu region | 25 South Saharan | 31 Fijian |
| 20 Madagascan | 26 Indian | 32 New Caledonian |
| 21 Angolo-Zambesian | 27 Indochinese | 33 New Zealand |
| 22 Guinean-Congolesean | 28 Malaysian | 34 Hawaiian |

Plant kingdom: Australis

Floral regions:

- 35 Northeast Australian
- 36 Central Australian
- 37 West Australian

Plant kingdom: Capensis

Floral regions:

- 38 Capensic

Plant kingdom: Antarctic

Floral regions:

- 39 South Chilean-Magellanic
- 40 Subantarctic

Fig. 4.2.9. Plant kingdoms and floral regions. (After Mattick 1964; Takhtajan 1986, from Richter 1997)

kingdoms, Antarctic, Capensis and Australis, is particularly important. The northern continents, which are still together, consist of the plant kingdom of middle and higher latitudes of the northern hemisphere, the Holarctic (see also Chaps. 4.1.1 and 4.1.2). In the lower latitudes of the tropics, the Palaeotropics and Neotropics are differentiated. Figure 4.2.9 illustrates the division of the earth's vegetation according to phy-

togeographical principles (areas). To define the plant kingdoms higher taxonomic units (families) are used. This definition is not just a matter of their exclusive distribution in individual plant kingdoms, but also of their spatial centres of distribution.

The Holarctic is the largest plant kingdom with distribution centres of many plant families (Apiaceae, Betulaceae, Brassicaceae, Caryophyllaceae,

Fagaceae, Primulaceae, Ranunculaceae, Rosaceae, Salicaceae). Current differences, e.g. between Holarctic spaces in North America and Eurasia, are caused by recent geological events (ice ages). However, in more recent geological periods, there have been no insurmountable barriers.

This does not apply to the southern, tropical regions. The separation of the African continent from South America led to the subdivision of these two tropical plant kingdoms; this subdivision is justified, despite existing parallels (pan-tropical species and families, e.g. Annonaceae). Particularly characteristic families in the Palaeotropics, including the African continent and the Southeast Asian archipelagoes, are Combretaceae, Dipterocarpaceae, Euphorbiaceae, Moraceae (with over 1000 species of the genus *Ficus*), Nepenthaceae, Pandanaceae and Zingiberaceae.

For the **Neotropics**, including most parts of Central and South America, species of Araceae, Bromeliaceae, Cactaceae and Solanaceae are particularly characteristic. Tropaeolaceae are entirely limited to this plant kingdom.

The **Capensis** in the southwest of the African continent is the smallest plant kingdom in area, but is a particularly autonomous realm, where some families have developed into many species. This applies particularly to Ericaceae and Mesembryanthemaceae. In these two families relations to the Holarctic and Antarctic become obvious. The Bruniaceae is an endemic family of the Cape, and representatives of the Proteaceae

and Restionaceae are dominant. The southern hemisphere plant kingdom of **Australis** comprises only the Australian continent and Tasmania; at the level of genera and species it is particularly rich in endemic species. *Eucalyptus* species (Myrtaceae) are particularly important and are now distributed worldwide. The neighbouring New Zealand belongs in part to the Palaeotropics, but in the south partly to the third plant kingdom of the southern hemisphere, the **Antarctic**, which has its largest area inhabited by plants in the southern tip of South America. In this region southern beeches (genus *Nothofagus*) developed. The floristic characteristics of the Andean mountain ranges in the south are relatively close to those of the neotropical high mountain areas in the north.

Plant kingdoms are subdivided into **floral regions** and **floral provinces**; divisions are not possible in the same detail for all plant kingdoms and boundaries differ at times. The subdivisions according to Takhtajan (1986; see Fig. 4.2.9) provide a good basis for discussion.

4.2.3

Relationship Between Area and Species

The type of distribution of plants living together in a space is called **sociability**. Developing patterns depend on the dispersal mechanisms of

Box 4.2.2

Characterisation of areas

The study of areas considers the results of plant dispersal, the plant species distribution. Distribution maps (mainly individual point distributions or grid maps) show the areas occupied by the species; these areas are characterised according to size. Plants distributed across climatic zones, over very large areas, are called cosmopolitans. They are often phylogenetically old species with particularly effective dispersal mechanisms having no specific environmental requirements. Species occurring in microspaces, e.g. only on an island or in an isolated mountain area, are called endemics. Areas are also characterised by their form with particular distinction drawn between closed and disjunct distribution areas. In the latter, the area of distribution consists

of several partial areas. Disjunct areas may be explained by climate changes and tectonic events. Disjunct areas also show that they are subject to changes over time (dynamic); they can grow if the local conditions change in their favour, or shrink if the opposite occurs.

Species occupying similar areas are characterised as area types (floristic elements or geoelements; e.g. Atlantic or boreal types). Area types are the basis for the organisation of large floristic provinces and regions, and finally of the six plant kingdoms of the earth, the northern hemisphere Holarctic, the Palaeotropics and Neotropics, as well as the southern hemisphere Australis, Capensis and Antarctic (see Fig. 4.2.11).

participating species, rates of reproduction, competitiveness, etc. In nature, clumped distribution is particularly frequent, i.e. distribution is not uniform, rather an “island-like” distribution exists, where larger or smaller spaces are covered more densely, so that there are differences in **abundance**. Ecologists seeking the origin of such developing patterns need to know how many species (and individuals) are able to live in a certain space, and whether – and if yes, which – interactions exist between number of species and size of area, the so-called **species area interaction**.

Interactions of the process of biological distribution, establishment of organisms and the size of areas have been particularly analysed for **islands**. Islands have fewer species than mainland areas of the same size, as in the latter plants are able to quickly establish from the surrounding area. Due to their spatial isolation, islands are rich in endemic species and are therefore special cases. They are clearly delimited, easy to comprehend, with a limited number of different habitats under relatively uniform climatic conditions. They occur in various sizes and are situated at different distances from the mainland and therefore serve as examples to clarify the following basic relations between number of species and size of area:

- How do plants establish on islands?
- What limits the number of species on islands?

The first question is relatively easily answered. Vectors for dispersal on islands situated far from the mainland, and thus from the closest source of propagules, can only be by **long-distance dispersal**; various types of autochory are not applicable. Transport by sea birds on various established routes may be a method of dispersal (particularly epichoric dispersal), but also abiotic vectors are possible, such as air and sea currents, or exceptional events, e.g. tropical cyclones. For the Pacific islands and groups of islands the proportion of participating vectors was estimated with morphological characteristics of propagules. On islands near the mainland birds are very important, for larger distances movement by wind and seas are dominating. Propagules are carried to islands from all directions. Almost half of all species on Hawaii originate from the Indo-Pacific region, more than a quarter from the Holarctic and 17% originate from cold temperate southern hemisphere areas (Fenner 1985).

It can also be shown how plants establish on islands; Arrhenius (1921) expressed the relation between the size of an island and number of species by the following equation:

$$S = CA^z \quad (4.2a)$$

i.e.

$$\log S = \log C + z \log A \quad (4.2b)$$

where S is the number of species of a taxon on the island, A the area, z a parameter without dimension (constant), which changes little worldwide (slope of the linear regression, when log S is plotted against log A, values between 0.17 and 0.4). C is the gradient dependent on the dimensions in which A was measured, the biogeographical area and the taxonomic group.

The relationship between species and area shown in equation 4.2 results in the fact that the number of species of the group considered is halved if the area is reduced by a factor of 10. This attempt to provide a mathematically comprehensible theoretical expression relating the number of species to the size of island is one of the important bases of the **island biogeography steady-state theory**. Darlington (1957) proved this empirically for reptiles on West Indian islands, and Johnson and Simberloff (1974) confirmed this for plant species of the Scottish Islands (Fig. 4.2.10). These relationships are explained by two hypotheses. The **habitat diversity hypothesis** (Gorman 1979), suggesting that on larger islands there is a greater number of diverse habitats, and the **area alone hypothesis** (Kohn and Walsh 1994) assuming a direct relationship between island size and number of species.

4.2.3.1

Island Biogeography Steady-State Theory According to Preston, MacArthur and Wilson

Preston (1962), but mainly MacArthur and Wilson (1963, 1967), built on previous knowledge of establishment and number of species on islands. They started from the premises that:

- Fewer species occurred on islands than on the same area on the mainland;
- The number of species on islands increased exponentially with the size of the island;
- The pools of species on the mainland supply propagules;

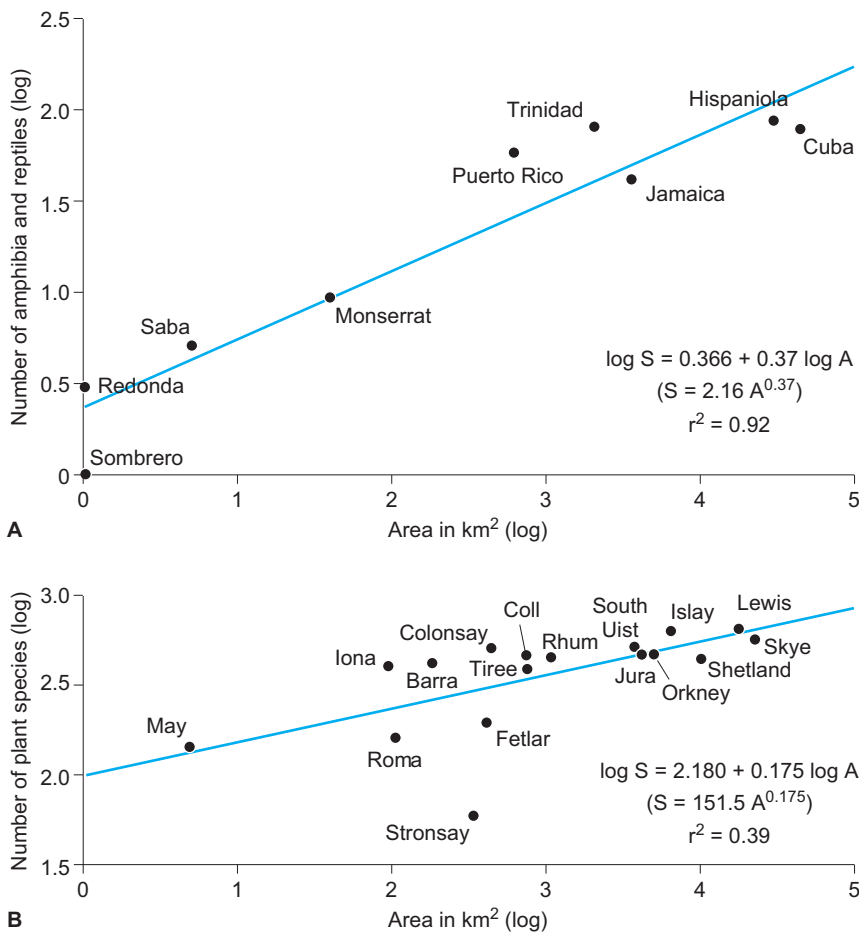


Fig. 4.2.10. Species-area relationships. **A** Reptile (herpeto-) fauna from selected West Indian islands (after Darlington 1957). **B** Plant species from selected Scottish islands. (After Johnson and Simberloff 1974)

- That the distance from the mainland is a very important determinant of the number of species on islands.

In addition, they assumed that the number of species on islands depends on the diversity of habitat and that other islands between the island and the mainland may play an important role as **stepping stones for island hopping**. It was also assumed that islands possess a limited capacity for taking in new species and that, therefore, an equilibrium between **colonisation** and **extinction** is established. It should be noted that some islands may be “oceanic” islands (e.g. formed by volcanic eruptions) and so never had direct contact to the mainland, or “continental” islands, where contact existed and where, therefore, a proportion of established species originated from that period of contact.

In summary, these observations and considerations lead to formulation of a general theory attempting to explain the different distributions

of organisms. The most important parameters for such an explanation were, as previously, the size of the area and the distance to the mainland. Three statements were made:

- increased size of islands means increased number of species;
- increased distance from the mainland (supplier of propagules) means decreased number of species;
- with a constant number of species a continuous shift of species results because of colonisation and extinction.

The course of **colonisation and extinction** is shown schematically in **Fig. 4.2.11 A** where the intersection of both curves, **number of species** and **turnover**, shows the steady state (balanced state). The **rate of establishment** is dependent on the distance from the mainland. The larger the distance, the more difficult is the establishment. The quality of the “source” as well as the type and number of propagules that might settle

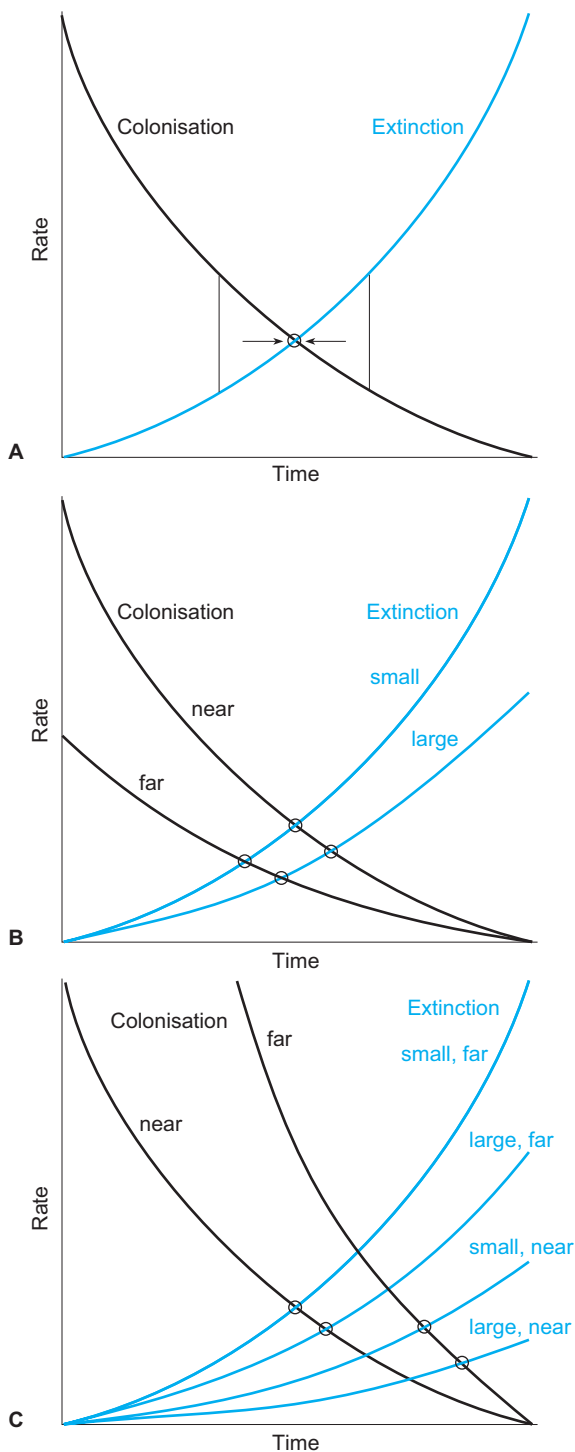


Fig. 4.2.11. Basic concepts in the theory of island biogeography. **A** Processes of colonisation and extinction. **B** Equilibrium model after MacArthur and Wilson (1967). **C** Survival effect according to the equilibrium theory. (After Brown and Gibson 1983)

on the island must also be noted. **Rate of extinction**, however, is determined by the size of the island and is higher on small islands than on large islands. This leads to an additional modification (Fig. 4.2.11 B) from which the following may be deduced:

- small islands have smaller numbers of species than large islands as well as higher turnover rates;
- islands near to the mainland have more species than those further away and also a faster turnover rate;
- an island near the mainland returns faster to the steady state after interference than one further away.

The steady-state theory was not generally accepted. Some of the predictions of the model were verified empirically, e.g. by Simberloff and Wilson (1969), who observed four islands off Florida after complete sterilisation and found re-establishment with the expected number of species and turnover rates in relation to size and position of the islands. Bush and Whittaker (1991) reconstructed rates of colonisation and extinction for spermatophytes on the volcano Rakata on the basis of expedition reports, and confirmed the theory (Fig. 4.2.12). On the other hand, different developments were observed, suggesting that extinction rate was not only dependent on the size of island, but also on the position of the island relative to the pool of propagules. The turnover of species on islands near the pool of propagules is rather low, because of the continuous supply of propagules which is of greater significance than the size of the island. This “salvation effect” is shown in Fig. 4.2.11 C.

Criticism of the models of MacArthur and Wilson (1963, 1967) is directed at the type of predictive mathematical models used. Barkman (1990), for example, believes that to describe complex functional relations in ecosystems only descriptive models with limited validity are possible. The main criticism of the theory of steady state of island biogeography is directed towards the characteristics of individual plant species and their behaviour towards each other (e.g. competitive relations) not considered at all in these models. It is also assumed that the increased number of species is exclusive due to colonisation; genetic evolution is not considered and neither are the **problems of saturation of species**. Climatic changes and geological tectonic events question the steady-state model as well.

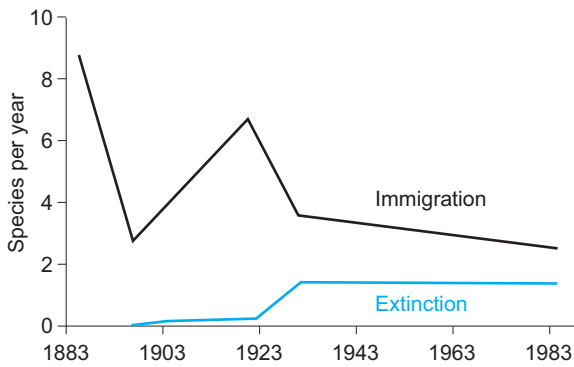


Fig. 4.2.12. Immigration and extinction of vascular plants on Rakata between 1883 and 1989. (After Bush and Whittaker 1991)

The role of stepping-stone biotopes is recognised but not considered further. The possibly important diversity of the habitat is not considered sufficiently, a factor which is very important, particularly in large habitats.

It is now difficult to find empirical proof for basically very simple assumptions of the theory of island geography, as experimental and model areas of islands which appeared ideal have been changed drastically by human influences. However, this theory has been and will be discussed because of its undisputed empirical significance and will be applied to contexts far beyond oceanic islands.

4.2.3.2

“Oceanic” and “Mainland” Islands

The results of island biogeography were formulated for islands and island groups in the sea and thus need not be applicable for all island-like habitats. Nevertheless, attempts have been made to transfer this knowledge to the mainland and island-like habitats there. These habitats are islands in lakes, mountain peaks in mountainous areas, “Inselberge” in the tropics and very small, well-isolated systems such as individual deciduous trees in a coniferous forest, caves or flower heads. Nowadays, all **anthropogenic forests** or **biotope fragments** in our managed landscapes could be interpreted as islands.

There certainly are a number of common aspects which appear to justify the application of island biogeography models to mainland islands. They have defined areas, relatively sharp borders to neighbouring habitats, are smaller than the

surrounding area, and are often situated in an hostile surrounding area, at least for the taxa within them. However, differences should not be overlooked and terms such as **isolates** (genetic separation) and **separates** (spatial separation) have been suggested (Kratochwil 1999). Usually, the distance to neighbouring islands (e.g. other forest fragments) is not very large, the surrounding area may be hostile, but allows short-term bridging. Most of all, the turnover is certainly increased as immigration rates are higher (e.g. by species avoiding intensive agriculture and fleeing into residual forests) as well as emigration rates (e.g. because of the relative proximity of comparable neighbouring islands or also sudden external interference).

The disappearance of a species in a habitat need not be connected to the extinction of the species at all. If the tree line in mountains is lower because of a deterioration of the climate, species probably find refuge in the valley. The risk of extinction is low. With subsequent warming these species will establish again in higher locations. The same principle can be applied to the diversity of species in regions which became mainland in cold periods and then became islands again in warm periods. In this case the steady state was contrasted with the **relict theory**, i.e. the present-day occurrence of species is explained by historical events.

For intensively used, managed landscapes with many small area habitats a “**mosaic concept**” was developed (Duelli 1993). The number of species is explained as individual stones in a mosaic; within the habitat the number of species increases with the number of habitat types (even those created by man). In a mosaic landscape there are several transitional stages (**ecotones**) which may be settled by specialists. Amongst animals the **diversity of the habitat** favours those which are dependent on a seasonal change of habitat. This concept touches on the importance of transitions and edges of regions.

For small forest islands, species-rich **marginal zones** can be observed where light-demanding species occur, but not actual forest species. In near-natural spaces, marginal zones are often **buffer zones** and provide a gradual transition to the inside of the island, forming an area of minimum size which provides the habitat for obligate forest species. In intensively used agricultural landscapes such buffer zones are often lacking and the gradient to the island edges is steeper.

The connection between number of species and area may also differ according to the proportion of the marginal and the core zone. In small spaces the spectrum of species is expressed by the species of the marginal zone. With increasing area, the relative diversity of species decreases and species typical of forests appear. The highest diversity is achieved in the transition from the marginal zone to the core zone. In special cases this apparently simple relation is complicated by the different influences of the marginal zone because of differences in the quality of the influences and the distance of these influences between the marginal and the core zone. A distinction must also be drawn between natural influences (radiation, wind) and anthropogenic influences (emissions, fertilisation, mechanical disturbance).

The function of **habitat fragmentation** in providing **stepping stones** between larger mainland islands should also be noted as they may stimulate exchange processes between habitats by allowing a transient residence of taxa without being the permanent habitat. At the same time

they may act as **refuges**. It is assumed that species expand more via stepping stones than without. This appears logical and intuitively correct, but empirical verification is still missing.

There are examples showing that mainland islands are a good proof of the validity of area and species relationships according to the theory of island biogeography, if the influences of man on the island are not too great (Fig. 4.2.13 A). These were confirmed, for example, by Porembski et al. (1995) for island mountains on the Ivory Coast, where the number of species increases steadily with increasing area. However, May and Stumpf (2000) report from a tropical rain forest in Malaysia that with increasing areas a significant saturation of species is found (in the reported case with an area of 50 ha; Fig. 4.2.13 B). This contradiction has far-reaching consequences, particularly as nowadays **extinction rates** of plant and animal species, for example for the increasing losses of tropical rain forests, are calculated on the basis of species area curves. The course of the curve shown here allows a (too) broad spread of extinction rates.

The saturation rate in tropical rainforests for an area of about 50 ha shown here also indicates that plant sociological research examining minimum areas in such forests is theoretically possible, but not practically.

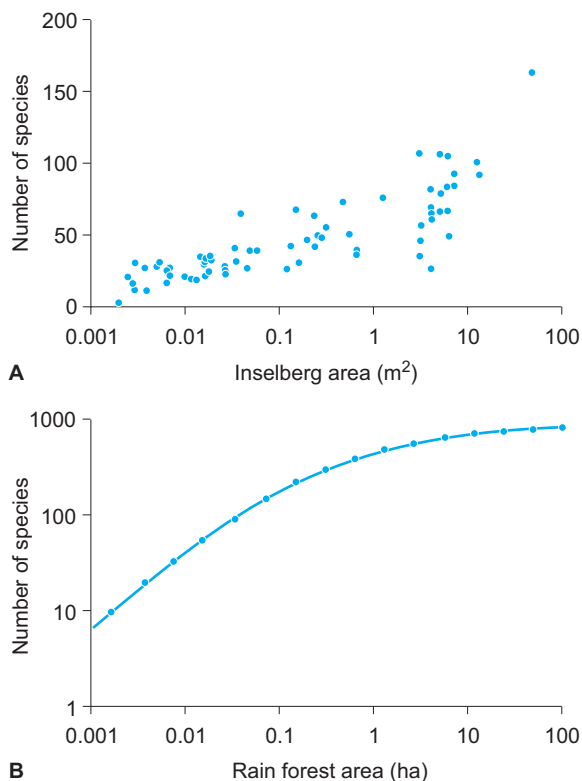


Fig. 4.2.13. Relationship between the number of species and surface area **A** on “Inselbergs” on the Ivory Coast (after Porembski et al. 1993); **B** in a tropical rainforest in Malaysia. (After May and Stumpf 2000)

4.2.3.3

Application of Steady-State Theory to Island Biogeography in Protected Areas

Today we live in managed landscapes with a high degree of fragmentation and therefore it appears obvious to apply island biogeography to the actual problems of **protected areas**. The relation of core to marginal zones in small habitats is important here. With a decrease in such habitats the diversity of conditions at the site increases linearly, but the quality of these conditions decreases exponentially (Mader 1983). Species with special demands – including demands for space – migrate, but broadly distributed species, well adapted to the site (euryoecic species), may remain established for a long time in the marginal zones, unless they lose their habitat by frequent interference. Therefore, application of the theory of island biogeography is, at the moment, only limited.

However, valid relations of size of area and distance (for mainland islands the degree of iso-

lation) have stimulated discussions on the **minimum size of areas which should be sustained**. Of course, the size of protected areas should not be calculated according the rules of island biogeography only, as strictly forest species would not be protected, because of the large demand for space. Habitats of the same or similar quality should be maintained not too far away as balancing spaces and (perhaps only intermittently required) refuge areas, pointing to the previously mentioned **stepping stones** by MacArthur and Wilson (1967). These stepping stones are an important component of the concept of **interconnecting biotopes** for protected areas. In our agriculturally managed landscape, such stepping stones could be small forest islands, as well as hedges, edges of fields, long-term fallow land, disused stone quarries or railway lines, etc. Concepts of nature protection must incorporate buffer zones and smaller areas of habitat fragments around the protected area, in addition to the closed protected areas which should be as large as possible. Number of species should not be the sole aim for protection. Large areas of **mosaics of optimal and suboptimal habitats** should be considered. There cannot be a generally applicable size for protected areas and stepping stones, nor for the spatial pattern of interconnected biotopes (particularly the distances between stepping stones and the protected area). These values depend on the communities to be protected. There are very few examples in which minimum areas and distances were established empirically for individual groups of organisms. Current, urgent attempts to create protected areas are decided on local conditions and considerations of plausibility. Increasingly, the more dynamic **metapopulation concept** by Gilpin and Hanski (1991) is becoming important.

4.2.3.4

Further Models of Island Biogeography Related to Number of Species and Area

The theory of island biogeography was taken as a paradigm. Results that did not fit into these models did not result in their rejection, rather the critical experiments and their results were questioned. Since the 1970s and 1980s various interpretations have been advanced and discussed. Those who emphasise stochastic processes explain establishment of plant species on islands differently to those who favour determin-

ism. All theoretical considerations are based on the same factors which are decisive for the establishment of plants; however, they are weighted differently. Particularly important are the pool of propagules on the mainland, mechanisms for dispersal, the distance to the island as well as its size, characteristics of the habitat, phases of succession and the conditions of competition on the island.

Connor and Simberloff (1979) assume in their simulation model that establishment of plants occurs **stochastically** without competition. They tested this model with actual data and concluded that competition does not play a role. In their interpretation, it was the parameters of dispersal that determined the success of a coloniser.

Gilpin and Diamond (1980, 1982) particularly criticised this interpretation, regarding **competition** as the decisive factor. They mentioned that closely neighbouring islands possess different spectra of species, so an exchange of species would be possible. However, it does not take place because the appropriate niches are already occupied and immigrants are not able to succeed in the face of already established competitors. In their more empirical model the explanation of diversity on islands is not possible without considering competition.

These and other models use only those parameters that are considered as important. The dimension of time is often not considered. However, time could – as shown by the models of Grime (1979) or Tilman (1988; see [Chap. 4.1.1.1](#)) – be the most important factor in the course of establishment of different strategies of species. One could – in order to build a bridge between the stochastic and deterministic interpretations – regard the former as early establishment phases and the latter as late phases.

The models by Whittaker and Jones (1994), which criticise purely stochastic models, show how much the immigration of species depends on the dispersing vector and on the stage of succession on the island of Rakata (Krakatau; [Fig. 4.2.14](#)) during the course of colonisation over 100 years. In the first phase, those species that reached the island across the sea established on almost undeveloped substrates. In the second phase, anemochoric species became more important. Only in the third phase, when substrates and first succession stages of vegetation had developed, did zoochory play an increasingly important role. These results also suggest

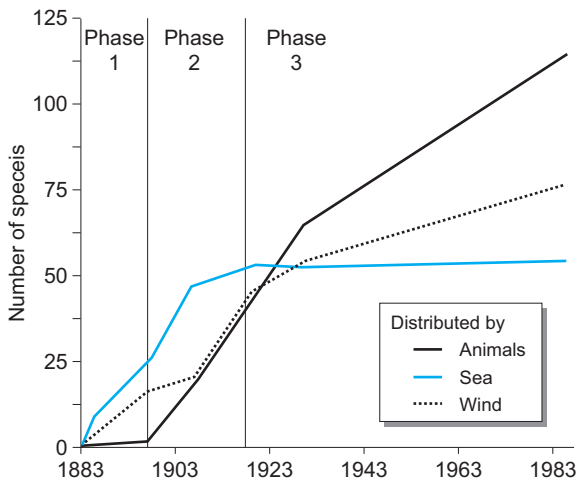


Fig. 4.2.14. Pioneer spermatophytes on Rakata from 1883 to 1989 (after Whittaker and Jones 1994). The calculation is based on a minimum turnover. On the y-axis the data for number of species from expeditions are shown. Species introduced by man are not considered

an initial stochastic but later deterministic establishment of species. It is overlooked in many interpretations that the change of species is not an inherent feature of the system, but is considerably regulated by changes in the environment. In the analysis and calculations by Whittaker and Jones a minimum turnover rate is considered, but actual numbers of species are not available.

More recent models clarifying species-area relations (e.g. Wissel and Maier 1992) have a decreasing empirical basis but increasing mathematical structure and so do not increase knowledge. Species-area relations, which appeared rather simple at first sight, are so complex that reductionism may lead to incorrect conclusions; holistic attempts, however, are often limited to superficial descriptions.

4.2.4

Biodiversity

Biodiversity has been, for a long time, an important subject of study in ecology. Beyond science, however, biodiversity gained interest with the general public after the Biodiversity Summit in Rio in 1992 where the ownership of **national genetic resources** was regulated (WBGU 2000). People from all walks of life, including politicians, became aware of the loss of species, a loss caused by human influences being a thousand-fold greater than natural rates of extinction. Scientists recognised that knowledge of biodiversity and topics linked to it was rather modest and feared that numerous organisms would become extinct without ever having been even scientifically recorded (Mooney et al. 1996).

Box 4.2.3

Steady-state theory in island biogeography

In vegetation ecology relationships between the size of an area and the number of living plant species are sought. Initially, islands were chosen for study with investigation of how they were colonised and how the number of species was determined. Understanding that developed from characterisation of an area and the species on it developed into the steady-state theory of island biogeography. This underlines the importance of stepping stones for the colonisation and is based on the idea that, over long periods of time, colonisation and extinction rates are in equilibrium. The number of species is determined by the size of the island and the distance from sources of diaspores of potential colonists, as well as the diversity of habitats which determines survival.

The theory of island biogeography was criticised mostly because the competitive relationships between species were not taken into account. Despite this, this theory is used in mainland “island” biogeography. It is the basis of biotope organisation and is used in determination of the minimum size for maintenance of habitats in nature conservation. Anthropogenic influences are present in almost all habitats, and the consequent disturbance of the environment, make it increasingly difficult to determine rules characterising areas. Currently, it is considered that the processes are less and less deterministic and are becoming increasingly stochastic.

Mere numbers of species were not regarded sufficient to understand communities in their habitats. Plants and animals were not only to be regarded as resources, but as decisive influences on processes in ecosystems (see Chap. 3). Clearly **biodiversity** developed through **evolutionary processes** by adaptation to abiotic conditions in areas with already established competitors. Why some plants form communities with few species and other with many species, what regulates the composition of species and how this influences ecosystem processes was – and still is – unknown.

At the moment ecosystems are increasingly disturbed by man and habitats are lost, whilst new sites are developed by human interference; man is responsible for the previously unknown diversity in traditional agricultural landscapes of central Europe and, therefore, it is very urgent to clarify important questions on development, loss and function of biodiversity.

A short examination of the present knowledge of the status of species will be followed by an examination of the origins of research on biodiversity based on the work of Whittaker. Questions about the hierarchy, and temporal and spatial dimensions of biodiversity will be central. Finally, functional aspects of biodiversity of biocenoses and ecosystems will be discussed (see Chap. 3) and questions related to loss of biodiversity discussed in relation to problems of environmental protection.

4.2.4.1

Species Diversity and Other Forms of Biotic Diversity

Numbers of species are only one out of several definitions of biodiversity. Without numbers and knowledge of these species – at least in their systematic structure – it would be impossible to understand the complicated topic of biodiversity. Thus recording **diversity of species** was the first aim of all inventories.

Records of numbers of species in the literature are wide-ranging. It is thought that almost 2 million plants have been described, of these about 270,000 are vascular plants. However, individual groups of species – according to their attractiveness, accessibility and ease of determination – have been recorded to different degrees. Probably a considerable proportion of flowering plants is known – the estimated total number is

320,000 – but it is assumed that less than 5% of microorganisms are described. Vertebrates are better researched than invertebrates, even though almost 1 million insect species have been recorded.

Estimates of the **total number of all species** on earth vary greatly. A realistic estimate is 10 million but the figure may be by a factor of ten greater (Groombridge 1992; Heywood and Watson 1995). On the basis of this incomplete knowledge and with particular assumptions, calculation of the total number has been attempted. One assumption is that the growth in number of species (for individual groups of organisms) described over time can be extrapolated. Numbers of endemic species or certain **keystone species** may be projected. Species occupying very large areas and therefore acting as a protection for others, so-called **umbrella species**, were chosen as well as those that are particularly favoured, so-called **flagship species**, e.g. orchids. From the number of primary consumers that of destruent is estimated, the absolute size of species is considered, as well as how common or rare they are (May 1988). Numbers calculated on such bases are contradictory and very questionable, as the importance of the selected species and parameters for diversity are not or only poorly known.

Not only the absolute number of species, but also their **spatial distribution** is of interest. Known species are not distributed evenly across the earth. There are hostile regions, e.g. permanent ice or extreme deserts, but also favourable regions such as coral reefs and tropical rain forests. The latter occupies only 6% of the surface of the earth, but more than 50% of all species live there. On a square kilometre of primary forest on the eastern slopes of the Andes in Ecuador, probably one of the regions with most flowering species, 1200 different plant species were found. The high diversity in the tropics is explained by the favourable climatic conditions enabling long and undisturbed **evolution and specialisation** as well as substantial **niche differentiation** which is an important precondition for evolution of species. Geologically, old crustal regions of the earth are generally particularly rich in species because of the long history, in addition regions where there are many small-scale structures (habitats) in a given space. Climatic regions requiring much adaptation by organisms, such as boreal forest biomes or tundras, are often relatively poor in species. According to Körner (1995), alpine mountain regions, in gen-

Table 4.2.6. The twenty-five hot spots of biodiversity currently known. (After Myers et al. 2000)

Hot spots	Original extent of natural vegetation (km ²)	Remnants of the natural vegetation (km ²) ^a	Protected areas (km ²) ^b	Plant species	Number of endemic plant species ^c
Tropical Andes	1 258 000	314 500 (25.0)	79 687 (25.3)	45 000	20 000 (6.7%)
Central America	1 155 000	231 000 (20.0)	138 437 (59.9)	24 000	5 000 (1.7%)
Caribbean	263 500	29 840 (11.3)	29 840 (100.0)	12 000	7 000 (2.3%)
Atlantic forests of Brazil	1 227 600	91 930 (7.5)	33 084 (35.9)	20 000	8 000 (2.7%)
West Ecuador	260 600	63 000 (24.2)	16 471 (26.1)	9 000	2 250 (0.8%)
Cerrado of Brazil	1 783 200	356 630 (20.0)	22 000 (6.2)	10 000	4 400 (1.5%)
Central Chile	300 000	90 000 (30.0)	9 167 (10.2)	3 429	1 605 (0.5%)
California	324 000	80 000 (24.7)	31 443 (39.3)	4 426	2 125 (0.7%)
Madagascar ^d	594 150	59 038 (9.9)	11 548 (19.6)	12 000	9 704 (3.2%)
Forests in Kenya and Tanzania	30 000	2 000 (6.7)	2 000 (100.0)	4 000	1 500 (0.5%)
Forests of West Africa	1 265 000	126 500 (10.0)	20 324 (16.1)	9 000	2 250 (0.8%)
Cape Province	74 000	18 000 (24.3)	14 060 (78.1)	8 200	5 682 (1.9%)
Succulent-rich Karoo	112 000	30 000 (26.8)	2 352 (7.8)	4 849	1 940 (0.6%)
Mediterranean area	2 362 000	110 000 (4.7)	42 123 (38.3)	25 000	13 000 (4.3%)
Caucasus	500 000	50 000 (10.0)	14 050 (28.1)	6 300	1 600 (0.5%)
Sunda Islands	1 600 000	125 000 (7.8)	90 000 (72.0)	25 000	15 000 (5.0%)
Wallacea	347 000	52 020 (15.0)	20 415 (39.2)	10 000	1 500 (0.5%)
Philippines	300 800	9 023 (3.0)	3 910 (43.3)	7 620	5 832 (1.9%)
Indo-Burmese border region	2 060 000	100 000 (4.9)	100 000 (100.0)	13 500	7 000 (2.3%)
Southern-central China	800 000	64 000 (8.0)	16 562 (25.9)	12 000	3 500 (1.2%)
Western Ghats and Sri Lanka	182 500	12 450 (6.8)	12 450 (100.0)	4 780	2 180 (0.7%)
South-western Australia	309 850	33 336 (10.8)	33 336 (100.0)	5 469	4 331 (1.4%)
New Caledonia	18 600	5 200 (28.0)	5 267 (10.1)	3 332	2 551 (0.9%)
New Zealand	270 500	59 400 (22.0)	52 068 (87.7)	2 300	1 865 (0.6%)
Polynesia and Micronesia	46 000	10 024 (21.8)	4 913 (49.0)	6 557	3 334 (1.1%)
Total	17 444 300	2 122 891 (12.2)	800 767 (37.7)	^e	133 149 (44%)

^a In parentheses, as % of the original area

^b In parentheses, as % of the hot-spot area

^c In parentheses, as % of the globally estimated endemic plant species (300,000)

^d Madagascar includes the neighbouring island groups

^e As some hot spots overlap, it is not possible to give a sum

eral, have only between 200 and 300 species. Generally, there is a global north–south gradient with increasing numbers of species. This has been often described, however, without giving conclusive explanations. Interactions between temperature and number of species are also assumed. Woodward (1987) found a linear relation between the number of plant families and the absolute minimum temperature (for land surfaces along 15°N latitude). In absolutely frost-free areas, the number of plant families exceeded 250; below a minimum of 10 °C, the number was less than 100.

So-called **hot spots**, **centres of high diversity**, are of particular scientific (and economic) importance; these have been determined from knowledge of the number of species and their distribution. For individual hot spots, information about the area of occurrence, protected areas, areas with almost natural vegetation, as well as number of species and endemics, has been established (Table 4.2.6). The high fre-

quency of centres of diversity in equatorial regions of South America and Oceania is very striking. Values are also relatively high for the European Mediterranean region. However, it cannot be excluded that regional differences are partly caused by more or less intensive knowledge about these regions.

Barthlott et al. (1996) presented a detailed world map of **phytodiversity** (of exclusively vascular plants) in which values from available floras were re-calculated to a 10,000-km² grid. Ten **diversity zones** are graded according to the number of species, from fewer than 100 to more than 5000. Despite the rough resolution, based only on vascular plants, such hot spots are recognisable: The centres are Costa Rica, tropical East Andes, Atlantic-Brazil, East Himalayas, North Borneo and New Guinea. Kleidon and Mooney (2000) compared the map by Barthlott et al. (1996) with a map in which the global diversity of vascular plants was constructed on the basis of a climate model. Despite the different

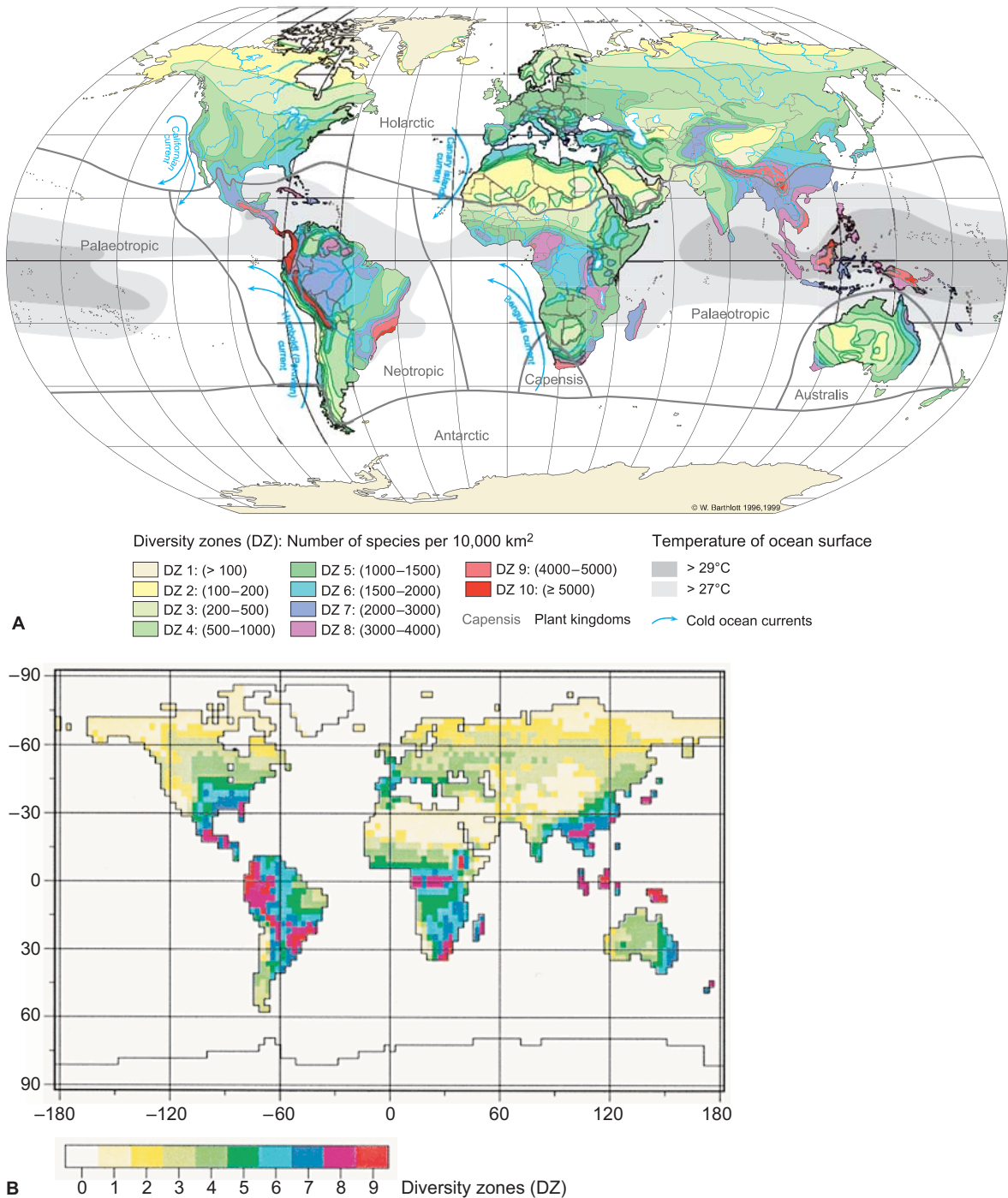


Fig. 4.2.15. Global species diversity. **A** Species diversity based on empirical data; map (above) from Barthlott et al. (1996, 1999). **B** Map from a simulation based on growth-limiting climatic scenarios by Kleidon and Mooney (2000)

resolutions, both maps agree to a large extent (Fig. 4.2.15). The authors concluded that climatic conditions explain biodiversity to a large extent. Precipitation at the time of germination and development of young plants appear decisive factors. The smaller the number of days with fa-

vourable conditions for plant growth, the larger the stress for growth and the lower the diversity of species.

Biodiversity not only comprises the number of species. Nowadays it is also assumed that **structures and functions** at the different integrational



Fig. 4.2.16. Species richness can be easily seen in a comparison of plant communities. **A** A species-rich natural, moist tropical forest in the Shimba Hills (Kenya) compared with **B** a coniferous forest in the Mediterranean region which has only one tree species (*Pinus halepensis*). In both cases, there has been little human interference in the forests. (Photos K. Müller-Hohenstein)

and organisational levels need to be considered and put into a spatial and temporal context. This complex topic area will be discussed after considering classical interpretations of biodiversity.

4.2.4.2

Classical Interpretations of Biodiversity

Research into biodiversity first considered the dimensionless number of species per unit of area (richness of species). Later, abundance and/or dominance values were added and distribution in the space (clumped, individual, etc.) was noted. **Figure 4.2.16 A,B** shows two forests, hardly influenced by man, which have very different numbers of species per unit area. The tropical humid forest from the Shimba Hills (Kenya) has many more species than the Mediterranean Aleppo pine forests in the central Atlas (Morocco).

Relations between the number of species per unit area were soon expressed in rules and indices. Two “**biocenotic basic laws**” that were advanced by Thienemann (1920) and modified by Remmert (1998) state:

- The more diverse the environmental conditions, and the closer they correspond to the biological optimum, the larger the number of species;

- The more extreme the environmental conditions and the further away from the basic biological optimum, the fewer species occur and the more dominant individual species become.

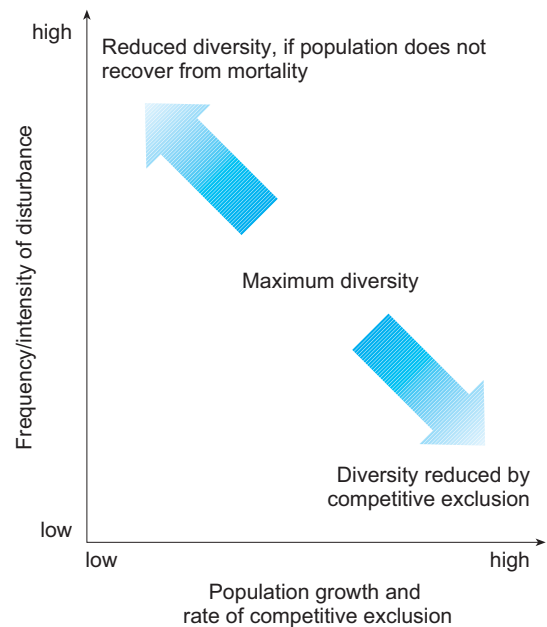


Fig. 4.2.17. Intermediate disturbance hypothesis. (After Huston 1997, from Refisch 2001)

Box 4.2.4 Quantification of biodiversity

The best-known and most frequently used index is that of Shannon and Weaver (1949):

$$H_s = - \sum_{i=1}^s (p_i \times \ln p_i)$$

H_s diversity index

S number of species present in the group

p_i relative frequency per area (abundance) of the i th species measured from 0–1

(e.g. the second most frequent species is given the value $i=2$, so if 10% of all individuals belong to this group, $p_i=0.10$)

$\ln p_i$ natural logarithm of p_i

With the help of this index the **abundance** and the **dominance** characteristics of plant communities can be described. The H_s value is a diversity index. It rises with increasing number of species and increasing uniformity of distribution of relative abundance (cover) of individual species. In habitats with single species the value is zero. A maximum H_s value indicates that all species in a habitat are evenly distributed although there could be a large number of species if the area is structurally homogeneous. This value says nothing about the characteristics of the individual species: all are treated equally. A value was introduced by Pielou (1966) to describe **evenness**, the uniformity of species distribution in a habitat. Haeupler (1982) used this value to develop comparative diagrams of habitats by taking into account the number of species.

Use of these indices and statistical processes provided research into biodiversity with quantitative and descriptive methods of analysis.

An initial inclusive concept to analyse diversity was provided by Whittaker (1962, 1972, 1977). He attempted to take account of all previous discussions on species diversity and particularly the spatial aspects. Distinction was drawn between:

- **alpha diversity** (discrete number of species within habitats);
- **beta diversity** (dimensionless comparative number of species in different units of vegetation or between habitats);
- **gamma diversity** (a discrete number of species in a limited space);
- **delta diversity** (dimensionless comparative number of species applied to changes over large scales, the functional equivalent of beta diversity at the higher organisational level of the landscape).

Alpha and gamma diversity are thus related and measured on particular areas, the former on those which are occupied by a community, the latter on larger spatial units; ecosystems, landscapes. Beta diversity, in contrast, describes alterations in the number of species in comparison of habitats on particular areas and must be calculated and may also be used for comparisons of number of species in the same habitat over time, and is then a measure of **species turnover**. Whittaker's measures of diversity are still used to describe spatial distribution of vegetation.

It should be stressed here that environmental conditions may also become more diverse because of disturbance (intermediate disturbance hypothesis) and the biological optimum also must consider all biological interactions (see Fig. 4.2.17).

4.2.4.3

Present Understanding of Biodiversity

It has long been thought that diversity is limited only to species diversity and is correlated to long-term development in undisturbed areas or

ecosystems. During the last two decades, the scope of the term biodiversity has been extended and, at the same time, used more frequently in public. The resulting complexity in the science, contrasting with simplification in general use, requires fundamental clarification.

The term, initially only used to refer to organisms (species), was transferred to other topics and levels of organisation. To fully understand biodiversity, other levels of integration of organs and cells, but most of all plant communities (and the difficulty to define biocenoses) and ecosystems, must be included (Fig. 4.2.18 and Chap. 3). Consideration of species not only concerns genetic di-

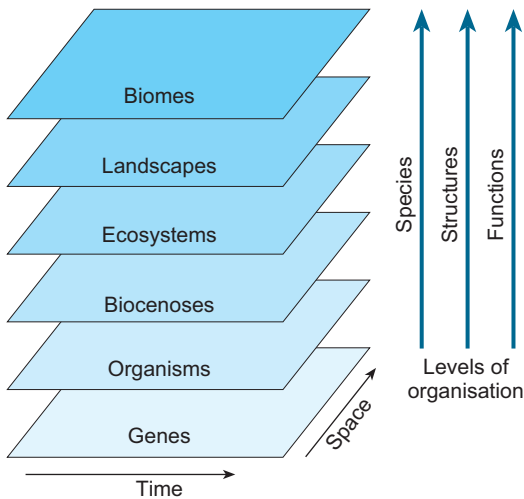


Fig. 4.2.18. Levels of organisation of biodiversity based on characteristics in space and time. (Beierkuhnlein 1999)

versity, but also structural diversity, related to composition or form of growth (Lamont 1995). Ultimately, the diversity of functions, of relations between species, and interactions between species and abiotic factors need to be considered.

This extended approach to describe biodiversity would not be complete without considering the required temporal and spatial dimensions which are partly contained in Whittaker’s con-

cept, and are regarded as particularly important. In Fig. 4.2.18 the elements mentioned, levels of organisations, and temporal and spatial scales of biodiversity are related. In the following, more detailed, discussion the temporal and spatial aspects of species and structures will be outlined. More detailed functional descriptions about biodiversity are given in Chapter 3.1.

Biodiversity cannot be described reasonably without considering **spatial** and **temporal scales**. Spatial characteristics of biodiversity are **patterns of distribution of individuals, species, genera, communities and ecosystems**. Recognition of these patterns depends on the scope of the research. Of course, to identify species diversity in a cushion of epiphytic living mosses on a tree trunk in the rain forest involves different spatial scales rather than recording communities in a landscape where spatial patterns depend on the **naturally determined diversity of the site**, as well as on **diversity due to human influences** (Fig. 4.2.19 A, B). The latter resulted in maximum species diversity in the traditionally managed landscapes of central Europe up to the middle of the last century, but thereafter it decreased due to intensification of land use (see also Chap. 4.1). For populations and plant communities, intra- and interspecific competition are the factors determining diversity.

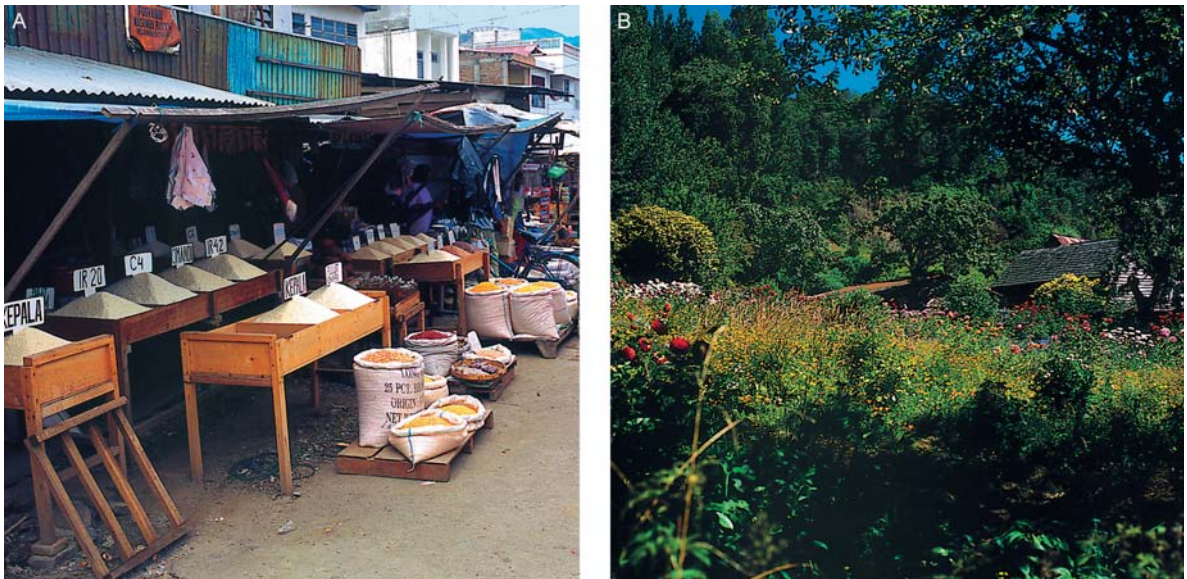


Fig. 4.2.19. Anthropogenic species diversity is to be found in all climatic zones in traditionally cultivated landscapes. This is shown by **A** the large number of cultivated rice varieties in a rural Indonesian market (Palu, Sulawesi) and **B** a home garden in southern Chile (Puerto Montt). In both cultivated areas agrochemicals and modern agronomic techniques have little impact. On such small-holdings, practicing subsistence agriculture, evidence of species diversity with intermediate disturbance (medium disturbance hypothesis) can be found. (Photos K. Müller-Hohenstein)

Table 4.2.7. Categories of plants by life form. From various authors. (After Schulze 1982)

Humboldt (1806)	Drude (1887)	Raunkiaer (1904)	Monsi (1960) and Walter (1973)	Schmithüsen (1968)
Palms	Woody plants with leaves	Phanerophytes	Herbaceous plants	Trees with crowns
Banana form	Trees	Chamaephytes	Annuals	Trees with apical bunched leaves
Mallow form	Bushes	Hemicryptophytes	Biennials	Giant grasses
Mimosa form	Lianas	Cryptophytes	Deciduous	Strangler figs
Heathers	Mangroves	Therophytes	Persistent	Lianas
Cactus form	Parasites on woody plants		Evergreen	Shrubs
Orchids	Leafless woody plants	Subdivided after	Persistent	Dwarf trees
Casuarinas	Stem succulents	Leaf size	Woody plants	Stem succulents
Pines	Leafless bushes	Leaf duration	Deciduous	Herbaceous plants
Arum form	Small bushes	Vegetative reproduction	Lignified	Epiphytes
Lianas	Perennial herbs		Evergreen	Dwarf bushes
Aloes	Rosette plants		Lignified	Small bushes
Grass form	Leaf succulents			Dwarf succulents
Ferns	Epiphytes			Chamaephytic perennial herbs
Lilies	Hapaxanthic plants			Hemicryptophytic woody plants
Willow form	Land plants			Hemicryptophytic perennial herbs
Myrtle form	Water plants			Winter annuals
Melastoma form	Lichens			Geophytic perennial herbs
Laurel form	Saprophytes/parasites			Therophytic herbs
				Floating leaf plants
				Submerged herbs

Similar considerations apply to **diversity of structures**. Important structural characteristics of a plant are leaf form and branching. Several attempts were made by plant geographers, as well as by ecologically orientated botanists, to differentiate between life forms based on structural features predominantly. These attempts show that it is very difficult to cope with the great diversity of structural features in the plant kingdom (Table 4.2.7). In closed stands, structures such as layering caused by the life form, type of canopy or intertwining with lianas increase structural diversity (Fig. 4.2.20). In a landscape, structures created by man must also be considered, e.g. fragments of almost natural stands or linear elements such as hedges and windbreaks. At this level it is clear that the natural heterogeneity contributes to high diversity, and that in transitional areas diversity changes greatly, for species as well as for structures (ecotone).

In landscape ecology, where the **importance of scale** is underlined, biodiversity is regarded as equal to geodiversity and summarised as **landscape diversity** (Leser and Nagel 1998). **Geodiversity** is defined here as the diversity of non-biotic systems. There is no doubt that abiotic

features of landscapes are very important for biodiversity. It is also understood that landscapes show diversity and that these may be described. However, it is difficult to measure – a problem which also exists for structures and functions. Species or genes can be counted and used for calculations. For communities and ecosystems – provided their existence is accepted – this is difficult because of defining limits. The same applies to attributes of geodiversity, such as classification of slopes and measuring water supply or salt content of soils. Such variables may be subdivided in many ways.

The evaluation of species as **endemic, dominant and keystone** is attempted in order to improve results. However, the biggest problem is insufficient and uneven knowledge of the spatial distributions of many groups of organisms. Despite this difficulty the three-dimensional, spatial diversity of species and structures at all organisational levels is an essential aspect when considering biodiversity.

This applies just as much to **temporal diversity**. Biodiversity is a mirror image of temporal processes and developments. The composition of species and their number change during the

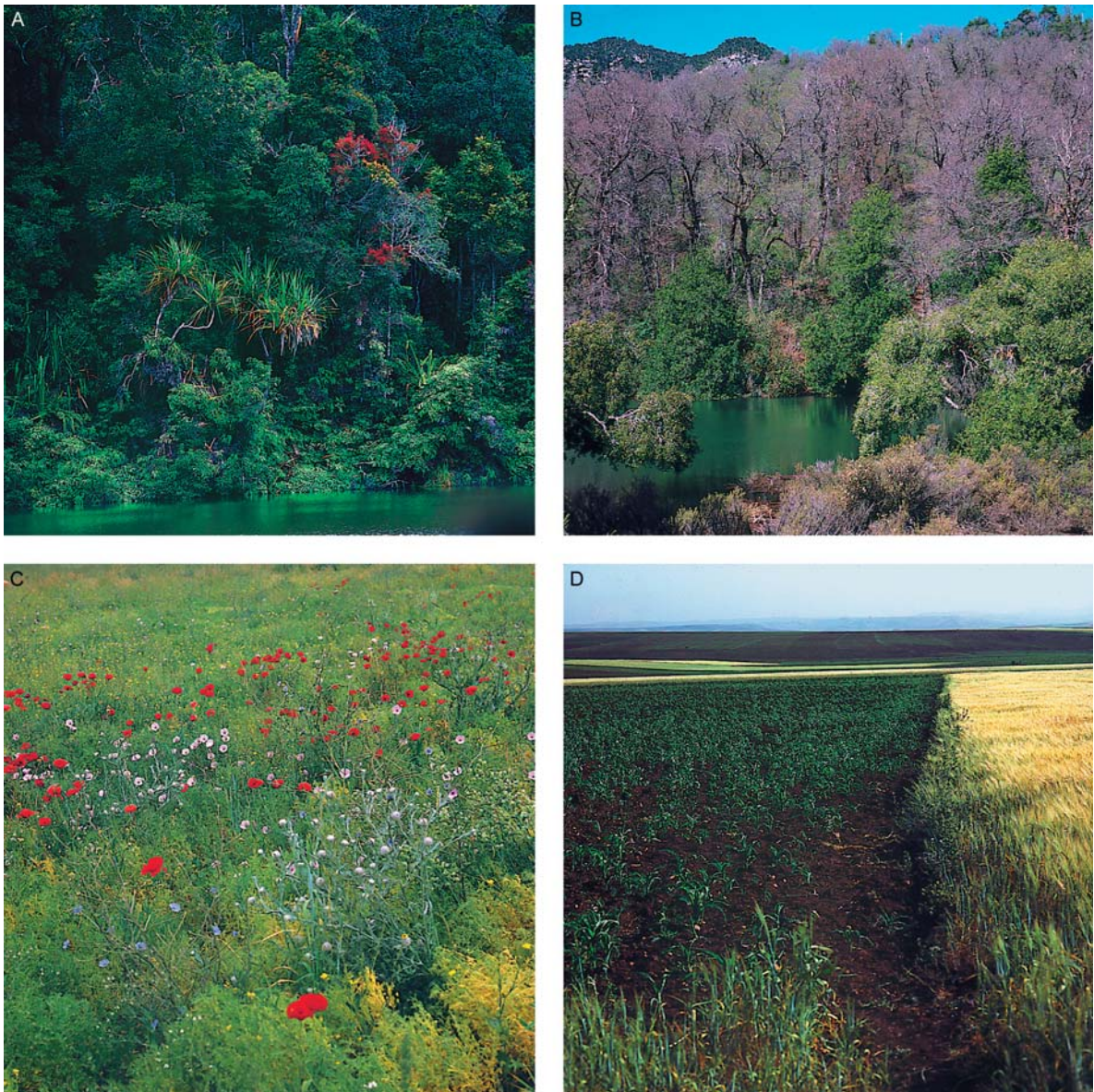


Fig. 4.2.20. Biodiversity is not only species-richness but also structural diversity. The photographs show clearly the association between the two aspects of diversity. **A** Combination of both characteristics in a tropical rain forest in Indonesia, rich in species and in structures. **B** An extra-tropical rain forest, poor in species but rich in structure. The number of higher plant species differs ten-fold. Cultivated cereal fields are single layered and poorer in structure than forests, although they can have more species. **C** A species-rich, but structure-poor fallow and **D** a species- and structure-poor cereal field, both influenced by the Mediterranean conditions in Morocco but on very differently cultivated areas. (Photos K. Müller-Hohenstein)

course of successions (see [Chap. 4.1](#)). Type, intensity and frequency of disturbance, e.g. landslides, fires, grazing, etc., influence species and structures, as well as the many functional interactions in biocenoses and ecosystems. It may be assumed that long periods with similar exogenous conditions and without disturbances are required for great diversity of species and ecosystems, particularly because it was possible to

develop a large diversity of habitats during such long periods.

The different scales of the “time” dimension must also be considered. Local and regional diversity is determined, to a large extent, by abiotic conditions and evolution. The time scale for the latter should also be applied to climate change (cold and warm periods) and to the diversity dynamics linked to it. In addition to this

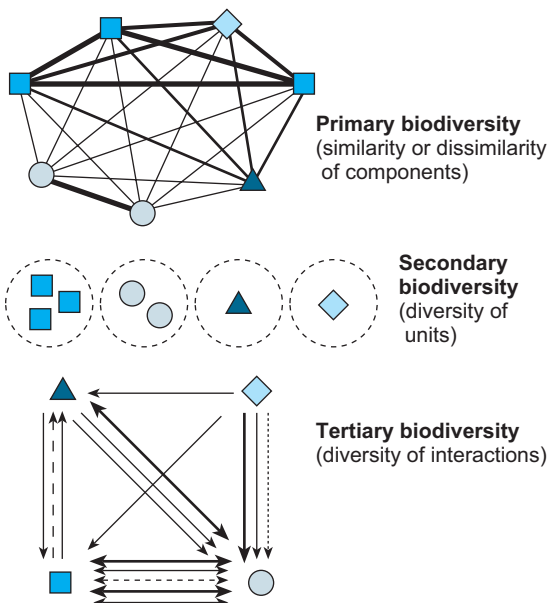


Fig. 4.2.21. Schematic of the three basic types of biodiversity: primary diversity (variability, beta diversity, turnover), secondary diversity (number, alpha and gamma diversity) and tertiary diversity (functional diversity, ecological complexity). (After Beierkuhnlein 1999)

“phylogenetic” time scale, other, shorter time scales – perhaps that of human influence or only a section of this, e.g. the industrial age – and their influence on biodiversity must be considered. **Regeneration phases** after disturbance, growing seasons and **phenophases** are further scales for research on biodiversity dynamics. Without considering temporal developments – the change from traditional to agro-industrial intensive agriculture with international markets and the resulting uniformity – changes of diversity at the level of species, structures and functions cannot be understood. The consideration of such changes in a relatively short time span contributed to the formulation of the **intermediate disturbance hypothesis** according to Huston (1997; see Fig. 4.2.17) which assumes that with average disturbance, e.g. in traditional agricultural landscapes, the highest diversity of species is achieved.

Beierkuhnlein (1999) formulated a new comprehensive **definition of biodiversity** considering spatial and temporal relations at various organisational levels (see Fig. 4.2.18) and their differentiation into actual things and abstract concepts (e.g. on one side individual, plant stand, landscape and on the other species, association, type of landscape). The definition states: “Biodi-

versity is an expression of the primary, secondary or tertiary diversity of organisms at all organisational levels in a factual or abstract, spatial or temporal sphere of relations.”

In this definition **primary diversity** is the similarity or (its reciprocal) difference between biotic units (Fig. 4.2.21) and corresponds to beta diversity or is now interpreted as turnover. The determination of the number of such units, which would correspond to the alpha and gamma diversity, is called here **secondary diversity**. **Tertiary diversity** is the diversity of relations between units and is very difficult to record as it relates to the complete ecological complexity, and concerns all functional connections and interactions which exist between qualitatively and quantitatively determined units.

4.2.4.4

Biodiversity and Stability

Pimm (1993), Tilman and Downing (1994) and Rejmanek (1996) regard higher diversity as greater complexity of function and deduce that this represents more resistance (e.g. immigration of neophytes) and resilience towards external influences. Loss of diversity thus leads to decreased ecological integrity and to more susceptible, labile systems (Chapin et al. 2000; Fig. 4.2.22).

Experiments have shown that ecosystems possess a surprising **buffer capacity** against **loss of species**. However, if a so-called **keystone species** (Bond 1993) is lost, which affects the complete system, they may change in the long term.

It is now known that species richness does not guarantee ecological stability, but this does not mean that species-poor systems are particularly labile. The nemoral forests of North America and Europe differ considerably in the number of species, but both forest ecosystems obviously “function” similarly. Facts applying to temperate zones need not apply to tropical habitats. Here, too, spatial and temporal aspect and scales need to be considered.

Recently, “rating” of species and thus identification of keystone species have been the focus of attention. Obviously, not all species have the same function in an ecosystem and even if this were the case, their abundance or even dominance should be weighted as much as their temporal occurrence (e.g. annuals in niches). Terms such as “**functional groups**” and “**plant func-**

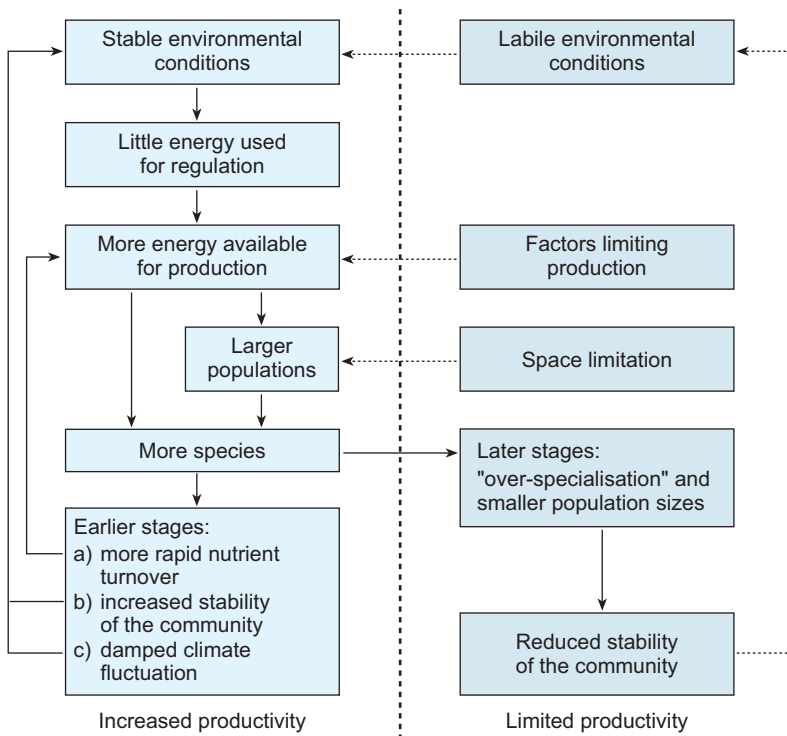


Fig. 4.2.22. Model of the relationships between diversity and stability (production and regulation of species diversity in ecosystems). (After Connell and Orias 1964, from Beierkuhnlein 1999)

tional types” (Smith et al. 1997) were created. These are species with **comparable physiological behaviour** (e.g. C_3 and C_4 plants), **similar morphology** (e.g. stem succulent bottle trees, lianas), **temporal niches** (e.g. spring geophytes, pluviotherophytes), **similar distribution syndromes** (e.g. anemochory, zoochory) and form **similar spatial patterns of distribution** (e.g. dominant species, marginal species). Plants were also grouped according to their demands on resources (water, light) or their effect in the system (shade). Subdivisions are easier according to morphological criteria and are much more detailed, as Denslow (1996) showed for tropical forests. Körner (1999) grouped plants of alpine ecosystems according to growth forms (dwarf shrubs, rosette-forming herbaceous plants, cluster grasses, cushion plants). A generally applicable classification, however, does not appear to be possible. The division depends on the question asked (Hector et al. 1999).

This approach, aimed directly at **functional diversity**, despite important historical approaches, duplicated a step which in animal ecology is already standard (Schulze 1982). In animal ecology, corresponding faunistic groups are called **“guilds”**. Predators, parasites, herbivores and carnivores, etc., can be regarded as such. It appears easier to order the fauna into such guilds

than plant organisms into plant functional types. Many plants may belong to several functional groups; at the same time they may be “ever-green”, “zoochoric”, “deep rooting”, “nitrate storing”, etc., to name just a few. According to the questions posed, the same species may be classified in different groups (Beierkuhnlein and Schulte 2000). No binding proposals have yet been made and a problem is that work with functional groups is undertaken without fully understanding the function. For the group Leguminosae it is easy to understand the function because of their ability to fix nitrogen and thus to classify them accordingly. However, for groups such as “grasses” or “herbaceous plants”, this applies only partially (position of leaves, capacity to form fine roots, etc.). It is thus questionable whether such a subdivision for plants would be justified in order to understand the ecological behaviour of a species within the plant community. Classification of species in a plant community according to functional groups is very difficult with our present knowledge of groups and their role in ecosystems (Schulze and Mooney 1993).

There is a further difficulty. As **plant functional types** are not only **abstract types** but also **concrete species**, and as they are seen as functionally equivalent in systems in which they live,

they are also classified as redundant. If a species with this function in the system is lost, it is replaced by one from the same functional group and, because of this compensation, the system is not affected. As plant types belong to different functional groups, it is generally only possible to classify some of their functions within ecosystems. Therefore, the term **redundancy** should be used very carefully. Structural redundancy is not necessarily ecological redundancy. The latter can only occur if two species in one system compete for the same limiting resource in the same way, which is unlikely. Redundancy suggests that it is possible to do without one of these species. As long as we do not know all the functions of individual species within the ecosystem and do not know how environmental conditions will change, so that each species will have in future a potential new, special functional meaning in the ecosystem or will be able to achieve it, so there is no redundancy. This shows clearly that biodiversity per se is important (Schmid 1996; Grime 1997).

As the role of biodiversity in ecosystems is only known approximately from a few experimental studies, and may be regarded as uncertain, and actual (empirical) data are lacking, it is important to return to hypotheses formulated during the last two decades.

A generally accepted **hypothesis** is the intermediate disturbance hypothesis of Connell and Slatyer (1977) and Huston (1994), in which **medium interference** to ecosystems leads to **high diversity of species**. The traditional central European agricultural landscapes support this. Similarly, the resource availability hypothesis by Tilman and Pacala (1993), according to which the diversity of species cannot be larger than the spatial and temporal availability of resources, is accepted.

Whilst these hypotheses describe diversity in ecosystems generally, the following are primarily targeted at the importance of diversity for ecosystem functions.

Theoretically, one could think of several connections between ecosystem functions and biodiversity (Vitousek and Hooper 1993; Tilman et al. 1997):

- The process observed increases linearly with the number of species;
- The process observed reaches saturation with a certain number of species;
- One species is sufficient to maintain the process.

Conversely, various consequences of a loss of species may be hypothesised:

- With decreasing number of species a threshold is reached at which the system collapses (rivet popper hypothesis; Ehrlich 1994). The hypothesis was formulated by analogy to an aeroplane from which more and more screws and rivets are removed: At first nothing happens, but after a certain number of missing connections the construction breaks down; the aeroplane crashes.
- With decreasing number of species there is an increasing probability that a keystone species is missing with disproportionate consequences (Bond 1993). This hypothesis assumes that some species are more important for the ecosystem than others, even though they only amount to a small proportion of the biomass or the turnover rate. The effect on the ecosystem is similar to that of the rivet popper hypothesis, only the reaction occurs in several steps with the disappearance of keystone species.
- Each loss of species contributes to decreased function of the ecosystem (diversity stability hypothesis; Johnson et al. 1996).
- Some species are important; however, most species are unimportant for the maintenance of processes. As long as all-important functional groups (e.g. N fixers, primary producers, detractors) are represented, the ecosystem may be depleted to a minimum diversity (redundant species hypothesis; Walker 1992).
- Under normal or average conditions only a few species are required to make the system function. With sudden changes, however, previously unimportant species may “jump in” and continue the system under changed conditions. These species function as “insurance” (the insurance hypothesis; Schulze 1995).
- There is a relationship between biodiversity and function of the ecosystem, but the direction and effect as well as the intensity cannot be predicted, because it depends on conditions and participating species (idiosyncratic response hypothesis; Lawton 1994).
- The **zero hypothesis** (Vitousek and Hooper 1993) states that diversity has no influence on the functions of ecosystems.
- With increasing number of species saturation is reached.

These hypotheses contradict each other in important aspects, and the authors provide proof

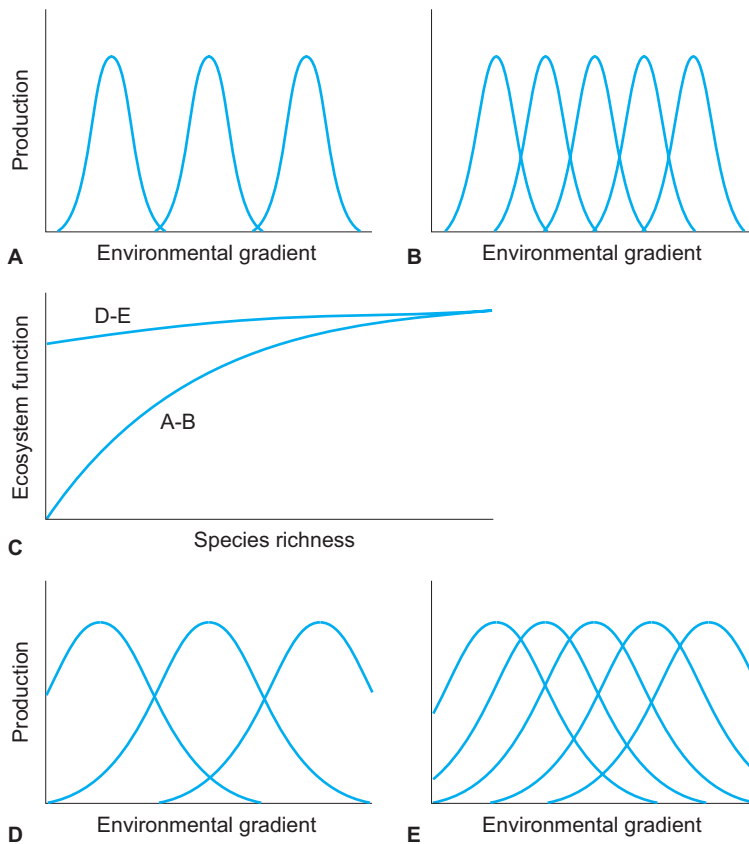


Fig. 4.2.23. Comparison of two models of the importance of the relationship between species-richness and ecosystem functions. **C** Species-poor and species-rich communities with relatively stenoeic species which have requirements (and functions) which hardly overlap (**A, B**) as well as species-poor and species-rich communities with relative euryoecic species which have requirements (and functions) which substantially overlap (**D, E**). In the two last cases functional redundancy occurs. (After Wright 1989)

and counter-proof. According to Schlöpfer et al. (1999), most ecologists regard the redundant species hypothesis as the most important one. However, the problem of redundancy of species must, once again, be clarified. The model according to Wright (1989) shows the different effect of redundancy on the functions of species-rich ecosystems and therefore species cannot be regarded as superfluous (Fig. 4.2.23).

4.2.4.5

Endangering and Protecting Biodiversity

During the course of global history, there has always been turnover of species. This means that species that did not find their niche died out or were eliminated by natural catastrophes. However, evolution and speciation balanced this loss of species. At present, vastly more species are lost than are formed during the same period. According to May (1988), about half of the species developed in the last 50–100 million years will be eradicated in the next 10–50 years, if the current scale of forest destruction in the tropics is maintained. This dramatic relationship be-

tween the rate at which new species form to the rate of species loss is possibly too optimistic according to Nepstadt et al. (1999), as the loss of species in the remaining tropical forests by fires and extensive use is not included in the loss calculations for tropical forests.

There is no linear relationship between number of species and area. Pimm and Raven (2000) predict that with loss of half of all humid forests “only” 15% of species living there would be lost. However, if only 5% of forests remain undisturbed, only half of the forest species will be able to survive. For hot spots of species distribution much higher losses are predicted. However, exact figures are hard to obtain and those available are unreliable. It is impossible to transfer loss of species from one group (e.g. butterflies) to another (e.g. birds) along a linear gradient of exploitation, as the loss in the same area differs considerably for different groups of organisms (Lawton et al. 1998).

At present, **direct and indirect human intervention** are the most important causes of the **increasing loss of species**. In the early years of growing environmental consciousness, pollution of the biosphere with pesticides and other toxic

substances was regarded as the main cause for the loss of species and Rachel Carson (1962) described this impressively in her book *The Silent Spring*. Today, increasing intensive agriculture and industrialisation are seen as causes. These are linked to fragmentation of the remaining almost natural areas, with drainage, eutrophication, loss of traditional rotation methods in agriculture and grazing, and replacement by monocultures, developments which are described by Krebs et al. (1999) as the “Second Silent Spring”. The consequence is not only the direct loss of species, but also the loss of rare habitats. Changes resulting from this **global change** (see Chap. 5) cannot yet be estimated.

Man is breaking all existing biogeographical barriers. In addition to **species extinction**, there is a noticeable invasion (**neophytisation**), particularly a trend to global floristic uniformity with euryoecic species dominating. Lövei (1997) speaks of a ‘MacDonaldisation’ of the biosphere.

Maintaining and protecting biological diversity at all organisational levels require no special reasons other than the numerous arguments from ethics, religion, economy and ecology. Because

we expect the decrease in species not only to affect the stability and function of our ecosystems, but also to limit future developments, we must apply controls and protective measures. Spatial and environmental planning requires instructions, to protect species, communities and their habitats, which are understandable and can be rapidly and practically applied. Simple **biomonitoring**, with individual species accurately registered and regularly traced during certain periods in controlled areas, would be a first step in underpinning assumptions and estimates with real data. Reduction in pollution of the environment and attempts to maintain the remnants of natural habitats in all biomes are obviously necessary.

Scientists have developed several instruments for the protection of the environment and some have already been successfully used in practice. It is clear that:

- protection of species alone does not suffice; the **habitat** and the natural processes occurring there must also be **protected**;
- increasing fragmentation must be counteracted by **integration of habitats** (biotope network);

Box 4.2.5 Biodiversity and stability

Biodiversity is mainly understood to be the number of species (richness). These developed, via evolutionary processes, over time and with spatial differentiation of specific niches in habitats. In the first inclusive concepts of biodiversity, particular attention was placed on the number of species in a specific area (i.e. plant communities) and between selected areas (within and between habitat diversity; Whittaker 1977). Later, it was shown that diversity could be described in another way. Thus, concepts such as keystone species were used to express the fact that not all species have the same function in an ecosystem. Discussion is now mainly on plant functional types, particularly those that have an important place in ecosystems and their interactions and functions.

Later, it was appreciated that biodiversity is not only the number of species. Of equal importance is the diversity of structures and the functional interactions between them. More importantly the increased numbers of aspects

that can be investigated – from molecular diversity, via species to communities of species to the ecosystem – in various types of habitat and at various times.

Current thinking is that the interactions between diversity and stability need to be clarified, since it has been shown that the species-richness does not guarantee stability of communities. Of the current hypotheses, particular attention is paid to the redundant species hypothesis, stating that in a community redundant species occur, i.e. their loss does not affect the stability of the community. However, it is difficult to establish redundancy in all aspects of the community (physiological, structural, ecological, etc.). The protection of a community has to reach beyond the maintenance of species and must take into account the protection of communities and habitats. Nevertheless, there are centres of high diversity, so-called hot spots, predominantly in the tropics and subtropics, which need particular attention.

- in managed landscapes **protection of traditional processes of sustainable management** must not be forgotten;
- **hot spots** require particular protection.

Decision-makers in politics and industry responsible for the implementation of protective measures and concepts always ask for data and numbers. Therefore, steps must be taken to establish the data on biodiversity. It is relatively easy to do this at the level of the species, even if in many habitats (tropics) and for taxonomic groups (e.g. mosses, lichens) there are still enormous difficulties. However, even if these difficulties have been solved, the indices designed by scientists must be tested for practical application. Knowledge is only useful if functions can be linked to the number of species. An enormous challenge for ecologists is to **quantify functions of ecosystems dependent on diversity**, as well as working out the connection between species and structures influencing the functioning of ecosystems. For obvious reasons this would mean in the first instance working with species and communities of the macroflora and macrofauna. However, the interactions at the microbial level should not be overlooked. There are important tasks for ecologists in the future.

It will become problematic at higher levels of aggregation. Is it possible to count communities or ecosystems? If yes, how can we count the rarity, the economic significance, or the aesthetic impression? Ecology must not shy away from normative approaches and must take a position in the problems of evaluation. This must happen soon, because the scientific protection of natural habitats puts plant ecology, as no other scientific discipline, under an enormous time pressure.

References

- Al Hubaishi A, Müller-Hohenstein K (1984) An introduction to the vegetation of Yemen. Ecological basis, floristic composition, human influence. GTZ, Eschborn
- Arrhenius O (1921) Species and area. *J Ecol* 9:95–99
- Barkman JJ (1990) Controversies and perspectives in plant ecology and vegetation science. *Phytocoenologia* 18:565–590
- Barthlott W, Lauer W, Placke A (1996) Global distribution of species diversity in vascular plants: towards a world map of phytodiversity. *Erdkunde* 50:317–327
- Barthlott W, Biedinger N, Braun G, Kier G, Mutke J (1999) Terminological and methodological aspects of the mapping and analysis of global diversity. *Acta Bot Fenn* 162:103–110
- Beierkuhnlein C (1999) Biodiversitätsuntersuchungen in nordbayerischen Landschaften. In: Beierkuhnlein C (Hrsg) Rasterbasierte Biodiversitätsuntersuchungen in nordbayerischen Landschaftsräumen. Bayreuther Forum Ökol 69:1–9
- Beierkuhnlein C, Schulte A (2000) Plant functional types – Einschränkungen und Möglichkeiten funktionaler Klassifikationsansätze in der Vegetationsökologie. In: Jax K, Breckling B (Hrsg) Funktionsbegriff und Unsicherheit in der Ökologie. Lang, Frankfurt
- Blüthgen J (1964) Allgemeine Klimageographie. Lehrbuch der allgemeinen Geographie, Band 2. De Gruyter, Berlin
- Bond WJ (1993) Keystone species. *Ecol Stud* 99:237–253
- Brown JH, Gibson AC (1983) Biogeography. Mosby, St. Louis
- Bush MB, Whittaker RJ (1991) Krakatau: colonisation patterns and hierarchies. *J Biogeogr* 18:341–356
- Carson R (1962) Silent spring. Houghton Mifflin, Boston
- Chambers JC (1994) A day in the life of a seed: movements and fates of seeds and their implications for natural and managed systems. *Annu Rev Ecol Sys* 25:263–292
- Chapin FS III, Zavaleta ES, Eviner VT, Naylor RL, Vitousek PM, Reynolds HL, Hooper DU, Lavorel S, Sala OE, Hobbie SE, Mack MC, Diaz S (2000) Consequences of changing biodiversity. *Nature* 405:234–242
- Connell JH, Orias E (1964) The ecological regulation of species diversity. *Am Nat* 98:399–414
- Connell JH, Slatyer RO (1977) Mechanisms of succession in natural communities and their role in community stability and organisation. *Am Nat* 111:1119–1144
- Connor EF, Simberloff D (1979) The assembly of species communities: change or competition? *Ecology* 60:1132–1140
- Darlington PJ (1957) Zoogeographie: the geographical distribution of animals. Wiley, New York
- Denslow JS (1996) Functional group diversity and responses to disturbance. In: Orias GH, Dirzo R, Cushman JH (eds) Biodiversity and ecosystem processes in tropical forests. Ecological Studies 122, Springer, Berlin
- Diels L (1908) Pflanzengeographie. GJ Göschen, Leipzig
- Duelli P (1993) Ökologischer Ausgleich in der Kulturlandschaft: Eine Herausforderung für Politik, Naturschutz und ökologische Forschung. *Verh Ökol* 22:3–8
- Ehrlich PR (1994) Energy use and biodiversity loss. *Philos Trans R Soc Lond* 344:99–104
- Engel TR (2000) Seed dispersal and forest regeneration in a tropical lowland biocoenosis (Shimba Hills, Kenya). PhD Thesis, University of Bayreuth, Germany
- Espigares T, Peco B (1993) Mediterranean pasture dynamics: the role of germination. *J Veg Sci* 4:189–194
- Evenari M, Shanan L, Tadmor N (1982) The challenge of a desert. Harvard University Press, Cambridge
- Fenner M (1985) Seed ecology. Chapman and Hall, London
- Filzer P (1963) Ein botanischer Beitrag zur Charakterisierung natürlicher Landschaften Süddeutschlands. *Ber Dtsch Landeskd* 31:69–83
- Frankenberg P (1978) Methodische Überlegungen zur floristischen Pflanzengeographie. *Erdkunde* 32:251–258
- Frey W, Lössch R (1998) Lehrbuch der Geobotanik. Pflanze und Vegetation in Raum und Zeit. Fischer, Stuttgart
- Gilpin ME, Diamond JM (1980) Subdivision of nature reserves and the maintenance of species diversity. *Nature* 285:567–568
- Gilpin ME, Diamond JM (1982) Factors contributing to non-randomness in species co-occurrences on islands. *Oecologia* 52:75–84
- Gilpin ME, Hanski I (1991) Metapopulation dynamic: empirical and theoretical investigations. Academic Press, London
- Grime JP (1979) Plant strategies and vegetation processes. Wiley, Chichester

- Grime JP (1997) Biodiversity and ecosystem function: the debate deepens. *Science* 277:1260–1261
- Gorman ML (1979) *Island ecology*. Chapman and Hall, London
- Groombridge B (ed) (1992) *Global biodiversity. Status of the earth's living resources. A report compiled by the World Conservation Monitoring Centre*. Chapman and Hall, London
- Haeupler H (1982) Evenness – als Ausdruck der Vielfalt in der Vegetation. *Dissertationes Botanicae* 65. Cramer, Vaduz
- Haeupler H, Schönfelder P (1988) *Atlas der Farn- und Blütenpflanzen der Bundesrepublik Deutschland*. Ulmer, Stuttgart
- Hector A, Schmid B, Beierkuhnlein C, Caldeira MC, Diemer M, Dimitrakopoulos PG, Finn J, Freitas H, Giller PS, Good J, Harris R, Höggberg P, Huss-Danell K, Joshi J, Jumpponen A, Körner C, Leadley PW, Loreau M, Minns A, Mulder CPH, O'Donovan G, Otway SJ, Pereira JS, Prinz A, Read DJ, Scherer-Lorenzen M, Schulze ED, Siamantziouras ASD, Spehn E, Terry AC, Troumbis AY, Woodward FI, Yachi S, Lawton JH (1999) Plant diversity and productivity experiments in European grasslands. *Science* 286:1123–1127
- Heywood VH, Watson RT (1995) *Global biodiversity assessment*. Cambridge University Press, Cambridge
- Howe HF, Smallwood J (1982) Ecology of seed dispersal. *Annu Rev Ecol Syst* 13:201–228
- Howe HF, Westley LC (1986) Ecology of pollination and seed dispersal. In: *Crawley MG (ed) Plant ecology*. Blackwell, Oxford, pp 185–215
- Huston MA (1997) Hidden treatments in ecological experiments: re-evaluating the ecosystem function of biodiversity. *Oecologia* 110:449–460
- Johnson MP, Simberloff DS (1974) Environmental determinants of island species in the British Isles. *J Biogeogr* 1:149–154
- Johnson KH, Vogt KA, Clark HJ, Schmitz OJ, Vogt DJ (1996) Biodiversity and the productivity and stability of ecosystems. *Trends Ecol Evol* 11:372–377
- Kleidon A, Mooney HA (2000) A global distribution of biodiversity inferred from climatic constraints: results from a process-based modelling study. *Global Change Biol* 6:507–523
- Körner C (1995) Alpine plant diversity: a global survey and functional interpretations. *Ecol Studies* 113:45–62
- Körner C (1999) *Alpine plant life. Functional plant ecology of high mountain ecosystems*. Springer, Berlin Heidelberg New York
- Kohn DD, Walsh DM (1994) Plant species richness – the effect of island size and habitat diversity. *J Ecol* 82:367–377
- Kratochwil A (1999) *Biodiversity in ecosystems*. Academic Press, Kluwer, New York, Dordrecht
- Krebs JR, Wilson JD, Bradbury RB, Siriwardena GM (1999) The second silent spring? *Nature* 400:611
- Kreeb KH (1983) *Vegetationskunde*. Ulmer, Stuttgart
- Kürschner H (1986) Omanisch-makranische Disjunktion. Ein Beitrag zur pflanzengeographischen Stellung und zu den floren-genetischen Beziehungen Omans. *Bot Jahrb Syst* 106:541–562
- Lamont BB (1995) Testing the effect of ecosystem composition/structure on its functioning. *Oikos* 74:283–295
- Lawton JH (1994) What do species do in ecosystems? *Oikos* 71:367–374
- Lawton JH, Bignell DE, Bolton B, Bloemers GF, Eggleton B, Hammond PM, Hodda M, Holt RD, Larsen TB, Mawdsley NA, Stork NE, Srivastava DS, Watt AD (1998) Biodiversity inventories, indicator taxa and effects of habitat modification in tropical forests. *Nature* 391:72–73
- Lepart J, Escarre J (1983) La succession végétale, mécanismes et modèles: analyse bibliographique. *Bull Ecol* 14:133–178
- Leser H, Nagel P (1998) Landscape diversity – a holistic approach. In: Barthlott W, Winiger M (eds) *Biodiversity. A challenge for development research and policy*. Springer, Berlin Heidelberg New York
- Lindacher H (1995) *Phanart. Datenbank der Gefäßpflanzen Mitteleuropas*. Veröff Geobot Inst ETH, Stiftung Rübel, Zürich 125:1–436
- Lövei GL (1997) Global change through invasion. *Nature* 388:627–628
- MacArthur RH, Wilson EO (1963) An equilibrium theory of insular zoogeography. *Evolution* 17:373–387
- MacArthur RH, Wilson EO (1967) *Biogeographie von Inseln*. Wissenschaftliche Taschenbücher, Goldmann, München
- Mader HJ (1983) Warum haben kleine Inselbiotope hohe Artenzahlen? *Nat Landschaft* 58:367–370
- May RM (1988) How many species are there on earth? *Science* 241:1441–1449
- May RM, Stumpf PH (2000) Species area relations in tropical forests. *Science* 290:2084–2086
- Merxmüller H (1952) Untersuchung zur Sipplgliederung und Arealbildung in den Alpen. I. *Jahrbuch des Vereins zum Schutz der Alpenpflanzen und -Tiere* 17:96–133
- Merxmüller H (1953) Untersuchung zur Sipplgliederung und Arealbildung in den Alpen. II. *Jahrbuch des Vereins zum Schutz der Alpenpflanzen und -Tiere* 18:135–158
- Merxmüller H (1954) Untersuchung zur Sipplgliederung und Arealbildung in den Alpen. III. *Jahrbuch des Vereins zum Schutz der Alpenpflanzen und -Tiere* 19:97–139
- Meusel H, Jäger EJ, Weinert E (1965) *Vergleichende Chorologie der zentral-europäischen Floren*, Bd. 1. Fischer, Jena
- Meusel H, Jäger EJ, Weinert E, Rauschert S (1978) *Vergleichende Chorologie der zentral-europäischen Floren*, Bd. 2. Fischer, Jena
- Mooney HA, Cushman JH, Medina E, Sala OE, Schulze ED (1996) *Functional roles of biodiversity*. Wiley, Chichester
- Müller-Hohenstein K (1981) *Die Landschaftsgürtel der Erde*, 2. Aufl. Teubner, Stuttgart
- Müller-Hohenstein K (1988) *Zur Arealkunde der arabischen Halbinsel*. *Die Erde* 119:65–74
- Müller-Schneider P (1977) *Verbreitungsbiologie (Diasporologie) der Blütenpflanzen*, 2. Aufl. Veröff Geobot Inst ETH, Stiftung Rübel, Zürich
- Myers N, Mittermeier RA, Mittermeier CG, da Fonseca GAB, Kent J (2000) Biodiversity hot-spots for conservation priorities. *Nature* 403:853–858
- Nepstadt DC, Verissimo A, Alencart A, Nobre C, Lima E, Lefebvre P, Schlesinger P, Potter C, Moutinho P, Mendoza E, Cochrane M, Brooks V (1999) Large-scale impoverishment of Amazonian forests by logging and fire. *Nature* 398:505–508
- Pielou EC (1966) Species-diversity and pattern-diversity in the study of biological collections. *J Theor Biol* 10:370–383
- Pimm SL (1993) *Biodiversity and the balance of nature*. *Ecol studies*, vol 99. Springer, Berlin Heidelberg New York, pp 347–359
- Pimm SL, Raven P (2000) Extinction by numbers. *Nature* 403:843–845
- Porembski S, Brown G, Barthlott W (1995) An inverted latitudinal gradient of plant diversity in shallow depressions on Ivorian inselbergs. *Vegetatio* 117:151–163

- Preston FW (1962) The canonical distribution of commonness and rarity. *Ecology* 43:185–215, 410–432
- Refisch (2001) Einfluss der Wilderei auf Affen und die sekundären Effekte auf die Vegetation im Tai-Nationalpark, Elfenbeinküste. Dissertation, University of Bayreuth, Germany
- Reichelt G, Wilmanns O (1973) Vegetationsgeographie. Das geographische Seminar. Westermann, Braunschweig
- Rejmanek M (1996) Species richness and resistance to invasions. *Ecol studies*, vol 122. Springer, Berlin Heidelberg New York, pp 153–172
- Remmert H (1998) Terrestrische Systeme. Spezielle Ökologie Bd 3. Springer, Berlin Heidelberg New York
- Richter M (1997) Allgemeine Pflanzengeographie. Teubner, Stuttgart
- Ryser P (1993) Influences of neighbouring plants on seedling establishment in limestone grassland. *J Veg Sci* 4:195–202
- Schläpfer F, Schmid B, Seidl I (1999) Expert estimates about effects of biodiversity on ecosystem processes and services. *Oikos* 84:346–352
- Schmid B (1996) Wieviel Natur brauchen wir? *GAIA* 5:225–235
- Schönfelder P, Bresinsky A (Hrsg) (1990) Verbreitungsatlas der Farn- und Blütenpflanzen Bayerns. Ulmer, Stuttgart
- Schulze ED (1982) Plant life forms related to plant carbon, water and nutrient relations. *Encycl Plant Physiol* 12B:615–676
- Schulze ED (1995) Flux control at the ecosystem level. *Trends Ecol Evol* 10:40–43
- Schulze ED, Mooney HA (1993) Biodiversity and ecosystem function. *Ecological studies*, vol 99. Springer, Berlin Heidelberg New York
- Schupp EW (1993) Quantity, quality and the effectiveness of seed dispersal by animals. *Vegetatio* 107:15–29
- Shannon CE, Weaver W (1949) The mathematical theory of communication. University of Illinois Press, Urbana
- Simberloff DS, Wilson EO (1969) Experimental zoogeography of islands: the colonisation of empty islands. *Ecology* 50:278–298
- Smith TM, Shugart HH, Woodward FI (1997) Plant functional types. Their relevance to ecosystem properties and global change. Cambridge University Press, Cambridge
- Strasburger E, Sittler P (1998) Lehrbuch der Botanik für Hochschulen. Fischer, Stuttgart
- Takhtajan A (1986) Floristic regions of the world. University of California Press, Berkeley
- Thienemann A (1920) Biologische Seentypen. *Arch Hydrobiol*
- Tilman D (1988) Plant strategies and the dynamic and structure of plant communities. Princeton University Press, Princeton
- Tilman D, Downing JA (1994) Biodiversity and stability in grasslands. *Nature* 367:363–365
- Tilman D, Pacala S (1993) The maintenance of species richness in plant communities. In: Ricklefs RE, Schlüter D (eds) Species diversity in ecological communities. University of Chicago Press, Chicago, pp 13–25
- Tilman D, Knops J, Wedin D, Reich P, Ritchie M, Siemann E (1997) The influence of functional diversity and composition on ecosystem processes. *Science* 277:1300–1302
- Vitousek PM, Hooper DM (1993) Biological diversity and terrestrial ecosystem biogeochemistry. *Ecological studies*, vol 99. Springer, Berlin Heidelberg New York, pp 3–14
- Walker BH (1992) Biodiversity and ecological redundancy. *Conserv Biol* 6:18–23
- Walter H (1986) Allgemeine Geobotanik. Ulmer, Stuttgart
- Walter H, Straka H (1970) Arealkunde (Floristisch-historische Geobotanik), 2. Aufl. Ulmer, Stuttgart
- Whittaker RH (1962) Classification of natural communities. *Ber Rev* 28:1–239
- Whittaker RH (1972) Convergences of ordination and classification. In: Tüxen H (Hrsg) Grundfragen und Methoden in der Pflanzensoziologie. Junk, Den Haag, pp 39–58
- Whittaker RH (1977) Evolution of species diversity in land communities. *Evol Biol* 10:1–67
- Whittaker RJ, Jones SH (1994) Structure in rebuilding insular ecosystems: an empirically derived model. *Oikos* 69:524–529
- Wissel C, Maier B (1992) A stochastic model for the species-area relationship. *J Biogeography* 19:355–362
- Wissenschaftlicher Beirat der Bundesregierung Globale Umweltveränderungen (WBGU) (2000) Welt im Wandel: Erhaltung und nachhaltige Nutzung der Biosphäre. Springer, Berlin Heidelberg New York
- Woodward FI (1987) Climate and plant distribution. Cambridge University Press, Cambridge
- Wright DH (1989) A simple, stable model of mutualism handling time. *Am Nat* 134:664–667

4.3

Interactions Between Vegetation and Abiotic and Biotic Environments – Synecology



Competition or coexistence? View of the almost completely closed canopy of a mountain rainforest on Kilimanjaro (Machame, 2400 m above sea level). Photo K. Müller-Hohenstein

Previous chapters discussed aspects of plants and development of plant communities in the course of time, and their distribution in space. This knowledge is indispensable for understanding plants and their spatial dynamics. The most important relations between plants and their environment are the requirements of individual species and the supply of abiotic factors – light, temperature, water, nutrients – which have been well studied (see Chap. 2).

Plants and plant communities also affect their environment, changing the climatic conditions and soils and thus contribute to temporal dynamics and spatial changes (see Chap. 4.1). How this change takes place and its intensity will be discussed here (Chap. 4.3.1) and illustrated with examples.

For the formation of plant communities, interactions between plant species, plant populations and within communities are just as important as the interactions between plants and their abiotic environment. Their niches in communities (**biocenoses**) are determined by **competition**

and **coexistence**, mutual relations are just as important as parasites and pathogens (Chap. 4.3.2).

Plant communities (**phytocenoses**) are only part of the whole community. Animals also influence the coexistence of organisms and affect plant communities discussed here; they work as pollinators and dispersers (see Chap. 4.2) and are also herbivores and consume seeds. Thus, the basis of **biocenotics** is the **interaction between plants and animals**, and this is the topic considered in Chapter 4.3.3.

For the synecological section, the following literature is recommended in addition to that previously mentioned in Chapters 4.1 and 4.2:

- Crawley MJ (1983) *Herbivory: the dynamics of animal-plant interactions*. Blackwell, Oxford
- Douglas AE (1994) *Symbiotic interactions*. Oxford Univ Press, Oxford
- Heywood VH, Watson RT (eds) (1995) *Global diversity assessment*. UNEP, Cambridge

- Huston MA (1994) Biological diversity. The coexistence of species on changing landscapes. Cambridge Univ Press, Cambridge
- Pielou EC (1974) Population and community ecology. Principles and methods. Gordon and Breach, New York
- Putman RJ (1994) Community ecology. Chapman & Hall, London
- Schulze ED, Mooney HA (eds) (1993) Biodiversity and ecosystem function. Ecol Stud 99, Springer, Berlin
- Tilman D (1982) Resource competition and community structure. Princeton Univ Press, Princeton

4.3.1

Influences of Vegetation on the Site

The extent to which vegetation influence the growing conditions at the site becomes clear when the vegetation is disturbed or completely removed. According to Lovelock (1992), there would be drastic changes on earth if there were no life, particularly the composition of the atmosphere, which would become oxygen-free, and the current surface temperatures of about 300 °C would be affected.

Plant cover not only influences the whole biological community, but also the abiotic environment. Already the **micro-climatic conditions** change over small distances. Increased **soil erosion** at an intermediate scale is witness to the change in runoff of water and to the protective effect of vegetation cover (Fig. 4.3.1). Over large areas the importance of climate for soils and water relations is discussed within the scope of the problems of global change (see Chap. 5).

Plants and plant communities not only obtain their requirements for light, water and nutrients from the supply in the area where they grow, but also affect it. This may improve the conditions at the site to the plant's advantage – by increasing the humus content of the soil which provides a better water supply due to the increased water storage capacity – or they make conditions worse because they create conditions for species which out-compete them (see the facilitation model according to Connell and Slatyer 1977; see also Chap. 4.1.5.3.5). Undemanding pioneers (e.g. lichens on bare rock) must make way for more demanding species, e.g. mosses

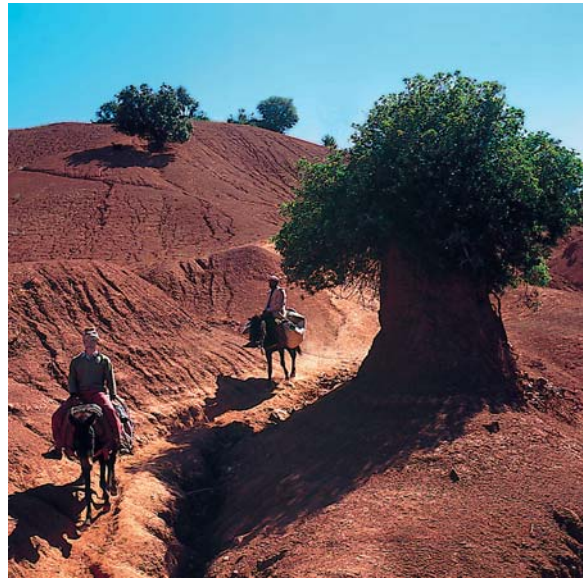


Fig. 4.3.1. Vegetation has a marked effect on the environment in this photograph of a lower hill slope, with advanced degradation of vegetation, in the central Atlas Mountains (Morocco). The roots of the few remaining bushes (*Quercus rotundifolia*, *Pistacia lentiscus*) protect the soil in which they are growing from being eroded. It looks as if the plants are growing on a pedestal. (Photo K. Müller-Hohenstein)

and flowering plants on the substrates prepared by **biogenic weathering**.

Wilson and Agnew (1992) distinguish various feedback switches, almost like electrical control systems, which are triggered by vegetation in relation to changes at the site. Thus a plant community not only changes its environment, but in addition also affects neighbouring plant communities (e.g. by shading, wind protection). In each of these cases such effects must be regarded as dynamic processes. They concern mostly the climatic and edaphic relations, but also aspects of relief formation and water and nutrient relations at several spatial and temporal scales. In the following, these connections will be explained with examples at the level of a stand of vegetation (community).

4.3.1.1

Effect of Vegetation on Climatic Conditions at Sites

Conditions at a site are related to the vegetation and include the **climate of the stand** (also **eco-climate**) and thus the areas occupied by the vegetation and directly influenced by it (see Chap.

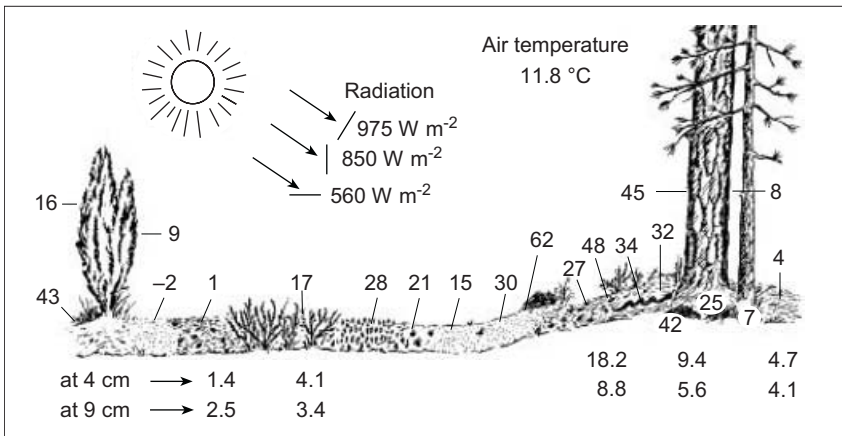


Fig. 4.3.2. Surface temperatures along a transect from a forest edge to a juniper heath in Holland (soil temperatures were measured at 4 and 9 cm depth, air temperature 1 m above the ground and was 11.8 °C, the input radiation to surfaces at different inclinations was 560, 850 or 975 W m⁻²). (After Stoutjesdijk 1977, from Stoutjesdijk and Barkman 1992)

2.1). In the case of forests this may be beyond the micro-climatic space (between soil surface and 2 m height). Within the space occupied by the vegetation, horizontal and vertical patterns and gradients of climatic parameters must be measured, in order to be able to recognise the interactions between vegetation and climate. **Figure 4.3.2** shows the degree of difference between stands, particularly at transitional sites, and the dependence on exposure of sites. Surface temperatures measured only a few metres apart at the edge of a forest in the Netherlands at noon on a clear day in March correspond, in their extremes, to those in boreal forests (north side) and temperate deserts (south side). However, these differences apply only under solar radia-

tion and disappear completely under cloudy skies. It is obvious that characterisation of the climate in a stand requires the temporal course of a climatic variable which is as important as spatial differentiation.

For the climate of a stand the **albedo** (see Chap. 2.1) is just as important as the layers of the vegetation, the type of branching of trees and shrubs, as well as the density and position of leaves. These structural characteristics of plant communities determine, ultimately, the amount of light reaching the assimilating organs of individual plants. A dense tree canopy may severely decrease the light available for light-requiring species, whilst also providing shade for shade-demanding plants. Oasis cultures occur all over the world: Their mul-

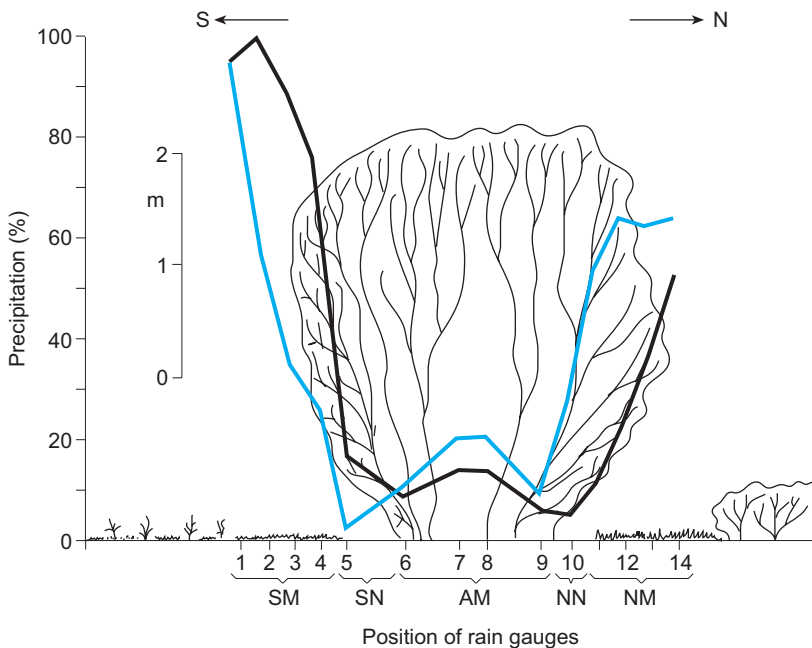


Fig. 4.3.3. Distribution of rainfall on a transect through a juniper bush measured with 14 rain gauges with a northerly wind (black line) and southerly wind (blue line). Maximum rainfall is equal to 100%. SM South, mossy; SN south, needle litter; AM without moss; NN north, needle litter; NM north mossy. (After Stoutjesdijk and Barkman 1992)

tiple layers of annual and permanent crops – cereals and vegetables, fruit-bearing shrubs and small trees, closed palm canopies – would not be possible without the shade provided by the date palms in the strong radiation conditions and with the dry air in arid regions.

In low, one-layered stands, e.g. in lichen communities and on moss carpets during the day, higher temperatures are reached than on neighbouring open areas. However, because of the high re-radiation during the night, temperatures may fall much more than in multi-layered stands. In the latter, **temperature layers** may be observed (see Chap. 2.1). The first maximum, higher than the temperature in open spaces, is reached in the canopy at higher day temperatures; a second occurs at the ground surface especially in more open areas. In the space between the canopy and soil surface temperatures are more balanced. Temperatures on the ground may even be further affected by the consistency of litter. According to Stoutjesdijk and Barkman (1992) on a clear winter night -4°C was measured under Douglas fir, under pine -9°C , but under larch and oaks -14°C . Thus, in near-natural, species-rich forests considerable differences occur over small spaces. For the development of spring geophytes, the favourable light and temperature conditions in deciduous forests are important; conditions under oak are more favourable than under beech and hornbeam.

Vegetation also influences precipitation over small distances (see Chap. 2.2). This was measured at different wind speeds by Barkman et al. in 1977 (in Stoutjesdijk and Barkman 1992) for isolated juniper bushes with dense needles on the southern side, standing in a shrub-bush and grass community (Fig. 4.3.3). **Interception** is very important in multi-layered stands. The path of a raindrop is determined primarily by the structural characteristics of plant cover. Some plant species are able, because of the form of their leaves or needles, to comb out precipitation (*Pinus patula*, *P. canariense*). Runoff paths on branches and stems and the distribution of water at the base of the stem are also important. In total, the measured interception by conifers is about twice that of deciduous trees, but also depends on the abundance and intensity of the precipitation. Gaps in the stand, development of greening (summer and winter) and layering of the stand are important determinants of the amount of water actually reaching the ground. Furthermore, relative humidity inside the stand

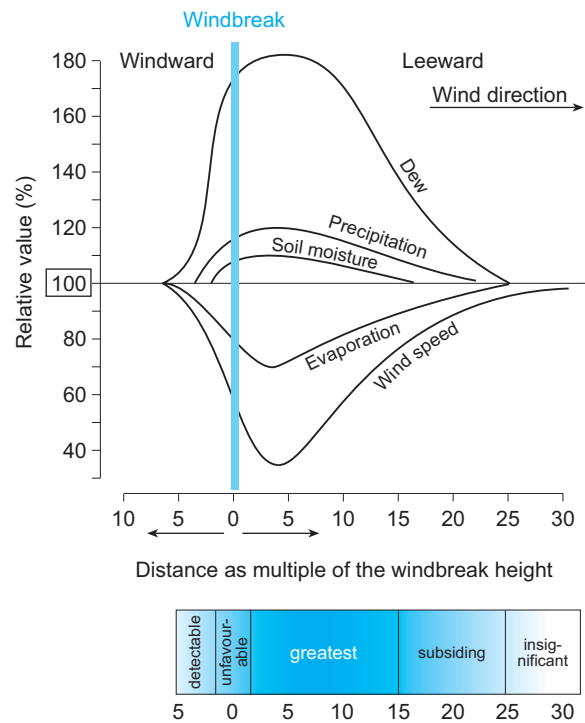


Fig. 4.3.4. Influence of a shelter belt on the microclimate. (After Reichelt and Wilmanns 1973)

is higher and more balanced than on open spaces.

Various forms of **wind shear** show impressively the influence of wind on vegetation. It may be concluded that plant stands also weaken wind, for hedges provide **protective wind barriers** (Fig. 4.3.4). There is a dependence on height, width and permeability of the vegetation and the reduction in wind speed and the development of turbulence, in turn, cause large differences in conditions within small patches of vegetation. Also the transport of energy and materials and how they are affected and absorbed by vegetation must be evaluated.

Dune systems along coastlines worldwide characterise the littoral zones. The sequence of different sites along the coast into the hinterland is shown in Fig. 4.3.5. Plants are able to stabilise the mobile sand, which is transported by **wind**, and influences transitions from the coast to the hinterland enormously. These plants are able to withstand the mechanical effects of wind and the salt carried by it. Following from the sea towards the land, communities are sea rocket (*Cakile maritima*), lyme grass (*Elymus arenarius*) and marram grass (*Ammophila arenaria*). The latter is the most important primary dune spe-

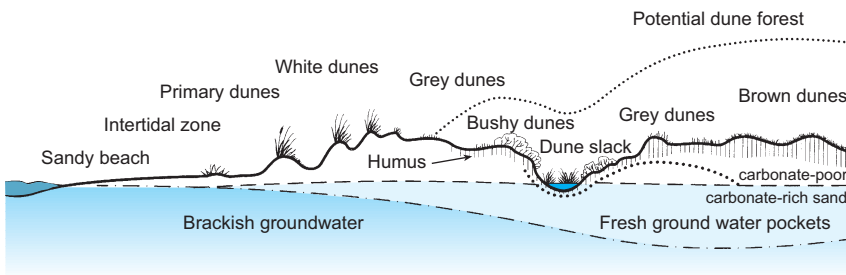


Fig. 4.3.5. Sequence of habitats in coastal regions with dune formation. (After Ellenberg 1996)

cies and is not only able to stabilise dunes, but also to tolerate being covered by sand because it forms layers of rhizomes and survives the cover of **primary dunes (white dunes)** which are often metres high. If the marram grass is not covered by sand, **secondary and tertiary dunes (grey and brown dunes)** develop from the gradual accumulation of humus from the decaying plant material. Tertiary dunes are recognised by an increasingly closed cover of dune grasses and shrub communities. Without plant species adapted in such a way, this formation of relief and zonation would not be possible. At the moment, dune complexes disturbed by tourism are successfully protected by planting with the salt-tolerant sand dune couch grass (*Agropyron junceum*) and marram grass (*Ammophila arenaria*) which are tolerant to being covered by sand.

Plants also play a role in triggering formation of inland dunes. Long (1954) traced the origin of the **Nebket** (Arabic term for dune systems) in North Africa to single, particularly resistant, dwarf shrubs. Sand blown in by the wind is deposited on the leeward and windward sides of these shrubs. With time the accumulation of sand improves nutrient and water supply of the 'initial shrub' which is able to grow better and thus offers possibilities for other plants to establish and finally for animals to settle. Thus, particularly at the edges of deserts, island-like dune systems develop with communities surprisingly rich in species in an otherwise hostile environment.

This shows that vegetation, with its floristic composition and most of all with its structural characteristics, greatly influences the variability of environmental conditions in the stand. Many vegetation patterns in small spaces can only be understood if the influences of vegetation which cause the differences in the local climate are known.

4.3.1.2

Influences of Vegetation on Weathering and Formation of Relief

Even though climatic and tectonic factors are most important for geomorphological processes, influences of organisms on the formation of relief and thus for changing areas must not be overlooked. Viles (1988) distinguishes, in his volume on biogeomorphology, between active and passive relations between organisms and the site factors which depend on relief. The former are biogenic weathering, formation of **biogenic sediments** (e.g. lime deposits), **bioturbation** (e.g. burrowing animals) and also **bioerosion** (e.g. from grazing animals). Passive relations, from interrelations between components of the vegetation, can be seen in dune formation and in accumulation of organic matter (e.g. in bogs or as a consequence of damming rivers). These interactions will be explained with some examples (see also Chap. 2.3).

Weathering or formation of soils was generally interpreted as an exogenous, climatic and physicochemically regulated process. Today, organisms are regarded as playing an important role in weathering in all climatic zones of the earth. For example, cyanobacteria participate in the formation of **desert varnish**, a covering of iron and manganese compounds – thus securing their own habitat with a protective crust. The metabolic processes of lichens, blue-green algae and fungi result in release of acids and chelating compounds which, under humid conditions, dissolve some components in rocks either completely (as with limestone) or selectively dissolve and remove the mineral components. Lichens, in particular those living within rocks (endolithic: types such as chasmoendoliths, euendoliths and cryptoendoliths) and also those living on the surface (epilithic), influence weathering in all climatic conditions (Belnap and Lange 2001). Under moist conditions, crusted rocky surfaces

are conserved by lichen cover, but in arid regions lichens can be very destructive. Danin (1986) recognised in the weathering forms observed in the Negev a dynamic equilibrium between surface destruction and crust formation. Formation of particular types of crusts and patterns of dissolution caused by different moisture conditions allow conclusions to be drawn about palaeoclimatic conditions.

Bioturbation and its various forms (e.g. by earthworms in temperate habitats, ground-living small mammals in tropical high mountains) and consequences for habitats are only mentioned here, as is **bioerosion** with its often catastrophic consequences in overgrazed mountain regions (see Fig. 4.1.30D and Chap. 4.1). An example of the passive role of vegetation in forming the relief is the living submerged macrophytic vegetation. **Dynamics of river beds and river valleys** is particularly regulated by vegetation. Plants occupying river banks, or submerged, influence water flow and thus affect erosion and deposition of materials transported in the river. In non-canalised rivers in Europe, for example the lower Loire, islands covered with canary grass (*Phalaris canariensis*) develop in the river bed. The German tamarisk (*Myricaria germanica*), now very endangered, not only withstands the mechanical strain of floods, but also contributes considerably to the stabilisation of river banks in Alpine low lands.

In other climatic zones there are similar, typical influences of vegetation on the formation of areas along rivers and their banks. For example, in the low land tropics, vegetation near river banks acts as zones trapping sediments and floating materials, thus slowing the flow of the river and providing protection from erosion by damming the river. In near-natural river valleys small mosaics of different plant communities frequently occur. These communities provide information on the water supply and the mechanical strain caused by water, as well as about the modifying influences of plants. Such mosaics can only be understood if the interactions between vegetation and site are considered (see also Fig. 4.1.38 and Chap. 4.1).

4.3.1.3

Influences of Vegetation on Soils

Influence of vegetation on the fertility and water relations of soils is considered by Van Breemen (1991) to be a prime example of biotic–abiotic

interactions in ecosystems. Earlier discussion of primary successions emphasised the contribution of pioneer plants in providing the first **organic litter** in formation of soils, and thus in preparing conditions at the site for more demanding plants (see also Chap. 2.3). For higher plants, **Leguminosae** play an important role in the accumulation of **nitrogen**. Quality and amount of organic litter are very important for pedogenic processes and the characteristics of soils. This litter determines the C/N ratio of soils as well as possibly starting or increasing soil acidification. Not only the content of certain nutrients, but particularly their availability, are closely linked to the organic material in soil. However, accumulation of **allelochemicals** and organic substances that are difficult to degrade may render a site unsuitable for a particular plant species.

Vegetation not only affects the chemistry of soils, but also their physical characteristics. Dependent on the rooting systems of plant species growing at a site and on the type of litter, soil structures are formed which allow aeration of the soil and contribute to the transformation of an abiotic substrate into a habitat for a very wide range of organisms in the soil. There are very close interactions between the organisms, and all trophic levels are represented in the smallest space. The organisms living in the soil (**edaphon**) may span from microbes to mammals.

Structural characteristics of soils and their content of organic substances brought about by vegetation are ultimately closely linked to the water relations of the soil. A close plant cover not only protects against erosion, but may also increase water retention, contributing to more balanced runoff and may limit flooding over large areas.

Vegetation also influences the **input of N** and other nutrients (as well as pollutants). Rode et al. (1996) showed, in northern Germany, how different these inputs are depending on the species of trees and shrubs. Input is particularly high in birch-pine forests, caused mainly by the roughness of these stands and the presence of needles on pines in winter. Interception is three to ten times higher than for oak and beech forests. That individual tree species and individuals are able to determine the chemical characteristics of soils was shown by Koch and Matzner (1993) for beech (*Fagus sylvatica*). The content of exchangeable nutrients (K, Mg, Ca, Al) in the

Box 4.3.1 Interactions between plants and their environment

Plants and their communities not only make demands on the habitat, but also change it. Through qualitative and quantitative changes in nutrient availability, and modification of the meso- and micro-climate, species alter conditions, in some cases making them more favourable to themselves, but in others making them less favourable, and providing the environment required for other species to establish.

The climate within the community is particularly important (eco-climate). In well-structured communities, i.e. forests, the environment within the crown, between the tree trunks, and close to the soil surface can be very different. Even amounts of precipitation are modified via the surface roughness and interception in comparison with the condi-

tions outside the forest. Also, the influence of the wind can be reduced, or it creates adapted plant types in small-scale vegetation patterns that can be seen in dune complexes, for example (see Fig. 4.3.5). Even the variations in river valleys and river beds are not caused just by the physical runoff, the vegetation plays a part. Plants assist in biological weathering as well as in weathering of stony material, aiding soil formation, and are responsible for the formation of surface crusts especially in dry areas. Furthermore, some plant species are able to influence the site by producing organic substances which are difficult to degrade and allelochemicals; others (e.g. Leguminosae) influence soil conditions, just as nitrogen fixation changes habitats by enrichment with nitrogen.

upper soil decreased, as did the soil pH, with increasing distance from the base of the stem. Detailed explanations of the effects of vegetation on soils, outlined here with a few examples, are given in Chapter 2.3.

4.3.2

Interactions Between Plants and Animals

Synecology is the science of relations between different organisms and their environment and includes interactions between plants and animals. For Tischler (1993), synecology is the ecology of communities, **biocenoses**. Kühnelt recognised as early as 1943 that the composition of **communities of organisms** is the best expression of all conditions in habitats. For a long time, abiotic conditions and the competition between plants were seen as decisive for their abundance and distribution. The influence of animals – pollination, dispersal, herbivory – was basically known, but not discussed further. Only in the science of ecosystems (see Chap. 3) were the far-reaching and complicated relations between plants and animals and their significance recognised.

Causal-analytical and functional interpretations are sought to develop general rules de-

scribing the relations between plants and animals. The question is what is the importance of an animal for functioning of the community. Plants are not only regulated by competition, nor are herbivores only affected by their natural enemies. Certain stress symptoms in a community may be explained by different causes such as competition and nutrient deficiency, but also depend on herbivory. What would happen to the stands of Siberian cedars (*Pinus cembra*) in the Central Alps if the bird nutcracker (*Nucifraga caryocatactes*) that disperses the seeds were to disappear. Or what would happen to the nutcracker if there were no seeds of Siberian cedars in its breeding areas. What sort of changes in dynamics would one expect? Answers to such questions are not only interesting from an ecological point of view, but are also very topical, practical questions.

Ecologists from botany and zoology should whenever possible work comparatively. This is difficult, because **animal communities** and **plant communities** differ for several reasons. Animal communities are species richer; complete recording of this diversity is very time consuming and can only be carried out by many specialists. Animals use spatially and temporally different resources, which allows them to move between sites. Consumers of the higher order are only indirectly bound to plants as resources. Animals differ in mobility and have different spheres of



action. This makes an assessment of animal communities difficult; for example, the seasonal migrations of many animal species relate to their ontogenetic development and the necessity to change abiotic and biotic conditions.

Therefore, animal ecologists have only recorded part of the **zoocenoses**, considering primarily groups (**guilds**, **taxonomic units**, **life forms**) which are easy to work with and have a high indicator value for their habitat. Grids selected for zoocenological research are usually well established, e.g. floristic-sociological, physiognomic-structural **phytocenoses** or phytocenose complexes, because they are relatively easy to interpret. Biocenology attempts to develop approaches that will lead to new methods (Kratowil and Schwabe 2001).

Initial research on plant–animal relations was at the level of individual organisms. Various types of relations were found, e.g. **mutualistic relations**, where both partners profit, such as animals visiting flowers for nectar or pollen leading to pollination and fruit set. Also there are **parasitic relations** as well as interactions of advantage to one partner and disadvantage to the other such as **herbivory** or **carnivory**. Various forms are distinguished: **Neutralism** where no partner suffers loss of fitness (e.g. chance, random visit to flowers); **amensalism** where one partner suffers (e.g. visit to rob flowers of seeds); **commensalism** where one partner is advantaged without negative influences on the other (e.g. visits to flowers as meeting places). **Figure 4.3.6** shows three examples of the diversity of relations between plants and animals.

In the following, some important relations between plants and animals at the level of species are listed. Of the important topics of plant–animal interactions, aspects of flower biology (**pollination**) and **herbivory** are considered (dispersal of propagules by animals; see **Chap. 4.2.1.1**). This chapter ends by presenting the basis for the emerging scientific discipline of biocenology. Results gained so far, particularly in the bioce-

Fig. 4.3.6. The three pictures show examples of the multiplicity of interactions which may occur between plants and animals in all habitats. *Drosophyllum lusitanicum* is a Mediterranean sundew that “catches” insects and thus derives additional nutrients (A). In wet mountainous areas of Ecuador, cicadas have a “meeting place” for mating on Solanaceae (B). “Termite savannahs” are a widespread vegetation type in the alternate wet and dry tropical African areas (C). (Photos K. Müller-Hohenstein)

notic research on functional interactions and relationships within communities, have shown that this discipline is particularly suited to uncover complex processes in ecosystems research.

4.3.2.1

Relations Between Plants and Animals as Organisms

Influence of Vegetation on Animals

Many characteristics of individual plants and of plant communities have considerable influence on animals. These are:

- **nutrient supply** (leaf mass, fruits, wood, nectar, pollen, etc.);
- **structure** (horizontal branches, closed canopy, dead wood, etc.);
- **information** (searching for partner, food and protection).

Food Supply

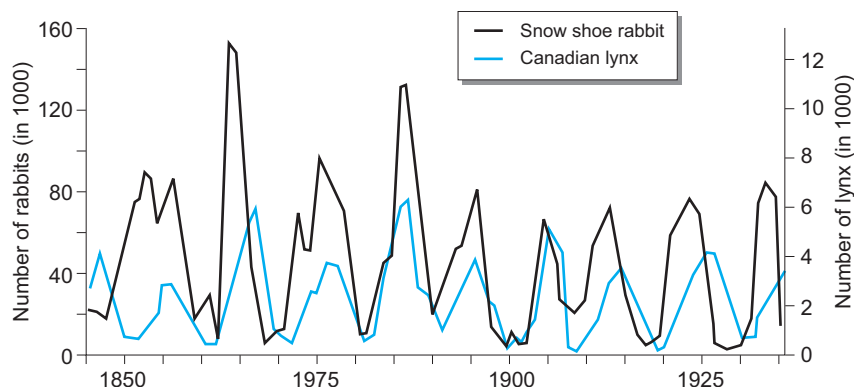
Food webs should be particularly noted, not only the direct consequences of eating and being eaten, but also the indirect and diverse feedback. Specialised food supplies may contribute to particular dispersal patterns and to succession and regeneration of plants, and so the diversity of plant and animal communities is affected. The example of interaction between the snow shoe rabbit and the Canadian lynx demonstrates that the long-discussed hypothesis of predation should be counteracted by a nutrient deficiency hypothesis, to provide the classical predator-prey relationship with a new aspect of interpretation, initially overlooked.

The **predation hypothesis** states that the rabbit population only increases if there is limited predation (Fig. 4.3.7). Because of the favourable

conditions for the prey, the number of lynx increases. However, the number of rabbits then decreases because of predation, the lynx population collapses because of insufficient food and the rabbit population is able to recover. The same events are also explained by the **nutrient deficiency hypothesis** but in a different way. Because of the large rabbit population and the consequent pressure on amount of grazing, the nutrient content of the fodder decreases (Holtmeier 1999). In the shoots which regenerate after herbivory, toxic substances and resins accumulate protecting the shoots from being eaten. The number of rabbits decreases because of starvation, and as a consequence the number of lynx also decreases. This example shows that the relations between plants and animals can be very complex and are not completely understood, in many cases.

Structure

Animals, except monophagous species, are not so much affected by the available plant species, but much more by the structure of plants and vegetation. Plants and vegetation are, in the broadest sense, sites where animals rest, but animals are very selective with respect to their resting site. Numerous invertebrates lay their eggs and find shelter from hostile weather conditions in leaves, under bark and in **dead wood**. Height and layering of plant stands are more important than their floristic composition. It is not the formation of a mesobrometum (dry *Bromus* grassland) which is the important aspect, but that it is a **dry grassland**. The meadow pipit (*Anthus pratensis*) makes its mating flight from green vegetation, whereas the tree pipit (*Anthus trivialis*) flies from tall trees at forest margins. Structural, and not floristic, characteristics of the vegetation are important, in both cases.



■ Fig. 4.3.7. Population cycles of Canadian lynx and snow shoe rabbit. (After Holtmeier 1999)



Fig. 4.3.8. Schematic of a capercaillie biotope. (After Von Hessberg, unpubl. results); 1. beech buds as spring fodder for hens; 2. protected nesting site; 3. courtship display area (tree display); 4. grit removal from root holes of up-rooted trees; 5. high and vital blueberry bushes; 6. dead wood for wood-living insects; 7. ant heap; 8. courtship display area (ground display); 9. pine needles for winter food; 10. grazing area; 11. sheltered root

Complex structured plants and types of vegetation offer numerous microhabitats for a species-rich fauna: similarly, **stand mosaics** are particularly important in satisfying demands of many birds. Birds require, in addition to food from plants and animals, nesting and breeding sites such as holes in trees, singing and hunting platforms, and mating and pairing sites, and they also require roosting sites and protection from enemies. For many species such a diverse environment is only available in a structure-rich landscape, where small vegetation units join up to form vegetation complexes. Kratochwil (1987) analysed habitats of the rock bunting (*Emberiza cia*) in the southern Black Forest and in Graubünden and showed that a very similar type of vegetation, particularly in its structure, was required. The demands of the capercaillie (*Tetrao urogallus*) demonstrate the great extent to which the floristic and structural characteristics of vegetation need to be interlinked to fulfil the bird's demands on the habitat (Fig. 4.3.8). Of the 11 habitat characteristics mentioned only three are linked to food and thus to particular plant species. The other characteristics refer to structural features of the vegetation required in the biotope for capercaillie.

Information

Plants can also inform animals about the state of available resources, the possible presence of a partner or enemy, and the suitability of the habitat for certain stages in the life cycle, for exam-

ple. Form, colour, smell and stage of development of plants are information carriers. Plants not only signal the current stage, but possibly also future development. Migratory birds breeding in meadows must know the future development of the vegetation when they arrive in spring, in order to be protected as much as possible during the breeding season. Many insect imagos are able to find the required type of vegetation early, to provide the habitat and food required for the later developmental stages of the larvae. Another example is the migratory locust in many dry regions of the Old World.

Effects of Animals on Vegetation

The effects of animals on individual plants and vegetation units may be interpreted, in many cases, as a response to the resources provided by plants. Animals need particular species and amounts of plants for their food supply, thus affecting plants directly, perhaps decreasing the photosynthetically active surface and influencing reproduction via pollination and thus propagation. Ultimately, many animals are the only, or most important, vector for the dispersal of numerous plant species in all biomes (see Chap. 4.2.1.1).

The far-reaching influences of animals on the formation of vegetation becomes obvious from terms such as termite savannah or beaver meadow. In tropical mountains and in the Andes, **animals** which **burrow** and live below ground cause partial or even complete destruction of

vegetation (Werner 1977). **Bioturbation** is only a side effect. Large mammals may contribute to soil compaction and, of course, to total destruction of vegetation.

In addition, organic substances are, in many cases, more easily degraded and the plant nutrition improved because of excretion by animals which changes the mineral status of soils. Research showed that 90% of the litter in tropical rain forests would not be degraded without invertebrates. Dung beetles are very important for such turnover. The widely occurring “fly pest” in Australia was only curtailed after introduction of dung beetles (species of *Scarabaeus* and *Onthophagus*). Birds are responsible for considerable transport of material: Sea birds transport large amounts of nutrients from the sea to the mainland and greatly affect sites. Guano deposits in the North Chilean coastal regions are witness to this.

Animals are also important as ‘switches’ and ‘amplifiers’ in the ecosystem (Remmert 1992). If deer in deciduous forests eat buds, and small mammals destroy seeds and seedlings but also disperse fruiting bodies of mycorrhizae, and birds pollinate flowers, the consequences for ecosystems are decisive, even though the energy turnover is only small. Animals often only use 10% of the material available in the ecosystem in which they live, but regulate the most important system processes (e.g. pollination, dispersal of propagules) and thus contribute substantially to the ecological stability of these systems. This shows that ecosystems cannot be described and understood by energy and material fluxes alone.

Pollination by Animals

An important field for interactions between plants and animals is **pollination biology**. Most flowering plants are not able to propagate without visitors to the flowers. Trees of nemoral forests are, to a large extent, wind pollinated, but in the shrub and herbaceous layers entomogamous species dominate. Richards (1991) classified plant communities in western Ireland according to the plant succession and the occurrence of wind and insect pollination. Figure 4.3.9 shows that in almost all plant communities insect pollination dominates and that special pollination mechanisms have developed, particularly in “old” species-rich communities (e.g. Festuco-Brometea and Sedo-Scleranthetea communities).

Teleologically expressed, many animals ‘expect’ to obtain ‘payment’ from flowering plants

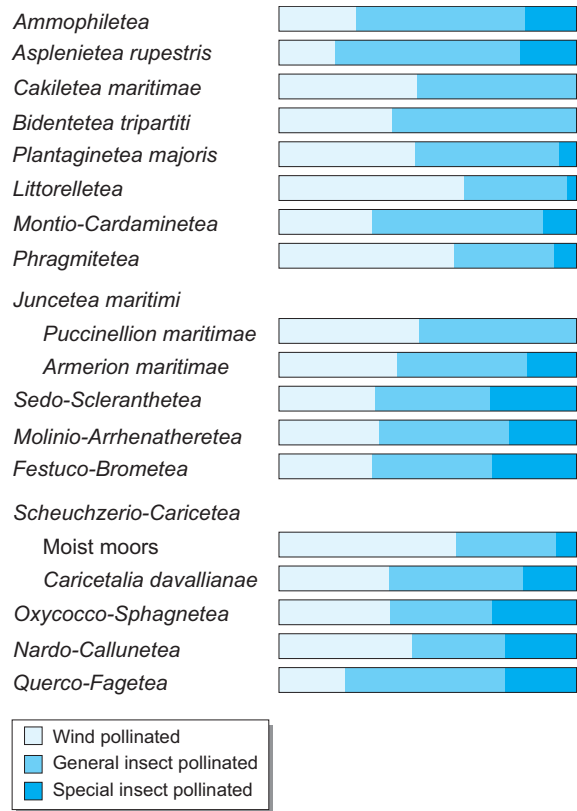


Fig. 4.3.9. Plant communities (classes) from western Ireland and the proportions of different methods of pollination. (After Richards 1991)

for their contribution to pollination and plants ‘expect’ to obtain ‘payment’ for the supply of ‘rewards’. Thus predominantly mutual relationships develop. Only in rare case are the ‘expectations’ of plants frustrated by pollen or nectar robbers or those of animals frustrated because flowers of plants mimic potential sexual partners (e.g. insect flowers such as various *Ophrys* species) or even flowers which keep visitors captive until the flower is pollinated (e.g. flowers that are insect traps such as *Arum* species).

In **pollination symbiosis**, pollen of a flower must stick to animals and should be transported to the stigma of the next flower. To enable this process to take place, plants must possess certain characteristics and provide ‘payments’ or ‘services’ (to use teleological expressions again). Animals are mainly attracted by various foods, but in arid regions a supply of water may also be important. The most important nutrients are energy-rich proteins and lipids in pollen, and nectar containing sugars, as well as oils and resins. The supply is often directed to particular

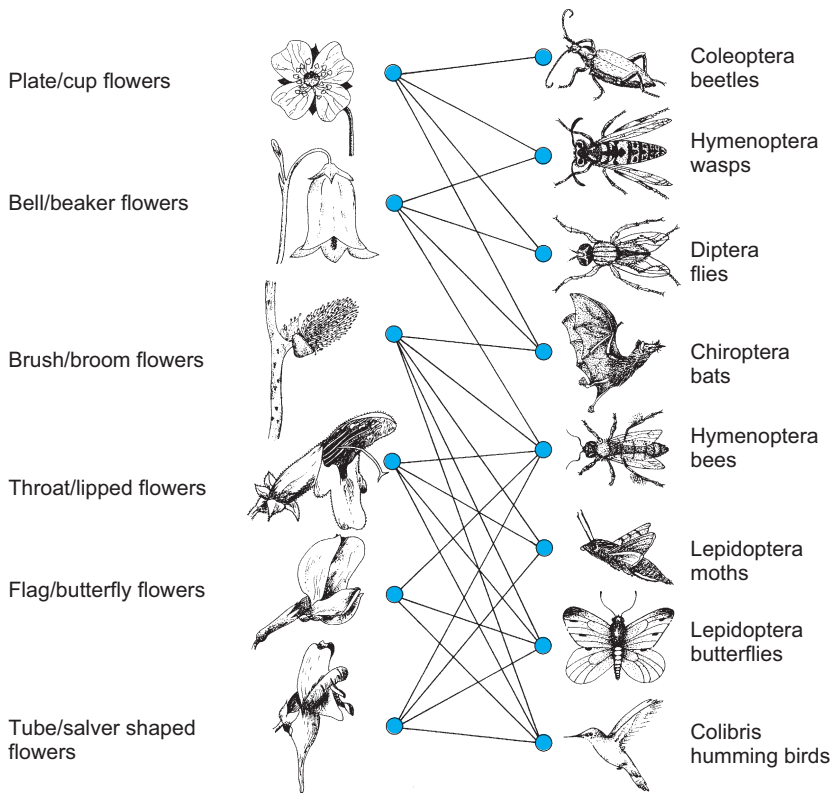


Fig. 4.3.10. Interaction of flower types and pollinators. (After Hess 1990)

visitors, where the flowers of plants attract by colours, shapes and smells. Thus, bats and bees do not profit from the same species. Usually, the supply of individual flowers is so limited that animals need to visit other flowers and thus pollination is more likely to become successful.

Birds and insects are usually enticed by the colour of flowers whereas bats, which play an important role as pollinators in tropical communities, are attracted by smell. The structure of some flowers is such that many pollinators gain access, and guarantee success. In many cases, however, there is a special combination which is particularly reliable for considerably less pollen. In anemophilic species the relation of pollen grains to pollinated ovules is between 10:1 to 6:1, but the ratio may be 1:1 for highly specialised entomogamous species (e.g. orchids).

Special plant animal combinations can be recognised from the forms of the flowers. Hess (1990) grouped the proportions of different types of flowers in particular groups. They are shown, together with their faunistic partners, in Fig. 4.3.10. Amongst insects, beetles (Coleoptera) are regarded as the original, oldest groups of pollinators, followed by the Hymenoptera, which are the most important group now, then the

Diptera. Only relatively recently did Lepidoptera, and finally vertebrates, particularly humming birds and nectar birds as well as bats and flying foxes, develop as pollinators.

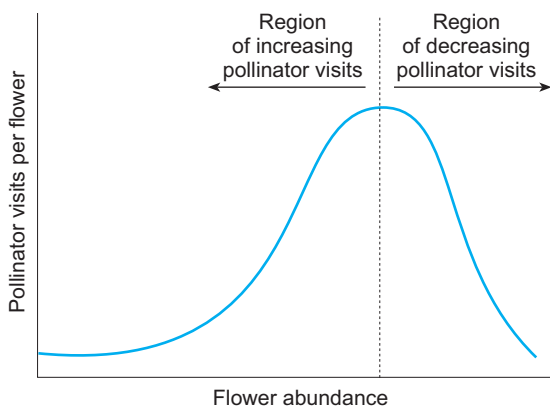
The many possible specialisations were seen as a solution to restrict the great **competition for pollinators**. This is also indicated by the fact that plants using the same pollinators flower at different times. In species-rich plant communities the number of species pollinated by insects increases, however, the number of pollinators also increases. As Boucher (1985) recognised, there is a relation between the density of plant species (and individual plants) and the available pollinators which plants attract (Fig. 4.3.11). With few flowers in an area, only few pollinators are attracted, with increasing numbers there are more, leading to mutualistic interactions. If the number of flowers increases further, a point is reached when the reservoir of pollinators is exhausted. There is, therefore, competition for pollinators.

Pollinators (and also herbivores) visit at a certain time and place flowers or plants which may be irregularly distributed. Such temporal and spatial scales have very rarely been considered in research into such plant–animal interactions.

Bronstein (1994) pointed out that the spatial relations between plants and their pollinators should be regarded quite differently from those between plants and herbivores. Plants need to attract pollinators, but at the same time need to avoid herbivores as much as possible, so time and space are important variables.

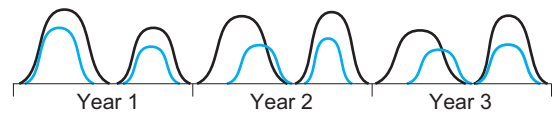
Many examples show that **flowering periods** of sympatric species competing for the same pollinators are shifted, particularly in regions without clearly differentiated seasons. Some species have very short flowering periods, others considerably longer. Flowering dates of individual flowers are not well synchronised. In regions without natural differences between seasons, temperature and photoperiod do not play an important role; species can flower once a year, as in temperate climates, or other flowering rhythms may occur. Bronstein (1994) distinguishes four different types: annual flowering, those that flower several times a year, those flowering at longer intervals, and those flowering continuously (Fig. 4.3.12 a–d).

Spatial aspects are linked to the number and distribution of potential food plants and pollinators. Theoretically, it might be assumed that animals gather food using the least possible energy. This is confirmed by systematic grazing and gathering, and limited maximum distances travelled, for example, by bees visiting sites of food and the nest (about 6 km). Tropical bats and flying foxes may cover many kilometres. Amongst birds there are real ‘nomad’ species that follow the regional gradient of flowering species, moving to different altitudes as required as their food species flower considerably later there. Others are aggressively “territorial”; e.g. some

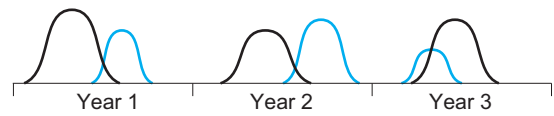


■ **Fig. 4.3.11.** Relationship between pollinator visits and flower density. (After Boucher 1985)

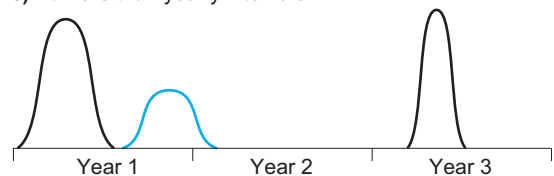
a) Frequently in the year at different times



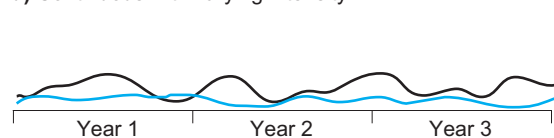
b) Once per year at different times



c) At more than yearly intervals



d) Continuous with varying intensity

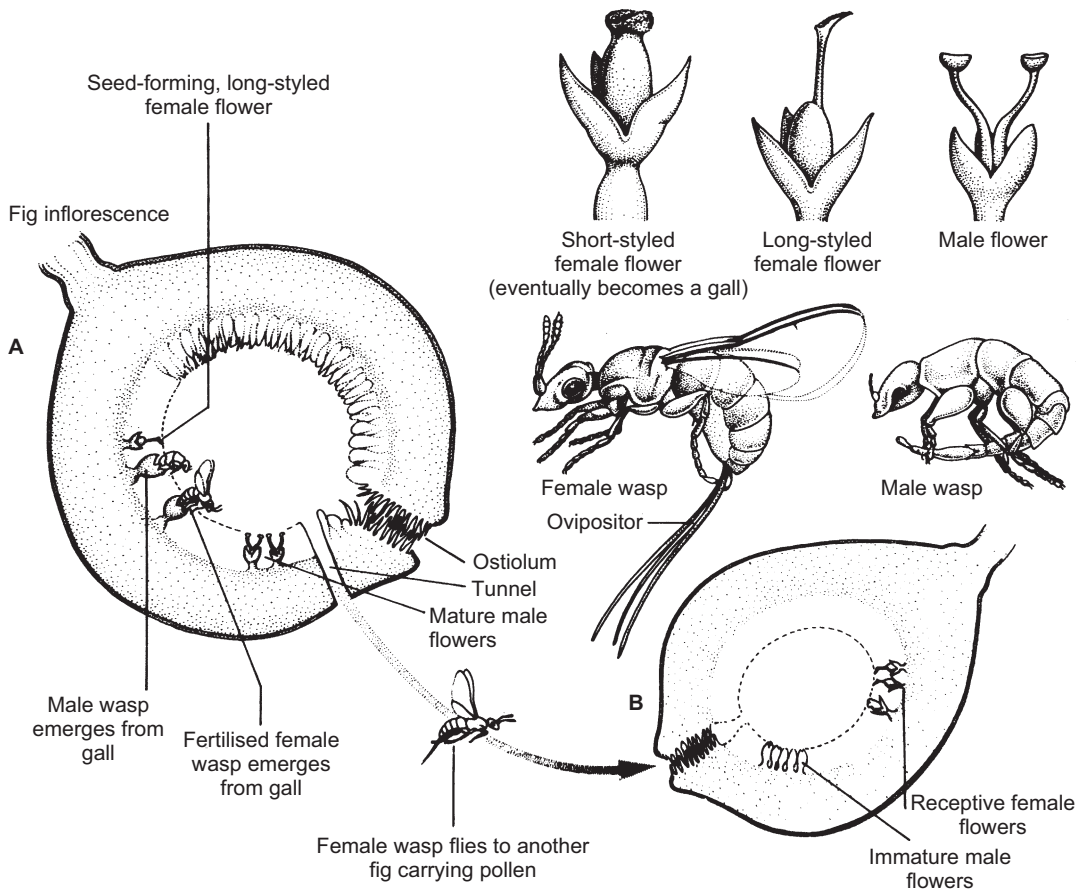


■ **Fig. 4.3.12.** Patterns of flowering relating to species from a tropical rainforest in Costa Rica. (After Newstrom et al. 1991, from Bronstein 1994)

humming birds in Ecuador occupy a region and defend it. These show the importance of assessing temporal and spatial aspects of interactions between pollinators and flowering plants.

Temporal and spatial synchronisation, particularly the very different forms of flowers and the corresponding mouth parts of insects or bills of birds, show the very close interdependence of plant and animal partners, and has often been interpreted as a result of co-evolutionary processes. The obligate linkage of many insect imagos with flowers providing nectar as their only food source supports such an interpretation.

Figures are often quoted as a remarkable example of a particularly specialised **pollination system** which cannot be interpreted as random. Bertin (1989) described the cycle for *Ficus sycomorus* (Fig. 4.3.13). The syconium, the large, almost closed inflorescence of *Ficus sycomorus*, has a small distal opening, the ostium. Females of one wasp genus, *Agaonides*, are attracted by the smell of the flowers and carry pollen through this opening into the inner space (only in one direction). They distribute pollen



■ **Fig. 4.3.13.** *Ficus sycomor* and its wasp pollinators. (After Meeuse and Morris 1984, from Bertin 1989)

to the numerous individual female flowers in the inner space. In some of them, particularly those with shorter stems, they lay eggs before they die. At the same time the individual figs develop and the larvae of the fig wasp feed on the gall-like growing fig tissue. First the male wasps hatch and find galls with females and fertilise them. The males die, or dig tunnels and reach the outside. The females pass through these tunnels to the outside, taking up pollen near the tunnel opening in the process, so the cycle starts again.

For such co-evolution, a common floristic and faunal history must be assumed. This also applies to herbivory, which is discussed next.

Basis of Herbivory

Herbivory is a very complex field of interaction between plants and animals. Plants are not just eaten. Herbivores influence plants in many ways, affecting their fitness and growth, including expansion of the area in which they grow and the distribution within it, as well as the composi-

tion, diversity, structure and dynamics of plant communities. They change the terms of competition and usually cause stress, tolerated by plants or not, but which they may counteract successfully.

For herbivory to occur, sufficient plants must be available so that animals may find them, for which they require suitable sensors. Animals will eat plants which provide them with suitable food and that are not able to protect themselves against being eaten. Sometimes whole plants are destroyed, sometimes only parts are lost which they may be able to compensate for and survive. These processes, which are simple to describe, not only occur for individual plants, but also for whole communities, where the interactions are much more complicated, particularly if the numerous feedback effects are incorporated together with the poorly understood synecological relations (Fig. 4.3.14 A, B).

The most important interactions between the supply of food from plants and the food requirements of animals are outlined in Box 4.3.2, in-



Fig. 4.3.14. A specific and well-known example of “indirect” herbivory between different types of trees and the leaf cutter ants (*Atta* of diverse species), often considered as symbiosis. The insects provide their symbiont fungus (e.g. *Rhizites* of diverse spp.) with chewed leaf material cut from leaves, as substrate (A), and often carried considerable distances to their nests (B). (Photo K. Müller-Hohenstein)

cluding effects beyond phytophagy. Consumption of phytomass (e.g. leaves, but also seeds) is a direct effect of herbivores and is important, but also the indirect effect, e.g. on the site and also on competition and vegetation dynamics, etc., must be considered.

In the following, various forms of herbivory are explained together with the possible responses of plants as well as the most important consequences.

Herbivores which only take pollen have little influence on plants and communities, but the influence of herbivores eating seed and seedlings is much greater. The particular demands of animals need to be known before their influence can be assessed.

The most important herbivores, because they are also the most well known, are the large vertebrates, for example in savannahs of semiarid tropical Africa and man-made vegetation in temperate climates. There are also many invertebrate species using vegetation and their herbivory need not only relate to eating leaves. Particularly invertebrates have found ways of using plant resources, and suck sap, eat pollen or seeds, or target other organs, such as buds or young shoots. It therefore seems useful to make a distinction between vertebrates and invertebrates.

In all vertebrate groups there are phytophagous species. Most important are, without

doubt, mammals, followed by frugivorous birds. Insects are the most important phytophagous group within the invertebrates, with molluscs and nematodes of lesser importance. They affect leaves, flowers, seeds and roots by eating, mining, boring and burrowing, sap-sucking, and forming galls. Reichelt and Wilmanns (1973) showed the different effects of guilds of phytophages on nemoral forest ecosystems and the different extent to which they are able to use resources from plants (Table 4.3.1).

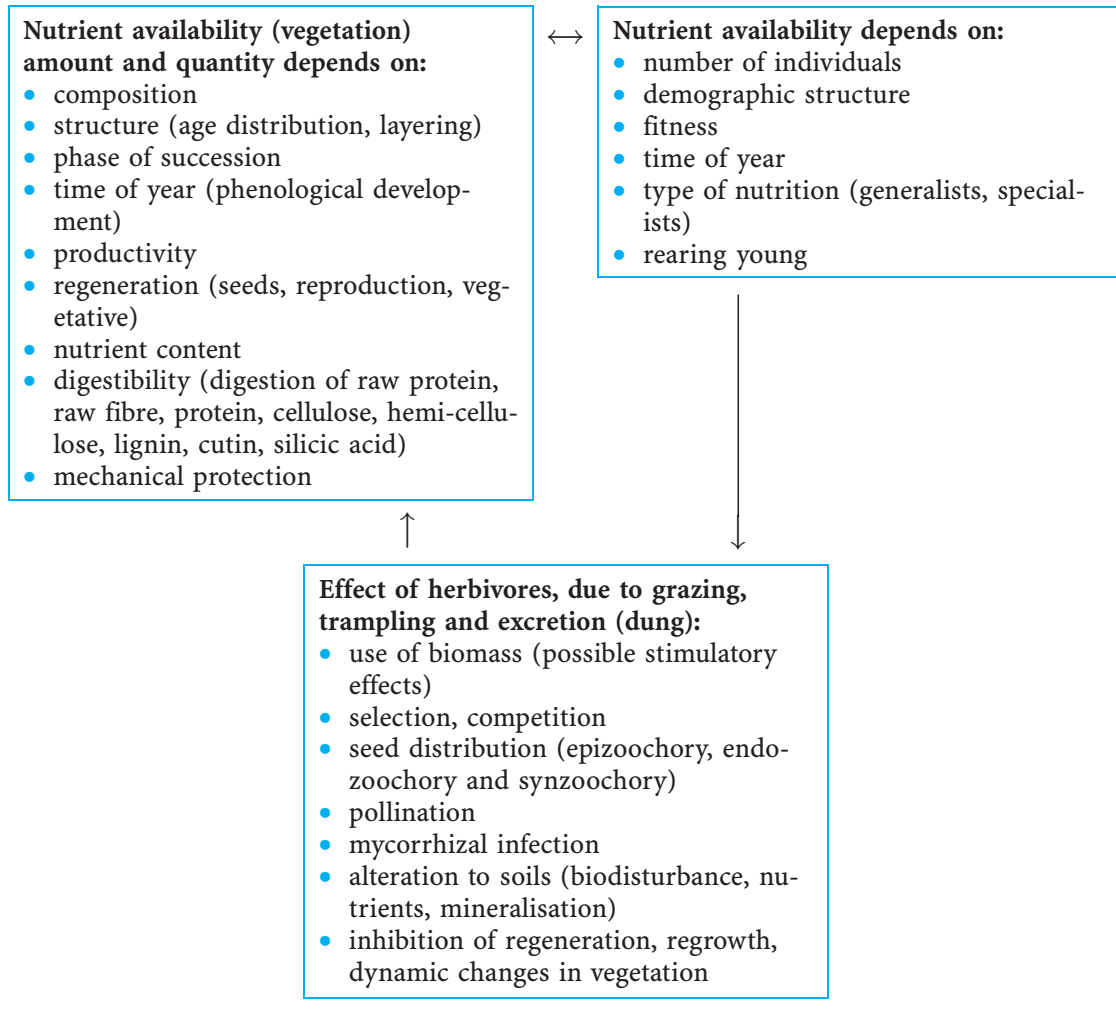
Vertebrates and invertebrates are able to disturb growth of plants in very similar ways, affecting their regeneration and contributing to early death. However, there are differences; different types of metabolism and mobility, and thus access to the required resources. Vertebrates are mostly polyphagous, with the exception of such specialists as the panda and koala which consume bamboo and eucalyptus species, respectively. Invertebrates are oligo- to monophage, thus their effects are much more selective than those of vertebrates. Vertebrates consume much more biomass because they are usually larger, sometimes consuming whole plants in one go. However, their populations are much smaller than those of invertebrates.

Tscharntke (1998) describes three possible interactions between plants and herbivores: (1) there is no damage to the plants as they are re-

Box 4.3.2**Relationship between nutrient availability and requirements and the effects of herbivores**

The relationship between nutrient availability from the vegetation and the nutrient requirement of herbivores living in the same biocenose depends not only on the floral composition of the vegetation, but also on the types of herbivores and their numbers and on many other factors. This already complex interac-

tion is further complicated as herbivores have other influences on plants and their environment in addition to consuming (phyto)biomass and the input of dung. Interactions are shown in a table, amended from Holtmeier (1999).



sistant; (2) if plants are not resistant predation takes place, i.e. the plant is eaten; and (3) parts of plants are eaten and damage is compensated by changes in growth or accelerated growth. Individual species show a wide range of resistance, predation or compensation responses.

Resistance means that the plant has defence mechanisms towards herbivory. Permanent and

induced resistance are distinguished. Permanent (and at least partial) protection is achieved by characteristics which are independent of the influence of herbivores, e.g. tannins in many trees or high content of silicic acid in some grasses. Induced defence (partially as well as permanent), for example by chemicals (**antixenosis**), which stops or limits damage, is possible. Long-

Table 4.3.1. Phytophagous insects in forest and woodland ecosystems in Germany. (After Reichelt and Wilmanns 1973)

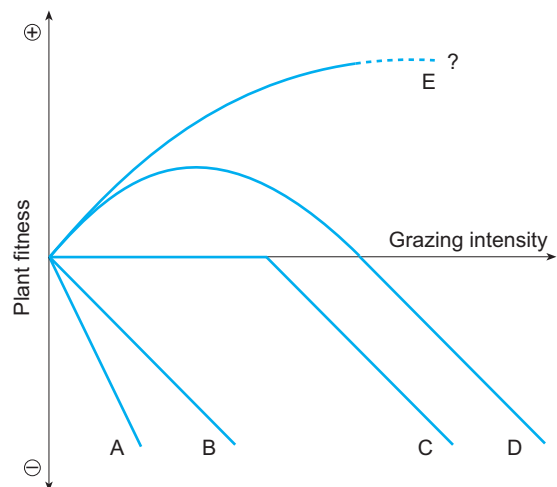
Life style	Examples
Leaf chewers	Gypsy moth (<i>Lymantria dispar</i>), black arches (<i>L. monacha</i>), pine looper moth (<i>Bupalus piniarius</i>), European saw fly (<i>Neodiprion sertifer</i>), little spruce sawfly (<i>Pristiphora abietma</i>), cock chafer (<i>Melolontha vulgaris</i>)
Excavators	White satin moth (<i>Leucoma salicis</i>), poplar leaf-beetle (<i>Chrysomela populi</i>)
Leaf miners	Larch case bearer moth (<i>Coleophora laricella</i>), horse chestnut leaf miner (<i>Cameraria ohridella</i>)
Bark borers	Large pine weevil (<i>Hylobius abietis</i>), European fir engraver beetle (<i>Pityokteines vorontzovi</i>), European spruce bark beetle (<i>Ips typographus</i>), pine shoot bark beetle (<i>Tomicus piniperda</i>), lesser pine shoot beetle (<i>T. minor</i>), large elm bark beetle (<i>Scolytus scolytus</i>), and smaller European elm bark beetle (<i>S. multistriatus</i>), carriers of Dutch elm disease
Wood borers	Various bark beetles, e.g. spruce bark beetle (<i>Dendroctonus micans</i>)
Sap suckers	Sitka spruce aphid (<i>Liosomaphis abietinum</i>), fir shoot aphid (<i>Chermes abietis</i>), fir aphid (<i>Dreyfusia nordmanniana</i>)
Bud and shoot eaters	Pine beetle (<i>Myelophilus</i> spp.), European oak leafroller (<i>Tortrix viridana</i>)
Root eaters	Larvae of click beetles (Elateridae) and cock chafer (<i>Melolontha vulgaris</i>)
Seedling eaters	Click beetle larvae (Elateridae), pine beauty (<i>Panolis flammea</i>)

lived plants contain substances such as lignified cell walls or tissues which are particularly rich in crude fibre and inhibit digestion. Short-lived species accumulate bitter substances and poisons (phenols, alkaloids, terpenes). The methods of plant defence need to be looked at from a cost-benefit aspect which suggests that plants should accumulate substances in such concentrations that eating occurs but digestion is affected so that they are avoided (**antibiosis**). Another mechanism of avoiding herbivores is to attract antagonists (e.g. parasitoides) and thus subject phytophages themselves to increased predation (**promotion of antagonists**). Kessler and Baldwin (2001) showed this experimentally and achieved over 90% reduction of herbivores on *Nicotiana attenuata* (Solanaceae).

Polyphages live in a different environment to monophages and deal with many plant toxins and defence mechanisms. Their food uptake is particularly limited by lignified and silicified tissues and they tolerate specific poisons because of the 'dilution effect' which occurs as a result of **polyphagy**. Monophages, amongst them many insects, need to find their food plant first. Their choice may be limited but competition from other potential herbivores is decreased by the plant's toxic materials which they are able to detoxify. Thus the same plant community may become the habitat for a monophagous insect and a polyphagous mammal.

If plants are not resistant to herbivores, they may be eaten (**predation**). Many species if they are only partially eaten with loss of leaves re-

spond with **compensatory growth**. This growth differs according to the type of plant. If grasses are eaten, formation of runners and tillers may be stimulated, for example. Trees and shrubs form thorns or significantly more resistant tissues. With little pressure from herbivores there may be over-compensation in growth. The theoretical effects of herbivory on growth and thus fitness of plants are outlined by Tscharrntke (1998; Fig. 4.3.15). Cases A and B assume that there is a linear relation between the intensity with which a plant is eaten and fitness (e.g. seed yield per plant). In case C herbivore pressure without visible effects is initially tolerated, only

**Fig. 4.3.15.** Hypothesis considering the consequences of herbivory for plant fitness. (After McNaughton 1983, from Tscharrntke 1998)

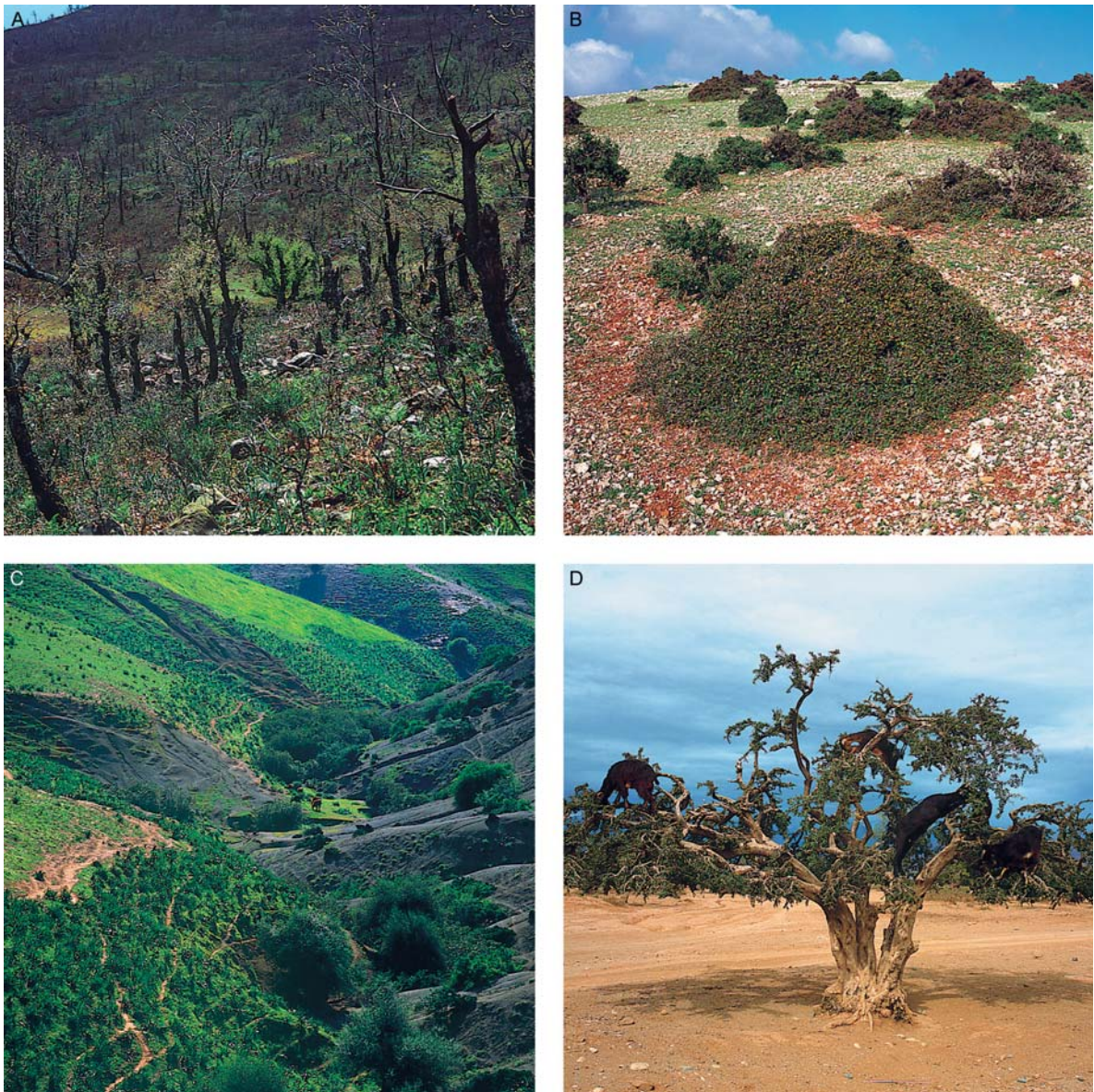


Fig. 4.3.16. Grazing may have very different consequences for the vegetation. In the Rif Mountains in northern Morocco, branches of summer green oaks (*Quercus faginea*) are cut when animal fodder is in short supply and the trees appear stunted (A). Extreme grazing pressure on *Quercus coccifera* in Jordan leads to stronger and sharper thorns on the small oak trees (B). Strong grazing pressure can also lead to increased frequency of toxic species, e.g. several Lilaceae, shown here in the pastures of the Plateau Central in Morocco (C). If herbs and grasses and other low-growing plants have already fallen victim to excessive grazing the remaining trees, e.g. *Argania spinosa*, are grazed by goats in the Sousse, south Morocco (D). (Photos K. Müller-Hohenstein)

later do significant losses occur. In cases D and E grazing stimulates at first, but this stimulation need not necessarily lead to increased fitness (E); after the initial transient increase there may also be a decrease (D). Increased phytomass production has often been shown following herbivory, but there are doubts that the compensatory growth is actually reflected in greater fitness of plants (Belsky 1986).

These rather theoretical considerations are supported by only qualitative information with very few measured, quantitative data for herbivore–plant relations. The data originate mainly from practical grazing management, fencing and rotation experiments, as well as from experiments with different types and numbers of animals. For many invertebrate phytophages there is controversy whether their number is limited

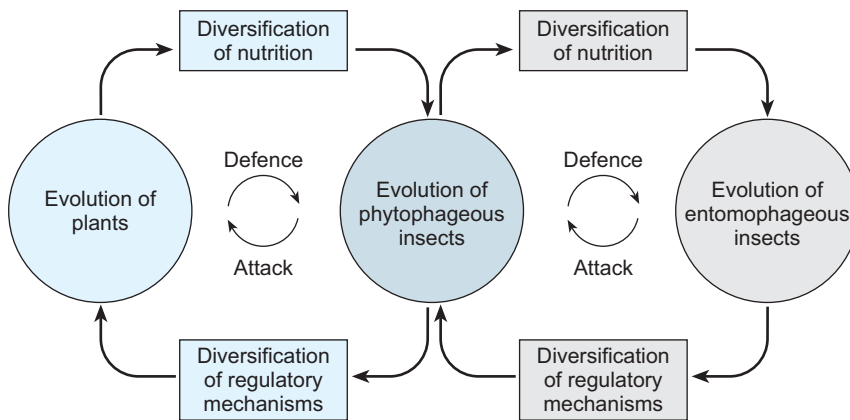


Fig. 4.3.17. Feedback processes in co-evolution of fodder plants, phytophages, and entomophages. (After Zwölfer 1978)

by the available food or by enemies. Figures published by Brunold et al. (1996) show to what different extents young plants in forests are eaten and how this regulates selection and succession. Aspen, elm and fir trees were less than 10% intact, for heather, blueberry and mountain ash about a quarter, but half of the viburnums and willows survived, whilst beech was almost undamaged. From grazing practice it is known that the age of grazed plants is a factor regulating the removal of biomass because of the changing nutrient and crude fibre contents. Spatial patterns of grazing in areas with few animals and plenty of available fodder look different to those where the grazing pressure is particularly high. Walter and Volk (1954) showed that with different grazing pressure concentric circles (including trampling damage) develop around water holes in otherwise homogeneous vegetation, with plant communities reacting specifically to different grazing pressure and the preferred grazing species become rarer and 'grazing weeds' (toxic, thorny species) increase. In Fig. 4.3.16 A–D various consequences of grazing for vegetation are shown.

Ultimately, herbivory leads to changes in the site and therefore indirectly influences plant cover. An extreme example is of areas where many animals congregate, such as resting places frequently visited by large, ruminating mammals, excreta of which significantly change the nutrient situation. Changes in the site may also occur by erosion or soil compaction caused by trampling and also by herbivorous burrowing animals.

Plants are protected by poisonous secondary materials or by mechanical barriers such as thorns and barbs. In parallel, herbivorous animals have developed morphological and physiological adaptations to overcome these impediments.

Some insects also accumulate plant poisons, to which they themselves are resistant, as protection against their enemies.

These evolutionary processes – similar to those for pollinators and their partners – are often interpreted as co-evolutionary. Even though there are some warnings not to overestimate the role of evolution (Howe and Smallwood 1982; Dirzo 1984), it is difficult to interpret some of these findings otherwise. Zwölfer (1978) sees the relations between flowering plants and insects (phytophagous and entomophagous species) as a process causing insects to store information about the plant (poisonous, difficult to digest, etc.); these processes may quickly lead to evolutionary processes starting the development of new species or races (Fig. 4.3.17). He considers this as explaining the extraordinarily fast, parallel phylogenetic development of insects and angiosperms during geological development (see Chap. 4.1.1).

Temporal and spatial intensity of grazing and the composition of the grazing animal population are important influences on vegetation and need to be known if grazing management is to be successful: grazers preferring grasses and herbaceous species and browsers which also eat lignified species. Feasibility studies for sustainable grazing management and acceptable numbers of animals are difficult to evaluate (Müller-Hohenstein 1999). Overgrazing is particularly apparent in the semi-arid subtropical and tropical regions, because the human populations involved in grazing management have not yet adopted suitable forms of management, and because of the generally rapid growth of populations. It is questionable whether information from northern European grazing management could be transferred to near-natural ecosystems

such as the savannahs of Africa, with their large herbivores. The visible effects of overgrazing are rare, even though herbivores take out between 20–60% of the phytomass for fodder. Corresponding losses in beech forests are below 10%. Similarly, these estimates should not be accepted uncritically. Not only is it difficult to measure such values, but also the consequences for the plant communities depend not only on how much is damaged or removed, but also what was eaten. Consumption of seeds and buds may have more far-reaching consequences for the whole ecosystem than consumption of the same amount of leaves.

The influence of grazing on plant diversity may be very large and reaches a maximum with medium grazing pressure. Medium to high grazing pressure has a strong influence on the composition of species and through selection has a noticeable effect on the structure of the vegetation. Poisonous and thorny species expand because of competitive advantages. Competitive conditions are changed anyway, leading to alterations in temporal dynamics and succession. In the early stages of succession herbivores are rare, but in the middle stages their numbers increase with generalists dominating. In later stages specialists dominate. Spatial patterns are thus changed and temporal patterns shifted. Ultimately, stress conditions also change. Herbivore stress is added to water stress, but light stress may decrease because of grazing.

4.3.2.2

Relations Between Plants and Animals in Communities – Basis of Biocenology

In the previous section relations between plants and animals as organisms could not always be separated from the relations between plant and animal communities. These are at the centre of considerations in **biocenology**. Plants and animals affect each other in many ways and, in doing so, are at least partially dependent on each other. This applies also to communities, i.e. biocenoses. Here, the results of phytocenology and zoocenology are combined, syntheses are aimed at a better understanding of ecosystems.

Kratochwil (1987) indicated that achieving advances in biocenology would be very difficult. **Phytocenology**, particularly in the form of plant sociology, is established as a discipline in biology and ecology in central Europe, whilst **zooc-**

nology is not equally established. The required synthesis is difficult not only because of the different methods used, but also because of the difficulty in counting animal communities with the same completeness as plant communities. Nevertheless biocenological information is very important, particularly for basic research on ecosystems and also for practical environmental protection.

Historical Approach:

Basic Principles in Biocenotics

Möbius (1877) introduced the term **biocenose** and applied it to a marine community of plants and animals in a limited space (**biotope**), where they undergo all stages of their development, and where species may promote or impede each other. The capacity for self-regulation in a **biocenotic equilibrium** is regarded as particularly important.

Other work followed much later. Thienemann (1920, 1939), working on limnic communities, formulated the first **biocenotic principles** (see Chap. 4.1):

- particularly diverse living conditions, with many species living in a biocenose, but usually with few individuals of a species, are difficult to record, because of the complexity;
- extreme (monocultural) living conditions, with species-poor biocenoses, often have many individuals of a species, and are easy to record because of their simple structure and interactions.

Krogerus (1932) added a third basic principle starting from the premise that:

- in diverse ecosystems euryoecic species are most abundant, in extreme systems stenoecic species.

Franz (1952) introduced another basic principle, taking into account historical aspects. However, the considerations on stability contained in this principle have been contradicted. This ‘rule’ states:

- The longer the period during which conditions at a site develop and the longer the same conditions have existed, the more species-rich, the more balanced and the more stable is the community.

Schwabe (1991) added important concepts to the basic principles of biocenotics and explained their validity not only for individual sites (bio-

topes) for which they were formulated, but also for higher and more varied complexes of sites and vegetation. This solved a difficult methodical problem in biocenotic research, namely that phytocenoses and zoocenoses have not (always) developed simultaneously in space and time. Schwabe also stressed human influences which have not been sufficiently considered: they may have positive effects (in the sense of variety of species and communities) if moderate, but if great then can cause monotonous and uniform stands.

Tüxen (1965) added further 'laws' to these basic principles. The first is the **law of social order of living organisms** and states that no organism, be it plant or animal, can live alone. The second law, the **law of exogenous order of communities**, is that only a few species can live in a biocenose, depending on conditions of the site. The third **law of temporal order** and the fourth **law of spatial order** stress that communities order themselves in a certain spatial coexistence (with contact communities) and a certain temporal dynamics. Ultimately, a fifth law becomes important, the **law of endogenous functional order**, implying that there are functional inter-linkages in metabolism, growth, expansion, ageing, decay and renewal of communities. These "laws" should not always be interpreted literally, but, together with the rules and principles mentioned, they provided a very early theoretical framework which was accepted only recently in biocenotic research.

Present Biocenology:

Definitions, Tasks and Aims

Research into biocenology aims to describe, record, examine and explain, by observation and experiments, characteristics of communities primarily in the field, and considering as many organisms as possible. The research also provides functional analyses: these can only be achieved with the close cooperation of plant, animal and landscape ecologists as well as of biogeographers and landscape scientists.

The central feature is the biocenose, defined by Kratochwil and Schwabe (1999) as follows:

A **biocenose** is a community with a composition of species which have similar requirements for abiotic and biotic conditions at a site. Mutual interactions (nutritional chains, mutualistic relations, and others) are available, at least for some of the species. Typical characteristics in relation to structural-functional interactions may be es-

tablished. Existing nutritional networks are not exclusively restricted to the biocenose, but are concentrated there in one or several places. Biocenoses are usually compartmented. Partial biocenoses, however, are dependent on the structure of the biocenose which is often determined by plants.

This precise definition differs from the original version by Möbius, particularly in not assuming that all species need to be in a biocenose during their complete ontogenesis. Influence by man is considered. There are also secondary biocenoses, for example there are often very young pioneer communities on sites affected by man with (still) very low numbers of species, in contrast to very old tropical biocenoses. Development can lead, albeit with large fluctuations, to species-rich systems for which a biocenotic equilibrium is assumed. The assembly of species is interpreted as occurring stochastically as well as deterministically.

The linkage of species to a biocenose is also seen very differently. According to Wittig (1993), species specific to a biocenose may spend their complete life cycle there (**homotope**), or at least spend a characteristic phase of the life cycle in it (**heterotope**), but a distinction is drawn between visitors with a short, targeted stay (**hospites**) and neighbours (**vicini**) entering for a short, random stay, or those passing through (**permigrants**), some perhaps arriving in certain seasons and some arriving by accident (**aliens**) and found episodically. A distinction is also drawn between species which are **euceonic** (including **stenoecic**, those using a special supply of a resource), **cenophilic** (with a preference), **tychozeonic** (**euryoecic**, using a broad spectrum of plants), **acoenic** (**ubiquists**) and **xenozoenic** (connection to another biocenose).

Because of the enormous complexity of biocenoses and, particularly, the almost impossible task of completely recording all groups of organisms, partial biocenoses and partial habitats have been analysed. In this, a subdivision similar to the **concept of synusiae** in geobotany proved useful in considering particular groups of organisms (guilds, life forms, functional groups) in certain parts of a biotope. Examples are a **stratocenose** in a **stratotope** (e.g. organisms in a layer, such as in the canopy or the herbaceous layer), **choriocenes** in a **choriotope** (e.g. inhabitants of a dead, woody stem or a moss cushion), and **merocenes** in a **merotope** (e.g. organisms on an inflorescence).

Methodical Approaches and Disciplines in Biocenology

At the beginning biocenology was purely descriptive. Later inductive-typological approaches became more important (Kratochwil 1999). The main problem is to decide at which level a phyto- and zoo-cenological synthesis (i.e. the bringing together of plants and animals) should take place to describe the biocenose. A system with two species may be characterised by biocenotic relations, whilst relations in communities can be shown much more comprehensively. Plant sociologists have provided a detailed reference system and offer a matrix into which animal communities may be added. A plant community does not always correspond to an animal community and this level is not always sufficient to recognise the coincidence of plant and animal communities. The **level of association** (provided by **plant sociology**) does not necessarily guarantee the required synthesis, but the **level of vegetation complexes** (provided by **sigma sociology**) and perhaps also the **science of communities of life forms** (provided on the bases of **structural characteristics** of plants and plant communities, e.g. of life forms) does. Only in this way is it possible to consider the multiple conditions, and the demands made on the habitat, during the life cycles of some animals. Particularly for bird communities, numerous relations to plant and vegetation structures have been shown (Blab 1979; Bezzel et al. 1980). Phyto- and zoo-cenolo-

gists need to be aware of the different levels and refer to actual examples in the same system.

In addition to the biocenological-symbiological approach of Wilmanns (1987), Kratochwil (1999) and Schwabe (1990), there are other approaches. Passarge (1981) proposed a typological approach. Animal communities should be recorded independent of plant communities, but characterised according to plant sociological patterns and called 'zoo-associations', and perhaps be incorporated into a plant sociological system later. Mühlenberg (1989) took a quantitative approach and sought connections between density of leaves, number of species and density of individual plants, for example. All approaches consider the functional relations and dynamics. Theoretically, listing all species is required but in practice this may only be accomplished partially by zoo-cenologists because of the many different groups of organisms. Different groups of insects are suitable invertebrate, and often birds have been chosen to represent vertebrates.

Kratochwil (1999) listed various research disciplines in biocenology, together with the most important methodical approaches, aims and problems. In **Box 4.3.3** the most important partial disciplines and research topics are listed (they may overlap of course). Thus **cenomorphology** provides an inventory of species and structure, **cenoecology** the exogenous effects of and on biocenoses, **cenochorology** and **cenoedynamics** assess the spatial distribution and tem-

Box 4.3.3

The biological disciplines involved in biocenology and their research tools. (After Kratochwil 1999)

A number of subsidiary disciplines have developed during the study of biocenoses, with their own research subjects and themes: the following are distinguished:

Biocenological subsidiary discipline	Research tools
Cenomorphology	Structure of the biocenose (structural organisation) – species inventories, dominance of individuals – attachment to the biocenose – dispersal of species and individuals
Research on functional interactions	Interactions of organisms (functional organisation)
Cenoecology	External biotic and abiotic factors
Cenochorology	Spatial distribution
Cenoedynamics	Short-term developments with time
Cenophylogeny/cenoevolution	Formation of biocenoses during the course of evolution
Cenosystematics/cenotaxonomy	Systematic grouping and naming of biocenoses
Experimental biocenology	Agricultural and forestry aspects, environmental protection

poral development. In **cenosystematics** the aim is to achieve a systematic order of biocenoses. Currently, applied **biocenology** is regarded as important as it is closely connected to environmental protection, where the protection of communities and habitats, in addition to the protection of species, is increasingly discussed.

Research into Functional Interactions

A particularly important field of biocenology is **research into functional interactions** between organisms. **Biocenotic interactions** describe the relations between organisms in a habitat or a smaller spatial unit (microhabitat). It is particularly characterised by nutritional requirements and dependencies, but also other (inter)actions (Schaefer 1992). The total direct and indirect linking be-

tween an organism and other plants (e.g. spruce in a coniferous forest and the herbaceous layer or epiphytic mosses), as well as all animals (nesting and seed-eating birds or damaging insects), is described by functional interactions which may also be at the level of the (obligate) cooperation of a plant and an animal, but usually a complete or partial biocenose is considered.

At the beginning of such research an inventory is always required. Rabeler (1967) discovered close relationships for various faunistic guilds in forest communities of northwest Germany. The list in [Table 4.3.2](#) may be interpreted as a plant community table. Besides those insects that occur frequently are several ubiquitous and also a range of characteristics and different species, which ultimately are closely linked with

Table 4.3.2. Distribution of specific animal groups in particular plant communities in northwest Germany. (Shortened and simplified from Rabeler 1967, in Wilmanns 1998)

Animal groups	Plant communities	Carici-Fagetum			Melico-Fagetum					Quercu-Carpinetum						
		Lithospermo-Quercetum	seslerietosum	typicum	typicum	elymetosum	elymetosum	typicum	typicum	allietosum	dryopteridetosum	asperuletosum	asperuletosum	athyrietosum	athyrietosum	Luzulo-Fagetum
<i>Limonia modesta</i>	S	+	+	+	+	+	+	+	+	+	+	+	+	+	+	-
<i>Stenodema laevigata</i>	W	+	+	+	+	+	+	+	+	+	+	+	+	+	+	-
<i>Lygus pratensis</i>	W	+	+	+	+	-	+	+	+	+	+	+	-	+	+	-
<i>Abax ater</i>	L	+	+	-	-	+	-	+	+	-	-	-	+	+	+	+
<i>Phyllobius argentatus</i>	R	-	+	+	-	+	+	+	+	+	+	+	+	+	+	+
<i>Abax ovalis</i>	L	+	+	+	+	+	+	-	+	+	+	-	-	-	+	+
<i>Athous haemorrhoidalis</i>	E	-	+	+	+	+	+	-	+	+	-	-	-	-	-	+
<i>Limonia maculata</i>	S	+	+	+	+	+	+	+	+	+	+	+	+	+	+	+
<i>Molops elatus</i>	L	-	-	+	-	+	-	-	-	-	-	-	-	-	-	-
<i>Athous vittatus</i>	E	-	-	+	-	+	-	+	+	+	+	+	+	+	+	-
<i>Tipula scripta</i>	S	-	-	+	-	+	+	-	-	-	+	+	-	+	+	+
<i>Allolobophora caliginosa</i>	A	-	-	-	+	+	+	+	+	+	+	+	+	+	-	-
<i>Philonothus decorus</i>	S	-	-	-	+	+	-	+	+	+	+	+	+	+	+	+
<i>Lumbricus rubellus</i>	A	-	-	-	-	-	+	+	-	+	+	+	+	+	+	+
<i>Pterostichus oblongopunctatus</i>	L	-	-	-	-	-	+	-	-	-	-	+	-	+	+	+
<i>Leptothorax nylanderi</i>	S	+	+	+	+	+	+	+	+	+	+	+	+	+	+	+
<i>Limonius parvulus</i>	E	+	+	-	-	-	-	-	-	-	-	-	-	-	-	-
<i>Ectobius sylvestris</i>	S	+	+	+	+	+	+	+	+	+	+	+	+	+	+	+
<i>Agriotes acuminatus</i>	E	-	-	-	-	+	-	-	-	+	-	-	-	-	-	-
<i>Pterostichus metallicus</i>	L	-	-	-	-	-	-	-	+	+	-	-	-	-	-	-
<i>Nebria brevicollis</i>	L	-	-	-	-	-	-	-	-	-	+	+	+	+	-	-
<i>Phytocoris longipennis</i>	W	-	-	-	-	-	-	-	-	-	-	-	+	+	+	+
<i>Coeliodes erythroleucus</i>	R	-	-	-	-	-	-	-	-	-	+	-	-	-	-	-
<i>Ceutorrhynchus rugulosus</i>	R	-	-	-	-	-	-	-	-	-	+	-	-	-	-	-

A=Earth worms (Lumbricidae); E=Click beetles (Elateridae); L=Ground beetles (Carabidae); W=Bugs (Hemiptera); R=Weevils (Curculionidae); S=Other: midges, ants

+, Several individuals caught; -, One individual caught

the selected forest communities. Similar relations were also found by Müller-Hohenstein (1978) for plant communities and beetle biocoenoses in dry regions of North Africa. This example shows that the relations are subject to considerable temporal dynamics and therefore the time of sampling is particularly important (Table 4.3.3).

Such listings of data do not provide information on causes and effects of biocenotic interactions, but are a necessary precondition. The concepts of guilds according to life forms or ecological demands or functional groups may lead to explanations. Thus biocenotic research into functional interactions is very closely related to functionally orientated ecosystem research.

4.3.3

Interactions Between Plants

Plants do not live with each other or next to each other at random. This becomes particularly obvious in vegetation units which abut, even if these units are not affected by man. A form of mutual relations is neutralism, where plants are able to live next to each other without influencing each other (recognisably), but this is a special case. The order observed in plant communities and ecosystems arises by interactions.

Interactions take place between individual plants of the same species (**intraspecific**) or also between individuals of different species (**interspecific**) and ultimately also at the level of plant

Table 4.3.3. Dynamics of species of beetles in a *Stipa tenacissima* community on the high plateau of eastern Morocco. (After Müller-Hohenstein 1978)

Date caught	26. X	14. XI	17. I	25. II	20. III	25. IV	24. V	15. VI
Pachychila lesnei	1	1						
Scaurus tristis	•	2						
Pachyscleodes semiasperula	•	•						
Trox barbarus	1		1					
Geotrupes puncticollis	•		1					
Paracelia simplex	1	1		•			•	
Ontophagus taurus	•	•			1	•		
Gonocephalum prolixum	2	2	2	1	2	2	1	
Cymindis setifensis	2	1	1	1	1	1		1
Micipsa instriata	1	1	2	1		•	•	1
Timarcha latipes	1	1	1	2	•	1	•	1
Pimelia boyeri	1	1	•	•	1	1	1	1
Hoplarion tumidum		2	1		•			
Gonocephalum rusticum		1		1		•		
Adelostema sulcatum		•		•			1	
Hoplarion latissimus			1	1		2		
Rhytirrhinus compressipennis			•			•	•	
Chrysomela hyperici			1			•	1	
Adesmia metallica ssp. faremonti			1		1	1	•	•
Entemocelis rumicis				1	•			
Chrysomela sanguinolenta				1	1		•	
Scarabaeus puncticollis					1	•		
Scarabaeus laticollis					1	•	2	
Onitis ion					2		•	
Scarabaeus variolosus					1	1		•
Pimelia gibba						•	1	
Graphopterus exclamationis						•	1	
Chrysomela bicolor						•	1	
Scaurus dubius						2		1
Julodis manipularis						•	1	•
Mylabris brevicollis							1	1
Mylabris baulnyi							1	2
Acinopus sabulosus							•	•
Aethiessa floralis							•	1
Zophosis ghilianii							1	1

Beetles were caught in the same area at approximately monthly intervals between October 1973 and June 1974 (• = only one, 1 = several, 2 = many)

communities (see Chap. 3). There is a certain selection and patterns become visible as a result of conditions at the site (**exogenic**) or by competition (**endogenic**). They are interlinked by coexistence as is clearly visible.

Competition and **coexistence** are two important forms of interaction between plants. There are, of course, other forms of interaction (also with animals, see Chap. 4.3.2) contributing to the formation of patterns of plant communities in space and time. However, the long-established idea that the phenomenon of competition alone is the decisive interaction between plants must be corrected.

It became obvious in the discussion of temporal vegetation dynamics (Chap. 4.1.1.1) that interactions may stimulate succession: They may be neutral or without influence, or they may be inhibitory (Connell and Slatyer 1977). Neutral coexistence of two species (in different ecological niches) may occur after competition over time.

According to Wilson (1969), there is an early pioneer stage in primary succession where there are no contacts between individual plants, the so-called non-interactive species equilibrium. Then the spaces fill in and there are interactions, the so-called interactive species equilibrium. After competition and occupation of space, and formation of niches, the assortative

species equilibrium follows with relatively stable self-renewal and maintenance of the community until the next disturbance, the so-called evolutionary species equilibrium. The word “equilibrium” is used here to mean balance of species.

Plants may have very different functions in the biocenose from the point of view of their plant or animal partners. Mistletoes are parasites for trees on which they grow, hosts for some plant-eaters and have mutualistic relations with birds. Some species live during their early development in symbioses with others, but later behave antagonistically. For herbaceous species shade trees are not competitors for light, but partners providing protection against climatic extremes and allowing coexistence.

Interactions become even more complicated when not two but several partners participate, with different effects on each other, or if the interactions at the level of plant communities and vegetation mosaics are studied. They are subjected to temporal dynamics and thus cause changes in the spectrum of interactions.

Possibilities outlined here show that it is difficult, because of the temporal change of interactions, to find a comprehensive typology of interactions. However, to gain an overview of minimum order, the attempts of Glavac (1996) and Schubert (1991) are discussed. Table 4.3.4 summarises current concepts.

Box 4.3.4 Interactions between plants and animals

Plants live together with animals in communities (biocenoses) and influence each other. Plants offer animals nutrition and they offer certain structures (e.g. nesting sites and mating areas) and are a framework for information (e.g. meeting places and nutrient availability). Animals influence plant life not only by herbivory and by modifying the site (e.g. soil burrowers and termites), but particularly in their roles as pollinators and dispersers. Here, there are countless mutual interactions. Birds and butterflies are pollinators during the day as they are attracted via the colours of flowers or availability of nectar and pollen, where as bats are active at night and are attracted by smell, e.g. of ripe fruit. Synchronised interactions are often very specialised in time and location, and are considered to result from co-evolution.

A large influence is herbivory: distinction is drawn between grazers which mainly eat herbs and grasses in pastures, and browsers which also eat woody species, often including roots. In natural ecosystems generally only a small proportion of the available standing biomass is used. Plants have developed chemical and physical defence mechanisms and respond with compensatory growth, overcoming excessive herbivory.

The relationship between plants and animals at the level of communities is considered in the biocenology. Here the principle of a biocenotic equilibrium is recognised, and countless rules describing community organisation in biocenoses have been formulated. A particularly rich area is research into functional interactions between single organisms and their environment.

Table 4.3.4. Potential interactions between two organisms

Type of interaction	Organism 1	Organism 2	Type of interaction
Symbiosis (mutualism and proto-cooperation)	+	+	Interaction beneficial to both organisms
Commensalism (parabiosis, epeceology, e.g. epiphytes, epizoics, metabiosis)	+	o	Interaction beneficial to one organism, without disadvantaging the other
Parasitism (antibiosis, allelopathy and antagonism)	+	-	Interaction benefits one organism to the detriment of the other
Neutralism	o	o	Interaction without a beneficial or detrimental effect
Amensalism	-	o	Interaction leads to a detrimental influence on one organism without aiding the other
Competition	-	-	Interaction leads to mutual disadvantage

o, neutral influence; +, positive, advantageous influence; -, negative, disadvantageous influence

4.3.3.1

Symbiosis and Other Mutualistic Relations

Symbiosis is understood as the interaction between two organisms, with advantages for both. If this interaction is obligate, it is a **eu-symbiosis (mutualism)**, if it is advantageous, but not required, it is called **proto-cooperation**. Thus the relations between plants and their pollinators and dispersers (Chap. 4.3.2) are in many cases to be regarded as proto-cooperative.

A number of obligate interactions such as lichens, nitrogen fixers and mycorrhizae are classified as eu-symbiosis; they are both scientifically interesting and economically important, particularly nitrogen fixers and mycorrhizae.

Lichens

Symbiosis between **autotrophic algae** [green and blue-green algae (cyanobacteria), photobionts] and **heterotrophic fungi** (ascomycetes, mycobionts) has long been known and investigated. Participating fungi receive from their algal partners carbohydrates and nitrogen compounds in particular. Fungi, in turn, offer algae enclosed in their thalli protection from external stress (excessive radiation, rapid drying, etc.). In addition, algae receive mineral substances from their fungal partners. It appears that algae are stimulated by fungi at certain times to produce more assimilates, at other times the fungal hyphae penetrate the algal cells and remove nutrients and live saprophytically on the dead algae. Lichen symbiosis is obligate, as the algae have lost their ability for reproductive propagation. Lichens are able to occupy the most extreme sites because of their close symbiosis and resistance against drying and thus can avoid competition



Fig. 4.3.18. In the Afro-Alpine region of Ethiopia at more than 4000 m above sea level, lichen communities live on rocks, which are subjected to frost and strong winds almost daily and receive most of their nutrition from bird droppings (ornithocrophily). (Photo K. Müller-Hohenstein)

from more demanding species (Fig. 4.3.18), but they grow very slowly. For *Rhizocarpon geographicum*, used in **lichenometry** to date recent geological deposits (e.g. moraines left after glacier movement), growth rates of a square centimetre in 60 years are recorded. Lichens play a considerable role in biological weathering of rocks in moist as well as in arid climates.

N₂-Fixing Microorganisms

Blue-green algae (cyanobacteria) are not only important partners in lichen communities; those

of the genus *Anabaena* form symbiosis with the water fern *Azolla* resulting in nitrogen fixation of up to $1000 \text{ kg N ha}^{-1} \text{ a}^{-1}$ in tropical rice fields and thus allows continuous rice cultivation in tropical regions.

Bacteria of the genus *Rhizobium* also fix N_2 in symbiosis with several genera of the Fabaceae which occur worldwide (see Chap. 3, N cycle). These bacteria live in nodules on the roots and are extremely effective, with N_2 fixation rates of $45\text{--}670 \text{ kg N ha}^{-1} \text{ a}^{-1}$, and are very important for the global nitrogen budget. In agriculture, many Fabaceae are used as green manures, being ploughed into the soil. Bacteria living saprophytically in the soil enter the roots of host plants and induce development of nodules. They receive water, minerals and assimilates; in turn, they supply the host with nitrogen. Young plants of Fabaceae need to be inoculated and acidify the soil because of proton release.

Comparable symbiosis exist in alder where roots are occupied by bacteria of the genus *Frankia*, and in some Poaceae which form symbiosis with bacteria of the genus *Azospirillum*. There are also 'above-ground' forms, e.g. some epiphytic blue-green algae supply their hosts with N. Also there are associations between particular *Rhizobium* species and Fabaceae (e.g. *Sesbania* spp.), with formation of shoot nodules which fix N_2 .

Mycorrhizae

Probably the most important and widest distributed form of symbiosis is characterised by the keyword **mycorrhizae** (see also Chap. 2.3). The most important studies were summarised by Smith and Read (1997). Almost all plants interact with mycorrhizal fungi, and in most cases real symbiosis occurs. Now it is assumed that all terrestrial plant communities (and ecosystems) are greatly influenced by mycorrhizae, amongst other factors (see Chap. 3). However, mycorrhizae are not so important in cold habitats, such as the polar regions and high mountains, or in most arid areas.

Mycorrhizae are a symbiosis between fungi (ascomycetes and basidiomycetes, but also zygomycetes) and roots or rhizoids of higher plants. The type of contact between the fungal hyphae and roots of the host plant, as well as the participating fungal species, leads to classification of mycorrhizae into several types (Allen 1991). Only the most important ones will be mentioned here. If fungi (e.g. basidiomycetes) form

a network (Hartig net) around the root tips of higher plants, e.g. coniferous trees, and only penetrate between the cells of the root cortex, then they are called **ectomycorrhizae**.

Forms of **endomycorrhizae** occur mainly with ascomycetes. Hyphae penetrate the root cortex but remain connected to the fungal mycelium in the external soil. **Ectendomycorrhizae** occur when an endomycorrhiza is linked to the intracellular fungal hyphae. Special forms of endomycorrhizae occur in the families of Ericaceae and Orchidaceae.

A frequent form of endomycorrhizae in herbaceous plants is the **vesicular-arbuscular mycorrhiza (VAM)**. Fungi (often zygomycetes) form finely intertwined, tree-like hyphae with haustoria (arbuscles). Forms of VAM are known which not only transfer material between fungus and higher plant, but also act almost as a bridge between different individual higher plants (see Chap. 3).

Fungi are often associated with a certain host plant, but host plants may associate with several mycorrhizae. Usually, host plants increase their phosphorus and nitrogen supply via mycorrhizae, and sometimes also their water supply, because the root surface is increased 100- to 1000-fold. It is also assumed that mycorrhizae protect against pathogenic organisms. In turn, higher plants provide carbon compounds to the fungus. Because of this exchange, plants are able to occupy nutrient-poor sites, where they would otherwise be unable to grow. Today, it is thought that forest damage might be a consequence of increased nitrogen input which damages mycorrhizae and thus disturbs the symbiosis.

4.3.3.2

Forms of One-Sided Benefit (Commensalism, etc.)

Interactions between organisms are not always of benefit to all participants. If only one partner is advantaged, and the other one is not disadvantaged, it is a form of **commensalism (parasitism)**. Such forms exist predominantly in animals, but the terms commensals and hosts are also applied to plants. Individuals of some plants live mainly or exclusively under the protection of other species (e.g. guests on cushion plants in dry areas or in high mountain habitats). In extreme cases they survive only because they cannot be eaten or are not exposed to excessive so-

lar or very strong winds. Dwarf shrub communities in Afro-Alpine regions are many such examples. In temperate zones herbaceous species are probably only able to survive in forests because of shade. The basis of all those relations is the variability over small areas caused by the plants themselves (climate of the stand, water relations, availability of nutrients).

Also, the so-called **paroecy** ('tolerated neighbourhood'), e.g. individuals of species living epiphytically on other species, could be interpreted as a form of commensalism. There are, however, transitions to forms of **amensalism**. Here, one partner is disadvantaged, without the other being significantly advantaged. This could be applied to epiphytes, as old trees with epiphytes growing on them may break because of the enormous mechanical stress. **Neutralism** should also be mentioned. It is assumed that regularly associated organisms neither suffer advantages nor disadvantages because of the coexistence. No partner influences the other visibly or in other ways so far identified. It is difficult to assess indirect interactions, in which one partner changes the site so that conditions previously unavailable are created for other species, but under which they can no longer exist. This form of **metabiosis** is the basis of the **facilitation theory** of Connell and Slatyer (1977); see [Chap. 4.1.5.3](#).

4.3.3.3

Parasitism

An antagonistic relationship, so-called parasitism, exists if a partner (**parasite**) inhibits or damages the other (**host**) and thus gains advantages. Most widespread examples are of one partner (the parasite) taking nutrients from the other (host) and thus increasing its growth and inhibiting growth of the host without, however, damaging the host severely. Parasitic plants are either **heterotrophic** (without chlorophyll, holoparasites or complete parasites), or they are able to produce assimilates themselves but use var-

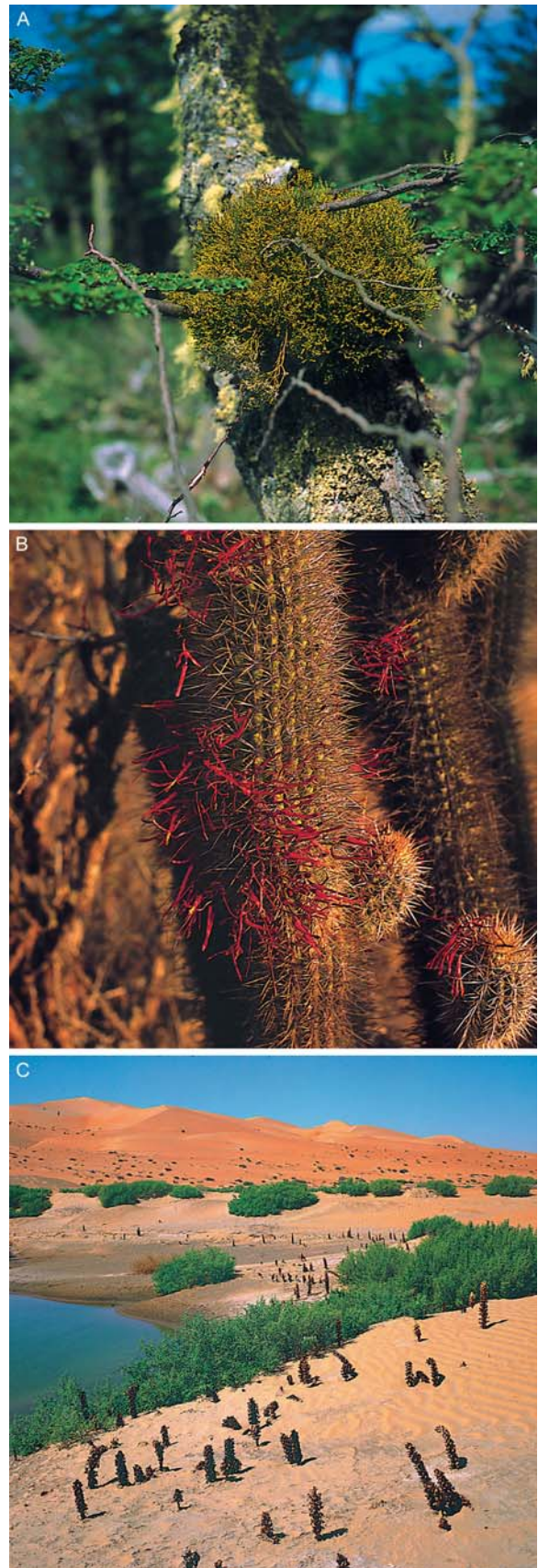


Fig. 4.3.19. Parasitic plants have developed in all biomes. **A** In cool temperate southern Chile *Misodendron punctatum* on southern beech (*Nothofagus antarctica*). **B** In semi-arid northern Chile a completely leafless Loranthaceae (*Tristerix aphyllus*) grows on many cacti (*Trichocereus* spp.). **C** In the completely arid Arabian desert *Cistanche violacea* is parasitic on various host plants, e.g. even on halophytes (*Suaeda fruticosa*). (Photos K. Müller-Hohenstein)

ious inorganic compounds and water from the host (hemiparasites). The former are species tapping the host via haustoria, below ground (*Orobanch* spp.) or above ground (*Cuscuta* spp.). The latter include Scrophulariaceae (species of *Bartsia*, *Melampyrum* and *Rhinanthus*) and Loranthaceae (species of *Viscum*) living epiphytically. Interaction forms similar to parasitism are classified as allelopathy. Examples of parasitism from different habitats are given in Fig. 4.3.19 A–C.

Allelopathy (also **antibiosis**) is a specific form of interaction. One partner excretes metabolites which inhibit the other. The partner excreting these materials is thus, indirectly, advantaged. Materials such as alkaloids, phenols, glucosides and terpenes can be formed in bark, leaves or roots, and inhibit germination and growth; they are actively released into the soil as root exudates. Occasionally, they are formed and released only during decay of dead organic material. Excreted substances not only inhibit growth, but may also prevent seeds from rotting. Comparable substances excreted by microorganisms are called **antibiotics**. Allelopathic substances often only affect certain types of organisms or certain stages of development of these species (perhaps seedlings).

One of the best-known examples of allelopathy is the walnut tree (*Juglans regia*). From the glucoside-rich litter, a toxic substance (juglon) is formed by hydrolysis and oxidation and inhibits development of many species. Other often-quoted examples are from vegetation of regions which are dry in summer, e.g. Mediterranean macchies (*Rosmarinus officinalis*) or the Californian chaparral (*Larrea* spp.).

4.3.3.4

Competition and Coexistence

Since Darwin (1859) identified “The struggle for survival”, it has been regarded as the mechanism and driving force of evolution. In subsequent decades unequivocal proof of the phenomenon of competition has been sought, but only been partly achieved. In addition to experimental studies to clarify the effect of competition, many models were developed to explain the coexistence of plants in, or their mutual exclusion from, communities.

Various approaches to understanding competition will be explained in the following, based

on experiments from which the basic rules of coexistence of plants will be derived and the characteristics underlying the competitive strength of individual species explained. As examples of application of practical evidence and experimental knowledge, indicator values and ecogrammes will be shown. Discussion of competition models with particular emphasis on niche concepts will address what is the basis of coexistence, at present stressed more than competition (Tokeshi 1998).

Concepts and Definitions of Competition

It is generally assumed that two living organisms with identical or very similar ecological demands can only coexist if there are few individual plants distributed in a large space so that the resources can be shared and are not fully used. It follows that **competition** starts when one or several of the required factors, essential for life, are only available in limited supply so that there is a shortage of these resources, resulting in adverse effects on (or even cessation of) survival, growth and propagation. Such a competitive situation not only necessarily leads to total elimination of the weaker, less competitive, species, but also to regulation of the density of participating populations. Regarding the type and amount of resources, several different forms of competition may be distinguished. Above ground there is, first and foremost, competition for light, carbon dioxide and favourable temperatures, as well as for pollinators and dispersers of propagules. Below ground there is competition for nutrients and water. The former often regulate composition of stands, the latter, so-called **root competition**, is additional to competition for light (as stated in the theory of self-thinning, see Chap. 3) and is responsible for the density of the stand.

However, competition for essential but limited requirements for life is only one of the several possible ways of understanding competition. There are direct, negative influences of one plant on another. Many species are able, for example, to suppress other species by excretion of special toxins or simply by shading shoots and leaves. There is, therefore, competition by interference in addition to competition for resources.

A further important difference between forms of competition is shown in the competition between individual plants (of one species), called **intraspecific**, and between species, called **interspecific**. The intraspecific form was regarded as

stimulating evolution. Selection results in the strongest, best-adapted individual surviving and thus contributing to maintenance of the species and its competitive strength. In interspecific competition, closely related species exclude each other completely in the extreme case, so possibilities for coexistence are restricted.

Intraspecific competition occurs particularly in crop plants. It has been shown, for example, that increasing sowing densities do not increase yields to the same extent, but increase mortality and self-thinning (see Chap. 3). Theoretically, more phytomass per unit area can only be achieved by taller growing individual plants. This is prevented by competition. Intraspecific competition is avoided if the habitat offers ways of avoidance (see later discussion of ecological niches) or by evolutionary processes (e.g. formation of ecotypes or new species in the course of adaptive radiation). **Interspecific competition** largely determines the actual distribution of representatives of different species in space. It is assumed that present distribution patterns may be a consequence of intensive competition a long time ago and that at present competition no longer exists.

Features and Characteristics of Competitive Strength

Following from the observations concerning intra- and interspecific competition, explanation of **competitive advantages** were sought, particularly genetically determined physiological and morphological characteristics which would improve success of species in competition with other species. It is assumed that such attributes of individual developmental phases of plants may be considered separately and that there are no linear relations between individual traits and competitive strength.

The **seed and germination stages** are the first important stages subject to competition. Early release of seed (in the vegetative period), an effective mechanism of dispersal, large content of reserves, a short period of dormancy, long duration of ability to germinate and high germination rates, as well as fast growth of seedlings, are all advantageous. Inhibitors, excreted by seedlings and impeding growth of competitors, are also beneficial (**allelopathy**, see Chap. 4.3.3.3).

The **growth stage** is the second important phase. Physiological characteristics such as high photosynthetic rates, and thus correspondingly

rapid growth of shoots and roots, are the most important. Adaptation of the life cycle to seasonal changes in conditions and, most of all, duration of the life span (annual/perennial) is important. Equally important is tolerance towards unfavourable environmental conditions (shade, water, nutrient deficiency, mowing and grazing). Competitive advantages are also achieved by symbiosis. The strength of competition is visible morphologically in the form of growth (e.g. tall plants, large leaves and a large, shading, crown) with a far-reaching root system, and adaptations to unfavourable environmental conditions (e.g. xeromorphic traits, succulence, formation of light and shade leaves, etc.).

The third stage is the **reproductive phase**. Species with many attractive flowers and quickly ripening pollen have considerable advantage, as do those with sexual reproduction as well as vegetative reproduction; further characteristics that bring advantages include self-fertilisation, formation of ecotypes, and capacity to adapt to changing conditions within the community.

Aarssen (1989) listed the most important attributes contributing to strength of competition. He assumed that these characteristics are linked to each other and may be ordered hierarchically (Box 4.3.5).

Experimental Approaches to Clarify Phenomena of Competition

The role of competition in nature is difficult to understand and competition is an ecological factor which is difficult to determine experimentally. There have been several attempts to clarify the role of competition experimentally, particularly as practical agriculture is looking for answers, e.g. for problems of competition between crops and segetal species. However, frequently only two (or a few) species were studied under the influence of a few, controlled, environmental factors, in an attempt to limit complexity.

Different approaches may be used. Species or layers are removed from existing stands (or added) and the effects observed. Sometimes the same or different seeds or seedlings of only two or a few species were sown on bare areas of land or in enclosures, and partially regulated external conditions (e.g. supply of water or fertilisers) applied: the success of the individual species was recorded. Occasionally, experiments were performed with functional groups of plants or with phytometers, target species from which much information is available.

Box 4.3.5

**Increasing competitive strength of plants.
(After Aarssen 1989)**

Primary attribute	Secondary attribute	Tertiary attribute
Better water use rate	← Higher root density	← Faster dispersal
	← Greater lateral distribution of roots	← Earlier germination
Better use of nutrients (N, P, K)	← Faster uptake by root hairs	← Larger seed diameter
	← Greater root density	← Higher photosynthesis rates
	← Taller growth forms	← Better use of surplus assimilates
Better use of light	← Larger leaf area index	← More effective association with mycorrhizae
	← Greater expansion of the plant	← Production of more toxic substances
	← More effective leaf arrangement	← Greater resistance to pathogens or robbers
More attractive to pollinators	← More flowers, high density of flowers	← Increased tolerance to lower temperatures
	← More attractive flowers	← Ability to attract pathogens or robbers or pass them to neighbours
More attractive to distributing organisms	← More fruits/seeds, high density of fruits/seeds	← Higher resistance to physical disturbance
	← More attractive fruits/seeds	← Greater use of other resources
Increased inhibition of competition	← More leaf shading	← Greater tolerance in use of resources by others
Increased inhibition of competition through pollination	← More effective pollen allelopathy	← Greater longevity (via clones)
Release of toxic substances in the soil		
Increased tolerance to water use by neighbouring plants		
Greater tolerance to use of nutrients by neighbouring plants		
Increased tolerance to light use by neighbouring plants		
Greater resistance to allelopathic substances		
Maximising fertility by use of resources not used by neighbours		

Observations under natural conditions, as well as from experiments in the field and under controlled conditions, have provided insight into the numerous mechanisms and features by which plants are able to compete effectively. Those listed here show the hierarchy of primary attributes, secondary attributes dependent on them, and the tertiary attributes that depend on the secondary ones.

Attempts to quantify competitive strength are not lacking. Groves and Williams (1975) showed that when *Trifolium subterraneum* and *Chondrilla juncea* were sown together, root competition reduced yield by 65%, but shoot competition by only 47%, compared with the pure crop. Measuring characteristics of competition under controlled conditions is very difficult. Grime (1973) tried, therefore, to determine the strength of competition by developing competition indices, in which height of plants, growth form and duration of life span of participating species were recorded (see Chap. 4.1.5.3).

The relative rate of growth is also seen as an approximation of competitiveness. The dry matter production of individual species in relation to that of all other species involved was used to assess their competitiveness. Bornkamm (1961) regarded the relative growth rate and the competitive pressure, which is given by the ratio of the dominant species to the total number of species, as suitable measures to describe success in competition. Further measurable indicators are the number of viable seeds or, depending on the question to be asked, phytomass production of particular parts, e.g. shoot-to-root dry matter ratio.

The “Hohenheimer groundwater experiment” in Stuttgart Hohenheim is a classical experiment for determination of interspecific competition, as it incorporates competitive exclusion, niching to avoid competition and the resulting divergent development in the direction of so-called site equivalence, namely relative site constancy. It shows that plants in nature do not necessarily grow where their demands are completely satisfied (**physiological area**) but that they compete with other species and usually exist in a smaller area (**ecological area**). Here, the relations to the so-called fundamental (corresponding to the physiological) and the actual niche are shown clearly (Howe and Westley 1993).

The experiment was conducted in a basin with a sloping surface so that with the same water supply different groundwater levels occurred. The area was subdivided into four plots, three with pure cultures of grasses – one with a dry-land grass species (*Bromus erectus*), another with a species from moist meadows (*Alopecurus pratensis*), and the third with oat grass (*Arrhenatherum elatius*) with intermediate characteris-

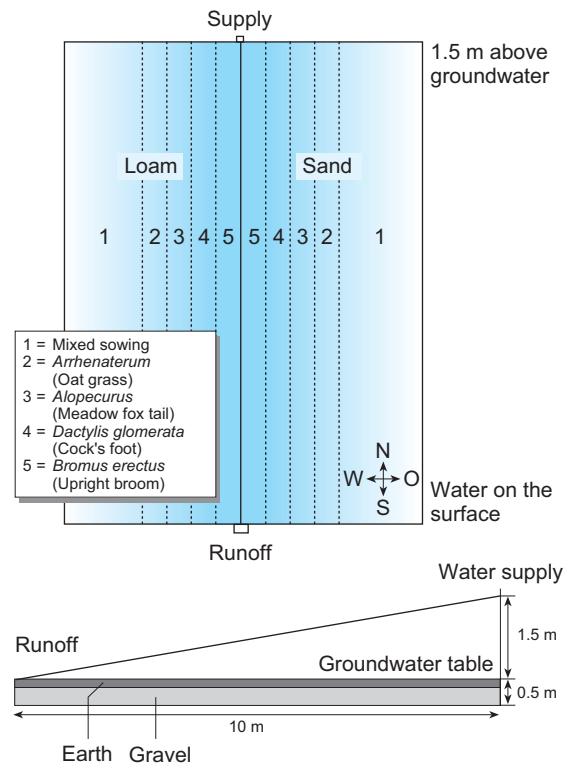


Fig. 4.3.20. Scheme of the “Hohenheimer groundwater experiment” in plan and section. (After Ellenberg 1953)

tics; another plot was sown with a mixture of all three grasses (Fig. 4.3.20). A fourth grass species, *Dactylis glomerata* was not included in the evaluation. The most important result was that all three grass species grew best at average to high moisture, but the ranges for optimum growth in the mixed sowing were significantly shifted. *Arrhenatherum* achieved greatest rates of production under average conditions, with relatively narrow physiological requirements. *Alopecurus* was most widely distributed in moist conditions, with *Bromus* in the dry zones. The latter two attained their ecological optimum under physiologically suboptimal conditions (Fig. 4.3.21).

Ellenberg (1953) concludes from this that a species which is particularly weak in competition and needs to evade it to survive has ecological and physiological optima which deviate considerably. He distinguishes between a **physiological potential** with an optimum, and a potential amplitude determined by the genetically determined range of responses to exogenous influences, as well as an **ecological potential** [which corresponds to the ecological optimum and according to Walter (1960) is the actual range in

Stuttgart Hohenheim is an agricultural university in Germany.

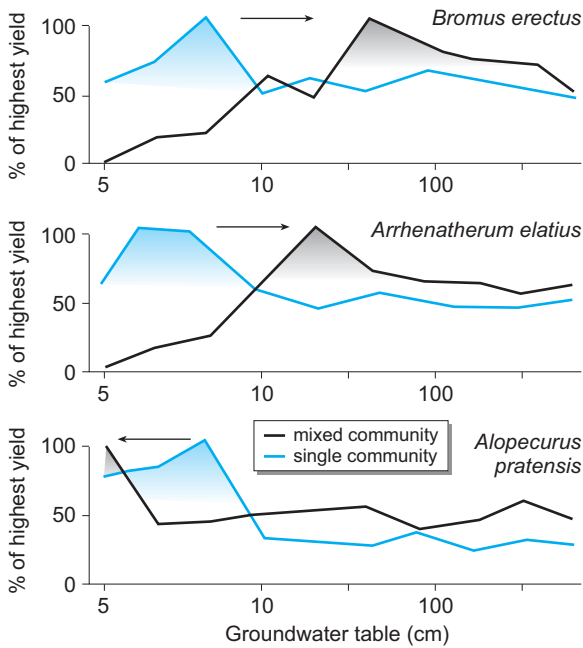


Fig. 4.3.21. Yields of the three meadow grasses *Arrhenatherum elatius*, *Alopecurus pratensis* and *Bromus erectus* in pure and mixed stands with differing soil moisture. (After Ellenberg 1953)

which the plant exists in nature], again with an optimal range.

Dierschke (1994) followed that there are several types of **ecological potential** and **ecological occurrence** (in the sense of the physiological and ecological optimum) based on the results by Ellenberg from these experiments; these are shown in Fig. 4.3.22. In the first two cases (top), the optimum lies in the average range but with broad and narrow amplitude, respectively. However, in the next two cases, the optimum is in suboptimal, marginal ranges. The strength of competition of one species, shown in the outline in the bottom row, at the same ecological potential becomes clear by the position of the existence optima. Cases 5 and 6 indicate similar competitive strength from the position of the

optima, but the other cases express weak competition, as the fields for potential and existence deviate strongly.

The Hohenheimer groundwater experiment, and the results shown here, were criticised as the effects of only one environmental factor – water supply – was considered in isolation. Compared with natural conditions the experiment was very simple and thus does not allow far-reaching conclusions about the physiological behaviour of plants. However, the opposite view is that the effects of environmental conditions may only be analysed by considering single factors. In any case, the experiment shows that conclusions about the physiological demands of plants should not be drawn from their occurrence in natural communities. The important difference between ecological and physiological potential and amplitude seen by Ellenberg is the basis of the ecogrammes discussed in the following.

Indicator Plants, Indicator Values and Ecogrammes

Results of experimental competition experiments and empirical results from plant ecology and land use led to the development of simple methods with practical applications.

Plants have long been used as **indicators** for site conditions in agriculture and forestry. Species tolerating alkaline or acid soils, standing water or drought are examples of this (see Chaps. 2.3.8 and 3.4). Such indicator plants were first identified by Ellenberg in 1965 (see Ellenberg 1974, 1992) for central Europe and later developed for other areas (Landolt 1977).

Plants are now assigned to indicator values which reflect important climatic and edaphic variables. In listing **indicator values** on relative scales (one-dimensional ordination), experience from many years is used for. They are not supported by measurements and are not experimen-

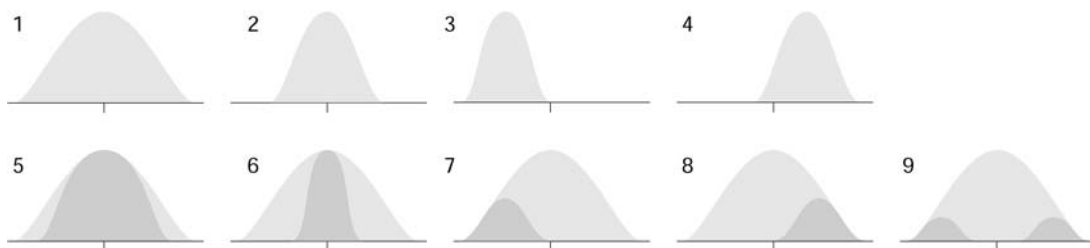


Fig. 4.3.22. Scheme of the theoretical position of ecological potential (1–4) and occurrence (5–9) of plant species related to an ecological gradient (average value shown). (After Dierschke 1994)

tally verified. Wetness indicators do not necessarily indicate that plants require moist conditions, but their tolerance. This reservation applies to other indicator characteristics as well. However, most importantly, indicator values for plants relate to their ecological behaviour, i.e. under conditions in the open field and in competition. They do not give the physiological requirements of plants, nor do they allow conclusions to be drawn about the amount of the resource, although they provide an indication. Ste-noecic plants (those with very narrow qualitative and quantitative requirements for resources) are best suited as indicator plants because they show the qualitative and quantitative limitations of a range of appropriate resources. Ellenberg et al. (1992) distinguished the following indicator values:

- L=light (radiation) from 1 (deep shade) to 9 (full sun) for plants in full leaf during the vegetative period.
- T=temperature, from 1 (cold indicator) to 9 (extreme heat indicator) at all altitudes from the nival belt to lowlands.
- K=continentality, from 1 (in oceanic regions) to 9 (the most continental sites in eastern central Europe) on an continentality gradient.
- F=moisture, from 1 (indicator for very dry sites) to 11 (water plant) and 12 (submerged plant) in a range of sites from dry rocks to free water.
- R=response, from 1 (strongly acid) to 9 (alkaline and limestone) following the soil pH.
- N=nitrogen, from 1 (nitrogen-poorest site) to 9 (nitrogen-richest sites) following the gradient of nitrogen available to plants.
- S=salinity, from 0 (not salt-tolerant) via 1 (salt-tolerant on salt-poor substrates) to 9 (hypersaline, on extremely saline substrates).

Using B or b for some species indicates the relative resistance to heavy metals. Over time, further characteristics were introduced, e.g. by Landolt (1977), for the humus content and aeration of soils. Other characteristics might be added with particular practical applications, such as fodder value and tolerance to mowing in grasslands.

Such indicator values and indicator plants have been criticised, particularly as many important features of the site were not considered (additional nutrients, tolerance to trampling, frost resistance, etc.). Also, the ecological amplitude of species was not described, nor were

complex interactions shown reliably. Yet indicator values are an attempt to quantify ecological behaviour. It is often forgotten that these values are cardinal numbers, so that values should not be averaged and that all mathematical calculations need to be interpreted very carefully. These indicator values do not indicate the demands of species, only their ecological behaviour within the range of a specific plant community.

Indicator plants and indicator values should not be used as ways of providing measured values. They only indicate type and magnitude of important environmental variables and have proved to be simple and easy to use values for comparison of sites and their conditions in space and time, and even dynamic changes. It is helpful to recognise, as early as possible, practical problems in many areas such as **land use and soil protection**, passive **bioindication**, **nature protection**, **environmental monitoring** and **early recognition of environmental damage**. Potential of sites may be shown, approximately, by indicator values of plants growing there.

Ecogrammes are also indications based on empirical results, and attempt to show the “spatial” neighbourhood of species in relation to selected site variables. Usually two variables are selected and expressed two-dimensionally. In the space between these variables the competitive interactions between these species (or communities) become clear in relation to the selected variables. A distinction is made between the physiologically determined possibilities (ecological potential) and the actual success in competition (ecological existence).

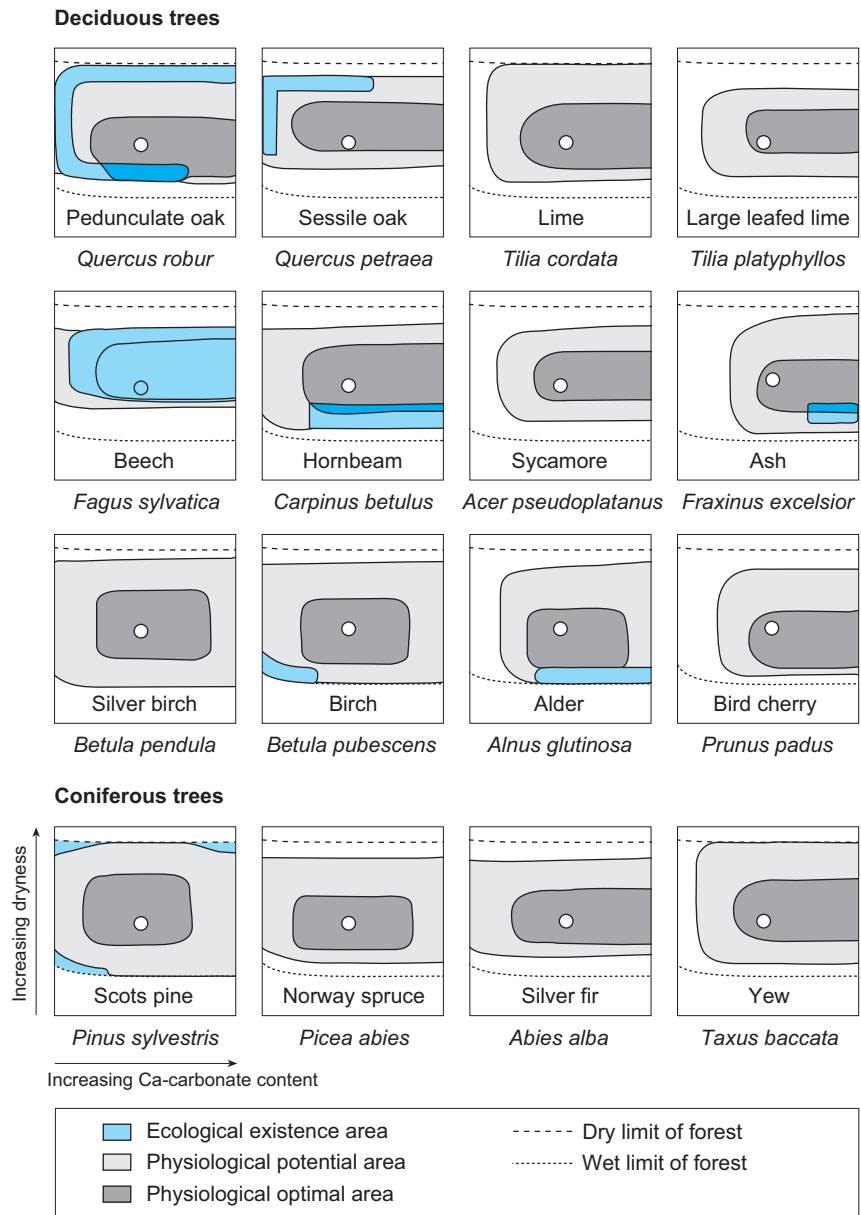
In the ecogrammes developed by Ellenberg (taken from Glavac 1996), soil moisture supply and acidity are used as variables in the submontane regions of central Europe. Temperature was regarded as less important in determining vegetation at this altitude. The ecogrammes for individual species (Ellenberg et al. 1992) show that some species actually occupy the physiologically optimal site (ecological potential; e.g. beech), so that ecological potential and ecological occurrence are almost the same. Other species are pushed out, into physiologically extreme regions. This applies, for example, to pine which requires light for germination and so is out-competed by shade trees ([Box 4.3.6](#)).

The pattern of distribution of central European forest trees must be understood as a consequence of the ecophysiological constitution of the trees as well as of the competitive behaviour

Box 4.3.6

Single ecogrammes for selected central European tree species. (After Ellenberg et al. 1992)

Ellenberg developed ecogrammes for the most important central European tree species, comparing similar site requirements (very similar potential ecological ranges). Individual species have different success rates, in part due to being pushed to the extremes of their distribution (their existence area) by more successful competitors. Note that these ecogrammes consider only soil moisture and soil pH (as a measure of nutrient availability). Also, only submontane regions of central Europe have been considered; in these areas there are locations that are too dry or wet for trees to grow and these have been taken into account.



towards sympatric species occurring in the same space, and of management by man. Competitive conditions between central European, forest tree species (submontane belt) are shown in Fig. 4.3.23. Ultimately, ecogrammes may also be constructed from field data, as shown by Böcker et

al. (1983) for southern German forest communities using data from Oberdorfer (1957). Numerical values for moisture and reaction numbers (Ellenberg et al. 1992) were used (Fig. 4.3.24). This constructed ecogramme confirms the one of Ellenberg (Fig. 4.3.23).

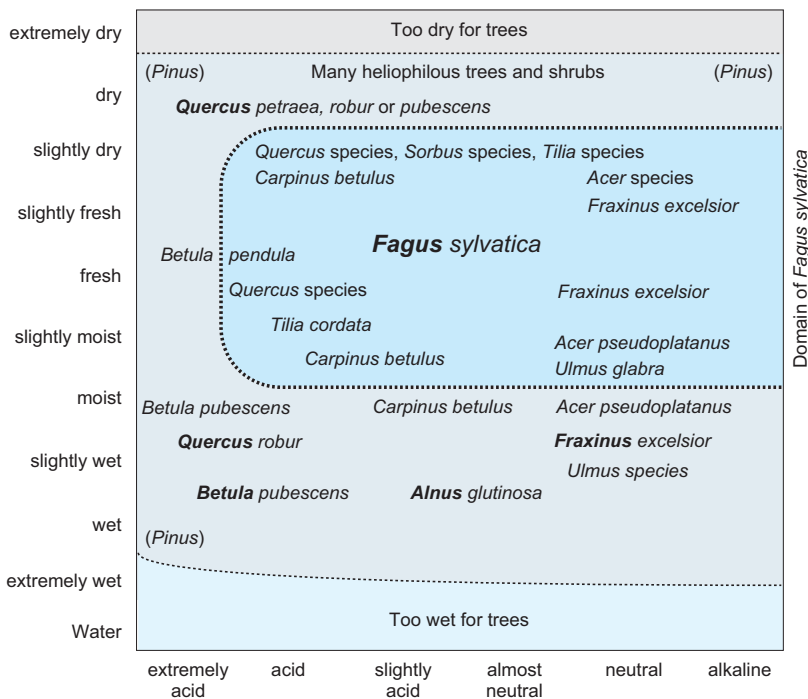


Fig. 4.3.23. Ecogramme of the most important submontane forest trees in central Europe. (After Ellenberg 1978, from Glavac 1996)

Models of Intra- and Interspecific Competition

Models were developed to explain and understand mechanisms of competition in addition to specific observations, empirical results and identification of single characteristics conferring and improving competitiveness. Two models, those of Grime (1979) and Tilman (1977, 1982), will be mentioned again; they were previously applied to vegetation dynamics (see [Chap. 4.1.5.3](#)).

It becomes clear in Grime's **three-strategy model** that **competitors** succeed at low interference rates and low stress. They are competitively strong, because they use the available resources particularly well. They are persistent, but not able to compete under stress, either excess or deficiency (e.g. of light and water). Many sites with different high stresses exist, and only **stress-tolerant** species are able to compete. **Ruderals** are best adapted as they are able to quickly occupy sites without competition.

According to Grime (1979) and Grime et al. (1988), competition occurs when plants species or individuals in close proximity use the same limited amounts of light, water, ions, etc. Grime assumes that productivity of a plant community increases in favourable conditions and the site is occupied by many productive plants; therefore, competition is intense. Between species growing slowly and with little demands, competition is weak. The intensity of competition grows with

increasing productivity. This applies particularly to sites with predominantly above-ground competition. On unproductive sites, below-ground competition increases (root competition).

Tilman considers that for each site there is one essential resource in limited supply so species compete. If it is nutrients, plants may form a larger root mass, and thus compete more in the soil. If it is light, more is invested in shoot and leaf growth. Species competing in such a way may also occur in successions ([Fig. 4.3.25](#)). Tilman developed from this evidence, which is experimentally supported, the **resource ratio model** with five types of competition-dependent occupation (see [Chap. 4.1.5.3](#)).

Grime considers the effect of total competition and assumes that it is stronger on productive sites; however, Tilman regards competition more specifically. He stressed bottlenecks for plant production and improvements for allocation used by plant species and individual plants to respond to them. Species able to lower their demands furthest will ultimately win the competition.

The contrasts outlined here are, in reality, not as large as is often expressed. It depends very much on what is considered: the total effect of competition or particular processes and mechanisms, or the complete stand of species or individual plant species. In 1994, Tilman developed

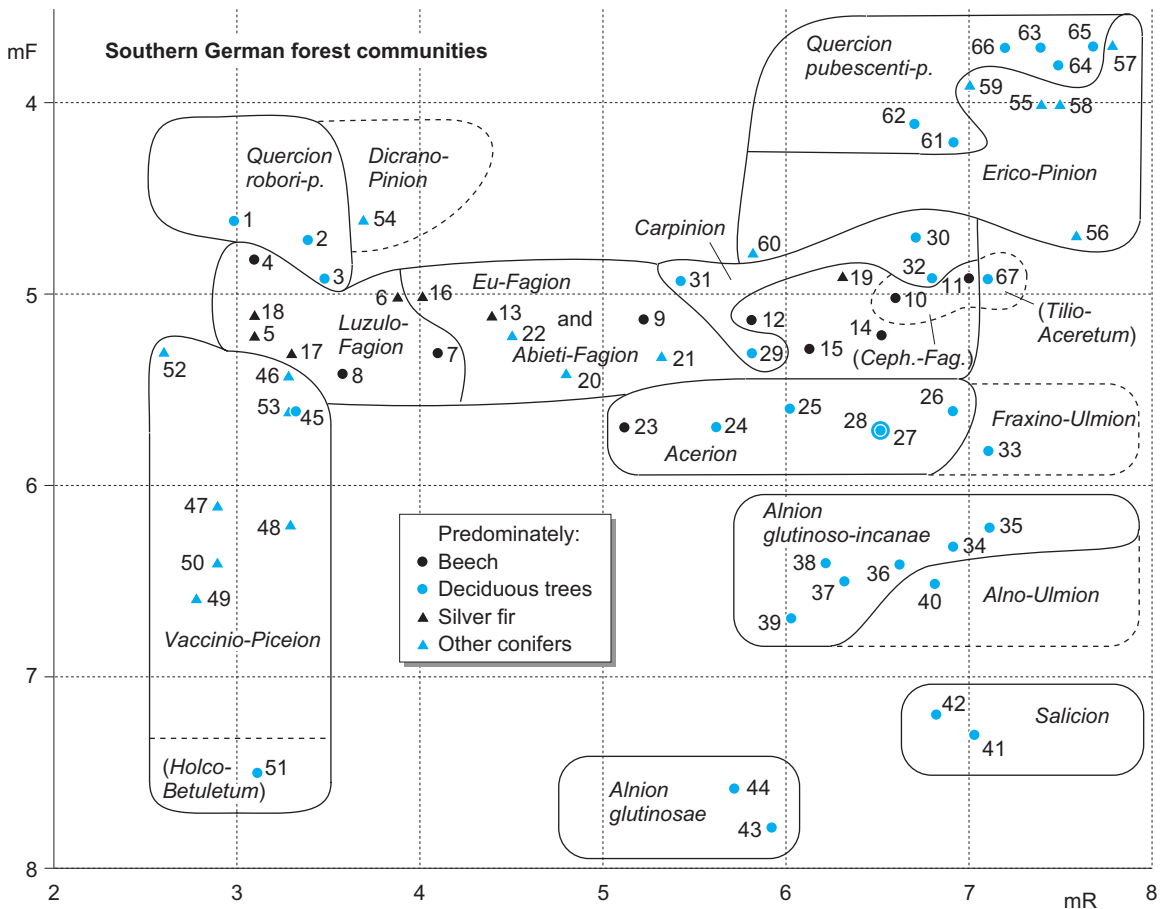


Fig. 4.3.24. Ecogramme based on the moisture and reaction indicator values (mF, mR) for forest communities in southern Germany described by Oberdorfer 1957. (After Böcker et al. 1983, from Glavac 1996)

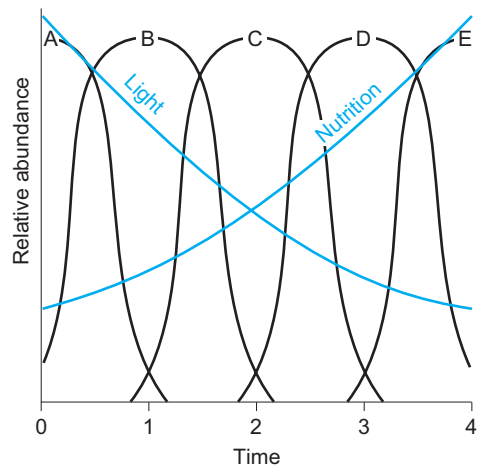


Fig. 4.3.25. Diagram of the relative abundance of light or nutritional limitation of species (A-E) in succession. (After Tilman 1994)

a mathematical model to describe the effects of neighbours on plants and patterns of distribution in competitive situations, showing that coexistence of many species and individuals is not only possible, but actually the rule (see the following paragraphs concerning coexistence).

Concept of Ecological Niches

The term “ecological niche” brings together the concepts of competition and coexistence. The **concept of niches** was developed in connection with questions of **coexistence** of organisms, and modified several times over the years. Niches refer to a synecological phenomenon, namely the coexistence of individuals and species in communities. They are regarded as important as they provide links between various areas of ecology.

A niche was first understood to be the habitat, but even then the question was asked whether all habitats in the observed communities are occupied, and whether several species

are able to occupy the same habitat. Relations between ecological potential of species and the resource potential of their habitat were considered. Spatial dimensions are just as important as nutrition.

In Elton's (1927) niche concept the coexistence of species in a niche is possible as soon as these species differ significantly in their demands, but are otherwise linked, e.g. via a nutrition chain. Niches are a micro-habitat linked to functional aspects; there are similar niches in every ecosystem which may be occupied by different species with the same function. Elton speaks of the "profession" of individual species, now called **site equivalence**. Finally, he not only considers the environmental demands of organisms in a niche, but the influence they have on their environment, particularly regarding the use of resources.

Hutchinson (1978) introduced another niche concept, separate from the ambiguous connections with spatial dimensions, defining a niche as the sum of all environmental factors influencing an organism. In an n-dimensional coordinate system where each axis represents an environmental factor, a virtual habitat may be defined in which an organism is able to exist and function in relation to its requirements (Cody 1991). This **ecological niche** offers the required abiotic and biotic factors. A niche is thus a system in which the organism occupies a permanent position ('job', role, status, address) and should not be confused with an actual space (e.g. ecotope) nor with the conditions in a site. The term niche shows that each organism has its place in an ecosystem and plays a certain role there with particular functions. In such a system new species may only settle when the niche is empty.

Competition arises in such an ecological niche when several organisms occur in the same niche at the same time, making demands on the same resources. It is thus important to differentiate between **fundamental** and **attained niches**. The former characterises a niche where an organism has unrestricted access to all available resources which are used to achieve particular functions. The attained niche is the area actually occupied by the organism, with sharing of resources and achieving certain functions in supplementing ways. This is shown in Fig. 4.3.26 where the niche of a plant is outlined three-dimensionally, corresponding to three selected resources. Each point in the space, resulting from

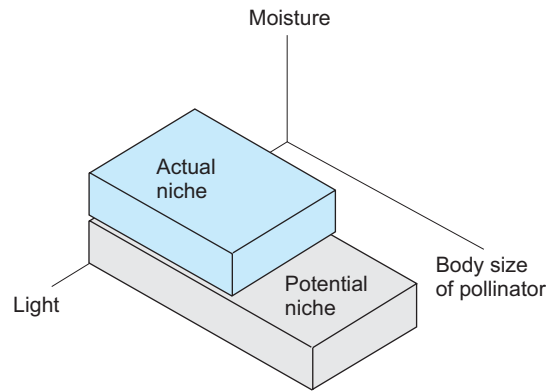


Fig. 4.3.26. Schematic representation of the niche of a plant species in relation to the resources of moisture, light and size of the pollinator. (After Howe and Westley 1993)

the variables light, moisture and size of pollinating bees, is shown in the virtual space and represents the conditions under which the plant is able to survive and propagate. In reality this space is reduced as bees also pollinate other plants so this resource has to be shared.

In interspecific competition several species have the potential to use the same niche, but are restricted to an attainable niche; consequently, with several competing species, the attainable niche becomes smaller for each. In contrast, intraspecific competition, and the resulting strengthening of the affected species, causes consolidation of the dominant species or expansion of the attainable niche. It is, however, also assumed that niches may overlap. According to Schoener (1985), this overlap is only slight if the competing species have 'arranged' themselves previously. If, however, there is a strong competition in small habitats (e.g. for nutrients), then niche overlap is possible. In large areas of resource-rich habitats, overlap will be small even if competition is strong. The actual niche is the product of intraspecific and interspecific competition. The niche structure of a plant community is the result of a long evolutionary adaptation in the sense of **synevolution** (Dierschke 1994). Competition may have been important in the past, even without **differentiation of niches**, which decreases interspecific competition but increases intraspecific competition.

To make the multidimensional, theoretical term 'niche' more practical, Grubb (1977) modified the concept distinguishing habitat niches, life form niches, regeneration niches and phenological niches. **Habitat niches** are characterised physically and chemically, **life form niches** have

close relations to production, the **regeneration niche** comprises all conditions for propagation, and the **phenological niche** is determined by temporal development. **Temporal niches** occur for species flowering at different times but at the same site and having the same pollinator; this also applies to spring geophytes in nemoral forests regarding the use of light.

Terms such as **spatial niche** (e.g. stones in a forest occupied by lichens and mosses) or **structural niches** (e.g. the habitat in dead wood) are also used, and there are nutritional niches and breeding site niches, together with niches for species and individual plants. This inflation of terms contributed to criticism of the niche concept. However, it should be remembered that, even though the concept of the ecological niche was questioned, it enriched discussions on basic questions of competition and coexistence, in connection with invaders (neophytes) and the question of 'open positions'. In this context, the principle of competitive exclusion (Gause 1934) is very important; this states that two species with identical demands cannot coexist in the same living space. The counter argument is, however, provided by **niche overlap** of species. Similar to the question of niches, the key phrase 'competitive exclusion' also leads to basic concepts of coexistence.

Competitive Exclusion or Coexistence?

The consequence of the **principle of competitive exclusion** enunciated by Gause (1934) is that species with identical ecological demands are not able to exist side by side. Thus, sympatric species are ecologically distinguished and do not compete.

Lotka (1932) and Volterra (1926) developed models supporting this principle mathematically. They assumed that each further individual arriving in an existing population (or community) worsens the existence and growth conditions as a whole. In this model of competition, growth rates of two species are related to each other in an equation. Gause established his ideas with *Paramecium*, but they are also applicable to plants arriving in an existing plant community (Law and Watkinson 1989).

Aarssen (1983), in particular, considered this principle of competitive exclusion postulating that one condition required for competition exclusion was a long period with constant conditions. However, these do not exist, because of continuous environmental changes. Endogenous

developments and exogenous interference lead continuously to the formation of new niches, enabling competing species to coexist and avoiding competitive exclusion. Permanent niche differentiation is an important process. Positive interactions which exceed the negative influences of competition lead to a (dynamic) contact between individuals and species, and to **coexistence**.

Aarssen (1983, 1989) developed three hypotheses which would lead to avoidance of competition and thus guarantee coexistence. In the first, the balance between supply and demand is decisive for the occurrence of species. Exclusion is only possible when supply is smaller than demand. The second relates to the limited demands of several species for the same resource: If the demands of species are focused on a particular resource, exclusion is the consequence, but not if the resources are different. The third hypothesis relates to the strength of competition: If this is the same or similar, coexistence is possible. These three hypotheses are the building blocks of Aarssen's **general evolution theory** of coexistence. His idea of **ecological combining ability** (niche differentiation) and **competitive combining ability** (competitive strength) aims at the evolutionary aspects of conditions at the site and the general conditions important for the coexistence of organisms. The classical theory of competitive exclusion is contrasted against a modern theory in which spatial and temporal scales of coexistence are incorporated with the same characteristics of competition. Differences in demographic processes have been little noted, nor the distribution of niches under aspects of patch dynamics, or succession and regeneration.

Hulme (1996) listed other theoretical approaches to explain coexistence (Table 4.3.5). They may be grouped into those where competition is regulated by resources, and those where competition is linked to the concept of ecological niches and niche differentiation ("peaceful niche sharing"). These results from the 1970s and 1980s are still discussed and show that there is still no unanimous theory or final clarification of the interconnections between competition and coexistence.

Growth of plants in close proximity cannot occur without mutual interference. Competition alone is not the decisive factor, as many species obviously do not compete with each other, but coexist. Competition and coexistence should not be regarded as opposites. Coexistence may be

Table 4.3.5. Summary of mechanisms often advanced for the coexistence of plants in natural communities. (After Hulme 1996)

Shorthand term for theory	General description	Most important assumptions	Author
(a) Competition for resources			
Resource sharing	Species differ in their ability to use resources	Trade-offs in ability to compete for two or more restricted resources	Tilman (1982)
Spatial heterogeneity	In one of many microhabitats one species is able to exclude all other species	There are as many species as there are habitats	Pacala and Roughgarden (1982)
Neighbour effect	Intraspecific and spatial aggregation increases intraspecific competition and aids coexistence	Clumped distribution of plant species involved	Pacala (1986)
Heterogeneity with time	Important species compete at different times	Communities consist of pioneers and long-lived species	Warner and Chesson (1986)
(b) Competition in niche differentiation			
Regeneration niches	No competition, as species differ in requirements for regeneration	Many different micro-habitats	Grubb (1977)
Disturbance	Species diversity is maximal at intermediate disturbance	Habitat productivity and disturbance are inversely proportional	Grime (1973)
Lottery model	Seeds colonise available microhabitats randomly and are strong enough to ensure further colonisation	Long-living, fertile species; colonisation is a function of seed production	Sale (1977)

reached by avoiding competition and thus by tolerating stress.

Experiments and Observations Showing Coexistence

Gigon (1994) and Gigon and Ryser (1996) listed experimental evidence of positive interactions between plants, and also provided important examples of proven and assumed positive influences. Facultative or obligate relationships between two partners are termed positive if one benefits and the other is not inhibited. It should be noted that these are relations between individuals, populations or species. Only the present, and sometimes subsequent, generations are considered if favourable conditions are indirectly created. The space is defined as a community and its site (ecosystem), as well as by directly neighbouring systems.

For a dry grassland in Switzerland, the question was asked how up to 40 different plant species manage to live together on 1 m² without negative effects, i.e. competition, reducing the number of species (Fig. 4.3.27). This is explained by the numerous positive interactions which prove that these plant species are mutually dependent. In a simplified scheme of the system, the interactions are outlined for only seven plant species, for the field mouse (*Microtus arvalis*), and the clover canker fungus (*Sclerotinia trifolii*)

as well as *Rhizobium*, mycorrhizae, pollinators and dispersers. This system is a close web of predominantly positive (direct or indirect) interactions between the participating partners.

A direct positive effect is provided, for example, by **nurse plants**, adult individuals which protect seedlings of their own species, or of a different species, by providing shade or because of protective thorns (Fig. 4.3.28). A positive influence is provided indirectly when a competing species is eliminated by pathogens or herbivores. Such indirect advantage occurs with *Trifolium pratense* in mixed cultures with *Dactylis glomerata*, where the grass provides a barrier for spread of the clover canker fungus, for example. Furthermore, *Dactylis* has the advantage of a better nitrogen supply. In principle a short-term negative 'nutritional relationship' may be positive in the long term for pasture plants.

Direct positive influences between two plant species (from grassland communities in central Europe) without participation of other organisms are:

- physical support from neighbouring plants (e.g. for epiphytes, vines or as protection from wind damage);
- stabilisation of mobile substrates (e.g. plants which stabilise rock and scree slopes);

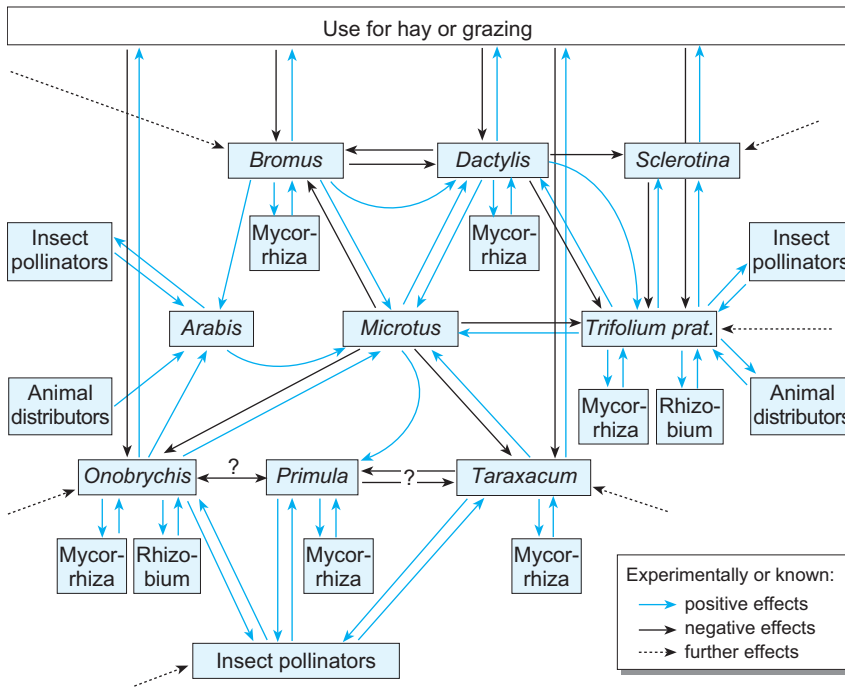


Fig. 4.3.27. Scheme of interactions between seven species of plants, a field mouse (*Microtus arvalis*), the fungus *Sclerotinia trifolium*, mycorrhizae, pollinators and dispersers in a semi-dry grassland. (After Gigon 1994)

- protection from extreme temperatures (e.g. frost protection for herbaceous species in dense clusters of lignified dwarf shrubs);
- advantage because of the reduction of salt content in soil solutions (e.g. salt-exporting halophytes);

- chemical advantage because of neighbouring plants (e.g. the previous example of *Trifolium* and *Dactylis*).

Indirect positive influences between two species with the participation of microorganisms or animals (multiple relations):

- advantage through Leguminosae (via nitrogen-fixing nodule bacteria);
- reduction of fungal infections (grasses are able to protect each other against infection with *Fusarium* spp.);
- reduction of insect damage (in mixed crops monophagous insects are more easily controlled by parasites);
- reduction of grazing (by toxic species protecting their non-toxic neighbours);
- promotion of pollination (by neighbouring species with attractive flowers).

It is deduced from these results that competition plays an important role for vegetation dynamics and thus for the development of ecosystems. However, in established, ecologically stable stages, coexistence of species and thus positive interactions are the determining characteristics.

Epiphytes are a very impressive example of coexistence in “old” communities. Epiphytes and lianas are examples of two types of plants able to exploit special resources. They are most diverse and frequent in canopies of mountainous forests



Fig. 4.3.28. A relatively robust cushion plant (*Plantago rigida*) in the paramo community in Ecuador protects a much more sensitive species (*Castilleja pumila*) with red flowers. The former species may be termed a “nurse plant”, the latter as a “cushion guest”. (Photo K. Müller-Hohenstein)

under very high rainfall. Exploitation of their niche may be interpreted as avoidance of competition, or as a special form of commensalism, but also as coexistence. They need to be physiologically and morphologically particularly adapted.

Lianas form special supporting tissues and vascular bundles situated next to each other in the cambium. Wide pores and efficient root pressure provide sufficient water and nutrients along the very long transport paths. Epiphytes secure their water and nutrient supplies by particular morphological structures (leaf rosettes and funnels) and special organs allow some orchids and bromeliads to take up water directly from fog and rain. Epiphyllic plants (a special case of epiphytes) have particular symbiotic relations, e.g. with Cyanophyceae.

Competition and Coexistence, Diversity and Dynamics

Both theoretical considerations and experimental results have shown that synecological relationships may be both positive and negative from the point of view of the participating partners. It must be possible to share a niche or the latter needs to be further differentiated. There must be spatial and temporal refuges safeguarding survival for competitively weak species. Important mechanisms in plant communities are only then understandable if both, competition and coexistence are recognised as basic principles.

Many interactions are still not well understood. Better explanations of many functions of characteristics and processes are required. Experiments in the laboratory and open field, as well as the use of mathematical models, have brought enormous advances in recent years. Better consideration of spatial and temporal scales has been identified as important as has working in the field. Descriptive work is often (unjustifiably) regarded as a pre-scientific stage and not regarded as valuable. It is forgotten that precise observation may be the basis for formulating good hypotheses to advance understanding.

Mathematical-statistical treatment of synecological questions has not always brought the required gain in knowledge. Even in developing models the complexity of ecosystem interactions is not fully understood, as each simplification means an increasing distance from reality. However, simulation and modelling should not be neglected as they also show gaps in knowledge and provide the basis for new questions. In vegetation ecology, the statement by Tischler in the

first edition of his *Introduction to Ecology* (1976) is confirmed: “Nature at the highest level of development of life does not allow itself to be forced into a few rules”.

References

- Aarssen LW (1983) Ecological combining ability and competitive combining ability in plants: towards a general evolutionary theory of coexistence in systems of competition. *Am Nat* 122:707–731
- Aarssen LW (1989) Competitive ability and species coexistence: a “plants eye” view. *Oikos* 56:386–401
- Allen MF (1991) *The ecology of mycorrhizae*. University Press, Cambridge
- Belnap J, Lange OL (eds) (2001) *Biological soil crusts. Structure, function and management. Ecological studies*, vol 150. Springer, Berlin Heidelberg New York
- Belsky AJ (1986) Does herbivory benefit plants? A review of the evidence. *Am Nat* 127:870–892
- Bertin RI (1989) Pollination biology. In: Abrahamson WG (ed) *Plant-animal interactions*. McGraw-Hill, New York
- Bezzel E, Lechner F, Ranftl H (1980) *Arbeitsatlas der Bruttvögel Bayerns*. Kilda, Greven
- Blab J (1979) *Schutzwürdige Natur und Landschaft im Bonner Raum. Rheinische Landschaften 16. Ges für Buchdruck*, Neuss
- Böcker R, Kowarik I, Bornkamm R (1983) Untersuchungen zur Anwendung der Zeigerwerte nach Ellenberg. *Verh Ges Ökol* 11:35–56
- Bornkamm R (1961) Zur quantitativen Bestimmung von Konkurrenzskraft und Wettbewerbsspannung. *Ber Dtsch Bot Ges* 74:75–83
- Boucher DH (1985) *The biology of mutualism*. Croom Helm, London
- Bronstein JL (1994) Our current understanding of mutualism. *Q Rev Biol* 69:31–51
- Brunold C, Rügsegger A, Brändle R (Hrsg) (1996) *Stress bei Pflanzen: Ökologie, Physiologie, Biochemie, Molekularbiologie*. Haupt, Bern
- Cody ML (1991) Niche theory and plant growth form. *Vegetatio* 97:39–55
- Connell JH, Slatyer RO (1977) Mechanisms of succession in natural communities and their role in community stability and organisation. *Am Nat* 111:1119–1144
- Danin A (1986) Patterns of biogenic weathering as indicators of palaeoclimates in Israel. *Proc R Soc Edinb Sect B (Biol)* 89b:243–253
- Darwin CR (1859) *The origin of species by means of natural selection, or the preservation of favoured races in the struggle for life*. Murray, London
- Dierschke H (1994) *Pflanzensoziologie. Grundlagen und Methoden*. Ulmer, Stuttgart
- Dirzo R (1984) Herbivory: a phytocentric overview. In: Dirzo R (ed) *Perspectives on plant population ecology*. Sinauer Assoc, Sunderland, pp 141–165
- Ellenberg H (1953) Physiologisches und ökologisches Verhalten derselben Arten. *Ber Dtsch Bot Ges* 65:350–361
- Ellenberg H (1996) *Die Vegetation Mitteleuropas mit den Alpen*. Ulmer, Stuttgart
- Ellenberg H, Weber HE, Düll R, Wirth V, Werner W, Paulsen D (1992) *Zeigerwerte von Pflanzen in Mitteleuropa*, 2. Aufl. *Ser Geobot* 18:1–258

- Elton C (1927) Animal ecology. Sidgwick and Jackson, London
- Franz H (1952/53) Dauer und Wandel der Lebensgemeinschaften. *Schr Ver Naturwiss Kenntnisse* 93:27–45
- Gause GF (1934) The struggle for existence. Williams and Wilkins, Baltimore (reprinted 1964 by Hafner, New York)
- Gigon A (1994) Positive Interaktionen bei Pflanzen in Tressen-Halbtrockenpflanzen. *Verh Ges Ökol* 23:1–7
- Gigon A, Ryser P (1986) Positive Interaktionen zwischen Pflanzenarten Teil I. *Veröff Geobot Inst ETH Stiftung, Rübel* 87:372–387
- Glavac V (1996) Vegetationsökologie. Grundfragen, Aufgaben, Methoden. Fischer, Jena
- Grime JP (1973) Competitive exclusion in herbaceous vegetation. *Nature* 242:344–347
- Grime JP (1979) Plant strategies and vegetation processes. Wiley, Chichester
- Grime JP, Hodgson JG, Hunt R (1988) Comparative plant ecology. Allen and Unwin, London
- Groves RH, Williams JD (1975) Growth of skeleton weed (*Chondrilla juncea* L.) as affected by growth of subterranean clover (*Trifolium, subterraneum* L.) and infection by *Puccinia chondrilla*, Bubak and Syd. *Aust J Agric Res* 26:975–983
- Grubb P (1977) The maintenance of species richness in plant communities: the importance of the regeneration niche. *Biol Rev Camb Philos Soc* 52:107–145
- Hess D (1990) Die Blüte. Ulmer, Stuttgart
- Holtmeier FK (1999) Tiere als ökologische Faktoren in der Landschaft. IFL, Westfälische Wilhelms-Universität, Münster
- Howe HF, Smallwood J (1982) Ecology of seed dispersal. *Ann Rev Ecol Sys* 13:201–228
- Howe HF, Westley LC (1993) Anpassung und Ausbeutung: Wechselbeziehungen zwischen Pflanzen und Tieren. Spektrum, Heidelberg
- Hulme PE (1996) Herbivory, plant regeneration and species coexistence. *Ecology* 84:609–613
- Hutchinson GE (1978) An introduction to population ecology. Yale University Press, New Haven
- Kessler A, Baldwin IT (2001) Defensive function of herbivore-induced plant volatile emissions in nature. *Science* 291:2141–2144
- Koch AS, Matzner E (1993) Heterogeneity of soil solution chemistry under Norway Spruce (*Picea abies* L.) as influenced by distance from the stem basis. *Plant Soil* 151:227–237
- Kratochwil A (1987) Zoologische Untersuchungen auf pflanzensoziologischem Raster – Methoden, Probleme und Beispiele bioökologischer Forschung. *Tüxenia* 7:15–51
- Kratochwil A (1999) Biodiversity in ecosystems. Academic Press/Kluwer, New York/Dordrecht
- Kratochwil A, Schwabe A (1999) Interaktion von Pflanzen- und Tierarten in Lebensgemeinschaften: ausgewählte Aspekte bioökologischer Forschung. *Ber Tüxen-Ges* 11:201–221
- Kratochwil A, Schwabe A (2001) Ökologie der Lebensgemeinschaften. Ulmer, Stuttgart
- Krogerus R (1932) Ökologie und Verbreitung der Arthropoden der Treibsandgebiete an den Küsten Finnlands. *Acta Zool Fenn* 12:1–308
- Kühnelt W (1942–1962) Handbuch der Biologie. Akad Verlag Athenaeon, Wiesbaden
- Landolt E (1977) Ökologische Zeigerwerte zur Schweizer Flora. *Veröff Geobot Inst ETH Stiftung Rübel* 64, Zürich
- Law R, Watkinson AR (1989) Competition. In: Cherrert JM (ed) Ecological concepts. Blackwell, Oxford, pp 243–284
- Long G (1954) Contribution a l'étude de la végétation de la Tunisie centrale. *Ann Serv Bot et Agric Tunisie* 27:1–38
- Lotka AJ (1932) The growth of mixed populations: two species competing for a common food supply. *J Wash Acad Sci* 22:461–469
- Lovelock J (1992) Gaia – Die Erde ist ein Lebewesen. Scherz, Munich
- Möbius K (1877) Die Auster und die Austernwirtschaft. Wiegand, Hempel und Parey, Berlin
- Mühlenberg M (1989) Freilandökologie, 2. Aufl. Quelle und Meyer, Heidelberg
- Müller-Hohenstein K (1978) Die ostmarokkanischen Hochplateaus. *Erlanger geographische Arbeiten* 7, Erlangen
- Müller-Hohenstein K (1999) Weideökologisches Management. Erfahrungen in der dritten Welt. *Geogr Rundsch* 51/5:275–279
- Oberdorfer E (1937) Süddeutsche Pflanzengesellschaften. Fischer, Jena
- Passarge H (1981) Gedanken zur Biozönoseforschung. *Tüxenia* 1:243–247
- Rabeler W (1967) Die Pflanzengesellschaften als Grundlage für landbioökologische Forschung. In: Tüxen R (Hrsg) Biosoziologie. Junk, Den Haag
- Reichelt G, Wilmanns O (1973) Vegetationsgeographie. Das geographische Seminar. Westermann, Braunschweig
- Remmert W (1992) Ökologie, 5. Aufl. Springer Berlin Heidelberg New York
- Richards AJ (1991) The pollination of flowers by insects. Academic Press, London
- Rode MW, Dageförde A, Görlitz G (1996) Einfluss der Baumart auf den Nährstoffeintrag und seine Bedeutung für die natürliche Waldentwicklung auf nährstoffarmen Böden Norddeutschlands. *Verh Ges Ökol* 26:139–145
- Schaefer M (1992) Ökologie. Fischer, Jena
- Schoener TW (1985) Some comments on Connells and my reviews of field experiments on inter-specific competition. *Ann Nat* 125:730–740
- Schwabe A (1990) Stand und Perspektiven der Vegetations-Komplex-Forschung. In: Pott R (Hrsg). *Ber Tüxen-Ges* 2:45–60
- Schwabe A (1991) Perspectives of vegetation complex research and bibliographic review of vegetation complexes in vegetation science and landscape ecology. *Exzerpta Bot* 28:223–243
- Smith SE, Read DJ (1997) Mycorrhizal symbiosis, 2nd edn. Academic Press, San Diego
- Stoudtjesdijk PH, Barkman JJ (1992) Microclimate, vegetation and fauna. Opulus Press, Knivsta
- Thienemann A (1920) Biologische Seentypen. *Arch Hydrobiol*
- Thienemann A (1939) Grundzüge einer allgemeinen Ökologie. *Arch Hydrobiol* 35:267–285
- Tilman D (1977) Resource competition between planctonic algae: an experimental and theoretical approach. *Ecology* 58:338–348
- Tilman D (1982) Resource competition and community structure. Princeton University Press, Princeton
- Tilman D (1994) Competition and biodiversity in spatially structured habitats. *Ecology* 75:2–16
- Tischler W (1993) Einführung in die Ökologie, 4. Aufl. Fischer, Stuttgart
- Tokeshi M (1998) Species coexistence and diversity. Ecological and evolutionary perspectives. Blackwell, Oxford
- Tscharntke T (1998) Populationsdynamik in der Agrarlandschaft: Wechselwirkungen zwischen Lebensraum-Inseln. *Schriftenr Landschaftspl Natursch* 56:121–146

- Tüxen R (1965) Wesenszüge der Biozönose. Gesetze des Zusammenlebens von Pflanzen und Tieren. In: Tüxen R (Hrsg) *Biozoologie*. Junk, Den Haag, pp 10–13
- van Breemen N (1991) Decomposition and accumulation of organic matter in terrestrial ecosystems: research priorities and approaches. Commission of the European Communities, Brussels
- Viles HA (1988) *Biogeomorphology*. Blackwell, Oxford
- Volterra V (1926) Variations and fluctuations of the numbers of individuals in animal species living together. Reprinted 1931. In: Chapman (ed) *Animal ecology*. McGraw Hill, New York
- Walter H (1960) *Grundlagen der Pflanzenverbreitung*. I. Teil: Standortslehre, 2. Aufl. Stuttgart
- Walter H, Volk O (1954) *Die Grundlagen der Farmwirtschaft in Südwestafrika*. Ulmer, Stuttgart
- Werner DJ (1977) Vegetationsveränderungen in der argentinischen Puna unter dem Einfluss von Bodenwühlern der Gattung *Ctenomys Blainville*. In: Tüxen R (ed) *Vegetation und Fauna*. Ber Int Symp Ver Vegetationsk, Rinteln, pp 433–449
- Wilmanns O (1987) Zur Verbindung von Pflanzensoziologie und Zoologie in der Biozönologie. *Tüxenia* 7:3–12
- Wilmanns O (1998) *Ökologische Pflanzensoziologie*, 6. Aufl. Quelle und Meyer, Heidelberg Wiesbaden
- Wilson EO (1969) The species equilibrium. In: *Diversity and stability in ecological systems*. Brookhaven Symposia in Biology 22, Brookhaven National Laboratory. Upton, New York, pp 38–47
- Wilson JB, Agnew DQ (1992) Positive-feedback switches in plant communities. In: Begon M, Fitter AH (eds) *Advances in ecological research* 23. Academic Press, London, pp 263–336
- Wittig R (1993) Biozönose. In: Kuttler W (Hrsg) *Handbuch zur Ökologie*. Analytica, Berlin, pp 89–91
- Zwölfer H (1978) Mechanismen und Ergebnisse der Co-Evolution von phytophagen und entomophagen Insekten und Höheren Pflanzen. *Sonderb Naturwiss Verh Hamburg* 2:7–50

Global Aspects of Plant Ecology



Opening page of chapter top left: Vapour trails from aeroplanes in the sky above Bayreuth, Upper Franconia, Germany. The vapour trails have an impact on the radiation balance of the earth and on the atmospheric chemical processes. Bottom left: Agricultural uses in the American mid-west, an area that was originally an open oak “woodland” and grassland. Top right: Thunderstorms caused by convection from forest fires which are used to clear land in Malaysia. Bottom right: Fish farms, used to rear crabs, on the north coast of Java, were originally mangrove swamps; due to the spread of diseases only a small proportion of this area is still useable. Photos E.-D. Schulze

5.1

Global Change and Global Institutions



The study of global change is primarily concerned with the question: In what way has man interfered with the structure and functioning of natural ecosystems? How many people can the earth sustain, i.e. what resources can man use? The figure shows a stream of people leaving Beijing for the surrounding hills on a public holiday. A tight snake of patient, happily conversing people make their way up a narrow path to the top of the "Fragrant Hill" to admire the view. They return to the bottom on a parallel path and the surrounding vegetation remains largely undisturbed. Many people carry a single, autumnal, coloured leaf back to Beijing as a memento of their trip. In the background, barely visible in the photochemical smog, is Beijing with 10 million inhabitants. Photo E.-D. Schulze

Recommended Literature

For a summary of problems of global change, see *World in transition: conservation and sustainable use of the biosphere* (WBGU 2001 a) and *The terrestrial biosphere and global change* (Walker et al. 1999). Current knowledge on climate change is summarised in the third report of the IPCC-WG I (IPCC-WG I 2001).

Global change includes changes in land use and climate of the planet caused naturally and by man (anthropogenic; definition from IGBP: Walker et al. 1999):

global change =
change in climate + changes in land use

Land use and changes in land use may have many direct and indirect consequences, for example, destruction of soil, erosion, and desertification. During geological time, changes in the earth's climate and vegetation have always occurred independently of these human influences. However, the rate and extent of the changes caused by human activity have increased dramatically since the beginning of industrialisation, so that, within a very short period of about 50 years, the conditions required for human life are in jeopardy. The plant ecological aspect of global change may be formulated as:

- Questions about the interaction between climate and land ecosystems (IPCC-WG I, Chap. 9; Melillo et al. 1996)

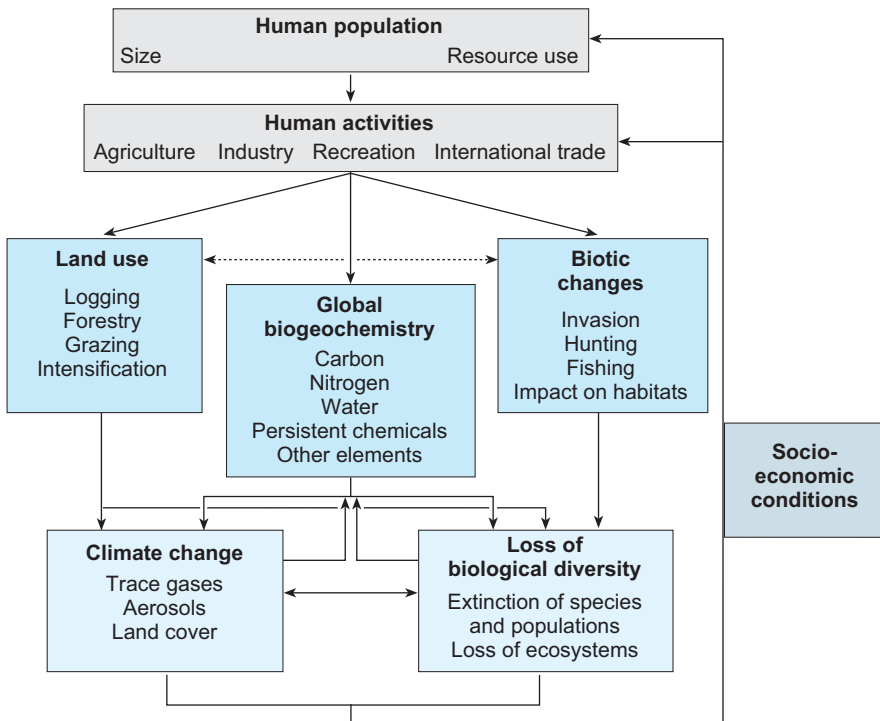


Fig. 5.1.1. Schematic illustration of the interaction between human activity and global change. Human population size and use of resources via specific activities (agriculture, industry, leisure and trade) have effects on land use, the global biogeochemical cycles and biodiversity. These influences initiate changes in climate and in biodiversity and both, in turn, influence populations and resources used by people. How this feedback occurs, and how strong it is, depends on socio-economic parameters. Thus it is difficult to predict scientifically how climate change will affect the situation in developed and in developing countries. After Vitousek et al. (1997)

- What are the effects on terrestrial ecosystems of changes in climate and land use?
- What are the effects on the climate of feedback reactions resulting from changes in terrestrial ecosystems?
- Questions about the importance of species for ecosystem function (GBA 1996, Chap. 7; Mooney et al. 1996)
 - Does the presence of many or few species have any effects on the “functioning” of ecosystems?
 - Are species with similar functions in ecosystems exchangeable, or are there effects on the material turnover in these ecosystems?

“Functions” of ecosystems are understood to be the many processes that are important to man, for example, biological productivity, filtration and purification of air and water, replacement of ground water, storage of carbon dioxide, etc.

The questions mentioned above are discussed at different levels elsewhere this volume (ecosystems: Chap. 3; synecology: Chap. 4). Some of

these questions will be discussed in the following at a global level with particular emphasis on the interactions between emissions, climate and global material cycles. Considering these aspects, plant ecology is part of other scientific subject areas particularly geo-ecology which considers anthropogenic pollutants, in addition to natural material changes. Also biogeochemistry examines material cycles between atmosphere, ocean and land. These global material cycles are regulated by organisms particularly with respect to changes at the boundary layer between atmosphere and land.

The influence of man on natural material cycles is determined by the population size and consumption of resources (Fig. 5.1.1; Vitousek et al. 1997) shown by “activities” in agriculture and forestry, industrial production, world trade and tourism. These activities are expressed as:

- land use,
- changes of the biological conditions in natural ecosystems,
- changes in global material cycles.

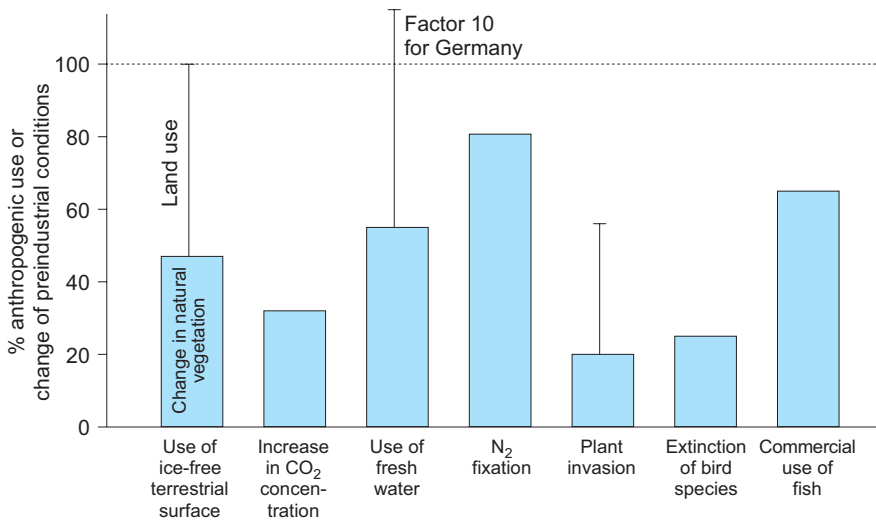


Fig. 5.1.2. An example of the influence of man on global processes in comparison to the period before industrialisation (conditions in 1880 = 100%). Here, the use of land area, the rise in CO₂ concentration, the extent of freshwater usage (in Germany one water molecule that falls as rain is used ten times, including as cooling water, before it reaches the sea), biological and industrial N₂ fixation, changes in natural flora by invasion of foreign species, loss of bird species and the use of natural fish stocks are shown. (After Vitousek et al. 1997)

These changes influence global climate and biodiversity and, by feedback reactions, may affect humanity. How these feedback reactions operate essentially depends on socio-economic parameters in the future (see below).

The extent of man's use of natural resources can no longer be neglected (Fig. 5.1.2, after Vitousek et al. 1997). At present, there is no spot on the ice-free surface of the earth that is not used by man for food production, raw material extraction and processing, settlements, infrastructure or tourism. Natural vegetation has been entirely displaced by man from about 50% of the earth's surface, and the other half is used for grazing, hunting, gathering and for tourism. This massive exploitation of the globe, together with industrialisation, is the cause of the CO₂ concentration of the earth's atmosphere to have increased by a third since industrialisation. Globally, about 50% of fresh water is used by humans. In Germany, the same litre of water is used two to three times before it reaches the sea (Lehn et al. 1996). On a global scale, industrial nitrogen fixation at present is similar in magnitude to natural N₂ fixation. Invading plants replace 20% of natural plants in ecosystems (up to 50% in some types of vegetation). About 20% of bird species are extinct, 60% of fish stocks is overused by man for food or to provide fish meal as food for farmed fish (Naylor et al. 2000). Thus, globally, man has intervened in all

aspects of life without evaluating the natural resources, let alone any consideration of planned management on a global scale.

Yet man's influence is not restricted to the present time (see also Chap. 4.2). Man's war of conquest against nature started at the transition from Pliocene to Pleistocene and reached Europe approximately 1.7 million years ago (China 1.9 million years ago and Java 1.8 million years ago; Fig. 5.1.3 A; Balter and Gibbons 2000). These are not individual immigration waves, but different immigrations by different subspecies of man (Balter 2001). Intensive settlement in the Mediterranean region occurred 30,000 years ago, when *Homo sapiens* lived together with *Homo neanderthalensis* in southern Europe (Gibbons 2001); probably at that time the first settlements occurred. North America was reached by man about 19,000 years ago.

The terms "environment" and "environmental change" have several meanings in the context of global change. Biological aspects need not necessarily be the most important. The following aspects should be distinguished:

- Conditions under which the individual lives and works (job security, social security, indoor climate, etc.). These social environmental conditions can be improved, independently of global ecological environmental problems. Social well-being does not mean a "healthy"

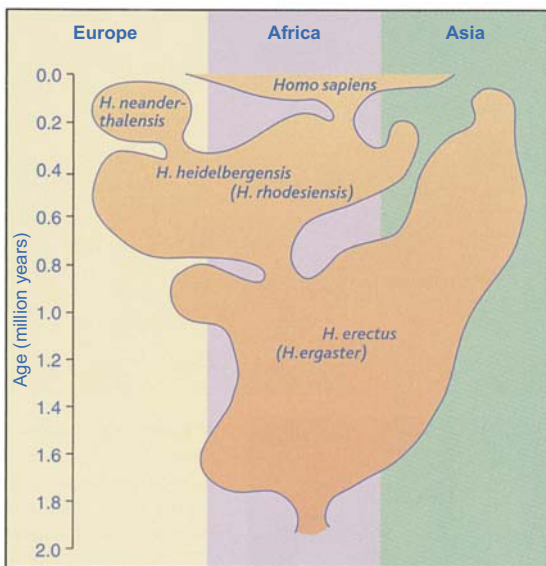
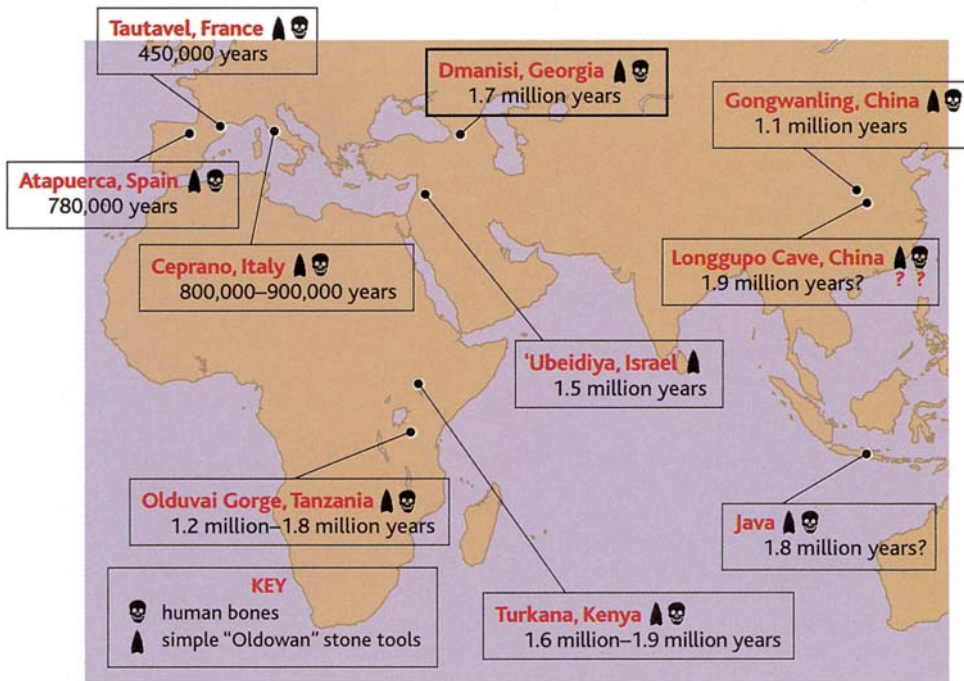


Fig. 5.1.3. A The oldest human fossils and tools in southern Europe and Asia (Balter and Gibbons 2000). B Development of the human species and subspecies in the last 2 million years and their distribution in Africa, Europe and Asia (Balter 2001). C The migration of modern man into southern Europe via the Middle East. (Gibbons 2001)

environment. Prosperous nations contribute substantially to global ecological and climatological problems even though the individual may live in a secure environment.

- Conditions of the economy at the national level. This includes exhaustion of resources, e.g. by clearing forests, use of mineral resources and increasing industrial production,

where economic growth and intervention in the biological environment are closely linked.

- Effects of certain measures on global cycles, particularly on emissions. This aspect is closely coupled with the points mentioned before but it is dealt with separately here, because of the effects of most emissions on climate.

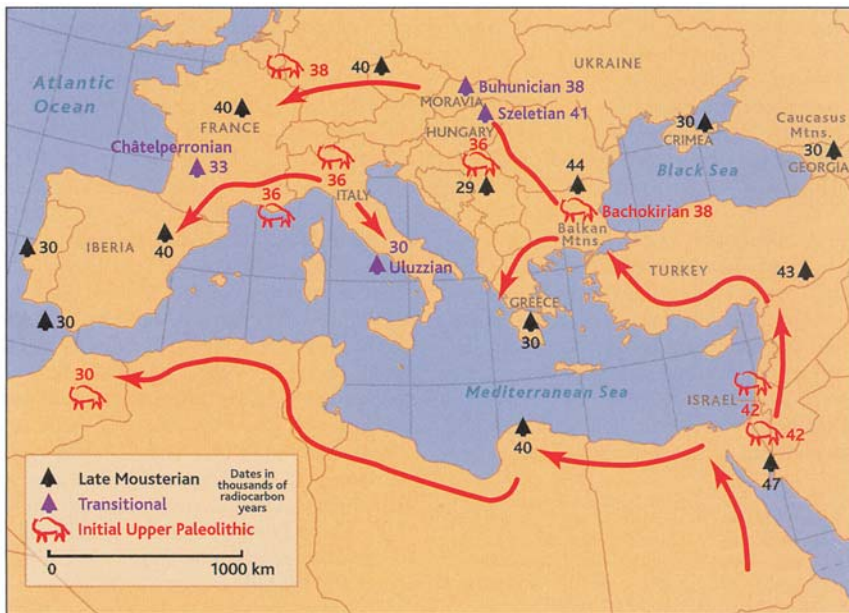


Fig. 5.1.3 C

Box 5.1.1 International organisations and analyses of global change

Global change is initiated by

1. Decisions made at national and international level
2. The sum of many small individual decisions: This ranges from individuals to the world society (see Fig. 5.4.3). Within this range are a number of organisations that have particular interest in global change (WBGU 2001b), those that have direct influence on land use, e.g. FAO (Food and Agriculture Organisation), or indirectly through the decisions it makes, e.g. the WTO (World Trade Organisation). Between these types of organisation are the financial organisations that have no direct contact with agriculture and forestry, but that distribute resources and so have a more direct impact on nations than the WTO. A few examples are the World Bank, IMF (International Monetary Fund) and the GEF (Global Environmental Facility, which finances projects in the area of biodiversity and energy saving), as well as the UNDP (United Nations Development Programme).

Parallel to these are organisations that scientifically study and analyse global change. These include:

- organisations of the UN (UN Environment Programme, UNEP), the World Meteorological Organisation (WMO) and the UN Educational, Scientific and Cultural Organisation (UNESCO);
- organisations that are financially involved also in the global environmental audits (e.g. World Bank);
- scientific organisations: ICSU (International Committee of Scientific Unions) and the ISSC (International Social Science Committee).

There are various organisations supporting worldwide studies of global change:

- WCRP (World Climate Research Programme), initiated by the WMO and supported directly by nations within WMO;
- IGBP (International Geosphere Biosphere Programme), a branch of the ICSU;

Box 5.1.1 International organisations and analyses of global change (continued)

- Diversitas (International Programme on the Documentation of Diversity) that was started by the International Union of Biological Sciences (IUBS);
- IHDP (International Human Dimension Programme) initiated by ISSC;
- SCOPE (Scientific Committee on Problems of the Environment), a UNESCO programme.

Also there are two large projects that study and analyse climate change and biodiversity, and report to the UN. These are:

- IPCC (Intergovernmental Panel on Climate Change) started in 1988 by the WMO and UNEP. In 2000 the IPCC was funded by the World Bank under the auspices of “Conference of the Parties” (COP), i.e. the 182 nations that signed the convention on climate change. The IPCC is subdivided into “Working group 1” (WG1) that studies the scientific fundamentals of climate change (IPCC-WG 1 1996, 2001) and WG II that studies the consequences, adaptive and mitigating strategies (IPCC-WG II 1996, 2001). WG III considers economic and social effects of global change (IPCC-WG III 1996, 2001). In 2001 the IPCC published the third report on climate (IPCC-WG I-III 2001), and additional “special” reports, such as the “Special Report on Land Use, Land Use Change and Forestry” which is important for ecology as it looks at the interactions of climate change and land use (IPCC LULUCF 2000). COP appoints the authors of the IPCC report, which is then being reviewed by independent scientists and by the nations belonging to COP. The final report is published by COP; the executive summary is discussed word for word by the signatory states who agree to the final version. The salient point of the executive summary in the IPCC report of 1996 was: “The balance of evidence suggests a discernible human influence on global climate”. This statement led to the discussion and finalisation of the Kyoto Protocol as part of the Framework Convention on Climate Change.

- The GBA (Global Biodiversity Assessment) report of 1140 pages, published in 1996 by the UNEP and financed by the World Bank (GBA 1996), is the first attempt to catalogue the earth’s biodiversity. In contrast to the IPCC, GBA is not part of the COP initiative on biological diversity. The report was evaluated by governments of countries that have signed the convention of biodiversity. So far the GBA process has not been repeated; instead UNEP plans a millennium assessment of global ecosystems.

For the second IPCC report about 4000 scientists were involved in writing and reviewing processes, for the GBA this meant about 1100 scientists. Hence, in both cases, an all-encompassing, well-balanced (i.e. minimum consensus) report was produced that describes the state of the world.

Environmental policy is organised in different ways, depending on nations. In Germany, for example, analysis and scientific recommendations to government occur via the following organisations:

- Council for Sustainable Development, whose remit is to make decisions concerning environmental policy accessible to the general public;
- Scientific Advisory Committee on Global Change (WBGU). This is an interdisciplinary group which advises the Federal Government on all matters relating to the environment, e.g. soil, drinking water, biodiversity and environmental risks (WBGU 1994, 1998, 1999, 2000 a);
- German Council of Environmental Experts (SRU). This advises the Environment Minister on questions of National and EU importance;
- National Committee of Global Changes (NKGK) of the German Research Council (DFG). This advises the DFG and the Federal Minister for Biological Research about scientific research programmes.

References

- Balter M, Gibbons A (2000) A glimpse of human's first journey out of Africa. *Science* 288:948–950
- Balter M (2001) In search of the first Europeans. *Science* 291:1722–1725
- EAO (2000) World Forest Resource Assessment, FAO
- GBA (1996) Global biodiversity assessment. Cambridge University Press, 1140 pp
- Gibbons A (2001) The riddle of coexistence. *Science* 291: 1725–1729
- IPCC-LULUCF (2000) Special report on land use, land use change and forestry (IPCC-XVI/Doc. 2). IPCC-Sekretariat der WMO, Genf
- IPCC-WG I (1996) Climate change 1995. The science of climate change. Contribution of Working Group I to the second assessment report of the Intergovernmental Panel on Climate Change. Cambridge University Press, 572 pp
- IPCC-WG II (1996) Climate change 1995. Impacts, adaptations and mitigation of climate change: scientific-technical analysis; Contribution of Working Group II to the second assessment report of the Intergovernmental Panel on Climate Change. Cambridge University Press, 878 pp
- IPCC-WG III (1996) Climate change 1995; economic and social dimensions of climate change; contribution of Working Group III to the second assessment report of the Intergovernmental Panel on Climate Change. Cambridge University Press
- IPCC-WG I (2001) Climate Change 2000. Third assessment report. Cambridge University Press, Cambridge
- IPCC-WG II (2001) Climate Change 2000. Third assessment report. Cambridge University Press, Cambridge
- IPCC-WG III (2001) Climate Change 2000. Third assessment report. Cambridge University Press, Cambridge
- Lehn H, Steiner M, Mohr H (1996) Wasser – die elementare Ressource. Leitlinien einer nachhaltigen Nutzung. Springer, Berlin Heidelberg New York, 368 pp
- Melillo JM, Prentice IC, Farquhar GD, Schulze E-D, Sala OE (1996) Terrestrial biotic responses to environmental change and feedbacks to climate. In: Climate change 1995, the science of climate change. Cambridge University Press, Cambridge, pp 445–482
- Naylor RL, Goldburg RJ, Primavera JH, Kautsky N, Beveridge MCM, Clay J, Folke C, Lubchenko J, Mooney H, Troell M (2000) Effect of aquaculture on world fish supply. *Nature* 405:1017–1025
- Vitousek PM, Mooney HA, Lubchenko J, Melillo JM (1997) Human domination of earth's ecosystems. *Science* 277:494–499
- Walker B, Steffen W, Canadell J, Ingram J (1999) The terrestrial biosphere and global change. IGBP book series 4. Cambridge University Press, Cambridge, 439 pp
- WBGU (1995) World in transition: the thread to soils. German Advisory Council on Global Change (WBGU), Economia, Bonn, 263 pp
- WBGU (1999) World in transition: ways towards sustainable management of freshwater resources. German Advisory Council on Global Change (WBGU). Springer, Berlin Heidelberg New York, 392 pp
- WBGU (2000) World in transition: strategies for managing global environmental risks. German Advisory Council on Global Change (WBGU). Springer, Berlin Heidelberg New York, 359 pp
- WBGU (2001 a) World in transition: conservation and sustainable use of the biosphere. German Advisory Council on Global Change (WBGU). Earthscan, London, 451 pp
- WBGU (2001 b) World in transition: new structures for global environmental policy. German Advisory Council on Global Change (WBGU). Earthscan, London, 211 pp

5.2

Global Element Cycles



Most element cycles are not closed entities in ecosystems. This is particularly true for water, carbon and the nutrients nitrogen and sulphur. At the scale of landscapes resources are often imported and exported from one ecosystem to another. The figure shows the export of soluble organic carbon in humic and fulvic acids, which co-transport heavy metals, from boreal pine forests of Siberia. The dissolved organic carbon reaches the ocean via streams and rivers. The river is the Dubces, a tributary of the Yenisei. Photo E.-D. Schulze

Element cycles (Fig. 5.2.1; Schulze 2000) of water, carbon, nitrogen and sulphur are characterised (1) by the degree of storage in the atmosphere, sea and on continents; (2) by the turnover between these compartments, the so-called fluxes; and (3) the turnover within the compartments, the so-called internal cycles of ecosystems. The turnover between the earth's surface and the atmosphere is essentially controlled by organisms, whilst the turnover in the atmosphere is predominantly dependent on energy from solar radiation. Global fluxes between continents, oceans and the atmosphere will be considered later. For comparison, it is important to know that the surface of the earth is about 505 million km² of which about 353 million km² are oceans, i.e. 70% of the earth's surface is covered by oceans. The area of continents is about 152 million km², but only 135 million km² (88% of continents) are ice-free. Europe (the 15 countries of the European Union, EU₁₅) has an area of 3.2 million km².

5.2.1

Water Cycle

The **water cycle** (Fig. 5.2.2; Schlesinger 1997; see also Chaps. 2.1.1 and 2.2.4) is characterised by the large reservoir in the oceans. An H₂O molecule has a mean residence time (MRT) in the ocean of about 37,000 years calculated as reservoir/flux. The MRT in groundwater of the continents is 300 years and water bound in ice 16,000 years; the MRT in the atmosphere is three orders of magnitude smaller (MRT: 9 days), the MRT for water in soil is 280 days.

Transport of water vapour from the ocean to land is smaller than the turnover across the oceans or land masses. This means that precipitation in coastal regions evaporates and this evaporated water is then precipitated over the interior of the land masses again (see Fig. 3.2.5). A “wave” of rain, evaporation and rain again “rolls” across the continent. In the case of the Eurosiberian regions, the same water molecule is calculated to undergo five to seven evapora-

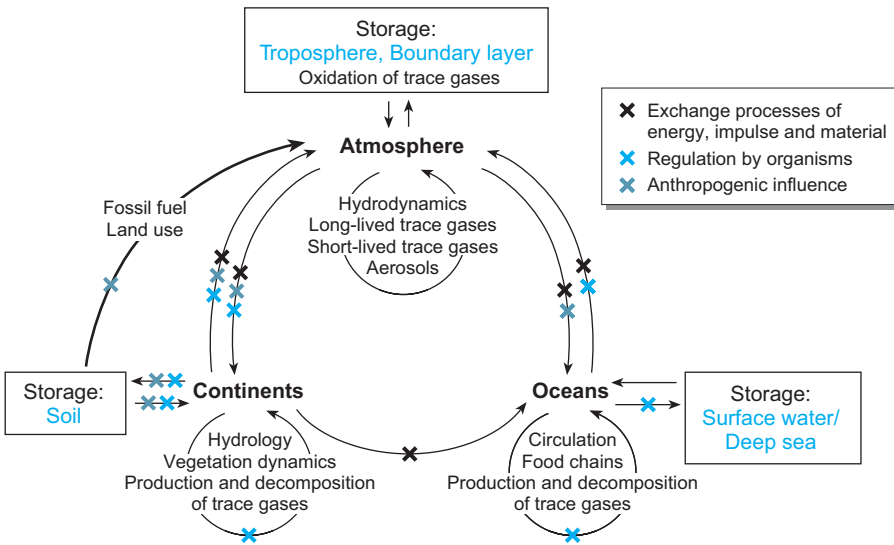


Fig. 5.2.1. Schematic presentation of the global cycling of material between land, sea and air. The arrows show the mass flows (mass per unit area per time). Crosses identify the places where the flow rates are controlled by organisms

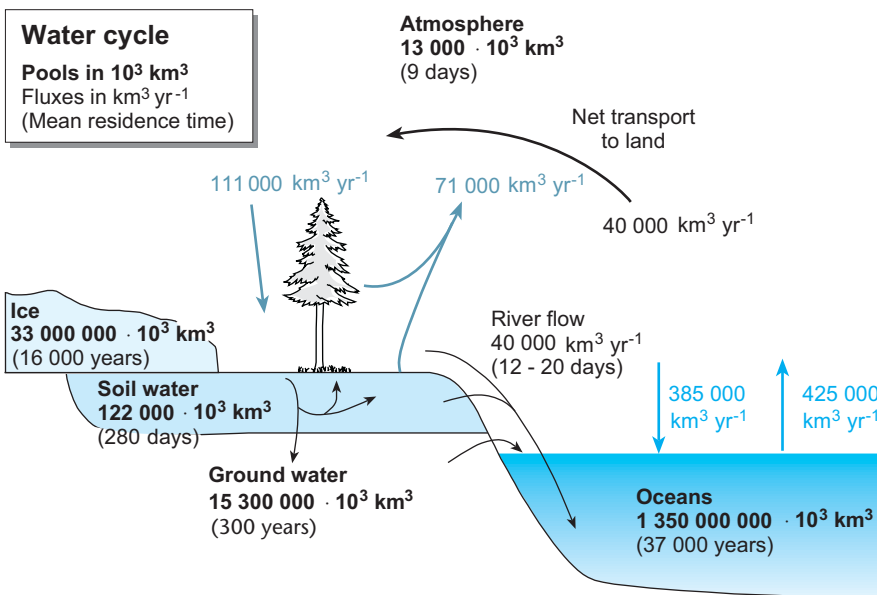


Fig. 5.2.2. Schematic presentation of the global water cycle. Shown are the reservoirs (pool sizes), the flows, and the average retention time of a molecule in each compartment. (After Schlesinger 1997; Reeburgh 1996)

tions and precipitation cycles before it reaches the Pacific. In this process losses by surface runoff and seepage occur, so that precipitation of about 1000 mm in montane regions of Germany is reduced to 300 mm in central Siberia and 150 mm in eastern Siberia (Schulze et al. 1999). Related to area, the average turnover of water on land is lower than the turnover of oceans.

With the large amounts of water vapour and precipitation which are converted globally it is

not surprising that humans do not have much influence, particularly as they use surface water predominantly, i.e. the excess of the hydrological balance (see Chap. 2.2.1). Despite the large amounts converted, there are human influences on the global water balance (see WBGU 1999), particularly:

- Changes in runoff because of changes in land use. These start with change from forest to

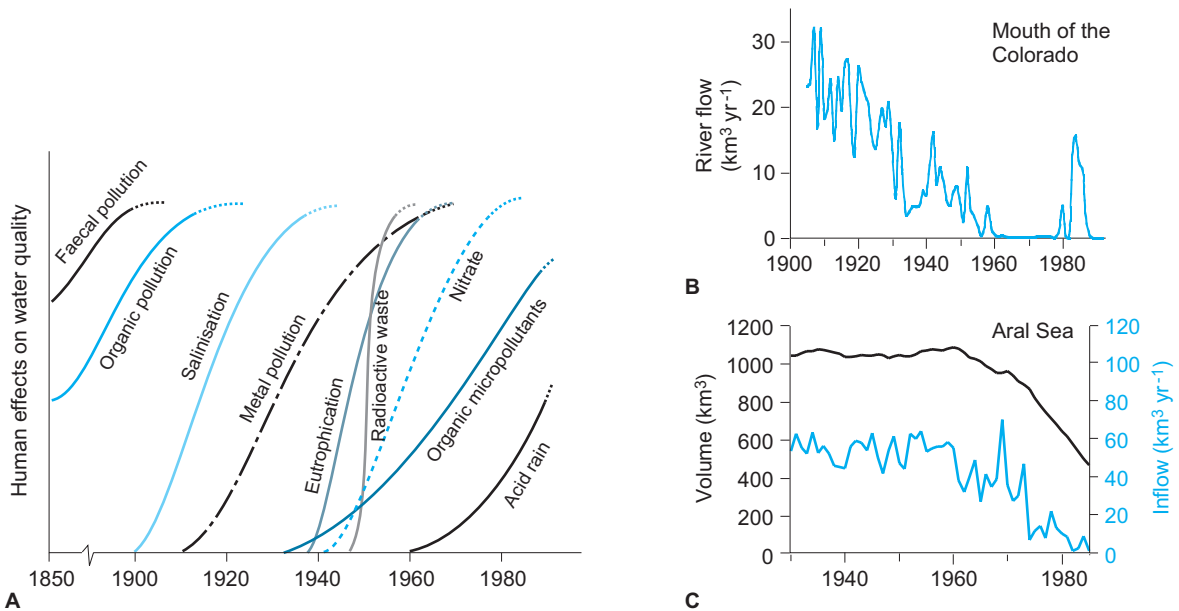


Fig. 5.2.3. A Changing water quality in the industrialised world from 1850 to the present; B change with time in the flow of the Colorado River below the dams; and C change in the volume of water reaching the Aral Sea since 1930. (WBGU 1999)

agriculture and continue with intensive mechanical working practices, fertilisation, use of pesticides and erosion on agricultural land, and last not least by construction. Changes in land use influence not only the amount, but also the quality of water (Fig. 5.2.3 A; WBGU 1999).

- Changes in runoff caused by dam building and irrigation (partially from fossil ground water storage). Well-known examples of the effects of irrigation and dam building on surface runoff are the drastically reduced flow of the Colorado in Arizona and the drying out of the Aral Sea (Fig. 5.2.3 B,C; WBGU 1999). Changes in water levels of the lake caused by the Aswan Dam (Egypt) and Lake Chad (Chad) are further impressive examples of global changes in the water cycle (Evans 1996).
- Changes in the distribution of precipitation (Fig. 5.2.4 A; Toon 2000; Fig. 5.2.4 B; Cervený and Balling 1998). Because of production of aerosols, more nucleation bodies reach the atmosphere so delaying precipitation (Toon 2000). This explains the statistically established periodicity in weekly precipitation (Cervený and Balling 1998) in the eastern USA where aerosol concentration increases rapidly at the beginning of the week and reaches a maximum on Wednesday/Thursday.

This delays rainfall from the atmosphere. Precipitation in the first half of the week is low, increases only in the second half of the week, and reaches its statistical maximum on Saturday. Statistically, least precipitation falls on Monday.

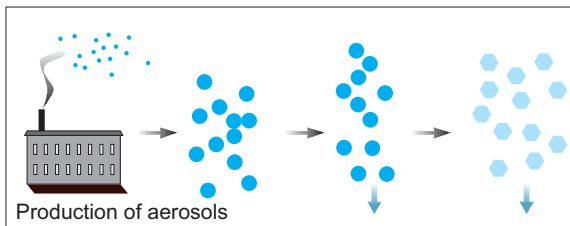
5.2.2

Carbon Cycle

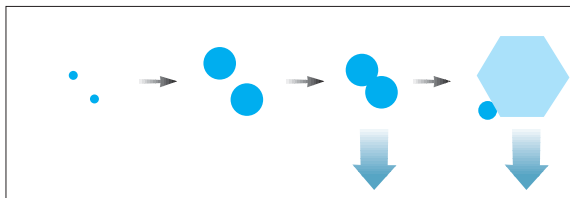
The **carbon cycle** (Fig. 5.2.5; Schlesinger 1997) has, as with the water cycle, a large reservoir in the ocean and additional large storage in sedimentary rocks. The CO₂ in the atmosphere is 2‰ of the amount in oceans, only slightly higher than the amount of C bound in the biomass of plants and only half that stored in the soil. The mean residence time of a CO₂ molecule in the atmosphere is three years. As CO₂ concentration is not only determined by re-assimilation but also by respiration during litter decomposition (see Fig. 3.3.1) it would take about 750 years to halve the present increase of CO₂, even if present emissions were stopped immediately. At present CO₂ increases in the atmosphere by 5% per year, i.e. 3×10^9 t carbon.

The biological carbon cycle is characterised by very high rates of carbon uptake and release.

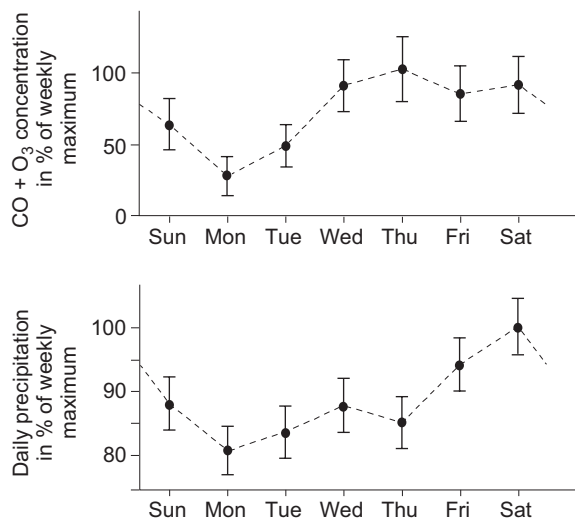
Anthropogenic impact on atmosphere



Natural atmosphere



A



B

Fig. 5.2.4. A Schematic presentation of droplet formation in the atmosphere, with or without aerosols. In the presence of aerosols the number of nuclei for condensation seed molecules rises. At constant water vapour concentration the size of the droplets and the amount of precipitation therefore decrease. In the atmosphere vapour remains as haze that does not develop into rain (after Toon 2000). B Statistical distribution of anthropogenic gases as an indicator of aerosols and of rainfall during a week in northeastern USA. (After Cerveny and Balling 1998)

Uptake is by CO₂ assimilation in photosynthesis, release by respiration of plants and heterotrophic organisms, as well as from burning vegetation (see Fig. 3.3.9). These fluxes are almost balanced under natural conditions. In addition there are two anthropogenic fluxes which are larger than the natural C balance from photo-

synthesis and respiration, namely emissions from consumption of fossil fuels and release of CO₂ by changes in land use. The human signal thus interferes significantly in the natural carbon cycle; the effects are analysed in Chapter 5.3.

The CO₂ cycle does not consider the turnover of further C-containing trace gases which can have an even greater effect on climate change than CO₂. In particular methane, produced mainly in wet areas of the globe, including rice cultivation, and also from rubbish heaps, termites, animal husbandry and burning of biomass (Reeburgh 1996).

5.2.3

Nitrogen Cycle

The largest amount of nitrogen (Fig. 5.2.6; Reeburgh 1996; Schlesinger 1997) is stored in gaseous form in the atmosphere (4×10^{15} t with a MRT of 10^7 years). Storage in other compartments is negligible compared with this, even though turnover rates are high. Biological N₂ fixation is the starting point of biological N turnover on continents and in oceans (see Fig. 3.3.12); it is significantly higher on land than in oceans. In contrast, denitrification on land and in the oceans is almost identical. The N cycle is particularly affected by industrial N₂ assimilation resulting in NH₃ production, and by NO_x production in combustion. The present rate of industrial N₂ fixation corresponds to biological N₂ fixation which is also influenced by growing Leguminosae in agriculture. Internal turnover of organically and inorganically bound nitrogen in ecosystems exceeds the net fluxes by about a factor of 10.

It is difficult to determine the global N balance because of uncertainties in estimating denitrification. Changes in the atmosphere are also difficult to measure directly, because of the large amount and high concentration of N₂. Estimates point to an eutrophication process in which N₂ fixation exceeds denitrification by a third (Table 5.2.1). It is possible, therefore, that denitrification in the stratosphere and in oceans is underestimated (Tabazadeh et al. 2001).

In Germany, the nitrate content in groundwater correlated linearly with N deposits from the atmosphere and fertilisation in agriculture (Lehn et al. 1996). In Baden-Württemberg, Ger-

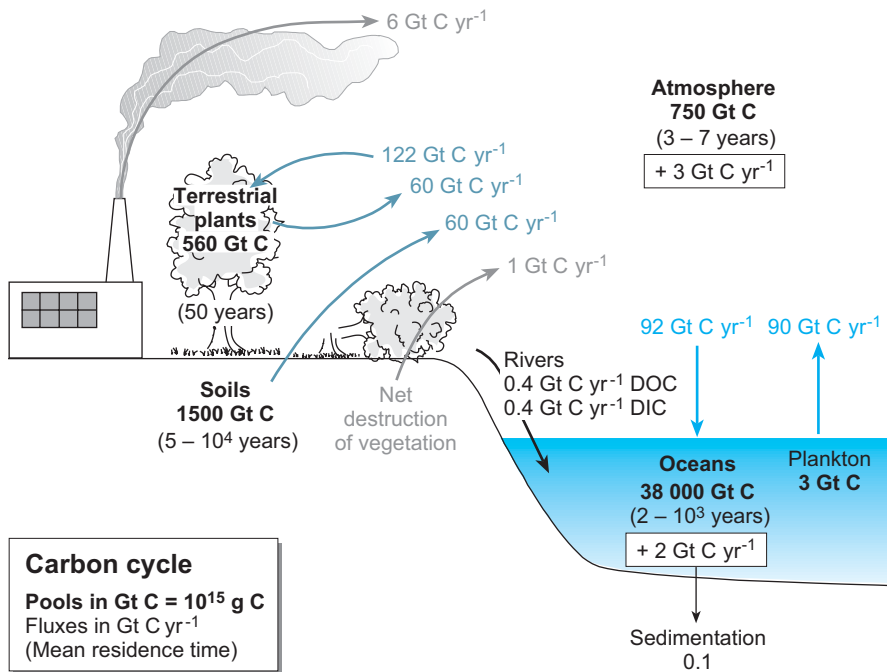


Fig. 5.2.5. Schematic presentation of the global carbon cycle. Shown are the reservoirs (pool sizes), the fluxes, and the mean residence time of a molecule in each compartment. *DOC* Dissolved organic carbon; *DIC* dissolved inorganic carbon. (After Schlesinger 1997; Reeburgh 1996)

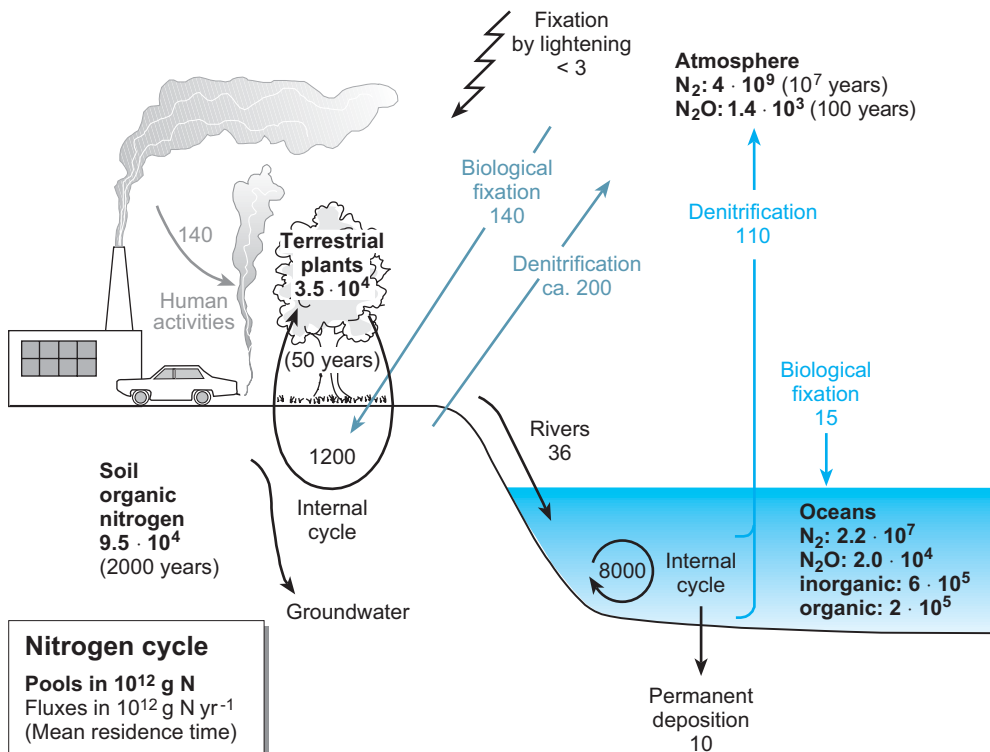


Fig. 5.2.6. Schematic presentation of the global nitrogen cycle. The reservoirs (pool sizes), the fluxes, and the mean residence time of a molecule in each compartment are shown. (After Schlesinger 1997; Reeburgh 1996)

Table 5.2.1. The global N₂ balance. All values are subject to considerable uncertainty. (After Reeburgh 1996; Schlesinger 1997; Vitousek et al. 1997)

Process	N ₂ fixation (10 ¹² g N a ⁻¹)	Denitrification (10 ¹² g N year ⁻¹)
Natural terrestrial	190	147
Natural oceanic	40	110
Planting Leguminosae	40	0
Fertilisers and industry	90	0
Industrial burning	20	20
Biomass burning		12
Sum	380	289

many, a total of 550 water sources (more than 20% of the total number) were taken out of the water supply network between 1980 and 1992 because of anthropogenic pollution. Thus, dependence on long-distance water supply was increased. In 1993 there were only three, large-volume, long-distance water supply systems left, the area called Donauried, Lake Constance, and the drinking water reservoirs in the Black Forest. The Donauried supplies the metropolitan region of Stuttgart. In this important region for water supply, nitrate concentration rose continuously from 10 mg l⁻¹ in 1930 to 40 mg l⁻¹ in 1993 (Fig. 5.2.7; Lehn et al. 1996). In 1990, it was predicted that this source region would have to be taken out of the supply network in 10–20 years (because the EU limit for nitrate in drinking water of 50 mg l⁻¹ would be exceeded). However, there are indications that nitrate pollution has stabilised, possibly as a consequence of environmental measures (reduced input of liquid fertiliser in the source region and nature protection). This shows that environmental problems can be managed if it is politically desired.

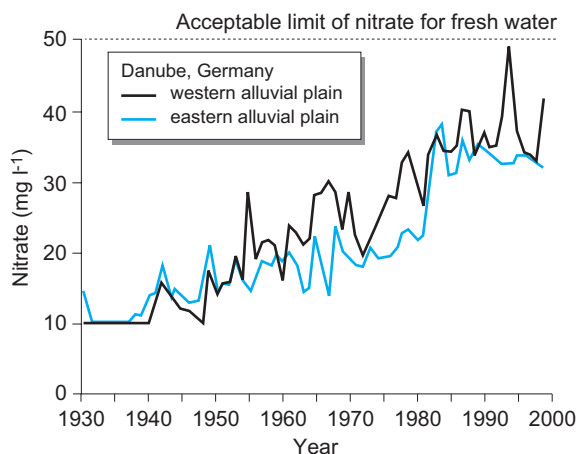


Fig. 5.2.7. The change in nitrate concentration in Donauried since 1930. (After Lehn et al. 1996)

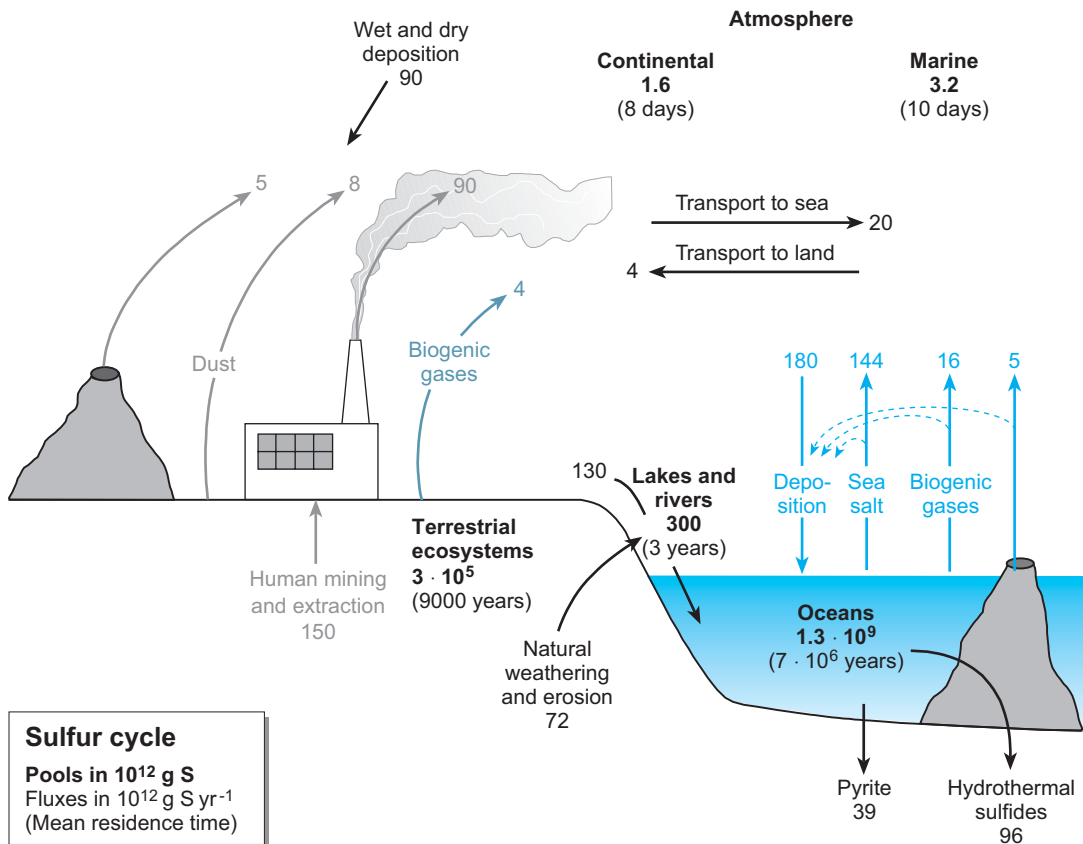
5.2.4

Sulphur Cycle

The **sulphur cycle** (Fig. 5.2.8; Reeburgh 1996; Schlesinger 1997) is characterised by high turnover across the oceans caused by the release of dimethyl sulphide (DMS), a gas produced by metabolism of several genera of marine algae which possess chlorophyll a and c. These are:

- all dinoflagellates
- green algal families in the Prasinophyceae
- almost all macro green algae
- a few Diatomeae
- a few Rhodophyceae
- no brown algae
- no cyanobacteria

The turnover rate of DMS in the atmosphere is very high (MRT: 1 day), as it is oxidised to sulphate, a large proportion of which usually returns to the oceans in rain. Natural turnover is two orders of magnitude lower on land than on oceans. Thus anthropogenic S emissions become the largest S sources on land, exceeding natural S emissions by approximately a factor of 10, and contributing significantly to acidification of soils (see Fig. 3.2.2). In Germany, SO₂ emissions were significantly reduced by regulation in 1983 of power plants and other large SO₂ sources (see Fig. 3.5.4), and presently reach a pre-industrial level.



■ **Fig. 5.2.8.** Schematic presentation of the global sulphur cycle. Reservoirs (pool sizes), fluxes, and mean residence time of a molecule in each compartment are shown. (After Schlesinger 1997; Reeburgh 1996)

References

- Cereny RS, Balling RC (1998) Weekly cycles of air pollutants, precipitation and tropical cyclones in the coastal NW Atlantic region. *Nature* 394:561–563
- Evans TE (1996) The effect of changes in the world hydrological cycle on availability of water resources. In: Bazzaz F, Sombroek W (eds) *Global climate change and agricultural production*. Wiley, Chichester, pp 15–48
- Lehn H, Steiner M, Mohr J (1996) *Wasser – die elementare Ressource. Leitlinien einer nachhaltigen Nutzung*. Springer, Berlin Heidelberg New York, 368 pp
- Reeburgh WS (1996) “Soft spots” in the global methane budget. In: Lidstrom ME, Tabita FR (eds) *Microbial growth on C1-compounds*. Kluwer, Amsterdam, pp 334–342
- Schlesinger WH (1997) *Biogeochemistry; an analysis of global change*. Academic Press, San Diego, 588 pp
- Schulze E-D (2000) Der Einfluß des Menschen auf die biogeochemischen Kreisläufe der Erde. *Max-Planck-Gesellschaft Jahrbuch 2000*, pp 39–58
- Schulze E-D, Lloyd J, Kelliher FM, Wirth C, Rebmann C, Lühker B, Mund M, Knohl A, Milvukova IM, Schulze W, Ziegler W, Varlagin AB, Sogachev AE, Valentini R, Dore S, Grigoriev S, Kolle O, Panfyorov MI, Tchebakova N, Vygodskaya NN (1999) Productivity of forests in the Euro-siberian boreal region and their potential to act as a carbon sink – a synthesis. *Global Change Biol* 5:703–722
- Tabazadeh A, Jensen EJ, Toon OB, Drdla K, Schoeberl MR (2001) Role of the stratospheric polar freezing belt in denitrification. *Science* 291:2591–2593
- Toon OB (2000) How pollution suppresses rain. *Science* 287:1763–1765
- Vitousek PM, Mooney HA, Lubchenco J, Melillo JM (1997) Human domination of earth’s ecosystems. *Science* 277: 494–499
- WBGU (1999) *World in transition: ways towards sustainable management of freshwater resources*. German Advisory Council on Global Change (WBGU). Springer, Berlin Heidelberg New York, 392 pp

5.3

Human Impacts on the Carbon Budget and Its Significance for the Global Climate



A particularly important form of human intervention in the carbon cycle is deforestation of primary forests (to obtain fibre and timber and to create usable land). In the tropics this is usually associated with land use change (slash and burn agriculture). In boreal forests deforestation is usually followed by regeneration. Even so, this initial harvest of trees is associated with a significant increase in carbon emissions, as primary forests have a higher biomass than secondary forests, and as a consequence of harvest there is a destruction of the organic layer which accumulated in primary forests over thousands of years. The top figure shows the fully mechanised harvest of a boreal forest in Russia, and the lower figure the boundary between primary forest and clear-cut areas in the Pacific northwest of Canada. Photo E.-D. Schulze

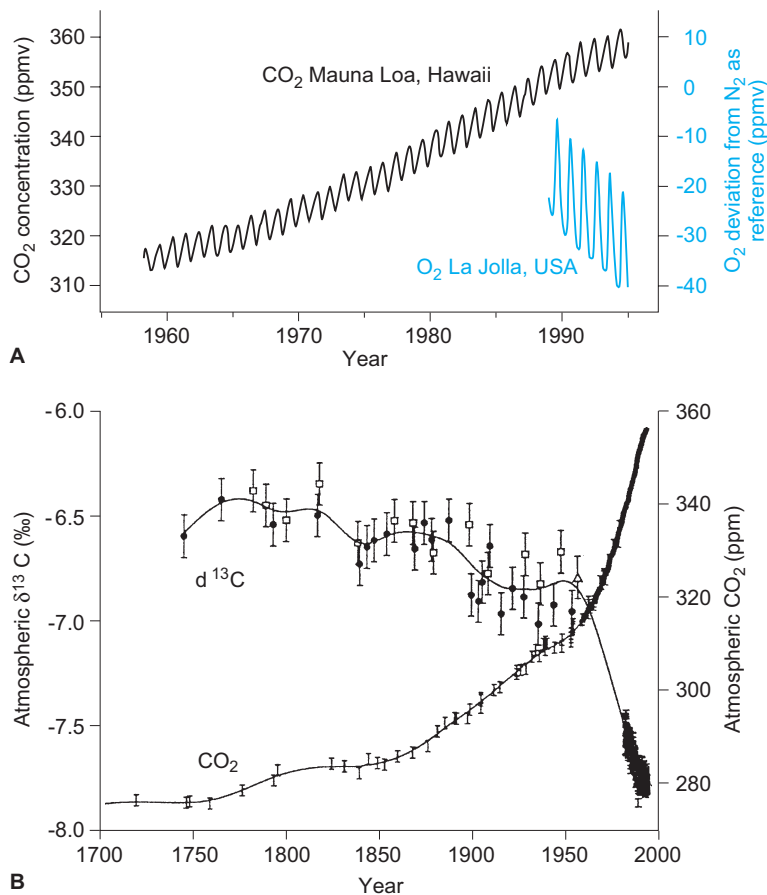


Fig. 5.3.1. A CO₂ concentration in the atmosphere measured on Mauna Loa. Here, continuous measurements have demonstrated the increasing trend of CO₂ concentration, and also the annual cycle with a minimum during the growing period in summer and a maximum during the dormant phase in winter of the northern hemisphere. The simultaneous reduction in O₂ concentration measured at La Jolla, California, is also shown. The O₂ concentration shows annual oscillations that are opposite to CO₂ (after Heimann 1997). B Changes in atmospheric CO₂ concentration and the δ¹³C value since 1700. Since 1960 the δ¹³C value has decreased with increasing CO₂

The CO₂ concentration in the atmosphere is currently increasing by 0.5% per year. To fully understand the implications, the long-term trend of CO₂ in the atmosphere needs to be considered. Also, it is important to know where the anthropogenic CO₂ originates from (Fig. 5.3.1 A; Heimann 1997). Since 1959 a continuous rise in CO₂ concentration has been measured on Mauna Loa on Hawaii with minima corresponding to the growing season in the northern hemisphere summer and maxima corresponding to the dormant phase in winter, when CO₂ production is also very high. A decrease in the oxygen concentration was observed in parallel to this increase in CO₂. It is proof that the rise in CO₂ is caused by combustion and is not the consequence of simple CO₂ release, for example, from the oceans. At the current rate of consumption, oxygen will be depleted in 50,000 years, but the potential use of oxygen also depends on the availability of fossil fuels. Estimates of reserves of fossil fuels are uncertain and depend on the costs of extraction. Extractable reserves of 600–1200 Gt (100–200 years supply at current rates

of use) are calculated. Including reserves that are difficult to extract, the figure is around 4000–7000 Gt, calculated as a mixture of sources, with 13.6 g C/MJ gas, 21.8 g C/MJ oil and 27.3 g C/MJ coal (1 kg oil = 1.44 mineral coal units).

The stable isotope ¹³C (Fig. 5.3.1 B) is another indicator showing that gases from fossil fuels enter the earth's atmosphere. In pre-industrial times, the so-called δ¹³C value (atmospheric ¹³C/¹²C ratio compared with a standard) was -6.5‰. Adding CO₂, depleted in ¹³C, from fossil C-sources has decreased the δ¹³C by ca. 1‰ in the last 40 years.

Parallel to the increase in CO₂ concentration the concentration of methane has also changed, rising with the increase in population as a consequence, to a large extent, of growing rice in wet areas and keeping ruminants (Krüger et al. 2001; see also Chap. 3).

Thus it has become clear from oxygen and isotope measurements that the increased CO₂ concentration in the atmosphere is a consequence of combustion. It is now necessary to explain how anthropogenic CO₂ enters into the

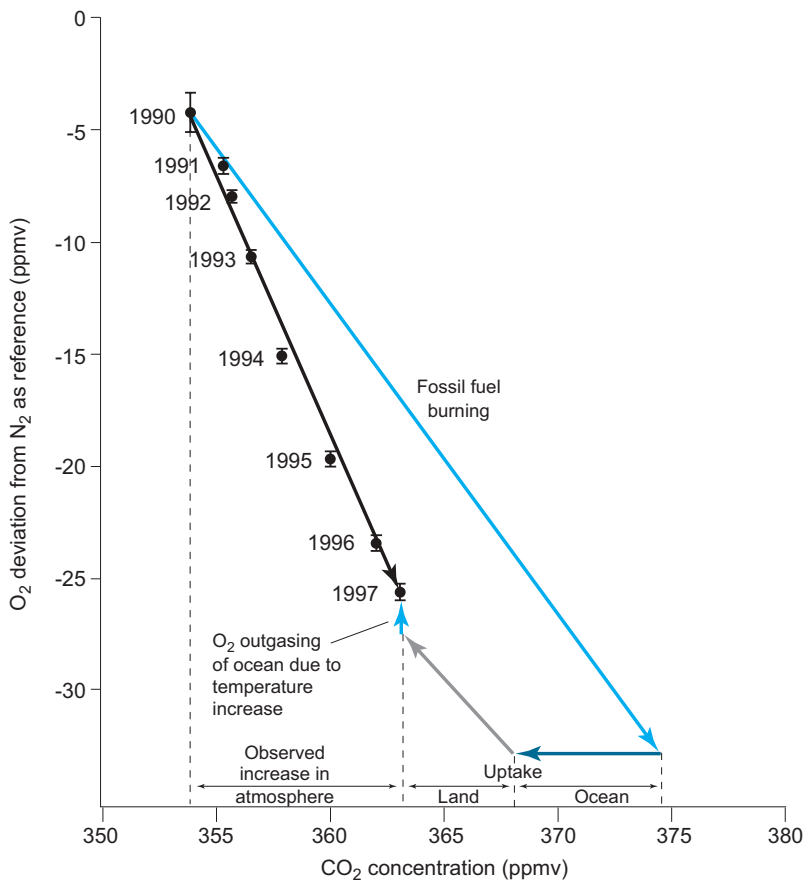


Fig. 5.3.2. Changes in the O₂ concentration and its dependence on CO₂. When fossil fuels are burnt O₂ consumption is proportional to the CO₂ released. However, CO₂ is absorbed by the oceans (without releasing an equivalent amount of O₂) and by photosynthesis (where O₂ is simultaneously produced). These three processes result in the changes in measured O₂ and CO₂. (After Keeling et al. 1996)

carbon cycle (Fig. 5.3.2; Keeling et al. 1996). During burning, a fixed amount of oxygen is consumed in relation to carbon. If the recent consumption of fossil fuels is known, it is possible to calculate the corresponding requirements for oxygen and the CO₂ produced and the concentration to be expected if the CO₂ formed remains in the atmosphere. Observations in the atmosphere show a significantly lower CO₂ concentration than expected from the use of fossil fuels. This difference is caused by photosynthesis of land plants in which oxygen proportional to CO₂ consumption is released into the air. At the surface of oceans more CO₂ is consumed than O₂, as the solubility of CO₂ in water at 20 °C (0.878 ml CO₂ l⁻¹ H₂O) is much greater than that of O₂ (0.0311 l O₂ l⁻¹ H₂O; Sestak et al. 1971). Calculated from these turnover rates ca. 50% of CO₂ from fossil fuels remains in the atmosphere, 30% is taken up by the oceans, and 20% is assimilated by plants (Keeling et al. 1996).

It is to be expected that the increased concentrations of CO₂, methane, N₂O and other anthro-

pogenic trace gases will affect climate because of their specific energy absorption characteristics (see Fig. 2.1.2). This is confirmed by geological events, in which a sudden release of marine methane hydrate caused a 5–7 K warming of the lower atmosphere (Norris and Röhl 1999). At the transition from the Palaeocene to the Eocene (55 million years ago), 1200–2000 Gt CH₄ was released at the continental shelf in the north Atlantic. This corresponds to the release of CO₂ expected from fossil fuels. In this process stable methane hydrates, formed under cooler conditions and buried under sediments, were released as gases as the water warmed, such as might occur in an interglacial period. At the foot of the continental shelf sediments slipped and the methane gas was released in a chain reaction (Kennet et al. 2000). Methane concentration in the atmosphere was high for 120,000 years until the gas was re-assimilated and the atmosphere cooled again. There are indications that the evolutionary separation of man from other apes occurred during this time of enormous warming at the transition from the Palaeocene to the Eo-

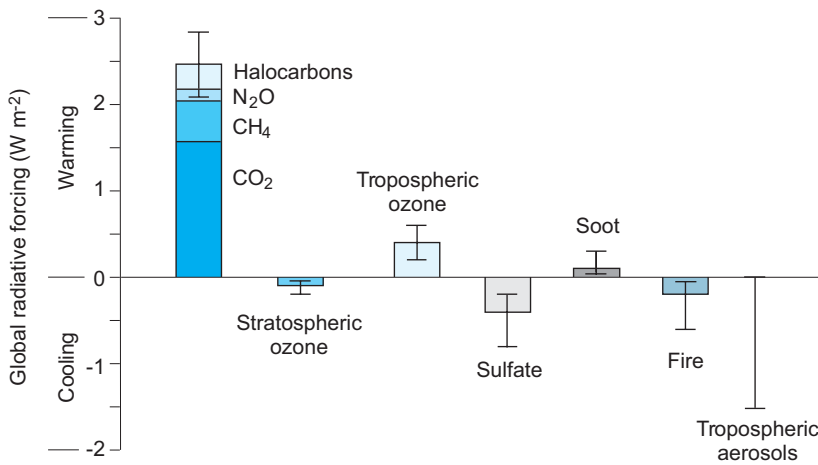


Fig. 5.3.3. Influence of trace gases and aerosols on the solar radiation balance of the earth. (Schimel et al. 1997)

cene (Dickens 1999). During the warming after the last ice age no such methane release occurred.

Independent of the indications of warming of the lower atmosphere with increasing CO₂ concentration, there are several uncertainties making predictions very difficult (see also Veizer et al. 2000). These uncertainties are in meteorology as well as in oceanography:

- Meteorological uncertainties

Aerosols: Radiation balance not only depends on outgoing radiation, but also on incoming radiation. Incoming radiation is reduced by the increased reflection of clouds and aerosols. This compensates for the effect of reduced re-radiation of long-wave heat radiation and therefore cooling caused by increased CO₂. The influence of gases and aerosols (Fig. 5.3.3) was assessed by IPCC-WG I (1996): Despite all uncertainties the conclusion remains that the predominant effect of trace gases is to cause global warming. The influence of incoming radiation had also been seriously discussed in a different connection, namely the atomic winter (Ehrlich et al. 1983; Turco et al. 1983). According to calculations, an atomic war would lead to an enormous development of soot and aerosols from fires in large cities, and this would decrease the incoming radiation to such an extent that within 1–2 weeks the earth's mean temperature would decrease to –15 to –25 °C for >1 year and thus survival of life on earth would be unlikely. This applies particularly to a start of such a war during the growing season in the northern hemisphere. This knowledge led to the realisation that an atomic war would jeopardise the sur-

vival of both sides, and it thus influenced negotiations on nuclear disarmament.

- Oceanographic uncertainties about **global marine currents**

Conveyor belt: One ocean current is particularly important for Europe, the oceanic conveyor belt, which connects the oceans (Fig. 5.3.4 A; Commission of Inquiry of Global Climate Change, Federal Parliament of Germany 1992). Warm surface water flows from the south Atlantic to the north Atlantic as the Gulf Stream. Because of evaporation, and the stream of salt-rich water from the Mediterranean, this water becomes increasingly more saline and therefore does not freeze when it meets the cold Arctic water and the front of sea ice off Greenland. The salt-rich water cools and sinks into the depth of the north Atlantic and flows back as a cold, salt-containing deep sea current. It has long been known that the heat released during the cooling and sinking of the surface stream causes the mild, moderate climate in Europe (Driscoll and Haug 1998). This oceanic conveyor belt reacts sensitively to the salt content of water in the north Atlantic. Salt-depleted water would not sink to the depth of the oceans. Thus heat would not be produced in the north Atlantic and Europe would cool down. This occurred during the post-glacial period when the large inland lake of North America, Agassiz, which formed from the melting ice in the region of Alberta, Saskatchewan and Montana, flowed into the north Atlantic. Consequently, the Younger Dryas ice age occurred in Europe. Melting ice in the Arctic or a decrease of water flow from the

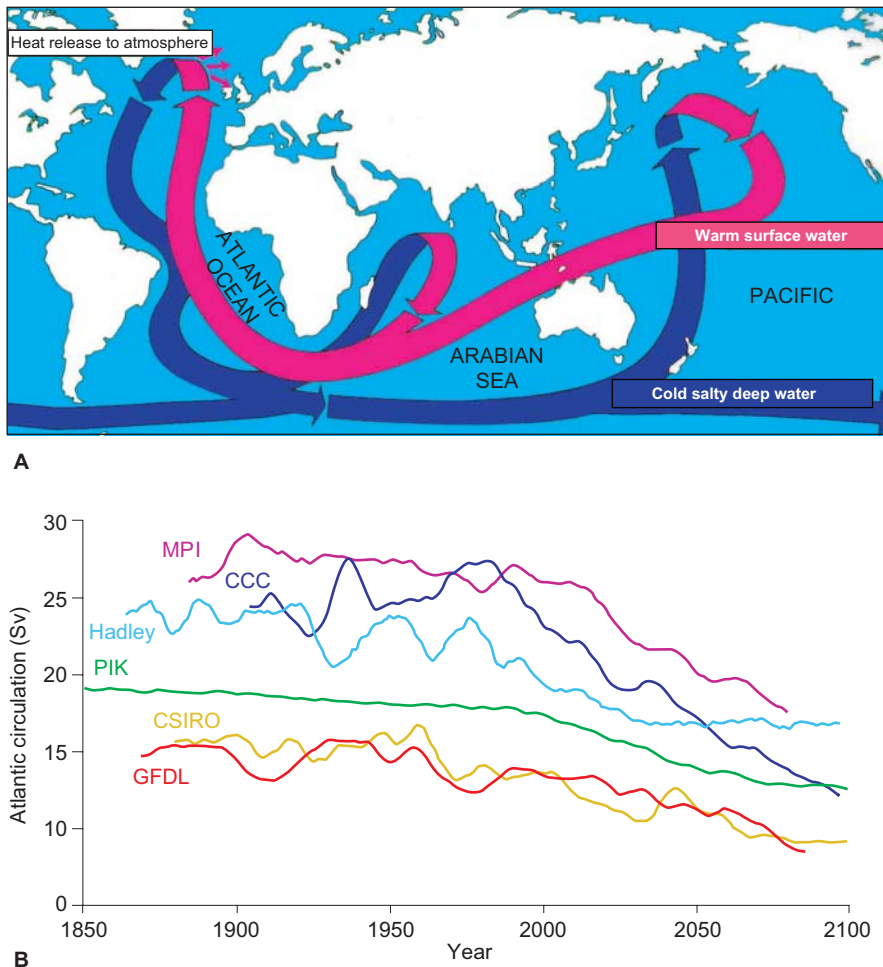


Fig. 5.3.4. A Schematic presentation of the oceanic “conveyor belt”: The warm upper currents spread from the Pacific to the Atlantic. This water becomes saltier and does not freeze when it meets the cold water and ice front of the Arctic. The surface water sinks near the coast of Norway and north of Iceland and forms deep, salty water that flows back to the Pacific (after the Commission of Enquiry of Global Climate Change of the Federal Republic of Germany; Ramstorf et al. 1999). B Comparison of models of deep-water formation in the north Atlantic. All models agree in predicting that, with further global warming, the strength of the Gulf Stream will be reduced. This has potentially serious consequences for the European climate. (After Ramstorf et al. 1999)

Siberian rivers could have a similar effect to a cooling of the Gulf Stream, as the Arctic ice masses are derived from the fresh water of the Siberian rivers. Redirection of the Siberian rivers for irrigation of Asiatic steppes, planned in the 1960s, would have had enormous climatic consequences for Europe. Even a weakened Gulf Stream could cause a cooling of western Europe and this would result in an enormous increase of atmospheric CO_2 , as the CO_2 -rich water would no longer sink into the deep sea and would produce a significant gradient of precipitation. A comparison of coupled ocean-atmosphere models shows a weakening of the Gulf Stream with continuing

warming (Fig. 5.3.4B; Broecker 1997; Rahmstorf 1999).

El Niño: There is another marine stream which affects climate, the so-called El Niño. Periodically, the surface water in the eastern Pacific becomes significantly warmer, so that the regular currents transporting water from east to west no longer occur. This has enormous effects on the weather conditions in such a year (Fig. 5.3.5; Bengtsson 1997). Catastrophic rainfall occurs in South America, and drought in Australia and parts of Indonesia. The harvest in South Africa is affected. In addition to changes in the distribution of precipitation, the warming of the Pacific leads to

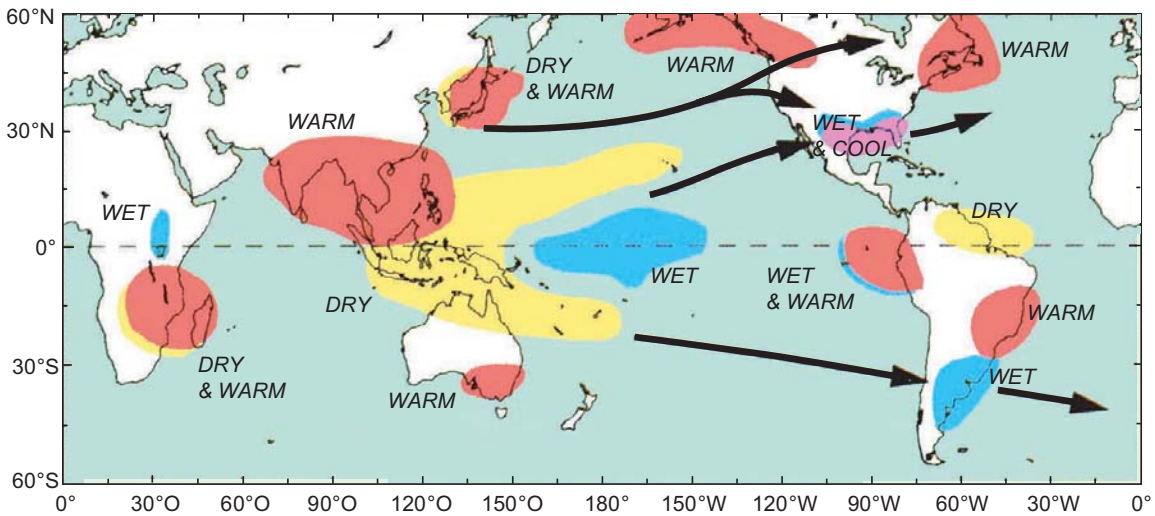


Fig. 5.3.5. Influence of the El Niño effect on the regional climates in Asia, Africa and America. (After Bengtsson 1997)

release of large amounts of CO_2 in the nearby continents. About 1 year later Europe notices the effects of El Niño, i.e. Europe's climate depends on events occurring in the Pacific (Taylor et al. 1998; Rodwell et al. 1999).

North Atlantic oscillation (NAO): This is a current in the north Atlantic corresponding to El Niño which determines the position of a high-pressure area in the Azores and thus the air pressure gradient between the Azores and the low-pressure areas over Iceland. The position of the Azores high pressure decides whether rain falls over the Mediterranean region in summer or over Scandinavia. NAO is positive, with a strong pressure gradient between Iceland and the Azores, a sign of a strong thermo-haline circulation (THC) and thus for a warm winter in northern Europe. Despite the prediction that the THC would decrease with global warming, at the moment an increased THC (possibly transient) is observed (Hurrell et al. 2001).

The *Intergovernmental Panel on Climate Change* (IPCC) discussed the effects that various scenarios of future increased CO_2 concentration would have on climate. The conclusion drawn, in 1996, from a wide scientific forum (Fig. 5.3.6A; Azar and Rodhe 1997), was that a short-term increase in CO_2 concentration to about 400 ppm, but a decrease to 350 ppm within the next 100 years, would increase global temperature by 0.5 K compared to the last 1000 years. A temperature increase of 1 K is regarded as a critical

limit. This limit is exceeded at 450 ppm. In the year 2000 the global CO_2 concentration was ca. 375 ppm and thus 95 ppm above the pre-industrial CO_2 concentration of 280 ppm. In 1998 the temperature increase was 0.75 K, near the critical limit of 1 K. At the moment, a doubling or tripling of the pre-industrial CO_2 concentration is predicted, leading to a calculated temperature increase of 3–4 K. This is confirmed in the third report of the IPCC.

Because of the complicated interaction between oceans and atmosphere, and because weather determines irregularities in marine currents, the validity of the prediction by the IPCC, that man was able to affect global climate, were regarded sceptically for a long time. However, the predictions of the IPCC have been confirmed over time. In 1998 the average global temperature differed significantly from the trend of the last 1000 years (Fig. 5.3.6B; Kerr 2000). The temperature increased by 0.75 K, exceeding the temperature maxima of the last 1000 years. The delay between the increase in CO_2 and temperature is caused by the heat capacity of oceans (they act as a heat sink; Levitus et al. 2000) and the melting of the polar ice caps (energy required to supply the latent heat required for melting; Robock et al. 1999). The observed global increase in temperature since 1960 is confirmed by worldwide analysis of the annual growth rings of trees (see, e.g., LaMarche et al. 1984; Vaganov et al. 1999). It has been shown that the warming of oceans since 1950 was caused by trace gases produced by human activity (Barnett et al. 2001).

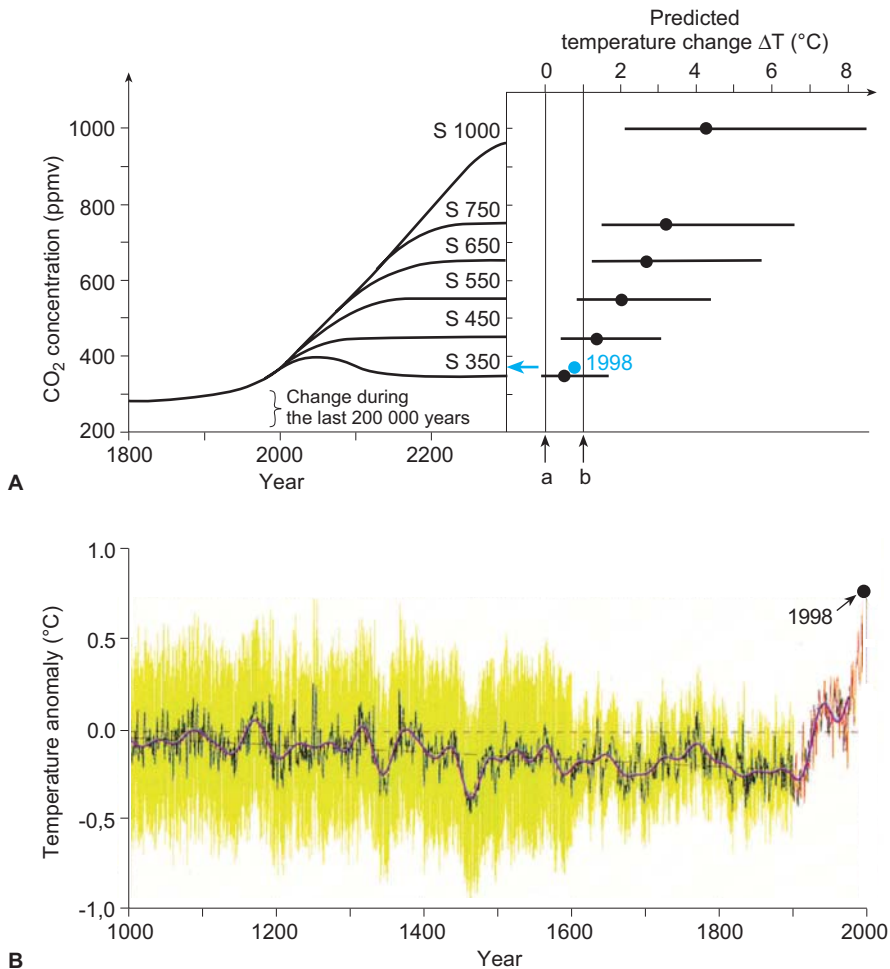


Fig. 5.3.6. A Model predicting the influence of future scenarios of higher CO₂ concentration on the average earth temperature. Shown are the scenarios used (S 350 to S 1000) and on the right the expected changes in the average global temperature. The vertical lines are the average pre-industrial temperature and the critical boundary at which significant effects are expected (1 K temperature rise). Average values are shown with the uncertainties in the predictions (vertical error bars) as well as measured values in 1998. B Global changes in temperature since the year 1000. Long-term trends from 1000 to 1900 (dotted line), the running averages for 30 years (bold line) and 5 years (thin black line), and the yearly extremes (thin red line) and 2-sigma uncertainty in the past (yellow thin line) are given. (After Kerr 2000)

The temperature trend of the last 1000 years shows a slight but continuous decrease up to 1900. The question is whether slight, but natural, fluctuations are noticed at all by man. There are several historic events that correlate with the temperature minima. Around 1200 the last major period of forest clearance started in Europe. In the second half of the nineteenth century large numbers of people emigrated to America after the catastrophic failure of harvests. The minimum at the turn of the century followed the eruption of Krakatau in 1883. The year 1880 is often regarded as the base year of pre-industrial times.

There are indications that anthropogenic sources are no longer the sole cause, but that there is a positive feedback of the temperature increase on respiration (degradation of organic matter; Stott et al. 2000). Schimel et al. (1994) calculated from the Century Model that the global C pool in soils decreases by 11 Gt per K temperature increase (this corresponds to a decrease of soil C by about 0.5%).

The evidence that anthropogenic trace-gas emissions may lead to climate change was the basis for the Framework Convention on Climate Change (FCCC) (Benedick 2001) and the commitment to reduce CO₂ emissions in the Kyoto Protocol (WBGU 1998); see also Chapter 5.4.2.

References

- Azar C, Rohde H (1997) Targets for stabilization of atmospheric CO₂. *Science* 276:1818–1819
- Barnett TP, Pierce DW, Schnur R (2001) Detecting of anthropogenic climate change in the world's oceans. *Science* 292:267–279
- Benedick RE (2001) Contrasting approaches: the ozone layer, climate change and resolving the Kyoto dilemma. In: Schulze E-D (ed) *Global biogeochemical cycles in the climate system*. Academic Press, San Diego, pp 317–331
- Bengtsson L (1997) Modelling and prediction of the climate system. *Alexander von Humboldt Magazine* 69:3–14
- Broecker WS (1997) Thermohaline circulation, the Achilles heel of our climate system: Will manmade CO₂ upset the current balance? *Science* 278:1582–1588
- Commission of Inquiry, Federal Parliament of Germany (1992) *Enquete-Kommission "Vorsorge zum Schutz der Erdatmosphäre" des Deutschen Bundestages*, Müller CF (ed). Economica Verlag, Heidelberg
- Dickens GR (1999) The blast in the past. *Nature* 401:752–753
- Driscoll NW, Haug GH (1998) A short circuit in the thermohaline circulation: A cause for northern hemisphere glaciation? *Science* 282:436–438
- Ehrlich PR, Harte J, Harwell MA, Raven PH, Sagan C, Woodwell GM, Berry J, Ayensu ES, Ehrlich AH, Eisner T, Gould JS, Grover HD, Herrera R, May RM, Mayr E, McKay CP, Mooney HA, Myers N, Pimentel D, Teal JM (1983) Long-term biological consequences of nuclear war. *Science* 222:1293–1300
- Heimann H (1997) A review of the contemporary global carbon cycle and as seen a century ago by Arrhenius and Högbom. *Ambio* 26:17–24
- Hurrell JW, Kushnir Y, Visbeck M (2001) The North Atlantic oscillation. *Science* 291:603–604
- IPCC-WG I (1996) *Climate change 1995; the science of climate change; contribution of Working Group I to the second assessment report of the Intergovernmental Panel on Climate Change*. Cambridge University Press, Cambridge, 572 pp
- Keeling RE, Piper SC, Heimann M (1996) Global and hemispheric CO₂ sinks deduced from changes in atmospheric O₂ concentration. *Nature* 381:218–221
- Kennett JP, Cannariato KG, Hendy IL, Behl BJ (2000) Carbon isotope evidence for methane hydrate instability during Quaternary intertidals. *Science* 288:128–133
- Kerr RA (2000) Draft report affirms human influence. *Science* 288:589–590
- Krüger M, Frenzel P, Conrad R (2001) Microbial processes influencing methane emission from rice fields. *Global Change Biol* 7:49–64
- LaMarche VC, Graybill DA, Fritts HC, Rose MR (1984) Increasing atmospheric carbon dioxide: tree ring evidence for growth enhancement in natural vegetation. *Science* 225:1019–1021
- Levitus S, Antonov JI, Boyer TP, Stephens C (2000) Warming of the world's oceans. *Science* 287:225–229
- Norris RD, Röhl U (1999) Carbon cycling and chronology of climate warming during the Palaeocene/Eocene transition. *Nature* 401:775–778
- Rahmstorf S (1999) Shifting seas in the greenhouse. *Nature* 399:523–524
- Robock A, Stouffer RJ, Walsh JE, Parkinson CL, Cavalier DJ, Mitchell JFB, Garrett D, Zakharov VF (1999) Global warming and northern hemisphere sea ice extent. *Science* 286:1934–1937
- Rodwell MJ, Rowell DP, Folland CR (1999) Oceanic forcing of the wintertime North Atlantic oscillation and European climate. *Nature* 398:320–322
- Schimel DS, Braswell BH, Holland E, McKowen R, Ojima DS, Painter TH, Parton WJ, Townsend AR (1994) Climatic, edaphic, and biotic controls over storage and turnover of carbon on soils. *Global Biogeochem Cycles* 8:279–293
- Sestak Z, Catsky J, Jarvis PG (1971) *Plant photosynthetic production. Manual of methods*. Junk, The Hague, 818 pp
- Stott PA, Tett SFB, Jons GS, Allen MR, Mitchell JEB, Jenkins GJ (2000) External control of 20th century temperature by natural and anthropogenic forcing. *Science* 290:2133–2137
- Taylor AM, Jordon MB, Stephens JA (1998) Gulf stream shifts following ENSO events. *Nature* 393:638–639
- Turco RP, Toon OB, Ackermann TP, Pollack JB, Sagan C (1983) Nuclear winter: global consequences of multiple nuclear explosion. *Science* 222:1283–1292
- Vaganov EA, Hughes MK, Kirilyanov AV, Schweingruber FH, Silkin PP (1999) Influence of snowfall and melting time on tree growth in subarctic Eurasia. *Nature* 400:149–151
- Veizer J, Godderis Y, Francois LM (2000) Evidence for decoupling of atmospheric CO₂ and global climate during the Phanerozoic eon. *Nature* 408:698–700
- WBGU (1998) *The accounting of biological sinks and sources under the Kyoto protocol: a step forwards or backwards for global environmental protection? German Advisory Council on Global Change (WBGU) Special Report 1998*. WBGU, Bremerhaven, 75 pp

5.4

Significance of Changes in Land Use for the Global Carbon Cycle



The Middle East is considered to be the oldest farmed area on earth. Deforestation and agricultural usage over the centuries have led to the erosion of soil from slopes and to secondary deposition of fine material in valley floors. The figure shows an agricultural area near Hebron, currently in Israel. From traces of worn paths it can be seen that the slopes were grazed. Small areas on the lower slopes were used for cereal crops. Fruit trees and cereal crops could only be grown in the floor of the valley where dry stone walls separated the fields and thus prevented loss of topsoil. Barley and wheat were the predominant cereals and almonds, apricots, pomegranates and peaches the main fruit trees. Photo E.-D. Schulze

5.4.1

Land Use and CO₂ Emissions

The influence of CO₂ emissions from burning of fossil fuels on the global climate is intensified by the release of CO₂ from changes in land use (see Fig. 5.2.6). Changes in land use amount to about 20% of global CO₂ emissions – the trend is increasing. Man influences the global C balance by:

- changing forests into agricultural and grazing systems. The biomass of the forest is used as firewood or it is destroyed in slash-and-burn clearing;
- mechanical working of soils of natural grasslands and of converted forest ecosystems. Mechanical working of prairie soils leads over a period of about 50 years to a loss of about

50% of the original natural C contents (Fig. 5.4.1; Matson et al. 1997) due to decomposition of easily mineralisable C compounds. It is unclear why decomposition of soil carbon stops at 50%, despite further working. It has been shown that the black soils of steppes and prairies were formed, to a large extent, from charcoal and soot particles as a result of vegetation burning about 5000 years ago (Schmidt et al. 1999). This black carbon (BC) is resistant to decomposition, even with mechanical working. Less intensive ploughing, the so-called low tillage cultivation, leads to renewed accumulation of soil C. This is caused by accumulation of an easily decomposable humus fraction which, however, can be easily mineralised again after a change of management (deep ploughing following low tillage).

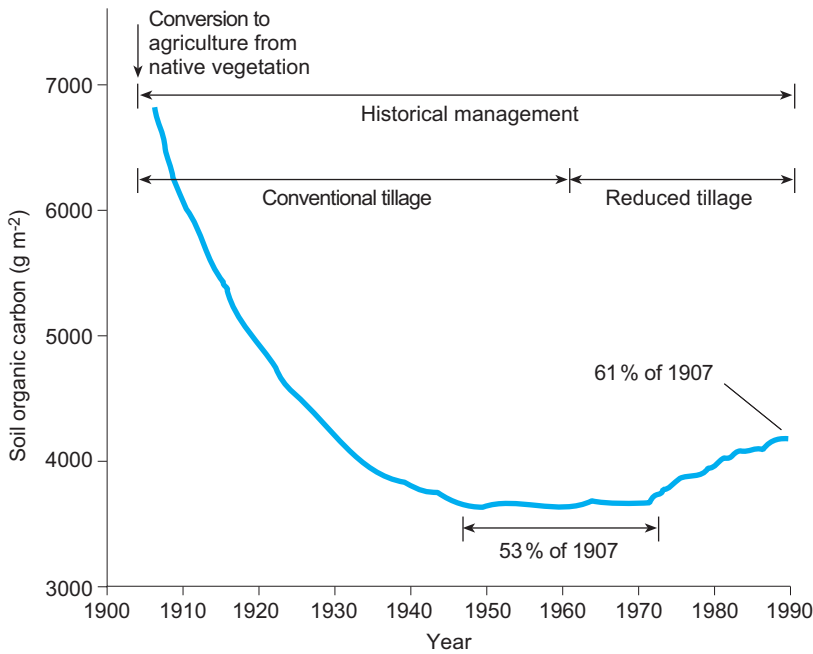


Fig. 5.4.1. Change in the carbon content of agricultural soils after the natural prairie soils were ploughed in 1900. Within 50 years the carbon content decreased to about half of the original value, then remained constant (until 1972) and then increased slightly. Recovery is related to the introduction of changes in ploughing technique, from conventional deep furrows to “reduced furrows” with a plate harrow (low-till). (After Matson et al. 1997)

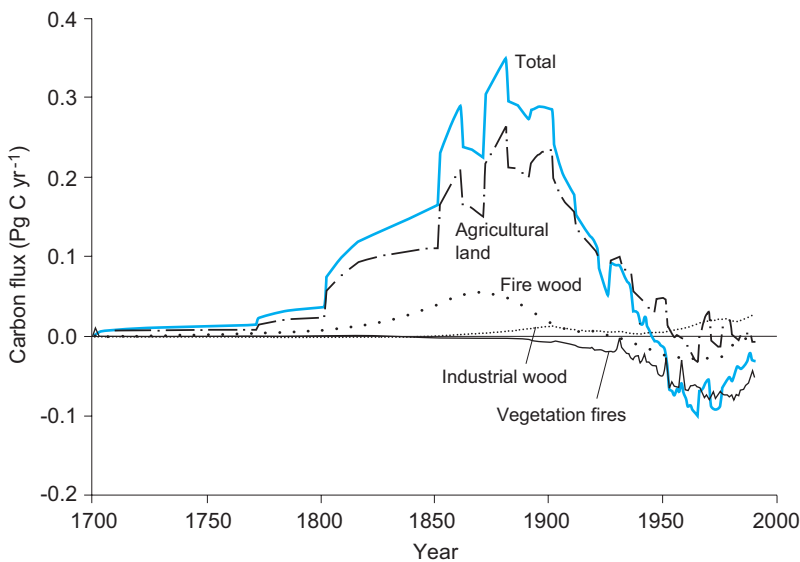


Fig. 5.4.2. Annual emission (source: positive values) and sequestration (sinks: negative values) of CO₂ in the USA from agriculture, forests and through fire. Total emissions from land use reached a maximum in 1900, subsequently they fell, and since 1950 the USA is a sink, due in great part to growth of young forests. The capacity to take up CO₂ has fallen more recently. (After Houghton et al. 1999)

The effects of changes in land use (clearing and mechanical working) on the C balance of a country was analysed, particularly in the USA, as the historical changes since the acquisition of land by European immigrants can still be reconstructed (Houghton et al. 1999). Since the acquisition of land in 1770, up to 1945, about 27×10^9 t C were released by changing grassland into agricultural land, by the use of wood for fuel and industry, as well as fire (Fig. 5.4.2; positive values characterise the flux from the land surface to the atmosphere), which was the domi-

nant factor. The highest annual loss to the atmosphere was 0.3×10^9 t C year⁻¹ in 1880. Release of C decreased after the turn of the century, as most of the large-scale changes had happened by then. Since 1945 the trend is reversed. Because of fire fighting and forest successions on open, marginal agricultural areas, the USA has become a C sink (Fig. 5.4.2; negative values indicate the flow from the atmosphere to the land). The sink capacity has decreased since 1970 and was almost balanced in 1990 (compensation point for C fluxes). The maximum C fixation by

Table 5.4.1. Carbon balance between 1980 and 1989 and from 1990 until 1999 (Gt C). Negative values show a flow from the atmosphere to the land or ocean. Numbers in brackets indicate predicted values. (After Schimel et al. 2001)

	1980–1989	1990–1999
Emissions (fossil fuels and cement)	5.4±0.3	6.3±0.4
Increase in the atmosphere	3.3±0.1	3.2±0.1
Atmosphere-ocean flow	-1.9±0.5	-1.7±0.5
Atmosphere-land flow	-0.2±0.7	-1.4±0.7
Changes in emission due to land use	1.7 (0.6–2.5)	1.6±0.8
Gross terrestrial sink	-1.9 (-3.8–0.3)	-3.0 (uncertain)
Net flow atmosphere-land		
North America	-0.8 (-2.1–0.1)	
Eurasia	-1.7 (-2.5–0.2)	
Northern hemisphere (non-tropical)	-2.4 (-4.3–1.5)	
Tropical and southern hemisphere	-0.4 (-1.2–0.8)	
Global	-2.8 (-4.3–1.7)	

the biological sink corresponded to about 10–30% of the US oil consumption. In 2000 a net sink of $-0.8 \text{ Gt year}^{-1}$ ($+0.1$ to $-2.1 \text{ Gt year}^{-1}$ as flux from the atmosphere into vegetation) was expected for North America (USA and Canada).

Conditions in the tropics are different. Research on the effects of clearing in Brazil shows that this region is at present a C source (0.2 Gt year^{-1}). This development corresponds to the situation in the USA in the year 1850 (Houghton et al. 2000). The tropical region is, despite clearing, a sink of $-0.4 \text{ Gt year}^{-1}$ (-1.2 to 0.8 ; see Table 5.4.1).

5.4.2

The Kyoto Protocol: Attempts to Manage the Global Carbon Cycle

It is clear from the global processes and from their effects on climate as discussed above that it is beyond the scope of a single nation to solve the problems of climate change, loss of biodiversity, destruction of soil, etc. These questions, therefore, were presented at the United Nations Summit Meeting for Climate, Environment and Development (UNCED) in 1992 in Rio de Janeiro. Various proposals were discussed for international conventions to address these prob-

lem areas, and three important conventions were signed (Fig. 5.4.3; WBGU 2001):

- the **Framework Convention on Climate Change (FCCC)**,
- the **convention on biodiversity (CBD)**,
- the **convention to combat formation of deserts (CCD, literally: Agreement of the United Nations to combat formation of deserts in countries heavily affected by drought and/or formation of deserts, particularly in Africa)**.

An international agreement to protect forests was not passed because of conflicting interests. The statement of the IPCC (1996) that “a recognisable influence of man on global climate” exists, resulted in the negotiations of the so-called **Kyoto Protocol (1997)** as part of FCCC. This protocol anticipated a legally binding obligation to reduce the emission of six greenhouse gases (CO_2 , CH_4 , N_2O , CFCs, PFCs, SF_6) on average by 5.2% below the level of 1990 within the period from 2008–2012. The European Union (EU) as a whole promised a reduction of 8%, Germany a reduction of 21%. This obligation to reduce emissions was carried by the 30 so-called Annex I states, i.e. industrial nations and states in transition to a market economy. The other 159 nations of the UN did not agree to such obligations. The ratification is still in progress. The United States decided not to sign the protocol.

Those areas causing global CO_2 emissions are not equally distributed across the globe (Fig. 5.4.4 A; Vitousek et al. 1997). The main sources are concentrated in the eastern USA, central Europe and eastern Asia. The anthropogenic contributions to the carbon cycle thus originate in particular groups of the 189 member states of the UN, that is the Annex I states. The same applies to N depositions (Fig. 5.4.4 B,C; WBGU 2000).

In order to achieve the reduction commitment not only by industrial activities, the Kyoto Protocol, for the first time, considers also an enhancement of biological sinks. The idea was to incorporate biological processes into the calculations, based on the fact that the obligation for a 5.2% reduction is only a fraction of the natural carbon fluxes of assimilation and respiration, and that a slight change in these fluxes would compensate, to a large extent, the obligations for reduction (see Fig. 5.2.5).

The following measures were considered in the Kyoto Protocol (Fig. 5.4.5):

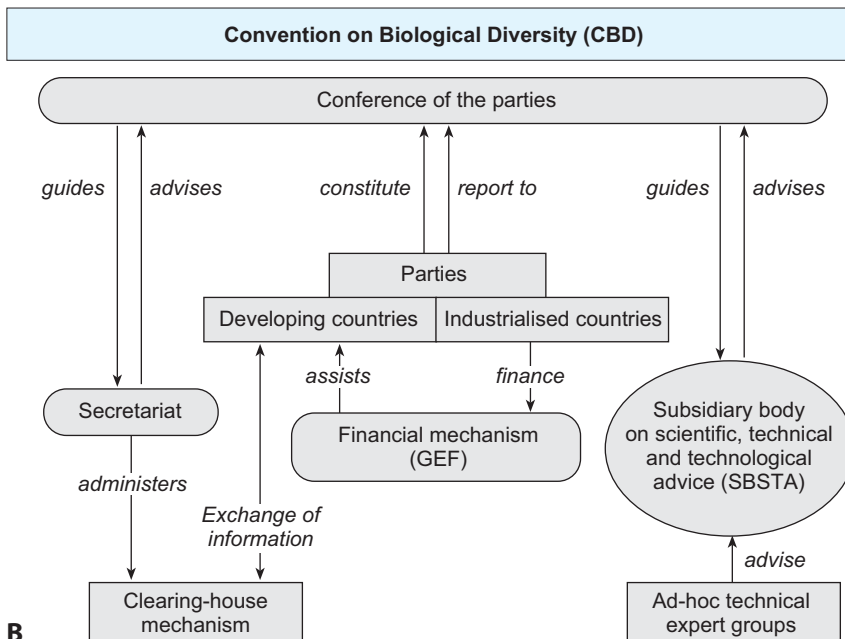
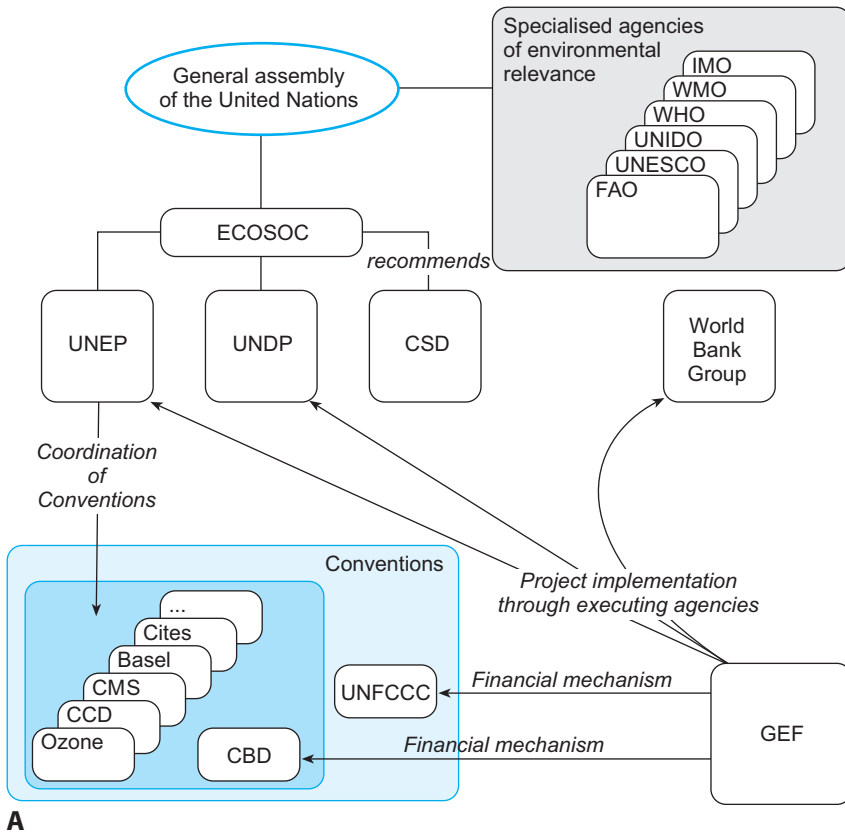
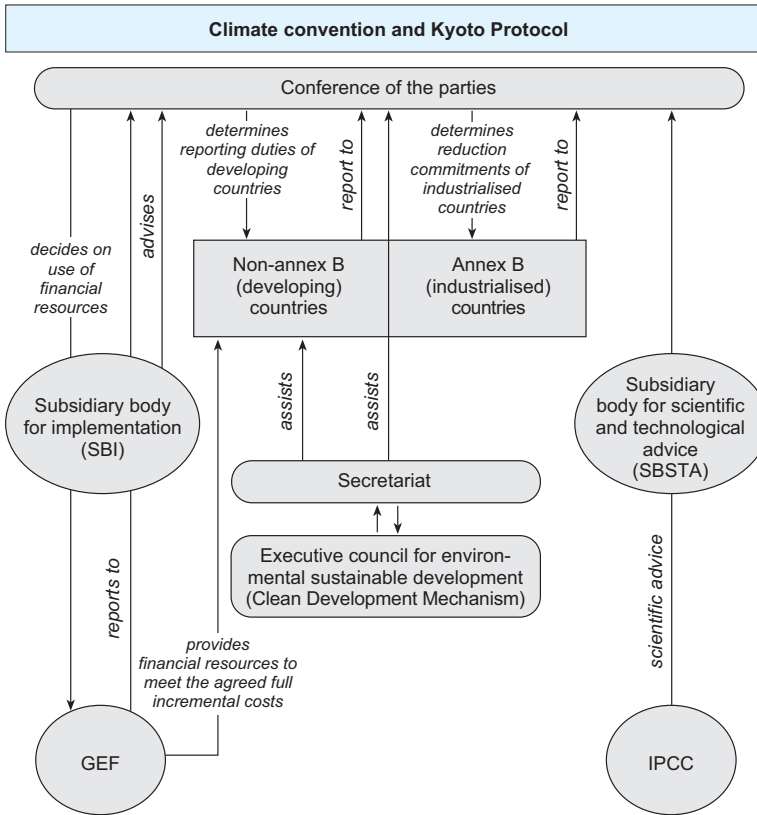
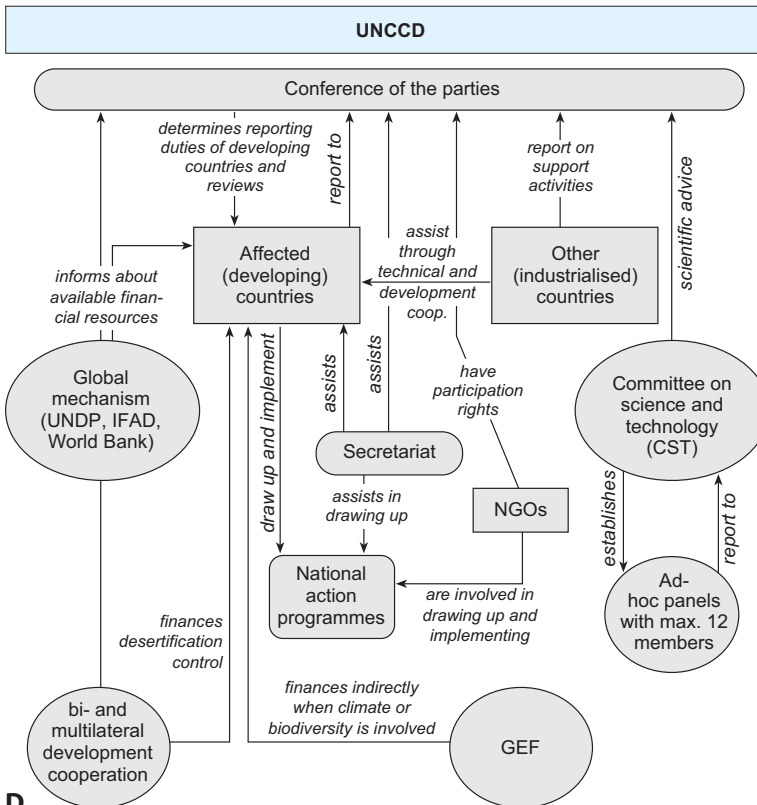


Fig. 5.4.3. A The environment as seen by the UN. The responsible organisations and conventions, as well as the methods of financing, are shown. *ECOSOC* United Nations Economic and Social Council; *UNEP* UN Environment Programme; *UNDP* UN Development Programme; *CSD* Commission for Sustainable Development; *IMO* International Maritime Organisation; *WMO* World Meteorological Organisation; *WHO* World Health Organisation; *UNIDO* UN Industrial Development Organisation; *UNESCO* UN Educational, Scientific and Cultural Organisation; *FAO* Food and Agricultural Organisation; *CITES* Convention on the International Trade in Endangered Species of Wild Flora and Fauna=Washington Agreement on the Protection of Species; *CMS* Convention on Migratory Species; *Basel* Basel agreement on the control of dangerous substances and their disposal across borders; *CCD* Convention on Commencement of Deserts; *UNFCCC* UN Framework Convention on Climate Change; *CBD* Convention on Biological Diversity; *GEF* Global Environment Facility. **B** Institutional structure of the Biodiversity Convention.



C



D

■ Fig. 5.4.3. C Institutional structure of the Climate Convention. D Institutional structure of the Desert Convention. (After WBGU 2001)

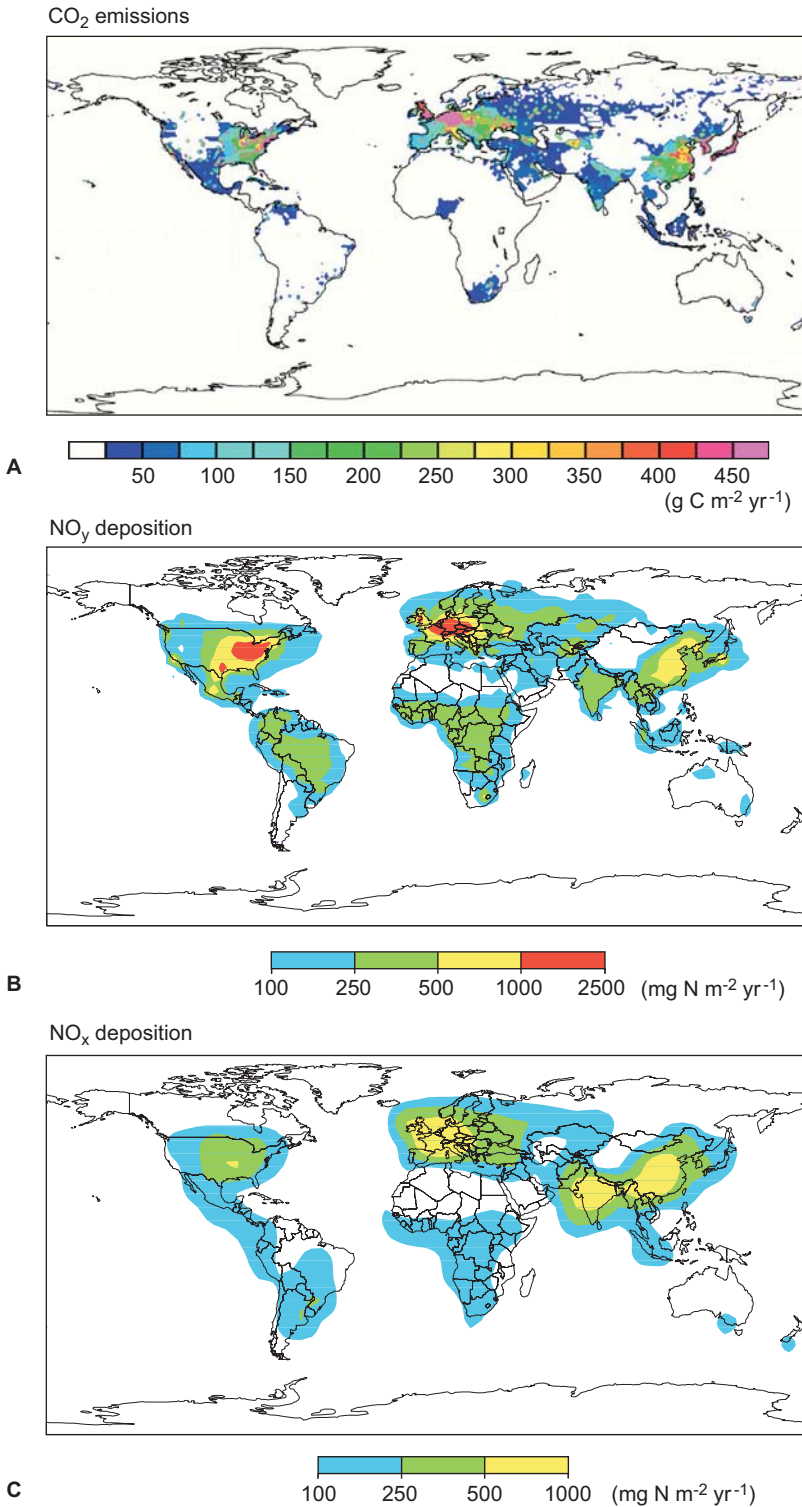


Fig. 5.4.4. A Global distribution of CO₂ emissions. From Vitousek et al. (1997). B Global distribution of oxidised nitrogen. From WBGU (2000). C Global distribution of reduced nitrogen emissions. (After WBGU 2000)

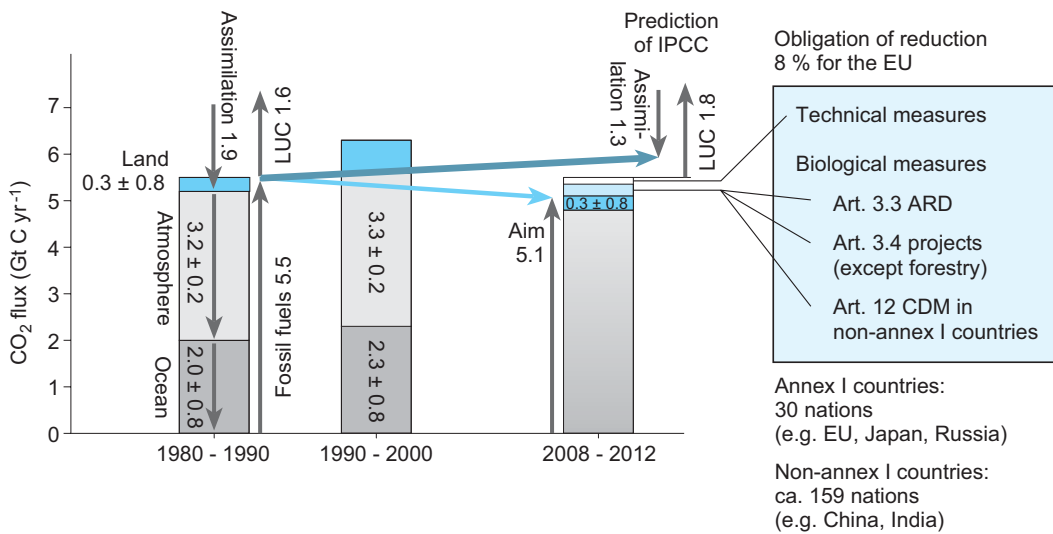


Fig. 5.4.5. *Left* Schematic representation of the global carbon sources and sinks considered important on the time scales of the Kyoto Protocol. *Right* Obligations and legal requirements of the Kyoto Protocol and nations participating in the Kyoto Protocol. *Art* Article; *ARD* afforestation, reforestation, deforestation; *CDM* clean development mechanism. The bars (*left*) show the CO₂ emissions in the years 1980–1990 and 1990–2000, as well as the planned emissions for the years 2008–2012 according to the Kyoto Protocol. The emissions are compensated via CO₂ uptake by the oceans and the land related to change in atmospheric CO₂ concentration. Net assimilation of the land is the consequence of emissions caused by land use changes (clearing, LUC) and net photosynthesis (the balance between photosynthesis and respiration at ecosystem level). The balance between net photosynthesis and emissions from land use was higher from 1990 to 2000 than between 1980 to 1990, possibly because of lower temperatures due to the eruption of Mt. Pinatubo and the effect of this on respiration. (Schulze 2000)

- Technical measures** to reduce emissions in the energy sector (including traffic), industry, agriculture and waste treatment;
 - Increase biological sinks in forests** by promoting afforestation and avoiding clearing (article 3.3);
 - Introduction of **emission reducing measures (article 3.4), e.g. in agriculture**. A conference of the nations bound by the protocol decides which additional measures will be credited and the criteria and guidelines for the obligation to reduce emission. Credit for forest management has been heatedly discussed, as the Annex I nations that are rich in primary forests (Canada and Russia) do not want to be impeded in their use of boreal natural forests, and transformation of primary forests into “sustainable” plantations which are not credited. Points 1 to 3 may be introduced by one nation, either on its own or together with another Annex I state.
 - Trade with emission certificates** between industrial nations is of particular interest to countries not able to reduce emissions in their own country compared to 1990. The trade with emission certificates is also sensible in those cases where a large decrease of emissions may be realised with relatively simple measures (threshold countries).
 - Projects in developing countries** to increase sinks and to reduce emission (e.g. by increasing the efficiency of energy use), the so-called **Clean Development Mechanism (CDM, article 12)**, where an industrial nation finances measures for CO₂ reduction in the area of agriculture and forestry in a developing country. The resulting CO₂ reduction is credited to the industrial nation. The industrial country is awarded rights of possession in the developing nation with forestry CDM projects.
- The measures proposed in the Kyoto Protocol were critically evaluated in WBGU (1998) and Schulze et al. (2002). The ecological effects were (partially) evaluated and discussed in the IPCC report on changes in land use and forestry (IPCC-LULUCF 2000). The main problems are
- The absence of protection of primary, natural forests which are not an “anthropogenic” sink and thus cannot be credited.
 - The “non-credit” of forestry. Problems occur, for example, because **harvest** is not credited as emission, as in sustainable forestry management the harvest corresponds to the in-

crease of biomass in younger stands. Only changing forests into other forms of use (**deforestation**) is calculated as emission, but harvesting prior to land-use change is also not considered as source. In the same way the **change** from primary forest into a forest plantation is not a land-use change and it is thus not calculated as emission. Thus, the Kyoto Protocol contributes to the expressed promotion of anthropogenic increased forest plantations and substantially contributes to the destruction of primary forests as they have assimilation of carbon that is not anthropogenic.

- The **forest** definition (forests are stands with trees greater than 0.5 ha, 2 m in height and with 10% cover) does not protect against degradation (over-use) of forests. Emissions resulting from degradation are not accounted.
- **Support for forest plantations** with fast-growing tree species, which very often are alien to the natural flora (*Eucalyptus* plantations in Portugal, *Pinus radiata* plantations in Chile and New Zealand, etc.). In plantations only the increase in stemwood (NPP) is counted, but not the C balance of the ecosystem (NEP), which contains soil respiration, and soil C may be lost under intensive forest cultivation.
- The transfer of food and wood production to developing nations with simultaneous afforestation (which is credited) in the industrial nations (**leakage**). As areas required in developing countries are made available by clearing primary forests, this process is an emission and not a sink in the global carbon balance. A process is started which begins with the harvesting of forests, which is not credited as emission, continues to degradation (not accounted) and deforestation (e.g. by slash and burn; not accounted in developing countries) and finally degradation to *Imperata* grasslands (see Chap. 4.1), which then are reforested as plantations (credited as sink).

By not incorporating forestry and relocation of production into the developing nations, there are many possibilities for crediting additional anthropogenic sinks, but without taking emissions into account. Only with a complete global and national C balance (**full carbon accounting**, in contrast to the above-mentioned partial processes which may be credited) will it be possible to monitor the goals of protection of the climate

in the Kyoto Protocol (Steffen 1998; Schulze et al. 2002).

In the period from 1980–1990, emissions of 5.5 Gt C year⁻¹ contributed to a large extent to the increased atmospheric CO₂ (Fig. 5.4.5). Net uptake by the land surface was very low in 1990, and was the result of two considerably larger partial fluxes. The CO₂ assimilation of the land surface was almost 2 Gt C year⁻¹, that is 36% of anthropogenic emissions. However, this sink capacity was compensated by forest clearing which released 1.6 Gt C year⁻¹. Basically, afforestation could be attempted or clearing could be stopped; this anthropogenic part of the reduction in emissions can be credited against the industrial emissions in the year 2010.

The reality in 1999 was quite different. Total emissions increased in 2000 to 6.3 Gt C year⁻¹. Surprisingly, the capacity of the biological sink on land doubled. However, this was not because of special human achievements in response to the Kyoto Protocol, but because of reduced respiration as a consequence of transient global cooling resulting from the eruption of Mt. Pinatubo. The increase of global sinks was a consequence of an increase in the ocean sink and not because of a change of the C uptake on the continents.

The predictions of the IPCC for 2010 are very different to those in the Kyoto Protocol (Kaisar 2000). Because developing nations are not obliged to reduce emissions, they will increasingly clear forests, in order to make available areas for the CDM measure of industrial countries. Thus Brazil plans to change 18 million ha of rainforest into agricultural areas for growing soya (Avanca-Brazil project; Bonnie et al. 2000), a goal which is strengthened by the predicted requirements for animal food in Europe as a consequence of the prohibition on use of animal meal because of BSE. This could result in C emissions of about 4.5×10^9 t C, doubling the annual increase of CO₂ in the atmosphere. This emission is not included in the calculations, as Brazil did not agree to the obligation to reduce emissions. In addition there are clearings around newly planned infrastructure and “hidden” (not recognisable on satellite pictures) changes (Nepstad et al. 1999), and the breakdown of fragmented jungle remnants (Laurance et al. 1997). The predicted fragmentation of the Amazon basin is shown in Fig. 5.4.6 A under favourable conditions (little expansion or degradation along the main infrastructure routes) and

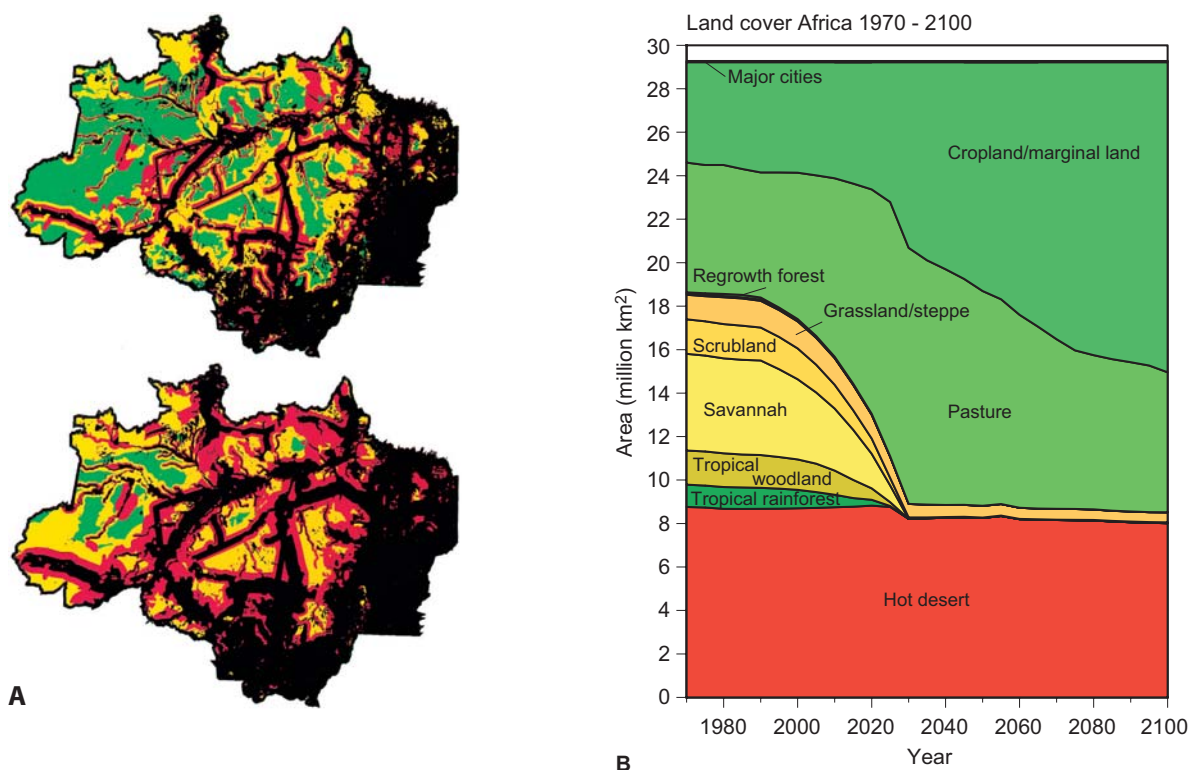


Fig. 5.4.6. A Expected changes in land use in Brazil up to 2020, calculated with optimistic (low rates of degradation along main roads) and pessimistic assumptions (increased land use along main roads). *Black* Deforested or strongly degraded; *red* degraded; *yellow* slightly degraded; *green* virgin primary forest (Laurance et al. 2001). B Changes in the land coverage of Africa from 1970 to 2100. (Leemanns, pers. comm.)

unfavourable conditions (with expansion of degradation along the routes). In any case, up to the year 2010, extensive fragmentation of the Brazilian primary forest is to be expected; in the worst scenario only a few remnants in the northeastern region of the country will remain. Similar predictions are made for Africa (Fig. 5.4.6B), where it is predicted that the primary forest will have to make way for an extension of agricultural areas and grazing land until the year 2020 (Leemanns, pers. comm.).

It is known that agricultural areas in tropical regions cannot be managed sustainably, thus these areas will degrade (Goldammer 1999) and be offered to industrial nations, within the framework of CDM measures for afforestation, at a later date. It will take centuries for the burned and mismanaged areas until forests form a biomass corresponding to that currently seen in primary forests. However, this is not to be expected, as afforestations will be required to yield building materials, fibres and fuels as soon as possible. Therefore, there is no intention to aim at a natural succession, but to establish planta-

tions with fast-growing tree species, fertilised (turnover time for *Pinus* in Brazil is ca. 8 years) without taking into account the effects of forest fertilisation and liming on the atmosphere. The effect of N₂O emissions on climate is a factor of 310 (g g⁻¹) greater than that of CO₂; the conversion factor for CH₄ is 21. It is predicted that in 2010 the biological balance will be shifted further in the direction of CO₂ emission, i.e. the acquisition of land will exceed assimilation by about 0.5 Gt C year⁻¹ (Kaisar 2000). This shows that the crediting of biological sinks within the framework of CDM measures leads to desertification of primary forests and to release of corresponding amounts of CO₂, with subsequent afforestation being very unlikely as long as the developing countries are not obliged to make any reductions in CO₂. Fertilisation of plantations and the N₂O emissions shift the CO₂ equivalent balance further in the direction of increased emissions. Effects on biological diversity are not even considered. Obviously, the implementation of the Kyoto Protocol is difficult because there are so many possible interpretations of what

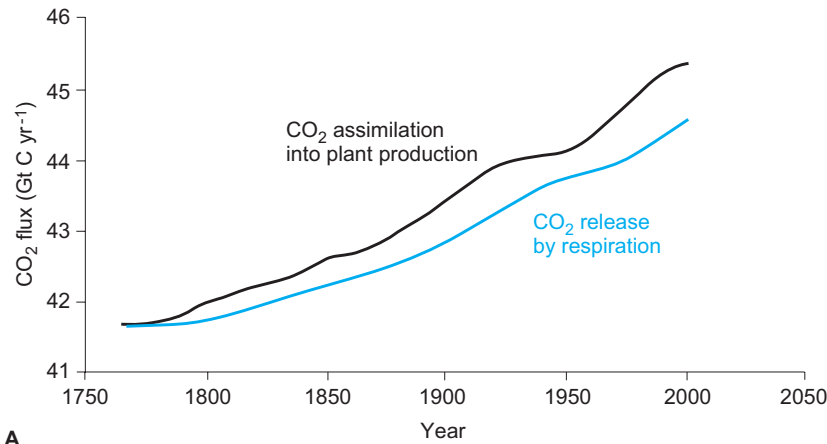
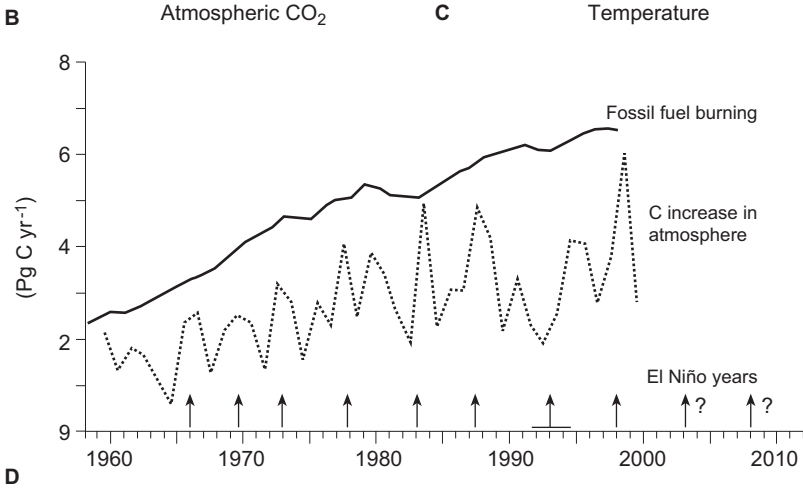
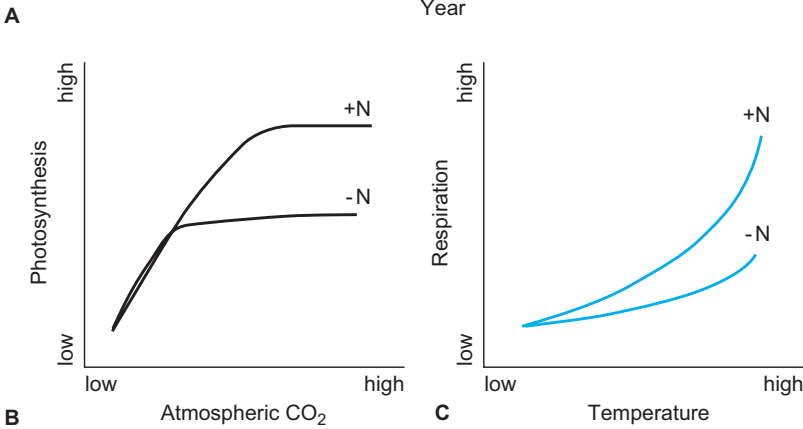


Fig. 5.4.7. A Large-scale change in CO₂ assimilation and respiration since 1750 (from Melillo et al. 1996). Schematic representations of B photosynthetic dependence on CO₂ concentration, C respiration and temperature, D trend in fossil fuel use since 1958 and annual increase in atmospheric CO₂ concentration. Annual changes in the atmosphere are controlled by the equilibrium between photosynthesis and ecosystem respiration (IPCC-WG 1 2001). The arrow on the x-axis shows the El-Niño event. The horizontal line over the x-axis shows when Mt. Pinatubo erupted. The area between the two lines represents the global carbon sink



constitutes a sink that might be taken into account, that emissions are covered (see Chap. 3, Fig. 3.3.9). This became obvious during negotiations in Den Haag (Töpfer 2001) and Bonn (Schulze et al. 2002).

Carbon emissions in the EU₁₅ were 0.905 Gt in 1990. With Norway, Switzerland and the new countries entering the EU the rates of emission will increase in the year 1990 to 1.325 Gt (Germany 0.275 Gt=30% of the emission of EU₁₅). In 1999, C emissions in the EU₁₅ were 0.892 Gt

(-1.5%). The C emissions in Germany decreased in 1998 to 0.239 Gt (-13%).

As the turnover of carbon in the different soil layers requires time, and a large number of soil organisms are involved in humus formation, carbon assimilation precedes decomposition (Fig. 5.4.7 A; Melillo et al. 1996). At the moment, plant production increases because of increased CO₂ concentration but decomposition is delayed by about 30 years. This could change in the future, as photosynthesis may reach saturation with in-

creasing CO₂ concentration (Fig. 5.4.7B). In contrast, decomposition of material by respiration will be stimulated by increasing temperatures and litter fall (Fig. 5.4.7C; see also Chap. 3.2.3). This means that plant production not only fluctuates considerably from year to year (Knapp and Smith 2001), but also that terrestrial ecosystems which are still a C sink at present CO₂ concentration and temperature may become a C source in the future. These differential responses of assimilation and respiration may lead to a self-perpetuating increase in temperature in the predictions by Stott et al. (2000).

The importance of respiration for the global CO₂ balance becomes obvious when the increase of atmospheric CO₂ concentration is considered (Fig. 5.4.7D). There are years with considerable increase in CO₂, followed closely by years with smaller increases. These fluctuations are apparently caused by changes in the ratio of respiration plus fire to assimilation. Years of El Niño events stand out, with very high CO₂ emissions. In 1998 the increase in CO₂ concentration in the atmosphere corresponded to the total consumption of fossil fuels, i.e. in the net balance, continents and oceans did not take up CO₂. The year 1990 is interesting regarding the Kyoto Protocol, as there was no El Niño and the increase in CO₂ concentration was low, i.e. the earth surface was a significant sink.

The Kyoto Protocol is obviously interested in a balance of environmental interests (reduction of emissions) and economic interests (use of primary forests and conversion in plantations). Therefore, the interests of the participating nations in this agreement are important. If the countries are subdivided according to their per head income and the per head forest area (Maini 2000; Schulze 2000), then there is no conflict between Annex I and non-Annex I countries, but there is conflict between forest-rich and forest-poor countries. In countries with high income and large forest area, the concern is sustainable development of the economy, independent of protection of the atmosphere. In countries with low income and large forest area, the use of the primary forest is directly for economic development. Forest-poor countries with low income are dependent on wood imports from forest-rich countries and thus are against protection of forests. There are other countries with high incomes and moderate forest areas that support protection of forests almost in isolation.

From 1989–1998, emissions from burning fossil fuels were on average 6.3×10^9 t year⁻¹ and

the net sink provided by the continents (considering the emissions from changes of land use) was -1.7×10^9 t year⁻¹. If the intention was to balance the total obligations for reduction (5.2% of emissions) by increasing the biological sink then the existing net sink of 0.7 Gt year⁻¹ would have to be increased by 0.33 Gt year⁻¹ by 2010, an increase of 47%. This appears impossible at present. Furthermore, the third IPCC report (Prentice et al. 2001) shows that with afforestation of all areas which have been cleared by man until now, the CO₂ concentrations in the atmosphere would only be decreased in 2010 by 40 ppm, whilst clearing the existing primary forests would increase the CO₂ concentration by about 200–400 ppm.

Independent of attempts to manage the carbon balance, there are also “futuristic” concepts for the technical removal of CO₂ (Keith 2001; Schneider 2001). These include placement of aerosols and reflectors in the stratosphere, so decreasing the net energy load on the earth, or sequestration of CO₂ by storage in deep layers of the ocean or in rocks.

5.4.3

Importance of Climate Change for Europe

A prediction of the effects of an increase in climate-effective trace gases (CO₂, N₂O, CH₄ and others) is only possible using model calculations based on certain “scenarios” of their increase (see Fig. 5.3.6A) and by coupling land, ocean and atmosphere processes to develop understanding of how the climate develops and changes. For Europe, such a model calculation (Parry 2000) has been made with the lower limit of CO₂ increase assumed to be 490 ppm and the upper limit to be 570 ppm in 2100. Since 1970 Europe has warmed up between 0.1 and 0.4 K per decade. It has been shown that the probability of a cold winter (one in 10 years) in northern Scandinavia would decrease to 0% by 2080. At the same time, the probability of a warm summer in northern and central Europe will decrease. However, the probability of a hot summer will increase in southern Europe. These temperature predictions show an increased effect of the Gulf Stream on Europe, with a change in precipitation as an immediate consequence. Ac-

cording to these predictions the Atlantic coast and northeast of Europe will become more humid, but central and southern Europe will become drier.

The predictions may be summarised as follows:

- warming will be greatest across north-eastern and southern Europe. Warming particularly affects winter temperatures (European Russia +0.15 to 0.6 K per decade). The warming in summer is less (0.08 to 0.3 K per decade for central Europe, 0.2 to 0.6 K for southern Europe). The probability that this warming will be a “natural trend” is 5%.
- precipitation is predicted to increase by 1–2% per decade in northern Europe and by 1% per decade in southern Europe. These changes are, to a large extent, within the range of natural variability. Winters will become moister and summers will show a steeper gradient between northern and southern Europe.

For land use in Europe the consequences will be:

- current differences in the water supply between northern and southern Europe will increase. This applies to extreme droughts as well as to an increased tendency of flooding in southern Europe.
- warming of northern Europe will have significant effects on soils (decomposition of humus), with the tree limit of conifers and deciduous species expanding northwards. The frequency of fires in southern Europe will increase.
- the NPP of managed forests in northern Europe will increase but decrease in southern Europe. Yields of agricultural crops are predicted to increase in northern Europe, in southern Europe the increasing drought will limit yields.
- several socio-economic consequences will occur because of the predicted increased gradient between northern and southern Europe. These include changes in the energy sector, changes in tourism (it will be too hot in southern Europe) and changes in the distribution of diseases.

References

- Bonnie R, Schwartzmann S, Oppenheimer M, Bloomfield J (2000) Counting the cost of deforestation. *Science* 288:1763–1764
- Goldammer G (1999) Forests on fire. *Science* 284:1782–1783
- Houghton RA, Hackler JL, Lawrence KT (1999) The US carbon budget: contributions from land use change. *Science* 285:574–578
- Houghton RA, Skole DL, Nohre CA, Hackler IL, Lawrence KT, Chomentowski WH (2000) Annual fluxes of carbon from deforestation and regrowth in the Brazilian Amazon. *Nature* 403:301–304
- IPCC-LULUCF (2000) Special report on land use, land use change and forestry (IPCC-XVI/Doc. 2). IPCC-Sekretariat der WMO, Genf
- IPCC (1996) Climate change 1995. Second assessment report. Cambridge University Press, Cambridge
- Kaisar J (2000) Panel estimates possible carbon ‘sinks’. *Science* 288:942–943
- Keith DW (2001) Geoengineering. *Nature* 409:420
- Knapp AK, Smith MD (2001) Variation among biomes in temporal dynamics of aboveground production. *Science* 291:481–484
- Kyoto Protocol (1997) Kyoto Protocol to the United Nations Framework Convention on Climate Change FCCC/CP/1997/Add. 1. Decision 1/CP 3, Annex 7
- Laurance WF, Laurance SG, Ferreira LV, Rankin-de Merona JM, Gascon C, Lovejoy TE (1997) Biomass collapse in Amazonian forest fragments. *Science* 278:1117–1118
- Laurance WF, Cochrane MA, Bergen S, Fearnside PM, Dalmonica P, Barber C, D’Angelo S, Fernandes T (2001) The future of the Brazilian Amazon. *Science* 291:438–439
- Maini JS (2000) Boreal forests: social, economic and environmental considerations. In: The role of boreal forests and forestry in the global carbon budget. Edmonton, May 8 to 12, 2000, Abstracts
- Matson PA, Parton WJ, Power WJ, Swift MJ (1997) Agricultural intensification and ecosystem properties. *Science* 277:504–508
- Melillo JM, Prentice IC, Farquhar GD, Schulze E-D, Sala OE (1996) Terrestrial biotic responses to environmental change and feedbacks to climate. In: IPCC, Climate change 1995. The science of climate change. Cambridge University Press, Cambridge, pp 445–482
- Nepstad DC, Verissimo A, Alencar A, Nobre C, Lima E, Lefebvre P, Schlesinger P, Potter C, Moutinho P, Mendoza E, Cochrane M, Brooks V (1999) Large-scale impoverishment of Amazonian forests by logging and fire. *Nature* 398:505–508
- Parry M (2000) Assessment of potential effects and adaptations for climate change in Europe. The Europe ACACIA Report. Jackson Environment Institute, University of East Anglia, Norwich, UK, 320 pp
- Prentice IC, Farquhar GD, Fasham MJR, Goulden ML, Heimann M, Jaramillo VJ, Kheshi HS, Le Quééré C, Scholes RJ, Wallace DWR (2001) The carbon cycle and atmospheric CO₂. In: IPCC-WG I third assessment report. Cambridge University Press, Cambridge
- Schimmel DS, House JI, Hibbard KA, Bousquet P, Ciais P, Peylin P, Braswell BH, Apps MJ, Baker D, Bondeau A, Canadell J, Chukina G, Cramer W, Denning AS, Friedlingstein P, Goodale C, Heimann M, Houghton RA, Melillo JM, Moore B III, Murdiyarsso D, Noble I, Pacala SW, Prentice IC, Raupach MR, Rayner JP, Scholes RJ, Steffen WL, Wirth C (2001) Recent patterns and

- mechanisms of carbon exchange by terrestrial ecosystems. *Nature* 414:169–172
- Schmidt MWI, Skjemstad JO, Gehrt E, Kögel-Knabner I (1999) Charred organic carbon in German chernozemic soils. *Eur J Soil Sci* 50:351–365
- Schneider SH (2001) Earth systems: engineering and management. *Nature* 409:417–421
- Schulze E-D (2000) Der Einfluß des Menschen auf die biogeochemischen Kreisläufe der Erde. Max-Planck-Gesellschaft. Jahrbuch 2000, pp 39–58
- Schulze E-D, Valentini R, Sanz M-J (2002) The long way from Kyoto to Marrakesh: implications of the Kyoto protocol negotiations for global ecology. *Global Change Biol* 8:505–518
- Steffen W (1998) The terrestrial carbon cycle: implications for the Kyoto protocol. The IGBP Terrestrial Carbon Working Group. *Science* 280:1393–1394
- Stott PA, Tett SFB, Jons GS, Allen MR, Mitchell JFB, Jenkins GJ (2000) External control of 20th century temperature by natural and anthropogenic forcing. *Science* 290:2133–2137
- Töpfer K (2001) Climate change: whither after The Hague? *Science* 291:2095–2097
- Vitousek PM, Mooney HA, Lubchenco J, Melillo JM (1997) Human domination of earth's ecosystems. *Science* 277:494–499
- WBGU (1998) The accounting of biological sinks and sources under the Kyoto Protocol: a step forward or backwards for global environmental protection? German Advisory Council on Global Change (WBGU). Special Report 1998. WBGU, Bremerhaven, 76 pp
- WBGU (2000) World in transition: strategies for managing global environmental risks. German Advisory Council on Global Change (WBGU). Springer, Berlin Heidelberg New York, 359 pp
- WBGU (2001) World in transition: new structures for global environmental policy. German Advisory Council on Global Change (WBGU). Earthscan, London, 211 pp

5.5

Influence of Human Activities on Biodiversity



Deserts are by no means places of low biological diversity; however, the majority of the plants occur as seeds in the soil (soil seed bank). After periodic, or often very occasional, rain a proportion of the seeds germinate. Germination is species-specific and variable, depending on temperature, intensity of rain and light conditions, etc. Hence the flora changes every time it rains. The photograph shows sand dunes in Harsi Fehl in southern Algeria. Photo E.-D. Schulze

5.5.1

Decrease in Biodiversity

Managing C sinks brings a conflict between the Climate Convention and the Biodiversity Convention, as the Kyoto Protocol explicitly avoids the protection of existing C storage in primary forests and aims at the establishment of plantations with low biomass, but high productivity (NPP), on cleared areas.

In Chapter 4 a detailed case is made that biodiversity means more than diversity of species. Despite this, diversity of species is the only parameter available for an assessment of the situation at global scale. Considering the world map of plant distribution (see also Chap. 4.1), there are 25 so-called **hot spots** (Fig. 5.5.1) – regions with very high diversity and **genetic centres** of crop plants, and they only partially overlap. Originally, these hot spots covered about 12% of the earth's surface. Including the genetic centres, both cover about 20% of the earth's surface. Currently, about 1.1 billion people live on the original

area of the hot spots (Cincotta et al. 2000); together with forestry industries and changes in land use they have decreased these areas to about 1.4% of the earth's surface. If it were possible to protect these residual spaces at present, it would be possible to protect 44% of all plant species, as well as 35% of birds, mammals, reptiles and amphibians. Whether this will succeed depends essentially on ecologists and their ability to bring together diversity and ecosystem research (Schulze and Mooney 1993), i.e. to create a bond between the Kyoto Protocol and the Biodiversity Convention.

The decline in species has several causes (Fig. 5.5.2 A; Schulze and Gerstberger 1993). For Germany, the changes in management of agriculture and forestry are responsible for 50% of the decline in species. The remaining 50% is due to changes in land use (tourism, mining, industry, infrastructure). Some species are also endangered because of scientific research, and from collectors.

In the German flora, orchids are particularly protected, but despite this the distribution of all

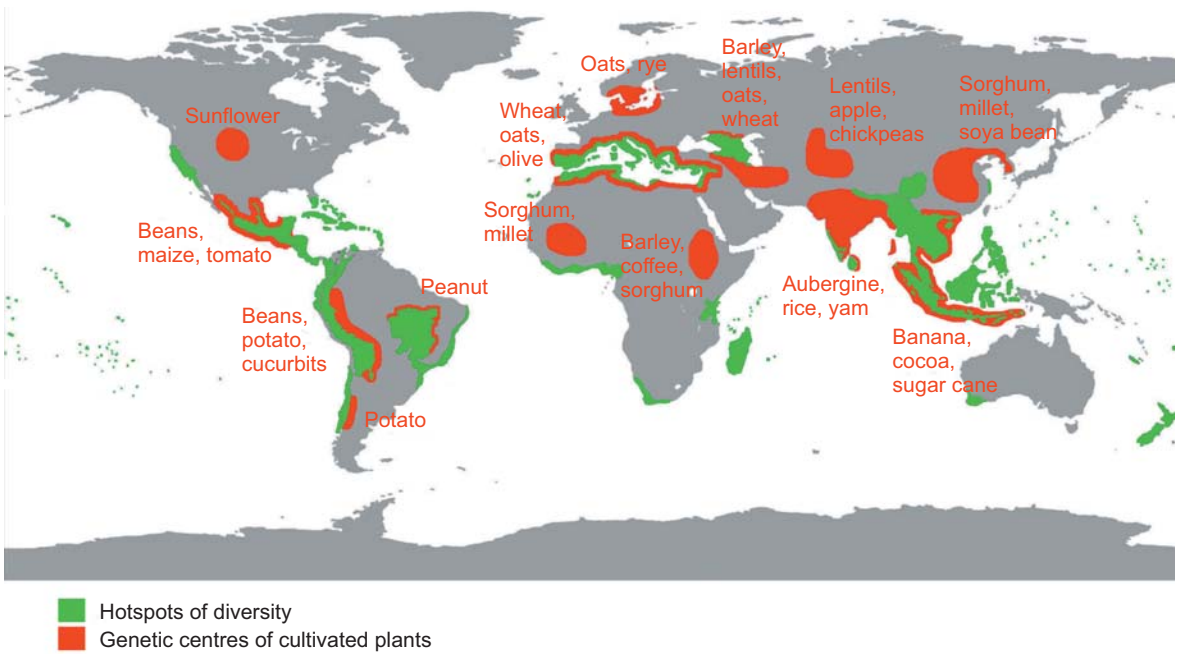
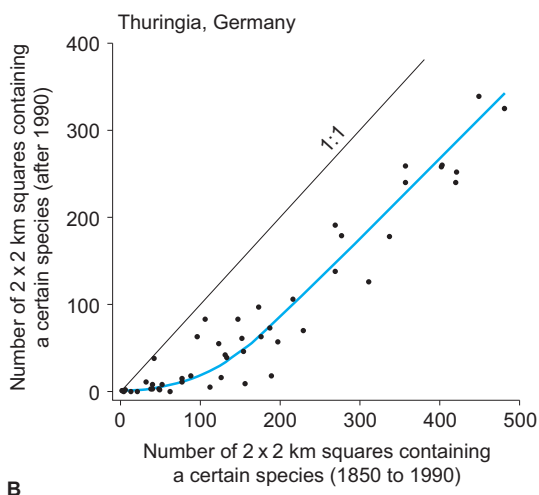
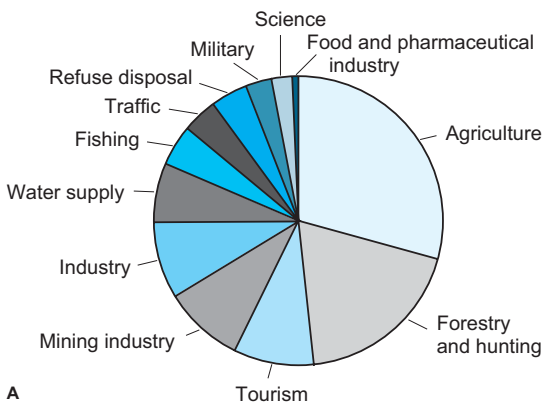


Fig. 5.5.1. Global distribution of the so-called diversity hot spots (Meyers et al. 2000) and the genetic origins of economically important plants (Reid and Miller 1989), with an indication of the most important crop plants



orchid species has significantly decreased (Fig. 5.5.2B). Species covering less than 100 grid cells (2x2 km) at the beginning of the last century are now almost extinct (2000 A.D.), showing the limitations of methods of protection, and also how relatively rare species assume a particular and important indicator function, to illustrate the effects of global change.

The effect of intensified and extended agriculture on the diversity of species can be seen worldwide. It is a direct consequence of increasing populations as well as of changes in food habits, including increased meat consumption which requires more animal feed (only 5% of N eaten by animals is converted into meat). Despite all attempts to increase agricultural production, cereal production per head of the world population (Fig. 5.5.3 A; WBGU 1999) is decreasing at present. With increasing scarcity of food, the scope for reduction of agricultural expansion is very limited, as is the scope for the stabilisation and protection of climate, and also for the

Fig. 5.5.2. A Anthropogenic factors that led to extinction of species in Germany (from Schulze and Gerstberger 1993). B Distribution of species of orchids in Thuringia, Germany, before 1990 (observed since 1900) compared to the period after 1990. All species showed a decline in distribution in about 150 grid cells (2x2 km). Each dot represents a species of orchid

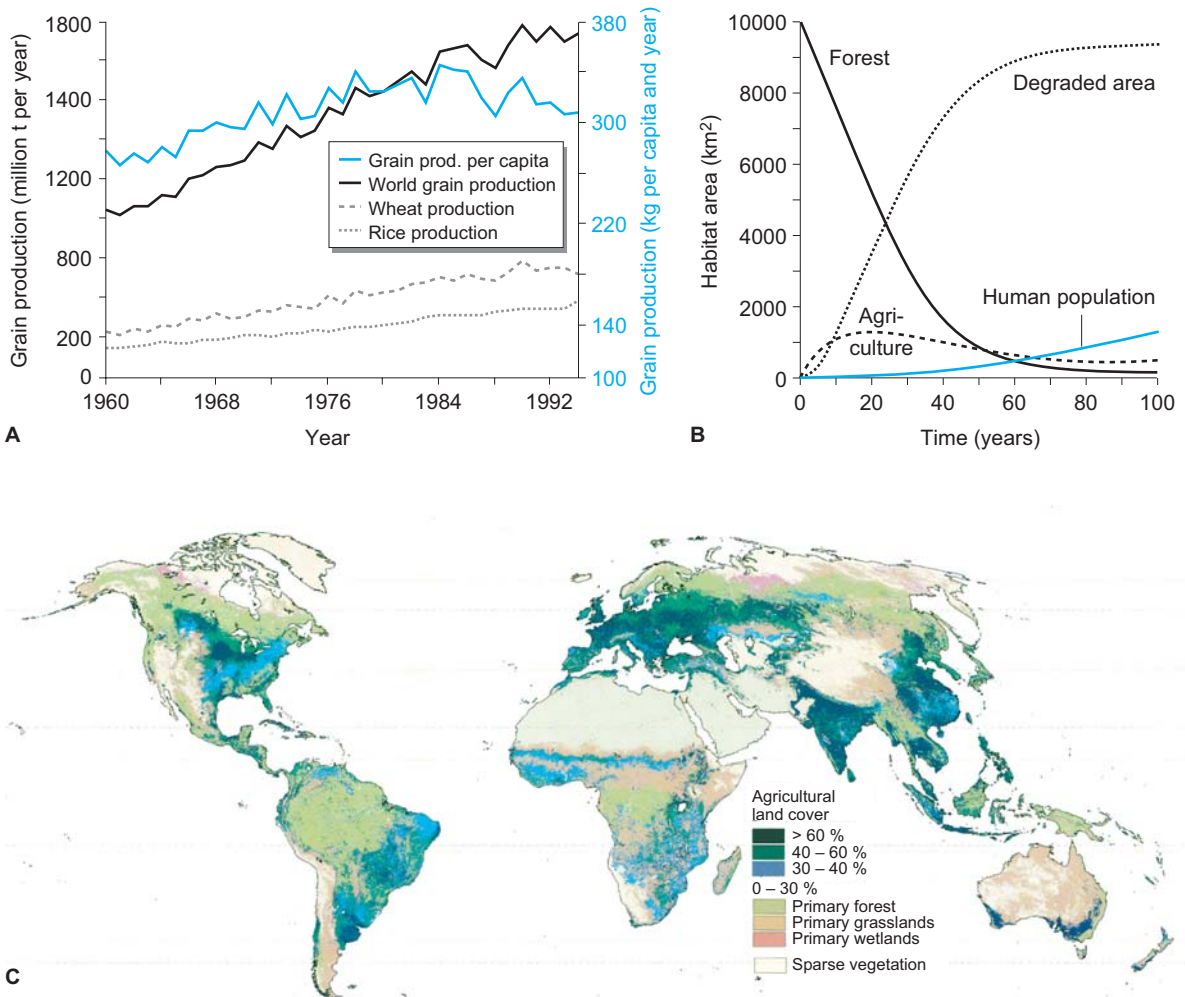


Fig. 5.5.3. A Changes in cereal production since 1960 (WBGU 1999). B A model of dynamic land use and human population on an area of 10,000 km² with an initial population of 50 people. The significant decrease in forest corresponds to the increase in degraded land and a slight decrease in the land available for agriculture is important (after Dobson et al. 1997). C Global distribution of agricultural land, both farmed and grazed. (World Resource Institute 2001)

protection of species. The estimated area of land suitable for agricultural use on earth is between 1.5×10^9 ha (used in 1990) and 4×10^9 ha (WBGU 2001). In 2001 a total of about 3.6×10^9 ha were used for agriculture (1.5×10^9) and for managed grazing (about 27% of the global land surface excluding Greenland and the Antarctic). Agricultural areas (Fig. 5.5.3 B) are concentrated in the temperate zones in the northern and southern hemisphere, India, southeast Asia and southeast Brazil. Large, extensively used regions are the Congo Basin and the Amazon. With steady yields and increasing population the potential agriculturally usable land may not be sufficient to feed humanity in the future. If the agricultural area were to remain constant, yield per area would have to increase by the year

2050 by a factor of 4. The increasing requirement for agriculturally usable land becomes clear from the changes in land use in Africa and South America (see Fig. 5.4.6).

According to model calculations, it is improbable that the estimated maximum agricultural area of 4×10^9 ha will ever be usable at any one time, as erosion, salinization, acidification of soils and other factors will result in a degradation of parts of the area (Fig. 5.5.3 B; Dobson et al. 1997). Obviously, long-term sustainability is not achieved in agriculture. Man continuously wastes land for food production. With degradation, agricultural production has to be relocated to other land and permanently new arable land will be required in order to keep the existing useable agricultural land area constant. Expan-

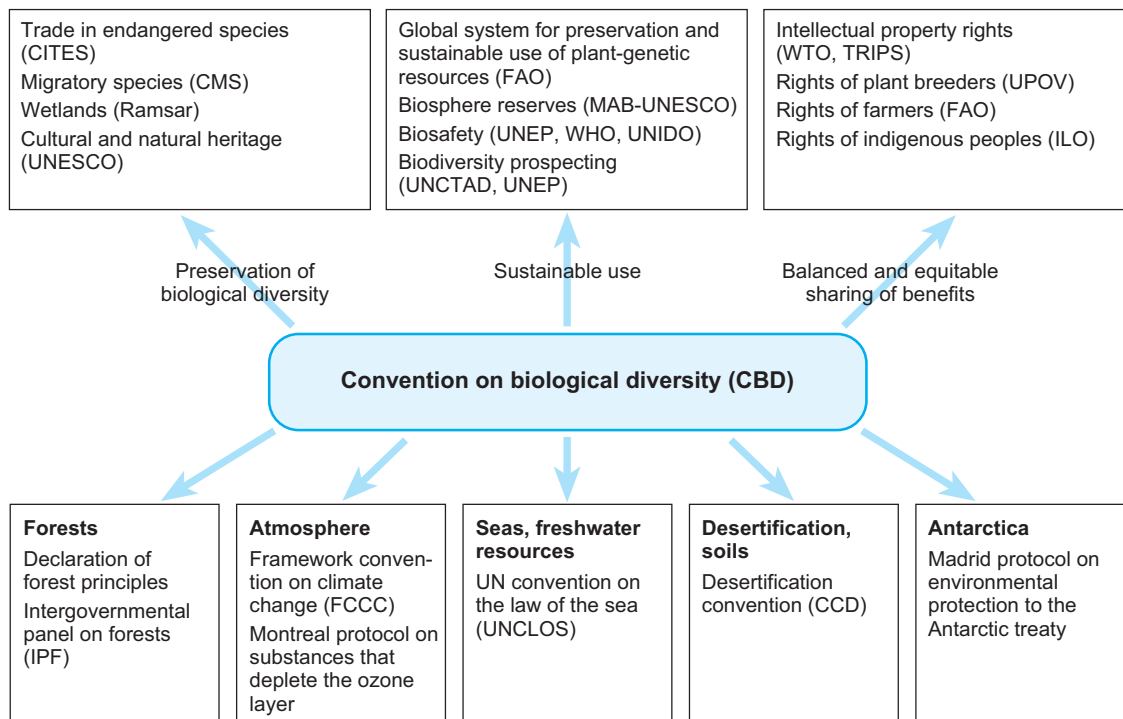
sion and compensation for degradation by agriculture occur primarily at the cost of forests, with the fully degraded areas having the potential to be reforested. This would be good for biodiversity if reforestation is not with fast-growing forest plantations (*Eucalyptus*, *Pinus*

spp.), which are generally monocultures. By implementing the Kyoto Protocol, the probability increases that these degraded areas will never return to a “semi-natural” condition of high biodiversity.

Box 5.5.1 Convention on Biological Diversity, CBD

The Convention on Biological Diversity was signed in 1992 in Rio de Janeiro, and was implemented in 1993; 160 of the 189 countries of the UN are signatories. This is an interdisciplinary convention (see Fig. 5.4.3; WBGU 1999) the goal of which was not only to maintain biological diversity, but also to sustain development and the equity of uses and advantages (Fig. 5.5.4). From this diverse focus and from the all-encompassing starting position stem the conflicts of the dual goals of protection and use, especially at the margins of agriculture and forestry. The convention also clarified the legal principles related to the use of genetic resources; these are no

longer a collective property that all have access to but are property of nations. Thus the interests of industries, the rights of local and indigenous peoples with their traditional knowledge, and the sovereignty of the nations have been brought together. The use of biotechnology (Biosafety) was added as an appendix in 1999. After terrestrial genetic resources belong to sovereign nations, only the sea remains as a collective resource. It is still unclear whether the transfer of the ownership of genetic resources also carries with it the responsibility of nations to maintain them for humanity.



■ Fig. 5.5.4. Integration of the Biodiversity Convention into environmental politics. (WBGU 1999)

References

- Cincotta RP, Wisnewski J, Engelmann R (2000) Human populations in the biodiversity hotspots. *Nature* 404:990–992
- Dobson AP, Bradshaw AD, Baker AJM (1997) Hopes for the future: restoration ecology and conservation biology. *Science* 277:515–522
- Reid WV, Miller KR (1989) Keeping options alive: the scientific basis for conserving biodiversity. World Resource Institute, Washington, 128 pp
- Schulze E-D, Gerstberger P (1993) Functional aspects of landscape diversity: a Bavarian example. *Ecological studies*, vol 99. Springer, Berlin Heidelberg New York, pp 453–466
- Schulze E-D, Mooney HA (1993) Biodiversity and ecosystem function. *Ecological studies*, vol 99. Springer, Berlin Heidelberg New York, 525 pp
- WBGU (1999) World in transition: Ways towards sustainable management of fresh water. German Advisory Council on Global Change (WBGU). Springer, Berlin Heidelberg New York, 392 pp
- WBGU (2001) World in transition: conservation and sustainable use of the biosphere. German Advisory Council on Global Change (WBGU). Earthscan, London, 451 pp
- World Resource Institute (2001) World Resources 2000–2001. People and ecosystems; the fraying web of life. World Resource Institute, Washington, 389 pp

5.6

Socio-economic Interactions



Increased agricultural production was only possible by breeding high-yielding crops. Despite concentration on a few, especially productive, crops it is necessary to maintain diversity, in order to maintain resistance to plant diseases in the high-yielding crops. This resistance is the result of cross-breeding with wild varieties. Genetic material for the maintenance of crop plants is held by international breeding institutes which collect and keep them. So the International Crop Research Institute for the Semi-arid Tropics, ICRISAT, Patancheru, near Hyderabad, India, is responsible for maintenance and breeding of pulses and has played an important part in the "green revolution". The picture shows (*above*) the experimental fields of chickpea (*Cicer arietinum*). Breeding high-yielding types does not necessarily lead to sustainable agriculture. More often exploitation and "dust bowls" are observed, indicating over-use of natural resources. The photograph shows (*below*) a dust storm in the wheat area near Adelaide, south-western Australia. The original grass-eucalyptus vegetation has been completely destroyed and the soil is bare of vegetation for almost half a year, when summer wheat is sown. Photo E.-D. Schulze

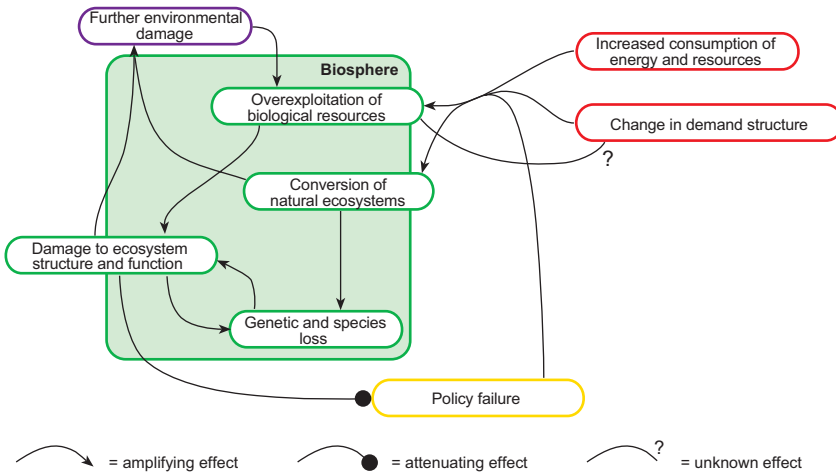
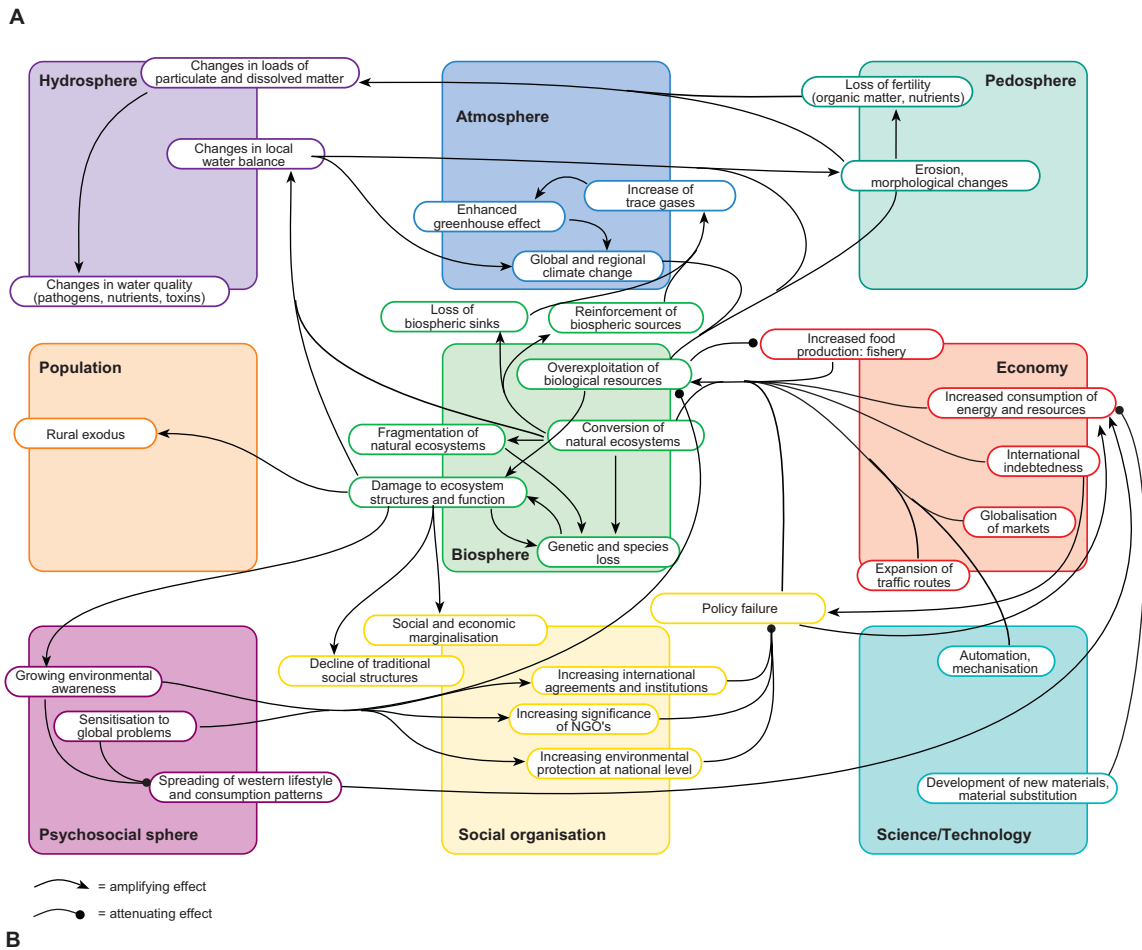


Fig. 5.6.1. A Global trends affecting bio-geochemical events in the hydro-, atmo-, pedo- and biospheres. Also, socio-economic factors such as population size, economic, psycho-social spheres and scientific/technical effects which change the global trends are indicated (WBGU 2001). **B** Example of a systems analysis of the exploitation syndrome. (WBGU 2001)



5.6.1 Syndromes

Previous considerations of C balance show that it is no longer possible to explain and predict global changes on a natural science basis only

(see Fig. 5.1.1, socio-economic feedback; see also Chapin et al. 2000).

To show the interactions with human activities more clearly, the so-called **syndrome concept** was developed. It is based on the view that there are global trends (WBGU 2000), arising from socio-economic as well as edaphic-climatic

Box 5.6.1

List of the syndrome groups as symptoms of global change
(for further information, see WBGU 1993)

1. Syndrome group “use”

- agricultural over-production in marginal areas: Sahel Syndrome;
- exploitation of natural ecosystems: Exploitation Syndrome;
- environmental degradation due to abandonment of traditional land use: Flight from the Land Syndrome;
- non-sustainable management of soil and water: Dust Bowl Syndrome;
- environmental degradation from use of non-renewable resources: Katanga Syndrome;
- containment and damage of natural spaces for recreation activities: Mass Tourism Syndrome;
- environmental damage due to military use: Burnt Earth Syndrome.

2. Syndrome group “development”

- environmental damage through mismanaged or unfinished, central government large-scale “projects”: Aral Sea Syndrome;
- environmental and development problems through adoption of agricultural

management regimes inappropriate to that situation. Green Revolution Syndrome;

- neglect of ecological standards during high economic growth: Small Tiger Syndrome;
- environmental degradation by unregulated urbanisation: Favela Syndrome;
- environmental degradation by planned expansion of towns and industries: *Suburbia* Syndrome;
- individual or localised anthropogenic environmental catastrophes from towns and infrastructure: Havarie Syndrome.

3. Syndrome group “sinks”

- environmental degradation due to large-scale, diffuse distribution of mostly long-lived active substances: High Chimney Syndrome;
- environmental use of controlled and uncontrolled dumping of refuse: Rubbish Dump Syndrome;
- local contamination of environments particularly by industrial sites: Brown Field Syndrome.

factors, which interact in various ways, i.e. they are not independent, but strengthen or weaken each other, and both influence land surface, land use and vegetation. Resulting from this are the so-called **interaction links** (Fig. 5.6.1 A,B; WBGU 2000), changing to “symptoms” or even **syndromes**, in certain circumstances. The syndrome concept thus considers the highly complicated dynamics of man–environment interaction between biosphere, atmosphere, pedosphere and hydrosphere, on the one hand, and economy, population, organisation of societies and psycho-social spheres, as well as science and technology, on the other.

In the following, the distribution of some global syndromes will be described to show that ecology alone will no longer be able to protect natural ecosystems, but that ecology is confronted with land use and over-use of biological resources everywhere on the globe. The essential element of anthropogenic changes in the biosphere is rooted in the socio-economic sphere.

The **Green Revolution** is an example of a syndrome occurring on large areas with direct effects on the ecological situation of a country (Fig. 5.6.2 A; WBGU 1998). The Green Revolution Syndrome describes the rapid modernisation of agriculture with imported, non-adapted agricultural technology over large areas, planned by the nation. Any negative side effects on the natural conditions of production or social structure over large areas are tolerated. In the first stage (1965–1975), the green revolution was effective in combating hunger and achieved the independence of nations from food imports by intensifying agriculture on their own territory. Growing crop plants twice a year led to new employment opportunities; however, these were lost again, because of increasing mechanisation. The decline in traditional agriculture was welcomed as a sign of progress. The high energy consumption linked to the green revolution played no major role at first because of low energy prices. The “oil crises” of the 1970s marked the end of

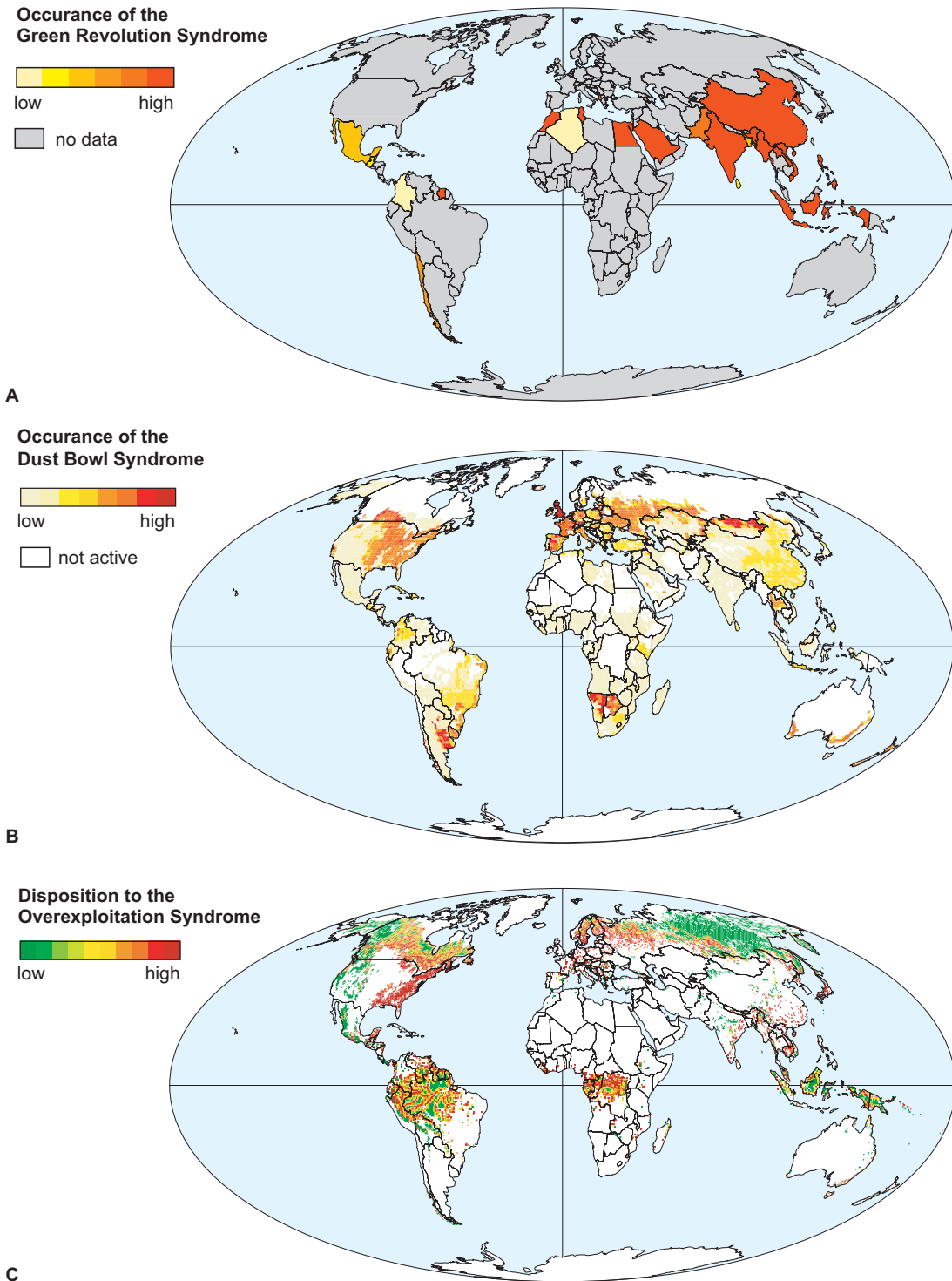


Fig. 5.6.2. Global distribution of **A** the Green Revolution (WBGU 1999), **B** the Dust Bowl Syndrome (WBGU 2000), and **C** the Exploitation Syndrome. (WBGU 2001)

the first phase. In the second stage (1975–1985), negative feedbacks came to the fore. Cultivation of cereals was expanded to climatically and edaphically unfavourable sites, and thus the expected yields were no longer achieved or maintained. The sensitivity of high-yielding varieties to pests and climatic extremes required additional intensification of pest control and irrigation. With decreasing water resources soils became increasingly saline and erosion was an additional consequence. Increasing mechanisation made manual workers increasingly redundant. Feudal power and land holdings resulted in production aimed at export of agricultural products and not at feeding the local population, and increased the trend. This led to the third phase (since the mid-1980s) characterised by food production stagnating or declining. Continued intensification of production (fertilisation, irrigation, pesticides) caused over-exploitation of soils. Resulting from the Green Revolution the Sahel Syndrome developed over time (agricultural over-use); the Fevala Syndrome (uncontrolled urbanisation), the Dust Bowl Syndrome (unsustainable land use) and the Aral Sea Syndrome (mismanaged large projects) followed.

The **Dust Bowl Syndrome** (Fig. 5.6.2B; WBGU 2000) relates to consequences in the natural environment resulting from industrialised, non-sustainable agriculture. The breadth of damage ranges from a change in hydrological conditions, to eutrophication and contamination of surface and groundwater reservoirs, and to losses of biodiversity, as well as to accumulation of pesticides in the food chain (with subsequent health damage), and emission of greenhouse gases (e.g. N_2O). The Dust Bowl Syndrome occurs in industrialised as well as developing countries. Typical for the Dust Bowl Syndrome are intensified agriculture with high-yielding varieties, fertilisation, irrigation and use of pesticides, and increased emission of methane from animal husbandry, as well as increased degradation of soils.

The **Exploitation Syndrome** takes a similar direction to the Dust Bowl Syndrome and the Green Revolution, but this syndrome is not only related to agriculture, but also to forestry (Fig. 5.6.2C; WBGU 2000). The essential characteristic is a discrepancy between the use of natural resources and their natural regeneration. Over-use leads to damage of managed systems, e.g. by soil compaction, erosion, acidification and salination. The exploited region is not regenerated,

rather the next region is exploited. This applies particularly to the use of primary forests. Exploitation is one of the most widespread syndromes covering the largest area. In the tropics it is the conversion of pristine ecosystems into agriculture, whilst in temperate and boreal climates degradation of ecosystems predominates (Fig. 5.6.3; WBGU 2000).

5.6.2

Evaluation of Risks to Biodiversity in Ecosystems

The declining number of species, the necessity to grow agricultural crops and the future aim to use the entire biosphere to compensate for human activities (protection of climate C sinks) requires careful differentiation between divergent aims. From an economic point of view, the problem of sustainable land use is often seen as a conflict between the economic interest for use (particularly of biomass production) and the required protection of the biosphere. The conflict may be solved despite the conflict with economy, as in many cases it is possible to develop protective measures and gradual differences exist. Different types of use exist:

- **protection from use:** This refers to landscape with particular value regarding environmental aspects. These are unique ecosystems (e.g. World Heritage Sites) or regionally important ecosystems needing protection from unlimited economic use (protected forests). Thus, the interest of environmental protection outweighs the economic value. The WBGU (2001) recommends that 10–20% of the earth's surface should be in this category. In 2004, 11% of the land surface was protected.
- **protection despite use:** In this case, exploitation (agriculture, mass tourism) outweighs other considerations. The introduction of environmental protective measures would bring great economic costs from not using the important economic development potential. Nevertheless, even in these intensively used areas, basic principles of environmentally friendly use need to be applied. Winter sport in the Alps and tourism in the Mediterranean region demonstrate that this does not always succeed and it is often too late when long-term consequences are recognised. Observa-

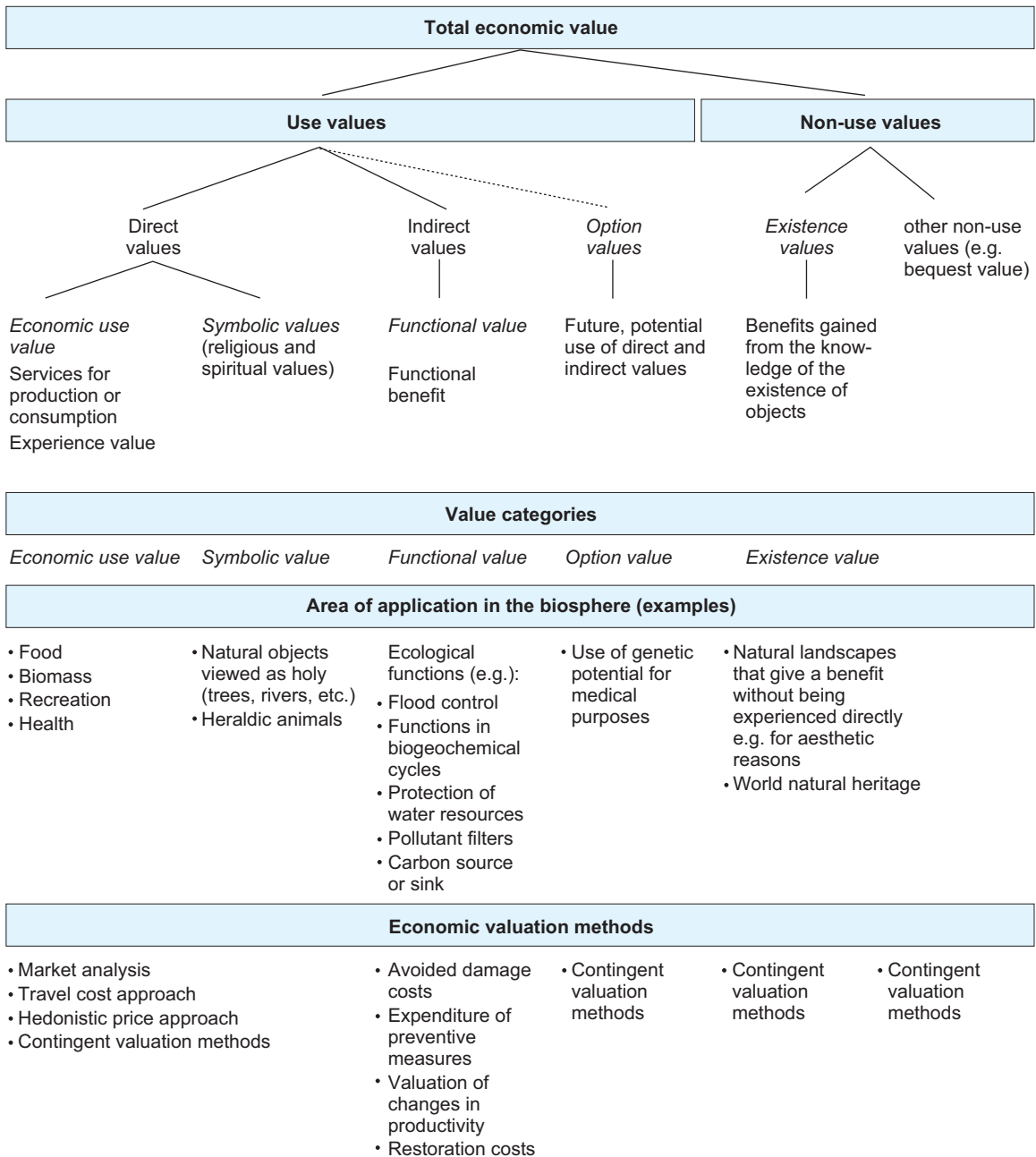


Fig. 5.6.3. Schematic of an ecological evaluation. (WBGU 2001)

tions in national parks in developing countries show an increasing degradation of these protected areas by illegal use (Liu et al. 2001).

- **protection by use:** This type of landscape is characterised by acceptance of a degree of human intervention, but the economic exploitation is limited (e.g. to maintain soils of medium fertility). Thus it is possible to satisfy both needs by natural and infrastructural measures (e.g. targeted tourism in national

parks). With regard to protection of species, protection by use may lead to better sustainability than protection from use.

In the final evaluation of which economic and ecological aims to pursue, it is necessary to also estimate the value of the biosphere (Fig. 5.6.3). The economic evaluation is as follows:

1. Identification of output and services from the biosphere, i.e. economic relevant functions.

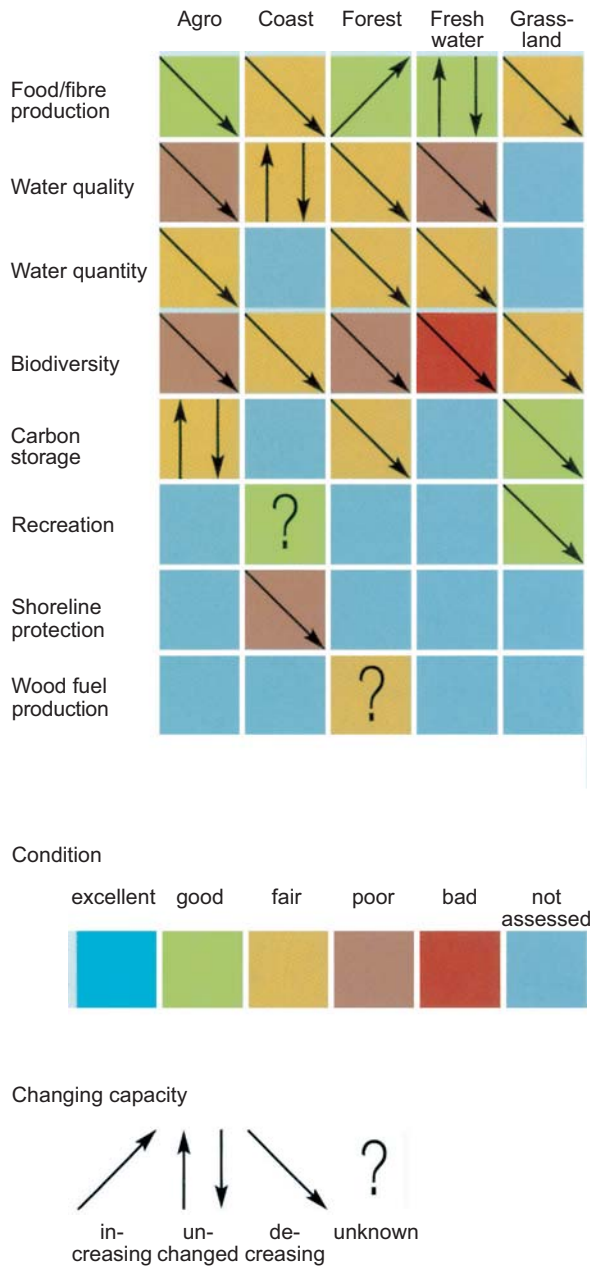


Fig. 5.6.4. Trends in the last 20–30 years in the situation of particular ecosystem “functions” in different biomes. (World Resources Institute 2001)

This step shows that in higher plants, for example, only 70,000 of the total 270,000 species are directly used:

- 3000 species of food plants
- 25,000 species of medicinal plants
- 10,000 species of wood-producing plants
- 5000 species of fibre-producing plants
- 10,000 species which improve sustainability, e.g. plants in the herb layer under an oak forest which help prevent production of sappy shoots by oak and so enable production of good quality veneer

- 15,000 species of ornamental plants
- 2000 species used scientifically

Of the 200,000 species which are not used, 25,000 are protected, and 30,000 are interesting for bioprospecting for future technological development. Thus about 145,000 species remain that are not directly of use to human beings, but fulfil very important ecological roles in the ecosystem, thus contributing to the stability or succession in ecosystems.

Box 5.6.2**Summary: global change**

- The Kyoto Protocol was the start of a new economic age, in which man actively determines the global element cycles through agriculture and forestry, but is not able to recognise the ecological issues appropriately.
- Global collective goods require special protection against economic pressures. Collective goods include the atmosphere, oceans and those parts of the genetic resources not belonging to nations (perhaps the ownership of genetic resources by nations is a step too far). To protect these global goods against the economic interests, organisational structures will be required. Exploitation of the element cycles of the earth is associated with high risks that occur because it is not currently possible to determine the point beyond which the resultant changes cannot be controlled technically.
- Predictions are uncertain as the socio-economic feedbacks have not yet been taken fully into account. The question whether policies such as the Kyoto Protocol's reduction of CO₂ emissions are effective will depend on the globalisation of world trade in developing countries which have no obligations to reduce emissions and which may develop industries with large CO₂ production. In this case the Kyoto Protocol would be met by the industrial nations but CO₂ concentrations would still rise.
- The projections for the biochemical cycles to take in the future require a strong environmental consciousness in all layers of society. People can live and work at much higher or lower temperatures, but agricultural plants and ecosystems are not able to withstand such changes. Beyond this, the carbon cycle is involved in our daily lives via our energy requirements. Therefore, without a deeper understanding of the long-term environmental risks for all human societies, the management of the carbon cycle will not be effective.

2. Monitoring the suitability of a cost benefit analysis for the biosphere. Criteria of limited substitution and irreversibility of damage are in the foreground, restricting the application of economic calculations.
3. Determining the monetary value (monetisation) according to various economic procedures.
4. Calculation of the present monetary value of use of resources; future use and damage need to be discounted at the present value. In this calculation, the determination of discounting factors presents enormous problems.

These considerations of protective categories and economic evaluation result in an **economic total value** (WBGU 2001). There have been very few attempts to work out the total economic value of the biosphere. Costanza et al. (1997) analysed a total of 17 ecosystem outputs (gas regulation, climate regulation, interference regulation, water regulation, water supply, degradation of pollutants, pollination, biological pest control, regulation of habitat, production of food, raw material production, genetic resources, recreation, cultural values) in a total of 12 types of

landscape, and found that the output of the biosphere exceeds economic output (measured as global gross national product) by a factor of 2. Valuation of coastal areas is large, based particularly on their effects on the food cycle.

The enormous speed at which global change is progressing justifies a risk analysis for the changes in material cycles and in climate (WBGU 2000). Analysing the probability of occurrence (P) and the extent of damage (D) (WBGU 2000), a range (P high, D low) of normal everyday risks with which mankind has to live, e.g. domestic refuse dumps, is obtained. There are further limiting areas requiring particular attention which should still be technically solvable, e.g. special refuse such as atomic waste, refuse dumps with P low, D very high, and those which should be avoided under all circumstances and without consideration of cost. In this category, for example, is the danger of reversal of the thermohaline circulation in the north Atlantic. On the path leading to this totally unacceptable range are various uncertain processes which cannot be fully evaluated (P high, D low), but which may reach a point where they can no longer be managed techni-

cally. These are the creeping climate changes, an increasing greenhouse effect and the loss of biodiversity.

Evaluation and risk assessment do not give an analysis of the effects of particular functions that are important to humans caused by changes in global ecosystems. The World Resource Institute (2001) has suggested a simple form of evaluation and indicated the development of “outputs” from five important biomes in the last 20–30 years as shown in Fig. 5.6.4 with arrows. Of the 24 areas analysed, there is only one arrow showing a tendency to increase, and that is the demand and supply for wood which is essentially covered by plantations in the northern hemisphere. All other “ecosystem functions” have decreased in intensity.

References

- Chapin FS III, Zavaleta ES, Eviner VT, Naylor RL, Vitousek PM, Reynolds HL, Hooper DU, Lavorel S, Sala OE, Hobbie SE, Mack MC, Diaz S (2000) Consequences of changing biodiversity. *Nature* 405:234–242
- Costanza R, Darge R, de Groot R, Farber S, Grasso M, Hannon B, Limburg K, Naeem S, O’Neill RV, Paruelo J, Raskin RG, Sutton P, van den Belt M (1997) The value of the world’s ecosystem services and natural capital. *Nature* 387:253–260
- Liu J, Linerman M, Ouyang Z, An L, Yang J, Zhang H (2001) Ecological degradation in protected areas: The case of Wolong Nature Reserve for Giant Pandas. *Science* 292:98–100
- WBGU (1993) World in transition: Basic structure of global human-environment interactions. German Advisory Council on Global Change (WBGU). *Economica*, Bonn, 224 pp
- WBGU (1999) World in transition: Ways towards sustainable management of freshwater resources. German Advisory Council on Global Change (WBGU). Springer, Berlin Heidelberg New York, 392 pp
- WBGU (2000) World in transition: Strategies for management of global environmental risks. German Advisory Council on Global Change (WBGU). Springer, Berlin Heidelberg New York, 359 pp
- WBGU (2001) World in transition: Conservation and sustainable use of the biosphere. German Advisory Council on Global Change (WBGU). Earthscan, London, 451 pp
- World Resource Institute (2001) World Resources 2000–2001. People and ecosystems; the fraying web of life. World Resource Institute, Washington, 389 pp

Subject Index

A

ABA see abscisic acid

Abies 476

– *alba*, silver fir 475, 613

– *cilicica* 499

– *pinsapo* 499

ABRE (ABA responsive element) 127, 141

abscisic acid (ABA) 10, 87, 92, 105, 123p, 132, 140, 151–154, 167, 173, 241, 299, 300, 434

– β -D-glucose ester, structure 124

– gene expression 127pp

– 8'-methylene-ABA 125

– receptor 126, 141

– responsive element 92, 127, 187

– sensitive gene 141

– structure 125

– transcription factors 193

– transporter 231

abundance of different

species 555

Acacia 360

– *albida* 478

– *cambaei* 342

– *ciliata* 285

– *detinens* 272

– *ehrenbergiana* 510

– *karroo* 285

– *oerfota* 510

– *reficiens* 274

– *tortilis* 510

Acanthosicyos

– *fuscata* 223

– *horrida* 272

ACC oxidase 106pp, 114p

ACC synthase 106, 114

accumulation, resources 377, 385

Acer 471, 475, 544

– *campestre* 294, 391p

– *monspessulanum* 552

– *pseudoplatanus*, sycamore 613

– *saccharum*, sugar maple 26, 290p

acetaldehyde 102

acetogenic microorganisms 432

acetylcholine 213

acetyl-CoA-synth(et)ase 66

acetylserine 335

achory 545p

acid

– deposition 408

– indicators 341

– growth 107

– phosphatase, cadmium

sensitive 185

– purple moor grass meadow (*Molinia caerulea*; Molinion) 489

– rain 217, 221, 231, 492

– small sedge marsh, *Carex nigra* 489

acidic anions 456

acidification of soil 221, 407p

– water 317

acoenic 599

Aconitum napellus 341

Acorus calamus, sweet flag 103, 105

acrotony 390

actin filaments 200

activation energy 49

actual niche 616

1-acylglycerol-3P-acyltransferase 66

Adansonia digitata 387

adaptation 254, 563

adaptive strategies 533

Adenium obesum 510

Adenocaulon bicolor 363

adenosine phosphosulfate (APS) 222, 335

S-adenosyl methionine (ado-met) 106, 163

adenylate energy charge (AEC) 102

ado-met synthetase 106

Adonis aestivalis 341, 487

Adonis vernalis 477, 552

ADP-glucose-pyrophosphorylase 338

ADP-ribose 125

Aegialitis, mangrove 163

Aegopodium podagraria 386

Aeonium 551

aerenchyma 99, 100, 102

– formation 106pp

aerial roots 123

– of *Ficus* 389

aerosol

– and climate 644p

– and rainfall 636

– formation 636

Aesculus 471

afforestation 480

African violet 12p, 94

Agaricus 186

Agassiz 644

Agatis australis 387p

Agave deserti 137, 386, 499

ageing and decaying phase 524

agochory 543

AGPase 53

agriculture 479

– and biodiversity 664

– and carbon dioxide emissions 655

– expansion 664

– land 428

– landscape 487

– methods 480

– productivity 451

agriophyte 493

Agrobacterium 19p, 216

agrochory 545

agroforestry 481, 506

Agropyron 474

– *junceum*, couch grass 386, 583

– *repens* 386

Agrostis tenuis 176

ahemerob 495

Ailanthus altissima 496

air humidity 366

air pollutants, nitrogen 328

air pollution 457

– controls 215

– SO₂ damage 322p

air seeding 293

air temperature 581

Aizoaceae 137

Aizoon 500

Alachlor 213

alanine 350, 352

β -alanine 163, 188, 193

β -alaninebetaine 132, 133, 163

albedo 255, 581

alcohol dehydrogenase 102, 103, 230

alder see *Alnus*

aldolase 103

Aldrovanda 332

alfalfa, decoupling factor 307

algae 278, 450

– carbon dioxide concentration 351

– temperature resistance 46

Algoncium 469

alien species 599

alkaline saturation 444

alkaloid 235, 342p

alkoxiradicals 69

alkylhydroperoxides, detoxification 242

allantoine 333p

allelopathy 250, 604, 607p

– intraspecific 250

– substances 584, 607

allene oxide cyclase 241

allene oxide synthase 241

Alleröd 476

Allium porrum 178, 488

Allocasia macrocarpa 386

allochory 543

allometry 392

- allopatric differentiation 550
allophan 315
allylthiocyanate 236
Alnus 474, 476
– *glutinosa* 108, 552, 613
– *viridis* 475
Aloe 137
Alopecurus pratensis 611
alphanoleic acid, melting point 49
alpine grass lands 380, 552
Altaea 372
altitude, changes in 552
aluminium 195–206, 408p, 458
– and elongation growth 198, 205
– buffer range 408
– complexed 196
– exclusion 200–206
– mononuclear 196
– oxalate 204p
– polynuclear 196
– resistance 200–206
– toxicity 195–206
– trap 201
– uptake 196
Amaranthus 499
– *albus* 490
Ambrosia 372
– *dumosa* 287
amensalism 586, 604, 606
amino acids 324
– as nitrogen store 333p
– uptake 326
 γ -amino butyric acid (GABA) 103
amino substances 320
1-aminocyclopropane-1-carboxylic acid (ACC) 106p, 213, 229
aminoethoxyvinyl glycine (AVG) 106
Ammi majus 499
Ammi visnaga 499
ammonia
– and ammonium 335
– and nutrition 329
– diffusion resistance 220
– production 638
ammonium 320, 328, 416
– cation 324
– excess 443
– nutrition 326
– uptake 326
– use 330
Ammophila arenaria 582p
amphiphilic lipids 75
amphiphilic molecules 118
amplification element 141
Amyema maidanii 342
amygdalin 236
 α -amylase 167
 β -amylase 102
Anabaena 604
anabolic metabolism 102
anaerobic polypeptides (ANP) 103, 115
anaerobic response element (ARE) 103, 115
anaerobic retreat 104
anaerobic stress proteins (ASP) 103
anaerobiosis 105p
Anagallis arvensis 499
Anagallis foemina 499
Anaseris minima 383
Anastatica hierochuntica 544
Andropogon 353
anemoballochory 543
anemochory 543, 546
Anemone 269
– *nemorosa* 268, 511
– *sylvestris* 552
angiosperm 471
– period 471
– diffuse porous 292
– ring porous 292
anhydrase 320
animals
– as vectors of diaspores 533
– communities 585
– congregation 597
– rearing 490
– which burrow 588
anion exchange capacity (AEC) 318
Anisotes trisulcus 510
annual plants 371, 373, 380pp, 427
– in deserts 513
anoxia 100, 105, 114
– avoidance of 115
antagonism 604
– promotion of 595
Antarctica 471, 554p
antenna growth 272p
antenna, peripheral or mobile 27
Anthemis arvensis 341
antheraxanthin 124
– structure 35, 42
anthocyanin 17, 132
– in young leaves 40
anthranilic acid 213
anthropochory 493, 545
antibiosis 595, 604, 607
antidotes 208, 211, 231
antifreeze protein 62, 83pp, 96
antiport 321
Antirrhinum majus 27
antixenosis 594
apatite 337
apophyte 493
apoplast 119, 126, 147–149, 154, 287p, 318
apoptosis, programmed cell death 106, 115
apples 499
appressorium 249
aquaporin 64, 119pp, 121, 140, 288
– hour glass model 120
Arabidopsis 65, 92, 110, 119, 123, 128, 133, 151, 153, 172, 187, 192, 196, 211, 214, 229
– aluminium resistance 203
Arabis hirsuta 548
arable field, carbon degradation 430
Araceae 255
arachidonic acid 49, 246
Arachis hypogaea 545
Aral Sea 635
– syndrome 671p
Araucaria 471
Arbutus andrachne 552
Arbutus unedo 552
Archaeon 469
archaeophyte 487p, 493
archetypal fern 470
arctic 552p
Arctium lappa 341, 384
Arctium tomentosum 382p
Arctostaphylos alpinus 552
arcto-tertiary relics 473
area
– actual 550
– alone hypothesis 556
– characterisation 550pp, 555
– definition 548
– potential 550
– reduction 550
– shifts 549p
– species, relationships 555
– types 552
Argania spinosa 596
arginine 103, 333p
arido-active 286
arido-passive 286
Aristida 353
– *sabulicola* 285
Aristolochia arborea 510
Arrhenatherum elatius 511, 611
arrowhead 106
arsenic 176
Artemisia 474, 476
– *austriaca* 511
– *californica* 250
– *tridentata* 294pp, 420
– *vulgaris* 482
ascorbate 69, 95
– oxidase 182
– peroxidase 69p, 129p
ash, *Fraxinus excelsior* 111, 314, 333, 613
asparagine 103, 333p
aspartate 351p
aspen 597
Asphodelus
– *fistulosus* 500
– *macrocarpus* 500
– *tenuifolius* 500
assimilation
– CO₂ see photosynthesis and carbon dioxide assimilation
– N see nitrate reduction, ammonium uptake, nitrogen fixation
associations 600
assortative species equilibrium 603
Aster
– *alpinus* 477
– *lanceolatus* 497
– *tradesantii* 497
Asteris 342
asteroid impacts 468
astragaline 41p
Astragalus 372
– *armatus* 499
– *danicus* 552
– *glycophyllos* 513
– *pattersoni* 191
– *spinosus*, balloon flier 544
Aswan dam 635

- atelochory 543, 545p
 atlantic 552p
 – period 475pp
 atmosphere
 – as habitat 257
 – carbon dioxide concentra-
 tion 642pp
 – composition 256, 280
 ATPase 146
 ATP-synthase 28
Attractylis serratuloides 499
 Atrazine 208–210, 213
Atriplex 294
 – *confertifolia* 511
 – *hymenelytra* 155
 – *nummularia* 153, 167
 – *patula* 364
 – *rosea* 364
 attractant 236
 augite 317
 Australis 471, 554p
 autecology 253–399
 – definition 254
 autoballochory 543
 autochory 542–646
 auxin 105
 Avanca-Brazil project 656
 avenic acid 180
 avocado 77
 avoidance 39
 – of freezing 87p
 – of heat stress 60
 – of salt stress 171
 – reactions 105
avr gene 248, 252
 awns 383
Azolla 605
Azospirillum 605
- B**
- Bacillus cereus* 77
Bacopa monniere 510
 bacteria 470
 – antifreeze protein 83
 – temperature resistance 46
Balanites aegyptiaca 478
 ballochory 543
 balloon flier, *Astragalus spinosus*
 544
 banana 481
 bark borers 595
 barley, *Hordeum vulgare* 19, 128p,
 131p, 187, 375p, 481p, 499
 – salt stress 146
 barochory 543, 546
Bartsia 607
 base cation buffer range 408
 base saturation 317
 basic leucine zipper 127
 basitonic growth form 391p
 Basta, phosphinothricin 209p, 216
Bauhinia purpurea 544
 beaker flower 590
 bean 273
 – aluminium sensitivity 204
 – cadmium content 184
 – ozone sensitivity 227
 Bedouin 373
- beech, *Fagus sylvatica* 26, 227, 229p,
 255, 271, 330, 367, 391p, 431, 480,
 499, 549, 552, 584, 597, 613
 – forest 485
 – hazel 483
 – leaf development 367
 – sun burn 272
 beet, ozone sensitivity 227
 beetle dynamics 602
 beetles as pollinators 590p
 begonia, ozone sensitivity 227
 behaviour conservative 371
 bell flower 590
Bellis perennis 511
 Benomyl 208p
 benzaldehyde 236
 benzimidazol, structure 209
 benzoic acid 248
 benzoyl-CoA 248
 benzoyl-glucose 248
Berkheya caddi 191
 beryllium 197
Beta vulgaris 153
 betaine 60, 129, 172
 betainealdehyde-dehydrogen-
 ase 163pp
 betalain 132
Betula 471, 476
 – *nana* 474, 477, 552
 – *pendula*, silver birch 613
 – *pubescens*, birch 227, 393, 613
 – *verrucosa* 552
Betulo-Quercetum 492
 Biber ice age 472
 biennials 382
 biman-glutathione, structure 212
 bindweed 50
 biocenology 598pp
 biocenose 579, 585, 598pp
 – definition 599
 biocentric 579p
 – basic laws 566
 – equilibrium 598
 – principles 598p
 biodiversity 412, 562, 626
 – and ecosystem
 processes 449–464
 – and man 633–677
 – and stability 571pp
 – convention 666
 – convention (CBD) 652
 – definition 571
 – evaluation of risks 673p
 – hotspots 575
 – organisational levels 568
 bioerosion 583
 biogenic sediment 583
 biogenic weathering 580
 biogeochemistry 626
 biolistic cloning 19
 biological pest control 506
 biomass 380, 428p
 – above ground 375p
 – formation 410
 – permanent 427
 biomembrane, lipid composition and
 stability 50
 biomonitoring 515, 526, 575
- of aerial pollutants 223
 bioprospecting 666
 biosphere reserves 666
 biotic interactions 466
 biotic stress 235–254, 322
 biotope 598
 – fragmentation, as islands 559
 – interconnecting 561
 – management 490
 bioturbation 583, 589
 bipartite promotor 128, 141
 bipolar areas 473
 birch, *Betula pubescens* 227, 393
 bird 544
 bird cherry, *Prunus padus* 613
 birds-foot trefoil, *Lotus
 corniculatus* 236
 bitter substances 594
 bittering agents 235p
 black carbon 407, 433p, 438, 649
 black soils, chernozem 433
 bladder hair 153, 172
 blastochory 542p
 bleached horizons 444
 blueberry 597
 bluegrass species 461
 bog, carbon degradation 430
 boleochory 543
 bony fish, antifreeze protein 83
 boreal 475pp, 552p
 – coniferous forest 428
 bornesitol 159p
 boron 408
Boscia foetida 272
Botrytis 169, 208
 bottle tree, *Adansonia digitata* 387
 boundary layer resistance 270, 280
Bouteloua 387, 421
 box trees 76
 bracken, *Pteridium* 24
 branching pattern 391p
Brassica 237
Briza media 415
 broad leaved crops 305
 broad leaved dock, *Rumex obtusifolius*
 235
Brocchinia 331
 bromeliad 136
Bromus 294, 421p
 – dry meadow (*Bromus spp.* associa-
 tion; Xerobromion) 489
 – *erectus* 552, 611
 – semidry meadow (*Bromus spp.* asso-
 ciation; Mesobromion) 489
 bronze age 473
 broom flower 590
 broom, decoupling factor 307
 brown dunes 583p
 brown field site syndrome 671
 browser 597, 603
Bryophyllum calycinum 351
 Bryophyta 470
 buckwheat 204, 482
 bud eaters 595
 bud scales 274p
Buellia canescens 223
 buffer capacity 571
 buffer zone 559

- bundle sheath 351, 357
 burnt earth syndrome 671
 butterfly flower 590
 Byblis 332
 bythiochory 543
 bZIP 92, 128
- C**
- $\delta^{13}\text{C}$ value 138, 353, 642
 C/N balance 328
 C3 plants 349p, 357, 364p, 426
 – annuals 373
 – distribution 371
 – dominance 373
 – evolution 354
 – grasses 371
 – metabolism 350
 – water use efficiency 136, 367
 C4 plants 349, 351, 357, 364p, 426
 – annuals 373
 – aspartate forming types 353pp
 – dominance 373
 – distribution 371
 – evolution 354
 – grasses 371
 – malate forming types 353pp
 – metabolic types 351
 – NAD-ME-type 353p
 – NADP type 353p
 – PCK type 353p
 – water use efficiency 136, 367
 cabbage white butterfly, *Pieris brassicae* 236
Cadaba farinosa 478
Cadaba rotundifolia 510
 cadmium 176, 190–193, 204
 caffeic acid 177, 179, 250
 caffeoylquinic acid 177, 195
 calcineurin 150p
 calcium 40, 121, 125p, 129, 141, 147–149, 153p, 197, 200, 205p, 320p, 339p, 408, 444, 456, 458
 – carbonate 339
 – deficiency 339, 343
 – dependent-protein-kinase (CDPK) 151
 – excess 339, 343
 – function 339
 – requirement 339, 343
 – uptake 339, 343
Calendula arvensis 499p
Calluna 387
 Calmodulin 339
Caloplaca aurantiaca 223
Caltha 106
 Calvin cycle 29, 33, 245, 352
Calycotome villosa 499
 calyptra, root cap 320
 CAM (Crassulacean Acid Metabolism) 135, 142, 351
 – cycling 136
 – idling 136
 – PEP carboxylase 138p
 CAM plants 357, 360
 – distribution 371
 – evolution 354
 – facultative 137p
 – water use efficiency 136, 367
- Cambrian 469
 canary grass, *Phalaris canariensis* 584
Candelaria concolor 223
 canopy conductance 304p
 Capensis 471, 554p
 capercillie biotope 588
 capillarity 282, 292
 capillary water 282p
Caraluma negevensis 367p
 carbohydrate 431
 – deficiency 329
 – flow 329
 – parasites 342p
 carbon
 – allocation 377
 – and climate 641–677
 – balance 254, 347–396, 373pp, 379, 435
 – cycle 30
 – ecosystem 347
 – flux 376p, 650
 – global 635p
 – sinks 347, 655
 – soluble organic 633
 – sources 655
 – turnover 427–438
 carbonate-rich *Molinia* meadows (*Molinia* association; Molinion) 489
 carbonate-rich small sedge marsh (*Carex davalliana* association) 489
 carbon dioxide 109, 127, 257–259, 279
 – and man 637
 – and plant production 658
 – and stomatal response 299
 – and temperature rises 646p
 – and vegetation 492
 – as greenhouse gas 260–263
 – atmospheric 642pp
 – availability 355
 – distribution in the atmosphere 635
 – emission, land use 649p
 – emissions 649p, 676
 – emissions, global distribution 654
 – fixation 136
 – fixing, efficiency 350
 – global atmosphere 627
 – historical changes 260–263
 – in the oceans 643
 – stomatal opening 301
 – uptake, apparent optimum 363
 carbon dioxide assimilation 347–356, 358p, 657
 – diffusion limitation 355p
 – global distribution 360
 – maximum 358–360
 – rate, middle 361
 – water use 367
 carbonic anhydrase 184
 Carboniferous 469pp
 carboxylase 361
 carboxylation 354
 – efficiency 349
 cardinal points of temperature tolerance 45
Carduncellus 499
Carex 473
Carex physodes 511
 carnivory 586
 carob tree 499
 carotenoid 132
 carousal dynamics 525
Carpinus 476
 – *betulus*, hornbeam 480, 483, 511, 552, 613
 – *orientalis* 499
 carrot antifreeze protein 83
 carrot ozone sensitivity 227
Carya 474
 caryophyllene 245
 Casparian bands 287p
Cassia senna 510
Castanea 471, 474
 – *sativa* 496
 catalase 129
 catastrophies 418
 catechin 224
Catha edulis 507
 cation
 – channel 150
 – deficiency 329, 459
 – exchange capacity (CEC) 318, 457
 – leaching 456
 – loess 444
 – transport 445
 – turnover 444
 – uptake 444p
Caulis platycarpus 487
 cavitation 292p, 297
Cecropia 23
 cedar 472, 502
Cedrus atlantica 485, 499
Cedrus libani 499
 cell death, programmed (PCD), apoptosis 106, 115
 cell elongation, salt stress 149
 cell lysis 111
 cell wall 190
 cellulase 112
 cellulose microfibrils 105
 cellulose degradation 431p
 cenochorology 600pp
 cenoecology 600
 cenocology 600pp
 cenoevolution 600
 cenophilic 599
 cenophylogeny 600
 cenoecology 600
 cenotaxonomy 600
Centaurea 474
 – *cyanus* 482
 – *nigra* 415
 – *stele* 287p
Centaurium erythraea 415
 Central Europe 552p
 – in the Pliocene 471
Centranthus ruber 496
 Century model 437
Cephalotus 331
Ceratonia siliqua 293p
 cereal crops 266, 481
 chalcone
 – flavanone isomerase 42
 – isomerase 224
 – structure 42

- synthase 42, 224, 230
- chamaechory 543
- chamaephyte 515
- chaos theory 533
- chaotropic compounds 165
- chaperone 127
 - chemical 60, 94
 - molecular 53, 58
 - reversible 131
- charcoal 433p
- chasmoendolith 583
- chelate reductase 177, 193
- chelate-mediated pollution extraction 192
- chelator 179, 193p
- chemical potential 283
- chemolithotrophs 439, 444
- chemoorganoheterotrophs 439
- Chenopodiaceae 18, 163
- Chenopodium* 474
 - *botrys* 490
 - *murale* 500
- chilling 61pp, 95
 - damage 12
- chitin 442
- chitinase 169, 171, 215, 230
- chitosan 241
- chloracetamide 208
- chlrenchyma 122p
- chloride 127, 141, 145-160, 456
- chlorinated phenol 213
- chlorine 320
- 2-chlor-N-acetamide, structure 208
- chlorofluorocarbons 260
- chlorogenic acid 195
- 4-chloro-N-methyl alanine 213
- chlorophyll
 - chlorophyll a, b 27
 - deficient leaves 342p
 - excited states 32
 - first singlet state 32
 - fluorescence 16, 32
 - non-photochemical quenching 29
 - quenching 33
 - stress 18
 - sulfur dioxide 221
- Chlorophytum comosum*, spider plant 230, 233
- chloroplast 66
 - and light climate 27pp
 - movement 25
 - non-appressed region 28
- chlorosis 176, 183, 193, 217, 322
- choline 163
 - sulfotransferase 163
 - monooxygenase 163p
 - O-sulfate 133, 163
- Chondrilla juncea* 610
- choriocenoses 599
- choriotope 599
- chromium 176, 193
- chronoelement 551
- Chrysanthemum leucanthemum* 511
- Chrysanthemum*, ozone sensitivity 227
- Chrysomelidae, leaf beetles 235
- Cicer arietinum* 669
- cinnamic acid 213, 248
- cinnamoyl alcohol dehydrogenase 224
- cinnamoyl-4-hydrolase 248
- cinnamoyl alcohol dehydrogenase 230
- cinnamoyl-CoA 224, 248
- cinnamoyl-CoA reductase 224
- cinnamoyl-glucose 248
- circadian rhythm 67
- Cirsium arvense* 488, 499
- cis*-9-dodecene-dicarboxylic acid 242
- 9-*cis* epoxy-carotenoid dioxygenase (NCE) 124
- Cissus quadrangularis* 510
- Cistanche violacea* 606
- CITES 666
- Citopsis* 302
- citric acid 179, 197, 201
- Citrullus colocynthis* 273
- Citrus limon* 77, 93, 302, 499
- Cladonia* 223, 295, 405
- clay content 437
- clay minerals 315, 317, 432
- Clean Development Mechanism (CDM) 655
- clear felling 480, 500
- Clements, F.E. 514pp
- climate
 - and carbon balance 641-677
 - at ground 263-265
 - change 263, 626
 - change convention (FCCC) 651p, 666
 - change, Europe 659p
 - gases influences 260
 - ground conditions 269
 - history 260-263
 - of the stand 580
 - regions 281
 - variations 472
 - vegetation canopy 269
- climatic change, trend of 263
- climatic optimum 476
- climax 514
 - communities 514
 - stage 524
- closed cycles 426
- cloud formation 636
- clover 273
- clover canker fungus 618
- club mosses 470
- Clusia* 138, 371
- clusianose 86
- CoA-ligase 248
- coarse sand 285
- coarse wood debris 411
- Coastal convention (CCD) 666
- coastal deserts, cool nights 371
- coastal succulent 371
- cobalt 176, 191, 193
- Cocos nucifera* 253, 481
- codon usage 85
- coevolution 470, 592, 597
- coexistence 579, 603, 615, 617
- Coffea arabica*, coffee plant 63p, 507
- cohesion theory 292
- cohort dynamics 525
- cohort, death of 525
- cold
 - acclimation proteins 62
 - adaptation proteins (CAPs) 87
 - as stress 60pp
 - damage 9, 63pp
 - death 45
 - periods 472
 - related proteins (COR) 72
 - rigidity 45
 - shock protein 62
 - stress 95
 - syndrome 94
- coldest place on earth 270
- Colletotrichum lagenarium* 249
- colline 552
- colonisation 546, 557
- Colorado 635
- commensalism 586, 604p
- Commiphora* 510
 - *africana* 504
- communities
 - and environment 585
 - biogeocenoses 466
 - different forms 600
 - dominated by herbs and grasses 484
 - meadow 413
 - of organisms 585
 - permanent 520
- compatible solute 10, 13, 16, 20, 60, 129, 133, 140, 156, 162, 172
- see also osmolytes 171
- compensation 593p
 - point 348, 351, 355, 357, 361
- compensatory growth 595, 603
- competition 579, 603p, 607pp
 - asymmetric 406
 - interspecific 608, 616
 - intraspecific 608, 616
- competitive
 - exclusion 617
 - strength 608pp, 617
- competitor 614
 - strategist 528
- complexity 534, 535
 - non-linear behaviour 409pp
- compound membrane 288
- conductance
 - boundary layer 303p
 - cuticular 220
 - specific 292
 - stomatal 297
 - surface 303
- conductivity
 - hydraulic 287pp, 293
 - saturated 286
 - stomatal 293
- Conference of the Parties (COP) 630
- conifer wood 293
- coniferous forest 266, 436
 - carbon balance 459p
 - ecosystem 460
 - humus formation 461p
 - hydrological balance 461p
 - light conditions 459p
 - nutrient balance 461p
 - SO₂ sensitivity 218
 - temperate 428

- conifers 292, 487
 coniferyl alcohol 213, 224, 431
 coniferyl aldehyde 224
Conizaeodion 223
 connectance 535
 constancy 534
 constituent water 281
 consumption 350
 continentality 280
 continuum concept 533
 contracted vegetation 593
 convective boundary layer 306
 convention
 – on biodiversity 651
 – on the seas (UNCLOS) 666
 – of climate change (FCCC) 651pp
 – to combat formation of deserts 651
 convergence 533
 conveyor belt 644p
 Convolvulaceae 163
Convolvulus 499
 – *arvensis* 488
Conyza 499
 cooling 88, 176, 191p, 193, 204, 320, 408
 – in plant metabolism 182
 – resistance 183
 – stress 186
 coppice with standards 480, 483
 coppiced forests 482p
 COR gene 128
 Cordiatae 470
Cordyline nubra 362
 core antenna 27
Coreopsis biglowii 382
 cormophyte temperature resistance 47
 cormophyte water flow 279
Cornus 391p
 – *stolonifera* 87
 coronatine 243
 COR-proteins, “cold related” proteins 87
Corydalis 269
 – *cava* 341, 544
Corylus 474, 476
 – *avellana*, hazel 302, 375, 380
 cosmopolitan 490, 550
 cost-benefit analysis 676, 358
 co-suppression 19
 co-transport 320
 cotton grass, *Eriophorum angustifolium* 99
 cotton, decoupling factor 307
 couch grass, *Agropyron junceum* 386, 583
 coumaric acid 41p, 248, 292
 coumarin, structure 42
 p-coumaroylstragalinal 40
 coumaryl alcohol 431
 coupling element 128p
 cow pea, *Vigna unguiculata* 271, 294, 302
 Cowles, H.C. 514
 Crassulaceae 137
 Crassulacean Acid Metabolism see CAM
Crataegus 372
 – *macrocarpa* 391p
Craterostigma plantaginea 123
 Cretaceous 468p
 Cromer warm period 474
 crop plants 380p
 – characteristics 384p
 – oil seed 481
 – potatoes, beet 481
 – rotation 481, 487p
 – SO₂ sensitivity 218
 cropping, multiple species 481
 cross protection 9, 96, 132, 188, 229, 231
 cross talk 129
 cross-tolerance 188
 CRT-repeat binding factor 92
 Cruciferae, sulfur requirement 336
 cryoprotective
 – agents 92, 96
 – solutes 96
 – substances 85p
 cryptochrome 19, 40, 43
 cryptoendolith 583
 cryptogamic communities 517
 C-S-R model 528
 cucumber 249
Cucumis sativus 178
 cup flower 590
 cuprophyte 191
Cupularia phase 515
Cuscuta 499, 607
 cuticle 280
 cuticular conductance 220
 cutin 242
 β -cyanoalanine synthase 236
 cyanobacteria 324, 440, 450, 470
 – nitrogen fixing bacteria 439
 Cyanolichens 366
 Cycads 470
 cyclicity 534
 cyclobutyl pyrimidine dimer 39
 cyclosilicates 317
trans-cycloocten 110
Cymbalaria muralis 496, 543
Cynanchum vincetoxicum 513
Cyperus 499
 cystein 119, 141, 193, 336
 2-cys-peroxiredoxin 242
 cytochrome b₆/f complex 28
 cytochrome c 441
 cytochrome oxidase 182
 cytochrome P-450 207, 211–233
 cytochrome P450 reductase 212
 cytokinin 377
 cytoplasm 126, 190
 cytorrhysis 120
 – freezing 74p
 cytoskeleton 205
 cytosol 125, 147–149
D
 D1 protein 27, 31pp, 37, 67, 362
 D2 protein 31
Dacrydium 449
Dactylis glomerata 618p
 dam building 635
 dambonitol 160
 D-amino acids 213
Danthonia forskalii 353
 Danube ice age 472
Daphne mezereum 552
 dark reaction 350
 dark respiration 349, 362, 375p
Darlingtonia 331
 Darwin, C. 607
Datura innoxia 188
Daucus carota 382, 385
 dead wood 403, 587
 – degradation 430
 deamination 440
 death from
 – cold 271
 – drought 271
 – freezing 9
 debranching enzyme 102
 deciduous 390
 – broad leaved trees 305
 – conifers 305
 deciduous forest 436
 – carbon balance 459p
 – ecosystem 460
 – humus formation 461p
 – hydrological balance 461p
 – light conditions 459p
 – nutrient balance 461p
 – SO₂ sensitivity 218
 – temperate 428
 decomposition 431p
 decoupling factor Ω 307p
 deep wells 502
 defence compounds 236
 deforestation 480, 641, 656
 – and forest damage 460
 deformation by stress, elastic and plastic 11p
 degradation 480
 degree of naturalisation 493
 dehardening 13
 dehydration
 – protective protein 128
 – response element (DRE) 128
 – stress detection 123
 dehydrin 62, 96, 130, 141, 243
 – nucleus localisation sequence 130
 – structure 131
 delphinidin-3-glucoside 195
Delphinium consolida 341
 delta diversity 567
Dendrographa minor 366
 denitrification 100, 440, 442, 636p
 denudation 521
 deposited humus 407p
Deschampsia 189
 desert 381, 428
 – annuals 513
 – areas 504
 – flowering 512
 – varnish 175, 583
 desertification 502p
 desiccation damage 122
Desmostachya bipinnata 510
 desoxy-xylulose-5-phosphate (DOXP) pathway 124, 141, 245
 determinate species 410
 detoxification 210

- Devonian 469
dew point temperature 256
D-glucuronate-1-P 158
diacetylglycerol-galactosyl transferase 66
diacylglycerol 114
diastase 102
dicarboxylate channels 138
dichloracetamide 208
dichlorimide 208
2,4-dichlorophenoxyacetic acid 211, 209, 214
2,6-dichloroisonicotinic acid 215
Dicksonia 449
di-coumaroylkaempferol-3 α -D-arabinosid 40
di-coumaroylquercetin 40
diethylhexylphthalate 213
differentiation of niches 617
differentiation zone 105p
diffusion 321, 348, 355
– coefficient, carbon dioxide 277
– Fick's law 99
– resistance 219
Digitalis 18
Digitalia phase 515
dihydroflavanol-4-reductase 42, 224
4'-dihydrophaseic acid (DPA) 124
dihydrosulfonate 220
di-linoleoylphosphatidylcholine 73
3-dimethylsulfonio proprionate 165, 172
dimethylsulfoniopropionate 132p
dimethyl-nonatriene 245
dimethylsulfide (DMS) 638
diminishing returns 359, 390
Dionaea 331
– *muscipula* 343
diopsite 317
dioxygenase 124
dipeptyltransferase 188
Diplotaxis species 499
Dipsacus sylvestris 385
diptera, as pollinators 590p
discharge 281
disjunct distribution 472
disjunct distribution areas 555
disjunction 477, 550p
– arcto-alpine 477
– causes 551
dispersal 542pp
– active process 548
– direct dispersal hypothesis 546
– passive process 548
– primary 546
– secondary 546
dissolved organic carbon 431p, 444p, 456
distress 13
disturbance 521
– animal burrows 588
– hypothesis 420, 566, 573
divergence 527, 533
Diversitas 630
diversity 505, 534
– alpha 567
– beta 567
– centres 551
– changes with time 570
– due to human influences 568
– gamma 567
– hotspots 564
– of a site 568
– of structures 568
– primary 571
– secondary 571
– stability hypothesis 573
– tertiary 571
– zones 564
DNA chaperones 128
DNA thymine dimerisation 38
DNAase, cadmium sensitive 185
DnaJ 59
DnaK 58p
dog's mercury 510
dominance 412, 513p
– apical 390
dormancy 512, 547pp
Douglas fir 581
DOXP pathway 124, 141
D-pinitol 158, 160
Draba aizoides 551
drifting sands 316
Drosophyllum 332
– *lustanicum* 586
drought
– regulated element 92
– regulated element binding factor 92
– stress 36, 117–142, 358
– tolerance 131
dry periods in summer 498
Dryas ice age 644
Dryas octopetala 473, 476p
dryness 322
dump syndrome 671
Dunaleilla 13, 149
dunes 582pp
– primary 583
– remobilisation 503
– secondary 583
– tertiary 583p
dung beetle 542
dust rubbish bowl syndrome 671
dust storms 503
dyer's woad 489
dyhydrin 87
dynamics of river beds 584p
dysochory 543
- E**
E. coli, *Escherichia coli* 53, 65, 77, 110, 123, 159, 215
early flowering 512
early interglacial period 473
early Tertiary 470
earth
– crust 468
– history 469
– human settlement 627p
Eburon cold period 474
EC system 183
Ecballium elaterium 544
Echinochloa polystachya 351
Echium italicum 499
ecoclimate 580, 585
ecogrammes 612pp
– forest 614p
ecological
– combining ability 617
– equilibrium 526, 534p
– feedback mechanisms 534
– instability 536
– lability 536
– redundancy 573
– stability, definition 536
– valency 542
economically productive grasslands 480p
ecosystem 398–465
– boundaries 400
– carbon turnover 427–438
– characteristics 401
– compartmentalisation 4012
– definition 400
– disturbance 402, 417
– functions 626p, 677
– maximum number 450
– production 450
ecotones 559
ectoin 132
ectomycorrhizae 413, 605
edaphon 584
Eddy covariance method 306, 435
Eem warm period 474
efflux carrier 124
EF-hand domain 151
EGTA 113
EIN2-protein 111
einkorn 482
El Niño 645p
elaiosome 544
elasticity, leaf 357p
elasticity modulus 11, 121
electrical conductivity, stress 18
elicitation 243
elicitor 229, 246, 248, 251
Ellenberg indicator 383
elm 597
Elodea canadensis 496p
elongase 66
elongation
– internodes 105pp
– reaction 115
– zone 105p
Elster cold period 474
Emberiza cia, rock bunting 588
embolism 293
emission 263
– certificates, trade with 655
– window 257, 263
emmer 482
Empetrum 473, 476
– *nigrum* 474
Encelia 271, 372
– *californica* 271, 362
– *farinosa* 271
– *virginiensis* 271
endemic 550
– species 555, 569
– proportion of 550
endochory 543, 546
endocytosis 196
endodermis 150, 287p

- endomycorrhizae 605
 endonuclease 112
 endoplasmic reticulum 64
 endozoochory 546
 energy
 – balance of leaves 269p
 – balance of the earth 257
 – charge of cells 102
 – flow, succession 519
 – metabolism, and phosphate 337p
 enolase 103
Enterobacter aerogenes 77
 environmental factor 7
 environmental protection and minimum size 561
 environmental radiation, modification of 264
 Environmental protocol, Madrid 666
 EnvZ protein 111
 Eocene 260
 eophytic 468
 epiphyte 493
Ephedra 474p
 ephemerophyte 494
 epichory 543, 545p
 epidermal hair 271
 epidermis 287p
 epiecolgy 604
 epigenetic changes 19
Epilobium 473
 epinasty 103
 epiphylls 620
 epiphytes 620
 epiphytic mosses 449
 epitonic 391p
 epizoochory 546
 12,13-epoxy-octadecatrienoic acid 242
 equilibrium freezing 79, 96
 Equisetacea 470
Eragrostis 353
 ergasiophyte 494
Erica 473
 – *cinerea* 552
 – *tetralix* 552
 Ericaceous dwarf shrubs 380
 Ericales 474
Eriophorum
 – *angustifolium*, cotton grass 99
 – *latifolium* 498
 – *scheuchzeri* 477
 erosion 501p, 505
Erwinia herbicola 76
 erythrose phosphate 224p
 escape hypothesis 546
Escherichia coli 53, 65, 77, 110, 123, 159, 215
Espeletia 89
 – *corymbosa* 89
 ethanol 102
 ethelochory 543, 545
 ethylene 10, 110pp, 114, 173, 209, 215, 231, 241
 – air pollutant 215
 – insensitive mutants 110
 – receptor 110
 – response mutants 110
 – structure 106p
 – synthesis 115
 ethyl-N,N-di-n-propylthiocarbamate, structure 208
Eucalyptus 64, 272, 390, 480, 499, 501
 – forest 305
 – *marginata* 307, 387
 – *pauciflora* 388
 euclidean 599
 euendolith 583
Euglena 53
 euhemerob 495
Euphorbia inarticulata 510
 Europe, climate change 659p
 eurycic 599
 eustatic changes 472
 eustress 13
 eu-symbiosis 604
 eu-synanthropic 495
 eutectic point 82
 eutrophication 489, 522
 evaporation 108, 191, 280, 304p, 410p, 426
 – energy turn-over 303
 – equilibrium 305–309
 – imposed 305–309
 – potential 427
 evapotranspiration 281, 410p
 evenness 535, 567
 evergreen 390
 – conifers 305
Evernia prunastri 223
 evolution 563p
 – animals 469pp
 – plants 469pp
 – theory 617
 evolutionary species equilibrium 603
 excavators 595
 exchanger 317
 exhaustion 14
 exodermis 100, 111, 287p
 expansin 115
 exploitation syndrome 671
 exposure 264
 extensin 170p, 173, 230
 extension zone 107
 extinction 265, 557
 – rate 557, 560
- F**
 Fabaceae 188, 605
 facilitation model 531p
 facilitation theory 606
 facultative elements 314
Fagus 471, 476
Fagus sylvatica, beech 26, 227, 229p, 255, 271, 330, 367, 391p, 431, 480, 499, 549, 552, 584, 597, 613
 – leaf development 367
Falcaria vulgaris 487
 farnesine 245
 fat and lean years 513
 fatty acid 240
 – desaturase, antioxidative system 92
 Favela syndrome 671p
 Fe/Al buffer range 408
 Fe chlorosis 180
 feed-back 401
 – regulation 297p
 – switches 580
 feed-forward 401
 – regulation 297
 feeding factor 236
 feldspar 315
 Fenton reaction 182
 ferns 188, 470
 – antifreeze protein 83
 – poikilohydric ferns, temperature resistance 46
 ferredoxin 28, 69, 335
 – NADP reduction 325
 ferrichrome 180
 ferriterobactin 180
 ferritin 182
 fertile crescent 479
 fertilisation 318
 fertilisers 488
 ferulic acid 41
Festuca 474
 – *ovina* 176, 415
 Fick's law of diffusion 99
Ficus, see also fig 389, 499
 – *benegalensis* 390
 – *superba* 389
 – *sycomorus*, pollination 592p
 field bean, decoupling factor 307
 field capacity 285pp
 field margin programme 490
 fig, *Ficus* 389, 499
 – as epiphytes 390
 – wasps 592p
Filago vulgaris 381
Filipendula 106
 fine roots 429, 438
 – length 428
 – life span 428
 fine sand 285
 fir 7, 597
 fire 393, 418, 435, 438, 498, 500
 – forest floor 405
 – ground level 430
 fish farms 623
 flag flower 590
 flagship species 563
 flavanes (flavonoids) 42
 flavanone dehydrogenase 42
 – structure 42
 flavanone-3-hydroxylase 224
 flavanonol 42
 flavone 42
 flavonoid 95, 213
 – 3'-hydroxylase 224
 – diacyl flavonoids 41
 flavonol 42
 – synthase 42
 flavoprotein 28
 flax 489
 flight from the land syndrome 671
 flooding 112
 flora, arcto-tertiary 471
 flora from the Geisel valley 471
 floral
 – mixing 495
 – provinces 555
 – regions 555
 floristic
 – composition 528

- element 551, 555
- realm 471, 554pp
- regions, map 554
- flowering
 - desert 512
 - patterns 591
 - periods 591
- fluctuation 513p, 516p
- fluorescence 362
- fluoride callose 198
- fluorine as airborne pollutant 219
- fluorochlorocarbon 258
- Fluorodifen 213
- flurazole 208
- Food and Agricultural Organisation (FAO) 629
- forest
 - boreal 381
 - broad leaved coniferous 381
 - broad leaved temperate 381
 - carbon degradation 430
 - change 487p
 - clearing 457
 - cultivated 406
 - damage 336, 340, 455, 457pp, 492p
 - decline 216, 227
 - decoupling factor 307
 - degradation 500p
 - development in Europe 485
 - economy 487
 - felling, umbrella felling 480
 - fires 623
 - grazing 482, 483
 - high 480, 488
 - history, Mediterranean 500
 - management 411, 480, 483
 - old stands, death of 404
 - plantation 666
 - protection 659
 - rejuvenation 492
 - shade-less 25
 - tropical 381
 - unmanaged 410
- formaldehyde 232
 - air pollutant 230-233
 - dehydrogenase 230-232
 - detoxification 231
- formononetin 42
- Forsythia* 111
- Fouquieria* 393
- foxglove, *Digitalis* 18
- Fragaria virginiana* 290
- Frankia* 605
- Fraxinus* 476, 544
 - *excelsior*, ash 613
- freeze desiccation 61, 72pp, 88
 - damage 95
- freezing
 - avoidance 97
 - avoidance mechanisms 72
 - curve 78, 83
 - cytorrhysis 96
 - drought 269
 - eutectic point 82
 - exotherm 80
 - point depression molal constant 82
 - temperatures and biomembranes 72pp
- frequency of mowing 485
- Frerea indica* 137
- fringed water lily, *Nymphoides peltatum* 108
- frost
 - as stressor 61, 72pp
 - damage 78
 - dehardening 50, 91
 - drought 93, 97
 - global distribution of 261
 - hardening 10, 13, 20, 50, 63p, 72, 91pp, 96
 - - and photosynthetic efficiency 93
 - - constitutive hardiness 92
 - - gene 92
 - - molecular biology 92p
 - - pine 15
 - - syndrome 94
 - protection proteins 87p
 - resistance 12, 72
 - stress 47p
 - tolerance 72
- fructan 132
- fructose 86, 159
- fructose-6-phosphate 338
- frugivorous birds, propagule dispersion 545
- frugivorous mammals, propagule dispersion 545
- fulvic acid 179
- Fumaria officinalis* 341
- Funaria hygrometrica* 25
- functional
 - diversity 572
 - group 380, 451, 527, 571
 - interactions 601pp
 - plant types 575
- fungus 188, 442
 - antifreeze protein 83
 - temperature resistance 46
- G**
- G proteins 112pp
- gadolinium 197
- galactolipid 50
- Galeopsis tetrahit* 383
- Galinsoga parviflora* 496
- Galium aparine* 490
- gall flies 470p
- gall gnats 470p
- gallic acid 250
 - tannin 433
- gallium 197
- Gallium aparine* 381
- Gams, H. 514
- gap 524
 - dynamics 516, 525
- garigue 500
- garlic 499
- gated channel 124, 148
- G-box 141
- gene
 - activator MYB 128p
 - exchange 342p
 - expression 378
 - induction 237
 - silencing 19
- General Sherman tree 387
- genetic centres 663p
- genetic resources 562
- Genlisea* 332
- genoelement 551
- Gentiana* 477
- geodiversity 569
- geoecology 626
- geoelement 551, 555
- geographical vicariance 551
- geophyte 515
 - spring 460, 510
- Geranium sanguineum* 513
- German Council of Environmental Experts (SRU) 630
- Germany, carbon dioxide emissions 657
- germination 329
 - in spring 47
 - in winter 47
- Getafix 342
- giant rosette plants 88p, 91
- gibberellic acid 105
- gibberellins 129
- gibbsite 196, 315
- ginger 481
- Ginkgo biloba* 470, 550
- glacial period 371
- glaciation 473
- Gleason, H. A. 514pp
- gley 176
- Global
 - Biodiversity Assessment (GBA) 630
 - change 625-677
 - Environmental Facility (GEF) 629
 - temperature, historic development 647
- β -glucanase 215, 230
- α -glucosidases 102
- glucose 86, 159
- glucose-6-phosphate 139, 157, 338
- glucose-6-P-isomerase 103
- glucosyl transferase 207, 248
- 5-glucosyl-1,4,5-trihydroxynaphthalene 250
- D-glucuronate-1-P 158
- glutamate 103, 159, 326, 350
- glutamate- γ -semialdehyde 159
- glutamic acid 216
- L-Glutamin 234
- glutamine 210, 326, 333p
- glutamine synthesis 210
- glutamin-oxoglutamate amino transferase (GOGAT) 326p
- γ -glutamyl kinase 134
- L-glutamyl- γ -phosphate 134
- glutamyl- γ -semialdehyde (GSA) 134
- glutathione (γ -glutamyl-cysteinylglycine) 95, 187, 207, 212-220
 - oxidised 214
 - peroxidase 42
 - pump 213, 231
 - reductase 42
 - S-transferase 130, 207, 213p, 231
- glyceollin 42
- glyceraldehydephosphate dehydrogenase 103
- glycerate 30

- glycerol 13–15, 60, 123, 156
 glycerol-3P-acyltransferase (GPAT) 65p
 glycine 163, 188, 193, 350
Glycine max 367
 glycinebetaine 132, 163pp
 – biosynthesis 163
 – cassette 165
 – structure 133
 glycolate pathway 29pp
 glycolysis 245
 glycophyte 145, 152, 171pp
 glycophytic plants 154
 glycosyl transferase 231
Gnaphalium supinum 477
 Goethe, J. W. 351
 goethite 176, 315, 337
 gold 193
 Gondwana 469
 Graham's law 109
 grain
 – production 665
 – yield 375p
 – yield of maize 330
 grana thylakoid 27pp
Graphis elegans 223
 grassland 305, 371, 428, 489
 – decoupling factor 307
 – fertilized 413p
 – species diversity 413p
 – unfertilized 413p
 grazer 597, 603
 grazing 387, 418, 421, 484, 486, 500, 596p
 – goats 483
 – intensity 597
 – management 513
 – weeds 597
 green bean, salt stress 146
 green cabbage, cadmium content 184
 green house effect 260
 green liver 210, 231, 233
 Green revolution 669p
 – syndrome 671
 greening of the landscape (Vergrünlandung) 488
 grey hair grass, *Corynephorus canescens* 489
 grey mould 208
 greywacke 316
 Grime, P. 379
Grimmia pulvinata 223
 GroEL 58
 gross primary production 374p, 427, 435, 438
 ground water 283, 290, 633
 – advective 426
 – run off, nitrate 445
 groundelder 386
 growth 376
 – conditions 417
 – elongation 172
 – form 304p, 391p, 572
 – – antenna growth 272p
 – induced respiration 375
 – phases 512
 – rate, relative 9
 – respiration 375p
 GrpE 59
 GSA dehydrogenase 134
 guano 337
 guard cell 125, 296, 298
 guild 572, 586
 gulf stream 644p
 Günz ice age 472
 gymnosperms 470
 gypsum 336
- H**
 H⁺-pyrophosphatases 146
 Haber-Bosch process 324
 Haber-Weiss reaction, Fenton chemistry 70
 habitat 615
 – characteristic 489
 – distribution 413
 – diversity 559
 – diversity hypothesis 556
 – fragmentation 560
 – niches 617
 – protection 575
 – variability 451p
 haem 181p
 haematite 176
 Hagen-Poiseuille law 292
 halloysite 315
 halophyte 145, 152, 154p, 171–173
 – plants, ash content 314
 haloserries 514
Haloxylon aphyllum 511
Haloxylon scoparium 500
Hamamelis mollis 45
Hamamelis virginiana, witch hazel 45
 hamamelose 86
Hammada scoparia 302, 370
Hammarbya paludosa 498
 hard grasses 505
 hardening 14, 39, 47, 60p
 harvest 410, 422, 435, 480
 – index 375p, 380, 382, 426
Haumaniastrum katangense 191
Haumaniastrum roberti 191
 HAV1 gene 131p
 Havarie syndrome 671
 hazel, *Corylus* 475, 480
 H-bonds between water molecules 117p
 heartwood 377, 387
 heat
 – avoidance 61
 – balance, coniferous forest 460
 – balance, deciduous forest 460
 – capacity, specific 118
 – conductivity, soil 264p
 – damage 9, 61
 – death 9
 – of fusion 80
 – release 362
 – resistance 61
 – sensible 410
 – storage 274p
 – storage, soil 264p
 – strain 50
 – stress 50, 52, 274
 – stress and biomass production 52p
 – tolerance 61
 heat shock 29, 51–57
 – cognate 58
 – element 56
 – gene 55p
 – granule 56
 – promoter 56
 – protein cycle 59
 – proteins (see also HSP) 10, 52–59, 87, 94
 – proteins as chaperones 59
 – reaction 52
 – response 94
 – transcription factor (HSF) 56pp, 94
 heather 597
 heathland, decoupling factor 307
 heavy metal 175–194
 – availability of 176
 – deficiency, symptoms 176
 – excess supply of 184
 – extraction 191
 – homeostasis 189
 – hyperaccumulator 176, 191
 – resistance, relative 612
 – tolerance 191
 – toxicity 182
 – xenobiotic 193
Hedera helix 26, 79, 552
 hedges 391p
 Heister 480
Heliamphora 331
Helianthemum nummularium 477
Helianthus
 – *annuus* 294, 302, 380
 – *tuberosus* 496
α-helices, amphiphilic 130, 141
Heliotropium curassavicum 499
Helminthosporium 169
 helophyte 102, 106
 hematite 315
 hemeroby 495
 hemerochor 493
 hemerochory 543, 545
 hemicellulose 112, 431
 hemicryptophyte 515
 hemiparasites 607
 henbane, *Hyoscyamus niger* 38
Heracleum mantegazzianum 496p
 herbaceous plants 292
 herbicide 208–233, 488
 – after planting 210
 – carotenoid biosynthesis 210p
 – effects, measurement of 209
 – photosynthesis 210p
 – post-emergence 210
 – pre-emergence 210
 – safeners 208
 – soil 210
 herbivores 471
 herbivory 235–254, 531, 586, 592pp
 – indirect 593
 – plant fitness 594
 herpochory 543
Hertia cheirifolia 500
 heterogenous nucleation 80
 – INA bacteria 76pp
 heterospory 545p
 heterotape 599

- heterotrophy in plants 606
 hexagonal-II-phase 132
 hexanal 242
 hexenal 245
 hexenyl acetate 245
 Heyne 351
Hieracium pilosella 415
 high chimney syndrome 671
 Hippocrates 342
Hippophae 476
 histidine kinase, two component sensor 110
 hoar frost 255
 Hohenheimer groundwater experiment 610pp
Holcus lanatus 290
 Holarctic 471, 553pp
 Holocene 469
 Holstein warm period 474
Homo
 – *erectus* 628
 – *ergaster* 628
 – *heidelbergensis* 628
 – *neanderthalensis* 627p
 – *rhodesiensis* 628
 – *sapiens* 627p
 homeostasis, succession 519
 homoglutathione (γ -glutamyl-cysteinyl- β -alanine) 212
 homiohydric 279p
 homophytochelatins 188
 homoterpenes 245
 homotope 599
Hordeum vulgare, barley 19, 128p, 131p, 187, 375p, 481p, 499
 hornbeam, *Carpinus betulus* 480, 483, 511, 552, 613
 hornblende amphibole 317
 horsetail, Dutch rush, *Equisetum hyemale* 470
 – antifreeze protein 83
 hospites 599
 host 606
 hotspots 564, 663p
 – biodiversity 575
 hour glass model 120
 housekeeping
 – enzyme 87
 – genes 52, 94
 – mRNA 56, 59
 – protein 58, 115
 – reactions 51–55
 HS granules 59
 HSP families 54p
 huertas 499
 human population 53, 626
 human settlement 627p
 humic acid 179
 humidity and photosynthesis 365pp
 humidity, stomatal opening 301
 humming birds as pollinators 590
 humus 317p, 433, 461
 – acidic 317
 – alkaline 317
 – raw 430
 – stabilisation 430
 HVA22 promoter 128
Hydrangea 195, 203
 hydration shell 281p
 hydration water 281, 283pp
 hydraulic
 – capacity 121
 – conductivity 119
 – lift 290p, 297
 hydrenchyma 122p
 hydroballochory 543
 hydrochory 543
 hydrogen sulfide 220
 hydrological balance 280
 hydrophobic interaction 117p
 hydroseries 514
 hydroxamate 180
p-hydroxybenzoic acid 250
 3'-hydroxylase 42
 3-hydroxymethyl-glutaryl-CoA-reductase (HMGR) 244
 3-hydroxymethyl-glutaryl-CoA synthase (HMGS) 230
 4-hydroxy-2,5-dichlorophenoxyacetic acid 213
 hydroxymethylglutathione, γ -glutamyl-cysteinyl-serine 212
 hydroxynitrilase 236
 12-hydroxyoctadecatrienoic acid 242
 hydroxyproline 163
 hydroxyprolinebetaine 133, 163
 hydroxysulfonic acid 220
 hymenoptera, as pollinators 590p
Hyoscyamus albus 500
Hyoscyamus niger 38, 500
 hypersensitive reaction 235, 248p
 hyperthermy 50
Hypogymnia physodes 223
 hypotony 390
 hypoxia 100pp, 105p, 114pp
 – metabolic changes 102
 – primary 101p
 – secondary 101p
 hysteresis, thermal 83p
I
Iberis intermedia 191
 ice
 – age 473
 – algae (*Haematococcus pluvialis*) 46
 – beard 255
 – crystal, formation 255
 – damage 255
 – detection by NMR spectroscopy
 – formation, intracellular 75, 88
 – nucleating proteins (INPs) 76, 87, 95
 – nucleation, heterogenous 80
 – nucleation, homogenous 80
 ichneumon wasps 471p
 ideal equilibrium freezing 79
 idiochlorophyte 493
 igneous rock 316
Ilex aquifolium 552
 illite 315
 immune chemical 215, 208, 231
 immunisation 250
 immunophilin, cyclophilin 55
 imogolite 315
Impatiens 296
 – *cylindrica* 481, 505p
 – *glandulifera* 383, 496
 – *parviflora* 496p
 improved three-field crop rotation 488
 INA bacteria 95
 – economic importance 77p
 – increased potential yield 490
 indanone-isoleucine methylester 243
 indicator plants 515, 611p
 – continentality 612p
 – light 612p
 – moisture 612p
 – nitrogen 612p
 – response 612p
 – salinity 612p
 – temperature 612p
 indole 245
 indole-3-glycerol phosphate 245
 influx carrier 124
Inhambanella henriquesii 40
 inhibition model 532
 inosilicates 317
 inositol 157–160
 inositol-methyl transferase 159
 inositol-1-phosphate synthase 159
 inositol-1,4,5-trisphosphate (InsP₃) 114, 141, 199
 insect pests 457
 insects, antifreeze protein 83
 insects, phytophages 595
 Inselbergs 560
 insurance hypothesis 573
 interaction 602
 – endogenous 603
 – exogenous 603
 – interspecific 603
 – intraspecific 603
 – species equilibrium 603
 – strength 535
 interannual variability 451p
 intercepted water 280
 interception 581, 584
 interglacial period 473
 interglacial vegetation 474
 Intergovernmental Panel on Climate Change (IPCC) 630
 Intergovernmental Panel on Forests (IPF) 666
 International Biological Program (IBP) 399, 427
 International Committee of Scientific Unions (ICSU) 629
 International Geosphere Biosphere Programme (IGBP) 629
 International Human Dimension Programme (IHDP) 630
 International Monetary Fund (IMF) 629
 International Social Science Committee (ISSC) 629
 International Union of Biological Sciences (IUBS) 630
Inula salicina 513
 invader 499, 617
 invasion and water use 420
 investment model 546
 iodine 314
 ion

- homeostasis 147–149, 150–153, 171p
 - stress 146
 - transport 320
 - uptake, competitive 321
 - uptake, roots 318
 - Iris germanica* 105
 - Iris pumila* 511
 - iron 176, 191, 193, 197, 320, 408
 - age 473
 - deficiency 176p, 181p, 322p
 - physiological consequences 181
 - plough 482
 - sulfur protein 28
 - Isatis tinctoria* 496
 - island
 - biogeography 556
 - competition model 560p
 - continental 557
 - hopping 557
 - in protected areas 560
 - invasion 555
 - oceanic 557
 - steady state theory 556pp, 562
 - stochastic model 560p
 - isoflavone, structure 42
 - isoflavonoid 213
 - isolation 559
 - isotopic deuterium relationship, soil 290
 - ivy, *Hedera helix* 10, 26, 79, 94
- J**
- Jatropha curcas* 510
 - Jatropha villosa* 510
 - jasmionate 10, 151, 167pp, 173, 241, 250
 - effect 243
 - induced proteins (JIPs) 239p
 - methylester 239
 - secondary plant metabolites 243
 - Jatropha curcas* 510
 - Juglans nigra* 250
 - Juglans regia* 250, 496, 607
 - Juniperus* 470
 - *communis* 485
 - *phoenicea* 499
 - Jurassic 469pp
 - juvenile anthocyanin 27
 - juvenile phase 524
- K**
- K strategists 527pp
 - K⁺/H⁺ symporter 148, 150
 - kairomone 246
 - Kalanchoe* 137
 - *daigremontiana* 250, 252
 - *pinnata* 351
 - kaolinite 315
 - Katanga syndrome 671
 - α -keto- γ -methylthiobutyric acid 106
 - key stone species 402, 411p, 451, 524, 563, 569, 571, 575
 - key-lock-model 498
 - Kleinia* 551
 - Knautia arvensis* 511
 - knockout mutants 187p
 - koala 593
 - Kranz structure 351
 - K-value 79
 - Kyoto protocol 651, 663, 666, 675
 - and forestry 656
- L**
- Laburnum anagyroides* 496
 - lactate dehydrogenase (LDH) 87, 103p
 - lactic acid 103
 - Lactuca seriola* 273
 - Lake Chad 635
 - Lambert-Beer 265p, 403
 - Lamium pomentosum* 511
 - land clearance, by fire 623
 - land coverage in Africa 657
 - land use 625pp
 - Brazil 657
 - changes 625pp
 - CO₂ emission 647p
 - global 665p
 - larch 227, 269, 581
 - forest 393
 - large leafed lime, *Tilia platyphyllos* 613
 - large sedge marsh, *Magnocari-cion* 489
 - Larix* 296
 - *decidua* 294, 552
 - *gmelinii* 411
 - Larrea* 607
 - *tridentata* 287, 372, 382
 - Laserpitium latifolium* 513
 - late embryogenesis abundant protein
 - see LEA protein
 - late flowering 512
 - latent heat 255, 308p
 - crystallisation 118
 - flux 260, 270, 303
 - vapourisation 118
 - latent life 52
 - Laurasia 469
 - laurel forests 426
 - law of
 - amount and stimulation 216
 - endogenous functional order 599
 - exogenous order of communities 599
 - quantity of stimuli 226
 - relative constant sites 496
 - social order of living organisms 599
 - spatial order 599
 - temporal order 599
 - Thienemann 466
 - Lawsonia inermis* 499
 - L-bornesitol 160
 - L-*chiro*-inositol 160
 - LD50 16
 - LEA-protein 16pp, 87, 92, 127, 130, 141, 151, 166p, 168, 170, 172
 - structure 130
 - leaching 444
 - from the crown 444
 - lead 176
 - leaf
 - angle 271p
 - area index 265, 269, 274, 281, 305p, 331, 347
 - beetles, Chrysomelidae 235
 - chewers 595
 - conductance 300
 - expansion 366
 - inclination 274
 - life span 390
 - mimicry 342
 - miners 471p, 595
 - morphology 272
 - movement 269, 271p
 - nitrogen concentration 360p
 - nitrogen, global distribution 360
 - nutrient concentration 358
 - position 37, 270, 383
 - shedding 269, 321, 367p
 - size 270p
 - temperature 270, 274
 - water content 302, 329
- Lecania cyrtella* 223
- Lecanora*
 - *conizaeoides* 223
 - *expallens* 223
 - *vinetorum* 191
- Lecanoraion dispersae* 223
- Lecidea scalaris* 223
- lectins 342p
- Ledum palustre* 552
- leek, cadmium content 184
- Leguminosae 413, 518, 584
 - sulfur requirement 336
- Lemna* 189
- Lens culinaris* 499
- Leontodon hispidus* 415
- lepidoptera pollinators 590
- Lepraria incana* 223
- lesser celandine, *Ranunculus ficaria* 510p
- lethal temperature 45
- lettuce 103
 - cadmium content 184
- leucoanthocyanidine-4-reductase 224
- level of naturalness 493
- lianas 292p, 620
- Libanotic sibirica* 513
- lichens 117, 232, 278, 374, 450
 - ash content 314
 - biomonitoring 223
 - clean air zone 223
 - desert 223
 - endolithic 175, 370
 - eu-symbiosis 604pp
 - flora 581
 - photosynthesis 365p
 - sulfur dioxide 222
 - temperature resistance 46
 - water use 367p
 - weathering 583p
 - zonation 223, 492p
- lichenometry 604
- life active 10
- life forms 586
 - niches 617
- life latent 10, 45
- light
 - as stress factor 23–44
 - extinction 265p, 403
 - fleck 36, 363

- harvesting chlorophyll protein II (LHC II) 28
- lack of 24
- parasites 25
- reaction 350
- response curve 29, 31
- saturation curve 68
- stomatal opening 301
- use of 404
- lignin 41, 224, 431
 - degradation, schematic 431p
- lignite deposits 471
- Likens, G. E. 400
- lime, *Tilia cordata* 613
- limestone 316
 - sites 462
- liming 318, 457
- limit of resistance 270
- Limonium vulgare* 153
- linalool 245
- linamarin 236
- Linaria haelva* 380
- linoleic acid 238p
- linolenic acid 238p, 242, 245p, 250
- linolenic acid hydroperoxide 242
- linseed 489
- Linum flavum* 477
- lipase 73, 250
- lipid 213
 - biosynthesis 66
 - degradation 432
 - hexagonal II phase 75
 - micelles 117
 - path 138, 140
 - pathway 119
- 13-lipoxygenase 241
- lipoxygenase 250
 - pathway 245
- lipid flower 590
- liquid manure 490
 - flora 490
- Liquidambar* 474
- Liriodendron* 192, 471
- litter 317, 406, 438, 584
 - degradation 427, 438
 - degradation and animals 589
 - formation 461
- loam 283
- loamy soil 285p
- Lobaria pulmonaria* 223
- Lobelia* 274, 386
 - *keniensis* 90
 - *rhynchoptalum* 48
 - *telekii* 90p
- location for time 515
- loess 316
- Loiseleuria procumbens* 474, 477, 552
- long chain carbohydrates, decomposition 432
- long distance dispersal 556
- loss of resources 407
- lotaustralin 236
- Lotus corniculatas*, birds-foot trefoil 236
- lotus, *Nelumbo nucifera* 99, 108p
- low investment model 546
- low tillerage cultivation 649
- lowering of freezing point 82
- Luronium* 106
- lutein 36
- Lycopersicon peruvianum* 238p
- Lycopodiinae 470
- lysine decarboxylase 135
- M**
- Macadamia neurophylla* 191
- macchie 499p
- macro elements 314
- macronutrients 324
- macrophyte 515
- Macropitilium purpureum* 272
- Macrozamia communis* 440
- magma 314
- magmatite 316
- magnesium 154, 197–200, 205, 320p, 338p, 408, 444, 455p
 - channels 197
 - deficiency 322p, 339p, 455, 457
 - deficiency, spruce 313
 - excess 339
 - function 338p
 - requirement 339p
 - uptake 339p
- Magnolia* 471
- maintenance centre 551
- maintenance respiration 375p
- maize 9, 38, 77, 106, 128, 149, 163p, 167, 185, 187, 201p, 208, 330, 351, 481, 490, 499
 - ozone sensitivity 227
 - salt stress 146
- malate 127, 141, 320, 351
- malate dehydrogenase 353p
 - cadmium sensitive 185
 - NAD dependent 135
- malate excretion 201
- malate/2H⁺ symport 138
- malic acid 135pp, 179, 201
 - storage of 138
- malic enzyme 138, 351, 353p
 - NADP dependent 135
- malonyl-CoA 224
- maltase 102
- Malva parviflora* 500
- mammals, water consumption 278
- man, and
 - biodiversity 663–667
 - carbon dioxide 637
 - vegetation 479
 - water balance 635
- managed forests 429
- management of raised bogs 488
- mandelonitrile 236
- Manduca sexta* 244
- manganese 176, 184, 191, 193, 204, 320
 - deficiency 322p
 - reduction 101
 - mobility 407p
- mango 481
- mangrove forests
 - cultivation of prawns 505
- mangrove plant, *Avicennia germinans* 153, 155
- manioc 481
- man-made deserts 502
- mannan 157
- mannitol 132, 162
- mannitol-1-phosphatodehydrogenase 157
- MAP kinase 92, 129, 238p, 243
 - cascade 123
- marl 316
- marsh marigold meadow (*Caltha palustris*; Calthion) 489
- mass tourism syndrome 671
- mast years 528
- master gene 92p
- master switch 96
- mat grass species 464
- material
 - balance 374p, 401, 406
 - cycles 425–457
 - - global 633–677
 - - open 425
 - fluxes 401
- matorral 500
- matrix potential 79, 119, 140, 283
- matt grass meadow (*Nardus stricta*; Nardion) 489
- mature community 495
- meadow carbon decomposition 430
- meadow plants 380
- mean residence time 407
- Medicago lupulina* 548
- medicarpin 42
- Mediterranean 552p
 - region 498p
 - sclerophyll 393
 - scrub 381
- Mehler reaction 29, 36, 69
- Melampyrum* 607
 - *nemorosum* 552
- Melastoma* 203
- Melia* 472
- Melilotus officinalis* 385
- melting point of fatty acids 49
- membrane
 - cold damage 63pp
 - damage 95
 - leakage 95
 - stability 10p
 - stiffening 64
 - viscosity 63pp
- Menap cold period 474
- mercurate reductase 192
- mercury 176, 192p
 - detoxification 192p
- meristem, intercalary 105p
- merocenes 599
- merotope 599
- Mesembryanthemum* 500
 - *crystallinum* 139, 159
- mesohemerob 495
- mesophiles 46, 94, 358
- mesophyll, conductance 348
- mesophyte 365, 468
- mesotonic 391p
- mesquite tree, *Prosopis* 26
- metabiosis 604, 606
- metabolic imbalance 67p
- meta-hemerob 495
- metallophyte 176, 191, 193

- metallothionein 186–189, 193, 204
metamorphic rock 314, 316
metapopulations concept 561
Metasequoia 472, 550
meteochoy 543
meteorology 257
methane 636
– climate 643p
– formation 101
– greenhouse gas 260–263
– hydrate 263
– in the atmosphere 642
methanogenic microorganisms 432
methionine 106, 165p, 209
methyljasmonate 152
methylmercury 192
5'-methylthioadenosine 106
5'-methylthioribose-1-P 106
methyltransferase 42
methylviologen, Paraquat 71, 165, 209pp
Metolachlor 208, 211
Metribuzin 213
Metrosideros 449
mevalonate pathway 124, 245
Mg protoporphyrin-IX-monomethyl-
ter cyclase 181
mica 315
Michael addition 207, 212p
micro climate 580
micronutrient element 175p, 192
microorganism, functional
groups 440
microtubuli 200–232
midday depression 367
migration 483
Milankovitch effect 263
mildew 208
millet 139
Mimosa pudica 343
Mimulus 187
– *guttatus* 497
mineral soil 317, 319
– bleached horizon 408
minerals 314
mineralisation 431p, 461
Minuartia sedoides 511
– *verna* 176
Misodendron punctatum 606
mistletoe 342p
– characteristics 342
– nutrient parasites 342p
– phosphate content 342p
mixed cropping 506
mixed forests 485
molybdenum 176, 193, 408
monetarisisation 676
monocarpic 386
monochlorobiman 212
monocotyledonous crops 305
monoculture 406, 411
monodehydroxyascorbate 69p
monooxygenase 163, 211p, 231
monophagy 595
monopodial 391p
monoterpene 245
– ozone formation 225
Monsi 379
montane 552
monetary value 676
Montreal ozone protocol 666
moraine, succession 518
mosaic cycle 525, 559
moss 188, 278, 470, 510
– antifreeze protein 83
– temperature resistance 46
mountain ash 597
mountain yellowing 313, 340
movement, regulation 343
mowing 387, 418
muginic acid 180
mulberry 499
mulch 506
multi-drug resistance associated
proteins (MPRs) 213, 231
multi-drug resistance proteins
(MDRs) 213
Muscari 488
mustard oil 336
– glycosides 236p
mutualism 586, 604
mycobionts 604
mycorrhiza 320, 326, 413, 422, 442p,
457, 470, 504, 618
– ammonium use 333
– distribution 416
– ericoid 416
– fungi 100
– nitrate use 333
– phosphate uptake 337
– succession 416
– symbionts 605p
– vesicular-arbuscular 605
mycosporines 42
myo-inositol 157–160, 172
Myricaria germanica 584
myrmacochoy 543p
Myronthamnus flabelliformis 279
myrosinase 236
N
N₂O 258
Na⁺ ATPase 150
Na⁺/H⁺ antiporter 148, 151, 153, 172
– gene 153
Na⁺/K⁺-ATPase 146, 193
Na⁺/H⁺ symporter 150
N-acetyltransferase, *Streptomyces* 216
NAD malate dehydrogenase 138
NADP⁺ oxidoreductase 325
nanophanerophyte 515
Nardus stricta 485
naringenine 224
Nartheicum ossifragum 498
National Committee of Global Changes
(NCGC) 630
nautochory 543
Nebket 583
necrosis 17
nectar collectors 471
Nelumbo nucifera, lotus 99, 108p
neoendemic species 550
Neolithic age 473, 479
Neolithic agriculture 482
neomycin 113
neophyte 468, 487p, 493p, 617
neophytisation 575
Neotropical 471, 554p
neoxanthin 36, 124p
Nepenthes 331
Nerium oleander 294, 300, 362
nesosilates 317
net biome productivity 435p
net carbon balance 435p
net ecosystem productivity 435, 438
net photosynthesis 347–358, 374p,
393
net primary productivity 374p, 379,
426, 435, 438
– annual 381, 451
– monthly 381
net radiation flux 269
nettle, *Urtica dioica* 385p, 405p
neutral red 17, 74, 113
neutralism 586, 604
N-glucosyltransferase 213
niche
– differentiation 617
– diversification 563
– ecological 615pp
– overlap 616p
nickel 176, 184, 191p, 193, 204
Nicotiana attenuata 246, 595
Nicotiana glauca 320, 499
nicotine 245, 251
nicotinic acid 213
Nigella arvensis 383
night buds 48, 88, 97
Nigritella nigra 477
nitrate 154, 320p, 324, 335, 413,
456
– ammonification 440
– ammonification, anaerobic 442
– balance, spruce 442
– leaching 329, 443
– loss 407p
– nitrogen store 333
– nutrition 326
– reductase 67p, 326
– reduction 100
– reduction, energy 442
– transport 327
– uptake 320, 335
– uptake and nutrition 326p
– use 332
nitric acid, diffusion resistance 220
nitrification 371, 440
nitrite 326
– oxidase 441
– oxidation 440
– reductase 325, 327p
– reduction 29, 325
Nitrobacter 441
nitrogen 109, 342p, 456
– as required nutrient 324
– availability and forest damage 458
– balance, global 638
– cycle 438–443
– cycle, global 636pp
– cycle, scheme 439
– deficiency 322p
– dioxide 215, 232
– dioxide, diffusion resistance 220
– excess 334

- fixation 324, 439pp, 584, 636p
 - fixation, symbiotic 604
 - fixing bacteria 326, 451
 - input, atmospheric 328
 - monoxide, diffusion resistance 220
 - nutrition 324, 326
 - oxide (NO_x) 215, 328
 - requirement 329pp
 - storage 333p
 - stress tolerance 333
 - supply and growth 329
 - uptake 324
 - nitrophilic species 486
 - Nitrosomonas* 441
 - nitrous oxide (NO_x) 324
 - nitrous oxide deposition global distribution 654
 - nival 552
 - N-malonyl-ACC 106
 - N-malonyltransferase 213
 - nomads 591
 - non-determinate species 410
 - non-G-Box-ABRE* 128
 - non-interactive species equilibrium 603
 - non-linear-systems 533
 - NO-ozone cycle 410
 - Norflurazon 210p
 - normoxia 100, 105, 114
 - North Atlantic oscillation (NAO) 646
 - Norway spruce, *Picea abies* 294, 367p, 410p, 430, 552, 613
 - Nothofagus* 449, 555
 - *antarctica* 606
 - *dombeyi* 518
 - *fusca* 309, 347
 - *menziesii* 347
 - *obliqua* 518
 - N-phosphonomethyl-glycine, glyphosate, round-up 209
 - nuclear localisation sequence 57
 - nucleation trigger 95
 - nucleic acid break-down 112
 - nucleolus 60
 - nucleotide binding 213
 - number of species 411pp
 - Nunataker 472p
 - Nuphar* 544
 - *lutea*, yellow water lily 108p
 - nutrient
 - availability 324
 - availability, for herbivores 594
 - balance 254, 407
 - cycles, succession 519
 - deficiency 322-324, 393, 587
 - imbalance 407
 - light relation model 532
 - relations of plants 313-324
 - requirement, for herbivory 594
 - store 376
 - transport 320
 - uptake 320, 324
 - use 321
 - nutrition and photosynthesis 365
 - Nymphaea* 544
 - Nymphoides* 106
 - *peltatum*, fringed water lily 108
- O**
- O₃ concentration 225
 - oak 292, 387, 480, 483, 581
 - bark, tanning 483
 - oat grass meadow (*Arrhenatherum*; *Arrhenatherion*) 489
 - oats 481
 - ocadaic acid 113
 - occurrence, ecological 611
 - ocean currents and climate 644p
 - oceanic index 553
 - oceanity 280
 - ocimene 245
 - O-glucosyltransferase 213
 - oleic acid, melting point 49
 - oligohermrob 495
 - olive 499
 - tree distribution limit 549
 - olivine 315p
 - O-malonyltransferase 213
 - ombrochory 543
 - ombrophytes 393
 - O-methyl-*muco*-inositol 160
 - OmpR protein 111
 - onion 499
 - ozone sensitivity 227
 - Ononis spinosa* 485
 - ononitol 159p
 - open chain polyol 157
 - Ophrys* 589p
 - Oppophyllum* 278
 - opportunistic 371, 420, 528, 533
 - optical characteristics of surfaces 264
 - optimal phase 524
 - optimum 9, 19
 - Opuntia* 137, 367, 499
 - *inermis* 370
 - orchid, extinction 664p
 - oreophytes 471
 - organic structure, succession 519
 - organisms, total number 563
 - organisms, types of 46
 - organomercury lyase 192
 - ornamental plants, SO₂ sensitivity 218
 - ornithine 134, 160
 - ornithochory 543
 - Orobanchae* 607
 - oromediterranean 499
 - Oryza sativa* 380
 - osmolyte 129, 132
 - osmosensor 13, 110, 123, 151
 - osmotic potential 79, 119p, 140, 153
 - osmotic pressure 282pp
 - gradient 295
 - osmotic stress, detection 149
 - osmoticum 172
 - osmotin 166-169, 172, 243
 - expression of 167-169
 - osmotin-like protein 166
 - ostiulum 591
 - outgoing radiation 303
 - overgrazing 597
 - over-yielding 406
 - oxaloacetate decarboxylating enzyme 353p
 - oxaloacetate-aspartate-transaminase 353p
 - Oxalis* 269
 - *phase* 515
 - oxidative burst 170, 248
 - oxidative smog 215
 - oxidative stress 68pp
 - oxisol 195
 - 12-oxo-phytodienoic acid 242
 - oxygen 99, 109
 - atmospheric concentration 642p
 - deficiency 99
 - deficiency and energy metabolism 101
 - evolving complex (OEC) 28
 - partial pressure 100, 102p, 115
 - radical 220
 - species, reactive 63, 68p, 114p, 149, 172, 179, 183,
 - triplet 68p
 - oxygenases, mixed function 163, 211p, 231
 - oxygenation 354
 - Oxyria digyna* 474
 - ozone 215, 232, 457
 - accumulated exposure 225
 - air pollutant 225
 - concentration, daily changes 226
 - damage 227, 322p
 - diffusion resistance 220
 - drought 227
 - exposure 225
 - hole 37p, 225
 - induced secondary metabolism 224
 - memory effect 228
 - partial pressure 225
 - pathogen related proteins 229-233
 - primary metabolism 228p
 - related proteins 229
 - secondary metabolism 228p
 - source 226
 - stomata 232
 - stomatal reaction 227p
 - stress, physiological effects 227-229
- P**
- Pachycereus pringlei* 372
 - Pachyman equivalents 198
 - Pachysandra terminalis* 74, 83, 122
 - Pacific madrone, strawberry tree, *Arbutus menziesii* 36
 - Palaeocene 260
 - palaeoendemics 551
 - palaeomagnetism 467p
 - palaeophytic 468
 - Palaeotropic 471, 554pp
 - Palaeozoic 469
 - palindrome 56
 - palmitic acid 65
 - melting point 49
 - palmitoleic acid, melting point 49
 - PAN see peroxyacetyl nitrate
 - panda 593
 - Pangaea 468
 - parabiosis 604p
 - parachutes, *Taraxacum officinale* 485, 509, 511, 544

- Paraquat, methylviologen 71, 165, 209pp
 parasite 606
 parasitism 586, 604, 606p
Parmelia caperata 223
Parmelia saxatilis 223
 paroecenes 606
 partial pressure of CO₂ 279
 Pasteur effect 102
 pasture, decoupling factor 307
 patch dynamics 516, 617
 patchiness 365
 pathogen
 – attack 246, 251
 – compatible interactions 246
 – incompatible interaction 246
 – induced defence 247–251
 – related protein 132, 166, 173
 pea 154
 pears 78, 499
 peat usage 483
 pectin 205
Pectis papposa 287
 pedunculate oak, *Quercus robur* 294, 511, 552, 613
Peganum harmala 500
Pennisetum setaceum 526
 Pennman-Monteith equation 303
 pentachlorophenol 213p
 pentose phosphate pathway 242
 PEP carboxykinase 87
 PEP carboxylase 135, 138p, 222, 320, 327, 351, 353p, 357, 365p, 371
 PEP regeneration 352
 PEP translocator 135
Peperomia trichocarpa 122p
 pepper 481
 perennial 371
 – grasses 373
 – species 385, 427
 periods of clearing 483
 permanent pioneer communities 518
 permanent plots 515
 permeability of tonoplast 119p
 Permian 468pp
 permigrants 599
 peroxyacetyl nitrate (PAN) 215
 – diffusion resistance 220
 peroxidase 179, 182
 – cadmium sensitive 185
 peroxygenase 242
 persistence 535
Pertusaria albescens 223
Pertusaria hemisphaerica 223
 pesticide, formulation 208
Petasites 413
 pH gradient 126
Phalaris canariensis 584
 phaseic acid (PA) 124
 phases of activity 512
 phenol oxidase 182
 phenology 508
 – maps 509
 – methods 509
 – niche 617
 – phases 511
 – plant types 509
 – spectrum 513
 – stages, reproductive 509
 – stages, vegetative 509
 phenophases 509
 phenylalanine 224, 248
 phenylalanine ammonia lyase 224, 230, 248
 phenyl-1,4-benzoquinone 165
 phenylpropane, lignin 433
 pheophytin 28, 221
 phloem 320
 – water 296
Phoenix dactylifera 499
 phosphate 176p, 457
 – nutrition 337p
 – uptake 337
 phosphatidic acid phosphatase 66
 phosphatidylcholine 72
 phosphatidylcholine synthase 66
 phosphatidylglycerol 65
 phosphatidylinositol 77
 phosphatidylinositol 4,5-bisphosphate 114
 phosphoenolpyruvate (PEP) 135, 224
 phosphoenolpyruvate carboxylase (PEPC) 141
 phosphinothricin, Basta 209p, 216
 phosphoinositol-4,5-bisphosphate (PIP₂) 199
 phospholipase 73
 phospholipase C 114, 127, 129
 phospho-relay signal system 110
 phosphorus 320p, 408, 456
 – deficiency 324p, 338
 – excess 338
 – uses 337
 phosphorylation 110
 – reversible 139
 photobionts 604
 photodestruction 35, 37, 39
 photoinhibition 27, 29, 31, 67, 95, 362p
 – *Lobelia rhynchopetalum* 24
 photolithoheterotrophs 439
 photon flux 31
 – density 292, 362
 photoorganoheterotrophs 439
 photooxidation 136, 232
 photoperiodic response 508
 photorespiration 29pp, 36, 362
 photosynthesis 409
 – capacity 12
 – climate factors 374p
 – exciton transfer 68
 – daily variation 370
 – light 361
 – limitation 8
 – regulation 343
 – response to environment 361–373
 – state transition 28, 33
 – salt stress 149
 – temperature 362pp
 photosynthetic capacity 12, 360
 – stomatal opening 298–301
 photosynthetic model 354p
 photosynthetically active radiation 266pp
 photosystem I 27pp, 31pp, 68, 325
 photosystem II 27pp, 34pp, 67p, 95
 phrygana 500
Phyla nodiflora 510
Phyllis 297
 phylloclade 279, 394
 phylloids 279, 360, 394
 phyllosilicates 317
Physcia
 – *ascendens* 223
 – *aipolia* 223
 – *orbicularis* 223
Physiconia pulverulenta 223
 phytate 158, 338
 phytoalexin 42, 229, 209, 243, 248
 phytoecology 598
 phytoecenes 579, 586
 phytochelatin 186, 188, 190p, 193
 – synthase 188
 – biosynthesis 187p
 phytochrome 43, 91
 phytodegradation 191
 phytodiversity 564
 phytoextraction 191
 phytoferritin 181p
 phytomining 191–193
 phytopathology 246
Phytophthora 418
 – *infestans* 169
 phytoremediation 192p, 231, 233
 phytosiderophore 179p, 193
 phytostabilisation 191
 phytothermal index 553
Picea 471
 – *abies*, Norway spruce 294, 367p, 410p, 430, 552, 613
 – *mariana* 419
 – *obovata* 393
 – *obovata* × *excelsa* 307
 – *schrenkiana* 265
 – *sitchensis* 302
 pigment, chymochrome 27
 pigments, UV-B absorbing 42
Pin2 mRNA 244
Pin2 protein 244
Pin gene 243
 pine see *Pinus*
Pinguicula 332
 – *vulgaris* 498
 pinitol 132, 158pp
 pinosylvine 224
 pinosylvine methylether 224
 pinosylvine-3-O-methyl transferase 224
Pinus, pine 94, 227p, 230, 308, 471, 480, 483, 581
 – *aristata* 387, 388p, 390, 429
 – *banksiana* 419
 – *brutia* 499
 – *canariense* 581
 – *contorta* 403
 – forest, boreal 392
 – *halepensis* 228, 499, 502
 – *halepensis* series 500
 – needles 43
 – *nigra* 499
 – *patula* 581
 – *pinaster* 499
 – *pinea* 499
 – *radiata* 499, 548

- *sylvestris*, Scots pine 64, 229, 295, 405p, 410p, 430, 499, 613
- *uncinata* 499
- woods, decoupling factor 307
- pipe model 387
- Pistacia vera* 294
- Pisum sativum* 187, 499
- pit-fall trap, *Darlingtonia californica* and *Nepenthes* spp. 332
- pits 293
- planar 552
- plant
 - animal interactions 587, 603
 - communities 585
 - communities, phytocenoses 466
 - communities, stability 534
 - diseases 322
 - fitness and herbivory 594
 - food 587
 - functional group 527, 571
 - growth 393
 - heterotrophs 606
 - high altitude 380
 - kingdom 471, 554pp
 - life forms 569
 - limestone 462
 - nutrients 313-347
 - poikilohydric 45p
 - protective agents, selectivity 208-233
 - secondary metabolites 235-254
 - sociology 600
 - structures 379
- Plantago amplexicaulis* 512
- Plantago lanceolata* 415, 482, 548
- Plantanus* 471
- plasma membrane 126pp, 147-149, 172, 190
 - H⁺-ATPase 148, 153
 - water permeability 119p
- plasmalemmasomes 119
- plasmolysis 17, 73p
- plastocyanin 182
- plastoglobuli 75
- plastoquinone 28
- platinum 193
- Pleistocene 469, 472
 - climate change 472pp
 - vegetation change 472pp
- Pliocene 470
- ploughing 480
- Plumbaginaceae 163
- Poa* 474
 - *alpina* 552
 - *annua* 487, 550
 - *compressa* 490
 - *pratensis* 415
- Poaceae 163
- podsol formation 456
- podsolisation 317
- poikilohydric 117, 123, 133, 278p, 370
- poisonous plants 235, 595
- poles, relocation 467p
- pollen
 - analysis 475pp
 - calendar 513
 - diagramme 474
 - map 475
- pollination 589
 - biology 589pp
 - symbiosis 589p
 - system 591
- pollinators, bats 545, 590
- pollutant gases 215-221, 457
- pollutant threshold 216
- polyamine 132
- polychory 546
- polycormone formation 519
- polycormophyte succession 523
- polyethylene glycol 162
- polygalacturonase inhibitor protein 249
- Polygonatum odoratum* 513
- Polygonum viviparum* 474
- Polylepsis* 479
- polyol 132, 157-163
- polyphagy 595
- Polypodium vulgare* 302
- Polypompholyx* 332
- polysome 56
- pomegranates 499
- pontic 552p
- pool size 401
- poplar, *Populus* 393, 499
 - antifreeze protein 83
 - leaves, *Populus deltoides* × *simonii* 50
- population cycles 587
- population size, maximum 527
- Populus deltoidea* 390
- porometer 306
- post-anoxic stress 115
- post glacial 473p
 - time 472p
- post interglacial period 473
- post-translational gene silencing (PTGS) 19
- potassium 126, 132, 141, 147-149, 173, 320p, 341, 444
 - deficiency 322p
 - function 341
- potato 85, 94, 167, 488
 - decoupling factor 307
 - ozone sensitivity 227
 - *Solanum commersonii* 10
 - *Solanum tuberosum*, heat stress 52
- potential
 - ecological 610p
 - natural vegetation 493
 - niche 616
 - physiological 610
- Potentilla pamirool* 511
- Pozoa volcanica* 517
- PR protein 215, 243, 251
- Praetegelen cold period 474
- pre-adaptation 254
- preboreal 476
- Precambrium 469
- precipitation 280
 - distribution 427
 - minimum 280
- predation 593p
 - hypothesis 587
- pre-emergence, herbicide 210
- pre-interglacial 473
- Prenia* 278
- pressure potential 79, 119p, 140
- pressure ventilation 106
- primary production 380
 - above ground 427
 - below ground 427
- Primula* 269, 477
 - *clusiana* 86
 - *elatior* 511
 - *verde* 548
- pristine forest 525
- privet 50
- processing of mRNA 95
- productivity, definition 435
- programmed cell death, apoptosis 106, 115
- proline 60, 92, 132, 159, 172
 - betaine 163
 - biosynthesis 163
 - dehydrogenase 133p
 - hydroxylase N-methyltransferase 163
 - metabolism 132
- propagules 542
 - bank 547p
 - germination 547pp
- Prosopis* 26
- pro-synanthropic 495
- prosystemin 237p, 250
- Proteaceae 418
- 26S proteasomes 60
- protection, use 673p
- protective reforestation 502
- protein
 - biosynthesis initiation complex 56
 - biosynthesis initiation factor 56
 - bodies 131
 - denaturation 56
 - denatured by heat 94
 - homeostasis 60
 - kinase 114, 121, 127, 141
 - phosphatase 28, 113
 - protective 140
 - 14-3-3-protein 127
 - proteinase inhibitor 247
 - proteolysis 60
- Proteus mirabilis* 77
- Proteus vulgaris* 77
- protocatechuic acid 250
- protocooperation 604
- proton pump pyrophosphate-dependent 138
- proton-ATPase 172
 - of the tonoplast 138
- protoplast 73
- PR-protein 169p, 232p, 248
- prunasin 236
- Prunus*
 - *armeniaca* 302, 370
 - *dulcis* 294, 392
 - *padus*, bird cherry 613
 - *serotina* 496, 496
 - *spinosa* 391p, 485
- pseudocyclic replacements 527
- pseudogley 100, 176
- Pseudomonas aeruginosa* 77
- Pseudomonas syringae* 76, 189
- pseudovivacious species 550

- psilophytes 470
Psychotria suerrensis 26p
 psychrometer 256
 psychrometric constant 256
 psychrophylic 46, 94
Pteridium aquilinum 506, 550
 Pteridosperms 470
Pteris vittata 176
 pterocarpane 213
 P-translocator 66
Puccinellia maritima 497
Pulmonaria officinalis 511
Pulsatilla alpina 477
Pulsatilla violacea 511
 pulses of growth 512
 Pyridazinon 209
 pyrophytes 47
 pyroxenite 315
 Δ^1 -pyrroline-5-carboxylate 160
 Δ^1 -pyrroline-5-carboxylate (P5C),
 structure 134
 Δ^1 -pyrroline-5-carboxylate synthetase
 (P5CS) 92, 133p, 160
 pyruvate 320, 352
 – decarboxylase 103
 – P_i dikinase 135, 140p, 353
 pyruvate-alanine-transaminase 353p
- Q**
- Q₁₀ 48p, 60
 quantum efficiency
 – actual 34
 – optimal 34
 quaternary 470p
 – ammonium compounds 160p
 quebrachitol 159
 – structure 160
 quenching
 – chlorophyll *a* fluorescence 33p
 – non-photochemical 33
 – photochemical 33p
Quercus-Carpinetum molinietosum 492
Quercus 471, 474, 476
 – *boissieri* 499
 – *coccifera* 499
 – *faginea* 485, 498
 – *ilex* 499p
 – *petraea*, sessile oak 552, 613
 – *phase* 515
 – *pubescens* 477, 498, 552, 549
 – *robur*, pedunculate oak 294, 511,
 552, 613
 – *rotundifolia* 485, 498, 552
 – *suber* 499
- R**
- R gene 248, 252
 r strategist 527pp, 533
 Rab protein 87, 130, 141
rab17 gene 128
 radiation
 – at earth surface 259
 – atmospheric 260
 – beech forest 268
 – flux 269
 – incident radiation 263p
 – long-wave 259
 – net 259
 – R_n 303
 – short-wave 259
 – soil 260
 – window 257
 radicals 63
 – acceptors 42
 – free 225
 – scavengers 38
 radiocarbon dating 475pp
 radish
 – cadmium content 184
 – ozone sensitivity 227
 radius of vessels 292p
 raffinose 158
 rain 281
 rainfall distribution 582
 rainfed agriculture 481
Ramalina
 – *calicaris* 223
 – *farinacea* 223
 – *fastigiata* 223
 – *maciformis* 363, 366
 Ramsar 666
 random coil 130, 141
 – secondary structure 87
 rank dominance 411p
Ranunculus
 – *acer* 511
 – *acris* 485
 – *ficaria*, lesser celandine 510p
 Raoult's law 81
 rape 481
Raphanus raphanistrum 341
Raphanus sativus 380
 Raunkiaer 379
Rauwolfia serpentina 188
 raw humus 407p
 Rd22 gene 128
Rd29A 128
 reactive oxygen species (ROS) 37, 95,
 248
Reaumuria 153
 recalcitrant carbon 430p
 recalcitrant humus 407
 recurrent frost 88
 red soils 195
 redox potential, soil 180
 reduction
 – of nitrite 29
 – of sulfate 29
 – of the freezing point 86
 – potential, soil 180
 reductive smog 215
 redundancy, structural 573
 redundant species hypothesis 573pp
 reference system 399
 reforestation 480, 483, 501p
 refuges 472, 560
 regeneration
 – ability 504
 – gap 525
 – niche 617
 – phase 571
 rejuvenating phase 524
 relative growth rate 330, 375p
 relative humidity 256
 relative leaf water content 302
 relict endemics 550
 relict palaeoendemic area 550
 relict theory 559
 relief, formation of 583
 replacement communities 467, 479,
 495, 505
 reporter gene 215
 reserve building 377
 resilience 534p
 resistance 534, 594p, 597
 – systemic 241
 – weeds 490
 resource
 – accumulation 377, 385
 – availability 378, 400, 408
 – availability hypothesis 573
 – exploitation 406pp
 – export 418
 – limited 532
 – -ratio model 530p, 614
 – respiration 374p
 – use 626
 respiration 375p, 379, 409
 – growth 375p
 – light induced 348
 – mitochondria 348
 response curve 348
 retained water 283p
 retention time 544
 reticulum, endoplasmatic 104
 re-translocation, salts 171
 retrogression 520
 Reuver 474
 revegetation 480
Reynoutria japonica 496, 497
Rhamnus cartatica 391p
 rhaphide 327
Rhinanthus 607
Rhizobium 605, 618
Rhizocarpon cf. geographicum, yellow
 green lichen 117, 604
 rhizodermis 112, 171, 177, 203, 288
 rhizofiltration 191
Rhizophora 171
 rhizosphere, alkalisation 202p
 rhodanese 237
Rhododendron
 – *ferrugineum* 9, 551
 – *hirsutum* 462
 – *ponticum* 472
 rhubarb 327
Ribes 391p
 ribulose biphosphate carboxylase see
 also Rubisco 183
 rice 103, 106, 132, 152, 168, 382, 481
 – cultivation 507
 – deep-water 105
 – growing 636
Ricinus 187
 – *communis* 499
Ridolfia segetum 499
 Rieske protein 28
 rigid state 45p
 risk analysis 676p
 Riss ice age 472
 river
 – bed, dynamics 584p
 – discharge 280
 – valley landscape 486

- rivet popper hypothesis 573
 RNAase, cadmium sensitive 185
 RNA-induced silencing complex (RISC) 19
 RNA-mediated resistance 19
Robinia pseudoacacia 496
 rock bunting, *Emberiza cia* 588
 rocks 316
 root 150
 - adventitious 111
 - anatomy 297
 - apex 203
 - cap 203
 - competition 413, 607
 - cortex 100, 287p
 - depth 383
 - eaters 595
 - hair 112, 203, 287, 320
 - shoot ratio 392p
 - signal 300
 - system 286
 - tip 320
 rooting depth 309p
 root-shoot communication 300
Roridula 331
 - *gorgonias* 331
 ROS see also oxygen species, reactive
 - detoxifying enzymes 114
 - scavenger enzyme 181
Rosa 391p
 rosette plants 89, 274, 309
Rosmarinus officinalis 607
 rotation 482
 Rubisco 136, 138p, 222, 228, 320, 348
 - limiting assimilation rate 354p
 RuBP
 - carboxylase 356p, 348pp
 - regeneration 354
 - carboxylase, see also Rubisco
Rubus species 485
 - *chamaemorus* 552
 - *phase* 515
 ruderal 614
 - strategists 529
 - vegetation 491
Rumex 106
 - *acetosa* 111, 415
 - *acetosella* 111p, 341
 - *crispus* 101
 - *maritimus* 101
 - *obtusifolius*, broad leaved dock 235
 - *palustris* 111p
 - *thyrsiflorus* 101
 runner bean 68
 rush flower 590
 rye 72p, 383, 481p
- S**
 Saale cold period 474
 safe site 514, 542, 545
 safener 208, 211, 231
 Sahara, climate history 478
 Sahel 502
 - syndrome 671p
Saintpaulia ionantha 11p, 63
 salicin 248
Salicornia europaea 497
Salicornia prostrata 156
 salicylic acid 248, 251
 - as signal molecule 248p
 - biosynthesis 248
 salicyloyl-glucose ester see salicin 248
 salinity
 - damage 149
 - stress 146
 - stress avoidance 173
 - tolerance 171
Salix 471, 476
 - *herbacea* 474, 477, 552
Salsola kali 421
 salt 582p
 - cascade, overly-sensitive 150p
 - damage 324
 - deposition 171
 - eliminations 153p
 - excretion 171
 - gland 153p
 - recreation 153p
 - sequestration 155
 - stress 145–174
 - stress and cell wall proteins 170p
 - succulence 155, 172
 - succulents 171
 - tolerance 132, 145–146, 172
Salvadora persica 510
 salvation effect 558
 salver flower 590
Salvia leucophylla 250
Salvia pratensis 485
Salvinia natans 498
 sandstone 316
 sandy soil 285p
Sanguisorba minor 548
 sap suckers 595
 saponin 235
 sapwood 295, 377, 387, 427
 - area 295
 - conducting 293
Sarothamnus scoparius 552
Sarracenia 331
 saturation deficit 426
 saturation function 409
 savannah 371, 428
 saver of water use 420
Saxifraga 477
 - *oppositifolia* 386, 511
 - scab 208
Scabiosa columbaria 415
 scavenger
 - for ROS 156, 159, 172
 - metabolites 114
Schizosaccharomyces 190
 Scientific Advisory Committee on Global Change (WBGU) 630
 Scientific Committee on Problems of the Environment (SCOPE) 630
Scleranthus annuus 341
 sclerophyll 358, 365
 sclerophyllic vegetation 472
Scolymus grandiflorum 500
Scolymus hispanicus 499
 Scots pine, *Pinus sylvestris* 64, 229, 295, 405p, 410p, 430, 499, 613
scyllo-inositol 160
 sea lavender, *Limonium vulgare* 153
- seasonal
 - changes 512
 - freezing tolerance 91
 - vegetation dynamics 508
Secale, rye 383
 secondary messenger 125, 247
 secondary thickening 386
 sediment biogenic 583
 sedimentary rock 316
 seed 280
 - bank 522, 547p
 - bank analysis 515
 - bank, permanent 547
 - bank, temporary 547
 - distribution, quality 547
 - distribution, quantity 547
 - plants, temperature resistance 46
 - rain 522
 - shade 543
 - wings see *Acer* and *Fraxinus*
 seed dispersal
 - achory 545p
 - agochory 543
 - ahemerob 495
 - agrochory 545
 - allochory 543
 - anemoballochory 543
 - anemochory 543, 546
 - anthropochory 493, 545
 - atelochory 543, 545p
 - autoballochory 543
 - autochory 542–646
 - ballochory 543
 - barochory 543, 546
 - blastochory 542p
 - boleochory 543
 - bythisochory 543
 - chamaechory 543
 - dysochory 543
 - effectiveness 545
 - endochory 543, 546
 - endozoochory 546
 - epichory 543, 545p
 - epizoochory 546
 - ethelochory 543, 545
 - hemerochory 543, 545
 - herpochory 543
 - hydroballochory 543
 - hydrochory 543
 - meteochory 543
 - myrmacochory 543p
 - nautochory 543
 - ombrochory 543
 - ornithochory 543
 - polychory 546
 - speirochory 543, 545
 - stomatochory 543
 - synchory 544
 - zooballochory 543
 - zoochory 543, 546
 seeders 387
 seedling eaters 595
 segetal flora 467, 488, 490, 499
 selection pressure 471
 selective thinning 480
 selenium 191
 self thinning 422, 524, 607p, 403pp
 - constant 404

- Selye, Hans 10
 semi-dry grassland, interactions 619
 semi-evergreen 390
Senecio 89, 386
 – *glaucus* 512
 – *keniensis* 90
 – *keniodendron* 89
 senescence 112, 322
 sensible heat 255, 308p
 – flux 260, 270
 sequential succession 527
Sequoia 472, 474
 – *gigantea* 293, 387, 550
 sequoyitol, structure 160
 serine-threonine-protein kinase 151
Sesamum indicum 302
Sesbania 605
 sesquiterpenes 245
 sessile oak, *Quercus petraea* 552, 613
 sewage sludge, application 182
 shade chloroplast 27pp
 shade leaf 26, 361, 367p
 shade plant *Oxalis oregana* 25
 shade plants, obligate 361
 shading 272p
 shelter
 – belts 582p
 – experiment 425
 – wood 480
 shifting cultivation 481
 – with slash and burn 505
 shikimate pathway 224, 245
 shoot
 – assimilation 394
 – differentiation 293
 – eaters 595
 – nodules 605
 shrub 387pp, 391p
 – land 305
 – vegetation 429
 Siberia, southern 552p
 Siberian larch 270
 sickle 482
 siderophore 180, 205
 – uptake system 197
 sigma sociology 525, 600
 signal
 – creation 13
 – peptide 58
 – receptor, two component 111
 – transduction in drought 129
Silene
 – *acaulis* 474
 – *cucubalus* 187
 – *villosa* 512
 – *vulgaris* 176, 189, 491
 silicates 314pp
 siliceous plants 462
 silicic acid 594
 Silurian 469p
 silver 193
 silver birch, *Betula pendula* 613
 silver fir, *Abies alba* 475, 613
Sinapis arvensis 341, 499
 sinapyl alcohol 431
 single copy genes 19
 singlet oxygen 68pp
 sinigrin 236
 sink leaf 322, 366
 sink organs 379
 sinks, carbon 347, 655
 site equivalence 610, 616
 size distribution, particle 317
 size of organs 274
 slash and burn 505
 – agriculture 641
 – management 486
 slate 316
 small nuclear ribonucleoproteins
 (snrNP) 56
 smectite 315
 smog
 – London 215
 – Los Angeles 215
 – oxidative 215, 231
 – reductive 215, 231
 snow damage 418
 snow patch communities 513
 SO₂ resistance 222
 – lichens 222
 sociability 555
 social fallow land 489
 sodium 145–174, 320
 – chloride 145–174
 – proton antiporter 150
 soil
 – acidification 326p, 329, 407, 430,
 456pp, 638
 – carbon 407, 649p
 – – and fire 419
 – – residence time 436
 – colloids 100
 – compaction 490
 – definitions 318
 – depth and moisture 265
 – erosion 580
 – fertility 317, 418
 – formation 583
 – four components 99
 – gas exchange 99
 – global distribution 319
 – plant-atmosphere continuum 283
 – pore water 99p
 – profile 515
 – salinity 145, 503
 – saturated conductivity 286
 – solution 317
 – structure 99p
 – temperature 581
 – unsaturated conductivity 286
 – water 290
 – – content 300
 – – relations 490
 – – holding capacity 283p
Solanum eleagnifolium 499
 – *nigrum* 500
 solar
 – constant 257, 259
 – effects 468
 – energy 259
 – radiation 259
 – – global distribution 261
Solidago
 – *canadensis* 497
 – *gigantea* 497
 – *vigaurea* 362
Sonneratia 171
 soot 433p
Sorbus terminalia 552
Sorghum 351
 – *bicolor* 507
 – *sudanense* 8
 sorosilicates 317
 sorrel see *Rumex*
 SOS systems 172
 source, leaf 322, 366
 soya bean 38, 187
 – salt stress 146
 space, exploitation 550
Spartina anglica 497
 spatial
 – distribution 548
 – niche 617
 – separation 559
 specialization 563
 species
 – abundance 566
 – characteristic 601
 – composition 419pp
 – distribution 563
 – diversity 563, 566
 – diversity, islands 557
 – loss 571
 – number, and area 535, 560p
 – protection 664
 – richness 566
 – saturation 559
 – structure, succession 519
 – turnover 567
 specific leaf area 357p
 speedwell, *Veronica spp.* 76
 speirochory 543, 545
 spelt 482
Spergula vernalis 341
 spermidine 132
 spermine 132
 spider plant, *Chlorophytum como-*
 sum 230, 233
 spinach 154
 – ozone sensitivity 227
 spring
 – cereals 481
 – geophytes 269
 – germination 47
 – traps, *Dionaea muscipula* 332
 – wheat 481
 sprouting plant 387, 388
 spruce 7, 13, 64, 222, 227, 230, 267,
 308, 330, 340, 375p, 387, 457, 475,
 483, 501
 – *Picea abies*, leaf development 367p
 squash 65
 squill 510
 stability 534, 537
 – and diversity 534
 – global 535
 – local 535
 stachyose 158
Stachys arvensis 341
 stand mosaics 587
 stands after fires 406
Staphylococcus epidermidis 77
 state transition 28, 33
 stearic acid, melting point 49

- stearyl-ACP desaturase 66
 Stefan-Boltzman law 257p
 stele 201
Stellaria decumbens 386
 – *media* 487
 stem length 382
 stem number 382
 steneonic 599
 steppe heathland theory 482
 steppe plants 380
 stepping stones 557, 560p
 – biotopes 559
 sticky traps, *Drosera* spp. 331
 stilbene 229
 – synthase 224, 230
Stipa 474, 477, 509
 – *capillata* 552
 – *lessingiana* 511
 – *pennata* 552
 – *tenacissima* 602
Stipagrostis capensis 500
 – *pungens* 500
 stomata 274, 279
 – aperture 297p
 – conductance 297
 – number of 296
 – see also stomatal opening
 – size 296
 stomatal
 – closure 365p
 – conductance 220, 270, 284, 348, 350, 365p
 – opening 296
 – regulation 125, 296–301
 – resistance 279
 – response 299
 – response, airborne pollutants 218
 stomatochory 543
 storage 385
 – organs 384
 – proteins 336
 – water 282
 strain 11pp, 20, 94, 123,
 – avoidance 11p
 – resistance 11p
 – stress 535
 strategy
 – Grime 528
 – model 527
 stratification 47, 511
 stratocenoses 599
 stratosphere 225
 stratotype 599
 strawberry 77
 stress 8, 63p, 123
 – abiotic 8
 – alleviation of 14
 – avoidance 11p
 – biotic 8
 – concepts 11p
 – definition 8
 – demonstrated in plants 16p
 – demonstration 20
 – duration 11
 – endogenous 8
 – exogenous 8
 – increase 14
 – intensity 11
 – light intensity 37
 – lignin 229
 – multiple 9, 13
 – osmolytes 156
 – oxidative 13, 193
 – ozone sensitivity 227
 – post-anoxic stress 114
 – perception 13pp
 – quantity law 219
 – reaction, specific 10
 – reaction, unspecific 9
 – release 14
 – resistance 11p
 – response, multiple 13
 – tolerance 11p, 20, 358, 528, 614
 – tolerance as competition
 strategie 614
 – tolerance by genetic engineer-
 ing 16pp
 – tolerant strategist 528
 stroma thylakoid 27
 strong acid indicators 341
 structural niches 617
 structural redundancy 573
 strut roots 389
Styrax 472
Suaeda fruticosa 606
 subalpine 552
 sub-Atlanticum 473
 sub-boreal 473
 sub-mediterranean 499
 subsidiary cell 299
 suburbia syndrome 671
 succession 513pp
 – allogenic 518
 – analysis, methods 515
 – autogenic 518, 523
 – autotrophic 516
 – cycle 516p, 523p
 – definition 514
 – energy flow 519
 – heterotrophic 516
 – homeostasis 519
 – in a Mediterranean oak forest 523
 – nutrient cycles 519
 – on fallow land 522
 – organic structure 519
 – pathway 531p
 – primary 514, 516p
 – primary change with time 518
 – regeneration 516p
 – regressive 520, 523p
 – research, applied 525
 – secondary 514, 516p, 520pp
 – secular 516
 – species structure 519
 – types of 516
 succinate 69
 succinic acid 201
 succulent 354, 371
 – plants 121p
 sucrose 86, 132, 159, 167, 320
 sucrose phosphate synthase
 (SPS) 67p
 sucrose synthase 53
 suction traps, *Urticularia* spp. 331
 sugar beet 18
 – salt stress 146
 sugar cane 499
 sugar maple, *Acer saccharum* 26
 sulfate 199, 325, 335p, 444, 456, 638
 – disposal 163
 – reducing microorganisms 432
 – reduction 29, 101
 – respiration 100
 sulfite anion 336
 sulfite reduction 325
 sulfonic acids 220
 sulfur 320
 – cycle, global 638p
 – deficiency 336
 – deposition and forest
 damage 459p
 – excess 336
 – importance for plants 335p
 – metabolism 335
 – nutrition 335p
 – uptake 336
 sulfur dioxide 215–221, 232, 336p
 – and photosynthesis 218–220
 – diffusion resistance 220
 – membrane damage 221
 – metabolism 218–220
 – sensitivity 218
 – uptake 219p
 sulfuric acid 215
 sulfurous acid 215
 summer
 – annuals 512
 – rain 371
 – rain water 287
 – smog 225
 sun burn, beech 272
 sun flecks 25, 269
 sun leaf 26, 361, 367
 sunflower 185, 386
 supercooling 87pp
 superoxide 70
 – dismutase 69, 114, 130, 221
 supply function 350
 supra-mediterranean 499
 surface
 – evaporation 280
 – run-off 281
 – temperature 581
 – tension 118
 surplus of light 25
 survival through dieback 390
 sweet flag, *Acorus calamus* 103, 105
 sycamore, *Acer pseudoplatanus* 613
 syconium 591
 symbiosis 603p
 symmetry, lateral 391p
 symmetry, longitudinal 391p
 symplast 154p, 287p, 318
 symport 321
 synanthropic successor 493
 synanthropic types 496
 synchorology 466, 541–578
 synchory 544
 syndrome concept 670p
 syndynamics 466
Synechocystis 49
Synechococcus 164p
 synecology 465pp, 579–625
 synevolution 616

- synusia 599
systemic acquired resistance 251
systemic defence reaction 241
systemically induced resistance 169
- T**
- tamarisk, *Myricaria germanica* 584
Tamarix 499
– nilotic 510
Tanacetum corymbosum 513
tannin 213, 205, 235p, 594
Tansley, A. G. 400
tantalum 191p, 193
Taraxacum officinale, parachutes 485, 509, 511, 544
taro 481
TATA box 56, 128
Taxodium 471, 474
taxonomic units 586
Taxus baccata, yew 613
tectosilicates 317
Teesdalea nudicaulis 383
Tegelen warm period 474
Teloschistes 278
– *flavicans* 223
temperate
– deciduous forest 392
– grassland 429
temperature 255–259
– adaptation 271pp
– daily changes 263–265
– earth 262p
– environmental 255
– enzyme activity 53
– extremes, Europe 657
– gradients 47
– layers 581
– limits 45
– optimum 46
– optimum, net photosynthesis 363
– physiologically acceptable range 274
– profile 264
– resistance 45p
– stomatal opening 301
– stressor 45–98
temporal niches 617
termite, savannas 586
termites and methane 636
terpene biosynthesis 245p
terpenoid 235
– air pollutant 215
territorial 591
Tertiary 469, 470pp
tertiary sulfonium compounds 160p
Tethys 468, 470
Tetraclinis articulata 499, 502
2,3,5,6-tetra-methyl-phenylenediamine 165
Thalictrum minus 513
thaumatin 167, 169
Thaumatococcus daniellii 167
thermal balance 254–275
– organs 255p
thermal hysteresis protein 83, 87, 96
thermal radiation 257
thermohaline circulation (THC) 646
thermo-osmosis 106pp, 114
– lacunar pressure 108
thermophiles 46, 94
thermotropic phase transition 64
therophyte 512, 515
thinning 411
thioglucosidase 236
thionein 186, 189
thiosulfate 220
Thlaspi caerulescens 191p
Thlaspi calaminare 191
three strategy model 614
throat flower 590
thunder, convective 410
thunderstorms 623
4,6-thymine dimers 39
thylakoid lipids 67
thylakoid membranes, lateral heterogeneity 28
tiger syndrome 671
Tilia 297, 471, 476
– *cordata*, lime 613
– *platyphyllos*, large-leafed lime 613
timber production 486
Ti-plasmid 19
tobacco 65, 151, 157, 164, 169, 188, 192, 230, 233, 383, 499
tocopherol 70, 95
Tofieldia calyculata 474
tolerance model 532
tomato 53, 57, 94, 167, 188, 237, 499
– ozone sensitivity 227
– salt stress 146
tomillares 500
tonoplast 140, 147–149, 172, 190
– cold sensitivity 64
topogenesis 58
total herbicide 210
– mode of action 211
total land surface, proportion 495
total potential 238
total suppression convergence 527
toxicity of xenobiotics 208
toxin, constitutive 236–238
toxin, environmental 231
toxi-tolerance 491
trace elements 192, 314
Tradescantia 297, 301
– *fluminensis* 51
transcription factor 92p, 127, 150
transfer cell 177
transhumance 499
transpiration 272, 281, 297p, 302p, 365, 426
– maximum rate of 308
– measurement 306
– of the stand 295
transport of water 117
tree 387pp, 391p
– barrel like 388p
– canopy, form of 307
– deciduous of temperate zones 380
– dwarf of the forest margins 380
– evergreen in taiga and mountain forests 380
– evergreen of tropical and subtropical forests 380
– fall gap 524, 548
– felling 486
– limit 7
– maximum age 387
– maximum height 387
– maximum volume 387
– stand, sparse 482
trehalose 162
triangle, strategy 528
Triassic 468p
s-Triazine 210
Tribulus terrestris 498
Trichocereus spp. 606
tridromorph 15
Tridestomia oblongifolia 364p
Trifolium 487, 548
– *pratense* 618p
– *rubrum* 413, 451
– *stellatum* 542p
– *subterraneum* 545, 610
2,3,5-triphenyl-tetrazolium chloride (TTC), structure 62
Triphyphyllum 332
triple response, ethylene 110
triskaidea-aluminium 196
Tristerix aphyllus 606
Triticale 383
Triticum 296
– *aestivum* 380, 382
tropical forests
– and climate change 505
– destruction 504p
– diversity 505
– wood management 505
tropical grassland 381
tropical rain forest 305, 428
tropical tree crop 305
tropics, daily fluctuation 88
troposphere 225
trypsin 167
– inhibitor 167
tryptophan 141
– pathway 245
tube flower 590
Tulipa sylvestris 488, 496
tundra 305, 428
– period, oldest 476
uranic 552p
turbulence 303
turgor 122, 283p, 296, 299, 365
– loss point 79, 119
– pressure 119, 122, 140
turn-over time, *Pinus* 657
turn-over, microbial 433
turn-over, species 557
tychozeonic 599
- U**
- ubiquist 550, 599
ubiquitin 60
UDP-glucuronate 158
UDP-apiose 158
UDP-arabinose 158
UDP-D-glucuronate 158
UDP-galacturonate 158
UDP-glucose 158
UDP-xylose 158
UGPase 53
Ulmus 475p
– *glabra* 614

- umbrella species 563
 - UN Educational, Scientific and Cultural Organisation (UNESCO) 629
 - UN Environment Programme (UNEP) 629
 - UN environmental organisation 652
 - uncoupling factor Ω 307
 - uniport 321
 - United Nations Development Programme (UNDP) 629
 - United Nations Economic and Social Council, ECOSOC 652
 - unregulated forest-field management 482
 - uptake of nutrients 320
 - uranium 193
 - urban ecology 490
 - Urocene/early atmosphere 469
 - Urtica* 376, 385p, 413
 - *dioica*, nettle 385p, 405p
 - *urens* 383
 - Usnea florida* 223
 - *subfloridana* 223
 - UV avoidance 38
 - UV detection 40
 - UV radiation, stress 37
 - UV-A 37, 40
 - UV-B 37p, 40
 - damage 38p
 - light as stressor 31
 - receptor 43
 - resistance 40
 - UV-C 37, 43
- V**
- Vaccinium* 203
 - vacuolar pigment 195
 - vacuole 126, 147–149, 154, 190
 - and water management 119p
 - VAM mycorrhiza 381
 - vanadate 213p
 - vanadium 314
 - vapour pressure, water 80
 - vapour trails 623
 - variability 536
 - vector 542
 - vegetation 393
 - actual 493
 - and site 580pp
 - Central Europe 473
 - climate 266
 - complexes 600
 - degree of naturalisation 493
 - development, modern times 487pp
 - greening of the landscape (Vergrünlandung) 488
 - dynamics 402, 508
 - dynamics, and animals 531
 - dynamics, cyclic 523
 - dynamics, long-term 513–533
 - history 467pp
 - map 548, 555
 - mosaic 541
 - on the forest floor 269
 - original 493
 - radiation absorption 265
 - reflection 265
 - zonation 510
 - vegetative propagules 542
 - Velamen radicum* 123
 - Venus fly trap 331
 - verbascode 158
 - Verbena officinalis* 498
 - vermiculite 315
 - vernalisation 511, 547
 - Veronica persica* 341
 - vesicular arbuscular mycorrhiza, VAM 333, 413, 605
 - vessel diameter 292
 - vessel length 292
 - Viburnum* 597
 - vicariance 551
 - ecological 551
 - vicarious species 462
 - Vicia* 487
 - *cracca* 482
 - *faba* 499
 - vicini 599
 - Vigna
 - *luteola* 302
 - *unguiculata*, cow pea 271, 294, 302
 - vines 499
 - vineyards 183
 - Viola*
 - *calaminaria* 176
 - *hirta* 513
 - *lutea* 192
 - violaxanthin 36p, 124
 - de-epoxidase 36p
 - structure 35
 - virulence 246
 - Viscum* 607
 - vitamin C 39
 - Vitis* 471, 474
 - vitrification 75p, 95
 - volcanic eruptions 517
 - volicitin 243
 - volume flux 292
- W**
- Waal warm period 474
 - Walker Box 213
 - wall
 - labyrinth 177
 - pressure 119p, 122
 - pressure potential 122
 - walnut tree, *Juglans regia* 607
 - Walter's law of the relative consistency of habitat 549
 - warm period 476p
 - waste remediation 192
 - water
 - activity 283
 - atmosphere 633
 - availability 280, 297
 - balance 254
 - balance of the cell 283p
 - boiling point 118
 - channels 288
 - clusters 80, 117p
 - conducts 279
 - consumption 277, 426
 - content 277
 - cycle (internal) of a plant 296p
 - cycle, global 633pp
 - deficiency 117–143
 - dipol 117
 - environmental factor 277–313
 - flows, intracellular 119
 - flux 292
 - freezing 72pp
 - from clouds 426
 - from xylem, deuterium isotopic ratio 287p
 - gradient 303
 - hygroscopically bound 283
 - line, hydraulic 286
 - mean residence time (MRT) 633p
 - melting point 118
 - molecules anomalies 117pp
 - nitrate content 638
 - oxidase 183
 - parasites 342p
 - pore 121
 - photosynthesis 365
 - relations 277–313
 - run off 280
 - saturation 256
 - saturation deficit 256
 - saving 303pp
 - seepage 280
 - soil, available for plants 284
 - status 288
 - status, stomatal opening 299, 301pp
 - storage 121p, 277pp
 - stress 350, 374p, 393
 - surface tension 284
 - turnover 426
 - uptake 283–297
 - use efficiency 136, 142, 358
 - vapour 256
 - partial pressure 279
 - water potential 79pp, 96, 118, 122, 140, 282p, 299p, 365
 - gradient 140, 297
 - leaf 300
 - pre-dawn 283, 366
 - xylem 294
 - water transport 283–303
 - phloem 295
 - xylem 292–295
 - watershed 400
 - wax, degradation 432
 - weather 417
 - weathering 583
 - weeds, arable fields 486
 - Weichsel cold period 474
 - Weinmannia* 449
 - Welwitschia mirabilis* 271p, 550
 - wet bulb temperature 256
 - wet nurse plants 618p
 - wheat 152, 187, 196p, 201, 267, 382, 482
 - aluminium resistance 204
 - ozone sensitivity 227
 - salt stress 146
 - white rot, fungus 431
 - willow 111, 597
 - wilting 119p
 - point, permanent 285p

- wind
- and dunes 582p
- barriers protective 582p
- damage 418
- shear 582p
winter
- annual 381, 512
- cereals 481
- flounder 84
- germination 47
- rainfall 287p
- wheat 9
- - antifreeze protein 83
witch hazel, *Hamamelis virginiana* 45
Withania somnifera 500
wood 427
- anemone 510
- borers 595
- ring-porous 293
wooden hook plough 482
woodland degradation 500p
woody growth 331
woody plants 387
World Bank 629p
World Climate Research Programme (WCRP) 629
World Heritage Sites 673p
World Meteorological Organisation (WMO) 629
World Trade Organisation (WTO) 629
wound reaction 238
wounding 250
Würm glaciation 472
- X**
Xanthium spinosum 499
xanthophyll 95, 141
- cycle 35pp
Xanthoria parietina 223
Xanthoria polycarpa 223
Xanthorion 223
xanthoxin 124
xenobiotic 184, 196
- glutathione conjugate 207
- sequestration 214
xenobiotica 207-233
- detoxification 211p
- definition 208
- gaseous 231
xenophyte 493
xenozoenic 599
xeroseries 514
xerotherm relicts 477
xylem 150, 203, 320
- area 297
- conductance 297
- flux 306
- parasites 342p
- parenchyma 150
- phloem, cycling 320
- water 290
- water potential 289, 295, 300
- Y**
Yang cycle 106
yeast 53, 123
yellow tail flounder 84
yellow tips 232
yellow water lily, *Nuphar lutea* 108p
yew, *Taxus baccata* 613
yield determination 330
- Z**
Zea mays 178
zeaxanthin 35p, 141
- epoxidase 35p, 124
- structure 35
zinc 176, 184, 191, 193, 204, 320, 408
zinnias, ozone sensitivity 227
Ziziphus 499
zooassociations 600
zooballochory 543
zoocenology 598
zoocenoses 586
zoochory 543, 546
zygaenae 236