

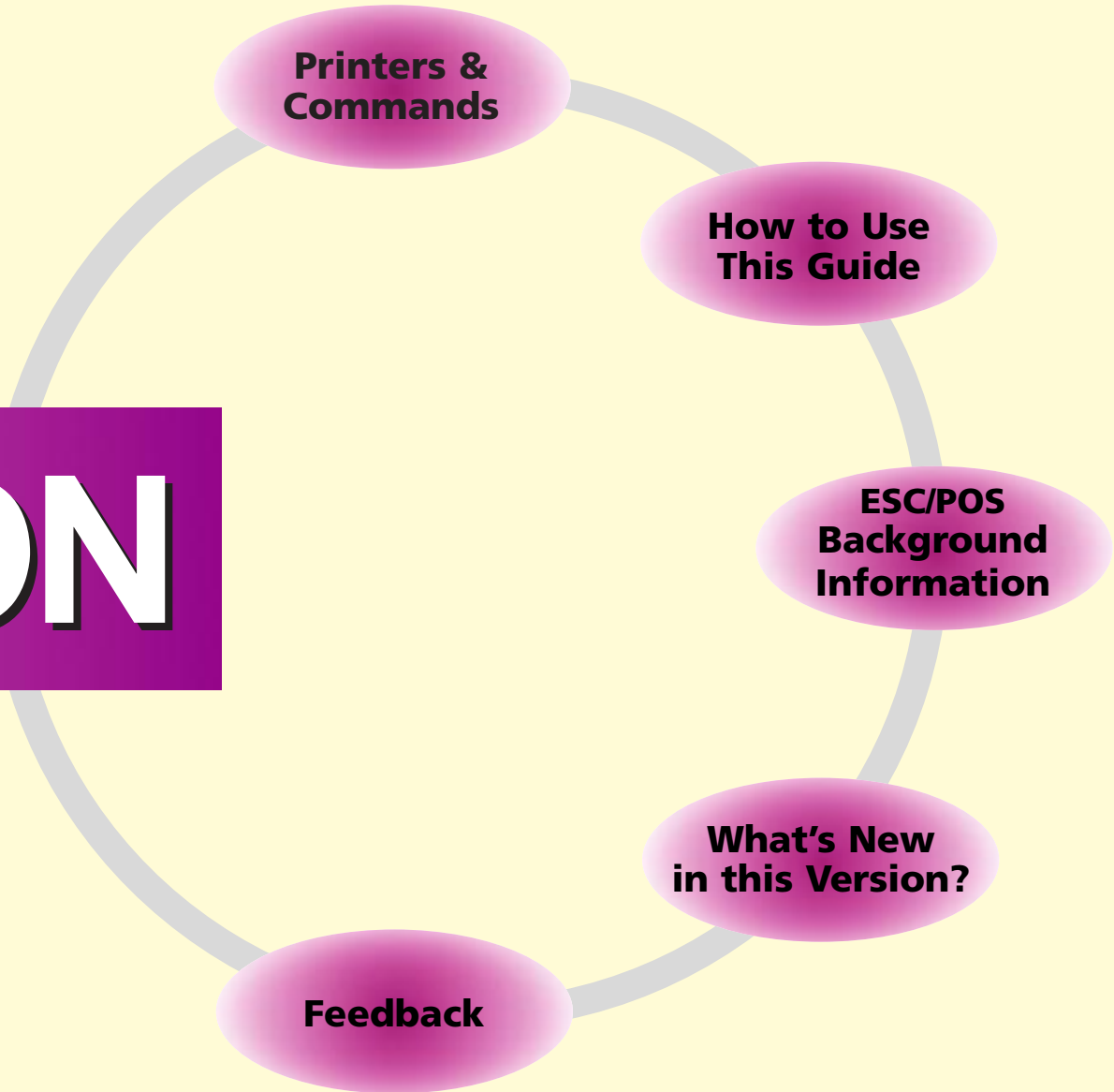

EPSON



[CLICK HERE](#) for a list of EPSON subsidiaries

[CLICK HERE](#) for "About This Manual"





EPSON

Printers & Commands

Paper roll

TM

Paper roll/cut sheet

TM-H5000
TM-U300C/D
TM-U325D
TM-U375
TM-U925

Receipt/journal/cut sheet

TM

Slip

TM



ESC/POS
ESC/POS
ESC/POS
ESC/POS
ESC/POS
ESC/POS
ESC/POS
ESC/POS
ESC/POS
ESC/POS
ESC/POS
ESC/POS

EPSON

Paper roll/slip/ validation printers

- **Commands listed by function**
- **Commands listed in alphanumeric order**
- **Character code tables**
- **Usable application programs and tips**
- **Definitions**

Features
& Technical
Information

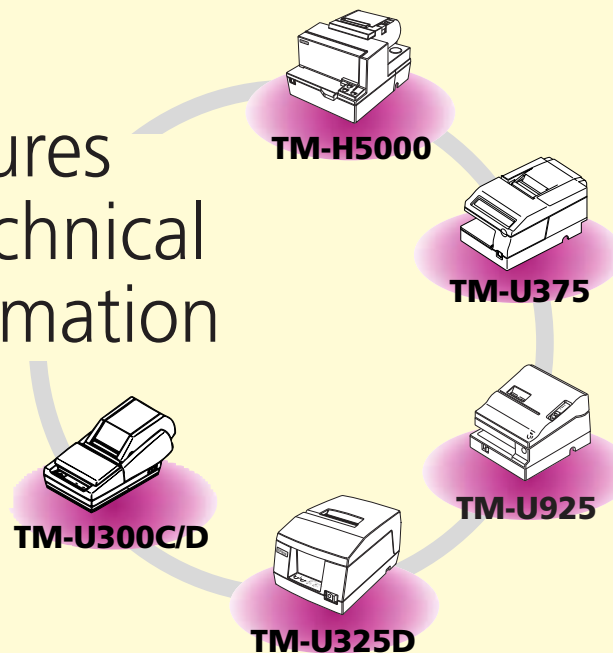

ESC/POS
ESC/POS
ESC/POS
ESC/POS
ESC/POS
ESC/POS
ESC/POS
ESC/POS
ESC/POS
ESC/POS
ESC/POS

EPSON

TM-H5000

- **Features**
- **Specifications**
- **Self test**
- **Hex dump**
- **Supported commands**



EPSON

TM-U375

- **Features**
- **Specifications**
- **Self test**
- **Hex dump**
- **Supported commands**



ESC/POS
ESC/
ESC/POS
ESC/POS
ESC/POS
ESC/POS
ESC/POS
ESC/POS
ESC/POS
ESC/POS
ESC/POS

EPSON

TM-U925

- **Features**
- **Specifications**
- **Self test**
- **Hex dump**
- **Supported commands**



ESC/POS
ESC/POS
ESC/POS
ESC/POS
ESC/POS
ESC/POS
ESC/POS
ESC/POS
ESC/POS
ESC/POS
ESC/POS
ESC/POS
ESC/POS
ESC/POS

EPSON

TM-U325D

- **Features**
- **Specifications**
- **Self test**
- **Hex dump**
- **Supported commands**



ESC/POS
ESC/POS
ESC/POS
ESC/POS
ESC/POS
ESC/POS
ESC/POS
ESC/POS
ESC/POS
ESC/POS
ESC/POS

EPSON

TM-U300C/D

- **Features**
- **Specifications**
- **Self test**
- **Supported commands**



How to use this guide *more*



Home: main menu

Takes you back to the main menu.



Return to previous view

Takes you back to the screen you were viewing previously.



more

Continued on next page

Takes you to the next page of any continued item.



Print

Gives you the print dialog box, where you can select which pages to print.



ESC J

Bookmarks

These are the words on the left side of the screen in the main body of this guide. Click a bookmark to instantly jump to its topic.



Resize bookmarks

If you wish, you can increase the size of the bookmark area by dragging the dividing bar to the right.



How to use this guide

(continued)

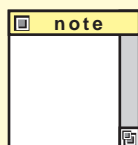

Note

These give you extra information, but they do not print. You can close or move them if you wish.



Zoom (on Acrobat toolbar)

Use the zoom tool on the Acrobat toolbar at the top of the screen to magnify the page display.



Page view (on Acrobat toolbar)

Returns to the full page view after zooming.



Select text (on the Acrobat toolbar)

Allows you to select text, which you can then copy and paste into another application.



Exit

This button (only on the home page) exits you from this guide.



ESC/POS
ESC/POS
ESC/POS
ESC/POS
ESC/POS
ESC/POS
ESC/POS
ESC/POS
ESC/POS
ESC/POS
ESC/POS

EPSON

What's new in this version?

**The TM-U325D and TM-U300C/D
are added since version 1.0**



ESC/POS
ESC/POS
ESC/POS
ESC/POS
ESC/POS
ESC/POS
ESC/POS
ESC/POS
ESC/POS
ESC/POS
ESC/POS

EPSON

Paper roll printers

The information for this category is not ready yet. Please use the printed manual until the next version of this online guide.



ESC/POS
ESC/POS
ESC/POS
ESC/POS
ESC/POS
ESC/POS
ESC/POS
ESC/POS
ESC/POS
ESC/POS
ESC/POS

EPSON

Slip printers

The information for this category is not ready yet. Please use the printed manual until the next version of this online guide.



ESC/POS
ESC/POS
ESC/POS
ESC/POS
ESC/POS
ESC/POS
ESC/POS
ESC/POS
ESC/POS
ESC/POS
ESC/POS

EPSON

Receipt/journal/ cut sheet printers

The information for this category is not ready yet. Please use the printed manual until the next version of this online guide.



ESC/POS
ESC/POS
ESC/POS
ESC/POS
ESC/POS
ESC/POS
ESC/POS
ESC/POS
ESC/POS
ESC/POS
ESC/POS



Subsidiaries

[more](#)

EPSON AMERICA INC./SED

20770 Madrona Ave.
Torrance, CA 90559-2842 U.S.A.
Tel: 1-310-787-6300
Fax: 1-310-782-5350

EPSON EUROPE B.V.

Prof. J.H. Bavincklaan 5
1183 AT Amstelveen The Netherlands
Tel: 31-(0)20-5475-251
Fax: 31-(0)20-6454-315

EPSON Deutschland GmbH

Zülpicher Strasse 6, 40549
Düsseldorf 11, Germany
Tel: 49-(0)211-5603218
Fax: 49-(0)211-8584768

EPSON U.K. LIMITED

Campus 100 Maylands Ave.
Hemel Hempstead Herts. HP2 7TJ
United Kingdom
Tel: 44-1(0)442-61144
Fax: 44-1-(0)442-227-244

EPSON FRANCE S.A.

68 Bis Rue Marjolin B.P. 320 92305
Levallois Perret Cedex, France
Tel: 33-(0)1-40-87-38-62
Fax: 33-(0)1-47-37-15-10

EPSON IBERICA, S.A.

Avda. de Roma, 18-26
08290 Cerdanyola del Vallès
(Barcelona), Spain
Tel: 34-(9)3-582-2500
Fax: 34-(9)3-582-1555

EPSON ITALIA S.P.A.

V.le F Ili Casiraghi, 427
20099 Sesto Si Giovanni (Milan), Italy
Tel: (39)226-2331
Fax (39)2244-0750

EPSON SINGAPORE PTE. LTD.

No. 1 Raffles Place #26-00 OUB
Centre Singapore, 0104
Tel: 5-530477
Fax: 5-5338119



EPSON

Subsidiaries

(continued)

EPSON HONG KONG LIMITED

25/F., Harbor Centre, 25, Harbor Road,
Wanchai, Hong Kong
Tel: 852-2-585-4663
Fax: 852-2-827-4346

EPSON TAIWAN TECHNOLOGY & TRADING LTD.

10f, No. 287, Nanking E. Road, Sec. 3
Taipei, Taiwan R.O.C.
Tel: 886-(0)2-717-7360
Fax: 886-(0)2-718-9366

SEIKO EPSON CORP.

KOREA OFFICE:
10F, KIL 63 Building 60,
Yoido Dong, Youngedungpo-Ku,
Seoul, Korea
Tel: 82-(0)2-784-6027
Fax: 82-(0)2-769-1049

EPSON AUSTRALIA PTY. LTD.

70 Gibbes Street,
Chatswood NSW 2067
Australia
Tel: 61-(0)2-415-9000
Fax: 61-(0)2-417-0077

EPSON HANBAI CO., LTD.

TOKYO OFFICE:
3F Building Kawaguchi
Fuda Chofu-Shi Tokyo 182 Japan
Tel: 0424-99-7829
Fax: 0424-99-7834

OSAKA OFFICE:
13F Shin-Osaka Daiichi-Seimei Bldg.
5-24 3-Chome Miyahara Yodogawa-ku
Osaka 532 Japan
Tel: 06-350-4964
Fax: 06-350-4968



**ESC/POS® Online Guide
Version 1.1
Seiko Epson Corporation
System Device Division**

**Copyright ©1997 by Seiko Epson Corporation, Nagano, Japan.
All rights reserved.**

EPSON

EPSON and ESC/POS are registered trademarks of Seiko Epson Corporation.

Acrobat® Reader™ copyright ©1987–1996 Adobe Systems Incorporated. All rights reserved.

Adobe and Acrobat are trademarks of Adobe Systems Incorporated.

August 1997



ESC/POS

The market for store automation equipment is changing rapidly with the widespread introduction of POS (point of sale) terminals. These terminals are now appearing even in small retail stores and specialty shops. They occupy a secure position in the range of applications available for personal computers.

As more personal computers come to be used as POS terminals, the demand for matching standardized peripheral devices is expected to rise. At present, however, many of the competing POS terminal printer displays on the market employ mutually incompatible command sets. This imposes limits on the expandability and range of applications possible with PC-based systems. There is a need for a new command set designed to provide the expandability and universal applicability demanded by the market.

To meet this need, Seiko Epson Corporation proposes the adoption of a newly developed command set to standardize POS terminal peripheral devices: ESC/POS (Epson Standard Code for Point of Sale).

The aim when developing ESC/POS was to create a set of control codes that could be used to operate any output device connected to a POS terminal. These new codes are intended to replace the mutually incompatible command sets previously in use.

TM/DM series models already support ESC/POS, and they are highly valued in the marketplace.

Seiko Epson Corporation plans to produce new models in the TM/DM series offering ESC/POS support and to continue to work for the standardization of the entire POS environment to promote the dissemination of ESC/POS.



ESC/POS FEATURES

ESC/POS is designed to reduce the processing load on the host computer in POS environments. It comprises a set of highly functional and efficient commands that enable the full realization of the potential of printers.

A command set designed for universal applicability

The commands that are supported by all printers and that are specific to individual models are clearly delineated. This means that a ESC/POS compatible type will work with any system regardless of manufacturer and be suitable for a wide range of applications.

Superb expandability allowing the addition of new functions

New functions can be added and accommodated by the categories already provided in the command system.

Allows more effective use of software

Once a software application has been created for one printer in the TM series, it can be used as the basis for versions for the other printers in the series. Only a small portion of the program source code needs to be modified.



COMMAND CLASSIFICATION

ESC/POS printer commands are classified by functions such as print, character, print position, printing paper, line spacing, panel button, paper sensor, mechanism control, status, bar code, bit-image, macro function, MICR, and miscellaneous functions. The classification is called function classification.

ESC/POS printer commands are also classified by sheet and grade. The sheet and grade classification is called matrix classification.

The sheet classification is divided into single sheet commands and multiple sheet commands. The grade classification is separated into basic commands and extension commands.

Basic commands are defined as fundamental printer controls, including print commands and character type selection commands. Extension commands are defined as control codes for functions specific to individual printers. These commands are further divided into mechanical extension commands that relate to additional mechanical functions such as stamp and auto-cutter units, hardware extension commands that relate to additional hardware functions such as panel button and status transmission controls, and software extension commands that relate to additional software functions such as user-defined and bar code controls. The next screen is an overview diagram of the matrix classification of ESC/POS.



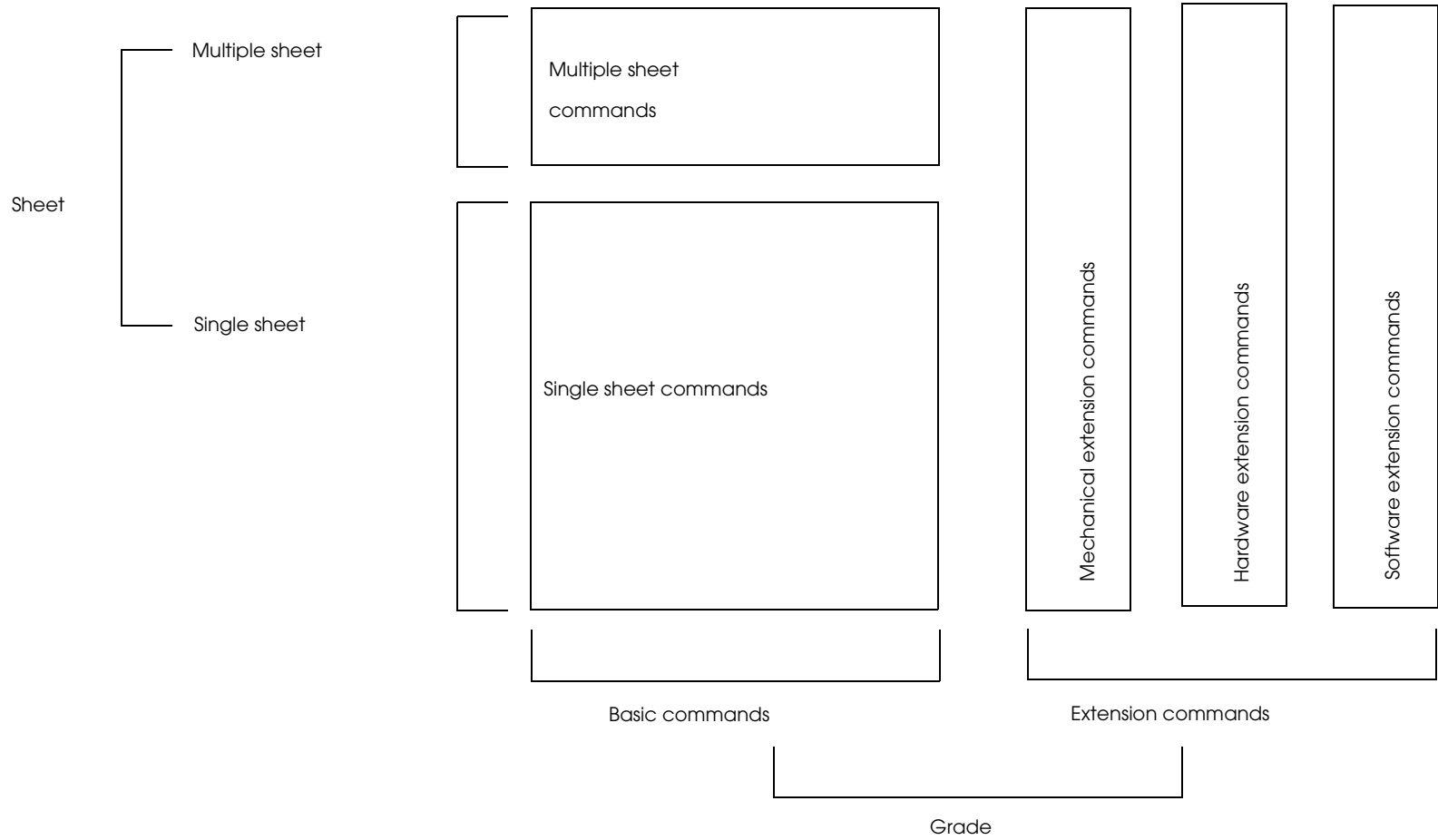

OVERVIEW OF DATA PROCESSING

Character Data and Normal Commands

The printer stores data sent from the host computer in the receive buffer temporarily and then the printer interprets the data and classifies them into commands or character data sequentially. If the data from the receive buffer is a normal command, the printer processes the command corresponding to its function. For example, if the data interpreted is **ESC 3**, the printer changes a setting value for the line spacing and if it is **LF**, the printer prints the data in the print buffer and feeds the paper one line.

If the data from the receive buffer is character data, the printer reads the appropriate font data from the resident character generator and writes image data to the print buffer.

Real-time Commands

The printer stores data sent from the host computer in the receive buffer, interprets the data, and processes the commands corresponding to their function one line at a time. The real-time commands are the commands that consist of a **DLE** extension, such as **DLE EOT** or **DLE ENQ**: They are processed immediately. The real-time commands are ignored as undefined codes in the main processing.



Data processing diagram

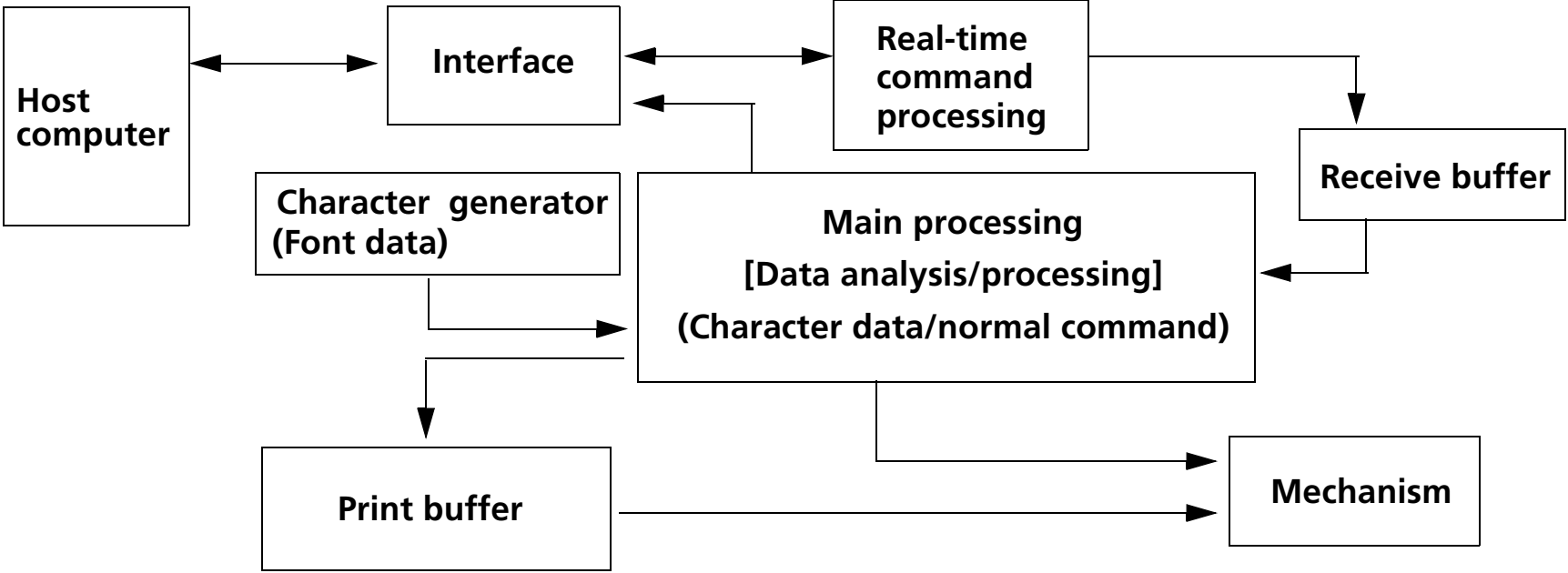

EXCEPTION PROCESSING

Undefined Codes

If a code which has not been defined as a command within 32 bytes listed as 00H (decimal 0) through 1FH (decimal 31) in the character code tables is sent from the host computer, the undefined byte (1 byte) is ignored, and the printer continues to process the next byte of information.

Example: If the data sequence 30H (48) 31H (49) 03H (3) 32H (50) 0AH (10) 33H (51) is sent from the host computer, 03H (3) is ignored, and the data is processed as if the sequence 30H (48) 31H (49) 32H (50) 0AH (10) 33H (51) had been received (0AH has been defined as **LF** and other data are character data).

Undefined Commands

If data that follows an **ESC** [1BH (27)], **FS** [1CH (28)], **GS** [1DH (29)], or **DLE** [10H (16)] code is not defined as a command, **ESC**, **FS**, **GS**, or **DLE** and the following code (a total of 2 bytes) are ignored.

Example: If the data sequence 30H (48) 1BH (27) 22H (34) 31H (49) 32H (50) is received, 1BH (27) and 22H (34) are ignored as undefined codes, and the data is processed as if the sequence 30H (48) 31H (49) 32H (50) had been received (these are character data).



Out-of-range Parameter Values

For commands in which a parameter value range is defined and a value sent to the printer is outside of the range, the command is ignored. Processing of commands with multiple parameters is terminated if a parameter outside of the range is encountered and the subsequent data is processed normally. If the command processed is a setting command, the previously set value does not change. If the command processed is an executing command, the printer executes nothing.

Example: If the data sequence 1BH (27) 52H (82) 15H (21) is sent from the host computer, 1BH (27) 52H (82) (**ESC R**) is a valid code, but the parameter 15H (21) is outside the range. Therefore, the printer ignores the code sequence and does not change the previous setting for the international character set.



USABLE APPLICATION PROGRAMS AND TIPS

System Processing

This example illustrates ESC/POS command functions and printing results. It shows a receipt issue processing and its procedure combining the TM-U375 (RS-232 serial interface model), DM-D102, and drawer.

Sets DIP switch 2-1 of the TM-U375 to On (customer display connected), insert the plug of the DM-D102 firmly into the customer display connector (DM-D) which is on the bottom of the printer, and then turn on the printer power.

Print Sample

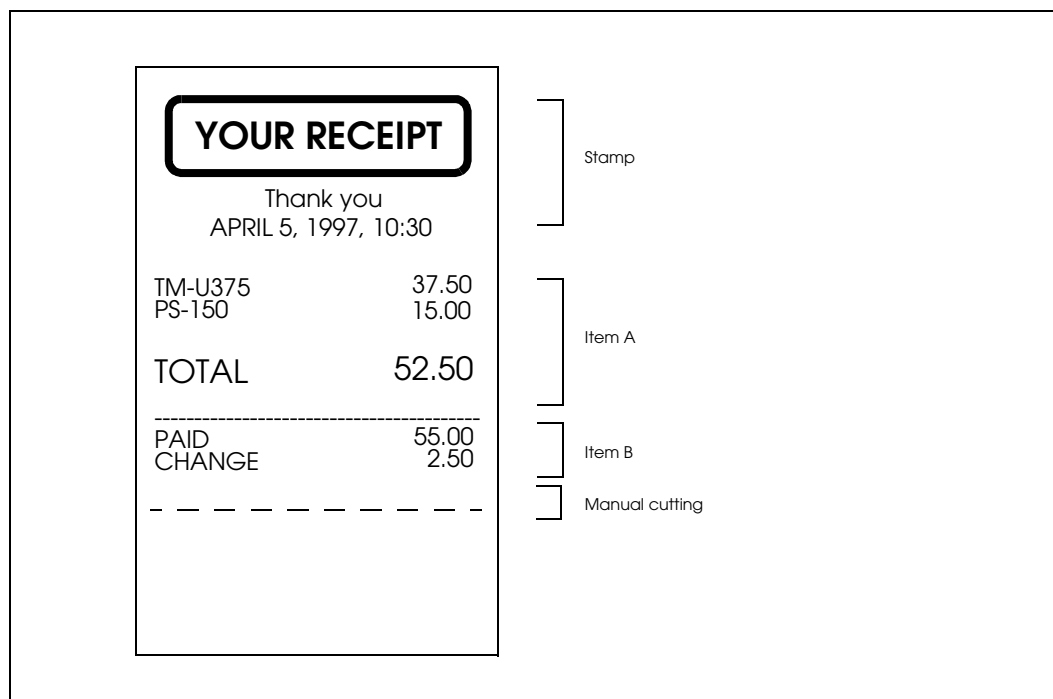

System Processing Procedure

Procedure	Commands Used	Description
1. Define stamp data	ESC =, GS *	Select the printer with ESC = and define a downloaded bit image for a stamp.
2. Display a message	ESC =	Select a customer display with ESC = and display a message and time.
3. Stamp	ESC =, ESC a, ESC U, GS /, ESC J, ESC d	After selecting the printer with ESC = and the center justification for the printing position with ESC a , print the stamp (downloaded bit image), date, and time.
4. Print item A Display item A	ESC a, ESC !, ESC =, LF, ESC U	Select font B with ESC ! to set 40 characters for a print column. Select both the printer and customer display with ESC = and print and display item A.
5. Print item B Display item B	ESC =, LF, ESC p, ESC d	Select the printer with ESC = and paper is fed to the manual cutting position after printing item B and executing a drawer operation. Display only amount paid on the display.
6. Display change	ESC =, GS !, LF	Select the printer with ESC = and print and display change and a message.
7. Manual cut		Use a manual cutter.



DM-D102 Display Result

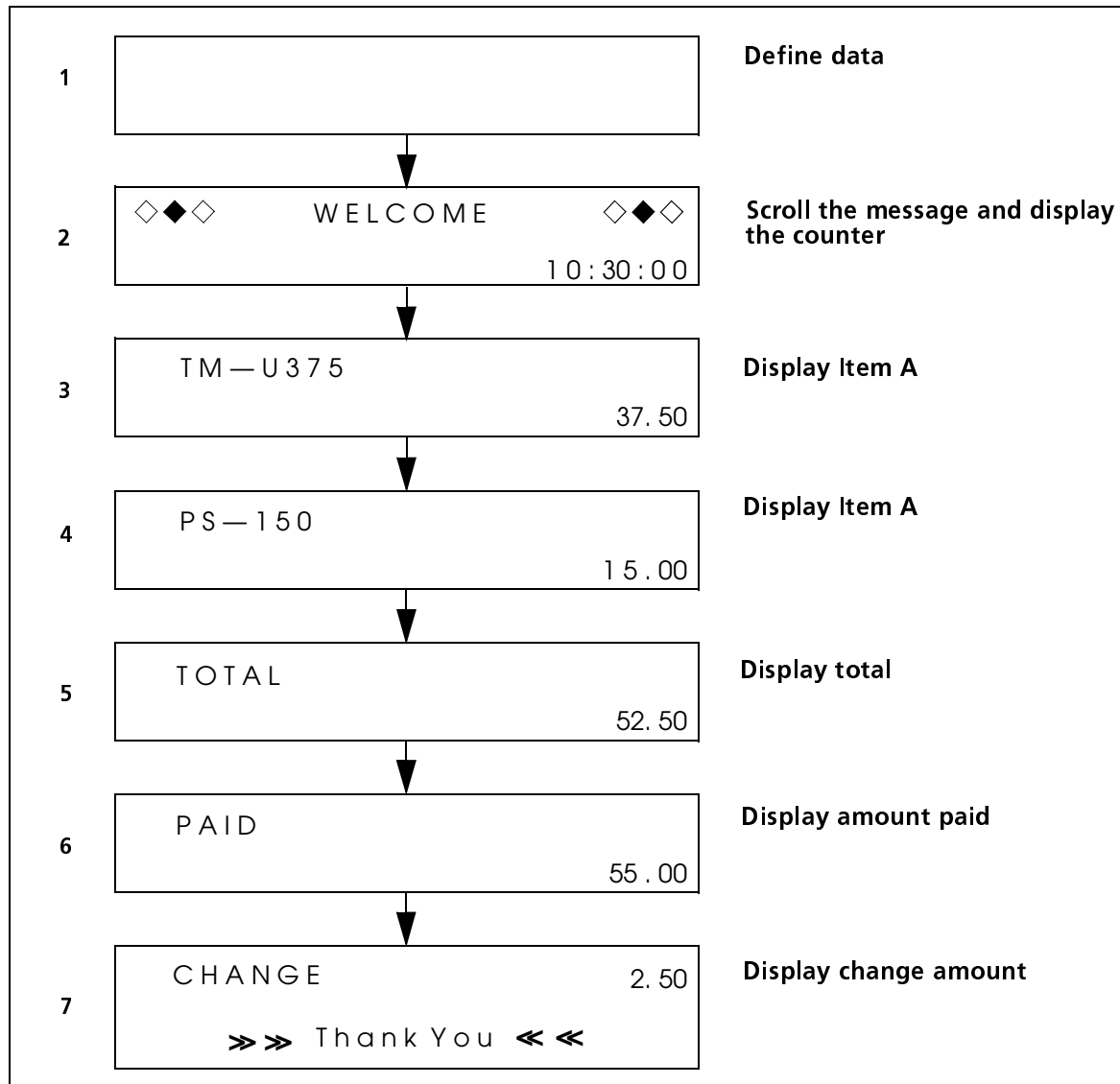

Program Example

```

PRINT #1, CHR$( &H1B ); "=" ; CHR$( 3 ); ← Select devices (printer and customer display)
PRINT #1, CHR$( &H1B ); "@" ; ← Initialize the devices

PRINT #1, CHR$( &H1B ); "=" ; CHR$( 1 ); ← Select the printer
PRINT #1, CHR$( &H1D ); "*" ; CHR$( 40 ); CHR$( 4 );
  FOR I=1 to 1280
    READ a$: PRINT #1, CHR$( VAL( "&H"+a$ ) );
  NEXT I
  ] Define stamp
  data
  (downloaded
  bit image)

PRINT #1, CHR$( &H1B ); "=" ; CHR$( 2 ); ← Select the device (customer display)
PRINT #1, CHR$( &H1B ); "t" ; CHR$( 1 );
PRINT #1, CHR$( &H1F ); "T" ; CHR$( 10 ); CHR$( 30 );
PRINT #1, CHR$( 229 ); CHR$( 230 ); CHR$( 229 ); " WELCOME " ; CHR$( 229 ); CHR$( 230 ); CHR$( 229 );

PRINT #1, CHR$( &H1B ); "=" ; CHR$( 1 ); ← Select the printer
PRINT #1, CHR$( &H1B ); "a" ; CHR$( 1 ); ← Justification (center)
PRINT #1, CHR$( &H1B ); "U" ; CHR$( 1 ); ← Select unidirectional printing
PRINT #1, CHR$( &H1D ); "/" ; CHR$( 0 ); ← Print downloaded bit image (normal mode)
PRINT #1, CHR$( &H1B ); "U" ; CHR$( 0 ); ← Cancel unidirectional printing
PRINT #1, CHR$( &H1B ); "J" ; CHR$( 10 );
PRINT #1, "Thank You" ; CHR$( &H1B ); "J" ; CHR$( 30 ); ← Print a message
PRINT #1, "APRIL 5, 1997, 10:30" ; CHR$( &H1B ); "d" ; CHR$( 3 ); ← Print date and time
  ] Execute
  a stamp

PRINT #1, CHR$( &H1B ); "a" ; CHR$( 0 ); ← Justification (left)
PRINT #1, CHR$( &H1B ); "!" ; CHR$( 1 ); ← Select font B
W$=INPUT(1); ← Waiting for input
PRINT #1, CHR$( &H1B ); "=" ; CHR$( 2 ); CHR$( &HC ); ← Clear the display
PRINT #1, CHR$( &H1B ); "=" ; CHR$( 3 ); ← Select the printer and customer display
PRINT #1, "TM-U375 37.50" ; CHR$( &HA ); CHR$( &HB );
W$=INPUT$(1) ← Waiting for input
PRINT #1, "PS-150 15.00" ; CHR$( &HA ); CHR$( &HB );
W$=INPUT$(1) ← Waiting for input
PRINT #1, CHR$( &H1B ); "=" ; CHR$( 1 ); ← Select the printer
PRINT #1, CHR$( &HA );
PRINT #1, CHR$( &H1B ); "U" ; CHR$( 1 ); ← Select unidirectional printing
PRINT #1, CHR$( &H1B ); "!" ; CHR$( 17 ); ← Select character size (double in vertical)
PRINT #1, CHR$( &H1B ); "=" ; CHR$( 3 ); ← Select the printer and customer display
PRINT #1, "TOTAL 52.50" ; CHR$( &HA ); CHR$( &HB );
  ] Print and
  display
  item A

```

(Continued on next page)



Program Example (continued)

```

PRINT #1, CHR$(&H1B); "=";CHR$(1); ← Select the printer
PRINT #1, CHR$(&H1B); "U";CHR$(0); ← Cancel unidirectional printing
PRINT #1, CHR$(&H1B); "!";CHR$(1); ← Select a character size (normal)
PRINT #1, "-----";CHR$(&HA);

W$=INPUT(1); ← Waiting for input
PRINT #1, CHR$(&H1B); "=";CHR$(3); ← Select the printer and customer display
PRINT #1, "PAID 55.00";CHR$(&HA);
PRINT #1, CHR$(&H1B); "=";CHR$(1); ← Select the printer
PRINT #1, CHR$(&H1B); "p";CHR$(0);CHR$(10);CHR$(100);← Output a pulse (drawer operation)
PRINT #1, "CHANGE 2.50";CHR$(&HA);
PRINT #1, CHR$(&H1B); "d";CHR$(11); ← Feed paper to the manual cutting position

PRINT #1, CHR$(&H1B); "=";CHR$(2); ← Select the customer display
PRINT #1, CHR$(&HC);
PRINT #1, "CHANGE 2.50";
PRINT #1,CHR$(237);CHR$(237); " Thank You ";CHR$(236);CHR$(236);
END

```

(Continued on next page)

Print and display item A

Print and display item B

Display change and message



Program Example (continued)

```

DATA 15,55,55,55,50,2A,AA,AA,AA,A8,55,55,55,55,54,A0,00,00,00,0A,40,00,00,00,04
DATA 80,00,00,00,02,40,00,00,00,04,80,00,00,00,02,48,00,00,00,04,85,00,00,00,02
DATA 4A,A0,00,00,04,85,54,00,00,02,4A,AA,80,00,04,85,55,50,00,02,40,AA,A8,00,04
DATA 80,15,54,00,02,40,02,AA,AA,A4,80,00,55,55,42,40,00,0A,AA,A4,80,00,55,55,42
DATA 40,02,AA,AA,A4,80,15,54,00,02,40,AA,A8,00,04,85,55,50,00,02,4A,AA,80,00,04
DATA 85,54,00,00,02,4A,A0,00,00,04,85,00,00,00,02,48,00,00,00,04,80,00,00,00,02
DATA 40,2A,AA,A8,04,80,55,55,54,02,40,AA,AA,AA,04,81,55,55,55,02,42,Aa,AA,AA,84
DATA 85,40,00,05,42,4A,80,00,02,A4,85,00,00,01,42,4A,80,00,02,A4,85,00,00,01,42
DATA 4A,80,00,02,A4,85,00,00,01,42,4A,80,00,02,A4,85,00,00,01,42,4A,80,00,02,A4
DATA 85,40,00,05,42,42,AA,AA,AA,84,81,55,55,55,02,40,AA,AA,AA,04,80,55,55,54,02
DATA 40,2A,AA,A8,04,80,00,00,00,02,40,00,00,00,04,80,00,00,00,02,4A,AA,AA,A8,04
DATA 85,55,55,54,02,4A,AA,AA,AA,04,85,55,55,55,02,4A,AA,AA,AA,84,80,00,00,05,42
DATA 40,00,00,02,A4,80,00,00,01,42,40,00,00,02,A4,80,00,00,01,42,40,00,00,02,A4
DATA 80,00,00,01,42,40,00,00,02,A4,80,00,00,01,42,40,00,00,02,A4,80,00,00,05,42
DATA 4A,AA,AA,AA,84,85,55,55,55,02,4A,AA,AA,AA,04,85,55,55,54,02,4A,AA,AA,A8,04
DATA 80,00,00,00,02,40,00,00,00,04,80,00,00,00,02,4A,AA,AA,AA,A4,85,55,55,55,42
DATA 4A,AA,AA,AA,A4,85,55,55,55,42,4A,AA,AA,AA,A4,85,00,14,00,02,4A,80,2A,00,04
DATA 85,00,14,00,02,4A,80,2A,00,04,85,00,15,00,02,4A,80,2A,80,04,85,00,15,40,02
DATA 4A,80,2A,AA,A4,85,55,55,55,42,42,AA,A8,AA,A4,81,55,50,55,42,40,AA,A0,2A,A4
DATA 80,55,40,00,02,40,00,00,00,04,80,00,00,00,02,40,00,00,00,04,80,00,00,00,02
DATA 40,00,00,04,80,00,00,00,02,40,00,00,00,04,80,00,00,00,02,4A,AA,AA,AA,A4
DATA 85,55,55,55,42,4A,AA,AA,AA,A4,85,55,55,55,42,4A,AA,AA,AA,A4,85,00,14,00,02
DATA 4A,80,2A,00,04,85,00,14,00,02,4A,80,2A,00,04,85,00,15,00,02,4A,80,2A,80,04
DATA 85,00,15,40,02,4A,80,2A,AA,A4,85,55,55,55,42,42,AA,A8,AA,A4,81,55,50,55,42
DATA 40,AA,A0,2A,A4,80,55,40,00,02,40,00,00,00,04,80,00,00,00,02,40,00,00,00,04
DATA 8A,AA,AA,AA,A2,45,55,55,55,44,8A,AA,AA,AA,A2,45,55,55,55,44,8A,AA,AA,AA,A2
DATA 45,00,50,01,44,8A,80,A8,02,A2,45,00,50,01,44,8A,80,A8,02,A2,45,00,50,01,44
DATA 8A,80,A8,02,A2,45,00,50,01,44,8A,80,A8,02,A2,45,00,00,01,44,8A,80,00,02,A2
DATA 40,00,00,04,80,00,00,00,02,40,00,00,00,04,80,15,55,50,02,40,2A,AA,A8,04
DATA 80,55,55,54,02,40,AA,AA,AA,04,81,55,55,55,02,42,A0,00,0A,84,85,40,00,05,42
DATA 4A,80,00,02,A4,85,00,00,01,42,4A,80,00,02,A4,85,00,00,01,42,4A,80,00,02,A4
DATA 85,00,00,01,42,4A,80,00,02,A4,85,00,00,01,42,4A,80,00,02,A4,80,00,00,00,02
DATA 40,00,00,04,80,00,00,00,02,4A,AA,AA,AA,A4,85,55,55,55,42,4A,AA,AA,AA,A4
DATA 85,55,55,55,42,4A,AA,AA,AA,A4,85,00,50,01,42,4A,80,A8,02,A4,85,00,50,01,42
DATA 4A,80,A8,02,A4,85,00,50,01,42,4A,80,A8,02,A4,85,00,50,01,42,4A,80,A8,02,A4
DATA 85,00,00,01,42,4A,80,00,02,A4,80,00,00,00,02,40,00,00,00,04,80,00,00,00,02
DATA 40,00,00,00,04,8A,AA,AA,AA,A2,45,55,55,55,44,8A,AA,AA,AA,A2,45,55,55,55,44

```



Program Example (continued)

```
DATA 8A,AA,AA,AA,A2,40,00,00,00,04,80,00,00,00,02,40,00,00,00,04,80,00,00,00,02
DATA 4A,AA,AA,AA,A4,85,55,55,55,42,4A,AA,AA,AA,A4,85,55,55,55,42,4A,AA,AA,AA,A4
DATA 85,00,14,00,02,4A,80,2A,00,04,85,00,14,00,02,4A,80,2A,00,04,85,00,14,00,02
DATA 4A,80,2A,00,04,85,00,14,00,02,4A,80,2A,00,04,85,55,54,00,02,42,AA,A8,00,04
DATA 81,55,50,00,02,40,AA,A0,00,04,80,55,40,00,02,40,00,00,00,04,80,00,00,00,02
DATA 4A,80,00,00,04,85,00,00,00,02,4A,80,00,00,04,85,00,00,00,02,4A,80,00,00,04
DATA 85,00,00,00,02,4A,80,00,00,04,85,00,00,00,02,4A,AA,AA,AA,A4,85,55,55,55,42
DATA 4A,AA,AA,AA,A4,85,55,55,55,42,4A,AA,AA,AA,A4,85,00,00,00,02,4A,80,00,00,04
DATA 85,00,00,00,02,4A,80,00,00,04,85,00,00,00,02,4A,80,00,00,04,85,00,00,00,02
DATA 4A,80,00,00,04,80,00,00,00,02,40,00,00,00,04,80,00,00,00,02,40,00,00,00,04
DATA A0,00,00,00,0A,55,55,55,55,54,2A,AA,AA,AA,A8,15,55,55,55,50,00,00,00,00,00
```



Page Mode Printing

This example illustrates ESC/POS command functions and printing results. The example shows a coupon issue processing and its procedure using page mode function with the TM-H5000. You can use the page mode to rotate data so that you can print characters, bar codes, and bit images that would not fit in the printable area in the standard mode.

Print Sample

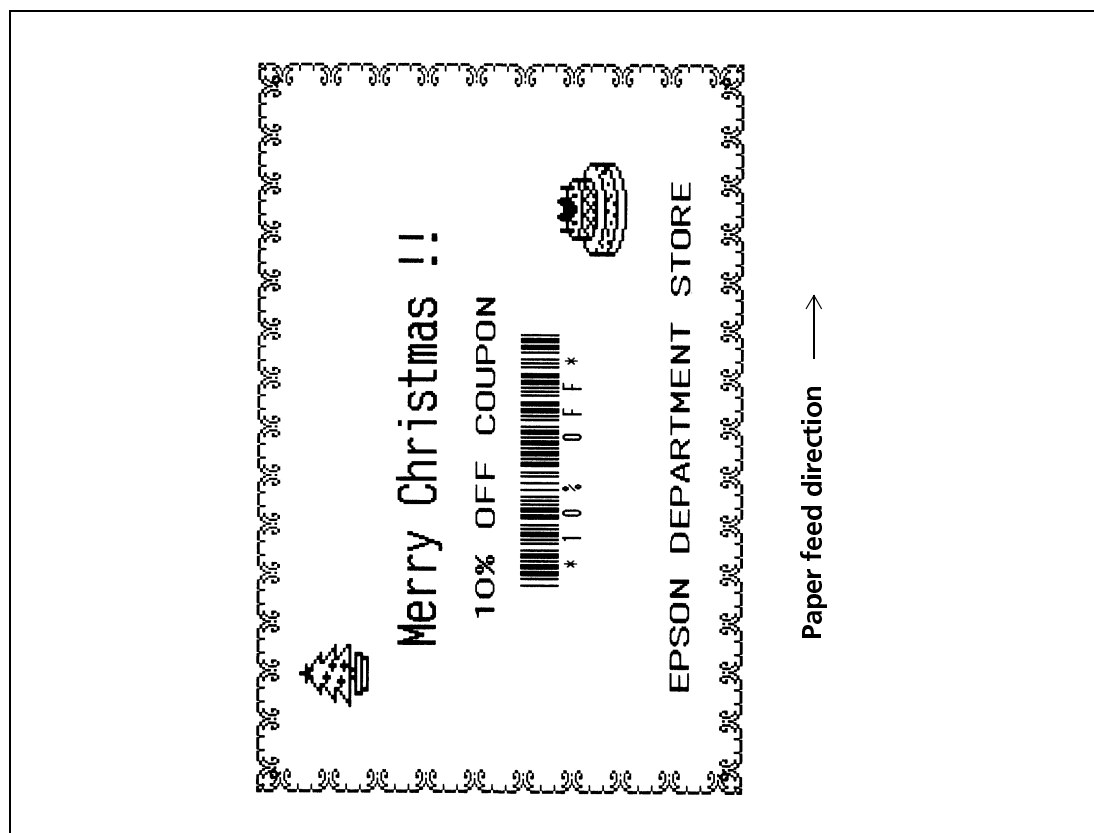

System Processing Procedure

Procedure	Commands Used	Description
1. Select page mode	ESC L, GS P	Select page mode. Change horizontal and vertical motion units to set normal dot units.
2. Transmit edge data	ESC W, ESC T, ESC *	Select the printing area for edge data with ESC W and the printing direction with ESC T . Transmit the edge data as bit image.
3. Transmit a message	ESC W, ESC T, GS !, LF, ESC J	Select the printing area for message data with ESC W and the printing direction with ESC T .
4. Transmit data for symbols A and B	ESC W, ESC T, ESC 3, ESC *	Select the printing area for symbol data with ESC W and the printing direction with ESC T . Transmit data for symbols A and B as bit image.
5. Transmit bar code data	ESC W, ESC T, GS H GS f, GS h, GS w, GS \$ GS k	Select the printing area for a bar code with ESC W and the printing direction with ESC T . After setting bit images with GS H and GS f , etc., transmit data for CODE 39 bar code to the printing position set by GS \$.
6. Printing all data	ESC FF, GS V	Print all data collectively in page mode and cut paper.
7. Return to standard mode	ESC S	Return to standard mode. All data in page mode are cleared.

When printing multiple coupons, transmits **ESC FF** and **GS V** times you want to print in procedure 6.



Program Example

```

PRINT #1, CHR$(&H1B);"@";           ← Initialize the printer

PRINT #1, CHR$(&H1B);"L";← Select page mode
PRINT #1, CHR$(&H1D);"P";CHR$(180);CHR$(180);← Set horizontal and vertical motion units

PRINT #1, CHR$(&H1B);"W";CHR$(6);CHR$(0);CHR$(0);CHR$(0);CHR$(244);CHR$(1);CHR$(238);CHR$(2);
PRINT #1, CHR$(&H1B);"T";CHR$(0);← Select printing direction (left to right)
n=10: GOSUB Edge
PRINT #1, CHR$(&H1B);"T";CHR$(1); ← Select printing direction (bottom to up)
n=15: GOSUB Edge
PRINT #1, CHR$(&H1B);"T";CHR$(2); ← Select printing direction (right to left)
n=10: GOSUB Edge
PRINT #1, CHR$(&H1B);"T";CHR$(3); ← Select printing direction (up to bottom)
n=15: GOSUB Edge

PRINT #1, CHR$(&H1B);"W";CHR$(140);CHR$(0);CHR$(118);CHR$(0);CHR$(104);CHR$(1);CHR$(16);CHR$(2);
PRINT #1, CHR$(&H1B);"T";CHR$(1); ← Select printing direction (bottom to up)
PRINT #1, CHR$(&H1D);"!";CHR$(17);
PRINT #1, CHR$(&HA);" Merry Christmas !!";CHR$(&HA);CHR$(&HA);
PRINT #1, CHR$(&H1D);"!";CHR$(16);
PRINT #1, " 10% OFF COUPON";CHR$(&H1B);"J";CHR$(200);
PRINT #1, "EPSON DEPARTMENT STORE";

PRINT #1, CHR$(&H1B);"W";CHR$(50);CHR$(0);CHR$(76);CHR$(2);CHR$(72);CHR$(0);CHR$(68);CHR$(0);
PRINT #1, CHR$(&H1B);"T";CHR$(1);← Select printing direction (bottom to up)
PRINT #1, CHR$(&H1B);"3";CHR$(24);
PRINT #1, CHR$(&H1B);"*";CHR$(0);CHR$(34);CHR$(0)
  FOR c=1 to 34 READ a$: PRINT #1, CHR$(VAL("&H"+a$));:NEXT c
PRINT #1, CHR$(&H1B);"*";CHR$(0);CHR$(34);CHR$(0)
  FOR c=1 to 34 READ a$: PRINT #1, CHR$(VAL("&H"+a$));:NEXT c
PRINT #1, CHR$(&H1B);"*";CHR$(0);CHR$(34);CHR$(0)
  FOR c=1 to 34 READ a$: PRINT #1, CHR$(VAL("&H"+a$));:NEXT c

```

Transmit edge data

Transmit a message

Transmit data for symbol A

(Continued on next page)



Program Example (continued)

```

PRINT #1, CHR$(&H1B);"W";CHR$(58);CHR $(1);CHR$(102);CHR$(0);CHR$(72);CHR$(0);CHR$(96);CHR$(0);
PRINT #1, CHR$(&H1B);"T";CHR$(1);← Select printing direction (bottom to up)
PRINT #1, CHR$(&H1B);"*";CHR$(0);CHR$(48);CHR$(0)
  FOR c=1 to 48 READ a$: PRINT #1, CHR$(VAL("&H"+a$));:NEXT c
PRINT #1, CHR$(&H1B);"*";CHR$(0);CHR$(48);CHR$(0)
  FOR c=1 to 48 READ a$: PRINT #1, CHR$(VAL("&H"+a$));:NEXT c
PRINT #1, CHR$(&H1B);"*";CHR$(0);CHR$(48);CHR$(0)
  FOR c=1 to 48 READ a$: PRINT #1, CHR$(VAL("&H"+a$));:NEXT c

PRINT #1, CHR$(&H1B);"W";CHR$(20);CHR $(1);CHR$(226);CHR$(0);CHR$(70);CHR$(0);CHR$(56);CHR$(1);
PRINT #1, CHR$(&H1B);"T";CHR$(1);← Select printing direction (bottom to up)
PRINT #1, CHR$(&H1D);"H";CHR$(2);← Select printing position of HRI characters (bottom)
PRINT #1, CHR$(&H1D);"f";CHR$(1);← Select font for HRI characters (font B)
PRINT #1, CHR$(&H1D);"h";CHR$(40);← Set bar code height
PRINT #1, CHR$(&H1D);"w";CHR$(2);← Set bar code width
PRINT #1, CHR$(&H1D);"$";CHR$(40);CHR$(0);← Set absolute vertical print position
PRINT #1, CHR$(&H1D);"k";CHR$(4);"*10% OFF*";CHR$(0);
PRINT #1, CHR$(&H1B);CHR$(&HC); ← Print data collectively
PRINT #1, CHR$(&H1D);"V";CHR$(66);CHR$(80); ←Cut paper
PRINT #1, CHR$(&H1B);"S"; ←Return to standard mode
END

Edge
FOR i=1 To n
PRINT #1, CHR$(&H1B);"*";CHR$(0);CHR$(25);CHR$(0);
  PRINT #1, CHR$(128);CHR$(128);CHR$(128);CHR$(96);CHR$(128);
  PRINT #1, CHR$(128);CHR$(128);CHR$(166);CHR$(165);CHR$(81);
  PRINT #1, CHR$(78);CHR$(32);CHR$(26);CHR$(32);CHR$(78);
  PRINT #1, CHR$(81);CHR$(165);CHR$(166);CHR$(128);CHR$(128);
NEXT i
RETURN

```

Transmit data for symbol B

Transmit bar code

Subroutine for transmitting the edge data



Program Example (continued)

```
DATA 00,00,00,00,00,00,01,01,03,03,05,05,28,28,38,38  
DATA F0,F0,38,38,28,28,05,05,03,03,01,01,00,00,00,00,00,00  
DATA 00,00,08,08,19,19,2A,2A,4C,4C,82,82,47,47,E2,E2  
DATA 40,40,11,11,3B,3B,91,91,4C,4C,2A,2A,19,19,08,08,00,00  
DATA 40,40,C0,C0,40,40,5C,5C,57,57,55,55,55,55,75,75  
DATA 55,55,75,75,D5,D5,55,55,57,57,5C,5C,40,40,C0,C0c40,40
```

Data for symbol A

```
DATA 00,00,00,00,00,00,00,00,07,07,09,09,7D,7D,10,10,16,16,78,F8,FC,7C,3E,3E  
DATA 3E,3E,7C,FC,F8,78,16,16,10,10,7D,7D,09,09,07,07,00,00,00,00,00,00,00,00  
DATA 1F,1F,24,24,41,41,42,42,F1,F1,29,29,49,49,AC,AC,94,94,AC,AC,C4,C4,AC,AC  
DATA 94,94,AC,AC,C4,C4,AC,AC,94,94,69,69,49,49,F1,F1,42,42,41,41,24,24,1F,1F  
DATA F0,F0,48,48,24,24,64,64,12,12,52,52,52,52,89,89,A9,A9,89,89,99,99,C9,C9  
DATA 89,89,99,99,C9,C9,A9,A9,89,89,12,12,52,52,12,12,24,24,A4,A4,C8,C8,F0,F0
```

Data for symbol B



Tips (standard mode/page mode)

Some of the TM printers, such as the TM-H5000 and the TM-U375, support two different print modes: standard mode and page mode.

The standard mode is supported by all printers and in this mode, the printers print data in the print buffer by executing the print commands (such as **LF**, **CR**, and **ESC J**) or when the buffer is full.

The standard mode is the print mode which prints data one line at a time.

The page mode executes batch printing with **FF** or **ESC FF** for all data in the print buffer stored after the page mode is selected with **ESC L**. In this mode, the print commands other than **FF** or **ESC FF**, such as **LF**, **CR**, or **ESC J**, only move the printing position and do not execute actual printing. Executing **ESC S** or **FF** returns to standard mode. The page mode is the print mode which prints data one page at a time.

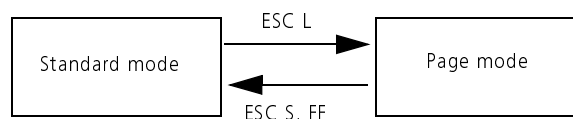

Basic processing procedure for the page mode:

1. Select the page mode with **ESC L** (standard mode is changed to page mode).
2. Set the position and size for the printing area with **ESC W**.
3. Select the starting position and the direction for data development with **ESC T**.
4. Store print data (such as characters or bit images) in the print buffer.
5. Print all data in the print buffer collectively with **ESC FF**.
6. Return to standard mode with **ESC S**.

(You can skip procedure 6 if you use **FF** instead of **ESC FF** in procedure 5.)



Characteristics of the page mode

- The flexible layout enables you to execute printing which you cannot accomplish in the standard mode.
 - Downloaded bit images or bar codes can be printed on the same line with characters at the same time.
 - Ladder bar code printing is possible.
 - Characters and bit images can be rotated (90× clockwise, 180× clockwise (upside down), or 90× counterclockwise).
- Data can be processed only in normal dot units.
 - Data cannot be processed in half dot units in the page mode.
- Copy printing is possible.
 - Because printing with **ESC FF** enables storing of data in the print buffer, executing **ESC FF** repeatedly results in the same printing. It is also possible to print repeated data with changes in some parts.



Receipt Issuing with Cut Sheet

The example shows a receipt issuing procedure and its programs with the TM-U925 for a pre-printed cut sheet form.

Print Sample

RECEIPT				
Name		EPSON		
ROOM No.	GUESTS	ARRIVAL	DEPARTURE	
1017	2	MAR. 20, 1997	MAR.22, 1997	
DATE	DESCRIPTION	CHARGE	BALANCE DUE	
MAR. 20	GUEST ROOM	114.00	114.00	
	ROOM TAX	15.96	129.96	
	ROOM SERVICE	18.00	147.96	
	PARKING	5.00	152.96	
MAR. 21	GUEST ROOM	114.00	266.96	
	ROOM TAX	15.96	282.92	
	PARKING	5.00	287.92	
		TOTAL	287.92	
		PAID	300.00	
		CHANGE	12.08	

(The shaded area indicates a pre-printed form.)

Item A

Item B

Item C



Receipt Issuing Procedure

Procedure	Commands Used	Description
1. Set the default	ESC @, ESC c 4, ESC c 1, ESC c 0	Execute initializing. Enable the slip sensor which stops printing when the paper runs out. Select the slip as the setting and printing sheets. * SLIP LED blinks when executing ESC c 0 , which is the slip insertion waiting status. Insert the slip paper.
2. Print item A	ESC U, ESC !, ESC \$, LF, ESC J	Set printing position with ESC \$ and ESC J and print NAME using quadruple size in the unidirectional print direction. After selecting font B (7×9), print ROOM No. ~ DEPARTURE using normal size.
3. Print item B	ESC \$, LF, ESC d	Set printing position with ESC \$ and print item B.
4. Print item C	ESC \$, LF	Set printing position and print item C.
5. Eject cut sheet	FF	Eject cut sheet. * SLIP LED blinks when paper feed is completed, which is the slip ejection waiting status. Remove the slip paper.



Program Example

```

PRINT #1, CHR$(&H1B);"@"; ← Initialize the printer
PRINT #1, CHR$(&H1B);"c4";CHR$(48); ← Enable a sensor to stop printing due to a paper end
PRINT #1, CHR$(&H1B);"c1";CHR$(4); ← Select a setting sheet (slip)
PRINT #1, CHR$(&H1B);"c0";CHR$(4); ← Select a print sheet (slip)

```

Set
default

```

PRINT #1, CHR$(&H1D);"J";CHR$(112); ← Set printing position
PRINT #1, CHR$(&H1B);"U";CHR$(1); ← Select unidirectional printing
PRINT #1, CHR$(&H1B);"!";CHR$(48); ← Select character size (double-height × double-width)
PRINT #1, CHR$(&H1B);"$";CHR$(60);CHR$(0) ←Set printing position
PRINT #1, "EPSON";CHR$(&H1B);"J";CHR$(68); ← Print and paper feed (68/144 inch)
PRINT #1, CHR$(&H1B);"U";CHR$(0); ← Cancel unidirectional printing
PRINT #1, CHR$(&H1B);"!";CHR$(1); ← Select character size (normal) and font B (7×9)
PRINT #1, CHR$(&H1B);"$";CHR$(60);CHR$(0); ← Set printing position
PRINT #1, "1017      2          MAR.20,1997          MAR.22,1997";
PRINT #1, CHR$(&H1B);"J";CHR$(108); ← Print and paper feed (108/144 inch)

```

Print
Item A

```

PRINT #1, "MAR. 20"
PRINT #1, CHR$(&H1B);"$";CHR$(135);CHR$(0);"GUEST ROOM";
PRINT #1, CHR$(&H1B);"$";CHR$(131);CHR$(1);"114.00";
PRINT #1, CHR$(&H1B);"$";CHR$(28);CHR$(2);"114.00";CHR$(&HA);
PRINT #1, CHR$(&H1B);"$";CHR$(135);CHR$(0);"ROOM TAX";
PRINT #1, CHR$(&H1B);"$";CHR$(131);CHR$(1);" 15.96";
PRINT #1, CHR$(&H1B);"$";CHR$(28);CHR$(2);"129.96";CHR$(&HA);
PRINT #1, CHR$(&H1B);"$";CHR$(135);CHR$(0);"ROOM SERVICE";
PRINT #1, CHR$(&H1B);"$";CHR$(131);CHR$(1);" 18.00";
PRINT #1, CHR$(&H1B);"$";CHR$(28);CHR$(2);"147.96";CHR$(&HA);
PRINT #1, CHR$(&H1B);"$";CHR$(135);CHR$(0);"PARKING";
PRINT #1, CHR$(&H1B);"$";CHR$(131);CHR$(1);" 5.00";
PRINT #1, CHR$(&H1B);"$";CHR$(28);CHR$(2);"152.96";CHR$(&HA);

```

Print
Item B

(Continued to the next page)



Program Example (continued)

```

PRINT #1, "MAR. 21"
PRINT #1, CHR$(&H1B);"$";CHR$(135);CHR$(0);"GUEST ROOM";
PRINT #1, CHR$(&H1B);"$";CHR$(131);CHR$(1);"114.00";
PRINT #1, CHR$(&H1B);"$";CHR$(28);CHR$(2);"266.960";CHR$(&HA);
PRINT #1, CHR$(&H1B);"$";CHR$(135);CHR$(0);"ROOM TAX";
PRINT #1, CHR$(&H1B);"$";CHR$(131);CHR$(1);" 15.96";
PRINT #1, CHR$(&H1B);"$";CHR$(28);CHR$(2);"282.92";CHR$(&HA);
PRINT #1, CHR$(&H1B);"$";CHR$(135);CHR$(0);"PARKING";
PRINT #1, CHR$(&H1B);"$";CHR$(131);CHR$(1);" 5.00";
PRINT #1, CHR$(&H1B);"$";CHR$(28);CHR$(2);"287.92";CHR$(&HA);
PRINT #1, CHR$(&H1B);"d";CHR$(13);← Print and 13-line paper feed

PRINT #1, CHR$(&H1B);"$";CHR$(113);CHR$(0);"TOTAL";
PRINT #1, CHR$(&H1B);"$";CHR$(28);CHR$(2);"287.92";CHR$(&HA);
PRINT #1, CHR$(&H1B);"$";CHR$(113);CHR$(0);"PAID";
PRINT #1, CHR$(&H1B);"$";CHR$(28);CHR$(2);"300.00";CHR$(&HA);
PRINT #1, CHR$(&H1B);"$";CHR$(113);CHR$(0);"CHANGE";
PRINT #1, CHR$(&H1B);"$";CHR$(28);CHR$(2);" 12.08";CHR$(&HA);

PRINT #1, CHR$(&HC);← Eject paper
END

```

Print
Item B

Print
Item C



Tips (paper roll/cut sheet)

If a TM printer can print on both paper roll (receipt or journal) and cut sheet (slip or validation paper), the paper roll is selected as the print sheet when the power is turned on. The printer prints on the paper roll after the print data and print commands are processed. In order to print on the cut sheet, first select slip or validation paper as the print sheet with **ESC c 0**.

Example for slip printing process:

1. Enable the slip sensor ($n = 48$) with **ESC c 4 n**.
2. Select the slip paper as the print sheet ($n = 4$) with **ESC c 0 n**.
3. Insert the slip paper after confirming that the SLIP LED blinks (slip insertion waiting status).
4. Process the print data (characters and bit images, etc.) and print commands (printing on the slip paper).
5. Eject the slip paper with **FF**.
6. Remove the ejected slip paper.

- Procedures 3 and 6 are the user operations.
- If you print on the validation paper, select the validation paper in procedures 1 and 2.
- It is not necessary to follow procedure 1, but the print result will be different.
 - With procedure 1: When a paper-end occurs in procedure 4, the printer goes back to procedure 3. Insert new slip paper. The printer prints the data that was not printed on the first slip paper.
 - Without procedure 1: The printer does not stop printing even if a paper-end occurs in procedure 4. The data are printed on the same line.



Relationship between the cut sheet and status:

The status of the cut sheet are as follows:

Status (corresponding commands)	Slip	Validation
Normal status	(GS r)	Paper sensor status ($n = 1, 49$)/cut sheet status ($n = 3, 51$)
	(ESC v)	Paper sensor status
ASB status	(GS a)	Third byte: Bits 5 and 6 Fourth byte: Bits 0 and 1
Real-time status	(DLE EOT)	Slip status ($n = 5$)
		Validation status ($n = 6$)



Relationship between slip printing and the ASB status:

GS a should be processed when the host computer checks the slip status using the ASB status. The relationship between the slip printing process and the ASB status is as follows:

ASB status	Transmission	Third byte		Fourth byte	
		Bit 5	Bit 6	Bit 0	Bit 1
GS a n (n = 32)	Processing	Paper not present	Paper not present	Not selected	Impossible to print
ESC c 4 n (n = 32)	Processing	—	—	Selected	—
Slip LED blinking (slip insertion waiting status)	No processing	—	—	—	—
Paper detection (start loading)	Processing	●	Paper present	—	—
Paper loading completion	Processing	●	●	—	Printing possible
Data printing	No processing	—	—	—	—
FF (start ejection)	Processing	●	●	—	Printing not possible
Paper ejection completion	Processing	Paper not present	Paper not present	Not selected	—

(Symbols: "—" indicates there is no change/"●" indicates the current status of the sensor.)



DEFINITIONS

- (1) Normal commands
Normal commands are all the commands except real-time commands. The normal commands are stored in the receive buffer temporarily and then processed sequentially.
- (2) Real-time commands
Real-time commands are the commands that consist of a **DLE** extension (e.g. **DLE EOT** or **DLE ENQ**). The real-time commands execute processing when received. After executing, they are stored in the receive buffer and then discarded as undefined codes when the normal commands are processed.
- (3) Receive buffer
The receive buffer is used to store data from the host computer. All received data is stored in this buffer and processed in the order received. Buffer capacity depends on the printer model used.
- (4) Print buffer
The print buffer is used to store image data for printing.
- (5) Print buffer-full
This is the state which occurs when the print buffer becomes full.



(6) Print buffer-full printing

If new print data (e.g. characters or bit images) or horizontal tabs are processed in standard mode when the print buffer is full, the image data already stored in the print buffer is printed and a line feed is executed. This is the same operation as **LF**. The data (print data or horizontal tab) which causes the print buffer-full is processed from the beginning of the next line.

If new print data (e.g. characters or bit images) or horizontal tab is processed in page mode when the print buffer is full, the printer moves the print position to the beginning of the next line (the same operation as **LF**) and processes the data (print data or horizontal tab) which causes the print buffer-full.

(7) Beginning of the line

The beginning of the line meets all of the following conditions:

- No data exists in the print buffer.
- No spaces are skipped by **HT** in the print buffer.
- The print position has not been specified by **ESC \$** or **ESC **.

In standard mode, the beginning of the line is the left margin.

(8) Printable area

This is the maximum printable area specified for each printer model.

(9) Printing area

This is the printing range set by a command. The printing area should be equal to or smaller than the printable area. In standard mode, the printing area is set by **GS L** and **GS W** and in page mode, it is set by **ESC W**.



(10) Ignoring a command

This is the printer state in which the printer does nothing after receiving all codes, including parameters.

(11) Horizontal/vertical direction

Horizontal direction is the direction which is perpendicular to the paper feed direction. Vertical direction is the paper feed direction. In page mode, however, horizontal/vertical direction differs depending on the print direction of a character, not the paper feed direction.

(12) Baseline

The baseline for character sets that are 9 dots high (for example, 7×9 and 9×9) is the invisible line marking the bottom of the character matrix (the bottom of the lowest dot possible), but for other character sets, the baseline is the bottom of all characters, except that descenders, such as the bottom parts of "g" and "y" are below the baseline.

(13) Setting commands

The commands that change printer status by processing a command and affect printer operation and print results thereafter. The commands that can specify enhanced characters, set paper feed amount, and select a character are setting commands and some of the normal commands are setting commands.

(14) Executing commands

The commands that affect printer operation and change the printer status temporarily but do not affect the following printer operation. Functions of printing, paper cutting, and status transmission are executing commands and the real-time commands and some of the normal commands are executing commands.

(15) MSB

Most Significant Bit



(16) LSB
Least Significant Bit

(18) Unrecommended commands

There are more suitable substitute commands for the following commands. These unrecommended commands may not be supported by future printer models: **ESC i**, **ESC m**, **ESC u**, **ESC v**, and **GS ENQ**

GSV is a substitute for **ESC i** and **ESC m**

GS r is a substitute for **ESC u** and **ESC v**

DLE EOT is a substitute for **GS ENQ**



FEATURES

The TM-H5000 and TM-H5000P are high-quality POS printers that can print on slip and receipt paper (paper roll). The printers have the following features:

Receipt Section

- High speed printing with collective printing.
- The standard auto-cutter provides easy user operation.
- Ladder bar code printing is possible by using a bar code command.
- New paper handling enables easy paper roll loading.

Slip Section

- Wide slip paper capability (maximum characters per line: 88 with font B (7 × 9)).
- Copy printing is possible.
- High throughput using bidirectional, minimum distance printing.

Both Receipt and Slip

- Optional Magnetic Ink Character Recognition (MICR) reader that enables the printer to perform consecutive reading and processing of MICR characters and printing endorsements.
- EPSON customer display series connection (DM-D102-012/DM-D203-012).
- Selectable receive buffer size (4K bytes or 45 bytes).
- Command protocol based on the ESC/POS standard.
- Automatic Status Back (ASB) function that automatically transmits changes in the printer status.



SPECIFICATIONS

Receipt Section

■ Printing specifications

Printing method: Thermal line printing
 Printing speed: Approximately 16.5 lines/second (1/6-inch)
 Dot density: 180 DPI (W) × 180 DPI (H) (the number of dots per 25.4 mm)
 Printing width: 72 mm (512 dot positions)

■ Character specifications

Character fonts: Font A (12 × 24) / Font B (9 × 24)
 Characters per line: 42 / 56
 Character pitch: 15 / 20 CPI
 Character size: 1.41 mm (W) × 3.39 mm (H) / 0.99 mm (W) × 3.39 mm (H)
 Character sets:
 ASCII: 95 characters
 International: 32 characters
 Extended graphics: 128 characters × 6 pages

■ Paper specifications

Paper type: Specified thermal roll paper, NTP080-80
 Paper size: 79 to 80 mm (W) × 83 mm diameter

■ Panel buttons:

FEED: Feed paper roll (this button also can be used for the self test and the hexadecimal dump printing).



- Panel LEDs:
 - POWER (green):
 - Off when the printer is off.
 - On when the printer is on.
 - ERROR (red):
 - Off when the printer is in normal operation.
 - On when the printer is off-line (except during paper feed using the FEED button and during the self test).
 - Blinks when an error occurs.
 - PAPER OUT (red):
 - Off when the paper roll is adequate.
 - On when paper roll is near-end or at end.
 - Blinks when the printer is waiting for the button to be pressed.

Slip Section

- Printing specifications
 - Printing method: 9-pin serial impact dot matrix
 - Printing speed:
 - Up to 233 characters per second, font A (9 × 9)
 - Up to 311 characters per second, font B (7 × 9)
- Character specifications
 - Character fonts: Font A (9 × 9) / Font B (7 × 9)
 - Characters per line: 66 / 88
 - Character pitch: 12.5 / 16.7 CPI
 - Character size: 1.6 mm (W) × 3.1 mm (H) / 1.3 mm (W) × 3.1 mm (H)
 - Character sets:
 - ASCII: 95 characters
 - International: 32 characters
 - Extended graphics: 128 characters × 6 pages



■ Paper specifications

Paper type: Normal paper (single-ply)
Carbon copy paper
Pressure sensitive paper

Paper size: 70 mm (W) × 70 mm (L) to 210 mm (W) × 297 mm (L) (A4)

Thickness: 0.09 to 0.36 mm

■ Panel buttons:

FORWARD: Feed the cut sheet in forward direction.
REVERSE: Feed the cut sheet in reverse direction (this button also can be used for the self test printing).
RELEASE: Release the cut sheet.

■ Panel LEDs:

POWER (green):
Off when the printer is turned off.
On when the printer is turned on.

ERROR (red):
Off when the printer is in normal operation.
On when the printer is off-line (except during paper feed using the FORWARD or REVERSE button and during the self test).
Blinks when an error occurs.

RELEASE (green):
Off when the cut sheet is clamped.
On when the cut sheet is released.
Blinks when the printer is waiting for the button to be pressed.

SLIP (green):
Off when the cut sheet is not selected.
On when the cut sheet is clamped.
Blinks when the printer is waiting for the cut sheet to be inserted or removed.



Both Receipt and Slip

- Interface: RS-232 (TM-H5000: serial interface)
IEEE 1284 (TM-H5000P: parallel interface)
RS-485 (dealer option)
- Receive buffer: 4K or 45 bytes (selectable by DIP switch)



DIP SWITCH FUNCTIONS

Serial Interface (TM-H5000)

DIP switch 1

SW	Function	ON	OFF
1-1	Data receive error	Ignored	Convert data to "?"
1-2	Receive buffer capacity	45 bytes	4K bytes
1-3	Handshaking	XON/XOFF	DTR/DSR
1-4	Data word length	7 bits	8 bits
1-5	Parity check	Enabled	Disabled
1-6	Parity selection	Even	Odd
1-7	Transmission speed		
1-8			

Transmission speed

Transmission speed bits per second (BPS)	SW 1-7	SW 1-8
2400	ON	ON
4800	OFF	ON
9600	ON	OFF
19200	OFF	OFF



DIP switch 2

SW	Function	ON	OFF
2-1	BUSY condition	Receive buffer full	Off line or receive buffer full
2-2	Customer display (DM-D) connection	Connected	Not connected
2-3	Selects print density		
2-4			
2-5	Undefined	—	—
2-6	Internal use	Fixed to Off	
2-7	I/F pin 6 reset signal	Enabled	Disabled
2-8	I/F pin 25 reset signal	Enabled	Disabled

Print density

Print density	SW 2-3	SW 2-4
1 (Light)	ON	ON
2	OFF	OFF
3	ON	OFF
4 (Dark)	OFF	ON



Parallel Interface (TM-H5000)

DIP switch 1

SW	Function	ON	OFF
1-1	Auto line feed	Always enabled	Always disabled
1-2	Receive buffer capacity	45 bytes	4K bytes
1-3 ~1-8	Undefined	—	—

DIP switch 2

SW	Function	ON	OFF
2-1	BUSY condition	Receive buffer full or reading data	Off line, receive buffer full, or receiving data
2-2	Reserved (Do not change settings)	Fixed to Off	
2-3	Selects print density		
2-4			
2-5 ~ 2-7	Reserved (Do not change settings)		
2-8	I/F pin 31 reset signal (Do not change settings)	Fixed to On	



Print density

Print density	SW 2-3	SW 2-4
1 (Light)	ON	ON
2	OFF	OFF
3	ON	OFF
4 (Dark)	OFF	ON



ERRORS

- Automatically recoverable errors:
 - Print head high temperature error
 - Paper roll cover open error during printing
- Recoverable errors:
 - Auto cutter error
 - Home position detection error
 - Carriage detection error
 - Front cover open error during printing
 - Cut sheet ejection error
- Unrecoverable errors:
 - R/W error in memory or gate array
 - High voltage error
 - Low voltage error
 - CPU execution error
 - Thermistor error
- Data receive errors:

If the following errors occur with a serial interface, the printer processes data depending on the setting of DIP switch 1-1.

 - Parity error
 - Framing error
 - Overrun error



OPTIONS

- EPSON power supply unit, PS-170.
- MICR reader (factory-installed option).
- Direct connection customer display, DM-D102-012/DM-D203-012.
(for only the RS-232 serial interface model)
- Front extended table.



SELF TEST FOR THE TM-H5000

The self test lets you know if your printer is operating properly. It checks the control circuits, printer mechanisms, print quality, ROM version, and DIP switch setting. (It also checks the MICR reader circuits if the printer is equipped with the optional MICR reader.) This test is independent of any other equipment or software.

Running the self test with a paper roll

1. Make sure the printer is turned off and the printer covers are closed properly.
2. While holding down the FEED button, turn on the printer using the power switch to begin the self test. The self test prints the printer settings and then prints the following, cuts the paper, and pauses. (The PAPER OUT light blinks.)

Self test printing.
Please press the Paper feed button.

3. Press the FEED button to continue printing. The printer prints a pattern using the resident characters.
4. The self test automatically ends and cuts the paper after printing the following:

completed

The printer is ready to receive data as soon as it completes the self test.



Running the self test with slip paper

1. Make sure the printer is turned off and the printer cover is closed properly.
2. While holding down the REVERSE button, turn on the printer using the power switch to begin the self test. (The SLIP light blinks.)
3. Feed a sheet of slip paper into the printer. The printer loads the paper automatically, prints the printer settings, and then ejects the paper.
4. Remove the paper from the printer and feed another sheet into the printer to print a pattern using the resident characters. Continue to feed the sheet into the printer until the self test prints the following:

completed

The printer is ready to receive data as soon as it completes the self test.



HEXADECIMAL DUMP FOR THE TM-H5000

This feature allows experienced users to see exactly what data has been received. This can be useful in finding software problems. When you turn on the hexadecimal dump function, the printer prints all commands and other data in hexadecimal format on paper roll to help you find specific commands.

To use the hexadecimal dump feature, follow these steps:

1. After you make sure that the printer is off, open the cover.
2. Hold down the FEED button while you turn on the printer.
3. Close the cover.
4. Run any software program that sends data to the printer. The printer prints "Hexadecimal Dump" and then all the codes it receives in a two-column format. The first column contains the hexadecimal codes and the second column gives the ASCII characters that correspond to the codes.

Hexadecimal Dump

1B	21	00	1B	26	02	40	40	.	!	.	.	&	.	@	@
1B	25	01	1B	63	34	00	1B	.	%	.	.	c	4	.	.
41	42	43	44	45	46	47	48	A	B	C	D	E	F	G	H

- A period (.) is printed for each code that has no ASCII equivalent.
- During the hexadecimal dump all commands except **DLE EOT** and **DLE ENQ** do not function.

5. Press the FEED button so that the printer will print the last line.
6. Turn off the printer or reset it to turn off the hexadecimal dump mode.



TM-H5000 SUPPORTED COMMANDS

Command	Name	Function Type	Classification		Range	Default
			Executing Cmds	Setting Cmds		
HT	Horizontal tab	Print position	0		—	—
LF	Print and line feed	Print	0		—	—
FF	① Print and eject cut sheet (in standard mode) ② Print and return to standard mode (in page mode)	Print	0		—	—
CR	Print and carriage return	Print	0		—	—
CAN	Cancel print data in page mode	Character	0		—	—
DLE EOT	Real-time status transmission	Status	0		$1 \leq n \leq 5$	—
DLE ENQ	Real-time request to printer	Miscellaneous function	0		$1 \leq n \leq 3$	—
ESC FF	Print data in page mode	Print	0		—	—
ESC SP	Set right-side character spacing	Character		0	$0 \leq n \leq 255$	$n=0$
ESC !	Select print mode(s)	Character		0	$0 \leq n \leq 255$	$n=0$



Command	Name	Function Type	Classification		Range	Default
			Executing Cmds	Setting Cmds		
ESC \$	Set absolute print position	Print position	0		$0 \leq nL \leq 255$, $0 \leq nH \leq 255$	—
ESC %	Select/cancel user-defined character set	Character		0	$0 \leq n \leq 255$	$n=0$
ESC &	Define user-defined characters	Character		0	$32 \leq c1 \leq c2 \leq 126$ $1 \leq x \leq 12$ (font A) $1 \leq x \leq 9$ (font B) $1 \leq d \leq 255$ Paper roll: $y=3$ Slip: $y=2$	—
ESC *	Select bit-image mode	Bit image	0		$32 \leq nL \leq 255$, $0 \leq nH \leq 3$ $0 \leq d \leq 255$ Paper roll: $m=0, 1, 32, 33$ Slip: $m=0, 1$	—
ESC -	Turn underline mode on/off	Character		0	$0 \leq n \leq 2$, $48 \leq n \leq 50$	$n=0$
ESC 2	Select default line spacing	Line spacing		0	—	—



Command	Name	Function Type	Classification		Range	Default
			Executing Cmds	Setting Cmds		
ESC 3	Set line spacing	Line spacing		0	$0 \leq n \leq 255$	Paper roll: $n=30$ Slip: $n=24$
ESC <	Return home	Mechanism control	0		—	—
ESC =	Select peripheral device	Miscellaneous function		0	$1 \leq n \leq 3$	$n=1$ or $n=2$
ESC ?	Cancel user-defined characters	Character		0	$32 \leq n \leq 126$	—
ESC @	Initialize printer	Miscellaneous function	0	0	—	—
ESC C	Set cut sheet eject length	Line spacing		0	$0 \leq n \leq 255$	$n=0$
ESC D	Set horizontal tab positions	Print position		0	$1 \leq n \leq 255$ $0 \leq k \leq 32$	$n=8, 16, 24...$ (every eight characters for font A)
ESC E	Turn emphasized mode on/off	Character		0	$0 \leq n \leq 255$	$n=0$
ESC F	Set/cancel cut sheet reverse eject	Mechanism control		0	$0 \leq n \leq 255$	$n=1$
ESC G	Turn double-strike mode on/off	Character		0	$0 \leq n \leq 255$	$n=0$



Command	Name	Function Type	Classification		Range	Default
			Executing Cmds	Setting Cmds		
ESC J	Print and feed paper	Print	0		$0 \leq n \leq 255$	—
ESC K	Print and reverse feed	Print	0		$0 \leq n \leq 255$	—
ESC L	Select page mode	Miscellaneous function	0		—	—
ESC R	Select an international character set	Character		0	$0 \leq n \leq 10$	$n=0$
ESC S	Select standard mode	Miscellaneous function	0		—	—
ESC T	Select print direction in page mode	Print position		0	$0 \leq n \leq 3,$ $48 \leq n \leq 51$	$n=0$
ESC U	Turn unidirectional printing mode on/off	Mechanism control		0	$0 \leq n \leq 255$	$n=0$
ESC V	Turn 90° clockwise rotation mode on/off	Character		0	$n=0, 1, 48, 49$	$n=0$
ESC W	Set printing area in page mode	Print position		0	$0 \leq xL \leq 255,$ $0 \leq xH \leq 255$ $0 \leq yL \leq 255,$ $0 \leq yH \leq 255$ $0 \leq dxL \leq 255,$ $0 \leq dxH \leq 255$ $0 \leq dyL \leq 255,$ $0 \leq dyH \leq 255$	$xL=0, xH=0$ $yL=0, yH=0$ $dxL=0, dxH=2$ $dyL=126,$ $dyH=6$



Command	Name	Function Type	Classification		Range	Default
			Executing Cmds	Setting Cmds		
ESC \	Set relative print position	Print position	○		$0 \leq nL \leq 255,$ $0 \leq nH \leq 255$	—
ESC a	Select justification	Print position		○	$0 \leq nL = \leq 2,$ $48 \leq n \leq 50$	$n=0$
ESC c 0	Select paper type(s) for printing	Printing paper	○	○	$1 \leq n \leq 4$	$n=3$
ESC c 1	Select paper type(s) for command settings	Printing paper		○	$1 \leq n \leq 4$	$n=3$
ESC c 3	Select paper sensor(s) to output paper-end signals	Paper sensor		○	$0 \leq n \leq 255$	$n=15$
ESC c 4	Select paper sensor(s) to stop printing	Paper sensor		○	$0 \leq n \leq 255$	$n=0$
ESC c 5	Enable/disable panel buttons	Panel button		○	$0 \leq n \leq 255$	$n=0$
ESC d	Print and feed n lines	Print	○		$0 \leq n \leq 255$	—
ESC e	Print and reverse feed n lines	Print	○		$0 \leq n \leq 255$	—
ESC f	Set cut sheet wait time	Printing paper		○	$0 \leq t1 \leq 15,$ $0 \leq t2 \leq 64$	$t1=0, t2=0$



Command	Name	Function Type	Classification		Range	Default
			Executing Cmds	Setting Cmds		
ESC p	Generate pulse	Miscellaneous function	0		$m=0, 1, 48, 49$ $0 \leq t1 \leq 255,$ $0 \leq t2 \leq 255$	—
ESC q	Paper release	Mechanism control	0		—	—
ESC t	Select character code table	Character		0	$0 \leq n \leq 5, n=255$	$n=0$
ESC {	Turn upside-down printing mode on/off	Character		0	$0 \leq n \leq 255$	$n=0$
GS !	Select character size	Character		0	$0 \leq n \leq 255$	$n=0$
GS \$	Set absolute vertical print position in page mode	Print position	0		$0 \leq nL \leq 255$ $0 \leq nH \leq 255$	—
GS *	Define downloaded bit image	Bit image		0	$1 \leq x \leq 255,$ $0 \leq d \leq 255$ Paper roll: $1 \leq y \leq 48,$ $x \times y \leq 1536$ Slip: $1 \leq n \leq 255,$ $x \times y \leq 404$	Undefined



Command	Name	Function Type	Classification		Range	Default
			Executing Cmds	Setting Cmds		
GS /	Print downloaded bit image	Bit image	0		Paper roll: $0 \leq m \leq 3,$ $48 \leq m \leq 51$ Slip: $m=0, 1, 48, 49$	—
GS :	Start/end macro definition	Macro function	0	0	—	—
GS B	Turn white/black reverse printing mode on/off	Character		0	$0 \leq n \leq 255$	$n=0$
GS H	Select printing position of HRI characters	Bar code		0	$0 \leq n \leq 3,$ $48 \leq n \leq 51$	$n=0$
GS I	Transmit printer ID	Miscellaneous function	0		$1 \leq n \leq 3,$ $49 \leq n \leq 51$	$n=0$
GS L	Set left margin	Print position		0	$0 \leq nL \leq 255,$ $0 \leq nH \leq 255$	$nL=0, nH=0$
GS P	Set horizontal and vertical motion units	Miscellaneous function		0	$0 \leq x \leq 255$ $0 \leq y \leq 255$	Paper roll: $x=180,$ $y=360$ Slip: $x=150,$ $y=144$



Command	Name	Function Type	Classification		Range	Default
			Executing Cmds	Setting Cmds		
GS V	Select cut mode and cut paper	Mechanism control	0		$m=1, 49$ $m=66, 0 \leq n \leq 255$	—
GS W	Set printing area width	Print position		0	$0 \leq nL \leq 255$ $0 \leq nH \leq 255$	Paper roll: $nL=0, nH=2$ Slip: $nL=32, nH=3$
GS \	Set relative vertical print position in page mode	Print position	0		$0 \leq nL \leq 255$ $0 \leq nH \leq 255$	—
GS ^	Execute macro	Macro function	0		$0 \leq r \leq 255,$ $0 \leq t \leq 255$ $m=0,1$	—
GS a	Enable/disable Automatic Status Back (ASB)	Status	0		$0 \leq n \leq 255$	$n=0$ or $n=2$
GS b	Turn smoothing mode on/off	Character	0		$0 \leq n \leq 255$	$n=0$
GS f	Select font for HRI characters	Bar code	0		$n=0,1,48,49$	$n=0$
GS h	Set bar code height	Bar code	0		$1 \leq n \leq 255$	$n=162$



Command	Name	Function Type	Classification		Range	Default
			Executing Cmds	Setting Cmds		
GS k	Print bar code	Bar code	0		$0 \leq m \leq 6$ k and d depend on a bar code $65 \leq m \leq 73$ n and d depend on a bar code	—
GS r	Transmit status	Status	0		$1 \leq n \leq 3,$ $49 \leq n \leq 51$	—
GS v 0	Print raster bit image	Bit image	0		$0 \leq m \leq 3,$ $48 \leq m \leq 51$ $0 \leq xL \leq 255$ $0 \leq xH \leq 255$ $0 \leq yL \leq 255$ $0 \leq d \leq 255$ $k = (xL + xH \times 256) \times (yL \times yH \times 256)$ $(k \neq 0)$	—
GS w	Set bar code width	Bar code	0		$2 \leq n \leq 6$	$n=3$



The following commands are supported only by the printer with the optional Magnetic Ink Character Recognition (MICR) reader. (The MICR reader is a factory-installed option.)

Command	Name	Function Type	Classification		Range	Default
			Executing Cmds	Setting Cmds		
DLE EOT BS	Real-time MICR status transmission	MICR	0		$n=1$	—
FS a 0	Read check paper	MICR	0		$0 \leq n \leq 255$	—
FS a 1	Load check paper to print starting position	MICR	0		—	—
FS a 2	Eject check paper	MICR	0		—	—
FS b	Request retransmission of check paper reading result	MICR	0		—	—
FS c	MICR mechanism cleaning	MICR	0		—	—



FEATURES

The TM-U375 and TM-U375P are high-performance POS printers that can print on slip, validation, and journal paper (paper roll). The printers have the following features:

- World's smallest multi-function printer.
- High-speed printing using logic seeking.
- Easy problem handling (e.g., paper jams or objects dropped into the printer) via a clamshell mechanism.
- Two cut-sheet entrances: from above for validation paper and from the front for slip paper.
- Free-format printing in page mode.
- Movable platen for easy paper insertion.
- Paper load switch for easy paper roll loading.
- Command protocol based on the ESC/POS standard.
- Automatic Status Back (ASB) function that automatically transmits changes in printer status.
- EPSON intelligent module connection (only the RS-232 serial interface model).
- EPSON customer display series connection (only the RS-232 serial interface model).



SPECIFICATIONS

■ Printing specifications

Printing method: 9-pin, serial impact dot matrix
 Printing speed: Approximately 3.5 LPS
 (40 columns, 16 CPI, continuous printing)

■ Character specifications

Character fonts: Font A (7 × 9) / Font B (5 × 9)
 Characters per line: 40 / 33
 Character pitch: 16 / 13.3 CPI
 Character size: 1.24 mm (W) × 3.1 mm (H) / 1.56 mm (W) × 3.1 mm (H)
 Character sets:
 ASCII: 95 characters
 International: 32 characters
 Extended graphics: 128 characters × 6 pages

■ Paper specifications

Paper type: Paper roll: Normal paper (single-ply)
 Pressure sensitive paper (2-ply)
 Cut sheet: Normal paper (single-ply)
 Carbon copy paper
 Pressure sensitive paper
 Paper size: Paper roll: 75.5-76.5 mm (W) × 83.0 mm diameter
 Slip paper: 70 mm (W) × 160 mm (L) – 182 mm (W) × 257 mm (L)
 Validation paper: 135 mm (W) × 70 mm (L) – 182 mm (W) × 257 mm (L)
 Thickness: Paper roll: 0.06 mm – 0.16 mm
 Slip paper: 0.09 mm – 0.31 mm



- Panel buttons
 - PAPER FEED:
Feed paper (this button also can be used for the self test and the hexadecimal dump printing).
 - RELEASE:
Release a paper clamp.

- Panel LEDs:
 - POWER (green):
Off when the printer is turned off.
On when the printer is turned on.
 - JOURNAL OUT (red):
Off when the paper roll is adequate.
On when the paper roll is near-end.
Blinks when the printer is in the self test printing standby state.
 - VALIDATION/SLIP (green):
Off when the printer selects the paper roll.
On when the printer selects the cut sheet.
Blinks when the printer is waiting for the cut sheet to be inserted or removed.
 - ERROR (red):
Off when the printer is in normal operation.
On when the printer is off-line (except during paper feed using the PAPER FEED button and during the self test).
Blinks when an error occurs.

- Interface:
 - RS-232 (TM-U375: serial interface)
 - IEEE-1284 (TM-U375P: parallel interface)

- Receive buffer:
 - 4K or 40 bytes (selectable by DIP switch)



DIP SWITCH FUNCTIONS

Serial Interface (TM-U375)

DIP switch 1

SW	Function	ON	OFF
1-1	Data receive error	Ignored	Convert data to "?"
1-2	Receive buffer capacity	40 bytes	4K bytes
1-3	Handshaking	XON/XOFF	DTR/DSR
1-4	Data word length	7 bits	8 bits
1-5	Parity check	Enabled	Disabled
1-6	Parity selection	Even	Odd
1-7	Transmission speed		
1-8			

Transmission speed

Transmission speed bits per second (BPS)	SW 1-7	SW 1-8
1200	ON	ON
2400	OFF	ON
4800	ON	OFF
9600	OFF	OFF



DIP switch 2

SW	Function	ON	OFF
2-1	Customer display (DM-D) connection	Connected	Not connected
2-2	Select the number of characters per line (CPL) Font A (7 × 9) / Font B (5 × 9)	42/35	40/33
2-3	BUSY condition	Receive buffer full	Off-line or receive buffer full
2-4~2-6	Internal use only (Do not change settings)		
2-7	I/F pin 6 reset signal	Enabled	Disabled
2-8	I/F pin 25 reset signal	Enabled	Disabled



Parallel Interface (TM-U375)

DIP switch 1

SW	Function	ON	OFF
1-1	Auto line feed	Always enabled	Always disabled
1-2	Receive buffer capacity	40 bytes	4K bytes
1-3~1-8	Undefined	—	—

DIP switch 2

SW	Function	ON	OFF
2-1	Internal use only	Fixed to OFF	
2-2	Selects the number of characters per line (CPL) Font A (7 × 9) / Font B (5 × 9)	42/35	40/33
2-3	BUSY condition	Receive buffer full	Off-line, receive buffer full, or receiving data
2-4~2-6	Internal use only (Do not change settings)		
2-7	Undefined	—	—
2-8	lnit reset signal	Fixed to On	



ERRORS

- Automatically recoverable errors:
 - Print head high temperature error
- Recoverable errors:
 - Home position detection error
 - Carriage detection error
 - Slip/validation ejection error
- Unrecoverable errors:
 - R/W error in memory or gate array
 - High voltage error
 - Low voltage error
 - CPU execution error
 - Drive circuit error
- Data receive errors:

If the following errors occur with a serial interface, the printer processes data depending on the setting of DIP switch 1-1.

 - Parity error
 - Framing error
 - Overrun error



OPTIONS

- EPSON power supply unit, PS-150 (not required when the TM-U375 is connected to an intelligent module).
- Direct connection customer display, DM-D102 and DM-D203 (for only the RS-232 serial interface model).
- Pass-through customer display, DM-D101II and DM-D202II (for only the RS-232 serial interface model).



SELF TEST FOR THE TM-U375

The self test lets you know if your printer is operating properly. It checks the control circuits, printer mechanisms, print quality, ROM version, and DIP switch setting. (It also checks the MICR reader circuits if the printer is equipped with the optional MICR reader.) This test is independent of any other equipment or software.

Running the self test with a paper roll

1. Make sure the printer is turned off and the printer covers are closed properly.
2. While holding down the PAPER FEED button, turn on the printer using the power switch to begin the self test. The self test prints the printer settings and then prints the following, cuts the paper, and pauses. (The PAPER OUT light blinks.)

Self test printing.
Please press the Paper feed button.

3. Press the PAPER FEED button to continue printing. The printer prints a pattern using the resident characters.
4. The self test automatically ends and cuts the paper after printing the following:

completed

The printer is ready to receive data as soon as it completes the self test.



Running the self test with the slip paper

1. Make sure the printer is turned off and the printer cover is closed properly.
2. While holding down the RELEASE button, turn on the printer using the power switch to begin the self test. (The VALIDATION/SLIP light blinks.)
3. Feed a sheet of slip paper into the printer. The printer loads the paper automatically, prints the printer settings, and then ejects the paper.
4. Remove the paper from the printer and feed another sheet into the printer to print a pattern using the resident characters. Continue to feed the sheet into the printer until the self test prints the following:

completed

The printer is ready to receive data as soon as it completes the self test.



HEXADECIMAL DUMP FOR THE TM-U375

This feature allows experienced users to see exactly what data has been received. This can be useful in finding software problems. When you turn on the hexadecimal dump function, the printer prints all commands and other data in hexadecimal format on paper roll to help you find specific commands.

To use the hexadecimal dump feature, follow these steps:

1. After you make sure that the printer is off, open the cover.
2. Hold down the PAPER FEED button while you turn on the printer.
3. Close the cover.
4. Run any software program that sends data to the printer. The printer prints "Hexadecimal Dump" and then all the codes it receives in a two-column format. The first column contains the hexadecimal codes and the second column gives the ASCII characters that correspond to the codes.

Hexadecimal Dump

1B	21	00	1B	26	02	40	40	.	!	.	.	&	.	@	@
1B	25	01	1B	63	34	00	1B	.	%	.	.	C	4	.	.
41	42	43	44	45	46	47	48	A	B	C	D	E	F	G	H

- A period (.) is printed for each code that has no ASCII equivalent.
- During the hexadecimal dump all commands except **DLE EOT** and **DLE ENQ** do not function.

5. Press the PAPER FEED button so that the printer will print the last line.
6. Turn off the printer or reset it to turn off the hexadecimal dump mode.



TM-U375 SUPPORTED COMMANDS

Command	Name	Function Type	Classification		Range	Default
			Executing Cmds	Setting Cmds		
HT	Horizontal tab	Print position	0		—	—
LF	Print and line feed	Print	0		—	—
FF	① Print and eject cut sheet (in standard mode) ② Print and return to standard mode (in page mode)	Print	0		—	—
CR	Print and carriage return	Print	0		—	—
CAN	Cancel print data in page mode	Character	0		—	—
DLE EOT	Real-time status transmission	Status	0		$1 \leq n \leq 6$	—
DLE ENQ	Real-time request to printer	Miscellaneous function	0		$1 \leq n \leq 3$	—
ESC SP	Set right-side character spacing	Character		0	$0 \leq n \leq 255$	$n=0$
ESC !	Select print mode(s)	Character		0	$0 \leq n \leq 255$	$n=1$



Command	Name	Function Type	Classification		Range	Default
			Executing Cmds	Setting Cmds		
ESC \$	Set absolute print position	Print position	0		$0 \leq nL \leq 255$, $0 \leq nH \leq 255$	—
ESC %	Select/cancel user-defined character set	Character		0	$0 \leq n \leq 255$	$n=0$
ESC &	Define user-defined characters	Character		0	$y=2$ $32 \leq c1 \leq c2 \leq 126$ $0 \leq x \leq 6$ (5 × 9 font) $0 \leq x \leq 10$ (7 × 9 font) $0 \leq d \leq 255$ $k=c2-c1+1$	—
ESC *	Select bit-image mode	Bit image	0		$m=0, 1$ $0 \leq nL \leq 255$ $0 \leq nH \leq 3$ $0 \leq d \leq 255$	—
ESC -	Turn underline mode on/off	Character		0	$n=0, 1, 48, 49$	$n=0$
ESC 2	Select default line spacing	Line spacing		0	—	—
ESC 3	Set line spacing	Line spacing		0	$0 \leq n \leq 255$	$n=24$



Command	Name	Function Type	Classification		Range	Default
			Executing Cmds	Setting Cmds		
ESC <	Return home	Mechanism control	0		—	—
ESC =	Select peripheral device	Miscellaneous function		0	$1 \leq n \leq 3$	Serial I/F: $n=1$ or $n=2$ Parallel I/F: $n=1$
ESC ?	Cancel user-defined characters	Character		0	$32 \leq n \leq 126$	—
ESC @	Initialize printer	Miscellaneous function	0	0	—	—
ESC C	Set cut sheet eject length	Line spacing		0	$0 \leq n \leq 255$	$n=0$
ESC D	Set horizontal tab positions	Print position		0	$1 \leq n \leq 255$ $0 \leq k \leq 32$	$n=8, 16, 24, 32\dots$ (every eight characters for 7×9 font)
ESC E	Turn emphasized mode on/off	Character		0	$0 \leq n \leq 255$	$n=0$
ESC G	Turn double-strike mode on/off	Character		0	$0 \leq n \leq 255$	$n=0$
ESC J	Print and feed paper	Print	0		$0 \leq n \leq 255$	—
ESC L	Select page mode	Miscellaneous function	0		—	—



Command	Name	Function Type	Classification		Range	Default
			Executing Cmds	Setting Cmds		
ESC R	Select an international character set	Character		O	$0 \leq n \leq 10$	$n=0$
ESC T	Select print direction in page mode	Print position		O	$0 \leq n \leq 3,$ $48 \leq n \leq 51$	$n=0$
ESC U	Turn unidirectional printing mode on/off	Mechanism control		O	$0 \leq n \leq 255$	Standard mode: $n=0$ Page mode: $n=1$
ESC V	Turn 90° clockwise rotation mode on/off	Character		O	$0 \leq n \leq 2,$ $48 \leq n \leq 50$	$n=0$
ESC W	Set printing area in page mode	Print position		O	$0 \leq xL \leq 255$ $0 \leq xH \leq 255$ $0 \leq yL \leq 255$ $0 \leq yH \leq 255$ $0 \leq dxL \leq 255$ $0 \leq dxH \leq 255$ $0 \leq dyL \leq 255$ $0 \leq dyH \leq 255$	$xL=0$ $xH=0$ $yL=0$ $yH=0$ $dxL=144$ $dxH=1$ $dyL=128$ $dyH=5$
ESC \	Set relative print position	Print position	O		$0 \leq nL \leq 255$ $0 \leq nH \leq 255$	—



Command	Name	Function Type	Classification		Range	Default
			Executing Cmds	Setting Cmds		
ESC a	Select justification	Print position		○	$0 \leq n \leq 2,$ $48 \leq n \leq 50$	$n=0$
ESC c 0	Select paper type(s) for printing	Printing paper	○	○	$1 \leq n \leq 11$	$n=1$
ESC c 1	Select paper type(s) for command settings	Printing paper		○	$1 \leq n \leq 15$	$n=15$
ESC c 3	Select paper sensor(s) to output paper-end signals	Paper sensor		○	$0 \leq n \leq 255$	$n=3$
ESC c 4	Select paper sensor(s) to stop printing	Paper sensor		○	$0 \leq n \leq 255$	$n=0$
ESC c 5	Enable/disable panel buttons	Panel button		○	$0 \leq n \leq 255$	$n=0$
ESC d	Print and feed n lines	Print	○		$0 \leq n \leq 255$	—
ESC f	Set cut sheet wait time	Printing paper		○	$0 \leq t1 \leq 15$ $0 \leq t2 \leq 64$	$t1=0$ $t2=10$
ESC p	Generate pulse	Miscellaneous function	○		$m=0, 1, 48, 49$ $0 \leq t1 \leq 255$ $0 \leq t2 \leq 255$	—
ESC q	Paper release	Mechanism control	○		—	—



Command	Name	Function Type	Classification		Range	Default
			Executing Cmds	Setting Cmds		
ESC t	Select character code table	Character		○	$n=254, 255$ $0 \leq n \leq 5$ (U375)	$n=0$
ESC u	Transmit peripheral device status	Status	○		$n=0,48$	—
ESC v	Transmit paper sensor status	Status	○		—	—
ESC {	Turn upside-down printing mode on/off	Character		○	$0 \leq n \leq 255$	$n=0$
GS *	Define downloaded bit image	Bit image		○	$1 \leq x \leq 255$ $1 \leq y \leq 255$ $x \times y \leq 512$ $0 \leq d \leq 255$	—
GS /	Print downloaded bit image	Bit image	○		$m=0, 1, 48, 49$	—
GS E	Select head control method	Miscellaneous function		○	$0 \leq n \leq 255$	Paper roll: $n=1$ Cut sheet: $n=0$
GS I	Transmit printer ID	Miscellaneous function	○		$1 \leq n \leq 3,$ $49 \leq n \leq 51$	—
GS L	Set left margin	Print position		○	$0 \leq nL \leq 255$ $0 \leq nH \leq 255$	$nL=0$ $nH=0$



Command	Name	Function Type	Classification		Range	Default
			Executing Cmds	Setting Cmds		
GS P	Set horizontal and vertical motion units	Miscellaneous function		0	$0 \leq x \leq 255$ $0 \leq y \leq 255$	$x=160$ $y=144$
GS W	Set printing area width	Print position		0	$0 \leq nL \leq 255$ $0 \leq nH \leq 255$	$nL=144$ $nH=1$
GS a	Enable/disable Automatic Status Back (ASB)	Status	0	0	$0 \leq n \leq 255$	$n=0$ or $n=2$
GS r	Transmit status	Status	0		$1 \leq n \leq 3,$ $49 \leq n \leq 51$	—



FEATURES

The TM-U925 is a high-quality POS printer that can print on slip paper and a paper roll. The printer has the following features:

- Wide slip paper capability (maximum characters per line: 88 with font B (7 × 9)).
- Interface connector within the printer's external dimensions.
- High-speed printing using logic seeking.
- Selectable receive buffer size (2K bytes or 32 bytes).
- Slip ejection sensor.
- Command protocol based on the ESC/POS standard.
- Automatic Status Back (ASB) function that automatically transmits changes in printer status.
- EPSON intelligent module connection.
- EPSON customer display series connection.
- Optional Magnetic Ink Character Recognition (MICR) reader that enables the printer to read and process MICR characters, in addition to printing endorsements.



SPECIFICATIONS

■ Printing specifications

Printing method: 9-pin, serial impact dot matrix
 Printing speed: 200-311 CPS

■ Character specifications

Character fonts: Font A (9 × 9) / Font B (7 × 9)
 Characters per line: 30 / 40 (paper roll), 66 / 88 (slip)
 Character pitch: 12.5 / 16.7 CPI
 Character size: 1.6 mm (W) × 3.1 mm (H) / 1.3 mm (W) × 3.1 mm (H)
 Character sets:
 ASCII: 95 characters
 International: 32 characters
 Extended graphics: 128 characters × 6 pages

■ Paper specifications

Paper type: Paper roll: Normal paper (single-ply)
 Slip paper: Normal paper (single-ply)
 Carbon copy paper
 Pressure sensitive paper
 Paper size: Paper roll: 69 – 70 mm (W) × 83.0 mm diameter
 Slip paper: 70 mm (W) × 70 mm (L) – 210 mm (W) × 297 mm (L) (A4)
 Thickness: Paper roll: 0.06 mm – 0.09 mm
 Slip paper: 0.09 mm – 0.36 mm

■ Panel buttons:

RECEIPT FEED:

Feed paper roll (this button also can be used for the self test and the hexadecimal dump printing).

SLIP FEED:

Feed slip paper.



- Panel LEDs:
 - POWER (green):
 - Off when the printer is turned off.
 - On when the printer is turned on.
 - RECEIPT OUT (red):
 - Off when the paper roll is adequate.
 - On when the paper roll is near-end or at end.
 - Blinks when the printer is in the self test printing standby state.
 - ERROR (red):
 - Off when the printer is in normal operation.
 - On when the printer is off-line (except during paper feed using the RECEIPT FEED or SLIP FEED button and during the self test).
 - Blinks when an error occurs.
 - SLIP (green):
 - Off when the printer selects the paper roll.
 - On when the printer selects the slip paper.
 - Blinks when the printer is in the slip insertion waiting state.
- Interface: RS-232 (serial interface)
- Receive buffer: 2K bytes or 32 bytes



DIP SWITCH FUNCTIONS

Serial Interface

DIP switch 1

SW	Function	ON	OFF
1-1	Data word length	7 bits	8 bits
1-2	Parity check	Enabled	Disabled
1-3	Parity selection	Even	Odd
1-4	Transmission speed		
1-5			
1-6	Customer display (DM-D) connection	Connected	Not connected
1-7	Data receive error	Ignored	Convert data to "?"
1-8	Handshaking	XON/XOFF	DTR/DSR

Transmission speed

Transmission speed bits per second (BPS)	SW 1-4	SW 1-5
1200	ON	ON
2400	OFF	ON
4800	ON	OFF
9600	OFF	OFF



DIP switch 2

SW	Function	ON	OFF
2-1	Auto line feed	Always enabled	Always disabled
2-2	Receive buffer capacity	32 bytes	2K bytes
2-3	Font selection (default)	Font A (9 × 9)	Font B (7 × 9)
2-4~	Carriage speed (default for paper roll printing)	Low	High
2-5	BUSY condition	Receive buffer full	Off-line or receive buffer full
2-6	Internal use only (Do not change settings)	Fixed to On	
2-7	I/F pin 6 reset signal	Enabled	Disabled
2-8	I/F pin 25 reset signal	Enabled	Disabled



ERRORS

- Automatically recoverable errors:
 - Print head high temperature error
- Recoverable errors:
 - Auto-cutter error
 - Home position detection error
 - Carriage detection error
 - Slip ejection error
- Unrecoverable errors:
 - R/W error in memory or gate array
 - High voltage error
 - Low voltage error
 - CPU execution error
 - Drive circuit error
 - Thermistor error
- Data receive errors:

If the following errors occur with a serial interface, the printer processes data depending on the setting of DIP switch 1-7.

 - Parity error
 - Framing error
 - Overrun error



OPTIONS

- EPSON power supply unit, PS-150 (not required when the TM-U925 is connected to an intelligent module).
- Magnetic Ink Character Recognition (MICR) reader (factory-installed option).
- Stamp unit (factory-installed option).
- Direct connection display modules, DM-D102 and DM-D203.
- Pass-through customer display, DM-D101II and DM-D202II.



SELF TEST FOR THE TM-U925

The self test lets you know if your printer is operating properly. It checks the control circuits, printer mechanisms, print quality, ROM version, and DIP switch setting. (It also checks the MICR reader circuits if the printer is equipped with the optional MICR reader.) This test is independent of any other equipment or software.

Running the self test with a paper roll

1. Make sure the printer is turned off and the printer covers are closed properly.
2. While holding down the RECEIPT FEED button, turn on the printer using the power switch to begin the self test. The self test prints the printer settings and then pauses. (The RECEIPT OUT light blinks.)

Self test printing.
Please press the Paper feed button.

3. Press the RECEIPT FEED button to continue printing. The printer prints a pattern using the resident characters.
4. The self test automatically ends and cuts the paper after printing the following:

completed

The printer is ready to receive data as soon as it completes the self test.



Running the self test with the slip paper

1. Make sure the printer is turned off and the printer cover is closed properly.
2. While holding down the SLIP FEED button, turn on the printer using the power switch to begin the self test. (The SLIP light blinks.)
3. Feed a sheet of slip paper into the printer. The printer loads the paper automatically, prints the printer settings, and then ejects the paper. (The SLIP light blinks.)
4. Remove the paper from the printer and feed another sheet into the printer to print a pattern using the resident characters. Continue to feed the sheet into the printer until the self test prints the following:

completed

The printer is ready to receive data as soon as it completes the self test.



HEXADECIMAL DUMP FOR THE TM-U925

This feature allows experienced users to see exactly what data has been received. This can be useful in finding software problems. When you turn on the hexadecimal dump function, the printer prints all commands and other data in hexadecimal format on paper roll to help you find specific commands.

To use the hexadecimal dump feature, follow these steps:

1. After you make sure that the printer is off, open the cover.
2. Hold down the RECEIPT FEED button while you turn on the printer.
3. Close the cover.
4. Run any software program that sends data to the printer. The printer prints "Hexadecimal Dump" and then all the codes it receives in a two-column format. The first column contains the hexadecimal codes and the second column gives the ASCII characters that correspond to the codes.

Hexadecimal Dump

1B	21	00	1B	26	02	40	40	.	!	.	.	&	.	@	@
1B	25	01	1B	63	34	00	1B	.	%	.	.	C	4	.	.
41	42	43	44	45	46	47	48	A	B	C	D	E	F	G	H

- A period (.) is printed for each code that has no ASCII equivalent.
- During the hexadecimal dump all commands except **DLE EOT** and **DLE ENQ** do not function.

5. Open the cover so the printer will print the last line.
6. Turn off the printer or reset it to turn off the hexadecimal dump mode.



TM-U925 SUPPORTED COMMANDS

Command	Name	Function Type	Classification		Range	Default
			Executing Cmds	Setting Cmds		
LF	Print and line feed	Print	0		—	—
FF	Print and eject cut sheet	Print	0		—	—
CR	Print and carriage return	Print	0		—	—
DLE EOT	Real-time status transmission	Status	0		$1 \leq n \leq 5$	—
DLE ENQ	Real-time request to printer	Miscellaneous function	0		$1 \leq n \leq 3$	—
ESC SP	Set right-side character spacing	Character		0	$0 \leq n \leq 255$	$n=0$
ESC !	Select print mode(s)	Character		0	$0 \leq n \leq 255$	$n=0$ or $n=1$
ESC \$	Set absolute print position	Print position	0		$0 \leq nL \leq 255$ $0 \leq nH \leq 255$	—
ESC %	Select/cancel user-defined character set	Character		0	$0 \leq n \leq 255$	$n=0$



Command	Name	Function Type	Classification		Range	Default
			Executing Cmds	Setting Cmds		
ESC &	Define user-defined characters	Character		0	$y=2$ $32 \leq c1 \leq c2 \leq 126$ $0 \leq x \leq 12$ (9 × 9 font) $0 \leq x \leq 9$ (7 × 9 font) $0 \leq d \leq 255$ $k=c2-c1+1$	—
ESC *	Select bit-image mode	Bit image	0		$m=0, 1$ $0 \leq nL \leq 255$ $0 \leq nH \leq 3$ $0 \leq d \leq 255$	—
ESC –	Turn underline mode on/off	Character		0	$n=0, 1, 48, 49$	$n=0$
ESC 2	Select default line spacing	Line spacing		0	—	—
ESC 3	Set line spacing	Line spacing		0	$0 \leq n \leq 255$	$n=24$
ESC <	Return home	Mechanism control	0		—	—
ESC =	Select peripheral device	Miscellaneous function		0	$1 \leq n \leq 3$	$n=1$ or $n=2$



Command	Name	Function Type	Classification		Range	Default
			Executing Cmds	Setting Cmds		
ESC ?	Cancel user-defined characters	Character		O	$32 \leq n \leq 126$	—
ESC @	Initialize printer	Miscellaneous function	O	O	—	—
ESC C	Set cut sheet eject length	Line spacing		O	$0 \leq n \leq 255$	$n=0$
ESC E	Turn emphasized mode on/off	Character		O	$0 \leq n \leq 255$	$n=0$
ESC G	Turn double-strike mode on/off	Character		O	$0 \leq n \leq 255$	$n=0$
ESC J	Print and feed paper	Print	O		$0 \leq n \leq 255$	—
ESC K	Print and reverse feed	Print	O		$0 \leq n \leq 255$	—
ESC R	Select an international character set	Character		O	$0 \leq n \leq 10$	$n=0$
ESC U	Turn unidirectional printing mode on/off	Mechanism control		O	$0 \leq n \leq 255$	$n=0$
ESC \	Set relative print position	Print position	O		$0 \leq nL \leq 255$ $0 \leq nH \leq 255$	—
ESC a	Select justification	Print position		O	$0 \leq n \leq 2,$ $48 \leq n \leq 50$	$n=0$



Command	Name	Function Type	Classification		Range	Default
			Executing Cmds	Setting Cmds		
ESC c 0	Select paper type(s) for printing	Printing paper	0	0	$1 \leq n \leq 4$	$n=3$
ESC c 1	Select paper type(s) for command settings	Printing paper		0	$1 \leq n \leq 7$	$n=7$
ESC c 4	Select paper sensor(s) to stop printing	Paper sensor		0	$0 \leq n \leq 255$	$n=12$
ESC c 5	Enable/disable panel buttons	Panel button		0	$0 \leq n \leq 255$	$n=0$
ESC d	Print and feed n lines	Print	0		$0 \leq n \leq 255$	—
ESC e	Print and reverse feed n lines	Print	0		$0 \leq n \leq 255$	—
ESC f	Set cut sheet wait time	Printing paper		0	$0 \leq t1 \leq 15$ $0 \leq t2 \leq 64$	$t1=0$ $t2=10$
ESC i	Partial cut (one point left uncut)	Mechanism control	0		—	—
ESC m	Partial cut (three points left uncut)	Mechanism control	0		—	—
ESC o	Stamp	Mechanism control	0		—	—



Command	Name	Function Type	Classification		Range	Default
			Executing Cmds	Setting Cmds		
ESC p	Generate pulse	Miscellaneous function	0		$m=0, 1, 48, 49$ $0 \leq t1 \leq 255$ $0 \leq t2 \leq 255$	—
ESC t	Select character code table	Character		0	$0 \leq n \leq 5,$ $n=254, 255$	$n=0$
ESC u	Transmit peripheral device status	Status	0		$n=0, 48$	—
ESC v	Transmit paper sensor status	Status	0		—	—
ESC {	Turn upside-down printing mode on/off	Character		0	$0 \leq n \leq 255$	$n=0$
GS ENQ	Transmit real-time printer status	Status	0		—	—
GS *	Define downloaded bit image	Bit image		0	$1 \leq x \leq 255$ $1 \leq y \leq 255$ (Receive buffer) $x \times y \leq 155$ (2K byte) $x \times y \leq 404$ (32 byte) $0 \leq d \leq 255$	—



Command	Name	Function Type	Classification		Range	Default
			Executing Cmds	Setting Cmds		
GS /	Print downloaded bit image	Bit image	0		$m=0, 1, 48, 49$	—
GS E	Select head control method	Miscellaneous function		0	$0 \leq n \leq 255$	Paper roll: $n=1$ or $n=17$ Slip: $n=16$
GS I	Transmit printer ID	Miscellaneous function	0		$1 \leq n \leq 3,$ $49 \leq n \leq 51$	—
GS P	Set horizontal and vertical motion units	Miscellaneous function		0	$0 \leq x \leq 255$ $0 \leq y \leq 255$	$x=150$ $y=144$
GS a	Enable/disable Automatic Status Back (ASB)	Status	0	0	$0 \leq n \leq 255$	$n=0$ or $n=2$
GS r	Transmit status	Status	0		$1 \leq n \leq 3,$ $49 \leq n \leq 51$	—



The following commands are supported only by the printer with the optional Magnetic Ink Character Recognition (MICR) reader. (The MICR reader is a factory-installed option.)

Command	Name	Function Type	Classification		Range	Default
			Executing Cmds	Setting Cmds		
DLE EOT BS	Real-time MICR status transmission	Status	0		$n=1$	—
FS a 0	Read check paper	MICR	0		$0 \leq n \leq 255$	—
FS a 1	Load check paper to print starting position	MICR	0		—	—
FS a 2	Eject check paper	MICR	0		—	—
FS b	Request retransmission of check paper reading result	MICR	0		—	—
FS c	MICR mechanism cleaning	MICR	0		—	—



FEATURES

The TM-U325D and TM-325PD are high quality printers for ECR and POS, and can print on paper roll and validation paper. The printers have the following features:

- Easily changeable interface specifications for serial or parallel by exchanging the interface board.
- Excellent reliability (long life) and good operability (drop-in paper loading).
- Multiple-line validation printing (possible to print a maximum of 9 lines).
- Compact and lightweight.
- High-speed printing through logic seeking control.
- Excellent reliability and long life due to adoption of stepping motor, both for moving the carriage and for paper feeding.
- Conforms with ESC/POS; excellent universality of control.
- Built-in drawer-kick interface provides capability to drive two drawers.
- Selectable character fonts (7 × 9 or 9 × 9).
- Semi-automatic paper loading capability.
- AC adapter provides compact power supply.
- Automatic status back (ASB) function that automatically transmits changes in printer status.



SPECIFICATIONS

■ Printing specifications

Printing method:	Serial impact dot matrix
Head wire configuration:	9-pin serial configuration
Printing speed:	Approximately 3.5 lines/second (40 column, 16 cpi) Approximately 6.4 lines/second (16 column, 16 cpi) (Excludes data transfer and processing time)
Printing feed speed:	Approximately 105.9 mm/second (4.17 inches/second) (25 lines/second during continuous feeding)
Printing directions:	Bi-directional printing (logic seeking)
Printing dots:	Number of dots in horizontal direction: 400 half-dots

■ Character specifications

Character fonts:	Font A (9 × 9) / Font B (7 × 9)
Characters per line:	33 / 40 (when using 3-half dot spacing) 35 / 42 (when using 2-half dot spacing) (selected by DIP switch)
Character size:	1.6 mm (W) × 3.1 mm (H) / 1.2 mm (W) × 3.1 mm (H)
Character sets:	ASCII: 95 characters International: 32 characters Extended graphics: 128 characters × 6 pages

■ Paper specifications

Paper size:	Paper roll: 76 ± 0.5 mm (W) × 83.0 mm diameter Validation paper: 135 mm (W) × 70 mm (L) – 182 mm (W) × 182 mm (L)
Thickness:	Paper roll: 0.6 mm - 0.085 mm (Normal paper) 0.05 mm - 0.08 mm (Pressure-sensitive paper) (Total thickness: 0.2 mm or less) Validation paper: 0.09 mm - 0.31 mm



Panel buttons:	FEED:	Feed paper (this button also can be used for the self test and the hexadecimal dump printing).
	RELEASE:	Release validation paper (this button also can be used for the self test printing).
Panel LEDs:	POWER (green):	Off when the printer is off. On when the printer is on.
	RECEIPT OUT (red):	Off when paper roll is adequate. On when paper roll is near-end or at end. Blinks when the printer waits for on-line status recovery after automatic paper feeding or for restarting test printing on paper roll.
	VALIDATION (green):	Off when validation paper is not selected. On when validation paper is inserted and the printer is ready to print. Blinks when the printer is in the validation insertion/removal state.
	ERROR (red):	Off when the printer is in normal operation. On when the printer is off-line (except during paper feed and during the self test). Blinks when an error occurs.
Interface:	RS-232 (serial interface) IEEE 1284 (parallel interface) or RS-485 (a dealer option)	
Receive buffer:	4K or 45 bytes (selectable by DIP switch)	



DIP SWITCH FUNCTIONS

Serial Interface (TM-U325D)

DIP switch 1

SW	Function	ON	OFF
1-1	Data receive error	Ignored	Convert data to "?"
1-2	Receive buffer capacity	45 bytes	4K bytes
1-3	Handshaking	XON/XOFF	DTR/DSR
1-4	Data word length	7 bits	8 bits
1-5	Parity check	Enabled	Disabled
1-6	Parity selection	Even	Odd
1-7	Transmission speed		
1-8			

Transmission speed

Transmission speed bits per second (BPS)	SW 1-7	SW 1-8
2400	ON	ON
4800	OFF	ON
9600	ON	OFF
19200	OFF	OFF



Dip Switch 2

SW	Function	ON	OFF
2-1	BUSY condition	Receive buffer full	Off-line or receive buffer full
2-2	Undefined	—	—
2-3	Select the number of characters per line (CPL) Font A (9 × 9) / Font B (7 × 9)	42/35	40/33
2-4~2-5	Undefined	—	—
2-6	Internal use only (Do not change settings)	Fixed to Off	
2-7	I/F pin 6 reset signal	Enabled	Disabled
2-8	I/F pin 25 reset signal	Enabled	Disabled



Parallel Interface (TM-U325D)

DIP switch 1

SW	Function	ON	OFF
1-1	Auto line feed	Always enabled	Always disabled
1-2	Receive buffer capacity	45 bytes	4K bytes
1-3 ~1-8	Undefined	—	—

DIP switch 2

SW	Function	ON	OFF
2-1	BUSY condition	Receive buffer full	Off-line or receive buffer full
2-2	Undefined	—	—
2-3	Selects the number of characters per line (CPL) Font A (9 × 9) / Font B (7 × 9)	42/35	40/33
2-4~2-5	Undefined	—	—
2-6	Internal use only (Do not change settings)	Fixed to Off	
2-7	Undefined	—	—
2-8	I/F pin 31 reset signal	Fixed to On	



ERRORS

- Automatically recoverable errors:
 - Print head high temperature error
- Recoverable errors:
 - Home position detection error
 - Validation ejection error
- Unrecoverable errors:
 - CPU execution error
 - R/W error in memory or gate array
 - High voltage error
 - Low voltage error
 - Circuit error



OPTIONS

- EPSON power supply unit, PS-170.
- Printer fastening tape (Model No. DF-10).



SELF TEST FOR THE TM-U325D

The self test lets you know if your printer is operating properly. It checks the control circuits, printer mechanisms, print quality, ROM version, and DIP switch setting. This test is independent of any other equipment or software.

Running the self test with a paper roll

1. Make sure the printer is turned off and the printer covers are closed properly.
2. While holding down the FEED button, turn on the printer using the power switch to begin the self test. The self test prints the printer settings and then prints the following, cuts the paper, and pauses. (The RECEIPT OUT light blinks.)

Self test printing.
Please press the Paper feed button.

3. Press the FEED button to continue printing. The printer prints a pattern using the resident characters.
4. The self test automatically ends and cuts the paper after printing the following:

completed

The printer is ready to receive data as soon as it completes the self test.



Running the self test with the validation paper

1. Make sure the printer is turned off and the printer cover is closed properly.
2. While holding down the RELEASE button, turn on the printer using the power switch to begin the self test. (The VALIDATION light blinks.)
3. Feed a sheet of validation paper into the printer. The printer loads the paper automatically, prints the printer settings, and starts 9-line test printing, and ejects paper.
4. Remove the paper from the printer and feed another sheet into the printer to print a pattern using the resident characters. Continue to feed the sheet into the printer until the self test prints the following:

completed

The printer is ready to receive data as soon as it completes the self test.



HEXADECIMAL DUMP FOR THE TM-U325D

This feature allows experienced users to see exactly what data has been received. This can be useful in finding software problems. When you turn on the hexadecimal dump function, the printer prints all commands and other data in hexadecimal format on paper roll to help you find specific commands.

To use the hexadecimal dump feature, follow these steps:

1. After you make sure that the printer is off, open the cover.
2. Hold down the FEED button while you turn on the printer.
3. Close the cover.
4. Run any software program that sends data to the printer. The printer prints "Hexadecimal Dump" and then all the codes it receives in a two-column format. The first column contains the hexadecimal codes and the second column gives the ASCII characters that correspond to the codes.

Hexadecimal Dump

1B	21	00	1B	26	02	40	40	.	!	.	.	&	.	@	@
1B	25	01	1B	63	34	00	1B	.	%	.	.	C	4	.	.
41	42	43	44	45	46	47	48	A	B	C	D	E	F	G	H

- A period (.) is printed for each code that has no ASCII equivalent.
- During the hexadecimal dump all commands except **DLE EOT** and **DLE ENQ** do not function.

5. Press the FEED button so that the printer will print the last line.
6. Turn off the printer or reset it to turn off the hexadecimal dump mode.



TM-U325D SUPPORTED COMMANDS

Command	Name	Function Type	Classification		Range	Default
			Executing Cmds	Setting Cmds		
HT	Horizontal tab	Print position	○		—	—
LF	Print and line feed	Print	○		—	—
FF	Print and eject cut sheet	Print	○		—	—
CR	Print and carriage return	Print	○		—	—
DLE EOT	Real-time status transmission	Status	○		$1 \leq n \leq 4$ $n=6$	—
DLE ENQ	Real-time request to printer	Miscellaneous function	○		$1 \leq n \leq 3$	—
ESC SP	Set right-side character spacing	Character		○	$0 \leq n \leq 255$	$n=0$
ESC !	Select print mode(s)	Character		○	$0 \leq n \leq 255$	$n=1$
ESC \$	Set absolute print position	Print position	○		$0 \leq nL \leq 255,$ $0 \leq nH \leq 255$	—
ESC %	Select/cancel user-defined character set	Character		○	$0 \leq n \leq 255$	$n=0$



Command	Name	Function Type	Classification		Range	Default
			Executing Cmds	Setting Cmds		
ESC &	Define user-defined characters	Character		0	$y=2$ $32 \leq c1 \leq c2 \leq 126$ $0 \leq x \leq 12$ (9 × 9 font) $0 \leq x \leq 9$ (7 × 9 font) $0 \leq d1 \dots$ $d(y \times xk) \leq 255$	—
ESC *	Select bit-image mode	Bit image	0		$m=0,1$ $0 \leq nL \leq 255$ $0 \leq nH \leq 3$ $0 \leq d \leq 255$ $k=nL + nH \times 255$	—
ESC -	Turn underline mode on/off	Character		0	$n=0, 1, 48, 49$	$n=0$
ESC 2	Select default line spacing	Line spacing		0	—	—
ESC 3	Set line spacing	Line spacing		0	$0 \leq n \leq 255$	$n=24$
ESC <	Return home	Mechanism control	0		—	—
ESC =	Select peripheral device	Miscellaneous function		0	$1 \leq n \leq 3$	$n=1$



Command	Name	Function Type	Classification		Range	Default
			Executing Cmds	Setting Cmds		
ESC ?	Cancel user-defined characters	Character		0	$32 \leq n \leq 126$	—
ESC @	Initialize printer	Miscellaneous function	0	0	—	—
ESC D	Set horizontal tab positions	Print position		0	$1 \leq n \leq 255$ $0 \leq k \leq 32$	$n=8, 16, 24, 32\dots$ (every eight characters for 7×9 font)
ESC E	Turn emphasized mode on/off	Character		0	$0 \leq n \leq 255$	$n=0$
ESC G	Turn double-strike mode on/off	Character		0	$0 \leq n \leq 255$	$n=0$
ESC J	Print and feed paper	Print	0		$0 \leq n \leq 255$	—
ESC K	Print and reverse feed	Print	0		$0 \leq n \leq 48$	—
ESC M	Select character font	Character		0	$n=0, 1, 48, 49$	$n=1$
ESC R	Select an international character set	Character		0	$0 \leq n \leq 10$	$n=0$
ESC U	Turn unidirectional printing mode on/off	Mechanism control		0	$0 \leq n \leq 255$	$n=0$



Command	Name	Function Type	Classification		Range	Default
			Executing Cmds	Setting Cmds		
ESC \	Set relative print position	Print position	0		$0 \leq nL \leq 255$ $0 \leq nH \leq 255$	—
ESC a	Select justification	Print position		0	$0 \leq n \leq 2,$ $48 \leq n \leq 50$	$n=0$
ESC c 0	Select paper type(s) for printing	Printing paper	0	0	$1 \leq n \leq 3$ $8 \leq n \leq 11$	$n=1$
ESC c 1	Select paper type(s) for command settings	Printing paper		0	$1 \leq n \leq 3$ $8 \leq n \leq 11$	$n=11$
ESC c 3	Select paper sensor(s) to output paper-end signals	Paper sensor		0	$0 \leq n \leq 255$	$n=15$
ESC c 4	Select paper sensor(s) to stop printing	Paper sensor		0	$0 \leq n \leq 255$	$n=12$
ESC c 5	Enable/disable panel buttons	Panel button		0	$0 \leq n \leq 255$	$n=0$
ESC d	Print and feed n lines	Print	0		$0 \leq n \leq 255$	—
ESC e	Print and reverse feed n lines	Print	0		$0 \leq n \leq 255$	—
ESC f	Set cut sheet wait time	Printing paper		0	$0 \leq t1 \leq 15$ $0 \leq t2 \leq 64$	$t1=0$ $t2=10$



Command	Name	Function Type	Classification		Range	Default
			Executing Cmds	Setting Cmds		
ESC p	Generate pulse	Miscellaneous function	0		$m=0, 1, 48, 49$ $0 \leq t1 \leq 255$ $0 \leq t2 \leq 255$	—
ESC q	Paper release	Mechanism control	0		—	—
ESC t	Select character code table	Character		0	$n=254, 255$ $0 \leq n \leq 5$	$n=0$
ESC {	Turn upside-down printing mode on/off	Character		0	$0 \leq n \leq 255$	$n=0$
GS !	Select character size	Character		0	$n=0, 1, 16, 17$	$n=0$
GS I	Transmit printer ID	Miscellaneous function	0		$1 \leq n \leq 3,$ $49 \leq n \leq 51$	—
GS L	Set left margin	Print position		0	$0 \leq nL \leq 255$ $0 \leq nH \leq 255$	$nL=0$ $nH=0$
GS V	Select cut mode and cut paper	Mechanism control	0		$n=65, 66$ $0 \leq n \leq 255$	—



Command	Name	Function Type	Classification		Range	Default
			Executing Cmds	Setting Cmds		
GS W	Set printing area width	Print position		○	$0 \leq nL \leq 255$ $0 \leq nH \leq 255$	$nL=144$ $nH=1$
GS a	Enable/disable Automatic Status Back (ASB)	Status	○	○	$0 \leq n \leq 255$	$n=0$ or $n=2$
GS r	Transmit status	Status	○		$1 \leq n \leq 3,$ $49 \leq n \leq 51$	—



FEATURES

The TM-U300C/D printers are designed to provide high performance at a low cost. They are compact, lightweight, and high quality printers for ECR and POS and can print on paper roll and validation paper. They have the following features:

- High-speed printing using logic seeking
- High-reliability and long life due to the use of stepping motors for both carriage return and paper feeding
- Various formats because the paper feeding pitch is selectable
- Command protocol based on the ESC/POS standard
- Internal drawer interface that allows 2 drawers to be driven
- Selectable character font (7 × 9 or 9 × 9)
- Compact and lightweight
- Semi-automatic paper loading
- Compact AC adapter power supply
- 1 line validation printing
- Selectable black or red printing (TM-U300D)
- Roll paper take-up device (TM-U300C)



SPECIFICATIONS

■ Printing specifications

Printing method:	Serial impact dot matrix
Head wire configuration:	9-pin serial configuration
Printing direction:	Bi-directional printing (logic seeking)
Printing speed:	Approximately 3.5 lines/second (40 column, 16 cpi) Approximately 5.8 lines/second (20 column, 16 cpi)

- NOTE:
1. During heavy use, printing is stopped to protect the print head. In this case, the actual printing speed may be slower than that listed above.
 2. Because switching operations are required for red printing and black/red printing, their printing speeds are slower than the black printing speed.

■ Character specifications

Character sets:	ASCII: 95 characters International: 32 characters Extended graphics: 128 characters × 6 pages
Character fonts:	7 × 9 / 9 × 9
Printing dots:	Number of dots in horizontal direction: 400 half-dots
Characters per line:	40/33
Character size:	ASCII and International: 1.24 × 3.1 mm (W × H)/1.56 × 3.1 mm (W × H) Extended graphics: 1.59 × 3.1 mm (W × H)/1.91 × 3.1 mm (W × H)



■ Paper specifications

Paper size:

Roll paper Paper width: 76 ± 0.5 mm (2.99 ± .02 in.)
 Maximum diameter: 83 mm (3.27 in.) (when 2-ply or 3-ply paper is used)
 For single-ply paper, the maximum diameter must be 60 mm (2.36 in.)

Paper roll inside dia.: 10.5 to 12.5 mm (.41 to .49 in.)

Normal paper:

Paper thickness 0.06 to 0.085 mm (.002 to .003 in.)
 (single-ply):
 Weight: 52.3 to 64 g/m² (13.9 to 17.0 lb)
 (45 to 55 Kg (20.41 to 24.94 lb)/1000 sheets
 1091 × 788 mm (42.95 × 31.02 in.))

Pressure sensitive paper

Maximum 1 original + 2 copies

Validation paper:

Type: Normal paper, pressure sensitive paper, carbon copy paper
 Width: 135 to 210 mm (5.32 to 8.27 in.)
 Length: 70 to 297 mm (2.76 to 11.69 in.)
 Thickness: 0.07 to 0.14 mm (.003 to .006 in.)
 Total thickness including roll paper:
 0.2 mm (.008 in.) or less

■ Receive Buffer

Serial interface: 1K or 40 bytes (selectable by DIP switch)

Parallel interface: 1K or 0 bytes (selectable by DIP switch)



Panel buttons:

FEED:

Feed paper (this button also can be used for the self test printing).

Panel LEDs:

POWER (green):

Off when the printer is off.

On when the printer is on.

PAPER (red):

Off when paper roll is adequate.

On when paper roll is near-end.

Blinks when the printer detects an error; the printer is in the test printing standby state; insertion or removal of validation paper is required; or printing stops because the printer exceeded the allowable print duty cycle.

Interface:

Serial

Parallel (Centronics compatible)



DIP SWITCH FUNCTIONS

Serial Interface (TM-U300C/D)

DIP switch 1

SW	Function	ON	OFF
1-1	Data receive error	Ignored	Convert data to "?"
1-2	Receive buffer capacity	40 bytes	1K bytes
1-3	Handshaking	XON/XOFF	DTR/DSR
1-4	Data word length	7 bits	8 bits
1-5	Parity check	Enabled	Disabled
1-6	Parity selection	Even	Odd
1-7	Transmission speed	Do not change the settings except when adjusting a print head duty control	
1-8			
1-9	Internal use		
1-10			

Transmission speed

Transmission speed bits per second (BPS)	SW 1-7	SW 1-8
1200	ON	ON
2400	OFF	ON
4800	ON	OFF
9600	OFF	OFF



Parallel Interface (TM-U300C/D)

DIP switch 1

SW	Function	ON	OFF
1-1	Auto line feed	Always enabled	Depends on AUTO FEED
1-2	Receive buffer capacity	0 bytes	1K bytes
1-3~1-8	Internal use (Do not change settings)* *DIP SW 1-3 Fixed Off DIP SW 1-4 Fixed On DIP SW 1-5 Fixed On DIP SW 1-6 Fixed Off	—	—



ERRORS

- Unrecoverable errors:
 - Home position detection error
 - Auto-cutting position error



OPTIONS

- Validation sensor (factory option).



SELF TEST FOR THE TM-U300C/D

The self test lets you know if your printer is operating properly. It checks the control circuits, printer mechanisms, print quality, ROM version, and DIP switch setting. This test is independent of any other equipment or software.

Running the self test

1. Make sure the printer is turned off and the printer covers are closed properly.
2. While holding down the FEED button, turn on the printer using the power switch to begin the self test. The self test prints the printer settings and then prints the following and pauses. (The PAPER light blinks.)

Self test printing.

Please press the Paper feed button.

3. Press the FEED button to continue printing. The printer prints a pattern using the resident characters.
4. The self test automatically ends and cuts the paper after printing the following:

completed

The printer is ready to receive data as soon as it completes the self test.



TM-U300C/D SUPPORTED COMMANDS

Command	Name	Function Type	Classification		Range	Default
			Executing Cmds	Setting Cmds		
HT	Horizontal tab	Print position	○		—	—
LF	Print and line feed	Print	○		—	—
CR	Print and carriage return	Print	○		—	—
ESC SP	Set right-side character spacing	Character		○	$0 \leq n \leq 32$	$n=0$
ESC !	Select print mode(s)	Character		○	$0 \leq n \leq 255$	$n=1$
ESC %	Select/cancel user-defined character set	Character		○	$0 \leq n \leq 255$	$n=0$
ESC &	Define user-defined characters	Character		○	$y=2$ $32 \leq c1 \leq c2 \leq 126$ $0 \leq x \leq 12$ (9 × 9 font) $0 \leq x \leq 10$ (7 × 9 font) $0 \leq d \leq 255$ $k=c2-c1+1$	—



Command	Name	Function Type	Classification		Range	Default
			Executing Cmds	Setting Cmds		
ESC *	Select bit-image mode	Bit image	0		$m=0, 1$ $0 \leq nL \leq 255$ $0 \leq nH \leq 3$ $0 \leq d \leq 255$	—
ESC -	Turn underline mode on/off	Character		0	$0 \leq n \leq 1$	$n=0$
ESC 2	Select default line spacing	Line spacing		0	—	—
ESC 3	Set line spacing	Line spacing		0	$0 \leq n \leq 255$	$n=24$
ESC <	Return home	Mechanism control	0		—	—
ESC @	Initialize printer	Miscellaneous function	0	0	—	—
ESC D	Set horizontal tab positions	Print position		0	$1 \leq n \leq 255$ $0 \leq k \leq 32$	$n=8, 16, 24, 32...$ (every eight characters for 7×9 font)
ESC J	Print and feed paper	Print	0		$0 \leq n \leq 255$	—
ESC K	Print and reverse feed	Print	0		$0 \leq n \leq 48$	—
ESC R	Select an international character set	Character		0	$0 \leq n \leq 10$	$n=0$



Command	Name	Function Type	Classification		Range	Default
			Executing Cmds	Setting Cmds		
ESC U	Turn unidirectional printing mode on/off	Mechanism control		0	$0 \leq n \leq 255$	$n=0$
ESC c 0	Select paper type(s) for printing	Printing paper	0	0	$n=1, 8, 9$	$n=1$
ESC c 3	Select paper sensor(s) to output paper-end signals	Paper sensor		0	$0 \leq n \leq 255$	$n=3$
ESC c 4	Select paper sensor(s) to stop printing	Paper sensor		0	$0 \leq n \leq 255$	$n=0$
ESC c 5	Enable/disable panel buttons	Panel button		0	$0 \leq n \leq 255$	$n=0$
ESC d	Print and feed n lines	Print	0		$0 \leq n \leq 255$	—
ESC e	Print and reverse feed n lines	Print	0		$0 \leq n \leq 2$	—
ESC f	Set cut sheet wait time	Printing paper		0	$0 \leq t1 \leq 15$ $0 \leq t2 \leq 64$	$t1=0$ $t2=10$
ESC p	Generate pulse	Miscellaneous function	0		$0 \leq m \leq 1$ $0 \leq t1 \leq t2 \leq 255$	—
ESC r	Select print color	Character		0	$n=0, 1$	$n=0$
ESC t	Select character code table	Character		0	$n=255$ $0 \leq n \leq 5$	$n=0$



Command	Name	Function Type	Classification		Range	Default
			Executing Cmds	Setting Cmds		
ESC u	Transmit peripheral device status	Status	0		$n=0$	—
ESC v	Transmit paper sensor status	Status	0		—	—
ESC {	Turn upside-down printing mode on/off	Character		0	$0 \leq n \leq 255$	$n=0$
GS E	Select head control method	Miscellaneous function		0	$0 \leq n \leq 255$	$n=1$



COMMANDS IN ALPHANUMERIC ORDER

In this table, click any name to see the command description with program examples and print samples.

The print samples are images of the printing results of the program examples; they do not represent actual printing.

Command	Name	Function Type
HT	Horizontal tab	Print position
LF	Print and line feed	Print
FF	① Print and eject cut sheet (in standard mode) ② Print and return to standard mode (in page mode)	Print
CR	Print and carriage return	Print
CAN	Cancel print data in page mode	Character
DLE EOT	Real-time status transmission	Status
DLE ENQ	Real-time request to printer	Miscellaneous function
ESC FF	Print data in page mode	Print
ESC SP	Set right-side character spacing	Character
ESC !	Select print mode(s)	Character
ESC \$	Set absolute print position	Print position
ESC %	Select/cancel user-defined character set	Character
ESC &	Define user-defined characters	Character
ESC *	Select bit-image mode	Bit image



Command	Name	Function Type
ESC –	Turn underline mode on/off	Character
ESC 2	Select default line spacing	Line spacing
ESC 3	Set line spacing	Line spacing
ESC <	Return home	Mechanism control
ESC =	Select peripheral device	Miscellaneous function
ESC ?	Cancel user-defined characters	Character
ESC @	Initialize printer	Miscellaneous function
ESC C	Set cut sheet eject length	Line spacing
ESC D	Set horizontal tab positions	Print position
ESC E	Turn emphasized mode on/off	Character
ESC F	Set/cancel cut sheet reverse eject	Mechanism control
ESC G	Turn double-strike mode on/off	Character
ESC J	Print and feed paper	Print
ESC K	Print and reverse feed	Print
ESC L	Select page mode	Miscellaneous function
ESC M	Select character font	Character
ESC R	Select an international character set	Character
ESC S	Select standard mode	Miscellaneous function
ESC T	Select print direction in page mode	Print position



Command	Name	Function Type
ESC U	Turn unidirectional printing mode on/off	Mechanism control
ESC V	Turn 90° clockwise rotation mode on/off	Character
ESC W	Set printing area in page mode	Print position
ESC \	Set relative print position	Print position
ESC a	Select justification	Print position
ESC c 0	Select paper type(s) for printing	Printing paper
ESC c 1	Select paper type(s) for command settings	Printing paper
ESC c 3	Select paper sensor(s) to output paper-end signals	Paper sensor
ESC c 4	Select paper sensor(s) to stop printing	Paper sensor
ESC c 5	Enable/disable panel buttons	Panel button
ESC d	Print and feed <i>n</i> lines	Print
ESC e	Print and reverse feed <i>n</i> lines	Print
ESC f	Set cut sheet wait time	Printing paper
ESC i	Partial cut (one point left uncut)	Mechanism control
ESC m	Partial cut (three points left uncut)	Mechanism control
ESC o	Stamp	Mechanism control
ESC p	Generate pulse	Miscellaneous function
ESC q	Paper release	Mechanism control
ESC r	Select print color	Character



Command	Name	Function Type
ESC t	Select character code table	Character
ESC u	Transmit peripheral device status	Status
ESC v	Transmit paper sensor status	Status
ESC {	Turn upside-down printing mode on/off	Character
GS ENQ	Transmit real-time printer status	Status
GS !	Select character size	Character
GS \$	Set absolute vertical print position in page mode	Print position
GS *	Define downloaded bit image	Bit image
GS /	Print downloaded bit image	Bit image
GS :	Start/end macro definition	Macro function
GS B	Turn white/black reverse printing mode on/off	Character
GS E	Select head control method	Miscellaneous function
GS H	Select printing position of HRI characters	Bar code
GS I	Transmit printer ID	Miscellaneous function
GS L	Set left margin	Print position
GS P	Set horizontal and vertical motion units	Miscellaneous function
GS V	Select cut mode and cut paper	Mechanism control
GS W	Set printing area width	Print position
GS \	Set relative vertical print position in page mode	Print position



Command	Name	Function Type
GS ^	Execute macro	Macro function
GS a	Enable/disable Automatic Status Back (ASB)	Status
GS b	Turn smoothing mode on/off	Character
GS f	Select font for HRI characters	Bar code
GS h	Set bar code height	Bar code
GS k	Print bar code	Bar code
GS r	Transmit status	Status
GS w	Set bar code width	Bar code

The following commands are supported only by the printers with the optional Magnetic Ink Character Recognition (MICR) reader. (The MICR reader is a factory-installed option.)

Command	Name	Function Type
DLE EOT BS	Real-time MICR status transmission	MICR
FS a 0	Read check paper	MICR
FS a 1	Load check paper to print starting position	MICR
FS a 2	Eject check paper	MICR
FS b	Request retransmission of check paper reading result	MICR
FS c	MICR mechanism cleaning	MICR



COMMANDS ARRANGED BY FUNCTION

The print samples are images of the printing results of the program examples; they do not represent actual printing.

In this table, click any item to see the command description with program examples and print samples. You can also use the bookmarks on the left side of the screen.

Print

Bit-image

Line spacing

Status

Character

Bar code

Printing paper

Macro function

Panel button

Mechanism control

Paper sensor

MICR

Print position

Miscellaneous function



USING BIT VALUE TABLES

For each command that has a complex method of determining the variable *n*, there is a table showing how to calculate the variable in three numbering systems: binary, hexadecimal, and decimal.

When you look at the table, first find the value of each component of the variable. Then add the values of the components together to determine the value of the variable *n*.

For example, here is how you would use the table below, which selects the print mode, to combine double-height, double-width, and underline. In the table, you see that bit 4 on (or hex 10 or decimal 16) turns on double-height, bit 5 on (or hex 20 or decimal 32) turns on double-width, and bit 7 on (or hex 80 or decimal 128) turns on underline mode.

To combine all three, turn on bits 4, 5, and 7, which is 10110000 in binary. Or you can add the hex values 10, 20, and 80 for the hex sum of B0, or you can add the decimal values 16, 32, and 128 for the decimal value of 176.

Therefore, you send the following to turn on double-height, double-width, and underline, depending on the numbering system used:

ASCII	ESC	!	<i>n</i>
Hex	1B	21	B0
Decimal	28	33	176



Bit	Off/On	Hex	Decimal	Function
0	Off	00	0	Character font A selected.
	On	01	1	Character font B selected.
1, 2	—	—	—	Undefined.
3	Off	00	0	Emphasized mode not selected.
	On	08	8	Emphasized mode selected.
4	Off	00	0	Double-height mode not selected.
	On	10	16	Double-height mode selected.
5	Off	00	0	Double-width mode not selected.
	On	20	32	Double-width mode selected.
6	—	—	—	Undefined.
7	Off	00	0	Underline mode not selected.
	On	80	128	Underline mode selected.

Note that the program examples throughout this chapter use decimal numbers, but binary, decimal, and hexadecimal numbers all have the same printing results.



PRINT COMMANDS

Command	Name
----------------	-------------

LF	Print and line feed
CR	Print and carriage return
ESC J n	Print and feed paper
ESC K n	Print and reverse feed
ESC d n	Print and feed <i>n</i> lines
ESC e n	Print and reverse feed <i>n</i> lines
FF	① Print and eject cut sheet (in standard mode) ② Print and return to standard mode (in page mode)
ESC FF	Print data in page mode



LF

[Name] Print and line feed

[Format] ASCII LF

Hex 0A

Decimal 10

[Range] None

[Default] None

[Printers not featuring this command] None

[Description] Prints the data in the print buffer and feeds one line.

- [Notes]
- The amount of paper fed per line is based on the value set using the line spacing command (**ESC 2** or **ESC 3**).
 - After printing, the printing position moves the beginning of the line. When a left margin is set in standard mode, the position of the left margin is the beginning of the line.
 - When this command is processed in page mode, only the printing position moves and the printer does not perform actual printing.

[Model-dependent variations] None

Program Example for all printers

```
PRINT #1, "AAAAA"; CHR$(&HA);  
PRINT #1, "BBBBB"; CHR$(&HA);
```

Print Sample

```
AAAAA  
BBBBB
```



CR

[Name] Print and carriage return
 [Format] ASCII CR
 Hex 0D
 Decimal 13
 [Range] None
 [Default] None
 [Printers not featuring this command] None
 [Description]

Print head	When auto line feed is enabled	When auto line feed is disabled
Line thermal	Executes printing and one line feed as LF	This command is ignored
Serial dot head	Executes printing and one line feed as LF	Prints data in print buffer and does not feed the paper



[Notes]

- With a serial interface, auto line feed is disabled.
- With a parallel interface, whether enabling or disabling the auto line feed can be selected by the DIP switch (Auto line feed).
- After printing, the printing position moves to the beginning of the line. When a left margin is set in standard mode, the position of the left margin is the beginning of the line.
- When this command is processed in page mode, only the printing position moves and the printer does not perform actual printing.

[Model-dependent variations]

TM-H5000

TM-U375

TM-U925

TM-U325D

TM-U300C/D

Program Example (Line thermal)

```
PRINT #1, "AAAAA";CHR$(&HD);  
PRINT #1, "      BBBBB";CHR$(&HA);
```

Print Sample (Line thermal)

```
AAAAA      ←Auto line feed enabled  
          BBBBB  
AAAAA      BBBBB ←Auto line feed disabled
```

Program Example (Serial dot head)

```
PRINT #1, "AAAAA";CHR$(&HD);  
PRINT #1, "      BBBBB";CHR$(&HA);
```

Print Sample (Serial dot head)

```
AAAAA  
      BBBBB ←Auto line feed enabled  
AAAAABBBBB ←Auto line feed disabled
```



TM-H5000

Auto line feed for a parallel interface is selected by DIP switch 1-1.

CR functions in a different way depending on the print sheet. The line thermal head is used for printing on a paper roll. The serial dot head is used for printing on a slip.

Print sheet	When auto line feed is enabled	When auto line feed is disabled
Paper roll	Executes printing and one line feed as LF	This command is ignored
Slip	Executes printing and one line feed as LF	Prints the data in the print buffer and does not feed the paper



TM-U375

Auto line feed for a parallel interface is selected by DIP switch 1-1.

These printers have only a serial dot head.



TM-U925

These printers have only a serial dot head.



TM-U325D

This printer has only a serial dot head. Auto line feed for a parallel interface is selected by DIP switch 1-1.



TM-U300C/D

This printer has only a serial dot head. Auto line feed for a parallel interface is selected by DIP switch 1-1.



ESC J *n*

[Name] Print and feed paper

[Format] ASCII ESC J *n*
 Hex 1B 4A *n*
 Decimal 27 74 *n*

[Range] $0 \leq n \leq 255$

[Default] None

[Printers not featuring this command] None

[Description] Prints the data in the print buffer and feeds the paper *n* × (vertical or horizontal motion unit).

- [Notes]
- The maximum paper feed amount is 40 inches. If the specified amount exceeds 40 inches, the paper feed amount is automatically set to 40 inches.
 - When standard mode is selected, the vertical motion unit is used.
 - When page mode is selected, the vertical or horizontal motion unit is used for the print direction set by **ESC T**.
 - When the starting position is set to the upper left or lower right of the printing area using **ESC T**, the vertical motion unit is used.
 - When the starting position is set to the upper right or lower left of the printing area using **ESC T**, the horizontal motion unit is used.
 - After printing, the printing position moves to the beginning of the line. When a left margin is set in standard mode, the position of the left margin



- When this command is processed in page mode, only the printing position moves and the printer does not perform actual printing.
- This command is used to temporarily feed a specific length without changing the line spacing set by other commands.

[Model-dependent variations]

TM-H5000

TM-U375

TM-U925

TM-U325D

TM-U300C/D

Program Example for all printers

```
PRINT #1, CHR$(&H1D); "P"; CHR$(180); CHR$(180);
PRINT #1, "AAAAA"; CHR$(&HA);
PRINT #1, "BBBBB"; CHR$(&H1B); "J"; CHR$(100);
PRINT #1, "CCCCC"; CHR$(&HA);
PRINT #1, "DDDDD"; CHR$(&HA);
```

Print Sample

```
AAAAA
BBBBB
      |
      | ESC J used to print one line and advance
      | the paper by 100/180 inch
      v
CCCCC
DDDDD
```



TM-H5000

The vertical or horizontal motion unit is specified by **GS P**.



TM-U375

The vertical or horizontal motion unit is specified by **GS P**.



TM-U925

The vertical motion unit is specified by **GS P**.

This command does not use the horizontal motion unit because the printer does not support Page mode.



TM-U325D

The vertical motion unit is 1/144 inches (the minimum movement amount). This value equals a half dot pitch. This command does not use the horizontal motion unit because the printer does not support Page mode.



TM-U300C/D

The vertical motion unit is 1/144 inches (the minimum movement amount). This value equals a half dot pitch. This command does not use the horizontal motion unit because the printer does not support Page mode.

When only validation paper is selected as the print sheet by **ESC c 0**, the printer only prints the data and does not feed the paper.



ESC K *n*

[Name] Print and reverse feed

[Format] ASCII ESC K *n*
 Hex 1B 4B *n*
 Decimal 27 75 *n*

[Range] $0 \leq n \leq 255$

TM-H5000 $0 \leq n \leq 255$

TM-U925 $0 \leq n \leq 255$

TM-U325D $0 \leq n \leq 48$

TM-U300C/D $0 \leq n \leq 48$

[Default] None

[Printers not featuring this command] **TM-U375**, **TM-U300C**

[Description] Prints the data in the print buffer and feeds the paper $n \times$ (vertical motion unit) in the reverse direction.

- [Notes]
- The maximum paper feed amount depends on the printer model.
 - After printing, the printing position moves to the beginning of the line. When a left margin is set, the position of the left margin is the beginning of the line.
 - This command is used to temporarily feed a specific length without changing the line spacing set by other commands.

[Model-dependent variations] **TM-H5000** **TM-U925**
TM-U325D **TM-U300C/D**



Program Example for all printers

```
PRINT #1, CHR$(&H1D);"P";CHR$(180);CHR$(180);  
PRINT #1, "AAAAA"; CHR$(&HA);  
PRINT #1, "BBBBB"; CHR$(&H1B);"K";CHR$(30);  
PRINT #1, "      CCCCC"; CHR$(&HA);
```

Print Sample

AAAAACCCCC
BBBBB



ESC K used to print one line and then reverse
feed the paper by
30/180 inch



TM-H5000

This command is ignored when the paper roll is selected as the print sheet by **ESC c 0**. The vertical motion unit is specified by **GS P**. In the reverse direction, the maximum paper feed amount is 40 inches. If the specified amount exceeds 40 inches, the paper feed amount is automatically set to 40 inches.



TM-U925

This command must not be executed continuously more than two times. The vertical motion unit is specified by **GS P**. In the reverse direction, the maximum paper feed amount is 1/6 inch. If the specified amount exceeds 1/6 inch, the printer prints the data and does not feed the paper.



TM-U325D

This command must not be executed continuously more than two times and must not be used when validation paper is selected. The vertical motion unit is $1/144$ inches (the minimum movement amount). This value equals a half dot pitch. In the reverse direction, the maximum paper feed amount is $48/144$ inches. If the specified amount exceeds $48/144$ inches, the printer only prints the data and does not feed the paper.



TM-U300C/D

This command must not be executed continuously more than two times and must not be used with the TM-U300C. The vertical motion unit is $1/144$ inches (the minimum movement amount). This value equals a half dot pitch. In the reverse direction, the maximum paper feed amount is $48/144$ inches. If the specified amount exceeds $48/144$ inches, the printer only prints the data and does not feed the paper.



ESC d *n*

[Name] Print and feed *n* lines

[Format]

ASCII	ESC	d	<i>n</i>
Hex	1B	64	<i>n</i>
Decimal	27	100	<i>n</i>

[Range] $0 \leq n \leq 255$

[Default] None

[Printers not featuring this command] None

[Description] Prints the data in the print buffer and feeds *n* lines.

- [Notes]
- The amount of paper fed per line is based on the value set using the line spacing command (**ESC 2** or **ESC 3**).
 - The maximum paper feed amount is 40 inches. If the specified amount exceeds 40 inches, the paper feed amount is automatically set to 40 inches.
 - After printing, the printing position moves to the beginning of the line. When a left margin is set in standard mode, the position of the left margin is the beginning of the line.
 - When this command is processed in page mode, only the printing position moves and the printer does not perform actual printing.
 - This command is used to temporarily feed a specific line without changing the line spacing set by other commands.

[Model-dependent variations] **TM-U300C/D**



Program Example for all printers

```
PRINT #1, "AAAAA"; CHR$(&HA);  
PRINT #1, "BBBBB"; CHR$(&H1B);"d";CHR$(6);  
PRINT #1, "CCCCC"; CHR$(&HA);
```

Print Sample

AAAAA
BBBBB

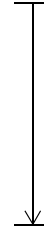

ESC d used to print one line and advance the paper by six lines

CCCCC



TM-U300C/D

When only validation paper is selected as the print sheet by **ESC c 0**, the printer only prints the data and does not feed the paper.



ESC e n

[Name] Print and reverse feed *n* lines

[Format] ASCII ESC e n
 Hex 1B 65 n
 Decimal 27 101 n

[Range] **TM-H5000** : $0 \leq n \leq 255$
TM-U925 : $0 \leq n \leq 255$
TM-U325D : $0 \leq n \leq 2$
TM-U300C/D : $0 \leq n \leq 2$

[Default] None

[Printers not featuring this command] **TM-U375, TM-U300C**

[Description] Prints the data in the print buffer and feeds *n* lines in the reverse direction.

- [Notes]
- The amount of paper fed per line is based on the value set using the line spacing command (**ESC 2** or **ESC 3**).
 - The maximum paper feed amount depends on the printer model.
 - After printing, the printing position moves to the beginning of the line. When a left margin is set, the position of the left margin is the beginning of the line.
 - This command is used to temporarily feed a specific line without changing the line spacing set by other commands.

[Model-dependent variations] **TM-H5000** **TM-U925**
TM-U325D **TM-U300C/D**



Program Example for all printers

```
PRINT #1, "AAAAA"; CHR$(&HA);  
PRINT #1, "BBBBB"; CHR$(&H1B);"e";CHR$(1);  
PRINT #1, "      CCCCC"; CHR$(&HA);
```

Print Sample

```
AAAAACCCCC  
BBBBB
```

┌
└ Paper reverse fed one line after printing the
line of Bs



TM-H5000

This command is ignored when the paper roll is selected as the print sheet by **ESC c 0**. The maximum reverse paper feed amount is 40 inches. If the specified amount exceeds 40 inches, the paper feed amount is automatically set to 40 inches.



TM-U925

This command must not be executed continuously more than two times. In the reverse direction, the maximum paper feed amount is 1/6 inch. If the specified amount exceeds 1/6 inch, the printer prints the data and does not feed the paper.



TM-U325D

This command must not be executed continuously more than two times and must not be used when validation paper is selected. In the reverse direction, the maximum paper feed amount is 48/144 inches. If the specified amount exceeds 48/144 inches, the printer only prints the data and does not feed the paper.



TM-U300C/D

This command must not be executed continuously more than two times and must not be used with the TM-U300C. In the reverse direction, the maximum paper feed amount is 48/144 inches. If the specified amount exceeds 48/144 inches, the printer only prints the data and does not feed the paper.



FF

[Name] ① Print and eject cut sheet (in standard mode)

[Format] ASCII FF
Hex 0C
Decimal 12

[Range] None

[Default] None

[Printers not featuring this command] **TM-U300C/D**

[Description] In standard mode, prints the data in the print buffer and ejects the cut sheet (slip paper or validation paper).

- [Notes]
- This command is enabled only when the cut sheet is selected as the print sheet by **ESC c 0**.
 - This command is enabled only in standard mode.
 - The amount of paper fed is based on the value set using **ESC C**.
 - The cut sheet is ejected in the direction specified by **ESC F**.
 - After the cut sheet is ejected, the printer selects the paper roll as the print sheet and the printing position moves to the beginning of the line. When a left margin is set, the position of the left margin is the beginning of the line.

[Model-dependent variations] None



Program Example for all printers

```
PRINT #1, CHR$(&H1B);"c0";CHR$(4); ← select print sheet  
PRINT #1, "AAAAA"; CHR$(&HA);  
PRINT #1, "BBBBB"; CHR$(&HC);
```

Print Sample

AAAAA
BBBBB

Slip paper ejected



FF

[Name] ② Print and return to standard mode (in page mode)

[Format] ASCII FF
 Hex 0C
 Decimal 12

[Default] None

[Range] None

[Printers not featuring this command] **TM-U925, TM-U325D, TM-U300C/D**

[Description] In page mode, prints the data in the print buffer collectively and returns to standard mode.

- [Notes] ■ This command is enabled only in page mode.
 ■ The data is deleted in the printing area after being printed.
 ■ This command returns the values set by **ESC W** to the default values.
 ■ The value set by **ESC T** is maintained.
 ■ After printing, the printing position moves to the beginning of the line. When a left margin is set, the position of the left margin is the beginning of the line.

[Model-dependent variations] None



Program Example for all printers

```
PRINT #1, CHR$(&H1B);"L"; ←Select page mode
PRINT #1, CHR$(&H1D);"P";CHR$(180);CHR$(180);
PRINT #1, CHR$(&H1B);"W";CHR$(0);CHR$(0);CHR$(0);
CHR$(0);CHR$(60);CHR$(0);CHR$(90);CHR$(0);
PRINT #1, CHR$(&H1B);"T";CHR$(0);
PRINT #1, "AAAAA"; CHR$(&HA); ←Store characters for printing
PRINT #1, "BBBBB"; CHR$(&HA); ←Store characters for printing
PRINT #1, "CCCCC"; CHR$(&HC); ←Batch print
```

Print Sample

```
AAAAA
BBBBB
CCCCC
```



ESC FF

[Name] Print data in page mode

[Format] ASCII ESC FF
 Hex 1B 0C
 Decimal 27 12

[Range] None

[Default] None

[Printers not featuring this command] **TM-U375, TM-U925, TM-U325D, TM-U300C/D**

[Description] In page mode, prints all buffered data in the printable area collectively.

- [Notes]
- This command is enabled only in page mode.
 - After printing, the printer does not clear the buffered data, the printing position, or values set by other commands.
 - The printer returns to standard mode with **FF**, **ESC S**, and **ESC @**. When it returns to standard mode by **ESC @**, all settings are canceled.
 - This command is used when the data in page mode is printed repeatedly.

[Model-dependent variations] None



Program Example for all printers

```
PRINT #1, CHR$(&H1B);"L"; ← Select page mode
PRINT #1, CHR$(&H1D);"P";CHR$(180);CHR$(180);
PRINT #1, CHR$(&H1B);"W";CHR$(0);CHR$(0);CHR$(0);
CHR$(0);CHR$(120);CHR$(0);CHR$(170);CHR$(0);
PRINT #1, CHR$(&H1B);"T";CHR$(0); ← Select print direction
PRINT #1, "AAAAA"; CHR$(&HA); ← Store characters for printing
PRINT #1, "BBBBB"; CHR$(&HA); ← Store characters for printing
PRINT #1, "CCCCC"; CHR$(&H1B);CHR$(&HC); ← Batch print
PRINT #1, CHR$(&HC); ← Batch print and return to standard mode
```

Print Sample

```
AAAAA
BBBBB
CCCCC
```

```
AAAAA
BBBBB
CCCCC
```



LINE SPACING COMMANDS

Command	Name
----------------	-------------

ESC 2	Select default line spacing
ESC 3 n	Set line spacing
ESC C n	Set cut sheet eject length



ESC 2

[Name] Select default line spacing

[Format] ASCII ESC 2
Hex 1B 32
Decimal 27 50

[Range] None

[Default] None

[Printers not featuring this command] None

[Description] Sets the line spacing to 1/6 inch.

- [Notes]
- This command is available for the paper type selected by **ESC c 1**. The line spacing can be set independently for paper roll, slip, and validation paper.
 - The line spacing can be set independently in standard mode and in page mode.

[Model-dependent variations] **TM-H5000** **TM-U375** **TM-U925**
TM-U325D **TM-U300C/D**

See program example for **ESC 2** and **ESC 3 n**.



TM-H5000

1/6 inch is equivalent to 30 dots for the paper roll and 12 dots for the slip.



TM-U375

1/6 inch is equivalent to 12 dots.



TM-U925

1/6 inch is equivalent to 12 dots.



TM-U325D

1/6 inch is equivalent to 12 dots.



TM-U300C/D

1/6 inch is equivalent to 12 dots.



ESC 3 *n*

[Name]	Set line spacing			
[Format]	ASCII	ESC	3	<i>n</i>
	Hex	1B	33	<i>n</i>
	Decimal	27	51	<i>n</i>
[Range]	$0 \leq n \leq 255$			
[Default]	1/6 inch or equivalent			

TM-H5000: For the paper roll: *n* = 60

For the slip paper: *n* = 24

TM-U375, TM-U925, TM-U325D, TM-U300C/D: *n* = 24

[Printers not featuring this command] None

[Description] Sets the line spacing to $n \times$ (vertical or horizontal motion unit).

- [Notes]
- When standard mode is selected, the vertical motion unit is used.
 - When page mode is selected, the vertical or horizontal motion unit is used for the print direction set by **ESC T**.
 - When the starting position is set to the upper left or lower right of the printing area using **ESC T**, the vertical motion unit is used.
 - When the starting position is set to the upper right or lower left of the printing area using **ESC T**, the horizontal motion unit is used.
 - This command is available for the paper type selected by **ESC c 1**. The line spacing can be set independently for paper roll, slip, and validation paper.
 - The line spacing can be set independently in standard mode and in page mode.

[Model-dependent variations] **TM-H5000** **TM-U375** **TM-U925**
 TM-U325D **TM-U300C/D**

See program example for **ESC 2** and **ESC 3 *n***.



Program example for ESC 2 and ESC 3 n

Program Example

```
PRINT #1, CHR$(&H1B);"c0";CHR$(1); ←Select print sheet
PRINT #1, CHR$(&H1B);"c1";CHR$(1); ←Select setting sheet
PRINT #1, CHR$(&H1D);"P";CHR$(180);CHR$(180);
FOR n=25 TO 50 STEP 5
  PRINT #1, CHR$(&H1B);"3";CHR$(n); ← Set line spacing
  PRINT #1, "AAAAA"; CHR$(&HA);
NEXT n
PRINT #1, CHR$(&H1B);"2"; ← Set the default
PRINT #1, "BBBBB"; CHR$(&HA);
PRINT #1, "CCCCC"; CHR$(&HA);
```

Print Sample

```
AAAAA
AAAAA ↓ 25/180-inch line spacing
AAAAA ↓ 30/180-inch line spacing
AAAAA ↓ 35/180-inch line spacing
AAAAA ↓ 40/180-inch line spacing
AAAAA ↓ 45/180-inch line spacing
AAAAA ↓ 50/180-inch line spacing
BBBBB ↓
CCCCC ↓ 1/6-inch line spacing
```



TM-H5000

The vertical or horizontal motion unit is specified by **GS P**.

This command does not use the horizontal motion unit because this printer does not support Page mode.



TM-U375

The vertical or horizontal motion unit is specified by **GS P**.



TM-U925

The vertical motion unit is specified by **GS P**.

This command does not use the horizontal motion unit because this printer does not support Page mode.



TM-U325D

The vertical motion unit is 1/144 inches (the minimum movement amount). This value equals a half dot pitch. This command does not use the horizontal motion unit because this printer does not support Page mode.



TM-U300C/D

The vertical motion unit is 1/144 inches (the minimum movement amount). This value equals a half dot pitch. This command does not use the horizontal motion unit because this printer does not support Page mode.



ESC C *n*

[Name] Set cut sheet eject length

[Format] ASCII ESC C *n*
 Hex 1B 43 *n*
 Decimal 27 67 *n*

[Range] $0 \leq n \leq 255$

[Default] $n = 0$

[Printers not featuring this command] **TM-U325D**, **TM-U300C/D**

[Description] Sets the eject length for the cut sheet (slip or validation paper) to *n* lines.

- When *n* = 0, the eject length setting is cancelled.

- [Notes]
- When *n* = 0, eject operation differs depending on the printer model.
 - This command is available for the paper type selected by **ESC c 1**. The eject length can be set independently for slip and validation paper.
 - The eject length set by this command is effective only when the cut sheet is selected as the print sheet and affects ejection.
 - The cut sheet eject direction is specified by **ESC F**.
 - The amount of paper fed per line is based on the value set using the line spacing commands (**ESC 2** or **ESC 3**).

[Model-dependent variations] **TM-H5000** **TM-U375** **TM-U925**



Program Example for all printers

```
PRINT #1, CHR$(&H1B);"c0";CHR$(4); ← Select print sheet
PRINT #1, CHR$(&H1B);"c1";CHR$(4); ← Select setting sheet
PRINT #1, CHR$(&H1B);"C";CHR$(8); ← Set eject length
PRINT #1, "AAAAA"; CHR$(&HA);
PRINT #1, "BBBBB"; CHR$(&HC);
```

Print Sample

AAAAA
BBBBB

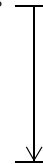

Eject length set to 8
lines using **ESC C**



TM-H5000

The maximum eject length is 17.72 inches. If the specified amount exceeds 17.72 inches, the eject length is automatically set to 17.72 inches.

When $n=0$, the printer continues paper feed until the printer gets to the position where the slip paper can be ejected.

Selecting paper type by **ESC c 1** is unnecessary because this printer has only a slip as the cut sheet.



TM-U375

The maximum eject length is 40 inches. If the specified amount exceeds 40 inches, the eject length amount is automatically set to 40 inches.

When $n = 0$, the printer continues paper feed until the cut sheet is ejected completely.

The eject length can be set independently for slip and validation paper selected by **ESC c 1**.



TM-U925

The maximum eject length is 40 inches. If the specified amount exceeds 40 inches, the eject length amount is automatically set to 40 inches.

When $n = 0$, the printer continues paper feed until the cut sheet is ejected completely.

Selecting paper type by **ESC c 1** is unnecessary because this printer has only a slip as the cut sheet.



CHARACTER COMMANDS

Command Name

ESC SP *n* Set right-side character spacing

ESC % *n* Select/cancel user-defined character set

ESC & *y c1 c2 [x1 d1 ... d(y × x1)] ... [xk d1 ... d(y × xk)]*

Define user-defined characters

ESC ? *n* Cancel user-defined characters

ESC R *n* Select an international character set

ESC t *n* Select character code table

ESC ! *n* Select print mode(s)

ESC - *n* Turn underline mode on/off

ESC E *n* Turn emphasized mode on/off

ESC M *n* Select character font

GS ! *n* Select character size

GS b *n* Turn smoothing mode on/off

ESC G *n* Turn double-strike mode on/off

ESC { *n* Turn upside-down printing mode on/off

ESC V *n* Turn 90° clockwise rotation mode on/off

GS B *n* Turn white/black reverse printing mode on/off

CAN Cancel print data in page mode

ESC r *n* Select print color



ESC SP *n*

[Name]	Set right-side character spacing			
[Format]	ASCII	ESC	SP	<i>n</i>
	Hex	1B	20	<i>n</i>
	Decimal	27	32	<i>n</i>
[Range]	TM-H5000, TM-U375, TM-U925, TM-U325D: $0 \leq n \leq 255$ TM-U300C/D: $0 \leq n \leq 32$			
[Default]	<i>n</i> = 0			
[Printers not featuring this command]	None			
[Description]	Sets the right-side character spacing to <i>n</i> × (horizontal or vertical motion unit).			
[Notes]	<ul style="list-style-type: none"> ■ The right-side character spacing set by this command is effective for all characters (except for HRI characters). ■ When characters are enlarged, the right-side character spacing is <i>n</i> times normal value. The right-side character spacing for double-width mode is twice the normal value. ■ When standard mode is selected, the horizontal motion unit is used. 			



- When page mode is selected, the vertical or horizontal motion unit is used for the print direction set by **ESC T**.
 - When the starting position is set to the upper left or lower right of the printing area using **ESC T**, the horizontal motion unit is used.
 - When the starting position is set to the upper right or lower left of the printing area using **ESC T**, the vertical motion unit is used.
- The right-side character spacing can be set independently in standard mode and in page mode.
- It is used to change the spacing between characters.

[Model-dependent variations] **TM-H5000** **TM-U375** **TM-U925**
 TM-U325D **TM-U300C/D**

Program Example for all printers

```
PRINT #1, CHR$(&H1D); "P"; CHR$(180); CHR$(180);
PRINT #1, CHR$(&H1B); " "; CHR$(0); ← Character spacing set to 0
PRINT #1, "AAAAA"; CHR$(&HA);
PRINT #1, CHR$(&H1B); " "; CHR$(6); ← Character spacing set to 6
PRINT #1, "BBBBB"; CHR$(&HA);
PRINT #1, CHR$(&H1B); " "; CHR$(12); ← Character spacing set to 12
PRINT #1, "CCCCC"; CHR$(&HA);
```

Print Sample

```
AAAAA ← 0-inch character spacing
BBBBB ← 6/180-inch character spacing
C C C C ← 12/180-inch character spacing
```



TM-H5000

The vertical or horizontal motion unit is specified by **GS P**.



TM-U375

The vertical or horizontal motion unit is specified by **GS P**.



TM-U925

The horizontal motion unit is specified by **GS P**.

This command does not use the vertical motion unit because this printer does not support Page mode.



TM-U325D

The horizontal motion unit is 1/160 inches (the minimum movement amount). This value equals a half dot pitch. This command does not use the vertical motion unit because the printer does not support Page mode.



TM-U300C/D

The horizontal motion unit is 1/160 inches (the minimum movement amount). This value equals a half dot pitch. This command does not use the vertical motion unit because the printer does not support Page mode.



ESC % *n*

[Name] Select/cancel user-defined character set

[Format] ASCII ESC % *n*
Hex 1B 25 *n*
Decimal 27 37 *n*

[Range] $0 \leq n \leq 255$

[Default] $n = 0$

[Printers not featuring this command] None

[Description] Selects or cancels the user-defined character set.

- When the LSB of *n* is 0, the user-defined character set is canceled.
- When the LSB of *n* is 1, the user-defined character set is selected.

[Note] ■ When the user-defined character set is canceled, the resident character set is automatically selected.

[Model-dependent variations] None

See program example for **ESC %**, **ESC &** and **ESC ?**.



ESC & y c1 c2 [x1 d1 ... d(y × x1)] ... [xk d1 ... d(y × xk)]

[Name]	Define user-defined characters				
[Format]	ASCII	ESC	&	y c1 c2	[x1 d1 ... d(y × x1)] ... [xk d1 ... d(y × xk)]
	Hex	1B	26	y c1 c2	[x1 d1 ... d(y × x1)] ... [xk d1 ... d(y × xk)]
	Decimal	27	38	y c1 c2	[x1 d1 ... d(y × x1)] ... [xk d1 ... d(y × xk)]

[Range] **TM-H5000: For the paper roll:**

$$y = 3$$

$$32 \leq c1 \leq c2 \leq 126$$

$$0 \leq x \leq 12 \text{ (Font A (12} \times \text{24))}$$

$$0 \leq x \leq 9 \text{ (Font B (9} \times \text{24))}$$

$$0 \leq d \leq 255$$

$$k = c2 - c1 + 1$$

For the slip paper:

$$y = 2$$

$$32 \leq c1 \leq c2 \leq 126$$

$$0 \leq x \leq 12 \text{ (Font A (9} \times \text{9))}$$

$$0 \leq x \leq 9 \text{ (Font B (7} \times \text{9))}$$

$$0 \leq d \leq 255$$

$$k = c2 - c1 + 1$$

TM-U375:

$$y = 2$$

$$32 \leq c1 \leq c2 \leq 126$$

$$0 \leq x \leq 6 \text{ (Font A (5} \times \text{9))}$$

$$0 \leq x \leq 10 \text{ (Font B (7} \times \text{9))}$$

$$0 \leq d \leq 255$$

$$k = c2 - c1 + 1$$



TM-U925: $y = 2$
 $32 \leq c1 \leq c2 \leq 126$
 $0 \leq x \leq 12$ (Font A (9 × 9))
 $0 \leq x \leq 9$ (Font B (7 × 9))
 $0 \leq d \leq 255$
 $k = c2 - c1 + 1$

TM-U325D: $y = 2$
 $32 \leq c1 \leq c2 \leq 126$
 $0 \leq x \leq 12$ (Font A (9 × 9))
 $0 \leq x \leq 10$ (Font B (7 × 9))
 $0 \leq d1 \dots d (y \times x) \leq 255$

TM-U300C/D: $y = 2$
 $32 \leq c1 \leq c2 \leq 126$
 $0 \leq x \leq 12$ (Font A (9 × 9))
 $0 \leq x \leq 10$ (Font B (7 × 9))
 $0 \leq d \leq 255$

[Default] None

[Printers not featuring this command] None

[Description] Defines user-defined characters from character code check **c1** to **c2**.

- **y** specifies the number of bytes in the vertical direction.
- **x** specifies the number of dots in the horizontal direction.
- **d** is the dot data for the user-defined characters.



[Notes]

- Character codes from the alphanumeric characters (20H (decimal 32) to 7EH (decimal 126)) can be defined.
- Data (**d**) specifies a bit printed to 1 and not printed to 0. The dot pattern is in the horizontal direction from the left side. Any remaining dots on the right side are blank.
- The data to define a user-defined character is (**y** × **x**) bytes.
- When the value of **y**, **c1**, **c2**, or **x** is out of the range, this command is canceled, and the following data is processed as normal data.
- This command can define user-defined characters for each font independently. To select a font, use **ESC !** or **ESC M**.
- A user-defined character and downloaded bit image cannot be defined simultaneously. When this command is executed, the downloaded bit image is cleared.
- Once the user-defined characters have been defined, they are available until **ESC ?**, **GS ***, or **ESC @**, is executed; the user-defined characters are redefined; the power is turned off; or the printer is reset.
- The user-defined characters are not defined at the default and the resident characters are printed.

[Model-dependent variations] **TM-H5000** **TM-U375** **TM-U925**
 TM-U325D **TM-U300C/D**

See program example for **ESC %**, **ESC &** and **ESC ?**.



TM-H5000

This command defines the pattern defined for the paper type selected by **ESC c 1**. The user-defined characters can be defined independently for paper roll and slip paper.

If the slip paper is selected, the dots adjoining each other horizontally cannot be printed. Only the MSB can be printed in the second byte for the vertical direction.



TM-U375

If the font B (7 × 9) is selected, the dots adjoining each other horizontally cannot be printed. Only the MSB can be printed in the second byte for vertical direction.



TM-U925

The dots adjoining each other horizontally cannot be printed. Only the MSB can be printed in the second byte for vertical direction.

The maximum number of user-defined characters differs depending on the receive buffer capacity as described below. When the maximum number of user-defined characters is defined, it is possible to redefine user-defined characters for the defined ASCII code, but not for the new ASCII code.

Receive buffer capacity	Maximum number of user-defined characters
2k bytes	23
32 bytes	71



TM-U325D

The dots adjoining each other horizontally cannot be printed. Only the MSB can be printed in the second byte for vertical direction.

The maximum number of user-defined characters differs depending on the receive buffer capacity as described below. When the maximum number of user-defined characters is defined, it is possible to redefine user-defined characters for the defined ASCII code, but not for the new ASCII code.

Receive buffer capacity	Maximum number of user-defined characters
4k bytes	20
45 bytes	95



TM-U300C/D

The dots adjoining each other horizontally cannot be printed. Only the MSB can be printed in the second byte for vertical direction.

The maximum number of user-defined characters differs depending on the receive buffer capacity as described below. When the maximum number of user-defined characters is defined, it is possible to redefine user-defined characters for the defined ASCII code, but not for the new ASCII code.

Receive buffer capacity	Maximum number of user-defined characters
512 bytes	4
40 bytes	20
0 bytes	22



ESC ? *n*

[Name] Cancel user-defined characters

[Format] ASCII ESC ? *n*
 Hex 1B 3F *n*
 Decimal 27 63 *n*

[Range] $32 \leq n \leq 126$

[Default] None

[Printers not featuring this command] **TM-U300C/D**

[Description] Cancels the user-defined characters defined for the character code *n*.

- [Notes]
- After the user-defined characters are canceled, the resident character set is printed.
 - This command can cancel user-defined characters for each font independently. To select a font, use **ESC !** or **ESC M**.

[Model-dependent variations] **TM-H5000**



Program example for ESC %, ESC &, and ESC ?

Program Example

```

PRINT #1, CHR$(&H1B); "&"; CHR$(2); "AC";
PRINT #1, CHR$(9);
FOR i=1 TO 2*9
  READ d: PRINT #1, CHR$(d);
NEXT i
PRINT #1, CHR$(9);
FOR i=1 TO 2*9
  READ d: PRINT #1, CHR$(d);
NEXT i
PRINT #1, CHR$(10);
FOR i=1 TO 2*10
  READ d: PRINT #1, CHR$(d);
NEXT i
PRINT #1, CHR$(&H1B); "%"; CHR$(0); ← Select resident character
PRINT #1, "A B C D E"; CHR$(&HA);
PRINT #1, CHR$(&H1B); "%"; CHR$(1); ← Select user-defined character
PRINT #1, "A B C D E"; CHR$(&HA);
PRINT #1, CHR$(&H1B); "?"; "A"; ← Cancel the user-defined character
PRINT #1, "A B C D E"; CHR$(&HA);

```

Defines the user-defined characters as "A", "B", and "C"

Program Example (continued)

```

DATA &H18,&H00,&H00,&H00,&H3C,&H00,&H00,&H00
DATA &H7E,&H00,&H00,&H00,&H3C,&H00,&H00,&H00
DATA &H18,&H00
DATA &H18,&H00,&H00,&H00,&H24,&H00,&H00,&H00
DATA &H42,&H00,&H00,&H00,&H24,&H00,&H00,&H00
DATA &H18,&H00
DATA &H00,&H00,&H10,&H00,&H20,&H00,&H5F,&H00
DATA &H00,&H00,&H81,&H00,&H00,&H00,&H5F,&H00
DATA &H20,&H00,&H10,&H00

```

Print Sample

```

A B C D E ← Characters from resident character set
♦ ◊ ↑ D E ← Characters from user-defined character set
A ◊ ↑ D E ← Characters from user-defined character set (cancel one character)

```



TM-H5000

This command cancels the pattern defined for the paper type selected by **ESC c 1**. The user-defined characters can be defined independently for paper roll and slip paper.



ESC R *n*

[Name] Select an international character set

[Format] ASCII ESC R *n*

 Hex 1B 52 *n*

 Decimal 27 82 *n*

[Range] $0 \leq n \leq 10$

[Default] $n = 0$

[Printers not featuring this command] **TM-U300C/D**



[Description] Selects an international character set *n* as follows:

<i>n</i>	Country	ASCII code												
		Hex	23	24	40	5B	5C	5D	5E	60	7B	7C	7D	7E
		Dec	35	36	64	91	92	93	94	96	123	124	125	126
0	U.S.A.	#	\$	@	[\]	^	`	{		}	~	
1	France	#	\$	à	°	ç	§	^	`	é	ù	è	¨	
2	Germany	#	\$	§	Ä	Ö	Ü	^	`	ä	ö	ü	ß	
3	U.K.	£	\$	@	[\]	^	`	{		}	~	
4	Denmark I	#	\$	@	Æ	Ø	Å	^	`	æ	ø	å	~	
5	Sweden	#	α	É	Ä	Ö	Å	Ü	é	ä	ö	å	ü	
6	Italy	#	\$	@	°	\	é	^	ù	à	ò	è	ì	
7	Spain	Pt	\$	@	i	Ñ	¿	^	`	¨	ñ	}	~	
8	Japan	#	\$	@	[¥]	^	`	{		}	~	
9	Norway	#	α	É	Æ	Ø	Å	Ü	é	æ	ø	å	ü	
10	Denmark II	#	\$	É	Æ	Ø	Å	Ü	é	æ	ø	å	ü	

[Model-dependent variations] None



Program Example for all printers

```
FOR n=0 TO 10
  PRINT #1, CHR$( &H1B ); "R"; CHR$(n);
  PRINT #1, "# $ @ [ \ ] ^ ` { | } ~"; CHR$( &HA );
NEXT n
```

Print Sample

```
# $ @ [ \ ] ^ ` { | } ~ ← n=0 (Default setting)
# $ à ° ç s ^ ` é ù è ~ ← n=1
# $ š Ā Ō Ū ^ ` ä ö ü ß ← n=2
£ $ @ [ \ ] ^ ` { | } ~ ← n=3
# $ @ Æ Ø Å ^ ` æ ø å ~ ← n=4
# □ É Ā Ō Ā Ū é ä ö å ü ← n=5
# $ @ ° \ é ^ ù à ò è ì ← n=6
π $ @ ; Ñ ¿ ^ ` " ñ } ~ ← n=7
# $ @ [ ¥ ] ^ ` { | } ~ ← n=8
# □ É Æ Ø Å Ū é æ ø å ü ← n=9
# $ É Æ Ø Å Ū é æ ø å ü ← n=10
```



TM-U300C/D

This command is ignored with the TM-U300D single-color model.



ESC t n

[Name] Select character code table

[Format] ASCII ESC t n
 Hex 1B 74 n
 Decimal 27 116 n

[Range] **TM-H5000: $0 \leq n \leq 5, n = 255$** ; **TM-U375: $0 \leq n \leq 5, n =, 254, 255$** ;
TM-U925: $0 \leq n \leq 5, n = 254, 255$; **TM-U325D: $0 \leq n \leq 5, n = 254, 255$** ;
TM-U300C/D: $0 \leq n \leq 5, n = 255$

[Default] $n = 0$

[Printers not featuring this command] None

[Description] Selects a page n from the character code table as follows:

n	Character Code Table
0	Page 0 [PC437 (U.S.A. , Standard Europe)]
1	Page 1 [Katakana]
2	Page 2 [PC850 (Multilingual)]
3	Page 3 [PC860 (Portuguese)]
4	Page 4 [PC863 (Canadian-French)]
5	Page 5 [PC865 (Nordic)]
254	Page 254
255	Page 255

[Note] ■ The alphanumeric characters (20H (decimal 32) to 7FH (decimal 127)) are the same for each page. The extended characters (80H (decimal 128) to FFH (decimal 255)) are different for each page.

[Model-dependent variations] **TM-H5000** **TM-U375** **TM-U925**
TM-U325D **TM-U300C/D**



Program Example for all printers

```

PRINT #1, CHR$(&H1B);"t";CHR$(0); ← Select page 0
GOSUB printing
PRINT #1, CHR$(&H1B);"t";CHR$(1); ← Select page 1
GOSUB printing
END

printing:
FOR i=&H20 TO &H7F
  PRINT #1, CHR$(i);
NEXT i
PRINT #1, CHR$(&HA);
FOR i=&H80 TO &HFF
  PRINT #1, CHR$(i);
NEXT i
PRINT #1, CHR$(&HA);
RETURN

```

Print Sample

<pre> !"###&'()*+,-./0123456789:;<=>?@ ABCDEFGHIJKLMNPOQRSTUVWXYZ[\]^_`a bcdefghijklmnopqrstuvwxyz{ }~ Çüéàáâäçèéëìíîïÿóôõö÷øùúûüýþÿ íóúûüö÷øùúûüýþÿ πΣαυτθΩδρϵζηξΰϕχψ !"###&'()*+,-./0123456789:;<=>?@ ABCDEFGHIJKLMNPOQRSTUVWXYZ[\]^_`a bcdefghijklmnopqrstuvwxyz{ }~ 。」「、・ヲイウエオカキクケコサシスセソチ ツテトナニヌノハヒフヘホマミムモヤヨリルロワン'°=≡≡ ≡≡≡≡≡≡≡≡≡≡≡≡≡≡≡≡≡≡≡≡≡≡≡≡ </pre>	<p>Page 0</p> <p>Page 1</p>
--	-----------------------------



TM-H5000

Page 255 for the paper roll and for font A (9 × 9) of the slip are the space characters. Page 255 for font B (7 × 9) of the slip is the special characters.



TM-U375

Pages 254 and 255 are the space characters.



TM-U925

Pages 254 and 255 are the space characters.



TM-U325D

Pages 254 and 255 are the space characters.



TM-U300C/D

Page 255 is the space characters.



ESC ! *n*

[Name] Select print mode(s)

[Format] ASCII ESC ! *n*
 Hex 1B 21 *n*
 Decimal 27 33 *n*

[Range] $0 \leq n \leq 255$

[Default] **TM-H5000: *n* = 0** **TM-U375: *n* = 1** **TM-U925: *n* = 0 or 1**
TM-U325D: *n* = 1 **TM-U300C/D: *n* = 1**

[Printers not featuring this command] None

[Description] Selects or cancels print modes collectively using ***n*** as follows:



Bit	Off/On	Hex	Decimal	Function
0	Off	00	0	Character font A selected.
	On	01	1	Character font B selected.
1, 2	—	—	—	Undefined.
3	Off	00	0	Emphasized mode not selected.
	On	08	8	Emphasized mode selected.
4	Off	00	0	Double-height mode not selected.
	On	10	16	Double-height mode selected.
5	Off	00	0	Double-width mode not selected.
	On	20	32	Double-width mode selected.
6	—	—	—	Undefined.
7	Off	00	0	Underline mode not selected.
	On	80	128	Underline mode selected.

■■■ *how to use this table*



[Notes]

- Functions for each bit can also be executed by the following commands:

Bit 0 (character font): **ESC M**

Bit 3 (Emphasized mode): **ESC E**

Bit 4, 5 (character size): **GS !**

Bit 7 (underline mode): **ESC -**

- Configurations of Font A and Font B are different, depending on the printer model.
- The print modes set by this command are effective for all characters (except for HRI characters).
- When some characters in a line are double-height, all characters on the line are aligned at the baseline.
- When double-width mode is turned on, the characters are enlarged to the right, based on the left side of the character.
- When both double-height and double-width modes are turned on, quadruple size characters are printed.
- In standard mode, the character is enlarged in the paper feed direction when double-height mode is selected, and it is enlarged perpendicular to the paper feed direction when double-width mode is selected. However, when character orientation changes in 90° clockwise-rotated mode, the relationship between double-height and double-width is reversed.
- In page mode, double-height and double-width are on the character orientation.
- The underline thickness is that specified by **ESC -**, regardless of the character size.



- When underline mode is turned on, 90° clockwise-rotated characters and white/black reverse characters cannot be underlined.
- The printer cannot underline the space set by **HT**, **ESC \$**, and **ESC **.

[Model-dependent variations] **TM-H5000** **TM-U375** **TM-U925**
TM-U325D **TM-U300C/D**

Program Example for all printers

```

PRINT #1, CHR$( &H1B);"!";CHR$(0); "AA";
PRINT #1, CHR$( &H1B);"!";CHR$(8); "BB";
PRINT #1, CHR$( &H1B);"!";CHR$(16); "CC";
PRINT #1, CHR$( &H1B);"!";CHR$(24); "DD";
PRINT #1, CHR$( &H1B);"!";CHR$(32); "EE";
PRINT #1, CHR$( &H1B);"!";CHR$(40); "FF";
PRINT #1, CHR$( &H1B);"!";CHR$(48); "GG";
PRINT #1, CHR$( &H1B);"!";CHR$(56); "HH"; CHR$( &HA);
PRINT #1, CHR$( &H1B);"!";CHR$(129); "AA";
PRINT #1, CHR$( &H1B);"!";CHR$(137); "BB";
PRINT #1, CHR$( &H1B);"!";CHR$(145); "CC";
PRINT #1, CHR$( &H1B);"!";CHR$(153); "DD";
PRINT #1, CHR$( &H1B);"!";CHR$(161); "EE";
PRINT #1, CHR$( &H1B);"!";CHR$(169); "FF";
PRINT #1, CHR$( &H1B);"!";CHR$(177); "GG";
PRINT #1, CHR$( &H1B);"!";CHR$(185); "HH"; CHR$( &HA);

```

Print Sample

AABBCCDD EEEFGGHH ← Font A
AABBCCDD EEEFGGHH ← Font B
with underline

AA: Normal
BB: Emphasized
CC: Double-height
DD: Emphasized + Double-height
EE: Double-width
FF: Emphasized + Double-width
GG: Double-height + Double-width
HH: Emphasized + Double-height + Double-width



TM-H5000

Character configurations

**Bit 0: Font A: 12 × 24 (paper roll), 9 × 9 (slip)
Font B: 9 × 24 (paper roll), 7 × 9 (slip)**



TM-U375

Character configurations

Bit 0: Font A: 5 × 9

Font B: 7 × 9

The character font B (7 × 9) and emphasized mode are not effective in page mode. If this command is processed in page mode, an internal flag is activated and this flag is enabled when the printer returns to standard mode.



TM-U925

Character configurations

Bit 0: Font A: 9×9
Font B: 7×9



TM-U325D

Character configurations

Bit 0: Font A: 9×9
Font B: 7×9



TM-U300C/D

Character configurations

Bit 0: Font A: 9 × 9
Font B: 7 × 9



ESC – *n*

[Name] Turn underline mode on/off

[Format] ASCII ESC – *n*
 Hex 1B 2D *n*
 Decimal 27 45 *n*

[Range] **TM-H5000: $0 \leq n \leq 2, 48 \leq n \leq 50$**
TM-U375, TM-U925: $n = 0, 1, 48, 49$
TM-U325D: $n = 0, 1, 48, 49$

[Default] $n = 0$

[Printers not featuring this command] None

[Description] Turns underline mode on or off using *n* as follows:

<i>n</i>	Function
0, 48	Turned off underline mode
1, 49	Turned on underline mode (1-dot thick)
2, 50	Turned on underline mode (2-dots thick)



[Notes]

- The underline mode is effective for all characters (except for HRI characters).
- When underline mode is turned on, 90° clockwise rotated characters and white/black reverse characters cannot be underlined.
- The printer cannot underline the space set by **HT**, **ESC \$**, and **ESC **.
- Changing the character size does not affect the current underline thickness.
- When underline mode is turned off, the following data cannot be underlined, but the thickness is maintained.
- This command and bit 7 of **ESC !** turn on and off underline mode in the same way.
- Some of the printer models support the 2-dot thick underline ($n = 2$ or 5).

[Model-dependent variations] **TM-H5000**

Program Example for all printers

```
PRINT #1, CHR$(&H1B); "-" ; CHR$(1); ← Select
PRINT #1, "AAAAA"; CHR$(&HA);
PRINT #1, CHR$(&H1B); "-" ; CHR$(0); ← Cancel
PRINT #1, "BBBBB"; CHR$(&HA);
```

Print Sample

```
AAAAA ← Underline (1-dot thick) turned on
BBBBB ← Underline turned off
```



TM-H5000

If the slip is selected as the print sheet set by **ESC c 0**, the underline is 1-dot wide when $n=2$ or 50.



ESC E *n*

[Name] Turn emphasized mode on/off

[Format] ASCII ESC E *n*
Hex 1B 45 *n*
Decimal 27 69 *n*

[Range] $0 \leq n \leq 255$

[Default] $n = 0$

[Printers not featuring this command] None

[Description] Turns emphasized mode on or off.

- When the LSB of *n* is 0, emphasized mode is turned off.
- When the LSB of *n* is 1, emphasized mode is turned on.

[Notes] ■ The emphasized mode is effective for all characters (except for HRI characters).
■ This command and bit 3 of **ESC !** turn on and off emphasized mode in the same way.

[Model-dependent variations] **TM-U375**

Program Example for all printers

```
PRINT #1, CHR$(&H1B);"E";CHR$(1); ← Select
PRINT #1, "AAAAA"; CHR$(&HA);
PRINT #1, CHR$(&H1B);"E";CHR$(0); ← Cancel
PRINT #1, "BBBBB"; CHR$(&HA);
```

Print Sample

```
AAAAA ← Emphasized
BBBBB ← Normal
```



TM-U375

The emphasized mode is not effective in page mode. If this command is processed in page mode, an internal flag is activated and this flag is enabled when the printer returns to standard mode.



ESC M *n*

[Name] Select character font

[Format] ASCII ESC M *n*
 Hex 1B 4D *n*
 Decimal 27 77 *n*

[Range] $n = 0, 1, 48, 49$

[Default] **TM-U325D: $n = 1$**

[Printers not featuring this command] **TM-H5000, TM-U375, TM-U925,**
TM-U300C/D

[Description] Selects a character font, using *n* as follows:

<i>n</i>	Font
0, 48	Font A
1, 49	Font B

- [Notes]
- The character font set by this command is effective for all characters (except for HRI characters).
 - Configurations of font A and font B depend on the printer model.
 - This command and bit 0 of **ESC !** select character font A or B in the same way.

[Model-dependent variations] **TM-U325D**



Program Example for all printers

```
PRINT #1, CHR$(&H1B);"M";CHR$(0);← Select font A  
PRINT #1, "AAAAA";CHR$(&HA);  
PRINT #1, CHR$(&H1B);"M";CHR$(1); ← Select font B  
PRINT #1,"BBBBB";CHR$(&HA);
```

Print Sample

```
AAAAA ← Font A  
BBBBB ← Font B
```



TM-U325D

Character configurations

Bit 0: Font A: 9×9
Font B: 7×9



GS ! n

[Name] Select character size

[Format] ASCII GS ! n
 Hex 1D 21 n
 Decimal 29 33 n

[Range] **TM-H5000:** $0 \leq n \leq 7, 16 \leq n \leq 23, 32 \leq n \leq 39, 48 \leq n \leq 55,$
 $64 \leq n \leq 71, 80 \leq n \leq 87, 96 \leq n \leq 103,$
 $112 \leq n \leq 119$
(1 ≤ height ≤ 8, 1 ≤ width ≤ 8)

TM-U325D: $n = 0, 1, 16, 17$

[Default] $n = 0$

[Printers not featuring this command] **TM-U375, TM-U925, TM-U300C/D**

[Description] Selects the character height (vertical number of times normal font size) using bits 0 to 2 and selects the character width (horizontal number of times normal font size) using bits 4 to 6, as follows:



Character Width Selection					
Bit6	Bit5	Bit4	Hex	Decimal	Width
Off	Off	Off	00	0	1 (normal)
Off	Off	On	10	16	2 (double-width)
Off	On	Off	20	32	3
Off	On	On	30	48	4
On	Off	Off	40	64	5
On	Off	On	50	80	6
On	On	Off	60	96	7
On	On	On	70	112	8

Character Height Selection					
Bit2	Bit1	Bit0	Hex	Decimal	Height
Off	Off	Off	00	0	1 (normal)
Off	Off	On	01	1	2 (double-height)
Off	On	Off	02	2	3
Off	On	On	03	3	4
On	Off	Off	04	4	5
On	Off	On	05	5	6
On	On	Off	06	6	7
On	On	On	07	7	8

[Notes]

- The character size set by this command is effective for all characters (except for HRI characters).
- When the characters are enlarged with different height on one line, all the characters on the line are aligned at the baseline.
- When the characters are enlarged with width, the characters are enlarged to the right, based on the left side of the character.
- **ESC !** can also turn double-width and double-height modes on or off.



- In standard mode, the character is enlarged in the paper feed direction when double-height mode is selected, and it is enlarged perpendicular to the paper feed direction when double-width mode is selected. However, when character orientation changes in 90° clockwise-rotated mode, the relationship between double-height and double-width is reversed.
- In page mode, double-height and double-width are on the character orientation.

[Model-dependent variations] **TM-H5000**

Program Example for all printers

```
PRINT #1, CHR$(&H1D);"!";CHR$(17);  
PRINT #1, "AAAAA"; CHR$(&HA);  
PRINT #1, CHR$(&H1D);"!";CHR$(0);  
PRINT #1, "BBBBB"; CHR$(&HA);
```

Print Sample

AAAAA ← Select quadruple (double-height x double-width)
BBBBB



TM-H5000

When the character width or height is set to three times of normal font size or more, double-width or double-height is printed with slip.



GS b n

[Name] Turn smoothing mode on/off

[Format] ASCII GS b n
Hex 1D 62 n
Decima 29 98 n

[Range] $0 \leq n \leq 255$

[Default] $n = 0$

[Printers not featuring this command] **TM-U375, TM-U925,**
TM-U325D, TM-U300C/D

[Description] Turns smoothing mode on or off.

- When the LSB of **n** is 0, smoothing mode is turned off.
- When the LSB of **n** is 1, smoothing mode is turned on.

[Note] ■ The smoothing mode is effective for all quadruple-size or larger characters (except for HRI characters).

[Model-dependent variations] **TM-H5000**

Program Example for all printers

```
PRINT #1, CHR$(&H1D);"!";CHR$(68); ← Select font size
PRINT #1, CHR$(&H1D);"b";CHR$(1); ← Select smoothing
PRINT #1, "AAAAA"; CHR$(&HA);
```

Print Sample

AAAAA



TM-H5000

Smoothing is available for quadruple-size or larger characters for paper roll. If this command is processed when the slip is selected as the print sheet, an internal flag is activated and the flag is enabled when the paper roll is selected.



ESC G *n*

[Name] Turn double-strike mode on/off

[Format] ASCII ESC G *n*
Hex 1B 47 *n*
Decimal 27 71 *n*

[Range] $0 \leq n \leq 255$

[Default] $n = 0$

[Printers not featuring this command] None

[Description] Turns double-strike mode on or off.

- When the LSB of *n* is 0, double-strike mode is turned off.
- When the LSB of *n* is 1, double-strike mode is turned on.

[Note] ■ The double-strike mode is effective for all characters (except for HRI characters).

[Model-dependent variations] **TM-U375**

Program Example for all printers

```
PRINT #1, CHR$(&H1B);"G";CHR$(1); ← Select
PRINT #1, "AAAAA"; CHR$(&HA);
PRINT #1, CHR$(&H1B);"G";CHR$(0); ← Cancel
PRINT #1, "BBBBB"; CHR$(&HA);
```

Print Sample

```
AAAAA ← Double-strike
BBBBB ← Normal
```



TM-U375

The double-strike mode is not effective in page mode. If this command is processed in page mode, an internal flag is activated and this flag is enabled when the printer returns to standard mode.



ESC { *n*

[Name] Turn upside-down printing mode on/off

[Format] ASCII ESC { *n*
 Hex 1B 7B *n*
 Decimal 27 123 *n*

[Range] $0 \leq n \leq 255$

[Default] $n = 0$

[Printers not featuring this command] None

[Description] In standard mode, turns upside-down printing mode on or off.

- When the LSB of *n* is 0, upside-down printing mode is turned off.
- When the LSB of *n* is 1, upside-down printing mode is turned on.



[Notes]

- When standard mode is selected, this command is enabled only when processed at the beginning of the line.
- The upside-down printing mode is effective for all data in standard mode.
- The upside-down printing mode has no effect in page mode. If this command is processed in page mode, an internal flag is activated and this flag is enabled when the printer returns to standard mode.
- When upside-down printing mode is turned on, the printer prints 180°-rotated characters from right to left. The line printing order is not reversed; therefore, be careful of the order of the data transmitted.

[Model-dependent variations] None

Program Example for all printers

```
PRINT #1, CHR$(&H1B); "{";CHR$(0); ← Cancel
PRINT #1, "ABCDE"; CHR$(&HA);
PRINT #1, "BCDEF"; CHR$(&HA);
PRINT #1, CHR$(&H1B); "{";CHR$(1); ← Select
PRINT #1, "ABCDE"; CHR$(&HA);
PRINT #1, "BCDEF"; CHR$(&HA);
```

Print Sample

Normal printing

ABCDE
BCDEF

ABCDE
BCDEF

Upside-down
printing



ESC V *n*

[Name] Turn 90° clockwise rotation mode on/off

[Format] ASCII ESC V *n*
 Hex 1B 56 *n*
 Decimal 27 86 *n*

[Range] **TM-H5000: *n* = 0, 1, 48, 49**
TM-U375: 0 ≤ *n* ≤ 2, 48 ≤ *n* ≤ 50

[Default] *n* = 0

[Printers not featuring this command] **TM-U925, TM-U325D, TM-U300C/D**

[Description] In standard mode, turns 90° clockwise rotation mode on or off, using *n* as follows:

<i>n</i>	Function
0, 48	Turns off 90° clockwise rotation mode.
1, 48	Turns on 90° clockwise rotation mode (1-dot character spacing).
2, 50	Turns on 90° clockwise rotation mode (1.5-dot character spacing).



[Notes]

- The 90° clockwise rotation mode is effective for all characters (except for HRI characters) in standard mode.
- When underline mode is turned on, the printer does not underline 90° clockwise-rotated characters.
- When character orientation changes in 90° clockwise rotation mode, the relationship between vertical and horizontal directions is reversed.
- The 90° clockwise rotation mode has no effect in page mode. If this command is processed in page mode, an internal flag is activated and this flag is enabled when the printer returns to standard mode.
- Some printer models support 90° clockwise rotation mode when $n = 2$ or 50.
- Some printer models have a font for which 90° clockwise rotation mode is not effective.

[Model-dependent variations] **TM-H5000** **TM-U375**



Program Example for all printers

```

PRINT #1, CHR$(&H1B);"c0";CHR$(1);← Select print sheet
PRINT #1, CHR$(&H1B);"c1";CHR$(1);← Select setting sheet
PRINT #1, CHR$(&H1D);"P";CHR$(180);CHR$(180);
PRINT #1, CHR$(&H1B);" ";CHR$(20);← Set character spacing
PRINT #1, CHR$(&H1B);"3";CHR$(15);← Set line spacing
PRINT #1, CHR$(&H1B);"V";CHR$(1);← Select
  PRINT #1, "AAAAA"; CHR$(&HA);
  PRINT #1, "BBBBB"; CHR$(&HA);
  PRINT #1, "CCCCC"; CHR$(&HA);
PRINT #1, CHR$(&H1B);"2";← Set line spacing
PRINT #1, CHR$(&H1B);"V";CHR$(0);← Cancel
  PRINT #1, "AAAAA"; CHR$(&HA);
  PRINT #1, "BBBBB"; CHR$(&HA);
  PRINT #1, "CCCCC"; CHR$(&HA);

```

Print Sample

Character spacing

Line spacing] ESC v 1

Line spacing] ESC v 0

Character spacing



TM-H5000

The 90° clockwise rotation mode affects printing on the paper roll in standard mode.

If this command is processed when the slip is selected as the print sheet, an internal flag is activated and this flag is enabled when the paper roll is selected.



TM-U375

The 90° clockwise rotation mode is not effective for font B (7 × 9).



GS B *n*

[Name] Turn white/black reverse printing mode on/off

[Format]

ASCII	GS	B	<i>n</i>
Hex	1D	42	<i>n</i>
Decimal	29	66	<i>n</i>

[Range] $0 \leq n \leq 255$

[Default] $n = 0$

[Printers not featuring this command] **TM-U375, TM-U925,**
TM-U325D, TM-U300C/D

[Description] Turns white/black reverse printing mode on or off.

- When the LSB of ***n*** is 0, white/black reverse printing mode is turned off.
- When the LSB of ***n*** is 1, white/black reverse printing mode is turned on.

[Notes]

- The white/black reverse printing mode is effective for all characters (except for HRI characters).
- When white/black reverse printing mode is turned on, it also affects the right-side character spacing set by **ESC SP**.



- When white/black reverse printing mode is turned on, it does not affect the space between lines.
- When underline mode is turned on, the printer does not underline white/black reverse characters.
- In white/black reverse printing mode, characters are printed in white on a black background.

[Model-dependent variations] **TM-H5000**

Program Example for all printers

```
PRINT #1, CHR$(&H1D);"B";CHR$(1); ← Select  
PRINT #1, "AAAAA"; CHR$(&HA);  
PRINT #1, CHR$(&H1D);"B";CHR$(0); ← Cancel  
PRINT #1, "BBBBB"; CHR$(&HA);
```

Print Sample

```
AAAAA ← White/black reverse printing  
BBBBB ← Normal printing
```



TM-H5000

This command is effective for all characters (except for HRI characters) for the paper roll. If this command is processed when the slip is selected as the print sheet, an internal flag is activated and this flag is enabled when the paper roll is selected.



CAN

[Name] Cancel print data in page mode

[Format] ASCII CAN

Hex 18

Decimal 24

[Range] None

[Default] None

[Printers not featuring this command] **TM-U925, TM-U325D, TM-U300C/D**

[Description] In page mode, deletes all the print data for the current printing area.

[Notes] ■ This command is enabled only in page mode

■ If data set in the previously specified printing area is set in the currently specified printing area, it is deleted.

[Model-dependent variations] **TM-H5000**

Program Example for all printers

```
PRINT #1, CHR$(&H1B);"L"; ← Select page mode
PRINT #1, CHR$(&H1D);"P";CHR$(180);CHR$(180);
PRINT #1, CHR$(&H1B);"W";CHR$(0);CHR$(0);CHR$(0);
CHR$(0);CHR$(240);CHR$(0);CHR$(44);CHR$(1);
PRINT #1, CHR$(&H1B);"T";CHR$(0); ← Select print direction
FOR i=1 TO 200 : PRINT #1, "A" : NEXT i
PRINT #1, CHR$(&H1B);"W";CHR$(60);CHR$(0);CHR$(90);
CHR$(0);CHR$(60);CHR$(0);CHR$(120);CHR$(0);
PRINT #1, CHR$(&H18); ← Cancel print data
PRINT #1, CHR$(&HC); ← Batch print and return to standard mode
```

Print Sample

```
AAAAAAAAAAAAAAAAAAAA
AAAAAAAAAAAAAAAAAAAA
AAAAAAAAAAAAAAAAAAAA
AAAAA AAAAAAAAAA
AAAAA AAAAAAAAAA
AAAAA AAAAAAAAAA
AAAAA AAAAAAAAAA
AAAAA AAAAAAAAAA
AAAAAAAAAAAAAAAAAAAA
AAAAAAAAAAAAAAAAAAAA
AAAAAAAAAAAAAAAAAAAA
```



TM-H5000

Page mode can be used only when the paper roll is selected as the print sheet.



ESC r n

[Name] Select print color

[Format] ASCII ESC r n
 Hex 1B 72 n
 Decimal 27 114 n

[Range] **TM-U300C/D: n = 0, 1**

[Default] n = 0

[Printers not featuring this command] **TM-H5000, TM-U375, TM-U925, TM-U325D**

[Description] Selects a print color, using *n* as follows:

<i>n</i>	Print color
0, 48	Black
1, 49	Red

- [Notes]
- When standard mode is selected, this command is enabled only when processed at the beginning of the line.
 - When page mode is selected, the color setting is the same for all data collectively printed by **FF** or **ESC FF**.

[Model-dependent variations] **TM-U300C/D**



Program Example for all printers

```
PRINT #1, CHR$(&H1B);"x";CHR$(1);← Select red  
PRINT #1, "AAAAA";CHR$(&HA);  
PRINT #1, CHR$(&H1B);"x";CHR$(0); ← Select black  
PRINT #1, "BBBBB";CHR$(&HA);
```

Print Sample

```
AAAAA ← Red  
BBBBB ← Black
```



TM-U300C/D

This command is ignored with the TM-U300D single-color model.



PRINTING PAPER COMMANDS

Command	Name
----------------	-------------

ESC c 0 n	Select paper type(s) for printing
------------------	-----------------------------------

ESC c 1 n	Select paper type(s) for command settings
------------------	---

ESC f t1 t2	Set cut sheet wait time
--------------------	-------------------------



ESC c 0 n

[Name]	Select paper type(s) for printing				
[Format]	ASCII	ESC	c	0	<i>n</i>
	Hex	1B	63	30	<i>n</i>
	Decimal	27	99	48	<i>n</i>
[Range]	TM-H5000: $1 \leq n \leq 4$ TM-U375: $1 \leq n \leq 11$ TM-U925: $1 \leq n \leq 4$ TM-U325D: $1 \leq n \leq 3, 8 \leq n \leq 11$ TM-U300C/D: $n = 1, 8, 9$				
[Default]	TM-H5000: $n = 3$ TM-U375: $n = 1$ TM-U925: $n = 3$ TM-U325D: $n = 1$ TM-U300C/D: $n = 1$				
[Printers not featuring this command]	None				



[Description] Selects paper type(s) for printing, using *n* as follows:

Bit	Off/On	Hex	Decimal	Function
0	Off	00	0	Paper roll disabled.
	On	01	1	Paper roll enabled.
1	Off	00	0	Paper roll disabled.
	On	02	2	Paper roll enabled.
2	Off	00	0	Slip paper disabled.
	On	04	4	Slip paper enabled.
3	Off	00	0	Validation paper disabled.
	On	08	8	Validation paper enabled.
4-7	Off	00	0	Undefined. Fixed to Off.

■■■ *how to use this table*



[Notes]

- This command is enabled only when processed at the beginning of the line in standard mode.
- If this command is processed in page mode, it is not enabled.
- When previously disabled cut sheet is enabled, the printer is in the cut sheet waiting status. The printer waits for the cut sheet until the cut sheet is inserted, the waiting time **t1** set by **ESC f** elapses, the printer is reset, or the power is turned off.
- When previously enabled cut sheet is disabled, the printer ejects the cut sheet.
- When previously enabled paper type is enabled again, this command is ignored.
- Both bits 0 and 1 indicate paper roll and when either bit 0 or bit 1 is on or both are on, the paper roll is selected as the print sheet.
- During the cut sheet waiting period, the printer processes only a real-time command, such as **DLE EOT** or **DLE ENQ**.
- It is possible to cancel the cut sheet waiting status using **DLE ENQ 3**. In this case, however, data in the print and receive buffers is cleared. The cut sheet insertion waiting status can be confirmed by **DLE EOT**.
- Multiple sheets with different printable areas cannot be selected simultaneously.

[Model-dependent variations]

TM-H5000
TM-U325D

TM-U375
TM-U300C/D

TM-U925



Program Example for all printers

```
PRINT #1, CHR$(&H1B);"c0";CHR$(1); ← Select print sheet (paper roll)
PRINT #1, "AAAAA"; CHR$(&HA); ← Print on paper roll
PRINT #1, CHR$(&H1B);"c0";CHR$(4); ← Select print sheet (slip)
PRINT #1, "BBBBB"; CHR$(&HC); ← Print on slip
```

Print Sample <paper roll>

AAAAA

Print Sample <slip>

BBBBB



TM-H5000

Paper roll and slip paper can be used as the print sheet. Bit 3 is undefined. Slip and paper roll cannot be selected simultaneously. When a slip is not inserted correctly, the printer ejects the slip and waits for the slip to be inserted.



TM-U375

Paper roll, slip, and validation can be used as the print sheet. Bit 3 is undefined. Slip and validation cannot be selected simultaneously. Be sure to use pressure-sensitive paper when the cut sheet and paper roll are selected simultaneously. Otherwise, the printing result will not be on the paper roll.



TM-U925

Paper roll and slip can be used as the print sheet. Bit 3 is undefined. Paper roll and slip cannot be selected simultaneously.



TM-U325D

Paper roll and validation can be used as the print sheet. Be sure to use pressure-sensitive paper when paper roll and validation are selected simultaneously. Otherwise, the printing result will not be on the paper roll.



TM-U300C/D

Bit 1 of n is undefined.

Paper roll and validation can be used as the print sheet. Be sure to use pressure-sensitive paper when paper roll and validation are selected simultaneously. Otherwise, the printing result will not be on the paper roll. The printer can print only one line with normal size or double-width characters on validation paper. After printing one line, the printer waits for the validation paper to be removed. After the validation paper is removed, paper roll is selected automatically.



ESC c 1 n

[Name] Select paper type(s) for command settings

[Format] ASCII ESC c 1 n
 Hex 1B 63 31 n
 Decimal 27 99 49 n

[Range] **TM-H5000:** $1 \leq n \leq 4$ **TM-U375:** $1 \leq n \leq 15$ **TM-U925:** $1 \leq n \leq 7$
TM-U325D: $1 \leq n \leq 3, 8 \leq n \leq 11$

[Default] **TM-H5000:** $n = 3$; **TM-U375:** $n = 15$; **TM-U925:** $n = 7$; **TM-U325D:** $n = 11$

[Printers not featuring this command] **TM-U300C/D**

[Description] Selects paper type(s) for setting, using **n** as follows:

Bit	Off/ On	Hex	Decimal	Function
0	Off	00	0	Paper roll disabled.
	On	01	1	Paper roll enabled.
1	Off	00	0	Paper roll disabled.
	On	02	2	Paper roll enabled.
2	Off	00	0	Slip paper disabled.
	On	04	4	Slip paper enabled.
3	Off	00	0	Validation paper disabled.
	On	08	8	Validation paper enabled.
4-7	Off	00	0	Undefined. Fixed to Off.

■■■ how to use
this table



[Notes]

- When multiple paper types are selected, each setting is used for all paper types selected.
- Both bits 0 and 1 indicate paper roll and when either bit 0 or bit 1 is on or both are on, the paper roll is selected as the setting sheet.
- The commands that need to select paper types for setting are **ESC 2**, **ESC 3**, **GS L**, and **GS W**.
- If the printer supports both slip and validation, **ESC C** needs to select paper types for setting.
- If the printer has multiple print heads with different pitches, the commands that need to select paper types for setting are **ESC &**, **ESC ?**, **GS ***, and **GS P**.

[Model-dependent variations] **TM-H5000** **TM-U375** **TM-U925** **TM-U325D**

Program Example for all printers

```
PRINT #1, CHR$(&H1B);"c1";CHR$(1); ← Select setting sheet (paper roll)
PRINT #1, CHR$(&H1D);"P";CHR$(180);CHR$(180);
PRINT #1, CHR$(&H1B);"3";CHR$(30); ← Set line spacing for paper roll
```



TM-H5000

Paper roll and slip paper can be used as the setting sheet. Bit 3 is undefined. Slip and paper roll cannot be selected simultaneously. The commands that need to select paper types for setting are **ESC &**, **ESC 2**, **ESC 3**, **ESC ?**, **GS ***, **GS L**, **GS P** and **GS W**.



TM-U375

Paper roll, slip and validation paper can be used as the setting sheet. It is possible to select multiple paper types. If different settings are set for the paper roll and the cut sheet, and both the paper roll and the cut sheet are selected for printing by **ESC c 0**, the printer operation is based on the setting for the cut sheet. The commands that need to select paper types for setting are **ESC 2**, **ESC 3**, **ESC C**, **GS L**, and **GS W**.



TM-U925

Paper roll and slip can be used as the setting sheet. Bit 3 is undefined. It is possible to select paper roll and slip simultaneously. The commands that need to select paper types for setting are **ESC 2** and **ESC 3**.



TM-U325D

Paper roll and validation can be used as the setting sheet. The commands that need to select paper type for setting are **ESC 2**, **ESC 3**, **GS L**, and **GS W**. If different settings are set for the paper roll and validation and both the paper roll and validation are selected for printing by **ESC c 0**, the printer operation is based on the setting for the validation.



ESC f *t1 t2*

[Name] Set cut sheet wait time

[Format] ASCII ESC f *t1 t2*
 Hex 1B 66 *t1 t2*
 Decimal 27 102 *t1 t2*

[Range] $0 \leq t1 \leq 15$
 $0 \leq t2 \leq 64$

[Default] $t1 = 0$

TM-H5000: $t2 = 5$; **TM-U375, TM-U925, TM-U325D,**
TM-U300C/D: $t2 = 10$

[Printers not featuring this command] None

[Description] Sets the time that the printer waits for the cut sheet (slip, validation, and check paper).

- The waiting time for the cut sheet to be inserted is $t1 \times 1$ minutes.
- The time from detection of the cut sheet to the start of printing is $t2 \times 0.1$ seconds.



[Notes]

- When **t1=0**, the cut sheet waiting time is not set and the printer continues waiting for the cut sheet to be inserted.
- If the sheet is not inserted within [**t1** × 1 minutes], the printer cancels the cut sheet and selects the paper roll as the print sheet.
- In the following cases, the printer continues waiting for the cut sheet to be inserted regardless of the settings of **t1**.
 - Waits for the cut sheet to be inserted when the paper sensor detects no paper with the cut sheet sensor enabled for paper-end stop by **ESC c 4**.
 - Waits for the cut sheet to be inserted when the printer recovers from an error.
- It is possible to cancel the cut sheet waiting state using **DLE ENQ 3**. In this case, however, the data in the print and receive buffers are cleared.
- This setting alone, however, does not cause the printer to immediately start waiting for the cut sheet to be inserted. The setting becomes effective when the printer executes **ESC c 0** or **FS a 0**.

[Model-dependent variations] **TM-U300C/D**

Program Example for all printers

```
PRINT #1, CHR$(&H1B); "f";CHR$(15);CHR$(20);  
PRINT #1, CHR$(&H1B); "c0";CHR$(4); ← Select print sheet
```



TM-U300C/D

The cut sheet wait time set by this command is effective only when the optional validation sensor is installed.



PANEL BUTTON COMMAND

Command **Name**

ESC c 5 n Enable/disable panel buttons



ESC c 5 n

[Name] Enable/disable panel buttons

[Format] ASCII ESC c 5 n
Hex 1B 63 35 n
Decimal 27 99 53 n

[Range] $0 \leq n \leq 255$

[Default] $n = 0$

[Printers not featuring this command] None

[Description] Enables or disables the panel buttons.

- When the LSB of n is 0, all buttons are enabled.
- When the LSB of n is 1, all buttons are disabled.

[Notes] ■ When the printer cover is open, there are buttons that are always enabled or disabled regardless of this command. The buttons are different, depending on the printer model.

■ When the LED blinks to indicate that the printer is waiting for a macro to be executed, the paper feed button is enabled (but paper cannot be fed).

■ To prevent problems caused by accidentally pressing the buttons, use this command to disable the buttons.

[Model-dependent variations] **TM-H5000** **TM-U375** **TM-U925**
TM-U325D **TM-U300C/D**

Program Example for all printers

```
PRINT #1, CHR$(&H1B);"c5";CHR$(1); ← Disable panel buttons
```



TM-H5000

The panel buttons are FEED, FORWARD, REVERSE, and RELEASE. When the PAPER OUT LED and RELEASE LED blink to indicate that the printer is waiting for a macro to be executed, the FEED, FORWARD, and REVERSE buttons are enabled regardless of the setting of this command (but paper cannot be fed).

When the paper roll cover is open, the FEED button is disabled regardless of the setting of this command.

When the front cover is open, the FORWARD, REVERSE, and RELEASE buttons are disabled regardless of the setting of this command.



TM-U375

The panel buttons are PAPER FEED and RELEASE.

When the cover is open, the PAPER FEED is disabled and RELEASE is enabled regardless of the settings of this command.



TM-U925

The panel buttons are RECEIPT FEED and SLIP FEED.

When the cover is open, these buttons are enabled regardless of the settings of this command.



TM-U325D

The panel buttons are FEED and RELEASE.

When the cover is open, these buttons are enabled regardless of the settings of this command.



TM-U300C/D

The panel button is FEED.

When the cover is open, this button is enabled regardless of the settings of this command.



PAPER SENSOR COMMANDS

Command **Name**

ESC c 4 n Select paper sensor(s) to stop printing

ESC c 3 n Select paper sensor(s) to output paper-end signals



ESC c 4 n

[Name]	Select paper sensor(s) to stop printing				
[Format]	ASCII	ESC	c	4	<i>n</i>
	Hex	1B	63	34	<i>n</i>
	Decimal	27	99	52	<i>n</i>
[Range]	$0 \leq n \leq 255$				
[Default]	TM-H5000 TM-U375: <i>n</i> = 0 TM-U925: <i>n</i> = 12 TM-U325D: <i>n</i> = 12 TM-U300C/D: <i>n</i> = 0				
[Printers not featuring this command]	None				



[Description] Selects whether to stop printing or not when the paper runs out using **n** as follows:

Bit	Off/On	Hex	Decimal	Function
0	Off	00	0	Paper roll near-end sensor disabled.
	On	01	1	Paper roll near-end sensor enabled.
1	Off	00	0	Paper roll near-end sensor disabled
	On	02	2	Paper roll near-end sensor enabled.
2	Off	00	0	Paper roll end sensor disabled.
	On	02	4	Paper roll end sensor enabled.
3	Off	00	0	Paper roll end sensor disabled.
	On	08	8	Paper roll end sensor enabled.
4	Off	00	0	Slip TOF sensor disabled.
	On	10	16	Slip TOF sensor enabled.
5	Off	00	0	Slip BOF sensor disabled.
	On	20	32	Slip BOF sensor enabled.

■■■ **how to use this table**



Bit	Off/On	Hex	Decimal	Function
6	Off	00	0	Validation TOF sensor disabled.
	On	40	64	Validation TOF sensor enabled.
7	Off	00	0	Validation BOF sensor disabled.
	On	80	128	Validation BOF sensor enabled.

[Notes]

- It is possible to select multiple sensors to stop printing. When any sensor detects a paper-end, printing stops.
- When a paper sensor is enabled with this command, printing stops only when the corresponding paper is selected as the print sheet. Print sheet can be selected by **ESC c 0**.
- Some sensors are not present, depending on the printer model.
- The names of some sensors differ depending on the printer model.
- The paper roll near-end sensor is enabled when either bit 0 or bit 1 is on or both are on.
- The paper roll end sensor is enabled when either bit 2 or bit 3 is on or both are on.



- When a paper near-end is detected, printing stops after printing the current line and feeding the paper. The printer goes off-line and Paper LED comes on after printing stops. To resume printing, cancel the "paper roll near-end" status by replacing the paper roll.
- If the paper roll near-end sensor is disabled and a paper near-end is detected, printing does not stop and the printer does not go off-line, but the Paper LED comes on.
- When a paper roll end is detected, the printer performs the same operations as when a paper roll near-end is detected.
- When the slip TOF sensor or the slip BOF sensor is enabled and a paper-end is detected, the printer ejects the paper after printing as much as possible and enters the cut sheet waiting state. The printer does not go off-line.
- When the slip TOF sensor or the slip BOF sensor is disabled and a paper-end is detected, the printer does not stop printing and ejects the paper.
- When the validation TOF sensor or the validation BOF sensor detects a paper-end, the printer performs the same operations as when the slip TOF sensor or the slip BOF sensor detects a paper-end.

[Model-dependent variations] **TM-H5000** **TM-U375** **TM-U925**

TM-U325D **TM-U300C/D**



Program Example for all printers

```
PRINT #1, CHR$(&H1B);"c4";CHR$(1); ← Paper roll near-end sensor enabled
```



TM-H5000

Bits 2, 3, 6 and 7 are undefined.

The paper roll end sensor is always enabled and when it detects a paper-end, the printer stops printing.

When a paper roll near-end or a paper roll end are detected, the PAPER OUT LED comes on.



TM-U375

Bits 2, 3, 4, and 6 are undefined.

When a paper roll near-end is detected, the JOURNAL OUT LED comes on.



TM-U925

Bit 6 and bit 7 are undefined.

Bits 4 and 5 indicate the same sensor. The name of the sensor is "slip insertion sensor". The slip insertion sensor is enabled when either bit 4 or bit 5 is on or both are on.

When a paper roll near-end or a paper roll end is detected, the RECEIPT OUT LED comes on.



TM-U325D

Bits 4 and 5 are undefined. Bits 6 and 7 indicate the same paper sensor. The name of the paper sensor is "validation sensor". When either bit is on or both are on, the validation sensor is enabled. When a paper roll near-end or a paper roll end is detected, the RECEIPT OUT LED comes on.



TM-U300C/D

Bits 1, 3, 4, 5, 6, and 7 are undefined.

When a paper roll near-end or a paper roll end is detected, the PAPER OUT LED comes on.



ESC c 3 n

[Name] Select paper sensor(s) to output paper-end signals

[Format] ASCII ESC c 3 n
 Hex 1B 63 33 n
 Decimal 27 99 51 n

[Range] $0 \leq n \leq 255$

[Default] **TM-H5000, TM-U325D: $n = 15$** **TM-U375, TM-U300C/D: $n = 3$**

[Printers not featuring this command] **TM-U925**

[Description] Selects whether to output paper-end signals to a parallel interface or not when a paper-end is detected by the sensor selected, using n as follows:

Bit	Off/On	Hex	Decimal	Function
0	Off	00	0	Paper roll near-end sensor disabled.
	On	01	1	Paper roll near-end sensor enabled.
1	Off	00	0	Paper roll near-end sensor disabled.
	On	02	2	Paper roll near-end sensor enabled.
2	Off	00	0	Paper roll end sensor disabled.
	On	02	4	Paper roll end sensor enabled.

■■■ **how to use this table**



Bit	Off/On	Hex	Decimal	Function
3	Off	00	0	Paper roll end sensor disabled.
	On	08	8	Paper roll end sensor enabled.
4	Off	00	0	Slip TOF sensor disabled.
	On	10	16	Slip TOF sensor enabled.
5	Off	00	0	Slip BOF sensor disabled.
	On	20	32	Slip BOF sensor enabled.
6	Off	00	0	Validation TOF sensor disabled.
	On	40	64	Validation TOF sensor enabled.
7	Off	00	0	Validation BOF sensor disabled.
	On	80	128	Validation BOF sensor enabled.

[Notes]

- This command is enabled only with a parallel interface and is ignored with a serial interface.
- The paper roll near-end sensor is enabled when either bit 0 or bit 1 is on or both are on.
- The paper roll end sensor is enabled when either bit 2 or bit 3 is on or both are on.



- It is possible to select multiple sensors to output signals. When any of the sensors detects a paper-end, the paper-end signal is output.
- Some sensors are not present, depending on the printer model.
- The names of some sensors differ depending on the printer model.

[Model-dependent variations] **TM-H5000** **TM-U375** **TM-U325D** **TM-U300C/D**

Program Example for all printers

```
PRINT #1, CHR$(&H1B); "c3"; CHR$(4); ← Paper roll end sensor enabled
```



TM-H5000

Bits 6 and 7 are undefined.



TM-U375

Bits 2 and 3 are undefined.

Bits 4, 5, 6, and 7 indicate the same sensor. The name of the sensor is cut sheet sensor. The cut sheet sensor is enabled when either bit 4, bit 5, bit 6, or bit 7 is on or all bits are on.



TM-U325D

Bits 4 and 5 are undefined. Bits 6 and 7 indicate the same paper sensor. The name of the paper sensor is "validation sensor".



TM-U300C/D

Bits 1, 3, 4, 5, 6, and 7 are undefined. Bit 6 or 7 is enabled only when the optional validation sensor is installed.



PRINT POSITION COMMANDS

Command	Name
HT	Horizontal tab
ESC D n1 ... nk NUL	Set horizontal tab positions
GS L nL nH	Set left margin
GS W nL nH	Set printing area width
ESC a n	Select justification
ESC \$ nL nH	Set absolute print position
ESC \ nL nH	Set relative print position
ESC W xL xH yL yH dxL dxH dyL dyH	Set printing area in page mode
ESC T n	Select print direction in page mode
GS \$ nL nH	Set absolute vertical print position in page mode
GS \ nL nH	Set relative vertical print position in page mode



HT

[Name] Horizontal tab

[Format] ASCII HT

Hex 09

Decimal 9

[Range] None

[Default] None

[Printers not featuring this command] **TM-U925**

[Description] Moves the printing position to the next horizontal tab.

- [Notes]
- This command is ignored unless the next horizontal tab position has been set.
 - Horizontal tab positions are set by **ESC D**.
 - If the next horizontal tab position exceeds the printing area, the printer sets the printing position to [Printing area width + 1].
 - If this command is processed when the printing position is at [Printing area width + 1], the printer executes print buffer-full printing of the current line and horizontal tab processing from the beginning of the next line. In this case, in page mode, the printer does not execute printing but the printing position is moved.

[Model-dependent variations] None

See program example for **HT** and **ESC D**.



ESC D *n1* ... *nk* NUL

[Name]	Set horizontal tab positions				
[Format]	ASCII	ESC	D	<i>n1</i> ... <i>nk</i>	NUL
	Hex	1B	44	<i>n1</i> ... <i>nk</i>	00
	Decimal	27	68	<i>n1</i> ... <i>nk</i>	0
[Range]	$1 \leq n \leq 255$				
	$0 \leq k \leq 32$				
[Default]	$n = 8, 16, 24, 32, \dots$ (Every eight characters for the default font set by ESC ! or ESC M)				
[Printers not featuring this command]	TM-U925				
[Description]	Sets a horizontal tab to <i>n</i> columns from the beginning of the line.				
[Notes]	<ul style="list-style-type: none"> • <i>k</i> indicates the number of horizontal tab positions to be set. 				
	<ul style="list-style-type: none"> ■ The horizontal tab position is stored as a value of [character width × <i>n</i>] measured from the beginning of the line. The character width includes the right-side character spacing, and double-width characters are selected with twice the width of normal characters. 				
	<ul style="list-style-type: none"> ■ A maximum of 32 horizontal tab positions can be set. Data exceeding 32 horizontal tab positions are processed as normal data. 				
<ul style="list-style-type: none"> ■ This command cancels any previous horizontal tab settings. 					



- Transmit $[n]k$ in ascending order and place a **NUL** code at the end. **ESC D NUL** cancels all horizontal tab positions.
- When $[n]$ is less than or equal to the preceding value $[n]k-1$, horizontal tab setting is finished and the following data is processed as normal data.
- k is not transmission data to the printer.

[Model-dependent variations] None

See program example for **HT** and **ESC D**.



Program example for HT and ESC D

Program Example

```
PRINT #1, "0123456789012345678901234567890123456";
PRINT #1, CHR$(&HA);
FOR i=1 TO 4
  PRINT #1, CHR$(&H9); "H"; ← Execute HT
NEXT i : PRINT #1, CHR$(&HA);
PRINT #1, CHR$(&H1B); "D";CHR$(10);CHR$(20);
PRINT #1, CHR$(30);CHR$(0); ← Set HT positions
FOR i=1 TO 4
  PRINT #1, CHR$(&H9); "H"; ← Execute HT
NEXT i : PRINT #1, CHR$(&HA);
```

Print Sample

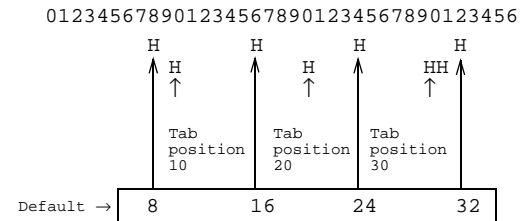

GS L *nL nH*

[Name] Set left margin

[Format] ASCII GS L *nL nH*
 Hex 1D 4C *nL nH*
 Decimal 29 76 *nL nH*

[Range] $0 \leq nL \leq 255$
 $0 \leq nH \leq 255$

[Default] $nL = 0, nH = 0$

[Printers not featuring this command] **TM-U925, TM-U300C/D**

[Description] In standard mode, sets the left margin to $(nL + nH \times 256) \times$ (horizontal motion unit) from the left edge of the printable area.

- [Notes]
- When standard mode is selected, this command is enabled only when processed at the beginning of the line.
 - The left margin has no effect in page mode. If this command is processed in page mode, the left margin is set and it is enabled when the printer returns to standard mode.
 - This command is available for the paper type selected by **ESC c 1**. The left margin can be set independently for paper roll and slip and validation paper.



- If the setting exceeds the printable area, the left margin is automatically set to the maximum value of the printable area.
- If this command and **GS W** set the printing area width to less than the width of one character, the printing area width is extended to accommodate one character for the line.

[Model-dependent variations] **TM-H5000** **TM-U375** **TM-U325D**
See program example for **GS L** and **GS W**.



TM-H5000

The horizontal motion unit is specified by **GS P**.



TM-U375

The horizontal motion unit is specified by **GS P**.



TM-U325D

The horizontal motion unit is 1/160 inches (the minimum movement amount). This value equals a half dot pitch.



GS W nL nH

[Name] Set printing area width

[Format] ASCII GS W nL nH
 Hex 1D 57 nL nH
 Decimal 29 87 nL nH

[Range] $0 \leq nL \leq 255$
 $0 \leq nH \leq 255$

[Default] Entire printable area

TM-H5000: For the paper roll: $nL = 0, nH = 2$

For the slip paper: $nL = 32, nH = 3$

TM-U375: $nL = 144, nH = 1$

TM-U325D: $nL = 144, nH = 1$

[Printers not featuring this command] **TM-U925, TM-U300C/D**

[Description] In standard mode, sets the printing area width to $(nL + nH \times 256) \times$ (horizontal motion unit).

- [Notes]
- When standard mode is selected, this command is enabled only when processed at the beginning of the line.
 - The printing area width has no effect in page mode. If this command is processed in page mode, the printing area width is set and it is enabled when the printer returns to standard mode.
 - This command is available for the paper type selected by **ESC c 1**. The printing area width can be set independently for paper roll and slip and validation paper.



- If the [left margin + printing area width] exceeds the printable area, the printing area width is automatically set to [printable area - left margin].
- If this command and **GS L** set the printing area width to less than the width of one character, the printing area width is extended to accommodate one character for the line.

[Model-dependent variations] **TM-H5000** **TM-U375** **TM-U325D**
See program example for **GS L** and **GS W**.



TM-H5000

The horizontal motion unit is specified by **GS P**.



TM-U375

The horizontal motion unit is specified by **GS P**.



TM-U325D

The horizontal motion unit is 1/160 inches (the minimum movement amount). This value equals a half dot pitch.



Program example for GS L and GS W

Program Example

```
PRINT #1, CHR$(&H1B);"c0";CHR$(1); ← Select print sheet
PRINT #1, CHR$(&H1B);"c1";CHR$(1); ← Select setting sheet
PRINT #1, CHR$(&H1D);"P";CHR$(180);CHR$(180);
PRINT #1, "01234567890123456789"; CHR$(&HA);
PRINT #1, CHR$(&H1D);"L";CHR$(60);CHR$(0); ← Set left margin
PRINT #1, CHR$(&H1D);"W";CHR$(120);CHR$(0); ← Set printing area width
PRINT #1, "01234567890123456789"; CHR$(&HA);
```

Print Sample

```
01234567890123456789
      0123456789
      0123456789
      |-----|
      Left   Printing area
      margin width
```



ESC a *n*

[Name] Select justification

[Format] ASCII ESC a *n*
 Hex 1B 61 *n*
 Decimal 27 97 *n*

[Range] $0 \leq n \leq 2, 48 \leq n \leq 50$

[Default] $n = 0$

[Printers not featuring this command] **TM-U300C/D**

[Description] In standard mode, aligns all the data in one line to a specified position, using *n* as follows:

<i>n</i>	Justification
0, 48	Left justification
1, 49	Centered
2, 50	Right justification



[Notes]

- When standard mode is selected, this command is enabled only when processed at the beginning of the line in standard mode.
- The justification has no effect in page mode. If this command is processed in page mode, an internal flag is activated and this flag is enabled when the printer returns to standard mode.
- This command executes justification in the printing area set by **GS L** and **GS W**.
- This command justifies printing data (such as characters, bit images, and bar codes) and space area set by **HT**, **ESC \$**, and **ESC **.

[Model-dependent variations] None

Program Example for all printers

```
FOR n=0 TO 2
  PRINT #1, CHR$(&H1B);"a";CHR$(n);
  PRINT #1, "ABC"; CHR$(&HA);
  PRINT #1, "ABCD"; CHR$(&HA);
  PRINT #1, "ABCDE"; CHR$(&HA);
NEXT n
```

Print Sample

```
ABC
ABCD
ABCDE ] ESC a 0

ABC
ABCD
ABCDE ] ESC a 1

ESC a 2 [ ABC
                        ABCD
                        ABCDE
```



ESC \$ *nL nH*

[Name] Set absolute print position

[Format] ASCII ESC \$ *nL nH*
 Hex 1B 24 *nL nH*
 Decimal 27 36 *nL nH*

[Range] $0 \leq nL \leq 255$
 $0 \leq nH \leq 255$

[Printers not featuring this command] **TM-U300C/D**

[Description] Sets the print starting position to $(nL + nH \times 256) \times$ (horizontal or vertical motion unit) from the beginning of the line.



[Notes]

- The printer ignores any setting that exceeds the printing area.
- When standard mode is selected, the horizontal motion unit is used.
- When page mode is selected, the horizontal or vertical motion unit is used for the print direction set by **ESC T**.
 - When the starting position is set to the upper left or lower right of the printing area using **ESC T**, the horizontal motion unit is used.
 - When the starting position is set to the upper right or lower left of the printing area using **ESC T**, the vertical motion unit is used.
- When a left margin is set in standard mode, the position of the left margin is the beginning of the line.

[Model-dependent variations] **TM-H5000** **TM-U375** **TM-U925** **TM-U325D**

See program example for **ESC \$** and **ESC **.



TM-H5000

The vertical or horizontal motion unit is specified by **GS P**.



TM-U375

The vertical or horizontal motion unit is specified by **GS P**.



TM-U925

The horizontal motion unit is specified by **GS P**. This command does not use the vertical motion unit because the printer does not support Page mode.



TM-U325D

The horizontal motion unit is 1/160 inches (the minimum movement amount). This value equals a half dot pitch. This command does not use the vertical motion unit because the printer does not support Page mode.



ESC \ *nL nH*

[Name] Set relative print position

[Format] ASCII ESC \ *nL nH*
 Hex 1B 5C *nL nH*
 Decimal 27 92 *nL nH*

[Range] $0 \leq nL \leq 255$
 $0 \leq nH \leq 255$

[Default] None

[Printers not featuring this command] **TM-U300C/D**

[Description] Moves the print starting position to $(nL + nH \times 256) \times$ (horizontal or vertical motion unit) from the current position.

- [Notes]
- The printer ignores any setting that exceeds the printing area.
 - A positive number specifies movement to the right, and a negative number specifies movement to the left.
 N pitch movement to the right: $(nL + nH \times 256) = N$.
 Use the complement of N for setting N pitch movement to the left: $(nL + nH \times 256) = 65536 - N$.
 - When standard mode is selected, the horizontal motion unit is used.



- When page mode is selected, the horizontal or vertical motion unit is used for the print direction set by **ESC T**.
 - When the starting position is set to the upper left or lower right of the printing area using **ESC T**, the horizontal motion unit is used.
 - When the starting position is set to the upper right or lower left of the printing area using **ESC T**, the vertical motion unit is used.

[Model-dependent variations] **TM-H5000** **TM-U375** **TM-U925** **TM-U325D**

See program example for **ESC \$** and **ESC **.



Program example for ESC \$ and ESC \

Program Example

```
PRINT #1, CHR$(&H1D); "P";CHR$(180);CHR$(180);  
PRINT #1, "ABCD";  
PRINT #1, CHR$(&H1B); "$";CHR$(90);CHR$(0); ←Set absolute position  
PRINT #1, "EFGH"; CHR$(&HA);  
PRINT #1, "ABCD";  
PRINT #1, CHR$(&H1B); "\";CHR$(90);CHR$(0); ←Set relative position  
PRINT #1, "EFGH"; CHR$(&HA);
```

Print Sample

90/180 inch
|----->
ABCD EFGH
ABCD EFGH
|----->
90/180 inch



TM-H5000

The vertical or horizontal motion unit is specified by **GS P**.



TM-U375

The vertical or horizontal motion unit is specified by **GS P**.



TM-U925

The horizontal motion unit is specified by **GS P**. This command does not use the vertical motion unit because this printer does not support Page mode.



TM-U325D

The horizontal motion unit is 1/160 inches (the minimum movement amount). This value equals a half dot pitch. This command does not use the vertical motion unit because the printer does not support Page mode.



ESC W xL xH yL yH dxL dxH dyL dyH

[Name]	Set printing area in page mode										
[Format]	ASCII	ESC	W	xL	xH	yL	yH	dxL	dxH	dyL	dyH
	Hex	1B	57	xL	xH	yL	yH	dxL	dxH	dyL	dyH
	Decimal	27	87	xL	xH	yL	yH	dxL	dxH	dyL	dyH
[Range]	$0 \leq xL, xH, yL, yH, dxL, dxH, dyL, dyH \leq 255$ (except for $dxL = dxH = 0$ or $dyL = dyH = 0$)										
[Default]	Horizontal logical origin and vertical logical origin = 0 $xL = 0, xH = 0, yL = 0, yH = 0$ Printing area width and printing area height = entire printable area TM-H5000: $dxL = 0, dxH = 2, dyL = 126, dyH = 6$ TM-U375: $dxL = 144, dxH = 1, dyL = 128, dyH = 5$										
[Printers not featuring this command]	TM-U925, TM-U325D, TM-U300C/D										
[Description]	In page mode, sets the size and the logical origin of the printing area as follows: <ul style="list-style-type: none"> • Horizontal logical origin = $(xL + xH \times 256) \times$ (horizontal motion unit) from absolute origin. • Vertical logical origin = $(yL + yH \times 256) \times$ (vertical motion unit) from absolute origin. • Printing area width = $(dxL + dxH \times 256) \times$ (horizontal motion unit) • Printing area height = $(dyL + dyH \times 256) \times$ (vertical motion unit) 										



[Notes]

- Both printing area width and height cannot be set to 0.
- The absolute origin is the upper left of the printable area.
- If the horizontal or vertical logical origin is set outside the printable area, this command is canceled, and the following data is processed as normal data.
- If [horizontal logical origin + printing area width] exceeds the printable area, the printing area width is automatically set to [horizontal printable area – horizontal logical origin].
- If [vertical logical origin + printing area height] exceeds the printable area, the printing area height is automatically set to [vertical printable area – vertical logical origin].
- The printing area and the logical origin set by this command is effective only in page mode.
- This command setting has no effect in standard mode. If this command is processed in standard mode, the logical origin and the printing area are set and they are enabled when the printer selects page mode.

[Model-dependent variations] **TM-H5000** **TM-U375**



Program Example for all printers

```
PRINT #1, CHR$(&H1B);"L";← Select page mode
PRINT #1, CHR$(&H1D);"P";CHR$(180);CHR$(180);
PRINT #1, CHR$(&H1B);"W";CHR$(0);CHR$(0);CHR$(0);CHR$(0);CHR$(180);
CHR$(0);CHR$(44);CHR$(1); ← Set printing area
PRINT #1, CHR$(&H1B);"T";CHR$(0); ← Select print direction
PRINT #1, "AAAAA"; CHR$(&HA);
PRINT #1, "BBBBB"; CHR$(&HA);
PRINT #1, CHR$(&H1B);"T";CHR$(2); ← Select print direction
PRINT #1, "CCCCC"; CHR$(&HA);
PRINT #1, "DDDDD"; CHR$(&HC); ← Batch print and return to standard mode
```

Print Sample

```
AAAAA
BBBBB

← Printing
area set
by ESC W

DDDDD
CCCCC
```



TM-H5000

Page mode can be used only when the paper roll is selected as the print sheet. However, the setting is always enabled.

The vertical or horizontal motion unit is specified by **GS P** for the paper roll.

The printable area width is 512/180 inches and the printable area height is 1662/360 inches.



TM-U375

The vertical or horizontal motion unit is specified by **GS P**.

The printable area width is 400/160 inches and the printable area height is 1408/144 inches.



ESC T *n*

[Name] Select print direction in page mode

[Format] ASCII ESC T *n*
 Hex 1B 54 *n*
 Decimal 27 84 *n*

[Range] $0 \leq n \leq 3, 48 \leq n \leq 51$

[Default] $n = 0$

[Printers not featuring this command] **TM-U925, TM-U325D, TM-U300C/D**

[Description] In page mode, selects the print direction and starting position using *n* as follows:

<i>n</i>	Print Direction	Starting Position
0, 48	Left to right	Upper left (A in the figure)
1, 49	Bottom to top	Lower left (B in the figure)
2, 50	Right to left	Lower right (C in the figure)
3, 51	Top to bottom	Upper right (D in the figure)

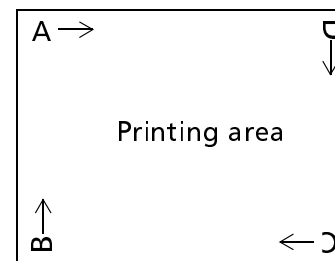

[Notes]

- The print direction set by this command is effective only in page mode.
- This command setting has no effect in standard mode. If this command is processed in standard mode, an internal flag is activated and this flag is enabled when the printer selects page mode.
- The parameters for the horizontal or vertical motion unit differs depending on the starting position of the printing area as follows:
 - If the starting position is the upper left or lower right of the printing area:
These commands use horizontal motion units:
**ESC SP, ESC \$, ESC **
These commands use vertical motion units: **ESC 3, ESC J, GS \$, GS **
 - If the starting position is the upper right or lower left of the printing area:
These commands use horizontal motion units:
**ESC 3, ESC J, GS \$, GS **
These commands use vertical motion units: **ESC SP, ESC \$, ESC **

[Model-dependent variations] **TM-H5000**



Program Example for all printers

```
PRINT #1, CHR$(&H1B);"L"; ← Select page mode
PRINT #1, CHR$(&H1D);"P";CHR$(180);CHR$(180);
PRINT #1, CHR$(&H1B);"W";CHR$(0);CHR$(0);CHR$(0);CHR$(0);
CHR$(240);CHR$(0);CHR$(200);CHR$(0); ← Set printing area
PRINT #1, CHR$(&H1B);"T";CHR$(0); ← Select print direction
PRINT #1, "AAAAA"; CHR$(&HA);
PRINT #1, "BBBBB"; CHR$(&HA);
PRINT #1, CHR$(&H1B);"T";CHR$(1); ← Select print direction
PRINT #1, "CCCCC"; CHR$(&HA);
PRINT #1, "DDDDD"; CHR$(&HA);
PRINT #1, CHR$(&H1B);"T";CHR$(2); ← Select print direction
PRINT #1, "EEEEEE"; CHR$(&HC); ← Batch print and return to standard mode
```

Print Sample

```
AAAAA
BBBBB
CCCCC
DDDDD
EEEEEE
```

← Printing area set by **ESC W**



TM-H5000

Page mode can be used only when the paper roll is selected as the print sheet. However, the setting is always enabled.



GS \$ nL nH

[Name] Set absolute vertical print position in page mode

[Format] ASCII GS \$ nL nH
Hex 1D 24 nL nH
Decimal 29 36 nL nH

[Range] $0 \leq nL \leq 255, 0 \leq nH \leq 255$

[Default] None

[Printers not featuring this command] **TM-U375, TM-U925, TM-U325D,**
TM-U300C/D

[Description] In page mode, sets the vertical printing position to $(nL + nH \times 256) \times$ (vertical or horizontal motion unit) from the starting position set by **ESC T**.

- [Notes]
- This command is enabled only in page mode. If this command is processed in standard mode, it is ignored.
 - The printer ignores any setting that exceeds the printing area set by **ESC W**.
 - The horizontal or vertical motion unit is used for the print direction set by **ESC T**.
 - When the starting position is set to the upper left or lower right of the printing area using **ESC T**, the vertical motion unit is used.
 - When the starting position is set to the upper right or lower left of the printing area using **ESC T**, the horizontal motion unit is used.

[Model-dependent variations] **TM-H5000** **TM-U325D**

See program example for **GS \$** and **GS **.



TM-H5000

Page mode can be used only when the paper roll is selected as the print sheet. The vertical or horizontal motion unit is specified by **GS P** for the paper roll.



TM-U325D

The horizontal motion unit is 1/160 inches (the minimum movement amount). This value equals a half dot pitch. This command does not use the vertical motion unit because the printer does not support Page mode.



GS \ nL nH

[Name] Set relative vertical print position in page mode

[Format] ASCII GS \ nL nH
 Hex 1D 5C nL nH
 Decimal 29 92 nL nH

[Range] $0 \leq nL \leq 255$
 $0 \leq nH \leq 255$

[Default] None

[Printers not featuring this command] **TM-U375, TM-U925,**
TM-U325D, TM-U300C/D

[Description] In page mode, moves the vertical printing position to $(nL + nH \times 256) \times$ (vertical or horizontal motion unit) from the current position.

- [Notes]
- This command is enabled only in page mode. If this command is processed in standard mode, it is ignored.
 - The printer ignores any setting that exceeds the printing area set by **ESC W**.
 - A positive number specifies movement to the downward, and a negative number specifies movement to the upward. N pitch movement to the downward: $(nL + nH \times 256) = N$. Use the complement of N for setting N pitch movement to the upward: $(nL + nH \times 256) = 65536 - N$.



- The horizontal or vertical motion unit is used for the print direction set by **ESC T**.
 - When the starting position is set to the upper left or lower right of the printing area using **ESC T**, the vertical motion unit is used.
 - When the starting position is set to the upper right or lower left of the printing area using **ESC T**, the horizontal motion unit is used.

[Model-dependent variations] **TM-H5000**

See program example for **GS \$** and **GS **.



Program example for GS \$ and GS \

Program Example

```
PRINT #1, CHR$(&H1B);"L"; ← Select page mode
PRINT #1, CHR$(&H1D);"P";CHR$(180);CHR$(180);
PRINT #1, CHR$(&H1B);"W";CHR$(0);CHR$(0);CHR$(0);CHR$(0);
CHR$(180);CHR$(0);CHR$(144);CHR$(1); ← Set printing area
PRINT #1, CHR$(&H1B);"T";CHR$(0); ← Select print direction
PRINT #1, "AAAAA"; CHR$(&HA);
PRINT #1, "BBBBB";
PRINT #1, CHR$(&H1D);"$";CHR$(90);CHR$(0); ← Set absolute position
PRINT #1, "CCCCC"; CHR$(&HA);
PRINT #1, "DDDDD"; CHR$(&HA);
PRINT #1, "EEEEEE";
PRINT #1, CHR$(&H1D);"\";CHR$(90);CHR$(0); ← Set relative position
PRINT #1, "FFFFFF"; CHR$(&HC); ← Batch print and return to standard mode
```

Print Sample

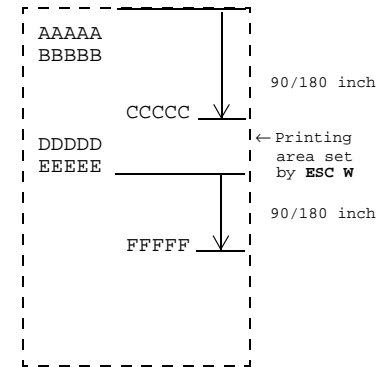

TM-H5000

Page mode can be used only when the paper roll is selected as the print sheet. The vertical or horizontal motion unit is specified by **GS P** for the paper roll.



BIT-IMAGE COMMANDS

Command	Name
ESC * m nL nH d1 ... dk	Select bit-image mode
GS * x y d1 ... d(x × y × 8)	Define downloaded bit image
GS / m	Print downloaded bit image
GS v 0 m xL xH yL yH d1 ... dk	Print raster bit image



ESC * *m nL nH d1 ... dk*

[Name] Select bit-image mode

[Format] ASCII ESC * *m nL nH d1 ... dk*

Hex 1B 2A *m nL nH d1 ... dk*

Decimal 27 42 *m nL nH d1 ... dk*

[Range] **TM-H5000:** For the paper roll: *m = 0, 1, 32, 33*

0 ≤ nL ≤ 255

0 ≤ nH ≤ 3

0 ≤ d ≤ 255

For the slip paper: *m = 0, 1*

0 ≤ nL ≤ 255

0 ≤ nH ≤ 3

0 ≤ d ≤ 255

TM-U375: *m = 0, 1*

0 ≤ nL ≤ 255

0 ≤ nH ≤ 3

0 ≤ d ≤ 255

TM-U925: *m = 0, 1*

0 ≤ nL ≤ 255

0 ≤ nH ≤ 3

0 ≤ d ≤ 255

TM-U325D: *m = 0, 1*

0 ≤ nL ≤ 255

0 ≤ nH ≤ 3

0 ≤ d ≤ 255

TM-U300C/D: *m = 0, 1*

0 ≤ nL ≤ 255

0 ≤ nH ≤ 3

0 ≤ d ≤ 255



[Default] None

[Printers not featuring this command] None

[Description] Selects a bit-image mode using m for the number of dots specified by $(nL + nH \times 256)$, as follows:

m	Mode	Number of Bits for Vertical data	Dot Density in Horizontal	Amount of Data (k)
0	8-dot single-density	8	Single-density	$nL + nH \times 256$
1	8-dot double-density	8	Double-density	$nL + nH \times 256$
32	24-dot single-density	24	Single-density	$(nL + nH \times 256) \times 3$
33	24-dot double-density	24	Double-density	$(nL + nH \times 256) \times 3$

- d indicates the bit image data.

[Notes]

- If the value of m or nH is out of the range, this command is canceled, and the following data is processed as normal data.
- Data (d) specifies a bit printed to 1 and not printed to 0.
- If the bit image data exceeds the number of dots to be printed on a line, the excess data is ignored.
- The bit-image is not affected by print mode (emphasized, double-strike, underline, character size, white/black reverse printing, or 90° clockwise-rotated), except for upside-down printing mode.
- After printing a bit image, the printer processes normal data.



- When printing multiple line bit images, selecting unidirectional printing mode with **ESC U** enables printing patterns in which the top and bottom parts are aligned vertically.
- This command is used to print a picture or logo.

[Model-dependent variations] **TM-H5000** **TM-U375** **TM-U925**
 TM-U325D **TM-U300C/D**



Program Example for all printers

```
m=0: GOSUB bitimage8 ← 8-dot single-density
m=1: GOSUB bitimage8 ← 8-dot double-density
END

bitimage8:
PRINT #1, CHR$(&H1B);"*";CHR$(m);CHR$(70);CHR$(0);
FOR i=1 TO 5
  PRINT #1, CHR$(1);CHR$(2);CHR$(4);CHR$(8);
  PRINT #1, CHR$(16);CHR$(32);CHR$(64);CHR$(128);
  PRINT #1, CHR$(64);CHR$(32);CHR$(16);CHR$(8);
  PRINT #1, CHR$(4);CHR$(2);
NEXT i
PRINT #1, CHR$(&HA);
RETURN
```

Print Sample

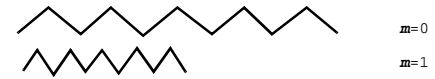

TM-H5000

The modes that can be specified are different for a paper roll and slip, using m as follows:

<Paper roll>

m	Mode	Vertical Dot Density	Horizontal Dot Density	Amount of Data (k)
0	8-dot single-density	60 DPI	90 DPI	$nL + nH \times 256$
1	8-dot double-density	60 DPI	180 DPI	$nL + nH \times 256$
32	24-dot single-density	180 DPI	90 DPI	$(nL + nH \times 256) \times 3$
33	24-dot double-density	180 DPI	180 DPI	$(nL + nH \times 256) \times 3$

<Slip>

m	Mode	Vertical Dot Density	Horizontal Direction		
			Dot Density	Set Adjacent Dots	Maximum Number of Dots
0	8-dot single-density	72 DPI	75 DPI	Permitted	400
1	8-dot double-density	72 DPI	150 DPI	Prohibited	800

Amount of data (k) is $(nL + nH \times 256)$.



TM-U375

In page mode, double-density bit image is disabled. If double-density bit image is processed when page mode is selected, this command is canceled, and the data following nL (and including nL) is processed as normal data. The modes selectable by m are as follows:

m	Mode	Vertical Dot Density	Horizontal Direction		
			Dot Density	Set Adjacent Dots	Maximum Number of Dots in standard mode
0	8-dot single-density	72 DPI	80 DPI	Permitted	200
1	8-dot double-density	72 DPI	160 DPI	Prohibited	400

Amount of data (k) is $(nL + nH \times 256)$.

In page mode, the maximum number of horizontal dots of single-density mode depends on the printing direction specified by **ESC T**, as follows:

- When the starting position is set to the upper left or lower right of the printing area using **ESC T**, the maximum number of horizontal dots is 200.
- When the starting position is set to the upper right or lower left of the printing area using **ESC T**, the maximum number of horizontal dots is 1408.



TM-U925

The modes selectable by m are as follows:

m	Mode	Vertical Dot Density	Horizontal Direction			
			Dot Density	Set Adjacent Dots	Maximum Number of Dots	
					Paper roll	Slip
0	8-dot single-density	72 DPI	75 DPI	Permitted	180	400
1	8-dot double-density	72 DPI	150 DPI	Prohibited	360	800

Amount of data (k) is $(nL + nH \times 256)$.



TM-U325D

The modes selectable by m are as follows:

m	Mode	Vertical Dot Density	Horizontal Direction		
			Dot Density	Set Adjacent Dots	Maximum Number of Dots in standard mode
0	8-dot single-density	72 DPI	80 DPI	Permitted	200
1	8-dot double-density	72 DPI	160 DPI	Prohibited	400

Amount of data (k) is $(nL + nH \times 256)$.



TM-U300C/D

The modes selectable by m are as follows:

m	Mode	Vertical Dot Density	Horizontal Direction		
			Dot Density	Set Adjacent Dots	Maximum Number of Dots in standard mode
0	8-dot single-density	72 DPI	80 DPI	Permitted	200
1	8-dot double-density	72 DPI	160 DPI	Prohibited	400

Amount of data (k) is $(nL + nH \times 256)$.



GS * x y d1 ... d(x × y × 8)

[Name]	Define downloaded bit image					
[Format]	ASCII	GS	*	x	y	d1 ... d(x × y × 8)
	Hex	1D	2A	x	y	d1 ... d(x × y × 8)
	Decimal	29	42	x	y	d1 ... d(x × y × 8)
[Range]	TM-H5000: For the paper roll: $1 \leq x \leq 255$ $1 \leq y \leq 48$ $x \times y \leq 1536$ $0 \leq d \leq 255$ For the slip paper: $1 \leq x \leq 255$ $1 \leq y \leq 255$ $x \times y \leq 404$ $0 \leq d \leq 255$ TM-U375: $1 \leq x \leq 255$ $1 \leq y \leq 255$ $x \times y \leq 512$ $0 \leq d \leq 255$ TM-U925: $1 \leq x \leq 255$ $1 \leq y \leq 255$ $x \times y \leq 155$ (when the receive buffer capacity is 2K bytes) $x \times y \leq 404$ (when the receive buffer capacity is 32 bytes) $0 \leq d \leq 255$					
[Default]	None					
[Printers not featuring this command]	TM-U325D		TM-U300C/D			



[Description] Defines a downloaded bit image using ($x \times 8$) dots in the horizontal direction and ($y \times 8$) dots in the vertical direction.

- ***d*** indicates the bit image data.

[Notes]

- Data (***d***) specifies a bit printed to 1 and not printed to 0.
- If the value of ***x***, ***y***, or (***x*** \times ***y***) is out of the range, this command is canceled, and the following data is processed as normal data.
- The downloaded bit image is not defined at the default.
- Once a downloaded bit image has been defined, it is available until another definition is made; **ESC &** or **ESC @** is executed; the printer is reset; or the power is turned off.
- Downloaded bit image and a user-defined character cannot be defined simultaneously. When this command is executed, the user-defined character is cleared.
- The downloaded bit image is printed by **GS /**.

[Model-dependent variations] **TM-H5000**

See program example for **GS *** and **GS /**.



TM-H5000

This command defines the pattern defined for the paper type selected by **ESC c 1**. The downloaded bit image can be set independently for paper roll and slip.



GS / m

[Name] Print downloaded bit image

[Format] ASCII GS / m
 Hex D 2F m
 Decimal 29 47 m

[Range] **TM-H5000: For the paper roll: $0 \leq m \leq 3$, $48 \leq m \leq 51$**
For the slip paper: $m = 0, 1, 48, 49$

TM-U375: $m = 0, 1, 48, 49$

TM-U925: $m = 0, 1, 48, 49$

[Default] None

[Printers not featuring this command] **TM-U325D** **TM-U300C/D**

[Description] Prints a downloaded bit image using the mode specified by ***m***, as follows:

<i>m</i>	Mode
0, 48	Normal
1, 49	Double-width
2, 50	Double-height
3, 51	Quadruple



[Notes]

- This command is ignored if a downloaded bit image has not been defined.
- When standard mode is selected, this command is enabled only when there is no data in the print buffer. If data exists in the print buffer, the printer processes *m* as normal data.
- When page mode is selected, this command develops the downloaded bit image data in the print buffer but the printer does not print the downloaded bit image data.
- If a downloaded bit image exceeds one line, the excess data is not printed.
- This command feeds as much paper as is required to print the downloaded bit image, regardless of the line spacing specified by **ESC 2** or **ESC 3**.
- The downloaded bit image is not affected by print mode (emphasized, double-strike, underline, character size, white/black reverse printing, or 90° clockwise-rotated), except for upside-down printing mode.
- When printing a downloaded bit image, selecting unidirectional printing mode with **ESC U** enables printing patterns in which the top and bottom parts are aligned vertically.
- The downloaded bit image is defined by **GS ***.

[Model-dependent variations] **TM-H5000** **TM-U375** **TM-U925**

See program example for **GS *** and **GS /**.



TM-H5000

The printer prints the downloaded bit image defined for the paper selected by **ESC c 0**. If the downloaded bit image is not defined for the paper selected by **ESC c 0**, this command is ignored. The modes that can be specified are different for the paper roll and the slip, using *m* as follows:

<Paper roll>

<i>m</i>	Mode	Vertical Dot Density	Horizontal Dot Density
0, 48	Normal	180 DPI	180 DPI
1, 49	Double-width	180 DPI	90 DPI
2, 50	Double-height	90 DPI	180 DPI
3, 51	Quadruple	90 DPI	90 DPI

<Slip>

<i>m</i>	Mode	Horizontal Direction			Vertical Dot Density
		Dot Density	Set Adjacent Dots	Maximum Number of Dots	
0, 48	Normal	150 DPI	Prohibited	800	72 DPI
1, 49	Double-width	75 DPI	Permitted	400	72 DPI



TM-U375

In page mode, the normal mode ($m = 0$ or 48) is disabled. If normal mode is processed when page mode is selected, this command is ignored. The modes selectable by m are as follows:

m	Mode	Horizontal Direction			Vertical Dot Density
		Dot Density	Set Adjacent Dots	Maximum Number of Dots in standard mode	
0, 48	Normal	160 DPI	Prohibited	400	72 DPI
1, 49	Double-width	80 DPI	Permitted	200	72 DPI

In page mode, the maximum number of horizontal dots of double-width mode depends on the printing direction specified by **ESC T**, as follows:

- When the starting position is set to the upper left or lower right of the printing area using **ESC T**, the maximum number of horizontal dots is 200.
- When the starting position is set to the upper right or lower left of the printing area using **ESC T**, the maximum number of horizontal dots is 1408.



TM-U925

The downloaded bit image mode for this printer is different from the standard ESC/POS downloaded bit image mode.

The modes selectable by *m* are as follows:

<i>m</i>	Mode	Horizontal Direction				Vertical Dot Density
		Dot Density	Set Adjacent Dots	Maximum Number of Dots		
				Paper roll	Slip	
0, 48	Single-density	75 DPI	Permitted	180	400	72 DPI
1, 49	Double-density	150 DPI	Prohibited	360	800	72 DPI



Program example for GS * and GS /

Program Example

```

PRINT #1, CHR$(&H1D); "*" ;CHR$(18);CHR$(5);
FOR i=1 TO 18*5*8
  READ a$: d=VAL("&H"+a$)
  PRINT #1, CHR$(d);
NEXT i

```

] Define
downloaded
bit image

```

PRINT #1, CHR$(&H1B); "U";CHR$(1);
PRINT #1, CHR$(&H1D); "/" ;CHR$(0);CHR$(&HA); ← Normal
PRINT #1, CHR$(&H1D); "/" ;CHR$(1);CHR$(&HA); ← Double width

```

```

DATA AA,AA,AA,AA,AA,55,55,55,55,54,80,00,00,00,02
DATA 40,00,00,00,04,80,00,00,00,02,40,00,00,00,04
DATA 8A,AA,AA,AA,A2,45,55,55,55,44,8A,AA,AA,AA,A2
DATA 45,55,55,55,44,8A,AA,AA,AA,A2,45,00,50,01,44
DATA 8A,80,A8,02,A2,45,00,50,01,44,8A,80,A8,02,A2
DATA 45,00,50,01,44,8A,80,A8,02,A2,45,00,50,01,44
DATA 8A,80,A8,02,A2,45,00,00,01,44,8A,80,00,02,A2
DATA 40,00,00,00,04,80,00,00,00,02,40,00,00,00,04
DATA 80,AA,00,02,A2,41,55,00,01,44,82,AA,80,02,A2
DATA 45,55,40,01,44,8A,AA,A0,02,A2,45,45,50,01,44
DATA 8A,82,A8,02,A2,45,01,54,01,44,8A,80,AA,02,A2
DATA 45,00,55,01,44,8A,80,2A,82,A2,45,00,15,55,44
DATA 8A,80,0A,AA,A2,45,00,05,55,44,8A,80,02,AA,82
DATA 40,00,01,55,04,80,00,00,00,02,40,00,00,00,04
DATA 80,00,00,00,02,40,15,55,50,04,80,2A,AA,A8,02
DATA 40,55,55,54,04,80,AA,AA,AA,02,41,55,55,55,04
DATA 82,A8,00,2A,82,45,50,00,15,44,8A,A0,00,0A,A2
DATA 45,40,00,05,44,8A,80,00,02,A2,45,00,00,01,44
DATA 8A,80,00,02,A2,45,00,00,01,44,8A,80,00,02,A2
DATA 45,00,00,01,44,8A,80,00,02,A2,40,00,00,00,04
DATA 80,00,00,00,02,40,00,00,00,04,80,00,00,00,62
DATA 40,00,00,03,84,80,00,00,1C,02,40,00,00,60,04
DATA 80,00,03,80,02,40,00,1C,00,04,80,00,60,00,02
DATA 40,03,80,00,04,80,0C,00,00,02,40,70,00,00,04

```

Program Example (continued)

```

DATA 83,80,00,00,02,4C,00,00,00,04,80,00,00,00,02
DATA 40,00,00,00,04,80,00,00,00,02,4A,AA,AA,AA,A4
DATA 85,55,55,55,42,4A,AA,AA,AA,A4,85,55,55,55,42
DATA 4A,AA,AA,AA,A4,85,00,05,00,02,4A,08,0A,80,04
DATA 85,00,05,00,02,4A,80,0A,80,04,85,00,05,00,02
DATA 4A,80,0A,80,04,85,00,05,00,02,4A,80,0A,80,04
DATA 85,55,55,00,02,42,AA,AA,00,04,81,55,54,00,02
DATA 40,AA,A8,00,04,80,55,50,00,02,40,00,00,00,04
DATA 80,00,00,00,02,40,00,00,00,04,80,2A,AA,A8,02
DATA 40,55,55,54,04,80,AA,AA,AA,02,41,55,55,55,04
DATA 82,AA,AA,AA,82,45,40,00,05,44,8A,80,00,02,A2
DATA 45,00,00,01,44,8A,80,00,02,A2,45,00,00,01,44
DATA 8A,80,00,02,A2,45,00,00,01,44,8A,80,00,02,A2
DATA 45,00,00,01,44,8A,80,00,02,A2,45,40,00,05,44
DATA 82,AA,AA,AA,82,41,55,55,55,04,80,AA,AA,AA,02
DATA 40,55,55,54,04,80,2A,AA,A8,02,40,00,00,00,04
DATA 80,00,00,00,02,40,00,00,00,04,80,AA,00,02,A2
DATA 41,55,00,01,44,82,AA,80,02,A2,45,55,40,01,44
DATA 8A,AA,A0,02,A2,45,45,50,01,44,8A,82,A8,02,A2
DATA 45,01,54,01,44,8A,80,AA,02,A2,45,00,55,01,44
DATA 8A,80,2A,82,A2,45,00,15,55,44,8A,80,0A,AA,A2
DATA 45,00,05,55,44,8A,80,02,AA,82,40,00,01,55,04
DATA 80,00,00,00,02,40,00,00,00,04,80,00,00,00,02
DATA 40,00,00,00,04,AA,AA,AA,AA,AA,55,55,55,55,54

```

Print Sample

ESC/POS ← GS / 0

ESC/POS ← GS / 1



GS v 0 m xL xH yL yH d1 ... dk

[Name] Print raster bit image

[Format] ASCII GS v 0 *m xL xH yL yH d1...dk*
 Hex 1D 76 30 *m xL xH yL yH d1...dk*
 Decimal 29 118 48 *m xL xH yL yH d1...dk*

[Range] **TM-H5000:** $0 \leq m \leq 3, 48 \leq m \leq 51$
 $0 \leq xL \leq 255$
 $0 \leq xH \leq 255$
 $0 \leq yL \leq 255$
 $0 \leq yH \leq 8$
 $0 \leq d \leq 255$
 $k = (xL + xH \times 256) \times (yL + yH \times 256)$
 (except for $k = 0$)

[Default] None

[Printers not featuring this command] **TM-U375** **TM-U925** **TM-U325D** **TM-U300C/D**

[Description] Prints a raster bit image using the mode specified by *m*, as follows:

<i>m</i>	Mode
0, 48	Normal
1, 49	Double-width
2, 50	Double-height
3, 51	Quadruple



- Prints a raster bit image using $(xL + xH \times 256)$ bytes in the horizontal direction.
- Prints a raster bit image using $(yL + yH \times 256)$ dots in the vertical direction.
- ***d*** indicates the bit image data.

[Notes]

- When standard mode is selected, this command is enabled only when there is no data in the print buffer. If data exists in the print buffer, the printer processes ***m*** and the following data as normal data.
- When page mode is selected, this command is enabled. If this command is processed in page mode, the printer processes ***m*** and the following data as normal data.
- Data (***d***) specifies a bit printed to 1 and not printed to 0.
- If a raster bit image exceeds one line, the excess data is not printed.
- The raster bit image is not affected by print modes (emphasized, double-strike, underline, character size, white/black reverse printing, upside-down printing, or 90° clockwise-rotated).
- This command feeds as much paper as is required to print the raster bit image, regardless of the line spacing specified by **ESC 2** or **ESC 3**.
- If this command is processed while a macro is being defined, the printer cancels macro definition, clears the definition, and prints a raster bit image.
- After printing a raster bit image, the printer processes normal data.

[Model-dependent variations] **TM-H5000**



Program Example

```
PRINT #1, CHR$( &HLB);"U";CHR$(1);← Select unidirectional printing
PRINT #1, CHR$( &HLD);"v0";CHR$(0);
PRINT #1, CHR$(16);CHR$(0);CHR$(40);CHR$(0);
FOR i=1 TO 16*40
  READ a$: d=VAL("&H"+a$)
  PRINT #1, CHR$(d);
NEXT i

DATA FF,FF,FF,FF,FF,FF,FF,FF,FF,FF,FF,FF,FF,FF,FF,FF
DATA FF,FF,FF,FF,FF,FF,FF,FF,FF,FF,FF,FF,FF,FF,FF,FF
DATA C0,00,00,00,00,00,00,00,00,00,00,00,00,00,00,00,03
DATA C0,00,00,00,00,00,00,00,00,00,00,00,00,00,00,00,03
DATA CF,FF,E0,FF,E0,3F,F8,00,5F,FF,80,1F,FC,00,FF,E3
DATA CF,FF,E3,FF,E0,FF,F8,00,5F,FF,E0,7F,FF,03,FF,E3
DATA CF,FF,E7,FF,E1,FF,F8,00,DF,FF,E0,FF,FF,87,FF,E3
DATA CF,FF,E7,FF,E1,FF,F8,00,9F,FF,F0,FF,FF,87,FF,E3
DATA CF,FF,EF,FF,E3,FF,F8,00,9F,FF,F1,FF,FF,CF,FF,E3
DATA CF,FF,EF,FF,E3,FF,F8,01,9F,FF,F1,FF,FF,CF,FF,E3
DATA CF,80,0F,E0,07,F0,00,01,1F,83,F9,F8,0F,CF,E0,03
DATA CF,80,0F,C0,07,F0,00,01,1F,81,F9,F8,0F,CF,C0,03
DATA CF,80,0F,C0,07,E0,00,03,1F,81,FB,F0,07,EF,C0,03
DATA CF,80,0F,C0,07,E0,00,02,1F,81,FB,F0,07,EF,C0,03
DATA CF,80,0F,E0,07,E0,00,06,1F,81,FB,F0,07,EF,E0,03
DATA CF,80,0F,F0,07,E0,00,04,1F,81,FB,F0,07,EF,F0,03
DATA CF,FF,C7,F8,07,E0,00,04,1F,81,FB,F0,07,E7,F8,03
DATA CF,FF,C7,FC,07,E0,00,0C,1F,81,FB,F0,07,E7,FC,03
DATA CF,FF,C3,FE,07,E0,00,08,1F,81,FB,F0,07,E3,FE,03
DATA CF,FF,C1,FF,07,E0,00,18,1F,83,FB,F0,07,E1,FF,03
DATA CF,FF,C0,FF,87,E0,00,18,1F,FF,F3,F0,07,E0,FF,83
DATA CF,FF,C0,7F,C7,E0,00,10,1F,FF,F3,F0,07,E0,7F,C3
```

Program Example (continued)

```
DATA CF,80,00,3F,E7,E0,00,30,1F,FF,F3,F0,07,E0,3F,E3
DATA CF,80,00,1F,E7,E0,00,20,1F,FF,E3,F0,07,E0,1F,E3
DATA CF,80,00,0F,F7,E0,00,20,1F,FF,E3,F0,07,E0,0F,F3
DATA CF,80,00,07,F7,E0,00,60,1F,FF,83,F0,07,E0,07,F3
DATA CF,80,00,03,F7,E0,00,40,1F,80,03,F0,07,E0,03,F3
DATA CF,80,00,03,F7,E0,00,C0,1F,80,03,F0,07,E0,03,F3
DATA CF,80,00,03,F7,F0,00,80,1F,80,01,F8,0F,C0,03,F3
DATA CF,80,00,07,F7,F0,00,80,1F,80,01,F8,0F,C0,07,F3
DATA CF,FF,EF,FF,F3,FF,F9,80,1F,80,01,FF,FF,CF,FF,F3
DATA CF,FF,EF,FF,F3,FF,F9,00,1F,80,01,FF,FF,CF,FF,F3
DATA CF,FF,EF,FF,F3,FF,F9,00,1F,80,00,FF,FF,8F,FF,F3
DATA CF,FF,EF,FF,E1,FF,FB,00,1F,80,00,FF,FF,8F,FF,F3
DATA CF,FF,EF,FF,C0,FF,FA,00,1F,80,00,7F,FF,0F,FF,C3
DATA CF,FF,EF,FF,00,3F,FA,00,1F,80,00,1F,FC,0F,FF,03
DATA C0,00,00,00,00,00,00,00,00,00,00,00,00,00,00,00,03
DATA C0,00,00,00,00,00,00,00,00,00,00,00,00,00,00,00,03
DATA FF,FF,FF,FF,FF,FF,FF,FF,FF,FF,FF,FF,FF,FF,FF,FF
DATA FF,FF,FF,FF,FF,FF,FF,FF,FF,FF,FF,FF,FF,FF,FF,FF
```

Print Sample

ESCPOS ← Normal mode



TM-H5000

This command is enabled when the paper roll is selected as the print sheet. If this command is processed when the slip paper is selected as the print sheet, the printer processes *m* as normal data. The modes selectable by *m* are as follows:

m	Mode	Vertical Dot Density	Horizontal Dot Density
0, 48	Normal	180 DPI	180 DPI
1, 49	Double-width	180 DPI	90 DPI
2, 50	Double-height	90 DPI	180 DPI
3, 51	Quadruple	90 DPI	90 DPI



STATUS COMMANDS

Command	Name
----------------	-------------

GS a n	Enable/disable Automatic Status Back (ASB)
---------------	--

GS r n	Transmit status
---------------	-----------------

DLE EOT n	Real-time status transmission
------------------	-------------------------------

ESC u n	Transmit peripheral device status
----------------	-----------------------------------

ESC v	Transmit paper sensor status
--------------	------------------------------

GS ENQ	Transmit real-time printer status
---------------	-----------------------------------



GS a n

[Name]	Enable/disable Automatic Status Back (ASB)			
[Format]	ASCII	GS	a	n
	Hex	1D	61	n
	Decimal	29	97	n
[Range]	$0 \leq n \leq 255$			
[Default]	When DIP switch (BUSY condition) is Off : $n = 0$			
	When DIP switch (BUSY condition) is On : $n = 2$			
[Printers not featuring this command]	TM-U300C/D			



[Description] Enable or disable ASB and specifies the status items to include, using *n* as follows:

Bit	Off/On	Hex	Decimal	Function
0	Off	00	0	Drawer kick-out connector pin 3 status disabled.
	On	01	1	Drawer kick-out connector pin 3 status enabled.
1	Off	00	0	On-line/off-line status disabled.
	On	02	2	On-line/off-line status enabled.
2	Off	00	0	Error status disabled.
	On	04	4	Error status enabled.
3	Off	00	0	Paper roll sensor status disabled.
	On	08	8	Paper roll sensor status enabled.
4	—	—	—	Undefined.
5	Off	00	0	Cut sheet sensor and status disabled.
	On	20	32	Cut sheet sensor and status enabled.
6,7	—	—	—	Undefined.

■■■ *how to use this table*



[Notes]

- ASB is enabled if any status item is selected. The printer transmits a 4-byte status when this command is executed. The printer automatically transmits a 4-byte status message whenever the status changes. The disabled status items may change, because each status transmission represents the current status.
- Multiple status items can be selected.
- When $n=0$, ASB is disabled.
- The 4-byte status are transmitted without confirming whether the host computer is ready to receive data. The 4-byte status must be consecutive, except for the XOFF code.
- If ASB is enabled when the printer is disabled by **ESC =**, the printer transmits the 4-byte status message whenever the status changes.
- The ASB statuses, corresponding to each bit for n are as follows:



<i>n</i>		ASB status	
Bit	Function	Bit	Status
0	Drawer kick-out connector pin 3 status.	Bit 2 of the first byte	Drawer kick-out connector pin 3 status.
1	On-line/off-line status.	Bit 3 of the first byte	On-line/ off-line status.
		Bit 5 of the first byte	Cover status.
		Bit 6 of the first byte	Paper is being fed by paper feed button status.
		Bit 0 of the second byte	Waiting for on-line recovery status.
2	Error status.	Bit 2 of the second byte	Mechanical error status.
		Bit 3 of the second byte	Auto-cutter error status.
		Bit 5 of the second byte	Unrecoverable error status.
		Bit 6 of the second byte	Automatically recoverable error status.

■■■ *how to use this table*



<i>n</i>		ASB status	
Bit	Function	Bit	Status
3	Paper roll sensor status.	Bits 0 and 1 of the third byte	Paper roll near-end sensor status.
		Bits 2 and 3 of the third byte	Paper roll end sensor status.
5	Cut sheet sensor and status.	Bit 5 of the third byte	Slip TOF sensor status.
		Bit 6 of the third byte	Slip BOF sensor status.
		Bit 0 of the fourth byte	Slip paper selection status.
		Bit 1 of the fourth byte	Slip printing status.
		Bit 2 of the fourth byte	Validation paper selection status
		Bit 3 of the fourth byte	Validation printing status.
		Bit 5 of the fourth byte	Validation TOF sensor status.
		Bit 6 of the fourth byte	Validation BOF sensor status.



■ The status to be transmitted are as follows:

- First byte (printer information)

Bit	Off/ On	Hex	Decimal	Status for ASB
0	Off	00	0	Not used. Fixed to Off.
1	Off	00	0	Not used. Fixed to Off.
2	Off	00	0	Drawer kick-out connector pin 3 is LOW.
	On	04	4	Drawer kick-out connector pin 3 is HIGH.
3	Off	00	0	On-line.
	On	08	8	Off-line.
4	On	10	16	Not used. Fixed to On.
5	Off	00	0	Cover is closed.
	On	20	32	Cover is open.
6	Off	00	0	Paper is not being fed by the paper feed button.
	On	40	64	Paper is being fed by the paper feed button.
7	Off	00	0	Not used. Fixed to Off.

■■■ how to use
this table



- Second byte (printer information)

Bit	Off/ On	Hex	Decimal	Status for ASB
0	Off	00	0	Not waiting for on-line recovery.
	On	01	1	Waiting for on-line recovery.
1	—	—	—	Undefined
2	Off	00	0	No mechanical error.
	On	04	4	Mechanical error occurred.
3	Off	00	0	No auto-cutter error.
	On	08	8	Auto-cutter error occurred.
4	Off	00	0	Not used. Fixed to Off.
5	Off	00	0	No unrecoverable error.
	On	20	32	Unrecoverable error occurred.
6	Off	00	0	No automatically recoverable error.
	On	40	64	Automatically recoverable error occurred.
7	Off	00	0	Not used. Fixed to Off.

■■■ *how to use
this table*



- If mechanical error (bit 2) or auto-cutter error (bit 3) occurs due to paper jams or the like, it is possible to recover by correcting a cause of the error and executing **DLE ENQ**. But if an error due to a circuit failure (e.g. wire break) occurs, it is impossible to recover.
- Printing is stopped while automatically recoverable error (bit 6) occurs.
- If an unrecoverable error (bit 5) occurs, turn off the power as soon as possible.



- Third byte (paper sensor information)

Bit	Off/ On	Hex	Decimal	Status for ASB
0, 1	Off	00	0	Paper roll near-end sensor: paper adequate.
	On	03	3	Paper roll near-end sensor: paper near end.
2, 3	Off	00	0	Paper roll end sensor: paper present.
	On	0C	12	Paper roll end sensor: paper not present.
4	Off	00	0	Not used. Fixed to Off.
5	Off	00	0	Slip TOF sensor: paper present.
	On	20	32	Slip TOF sensor: paper not present.
6	Off	00	0	Slip BOF sensor: paper present.
	On	40	64	Slip BOF sensor: paper not present.
7	Off	00	0	Not used. Fixed to Off.

■■■ *how to use this table*

- Some paper sensors are not present, depending on the printer model.
- The names of some paper sensors are different, depending on the printer model.



- Fourth byte (paper sensor information)

Bit	Off/ On	Hex	Decimal	Status for ASB
0	Off	00	0	Slip paper selected.
	On	01	1	Slip paper not selected.
1	Off	00	0	Slip printing possible.
	On	02	2	Slip printing not possible.
2	Off	00	0	Validation paper selected.
	On	04	4	Validation paper not selected.
3	Off	00	0	Validation printing possible.
	On	08	8	Validation printing not possible.
4	Off	00	0	Not used. Fixed to Off.
5	Off	00	0	Validation TOF sensor: paper present.
	On	20	32	Validation TOF sensor: paper not present.

■■■ *how to use
this table*



Bit	Off/ On	Hex	Decimal	Status for ASB
6	Off	00	0	Validation BOF sensor: paper present.
	On	40	64	Validation BOF sensor: paper not present.
7	Off	00	0	Not used. Fixed to Off.

- Some paper sensors are not present, depending on the printer model.
- The names of some paper sensors are different, depending on the printer model.

[Model-dependent variations] **TM-H5000** **TM-U375** **TM-U925** **TM-U325D**

Program Example for all printers

```
PRINT #1, CHR$(&H1D);"a";CHR$(4); ← Enable "Error" status
```



TM-H5000

The default value is set by DIP switch 2-1.

■ Second byte (printer information)

Bits 0 of the second byte is undefined.

Mechanical error indicates the home position detection error, carriage detection error, cut sheet (slip or check paper) ejection error, or front cover open error during printing.

Automatically recoverable error indicates the high head temperature error or the paper roll cover open error during printing.

■ Third byte (paper sensor information)

When the paper roll cover is open, paper detection (detected by the paper roll end sensor) may be incorrect.

■ Fourth byte (paper sensor information)

Bits 2, 3, 5, and 6 of the fourth byte are undefined.



TM-U375

The default value is set by DIP switch 2-3.

Bits 5 and 6 of the third byte and bits 5 and 6 of the fourth byte indicate the same paper sensor. The name of the paper sensor is "cut sheet sensor".

■ Second byte (printer information)

Bits 0 and 3 of the second byte are undefined.

Mechanical error indicates the home position detection error, carriage detection error, or cut sheet (slip or validation) ejection error.

Automatically recoverable error indicates the high head temperature error.

■ Third byte (paper sensor information)

Bits 2 and 3 of the third byte are undefined.



TM-U925

The default value is set by DIP switch 2-5.

■ Second byte (printer information)

Bit 0 of the second byte is undefined.

Mechanical error indicates the home position detection error, carriage detection error, or cut sheet (slip or check paper) ejection error.

Automatically recoverable error indicates the high head temperature error.

■ Third byte (paper sensor information)

The names of the paper sensors for bits 5 and 6:

- Slip insertion sensor is the same sensor as the Slip TOF sensor.
- Slip ejection sensor is the same sensor as the Slip BOF sensor.

■ Fourth byte (paper sensor information)

Bits 2, 3, 5, and 6 of the fourth byte are undefined.



TM-U325D

The default value is set by DIP switch 2-1.

■ Second byte (printer information)

Bits 0 and 3 of the second byte are undefined.

Mechanical error indicates the home position detection error or validation ejection error.

Automatically recoverable error indicates the high head temperature error.

■ Third byte (paper sensor information)

Bits 5 and 6 of the second byte are undefined.

■ Fourth byte (paper sensor information)

Bits 0 and 1 of the second byte are undefined.

Bits 5 and 6 indicate the same paper sensor. The name of the paper sensor is "validation sensor".



GS r n

[Name] Transmit status

[Format] ASCII GS r n
 Hex 1D 72 n
 Decimal 29 114 n

[Range] $1 \leq n \leq 3$
 $49 \leq n \leq 51$

[Default] None

[Printers not featuring this command] **TM-U300C/D**

[Description] Transmits 1 byte of status data using **n** as follows:

n	Function
1, 49	Transmits paper sensor status
2, 50	Transmits drawer kick-out connector status
3, 51	Transmits cut sheet (slip or validation) status

- [Notes]
- When DTR/DSR control is selected by DIP switch (Handshaking) with a serial interface, the printer transmits the status after confirming that the host is ready to receive data. If the host computer is not ready to receive data, the printer waits until the host becomes ready.
 - When XON/XOFF control is selected by DIP switch (Handshaking) with a serial interface, the printer transmits the status without confirming whether the host computer can receive data.



■ The status to be transmitted is as follows:

- Paper sensor status ($n=1, 49$)

Bit	Off/ On	Hex	Decimal	Status
0, 1	Off	00	0	Paper roll near-end sensor: paper adequate.
	On	03	3	Paper roll near-end sensor: paper near end.
2, 3	Off	00	0	Paper roll end sensor: paper present.
	On	0C	12	Paper roll end sensor: paper not present.
4	Off	00	0	Not used. Fixed to Off.
5	Off	00	0	TOF sensor: paper present.
	On	20	32	TOF sensor: paper not present.
6	Off	00	0	BOF sensor: paper present.
	On	40	64	BOF sensor: paper not present.
7	Off	00	0	Not used. Fixed to Off.

■■■ *how to use this table*

- Some paper sensors are not present, depending on the printer model.



- The names of some paper sensors are different, depending on the printer model.
- Drawer kick-out connector status ($n=2, 50$)

Bit	Off/On	Hex	Decimal	Status
0	Off	00	0	Drawer kick-out connector pin 3 is LOW.
	On	01	1	Drawer kick-out connector pin 3 is HIGH.
1-3	—	—	—	Undefined.
4	Off	00	0	Not used. Fixed to Off.
5, 6	—	—	—	Undefined.
7	Off	00	0	Not used. Fixed to Off.

■■■ *how to use this table*

- Cut sheet status ($n=3, 51$)
Transmits the remaining printing area (times the number of dots for the resident characters in vertical) by using the values from 00H to 0FH. When the cut sheet is not selected as the print sheet, the status is 00H. The range for the cut sheet status is different, depending on the printer model.

[Model-dependent variations] **TM-H5000** **TM-U375** **TM-U925** **TM-U325D**

Program Example for all printers

```
PRINT #1, CHR$(&H1D);"x";CHR$(1); ← Transmits paper sensor status
```



TM-H5000

Handshaking for a serial interface is selected by DIP switch 1-3.

■ Paper sensor status ($n = 1, 49$)

When the paper roll end sensor detects a paper-end, the printer goes off-line and does not execute this command. Therefore, bits 2 and 3 of the paper sensor status do not transmit a paper-end status.

When the paper roll cover is open, paper detection (detected by the paper roll end sensor) may be incorrect.

■ Slip status ($n = 3, 51$)

Slip status is used as Cut sheet status.

The slip status transmits the value from 00H to 06H based on times the number of dots for 9-dot.

The Number of Remaining Dots	Hex	Decimal
0 to 8	00	0
9 to 17	01	1
18 to 26	02	2
27 to 35	03	3
36 to 44	04	4
45 to 53	05	5
54 or more	06	6



TM-U375

Handshaking for a serial interface is selected by DIP switch 1-3.

■ Paper sensor status ($n = 1, 49$)

Bits 2 and 3 of the paper sensor status are undefined. Bits 5 and 6 indicate the same paper sensor. The name of the paper sensor is "cut sheet sensor".

■ Cut sheet status ($n = 3, 51$)

The cut sheet status sensor transmits the values from 00H to 0FH based on times the number of dots for 9-dot.

The Number of Remaining Dots	Hex	Decimal
0 to 8	00	0
9 to 17	01	1
:	:	:
126 to 134	0E	14
135 or more	0F	15



TM-U925

Handshaking for a serial interface is selected by DIP switch 1-8.

■ Paper sensor status ($n = 1, 49$)

The names of the paper sensors for bits 5 and 6:

- Slip insertion sensor is the same sensor as the TOF sensor.
- Slip ejection sensor is the same sensor as the BOF sensor.

■ Slip status ($n = 3, 51$)

Slip status is used as Cut sheet status.

The slip status information for this printer is different from the standard ESC/POS cut sheet status information as follows:

Slip Status	Status	
	Hex	Decimal
No printing area or slip not selected.	00	0
1-line printing excluding double-height characters is possible.	01	1
1-line printing including double-height characters is possible.	02	2
One or more lines can be printed with the line spacing to have been set.	03	3



TM-U325D

Handshaking for a serial interface is selected by DIP switch 1-3.

- Paper sensor status ($n = 1, 49$)

Bits 5 and 6 indicate the same paper sensor. The name of the paper sensor is "validation sensor".

- Validation sensor status ($n = 3, 51$)

Validation status can be confirmed by cut sheet status.

The validation status transmits the value from 00H to 0CH based on times the number of dots for 9-dot.

The Number of Remaining Dots	Hex	Decimal
0 to 8	00	0
9 to 17	01	1
:	:	:
99 to 107	0B	11
108 or more	0C	12



DLE EOT *n*

[Name] Real-time status transmission

[Format] ASCII DLE EOT *n*
 Hex 10 04 *n*
 Decimal 16 4 *n*

[Range] **TM-H5000, TM-U925: $1 \leq n \leq 5$, TM-U375: $1 \leq n \leq 6$**
TM-U325D: $1 \leq n \leq 4, n = 6$

[Default] None

[Printers not featuring this command] **TM-U300C/D**

[Description] Transmits 1 byte of status data specified in real time, using *n* as follows:

<i>n</i>	Function
1	Transmit printer status
2	Transmit off-line status
3	Transmit error status
4	Transmit paper roll sensor status
5	Transmit slip status
6	Transmit validation status



[Notes]

- The printer executes this command upon receiving it.
- The printer transmits the status without confirming whether the host computer can receive data.
- With a serial interface model, this command is executed even when the printer is off-line, the receive buffer is full, or an error occurs.
- With a parallel interface model, this command is not executed in following status, because the printer is busy and unable to receive data from the host computer. The DIP switch (BUSY condition) is different, depending on the printer model.
 - Receive buffer is full when DIP switch is set to On.
 - Printer is off-line, an error occurs, or receive buffer is full when DIP switch is set to Off.
- This command is ignored during a process of transmitting the check paper reading result (only with the MICR reader model).



■ The real-time status to be transmitted is as follows:

- Printer status ($n=1$)

Bit	Off/ On	Hex	Decimal	Status
0	Off	00	0	Not used. Fixed to Off.
1	On	02	2	Not used. Fixed to On.
2	Off	00	0	Drawer kick-out connector pin 3 is LOW.
	On	04	4	Drawer kick-out connector pin 3 is HIGH.
3	Off	00	0	On-line.
	On	08	8	Off-line.
4	On	10	16	Not used. Fixed to On.
5	Off	00	0	Not waiting for on-line recovery.
	On	20	32	Waiting for on-line recovery.
6	—	—	—	Undefined.
7	Off	00	0	Not used. Fixed to Off.

■■■ *how to use this table*



- Off-line status ($n=2$)

Bit	Off/On	Hex	Decimal	Status
0	Off	00	0	Not used. Fixed to Off.
1	On	02	2	Not used. Fixed to On.
2	Off	00	0	Cover is closed.
	On	04	4	Cover is open.
3	Off	00	0	Paper is not being fed by the paper feed button.
	On	08	8	Paper is being fed by the paper feed button.
4	On	10	16	Not used. Fixed to On.
5	Off	00	0	No paper-end stop.
	On	20	32	Printing stops due to a paper-end.
6	Off	00	0	No error.
	On	40	64	Error occurred.
7	Off	00	0	Not used. Fixed to Off.

■■■ *how to use this table*

- Bit 5 becomes on when the paper roll sensor (near-end sensor or end sensor) detects a paper-end and printing stops.



- Error status ($n=3$)

Bit	Off/On	Hex	Decimal	Status
0	Off	00	0	Not used. Fixed to Off.
1	On	02	2	Not used. Fixed to On.
2	Off	00	0	No mechanical error.
	On	04	4	Mechanical error occurred.
3	Off	00	0	No auto-cutter error.
	On	08	8	Auto-cutter error occurred.
4	On	10	16	Not used. Fixed to On.
5	Off	00	0	No unrecoverable error.
	On	20	32	Unrecoverable error occurred.
6	Off	00	0	No auto-recoverable error.
	On	40	64	Auto-recoverable error occurred.
7	Off	00	0	Not used. Fixed to Off.

■■■ *how to use this table*

- If mechanical error (bit 2) or auto-cutter error (bit 3) occurs due to paper jams or the like, it is possible to recover by correcting a cause of the error and executing **DLE ENQ**. But if an error due to a circuit failure (e.g. wire break) occurs, it is impossible to recover.



- When printing is stopped during automatically recoverable error (bit 6) occurs.
- If an unrecoverable error (bit 5) occurs, turn off the power as soon as possible.
- Paper roll sensor status ($n=4$)

Bit	Off/ On	Hex	Decimal	Status
0	Off	00	0	Not used. Fixed to Off.
1	On	02	2	Not used. Fixed to On.
2, 3	Off	00	0	Paper roll near-end sensor: paper adequate.
	On	0C	12	Paper roll near-end sensor: paper near end.
4	On	10	16	Not used. Fixed to On.
5, 6	Off	00	0	Paper roll end sensor: paper present.
	On	60	96	Paper roll end sensor: paper not present.
7	Off	00	0	Not used. Fixed to Off.

■■■ *how to use this table*

- Some paper sensors are not present, depending on the printer model.
- The names of some paper sensors are different, depending on the printer model.



- Slip status ($n=5$)

Bit	Off/On	Hex	Decimal	Status
0	Off	00	0	Not used. Fixed to Off.
1	On	02	2	Not used. Fixed to On.
2	Off	00	0	Slip paper selected.
	On	04	4	Slip paper not selected.
3	Off	00	0	Does not wait for slip paper insertion.
	On	08	8	Waits for slip insertion.
4	On	10	16	Not used. Fixed to On.
5	Off	00	0	Slip TOF sensor: paper present.
	On	20	32	Slip TOF sensor: paper not present.
6	Off	00	0	Slip BOF sensor: paper present.
	On	40	64	Slip BOF sensor: paper not present.
7	Off	00	0	Not used. Fixed to Off.

■■■ *how to use this table*

- Some paper sensors are not present, depending on the printer model.
- The names of some paper sensors are different, depending on the printer model.



- Validation status ($n=6$)

Bit	Off/On	Hex	Decimal	Status
0	Off	00	0	Not used. Fixed to Off.
1	On	02	2	Not used. Fixed to On.
2	Off	00	0	Validation paper selected.
	On	04	4	Validation paper not selected.
3	Off	00	0	Does not wait for validation paper insertion.
	On	08	8	Waits for validation insertion.
4	On	10	16	Not used. Fixed to On.
5	Off	00	0	Validation TOF sensor: paper present.
	On	20	32	Validation TOF sensor: paper not present.
6	Off	00	0	Validation BOF sensor: paper present.
	On	40	64	Validation BOF sensor: paper not present.
7	Off	00	0	Not used. Fixed to Off.

■■■ *how to use this table*



- Some paper sensors are not present, depending on the printer model.
- The names of some paper sensors are different, depending on the printer model.

[Model-dependent variations] **TM-H5000** **TM-U375** **TM-U925** **TM-U325D**

Program Example for all printers

```
PRINT #1, CHR$(&H10);CHR$(&H4);CHR$(2); ← Transmits off-line status
```



TM-H5000

BUSY condition for a parallel interface is selected by DIP switch 2-1.

- Printer status ($n = 1$)

Bits 5 of the printer status is undefined.

- Error status ($n = 3$)

Mechanical error indicates the home position detection error, carriage detection error, cut sheet (slip or check paper) ejection error, or front cover open error during printing.

Automatically recoverable error indicates the high head temperature error or paper roll cover open error during printing.

- Paper roll sensor status ($n = 4$)

When the paper roll cover is open, paper detection (detected by the paper roll end sensor) may be incorrect.



TM-U375

BUSY condition for a parallel interface is selected by DIP switch 2-3.

Bits 5 and 6 of the slip status and bits 5 and 6 of the validation status indicate the same paper sensor. The name of the paper sensor is "cut sheet sensor".

- Printer status ($n = 1$)

Bit 5 of the printer status is undefined.

- Error status ($n = 3$)

Bit 3 of the error status is undefined.

Mechanical error indicates the home position detection error, carriage detection error, or cut sheet (slip or validation) ejection error.

Automatically recoverable error indicates the high head temperature error.

- Paper roll status ($n = 4$)

Bits 5 and 6 of the paper sensor status are undefined.



TM-U925

BUSY condition for a parallel interface is selected by DIP switch 2-5.

■ Printer status ($n = 1$)

Bit 5 of the printer status is undefined.

■ Error status ($n = 3$)

Mechanical error indicates the home position detection error, carriage detection error, or cut sheet (slip or validation) ejection error.

Automatically recoverable error indicates the high head temperature error.

■ Slip status ($n = 5$)

The names of the paper sensors for bits 5 and 6:

- Slip insertion sensor is the same sensor as the Slip TOF sensor.
- Slip ejection sensor is the same sensor as the Slip BOF sensor.



TM-U325D

BUSY condition for a parallel interface is selected by DIP switch 2-1.

- Printer status ($n = 1$)

Bit 5 of the printer status is undefined.

- Error status ($n = 3$)

Bit 3 of the printer status is undefined.

Mechanical error indicates the home position detection error or validation ejection error.

Automatically recoverable error indicates the high head temperature error.

- Validation status ($n = 6$)

Bits 5 and 6 indicate the same paper sensor. The name of the paper sensor is "validation sensor".



ESC u n

[Name]	Transmit peripheral device status			
[Format]	ASCII	ESC	u	n
	Hex	1B	75	n
	Decimal	27	117	n
[Range]	TM-U375, TM-U925: n = 0, 48; TM-U300C/D: n = 0			
[Default]	None			
[Printers not featuring this command]	TM-H5000, TM-U325D			
[Description]	Transmits the status of drawer kick-out connector pin 3 as 1 byte of data when n=0 or 48.			
[Notes]	<ul style="list-style-type: none"> ■ GS r 2 can also be used to check the status. GS r is recommended for transmitting the peripheral device status. ESC u is not a recommended command. ■ When DTR/DSR control set by DIP switch (Handshaking) is selected with a serial interface, the printer transmits the status after confirming that the host is ready to receive data. If the host computer is not ready to receive data, the printer waits until the host becomes ready. ■ When XON/XOFF control is selected by DIP switch (Handshaking) with a serial interface, the printer transmits the status without confirming whether the host computer can receive data. 			



- The peripheral device status to be transmitted is as follows:

Bit	Off/On	Hex	Decimal	Status
0	Off	00	0	Drawer kick-out connector pin 3 is LOW.
	On	01	1	Drawer kick-out connector pin 3 is HIGH.
1-3	—	—	—	Undefined.
4	Off	00	0	Not used. Fixed to Off.
5, 6	—	—	—	Undefined.
7	Off	00	0	Not used. Fixed to Off.

... *how to use this table*

[Model-dependent variations] **TM-U375** **TM-U925** **TM-U300C/D**

Program Example for all printers

```
PRINT #1,CHR$(&H1B);"u";CHR$(0);
```



TM-U375

Handshaking for a serial interface is selected by DIP switch 1-3.



TM-U925

Handshaking for a serial interface is selected by DIP switch 1-8.



TM-U300C/D

Handshaking for a serial interface is selected by DIP switch 1-3.



ESC v

[Name] Transmit paper sensor status

[Format] ASCII ESC v
 Hex 1B 76
 Decimal 27 118

[Range] None

[Default] None

[Printers not featuring this command] **TM-H5000, TM-U325D**

[Description] Transmits the status of paper sensor(s) as 1 byte of data.

- [Notes]
- **GS r 1** can also be used to check the status. **GS r** is recommended for transmitting the paper sensor status. **ESC v** is not a recommended command.
 - When DTR/DSR control is selected by DIP switch (Handshaking) with a serial interface, the printer transmits the status after confirming that the host is ready to receive data. If the host computer is not ready to receive data, the printer waits until the host becomes ready.
 - When XON/XOFF control is selected by DIP switch (Handshaking) with a serial interface, the printer transmits the status without confirming whether the host computer can receive data.
 - Some paper sensors are not present, depending on the printer model.
 - The names of some paper sensors are different, depending on the printer model.



■ The peripheral device status to be transmitted is as follows:

Bit	Off/ On	Hex	Decimal	Status
0, 1	Off	00	0	Paper roll near-end sensor: paper adequate.
	On	03	3	Paper roll near-end sensor: paper near end.
2, 3	Off	00	0	Paper roll end sensor: paper present.
	On	0C	12	Paper roll end sensor: paper not present.
4	Off	00	0	Not used. Fixed to Off.
5	Off	00	0	TOF sensor: paper present.
	On	20	32	TOF sensor: paper not present.
6	Off	00	0	BOF sensor: paper present.
	On	40	64	BOF sensor: paper not present.
7	Off	00	0	Not used. Fixed to Off.

■■■ *how to use
this table*

[Model-dependent variations]

TM-U375

TM-U925

TM-U300C/D

Program Example for all printers

```
PRINT #1,CHR$(&H1B);"v";
```



TM-U375

Handshaking for a serial interface is selected by DIP switch 1-3.

Bits 2 and 3 of the status are undefined.

Bits 5 and 6 indicate the same paper sensor. The name of the paper sensor is "cut sheet sensor".



TM-U925

Handshaking for a serial interface is selected by DIP switch 1-8.

The names of the paper sensors for bits 5 and 6:

- Slip insertion sensor is the same sensor as the TOF sensor.
- Slip ejection sensor is the same sensor as the BOF sensor.



TM-U300C/D

Handshaking for a serial interface is selected by DIP switch 1-3.

The paper sensor status information of this command for this printer is different from the standard ESC/POS paper sensor status information as follows:

- Bits 1, 3, and 5 of the status are undefined.
- Bits 6 and 7 indicate the same paper sensor. The name of the paper sensor is "validation sensor".



GS ENQ

[Name] Transmit real-time printer status

[Format] ASCII GS ENQ
 Hex 1D 05
 Decimal 29 5

[Range] None

[Default] None

[Printers not featuring this command] **TM-H5000**, **TM-U375**, **TM-U325D**,
TM-U300C/D

[Description] Transmits the printer status as 1 byte of data in real time.

- [Notes]
- **DLE EOT** can also be used to check the status. **DLE EOT** is recommended for transmitting the real-time status. **GS ENQ** is not a recommended command.
 - The printer executes this command upon receiving it.
 - The printer transmits the status without confirming whether the host computer can receive data.
 - With a serial interface model, this command is executed even when the printer is off-line, the receive buffer is full, or an error occurs.



- With a parallel interface model, this command is not executed in the following status, because the printer is busy and unable to receive data from the host computer.
 - Receive buffer is full when DIP switch 2-5 (BUSY condition) is set to On.
 - Printer is off-line, an error occurs, or receive buffer is full when DIP switch 2-5 (BUSY condition) is set to Off.
- This command is ignored during a process of transmitting the check paper reading result (only with MICR reader model).
- The real-time printer status to be transmitted is as follows:

Bit	Off/On	Hex	Decimal	Status
0, 1	Off	00	0	Paper roll near-end sensor: paper adequate.
	On	03	3	Paper roll near-end sensor: paper near end.
2	Off	00	0	Cover is closed.
	On	04	4	Cover is open.
3	Off	00	0	On-line.
	On	08	8	Off-line.

■■■ *how to use this table*



Bit	Off/On	Hex	Decimal	Status
4	Off	00	0	Drawer kick-out connector pin 3 is LOW.
	On	10	16	Drawer kick-out connector pin 3 is HIGH.
5	Off	00	0	Slip insertion sensor: paper present.
	On	20	32	Slip insertion sensor: paper not present.
6	Off	00	0	No error.
	On	40	64	Error occurred.
7	On	80	128	Not used. Fixed to On.

Program Example for all printers

```
PRINT #1,CHR$(&H1D);CHR$(&H5);
```



BAR CODE COMMANDS

Command Name

① **GS k m d1 ... dk NUL** ② **GS k m n d1 ... dn**

Print bar code

GS h n Set bar code height

GS w n Set bar code width

GS H n Select printing position of HRI characters

GS f n Select font for HRI characters



① **GS k m d1 ... dk NUL** ② **GS k m n d1 ... dn**

[Name] Print bar code

[Format]	① ASCII	GS	k	<i>m</i>	<i>d1 ... dk</i>	<i>NUL</i>
	Hex	1D	6B	<i>m</i>	<i>d1 ... dk</i>	<i>00</i>
	Decimal	29	107	<i>m</i>	<i>d1 ... dk</i>	<i>0</i>
	② ASCII	GS	k	<i>m</i>	<i>n</i>	<i>d1 ... dn</i>
	Hex	1D	6B	<i>m</i>	<i>n</i>	<i>d1 ... dn</i>
	Decimal	29	107	<i>m</i>	<i>n</i>	<i>d1 ... dn</i>

[Range] ① **TM-H5000: $0 \leq m \leq 6$ (*k* and *d* depend on the bar code system used)**
 ② **TM-H5000: $65 \leq m \leq 73$ (*n* and *d* depend on the bar code system used)**

[Default] None

[Printers not featuring this command] **TM-U375, TM-U925, TM-U325D, TM-U300C/D**

[Description] Select a bar code system and print the bar code.

- ***k*** of ① indicates the number of the bar code data to be printed.
- ***n*** of ② indicates the number of the bar code data.
- ***d*** indicates the character code of the bar code data to be printed.



- **m** specifies a bar code system as follows:

m	Bar Code System	Number of Data	Number of Characters	Characters	Remarks	
①	0	UPC-A	Fixed	$11 \leq k \leq 12$	0~9	$48 \leq d \leq 57$
	1	UPC-E	Fixed	$11 \leq k \leq 12$	0~9	$48 \leq d \leq 57$
	2	JAN13 (EAN13)	Fixed	$12 \leq k \leq 13$	0~9	$48 \leq d \leq 57$
	3	JAN8 (EAN8)	Fixed	$7 \leq k \leq 8$	0~9	$48 \leq d \leq 57$
	4	CODE39	Can be changed	$1 \leq k$	0~9, A~Z SP, \$, %, +, -, ., /, * (start/stop character)	$48 \leq d \leq 57, 65 \leq d \leq 90,$ $d = 32, 36, 37, 43, 45,$ 46, 47 $d = 42$ (start/stop character)
	5	ITF (Interleaved 2 of 5)	Can be changed	$1 \leq k$ (even number)	0~9	$48 \leq d \leq 57$
6	CODABAR (NW7)	Can be changed	$1 \leq k$	0~9, A~Z \$, +, -, ., /, :	$48 \leq d \leq 57, 65 \leq d \leq 68,$ $d = 36, 43, 45, 46, 47, 58$	

<i>m</i>	Bar Code System	Number of Data	Number of Characters	Characters	Remarks	
②	65	UPC-A	Fixed	$11 \leq n \leq 12$	0~9	$48 \leq d \leq 57$
	66	UPC-E	Fixed	$11 \leq n \leq 12$	0~9	$48 \leq d \leq 57$
	67	JAN13 (EAN13)	Fixed	$12 \leq n \leq 13$	0~9	$48 \leq d \leq 57$
	68	JAN8 (EAN8)	Fixed	$7 \leq n \leq 8$	0~9	$48 \leq d \leq 57$
	69	CODE39	Can be changed	$1 \leq n \leq 255$	0~9, A~Z SP, \$, %, +, -, .., /, * (start/stop character)	$48 \leq d \leq 57, 65 \leq d \leq 90,$ $d = 32, 36, 37, 43, 45,$ 46, 47 $d = 42$ (start/stop character)
	70	ITF (Interleaved 2 of 5)	Can be changed	$1 \leq n \leq 255$ (even number)	0~9	$48 \leq d \leq 57$
	71	CODABAR (NW7)	Can be changed	$1 \leq n \leq 255$	0~9, A~Z \$, +, -, .., /, :	$48 \leq d \leq 57, 65 \leq d \leq 68,$ $d = 36, 43, 45, 46, 47, 58$
	72	CODE93	Can be changed	$1 \leq n \leq 255$	NUL~DEL	$0 \leq d \leq 127$
	73	CODE128	Can be changed	$2 \leq n \leq 255$	NUL~DEL	$0 \leq d \leq 127$

[Notes for ① and ②]

- When standard mode is selected, this command is enabled only when no data exists in the print buffer. If data exists in the print buffer, the printer processes the data following *m* as normal data.
- If *d* is out of the specified range, this command is canceled and the printer processes the following data as normal data. In this case, when standard mode is selected, the printer only feeds paper and when page mode is selected, the printing position does not change. This applies to all bar code systems.
- When standard mode is selected, if the bar code width exceeds the printing area, the printer only feeds paper.
- When page mode is selected, if the bar code width exceeds the printing area, the printer does not print the bar code but moves the printing position to [printing area + 1].
- This command feeds as much paper as is required to print the bar code, regardless of the line spacing specified by **ESC 2** or **ESC 3**.
- When page mode is selected, this command develops the bar code data in the print buffer but the printer does not print the bar code data.



- The bar code is not affected by print mode (emphasized, double-strike, underline, character size, white/black reverse printing, or 90° clockwise-rotated), except for upside-down printing mode.
- The values of *m* from 0 to 6 and from 65 to 71 select the same bar code system, respectively. The printing results are the same.



- [Notes for ①] ■ This command ends with a **NUL** code.
- **k** is not transmission data to the printer.
 - When the bar code system used is UPC-A, UPC-E, JAN13 (EAN13), or JAN8 (EAN8) bar code system (**m** = 0, 1, 2, 3), if the number of the bar code data is less than **k**, this command is ignored.
 - When the bar code system used is UPC-A, UPC-E, JAN13 (EAN13), or JAN8 (EAN8) bar code system (**m** = 0, 1, 2, 3), if the number of characters is more than **k**, the printer prints the bar code data after receiving **k**-byte data and the excess data is processed as normal data.
 - For the bar code (CODE39 (**m**=4), the printer processes "*" <ASCII code=42>" as follows:
 - When the first bar code (**d1**) is "*", the printer processes the data as a start character. If the first bar code (**d1**) is not "*", the printer adds a start character (*) automatically.
 - When data (**dk**) just before NUL code is "*", the printer processes "*" as a stop character. If data just before NUL is not "*", the printer adds a stop character (*) automatically.
 - When "*" is processed during bar code data processing, the printer processes "*" as a stop character. The printer prints data proceeding "*" and finishes command processing. Therefore, data following "*" are processed as normal data.



- The number of data for ITF bar code system ($m = 5$) must be even numbers. When an odd number of data is processed, the printer ignores the last received data.

[Notes for ②] ■ The printer processes n bytes from the next data as bar code data.

- If n is out of the specified range or if n is an odd number when ITF bar code system ($m = 70$) is selected, this command is canceled and the following data is processed as normal data.

- For the bar code (CODE39 ($m=69$), the printer processes " $* <ASCII\ code=42>$ " as follows:

- When the first bar code ($d1$) is " $*$ ", the printer processes the data as a start character. If the first bar code ($d1$) is not " $*$ ", the printer adds a start character ($*$) automatically.
- When the last data (dn) is " $*$ ", the printer processes " $*$ " as a stop character. If the last data is not " $*$ ", the printer adds a stop character ($*$) automatically.
- When " $*$ " is processed during bar code data processing, the printer processes " $*$ " as a stop character. The printer prints data proceeding " $*$ " and finishes command processing. Therefore, data following " $*$ " are processed as normal data.



- When CODE93 bar code ($m = 72$) is used:
 - The printer prints an HRI character " □ " as start and stop character.
 - The printer prints HRI characters "■ + an alphabetic character" as a control character (00H to 1FH and 7FH).
- When CODE128 bar code ($m = 73$) is used:
 - The printer does not print HRI characters that correspond to the shift character (SHIFT) or code set selection characters (CODE A, CODE B, and CODE C).
 - HRI characters for the function characters (FNC1, FNC2, FNC3, and FNC4) are spaces.
 - HRI characters for the control characters (00H to 1FH and 7FH) are spaces.
 - The top of the bar code data string must be code set selection character (any of CODE A, CODE B, or CODE C) which selects the first code set.
 - Special characters are defined by combining two characters "{ + an alphanumeric character". The ASCII character "{" is defined by transmitting "{" twice consecutively.



Specific character	Transmit data		
	ASCII	Hex	Decimal
SHIFT	{S	7B, 53	123, 83
CODE A	{A	7B, 41	123, 65
CODE B	{B	7B, 42	123, 66
CODE C	{C	7B, 43	123, 67
FNC1	{1	7B, 31	123, 49
FNC2	{2	7B, 32	123, 50
FNC3	{3	7B, 33	123, 51
FNC4	{4	7B, 34	123, 52
{	{{	7B, 7B	123, 123

[Model-dependent variations] **TM-H5000**

Program Example for all printers

```
PRINT #1, CHR$(&H1D);"h";CHR$(80); ← Set height
PRINT #1, CHR$(&H1D);"k";CHR$(2); ← Print bar code
PRINT #1, "496595707379";CHR$(0);
PRINT #1, CHR$(&HA);
PRINT #1, CHR$(&H1D);"k";CHR$(67);CHR$(12);
PRINT #1, "496595707379"; ← Print bar code
```

Print Sample

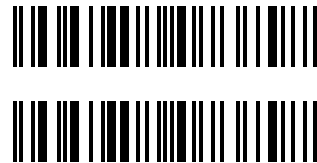

TM-H5000

A bar code can be printed only when the paper roll is selected as the print sheet.



GS h n

[Name] Set bar code height

[Format] ASCI GS h *n*
 Hex 1D 68 *n*
 Decimal 29 104 *n*

[Range] $1 \leq n \leq 255$

[Default] **TM-H5000: *n* = 162**

[Printers not featuring this command] **TM-U375, TM-U925, TM-U325D,**
TM-U300C/D

[Description] Sets the height of a bar code.

- *n* specifies number of dots in the vertical direction of a bar code.

[Model-dependent variations] **TM-H5000**

Program Example for all printers

```
PRINT #1, CHR$(&H1D);"h";CHR$(50); ← Set height to 50
PRINT #1, CHR$(&H1D);"k";CHR$(2); ← Print bar code
PRINT #1, "496595707379";CHR$(0);
PRINT #1, CHR$(&HA);
PRINT #1, CHR$(&H1D);"h";CHR$(100); ← Set height to 100
PRINT #1, CHR$(&H1D);"k";CHR$(2); ← Print bar code
PRINT #1, "496595707379";CHR$(0);
```

Print Sample

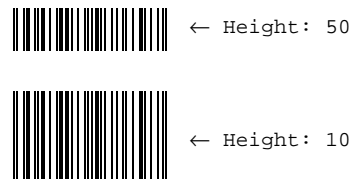

TM-H5000

A bar code can be printed only when the paper roll is selected as the print sheet.

One dot corresponds to 1/180 inch.



GS w n

[Name] Set bar code width

[Format] ASCII GS w n
Hex 1D 77 n
Decimal 29 119 n

[Range] **TM-H5000: $2 \leq n \leq 6$**

[Default] **TM-H5000: $n = 3$**

[Printers not featuring this command] **TM-U375, TM-U925, TM-U325D,
TM-U300C/D**

[Description] Sets the horizontal size of a bar code.

- **n** specifies the bar code width.

[Note] ■ The units for **n** depend on the printer model.

[Model-dependent variations] **TM-H5000**

Program Example for all printers

```
PRINT #1, CHR$(&H1D); "h"; CHR$(80); ← Set height
PRINT #1, CHR$(&H1D); "w"; CHR$(3); ← Set width size to 3
PRINT #1, CHR$(&H1D); "k"; CHR$(2); ← Print bar code
PRINT #1, "496595707379"; CHR$(0);
PRINT #1, CHR$(&HA);
PRINT #1, CHR$(&H1D); "w"; CHR$(4); ← Set width size to 4
PRINT #1, CHR$(&H1D); "k"; CHR$(2); ← Print bar code
PRINT #1, "496595707379"; CHR$(0);
PRINT #1, CHR$(&HA);
PRINT #1, CHR$(&H1D); "w"; CHR$(5); ← Set width size to 5
PRINT #1, CHR$(&H1D); "k"; CHR$(2); ← Print bar code
PRINT #1, "496595707379"; CHR$(0);
```

Print Sample



TM-H5000

A bar code can be printed only when the paper roll is selected as the print sheet.

n specifies the bar code width as follows:

<i>n</i>	Module Width (mm) for Multilevel Bar Code	Binary Level Bar Code	
		Thin Element Width (mm)	Thick Element Width (mm)
2	0.282	0.282	0.706
3	0.423	0.423	1.129
4	0.564	0.564	1.411
5	0.706	0.706	1.834
6	0.847	0.847	2.258

The multilevel bar codes are UPC-A, UPC-E, JAN13 (EAN13), JAN8 (EAN8), CODE93, and CODE128. The binary level bar codes are CODE39, ITF, and CODABAR.



GS H *n*

[Name] Select printing position of HRI characters

[Format] ASCII GS H *n*
 Hex 1D 48 *n*
 Decimal 29 72 *n*

[Range] $0 \leq n \leq 3$
 $48 \leq n \leq 51$

[Default] $n = 0$

[Printers not featuring this command] **TM-U375, TM-U925**

[Description] Selects the printing position for Human Readable Interpretation (HRI) characters when printing a bar code, using ***n*** as follows:

<i>n</i>	Printing Position
0, 48	Not printed
1, 49	Above the bar code
2, 50	Below the bar code
3, 51	Both above and below the bar code

[Note] ■ HRI characters are printed using the font specified by **GS f**.

[Model-dependent variations] **TM-H5000**



Program Example for all printers

```
PRINT #1, CHR$(&H1D);"h";CHR$(80); ← Set height
FOR n=0 to 3
  PRINT #1, CHR$(&H1D);"H";CHR$(n); ← Select print position
  PRINT #1, CHR$(&H1D);"k";CHR$(2); ← Print bar code
  PRINT #1, "4965957073797";CHR$(0);
  PRINT #1, CHR$(&HA);
NEXT n
```

Print Sample



TM-H5000

A bar code can be printed only when the paper roll is selected as the print sheet.



GS f n

[Name] Select font for HRI characters

[Format] ASCII GS f n
 Hex 1D 66 n
 Decimal 29 102 n

[Range] $n = 0, 1, 48, 49$

[Default] $n = 0$

[Printers not featuring this command] **TM-U375, TM-U925, TM-U325D, TM-U300C/D**

[Description] Selects a font for the Human Readable Interpretation (HRI) characters when printing a bar code, using n as follows:

n	Font of HRI characters
0, 48	Font A
1, 49	Font B

- [Notes]
- The font set by this command is effective only for HRI character.
 - Configurations of font A and font B are different, depending on the printer model.
 - HRI characters are printed at the position specified by **GS H**.

[Model-dependent variations] **TM-H5000**



Program Example for all printers

```
PRINT #1, CHR$(&H1D);"h";CHR$(80); ← Set height
PRINT #1, CHR$(&H1D);"H";CHR$(2); ← Select print position
PRINT #1, CHR$(&H1D);"f";CHR$(0); ← Select font
PRINT #1, CHR$(&H1D);"k";CHR$(2); ← Print bar code
PRINT #1, "496595707379";CHR$(0);
PRINT #1, CHR$(&HA);
PRINT #1, CHR$(&H1D);"f";CHR$(1); ← Select font
PRINT #1, CHR$(&H1D);"k";CHR$(2); ← Print bar code
PRINT #1, "496595707379";CHR$(0);
```

Print Sample



TM-H5000

A bar code can be printed only when the paper roll is selected as the print sheet.

**Character configurations: Font A: 12 × 24
Font B: 9 × 24**



MACRO FUNCTION COMMANDS

Command **Name**

GS : Start/end macro definition

GS ^ r t m Execute macro



GS :

[Name] Start/end macro definition

[Format] ASCII GS :
 Hex 1D 3A
 Decimal 29 58

[Range] None

[Default] None

[Printers not featuring this command] **TM-U375, TM-U925, TM-U325D,**
TM-U300C/D

[Description] Starts or ends macro definition.

- [Notes]
- Macro definition starts when this command is processed during normal operation and ends when it is processed during macro definition.
 - While the macro is defined, the printing is also executed.
 - The maximum number of data to be defined as a macro is different, depending on the printer model. If the macro definition exceeds the maximum number of data, the excess data is not stored.
 - If the printer processes this command again immediately after previously processing it, the printer clears the definition.
 - If **GS ^** is processed during macro definition, this command is canceled and clears the definition.



- Macro is not defined when the power is turned on.
- The defined contents of the macro are not cleared by **ESC @**.
- The macro is executed by **GS ^**.

[Model-dependent variations] **TM-H5000**

See program example for **GS :** and **GS ^**.



TM-H5000

The maximum number of data to be defined is 2048 bytes.



GS ^ r t m

[Name] Execute macro

[Format] ASCII GS ^ r t m
 Hex 1D 5E r t m
 Decimal 29 94 r t m

[Range] $0 \leq r \leq 255$
 $0 \leq t \leq 255$
 $m = 0, 1$

[Default] None

[Printers not featuring this command] **TM-U375, TM-U925, TM-U325D,**
TM-U300C/D

[Description] Executes a macro **r** times while waiting **t** × 100 msec for each macro execution, using the mode specified by **m** as follows:

- When **m=0**, the macro executes **r** times continuously at the interval specified by **t**.
- When **m=1**, the printer waits for the period specified by **t**, blinks the LED, and then waits for the Paper feed button to be pressed. After this button is pressed, the printer executes the macro once. The printer repeats this operation **r** times.



[Notes]

- If a macro is not defined or if r is 0, this command is ignored.
- If this command is processed while a macro is being defined, the printer cancels macro definition and clears the definition.
- When $m = 1$, paper cannot be fed with the Paper feed button.
- The LED and the Paper feed button are different, depending on the printer model.
- The macro is defined by **GS** :.
 Macro function is useful to print the same data repeatedly. To define a macro definition, send **GS** : just before and after the data desired to be repeated. And then execute macro by using **GS** ^ to print the same data repeatedly. Macro function eliminates the need for sending all the print data every time.

[Model-dependent variations] **TM-H5000**

See program example for **GS** : and **GS** ^.



Program example for GS : and GS ^

Program Example

```
PRINT #1, CHR$(&H1D); ":";
PRINT #1, CHR$(&H1B); "a";CHR$(1);
PRINT #1, "*** Hello";
PRINT #1, CHR$(&H1D); "!";CHR$(17);
PRINT #1, "EPSON";
PRINT #1, CHR$(&H1D); "!";CHR$(0);
PRINT #1, "World! ***";
PRINT #1, CHR$(&HA); CHR$(&HA);
PRINT #1, CHR$(&H1B); "a";CHR$(0);
PRINT #1, CHR$(&H1B); "-";CHR$(1);
PRINT #1, "No.                "; CHR$(&HA);
PRINT #1, "Name                "; CHR$(&HA);
PRINT #1, "Address              "; CHR$(&HA);
PRINT #1, CHR$(&H1B); "d";CHR$(5);
PRINT #1, CHR$(&H1B); "-";CHR$(0);
PRINT #1, CHR$(&H1D); ":";
PRINT #1, CHR$(&H1D); "^";CHR$(2);CHR$(0);CHR$(0);
```

Defines
a macro

Print Sample

*** Hello EPSON World! ***

No. _____

Name _____

Address _____

*** Hello EPSON World! ***

No. _____

Name _____

Address _____



TM-H5000

When $m = 1$, the PAPER OUT and RELEASE LED indicators blink during a macro waiting state.

When $m = 1$, the FEED, FORWARD, and REVERSE can be Paper feed buttons.



MECHANISM CONTROL COMMANDS

Command Name

ESC U n Turn unidirectional printing mode on/off

ESC < Return home

ESC F n Set/cancel cut sheet reverse eject

ESC q Paper release

ESC o Stamp

① **GS V m** ② **GS V m n**

Select cut mode and cut paper

ESC i Partial cut (one point left uncut)

ESC m Partial cut (three points left uncut)



ESC U *n*

[Name] Turn unidirectional printing mode on/off

[Format] ASCII ESC U *n*
 Hex 1B 55 *n*
 Decimal 27 85 *n*

[Range] $0 \leq n \leq 255$

[Default] **TM-H5000, TM-U925:** *n* = 0
TM-U375: Standard mode: *n* = 0
 Page mode: *n* = 1
TM-U325D: *n* = 0
TM-U300C/D: *n* = 0

[Printers not featuring this command] None

[Description] Turns unidirectional printing mode on or off.

- When the LSB of *n* is 0, unidirectional printing mode is turned off.
- When the LSB of *n* is 1, unidirectional printing mode is turned on.

[Notes] ■ This mode can be set independently in standard mode and in page mode.
 ■ When unidirectional printing mode is turned off, bidirectional printing mode is automatically turned on.



- When page mode is selected, the printer performs unidirectional printing for all data that is to be collectively printed using **FF** or **ESC FF**.
- Unidirectional printing mode can be turned on when printing double-height characters or downloaded bit image to ensure that the top and bottom of the printing patterns are aligned.

[Model-dependent variations] **TM-H5000**

Program Example for all printers

```
PRINT #1, CHR$(&H1B);"U";CHR$(1); ← Unidirectional printing mode turned on
```



TM-H5000

This command is effective only when the slip is selected as the print sheet.



ESC <

[Name] Return home

[Format] ASCII ESC <
Hex 1B 3C
Decimal 27 60

[Range] None

[Default] None

[Printers not featuring this command] None

[Description] Moves the print head to the standby position.

[Note] ■ The standby position is different, depending on the printer model.

[Model-dependent variations] **TM-H5000** **TM-U375** **TM-U925**
TM-U325D **TM-U300C/D**

Program Example for all printers

```
PRINT #1, CHR$(&H1B); "<" ;
```



TM-H5000

The standby position is in the left.

This command is effective only when the slip is selected as the print sheet.



TM-U375

The standby position is in approximately the center of the line.

Do not use **ESC** < with the cut sheet inserted. Otherwise, a paper jam will occur.



TM-U925

The standby position is in the right.



TM-U325D

The standby position is in the left.



TM-U300C/D

The standby position is in the left.



ESC F *n*

[Name] Set/cancel cut sheet reverse eject

[Format] ASCII ESC F *n*

Hex 1B 46 *n*

Decimal 27 70 *n*

[Range] $0 \leq n \leq 255$

[Default] **TM-H5000: *n* = 1**

[Printers not featuring this command] **TM-U375, TM-U925,**
TM-U325D, TM-U300C/D

[Description] Sets or cancels the cut sheet (slip or validation) reverse eject.

- When the LSB of *n* is 0, the cut sheet reverse ejection is canceled.
- When the LSB of *n* is 1, the cut sheet reverse ejection is set.

- [Notes]
- When the cut sheet reverse ejection is canceled, the forward ejection is set.
 - The eject direction set by this command is effective only when the cut sheet is ejected.
 - The eject length specified by **ESC C**.

[Model-dependent variations] **TM-H5000**

Program Example for all printers

```
PRINT #1, CHR$(&H1B);"F";CHR$(0); ← cancel reverse eject
```



TM-H5000

This command is effective only when the slip is selected as the print sheet and affects ejection.



ESC q

[Name] Paper release
 [Format] ASCII ESC q
 Hex 1B 71
 Decimal 27 113

[Range] None

[Default] None

[Printers not featuring this command] **TM-U925, TM-U300C/D**

[Description] Releases the cut sheet.

- [Notes]
- When the cut sheet (slip or validation) is selected as the print sheet, the printer waits for the paper to be removed after executing a release; then the printer selects the paper roll as the print sheet.
 - When the paper roll is selected as the print sheet, the printer starts the next operation immediately after executing a release.

[Model-dependent variations] **TM-H5000**

Program Example for all printers

```
PRINT #1, CHR$(&H1B); "q";
```



TM-H5000

When standard mode is selected, this command is enabled only when processed at the beginning of the line.



ESC o

[Name] Stamp

[Format] ASCII ESC o
 Hex 1B 6F
 Decimal 27 111

[Range] None

[Default] None

[Printers not featuring this command] **TM-H5000, TM-U375, TM-U325D,**
TM-U300C/D

[Description] Executes stamp printing on the paper roll.

- [Notes]
- This command is enabled only when the paper roll is selected as the print sheet. If the cut sheet (slip or validation) is selected as the print sheet, this command is ignored.
 - When standard mode is selected, this command is enabled only when processed at the beginning of the line.
 - If a stamp is not provided for the paper roll selected as the print sheet, this command is ignored.
 - When using this command, there is a gap between the stamp position and the printing position.

[Model-dependent variations] None



Program Example for all printers

```
PRINT #1,CHR$(&H1B);"c0";CHR$(2); ← Select print sheet
PRINT #1,CHR$(&H1B);"o"; ← stamp
PRINT #1,CHR$(&H1B);"d";CHR$(13);
PRINT #1,"    AAAAA";CHR$(&HA);
```

Print Sample

YOUR RECEIPT

Thank you
Call again

AAAAA



① **GS V m** ② **GS V m n**

[Name] Select cut mode and cut paper

[Format] ① ASCII GS V *m*
 Hex 1D 56 *m*
 Decimal 29 86 *m*
 ② ASCII GS V *m n*
 Hex 1D 56 *m n*
 Decimal 29 86 *m n*

[Range] ① **TM-H5000: *m* = 1, 49**
 ② **TM-H5000: *m* = 66, 0 ≤ *n* ≤ 255**
 TM-U325D: *m* = 65, 66, 0 ≤ *n* ≤ 255

[Default] None

[Printers not featuring this command] **TM-U375, TM-U925, TM-U300C/D**

[Description] Select a paper cutting mode using *m* and then cut the paper, as follows:

<i>m</i>	Function	
①	0, 48	Executes a full cut (cuts the paper completely).
	1, 49	Executes a partial cut (one point left uncut).
②	65	Feeds paper to (cutting position + <i>n</i> × vertical motion unit) and executes a full cut (cuts the paper completely).
	66	Feeds paper to (cutting position + <i>n</i> × vertical motion unit) and executes a partial cut (one point left uncut).



[Notes for ① and ②]

- These commands are enabled only when the paper roll is selected as the print sheet. If the cut sheet (slip or validation) is selected as the print sheet, these commands are ignored.
- When standard mode is selected, these commands are enabled only when processed at the beginning of the line.
- Some printer models support a full cut ($m = 0, 48$ or 65).
- When using these commands, there is a gap between the auto-cutter position and the printing position.

[Note for ①] ■ If an auto-cutter is not provided for the paper roll selected as the print sheet, this command is ignored.

- [Notes for ②] ■ When $n = 0$, the printer feeds the paper to the cutting position and cut it.
- If an auto-cutter is not provided for the paper roll selected as the print sheet, the printer only feeds the paper to manual-cutter position.

[Model-dependent variations] **TM-H5000** **TM-U325D**

Program Example for all printers

```
PRINT #1, CHR$(&H1B); "c0"; CHR$(2); ← Select print sheet
PRINT #1, "      AAAAA"; CHR$(&HA);
PRINT #1, CHR$(&H1D); "V"; CHR$(66); CHR$(0); ← Feed paper and cut
```

Print Sample

AAAAA

Paper fed to the cutting position and
partial cut (one point left uncut)
performed



TM-H5000

The vertical motion unit is specified by **GS P**.



TM-U325D

The printer feeds the paper to [cutting position + $n \times (1/144$ inch)]. The cutting position is the manual cutter position. The printer does not have the auto cutter; therefore, paper cannot be cut automatically.



ESC i

[Name] Partial cut (one point left uncut)

[Format] ASCII ESC i
Hex 1B 69
Decimal 27 105

[Range] None

[Default] None

[Printers not featuring this command] **TM-H5000, TM-U375, TM-U325D,**
TM-U300C/D

[Description] Executes a partial cut of the paper roll with one point left uncut.

- [Notes]
- **GS V** can also be used to cut paper. **GS V** is recommended for cutting paper. **ESC i** is not a recommended command.
 - This command is enabled only when the paper roll is selected as the print sheet. If the cut sheet (slip or validation) is selected as the print sheet, this command is ignored.
 - When standard mode is selected, this command is enabled only when processed at the beginning of the line.
 - If an auto-cutter is not provided for the paper roll selected as the print sheet, This command is ignored.
 - When using this command, there is a gap between the auto-cutter and printing position.

[Model-dependent variations] None

See program example for **ESC i** and **ESC m**.



ESC m

[Name] Partial cut (three points left uncut)

[Format] ASCII ESC m
 Hex 1B 6D
 Decimal 27 109

[Range] None

[Default] None

[Printers not featuring this command] **TM-H5000**, **TM-U375**, **TM-U325D**,
TM-U300C/D

[Description] Executes a partial cut of the paper roll with three points left uncut.

- [Notes]
- **GS V** can also be used to cut paper. **GS V** is recommended for cutting paper. **ESC m** is not a recommended command.
 - This command is enabled only when the paper roll is selected as the print sheet. If the cut sheet (slip or validation) is selected as the print sheet, this command is ignored.
 - When standard mode is selected, this command is enabled only when processed at the beginning of the line.
 - If an auto-cutter is not provided for the paper roll selected as the print sheet, this command is ignored.
 - When using this command, there is a gap between the auto-cutter and printing position.

[Model-dependent variations] None

See program example for **ESC i** and **ESC m**.



Program example for ESC i and ESC m

Program Example

```
PRINT #1,CHR$(&H1B);"c0";CHR$(2); ← Select print sheet
PRINT #1,"    AAAAA";
PRINT #1,CHR$(&H1B);"d";CHR$(5);
PRINT #1,CHR$(&H1B);"m"; ← Cut paper
PRINT #1,"    BBBBB";
PRINT #1,CHR$(&H1B);"d";CHR$(5);
PRINT #1,CHR$(&H1B);"i"; ← Cut paper
```

Print Sample

AAAAA

ESC m leaves paper joined in three places.

BBBBB

ESC i leaves paper joined in one place.



MICR (MAGNETIC INK CHARACTER RECOGNITION) COMMANDS

Command	Name
FS a 0 n	Read check paper
FS a 1	Load check paper to print starting position
FS a 2	Eject check paper
FS b	Request retransmission of check paper reading result
FS c	MICR mechanism cleaning
DLE EOT BS n	Real-time MICR status transmission



FS a 0 n

[Name] Read check paper

[Format] ASCII FS a 0 n
 Hex 1C 61 30 n
 Decimal 28 97 48 n

[Range] $0 \leq n \leq 255$

[Default] None

[Printers not featuring this command] **TM-U375, TM-U325D, TM-U300C/D**

[Description] Selects the MICR function and reads the check paper, using **n** as follows:

Bit	Off/On	Hex	Decimal	Function
0	Off	00	0	Readable fonts. See the table on the next screen.
	On	01	1	
1	Off	00	0	
	On	02	2	
2,3,4, 5,6,7	—	—	—	Undefined.



Readable fonts:

Bit 1	Bit 0	Hex	Decimal	Font
Off	Off	00	0	E13B
Off	On	01	1	CMC7
On	Off	02	2	Undefined
On	On	03	3	Undefined

- If an undefined font is selected, this command is ignored.

[Notes]

- Readable fonts indicate the character standard for converting a readable waveform to a character data.
- This command supports the printers with the MICR option.
- This command is enabled only when processed at the beginning of the line in standard mode.
- If this command is processed in page mode, it is ignored.
- If MICR function is not selected when this command is executed, the MICR function is selected and the printer is in the check paper waiting status. The printer waits for the check paper until the check paper is inserted, the waiting time **t1** set by **ESC f** elapses, the printer is reset, or the power is turned off. Selected/unselected of the MICR function is confirmed by **DLE EOT BS**.



- During the check paper waiting period, the printer processes only a real-time command, such as **DLE EOT** or **DLE ENQ**.
- It is possible to cancel the check paper waiting status using **DLE ENQ 3**. In this case, however, data in the print and receive buffer is cleared. The check paper insertion waiting status can be confirmed by **DLE EOT BS**.
- If a character detected cannot be identified as the specified character font, the printer ends this command at this point and transmits "header + reading status (abnormal end) + NUL" (bit 5 of Reading status is On) to the host computer.
- The printer transmits a reading result to the host computer after reading.
 - When the printer ends reading normally, it transmits "① header + ② reading status (normal end) + ③ data + ④ NUL" to the host computer.



- When a reading result is abnormal, the printer transmits “① header + ② reading status (abnormal end) + ④ NUL” to the host computer. The printer does not transmit “③ data”.

① Header: 5FH (decimal 95)

② Reading status:

Bit	Off/On	Hex	Decimal	Function
0	Off	00	0	Readable fonts. See the table on the next screen.
	On	01	1	
1	Off	00	0	
	On	02	2	
2, 3	—	—	—	Undefined.
4	Off	00	0	Rereading possible.
	On	10	16	Rereading not possible.
5	Off	00	0	Reading: Normal end.
	On	20	32	Reading: Abnormal end.
6	On	40	64	Not used. Fixed to On.
7	Off	00	0	Not used. Fixed to Off.



Readable fonts:

Bit 1	Bit 0	Hex	Decimal	Font
Off	Off	00	0	E13B
Off	On	01	1	CMC7
On	Off	02	2	Undefined
On	On	03	3	Undefined

③ Data: Identified character strings (ASCII code).

④ NUL: 00H (decimal 0)

- Bits 0 and 1 of the Reading status indicate identified character fonts. When an abnormal end occurs, bit 0 and bit 1 have no meaning.
- In the following cases, rereading is not possible (bit 4 is On):
 - When an abnormal end occurs.
 - When the printer gets to the maximum times for rereading (the maximum time is different for different models).
 - When the MICR status is not selected.



- The following cases are abnormal ends (bit 5 of Reading status is On):
 - Character waveforms cannot be detected.
 - Normal waveform reading cannot be detected.
 - The check paper waiting status is canceled by **DLE ENQ 3**.
 - The wait time **t1** set by **ESC f** has elapsed.
 - An error occurs during the period from the start of command processing to the transmission of Header.
 - When an error occurs (errors are different depending on the printer).
- When bit 4 of Reading status is Off (rereading possible) and codes other than **FS a 0**, **FS a 1**, **FS a 2**, **FS b**, or real-time commands are processed, the printer ejects the check paper, ends MICR function, bit 4 becomes On (rereading not possible), and selects the paper roll as the print sheet.
- When bit 4 of Reading status is On (rereading not possible) and codes other than **FS a 1**, **FS a 2**, **FS b**, or real-time commands are processed, the printer ejects the check paper, ends MICR function, and selects the paper roll as the print sheet.



- When bit 5 of Reading status is Off (reading ends normally), the printer transmits "Header ~ NUL" to the host computer but does not eject the check paper. And then, codes other than **FS a 1**, **FS a 2**, **FS b**, or real-time commands are processed, the printer ejects the check paper, ends MICR function, and selects the paper roll as the print sheet.
 - When an abnormal end occurs, the printer ejects the check paper, unselects the MICR function, and selects the paper roll as the print sheet.
- When an abnormal end occurs due to a recoverable error, the printer does not transmit "Header ~ NUL". The printer recovers from the error by **DLE ENQ 1** or **DLE ENQ 2** after removing a cause of the error, ejects the check paper, unselects the MICR function, and selects the paper roll as the print sheet.
- The printer ignores real-time commands during "Header ~ NUL" transmission.
- Even if the ASB function is selected, the ASB status is not transmitted during reading and "Header ~ NUL" transmission.



- When DTR/DSR control is selected by DIP switch (Handshaking) with a serial interface, the printer confirms just before transmitting the Header that the host computer is ready to receive data. If the host computer is not ready to receive data, the printer waits until the host becomes ready. After transmitting the Header, the printer transmits all data without confirming whether the host computer can receive data.
- When XON/XOFF control is selected by DIP switch (Handshaking) with a serial interface, the printer transmits "Header ~ NUL" consecutively without confirming whether the host computer can receive data.
- The Reading status is not cleared until the next **FS a 0** is executed, **ESC @** is executed, the printer is reset, or the power is turned off.
- Paper feeding with the Paper feed button cannot be performed during the period from starting MICR reading to ending check paper ejection.

[Model-dependent variations] **TM-H5000** **TM-U925**

Program Example for all printers

```
PRINT #1, CHR$(&H1C); "a0"; CHR$(0); ← Readable font as E13B
```



TM-H5000

Handshaking for a serial interface is selected by DIP switch 1-3.

The printer does not support rereading function.

Bit 4 of Reading status is always fixed to On (Rereading not possible).

Abnormal ends occur:

- When the length of a check paper is outside of the specified range.
- When the front cover is open during reading.



TM-U925

Handshaking for a serial interface is selected by DIP switch 1-8.
The printer can only reread once. No individual abnormal ends.



FS a 1

[Name] Load check paper to print starting position

[Format] ASCII FS a 1
Hex 1C 61 31
Decimal 28 97 49

[Range] None

[Default] None

[Printers not featuring this command] **TM-U375, TM-U325D, TM-U300C/D**

[Description] Loads the check paper to the print starting position.

- [Notes]
- This command supports the printers with the MICR option.
 - This command is ignored unless the MICR function is selected.
 - When this command is executed, bit 4 of Reading status for **FS b** is On (Rereading not possible).
 - After loading the check paper, the printer ends the MICR function and selects the slip paper as the print sheet.

[Model-dependent variations] None

Program Example for all printers

```
PRINT #1, CHR$(&H1C);"a1";
```



FS a 2

[Name] Eject check paper

[Format] ASCII FS a 2
Hex 1C 61 32
Decimal 28 97 50

[Range] None

[Default] None

[Printers not featuring this command] **TM-U375, TM-U325D, TM-U300C/D**

[Description] Ejects the check paper.

- [Notes]
- This command supports the printers with the MICR option.
 - This command is ignored unless the MICR function is selected.
 - When this command is executed, bit 4 of Reading status for **FS b** is On (Rereading not possible).
 - After ejecting the check paper, the printer ends the MICR function and selects the paper roll as the print sheet.

[Model-dependent variations] None

Program Example for all printers

```
PRINT #1, CHR$(&H1C);"a2";
```



FS b

[Name]	Request retransmission of check paper reading result		
[Format]	ASCII	FS	b
	Hex	1C	62
	Decimal	28	98
[Range]	None		
[Default]	None		
[Printers not featuring this command]	TM-U375, TM-U325D, TM-U300C/D		
[Description]	Retransmits the previous check paper reading results.		
[Notes]	<ul style="list-style-type: none"> ■ This command supports the printers with the MICR option. ■ The transmitted information is the same as that previously transmitted by FS a 0. <ul style="list-style-type: none"> • Header: 5FH (decimal 95) 		



- Reading status:

Bit	Off/On	Hex	Decimal	Function
0	Off	00	0	Readable fonts. See the table below.
	On	01	1	
1	Off	00	0	
	On	02	2	
2, 3	—	—	—	Undefined.
4	Off	00	0	Rereading possible.
	On	10	16	Rereading not possible.
5	Off	00	0	Reading: Normal end.
	On	20	32	Reading: Abnormal end.
6	On	40	64	Not used. Fixed to On.
7	Off	00	0	Not used. Fixed to Off.

Readable fonts:

Bit 1	Bit 0	Hex	Decimal	Font
Off	Off	00	0	E13B
Off	On	01	1	CMC7
On	Off	02	2	Undefined
On	On	03	3	Undefined

- Data: Identified character strings (ASCII code).
- NUL: 00H (decimal 0)



- Bits 0 and 1 of the Reading status indicate identified character fonts. When an abnormal end occurs, both bit 0 and 1 have no meaning.
- In the following cases, rereading is not possible (bit 4 is On):
 - When an abnormal end occurs.
 - When the printer gets to the maximum times for rereading (the maximum time is different for different models).
 - When the MICR status is not selected.
 - If **FS a 0** is not executed after executing **ESC @**, resetting, or turning power on.
- “③ data” is transmitted when the printer ends reading normally.
- The following cases are abnormal ends (bit 5 of Reading status is On):
 - **FS a 0** is not executed after executing **ESC @**, resetting, or turning power on.
 - Character waveforms cannot be detected.
 - Normal waveform reading cannot be detected.
 - The check paper waiting status is canceled by **DLE ENQ 3**.
 - The wait time **t1** set by **ESC f** has elapsed.



- An error occurs during the period from the start of command processing to the transmission of Header.
- When an error occurs (errors are different depending on the printer).
- If **FS a 0** is not executed before **FS b**, the printer transmits "① Header + ② Reading status (abnormal end) + ④ NUL". "③ data" is not transmitted.
- The printer ignores real-time commands during "Header ~ NUL" transmission.
- Even if the ASB function is selected, the ASB status is not transmitted during "Header ~ NUL" transmission.
- When DTR/DSR control is selected by DIP switch (Handshaking) with a serial interface, the printer confirms just before transmitting the Header that the host computer is ready to receive data. If the host computer is not ready to receive data, the printer waits until the host becomes ready. After transmitting the Header, the printer transmits all data without confirming whether the host can receive data.
- When XON/XOFF control is selected by DIP switch (Handshaking) with a serial interface, the printer transmits "Header ~ NUL" consecutively without confirming whether the host computer can receive data.

[Model-dependent variations] **TM-H5000** **TM-U925**

Program Example for all printers

```
PRINT #1, CHR$(&H1C); "b";
```



TM-H5000

Handshaking for a serial interface is selected by DIP switch 1-3.

This printer does not support rereading function.

Bit 4 of the Reading status is always fixed to On (Rereading not possible).

Abnormal ends occur:

- When the length of a check paper is outside of the specified range.
- When the front cover is open during reading.



TM-U925

Handshaking for a serial interface is selected by DIP switch 1-8.

The printer can only reread once.

No individual abnormal ends.



FS c

[Name] MICR mechanism cleaning

[Format] ASCII FS c
 Hex 1C 63
 Decimal 28 99

[Range] None

[Default] None

[Printers not featuring this command] **TM-U375**, **TM-U325D**, **TM-U300C/D**

[Description] Cleans the MICR mechanism.

- [Notes]
- This command supports the printers with the MICR option.
 - This command is enabled only when processed at the beginning of the line in standard mode.
 - If this command is processed in page mode, it is ignored.
 - When this command is executed, the printer is in the cleaning sheet waiting status. Insert the cleaning sheet into the check paper entrance. The printer waits for the cleaning sheet until a cleaning sheet is inserted, the waiting time **t1** set by **ESC f** elapses, the printer is reset, or the power is turned off.



- During the cleaning sheet waiting period, the printer processes only a real-time command, such as **DLE EOT** or **DLE ENQ**.
- It is possible to cancel the cleaning sheet waiting status using **DLE ENQ 3**. In this case, however, data in the print and receive buffer is cleared. The cleaning sheet insertion waiting status can be confirmed by **DLE EOT BS**.
- After cleaning the MICR mechanism, the printer automatically selects the paper roll as the print sheet.

[Model-dependent variations] None

Program Example for all printers

```
PRINT #1, CHR$(&H1C); "c";
```



DLE EOT BS *n*

[Name] Real-time MICR status transmission

[Format]	ASCII	DLE	EOT	BS	<i>n</i>
	Hex	10	04	08	<i>n</i>
	Decimal	16	4	8	<i>n</i>

[Range] $n = 1$

[Default] None

[Printers not featuring this command] **TM-U375, TM-U325D, TM-U300C/D**

[Description] Transmits 1 byte of MICR status in real time when $n=1$.

- [Notes]
- This command supports the printers with the MICR option.
 - The printer executes this command upon receiving it.
 - The printer transmits the status without confirming whether the host computer can receive data.
 - With a serial interface model, this command is executed even when the printer is off-line, the receive buffer is full, or an error occurs.
 - With a parallel interface model, this command is not executed in following statuses, because the printer is busy and unable to receive data from the host computer. The DIP switch (BUSY condition) is different, depending on the printer model.
 - Receive buffer is full when DIP switch is set to On.
 - Printer is off-line, an error occurs, or receive buffer is full when DIP switch is set to Off.



- This command is ignored during a process of transmitting the check paper reading result.
- The MICR status to be transmitted is as follows:
 - MICR status ($n=1$)

Bit	Off/ On	Hex	Decimal	Function
0	Off	00	0	Not used. Fixed to Off.
1	On	02	2	Not used. Fixed to On.
2	Off	00	0	MICR function selected.
	On	04	4	MICR function not selected.
3	Off	00	0	Does not wait for check paper or cleaning sheet insertion.
	On	08	8	Waits for check paper or cleaning sheet insertion.
4	On	10	16	Not used. Fixed to On.
5	Off	00	0	TOF sensor: paper present.
	On	20	32	TOF sensor: paper not present.

■■■ *how to use this table*



Bit	Off/ On	Hex	Decimal	Function
6	Off	00	0	BOF sensor: paper present.
	On	40	64	BOF sensor: paper not present.
7	Off	00	0	Not used. Fixed to Off.

- Some paper sensors are not present, depending on the printer model.
- The names of some paper sensors are different, depending on the printer model.

[Model-dependent variations] **TM-H5000** **TM-U925**

Program Example for all printers

```
PRINT #1, CHR$(&H10);CHR$(&H4);CHR$(&H8);CHR$(1); ← Transmits MICR status
```



TM-H5000

BUSY condition for a parallel interface is selected by DIP switch 2-1.



TM-U925

BUSY condition for a parallel interface is selected by DIP switch 2-5.

The names of the paper sensors for bits 5 and 6:

- Check insertion sensor is the same sensor as the TOF sensor.
- Check ejection sensor is the same sensor as the BOF sensor.



MISCELLANEOUS COMMANDS

Command	Name
ESC @	Initialize printer
GS I n	Transmit printer ID
GS P x y	Set horizontal and vertical motion units
ESC p m t1 t2	Generate pulse
ESC = n	Select peripheral device
ESC L	Select page mode
ESC S	Select standard mode
GS E n	Select head control method
DLE ENQ n	Real-time request to printer



ESC @

[Name] Initialize printer

[Format] ASCII ESC @
 Hex 1B 40
 Decimal 27 64

[Range] None

[Default] None

[Printers not featuring this command] None

[Description] The data in the print buffer is cleared and the printer mode(s) is reset to the mode that was in effect when the power was turned on.

- [Notes]
- The DIP switch settings are not checked again.
 - The data in the receive buffer is not cleared.
 - Any macro definitions are not cleared.



- When **ESC @** is executed, the setting of **ESC =** (Select peripheral device) differs from the default value when the power is turned on.
 - The value of ***n*** after **ESC @** is executed is different depending on the status of the peripheral device selection just before executing **ESC @** and the DIP switch setting (customer display (DM-D) connection) as follows:)

		<i>n</i>		
Setting when the power is turned on	DIP switch (Customer display (DM-D) connection is off.)	1		
	DIP switch (Customer display (DM-D) connection is on.)	2		
Setting just before executing ESC @		1	2	3
Setting after executing ESC @	DIP switch (Customer display (DM-D) connection is off.)	1	2	1
	DIP switch (Customer display (DM-D) connection is on.)	1	2	2

- If the printer does not support the DIP switch (connection of customer display), the setting is the same as when the DIP switch is off.



- When this command is processed with the cut sheet selected as the print sheet, all settings are initialized after ejecting the cut sheet.
- When this command is processed in page mode, the printer deletes the data in the printing areas, initializes all settings, and selects standard mode.
- This command can cancel all the settings such as print mode and line feed at the same time.

[Model-dependent variations] None

Program Example for all printers

```
PRINT #1, CHR$( &H1D); "P";CHR$(180);CHR$(180);
PRINT #1, CHR$( &H1B); "3";CHR$(60);
PRINT #1, CHR$( &H1B); "U";CHR$(1);
PRINT #1, CHR$( &H1B); "E";CHR$(1);
PRINT #1, CHR$( &H1B); "-";CHR$(1);
PRINT #1, CHR$( &H1D); "!";CHR$(17);
PRINT #1, "AAAAA"; CHR$( &HA);
PRINT #1, CHR$( &H1B); "@";   ← Initialize printer
PRINT #1, "BBBBB"; CHR$( &HA);
```

Print Sample

AAAAA

BBBBB

← All settings are canceled after **ESC @** is executed



GS I *n*

[Name] Transmit printer ID

[Format] ASCII GS I *n*
 Hex 1D 49 *n*
 Decimal 29 73 *n*

[Range] $1 \leq n \leq 3$
 $49 \leq n \leq 51$

[Default] None

[Printers not featuring this command] None

[Description] Transmits 1 byte of printer ID using *n* as follows:

<i>n</i>	Printer ID	Specification
1, 49	Printer model ID	Printer model
2, 50	Type ID	Printer type
3, 51	Version ID	Firmware version



[Notes]

■ Printer model ID depends on the printer model.

■ Type ID to be transmitted is as follows:

Bit	Off/On	Hex	Decimal	Function
0	Off	00	0	Two-byte character code not supported.
1	Off	00	0	Not auto-cutter equipped.
	On	02	2	Auto-cutter equipped.
2	Off	00	0	DIP switch (Connection of customer display) is Off.
	On	04	4	DIP switch (Connection of customer display) is On.
3	Off	00	0	Without MICR reader.
	On	08	8	With MICR reader.
4	Off	00	0	Not used. Fixed to Off.
5, 6	—	—	—	Undefined.
7	Off	00	0	Not used. Fixed to Off.

■■■ *how to use this table*

- With a parallel interface model, bit 2 is fixed to Off.



- When DTR/DSR control is selected by DIP switch (Handshaking) with a serial interface, the printer transmits the ID data after confirming that the host is ready to receive data. If the host computer is not ready to receive data, the printer waits until the host becomes ready.
- When XON/XOFF control is selected by DIP switch (Handshaking) with a serial interface, the printer transmits the ID data without confirming whether the host computer can receive data.

[Model-dependent variations] **TM-H5000** **TM-U375** **TM-U925**
TM-U325D

Program Example for all printers

```
PRINT #1, CHR$(&H1D);"I";CHR$(1);← Transmits printer ID
```



TM-H5000

Handshaking for a serial interface is selected by DIP switch 1-3.

Connection of customer display for a serial interface is selected by DIP switch 2-2.

- Printer model ID ($n = 1, 49$)

Hex: 0FH / Decimal: 15

- Type ID ($n = 2, 50$)

Bit 1 is fixed to On (auto-cutter equipped).



TM-U375

Handshaking for a serial interface is selected by DIP switch 1-3.

Connection of customer display for a serial interface is selected by DIP switch 2-1.

- Printer model ID ($n = 1, 49$)

Hex: 0AH / Decimal: 10

- Type ID ($n = 2, 50$)

Bit 1 is fixed to Off (not auto-cutter equipped).

Bit 3 is fixed to Off (without MICR reader).



TM-U925

Handshaking for a serial interface is selected by DIP switch 1-8.

Connection of customer display for a serial interface is selected by DIP switch 1-6.

- Printer model ID ($n = 1, 49$)

Hex: 0CH / Decimal: 12

- Type ID ($n = 2, 50$)

Bit 1 is fixed to On (auto-cutter equipped).



TM-U325D

Handshaking for a serial interface is selected by DIP switch 1-3.

- Printer model ID ($n = 1, 49$): Hex: 22 / Decimal: 34
- Type ID ($n = 2, 50$)

Bit 1 is fixed to Off (not auto-cutter equipped).

Bit 2 is fixed to Off (DIP switch [connection of customer display] is Off).

Bit 3 is fixed to Off (without MICR reader).



GS P x y

[Name] Set horizontal and vertical motion units

[Format] ASCII GS P x y
 Hex 1D 50 x y
 Decima 29 80 x y

[Range] $0 \leq x \leq 255$
 $0 \leq y \leq 255$

[Default] **TM-H5000: For the paper roll: $x = 180, y = 360$**
For the slip paper: $x = 150, y = 144$
TM-U375: $x = 160, y = 144$
TM-U925: $x = 150, y = 144$

[Printers not featuring this command] **TM-U325D, TM-U300C/D**

[Description] Sets the horizontal and vertical motion units to $1/x$ and $1/y$ inches, respectively.

- When $x = 0$, the default setting of horizontal value is used.
- When $y = 0$, the default setting of vertical value is used.

[Notes] ■ The horizontal direction is perpendicular to the paper feed direction and the vertical direction is the paper feed direction.
 ■ The horizontal and vertical motion units indicate the minimum pitch used for calculating the values of related commands (shown on the next screen).



- In standard mode, the following commands use **x** or **y**.
 - Commands using **x**: **ESC SP**, **ESC \$**, **ESC **, **GS L**, and **GS W**
 - Commands using **y**: **ESC 3**, **ESC J**, **ESC K** and **GS V**
- In page mode, the following commands use **x** or **y**, when the starting position is set to the upper left or lower right of the printing area using **ESC T**.
 - Commands using **x**: **ESC SP**, **ESC \$**, **ESC W**, and **ESC **
 - Commands using **y**: **ESC 3**, **ESC J**, **ESC W**, **GS \$**, **GS V**, and **GS **
- In page mode, the following commands use **x** or **y**, when the starting position is set to the upper right or lower left of the printing area using **ESC T**.
 - Commands using **x**: **ESC 3**, **ESC J**, **ESC W**, **GS \$**, and **GS **
 - Commands using **y**: **ESC SP**, **ESC \$**, **ESC W**, **ESC ** and **GS V**
- The calculated result from combining this command with others is truncated to the minimum value of the mechanical pitch.
- This command does not affect the current setting values.

[Model-dependent variations] **TM-H5000** **TM-U375** **TM-U925**



Program Example for all printers

```
PRINT #1, CHR$(&H1D);"P";CHR$(180);CHR$(180);
PRINT #1, CHR$(&H1B);"3";CHR$(30); ← Set line spacing
PRINT #1, "AAAAA"; CHR$(&HA);
PRINT #1, "BBBBB"; CHR$(&HA);
PRINT #1, CHR$(&H1D);"P";CHR$(180);CHR$(90);
PRINT #1, CHR$(&H1B);"3";CHR$(30); ← Set line spacing
PRINT #1, "CCCCC"; CHR$(&HA);
PRINT #1, "DDDDD"; CHR$(&HA);
PRINT #1, "EEEEE"; CHR$(&HA);
```

Print Sample

```
AAAAA ───┐
          │
BBBBB ───┘
          │
CCCCC ───┘ 30/180-inch line spacing
          │
          │
DDDDD ───┘
          │
          │ 30/90-inch line spacing
EEEEE ───┘
```



TM-H5000

This command sets the motion units for the paper type selected by **ESC c 1**. The horizontal and vertical motion units can be set independently for paper roll and slip paper.

The default values for the paper roll equal a normal dot pitch in horizontal and a half dot pitch in vertical. The default values for the slip equal a half dot pitch in horizontal and 1/2 dot pitch in vertical.



TM-U375

The default values equal a half dot pitch in horizontal and 1/2 dot pitch in vertical.



TM-U925

The default values equal a half dot pitch in horizontal and 1/2 dot pitch in vertical.



ESC p m t1 t2

[Name] Generate pulse

[Format] ASCII ESC p m t1 t2
 Hex 1B 70 m t1 t2
 Decimal 27 112 m t1 t2

[Range] $m = 0, 1, 48, 49$
 $0 \leq t1 \leq 255$
 $0 \leq t2 \leq 255$

[Default] None

[Printers not featuring this command] None

[Description] Outputs the pulse specified by **t1** and **t2** to the specified connector pin *m* as follows:

<i>m</i>	Connector pin
0, 48	Drawer kick-out connector pin 2
1, 49	Drawer kick-out connector pin 5

- **t1** indicates ON time and t2 indicates OFF time.

[Notes] ■ If **m** is out of range, this command is canceled and the following data is processed as normal data.
 ■ If **t2 < t1**, the OFF time is equal to the ON time.

[Model-dependent variations] **TM-H5000** **TM-U375** **TM-U925**
TM-U325D **TM-U300C/D**



Program Example for all printers

```
PRINT #1, CHR$( &H1B ); "p"; CHR$( 0 ); CHR$( 25 ); CHR$( 250 );
```



TM-H5000

A pulse is (ON time= $t1 \times 2$ msec / OFF time= $t2 \times 2$ msec).



TM-U375

A pulse is (ON time= $t_1 \times 2$ msec / OFF time= $t_2 \times 2$ msec).



TM-U925

A pulse is (ON time= $t1 \times 10$ msec / OFF time= $t2 \times 10$ msec).



TM-U325D

A pulse is (ON time= $t1 \times 2$ msec / OFF time= $t2 \times 2$ msec).



TM-U300C/D

A pulse is (ON time= $t1 \times 2$ msec / OFF time= $t2 \times 2$ msec).



ESC = *n*

[Name] Select peripheral device

[Format] ASCII ESC = *n*
 Hex 1B 3D *n*
 Decimal 27 61 *n*

[Range] $1 \leq n \leq 3$

[Default] A serial interface model:

When DIP switch (connection of customer display) is Off:
 $n = 1$.

When DIP switch (connection of customer display) is On:
 $n = 2$.

A parallel interface model: $n = 1$.

[Printers not featuring this command] **TM-U300C/D**

[Description] Selects the device to which the host computer sends data, using ***n*** as follows:

<i>n</i>	Peripheral Device Status
1	Only printer selected (customer display is disabled).
2	Only customer display selected (printer is disabled).
3	Both printer and customer display selected.



[Notes]

- When the printer is disabled ($n=2$), it ignores all received data with the exception of **DLE ENQ 1** and **DLE ENQ 2**.
- If ASB is enabled when the printer is disabled by this command, the printer transmits 4-byte status message whenever the status changes.
- When executing **ESC @**, the default value of this command is as follows, depending on the value set by this command just before processing **ESC @** and on the setting of DIP switch (connection of customer display).

		<i>n</i>		
Before ESC @ processing		1	2	3
After ESC @ processing	When DIP switch (connection of customer display) is Off	1	2	1
	When DIP switch (connection of customer display) is On	1	2	2

If the printer does not support DIP switch (connection of customer display), the default value of this command is the same as when DIP switch is Off.

[Model-dependent variations] **TM-H5000** **TM-U375** **TM-U925** **TM-U325D**



Program Example for all printers

```
PRINT #1, CHR$(&H1B); "=";CHR$(1); ← Only printer selected  
PRINT #1, "AAAAA";  
PRINT #1, CHR$(&H1B); "=";CHR$(2); ← Only customer display selected  
PRINT #1, "BBBBB";  
PRINT #1, CHR$(&H1B); "=";CHR$(3);← Both printer and customer  
display selected  
PRINT #1, " CCCCC"; CHR$(&HA);
```

Print Sample

AAAAA CCCCC

Customer Display Sample

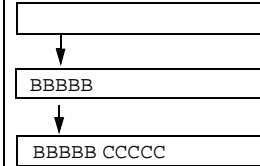

TM-H5000

Connection of customer display for a serial interface is selected by DIP switch 2-2.



TM-U375

Connection of customer display for a serial interface is selected by DIP switch 2-1.



TM-U925

Connection of customer display for a serial interface is selected by DIP switch 1-6.



TM-U325D

The printer does not support the DIP switch for connection of customer display.



ESC L

[Name] Select page mode

[Format] ASCII ESC L
 Hex 1B 4C
 Decimal 27 76

[Range] None

[Default] None

[Printers not featuring this command] **TM-U925, TM-U325D, TM-U300C/D**

[Description] Switches from standard mode to page mode.

- [Notes]
- This command is enabled only when processed at the beginning of the line in standard mode. In other cases, this command is ignored.
 - The printing position is the starting position specified by **ESC T** within the printing area defined by **ESC W**.
 - The following commands switch the settings for page mode. Because, these commands can be set independently in standard mode and in page mode:
 - **ESC SP, ESC 2, ESC 3, and ESC U**
 - In page mode, **ESC c 0** and **FS a 0** are disabled.



- The following commands are not effective in page mode. If these commands are processed in page mode, an internal flag is activated and this flag is enabled when the printer returns to standard mode.
 - **ESC V, ESC a, ESC {, GS L, and GS W**
- The printer returns to standard mode with **ESC S, FF,** and **ESC @**. When it returns to standard mode by **ESC @**, all settings are canceled.
- Standard mode is selected as the default.
- In page mode, the printer prints the data in the print buffer for the printing area specified by **ESC W** collectively by **FF** or **ESC FF**. When executing the print and paper feed commands, such as **LF, CR, ESC J,** and **ESC d**, only the printing position moves and the printer does not perform actual printing.

[Model-dependent variations] **TM-H5000** **TM-U375**

See program example for **ESC L** and **ESC S**.



TM-H5000

Page mode can be used only when the paper roll is selected as the print sheet.



TM-U375

The following commands are not effective in page mode. If these commands are processed in page mode, an internal flag is activated and this flag is enabled when the printer returns to standard mode:

- **ESC !** (select character font B (7×9) and emphasized mode), **ESC E**, **ESC G**, **ESC V**, **ESC a**, **ESC {**, **GS L**, and **GS W**

The following commands are disabled in page mode:

- **ESC *** (8-dot double-density mode) and **GS /** (normal mode)



ESC S

[Name] Select standard mode

[Format] ASCII ES S
 Hex 1B 53
 Decimal 27 83

[Range] None

[Default] None

[Printers not featuring this command] **TM-U375, TM-U925, TM-U325D, TM-U300C/D**

[Description] Switches from page mode to standard mode.

- [Notes]
- This command is enabled only in page mode. If this command is processed in standard mode, it is ignored.
 - When this command is executed, data in all the printing areas are cleared, the printing area set by **ESC W** returns to the default value, but the value set by **ESC T** is maintained.
 - The following commands switch the settings for standard mode. Because, these commands can be set independently in standard mode and in page mode:
 - **ESC SP, ESC 2, ESC 3, and ESC U**
 - In standard mode, **CAN, ESC FF, GS \$, and GS ** are ignored.



- The settings of **ESC T** and **ESC W** are not effective in standard mode. If these commands are processed in standard mode, an internal flag is activated and this flag is enabled when the printer selects page mode.
- The printer selects page mode with **ESC L**.
- Standard mode is selected as the default.

[Model-dependent variations] None



Program Example for ESC L and ESC S.

Program Example for all printers

```
PRINT #1, CHR$(&H1B);"L"; ← Select page mode
PRINT #1, CHR$(&H1D);"P";CHR$(180);CHR$(180);
PRINT #1, CHR$(&H1B);"W";CHR$(0);CHR$(0);CHR$(0);
CHR$(0);CHR$(240);CHR$(0);CHR$(200);CHR$(0);
PRINT #1, CHR$(&H1B);"T";CHR$(0); ← Select print direction
PRINT #1, "AAAAA"; CHR$(&HA);
PRINT #1, "BBBBB"; CHR$(&HA);
PRINT #1, "CCCCC";
PRINT #1, CHR$(&H1B);CHR$(&HC); ← Batch print
PRINT #1, CHR$(&H1B);"S"; ← Select standard mode
```

Print Sample

```
AAAAA
BBBBB
CCCCC
```



GS E n

[Name] Select head control method

[Format] ASCII GS E n
 Hex 1D 45 n
 Decimal 29 69 n

[Range] $0 \leq n \leq 255$

[Default] **TM-U375:** For the paper roll: $n = 1$
 For the cut sheet : $n = 0$
TM-U925: For the paper roll: when DIP switch 2-4 is Off, $n = 1$
 when DIP switch 2-4 is On, $n = 17$
 For the slip paper: $n = 16$
TM-U300C/D: $n = 1$

[Printers not featuring this command] **TM-H5000**

[Description] Selects the print speed and head energizing time, using n as follows:

Bit	Off/On	Hex	Decimal	Function
0	Off	00	0	Head energizing time: Copy.
	On	01	1	Head energizing time: Normal.
1-3	—	—	—	Undefined.
4	Off	00	0	Printing speed: HIGH.
	On	10	16	Printing speed: LOW.
5-7	—	—	—	Undefined.

■■■ how to use this table



[Notes]

- When standard mode is selected, this command is enabled only when processed at the beginning of the line.
- This command is available for paper type selected by **ESC c 0**. The head control method can be selected independently for paper roll, slip, and validation paper.
- In page mode, the setting for this command is effective for all data to be printed collectively by **FF** or **ESC FF**.

[Model-dependent variations] **TM-U375** **TM-U925** **TM-U300C/D**

Program Example for all printers

```
PRINT #1,CHR$(&H1D);"E";CHR$(16); ← Select printing speed to Low
```



TM-U375

Bit 4 is undefined.

When both the paper roll and cut sheet are selected for the paper type set by **ESC c 0**, the head energizing time for the cut sheet is enabled.



TM-U925

In this printer, high printing speed and copy head energizing time cannot be set simultaneously. *n* is used as follows:

<i>n</i>	Printing speed	Head energizing time
1	High	Normal
16	Low	Copy
17	Low	Normal



TM-U300C/D

Bit 4 is undefined.



DLE ENQ *n*

[Name] Real-time request to printer

[Format] ASCII DLE ENQ *n*
 Hex 10 05 *n*
 Decimal 16 5 *n*

[Range] $1 \leq n \leq 3$

[Default] None

[Printers not featuring this command] **TM-U300C/D**

[Description] Responds to a request in real time from the host computer, using *n* as follows:

<i>n</i>	Request
1	Restarts printing from the beginning of the line where an error occurred, after recovering from the error.
2	Recovers from an error after clearing the receive and print buffers.
3	Cancel the cut sheet waiting status after clearing the receive and print buffers.



[Notes]

- The printer executes this command upon receiving it.
- With a serial interface model, this command is executed even when the printer is off-line, or the receive buffer is full.
- With a parallel interface model, this command is not executed in the following statuses, because the printer is busy and unable to receive data from the host computer. The DIP switch (BUSY condition) is different, depending on the printer model.
 - Receive buffer is full when DIP switch is set to On.
 - Printer is off-line or receive buffer is full when DIP switch is set to Off.
- This command is ignored during a process of transmitting the check paper reading result (only with MICR reader model).
- When a recoverable error occurs, after removing a cause of the error, the printer can recover from the error by transmitting **DLE ENQ 1** or **DLE ENQ 2** without turning off the power.
- **DLE ENQ 1** or **DLE ENQ 2** is enabled only when a recoverable error occurs with the exception of an automatically recovered error, and is ignored in other cases. Errors recoverable by **DLE ENQ 1** or **DLE ENQ 2** depend on the printer model.



- **DLE ENQ 1** or **DLE ENQ 2** is also executed to recover from a recoverable error when the printer is disabled by **ESC =**.
- When the printer recovers from an error using **DLE ENQ 1** with the cut sheet (slip or validation paper) selected, the printer ejects the current sheet completely and waits for new sheet insertion. However, the printer only ejects the sheet and does not wait for new sheet insertion when the printer recovers from a cut sheet ejection error.
- When the printer recovers from an error using **DLE ENQ 2** with the cut sheet selected, the printer ejects the current sheet completely and selects the paper roll as the print sheet.
- In page mode, if the printer recovers from a recoverable error by using **DLE ENQ 2**, the printer returns to standard mode after clearing the data in receive and print buffers and changing the values set by **ESC W** to the default values.
- **DLE ENQ 3** is enabled only when the printer is in the cut sheet (slip paper, validation paper, check paper, and cleaning sheet) insertion waiting status, and is ignored in other cases. The slip paper or validation paper insertion waiting status can be confirmed by **DLE EOT**. And the check paper or cleaning sheet insertion waiting status can be confirmed by **DLE EOT BS**.
- When the cut sheet waiting status is canceled using **DLE ENQ 3**, the printer selects the paper roll as the print sheet.

[Model-dependent variations]

TM-H5000
TM-U325D

TM-U375

TM-U925



Program Example for all printers

```
PRINT #1, CHR$(&H10);CHR$(&H5);CHR$(2);
```



TM-H5000

BUSY condition for a parallel interface is selected by DIP switch 2-1.

Recoverable error indicates the auto-cutter error, home position detection error, carriage detection error, cut sheet (slip or check paper or cleaning sheet) ejection error, or front cover open error during printing.



TM-U375

BUSY condition for a parallel interface is selected by DIP switch 2-3.

Recoverable error indicates the home position detection error, carriage detection error, or cut sheet (slip or validation paper) ejection error.



TM-U925

BUSY condition for a parallel interface is selected by DIP switch 2-5.

Recoverable error indicates the auto-cutter error, home position detection error, carriage detection error, or cut sheet (slip or check paper or cleaning sheet) ejection error.



TM-U325D

BUSY condition for the parallel interface is selected by DIP switch 2-1.

Recoverable error indicates a home position detection error or validation ejection error.



CHARACTER CODE TABLES

SP in a table represents space. Refer to [Using the Character Code Tables](#) for information on how to read these tables.

Page 0 (PC437: U.S.A., Standard Europe) (International character set: U.S.A)

HEX	0	1	2	3	4	5	6	7	8	9	A	B	C	D	E	F	
HEX	BIN	0000	0001	0010	0011	0100	0101	0110	0111	1000	1001	1010	1011	1100	1101	1110	1111
0	0000	NUL	DLE	SP	0	@	P	^	p	Ç	É	á	¸	¸	¸	¸	¸
1	0001		!	1	A	Q	a	q	ü	æ	í	¸	¸	¸	¸	¸	¸
2	0010		"	2	B	R	b	r	é	Æ	ó	¸	¸	¸	¸	¸	¸
3	0011		#	3	C	S	c	s	â	ô	ú		¸	¸	¸	¸	¸
4	0100	EOT	\$	4	D	T	d	t	ä	ö	ñ	¸	¸	¸	¸	¸	¸
5	0101	ENQ	%	5	E	U	e	u	à	ò	ñ	¸	¸	¸	¸	¸	¸
6	0110		&	6	F	V	f	v	å	û	¸	¸	¸	¸	¸	¸	¸
7	0111		'	7	G	W	g	w	ç	ù	¸	¸	¸	¸	¸	¸	¸
8	1000	BS	CAN	(8	H	X	h	x	ê	ÿ	¸	¸	¸	¸	¸	¸
9	1001	HT)	9	I	Y	i	y	ë	ÿ	¸	¸	¸	¸	¸	¸	¸
A	1010	LF	*	:	J	Z	j	z	è	Û	¸	¸	¸	¸	¸	¸	¸
B	1011		ESC	+	;	K	[k	{	ì	¸	¸	¸	¸	¸	¸	¸
C	1100	FF	FS	,	<	L	\	l	!	î	£	¸	¸	¸	¸	¸	¸
D	1101	CR	GS	-	=	M]	m	}	ï	¥	¸	¸	¸	¸	¸	¸
E	1110		.	>	N	^	n	~	À	Pt	«	¸	¸	¸	¸	¸	¸
F	1111		/	?	O	_	o	SP	Å	f	»	¸	¸	¸	¸	¸	¸



Page 1 (Katakana)

	HEX	8	9	A	B	C	D	E	F
HEX	BIN	1000	1001	1010	1011	1100	1101	1110	1111
0	0000	ー 128	上 144	SP 160	ー 176	タ 192	ミ 208	二 224	× 240
1	0001	ー 129	〒 145	。 161	ア 177	チ 193	ム 209	フ 225	円 241
2	0010	ー 130	ト 146	「 162	イ 178	ツ 194	メ 210	キ 226	年 242
3	0011	■ 131	ト 147	」 163	ウ 179	テ 195	モ 211	コ 227	月 243
4	0100	■ 132	ー 148	、 164	エ 180	ト 196	ヤ 212	▲ 228	日 244
5	0101	■ 133	ー 149	・ 165	オ 181	ナ 197	ユ 213	▲ 229	時 245
6	0110	■ 134	 150	ヲ 166	カ 182	ニ 198	ヨ 214	▲ 230	分 246
7	0111	■ 135	 151	ア 167	キ 183	ヌ 199	ラ 215	▲ 231	秒 247
8	1000	 136	「 152	イ 168	ク 184	ネ 200	リ 216	♠ 232	千 248
9	1001	 137	「 153	ウ 169	ケ 185	ノ 201	ル 217	♥ 233	市 249
A	1010	 138	「 154	エ 170	コ 186	ハ 202	レ 218	♦ 234	区 250
B	1011	■ 139	「 155	オ 171	サ 187	ヒ 203	ロ 219	♣ 235	町 251
C	1100	■ 140	「 156	ヤ 172	シ 188	フ 204	ワ 220	● 236	村 252
D	1101	■ 141	「 157	ユ 173	ス 189	ヘ 205	ン 221	○ 237	人 253
E	1110	■ 142	「 158	ヨ 174	セ 190	ホ 206	ン 222	／ 238	罫 254
F	1111	＋ 143	「 159	ツ 175	ソ 191	マ 207	。 223	＼ 239	SP 255



Page 2 (PC850: Multilingual)

	HEX	8	9	A	B	C	D	E	F
HEX	BIN	1000	1001	1010	1011	1100	1101	1110	1111
0	0000	Ç 128	É 144	á 160	⌘ 176	Ł 192	Š 208	Ó 224	— 240
1	0001	ü 129	æ 145	í 161	⌘ 177	ł 193	Š 209	ß 225	± 241
2	0010	é 130	Æ 146	ó 162	⌘ 178	Ṛ 194	Ê 210	Ô 226	= 242
3	0011	â 131	ô 147	ú 163	 179	Ṛ 195	Ë 211	Ò 227	$\frac{3}{4}$ 243
4	0100	ä 132	ö 148	ñ 164	† 180	— 196	Ë 212	ō 228	¶ 244
5	0101	à 133	ò 149	Ñ 165	À 181	† 197	ı 213	Ō 229	§ 245
6	0110	â 134	û 150	ä 166	Ā 182	ã 198	í 214	μ 230	÷ 246
7	0111	ç 135	ù 151	ó 167	Ā 183	Ā 199	î 215	þ 231	ˆ 247
8	1000	ê 136	ÿ 152	ı 168	© 184	Ł 200	İ 216	þ 232	° 248
9	1001	ë 137	ö 153	® 169	‡ 185	Ṛ 201	Ɔ 217	Ů 233	ˆ 249
A	1010	è 138	Û 154	¬ 170	 186	Ł 202	Ṛ 218	Ů 234	· 250
B	1011	ï 139	ø 155	$\frac{1}{2}$ 171	¶ 187	Ṛ 203	■ 219	Û 235	¹ 251
C	1100	î 140	£ 156	$\frac{1}{4}$ 172	¶ 188	Ṛ 204	■ 220	ý 236	³ 252
D	1101	ì 141	Ø 157	ı 173	ϕ 189	= 205	ı 221	Ÿ 237	² 253
E	1110	Ä 142	× 158	« 174	¥ 190	† 206	î 222	— 238	■ 254
F	1111	Å 143	f 159	» 175	Ṛ 191	Ṛ 207	■ 223	' 239	SP 255



HEX	8	9	A	B	C	D	E	F	
HEX	BIN	1000	1001	1010	1011	1100	1101	1110	1111
0	0000	Ç 128	É 144	á 160	☼ 176	Ł 192	⊥ 208	α 224	≡ 240
1	0001	ü 129	À 145	í 161	☼ 177	⊥ 193	⊥ 209	β 225	± 241
2	0010	é 130	È 146	ó 162	☼ 178	⊥ 194	⊥ 210	Γ 226	≥ 242
3	0011	â 131	ô 147	ú 163	 179	⊥ 195	⊥ 211	π 227	≤ 243
4	0100	ã 132	õ 148	ñ 164	† 180	— 196	⊥ 212	Σ 228	ƒ 244
5	0101	à 133	ò 149	Ñ 165	† 181	† 197	⊥ 213	σ 229	J 245
6	0110	Á 134	Ú 150	á 166	‡ 182	‡ 198	⊥ 214	μ 230	÷ 246
7	0111	ç 135	ù 151	ó 167	‡ 183	‡ 199	⊥ 215	τ 231	≈ 247
8	1000	ê 136	î 152	¿ 168	‡ 184	⊥ 200	⊥ 216	Φ 232	° 248
9	1001	Ê 137	Ï 153	Ò 169	‡ 185	⊥ 201	⊥ 217	θ 233	• 249
A	1010	è 138	Û 154	¬ 170	‡ 186	⊥ 202	⊥ 218	Ω 234	· 250
B	1011	í 139	ϕ 155	½ 171	‡ 187	⊥ 203	■ 219	δ 235	√ 251
C	1100	Ô 140	£ 156	¼ 172	‡ 188	‡ 204	■ 220	∞ 236	n 252
D	1101	ì 141	Û 157	ı 173	‡ 189	⊥ 205	■ 221	∅ 237	² 253
E	1110	Ā 142	ϖ 158	« 174	‡ 190	⊥ 206	■ 222	ε 238	■ 254
F	1111	Ă 143	Ó 159	» 175	‡ 191	⊥ 207	■ 223	∩ 239	SP 255



Page 4 (PC863: Canadian-French)

HEX	HEX	8	9	A	B	C	D	E	F
HEX	BIN	1000	1001	1010	1011	1100	1101	1110	1111
0	0000	Ç 128	É 144	Ï 160	Ë 176	Ł 192	ł 208	α 224	≡ 240
1	0001	ü 129	È 145	’ 161	Ë 177	ł 193	ł 209	β 225	± 241
2	0010	é 130	Ê 146	ó 162	Ë 178	ł 194	ł 210	Γ 226	≥ 242
3	0011	â 131	ô 147	ú 163	Ë 179	ł 195	ł 211	π 227	≤ 243
4	0100	Â 132	Ë 148	Ë 164	Ë 180	ł 196	ł 212	Σ 228	ƒ 244
5	0101	à 133	ï 149	Ë 165	Ë 181	ł 197	ł 213	σ 229	Ƶ 245
6	0110	¶ 134	û 150	³ 166	Ë 182	ł 198	ł 214	μ 230	÷ 246
7	0111	ç 135	ù 151	Ë 167	Ë 183	ł 199	ł 215	τ 231	≈ 247
8	1000	ê 136	œ 152	î 168	Ë 184	ł 200	ł 216	φ 232	° 248
9	1001	è 137	ô 153	Ë 169	Ë 185	ł 201	ł 217	θ 233	• 249
A	1010	è 138	Û 154	Ë 170	Ë 186	ł 202	ł 218	Ω 234	· 250
B	1011	ï 139	φ 155	½ 171	Ë 187	ł 203	■ 219	δ 235	√ 251
C	1100	î 140	£ 156	¼ 172	Ë 188	ł 204	■ 220	∞ 236	n 252
D	1101	— 141	Û 157	¾ 173	Ë 189	ł 205	■ 221	∅ 237	² 253
E	1110	À 142	Û 158	« 174	Ë 190	ł 206	■ 222	€ 238	■ 254
F	1111	§ 143	f 159	» 175	Ë 191	ł 207	■ 223	∩ 239	SP 255



	HEX	8	9	A	B	C	D	E	F
HEX	BIN	1000	1001	1010	1011	1100	1101	1110	1111
0	0000	Ç 128	É 144	á 160	☒ 176	Ł 192	⊥ 208	α 224	≡ 240
1	0001	ü 129	æ 145	í 161	☒ 177	± 193	⊥ 209	β 225	± 241
2	0010	é 130	Æ 146	ó 162	☒ 178	⊥ 194	⊥ 210	Γ 226	≥ 242
3	0011	â 131	ô 147	ú 163	 179	⊥ 195	⊥ 211	π 227	≤ 243
4	0100	ä 132	ö 148	ñ 164	⊥ 180	- 196	⊥ 212	Σ 228	† 244
5	0101	à 133	ò 149	Ñ 165	⊥ 181	⊥ 197	⊥ 213	σ 229	J 245
6	0110	å 134	û 150	ä 166	⊥ 182	⊥ 198	⊥ 214	μ 230	÷ 246
7	0111	ç 135	ù 151	ó 167	⊥ 183	⊥ 199	⊥ 215	τ 231	≈ 247
8	1000	ê 136	ÿ 152	č 168	⊥ 184	⊥ 200	⊥ 216	Φ 232	° 248
9	1001	ë 137	Ö 153	⊥ 169	⊥ 185	⊥ 201	⊥ 217	θ 233	• 249
A	1010	è 138	Û 154	⊥ 170	⊥ 186	⊥ 202	⊥ 218	Ω 234	· 250
B	1011	ï 139	ø 155	½ 171	⊥ 187	⊥ 203	■ 219	δ 235	√ 251
C	1100	î 140	£ 156	¼ 172	⊥ 188	⊥ 204	■ 220	∞ 236	n 252
D	1101	ì 141	Ø 157	i 173	⊥ 189	= 205	■ 221	∅ 237	² 253
E	1110	Ä 142	Þ 158	« 174	⊥ 190	⊥ 206	■ 222	€ 238	■ 254
F	1111	Å 143	f 159	œ 175	⊥ 191	⊥ 207	■ 223	∩ 239	SP 255



USING THE CHARACTER CODE TABLES

The example below uses Page 0 (PC437) to illustrate the use of the character code tables.

You can find the character "A" in Page 0 as follows:

The decimal value for the character "A" is 65.

Follow its column straight up to find the digits.

Hexadecimal 4

Binary 0100

These numbers are the most significant bits of the ASCII code.

Follow its row to the left to find the digits.

Hexadecimal 1

Binary 0001

These numbers are the least significant bits of the ASCII code.

The combination of the numbers above is the ASCII code for character "A".

Decimal 65

Hexadecimal 41

Binary 01000001





Please answer the questions below. Then print this form and fax it to help us improve our score.

Select 1, 2, or 3 with 1 being best. 1 2 3

Ease of use:

Ease of finding information:

Ease of understanding information:

How would you improve our online guide?

Name:

Location:

Please complete, print, and fax us right away at:

81-263-86-9930 or e-mail to:

fukuda.akiko@exc.epson.co.jp

Thank you!