

# VU<sup>+</sup> Ultimo

## User Manual

Your **Smart** Linux TV Player

English

- Large Graphic Type VFD Display (256x64 pixels)
- Tripple Pluggable Tuner System for DVB-S2 or DVB-C/T
- Advanced Blind Scan
- 1GB NAND Flash Memory
- QWERTY Keyboard RCU
- High Speed Wi-Fi USB Dongle (300Mbps)
- Temperature Sensor based Automatic FAN Speed Control



# Contents

(A) PRECAUTION!!! .....	4
(B) Packaging Contents .....	6
(C) Product Descriptions .....	7
(D) Conditional Access .....	9
(E) Remote Control .....	11
(F) Main Features .....	14
(G) Technical Data .....	15
<b>I. Installation of Vu+</b>	
1. Connecting Signal Cable .....	16
2. Connecting TV .....	17
3. Connecting Power .....	19
4. Power ON/OFF .....	19
<b>II. First Time Installation (using Wizard)</b>	
Step 1. Language Selection .....	20
Step 2. Configuring Satellite Connection .....	20
Step 3. Installing Default Satellite List .....	26
Step 4. Parental Control Option .....	26
<b>III. Basic Operations</b>	
1. Switching Channel .....	27
2. Volume Control .....	27
3. Selecting Audio Track .....	28
4. Subtitle .....	28
5. Teletext .....	29
6. Program Information (InfoBar) .....	30
7. Channel List .....	31
8. Electronic Program Guide (Event View) .....	33
9. Timeshift .....	36
10. Recording .....	37
11. Recording Play .....	41
12. Managing Recording Files .....	42
13. Media Player .....	43
14. Plug-ins .....	44
15. Sleep Timer .....	45

## IV. System Configuration

1. Main Menu .....	46
2. System Setup .....	47
2-1. Service Searching .....	47
A. Tuner Configuration .....	47
B. Loading Default Service Lists .....	48
C. Automatic Scan of Services .....	48
D. Manual Scan of Services .....	49
E. Selecting Tuner Type (for DVB-C/T Tuner) .....	51
2-2. System Configuration .....	53
A. A/V Settings .....	53
B. Language Selection .....	55
C. Customization .....	55
D. Selecting Time Zone .....	57
E. Hard Disk Set Up .....	58
F. Front Display Setup .....	58
G. Network Setup .....	59
H. Skin Change .....	61
2-3. Checking CAM .....	61
2-4. Parental Control .....	62
2-5. Factory Reset .....	64
2-6. Checking H/W and S/W Information .....	65
A. Service Information .....	65
B. System Information .....	66
2-7. Wi-Fi dongle installation .....	67
2-8. Inserting Tuner .....	70
2-9. HDD Mounting .....	71
2-10. Remote Control Unit (RCU) Set-up .....	72
A. User Guide of Vu+ Universal RCU .....	72
B. Function Key Table .....	74
C. TV Code List .....	75
V. Copyright - GNU GPL .....	87
VI. Menu Structure .....	91
VII. Troubleshooting .....	92
VIII. Glossary .....	93

## (A) PRECAUTION!!!

This Product has been designed and manufactured in compliance with EU consumer safety requirements (CE). Please read the following safety precautions carefully.

### 1. Connecting Power

- This product operates only in the range of AC100-240V and 50Hz/60Hz. Please check first your power supply to see if it fits this range.
- Please be noted that you need to disconnect from the mains before you start any maintenance or installation procedures.
- Make sure that the power cord is placed in a position where it is easy to unplug it from the mains in an emergency.

### 2. Overloading

- Do not overload a wall outlet, extension cord or adapter as this may cause electrical fire or shock.

### 3. Liquid

- This product is not water-proof and should not be exposed to dripping, splashing, or any type of liquid.
- No objects filled with liquid such as base shall be placed on the product.
- Please do not clean the product with wet cloth, which may cause a short circuit.
- No wet objects should be placed near the product.

### 4. Ventilation

- Allow a sufficient space between the product and other objects to make sure air ventilation of the product.
- Do not block the top or rear of the product with an object, which will close the ventilation holes and lead to a high temperature of the system. This may cause a failure of the product.
- Do not stack other electronic devices on top of the product.
- Do not insert any kind of pointed objects like screw, gimlet, etc. into the ventilation holes of the product. This will damage the product.

### 5. Connecting the Satellite Cable.

- Disconnect the power of the product before you connect the satellite cable to the product. Otherwise, it may cause damage to the LNB.

### 6. Grounding

- The LNB must be earthed to the system earth for the satellite dish.

### 7. Location

- Place the product indoor.
- Do not expose the product to rain, sun or lightening.
- Do not place the product near any heat appliances as a radiator.
- Ensure that there is more than 10 cm distance from any electrical devices and wall.



## 8. Lightening, Storm or Not In Use.

- Unplug the product and disconnect the antenna cable during a thunderstorm or lightening, especially when left unattended and unused for a long period of time. This will prevent possible damages from power surges or lightening.

## 9. Replacement of Parts

- Unauthorized part replacements, especially by one who is not a qualified technician may result in damage to the product.
- Ensure that when part replacements are necessary qualified technicians perform the task using the components specified by the manufacturer.

## 10. Hard Disk Drive

- Do not move the product or turn the power off suddenly while the Hard Disk Drive (HDD) is still running. This may result in damage to the HDD and thus the system.
- The company shall not be liable for any corruption of data on the HDD caused by careless use or misuse of users.

## 11. Battery

- There is danger of explosion if batteries are incorrectly replaced.
- Replace batteries only with the same or equivalent type.

## Dolby Digital Plus :

Manufactured under license from Dolby Laboratories. Dolby and the double - D symbol are trade marks of Dolby laboratories.

## DTS 2.0+Digital Out™

Manufactured under license under U.S. Patent Nos: 5,956,674; 5,974,380; 6,487,535 & other U.S. and worldwide patents issued & pending. DTS, the Symbol, & DTS and the Symbol together are registered trademarks & DTS 2.0+Digital Out is a trademark of DTS, Inc. Product includes software. © DTS, Inc. All Rights Reserved.



- o "WEEE" Symbol instructions.

This product should not be disposed with other house hold wastes at the end of its working life. Please separate this from other types of wastes and recycle it responsibly to promote the sustainable reuse of material resources. This will help prevent harm to the environment or human health from uncontrolled waste disposal.

## (B) Packaging Contents

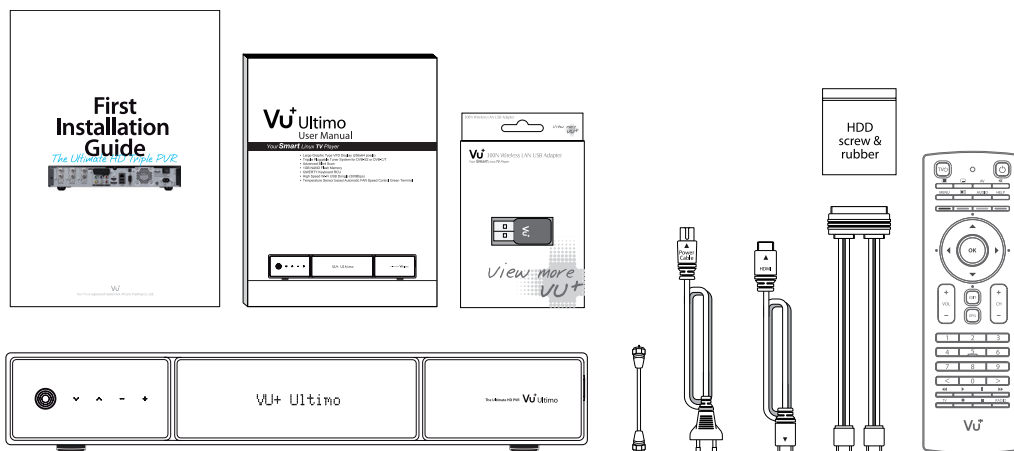

Please check all package contents before using your product.

- Ultimo RCU (with two coin batteries inserted)
- User Manual
- First Installation Guide
- HDMI cable
- Power cable
- Loop-through cable (for Satellite only)
- SATA cable
- HDD mount screws and rubber washers

**NOTE :** Two coin batteries(2xCR2032) are used for the remote control.  
Please pull out the plastic battery cover to use the remote control.



## (C) Product Descriptions

### ● Front Panel



① Buttons (STANDBY, Ch-/+, Vol-/+)

② Display

Displays the current menu and program information.  
Large Graphic VFD(256x64 pixels)

③ USB Host

Connects to the USB memory stick or external HDD.

④ Smartcard reader slot

Two Smartcard slots are provided.

⑤ CI Module slot

Two CI module slots are provided.

## ● Rear Panel

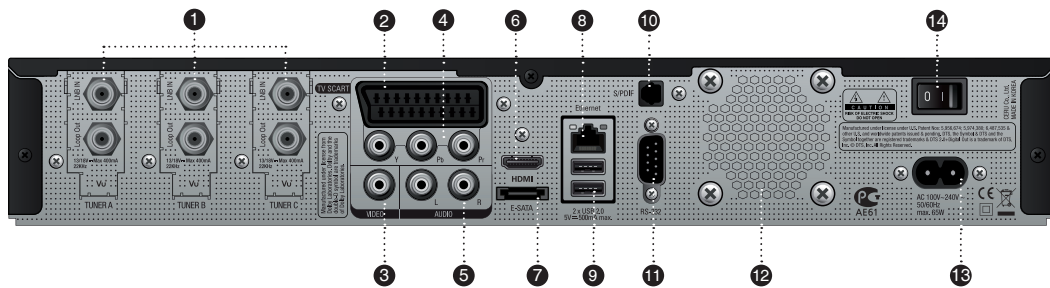

- ① **Three Pluggable Tuner Slots**  
Pluggable Type DVB-S2 and DVB C/T Hybrid Tuner available.
- ② **SCART**  
One SCART connector is provided for TV using SCART cable.
- ③ **Video output**  
Connects to TV using RCA cable(composite YPbPr)
- ④ **Component (YPbPr)**  
Connects to TV using a component cable
- ⑤ **Audio output**  
Connects to TV using RCA cable.
- ⑥ **HDMI**  
Connects to TV using a HDMI cable for both audio and video signals.
- ⑦ **e-SATA**  
Connects the external HDD using e-SATA cable.
- ⑧ **Ethernet**  
Connects the PC or another set top box of Vu+.
- ⑨ **USB**  
Connects the USB memory stick or external HDD.
- ⑩ **S/PDIF**  
Connects to a digital audio system using S/PDIF cable.
- ⑪ **RS232**  
RS232 data port is provided.
- ⑫ **FAN**
- ⑬ **Power Inlet**  
Connects the detachable power cord.
- ⑭ **On/Off Switch**  
Powers on/off.

## (D) Conditional Access

Amongst the channels that are scanned via Vu+, some channels can be properly tuned in only with the corresponding Smartcard and/or CAM (Conditional Access Module). Vu+ provides two Smartcard Reader slots and two Conditional Interface slots and users need to purchase those Smartcards and CAMs that are required for viewing such subscription based services.

### Insertion of Smartcard

Vu+ supports Xcrypt. Users need to buy only these Smartcards without having to buy additional CAMs to watch those channels that are encrypted in Xcrypt.

- ① Open the door on the left side.
- ② Insert Xcrypt Smartcard as in the following instruction.
- ③ Make sure that the Smartcard remains inserted while viewing.

**NOTE :** Insert the card while the smart card IC is downward.

Insertion

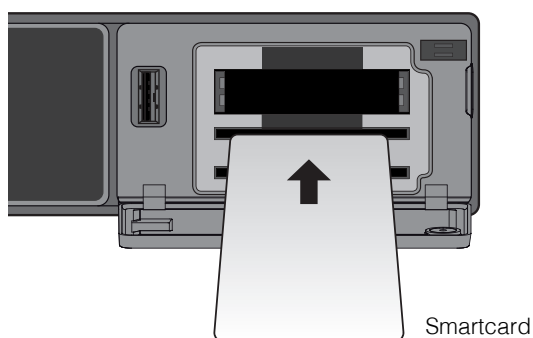

### Insertion of CAM (Conditional Access Module)

There are several Conditional Access Systems (CAS), other than Xcrypt that Vu+ supports. To be able to watch channels that are encrypted in such CAS as Nagravision, NDS, Irdeto, Viaccess, etc, users need to purchase a CAM that is corresponding to each CAS, as well as Smartcard to decrypt those encrypted channels.

- ① Insert a Smartcard into the CAM as in the below picture.
- ② Once the Smartcard inserted into the CAM, insert the CAM into the CI slot.
- ③ Make sure that the CAM remains inserted while viewing.

#### Insertion

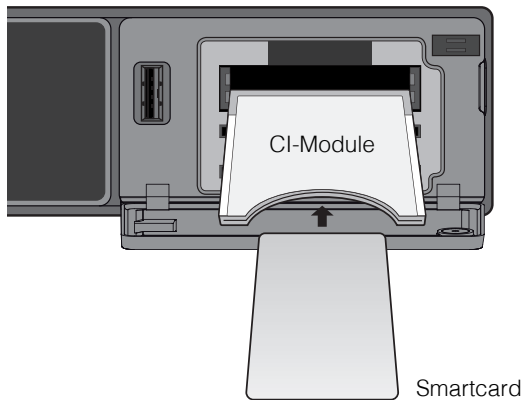

## (E) Remote Control

Ultimo Remote Control(RCU) is a universal and QWERTY keyboard RCU and users can control Ultimo and TV. The double sided design of Ultimo RCU makes typing on TV easier than ever.

Please refer to **IV. System Configuration 2.9 Remote Control Unit Set-up** section for more explanation.

### ① TV Power

Once configured for TV remote control, this button is for TV power on/off.

### ② STB Power

When the STB is turned on, normal press of this button puts the STB into standby mode instantly. When the STB is turned off, normal press of this button turns the STB on instantly.

Long press activates Standby /Restart menu.

### ③ Teletext

Displays the teletext information of the current channel if the channel provides subtitles.

### ④ Subtitle

Displays the subtitle of the current channel if the channel provides subtitle.

### ⑤ AV

This button is used when selecting video source of TV.

### ⑥ Mute

Silences the audio temporarily.

**NOTE :** when Teletext is activated,  key is also used when toggling between the Teletext page and the live mode.

### ⑦ Menu

Displays the main menu.

### ⑧ Recording List

Displays the list of recordings stored on the internal HDD if any.

### ⑨ Audio

Displays the audio track option to choose (e.g. ACS, Stereo).

### ⑩ Help

Displays major important operation methods of Vu+.  
This provides users with a quick guide of using Vu+.

### ⑪ Color Keys

Each key is assigned a specific function that may be different in each menu.

- Red – mainly used for REC, Cancel, etc.
- Green – mainly used for OK
- Yellow
- Blue

### ⑫ Navigation Keys

Navigates up/down and left/right on the menu options.  
Up/down keys are used to call up the channel list.

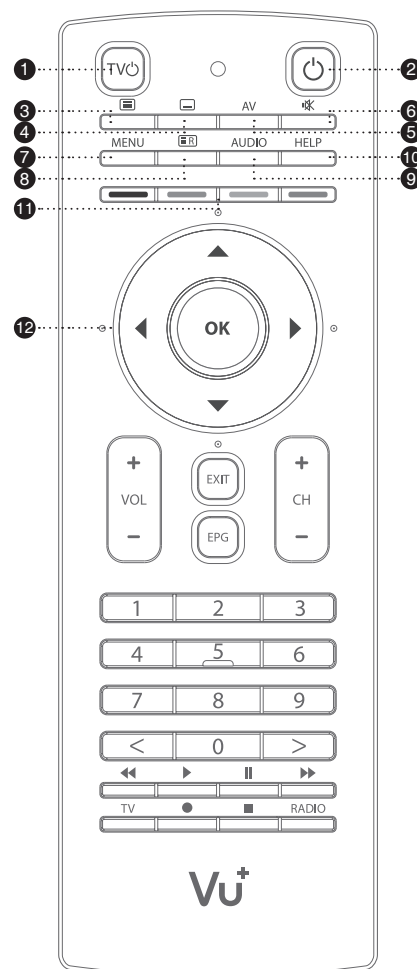

- ⑬ **OK**  
Confirms the selected menu option.
- ⑭ **EXIT**  
Exits the current menu option into the live mode, or switches one step back of the menu.
- ⑮ **Volume + / -**  
Adjusts the audio volume.
- ⑯ **Channel + / -**  
Navigates through the scanned channel list.
- ⑰ **EPG**  
Displays the Electronic Program Guide (EPG) information if provided.
- ⑱ **Numeric Keys**  
Enters a channel number or numbers required to be input according to menu options.
- ⑲ **Fast Rewind**  
Fast rewinds at up to 128 times faster than the normal speed (x2 / 4 / 8 / 16 / 32 / 64 / 128).
- ⑳ **Play**  
Plays the selected file (e.g. recording) at the normal speed.
- ㉑ **Pause**  
Pauses the live program or recording play.
- ㉒ **Fast Forward**  
Fast forwards at up to 128 times faster than the normal speed (x2 / 4 / 8 / 16 / 32 / 64 / 128).
- ㉓ **TV**  
Displays the TV Channel list.
- ㉔ **Recording**  
Displays instantly the recording menu.
- ㉕ **Stop**  
Stops playing of a recording and goes to the live mode.
- ㉖ **Radio**  
Displays the Radio channel list.

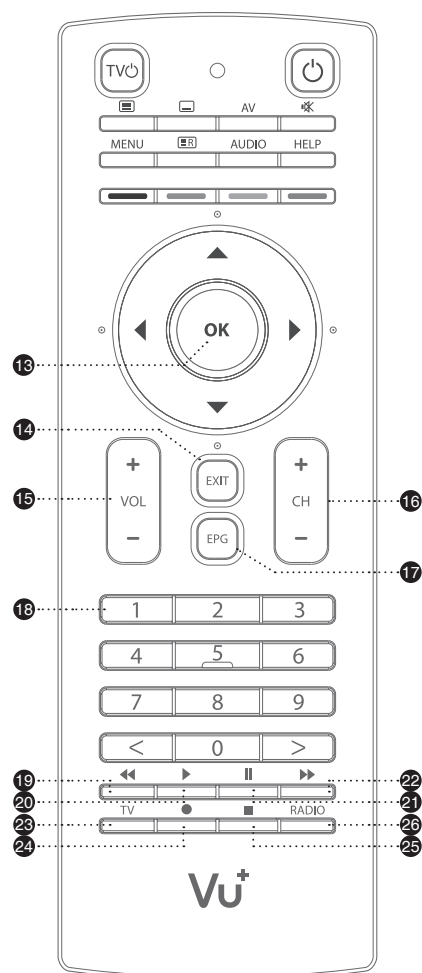



**27** Unlock

This button is used to unlock the operation of keyboard.  
Any touch on any of the buttons on the remote control side is to lock the operation of keyboard.

- To unlock the keyboard - Press the unlock.
- To lock the keyboard - Press any button on the remote control side.

**28** FN

Function button to activate function buttons in blue.



(Remote control side)

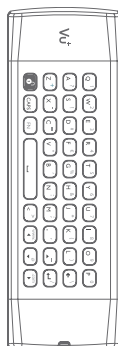

(Keyboard side)

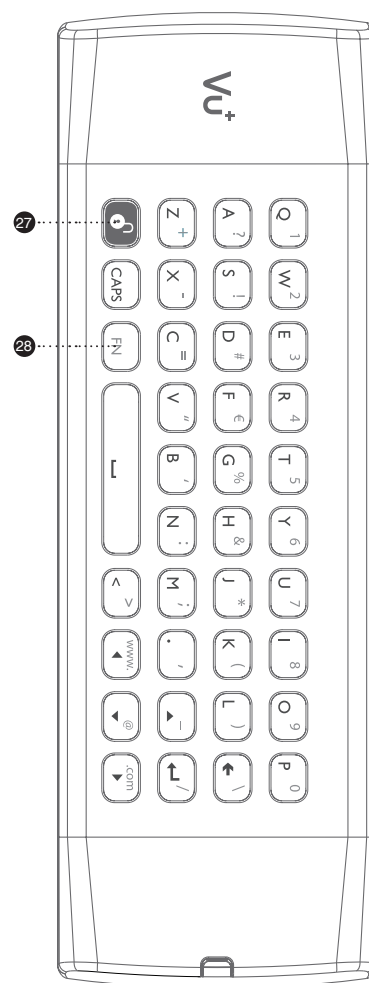

**NOTE :** Two coin batteries (CR2032) are used in the remote control.

The estimated battery lifetime is around 1year.  
To replace batteries use a screwdriver to pry open the lid.

## (F) Main Features

- 405 MHz MIPS Processor
- Linux Operating System
- Media Player
- Downloadable Plug-ins supported
- 2 x Smartcard Readers (Xcrypt)
- 2 x Common Interface
- MPEG2 / H.264 Hardware Decoding
- Three pluggable tuner system for DVB-S2 and/or DVB C/T hybrid tuner.
- Large graphic type VFD - 256x64 pixels
- 1GB NAND Flash / 512 MB RAM
- External SATA supported
- 10/100MB Ethernet Interface
- 3 x USB 2.0
- RS232
- HDMI
- Composite Video / Component Video
- 1 x SCART
- SPDIF for digital bit stream out (optical)
- EPG supported
- Automatic & Manual Service Scan supported
- Multiple LNB control (DiSEqC) supported
- Skin change supported
- Stable SMPS integrated
- Automatic temperature sensor based FAN speed control system.

## (G) Technical Data

Vu+ Technical Specifications		
Front Panel	Display	256x64pixel large graphic VFD with status icons displaying channel names and program information
	Smart card slot	2
	Common Interface	2
	USB 2.0	1
	Key	Ch+/-, Vol+/-, Standby
Rear Panel	Power switch	1
	Sat-IF input/output	3 x F-type (or DIN) Socket
	Connection TV	1 x Scart socket
	Video output (analogue)	3 x Cinch socket(Y/Pb/Pr) / 1 x Cinch-socket
	Video/audio output (digital)	1 x HDMI
	Audio output (analogue)	2 x Cinch socket
	Audio output (digital)	Standard optical (SPDIF)
	USB 2.0	2
	eSATA	1
	Ethernet	1
	RS 232	1
Power	Mains voltage	AC100-250V / 50-60Hz
	Power consumption (Max./typ. operation/stand-by)	65/25/1W
RF	RF range	950-2,150 MHz
	Modulation, FEC, de-multiplexer	DVB-S/DVB-S2 standard
Video	Video resolution	CCIR 601 (720 x 576 lines), 576p, 720p, 1080i
	Video decoding	MPEG-2, MPEG-4 compatible
	Input data rate	2-45 MSymb/s
	S/N	> 53 dB
Decoding	Decoding	Dolby Digital, MPEG-4 (AAC-HE), MPEG-1, Layer 1, 2 and 3
	Sampling rate	32/4.1/48 kHz
	S/N	> 65 dB
LNB	LNB supply (horiz./vert.)	14/18V / Max.400mA
	Control signal	22kHz ; ToneBurst ; DiSEqCTM1.0/1.1/1.2
General	Dimensions (W x H x D)	380 x 290 x 60 mm
	Weight (without HDD)	3kg (Without HDD)

**NOTE :** ⓘ means Remote control operation order.

# I. Installation of Vu+

This chapter will guide you through the whole installation process of Vu+. Please read each section carefully to make sure that the system runs properly.

## 1. Connecting Signal Cable

Vu+ Ultimo is designed to integrate three pluggable tuners. For the best use of Vu+ Ultimo the following tuner combinations are recommended.

A. DVB-S2 + DVB-S2 + DVB-S2

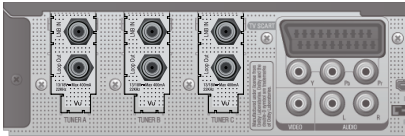

B. DVB-S2 + DVB-S2 + DVB-C/T

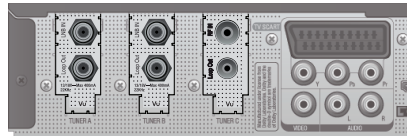

C. DVB-S2 + DVB-C/T + DVB-C/T

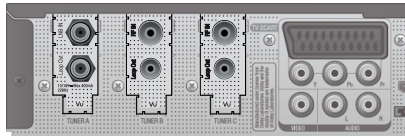

**NOTE :** Using tuner A & C without tuner B is not supported.

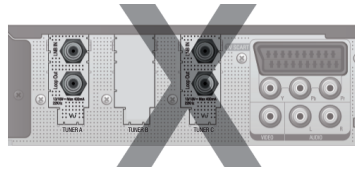

**NOTE :** Loop-through connection

Instead of using two or three separate signal cables, it is also possible to connect cables in loop-through mode.

example A.

If two DVB-S2 tuners are mounted.

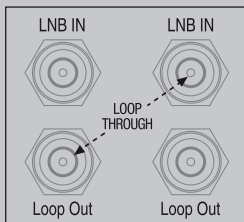

A loop-through cable for satellite is included in the accessory box.

example B.

If two DVB-C/T tuners are mounted.

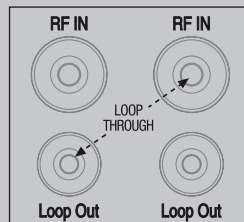

You need to purchase a loop-through cable for DVB-C/T tuner.

## 2. Connecting the TV

Vu+ provides a variety of audio/video connection methods.

### A. Connecting TV via HDMI cable

For the sake of the best picture quality, especially for digital TV, HDMI connection is recommended. Most HDTVs have HDMI connectors to ensure the highest picture quality. In the rear panel of Vu+ one HDMI connector is available for this purpose. Connect your TV to Vu+ using a HDMI cable as follows.

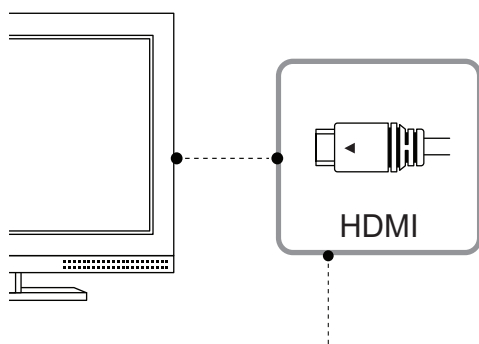

### B. Connecting TV via Composite or Component connection

Vu+ provides Composite and Component connectors for both audio and video. Connect your TV to Vu+ as follows:

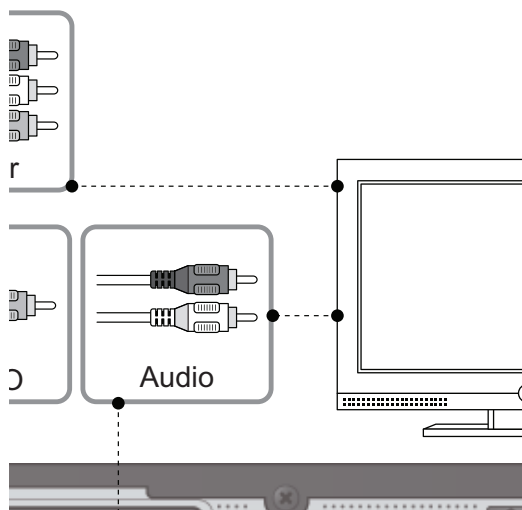

**NOTE :** When you have an A/V receiver with S/PDIF digital audio input, this connection is recommended to enjoy the best audio quality, especially for the Dolby Digital sound.

### C. Connecting TV via SCART cable.

In case your TV is analogue TV, SCART cable is the most common method. Connect your TV to Vu+ using SCART cable as follows.

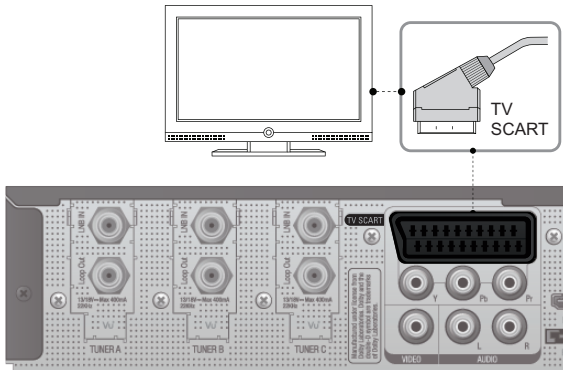

### 3. Connecting Power

A power cord is provided as one of the basic accessories of Vu+.

- ① Connect the power cord to the connector at the rear panel of Vu+.
- ② Connect the power cord to a power outlet.
- ③ Turn on the power switch at the rear panel.

#### NOTE : AC input condition

- Nominal Voltage Range: 100 – 250 VAC
- Maximum Voltage Range: 90 – 264 VAC
- Nominal Frequency: 50 / 60 Hz
- Maximum Frequency Range: 47 – 63 Hz

NOTE : ⓘ means Remote control operation order.

### 4. Power ON/OFF

[ ⓘ : Press Power (⏻) key / Press MENU (MENU) > Select Standby/Reset]

There are several ways to turn your Vu+ ON or OFF

#### • Complete Power Shutdown

There is a Power Switch in the rear panel and once it is ON, you do not need to turn it on or off each time. It takes a longer time to boot the system if you turn it off by this switch.

#### • Standby Mode

POWER key is normally used to turn the power of Vu+ on or off. If you press **POWER**, it instantly switches your Vu+ off or on. In this mode, the system is not completely shutdown and thus it takes a shorter time to turn it on and off.

#### • Deep Standby Mode [ ⓘ : Menu > Standby/Restart > Deep Standby]

Deep Standby is used to reduce the standby power consumption. Vu+ is designed to be energy efficient and to guarantee the power consumption to be under 1W in the deep standby mode.



## II. First Time Installation (using Wizard)

When you turn on Vu+ for the first time after purchase, an installation wizard will begin step by step.

**NOTE :** OK key is used for confirmation and turns to the next step. Press EXIT key to return to the previous page.

### Step 1. Language Selection

Vu+ provides various languages and here you can choose the main language for your Vu+. Use UP/DOWN key to scroll up and down to find the language you want.

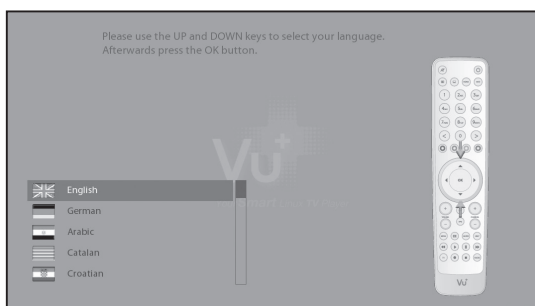

### Step 2. Configuring Satellite Connection

From now on you need to configure the satellite connection. You have two options:

- Use wizard to set up basic features
- Exit wizard

You are strongly recommended to use wizard as it is designed to guide you through the configuration process.





## A. Configuring Tuner A - DVB-S2

NOTE : If DVB-S2 tuner is mounted, read the following instructions.

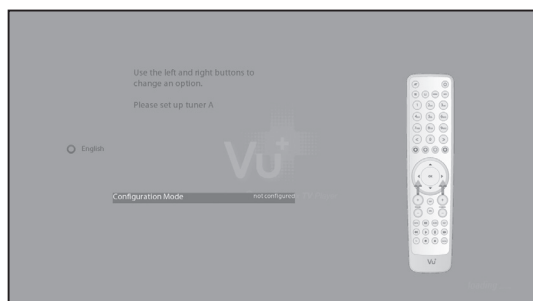

Using **LEFT/RIGHT** key, you can choose one of the following Configuration Modes:

- Nothing connected
- Simple
- Loop through to: mode to make the LNB1 be internally connected to the LNB2 in.
- Equal to: mode to use the same configuration as that of Tuner B.
- Advanced: for an advanced user configuration.

If you choose Simple configuration mode, the following picture will appear.

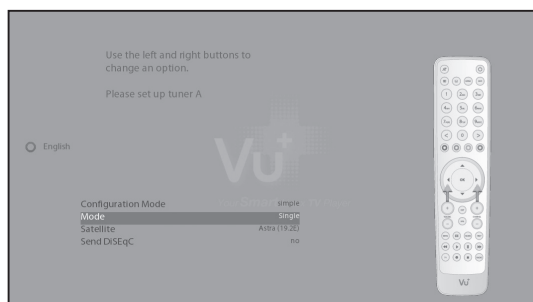

The five modes are available for the satellite cable connection between LNB and your Vu+ as below :

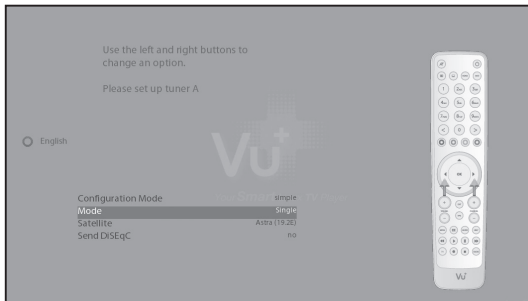

- **Single**

This option is used to receive a single satellite with a single LNB. The cable from LNB is directly connected to Vu+.

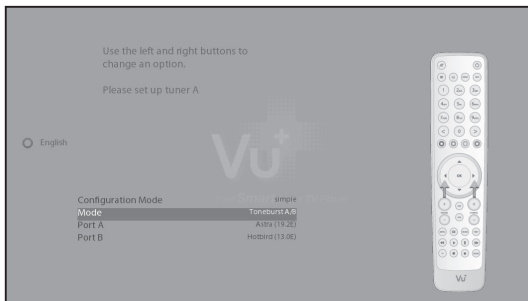

- **Toneburst A/B**

This option is used if you want to receive two satellites using a Toneburst switch.

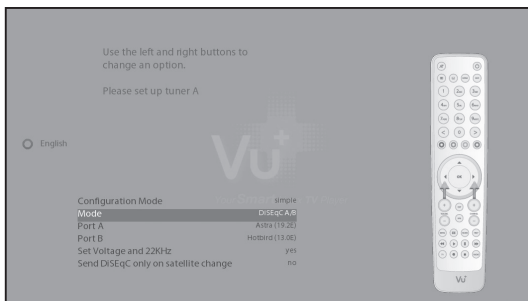

- **DiSEqC A/B**

This option allows you to configure two satellites in Port A and Port B.

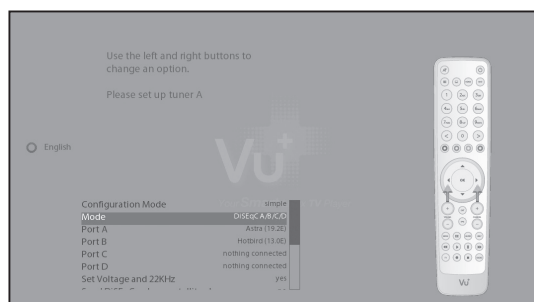

#### • DiSEqC A/B/C/D

This option allows you to configure four satellites in Port A, Port B, Port C and Port D.

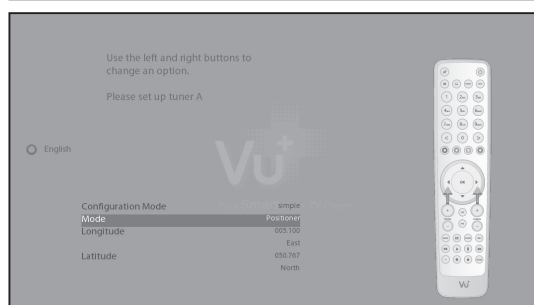

#### • Positioner

This option is used when you have a motorized satellite antenna.

## B. Configuring Tuner A - DVB-C/T

### • Selecting Tuner Type

Suppose that you have installed DVB-C/T tuner of Vu+, you can select between DVB-C or DVB-T by using LEFT/RIGHT button.

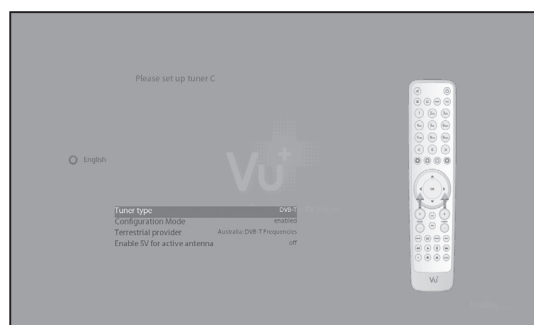

\* DVB-C/T Tuner of Vu+ is a hybrid tuner that can be used for DVB-T or DVB-C selectively. However, you can tune into only one mode at a time.

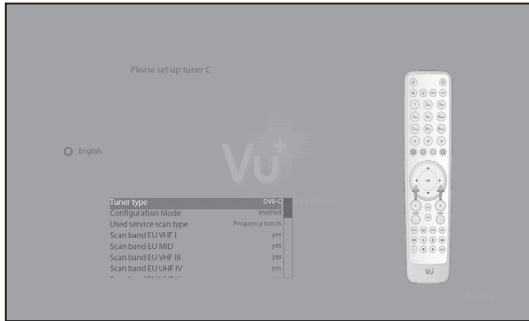

• **Configuring DVB-T / C Tuner**

If configured for DVB-T, this step allows you to choose one of the four “Terrestrial provider” depending on your location.

- Australia: DVB-T Frequencies
- Europe, Middle East, Africa: DVB-C Frequencies
- Europe, Middle East, Africa: DVB-T Frequencies
- Iceland: DVB-T Frequencies



If configured for DVB-C, this step allows you to decide whether to scan each of the various scan band in the list.



• **Installing default channel list**

Here you can decide whether to install the default channel lists or not.

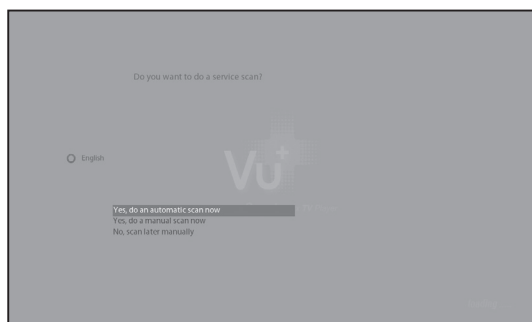

### • Selecting Scan Mode - Automatic Scan / Manual Scan

Channel scanning is possible either in Automatic Scan mode or Manual Scan mode.

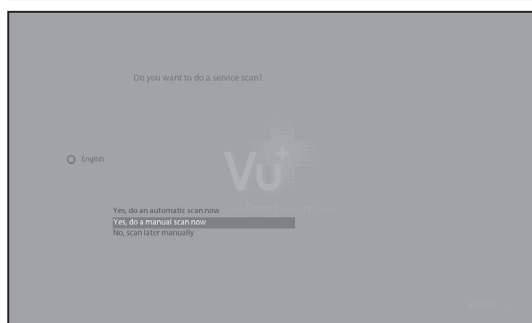

### • Automatic Scan

If you choose Automatic Scan, you will be asked whether to erase all the existing channels before scanning.

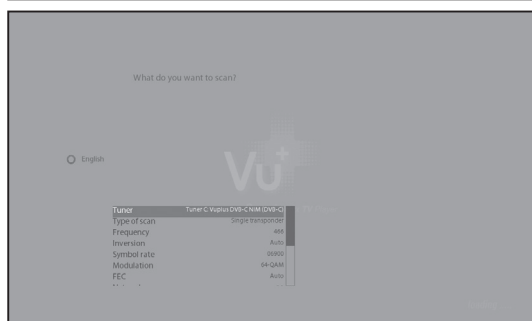

### • Manual Scan

If you choose Manual Scan for DVB-T or C, you can also select the type of scan between Complete and Single Transponder.

Press **OK** to initiate the channel scan.

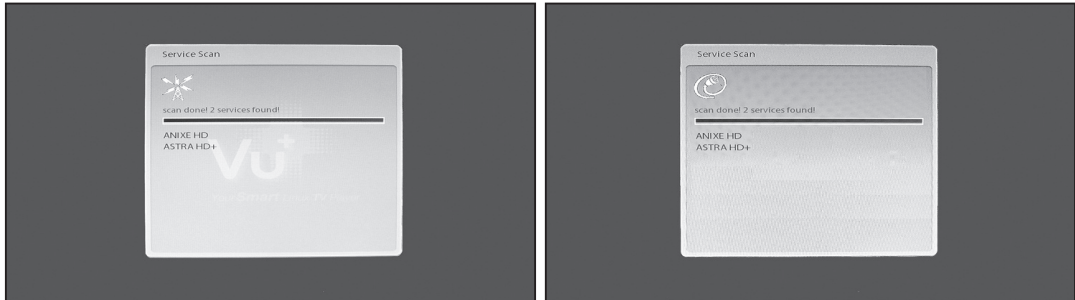

- **Channel Scanning**

The scanned channels will be displayed if the previous configurations have been done correctly.

### Step 3. Installing Default Satellite List

Here you will be asked whether you want to install the default satellite lists. Press **OK** and the following image appears:



### Step 4. Parental Control Option

Here you can choose whether to enable the parental control option. If you press **OK**, you will be asked to enter PIN number



## III. Basic Operations

### 1. Switching Channel

[**i**] : Press **▲** / **▼**, CHANNEL **+** / **-** key / Press **◀** / **▶** to move to the next channels]

Vu+ offers various channel zapping methods. You can switch the current channel by pressing

- **UP/DOWN** key

If you press **UP** or **DOWN** key, *Channel Selection* menu appears.

You can move up and down to select the channel that you want to tune into.

- **LEFT/RIGHT** key

If you press **LEFT** or **RIGHT** key, the previous or subsequent channel of the current channel is tuned in.

- **CHANNEL +/-** key

If you press CHANNEL **+** or **-** key, this will call up the *Channel Selection* menu.

- **Channel Number**

Enter a channel number, and it will instantly tune into the channel.

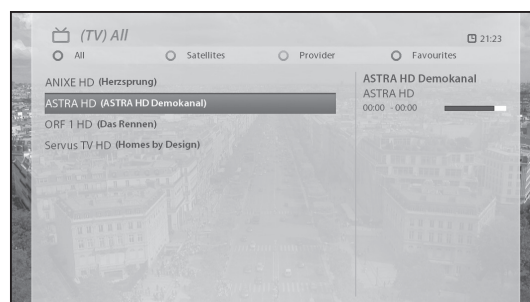

**NOTE** : If channel change is not done, it is probably because the selected channel is encrypted and you do not have a proper smartcard.

### 2. Volume Control

[**i**] : Press VOLUME **+** / **-** key]

You can adjust the audio volume by pressing **VOLUME +/-** key. You can also mute or unmute the audio temporarily by pressing **MUTE** key (**🔇**)



### 3. Selecting Audio Track

[**i**] : Press AUDIO (AUDIO) key]

You can check what audio tracks are available to choose by pressing **AUDIO** key.

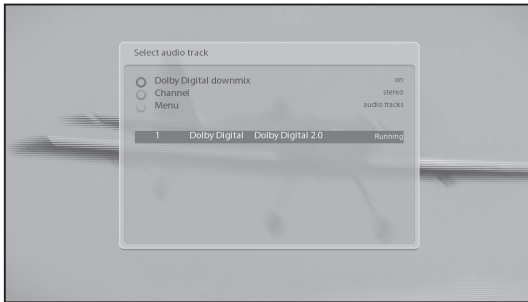

By using **UP/DOWN** key and Color key, you can select a different audio language or Stereo sound.

**NOTE** : Available options on this menu will differ depending on the service.

### 4. Subtitle

[**i**] : Press SUBTITLE (SUBTITLE) key or Press MENU (MENU) > Subtitle]

You can view the subtitle of the current program if the program provides the subtitle. Press **SUBTITLE** (SUBTITLE) key and **Subtitle selection** menu appears as below.

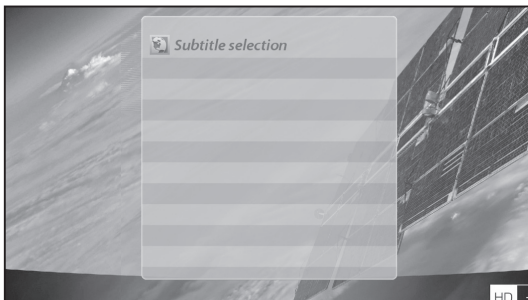

Available subtitles, if any, will display. By using **UP/DOWN** navigate the list to select a subtitle that you want to play and press **OK** to activate it.



## 5. Teletext

[ : Press TELETEXT () key]

You can call up Teletext information by pressing TELETEXT key (). It will take some time to load all the information.

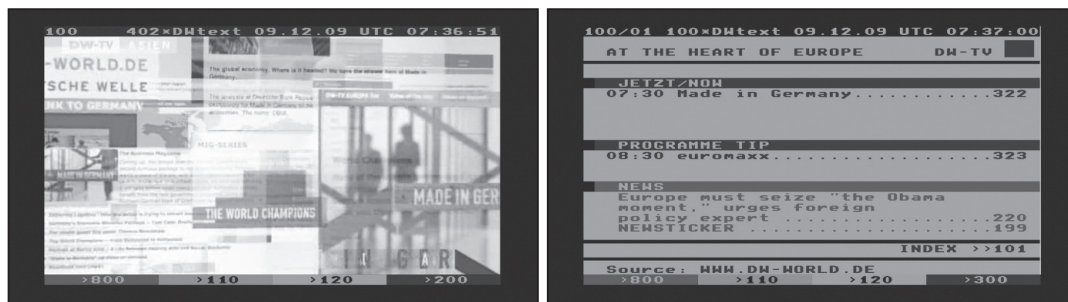

You can navigate through the Teletext page by using UP/DOWN key to select a text page. Also, just simply enter the page number that you want to read.

- **MUTE** key  
Once you activated Teletext, you can toggle between the live mode and the Teletext page by pressing MUTE () key instantly. In this case, loading of the Teletext page takes place instantly.
- **VOLUME +**  
If you want to enlarge the page, press **VOLUME +** key.

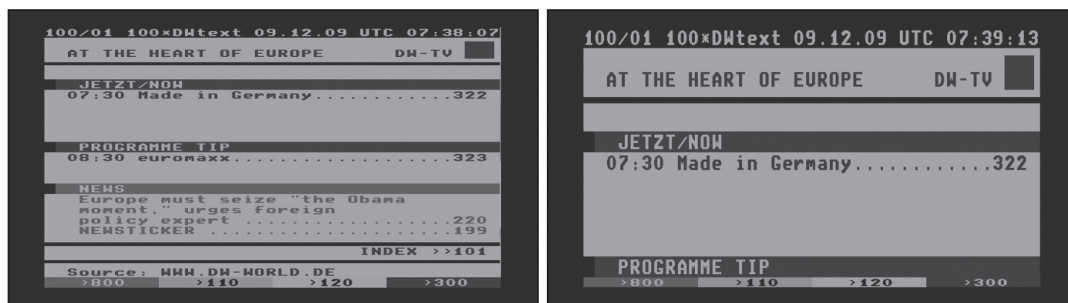

- **VOLUME** -  
If you want to reduce the page size, press **VOLUME –** key.

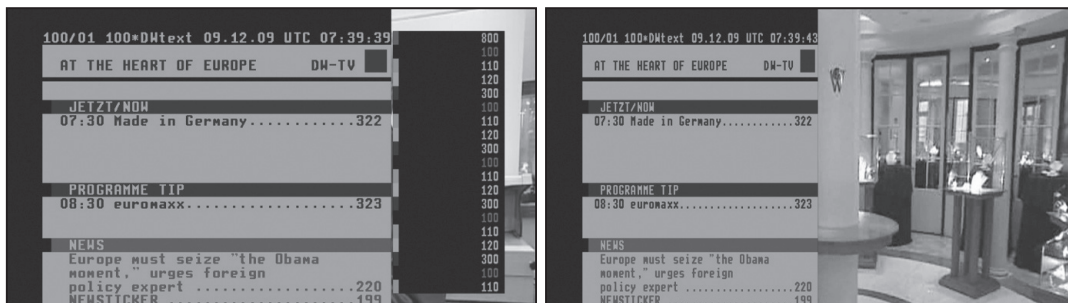

## 6. Program Information (Infobar)

[**i**] : Press OK (**OK**) key

Whenever you change the channel, infobar is always displayed for 5 seconds (default setting). Infobar is designed to provide you comprehensive information of the channel that you are currently watching.

- Press **OK** to call up infobar.

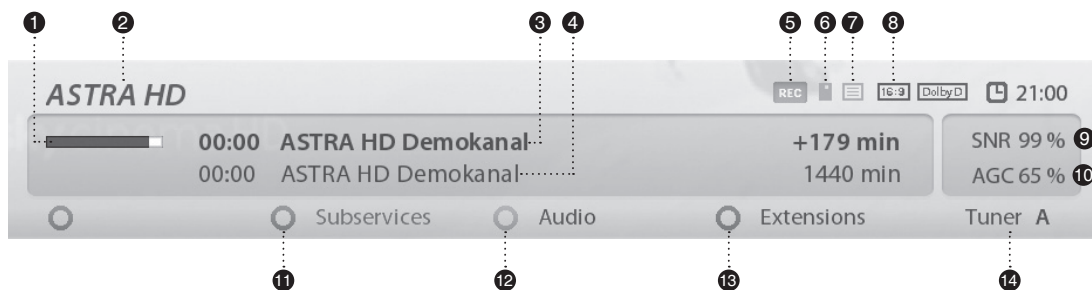

- ① Remaining time of the current program
- ② The name of the current channel
- ③ The current program
- ④ The next program
- ⑤ **REC** : Highlighted in red when recording is in progress.
- ⑥ **CAS** (■) : Encrypted program
- ⑦ **Teletext** (≡) : Highlighted when the program provides Teletext.
- ⑧ **16:9** : Screen ratio

- ⑨ SNR (Signal to Noise Ratio) : Signal Level
- ⑩ AGC (Automatic Gain Control) : Signal Strength
- ⑪ GREEN : to call up Subservices, if available
- ⑫ Audio : to display available audio tracks.
- ⑬ Extensions : to call up a Picture in Picutre.
- ⑭ A : The tuner being used for the current channel.

## 7. Channel List (Channel Selection Menu)

[**i**] : Press **▲** / **▼**, CHANNEL **+** / **-** key]

If press **UP/DOWN** key, this will activate *Channel Selection* Menu as below.  
Four types of the channel lists are available to help you manage your channel selection.

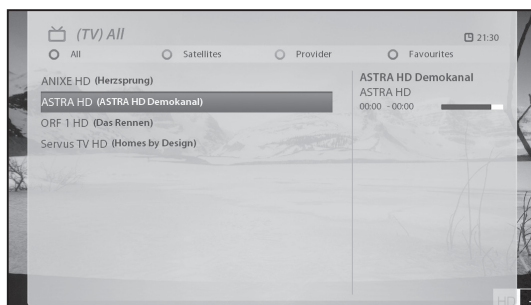

- RED displays the list of all scanned channels.

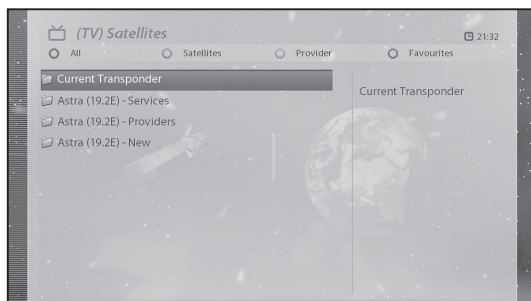

- GREEN displays the list of all scanned satellites.  
Per each satellite, channels are arranged according to *Services*, *Provider*, and *New*.

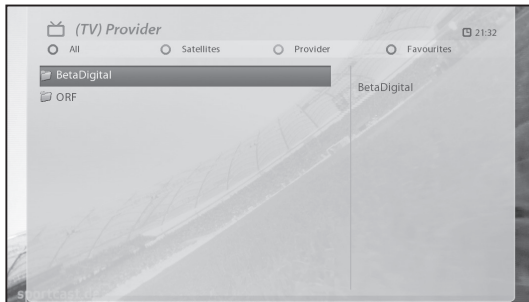

- **YELLOW** displays the list of providers.

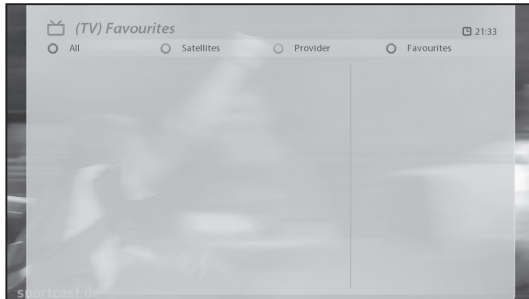

- **BLUE** displays the list of your favorite channels.

In order for you to add certain channels to this *Favourites* list,

- ① Call up the *Channel Selection* list by pressing **UP** or **DOWN** key.
- ② Go to the *All* list by pressing **RED**.
- ③ Select the channel that you want to add to the *Favourites* list.
- ④ Press **MENU** key on the selected channel and the following menu appears.

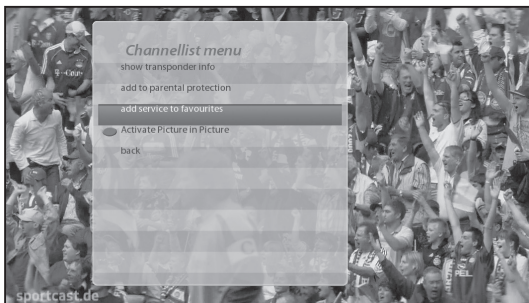

- ⑤ Choose “*add service to favourites*” and press **OK**.
- ⑥ Go to the *Favourites* list by pressing **BLUE** to confirm that the selected channel is correctly included in the list.

## 8. Electronic Program Guide (Event View)

[**i**] : Press EPG (**EPG**) key]

The Electronic Program Guide (EPG) displays the program information of each channel, if provided, in time and date order. You can view the detailed program information by pressing **EPG** key and the following menu, *Eventview* appears.

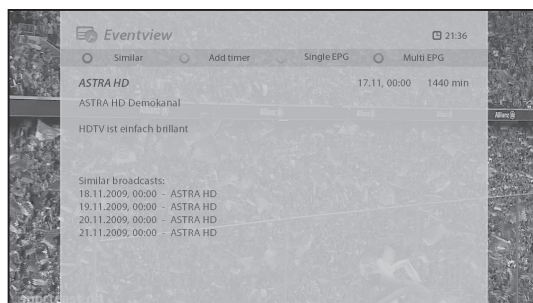

Detailed information of the current channel will be displayed on EPG. On this menu, three options are provided.

- **RED (Similar)**

This option helps you find similar programs. If there are one or more programs that are similar to the current program, *EPG Selection* window displays them as below.

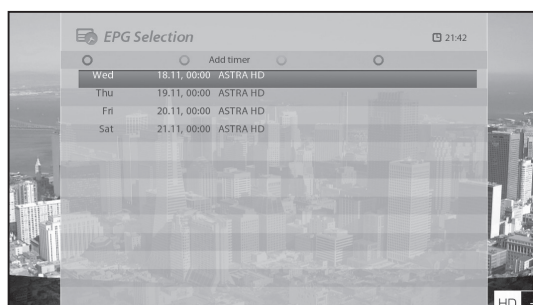

- **GREEN (Add Timer)**

If you press **GREEN** key, *Timer entry* menu appears as below. This option is used to set up a new timer for recording or zapping.

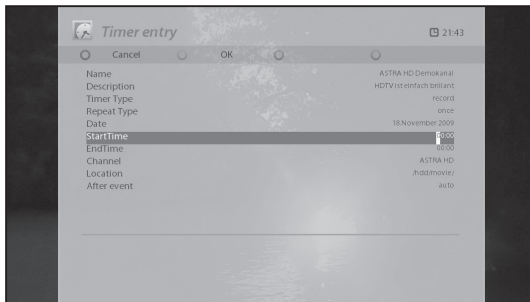

- **Name**

Displays the name of the selected program.

- **Description**

Displays a short description of the selected program.

- **Timer Type**

- Select **Zap** for channel tuning reservation.
- Select **Record** for recording reservation.

- **Repeat Type**

- Select **Once** for one time of zapping or recording reservation.
- Select **Repeated** for repeated zapping or recording reservation.
- Repeats - This option is given only when you selected "**Repeated**" in the Repeat Type. You can reserve zapping or recording per Daily / Weekly / Mon-Fri / User-defined.

- **Date**

Displays the current date. This entry is on when you selected **Once**, in the Repeat Type.

- **Start Time**

You can set the time to begin recording or zapping.

- **End Time**

You can set the time to end recording or zapping

- **Channel**

This entry allows you to change the channel. Press **LEFT/RIGHT** key to call up **Channel Selection** menu. You can select a different channel from this list using this option. To return to *Timer entry* menu, press **EXIT**.

- **After event**

This option allows you to choose from auto, do nothing, go to standby, and go to deep standby after the timer event is done.

### • YELLOW (Single EPG)

Press **YELLOW** while *Eventview* menu is on, to call up the program event schedules of the selected channel.

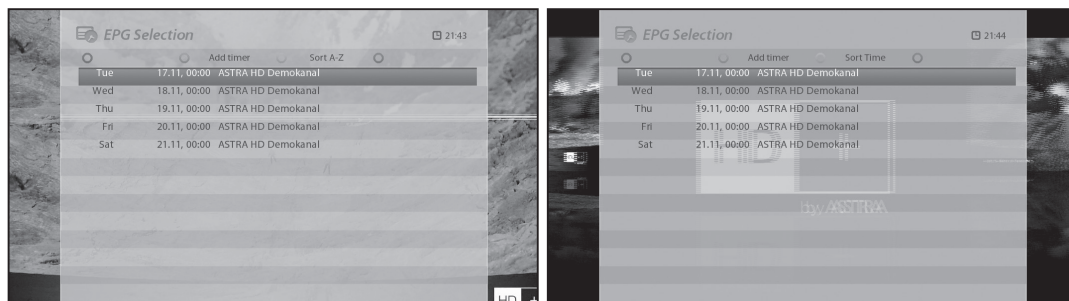

In this state, you can sort the list according to A-Z order or Time by pressing **YELLOW**.

**NOTE :** To add a timer for recording or zapping, press **GREEN**.

### • BLUE (Multi EPG)

Press **BLUE** to activate *EPG Selection Multi* window.

- You can move the previous or next program within the same channel by using **YELLOW** (Previous)/ **BLUE** (Next).



**NOTE :** Not all channels provide EPG information and thus in case of no EPG data, nothing will be displayed except for the channel name.

- You can switch to another channel by using **UP/DOWN** key.
- **RED** key is used to instantly tune into the selected channel.
- **GREEN** key is used to reserve recording or zapping of the selected program.



## 9. Timeshift

[**i**] : Press **▶** or **⏸** key

For your information, Timeshift is an instant recording of the current program that you are watching. Press **PLAY** or **PAUSE** key, it will instantly pause the audio and video of the program, and a small window displaying elapsing time information will appear on the left upper side of the screen as below.

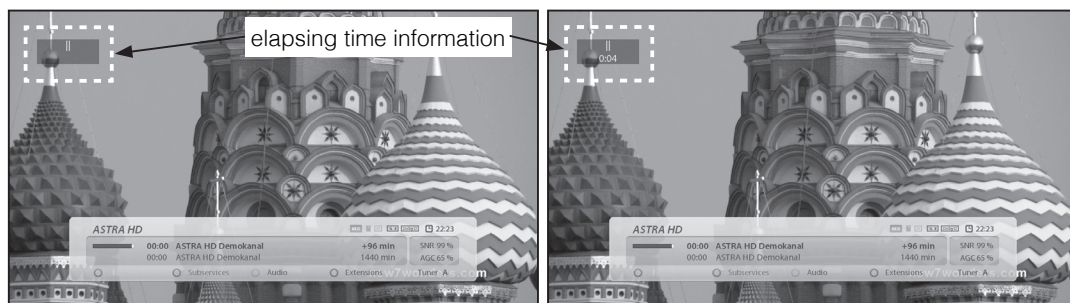

In this state, Timeshifted recording is running until you press either **PLAY** or **PAUSE** again. You can restart viewing of the program.

If you want to stop Timeshifted recording and to return to the live mode, press **STOP** key.

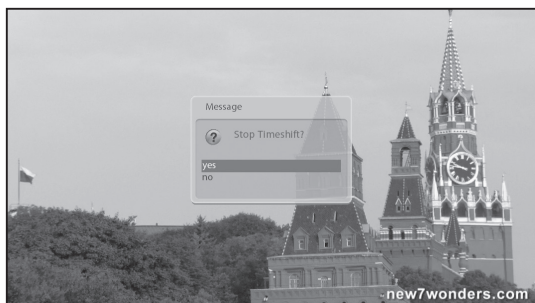

You will be asked of **Yes** or **No** to stop Timeshift.

**NOTE** : What is different from normal recording is that Timeshifted recording is not meant to be stored on HDD. If you stop Timeshift, you cannot replay the Timeshifted recording.



## 10. Recording

Vu+ Ultimo supports multiple recordings up to 8 recording at the same time.

### ① Instant Recording

[**i**] : Press REC **(i)** key]

Press **REC** key to start the recording of the current program.

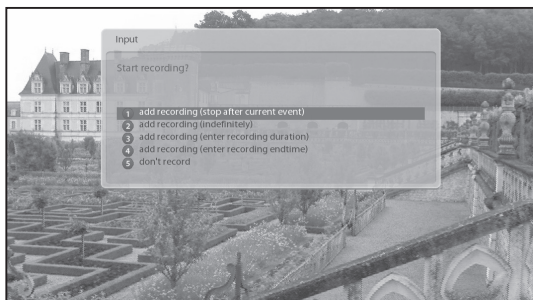

Five recording options are given.

#### - Add recording (stop after current event)

This option is used when you want to end recording when the current program ends.

#### - Add recording (enter recording duration)

This option is used when you want to manually set the length of recording by entering a certain number as below:



### - Add recording (enter recording end time)

This option is used when you want to define a certain date and time when the recording is stopped.



### - Add recording (indefinitely)

This option is used when you want to keep recording running without a specific end time. Recording will continue unless you stop it.

### - Don't record

This option is used to exit from this menu without recording.

## ② Recording by Timer

[**i**] : Press MENU (MENU) key > Select Timer]

You can manage recording process using *Timer List* menu. Press **MENU** and select *Timer* on the menu.

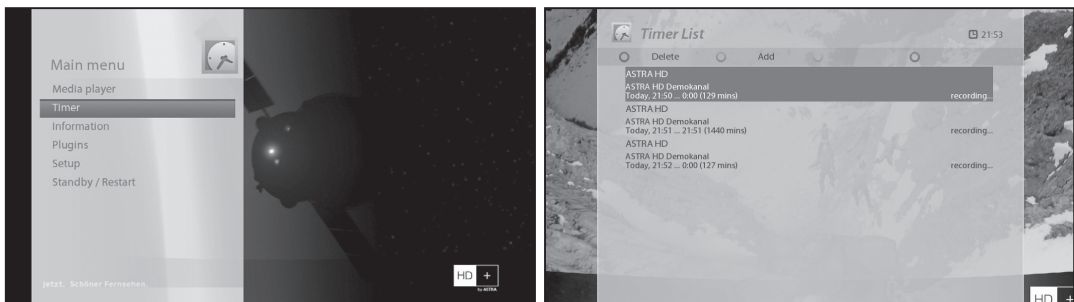

In this menu, color keys are assigned for each different function.

**- RED (Delete)**

This option is used to delete a timer.

**- GREEN (Add)**

This option is used to add a timer.

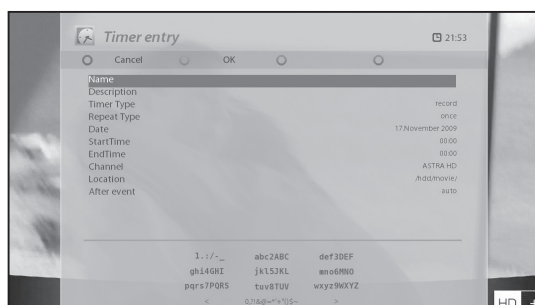

**- YELLOW (Disable)**

This option is used to disable the timer and X mark will appear.

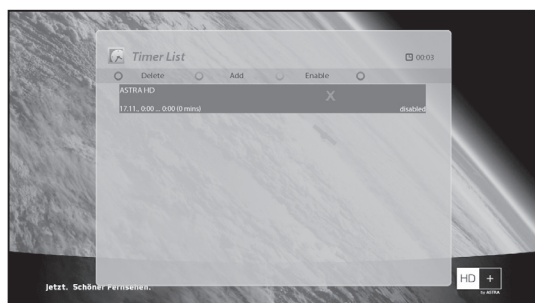

**NOTE :** if you want to enable the disabled timer, press **YELLOW** again.

- **BLUE (Cleanup)**

This option is used to remove those finished timers from the *Timer List*.

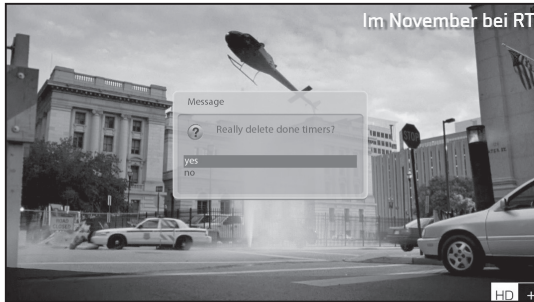

**NOTE :** Make sure that the HDD on your Vu+ has enough free space available for recording. If the free space on the HDD is not sufficient, recording might stop before the defined end time.

- **Stop Recording** (  ) : Press **REC** (  ) key > Select **“Stop Recording”**

If you want to stop recording, press **REC** again while recording is running. Select **Stop Recording**.

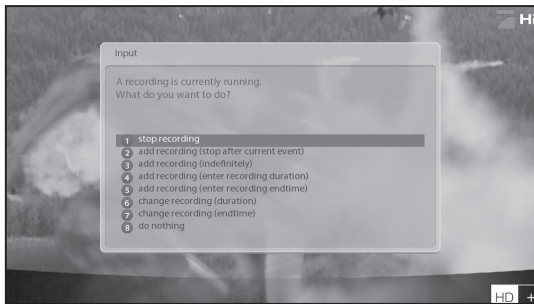

## 11. Recording Play

[ : Press Recording List () key]

You can view recorded files on the *Recorded files* menu. Press **Recording List** () to activate this menu.

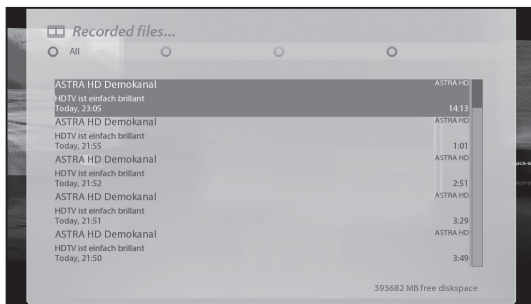

Select the file that you want to play. It will instantly replay the file and display the recording infobar.

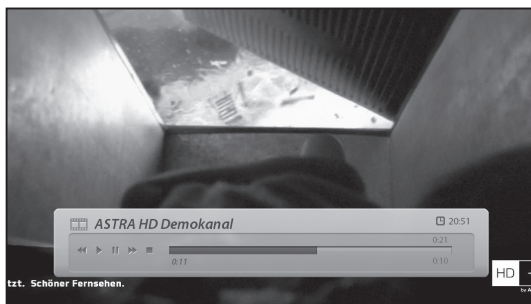

This infobar gives you the following information of the recording.

- ① Title of the recording
- ② Total duration of recording
- ③ Remaining time
- ④ Progressive bar
- ⑤ Elapsed time

## 12. Managing Recording Files

[**i**] : Press Recording List (**ER**) key > Press MENU key]

If you want to delete a recording file, press **MENU** key while *Recorded files* menu is on.



Select "**delete**" and confirm **OK** to delete.

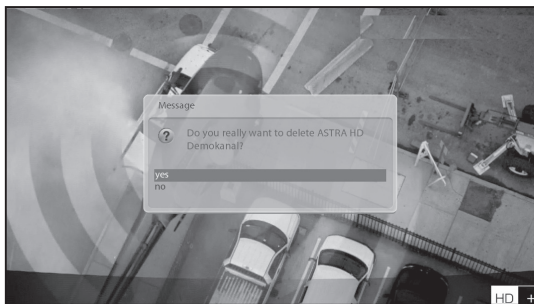

Other than "**delete**", in this menu, you have options in sorting and listing of the recording files.

- Sort by date
- List style default
- List style compact with description
- List style compact
- List style single line
- Hide extended description.

## 13. Media Player

[**i**] : MENU (MENU) > Media Player]

Vu+ is truly a multimedia receiver capable of playing media contents. Using Media Player, you can enjoy Music, Photo and Video contents stored on the internal HDD and/or an USB memory stick plugged into Vu+.

If you play **Media Player**, the following player will appear.

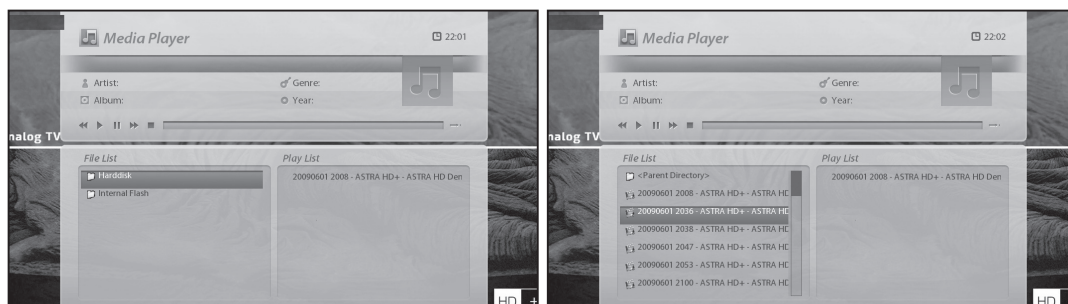

- ① Go into any directory of the HDD or plugged USB.
- ② Select a file in the **File List** to play and press **OK**. The selected file will be displayed in the **PlayList**.
  - \* Supported formats are mainly JPG, MP3, AVI, etc.
- ③ In the same way, you can play the recording files stored on the HDD.
- ④ To move between **File List** and **Play List**
  - Press **CH-** to go into **Play List**
  - Press **CH+** to go into **File List**
- ⑤ To call up **Media Player** window
  - Press **Play** (▶), or **Pause** (⏸) or **Stop** (■)
- ⑥ To play
  - Select a file in the **Play List** and press **OK**.

## 14. Plug-ins

[**i** : MENU **MENU** > Plugins]

Vu+ is integrated with standard 10/100Mbps Ethernet with RJ 45 connector. You are recommended to use this network capability of Vu+ to fully enjoy the system. If your Vu+'s network connection is established, you can directly download plug-ins from a designated website of Vu+.

- ① Press **MENU** and select **Plugins** menu to active **Plugin browser**.
- ② Press **GREEN** key to download a list of plug-ins available.
- ③ Once the download is done, a list of plug-ins will be displayed.
- ④ Select a plug-in to download.
- ⑤ You can check if the download is done properly on the Plugin browser

From this site, you can check available plug-ins to download as below.

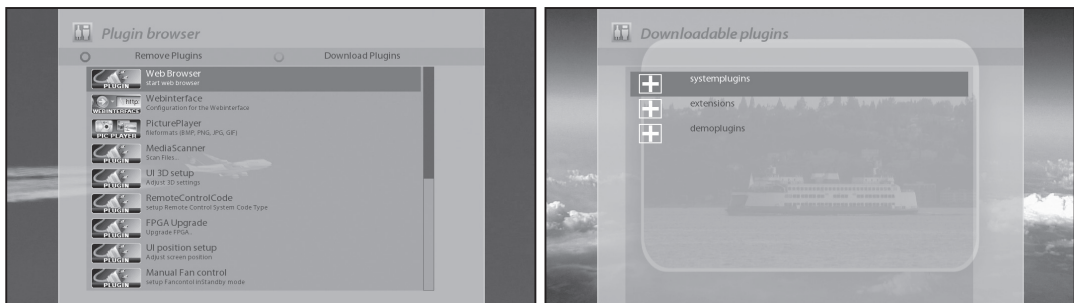



## 15. Sleep Timer

[**i** : MENU **(MENU)** > Standby/ Restart > Sleep Timer]

You can set a specific time when your Vu+ goes into Standby mode or Deep Standby mode, using this menu. Three color keys are used to set up this sleep timer.

### ① RED

This option is used to enable or disable *Sleep Timer*.

### ② GREEN

This option is used to choose between *Standby mode* and *Deep Standby mode*.

### ③ YELLOW

This option is used to choose whether to be asked of confirmation before system shutdown.

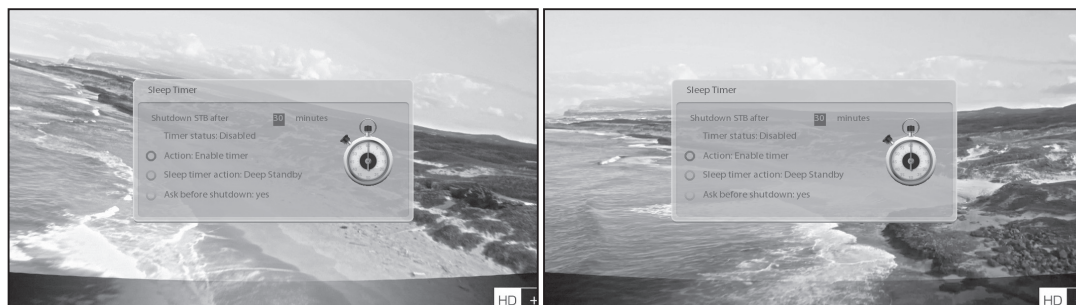

## IV. System Configuration

Vu+ is a very sophisticated device designed to allow users a variety of system setting options. You can fine-tune your Vu+ to be your OWN system to fit your taste. This chapter will guide you through the entire menu of system configuration.

Prior to System Configuration, please take a notice on the menu structure of Vu+ first.

### 1. Main Menu

[**i**] : Press MENU (MENU)

The main menu of Vu+ consists of the following sub menus.

① **Media player**

Activate Media player of Vu+. For more information, please refer to Media Player section

② **Timer**

Activate Media player of Vu+. For more information, please refer to Media Player section

③ **Information**

Has two sub menus for *Service / About*. *Service* menu provides the detailed information of the current channel. *About* menu provides the detailed information of the H/W and S/W system of your Vu+.

④ **Plugins**

Activates Plugin browser of Vu+. Using this browser, you can log onto the designated website and you can download a variety of new plug-ins.

⑤ **Setup**

Provides all of the system settings.

⑥ **Standby / Restart**

Provides options for power on/off and sleep timer.



## 2. System Setup

[**i**] : Press MENU (MENU) > Select Setup]

The Setup menu consists of the following sub-menus.

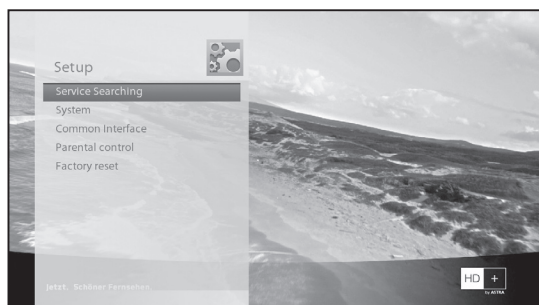

- ① Service Searching
- ② System
- ③ Common Interface
- ④ Parental Control
- ⑤ Factory reset

### 2-1. Service Searching

[**i**] : Press MENU (MENU) > Setup > Service Searching]

Here you set up the tuners of your Vu+ and run channel scanning automatically or manually.

#### A. Tuner Configuration

[**i**] : MENU (MENU) > Setup > Service Searching > Tuner Configuration]

If you run the First Time Installation process, the Tuner A is already configured. You can check the information of Tuner A and which satellites are scanned, as follows.

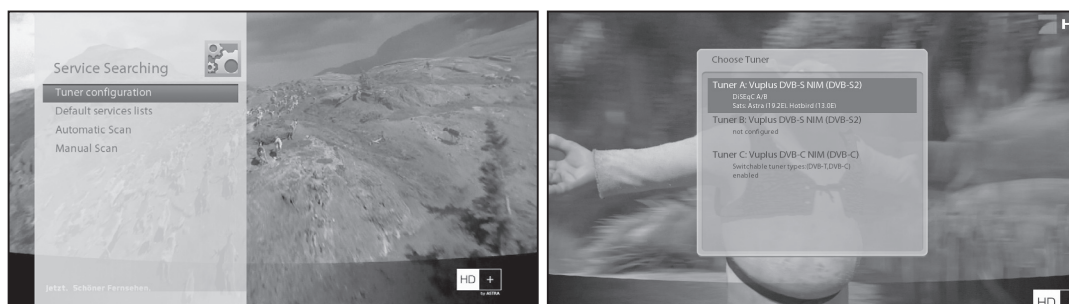

## B. Loading Default Service Lists

[**i**] : MENU (MENU) > Setup > Service Searching > Default Service List]

In case there are service lists available for certain satellites, for example, Astra or Hotbird, you can install the lists in the channel list of your Vu+.

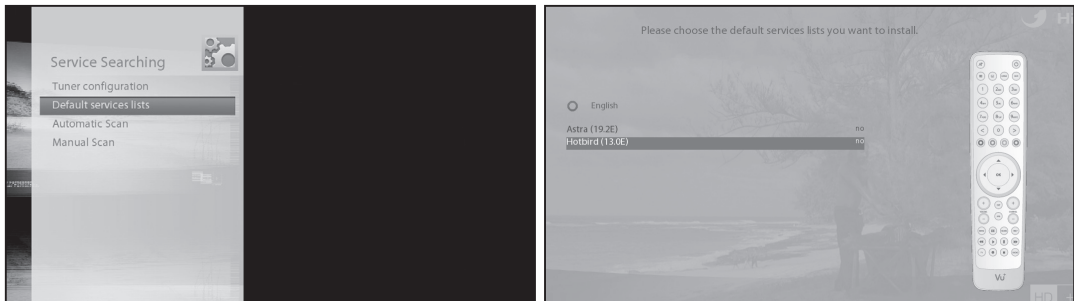

If default service lists are not available, you can run the service scan automatically or manually to add TV and radio channels into the channel list of your Vu+.

## C. Automatic Scan of Services

[**i**] : MENU (MENU) > Setup > Service Searching > Automatic Scan]

The easiest way to scan services is to use **Automatic Scan**. In the **Automatic Scan** menu, there are two options to choose from as below.

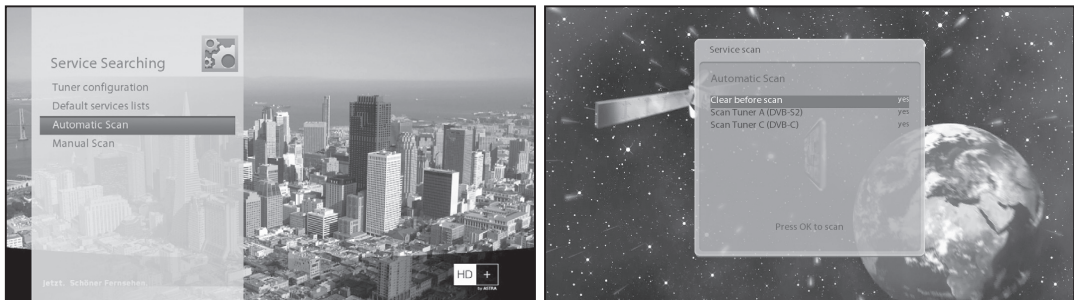

- **Clear Before Scan**

**YES** is used when you want to delete the existing channel list before you start the automatic scan. If you want to keep the existing list, select **NO**.

Press **OK** to activate the automatic scan. This will take some minutes. As the scan proceeds, you will see the progressive bar and the newly found services underneath.



#### D. Manual Scan of Services

[**i**] : MENU (MENU) > Setup > Service Searching > Manual Scan]

If you know well enough to configure each exact setting required for manual search of services, you can do manual scan as well. There are many parameter values that you need to decide as below.

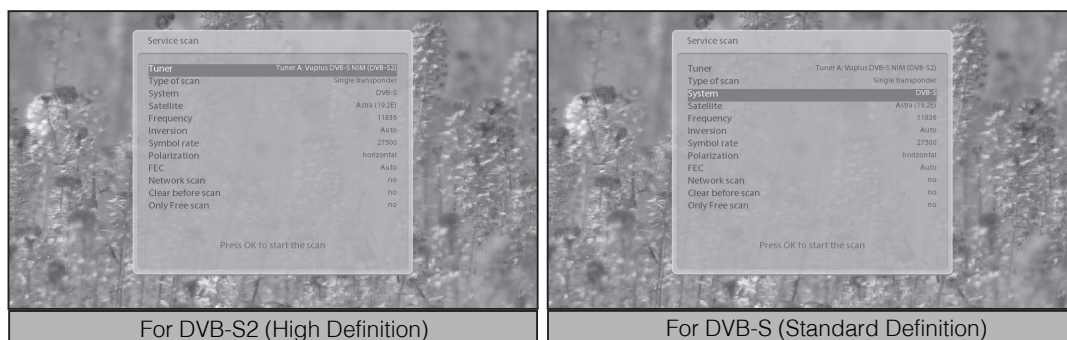

For DVB-S2 (High Definition)

For DVB-S (Standard Definition)

Amongst other things, the below parameters are what you need to decide prior to manual scan.

##### ① Tuner

You need to decide which tuner you want to use for manual scan.

##### ② System

Here you have two options between DVB-S (SD) and DVB-S2 (HD), if DVB-S2 tuner is mounted.

### ③ Frequency

You need to enter the exact frequency of the transponder that you want to scan.

### ④ Symbol Rate

You need to enter the exact symbol rate of the transponder that you want to scan

### ⑤ Polarity

Here, you have options for Horizontal, Vertical, Circular Left and Circular Right. You need to know the polarity of the transponder that you want to scan.

### ⑥ FEC (Forward Error Correction)

You need to enter the exact FEC value of the transponder that you want to scan

### ⑦ Modulation

Here you have two options for QPSK (SD) and 8PSK (HD).

### ⑧ Network Scan

Here you have two options for **YES** and **NO**. **NO** is used to scan the transponder (TP) based on the data that your Vu+ currently has. **YES** is used to scan the TP not just based on the existing TP data but also using new TP data, if there is TP data newly transported from the TP. Naturally, **YES** option takes longer while it may results in a better scan result.

### ⑨ Clear Before Scan

**YES** is used when you want to delete the existing channel list before you start the automatic scan. If you want to keep the existing list, select **NO**.

### ⑩ Only Free Scan

Here you have two options for **YES** and **NO**. If you want to scan only Free To Air channels without any encryption, select **YES**. Otherwise, select **NO** to scan all FTA and CAS channels.

Press **OK** to activate the manual scan. This will take some minutes. As the scan proceeds, you will see the progressive bar and the newly found services underneath.





## E. Selecting Tuner Type (for DVB-C/T Tuner)

If you have installed DVB-C/T Tuner of Vu+, you need to configure it as follows:

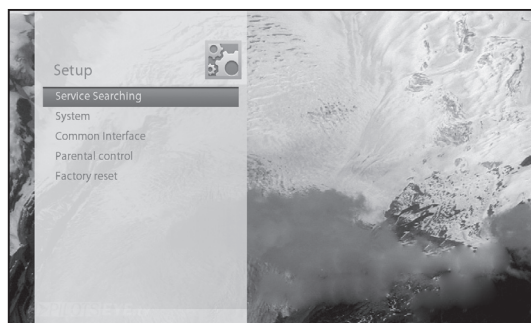
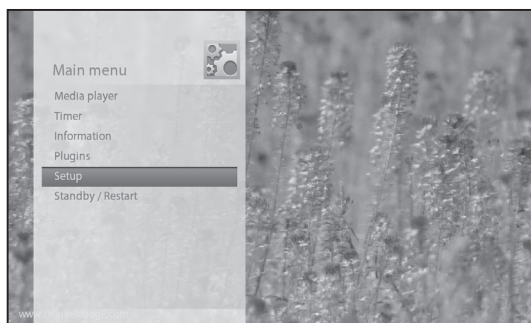

1. Go to Setup => Service Searching => Tuner Configuration

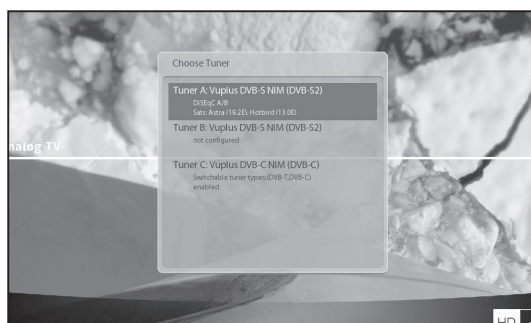
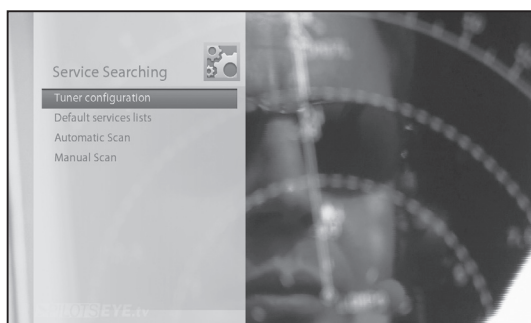

2. Press OK to activate Tuner A window

3. Press OK again Reception Setting window

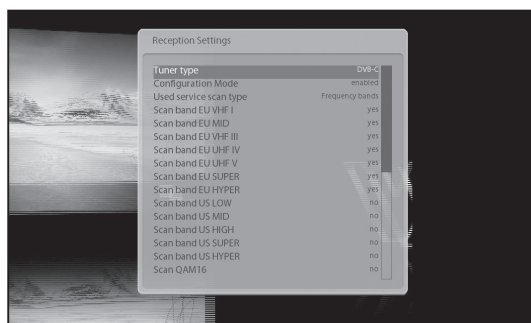
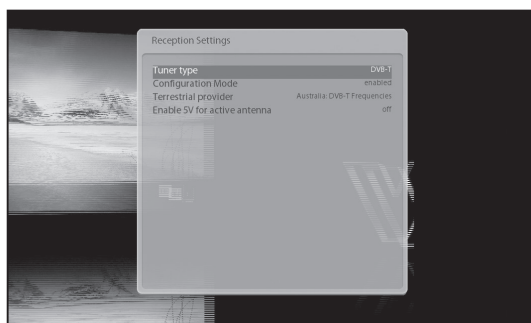

4. You can select DVB-C or DVB-T tuner by using LEFT/RIGHT button. Now the tuner configuration is done.



5. Go to Setup => Service Searching  
For the channel scan, you can select between Automatic Scan and Manual Scan.

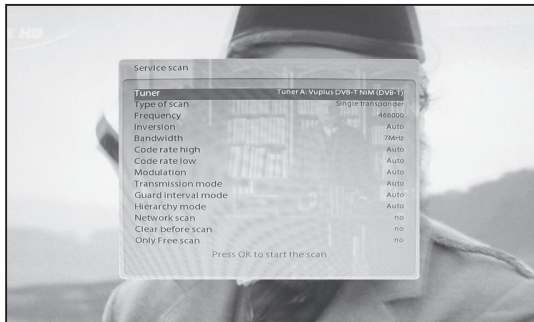

6. Press **OK** to call up Service Scan window.  
If the tuner is configured for DVB-T, channel scanning will be done in DVB-T mode.  
If the tuner is configured for DVB-C, channel scanning will be done in DVB-C mode.



7. Press **OK** to begin the channel scan.  
Once the scan is done, the scan results will be displayed.



## 2-2. System Configuration

[**i**] : Press MENU (MENU) > Setup > System]

Here you can find most of the necessary settings that you might need to optimize your Vu+ in the way you like it. Please read the followings carefully.

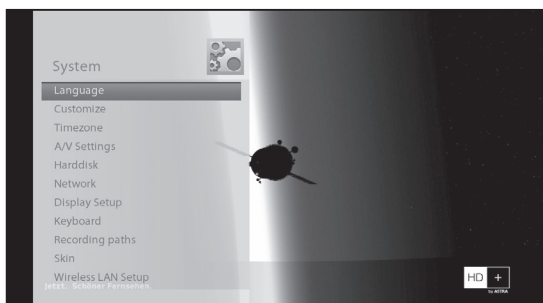

### A. A/V Settings

[**i**] : MENU (MENU) > Setup > System > A/V Settings]

Here you will find options necessary to set up the audio and video configuration of your Vu+.

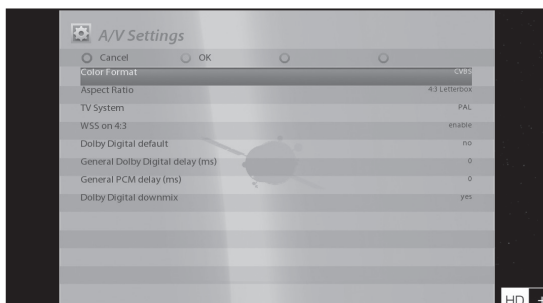

**NOTE** : RED is for cancel and GREEN is OK. OK key of RCU is not working in this mode.

Amongst the parameters given in this menu, the following ones are generally what you need to decide for the audio and video.

### ① Video output

Here you need to decide which video output you want to use between your TV and Vu+. The available options are as below.

- CVBS
- S-Video
- RGB

### ② Mode

You need to decide which resolution to use according to the video output above and your TV amongst the following options.

	Scart
Resolution	PAL NTSC Multi

### ③ Dolby Digital Default

**YES** is used when you want to set Dolby Digital audio as the default audio. If the program you are watching has Dolby Digital and Stereo, Dolby Digital is used.

On the other hand, **NO** is used when you do not want to set Dolby Digital audio as the default audio. If the program that you are watching has Dolby Digital and Stereo audio, Stereo audio is used.

### ④ Dolby Digital Downmix

**YES** is used when you want to set the audio output to be down-mixed from Dolby Digital to Stereo. **NO** is used when you do not want to set the audio output to be down-mixed from Dolby Digital to Stereo. If **NO** is on and you are using only HDMI or SCART connection, there can be no audio sometimes, if the program that you are watching provides Dolby Digital only. This option is recommended when you are using S/PDIF connection.

## B. Language Selection

[**i** : MENU (MENU) > Setup > System > Language]

A variety of languages are available for the OSD(On-Screen Display) of Vu+.

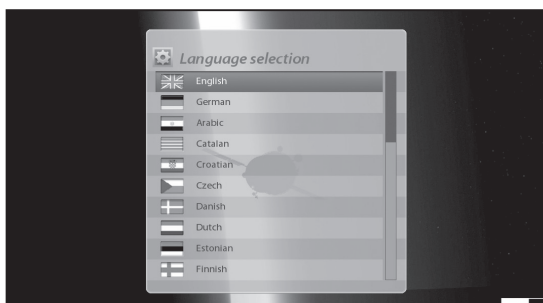

## C. Customization

[**i** : MENU (MENU) > Setup > System > Customize]

In this menu you will find various customization options and this menu can be displayed in three different formats: *Simple*, *Intermediate*, and *Expert*.

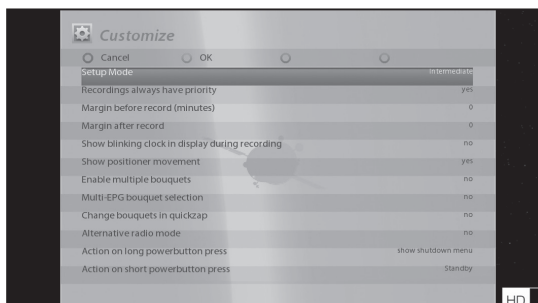
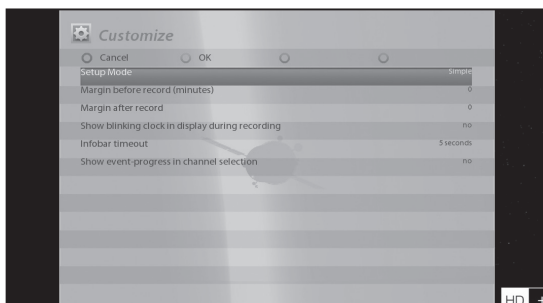

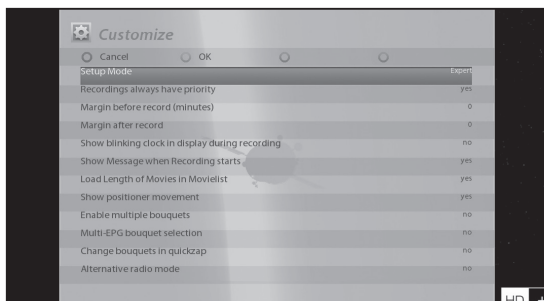

**NOTE :** RED is for cancel and GREEN is OK. **OK** key of RCU is not working in this mode.

Amongst the options given in this menu, the following ones are generally what you may need to know.

### ① Recording always have priority

**YES** option is used to set the recording to have a priority over any existing timer. If there occurs a conflict between a timer and a recording in progress, the recording has a priority over the timer. If you set this option at **NO**, you will be asked whether to switch to the service to record or not.

### ② Margin before record (minutes)

If you enter a number here, for example, 5, the recording will begin 5 minutes before the defined time. If it is "0", it means that the recording starts exactly at the defined time. This option comes in handy, just in case that a program starts earlier than the original schedule.

### ③ Margin after record

If you enter a number here, for example, 5, the recording will stop 5 minutes after the defined time. If it is "0", it means that the recording stops exactly at the defined time. This option comes in handy, just in case that a program ends later than the original schedule.

#### ④ Show Message when Recording starts

If you set this option at **YES**, a message saying that a recording has started appears as below.

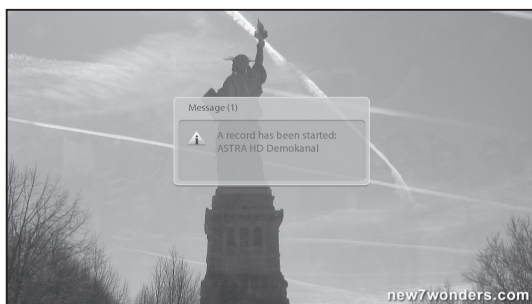

#### ⑤ Enable multiple bouquets

If you set this option at **YES**, it will enable multiple bouquets.

### D. Selecting Time Zone

[**(i)** : MENU **(MENU)** > Setup > System > Timezone]

You can set your time zone in this menu.

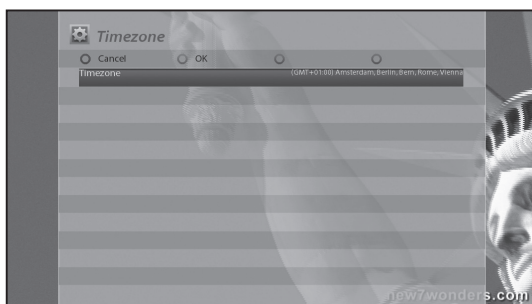

Using **LEFT/RIGHT** key, you can find a time zone that you want to use for your Vu+. After selecting a time zone, press **GREEN** to confirm and save the changed setting.

## E. Hard Disk Set Up

[**i**] : MENU (MENU) > Setup > System > Harddisk > Harddisk setup]

You can set the duration of time after which HDD is to be put into standby mode.

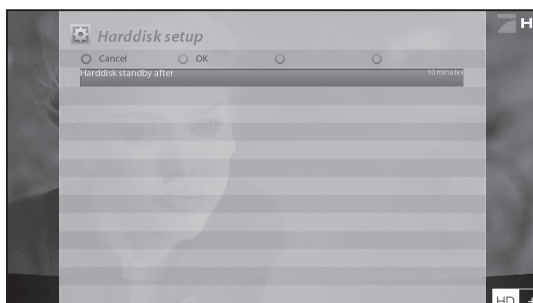

Here, you can choose from

- No standby
- 10 or 30 seconds
- 1, 2, 5, 10, 20, 30 minutes
- 1, 2, 4 hours.

Once you set this option, press **GREEN** key to confirm the change.

## F. Front Display Setup

[**i**] : MENU (MENU) > Setup > System > Display Setup]

There is a Large graphicVFD display on the front panel of Vu+. This display shows various information like the current menu, channel, HD icon, and so on. You can adjust the brightness of this display using this menu.

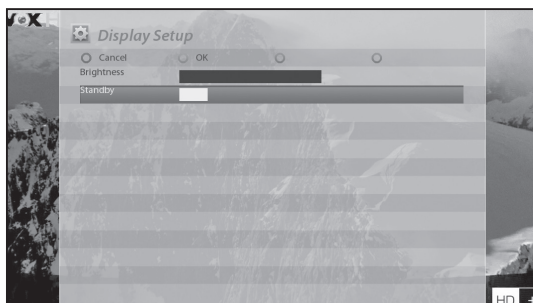

### ▪ Brightness

You can change the brightness of the front VFD display using **LEFT/RIGHT** key when Vu+ is in use.

### ▪ Standby

You can change the brightness of the front VFD display using **LEFT/RIGHT** key when Vu+ is in standby mode.

Once you completed this option, press **GREEN** key to confirm the change.

## G. Network Setup

[**i**] : MENU (MENU) > Setup > System > Network]

Vu+ is integrated with standard 10/100Mbps Ethernet with RJ 45 connector. You are recommended to use this network capability of Vu+ to fully enjoy the system. You can set up the network settings through this *Network Configuration* menu.

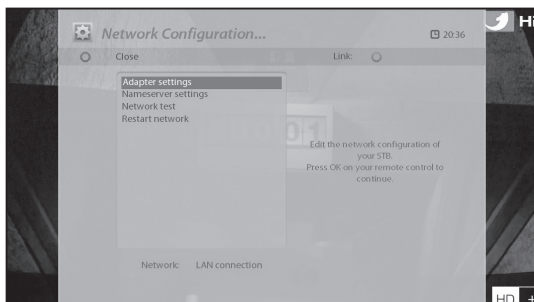

In the *Network Configuration* menu, you will see five sub menus as follows:

### ① Adapter settings

Through this menu, you can set the basic Ethernet configuration.

#### ▪ User Interface

**YES** is used to activate the Ethernet. If you set this option at **NO**, the Ethernet will not work.

#### ▪ Use DHCP

**YES** is used to use *DHCP (Dynamic Host Configuration Protocol)*. If you set this option at **YES**, it will automatically detect the correct IP address. **NO** is used when you want to use a certain fixed IP address. In this case, you need to enter correct addresses in each field.

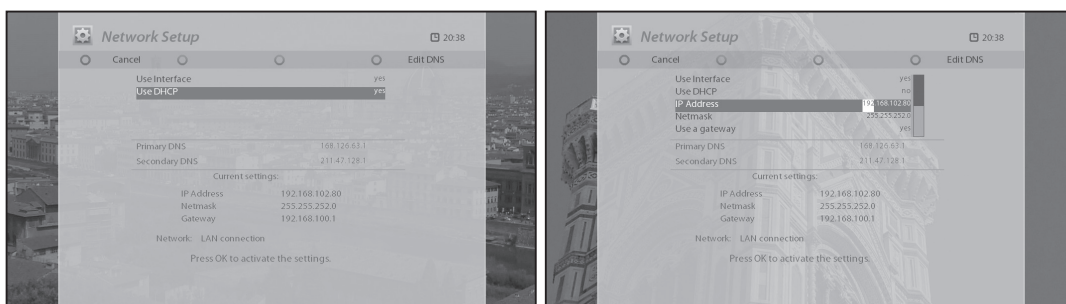

## ② Nameserver settings

This option is required when you selected not to use DHCP. You need to enter the address of the Nameserver.

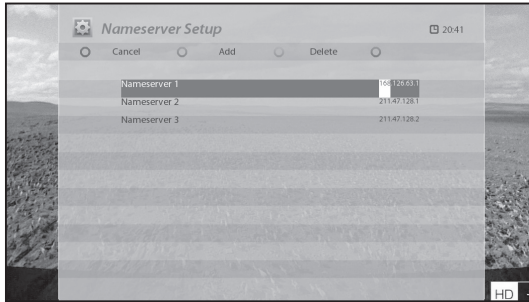

## ③ Network test

When you are not sure whether the network configuration has been done correctly or not, you can run this test.



## ④ Restart Network

This option is used when you want to reboot the Ethernet of your Vu+.



## H. Skin Change

[**i**] : MENU (MENU) > Setup > System > Skin]

Vu+ is a Linux based set top box and there are a lot of Skins available for Linux set top box. Using this menu, you can use a different Skin other than the default one.

**NOTE** : It takes some minutes since the change of Skin requires a complete system shutdown. Please wait patiently until the system reboots with a newly selected Skin.

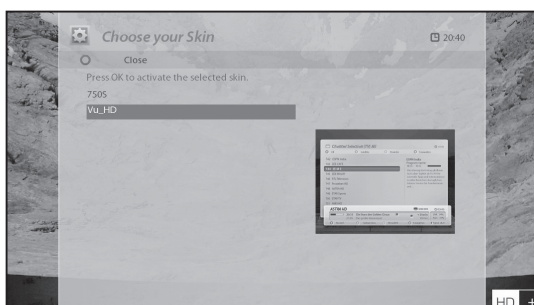

## 2-3. Checking CAM

[**i**] : MENU (MENU) > Setup > Common Interface]

To be able to watch CAS channels, you need to have a proper CAM and a Smartcard. Vu+ is integrated with two Common Interface slots. If you have two CAM modules and keep them inserted in your Vu+, it will reduce the trouble of changing CAM.

If you have inserted one or two CAMs, you can check the information of the inserted CAMs, through this menu as below:

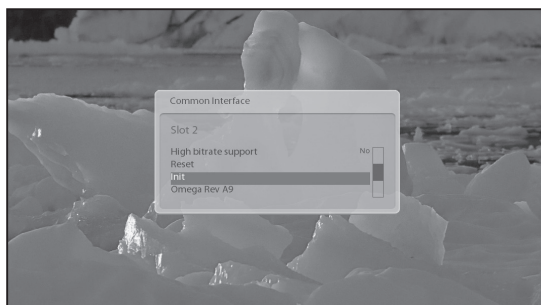

## 2-4. Parental Control

[**i**] : MENU (MENU) > Setup > Parental Control]

If you want to prevent certain channels from being accessed by others, you can do so using this menu.

① Go to Parental Control menu by pressing MENU > Setup > Parental Control.



② Set the parental control option at **YES** using LEFT/RIGHT key. The menu will change as below.

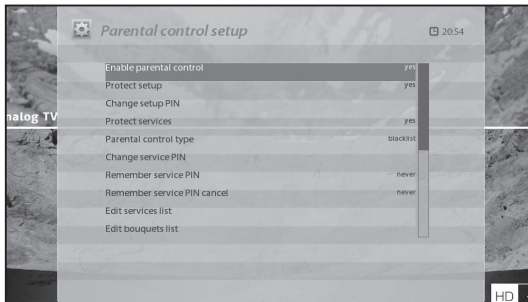

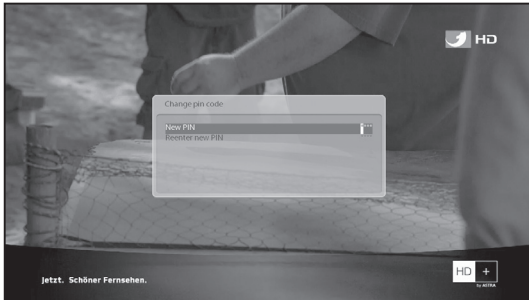

#### ■ Protect setup

If you set this option at **YES**, you will be asked to enter PIN code when you enter this **Parental setup** menu.

#### ■ Change setup pin

If you want to change the existing PIN code for Parental setup, you can do so using this menu.

You need to enter a new PIN code twice.

#### ■ Protect services

You need to set this option at **YES**, if you want to lock certain channels with PIN code.

#### ■ Parental control type

This option will be activated only when you set **Protect services** at **YES**. Here there are two options:

- **White list** : This option is used to block all channels except those channels in the parental control list.
- **Black list** : This option is used to block only those channels included in the parental control list.

#### ■ Change service pin

Here you can define a PIN code required to change services to be included in the parental control list.

**NOTE:** PIN code here is used for Change service and thus you are recommended to use a PIN code different from that used for **Protect services**.

- Edit service list

Here you can add services that you want to lock with PIN code. Services will be arranged in the alphabetical order and you can select an alphabet to enter into the list where you can find the channel that you want to lock.



Here, T is selected and TV5 is locked in the list as an example.

Next time when you or anyone else want to tune into this service, the menu asking for PIN code will appear instantly as below.

**NOTE :** It is very important not to lose this PIN code.

## 2-5. Factory Reset

[**i**] : MENU (MENU) > Setup > Factory Reset]

If you want to erase all installed service list as well as all configurations, run the **Factory Reset** process. Select **YES** in the below menu to run the factory reset.

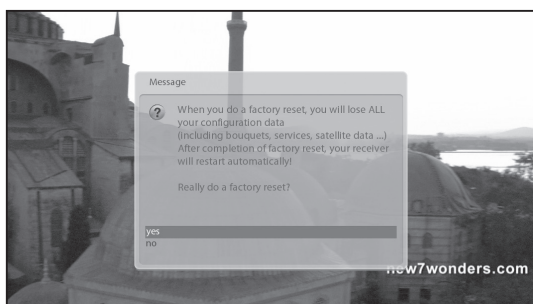

Upon the completion of factory reset process, your Vu+ will reboot automatically and start the **First Time Installation** process.

**NOTE :** If you do this factory reset, all of your configuration data including bouquets, service lists, satellite parameters, and so on will be erased.

## 2-6. Checking H/W & S/W Information

[**i** : MENU (MENU) > Information]

If you want to check the H/W or S/W system of your Vu+, this is the menu that you need to use. Also, here you can check very detailed information of a specific service.

### A. Service Information

[**i** : MENU (MENU) > Information > Service]

In this menu, you can see all the parameter data of the current channel. The service information is well arranged in four sections as below:

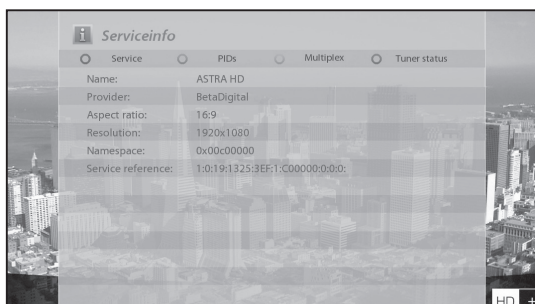

① Service info

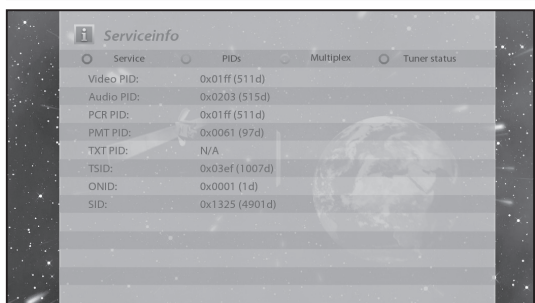

② PIDs

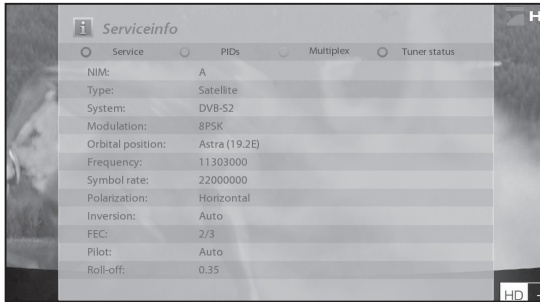

③ Transponder



④ Tuner Status

## B. System Information

[**i**] : MENU (MENU) > Information > About]

This menu is for you to check the current system of your Vu+. You can see the following information:

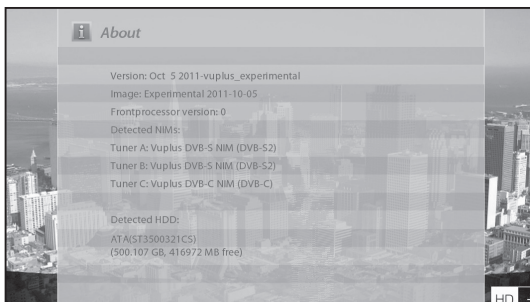

- ① S/W version
- ② Detected NIMs
- ③ Detected HDD

## 2-7. Wi-Fi Dongle Installation

Vu+ provides USB Wi-Fi dongle for convenient network connection. Please read the following guide carefully in order for successful setup.

1. Insert the dongle into the UBS port of Vu+.
2. Turn on the power of Vu+.

### NOTE

- If the set is already turned on, you can try the following sequence as well.  
Go to Menu > Standby / Restart > Restart GUI (or Restart).
- “Restart GUI” is displayed on the menu only on Expert mode.  
Go to Menu > Setup > System > Customize > Setup Mode. Set the Setup Mode as in “Expert” by using Left/Right button.

3. Go to Menu > Setup > System > Wireless LAN Setup. Press **OK**.

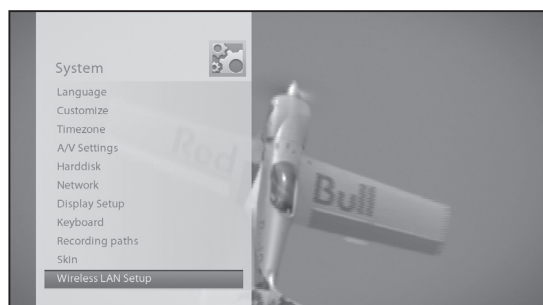

4. The connected USB Wi-Fi device will be listed. Select the device by pressing “Green” button.
5. Select “Adapter Settings” for wireless configuration.

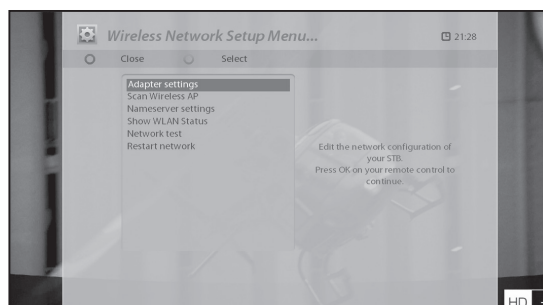

6. Configure each setting by using Left/Right button and save the changed settings by using Green button.

- (a) Use Device: Activate/Deactivate Wireless LAN module.
- (b) Use DHCP: If select “NO”, “IP, NETMASK, GATEWAY need to be configured manually.
- (c) ESSID: Select AP
- (d) Input Hidden ESSID: If the AP to select is set as “hidden mode”, select “Input hidden ESSID” in “ESSID”, and enter ESSID of AP directly.

7. Encrypt: If the chosen AP requires wireless security configuration, select “Yes”.

(a) Configuration

- Wireless security method – WEP, WPA, WPA2, WPA-WPA2.
- Key Type – ASCII, HEX
- Network Key

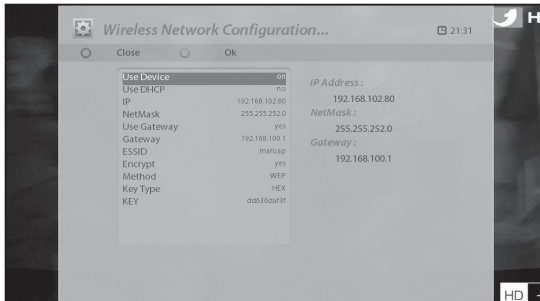

8. If the ethernet is activated, decide whether to deactivate it or not. In order to avoid conflicts between network devices, deactivation is recommended.

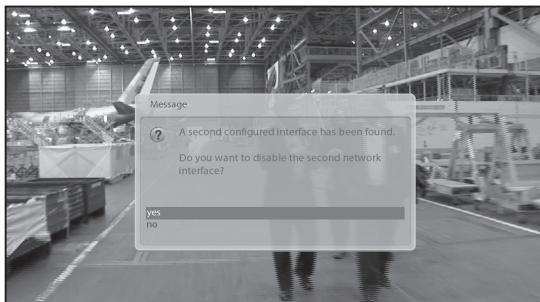

9. Select “Scan Wireless AP” to check accessible AP.

(a) Place the highlight bar on the AP to connect, and press “Blue” button to move to “Adapter Setting” menu.

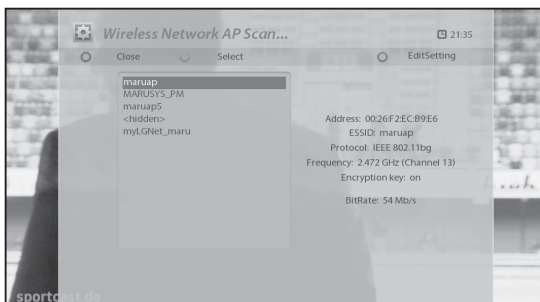

10. You can change the settings of name server in “Nameserver settings”.

(a) It is possible to add up to 4 name servers by using “Add”(Green) button.

(b) And it is also possible to delete name server by using “Delete” (Yellow) button.



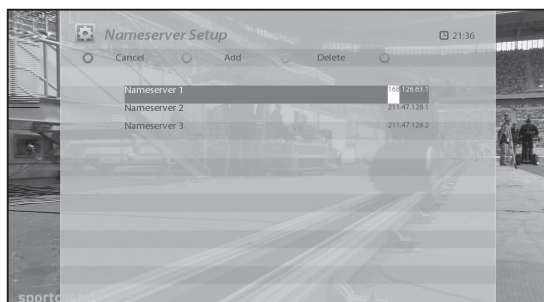

**NOTE :** If DHCP is used, nameservers are automatically configured.

11. “Show WLAN Status” displays the status of the wireless network that is currently connected.  
 (a) If wireless network is not connected, this menu is not to be displayed.

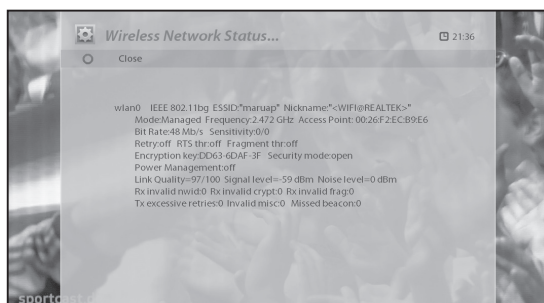

12. Test the network status in “Network test”  
 (a) Start the test by using “Green” button.  
 (b) After the five test items are finished, you can check further information (“Show Info”) on each test item by press “OK”.  
 (c) If the test result is not satisfactory, try reconfiguring the wireless.  
 (d) network setting by selecting “Edit settings” menu.

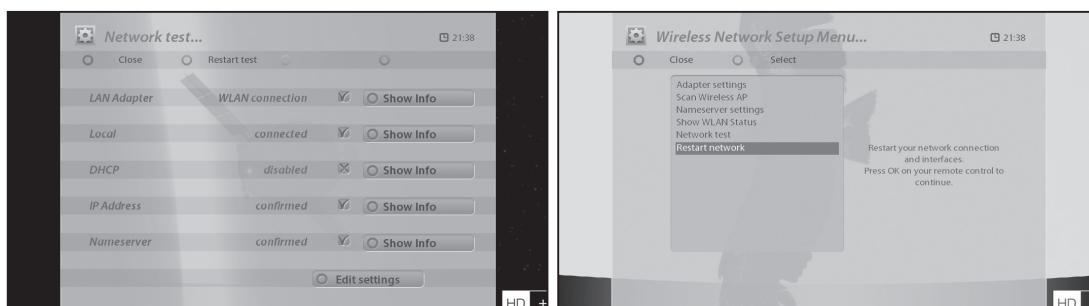

13. If necessary, it is possible to restart the wireless network connection by “Restart network” menu.

## 2-8. Inserting Tuner

Vu+ Ultimo adopts triple pluggable tuner system. You can additionally purchase DVB-S2 and DVB-C/T Tuner.

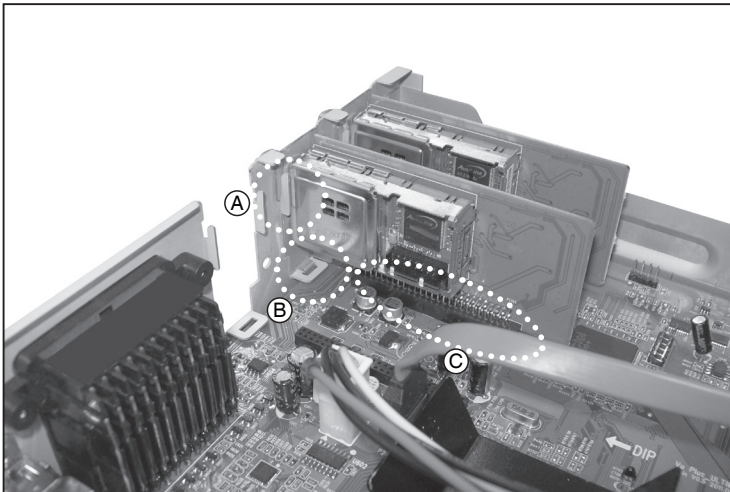
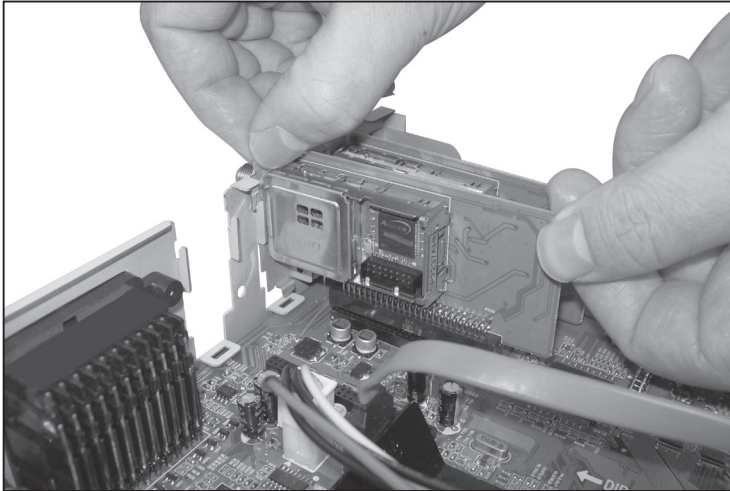

When you install a new tuner, please make sure that three points described in A, B and C be correctly mounted.

## 2-9. HDD Mounting

Vu+ HDD bracket is designed to mount 2.5" and 3" HDD.

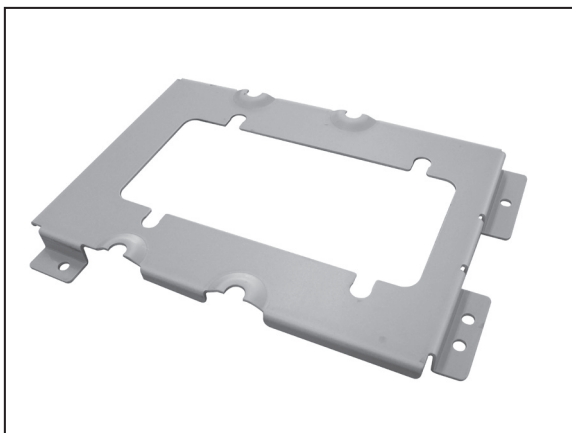

You can mount 2.5" HDD or 3" HDD using this bracket.

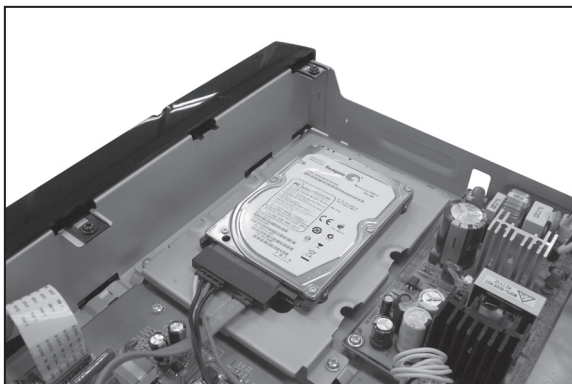

When 2.5" HDD is mounted.

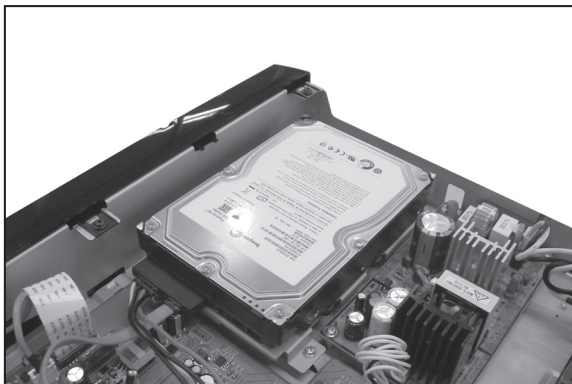

When 3" HDD is mounted.

## 2-10. Remote Control Unit (RCU) Set-up

Vu+ RCU is a universal RCU that can be used for TV and STB at the same time.

### A. User Guide of Vu+ Universal RCU

#### Pre-note

<< >> means long press

< > means normal press

4 digit code can be found in the TV brand code list of the user manual.

The new RCU of Vu+ is a universal type and you can control your Vu+ STB and TV at the same time. This universal RCU is a modeless design. While offering the basic control functions of your TV (TV Power, Volume +/-, Mute, AV), you can control STB without having to select mode between TV and STB every time. Compared to those universal RCU of mode selection types, the modeless universal RCU of Vu+ is clearly a smarter choice by eliminating unneeded control functions.

#### 1. TV setting

**Set-up Sequence:** <<1 + 3>>, <4digit brand-code>, <<Mute or Power>>

1. Press number 1 and 3 for three seconds until LED is on.
2. Find your TV brand-code from the TV code list and insert 4 digit code.
  - If you press "0000", Full Automatic Scan will start. This will take a while.
3. Keep Mute button (or Power) pressed until your TV is muted (or turned off).
4. If your TV is muted (or turned off), stop pressing Mute button.
5. Now, your RCU is in test mode and press Volume +/- to check if your TV responds.
6. If the volume buttons are operational, Press <OK + STOP (⏻)> to escape from the set-up mode.

#### 2. AV setting

AV button is for the selection of TV video source. AV button may be automatically set up depending on TV models. In case it is not automatically configured, please follow the instructions below.

**Set-up Sequence** <<1 + 9>>, <<AV>>

1. Press 1 and 9 for three seconds until LED is turned on.
2. Keep AV button pressed until your TV responds and displays the video input source.
3. If AV button is working, check if AV button is properly working several times.
4. Press <OK + STOP (⏻)> to escape from the set-up mode.

#### 3. RCU Buttons for TV

- \* Buttons for TV only: TV Power, AV
- \* Buttons switchable between TV and STB: Volume +/- and Mute
  - These buttons are for STB only before the RCU set-up is done.
  - It is switchable only after the configuration is done.
- \* All the other buttons are for STB only

#### 4. Mode Switch of Volume +/- and Mute

For the sake of easy volume control, please set the STB volume at 50% of the maximum level and set this level as the default volume level from STB. Then, you just have to control your TV volume only without having to adjust STB volume at the same time.

**Set-up Sequence:** <<1 + 6>>, <9>, <9>, <3>, <TV Power or STB Power>

1. Press 1 and 6 for three seconds until LED is on.
2. Press <9>, <9>, <3>.
3. If you want to control of TV volume, press TV Power button. If you want to control STB volume, press STB Power button.

#### 5. Reset of TV Set-up

In case you want to reset the configured TV set-up of your RCU,

**Press Sequence:** <<1 + 6>>, <9>, <9>, <6>

1. Press 1 and 6 for three seconds until LED is on.
2. Press <9>, <9>, <6>.
3. This will reverse the RCU into no configuration state.

#### 6. System Code Change.

You can change the system code of your Vu+ universal RCU according to the Vu+ model that you want to control. The default system code is Mode 2.

Mode 1 : SOLO / DUO

Mode 2 : UNO / Ultimo (\*Note : The keyboard of Ultimo remote cannot be used for SOLO,DUO & UNO.)

Mode 3 & 4 : reserved for future models.

**Press <<2 + 7>>, <HELP>, <0001 or 0002 or 0003 or 0004>**

1. Press 2 and 7 for three seconds until LED is on.
2. Press HELP
3. Press <0001 or 0002 or 0003 or 0004>

### DISCLAIMER

Vu+ universal remote controller (RCU) is developed with Philips Electronics. The database used in the Vu+ RCU supports more than 90% of the TV brands available on market. This means that your TV may not be compatible with this universal RCU in some rare cases. In this case, Vu+ RCU can be used only for Vu+ set top box.

## B.Function Key Table

Number	Key description	STB mode description	TV mode description
1	STB Power	STB Power Toggle	-
2	TV Power	-	TV Power toggle*
3		STB TELETEXT	-
4		STB SUBTITLE	-
5	AV	-	TV AV*
6	MUTE	STB Mute	TV Mute*
7	Digit 1	STB Digit 1	-
8	Digit 2	STB Digit 2	-
9	Digit 3	STB Digit 3	-
10	Digit 4	STB Digit 4	-
11	Digit 5	STB Digit 5	-
12	Digit 6	STB Digit 6	-
13	Digit 7	STB Digit 7	-
14	Digit 8	STB Digit 8	-
15	Digit 9	STB Digit 9	-
16		STB Delete previous character	-
17	Digit 0	STB Digit 0	-
18		STB Delete next character	-
19	Red	STB Red	-
20	Green	STB Green	-
21	Yellow	STB Yellow	-
22	Blue	STB Blue	-
23	Up	STB Cursor Up	-
24	Left	STB Cursor Left	-
25	OK	STB OK	-
26	Right	STB Cursor Right	-
27	Down	STB Cursor Down	-
28	VOL+	STB Volume up	TV Volume Up*
29	EXIT	STB EXIT	-
30	CH+	STB Channel Up	-
31	VOL-	STB Volume down	TV Volume Down*
32	EPG	STB EPG	-
33	CH-	STB Channel Down	-
34	MENU	STB MENU	-
35		STB ARCHIV	-
36	AUDIO	STB AUDIO	-
37	HELP	STB HELP	-
38	Fast Rewind	STB Fast Rewind	-
39	Play	STB Play	-
40	Pause	STB Pause	-
41	Fast Forward	STB Fast Forward	-
42	TV	STB Go to TV channel list	-
43	Record	STB Record	-
44	Stop	STB Stop	-

\* Shall only be available when the user configure the related feature (TV-setup and/or Volume Punch through)

**C.TV Code List**  
Brand ID for Device TV:

A.R. Systems	0012	Ampro	0139
Abex	0014	Amstrad	0140
ABS	0016	Anam	0146
Accent	0019	Anam National	0147
Acer	0028	Andersson	0148
Acoustic Solutions	0032	Anglo	0151
Action	0033	Anitech	0154
Acura	0036	Ansonic	0156
ADA	0038	AOC	0165
ADC	0040	Apex Digital	0170
Addison	0043	Apollo	0171
Admiral	0046	Apple	0172
Advent	0054	Arc En Ciel	0178
Adventura	0055	Arcam	0179
Adyson	0058	Ardem	0184
AEG	0059	Aristona	0192
Agashi	0063	ART	0199
AGB	0064	Arthur Martin	0200
Aiko	0069	ASA	0202
Aim	0070	Asberg	0205
Aiwa	0072	Astar	0218
Akai	0074	Astra	0221
Akashi	0075	Asuka	0227
Akiba	0078	ATD	0229
Akira	0079	Atlantic	0233
Akito	0082	Atori	0237
Akura	0083	Auchan	0240
Alaron	0085	Audiosonic	0264
Alba	0086	Audioton	0266
Albatron	0087	Audiovox	0268
Alcyon	0093	Audioworld	0269
Alienware	0099	Ausind	0276
Allorgan	0105	Autovox	0280
Allstar	0108	Aventura	0287
America Action	0123	Awa	0296
Amoi	0132	Axxon	0303
Amplivision	0138		

Baird	0311	C-Tech	0449
Bang & Olufsen	0314	Caihong	0462
Barco	0319	Caishi	0465
Basic Line	0325	Candle	0480
Bastide	0327	Capsonic	0486
Baur	0331	Carad	0488
Baysonic	0333	Carena	0489
Bazin	0335	Carnivale	0491
Beaumark	0340	Carrefour	0492
Beijing	0345	Carver	0494
Beko	0346	Cascade	0496
Belcor	0348	Casio	0499
Bell & Howell	0350	Cathay	0501
Belson	0355	CCE	0504
Belstar	0357	Celebrity	0509
BenQ	0359	Celera	0510
Beon	0361	Celestial	0511
Berthen	0363	Centrex	0516
Best	0364	Centrum	0519
Bestar	0368	Centurion	0520
Bestar-Daewoo	0369	Century	0521
Binatone	0378	CGE	0523
Black Diamond	0384	Changcheng	0526
Black Star	0386	Changfei	0527
Blackway	0388	Changfeng	0528
Blaupunkt	0390	Changhai	0529
Blue Sky	0395	Changhong	0530
Blue Star	0396	Chun Yun	0545
Boca	0399	Chunfeng	0546
Bondstec	0403	Chung Hsin	0547
Boots	0405	Chunsun	0549
BPL	0413	Cimline	0552
Bradford	0414	Cinex	0563
Brandt	0416	Citizen	0567
Brilliant	0422	City	0569
Brinkmann	0423	Clarion	0575
Brionvega	0424	Clarivox	0576
Britannia	0425	Clatronic	0581
Brockwood	0430	Clayton	0582
Broksonic	0432	CMS	0590
Bruns	0435	CMS Hightec	0591
BskyB	0436	Coby	0597
BSR	0437	Commercial Solutions	0615
BTC	0439	Concerto	0625
Bush	0445	Concorde	0626
Byd:sign	0448	Condor	0627
		Conia	0628



Conrowa	0634	Donghai	0821
Contec	0635	Drean	0832
Continental Edison	0637	DSE	0833
Cosmel	0647	DTS	0837
Craig	0650	Dual	0838
Crosley	0655	Dumont	0840
Crown	0658	Durabrand	0842
CS Electronics	0663	Dux	0843
CTC	0664	DVX	0847
CTX	0665	Dwin	0848
Curtis	0666	DX Antenna	0849
Curtis Mathes	0667	Dynatron	0855
CXC	0670	Easy Living	0860
CyberPower	0674	Ecco	0864
Cybertron	0675	ECE	0865
Cytron	0680	Elbe	0880
D-Vision	0684	Elcit	0883
Daewoo	0692	Electroband	0888
Dainichi	0694	Electrograph	0889
Dansai	0699	Electrohome	0890
Dantax	0702	Elektra	0896
Datsura	0703	Elfunk	0899
Dawa	0707	ELG	0900
Daytron	0710	Elin	0902
De Graaf	0716	Elite	0903
DEC	0717	Elman	0907
Decca	0718	Elta	0910
Deitron	0722	Emerson	0917
Dell	0725	Emperor	0921
Denon	0731	Emprex	0922
Denver	0733	Envision	0933
Desmet	0738	Enzer	0934
Diamant	0746	Epson	0937
Diamond	0747	Erres	0942
Diamond Vision	0748	ESA	0943
Dick Smith Electronics	0750	ESC	0945
Digatron	0751	Etron	0949
Digihome	0758	Eurofeel	0954
Digiline	0759	EuroLine	0955
Digital Life	0772	Euroman	0956
Digitex	0780	Europa	0957
Digitor	0781	Europhon	0959
DirectTV	0794	Evesham	0972
Dixi	0807	Evolution	0973
DL	0810	Excello	0975
Domeos	0817	Expert	0976
Dongda	0820	Exquisit	0978

Feilang	0990	GP	1147
Feilu	0991	GPM	1149
Feiyue	0993	GPX	1150
Fenner	0994	Gradiente	1151
Ferguson	0996	Graetz	1152
Fidelity	0998	Granada	1154
Filsai	1000	Grandin	1156
Finlandia	1003	Gronic	1160
Finlux	1004	Grundig	1162
Firstline	1008	Grunkel	1164
Fisher	1009	Grunpy	1165
Flint	1014	Haaz	1172
FNR	1016	Haier	1175
Formenti	1023	Haihong	1176
Formenti-Phoenix	1024	Halifax	1179
Fortress	1027	Hallmark	1180
Fraba	1030	Hampton	1183
Friac	1040	Hankook	1188
Frontech	1042	Hannspree	1189
Fujitsu	1052	Hanseatic	1190
Fujitsu General	1053	Hantarex	1192
Fujitsu Siemens	1054	Hantor	1193
Funai	1056	Harley Davidson	1197
Furichi	1058	Harman/Kardon	1198
Futronic	1061	Harvard	1202
Futuretech	1064	Harwa	1203
Galaxi	1068	Harwood	1204
Galaxis	1069	Hauppauge	1206
Gateway	1076	Havermy	1208
GBC	1078	HCM	1210
GE	1081	Helios	1219
Geant Casino	1082	Hello Kitty	1221
GEC	1083	Hema	1222
Geloso	1087	Hemmermann	1223
General Technic	1095	Hewlett Packard	1229
Genesis	1096	Hifivox	1233
Genexxa	1097	Higashi	1234
Giant	1113	Highline	1236
Gibraltar	1114	Hikona	1237
Go Video	1126	Hinari	1243
Goldfunk	1135	Hisawa	1247
GoldHand	1136	Hisense	1249
Goldline	1138	Hitachi	1251
GoldStar	1140	Hitachi Fujian	1252
Goodmans	1142	Hitec	1253
Gorenje	1144	Hitsu	1257
		Hoehner	1262

Hongmei	1272	ITT	1406
Hornyphon	1277	ITT Nokia	1407
Hoshai	1278	ITV	1408
Howard Computers	1281	Janeil	1414
HP	1283	JBL	1420
Huafa	1287	JCB	1421
Huanghaimei	1288	Jean	1424
Huanghe	1289	JEC	1426
Huanglong	1290	Jensen	1429
Huangshan	1291	Jiahua	1435
Huanyu	1292	Jinfeng	1438
Huari	1294	Jinhai	1439
Humax	1298	Jinxing	1442
Hush	1304	JMB	1445
Hygashi	1308	JNC	1446
Hyper	1309	Jocel	1448
Hypson	1312	Jubilee	1460
Hyundai	1315	JVC	1464
Iberia	1320	Kaisui	1471
iBUYPOWER	1322	Kamp	1475
ICE	1324	Kangchong	1476
ICeS	1325	Kanghua	1477
iLo	1341	Kapsch	1483
Imperial	1346	Karcher	1484
Indesit	1349	Kathrein	1486
Indiana	1350	Kawa	1487
Infinity	1352	Kawasho	1489
InFocus	1353	KDS	1494
Ingelen	1354	KEC	1496
Ingersol	1355	Ken Brown	1499
Initial	1356	Kendo	1500
Inno Hit	1358	Kennedy	1504
Innova	1359	Kennex	1505
Innovation	1360	Kenwood	1507
Inotech	1364	Khind	1511
Insignia	1368	KIC	1512
Inteq	1373	Kingsley	1520
Interbuy	1376	Kiota	1522
Interfunk	1377	Kioto	1523
Internal	1379	Kiton	1525
International	1380	KLH	1529
Intervision	1386	KLL	1531
Irradio	1396	Kloss	1532
IRT	1397	Kneissel	1535
Isukai	1402	Kolin	1541
ITC	1404	Kolster	1543
ITS	1405	Konig	1547

Konka	1548	Mandor	1717
Korpel	1552	Manesth	1718
Korting	1554	Manhattan	1719
Kosmos	1557	Marantz	1724
Koyoda	1561	Marelli	1729
KTV	1572	Mark	1731
Kunlun	1578	Mascom	1738
Kuro	1579	Mastro	1743
Kyoshu	1583	Masuda	1744
Kyoto	1585	Matsui	1750
L&S Electronic	1588	Matsushita	1751
LaSAT	1597	Maxdorf	1756
Lavis	1602	Maxent	1757
Lecson	1606	Maxim	1759
Lenco	1615	McMichael	1768
Lenoir	1617	Meck	1775
Lesa	1622	Media Center PC	1777
Lexsor	1626	Mediator	1784
Leyco	1627	Medion	1787
LG	1628	Medison	1788
Liesenk & Tter	1630	Megapower	1791
Liesenkotter	1631	Megatron	1795
Lifetec	1633	MEI	1796
Linksys	1640	Melvox	1799
Lloyd's	1648	Memorex	1800
Local India TV	1653	Memphis	1802
Local Malaysia TV	1656	Mercury	1804
Lodos	1659	Mermaid	1806
Loewe	1660	Metronic	1809
Logik	1661	Metz	1810
Logix	1663	MGA	1811
Luma	1674	Micromaxx	1822
Lumatron	1676	Microsoft	1826
Lux May	1680	Microstar	1827
Luxman	1682	MicroTEK	1829
Luxor	1683	Midland	1831
LXI	1686	Mikomi	1833
M Electronic	1688	Minato	1835
Madison	1698	Mind	1837
MAG	1701	Minerva	1838
Magnadyne	1702	Minoka	1840
Magnafon	1703	Mintek	1845
Magnasonic	1704	Minutz	1847
Magnavox	1706	Mitsubishi	1855
Magnin	1708	Mivar	1857
Magnum	1709	Monivision	1872
Majestic	1713	Morgan's	1875

Motion	1877	Nu-Tec	2048
Motorola	1878	NuVision	2053
MTC	1889	Oceanic	2061
MTEC	1890	Okano	2065
MTlogic	1892	Olevia	2067
Mudan	1896	Omni	2074
Multistandard	1904	Onida	2081
Multitec	1906	Onimax	2082
Multitech	1907	Onwa	2087
Murphy	1911	Opera	2090
Musikland	1915	Oppo	2092
Myryad	1922	Optimus	2095
NAD	1926	Optoma	2097
Naiko	1930	Optonica	2099
Nakimura	1933	Orbit	2103
Naonis	1936	Orion	2111
NAT	1941	Orline	2113
National	1942	Ormond	2114
NEC	1950	Orsowe	2116
Neckermann	1951	Osaki	2118
NEI	1952	Osio	2121
Nesco	1960	Oso	2122
Netsat	1966	Osume	2123
NetTV	1967	Otic	2125
Network	1968	Otto Versand	2126
Neufunk	1970	Pacific	2135
New Tech	1979	Packard Bell	2138
New World	1980	Pael	2140
Newave	1981	Palladium	2145
Nicamagic	1994	Palsonic	2147
Nikkai	1998	Panama	2149
Nikkei	1999	Panasonic	2153
Nikko	2000	Panavision	2154
Nintaus	2006	Panda	2155
Niveus Media	2012	Pathe Cinema	2168
Noblex	2013	Pathe Marconi	2169
Noblisko	2014	Pausa	2171
Nogamatic	2016	Peng Sheng	2181
Nokia	2017	Penney	2182
Norcent	2020	Perdio	2185
Nordic	2021	Perfekt	2186
Nordmende	2022	Petters	2189
Normerel	2024	Philco	2192
Northgate	2027	Philharmonic	2194
Norwood Micro	2029	Philips	2195
Novatron	2035	Phocus	2198
NTC	2045	Phoenix	2199

Phonola	2201	Rank Arena	2346
Phonotrend	2202	RBM	2350
Pilot	2207	RCA	2351
Pioneer	2212	Realistic	2354
Pionier	2213	Recco	2358
Plantron	2219	Recor	2359
Playsonic	2224	Rectiligne	2362
Polaroid	2230	Rediffusion	2364
Poppy	2236	Redstar	2366
Portland	2238	Reflex	2368
Powerpoint	2241	Relisys	2374
Precision	2244	Remotec	2377
Premier	2248	Reoc	2379
President	2250	Revox	2383
Prima	2253	Rex	2385
Princeton	2258	RFT	2386
Prinston	2259	Rhapsody	2387
Prinz	2260	Ricavision	2388
Prism	2261	Rinex	2392
Profex	2269	Roadstar	2398
Profilo	2272	Robotron	2401
Profitronic	2273	Rolson	2410
Proline	2274	Rowa	2416
Promax	2275	Royal Lux	2420
Proscan	2279	Runco	2423
Proscop	2280	Saba	2429
Prosonic	2282	Sagem	2434
Protech	2284	Saisho	2437
Proton	2288	Saivod	2439
Protron	2289	Salora	2443
Proview	2290	Sambers	2445
ProVision	2291	Sampo	2446
Pulsar	2296	Samsung	2448
Pye	2302	Samsux	2449
Pymi	2304	Sandra	2454
Qingdao	2308	Sansui	2458
Quasar	2320	Sanyo	2462
Quelle	2322	Sanyuan	2464
Questa	2324	SBR	2492
R-Line	2327	Sceptre	2498
Radialva	2329	Schaub Lorenz	2500
Radiola	2330	Schneider	2501
Radiomarelli	2331	Scimitsu	2505
Radionette	2332	Scotch	2506
RadioShack	2333	Scott	2508
Radiotone	2334	Sears	2514
Rank	2345	Seaway	2515

Seelver	2520	Sonneclair	2673
SEG	2522	Sonoko	2675
SEI	2524	Sonolor	2676
Sei-Sinudyne	2525	Sontec	2677
Seleco	2528	Sony	2679
Semivox	2529	Sound & Vision	2680
Semp	2530	Soundesign	2684
Sencora	2531	Soundwave	2689
Sentra	2534	Sova	2690
Serie Dorada	2538	Sowa	2691
Serino	2539	Soyea	2692
Shanghai	2547	Soyo	2693
Shaofeng	2549	Spectroniq	2701
Sharp	2550	Squareview	2703
Shencai	2553	SSS	2708
Sheng Chia	2554	Stack 9	2710
Shenyang	2555	Standard	2713
Sherwood	2557	Starlite	2728
Shintoshi	2564	Stenway	2739
Shivaki	2567	Stern	2741
Shogun	2568	Strato	2745
Shorai	2569	Strong	2748
Siam	2572	Studio Experience	2750
Siarem	2573	Stylandia	2752
Siemens	2574	SunBrite	2759
Siera	2576	Sunkai	2762
Siesta	2577	Sunny	2764
Signature	2582	Sunstar	2768
Silva	2591	Sunwood	2772
Silva Schneider	2592	Superla	2782
Silver	2594	Superscan	2786
SilverCrest	2595	Supersonic	2787
Simpson	2598	SuperTech	2789
Singer	2599	Supervision	2791
Sinotec	2600	Supra	2792
Sinudyne	2601	Supre-Macy	2794
Skantic	2605	Supreme	2795
SKY	2610	Susumu	2797
Skysonic	2627	Sutron	2798
Skyworth	2631	SVA	2800
SLX	2638	Svasa	2801
Sogera	2649	Swisstec	2806
Solavox	2654	Sydney	2808
Sole	2655	Sylvania	2809
Sonawa	2663	Symphonic	2810
Soniko	2669	Synco	2811
Sonitron	2671	Syntax	2814

Sysline	2815	Tennessee	2952
Systemax	2817	Tensai	2954
Sytong	2820	Tenson	2955
Tacico	2823	Tevion	2962
Tactus	2825	Texet	2963
Tagar Systems	2831	Thomas	2971
Taishan	2835	Thomson	2972
Talent	2838	Thorn	2974
Tandberg	2842	TMK	2994
Tandy	2843	TML	2995
Tashiko	2850	TNCi	2996
Tatung	2852	Tobo	2999
TCL	2856	Tokai	3001
TCM	2857	Tokaido	3002
Teac	2860	Tokyo	3004
Tec	2861	Tomashi	3006
Tech Line	2863	Topline	3016
Tehica	2865	Toshiba	3021
Technema	2866	Totevision	3024
Technica	2868	Touch	3025
Technics	2869	Towada	3028
Technika	2870	Toyoda	3030
TechniSat	2873	Trakton	3036
Technisson	2874	Trans Continens	3037
Technol Ace	2875	TRANS-continents	3039
Technosonic	2878	Transonic	3041
Techview	2883	Transtec	3042
Techwood	2884	Triad	3049
Tecnimagen	2885	Trident	3054
Teco	2886	Tristar	3057
Tedalex	2889	Triumph	3058
Tek	2892	TVS	3081
Teknika	2895	TVTEXT 95	3082
Teleavia	2901	Uher	3089
Telecor	2910	Ultra	3093
Telefunken	2914	Ultravox	3095
Telefusion	2915	Unic Line	3100
Telegazi	2917	United	3106
Telemeister	2924	Universal	3113
Telesonic	2930	Universum	3115
Telestari	2931	Univox	3116
Teletech	2934	US Logic	3124
Teleton	2935	Vector Research	3137
Televideon	2938	Venturer	3143
Television	2939	VEOS	3144
Televiso	2941	Vestel	3148
Temco	2946	Vexa	3149



Vibrant	3154	Xinrisong	3308
Victor	3155	XLogic	3310
Videocon	3163	Xoro	3315
Videologic	3165	Xrypton	3317
Videologique	3166	Xuelian	3320
Videosat	3170	Yamaha	3326
VideoSystem	3172	Yamishi	3328
Videotechnic	3173	Yokan	3335
Videoton	3174	Yoko	3336
Vidikron	3178	Yorx	3340
Vidtech	3179	Yuhang	3345
Viewsonic	3186	Zanussi	3349
Viking	3188	Zenith	3356
Viore	3192	ZhuHai	3364
Visiola	3197	Zonda	3369
Vision	3198	ZT Group	3370
Vistar	3207	Arena	3375
Vizio	3211	G-Hanz	3397
Voodoo	3215	I-Inc	3462
Vortec	3217	TruTech	3467
Voxson	3220	Afron	3470
Vue	3225	Dynex	3476
Waltham	3230	Element	3477
Wards	3231	Hanns.G	3478
Watson	3233	RevolutionHD	3503
Watt Radio	3234	BGH	3507
Waycon	3237	GVA	3510
Wega	3238	Princess	3514
Wegavox	3239	Acme	3521
Welltech	3244	Agazi	3522
Weltblick	3245	Alkos	3523
Weltstar	3247	Arcam Delta	3524
Westinghouse	3249	Ayomi	3525
Weston	3251	Blacktron	3526
Wharfedale	3255	Dual-Tec	3528
White Westinghouse	3258	Elbe-Sharp	3529
Wilson	3260	Electa	3530
Windsor	3265	ELECTRO TECH	3531
Windstar	3266	HiLine	3533
Windy Sam	3267	Interactive	3534
Wintel	3271	Kamosonic	3535
Wyse	3288	LG/Goldstar	3536
Xenius	3297	Liesenk	3537
Xiahua	3299	Life	3538
Xiangyu	3302	Loewe Opta	3540
Xingfu	3305	Nordvision	3543
Xinghai	3306	ONCEAS	3544

Quandra Vision	3546
Radio Shack	3547
RTF	3548
Tesmet	3550
Aomni	3555
Chimei	3563
Digital Lifestyles	3567
YU-MA-TU	3603
Bork	3615
iDEAL	3641
JTV	3645
Meletronic	3654
Onn	3663
Tesla	3680
Kenstar	3756
Vistron	3773
Pensonic	3778
Union	3781
DigiMax	3808
GFM	3820
Mitsai	3851
Nortek	3862
Camper	3911
Nexus Electronics	3948
PARK	3951
BARON	3959
Morgans	3970
Ziggo	4007
Cameron	4032
Gaba	4059
Nimbro	4065
Quadro	4071
Shinelco	4074
VU	4078
Catha	4094
Chuangjia	4096
Duongjie	4101
Fagor Life	4102
Fenmenti	4103
Great Wall	4105
Huijiaban	4108
IR	4110
Kangwei	4115
Layco	4117
Multisystem	4121
Okana	4122
Oulin	4123
Prandoni Prince	4125
Profekt	4126
Radio	4128
Shanshui	4133
Songdian	4136
Srypton	4138
Teachimagen	4140
Tiankeban	4142
Transfec	4143
Datron	4201
ShengCai	4217
Ministry Of Sound	4247
Inspira	4296
O.K.Line	4301
Onei	4302
Polyvision	4304
Walker	4311
Moree	4565
Nikai	4566
Novex	4567

## V. Copyright - GNU GPL

### GNU GENERAL PUBLIC LICENSE

Version 2, June 1991

Copyright (C) 1989, 1991 Free Software Foundation, Inc.  
51 Franklin Street, Fifth Floor, Boston, MA 02110-1301, USA

Everyone is permitted to copy and distribute verbatim copies of this license document, but changing it is not allowed.

#### Preamble

The licenses for most software are designed to take away your freedom to share and change it. By contrast, the GNU General Public License is intended to guarantee your freedom to share and change free software—to make sure the software is free for all its users. This General Public License applies to most of the Free Software Foundation's software and to any other program whose authors commit to using it. (Some other Free Software Foundation software is covered by the GNU Lesser General Public License instead.) You can apply it to your programs, too.

When we speak of free software, we are referring to freedom, not price. Our General Public Licenses are designed to make sure that you have the freedom to distribute copies of free software (and charge for this service if you wish), that you receive source code or can get it if you want it, that you can change the software or use pieces of it in new free programs; and that you know you can do these things.

To protect your rights, we need to make restrictions that forbid anyone to deny you these rights or to ask you to surrender the rights. These restrictions translate to certain responsibilities for you if you distribute copies of the software, or if you modify it.

For example, if you distribute copies of such a program, whether gratis or for a fee, you must give the recipients all the rights that you have. You must make sure that they, too, receive or can get the source code. And you must show them these terms so they know their rights.

We protect your rights with two steps: (1) copyright the software, and (2) offer you this license which gives you legal permission to copy, distribute and/or modify the software.

Also, for each author's protection and ours, we want to make certain that everyone understands that there is no warranty for this free software. If the software is modified by someone else and passed on, we want its recipients to know that what they have is not the original, so that any problems introduced by others will not reflect on the original authors' reputations.

Finally, any free program is threatened constantly by software patents. We wish to avoid the danger that redistributors of a free program will individually obtain patent licenses, in effect making the program proprietary. To prevent this, we have made it clear that any patent must be licensed for everyone's free use or not licensed at all.

The precise terms and conditions for copying, distribution and modification follow.

#### TERMS AND CONDITIONS FOR COPYING, DISTRIBUTION AND MODIFICATION

0. This License applies to any program or other work which contains a notice placed by the copyright holder saying it may be distributed under the terms of this General Public License. The "Program", below, refers to any such program or work, and a "work based on the Program" means either the Program or any derivative work under copyright law: that is to say, a work containing the Program or a portion of it, either verbatim or with modifications and/or translated into another language. (Hereinafter, translation is included without limitation in the term "modification".) Each licensee is addressed as "you".

Activities other than copying, distribution and modification are not covered by this License; they are outside its scope. The act of running the Program is not restricted, and the output from the Program is covered only if its contents constitute a work based on the Program (independent of having been made by running the Program). Whether that is true depends on what the Program does.

1. You may copy and distribute verbatim copies of the Program's source code as you receive it, in any medium, provided that you conspicuously and appropriately publish on each copy an appropriate copyright notice and disclaimer of warranty; keep intact all the notices that refer to this License and to the absence of any warranty; and give any other recipients of the Program a copy of this License along with the Program. You may charge a fee for the physical act of transferring a copy, and you may at your option offer warranty protection in exchange for a fee.

2. You may modify your copy or copies of the Program or any portion of it, thus forming a work based on the Program, and copy and distribute such modifications or work under the terms of Section 1 above, provided that you also meet all of these conditions:

- a) You must cause the modified files to carry prominent notices stating that you changed the files and the date of any change.
- b) You must cause any work that you distribute or publish, that in whole or in part contains or is derived from the Program or any part thereof, to be licensed as a whole at no charge to all third parties under the terms of this License.
- c) If the modified program normally reads commands interactively when run, you must cause it, when started running for such interactive use in the most ordinary way, to print or display an announcement including an appropriate copyright notice and a notice that there is no warranty (or else, saying that you provide a warranty) and that users may redistribute the program under these conditions, and telling the user how to view a copy of this License. (Exception: if the Program itself is interactive but does not normally print such an announcement, your work based on the Program is not required to print an announcement.)

These requirements apply to the modified work as a whole. If identifiable sections of that work are not derived from the Program, and can be reasonably considered independent and separate works in themselves, then this License, and its terms, do not apply to those sections when you distribute them as separate works. But when you distribute the same sections as part of a whole which is a work based on the Program, the distribution of the whole must be on the terms of this License, whose permissions for other licensees extend to the entire whole, and thus to each and every part regardless of who wrote it. Thus, it is not the intent of this section to claim rights or contest your rights to work written entirely by you; rather, the intent is to exercise the right to control the distribution of derivative or collective works based on the Program.

In addition, mere aggregation of another work not based on the Program with the Program (or with a work based on the Program) on a volume of a storage or distribution medium does not bring the other work under the scope of this License.

3. You may copy and distribute the Program (or a work based on it, under Section 2) in object code or executable form under the terms of Sections 1 and 2 above provided that you also do one of the following:

- a) Accompany it with the complete corresponding machine-readable source code, which must be distributed under the terms of Sections 1 and 2 above on a medium customarily used for software interchange; or,
- b) Accompany it with a written offer, valid for at least three years, to give any third party, for a charge no more than your cost of physically performing source distribution, a complete machine-readable copy of the corresponding source code, to be distributed under the terms of Sections 1 and 2 above on a medium customarily used for software interchange; or,

- c) Accompany it with the information you received as to the offer to distribute corresponding source code. (This alternative is allowed only for noncommercial distribution and only if you received the program in object code or executable form with such an offer, in accord with Subsection b above.)

The source code for a work means the preferred form of the work for making modifications to it. For an executable work, complete source code means all the source code for all modules it contains, plus any associated interface definition files, plus the scripts used to control compilation and installation of the executable. However, as a special exception, the source code distributed need not include anything that is normally distributed (in either source or binary form) with the major components (compiler, kernel, and so on) of the operating system on which the executable runs, unless that component itself accompanies the executable.

If distribution of executable or object code is made by offering access to copy from a designated place, then offering equivalent access to copy the source code from the same place counts as distribution of the source code, even though third parties are not compelled to copy the source along with the object code.

4. You may not copy, modify, sublicense, or distribute the Program except as expressly provided under this License. Any attempt otherwise to copy, modify, sublicense or distribute the Program is void, and will automatically terminate your rights under this License. However, parties who have received copies, or rights, from you under this License will not have their licenses terminated so long as such parties remain in full compliance.

5. You are not required to accept this License, since you have not signed it. However, nothing else grants you permission to modify or distribute the Program or its derivative works. These actions are prohibited by law if you do not accept this License. Therefore, by modifying or distributing the Program (or any work based on the Program), you indicate your acceptance of this License to do so, and all its terms and conditions for copying, distributing or modifying the Program or works based on it.

6. Each time you redistribute the Program (or any work based on the Program), the recipient automatically receives a license from the original licensor to copy, distribute or modify the Program subject to these terms and conditions. You may not impose any further restrictions on the recipients' exercise of the rights granted herein. You are not responsible for enforcing compliance by third parties to this License.

7. If, as a consequence of a court judgment or allegation of patent infringement or for any other reason (not limited to patent issues), conditions are imposed on you (whether by court order, agreement or otherwise) that contradict the conditions of this License, they do not excuse you from the conditions of this License. If you cannot distribute so as to satisfy simultaneously your obligations under this License and any other pertinent obligations, then as a consequence you may not distribute the Program at all. For example, if a patent license would not permit royalty-free redistribution of the Program by all those who receive copies directly or indirectly through you, then the only way you could satisfy both it and this License would be to refrain entirely from distribution of the Program.

If any portion of this section is held invalid or unenforceable under any particular circumstance, the balance of the section is intended to apply and the section as a whole is intended to apply in other circumstances.

It is not the purpose of this section to induce you to infringe any patents or other property right claims or to contest validity of any such claims; this section has the sole purpose of protecting the integrity of the free software distribution system, which is implemented by public license practices. Many people have made generous contributions to the wide range of software distributed through that system in reliance on consistent application of that system; it is up to the author/donor to decide if he or she is willing to distribute software through any other system and a licensee cannot impose that choice.

This section is intended to make thoroughly clear what is believed to be a consequence of the rest of this License.

8. If the distribution and/or use of the Program is restricted in certain countries either by patents or by copyrighted interfaces, the original copyright holder who places the Program under this License may add an explicit geographical distribution limitation excluding those countries, so that distribution is permitted only in or among countries not thus excluded. In such case, this License incorporates the limitation as if written in the body of this License.

9. The Free Software Foundation may publish revised and/or new versions of the General Public License from time to time. Such new versions will be similar in spirit to the present version, but may differ in detail to address new problems or concerns.

Each version is given a distinguishing version number. If the Program specifies a version number of this License which applies to it and "any later version", you have the option of following the terms and conditions either of that version or of any later version published by the Free Software Foundation. If the Program does not specify a version number of this License, you may choose any version ever published by the Free Software Foundation.

10. If you wish to incorporate parts of the Program into other free programs whose distribution conditions are different, write to the author to ask for permission. For software which is copyrighted by the Free Software Foundation, write to the Free Software Foundation; we sometimes make exceptions for this. Our decision will be guided by the two goals of preserving the free status of all derivatives of our free software and of promoting the sharing and reuse of software generally.

NO WARRANTY

11. BECAUSE THE PROGRAM IS LICENSED FREE OF CHARGE, THERE IS NO WARRANTY FOR THE PROGRAM, TO THE EXTENT PERMITTED BY APPLICABLE LAW. EXCEPT WHEN OTHERWISE STATED IN WRITING THE COPYRIGHT HOLDERS AND/OR OTHER PARTIES PROVIDE THE PROGRAM "AS IS" WITHOUT WARRANTY OF ANY KIND, EITHER EXPRESSED OR IMPLIED, INCLUDING, BUT NOT LIMITED TO, THE IMPLIED WARRANTIES OF MERCHANTABILITY AND FITNESS FOR A PARTICULAR PURPOSE. THE ENTIRE RISK AS TO THE QUALITY AND PERFORMANCE OF THE PROGRAM IS WITH YOU. SHOULD THE PROGRAM PROVE DEFECTIVE, YOU ASSUME THE COST OF ALL NECESSARY SERVICING, REPAIR OR CORRECTION.

12. IN NO EVENT UNLESS REQUIRED BY APPLICABLE LAW OR AGREED TO IN WRITING WILL ANY COPYRIGHT HOLDER, OR ANY OTHER PARTY WHO MAY MODIFY AND/OR REDISTRIBUTE THE PROGRAM AS PERMITTED ABOVE, BE LIABLE TO YOU FOR DAMAGES, INCLUDING ANY GENERAL, SPECIAL, INCIDENTAL OR CONSEQUENTIAL DAMAGES ARISING OUT OF THE USE OR INABILITY TO USE THE PROGRAM (INCLUDING BUT NOT LIMITED TO LOSS OF DATA OR DATA BEING RENDERED INACCURATE OR LOSSES SUSTAINED BY YOU OR THIRD PARTIES OR A FAILURE OF THE PROGRAM TO OPERATE WITH ANY OTHER PROGRAMS), EVEN IF SUCH HOLDER OR OTHER PARTY HAS BEEN ADVISED OF THE POSSIBILITY OF SUCH DAMAGES.

END OF TERMS AND CONDITIONS

## VI. Menu Structure

Main menu						
1st level	2nd level	3rd level	4nd level	5nd level		
Media player	Media Player					
Timer	Timer List					
Information	Service	Service info				
	About	About				
Plugins	Plugin browser					
Setup	Service Searching	Tuner Configuration	Tuner A,B,C			
		Default Service lists				
		Automatic Scan	Service scan Window			
		Manual Scan	Service scan Window			
			Language	Language Selection Window		
			Customize	Customize Window		
			Timezone	Timezone Window		
			Harddisk	Harddisk setup	Harddisk setup	
				Initialization	Initialization	
				Filesystem Check	Filesystem Check	
			A/V Settings	A/V Settings Window		
			Display Setup	Display Setup Window		
			Network	Network Configuration Window		
			Keyboard	Keyboard Setup Window		
	Skin					
	Common Interface					
	Parental control	Parental control setup				
Factory reset						
Standby / Restart	Sleep Timer					
	Standby					
	Restart					
	Deep Standby					

## VII. Troubleshooting

Before you contact your local service center, please read the following tips carefully.

**NOTE** : if the antenna is covered with snow or the RF signal is weakened by heavy rain, the quality of audio and video may become temporarily poor. If you experience poor audio and video quality due to bad weather conditions, please check if your satellite antenna is oriented in the original direction. And see if it is covered by snow. Also, check if your LNB is not damaged.

### 1. No video on TV

- Check first if the product is powered on and in operation mode.
- Check if the video cable is properly connected between TV and Vu+.
- Check if the satellite cable is properly connected to Vu+.
- Check if the selected channel is currently on air.
- Check if the selected channel is encrypted and if you have a corresponding access smartcard.

### 2. Problem with audio quality

- Check if your audio cable is connected correctly.
- Check the volume level of your TV and Vu+.
- Check if Vu+ or TV is on mute.
- Check the audio option if it is correctly selected for the program that you are currently watching.

### 3. Remote control problem

- Check if the batteries are correctly mounted.
- If your remote control has been used for long, change the batteries.
- Point the remote control directly toward Vu+.
- Make sure that nothing blocks the front panel display.

### 4. Channel search problem

- Make sure if tuner configurations are all correctly made.
- Check if the antenna cable(s) are properly connected.

### 5. Encrypted channel viewing problem

- Check if you have the appropriate Smartcard and/or CAM.
- Take the Smartcard and CAM out and re-insert them to re-initialize.
- Check if your system correctly detects the smartcard and CAM.

### 6. Recording problem

- Check if the HDD has a sufficient space for recording.
- Check if there is a conflict between recording timer.

### 7. Noise

- Vu+ has an integrated FAN. This may create a noise but is inevitable to make sure the safety of the product.
- Also, when HDD is running, you may hear a noise.



## VIII. Glossary

8PSK	8-PSK is usually the highest order PSK constellation deployed. With more than 8 phases, the error-rate becomes too high and there are better, though more complex, modulations available such as quadrature amplitude modulation (QAM). Although any number of phases may be used, the fact that the constellation must usually deal with binary data means that the number of symbols is usually a power of 2 — this allows an equal number of bits-per-symbol.
CAM	Conditional Access Module is an electronic device, usually incorporating a slot for a smart card, which equips an Integrated Digital Television or set-top box with the appropriate hardware facility to view conditional access content that has been encrypted using a conditional access system. They are normally used with direct broadcast satellite (DBS) services.
Composite Video	Composite video is the format of an analog television (picture only) signal before it is combined with a sound signal and modulated onto an RF carrier. Composite video is often designated by the CVBS acronym, meaning "Color, Video, Blank and Sync". In German (with PAL being a German invention by Telefunken's Walter Bruch) the abbreviation FBAS (Farbe-Bild-Austastung-Synchron) means the same. It is usually in standard formats such as NTSC, PAL, and SECAM. It is a composite of three source signals called Y, U and V (together referred to as YUV) with sync pulses. Y represents the brightness or luminance of the picture and includes synchronizing pulses, so that by itself it could be displayed as a monochrome picture. U and V represent hue and saturation or chrominance; between them they carry the color information. They are first modulated on two orthogonal phases of a color carrier signal to form a signal called the chrominance. Y and UV are then combined. Since Y is a baseband signal and UV has been mixed with a carrier, this addition is equivalent to frequency-division multiplexing.
Conditional Access System	Several companies provide competing Conditional Access Systems; Irdeto Access, Nagravision, Viaccess, Verimatrix and NDS are among the most commonly used CAS systems.
DiSEqC	Stands for Digital Satellite Equipment Control. It is a special communication protocol for use between a satellite receiver and a device such as a multi-dish switch or a small dish antenna rotor. DiSEqC was developed by European satellite provider Eutelsat, which now acts as the standards agency for the protocol.
Dolby Digital	Dolby Digital is the common version containing up to six discrete channels of sound. The most elaborate mode in common usage involves five channels for normal-range speakers (20 Hz – 20,000 Hz) (right front, center, left front, right rear and left rear) and one channel (20 Hz – 120 Hz allotted audio) for the subwoofer driven low-frequency effects. Mono and stereo modes are also supported. Dolby Digital supports audio sample-rates up to 48 kHz. * Dolby Digital * <b>DD</b> (an abbreviation for Dolby Digital, often combined with channel count; for instance, <b>DD</b> 2.0, <b>DD</b> 5.1)

EPG	Electronic Program Guide is a digital guide to scheduled broadcast television or radio programs, typically displayed on-screen with functions allowing a viewer to navigate, select, and discover content by time, title, channel, genre, etc. by use of their remote control, a keyboard, or other input devices such as a phone keypad. Content can also be scheduled for future recording by a personal video recorder (PVR). The on-screen information may be delivered by a dedicated channel or assembled by the receiving equipment from information sent by each program channel.
eSATA	A variant of SATA meant for external connectivity with the following characteristics: * Minimum transmit potential: Range is 500–600 mV. * Minimum receive potential: Range is 240–600 mV. * Identical protocol and logical signaling (link/transport-layer and above), allowing native SATA devices to be deployed in external enclosures with minimal modification.
FEC	Stands for Forward Error Correction. This is a system of error control for data transmission, whereby the sender adds redundant data to its messages, also known as an error-correction code. This allows the receiver to detect and correct errors (within some bound) without the need to ask the sender for additional data. The advantages of forward error correction are that a back-channel is not required and retransmission of data can often be avoided (at the cost of higher bandwidth requirements, on average).
HDMI	Stands for High-Definition Multimedia Interface. It is a compact audio/video interface for transmitting uncompressed digital data. HDMI connects digital audio/video sources—such as set-top boxes, Blu-ray Disc players, personal computers (PCs), video game consoles (such as the PlayStation 3 and some models of Xbox 360), and AV receivers—to compatible digital audio devices, computer monitors, and digital televisions. As an uncompressed connection, HDMI is independent of the various digital television standards used by individual devices, such as ATSC and DVB, as these are encapsulations of compressed MPEG video streams (which can be decoded and output as an uncompressed video stream on HDMI).
LNB	Stands for Low-Noise Block converter. This is the (receiving, or downlink) antenna of what is commonly called the parabolic satellite dish commonly used for satellite TV reception. The LNB is usually fixed on or in the satellite dish. The purpose of the LNB is to take a wide block (or band) of relatively high frequencies, amplify and convert them to similar signals carried at a much lower frequency (called intermediate frequency or IF). These lower frequencies travel through cables with much less attenuation of the signal, so there is much more signal left on the satellite receiver end of the cable. It is also much easier and cheaper to design electronic circuits to operate at these lower frequencies, rather than the very high frequencies of satellite transmission.
PID	Stands for Packet Identifier. This is a set of numbers identifying stream packets contained within a single data stream
Polarization	The orientation of the electrical and magnetic fields of a signal. Satellites use mainly vertical and horizontal polarization.

S/PDIF	Stands for Sony/Philips Digital Interconnect Format. A common use for the S/PDIF interface is to carry compressed digital audio as defined by the standard IEC 61937. This mode is used to connect the output of a DVD player to a home theater receiver that supports Dolby Digital or DTS surround sound. Another common use is to carry uncompressed digital audio from a CD player to a receiver. This specification also allows for the coupling of personal computer digital sound (if equipped) via optical or coax to Dolby Digital or DTS capable receivers.
SCART	A French-originated standard and associated 21-pin connector for connecting audio-visual (AV) equipment together. SCART is one of the most common method of connecting audio-visual equipment together. However, transferring analogue standard-definition content, SCART is becoming obsolete with the introduction of new digital standards such as HDMI, which can also carry high-definition content and multichannel audio.
Smartcard	A pocket-sized card with embedded Integrated Circuits which can process data. It can receive input which is processed and delivered as an output. The card may embed a hologram to avoid counterfeiting. It is used for accessing encrypted TV channels or services.
Teletext	A television information retrieval service developed in the United Kingdom in the early 1970s. It offers a range of text-based information, typically including national, international and sporting news, weather and TV schedules. Subtitle (or closed captioning) information is also transmitted in the teletext signal, typically on page 888 or 777.
Xcrypt	One of the Conditional Access Systems by Xcrypt.
YPbPr	<p>A color space used in video electronics, in particular in reference to component video cables. YPbPr is the analog version of the YCBCR color space; the two are numerically equivalent, but YPBPR is designed for use in analog systems whereas YCBCR is intended for digital video. YPbPr is commonly called "component video", but this is a misnomer, as there are many other types of component video (mostly RGB with sync either on green or one or two separate signals).</p> <p>YPbPr is converted from the RGB video signal, which is split into three components, Y, PB, and PR.</p> <ul style="list-style-type: none"> <li>* Y carries luma (brightness) and sync information.</li> <li>* PB carries the difference between blue and luma (B - Y).</li> <li>* PR carries the difference between red and luma (R - Y).</li> </ul> <p>Sending a green signal would be redundant, as it can be derived using the blue, red and luma information.</p>