WITH EFFECT FROM 12TH JANUARY, 2022

Electrification products price list (₹)



Electrification products

ABB is a global leader in power and automation technologies that enable utility and industry customers to improve performance while lowering environmental impact. ABB in India serves customers in process, manufacturing and consumer industries, utilities, the oil & gas sector and infrastructure markets through a wide manufacturing and marketing network.

ABB offers a full range of low-voltage and medium-voltage solutions to connect, protect, control and measure a wide range of electrical systems for all major industries, including the residential sector.

The business improves the reliability and efficiency of electrical installations through modular substation packages, distribution automation products, switchgear, circuit breakers, measuring and sensing devices, control products, wiring accessories, and enclosures and cabling

systems, including KNX systems designed to integrate and automate a building's lighting, ventilation, heating, security and data communication networks.

ABB's product range serves the diverse needs of customers, offering value-for-money and high levels of quality and reliability. These products are backed by the technological expertise of ABB's centres of excellence across the globe, each of which excel in a specific range of low voltage products.

ABB's electrification products offering in India are designed, manufactured and tested in-house in conformance with requirements of the ISO 9000 series. These products conform to the latest IEC standards, EN specifications, national standards such as IS, BS, VDE, etc., in addition to the "CE" mark.

Table of contents

Smart Power products

09	ABB's comprehensive range of breakers and switches
10-11	Introduction SACE Emax 2
12-13	Formula Air
14-15	SACE Tmax XT
16	ArTuK Born certified
17-19	ABB Ability™ Energy and Asset Manager
20-22	Architecture Truly plug & play
23-23	ABB FORMULA DSP P1-P4 - New
24	Tmax molded case circuit breakers
25-30	Tmax circuit breakers
31-34	Tmax power distribution circuit breakers - New
35	Tmax motor protection circuit breakers
36	Tmax motor distribution circuit breakers
37-38	Tmax motor protection circuit breakers
39-48	Tmax accessories
49-50	Tmax accessories kit
51	Tmax PV: Photovoltaic range molded case switch disconnectors
52-54	FORMULA DSA Molded case circuit breaker
55	Switches
56	Optimized two-poles 1500V DC switch disconnectors
57	DC switch disconnectors for PV application
58	ONE20
59-60	Fusegear
61	Vertical Fuse Switch Disconnectors
62	OFAF HRC fuse links and base, DIN-type
63	OFF HRC fuse links and base, BS-type
64	OESA/OS switch disconnector fuse, DIN-type
65	OESA/OS switch disconnector fuse, BS-type
66	Accessories for OESA/OS switch disconnector fuse, 32..800 A
67-68	OT switch disconnectors
69	OT switch disconnector accessories
70	Enclosed switches
71	Zenith Auto Transfer Switch
72	The world's first true ATS is here Introducing TruONE.
73	Automatic transfer switches - IEC
74	Enclosed automatic transfer switches - IEC
75	Compact ATS

76	OT automatic transfer switches
77	OT manual changeover switches
78	OT motorized changeover switches
79	Kabeldon low voltage switchgear system
80	ABB's comprehensive range of LV control products
81	Motor starting and protection
82	Enhanced solutions
83	Advanced solutions
84	Complete solutions for control panels
85	Auxiliary contactors
86	3 pole contactors: AX09...AX370 : AC operated
87	3 pole contactors: AC operated
88	4 pole contactors: AC operated
89	3 pole contactors AL and TAL range: DC operated
90	Contactors for special application-capacitors switching
91	Contactors for DC circuit switching: AC/DC operated
92-93	Accessories for contactors
94	Contactors: Wide band AC/DC operated
95	Novolink™ – smart function and sensor modules for AF contactors - New
96	Digitalize one of the best motor starting portfolios on the market
97	3 pole contactors AF range: Wide band AC/DC operated
98	4 pole contactors: Wide band AC/DC operated
99	Accessories for AF contactors
100	AFC contactors for AC control applications - New
101	AFC contactors: AC operated
102	Accessories for AF contactors
103	Powerful light switching made easy
104-106	ESB and EN Installation contactors
107	Mini contactors
108	Spares for contactors
109	DOL and star delta starters
110-114	Manual motor starter
115-117	Thermal overload relays
118	Electronic overload relays class 10, 20, 30
119	Just push it
120	Push-in Spring motor starting solution
121	Softstarters - New
122	Softstarters selection - New

Table of contents

123	Softstarters - New
124-125	Softstarters
126	AFS contactors with front-mounted auxiliary contact blocks
127	M mini contactors and contactor relays
128	M Mini contactors with screw connection
129	M Mini contactor relay - New
130	Electronic compact starters: HF range
131-143	Pilot devices
144	Signal tower and beacons
145-146	Signal towers
147	Electronic products and relays
148	Time relays
149	CT-C Range
150	ABB CT-C Product Portfolio
151-154	Electronic products and relays
155	Electronic products and relays Power supplies
156-157	Smart temperature monitoring relay - New
158-159	Intelligent motor management system - UMC100.3
160	Fieldbus interfaces
161	Ethernet interfaces
162	Adapter and accessories
163	Earth fault monitors, current transformers
164	Arc flash protection and mitigation solutions
165	Arc Guard System TVOC-2
166-167	Production-friendly safety systems
168-175	ABB jokab safety
176	We Develop Solutions To Move E-Mobility Forward
177	We develop solutions to move you
178	Enabling your charging operation
179	Public and commercial car charging - Use cases
180	Terra AC wallbox
181	Terra AC wallbox benefits
182	Terra DC wallbox
183	Terra AC wallbox benefits
184	Terra 54 DC Fast Charger
185	Fast charging beyond 50 kW
186	Ordering codes
187-188	ABB Heavy Commercial Vehicle charging
189	Pantograph up
191	Uninterruptible power supply systems
192-195	UPS product overview 1 kVA to 5 MVA

Smart Building products

196-199	Introduction - Electrical installation solutions for buildings
200	Miniature Circuit Breaker SB200 M
201	Miniature Circuit Breaker SB200 M - B characteristic
202-204	Miniature Circuit Breaker SB200 M - C characteristic
205-206	Miniature Circuit Breaker SB200 M - D characteristic
207-208	Miniature Circuit Breaker SB200 DC
209-210	Miniature Circuit Breaker SB200 M - C characteristic
211	Miniature Circuit Breaker (MCB) S200 series - 80, 100A
212	High performance MCB S800 series 80 to 125A
213-215	Switch Disconnecter SDB200
216-217	Residual Current Circuit Breaker FB200
218-219	RCCB FB200 and F200 higher rating
220	Residual current circuit breaker with overcurrent protection RCBO - DS200M series
221	Residual current circuit breaker with overcurrent protection RCD blocks - DDA200 + S200 M series (RCBO combinations)
222	Miniature circuit breaker (MCB) S200M series
223	S200M - MCBs, C characteristics - 10 kA
224	S200M - MCBs, D characteristics - 10 kA
225	Solution for unwanted tripping - AP-R type (high immunity) RCCB / RCBO
226	RCCB - F200 series: AP-R (high immunity)
227-230	System pro M
231	Accessories
232-234	Auxiliary elements
235	Accessories Rotary operating mechanism for SB200 M
236-237	Auxiliary elements
238-239	Wiring diagram
240-241	Overall dimensions
242	Surge protection devices - The new OVR QuickSafe®
243	Surge protection devices (OVR)
244-245	DBT Timer digital time switches
246-247	SMISLINE TP plug-in system
248	ELR, Earth leakage relay - (DIN & front panel mountable)
249-265	Measurement devices
266-275	ABB ITUS Enclosures
276-282	Elegance series Enclosures
283-288	Classic series Enclosures
289	Mistral IP 65 enclosures
290	Gemini switchboard
291-292	Wiring Accessories - Millenium
293-295	Wiring Accessories - Zenit
296-309	Wiring Accessories - IVIE
310-314	Wiring Accessories - ABB Tvisha
315-316	Wiring Accessories - Snio
317-319	Busch-Presence detectors
320	Emergency lighting systems
321-324	Industrial plugs and sockets

Table of contents

Installation products

325	Installation products
326	Flexible conduit system
327-329	External lightning protection

Protection and Automation Relays

330	Section I: Auxiliary relays, tripping relays and timers
331-332	Section II: Electro-mechanical high speed tripping relays, bi-stable relays and static relays
333	Section III: Numerical protection and control relays
334	Section IV: Grid automation, FBT, arc protection, load shedding, engineering tools and miscellaneous items
335-338	Type 2 co-ordination
339	ABB low voltage air circuit breakers
340	Introduction
341	Service portfolio
342-344	Materials
345	Electrification India eMart
346-347	Offerings from eMart
348-349	General conditions of sale

ABB's comprehensive range of breakers and switches

The range of ABB breakers and switches ranks amongst the most extensive on the market with a full range of innovative solutions for various applications, helping to optimise resources, reduce energy costs, boost productivity.

- Air circuit breakers
- Molded case circuit breakers
- HRC fuse & fuse base
- Switch disconnecter fuse
- Switch disconnectors
- Changeover switches - manual & motorized
- Auto transfer switches
- Cam switches
- Cable distribution cabinet - Kabeldon
- Fuse gear - easyline and inline (Fuse switch disconnecter)
- Switch disconnecter for DC and photovoltaic application
- MCCB for DC and photovoltaic application



Introduction SACE Emax 2

The all-in-one innovation



—

The world of electrical power distribution changes fast and major new trends such as renewables, energy storage and microgrids are now crowding onto the stage. These trends lead to new customer and application demands.

To meet these demands, ABB has now unveiled the innovative Emax 2 all-in-one, the evolution of the Emax 2 into a multifunctional platform that is able to manage the next generation of electrical distribution systems such as microgrids.

Emax 2 all-in-one is the first circuit breaker that meets new grid requirements. It enables

a direct communication to the new energy management cloud-computing platform ABB Ability™ Electrical Distribution Control System.

Smart plug and play architecture makes Emax 2 all-in-one easy to use. Leveraging also unmatched electrical performances, Emax 2 sets a new circuit breaker benchmark for the needs of today and tomorrow.

SACE Emax 2, the all-in-one solution to manage "low-voltage distribution systems".

Efficiency and control

The power needed, when needed

Efficiency

Achieving maximum efficiency of an electrical installation requires intelligent management of power supplies and energy use. For this reason, the new technologies used in the SACE Emax 2 circuit breakers allow the productivity and reliability of installations to be optimized, and at the same time, power consumption to be reduced while fully respecting the environment.

New advanced functionalities, together with Protection trip units, Communication and system devices contribute to make SACE Emax 2 the circuit breaker that maximizes efficiency in all low-voltage electrical installation.

Control

SACE Emax 2 circuit breaker is the first single device ready to manage all the dynamics of a low-voltage electrical installation.

Managing loads in any condition is now possible thanks to Advanced Functionalities such as:

- **Adaptive load shedding.**
Fast load shedding to guarantee continuity for critical loads during black-outs. Typical scenario is when LV distribution is disconnected from the grid (MV).
- **Predictive load shedding.**
Slow load shedding to avoid overloads, giving the possibility to modulate loads consumption.

- **Power controller.**

Patented algorithm to reduce the peak of power consumed, allowing savings on electricity bills. Managing different power sources and connecting them to main grid is also crucial, so that service continuity is maximized.

- **Embedded ATS functions.**

An automatic transfer switch system used in all application where continuity is essential and where there are multi source supplies.

- **Synchro-reclosing.**

Synchronization and automatic reconnection of the Microgrid to the main grid when the power is back. Emax 2 is able to act as a controller of Main grid condition, disconnecting a plant when necessary and also to adapt protection to on-grid or off-grid conditions.

- **Interface protection system and Interface Device.**

Check of grid-connected operation that shall be immediately and automatically interrupted in case of outage of the distribution grid or when the voltage and frequency values of the grid itself are out of the range of values defined by the Distribution System Operator (DSO).

- **Adaptive protection.**

Network changes recognition and automatic set of thresholds to guarantee protection and coordination in on-grid and off-grid conditions.

FORMULA AIR

Simplicity and safety, up to 50kA



Formula Air NEW

Simplicity and safety, up to 50kA

Formula Air is an ideal solution for main installation requirements, from distribution switchboards to onboard compartments. This comprehensive range offers the most suitable solution for each specific set of requirements. Easy to use Formula Air products are also easy to order.

The automatic circuit-breakers and switch disconnectors are available three sizes from 800A to 4000A, with short-circuit performance levels up to 50kA.

The installation of Formula Air and its accessories is simple, quick and safe. The accessories, pre-cabled and common to all the three frames, allow for rapid mounting and a significant reduction in warehouse stock.

The innovative design guarantees flexibility in the installation of the circuit-breaker and permits last-minute changes.

It is actually possible to change, on site, the orientation of the rear terminals from horizontal to vertical or vice versa. If you need a switchboard with more compact dimensions, front terminals are available for breakers up to 1600A in fixed version.

With High Mechanical and electrical life Formula Air circuit breakers offer high longevity to the installation



Ratings available

Frame	630A	800A	1000A	1250A	1600A	2000A	2500A	3200A	4000A
FA1	•	•	•	•	•				
FA2					•	•			
FA4							•	•	•

Flexibility:

Rear power terminals can be rotated between horizontal and vertical position, easily on site. In alternative, the range offers front and spread terminals for different panel solutions

Intuitive interfaces:

Clear icons on a wide LCD screen or LEDs indicating the circuit-breaker status, saving time to on site setting up and maintain

Standardization:

All frames have common trip unit, and most common mechanical and electrical accessories, enabling stock reduction

Fast accessorizing:

Plug-in installation, allowing up to 30% time saving

Protection releases

Parameters	EK1 - LI	EK1 - LSIG	EK2 - LSIG
Overload (L - ANSI 49)	•	•	•
Time-delayed overcurrent (S - ANSI 51 & 50TD)		•	•
Instantaneous overcurrent (I - ANSI 50)	•	•	•
Earth Fault (G - ANSI 51N & 50NTD)		•	•
Neutral Protection	•	•	•
Switchable Thermal Memory	•	•	•
Graphical display with Current metering			•
Closing on short-circuit (MCR)			•
Start-up function			•
Instantaneous Earth Fault (G-ANSI 50N)			•
20 Trip history & 100 Events			•
Download breaker maintenance data from ACB	•	•	•

MOLDED CASE CIRCUIT-BREAKERS

SACE Tmax XT

Break new ground



SACE Tmax XT overview

Break new ground

Break new ground simply means delivering value through the entire customer journey by leaving behind the traditional concept of circuit-breaker. The SACE Tmax XT range offers a unique customer experience that, sharing the same features and logics with the Emax 2 range, for the first time ever overcomes the differences between molded case and air circuit-breakers. The most advanced products designed to maximize data and connectivity, ease of use and installation, performance and protection, safety and reliability.

The SACE Tmax XT range offers higher performance, better protection and more precise metering than equivalent units, and can handle from 160 up to 1600A.

Combined with the world's most precise electronic trip units in the smallest frames, the new range delivers significant time savings and enhances installation quality.

Reliability is further increased, and speed of installation reduced, thanks to Bluetooth and Ekip connectivity for mobile devices.

The SACE Tmax XT family's built-in connectivity links smartphones, tablets and PCs to data analysis tools on the ABB Ability™ cloud platform in real time. The extreme precision of the data measured means users have access to accurate information anywhere and anytime, making it easier to monitor resources and identify savings opportunities.

Using the embedded smart power controller can help reduce energy consumption by up to 20 percent. Upgrading the breakers is straightforward: for the first time, customers can download new functions from the ABB Ability Marketplace™, choosing from among more than 50 different protection, metering and automation functionalities.



Distinctive features

Data and connectivity

Plant management of the future – SACE Tmax XT sets standards in modern plant and energy management. Access, monitor and control information remotely, anywhere, at any time. Improving efficiency and saving energy. The SACE Tmax XT is the first molded case circuit-breaker to become an active element inside the electrical plant without using external accessories.

Local connection and Remote communication

Commissioning and device setting have never been so easy thanks to the Bluetooth connectivity and the Ekip Connect software. All the data of the electrical plant are accessible and the interaction with the breakers from remote is straightforward thanks to the several communication protocols available.

Cloud connectivity

Cloud connection is now possible to exploit the full service of ABB Ability™ Energy and Asset Management thanks to the Ekip Com HUB.

Ease of use and installation

Maximum flexibility for every application – SACE Tmax XT sets standards for electrical installations. Easy selection, one-fits-all accessories and intuitive design pave the way for fast upgrades and create values through the entire customer journey. Even for the most critical projects.



Performance and protection

Continuity of service and equipment protection – SACE Tmax XT sets standards when extreme breaking capacity is needed. Sharing the same logics, interfaces and features regardless of operating voltage environmental conditions. Embedding the most advanced protections into the smallest of frames.

Electrical performances

SACE Tmax XT is designed and tested to meet any installation requirement, even the most critical ones.

Metering

SACE Tmax XT provides all the tools needed to set up a competent and effective energy management strategy thanks to the trip units able to measure electrical parameters with 1% accuracy certification.

Protections and logics

SACE Tmax XT integrates extra functionalities into the size of a standard molded case circuit-breaker. The most advanced protection functions and logics are available thanks to its cutting-edge trip units.

Safety and reliability

Absolute attention to detail, with style from design to manufacturing SACE Tmax XT sets standards for edge technologies. Half a century of research and experience means top-level products that are ready to face future challenges.



ArTuK Born certified

Fully checked and certified (IEC 60439-1 and IEC 61439-1 and 2 Standard) by an external independent organisation (Acea Lovag, CPRI & ERDA), the ArTu switchgear is a synonym of safety and quality. The certification is the fruit of severe tests carried out on the whole configuration, consisting of metalwork structures, circuit-breakers and busbar system.

The ArTu K series switchgear is ideal for primary distribution board, motor control center, power control center etc. upto 6300A with air and molded-case circuit-breakers and any internal segregations up to Form 4, and for floor-mounted secondary distribution switchgear with molded-case and modular circuit-breakers. The switchgear has been tested for Internal Arc (as per IEC 61641) and Seismic (as per IEC 60068).

Smart Low Voltage switchboard

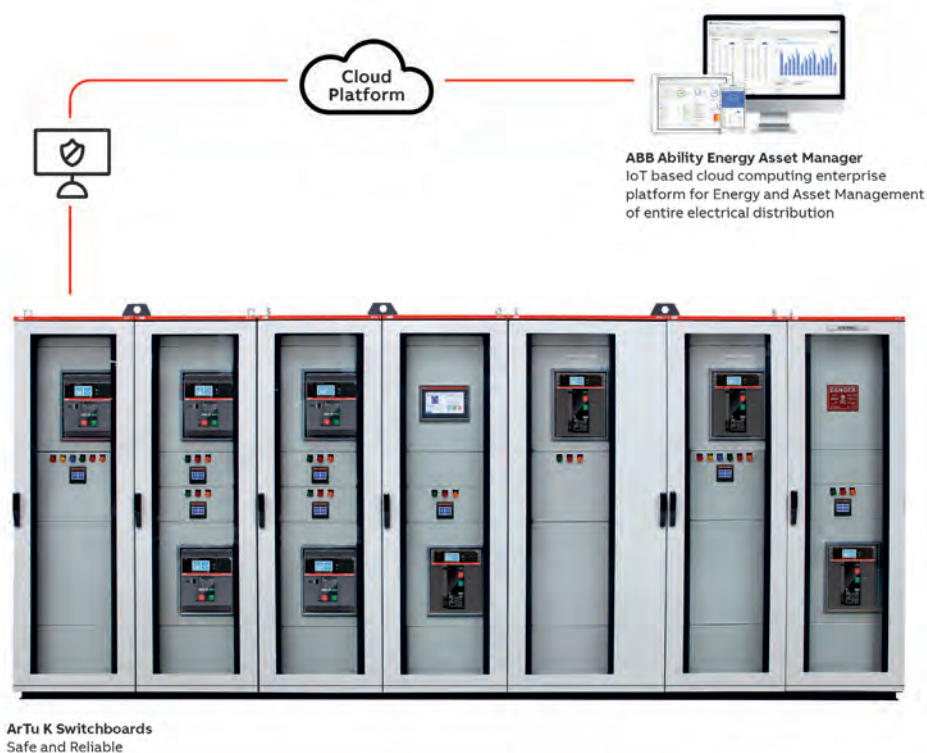

The ArTu switchgear is noted for the following features:

- Integrated range of modular metalwork structures up to 6300 A with common accessories.
- Possibility of fulfilling all application requirements in terms of installation (floorstanding, modular and corner versions) and degree of protection (IP31, IP41, IP 42, IP54 & IP65).
- Maximum integration with modular apparatus and the molded-case and air circuit-breakers, so that additional drilling or adaptations are not required.
- Minimum switchgear assembly time, thanks to the simplicity of the kits, standardization of the small assembly items, self-supporting elements and the presence of clear reference points for assembly of the plates and panels – Segregations in kits up to Form 4.

The use and installation of the kits according to the instructions provided means that assembly and cabling times can be reduced to a minimum, for example, thanks to the reference points for positioning the panels and plates, and that respect of the insulation distances and the rated characteristics of the circuit-breakers are guaranteed.

—

ABB Ability™

Energy and Asset Manager

Understanding power and assets



ABB Ability™ Energy and Asset Manager

Understanding power and assets

ABB Ability™ Energy and Asset Manager is a state-of-the-art cloud solution that integrates energy and asset management in a single intuitive dashboard. Providing full remote visibility of asset and electrical-system behavior, ABB Ability™ Energy and Asset Manager provides insights that help you minimize cost and risk and maximize performance and safety across your operations. Want to get started now? Testing and purchasing Energy and Asset Manager is easy on the ABB Ability Marketplace™.

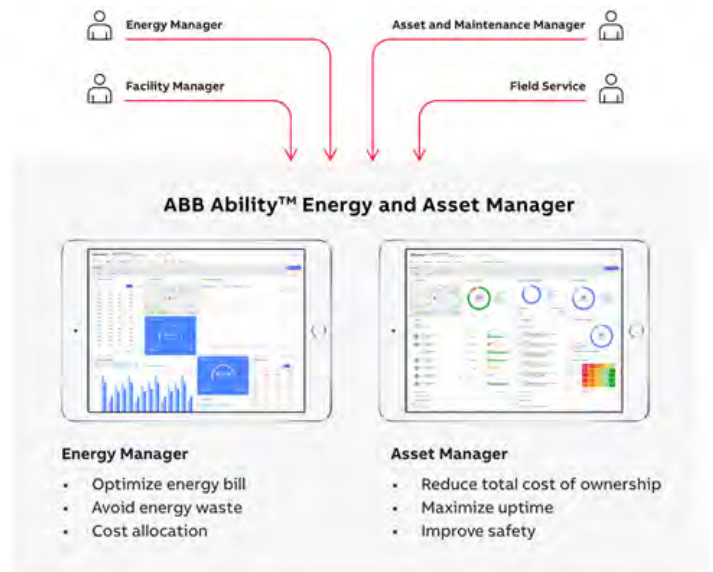

Energy and Asset management made easy

The energy and asset management modules can be purchased separately or together, depending on your needs. Monitoring can also be segmented down to individual pieces of equipment and/or sub-systems-such as an elevator, a single HVAC system, or a production line.



ABB Ability™ Energy Manager

Energy efficiency has become essential to running cost-efficient operations. ABB Ability™ Energy Manager provides real-time understanding of your energy consumption and identifies areas of improvement. And it's scalable, from a single site to a multi-facility system with hundreds of users.

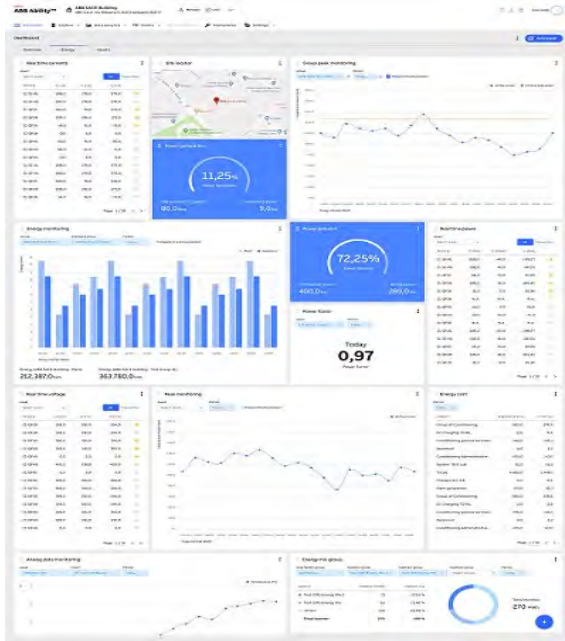

Monitor

Discover Site performance, supervise the electrical system and allocate costs.



Analyze

Schedule automatic data exports, improve the use of assets and take the right business decision.



Act

Set up alerts and notify to key personnel and remotely implement an effective efficiency strategy to achieve energy savings in a simple way.

ABB Ability™ Asset Manager



ABB Ability™ Asset Manager sets a new benchmark for simplicity and flexibility in asset-performance management. It gives you the power of seeing and optimizing your site equipment behavior anytime, anywhere via an intuitive graphic interface, resulting in greater reliability and availability and minimized unplanned maintenance.



Condition Monitoring

ABB Ability™ Asset Manager provides granular visibility of your asset behavior in real time for both LV and MV environments

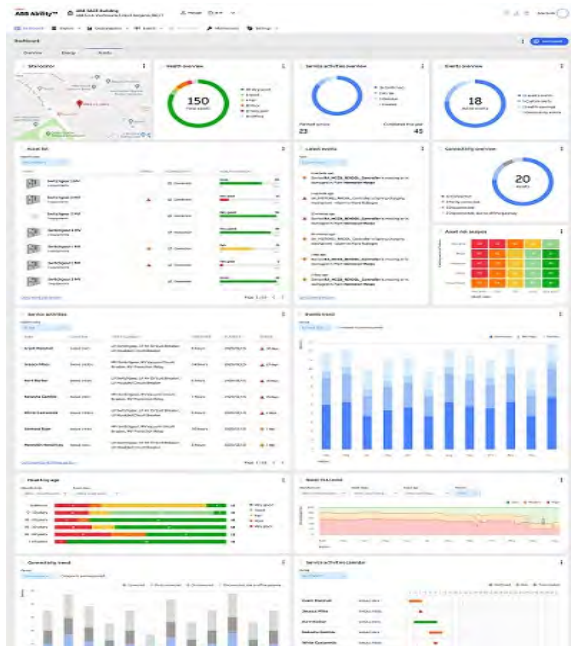

Predictive Analytics

Detect potential faults through condition assessment, performance trends and pre-alarm notifications.



Maintenance Planning

Root-cause analysis of asset condition enables predictive maintenance that significantly reduces unplanned downtime and operational costs.

Lite panel

One digital panel fits all



Lite Panel is the new switchboard HMI able to monitor and control until 28 electrical assets at the same time, directly connected in the on-premise communication network, showing their data as digital twins through predefined templates.

Value proposition



Safety

Monitoring and control the electrical assets, also with fault detections and diagnostics data check, far from the switchboard power sections reduce the risk of serious incidents.



Energy efficiency

Supervision of assets status, energy and power quality from a unique panel improves the data collection efficiency with less 70% of time spent nearby electrical rooms and enables analytics to plan saving actions.



Easy to install

The plug & play panel architecture saves more than 4 times the components and wirings compared to traditional market benchmarks.



Optimum interface

Until 28 digital-twin devices are available from a single interface within the local secure network, so leveraging on the already present communication tag points.

Architecture

Truly plug & play

Embedded solution with Ekip Com Hub
 Emax 2, Ekip UP and TruONE equipped with the new Ekip Com Hub establishes the cloud connection for the whole switchboard.

This dedicated cartridge-type communication module just needs to be inserted into the terminal box and connected to the internet.

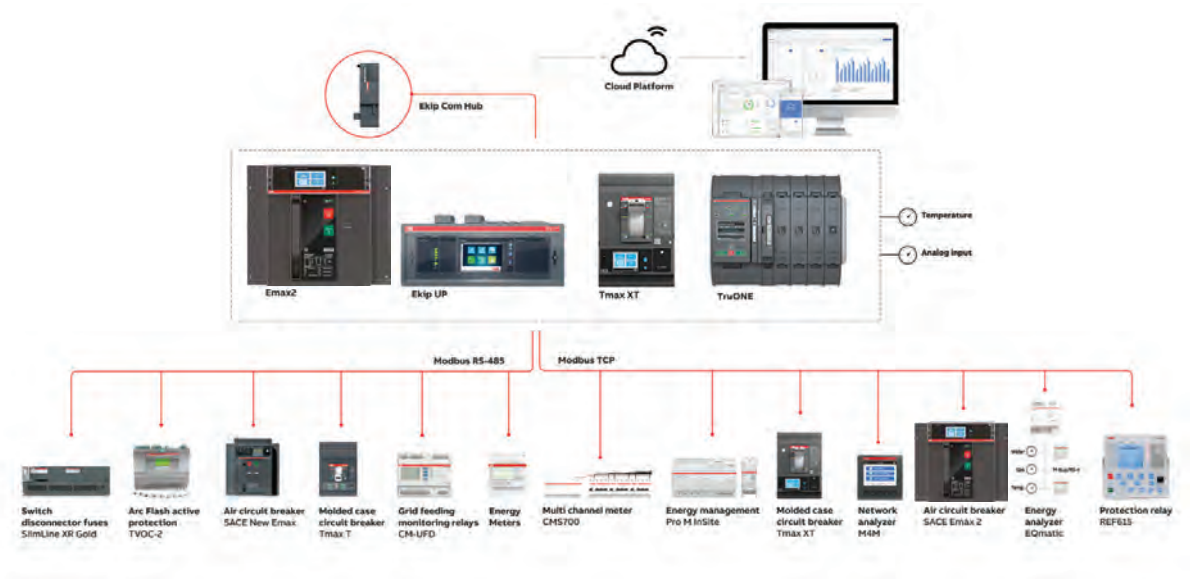

External solution with ABB Ability™ Edge Industrial gateway
 The ABB Ability™ Edge Industrial gateway module can be mounted on DIN rail to collect data throughout the system. You can also connect sensors to measure environmental parameters (temperature, water, gas) via both

analog and digital I/O. ABB Ability™ Edge Industrial gateway has enhanced connectivity functionalities, providing Wi-Fi or 3G/4G connectivity.



ABB showcases a further evolution in the low-voltage distribution business, establishing a new benchmark in terms of simplicity and performance.

ABB Ability™ Energy and Asset Manager enables the collection of relevant information from the ABB devices installed in the low-voltage power distribution system.

These devices can be connected to the cloud-computing platform to share data with Emax 2 (equipped with Ekip Com Hub) or with ABB Ability™ Edge Industrial gateway via Modbus RS-485, Modbus TCP and Ekip Link.

		INFORMATION									COMMUNICATION	
Family	Device	State	Current	Voltages	Power	Energy	Power factor	Power quality	Maintenance & Diagnostics	Load management	Analog or pulse/digital inputs	Protocol
Low voltage MCCB	Tmax XT	•	•	•	•	•	•	•	•	•	•	Modbus RS485, Modbus TCP, Ekip Com Hub
	Tmax T	•	•	•	•	•	•	•	•	•	•	Modbus RS485
Low voltage ACB	New Emax	•	•	•	•	•	•	•	•	•	•	Modbus RS485
	Emax 2	•	•	•	•	•	•	•	•	•	•	Modbus RS485, Modbus TCP, Ekip Com Hub
Digital units	Ekip UP	•	•	•	•	•	•	•	•	•	•	Modbus RS485, Modbus TCP, Ekip Com Hub
Low voltage switches and fusegear	TruONE ATS	•	•	•	•	•	•	•	•	•	•	Modbus RS485, Modbus TCP, Ekip Com Hub
	Slimline XR ITS 2.1	•	•	•	•	•	•	•	•	•	•	Modbus RS485
Digital inputs interface	Ekip signalling MODBUS TCP	•									•	Modbus TCP
Sub-Metering	EQ meters		•	•	•	•	•	•				Modbus RS485
Power meters	M4M		•	•	•	•	•	•				Modbus RS485, Modbus TCP
Energy management	System pro M compact® InSite	•	•	•	•	•	•	•		•	•	Modbus RS485, Modbus TCP
MV relays	615 Series	•	•	•	•	•	•	•	•	•	•	Modbus TCP
MV condition monitoring	SWICOM								•			Modbus TCP
And many others to come...		*Provided with dedicated accessories for communication and metering functions ** Only with ABB Ability Edge Industrial gateway										

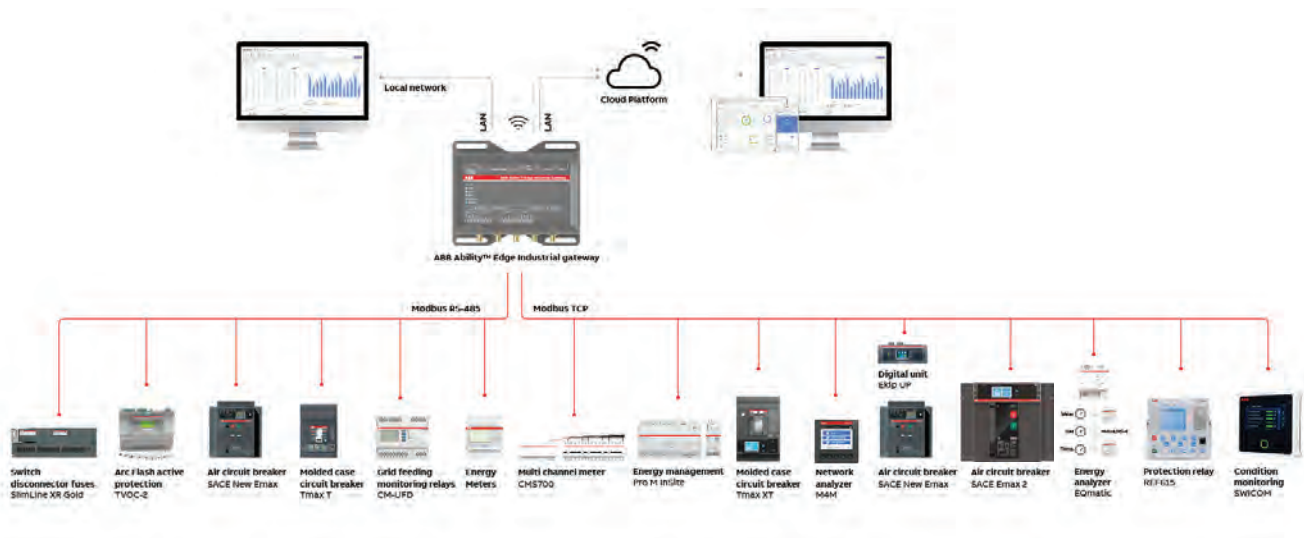
—
ABB Ability™ Electrical Distribution Control System brings advantages to customers from the design to the operations stage.

The digital solution adds value to facilities, meeting customer demands and enabling them to comply with higher energy efficiency standards.

Real time analysis of valuable data from field devices enables customers to closely monitor the performance of multiple installations with a single supervision system.

Clear information about consumption and improvement opportunities makes cutting waste and improving energy efficiency simple. Customers also benefit from lower energy bills and reductions in unplanned downtime.

ABB's "plug and play" devices make installation quick and easy. Customers can make existing installations smart with no need to replace components. New and retrofitted solutions are up and running in no time, immediately starting to collect data.



Speed up your projects

- Increase the facility's value by 5%
- Reduce investment in supervision systems by 15%
- Achieve compliance or higher class of energy efficiency standards
- Faster payback



Easy to install

- Connect to the cloud in only 10 minutes
- Reduce cabling by 60% and connectivity components by 25%
- Upgrade in 1 day the existing installation
- Upgrade with zero component replacement and existing installation



Energy efficiency

- Save up to 20% on maintenance costs
- Save up to 20% on energy bill
- Get proactive alerts and guarantee operations in 1 minute
- Remove energy inefficiency by up to 10%



—
Global website for
ABB Ability™ EDCS

ABB FORMULA DSP P1-P4

Performance made simple

NEW



The new SACE FORMULA DSP family consists of four frames (P1, P2, P3 and P4) reaching up to 160A, 250A, 630A and 800A respectively. The four frames are available with thermal-magnetic trip units to cover the most common AC and DC fields. Availability of most requested accessories guarantees the possibility to fulfil the main applications needs.



Easy to install

Click-in fixing for accessories to guarantee time saving and fast installations.



Simplified selection

Availability of a short list of codes enables simplified product selection and easy ordering.



Quality

ABB long experience in molded-case circuit breakers design is a guarantee of quality.



Sustainability

Compliance with the international regulations of Product Materials and Environmental Health and Safety.



- Compliance to IEC 60947-2 standards
- Offering from 40A to 800A in 4 frame sizes
- Available upto 50kA performance levels (Icu = Ics)
- Circuit breakers for AC and DC applications
- Double insulation
- Isolation behaviour
- Positive operation
- Accessories covering the main standard applications and needs

Power distribution protection

Field of application	Trip Unit	L – Overload Protection								I – Short-circuit Protection			
		Current Threshold				Trip Time				Current Threshold		Trip Time	
Power Distribution Protection	TMD	Adjustable				Fixed				Fixed		Fixed instantaneous	
	TMA	Adjustable				Fixed				Adjustable		Fixed instantaneous	
	In [A]	40	63	80	100	125	160	200	250	320	400	630	800
TMD	P1	•	•	•	•	•	•						
	P2							•	•				
TMA	P3									•	•	•	
	P4												•

Tmax molded case circuit breakers

Tmax molded-case circuit-breakers guarantee an extremely high performance level while being progressively smaller in size, simple to install and able to provide increasingly better safety guarantees for the operator. In addition to being ideal for the secondary distribution of alternate and direct current, they feature dedicated solutions for all application requirements.

Molded-case circuit-breakers can be used in low voltage civil and industrial installations with 1 to 3200 A operating current. The Tmax family includes 9 circuit-breaker sizes in three- or four-pole versions:

- XT1, XT2, XT3 and XT4 up to 250A;
- T4, T5 and T6 up to 1000A;
- XT5, XT6, XT7 / XT7M upto 1600A
- T7 and T8 up to 3200A.

The ultimate short-circuit breaking capacity (Icu) at 415V ranges from 18kA to 200kA, or up to 100kA for 690V. The following ranges are available:

- Circuit-breakers for AC and DC power distribution;
- Circuit-breakers for zone selectivity;
- Circuit-breakers for motor protection;
- Circuit-breakers for application up to 1150V AC and 1500V DC;
- Switch-disconnectors.

Tmax circuit-breakers can be equipped with thermomagnetic, magnetic only or electronic trip units; all of which are interchangeable. Since assembly instructions are simple, trip units can quickly and easily be replaced; even in the field. All this makes the circuit-breakers very easy to operate with considerable savings due to rationalized stock management.

All Tmax circuit breakers can be enhanced with a vast range of standardized accessories. This convenience not only cuts down on inventory, but creates an extremely flexible and easily managed solution.



XT5, XT6, XT7 / XT7M upto 1600A



Tmax circuit breakers

Type	Iu (40° C) [A]	Ue [V]		Category	Release	Icu (380 - 415 V AC) [kA]											
		AC	DC			16	25	36	50	70	85	100	120	150	200		
XT1	160	690	500	A	TMD/TMF MF/MA	B	C	N	S	H							
XT2	160	690	500	A	TMD/TMA MF/MA Ekip LS/I Ekip I Ekip LSI Ekip LIG Ekip LSIG Ekip M-I Ekip M-LIU Ekip M-LRIU Ekip N-LS/I			N	S	H			L		V		
XT3	250	690	500	A	MF/MA TMD TMG			N	S								
XT4	250	690	500	A	TMD/TMA MF/MA Ekip LS/I Ekip I Ekip LSI Ekip LIG Ekip LSIG Ekip E-LSIG Ekip M-LIU Ekip M-LRIU Ekip G-LS/I Ekip N-LS/I			N	S	H			L		V		
T5	400 630	690 1150	750 1000	B (400 A) A (630 A)	TMA (500 A) TMG (500 A) PR221DS PR222DS Ekip M			N	S	H			L		V		
T6	630 800 1000	690 1150	750 1000	B (630A - 800 A) A (1000 A)	TMA (800 A) PR221DS PR222DS Ekip M			N	S	H			L		V		
T7	800 1000 1250 1600	690		B	PR231/P PR232/P PR331/P PR332/P				S	H			L		V		

Trip Units

Thermal magnetic trip units

- MA - Magnetic only trip unit with adjustable magnetic thresholds for motor protection
- TMF - Fixed thermal and fixed magnetic for power distribution
- TMD - Adjustable thermal (70-100% of In) and fixed magnetic (10 x In) for power distribution
- TMA - Adjustable thermal (70-100% of In) and adjustable magnetic (5-10 of In) for power distribution
- TMG - Adjustable thermal (70-100% of In) and low fixed magnetic (3 x In) for generator protection

Microprocessor based electronic trip units

Ekip LS/I or Ekip LSI	L = 0.40 - 1 of In	Ekip LIG	L = 0.40 - 1 of In	Ekip LSI or Ekip E-LSIG	L = 0.4 - 1 of In	Ekip M-LIU	L = 0.4 - 1 of In	Ekip M-LRIU	L = 0.4 - 1 of In
	S = 1 - 10 of In		I = 1 - 10 of In		S = 0.6 - 10 of In		I = 6 - 13 of In		R = 3 - 9 of In
	I = 1 - 10 of In		G = 0.2 - 1 of In		I = 1.5 - 12 of In		U* = ON or OFF		I = 6 - 13 of In
		New			G = 0.2 - 1 of In				G = 0.2 - 1 of In
									U* = ON or OFF
PR221	L = 0.40 - 1 of In	PR222	L = 0.4 - 1 of In	PR231	L = 0.4 - 1 of In	PR331	L = 0.4 - 1 of In	PR331	L = 0.4 - 1 of In
	S = 1 - 10 of In		S = 0.6 - 10 of In		S = 1 - 10 of In		S = 0.6 - 10 of In		
	I = 1 - 10 of In		I = 1.5 - 12 of In		I = 1 - 12 of In		I = 1.5 - 15 of In		
			G = 0.2 - 1 of In						G = 0.2 - 1 of In

L = Overload S = Short circuit I = Instantaneous short circuit G = Earth fault

U = phase loss (U): With selector in ON position, circuit breaker trips if at least one current phase is lower than 0.1xIn and at least a second one higher than 0.25xIn;

Ekip N-LS/I: Neutral can be set in the OFF or ON positions, at 100% or at 160% of the phases;

Ekip G-LS/I: Neutral, in four-pole circuit-breakers, can be set in the OFF, ON positions at 50% or 100% of the phases;

Note: For detailed information about trip units, refer technical catalogue.

Tmax power distribution circuit breakers

XT1



Breaking capacity at 415VAC

	Icu	Ics (Icu)
B	18kA	100%
C	25kA	100%
N	36kA	100%

TMD			B		C		N	
Frame	In (A)	Poles	Ordering code	L.P.(₹)	Ordering code	L.P.(₹)	Ordering code	L.P.(₹)
XT1 160	16	3	1SDA066799R1	8,530	1SDA080825R1 *	9,310	1SDA080827R1 *	12,280
	20		1SDA066800R1		1SDA080826R1 *		1SDA080828R1 *	
	25		1SDA066801R1		1SDA067391R1		1SDA080829R1	
	32		1SDA066802R1		1SDA067392R1		1SDA067411R1	
	40		1SDA066803R1 ■		1SDA067393R1 ■		1SDA067412R1 ■	
	50		1SDA066804R1 ■		1SDA067394R1 ■		1SDA067413R1 ■	
	63		1SDA066805R1 ■		1SDA067395R1 ■		1SDA067414R1 ■	
	80		1SDA066806R1 ■		1SDA067396R1 ■		1SDA067415R1 ■	
	100	1SDA066807R1 ■	1SDA067397R1 ■	1SDA067416R1 ■				
	125	1SDA066808R1 ■	1SDA067398R1 ■	1SDA067417R1 ■	14,370			
	160	1SDA066809R1 ■	13,640	1SDA067399R1 ■	17,870	1SDA067418R1 ■	18,690	
	16	4	1SDA066810R1	11,870	1SDA080840R1 *	13,360	1SDA080842R1 *	15,710
	20		1SDA066811R1		1SDA080841R1 *		1SDA080843R1 *	
	25		1SDA066812R1		1SDA067400R1		1SDA080844R1 ■	
	32		1SDA066813R1 ■		1SDA067401R1 ■		1SDA067419R1 ■	
	40		1SDA066814R1 ■		1SDA067402R1 ■		1SDA067420R1 ■	
50	1SDA066815R1		1SDA067403R1 ■		1SDA067421R1			
63	1SDA066816R1 ■		1SDA067404R1 ■		1SDA067422R1 ■			
80	1SDA066817R1 ■		1SDA067405R1 ■		1SDA067423R1 ■			
100	1SDA066818R1 ■	1SDA067406R1 ■	1SDA067424R1 ■					
125	1SDA066888R1 ■	14,950	1SDA067409R1 ■	16,790	1SDA067427R1 ■	19,700		
160	1SDA066821R1 ■	18,970	1SDA067410R1 ■	21,650	1SDA067428R1 ■	23,040		

*TMF trip unit

■ Stock items

Tmax power distribution circuit breakers

XT1



Breaking capacity at 415VAC

	Icu	Ics (Icu)
S	50kA	75%
H	70kA	50%

TMD / TMF*

Frame	In (A)	Poles	S		H	
			Ordering code	L.P.(₹)	Ordering code	L.P.(₹)
XT1 160	16	3	1SDA080830R1*	13,030	1SDA080835R1*	15,620
	20		1SDA080831R1*		1SDA080836R1*	
	25		1SDA080832R1		1SDA080837R1	
	32		1SDA080833R1 ■		1SDA080838R1	
	40		1SDA080834R1 ■		1SDA080839R1	
	50		1SDA067431R1		1SDA067449R1	
	63		1SDA067432R1 ■		1SDA067450R1	
	80		1SDA067433R1 ■		1SDA067451R1	
	100		1SDA067434R1 ■		1SDA067452R1	
	125	1SDA067435R1 ■	17,580	1SDA067453R1	22,550	
	160	1SDA067436R1 ■	21,560	1SDA067454R1	25,720	
	16	4	1SDA080845R1*	19,060	1SDA080850R1*	21,690
	20		1SDA080846R1*		1SDA080851R1*	
	25		1SDA080847R1		1SDA080852R1	
	32		1SDA080848R1		1SDA080853R1	
	40		1SDA080849R1		1SDA080854R1	
	50		1SDA067439R1		1SDA067457R1	
	63		1SDA067440R1 ■		1SDA067458R1	
80	1SDA067441R1		1SDA067459R1			
100	1SDA067442R1 ■		1SDA067460R1			
125	1SDA067445R1 ■	22,270	1SDA067463R1	26,670		
160	1SDA067446R1	24,840	1SDA067464R1	28,200		

*TMF trip unit

XT3

Breaking capacity at 415VAC

	Icu	Ics(Icu)
N	36kA	75%
S	50kA	50%

Frame	In (A)	Poles	N		S	
			Ordering code	L.P.(₹)	Ordering code	L.P.(₹)
XT3 250	200	3	1SDA068058R1 ■	22,100	1SDA068220R1 ■	24,470
	250		1SDA068059R1 ■	25,660	1SDA068221R1 ■	27,220
	200	4	1SDA068069R1 ■	24,320	1SDA068231R1 ■	28,420
	250		1SDA068070R1 ■	29,020	1SDA068232R1 ■	31,190

■ Stock items

Tmax power distribution circuit breakers

Protection: TMD/TMA

XT2/XT4/T5/T6



Breaking capacity at 415VAC

	Icu	Ics (Icu)
N	36kA	100%
S	50kA	100%
H	70kA	100%



TMD / TMA*

TMD / TMA*		N	S	H
Frame	In (A)	Ordering code	Ordering code	Ordering code
XT2160	1.6	1SDA067000R1	1SDA067540R1	1SDA067584R1
	2	1SDA067001R1	1SDA067541R1	1SDA067585R1
	2.5	1SDA067002R1	1SDA067542R1	1SDA067586R1
	3.2	1SDA067003R1	1SDA067543R1	1SDA067587R1
	4	1SDA067004R1	1SDA067544R1	1SDA067588R1
	5	1SDA067005R1	1SDA067545R1	1SDA067589R1
	6.3	1SDA067006R1	1SDA067546R1	1SDA067590R1
	8	1SDA067007R1	1SDA067547R1	1SDA067591R1
	10	1SDA067008R1	1SDA067548R1 ■	1SDA067592R1
	12.5	1SDA067009R1	1SDA067549R1	1SDA067593R1
	16	1SDA067010R1 ■	1SDA067550R1 ■	1SDA067594R1
	20	1SDA067011R1 ■	1SDA067551R1	1SDA067595R1
	25	1SDA067012R1	1SDA067552R1 ■	1SDA067596R1
	32	1SDA067013R1 ■	1SDA067553R1 ■	1SDA067597R1
	40	1SDA067014R1 ■	1SDA067554R1 ■	1SDA067598R1
	50	1SDA067015R1	1SDA067555R1 ■	1SDA067599R1
63	1SDA067016R1 ■	1SDA067556R1 ■	1SDA067600R1 ■	
80	1SDA067017R1	1SDA067557R1 ■	1SDA067601R1	
100	1SDA067018R1 ■	1SDA067558R1 ■	1SDA067602R1 ■	
125	1SDA067019R1 ■	1SDA067559R1 ■	1SDA067603R1 ■	
160	1SDA067020R1 ■	1SDA067560R1 ■	1SDA067604R1	
XT4 250	200	1SDA068090R1 ■	1SDA068310R1 ■	1SDA068343R1
	225	1SDA068091R1	1SDA068311R1	1SDA068344R1
	250	1SDA068092R1 ■	1SDA068312R1 ■	1SDA068345R1 ■
T5	320	1SDA054436R1 ■	1SDA054440R1 ■	1SDA054444R1 ■
	400	1SDA054437R1 ■	1SDA054441R1 ■	1SDA054445R1 ■
	500	1SDA054456R1 ■	1SDA054461R1 ■	1SDA054465R1
T6	630	1SDA060202R1 ■	1SDA060204R1 ■	1SDA060206R1
	800	1SDA060214R1 ■	1SDA060216R1 ■	1SDA060218R1 ■

* 40 A onwards

■ Stock items

Tmax power distribution circuit breakers

Protection: TMA



Breaking capacity at 415VAC

	Icu	Ics (Icu)
N	36kA	100%
S	50kA	100%
H	70kA	100%



TMD / TMA*

TMD / TMA*			N		S		H	
Frame	In (A)	Poles	Ordering code	L.P.(₹)	Ordering code	L.P.(₹)	Ordering code	L.P.(₹)
XT2160	1.6	4	1SDA067021R1	19,460	1SDA067561R1	21,050	1SDA067605R1	27,320
	2		1SDA067022R1		1SDA067562R1		1SDA067606R1	
	2.5		1SDA067023R1		1SDA067563R1		1SDA067607R1	
	3.2		1SDA067024R1		1SDA067564R1		1SDA067608R1	
	4		1SDA067025R1		1SDA067565R1		1SDA067609R1	
	5		1SDA067026R1		1SDA067566R1		1SDA067610R1	
	6.3		1SDA067027R1		1SDA067567R1		1SDA067611R1	
	8		1SDA067028R1		1SDA067568R1		1SDA067612R1	
	10		1SDA067029R1		1SDA067569R1		1SDA067613R1	
	12.5		1SDA067030R1		1SDA067570R1		1SDA067614R1	
	16		1SDA067031R1		1SDA067571R1		1SDA067615R1	
	20		1SDA067032R1		1SDA067572R1		1SDA067616R1	
	25		1SDA067033R1		1SDA067573R1		1SDA067617R1	
	32		1SDA067034R1		1SDA067574R1 ■		1SDA067618R1	
	40		1SDA067035R1		1SDA067575R1		1SDA067619R1	
	50		1SDA067036R1		1SDA067576R1		1SDA067620R1	
63	1SDA067037R1 ■	1SDA067577R1 ■	1SDA067621R1					
80	1SDA067038R1	1SDA067578R1	1SDA067622R1					
100	1SDA067039R1 ■	1SDA067579R1 ■	1SDA067623R1					
125	1SDA067042R1 ■	1SDA067582R1 ■	1SDA067626R1					
160	1SDA067043R1 ■	1SDA067583R1 ■	1SDA067627R1					
200	1SDA068109R1 ■	1SDA068329R1 ■	1SDA068362R1					
225	1SDA068110R1	1SDA068330R1	1SDA068363R1					
250	1SDA068111R1 ■	1SDA068331R1 ■	1SDA068364R1					
320	1SDA054477R1 ■	1SDA054479R1 ■	1SDA054481R1					
T5	400	1SDA054478R1 ■	1SDA054480R1 ■	1SDA054482R1 ■				
	500	1SDA054487R1 ■	1SDA054489R1 ■	1SDA054491R1 ■				
T6	630	1SDA060210R1 ■	1SDA060211R1 ■	1SDA060212R1				
	800	1SDA060222R1 ■	1SDA060223R1 ■	1SDA060224R1				

* 40 A onwards

■ Stock items

Tmax power distribution circuit breakers

Protection: LS/I

XT2/XT4/T5/T6



Breaking capacity at 415VAC

	Icu	Ics (Icu)
N	36kA	100%
S	50kA	100%
H	70kA	100%



Protection : LS/I

Protection : LS/I			N		S		H	
Frame	In (A)	Poles	Ordering code	L.P. (₹)	Ordering code	L.P. (₹)	Ordering code	L.P. (₹)
XT2 160	10	3	1SDA067054R1	22,980	1SDA067800R1	27,470	1SDA067857R1	31,110
	25		1SDA067055R1		1SDA067801R1		1SDA067858R1	
	63		1SDA067056R1		1SDA067802R1		1SDA067859R1	
	100		1SDA067057R1		1SDA067803R1		1SDA067860R1	
	160		1SDA067058R1		1SDA067804R1		1SDA067861R1	
XT4 250	250	4	1SDA068126R1	32,940	1SDA068475R1	37,610	1SDA068515R1	43,040
T5 400	400		1SDA054317R1	45,670	1SDA054333R1	47,730	1SDA054349R1	54,720
T5 630	630		1SDA054396R1	48,270	1SDA054404R1	49,470	1SDA054412R1	58,170
T6 800	800		1SDA060268R1	68,270	1SDA060278R1	75,680	1SDA060289R1	91,220
T6 1000*	1000		1SDA060537R1	1,04,960	1SDA060547R1	1,13,240	1SDA060561R1	1,31,400
XT2 160	10	4	1SDA067090R1	28,950	1SDA067833R1	34,040	1SDA067890R1	38,070
	25		1SDA067091R1		1SDA067834R1		1SDA067891R1	
	63		1SDA067092R1		1SDA067835R1		1SDA067892R1	
	100		1SDA067093R1		1SDA067836R1		1SDA067893R1	
	160		1SDA067095R1		1SDA067838R1		1SDA067895R1	
XT4 250	250	1SDA068147R1	46,100	1SDA068495R1	49,370	1SDA068535R1	63,340	
T5 400	400	1SDA054325R1	52,130	1SDA054341R1	62,600	1SDA054357R1	72,010	
T5 630	630	1SDA054400R1	61,960	1SDA054408R1	64,910	1SDA054416R1	86,570	
T6 800	800	1SDA060273R1	76,750	1SDA060283R1	94,500	1SDA060294R1	1,15,230	
T6 1000*	1000	1SDA060542R1	1,49,020	1SDA060556R1	1,57,310	1SDA060566R1	1,91,450	

Note: XT2/XT4 with Ekip LS/I release ; T5-T6 with PR221 LS/I release
 *Extended front (EF) terminals are supplied as standard in T6 1000A MCCB

Tmax power distribution circuit breakers

NEW

Protection: LIG

MCCBs with Overload, Short circuit and Earth Fault Protections XT2/XT4



Ekip DIP LIG with XT2/XT4 MCCBs

Microprocessor based electronic trip units

Protection functions	Threshold
Overload "L" Protection	0.4...1 x In in steps of 0.04
Inst. Short-circuit "I" Protection	OFF - 1...10 x In
Earth Fault "G" Protection	OFF - 0.2 to 1 x In

Ekip LIG		N Version (Icu=Ics=36kA @ 415 V AC)		S Version (Icu=Ics=50kA @ 415 V AC)		
Frame	Poles	In (A)	Ordering Code	L.P.(₹)	Ordering Code	L.P.(₹)
XT2 160	3	63	1SDA100012R1 ■	30,280	1SDA100042R1 ■	31,880
		100	1SDA100013R1 ■	30,280	1SDA100043R1 ■	31,880
		160	1SDA100014R1 ■	35,230	1SDA100044R1 ■	37,580
XT4 250		250	1SDA100185R1 ■	37,040	1SDA100215R1 ■	39,140
XT2 160	4	63	1SDA100027R1 ■	39,170	1SDA100057R1 ■	41,260
		100	1SDA100028R1 ■	39,170	1SDA100058R1 ■	41,260
		160	1SDA100029R1 ■	45,620	1SDA100059R1 ■	48,670
XT4 250		250	1SDA100200R1 ■	47,960	1SDA100230R1 ■	50,700

■ Stock items

Tmax power distribution circuit breakers

Protection: LSIG

XT2/XT4/T5/T6



Breaking capacity at 415VAC

	Icu	Ics (Icu)
N	36kA	100%
S	50kA	100%
H	70kA	100%



Ekip LSIG/XT2-XT4 Ekip LSIG/ T5/T6 PR222DS/P-LSIG

			N	S	H				
Frame	In (A)	Poles	Ordering code	L.P. (₹)	Ordering code	L.P. (₹)	Ordering code	L.P. (₹)	
XT2 160	10	3	1SDA067072R1	42,510	1SDA067815R1	45,490	1SDA067872R1	52,250	
	25		1SDA067073R1		1SDA067816R1 ■		1SDA067873R1		
	63		1SDA067074R1 ■		1SDA067817R1 ■		1SDA067874R1		50,110
	100		1SDA067075R1 ■		1SDA067818R1 ■		1SDA067875R1		
	160		1SDA067076R1 ■		1SDA067819R1 ■		1SDA067876R1		
XT4 250	250	1SDA068141R1 ■	50,570	1SDA068490R1 ■	55,220	1SDA068530R1 ■	58,340		
T5 400	400	3	1SDA054323R1 ■	61,920	1SDA054339R1 ■	66,400	1SDA054355R1	79,890	
T5 630	630		1SDA054399R1 ■	70,190	1SDA054407R1 ■	72,390	1SDA054415R1 ■	82,560	
T6 800	800		1SDA060271R1 ■	1,03,730	1SDA060281R1 ■	1,09,550	1SDA060292R1	1,24,680	
T6 1000*	1000		1SDA060540R1	1,40,540	1SDA060554R1 ■	1,55,920	1SDA060564R1	1,78,670	

PR222DS/P-LSIG

			N	S	H				
Frame	In (A)	Poles	Ordering code	L.P. (₹)	Ordering code	L.P. (₹)	Ordering code	L.P. (₹)	
XT2 160	10	4	1SDA067108R1	50,830	1SDA067851R1	53,960	1SDA067908R1	62,050	
	25		1SDA067109R1		1SDA067852R1		1SDA067909R1		
	63		1SDA067110R1 ■		1SDA067853R1 ■		1SDA067910R1		59,750
	100		1SDA067111R1 ■		1SDA067854R1 ■		1SDA067911R1		
	160		1SDA067113R1 ■		1SDA067856R1 ■		1SDA067913R1		
XT4 250	250	1SDA068162R1 ■	63,910	1SDA068510R1 ■	65,420	1SDA068550R1	82,500		
T5 400	400	4	1SDA054331R1 ■	69,560	1SDA054347R1 ■	76,480	1SDA054363R1	99,670	
T5 630	630		1SDA054403R1 ■	81,860	1SDA054411R1 ■	88,770	1SDA054419R1	1,13,170	
T6 800	800		1SDA060276R1 ■	1,16,230	1SDA060286R1 ■	1,26,150	1SDA060297R1	1,57,980	
T6 1000*	1000		1SDA060545R1 ■	1,80,150	1SDA060559R1	1,86,220	1SDA060569R1	2,26,430	

Note: *Extended front (EF) terminals are supplied as standard in T6 1000A MCCB

■ Stock items

Tmax power distribution circuit breakers

For MODBUS communication (LSIG)

XT2/XT4/T5/T6



Breaking capacity at 415VAC

	Icu	Ics (Icu)
N	36kA	100%
S	50kA	100%
H	70kA	100%



Ekip LSIG

Frame	In (A)	Poles
XT2 160	10	3
	25	
	63	
	100	
	160	
XT4 250	250	

N	
Ordering code	L.P. (₹)
1SDA067072R1	42,510
1SDA067073R1	
1SDA067074R1 ■	41,460
1SDA067075R1 ■	
1SDA067076R1 ■	45,100
1SDA068141R1 ■	50,570

S	
Ordering code	L.P. (₹)
1SDA067815R1	45,490
1SDA067816R1 ■	
1SDA067817R1 ■	44,230
1SDA067818R1 ■	
1SDA067819R1 ■	51,680
1SDA068490R1 ■	55,220

H	
Ordering code	L.P. (₹)
1SDA067872R1	55,250
1SDA067873R1	
1SDA067874R1	51,120
1SDA067875R1	
1SDA067876R1	62,910
1SDA068530R1 ■	64,180

Note : Consider ordering "Ekip Com" for MODBUS communication (Refer page no 50)

PR222DS/PD-LSIG

Frame	In (A)	Poles
T5 400	400	3
T5 630	630	
T6 800	800	
T6 1000*	1000	

Ordering code	L.P. (₹)
1SDA081522R1	96,150
1SDA081523R1	1,00,060
1SDA081540R1	1,36,520
1SDA081541R1	1,73,680

Ordering code	L.P. (₹)
1SDA081525R1 ■	98,830
1SDA081526R1 ■	1,02,850
1SDA081546R1	1,41,350
1SDA081547R1	1,87,720

Ordering code	L.P. (₹)
1SDA081528R1	1,15,640
1SDA081529R1	1,18,450
1SDA081552R1	1,56,480
1SDA081553R1	2,10,470

Note: Order X3 connector - 1SDA055059R1 along with PR222DS/PD-LSIG
 *Extended front (EF) terminals are supplied as standard in T6 1000A MCCB

■ Stock items

Tmax power distribution circuit breakers

T7

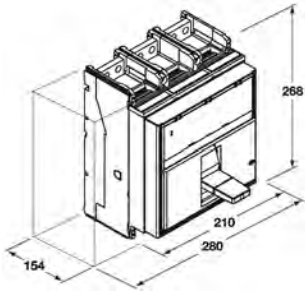

Breaking capacity at 415VAC

	Icu	Ics (Icu)
S	50kA	100%
H	70kA	100%

T7 1250/1600 PR231/P LS/I

In (A)	Poles
1250	3
1600	
1250	4
1600	

S

Ordering code	L.P. (₹)
1SDA062866R1	1,40,240
1SDA062994R1 ■	1,67,620
1SDA062874R1 ■	1,82,780
1SDA063002R1	2,01,060

H

Ordering code	L.P. (₹)
1SDA062898R1	1,97,350
1SDA063026R1	2,16,690
1SDA062906R1	2,35,540
1SDA063034R1	2,61,200

PR331/P LSIG

In (A)	Poles
1250	3
1600	
1250	4
1600	

Ordering code	L.P. (₹)
1SDA062868R1 ■	1,80,000
1SDA062996R1	1,94,330
1SDA062876R1	1,99,800
1SDA063004R1	2,28,380

Ordering code	L.P. (₹)
1SDA062900R1	2,15,750
1SDA063028R1	2,45,580
1SDA062908R1	2,54,310
1SDA063036R1	2,85,650

T7 1250M/1600M PR231/P LS/I

In (A)	Poles
1250	3
1600	
1250	4
1600	

S

Ordering code	L.P. (₹)
1SDA062882R1	1,67,620
1SDA063010R1	1,85,790
1SDA062890R1	1,86,800
1SDA063018R1	2,24,090

H

Ordering code	L.P. (₹)
1SDA062914R1	2,18,590
1SDA063042R1	2,44,260
1SDA062922R1	2,62,510
1SDA063050R1	2,91,850

PR331/P LSIG

In (A)	Poles
1250	3
1600	
1250	4
1600	

Ordering code	L.P. (₹)
1SDA062884R1	1,95,500
1SDA063012R1	2,13,200
1SDA062892R1	2,27,090
1SDA063020R1	2,52,070

Ordering code	L.P. (₹)
1SDA062916R1	2,48,670
1SDA063044R1	2,71,230
1SDA062924R1	2,91,280
1SDA063052R1	3,20,750

Note : For Motorizable T7 M frame, order along with above code, motor operator, shunt opening coil & shunt closing coil of required voltage.

■ Stock items

Tmax motor protection circuit breakers

Characteristics of circuit-breakers for protecting motors in three pole versions.

Tmax Motor Protection Trip units

> Magnetic trip units:

Frame	Protection	Range
XT2 160	MF ($I_n \leq 12.5A$)	14 x I_n
	MA ($12.5A < I_n \leq 160$)	6..14 x I_n
XT3 250	MA	6..12 x I_n
XT4 250	MA	5..10 x I_n

MF – Magnetic fix

MA- Magnetic Adjustable

> Microprocessor trip units:

o Only Short circuit protection release

	XT2/XT4	T5/T6	T7/T7M
Ekip M-I	I = 6 - 14 of I_n	PR221 DS-I I = 1 - 10 of I_n	PR231P-I I = 1 - 10 of I_n

o Advanced Motor protection release

	XT2/XT4		XT2/XT4/T5/T6
Ekip M-LIU	L = 0.4 - 1 of I_n	Ekip M-LRIU	L = 0.4 - 1 of I_n
	I = 6 - 13 of I_n		R = 3 - 9 of I_n
	U* = ON or OFF		I = 6 - 13 of I_n
			G = 0.2 - 1 of I_n
			U* = ON or OFF

L = Overload; R = Protection against rotor blockage; I = Instantaneous short circuit; G = Earth fault

U = phase loss (U): With selector in ON position, circuit breaker trips if at least one current phase is lower than $0.1I_n$ and at least a second one higher than $0.25I_n$.



Tmax motor protection circuit breakers

Advantages of Ekip M-LRIU protection unit:

Duty mode setting (Normal/Heavy):

- Normal duty mode requires use of a circuit-breaker and a contactor. In the case of tripping, the Ekip M-LRIU release commands the opening of the contactor via PR212/CI;
- Heavy duty mode foresees circuit-breaker opening for all overcurrent conditions, and just the function of motor operation is entrusted to the contactor

PTC protection setting:

- PTC: this protection, monitors the temperature inside the protected motor by means of a PTC sensor.

❖ ABB solutions for starting, switching and protection of three-phase asynchronous motors:

- o A traditional system
- o A system of integrated protection

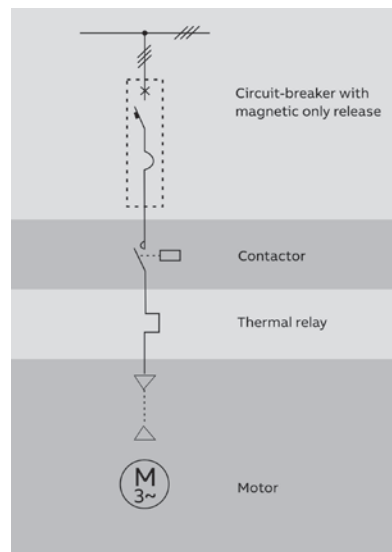

Traditional System

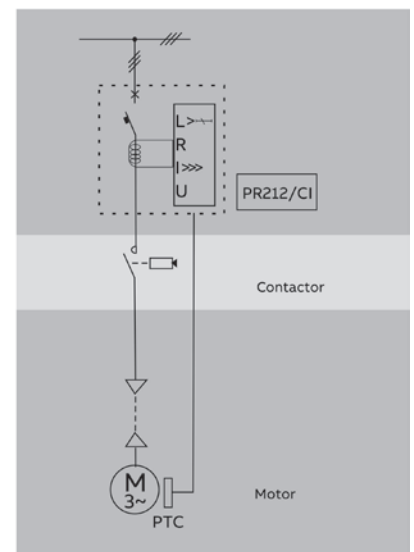

System of integrated protection

Tmax motor distribution circuit breakers

Protection: Magnetic only

XT2/XT4



Breaking capacity at 415VAC

	Icu	Ics (Icu)
N	36kA	100%
S	50kA	100%
H	70kA	100%

MF/MA*

			N		S		H	
In (A)	In (A)	Poles	Ordering code	L.P. (₹)	Ordering code	L.P. (₹)	Ordering code	L.P. (₹)
XT2 160	1	3	1SDA067044R1	14,990	1SDA067760R1	16,170	1SDA067770R1	18,160
	2		1SDA067045R1		1SDA067761R1		1SDA067771R1	
	4		1SDA067046R1		1SDA067762R1		1SDA067772R1	
	8.5		1SDA067047R1		1SDA067763R1 ■		1SDA067773R1	
	12.5		1SDA067048R1 ■		1SDA067764R1 ■		1SDA067774R1	
	20		1SDA067049R1 ■		1SDA067765R1 ■		1SDA067775R1	
	32		1SDA067050R1 ■		1SDA067766R1 ■		1SDA067776R1	
	52		1SDA067051R1 ■		1SDA067767R1 ■		1SDA067777R1	
	80		1SDA067052R1 ■		1SDA067768R1 ■		1SDA067778R1	
	100		1SDA067053R1 ■		1SDA067769R1 ■		1SDA067779R1	
XT4 250	160	1SDA076529R1	19,350	1SDA076530R1 ■	21,120	1SDA076535R1	26,940	
	200	1SDA068121R1	33,310	1SDA068440R1 ■	36,230	1SDA068450R1	43,870	

* 20 amps onwards

XT3



Breaking capacity at 415VAC

	Icu	Ics (Icu)
N	36KA	75%
S	50KA	50%

MA

			N		S	
Frame	In (A)	Poles	Ordering code	L.P.(₹)	Ordering code	L.P.(₹)
XT3 250	100	3	1SDA068071R1	17,670	1SDA068279R1	18,370
	125		1SDA068072R1		1SDA068280R1	
	160		1SDA068073R1		1SDA068281R1	
	200		1SDA068074R1		1SDA068282R1 ■	

■ Stock items

Tmax motor protection circuit breakers

Microprocessor based short circuit protection MCCBs

XT2/XT4/T5/T6/T7/T7M



Breaking capacity at 415VAC

	Icu	Ics (Icu)
N	36KA	100%
S	50KA	100%
H	70KA	100%



Ekip M-I

In (A)	In (A)	Poles
XT2 160	20	3
	32	
	52	
	100	
	160	
XT4 250	250	

N	
Ordering code	L.P. (₹)
1SDA067086R1	
1SDA067087R1	19,890
1SDA067088R1	
1SDA067089R1	
1SDA067063R1	24,510
1SDA068131R1 ■	37,270

S	
Ordering code	L.P. (₹)
1SDA067829R1	
1SDA067830R1	23,810
1SDA067831R1	
1SDA067832R1	
1SDA067809R1	32,020
1SDA068480R1 ■	40,420

H	
Ordering code	L.P. (₹)
1SDA067886R1	
1SDA067887R1	25,670
1SDA067888R1	
1SDA067889R1	
1SDA067866R1	34,900
1SDA068520R1	48,360

T5

PR221 DS-I

In (A)	Poles
400	3
630	

N	
Ordering code	L.P.(₹)
1SDA054319R1	42,480
1SDA054397R1 ■	45,240

S	
Ordering code	L.P.(₹)
1SDA054335R1 ■	46,940
1SDA054405R1 ■	51,050

H	
Ordering code	L.P.(₹)
1SDA054351R1	57,290
1SDA054413R1	60,930

T6 800

PR221 DS-I

In (A)	Poles
800	3
1000	

N	
Ordering code	L.P.(₹)
1SDA060269R1	73,530
1SDA060538R1	1,12,570

S	
Ordering code	L.P.(₹)
1SDA060279R1	82,370
1SDA060548R1	1,21,430

H	
Ordering code	L.P.(₹)
1SDA060290R1	1,01,310
1SDA060562R1	1,55,220

T7 1250/1600

PR231/P I

In (A)	Poles
1250	3
1600	3

S	
Ordering code	L.P. (₹)
1SDA062865R1	1,47,340
1SDA062993R1	1,77,160

H	
Ordering code	L.P. (₹)
1SDA062897R1	2,08,930
1SDA063025R1	2,29,760

T7 1250M/1600M

PR231/P I

In (A)	Poles
1250	3
1600	3

S	
Ordering code	L.P. (₹)
1SDA062881R1	1,82,110
1SDA063009R1	1,96,740

H	
Ordering code	L.P. (₹)
1SDA062913R1	2,31,780
1SDA063041R1	2,59,260

■ Stock items

Tmax motor protection circuit breakers

Advanced Motor Protection MCCBs

T5/T6



Breaking capacity at 415VAC

	Icu	Ics (Icu)
N	36kA	100%
S	50kA	100%
H	70kA	100%



T5 Ekip M-LRIU

In (A)	Poles
320	3
400	3

N	
Ordering code	L.P.(₹)
1SDA054551R1	69,580
1SDA064157R1	

S	
Ordering code	L.P.(₹)
1SDA054553R1	77,900
1SDA064158R1	

T6 Ekip M-LRIU

In (A)	Poles
630	3

N	
Ordering code	L.P.(₹)
1SDA060311R1	97,380

S	
Ordering code	L.P.(₹)
1SDA060312R1	1,06,350

H	
Ordering code	L.P.(₹)
1SDA060313R1	1,23,330

Tmax switch disconnectors



SD Frame	In(A)	Icw kA (1s)	Poles	Ordering code	L.P.(₹)	Poles	Ordering code	L.P.(₹)
XT1D	160	2	3	1SDA068208R1	10,140	4	1SDA068209R1	15,000
XT3D	250	3		1SDA068210R1	22,480		1SDA068211R1	26,870
XT4D	250	3.6		1SDA068212R1	25,420		1SDA068213R1	33,690
T5D	400	3.6		1SDA054599R1	32,980		1SDA054600R1	41,810
T5D	500	3.6		1SDA054601R1	40,090		1SDA054602R1	51,030
T6D	630	15		1SDA060343R1	45,320		1SDA060344R1	54,440
T6D	800	15		1SDA060345R1	50,040		1SDA060346R1	81,580
T6D	1000	15		1SDA060594R1	86,980		1SDA060595R1	1,08,580
T7D	1000	20		1SDA062032R1	98,690		1SDA062033R1	1,25,730
T7D	1250	20		1SDA062036R1	1,31,790		1SDA062037R1	1,62,040
T7D	1600	20	1SDA062040R1	1,34,330	1SDA062041R1	1,65,150		
T7D M	1000	20	1SDA062034R1	1,39,960	1SDA062035R1	1,72,200		
T7D M	1250	20	1SDA062038R1	1,53,980	1SDA062039R1	1,89,430		
T7D M	1600	20	1SDA062042R1	1,69,470	1SDA062043R1	2,11,800		

Tmax accessories



Accessories for T-Max MCCBs

Extended spreaded terminals - ES

Frame	Description	Ordering code	L.P. (₹)
XT1	KIT ES XT1 6pcs	1SDA066891R1 ■	2,090
	KIT ES XT1 8pcs	1SDA066892R1 ■	2,800
XT2	KIT ES XT2 6pcs	1SDA066895R1 ■	2,840
	KIT ES XT2 8pcs	1SDA066896R1 ■	3,460
XT3	KIT ES XT3 6pcs	1SDA066899R1 ■	3,050
	KIT ES XT3 8pcs	1SDA066900R1 ■	3,880
XT4	KIT ES XT4 6pcs	1SDA066903R1 ■	3,510
	KIT ES XT4 8pcs	1SDA066904R1 ■	4,410
T5	Kit EST5 6pcs	1SDA055038R1 ■	5,010
	Kit EST5 8pcs	1SDA055039R1 ■	6,650

Note: Phase barrier supplied as standard with above copper spreaders.



Separator - PB

Frame	Description	Ordering code	L.P. (₹)
XT1-XT3	PB 100mm 4pcs XT1-XT3 3p	1SDA066676R1	810
	PB 200mm 4pcs XT1-XT3 3p	1SDA066678R1	1,080
	PB 100mm 6pcs XT1-XT3 4p	1SDA066681R1	1,190
	PB 200mm 6pcs XT1-XT3 4p	1SDA066683R1	1,580
XT2-XT4	PB 100mm 4pcs XT2-XT4 3p	1SDA066675R1	910
	PB 200mm 4pcs XT2-XT4 3p	1SDA066677R1 ■	1,360
	PB 100mm 6pcs XT2-XT4 4p	1SDA066680R1	1,360
	PB 200mm 6pcs XT2-XT4 4p	1SDA066682R1	2,010
T5	PB100 4 pcs - Low T4, T5	1SYN850207R0001	1,200
	PB100mm 4pcs T4-5-T7-A3 3P	1SDA054970R1	1,120
	PB 100mm 6pcs T4-5-T7-A3 3P	1SDA054971R1	1,620
	PB100 4 pcs - Low T4, T5	1SYN850207R0001	1,200
	PB100 6 pcs - Low T4, T5 - 400A	1SYN850210R0001 ■	1,690

Note: For T5 630A contact the nearest sales office

Rotary handle operating mechanism

Direct - RHD

Frame	Description	Ordering code	L.P. (₹)
XT1...XT4	RHD XT1-XT3 F/P STANDARD DIRECT	1SDA066475R1 ■	1,970
	RHD XT2-XT4 F/P STANDARD DIRECT	1SDA069053R1 ■	2,340
	RHD XT2-XT4 W STANDARD DIRECT	1SDA066476R1	2,340
T5	RHD Normal for Fixed/Plug-in T4-T5	1SDA054926R1 ■	4,140
	RHD Normal for withdrawable T4-T5	1SDA054928R1	4,580
T6	RHD Normal for fixed T6	1SDA060405R1 ■	5,650
	RHD Normal for withdrawable T6	1SDA060407R1	7,110
T7	RHD Normal for Fixed/Plug-in T7	1SDA062120R1	7,330

Note:- F/P: Fixed/Plug-in ; W:Withdrawable



Tmax accessories



Transmitted - RHE			
Frame	Description	Ordering code	L.P. (₹)
XT1...XT4	RHE XT1-XT3 F/P STANDARD RETURNED(250mm)	1SDA082810R1 ■	1,810
	RHE XT1-XT3 F/P STANDARD RETURNED (500mm)	1SDA066479R1	2,050
	RHE XT2-XT4 F/P STANDARD RETURNED (250mm)	1SDA082811R1 ■	2,390
	RHE XT2-XT4 F/P STANDARD RETURNED (500mm)	1SDA069055R1	2,640
	RHE XT2-XT4 W STANDARD RETURNED	1SDA066480R1 ■	2,640
	RHS L XT2-XT4 F/P STAND. SX LATERAL	1SDA069058R1	4,210
	RHS R XT2-XT4 F/P STAND. DX LATERAL	1SDA069060R1	4,150
T5	RHE Normal for Fixed/Plug-in T4-T5 250mm	1SDA070447R1 ■	3,840
	RHE Normal for Withdrawble T4-T5	1SDA054933R1 ■	6,980
T6	RHE Normal for Fixed T6	1SDA060409R1 ■	7,300
	RHE Normal for Withdrawble T6	1SDA060411R1	8,470
T7	RHE Normal for Fixed/Plug-in T7	1SDA062122R1 ■	8,860

Note:- F/P: Fixed/Plug-in ; W:Withdrawable



Electrical signals

Auxillary contact - AUX (Uncabled version)			
Frame	Description	Ordering code	L.P. (₹)
XT1....XT4	AUX 1Q 250Vac/dc XT1...XT4	1SDA066422R1 ■	1,100
	AUX 1Q 24Vdc XT1...XT4	1SDA066423R1	1,690



Auxillary contact - AUX			
Frame	Description	Ordering code	L.P. (₹)
T5..T6(1)	AUX 1Q 1SY 250V AC/DC T1...T6 (1)	1SDA051368R1 ■	1,930
	AUX 3Q 1SY 250V AC/DC T1...T6 (1)	1SDA051369R1	3,090
	AUX 3Q 1SY 24V DC T1...T6 (1)	1SDA054914R1	2,980
T5	AUX-SA 1 S51 T4-T5	1SDA055050R1	
T7M	AUX 2Q 24V DC T7M-X1	1SDA062101R1	1,930
	AUX 2Q 400V AC T7M-X1	1SDA062102R1	
T7M	AUX SA T7M-X1 S51 24VDC	1SDA066100R1	7,290
	AUX SA T7M-X1 S51 250VAC	1SDA063553R1	8,470
T7	AUX 1Q + 1SY 24V DC T7	1SDA062103R1	
	AUX 1Q + 1SY 400V AC T7	1SDA062104R1 ■	2,980

Note : Q=Changeover contact;SY= Trip indication contact
For T7 / T7M in Withdrable version sliding contact blocks for fixed and moving parts are necessary.

Cabled contact in electronic version			
Frame	Description	Ordering code	L.P. (₹)
T5	AUX-E-C 1Q 1SY T4-T5	1SDA054916R1	6,270
T6	AUX-E-C 1Q 1SY T6	1SDA064161R1	7,300

■ Stock items

Tmax accessories



Auxiliary contact cabled-version - AUX - C			
Frame	Description	Ordering code	L.P. (₹)
XT1....XT4	AUX-C 1Q+1SY 250V AC/DC XT1..XT4 F/P	1SDA066431R1 ■	1,830
	AUX-C 2Q+1SY 250VAC/DC XT1..XT4 F/P	1SDA066433R1 ■	2,900
	AUX-C 3Q+1SY 250VAC/DC XT2..XT4 F/P	1SDA066434R1 ■	3,440
	AUX-C 3Q+2SY 250VAC/DC XT2-XT4 F/P	1SDA066436R1	4,220
	AUX-C 2Q+2SY+1S51 250VAC/DC XT2-XT4 F/P	1SDA066438R1	4,560
	AUX-C 2Q 400V AC XT2-XT4 F/P	1SDA066440R1	2,190
	AUX-C 1Q+1SY 400Vac XT2-XT4 F/P	1SDA066444R1	3,460
	AUX-C 1Q+1SY 24Vdc XT1..XT4 F/P	1SDA066446R1 ■	2,550
T5-T6	AUX-C 3Q+1SY 24VDC XT2..XT4 F/P	1SDA066448R1	3,980
	AUX-C 1Q 1SY 250V AC/DC C T4-T5-T6	1SDA054910R1	2,550
	AUX-C 1Q 1SY 400V AC C T4-T5-T6	1SDA054912R1	3,730
	AUX-C 2Q 400V AC C T4-T5-T6	1SDA054913R1	4,280
	AUX-C 3Q 1SY 24VDC C T4-T5-T6	1SDA054915R1	4,010
	AUX-C 3Q 1SY 250V AC/DC C T4-T5-T6	1SDA054911R1 ■	4,740

Note : Q=Changeover contact;SY= Trip indication contact ;F/P: Fixed/Plug-in ; W:Withdrawable

Opening release

Shunt opening release - SOR (Un-cabled version - For Fixed and Plug-in circuit breakers)			
Frame	Description	Ordering code	L.P. (₹)
XT1....XT4	SOR XT1..XT4 12 VDC	1SDA066313R1	2,550
	SOR XT1..XT4 24-30 V AC/DC	1SDA066314R1 ■	
	SOR XT1..XT4 48-60 V Ac/DC	1SDA066315R1	
	SOR XT1..XT4 110...127 V ac-110...125 V dc	1SDA066316R1	
	SOR XT1..XT4 220...240 V ac-220...250 V dc	1SDA066317R1 ■	
	SOR XT1..XT4 380-440 V ac	1SDA066318R1	
	SOR XT1..XT4 480-525 V ac	1SDA066319R1	
T5-T6	SOR 12V DC T4-T5-T6	1SDA054862R1	3,840
	SOR 24V AC/DC T4-T5-T6	1SDA054863R1	
	SOR 48...60V AC/DC T4-T5-T6	1SDA054864R1	
	SOR 110...120V AC-110...125V DC T4-T5-T6	1SDA054865R1 ■	
	SOR 220...240V AC-220...250V DC T4-T5-T6	1SDA054866R1	
	SOR 380...440V AC T4-T5-T6	1SDA054867R1	
T7-T7M-X1	SOR 480...500V AC T4-T5-T6	1SDA054868R1	7,470
	SOR 24V AC/DC T7-T7M-X1	1SDA062065R1	
	SOR 30V AC/DC T7-T7M-X1	1SDA062066R1	
	SOR 48V AC/DC T7-T7M-X1	1SDA062067R1	
	SOR 60V AC/DC T7-T7M-X1	1SDA062068R1	
	SOR 110...120V AC/DC T7-T7M-X1	1SDA062069R1	
	SOR 120...127V AC/DC T7-T7M-X1	1SDA063547R1	
	SOR 220...240V AC/DC T7-T7M-X1	1SDA063548R1	
	SOR 240...250V AC/DC T7-T7M-X1	1SDA062070R1	
	SOR 380...400V AC T7-T7M-X1	1SDA062071R1	
SOR 415...440V AC T7-T7M-X1	1SDA062072R1		

Note: For T7 / T7M in Withdrawable version sliding contact blocks for fixed and moving parts are necessary.

Tmax accessories



Shunt opening release - SOR - C (Cabled version)				
Frame	Description	Ordering code	L.P. (₹)	
XT1...XT4	SOR-C XT1...XT4 F/P 12 Vdc	1SDA066321R1	3,880	
	SOR-C XT1...XT4 F/P 24-30 Vac/dc	1SDA066322R1		
	SOR-C XT1...XT4 F/P 48-60 Vac/dc	1SDA066323R1		
	SOR-C XT1...XT4 F/P 110-127Vac-110-125Vdc	1SDA066324R1		
	SOR-C XT1...XT4 F/P 220-240Vac-220-250Vdc	1SDA066325R1		
	SOR-C XT1...XT4 F/P 380-440 Vac	1SDA066326R1		
	T5-T6	SOR-C XT1...XT4 F/P 480-525 Vac	1SDA066327R1	4,540
		SOR-C XT2-XT4 W 12 Vdc	1SDA066328R1	
		SOR-C XT2-XT4 W 24-30 Vac/dc	1SDA066329R1	
		SOR-C XT2-XT4 W 48-60 Vac/dc	1SDA066330R1	
		SOR-C XT2-XT4 W 110-127Vac-110-125Vdc	1SDA066331R1	
		SOR-C XT2-XT4 W 220-240Vac-220-250Vdc	1SDA066332R1	
T5-T6		SOR-C XT2-XT4 W 380-440 Vac	1SDA066333R1	6,770
		SOR-C XT2-XT4 W 480-525 Vac	1SDA066334R1	
		SOR-C 12V DC T4-T5-T6	1SDA054869R1	
		SOR-C 24V AC/DC T4-T5-T6	1SDA054870R1	
		SOR-C 48...60V AC/DC T4-T5-T6	1SDA054871R1	
		SOR-C 110...120V AC-110...125V DC T4-T5-T6	1SDA054872R1	
T5-T6	SOR-C 220...240V AC-220...250V DC T4-T5-T6	1SDA054873R1 ■	6,890	
	SOR-C 380...440V AC T4-T5-T6	1SDA054874R1		
	SOR-C 480...525V AC T4-T5-T6	1SDA054875R1		

Note:- F/P: Fixed/Plug-in ; W: Withdrawable



Under voltage release - UVR (Un-cabled version - For Fixed and Plug-in circuit breakers)			
Frame	Description	Ordering code	L.P. (₹)
XT1...XT4	UVR XT1...XT4 24-30 VAC/DC	1SDA066389R1	4,770
	UVR XT1...XT4 48 VAC/DC	1SDA069064R1	
	UVR XT1...XT4 60 VAC/DC	1SDA066390R1	
	UVR XT1...XT4 110-127Vac-110-125Vdc	1SDA066391R1	
	UVR XT1...XT4 220-240Vac-220-250Vdc	1SDA066392R1 ■	
	UVR XT1...XT4 380-440 Vac	1SDA066393R1 ■	
T5-T6	UVR XT1...XT4 480-525 Vac	1SDA066394R1	8,860
	UVR 24V AC/DC T4-T5-T6	1SDA054880R1	
	UVR 48V AC/DC T4-T5-T6	1SDA054881R1	
	UVR 60V AC/DC T4-T5-T6	1SDA054882R1	
	UVR 110...120V AC-110...125V DC T4-T5-T6	1SDA054883R1 ■	
	UVR 220...240V AC-220...250V DC T4-T5-T6	1SDA054884R1 ■	
T7-T7M	UVR 380...440V AC T4-T5-T6	1SDA054885R1 ■	9,950
	UVR 480...500V AC T4-T5-T6	1SDA054886R1	
	UVR 24V AC/DC T7-T7M-X1	1SDA062087R1	
	UVR 30V AC/DC T7-T7M-X1	1SDA062088R1	
	UVR 48V AC/DC T7-T7M-X1	1SDA062089R1	
	UVR 60V AC/DC T7-T7M-X1	1SDA062090R1	
	UVR 110...120V AC/DC T7-T7M-X1	1SDA062091R1	
	UVR 120...127V AC/DC T7-T7M-X1	1SDA063551R1	
	UVR 220...240V AC/DC T7-T7M-X1	1SDA063552R1	
	UVR 240...250V AC/DC T7-T7M-X1	1SDA062092R1	
	UVR 380...400V AC T7-T7M-X1	1SDA062093R1	
	UVR 415...440V AC T7-T7M-X1	1SDA062094R1	

Note: For T7 TM in Withdrawable version sliding contact blocks for fixed and moving parts are necessary.

■ Stock items

Tmax accessories



Under voltage release C - UVR - C (Cabled version)				
Frame	Description	Ordering code	L.P. (₹)	
XT1....XT4	UVR-C XT1..XT4 F/P 24-30 VAC/DC	1SDA066396R1	7,460	
	UVR-C XT1..XT4 F/P 48 Vac/dc	1SDA069065R1		
	UVR-C XT1..XT4 F/P 60 Vac/dc	1SDA066397R1		
	UVR-C XT1..XT4 F/P 110-127Vac-110-125Vdc	1SDA066398R1		
	UVR-C XT1..XT4 F/P 220-240Vac-220-250Vdc	1SDA066399R1 ■		
	UVR-C XT1..XT4 F/P 380-440 Vac	1SDA066400R1		
	UVR-C XT1..XT4 F/P 480-525 Vac	1SDA066401R1		
	UVR-C XT2-XT4 W 24-30 Vac/dc	1SDA066403R1		
	UVR-C XT2-XT4 W 48 Vac/dc	1SDA069066R1		
	UVR-C XT2-XT4 W 60 Vac/dc	1SDA066404R1		
	UVR-C XT2-XT4 W 110-127Vac-110-125Vdc	1SDA066405R1		8,070
	UVR-C XT2-XT4 W 220-240Vac-220-250Vdc	1SDA066406R1		
	UVR-C XT2-XT4 W 380-440 Vac	1SDA066407R1		
	UVR-C XT2-XT4 W 480-525 Vac	1SDA066408R1		
UVR-C 24V AC/DC T4-T5-T6	1SDA054887R1	11,980		
UVR-C 48V AC/DC T4-T5-T6	1SDA054888R1			

Note:- F/P: Fixed/Plug-in ; W: Withdrawable



Time delay device for under voltage release- UVD			
Frame	Description	Ordering code	L.P. (₹)
XT1....XT4	UVD T1...T6 - XT1...XT4 24...30 Vac/dc	1SDA051357R1	40,240
	UVD T1...T6 - XT1...XT4 48...60 Vac/dc	1SDA051358R1	
	UVD T1...T6 - XT1...XT4 110...125 Vac/dc	1SDA051360R1	
	UVD T1...T6 - XT1...XT4 220...250 Vac/dc	1SDA051361R1	
T5...T6	UVD 24...30V AC/DC T1...T6	1SDA051357R1	13,930
	UVD 48...60V AC/DC T1...T6	1SDA051358R1	
	UVD 110...125V AC/DC T1...T6	1SDA051360R1	
T7-T7M	UVD 220...250V AC/DC T1...T6	1SDA051361R1	14,190
	UVD 24/30V AC/DC E1/6 - T7-T7M-X1	1SDA038316R1	
	UVD 48V AC/DC E1/6 - T7-T7M-X1	1SDA038317R1	
	UVD 60V AC/DC E1/6 - T7-T7M-X1	1SDA038318R1	
	UVD 110...125V AC/DC E1/6 - T7-T7M-X1	1SDA038319R1	
	UVD 220...250V AC/DC E1/6 - T7-T7M-X1	1SDA038320R1	

Note: Order along with relative UV release

Shunt closing release



Frame	Description	Ordering code	L.P. (₹)
T7M	SCR 24V AC/DC T7M-X1	1SDA062076R1	9,510
	SCR 30V AC/DC T7M-X1	1SDA062077R1	
	SCR 48V AC/DC T7M-X1	1SDA062078R1	
	SCR 60V AC/DC T7M-X1	1SDA062079R1	
	SCR 110...120V AC/DC T7M-X1	1SDA062080R1	
	SCR 120...127V AC/DC T7M-X1	1SDA063549R1	
	SCR 220...240V AC/DC T7M-X1	1SDA063550R1	
	SCR 240...250V AC/DC T7M-X1	1SDA062081R1	
	SCR 380...400V AC T7M-X1	1SDA062082R1	
	SCR 415...440V AC T7M-X1	1SDA062083R1	

Note: For T7 M in withdrawable version sliding blocks for fixed and moving parts are necessary.

Tmax accessories

Key lock

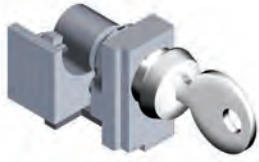

Key Lock - KLC			
Frame	Description	Ordering code	L.P. (₹)
KLC for Manual Breaker			
XT1....XT4	KLC XT1 KEY LOCK RONIS ON CB DIFF.KEY	1SDA066593R1	2,330
	KLC XT1 KEY LOCK RONIS ON CB TYPE A	1SDA066594R1	
	KLC XT1 KEY LOCK RONIS ON CB TYPE B	1SDA066595R1	
	KLC XT1 KEY LOCK RONIS ON CB TYPE C	1SDA066596R1	
	KLC XT1 KEY LOCK RONIS ON CB TYPE D	1SDA066597R1	
	KLC XT1 KEY LOCK RONIS EQ.FEL.A OP/CL	1SDA066598R1	
	KLC XT2-XT4 KEY LOCK RONIS SE.OP.xC.BRE.	1SDA066599R1	
	KLC XT2-XT4 KEY LOCK RONIS ON CB TYPE A	1SDA066600R1 ■	
	KLC XT2-XT4 KEY LOCK RONIS ON CB TYPE B	1SDA066601R1	
	KLC XT2-XT4 KEY LOCK RONIS ON CB TYPE C	1SDA066602R1	
	KLC XT2-XT4 KEY LOCK RONIS ON CB TYPE D	1SDA066603R1	
	KLC XT2-XT4 KEY LOCK RONIS EQ.FE.A OP/CL	1SDA066604R1	
	KLC XT3 KEY LOCK RONIS SEV.OP. X C.BREA.	1SDA066605R1	
	KLC XT3 KEY LOCK RONIS ON CB TYPE A	1SDA066606R1	
KLC XT3 KEY LOCK RONIS ON CB TYPE B	1SDA066607R1		
KLC XT3 KEY LOCK RONIS ON CB TYPE C	1SDA066608R1		
KLC XT3 KEY LOCK RONIS ON CB TYPE D	1SDA066609R1		
KLC XT3 KEY LOCK RONIS EQ.FEL.A OP/CL	1SDA066610R1		
T7	KLC-D Key Lock - Different Key in Open Position T7	1SDA062134R1	4,010
	KLC-S Same Key for Different Groups of Circuit Breakers (N. 20005) T7	1SDA062135R1	
	KLC-S Same Key for Different Groups of Circuit Breakers (N. 20006) T7	1SDA062136R1	
	KLC-S Same Key for Different Groups of Circuit Breakers (N. 20007) T7	1SDA062137R1	
	KLC-S Same Key for Different Groups of Circuit Breakers (N. 20008) T7	1SDA062138R1	
T7 M	KLC Arrangement for Ronis Key Lock T7	1SDA062139R1	4,240
	KLC Arrangement for Profalux Key Lock T7	1SDA062140R1	
	KLC-D Different Key in open Position T7M	1SDA062141R1	
	KLC-S Same Key for Different Groups of Circuit Breakers (N. 20005) T7M	1SDA062142R1	
	KLC-S Same Key for Different Groups of Circuit Breakers (N. 20006) T7M	1SDA062143R1	
KLC-S Same Key for Different Groups of Circuit Breakers (N. 20007) T7M	1SDA062144R1		
KLC-S Same Key for Different Groups of Circuit Breakers (N. 20008) T7M	1SDA062145R1		
KLC Same Key Ronis-Profalux T7M	1SDA062146R1		

Pad Lock - KLC			
Frame	Description	Ordering code	L.P. (₹)
KLC for Manual breaker			
XT1....XT4	PLL XT1-XT3 REMOV.PADL.DEVICE OPEN PLUG	1SDA066588R1	1,720
	PLL XT1-XT3 PADLOCKS DEVICE OPEN	1SDA066589R1	
	PLL XT2-XT4 PADLOCKS DEVICE OPEN	1SDA066590R1	
	PLL XT1-XT3 PADLOCKS DEVICE OP/CL	1SDA066591R1	
	PLL XT2-XT4 PADLOCKS DEVICE OP/CL	1SDA066592R1	

Key Lock for Rotary Handle - RHL			
Frame	Description	Ordering code	L.P. (₹)
XT1....XT4	RHL XT1..XT4 KEY LOCK RONIS SEVERAL	1SDA066617R1 ■	1,840
	RHL XT1..XT4 KEY LOCK RONIS TYPE A	1SDA066618R1 ■	
	RHL XT1..XT4 KEY LOCK RONIS TYPE B	1SDA066619R1	
	RHL XT1..XT4 KEY LOCK RONIS TYPE C	1SDA066620R1	
	RHL XT1..XT4 KEY LOCK RONIS TYPE D	1SDA066621R1	
	RHL XT1..XT4 KEY LOCK RONIS SEVER. OP/CL	1SDA066622R1	
	RHL XT1..XT4 KEY LOCK RONIS SEVER. OP/CL	1SDA069182R1	
	MOL-D XT1-XT3 KEY LOCK RONIS DIFF. KEY	1SDA066623R1	

■ Stock items

Tmax accessories

Key Lock for Front/Rotary/Fixed Part- KLF			
Frame	Description	Ordering code	L.P. (₹)
T5	KLF-D Lock for Front/Rotary Handle - Different Key in open Position T4-T5	1SDA054939R1	3,940
	KLF-S Block for Front/Rotary Handle - Same Key (N. 20005) T4-T5	1SDA054940R1 ■	
	KLF-S Block for Front/Rotary Handle - Same Key (N. 20006) T4-T5	1SDA054941R1	
	KLF-S Block for Front/Rotary Handle - Same Key (N. 20007) T4-T5	1SDA054942R1	
	KLF-S Block for Front/Rotary Handle - Same Key (N. 20008) T4-T5	1SDA054943R1	
T5-T6	KLF-D FP Different Key for Each Circuit Breaker T4-T5-T6	1SDA055230R1	3,740
	KLF-D FP Same Key for Different Groups of Circuit Breakers T4-T5-T6	1SDA055231R1	
	KLF-D Ronis Fixed Part- Lock Type Ronis T4-T5-T6	1SDA055233R1	
T6	KLF-D Different Key in open Position T6	1SDA060658R1	3,840
	KLF-S Same Key for Different Groups of Circuit Breakers (N. 20005) T6	1SDA060659R1	
	KLF-S Same Key for Different Groups of Circuit Breakers (N. 20006) T6	1SDA060660R1	
	KLF-S Same Key for Different Groups of Circuit Breakers (N. 20007) T6	1SDA060661R1	
	KLF-S Same Key for Different Groups of Circuit Breakers (N. 20008) T6	1SDA060662R1	
	KLF-D Different Key in open Position T7	1SDA063555R1	
T7	KLF-S Same Key for Different Groups of Circuit Breakers (N. 20005) T7	1SDA063556R1	3,840
	KLF-S Same Key for Different Groups of Circuit Breakers (N. 20006) T7	1SDA063557R1	
	KLF-S Same Key for Different Groups of Circuit Breakers (N. 20007) T7	1SDA063558R1	
	KLF-S Same Key for Different Groups of Circuit Breakers (N. 20008) T7	1SDA063559R1	
	KLF Arrangement for Ronis key lock T7	1SDA063560R1	
	KLF Arrangement for Profalux key lock T7	1SDA063561R1	

Key lock for motor operated- MOL

Frame	Description	Ordering code	L.P. (₹)
XT1-XT3	MOL-S XT1-XT3 KEY LOCK RONIS TYPE A	1SDA066624R1	3,990
	MOL-S XT1-XT3 KEY LOCK RONIS TYPE B	1SDA066625R1	
	MOL-S XT1-XT3 KEY LOCK RONIS TYPE C	1SDA066626R1	
	MOL-S XT1-XT3 KEY LOCK RONIS TYPE D	1SDA066627R1	
XT2-XT4	MOL-D XT2-XT4 KEY LOCK RONIS DIFF. KEY	1SDA066629R1	3,990
	MOL-S XT2-XT4 KEY LOCK RONIS TYPE A	1SDA066630R1	
	MOL-S XT2-XT4 KEY LOCK RONIS TYPE B	1SDA066631R1	
	MOL-S XT2-XT4 KEY LOCK RONIS TYPE C	1SDA066632R1	
	MOL-S XT2-XT4 KEY LOCK RONIS TYPE D	1SDA066633R1	
	MOL-M XT2-XT4 KEY LOCK RONIS MAN. OPER.	1SDA066634R1	
	MOL-D - Same Key T4-T5	1SDA054904R1	
T5	MOL-S - Same Key for Different Groups of Circuit Breakers (N. 20005) T4-T5	1SDA054905R1 ■	3,990
	MOL-S - Same Key for Different Groups of Circuit Breakers (N. 20006) T4-T5	1SDA054906R1	
	MOL-S - Same Key for Different Groups of Circuit Breakers (N. 20007) T4-T5	1SDA054907R1	
	MOL-S - Same Key for Different Groups of Circuit Breakers (N. 20008) T4-T5	1SDA054908R1	
T5-T6	MOL-M - Lock only on Manual Operation - Same Key T4-T5-T6	1SDA054909R1	3,990
	MOL-D - Different Key T6	1SDA060611R1	
T6	MOL-S - Same Key for Different Groups of Circuit Breakers (N. 20005) T6	1SDA060612R1	3,990
	MOL-S - Same Key for Different Groups of Circuit Breakers (N. 20006) T6	1SDA060613R1	
	MOL-S - Same Key for Different Groups of Circuit Breakers (N. 20007) T6	1SDA060614R1	
	MOL-S - Same Key for Different Groups of Circuit Breakers (N. 20008) T6	1SDA060615R1	



Motor operator with direct action - MOD

Frame	Description	Ordering code	L.P. (₹)
XT1-XT3	MOD XT1-XT3 24 V dc	1SDA066457R1	25,460
	MOD XT1-XT3 48...60 V dc	1SDA066458R1	
	MOD XT1-XT3 110...125 V ac/dc	1SDA066459R1	
	MOD XT1-XT3 220...250 V ac/dc	1SDA066460R1 ■	21,880
	MOD XT1-XT3 380...440 V ac	1SDA066461R1	
	MOD XT1-XT3 480...525 V ac	1SDA066462R1	



Tmax accessories



Stored Energy Motor Operator - MOE			
Frame	Description	Ordering code	L.P. (₹)
XT2-XT4	MOE XT2-XT4 24 V dc	1SDA066463R1	35,960
	MOE XT2-XT4 48...60 V dc	1SDA066464R1	
	MOE XT2-XT4 110...125 V ac/dc	1SDA066465R1	30,980
	MOE XT2-XT4 220...250 V ac/dc	1SDA066466R1 ■	
	MOE XT2-XT4 380...440 V ac	1SDA066467R1	35,960
	MOE XT2-XT4 480...525 V ac	1SDA066468R1	
T5	MOE 24 V DC T4-T5	1SDA054894R1	37,180
	MOE 48...60 V DC T4-T5	1SDA054895R1	
	MOE 110...125 V AC / DC T4-T5	1SDA054896R1	
	MOE 220...250 V AC / DC T4-T5	1SDA054897R1 ■	
	MOE 380 V AC T4-T5	1SDA054898R1	
T6	MOE 24 V DC T6	1SDA060395R1	46,110
	MOE 48...60 V DC T6	1SDA060396R1	
	MOE 110...125 V AC/DC T6	1SDA060397R1	
	MOE 220...250 V AC/DC T6	1SDA060398R1 ■	
	MOE 380 V AC T6	1SDA060399R1	



Stored energy motor operator with electronics - MOE-E			
Frame	Description	Ordering code	L.P. (₹)
XT2 - XT4	MOE-E XT2-XT4 24V dc X REM.CONTR.	1SDA066469R1	38,770
	MOE-E XT2-XT4 48...60V dc X REM.CONTR.	1SDA066470R1	
	MOE-E XT2-XT4 110..125V ac/d X REM.CONTR.	1SDA066471R1	
	MOE-E XT2-XT4 220..250V ac/dc X REM.CONTR.	1SDA066472R1	
	MOE-E XT2-XT4 380...440V ac X REM.CONTR.	1SDA066473R1	
	MOE-E XT2-XT4 480..525V ac X REM.CONTR.	1SDA066474R1	
T5	MOE-E 24 V DC T4-T5	1SDA054899R1	50,180
	MOE-E 48...60 V DC T4-T5	1SDA054900R1	
	MOE-E 110...125 V AC / DC T4-T5	1SDA054901R1	
	MOE-E 220...250 V AC / DC T4-T5	1SDA054902R1 ■	
T6	MOE-E 380 V AC T4-T5	1SDA054903R1	61,760
	MOE-E 24 V DC T6	1SDA060400R1	
	MOE-E 48...60 V DC T6	1SDA060401R1	
	MOE-E 110...125 V AC/DC T6	1SDA060402R1	
	MOE-E 220...250 V AC/DC T6	1SDA060403R1	
	MOE-E 380 V AC T6	1SDA060404R1	



Spring charging motor- M			
Frame	Description	Ordering code	L.P. (₹)
T7M	M 24...30V AC/DC T7M	1SDA062113R1	47,920
	M 48...60V AC/DC T7M	1SDA062114R1	50,430
	M 100...130V AC/DC T7M	1SDA062115R1	47,920
	M 220...250V AC/DC T7M	1SDA062116R1	
	M 380...415V AC T7M	1SDA062117R1	



High insulating terminal covers - HTC			
Frame	Description	Ordering code	L.P. (₹)
XT1...XT4	HTC XT1 3p TERMINAL COVERS HIGH 2pcs	1SDA066664R1	3,050
	HTC XT2 3p TERMINAL COVERS HIGH 2pcs	1SDA066666R1	3,460
	HTC XT3 3p TERMINAL COVERS HIGH 2pcs	1SDA066668R1	3,750
	HTC XT4 3p TERMINAL COVERS HIGH 2pcs	1SDA066670R1	4,180
	HTC XT1 4p TERMINAL COVERS HIGH 2pcs	1SDA066665R1	4,050
	HTC XT2 4p TERMINAL COVERS HIGH 2pcs	1SDA066667R1	4,580
	HTC XT3 4p TERMINAL COVERS HIGH 2pcs	1SDA066669R1	5,010
	HTC XT4 4p TERMINAL COVERS HIGH 2pcs	1SDA066671R1	5,550

■ Stock items

Tmax accessories



Low insulating terminal covers - LTC				
Frame	Description	Ordering code	L.P. (₹)	
XT1....XT4	LTC XT1 3p TERMINAL COVERS LOW 2pcs	1SDA066655R1	2,240	
	LTC XT2 3p TERMINAL COVERS LOW 2pcs	1SDA066657R1		
	LTC XT3 3p TERMINAL COVERS LOW 2pcs	1SDA066660R1		
	LTC XT4 3p TERMINAL COVERS LOW 2pcs	1SDA066662R1		
	T5	LTC XT1 4p TERMINAL COVERS LOW 2pcs	1SDA066656R1	2,600
		LTC XT2 4p TERMINAL COVERS LOW 2pcs	1SDA066659R1	
		LTC XT3 4p TERMINAL COVERS LOW 2pcs	1SDA066661R1	
		LTC XT4 4p TERMINAL COVERS LOW 2pcs	1SDA066663R1	
T5	LTC 3p T5	1SDA054968R1	3,140	
	LTC 4p T5	1SDA054969R1	4,110	
T6	LTC 3p T6	1SDA014038R1	3,430	
	LTC 4p T6	1SDA014039R1	4,540	
T7-T7M	LTC 3p T7-T7M	1SDA063093R1	5,200	
	LTC 4p T7-T7M	1SDA063094R1	6,650	

X3 connector			
Frame	Description	Ordering code	L.P. (₹)
T5-T6	X3 Connector for fixed circuit-breaker PR222DS or PR223DS	1SDA055059R1	4,280
	X3 Connector for plug-in/withdrawable circuit-breaker	1SDA055061R1	

X4 Connector			
Frame	Description	Ordering code	L.P. (₹)
T5-T6	X4 Connector for fixed circuit-breaker	1SDA055060R1	4,280
	X4 Connector for plug-in/withdrawable circuit-breaker	1SDA055062R1	



Residual current devices			
Frame	Description	Ordering code	L.P. (₹)
XT1	RC Inst x XT1 3p F	1SDA067122R1	24,040
	RC Sel x XT1 3p F	1SDA067123R1	
	RC Sel 200 x XT1 4p F	1SDA067121R1	
	RC Inst x XT1 4p F	1SDA067124R1	
	RC Sel x XT1 4p F	1SDA067125R1	
XT2	RC Sel x XT2 4p F	1SDA067126R1	50,870
	RC Inst x XT3 3p F	1SDA067127R1	59,610
	RC Sel x XT3 3p F	1SDA067128R1	66,220
XT3	RC Inst x XT3 4p F	1SDA067129R1	64,110
	RC B Type x XT3 4p F	1SDA067132R1	99,560
	RC Sel x XT3 4p F	1SDA067130R1	70,540
T5	RC222/5 4p Fixed T5	1SDA054955R1	72,700

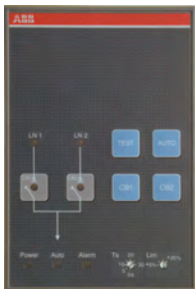

Automation transfer switch - ATS

Automatic transfer switch			
Frame	Description	Ordering code	L.P. (₹)
XT2-XT4/ T5- T7/ E1-E6	ATS021	1SDA065523R1	98,250
	ATS022	1SDA065524R1	1,07,800

Note : ATS will be used along with either two motorized ACB or MCCBs with required interlocking and changeover base plate as per the requirement.

Tmax accessories



Mechanical interlock between circuit breakers			
Frame	Description	Ordering code	L.P. (₹)
XT1...XT4	MIR-HR XT1..XT4 MECH INTERLOCK HOR. 2 CB**	1SDA066637R1	16,520
	MIR-VR XT1..XT4 MECH INTERLOCK VER. 2 CB**	1SDA066638R1	
	MIR-P PLATE x XT1 F	1SDA066639R1	5,780
	MIR-P PLATE x XT2 F	1SDA066641R1	
	MIR-P PLATE x XT3 F	1SDA066643R1	
	MIR-P PLATE x XT4 F	1SDA066645R1	

Note : ** Following must be ordered to make the rear interlock.

1. A MIR-HR or MIR-VR
2. A plate MIR-P for each circuit breaker to be interlocked



Mechanical interlock between circuit breakers - MIR - to be used with copper spreaders only			
Frame	Description	Ordering code	L.P. (₹)
T5	MIR-HB Horizontal Interlock Frame Unit T4-T5	1SDA054946R1	12,530
	MIR-VB Vertical Interlock Frame Unit T4-T5	1SDA054947R1	
	MIR-P Plate for Interlock Type D T5 400 (F-P-W) or T5 630 (F)+T5 400 (F-P-W) or T5 630 (F)	1SDA054951R1	6,470
	MIR-P Plate for Interlock Type E T5 400 (F-P-W) or T5 630 (F) + T5 630 (P-W)	1SDA054952R1	
	MIR-P Plate for Interlock Type F T5 630 (P-W) + T5 630 (P-W)	1SDA054953R1	6,100
T6	MIR-H Horizontal Mechanical Interlock T6	1SDA060685R1	19,630
	MIR-V Vertical Mechanical Interlock T6	1SDA060686R1	

Note: For interlocking in T4-T5, Order both frame and plate unit

Mechanical interlock with cables between 2 circuit breakers			
Frame	Description	Ordering code	L.P. (₹)
T7-T7M	Cable Kit for InterlockT7-T7M	1SDA062127R1	8,400
	Cable Kit for InterlockT7-T7M with E1-6	1SDA064568R1	9,110
	Plate for Interlock T7-T7M Fixed	1SDA062129R1	32,280
	Plate for Interlock T7-T7M withdrawable	1SDA062131R1	34,510

Note: It is necessary to order 2 plates and one kit of cables



Accessories for electronic trip units			
Frame	Description	Ordering code	L.P. (₹)
	EKIP COM x LSI-LSIG-M/LRIU XT2-XT4 F/P	1SDA068661R1	21,780
	EKIP COM x LSI-LSIG-M/LRIU XT2-XT4 W	1SDA068662R1	
	KIT x CONNECTION Vaux 24Vdc XT2-XT4 F/P	1SDA066980R1	4,710
	KIT x CONNECTION Vaux 24Vdc XT2-XT4 W	1SDA066981R1	5,290

Note:- F/P: Fixed/Plug-in ; W:Withdrawable



Test and configuration unit			
Frame	Description	Ordering code	L.P. (₹)
XT2 - XT4	Ekip TT Trip test unit	1SDA066988R1	7,440

Bracket for fixing onto DIN rail			
Frame	Description	Ordering code	L.P. (₹)
XT1	KIT DIN50022 XT1 3p PLATE DIN	1SDA066652R1	1,850
	KIT DIN50022 XT1 4p PLATE DIN	1SDA066419R1	1,970
	KIT DIN50022 XT1+RC Sel 200 PLATE DIN	1SDA067134R1	2,160
	KIT DIN50022 XT1+RC PLATE DIN	1SDA067135R1	
XT3	KIT DIN50022 XT3 3p PLATE DIN	1SDA066420R1	2,340
	KIT DIN50022 XT3 4p PLATE DIN	1SDA066421R1	
	KIT DIN50022 XT3+RC PLATE DIN	1SDA067139R1	2,570
XT2	KIT DIN50022 XT2-XT4 PLATE DIN	1SDA066653R1	1,850



IP54 Protection for transmitted rotary handle			
Frame	Description	Ordering code	L.P. (₹)
XT1...XT4	IP54 Protection for transmitted rotary handle-RHE	1SDA066587R1	2,800

Tmax conversion kit

Plug-in and drawout conversion



Frame	Pole	Type	Description	Ordering code	L.P. (₹)
XT1			KIT P MP XT1 3p	1SDA066276R1	4,970
			XT1 P FP 3p EF	1SDA068183R1	9,120
XT2			KIT P MP XT2 3p	1SDA066278R1	5,530
			XT2 P FP 3p EF	1SDA068187R1	9,970
XT3			KIT P MP XT3 3p	1SDA066280R1	6,870
			XT3 P FP 3p EF	1SDA068192R1	10,260
XT4		Plug-in kit	KIT P MP XT4 3p	1SDA066282R1	8,050
			XT4 P FP 3p EF	1SDA068196R1	11,100
T5			KIT MP T5 400 P 3p	1SDA054843R1	10,170
			T5 400 P FP 3p EF	1SDA054749R1	18,340
			KIT MP T5 630 P 3p	1SDA054847R1	11,690
			T5 630 P FP 3p EF	1SDA054762R1	20,690
	3P				
XT2			KIT W MP XT2 3p	1SDA066284R1	9,150
			XT2 W FP 3p EF	1SDA068200R1	20,450
XT4			KIT W MP XT4 3p	1SDA066286R1	10,430
			XT4 W FP 3p EF	1SDA068204R1	21,470
T5		Drawout kit	KIT MP T5 400 W 3p	1SDA054845R1	15,580
			T5 400 W FP 3p EF	1SDA054755R1	32,460
			KIT MP T5 630 W 3p	1SDA054849R1	20,030
			T5 630 W FP 3p EF	1SDA054768R1	33,640
T6			KIT MP T6 630/800 W 3p	1SDA060390R1	22,820
			T6 W FP 3p EF	1SDA060384R1	47,930
T7			KIT MP T7-T7M-X1 W 3p	1SDA062162R1	37,040
			T7-X1 W FP 3p EF-EF	1SDA062045R1	77,820

Note:

The plug-in version must be composed as follows:

- 1) Fixed circuit-breaker
- 2) Conversion kit from fixed into moving part of plug-in
- 3) Fixed part of plug-in
- 4) For T5 630 -circuit-breaker and switch-disconnector in Plug-in and withdrawable version In max = 570 A

Note:

The withdrawable version must be composed as follows:

- 1) Fixed circuit-breaker
- 2) Conversion kit from fixed into moving part of withdrawable
- 3) Fixed part of withdrawable
- 4) Front for lever operating mechanism or rotary handle or motor operator
- 5) Sliding contacts blocks if the circuit-breaker is automatic or fitted with electrical accessories (only for T7)
- 6) For T5 630 -circuit-breaker and switch-disconnector in Plug-in and withdrawable version In max = 570 A

Tmax conversion kit

Plug-in and drawout conversion



Frame	Pole	Type	Description	Ordering code	L.P. (₹)
XT1	4P	Plug-in kit	KIT P MP XT1 4p	1SDA066277R1	6,610
			XT1 P FP 4p EF	1SDA068185R1	12,450
XT2	4P	Plug-in kit	KIT P MP XT2 4p	1SDA066279R1	7,220
			XT2 P FP 4p EF	1SDA068190R1	13,620
XT3	4P	Plug-in kit	KIT P MP XT3 4p	1SDA066281R1	8,120
			XT3 P FP 4p EF	1SDA068194R1	14,310
XT4	4P	Plug-in kit	KIT P MP XT4 4p	1SDA066283R1	10,540
			XT4 P FP 4p EF	1SDA068198R1	14,780
T5	4P	Drawout kit	KIT MP T5 400 P 4p		13,730
			T5 400 P FP 4p EF	1SDA054752R1	21,900
T5	4P	Drawout kit	KIT MP T5 630 P 4p	1SDA054848R1	16,060
			T5 630 P FP 4p EF	1SDA054765R1	25,410
XT2	4P	Drawout kit	KIT W MP XT2 4p	1SDA066285R1	12,450
			XT2 W FP 4p EF	1SDA068202R1	27,110
XT4	4P	Drawout kit	KIT W MP XT4 4p	1SDA066287R1	13,620
			XT4 W FP 4p EF	1SDA068206R1	28,650
T5	4P	Drawout kit	KIT MP T5 400 W 4p	1SDA054846R1	21,900
			T5 400 W FP 4p EF	1SDA054758R1	40,600
T5	4P	Drawout kit	KIT MP T5 630 W 4p	1SDA054850R1	24,250
			T5 630 W FP 4p EF	1SDA054771R1	49,950
T6	4P	Drawout kit	KIT MP T6 630/800 W 4p	1SDA060391R1	27,880
			T6 W FP 4p EF	1SDA060387R1	61,900
T7	4P	Drawout kit	KIT MP T7-T7M-X1 W 4p	1SDA062163R1	43,020
			T7-X1 W FP 4p EF-EF	1SDA062049R1	1,03,750

Accessories:

Frame / Type	Description	Ordering code	L.P. (₹)
Connector	Socket-plug panel connector with 3PINS (XT1...XT4)	1SDA066409R1	1,400
	Socket-plug panel connector with 6PINS (XT1...XT4)	1SDA066410R1	2,730
	Socket-plug panel connector with 9PINS (XT1...XT4)	1SDA066411R1	4,120
	Socket-plug panel connector with 15PINS (XT1...XT4)	1SDA066412R1	6,770
	Socket-plug connector of moving part 12PINS (XT2...XT4)	1SDA066413R1	7,310
	Socket-plug connector of fixed part 12PINS (XT2...XT4)	1SDA066414R1	
	Connector 4th pole SOR-PS-SOR (XT2...XT4)	1SDA066415R1	1,390
	Connector 4th pole UVR (XT2...XT4)	1SDA066418R1	1,280
	ADP 5pin SOR-C /UVR-C T4-T5-T6 P/W	1SDA055173R1	2,370
	ADP 6pin AUX -C T4-T5-T6 P/W	1SDA054922R1 ■	2,050
	ADP 10pin MOE AUE -C T4-T5-T6 P/W	1SDA054924R1	2,600
	ADP 12pin AUX -C T4-T5-T6 P/W	1SDA054923R1	3,320
	MOT T7M	LEFT SLIDING CONTAC.MP C.BR.T7-T7M-X1	1SDA062164R1
LEFT SLIDING CONTAC.FP C.BR.T7M-X1		1SDA062167R1	8,050
SOR/SCR/UVR/AUX - T7-T7M	RIGHT SLIDING CONTAC.MP C.BR.T7-T7M-X1	1SDA062166R1	5,460
	RIGHT SLIDING CONTAC.FP C.BR.T7M-X1	1SDA062169R1	8,050
Central Block for T7-T7M	Central block - MP T7 - T7M	1SDA062165R1	5,460
	Central block - FP T7 - T7M	1SDA062168R1	8,050

■ Stock items

Tmax PV: Photovoltaic range molded case switch disconnecter



Tmax PV is the latest T Generation product up to 1600 A/1100 V DC/1500V DC.

- IEC 60947-3 certification
- 6 different sizes: from the compact T1 (which can be mounted on DIN rail) to high-performance
- T7, available in the two versions, with lever operating mechanism and motor operator
- Rated insulation voltage up to 1150 V DC/1500V DC
- Advantages like
 - excellent performance-dimensions
 - vast and complete range of accessories for all requirements
 - complete remote control with MOE options

Rated current In (A)	Rated voltage	Description	Version / Poles	Ordering code	L.P. (₹)
160	1100 V DC	T1D/PV 160 4p F FC Cu 1100V DC	Fixed / 4p	1SDA069816R1	Upon request
200		T3D/PV 200 4p F FC Cu 1100V DC	Fixed / 4p	1SDA069822R1	
250		T4D/PV 250 4p F F 1100V DC	Fixed / 4p	1SDA069823R1	
500		T5D /PV 500 4p F F 1100V DC	Fixed / 4p	1SDA069824R1	
800		T6D/PV 800 4p F F 1100V DC	Fixed / 4p	1SDA069825R1	
1250		T7D/PV 1250 4p F F 1100V DC	Fixed / 4p	1SDA069826R1	
1250M		T7D/PV 1250 4p F F M 1100V DC	Fixed / 4p	1SDA069827R1	
1600		T7D/PV 1600 4p F F 1100V DC	Fixed / 4p	1SDA069828R1	
1600M		T7D/PV 1600 4p F F M 1100V DC	Fixed / 4p	1SDA069829R1	

Rated current In (A)	Rated voltage	Description	Version / Poles	Ordering code	L.P. (₹)
250	1500V DC	T4D/PV-E 250 4p F F 1500V DC	Fixed / 4p	1SDA073559R1	Upon request
500		T5D/PV-E 500 4p F F 1500V DC	Fixed / 4p	1SDA076898R1	
1250		T7D/PV-E 1250 4p F F M 1500V DC	Fixed / 4p	1SDA073560R1	
1600		T7D/PV-E 1600 4p F F M 1500V DC	Fixed / 4p	1SDA073561R1	Upon request
250		KIT 2JUMPER U 2+2PS T4D/PV 250	Kit jumpers	1SDA070454R1	
500		KIT 2JUMPER U 2+2PS T5D/PV-E 500	Kit jumpers	1SDA076899R1	
1250		KIT JUMPER U 2+2PS T7D/PV 1250	Kit jumpers	1SDA070429R1	
1600	KIT JUMPER U 2+2PS T7D/PV 1600	Kit jumpers	1SDA070431R1		

*For information contact our nearest sales office

*Jumper kit is compulsory to order with 1500V DC version

FORMULA DSA Molded case circuit breaker

New low voltage molded case circuit breakers up to 630A

General characteristics

- Conforms to IEC 60947-2
- Fixed thermal magnetic release throughout the range
- Compact dimensions
- Common range of accessories
- Available in 1P, 2P, 3P & 4 pole versions
- Line-load reversibility
- Suitable for DC application till 250Vdc
- Operation voltage till 550VAC, insulation voltage of 690VAC and impulse voltage of 6KV

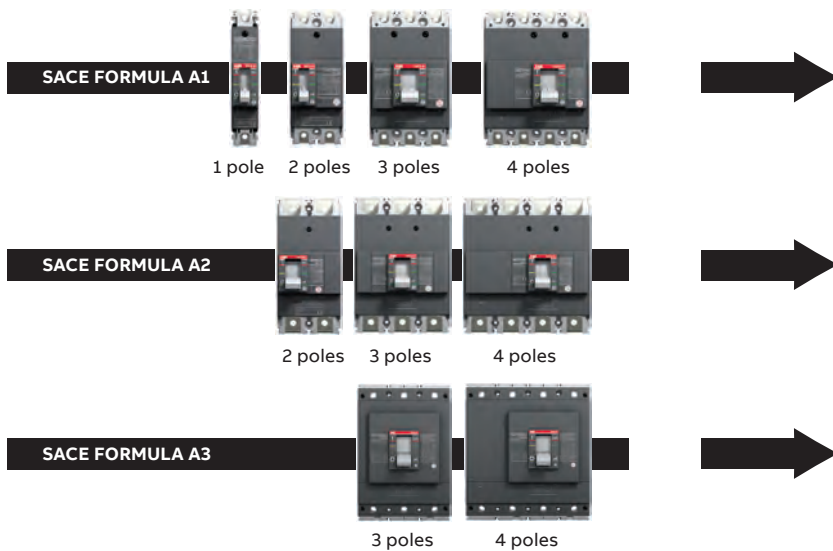

FORMULA A1

- Rated current, I_n 15...125A
- 1, 2, 3, 4 pole versions
- I_{cu} = 10, 18, 25, 36KA

FORMULA A2

- Rated current, I_n 125...250A
- 2, 3, 4 pole versions
- I_{cu} = 18, 25, 36KA

FORMULA A3

- Rated current, I_n 320...630A
- 3, 4 pole versions
- I_{cu} = 36, 50KA

FORMULA link system

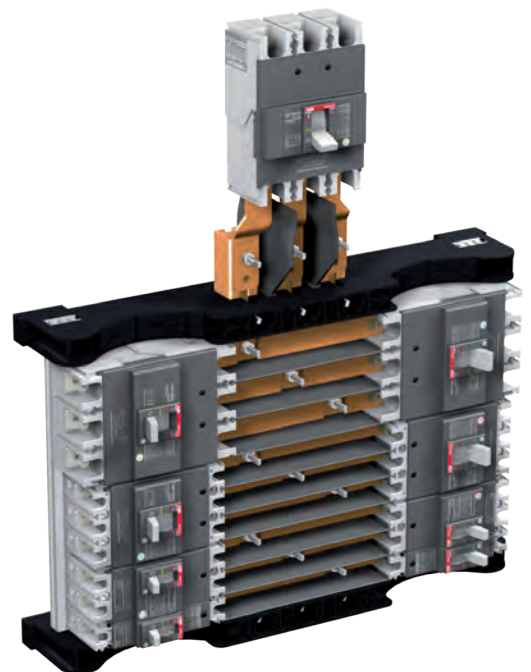
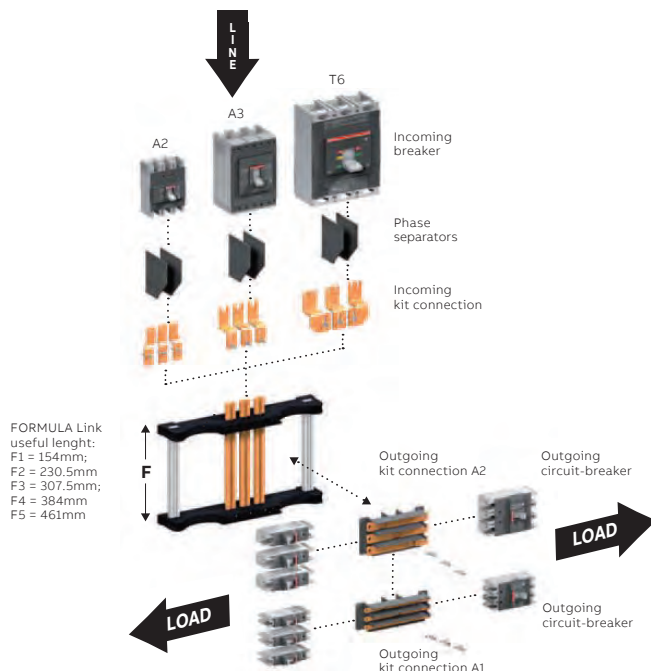

FORMULA DSA Molded case circuit breaker

- FORMULA link in accordance with IEC 60439 Standard
- FORMULA link is a component of a power distribution system which divides the main power supply over different users
- The FORMULA link is characterised on the supply side by a main circuit-breaker which protects the whole distribution system, and on the load side by smaller sized circuit-breakers, dedicated to the individual users
- FORMULA link assembly for total discrimination between upstream and downstream devices

FORMULA link - Electrical characteristics

FORMULA link frame	[A]	250	400	630/800
Incoming breaker		A2	A3	T6
Outgoing breaker		A1	A1-A2	A1-A2
Rated operational voltage 50/60 Hz	[V]	550AC	550AC	550AC
Rated insulation voltage	[V]	690AC	690AC	690AC
Rated short time withstand current (1s)	[KA]	30	40	40



Fixed thermal and fixed magnetic MCCB

A1 125 TMF

A1A 125 Icu = 10KA

A 1B 125 Icu = 18KA

A 1C 125 Icu = 25KA

A 1N 125 Icu = 36KA

In(A)	Poles	Ordering code	L.P. (₹)	Ordering code	L.P. (₹)	Ordering code	L.P. (₹)	Ordering code	L.P. (₹)
25	3	1SDA066512R1 ■	4,150	1SDA066699R1	5,540	1SDA066711R1	6,510	1SDA066723R1	7,920
32		1SDA068757R1 ■		1SDA068758R1 ■		1SDA068759R1 ■		1SDA068760R1	
40		1SDA066514R1 ■		1SDA066701R1		1SDA066713R1		1SDA066725R1	
50		1SDA066515R1 ■		1SDA066702R1		1SDA066714R1		1SDA066726R1	
63		1SDA068768R1 ■		1SDA068769R1 ■		1SDA068770R1 ■		1SDA068771R1 ■	
80		1SDA066518R1 ■		1SDA066705R1		1SDA066717R1 ■		1SDA066729R1	
100		1SDA066520R1 ■		1SDA066707R1 ■		1SDA066719R1 ■		1SDA066731R1 ■	
125	1SDA066521R1 ■	4,900	1SDA066708R1 ■	6,360	1SDA066720R1 ■	7,120	1SDA066732R1 ■	8,330	
25	4	1SDA066526R1	5,570	1SDA066735R1	7,210	1SDA066747R1	8,640	1SDA066759R1	9,860
32		1SDA068761R1 ■		1SDA068762R1		1SDA068763R1 ■		1SDA068764R1	
40		1SDA066528R1		1SDA066737R1		1SDA066749R1		1SDA066761R1	
50		1SDA066529R1		1SDA066738R1		1SDA066750R1		1SDA066762R1	
63		1SDA068772R1 ■		1SDA068773R1 ■		1SDA068774R1 ■		1SDA068775R1 ■	
80		1SDA066532R1		1SDA066741R1		1SDA066753R1		1SDA066765R1	
100		1SDA066534R1 ■		1SDA066743R1 ■		1SDA066755R1 ■		1SDA066767R1 ■	
125	1SDA066535R1 ■	5,950	1SDA066744R1 ■	7,630	1SDA066756R1 ■	9,080	1SDA066768R1 ■	10,570	

FORMULA DSA Molded case circuit breaker

A2 250 TMF

In(A)	Poles
160	3
200	
250	
160	4
200	
250	

A2B 250 Icu = 18KA

Ordering code	L.P. (₹)
1SDA066549R1 ■	10,960
1SDA066551R1 ■	12,800
1SDA066553R1 ■	13,750
1SDA066555R1 ■	14,330
1SDA066557R1 ■	16,370
1SDA066559R1 ■	17,840

A2C 250 Icu = 25KA

Ordering code	L.P. (₹)
1SDA066776R1 ■	11,690
1SDA066778R1 ■	13,750
1SDA066780R1 ■	14,690
1SDA066788R1 ■	15,250
1SDA066790R1 ■	17,660
1SDA066792R1 ■	20,240

A2N 250 Icu = 36KA

Ordering code	L.P. (₹)
1SDA066782R1 ■	11,940
1SDA066784R1 ■	15,060
1SDA066786R1 ■	16,880
1SDA066794R1 ■	15,600
1SDA066796R1 ■	19,500
1SDA066798R1 ■	21,500

A3 400/630 TMF

In(A)	Poles
320	3
400	
500	
630	

A3N Icu = 36KA

Ordering code	L.P. (₹)
1SDA066560R1	33,060
1SDA066561R1	
1SDA066564R1	40,410
1SDA066566R1	46,820

A3S Icu = 50KA

Ordering code	L.P. (₹)
1SDA066562R1	36,210
1SDA066563R1	
1SDA066565R1	42,860
1SDA066567R1	47,980

A3 400/630 TMF

In(A)	Poles
320	4
400	
500	
630	

A3N Icu = 36KA

Ordering code	L.P. (₹)
1SDA066568R1	41,510
1SDA066569R1	
1SDA066572R1	51,850
1SDA066574R1	60,100

A3S Icu = 50KA

Ordering code	L.P. (₹)
1SDA066570R1	45,820
1SDA066571R1	
1SDA066573R1	54,480
1SDA066575R1	62,960

Accessories

Terminals			
Front extended spread terminal - ES	Poles	Ordering code	L.P. (₹) 6 pieces
A1	3P	1SDA082242R1 ■	660
A2		1SDA082247R1 ■	1,860

Terminals			
Front extended spread terminal - ES	Poles	Ordering code	L.P. (₹) 8 pieces
A1	4	1SDA082243R1 ■	910
A2		1SDA082248R1 ■	2,080

	Description	A1-A2	
		Ordering code	L.P. (₹)
Rotary handle	RHD - Operating mechanism direct handle	1SDA066154R1 ■	1,610
	RHE - Operating mechanism transmitted handle	1SDA066158R1 ■	1,520
Shunt opening release – SOR-C Cabled version	SOR-C 220...240 VAC - 220...250 VDC	1SDA066137R1	1,850
	SOR-C 380...440 VAC	1SDA066138R1	1,850
Auxiliary contacts – AUX-C Cabled version	AUX-C 1Q + 1SY 250 VAC/DC	1SDA066149R1	2,150
	AUX-C 1Q 250V AC/DC A1-A2	1SDA066258R1 ■	910
Undervoltage release – UVR-C Cabled version	UVR-C 220...240 VAC - 220...250 VDC	1SDA066146R1	3,390
	UVR-C 380...440 VAC	1SDA066147R1	

■ Stock items

Switches

ABB has a wide portfolio of low voltage switches. They are suitable for diverse applications, in motor control centers, in switch boards and as main switches in various equipments and machines. From single to 8 poles and combination switches for change-over, automatic transfer, bypass, reversing, etc.

Switch disconnectors 16 – 4000 A

The switch disconnector is largely used as the main switch in low voltage switchgears for distribution of power, starting and stopping motors and isolating loads during maintenance.

The range from 16 to 125 Amps are either base plate or door mounted by snap-on or screw fitting front operated 3, 4, 6 and 8-pole are available as standard.

From 160 to 4000 Amps the switch disconnectors, also called load break switches, are designed as pole modules and they are available as 1, 2, 3 and 4-pole versions, front or side operated.

Switch disconnectors OTDC and OTDCP 10 – 1600 A

The OTDC range of switch-disconnectors is specially designed for DC applications. Thanks to a compact design, efficiency and reliability, OTDC switches bring photovoltaic installations to the next level.

Switch disconnector fuses 16 – 1250 A

The switch disconnector fuse is used as the main switch in low voltage switchgears in industry for distributing power and protecting motors, cables and other devices against short circuits and over loads.

The switch disconnector fuses are available for all types of fuse links, DIN, BS, NFC, UL, CSA.

The range includes single pole to four pole versions, front-or side-operated. The pole module design enables location of the operating mechanism in any position together with the direction of the terminals giving flexibility to installation in different types of cubicle designs.

Change-over and transfer switches 16 – 3200 A

ABB's change-over and transfer switches are designed to transfer loads from one power source to another in a wide variety of applications.

The range includes switches from 16 to 3200 Amperes, which can be operated manually, remotely by using a motor or automatically.

ABB's change-over and transfer switches are tested according to IEC 60947-6-1 and IEC 60947-3 standards. The switches have ratings in AC31 and AC33 utilization categories, up to 415 V. In motorized switches, the motor operators have a wide voltage operation range.

Enclosed switches 16 – 1600 A

The ABB enclosed switches are suitable for power distribution in factories and buildings, as local motor isolators and as main switches. Each incoming supply shall be provided with a hand operated main switch-disconnector according to the Machine Directive EN 60204 and isolate reliably the electrical equipment from the supply.

ABB enclosed switches are designed and tested to meet these requirements and complies with IEC 60 947-3.

The enclosed switches are easy to install and safe to use in industrial, public and residential environments. The indication of the handle is always reliable and lockable in the OFF-position with a standard padlock. ABB's long experience in switch disconnects guarantees a long and safe use.

Auto Transfer Switches 40 – 4000 A

Technologies for external environment Complete range 40-4000 A. ABB offers a wide selection of automatic transfer switches (ATS). They have the features and functionality that make them suitable for diverse applications.





Optimized two-poles 1500V DC switch disconnectors

Small sized and with increased
efficiency and performance

A fully optimized range of two-pole DC switch-disconnectors for 1500V utility-scale photovoltaic power plants covering 315-800A current range. The new design offers both a size reduction and an increase in efficiency and performances, helping manufacturers to adapt quickly to the industry's rapid adoption of 1500V DC solutions. A switch range that allows manufacturers and utilities to improve their systems efficiency, lowering power losses and reducing the size of combiner boxes, enclosures and inverters. <https://go.abb/otdc>

ABB

DC switch disconnectors for PV application



OTDC 10...32A

- Modular design
- Simple and fast installation
- DIN rail or screw mounted
- Tunnel terminals for easy termination
- Shortcircuit bars are pre-installed as standard
- Maximum energy efficiency
- Available in plastic enclosure



OTDC 100A....1600A

- ABB offers a compact DC switch range for single and multi circuit disconnecting
- Carefully designed arc plates and dual magnetic breaking, breaking power is optimized across the entire current range
- As a result of symmetric pole design, the connections are independent of polarity. The user can make the connections in both ways
- OTDC is the only DC switch in the market that has visible contacts
- The mechanism can be located between the poles or on the side of the switch
- Special four pole versions can be made for double circuit applications
- The operation of the switch is not vulnerable to voltage peaks and it is independent of the user (quick make quick brake)
- The switches are available in direct mounting handle version as well as external door mounted handle version
- The power losses are very low, results in high efficiency



Rated current In (A)	Rated voltage	Description	Ordering code	L.P. (₹)
10	1000 V DC	OTDC16F2	1SCA121454R1001	Upon request
16		OTDC16F3	1SCA121457R1001	
25		OTDC25F3	1SCA121458R1001 ■	
32		OTDC32F3	1SCA121459R1001 ■	
100		OTDC100E11K	1SCA127730R1001	
160		OTDC160E11K	1SCA127736R1001	
200		OTDC200E11K	1SCA127739R1001 ■	
250		OTDC250E11K	1SCA127742R1001 ■	
315		OTDC315F11K	1SCA158258R1001	
400		OTDC400F11K	1SCA158266R1001	
500		OTDC500F11K	1SCA158274R1001	
630		OTDC630F11K	1SCA158282R1001	
800		OTDC800F11K	1SCA158854R1001	
1000		OTDC1000F22 *	1SCA161286R1001	
315	1500 V DC	OTDC315FV11K	1SCA158260R1001	Upon request
400		OTDC400FV11K	1SCA158268R1001	
500		OTDC500FV11K	1SCA158276R1001	
630		OTDC630FV11K	1SCA158284R1001	
800		OTDC800FV11K	1SCA158857R1001	
1000		OTDC1000FV22 *	1SCA161288R1001	

Note: The above are direct mounted handle version, we also offer door mounted handle as suffix P version of same ratings.
 * Handled to be consider extra

■ Stock items **For information contact our nearest sales office

ONE20

Enclosed switches for residential and commercial installations

ONE20

Switches can be used as main switches or for local isolation in various applications, such as HVAC, residential water pumps and heat pumps or commercial lighting.

High quality

ABB is a synonym of quality: each ONE20 switch is tested and approved at the factory. The enclosures are made of durable materials with high UV resistance, which makes it suitable for indoor or outdoor use.

Reduced installation time

Compression glands are included in the delivery. They can be easily installed on the threaded knock-out cable entry.

Simple and modern design

The enclosure is compact and has the same size for 2, 3 and 4 pole types. ONE20 is available in three colors.

Maximized safety

The handle can be padlocked in the OFF position with up to three padlocks and in ON position with one padlock.

Features

- Available in 2-, 3- and 4-pole versions
- Thermal current (Ith) 20A
- Color options: light grey, dark grey, red-yellow
- Weather proof enclosure due to high IP class (IP67) and
- UV resistant material



Enclosed switches ONE20

Poles	Description	Ordering code	L.P. (₹)
2	ONE20M2W	1SCA138456R1001	1,140
3	ONE20M3W	1SCA138457R1001	1,700
4	ONE20M4W	1SCA138459R1001	2,000
2	ONE20M2G	1SCA135532R1001	1,150
3	ONE20M3G	1SCA135535R1001	1,700
4	ONE20M4G	1SCA135538R1001	2,000
2	ONE20M2Y	1SCA135533R1001	1,150
3	ONE20M3Y	1SCA135536R1001	1,700
4	ONE20M4Y	1SCA135540R1001	2,000

Fusegear

Easyline - XLP

Fuse Switch Disconnecter 1, 2, 3 & 4P for both AC and DC application 160...630A

All units are applicable for AC voltage, and the 1-pole and 2-pole range are also rated for DC voltage. In addition to be used as single apparatus, the 3-pole range from size 00 to size 3 (160A - 630A) are also designed to be used in distribution systems by use of a busbar adapter for easy installation. The busbar adapters are available for 40 mm, and 60 mm distance in-between centre of the phases for each busbar

systems. The whole EasyLine range got a sturdy, uniform design that is operator friendly and safe with IP 30 from front in closed position and IP 20 in open position. EasyLine Fuse Switch Disconnectors are developed and type tested according to IEC60947-3 and based on a long history, going back to 1958 when we successfully introduced the manually dependent operated LHB.



Features

- All the XLP cable terminals can be delivered with integrated bolts for cable lugs or with integrated bridge clamps (BC) for easy direct cable connection
- Typetested according to EN60947-3
- Easy to recycle/EN14001 standards
- Quick-make operation device
- Integrated IP20 cable termination
- IP30 degree of protection from the front
- Replacement compatible to similar types in the market
- Voltage measuring from the front
- V-0 plastic materials

Advantages

- Easy to install
- Easy to operate
- Sturdy design
- High personal safety
- Wide range of cable terminals and snap-on accessories
- Compact, add-on Electronic Fuse Monitoring (EFM)
- Busbar adapters

Applications

- UPS: Uninterruptible Power Supply, used for the power supply for computer/servers, storage devices, communication network systems, industry control systems, etc.
- Telecom power supplies
- General protection in smaller distribution panels using 1-pole or 2-pole configurations AC or DC

Fusegear - Fuse switch disconnecter

Description	Ordering code	L.P. (₹)
XLP000-6CC	1SEP201428R0001	4,210
XLP00-6BC	1SEP101890R0002	5,420
XLP1-6BC	1SEP101891R0002	13,850
XLP2-6BC	1SEP101892R0002	21,670
XLP3-6BC	1SEP101975R0002	35,510

Fusegear

InLine II - ZLBM/ZHBM

Designed for the future

ABB is proud to introduce the latest technology of Fuse Switch Disconnectors to ensure the best stability and highest safety in the power distribution network.

The new generation InLine II also offers the highest level of personal safety during operation and service.



Features

- Available as 160A, 250A, 400A, 630A, 800 and 1250A types in combination with NH/DIN HRC Fuse Links acc. to EN/IEC 60269
- Type tested in accordance to EN/IEC 60947-3
- 1 - pole and 3 - pole variants
- For vertical and horizontal installations
- Designed for 185 mm busbar distance
- IP30 degree of protection from the front
 - Padlocking in open and closed position at the 3 - pole version
 - Padlocking in closed position at the 1 - pole version
- Park position with possible padlocking at the 1 - pole type
- Sealing solutions
- Wide range of accessories and cable terminal connections
- Compatible dimensions to equivalent products in the market

Advantages

- High level of personal safety by:
 - Safe and reliable operation ON/OFF
 - Safe and simple replacement of the NH fuse links

- Universal terminal bolts offering standing bolt or fixed nut for high flexibility of cable connections
- Variants with integrated V-clamps
- Available in two alternative depths (ZLBM/ZHBM), L-version (ZLBM) will save space in Cable Distribution Cabinets by offering reduced depth
- Easy installation of current transformers in the H-version (ZHBM)
- Variants with non corrosive steel materials (stainless steel)
- Designed for intelligent communication to support a high level of stability in the power distribution network

Applications

- Cable Distribution Cabinets (CDC)
- Low voltage distribution in compact secondary substations (CSS)
- Distribution boards for industry, housing and office buildings
- Installations

Vertical Fuse Switch Disconnectors

InLine II - ZLBM/ZHBM



ZLBM - 1-pole, Depth 121 mm

Type	Ie [A]	Description	Order code	L.P. (₹)	
Basic versions					
ZLBM00-1P-M8	160	3 x M8 Bolts	1SEP620010R1000	Upon request	
ZLBM00-1P-V	160	3 x V-Clamps	1SEP620010R1020		
ZLBM1-1P-M12	250	3 x M12 Universal Bolts	1SEP620011R1000		
ZLBM1-1P-V	250	3 x V-Clamps	1SEP620011R1020		
ZLBM2-1P-M12	400	3 x M12 Universal Bolts	1SEP620012R1000		
ZLBM2-1P-V	400	3 x V-Clamps	1SEP620012R1020		
ZLBM3-1P-M12	630	3 x M12 Universal Bolts	1SEP620013R1000		
ZLBM3-1P-V	630	3 x V-Clamps	1SEP620013R1020		
ZLBM800A-1P-M12	800	12 x M12 Universal Bolts	1SEP620014R1000		
ZLBM910A-1P-M12	910	2 x 3 M12 bolts	1SEP620053R1000		
ZLBM910A-1P-M12-MB	910	2 x 3 M12 bolts, connection on rear side	1SEP620053R1050		
Long terminal cover, 3U shaped busbar versions					
ZLBM00-1P-3U-M8	160	3 x M8 Bolts	1SEP620170R1200		
ZLBM1-L-1P-3U-M12	250	3 x M12 Universal Bolts	1SEP620171R1200		
ZLBM2-L-1P-3U-M12	400	3 x M12 Universal Bolts	1SEP620172R1200		
ZLBM3-L-1P-3U-M12	630	3 x M12 Universal Bolts	1SEP620173R1200		



ZLBM - 3-pole, Depth 121 mm

Type	Ie [A]	Description	Order code	L.P. (₹)	
ZLBM00 3-pole, 100 mm busbar distance. Cable shroud included.					
ZLBM00-100-3P-M8	160	3 x M8 Bolt	1SEP620150R3000	Upon request	
Basic versions					
ZLBM00-3P-M8	160	3 x M8 Bolts	1SEP620010R3000		
ZLBM00-3P-V	160	3 x V-Clamps	1SEP620010R3020		
ZLBM1-3P-M12	250	3 x M12 Universal Bolt	1SEP620011R3000		
ZLBM1-3P-V	250	3 x V-Clamps	1SEP620011R3020		
ZLBM2-3P-M12	400	3 x M12 Universal Bolt	1SEP620012R3000		
ZLBM2-3P-V	400	3 x V-Clamps	1SEP620012R3020		
ZLBM3-3P-M12	630	3 x M12 Universal Bolt	1SEP620013R3000		
ZLBM3-3P-V	630	3 x V-Clamps	1SEP620013R3020		
ZLBM800A-3P-M12	800	12 x M12 Universal Bolts	1SEP620014R3000		
ZLBM800A-3P-V	800	12 x V-Clamps	1SEP620014R3020		
ZLBM910A-3P-M12	910	2 x 3 M12 bolts	1SEP620053R3000		
ZLBM910A-3P-M12-MB	910	2 x 3 M12 bolts, connection on rear side	1SEP620053R3050		
ZLBM1250A-3P-M12	1250	12 x M12 Universal Bolt	1SEP620015R3000		
ZLBM1250A-3P-V	1250	12 x V-Clamps	1SEP620015R3020		
Without V-Clamps					
ZLBM00-3P-NOV	160	Without V-Clamps	1SEP620010R3010		
ZLBM1-3P-NOV	250	Without V-Clamps	1SEP620011R3010		
ZLBM2-3P-NOV	400	Without V-Clamps	1SEP620012R3010		
ZLBM3-3P-NOV	630	Without V-Clamps	1SEP620013R3010		
Long terminal cover, 3U shaped busbar versions					
ZLBM00-3P-3U-M8	160	3 x M8 Bolts	1SEP620170R3200		
ZLBM1-L-3P-3U-M12	250	3 x M12 Universal Bolts	1SEP620171R3200		
ZLBM2-L-3P-3U-M12	400	3 x M12 Universal Bolts	1SEP620172R3200		
ZLBM3-L-3P-3U-M12	630	3 x M12 Universal Bolts	1SEP620173R3200		

OFAF HRC fuse links and base, DIN-type

DIN -type fuse links, gG, 500 V, 80 kA

The ordering code includes one fuse link, the delivery batch is according to the column.

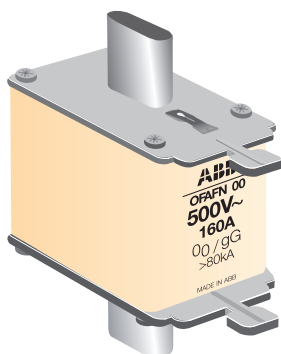

Fuse size	Rated current In (A)	Description	Delivery batch [pcs]	Ordering code	L.P. (₹)
000	2	OFAFN000GG2	6	1SCA107747R1001 ■	250
	6	OFAFN000GG6	6	1SCA107748R1001 ■	
	10	OFAFN000GG10	6	1SCA107749R1001 ■	
	16	OFAFN000GG16	6	1SCA107750R1001 ■	
	20	OFAFN000GG20	6	1SCA107751R1001 ■	
	25	OFAFN000GG25	6	1SCA107751R1002 ■	
	32	OFAFN000GG32	6	1SCA107752R1001 ■	
00	63	OFAFN000GG63	6	1SCA107753R1001 ■	570
	6	OFAFN00GG6	6	1SCA107754R1001	
	10	OFAFN00GG10	6	1SCA107755R1001	
	16	OFAFN00GG16	6	1SCA107756R1001	
	20	OFAFN00GG20	6	1SCA107757R1001	
	25	OFAFN00GG25	6	1SCA107758R1001	
	32	OFAFN00GG32	6	1SCA107759R1001 ■	
	50	OFAFN00GG50	6	1SCA107760R1001 ■	
	63	OFAFN00GG63	6	1SCA107761R1001 ■	
	80	OFAFN00GG80	6	1SCA107762R1001 ■	
	100	OFAFN00GG100	6	1SCA107763R1001 ■	
0	125	OFAFN00GG125	6	1SCA107764R1001 ■	1,100
	160	OFAFN00GG160	6	1SCA107765R1001 ■	
	160	OFAF0H160	3	1SCA022627R3170	
1	200	OFAF0H200	3	1SCA022629R5140 ■	820
	32	OFAFN1GG32	6	1SCA107766R1001	
	50	OFAFN1GG50	6	1SCA107767R1001	
	63	OFAFN1GG63	6	1SCA107768R1001	
	80	OFAFN1GG80	6	1SCA107769R1001	
	100	OFAFN1GG100	6	1SCA107770R1001	
	125	OFAFN1GG125	6	1SCA107771R1001	
	160	OFAFN1GG160	6	1SCA107772R1001 ■	
2	200	OFAFN1GG200	3	1SCA107773R1001 ■	1,200
	250	OFAFN1GG250	3	1SCA107774R1001 ■	
	100	OFAFN2GG100	3	1SCA107775R1001	
	125	OFAFN2GG125	3	1SCA107776R1001	
	250	OFAFN2GG250	3	1SCA107778R1001	
3	315	OFAFN2GG315	3	1SCA107779R1001 ■	1,860
	400	OFAFN2GG400	3	1SCA107780R1001 ■	
	315	OFAFN3GG315	3	1SCA107781R1001	
	500	OFAFN3GG500	3	1SCA107783R1001 ■	
4	630	OFAFN3GG630	3	1SCA107784R1001 ■	1,860
	800	OFAFN3GG800	3	1SCA107785R1001 ■	
	1250	OFAF4H1250	1	1SCA022627R7830	
4a	1250	OFAF4AH1250	1	1SCA022637R4360	Upon request



Fuse size	Rated current In (A)	Description	Ordering code	L.P. (₹)
00	160		1SCA833001R2001 ■	470
1	250	Fuse Base -	1SCA833001R2002 ■	950
2	400	Din type	1SCA833001R2003 ■	1,620
3	630		1SCA833001R2004 ■	2,160

■ Stock items

OFF HRC fuse links and base, BS-type

BS -type fuse links, gG, 415 V, 80 kA

The type code includes one fuse link, but the delivery batch is according to the column.



Fuse size	Rated current In [A]	Description	Delivery batch [pcs]	Ordering code	L.P. (₹)
Offset blade tag fuse link					
F1	2	OFFNF1GG2	10	1SCA107786R1001 ■	90
	4	OFFNF1GG4	10	1SCA107787R1001 ■	
	6	OFFNF1GG6	10	1SCA107788R1001 ■	
	10	OFFNF1GG10	10	1SCA107789R1001 ■	
	16	OFFNF1GG16	10	1SCA107790R1001 ■	
	20	OFFNF1GG20	10	1SCA107791R1001 ■	
	25	OFFNF1GG25	10	1SCA107792R1001 ■	
	32	OFFNF1GG32	10	1SCA107793R1001 ■	100
Offset bolted tag fuse link					
A2	6	OFFNA2GG6	10	1SCA107795R1001	120
	10	OFFNA2GG10	10	1SCA107796R1001	
	16	OFFNA2GG16	10	1SCA107798R1001	
	20	OFFNA2GG20	10	1SCA107827R1001	
	25	OFFNA2GG25	10	1SCA107800R1001	
A3	32	OFFNA2GG32	10	1SCA107801R1001 ■	150
	40	OFFNA3GG40	10	1SCA107803R1001 ■	
	50	OFFNA3GG50	10	1SCA107804R1001	
A4	63	OFFNA3GG63	10	1SCA107805R1001 ■	310
	50	OFFNA4GG50	10	1SCA107806R1001	
	63	OFFNA4GG63	10	1SCA107807R1001	
	80	OFFNA4GG80	10	1SCA107808R1001	
	100	OFFNA4GG100	10	1SCA107809R1001 ■	
	125	OFFNA4GG125	10	1SCA107810R1001 ■	
Central bolted tag fuse link					
B1	50	OFFNB1GG50	10	1SCA107811R1001	370
	63	OFFNB1GG63	10	1SCA107812R1001	
	80	OFFNB1GG80	10	1SCA107813R1001	
B2	100	OFFNB1GG100	10	1SCA107814R1001	560
	125	OFFNB2GG125	10	1SCA107816R1001	
	160	OFFNB2GG160	5	1SCA107817R1001 ■	
B3	200	OFFNB2GG200	5	1SCA107818R1001 ■	570
	250	OFFNB3GG250	1	1SCA107819R1001 ■	790
	315	OFFNB3GG315	1	1SCA107820R1001	850
B4	400	OFFNB4GG400	1	1SCA107822R1001	1,390
C1	400	OFFNC1GG400	1	1SCA107823R1001	2,110
C2	500	OFFNC2GG500	1	1SCA107824R1001	2,390
C2	630	OFFNC2GG630	1	1SCA107825R1001	2,390
C3	800	OFFNC3GG800	1	1SCA107826R1001	3,020



Fuse size	Rated current In [A]	Description	Delivery batch [pcs]	Ordering code	L.P. (₹)
F1	20	Control Fuse	100	1SYN833001R2005 ■	160
	32	Base	100	1SYN833001R2009 ■	200

OESA/OS switch disconnecter fuse, DIN-type

DIN type

32 - 800A SDF supplied with shaft and handle, Mechanism at the end of the switch fuse



Rated current In [A]	Poles	Recommend Fuse size	Description	Ordering code	L.P. (₹)	
32	2	000/ 00	OESA0032D2	1SYN790290P0492	2,390	
63			OESA0063D2	1SYN790290P0496	2,970	
100		00	OESA00100D2	1SYN790290P0508	5,740	
125			OESA125D2	1SYN790290P0511	7,670	
160		0	OESA00160D2	1SYN790290P0503	8,200	
200			OS200D02P	1SCA022759R9220	10,550	
250		0-1	OS250D02P	1SCA022760R0170	13,140	
315		0-2	OS315D02P	1SYN833040R2012	17,450	
400			OS400D02P	1SCA022811R2740	19,600	
630		3	OS630D02P	1SCA107745R1001	33,370	
800			OS800D02P	1SCA022837R2650	37,880	
1250		4	OS1250D02P	1SCA114051R1001	Upon request	
32		3	000/ 00	OESA00-32	1SYN790290P0493 ■	2,620
63				OESA 00-63	1SYN790290P0497 ■	3,600
100	00		OESA00100	1SYN790290P0509 ■	6,910	
125			OESA 00125	1SYN790290P0500 ■	9,260	
160	0		OESA00-160	1SYN790290P0504 ■	9,910	
200			OS200D03P	1SYN022709R9500 ■	12,770	
250	0-1		OS250D03P	1SYN022719R0090	15,880	
315	0-2		OS315D03P	1SYN953046P3001 ■	21,100	
400			OS400D03P	1SYN022719R0250 ■	23,720	
630	3		OS630D03P	1SYN022825R2830 ■	40,360	
800			OS800D03P	1SYN022825R4880 ■	42,960	
1250	4		OS1250D03P	1SCA105475R1001	Upon request	
32	TPN Neutral in mechanism (Wrapped)		000/ 00	OESA0032N ■	1SYN790290P0494	2,750
63				OESA0063N ■	1SYN790290P0498	3,710
100		00	OESA00100N ■	1SYN790290P0499	7,300	
125			OESA00125N ■	1SYN790290P0501	9,780	
160		0	OESA00160N ■	1SYN790290P0505	10,940	
200			OS200D03N3P	1SYN022749R8710 ■	13,820	
250		0-1	OS250D03N3P	1SYN022749R9430 ■	16,680	
315		0-2	OS315D03N3P	1SYN953047P3001 ■	22,390	
400			OS400D03N3P	1SYN022753R9320 ■	24,730	
630		3	OS630D03N3P	1SYN100858R1001 ■	41,000	
800			OS800D03N3P	1SYN100859R1001 ■	44,260	
1250		4	OS1250D03N3P	1SCA107932R1001	Upon request	
32		4 (Solid Neutral)	000/ 00	OESA 00-32A4	1SYN790290P0495	3,000
63				OESA 00-63A4	1SYN790290P0507 ■	3,920
100	00		OESA00100A4	1SYN790290P0510	7,570	
125			OESA00125A4	1SYN790290P0502	10,410	
160	0		OESA 00-160A4	1SYN790290P0506	11,720	
200			OS200D04N2P	1SYN022709R9680	15,110	
250	0-1		OS250D04N2P	1SYN022719R2380	17,720	
315	0-2		OS315D04N2P	1SYN953048P3001 ■	25,390	
400			OS400D04N2P	1SYN022719R2460 ■	27,330	
630	3		OS630D04N2P	1SYN022825R4290 ■	43,750	
800			OS800D04N2P	1SYN022825R5180 ■	49,670	
1250	4		OS1250D04N2P	1SCA105248R1001	Upon request	

Notes:
4th pole of all SFU's are 100% rated and are in the switched neutral (SN) version.

- Contact our nearest sales office
- For mechanism inbetween poles configuration
 - For motorized switch disconnecter fuse requirement
 - For 4th pole with fuse protection
 - For Switch disconnecter fuse with direct mounting handle

OESA/OS switch disconnecter fuse, BS-type

BS

32 - 800A SDF supplied with shaft and handle

Mechanism at the end of the switch fuse

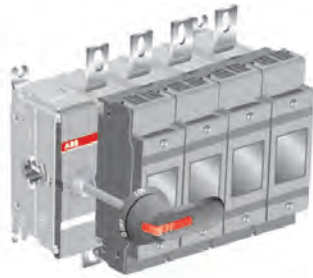

Rated current In [A]	Poles	Recommend Fuse size	Description	Ordering code	L.P. (₹)	
32	2	A2	OESA32G2	1SYN790290P0512	2,110	
63		A3	OESA63G2	1SYN790290P0516	2,890	
100		A4	OESA100G2	1SYN790290P0520	5,610	
125			OESA125G2	1SYN790290P0524	7,120	
160		B2	OESA160B2	1SYN790290P0528	7,760	
200		B1-B2	OS200B02P	1SCA022769R7820	9,380	
250		B1-B3	OS250B02P	1SCA022769R9440	11,950	
315		B1-B4	OS315B02P	1SCA022817R3450	17,350	
400			OS400B02P	1SCA022813R7220	17,650	
630		C1-C2	OS630B02P	1SCA113529R1001	30,670	
800		C1-C3	OS800B02P	1SCA022837R6480	36,620	
1250		D1	OS1250B02P	1SCA114070R1001	Upon request	
32		3	A2	OESA32G1	1SYN790290P0513	2,550
63			A3	OESA63G1	1SYN790290P0517 ■	3,470
100	A4		OESA100G1	1SYN790290P0521 ■	6,790	
125			OESA125G1	1SYN790290P0525	8,610	
160	B2		OESA160B3	1SYN790290P0529	9,380	
200	B1-B2		OS200B03P	1SYN022709R9330	11,340	
250	B1-B3		OS250B03P	1SYN022750R6660	14,460	
315	B1-B4		OS315B03P	1SYN022719R0680	20,970	
400			OS400B03P	1SYN022719R0840	21,360	
630	C1-C2		OS630B03P	1SYN022825R5850	37,100	
800	C1-C3		OS800B03P	1SYN022825R7550	44,260	
1250	D1		OS1250B03P	1SCA105250R1001	Upon request	
32	TPN		A2	OESA32G1N ■	1SYN790290P0514 ■	2,690
63			A3	OESA63G1N ■	1SYN790290P0518 ■	3,600
100		A4	OESA100G1N ■	1SYN790290P0522 ■	7,170	
125			OESA125G1N ■	1SYN790290P0526 ■	8,860	
160		B2	OESA160B3N ■	1SYN790290P0530	9,660	
200		B1-B2	OS200B03N3P	1SYN022750R0620 ■	12,130	
250		B1-B3	OS250B03N3P	1SYN022750R8010 ■	15,640	
315		B1-B4	OS315B03N3P	1SYN022753R8940	21,490	
400			OS400B03N3P	1SYN022753R9160	22,540	
630		C1-C2	OS630B03N3P	1SYN100860R1001	37,750	
800		C1-C3	OS800B03N3P	1SYN100861R1001	42,290	
1250		D1	OS1250B03N3P	1SCA107936R1001	Upon request	
32		4	A2	OESA32G4	1SYN790290P0515	3,080
63			A3	OESA63G4	1SYN790290P0519	3,920
100	A4		OESA100G4	1SYN790290P0523	8,460	
125			OESA125G4 ■	1SYN790290P0527	10,410	
160	B2		OESA160B4	1SYN790290P0531	11,720	
200	B1-B2		OS200B04N2P	1SYN022709R9410	15,240	
250	B1-B3		OS250B04N2P	1SYN022750R7800	17,970	
315	B1-B4		OS315B04N2P	1SYN022719R2710	25,770	
400			OS400B04N2P	1SYN022719R2890	26,040	
630	C1-C2		OS630B04N2P	1SYN022825R6230	44,910	
800	C1-C3		OS800B04N2P	1SYN022825R8010	51,430	
1250	D1		OS1250B04N2P	1SCA105469R1001	Upon request	

Note:
4th pole of all SFU's are 100% rated and are in the switched neutral (SN) version.

- Contact our nearest sales office
- For 1250A switch disconnecter fuse requirement
 - For mechanism in between poles configuration
 - For motorized switch disconnecter fuse requirement
 - For 4th pole with fuse protection

Accessories for OESA/OS switch disconnecter fuse, 32..800 A



Phase barriers

Frame	Pole	Height (mm)	Description	Ordering code	L.P. (₹)
OS200...400	3	100	PB100 low	1SDA054970R1 ■	1,120
	4	100	PB100 low	1SDA054971R1 ■	1,620



Auxiliary contacts

Frame	Contact function	Description	Ordering Code	L.P. (₹)
OESA 32...160	1NO+1NC	OESAZX 15	1SYN790290P0532	590
	2NO+2NC	OESAZX 16	1SYN790290P0533	1,140
OS200...800	1NO	OA1G10	1SCA022353R4970	620
	1NC	OA3G01	1SCA022456R7410	680
Screw mounting to the left side of the switch		OEA28	1SCA022714R8810 ■	810

Note: OEA 28 has to be order along with 200 & 250A TPN switch only



Fuse monitor

Frame	Rated voltage [Vac]	Description	Ordering code	L.P. (₹)
OS200...800	100...260	OFS260	1SCA022716R0180	8,410
	380...690	OFS690	1SCA022715R9920	8,620



Wrapped neutral link

Frame	Description	Ordering code	L.P. (₹)
OESA32...63	OESAZX87	1SYN790290P0534	530
OESA100	OESAZX 86/1	1SYN790290P0535	950
OESA125...160	OESAZX86	1SYN790290P0536	1,040
OS200...250	OXN250	1SCA022752R9950	4,790
OS315...400	OXN400	1SCA022770R3060	12,520
OS630...800	OXN800S	1SCA022831R4880	14,350

Handle adaptor

OHB145...OHB175	OHBZX200	1SCA125960R1001	1,490
-----------------	----------	-----------------	-------

Handles

Frame	Description	Ordering code	L.P. (₹)
OESA32...63	YASDB51	1SYN790290P0537	870
OESA100...160	YASDB10	1SYN790290P0538	1,310
OS200...250	OHB80J6	1SCA022381R0240 ■	1,800
OS315...400	OHB145J12	1SCA022381R2110	2,200
OS630...800	OHB175J12	1SCA022381R2450	2,610

Shaft

Frame	Description	Ordering code	L.P. (₹)
OESA/OS32...250	OXP6X210	1SCA022295R6080	460
OS315...400	OXP12X250	1SCA022325R6980	910
OS630...800	OXP12X280	1SCA022137R5140	1,170

Fuse covers for OESA switch disconnecter fuse

Frame	Type	Description	Ordering code	L.P. (₹)
32...63	DIN		1SYN833035R2012	90
32...63	BS	Fuse cover	1SYN833036R2012	90
100...160	DIN		1SYN833037R2012	100

Note: Ordering code mentioned above for fuse cover is per piece

OT switch disconnectors



Front operated switch-disconnectors with direct knob type handle

Rated current In [A]	Pole	Description	Ordering code	L.P.(₹)	Pole	Description	Ordering code	L.P.(₹)
16		OT16F3	1SCA104811R1001	1,300		OT16F4N2	1SCA104829R1001	1,630
25		OT25F3	1SCA104857R1001 ■	1,360		OT25F4N2	1SCA104886R1001	1,690
40		OT40F3	1SCA104902R1001	1,540		OT40F4N2	1SCA104932R1001	1,920
63	3	OT63F3	1SCA105332R1001	1,660	4	OT63F4N2	1SCA105365R1001	2,240
80		OT80F3	1SCA105798R1001	3,310		OT80F4N2	1SCA105413R1001	4,140
100		OT100F3	1SCA105004R1001	4,550		OT100F4N2	1SCA105018R1001	5,690
125		OT125F3	1SCA105033R1001	4,660		OT125F4N2	1SCA105051R1001	5,820

Door mounted switch-disconnectors with snap on and screw type mounting Handle for screw and snap on mouting to be ordered seperately



Rated current In [A]	Pole	Description	Ordering code	L.P.(₹)	Pole	Description	Ordering code	L.P.(₹)
16		OT16FT3	1SCA104838R1001 ■	1,430		OT16FT4N2	1SCA105711R1001	1,790
25		OT25FT3	1SCA104884R1001	1,780		OT25FT4N2	1SCA104900R1001	2,220
40		OT40FT3	1SCA104940R1001 ■	2,140		OT40FT4N2	1SCA104956R1001	2,670
63	3	OT63FT3	1SCA105382R1001	2,950	4	OT63FT4N2	1SCA105393R1001	3,690
80		OT80FT3	1SCA105431R1001	3,640		OT80FT4N2	1SCA105499R1001	4,550
100		OT100FT3	1SCA105023R1001	6,070		OT100FT4N2	1SCA105031R1001	7,580
125		OT125FT3	1SCA105060R1001	7,750		OT125FT4N2	1SCA105066R1001	9,690

OT switch disconnector accessories 16..125 A

Accessories for OT 16..125 F / FT



Screw mounting, hole distance 36 mm

Padlockable with max. 3 padlocks, IP65, hole distance 36/48 mm, NEMA 1, 3R, 12

Accessories for OT 16..125 F

Accessories for OT 16..125 FT

Frame	Description	Ordering code	L.P. (₹)	Description	Ordering code	L.P. (₹)
OT16...125F- Black	OHBS2AJ	1SCA105213R1001	680	OHBS2RJ	1SCA105232R1001	790
OT16...125F-Red-yellow	OHYS2AJ	1SCA105296R1001	820	OHYS2RJ	1SCA105323R1001	830

Note:

For any different arrangement kindly contact our nearest sales office.

Shafts

Suitable for all the switches in this section, OT16...125F

Frame	Description	Ordering code	L.P. (₹)
OT16...125F	OXS6X130	1SCA101655R1001 ■	520

■ Stock items

OT switch disconnectors

Front operated switch-disconnectors

OT 16A-3200A switch disconnector supplied with extended shaft and IP 65 pistol type handle



Contact our nearest sales office

- For Door mounted switch disconnector
- For different configuration of Shaft and Handle (selector type)
- For 6 & 8 pole switch disconnector requirement
- 1 pole switch disconnector also available on request

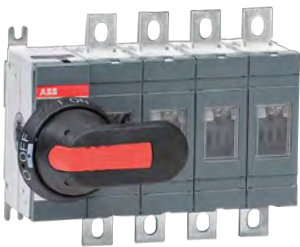

Note:

Contact our nearest sales office

- For requirement of motorized isolators
- For mechanism in between poles configuration
- For switch disconnector with direct mounted handle
- For side operated switches

Rated current In [A]	Poles	Description	Ordering code	L.P. (₹)
160	2	OT160EV02P	1SCA120508R1001	7,100
200		OT200E02P	1SCA022751R1400	7,540
250		OT250E02P	1SCA022735R2500	9,300
315		OT315E02P	1SCA022866R5590	10,700
400		OT400E02P	1SCA022741R7210	14,420
630		OT630E02P	1SCA022866R5670	18,080
800		OT800E02P	1SCA022835R4830	22,330
1000		OT1000E02P	1SCA105795R1001	46,480
1250		OT1250E02P	1SCA106136R1001	56,830
1600		OT1600E02P	1SCA106142R1001	75,760
2000		OT2000E02P	1SCA120025R1001	94,700
2500		OT2500E02P	1SCA113956R1001	1,18,380
3200	OT3200E02P	1SCA128581R1001	1,70,470	
4000	OT4000E02P	1SCA128595R1001	198,890	
16	3	OT16F3	1SYN104811R1001 ■	2,540
25		OT25F3	1SYN104857R1001 ■	2,570
40		OT40F3	1SYN104902R1001 ■	2,670
63		OT63F3	1SYN105332R1001 ■	2,700
80		OT80F3	1SYN105798R1001 ■	4,340
100		OT100F3	1SYN105004R1001 ■	5,790
125		OT125F3	1SYN105033R1001 ■	5,900
160		OT160G03P	1SCA135139R1001	7,490
160		OT160EV03P	1SCA120514R1001 ■	7,870
200		OT200E03P	1SCA022712R0800 ■	8,790
250		OT250E03P	1SCA022710R0100 ■	10,840
315		OT315E03P	1SCA022718R8510 ■	11,890
400	OT400E03P	1SCA022718R8780 ■	16,020	
630	OT630E03P	1SCA022718R8940 ■	19,850	
800	OT800E03P	1SCA022718R9410 ■	24,800	
1000	OT1000E03P	1SCA022860R5930 ■	48,540	
1250	OT1250E03P	1SCA022860R6230 ■	63,140	
1600	OT1600E03P	1SCA022860R6580 ■	84,180	
2000	OT2000E03P	1SCA108036R1001	1,03,130	
2500	OT2500E03P	1SCA104972R1001 ■	1,33,960	
3200	OT3200E03P	1SCA128481R1001	1,89,400	
4000	OT4000E03P	1SCA124848R1001	2,08,530	
16	4	OT16F4N2	1SYN104829R1001	2,740
25		OT25F4N2	1SYN104886R1001	2,850
40		OT40F4N2	1SYN104932R1001 ■	2,910
63		OT63F4N2	1SYN105365R1001	3,320
80		OT80F4N2	1SYN105413R1001 ■	5,700
100		OT100F4N2	1SYN105018R1001 ■	6,020
125		OT125F4N2	1SYN105051R1001 ■	6,210
160		OT160G04P	1SCA135140R1001	10,280
160		OT160EV04P	1SCA120521R1001 ■	10,840
200		OT200E04P	1SCA022713R4930 ■	11,070
250		OT250E04P	1SCA022710R0520 ■	12,630
315		OT315E04P	1SCA022719R1730 ■	13,440
400	OT400E04P	1SCA022719R1810 ■	17,260	
630	OT630E04P	1SCA022719R2030 ■	23,570	
800	OT800E04P	1SCA022719R2110 ■	28,400	
1000	OT1000E04P	1SCA022860R6150	64,030	
1250	OT1250E04P	1SCA022860R6310	80,550	
1600	OT1600E04P	1SCA022860R6740	1,03,280	
2000	OT2000E04P	1SCA108038R1001	1,24,170	
2500	OT2500E04P	1SCA105140R1001	1,58,240	
3200	OT3200E04P	1SCA128482R1001	2,16,590	
4000	OT4000E04P	1SCA124856R1001	2,46,510	

■ Stock items

OT switch disconnecter accessories



Handles

Frame	Description	Ordering code	L.P. (₹)
OT16...125	OHB45J6	1SCA022380R8770 ■	1,050
OT160...250	OHB65J6	1SCA022380R9660 ■	1,430
OT315...400	OHB95J12	1SCA022381R0830	1,650
OT630...800	OHB125J12	1SCA022381R1560 ■	1,780
OT1000...4000	OHB274J12	1SCA115920R1001 ■	5,050

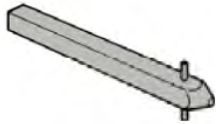

Shaft

Frame	Description	Ordering code	L.P. (₹)
OT16...125	OXp6X170	1SCA108224R1001 ■	390
OT160...250	OXp6X210	1SCA022295R6080	460
OT315...800	OXp12X185	1SCA022325R6710	720
OT1000...4000	OXp12X280	1SCA022137R5140	1,170



Auxiliary contact

Frame	Contact function	Description	Ordering code	L.P. (₹)
OT16...4000	1NO	OA1G10	1SCA022353R4970 ■	620
OT16...125	1NC	OA1G01	1SCA022353R4890 ■	620
OT160EV...4000	1NC	OA3G01	1SCA022456R7410 ■	680



Phase barrier

Frame	Poles	Description	Ordering code	L.P. (₹)
OT160...OT800	3	PB100 low	1SDA054970R1	1,120
OT160...OT800	4	PB100 low	1SDA054971R1	1,620
OT1000...2500	3 & 4	OTB1600/6	1SCA100768R1001	4,550
OT3200...4000	3 & 4	OTB4000/6	1SCA129040R1001	4,550



Mechanical interlock mechanism

(Prevents one switch from closing to ON-position, if the other is not in OFF-position)

Frame	Shaft distance [mm]	Description	Ordering code	L.P. (₹)
OT16...125	100	OTZW24	1SCA022639R5610	2,310
OT160...250	190	OTZW10	1SCA022431R5280	2,800
OT315...400	250	OETLZW14	1SCA022077R3410	7,130
OT315...800	300	OETLZW3	1SCA022049R0380	7,440
OT315...4000	500	OETLZW15	1SCA022081R9340	8,270



Terminal shrouds snap-on mounting, transparent

For 3-pole switches

Frame	Description	Ordering code	L.P. (₹)
OT 16...40F3	OTS40T3	1SCA105317R1001	400
OT63...80F3	OTS63T3	1SCA022353R6750 ■	290
OT 100...125F3	OTS125T3	1SCA022379R968	590

Note:

for requirement of terminal shrouds for higher current rating contact our nearest sales office

Enclosed switches

Wide range of enclosed heavy duty switches
From 16 to 1600 Amperes, 690 V



Enclosed switches are designed and used as main switches for applications, which need to be isolated from the network. The range includes front operated and side operated switch disconnectors, switch fuses and changeover switches enclosed in plastic, steel sheet or stainless steel sheet and aluminium enclosures. They are rated for utilization categories including disconnecting as well as making and breaking the load. In addition, the switch fuses equipped with fuse links protects the application and the cables from overload currents and short circuits.

Plastic enclosures

The plastic enclosures are most suitable for locations with high chemical and moisture requirements. In addition, they are light and easy to install and handle.

Steel sheet enclosures

The steel sheet enclosures are hot dip galvanized and the surface is polyester powder painted. The enclosures are durable and robust for various environments.

Stainless steel sheet enclosures

The stainless steel sheet enclosures are made of AISI 304 stainless steel. They are used particularly in the food and

beverage industry and in locations where high hygiene is required. The smooth surface does not require any painting and is easy to clean.

Aluminum alloy enclosures

Aluminum enclosures have very good impact strength and protection against UV light. They are suitable both for indoor and outdoor use in medium to heavy-duty applications.

Safety for personnel – reliable position indication

- Padlocking in the OFF-position with one, three or six (with the shackle L6) padlocks against unintentional start-up. The handle cannot be padlocked in the OFF-position if one of the contacts is not in the OFF position
- The cover cannot be removed if the handle is padlocked
- Door interlock in the ON-position
- Arc proof, short circuit durability function: Expander washers in aluminium enclosures with $I_e > 160$ A and door locking release in large metal sheet enclosures type MSC
- Door interlock defeatable with rectangular and pistol type handles

Zenith Auto Transfer Switch

Transfer/Bypass-Isolation Transfer Switches



Performance Features:

- Incorporates the applicable features of the ZTS and ZBTS Series
- Source parallel time of less than 100 milliseconds
- Closed transition operation (no power interruption) during transfer and retransfer when sources are within specified parameters
- Open transition transfer operation is initiated upon a source failure
- Available in ZTSCT (utility-generator), ZTSCTU (utility-utility) and ZTSCTM (manual) configurations
- Short Time rated 1600-3000A (Non-bypass) ATS for 0.50 sec and 1.0 sec time duration

Introduction:

ABB's Zenith ZBTS Series Bypass Isolation Transfer Switch consists of two major modules – the automatic transfer and the bypass isolation switches. The automatic transfer switch module is ABB's proven Zenith ZTS Series, built in ZTS, ZTSD or ZTSCT configuration and constructed for rugged, reliable operation. The same components – heavy-duty silver alloy contacts, rugged drive mechanism and silver plated bus bar inter-connections are used throughout the ZBTS Series.

Features and Benefits:

ABB's design requires no additional load break contacts. Therefore, they are not constantly exposed to the destructive effects of potential fault currents. All current carrying components provide high withstand current ratings in excess of those specified in UL 1008 standards.

Advantages:

- Load is not interrupted during bypass operation
- High close-in and withstand capability
- Temperature rise test per UL 1008 conducted after overload and endurance tests exceeds UL requirements
- Available in ZBTS (utility-generator), ZBTSU (utility-utility), ZBTSU (generator-generator) and ZBTSU (manual) configurations; models include standard, delayed and closed transition

Electrical ratings:

- Ratings 40 to 4000 amperes
- 2, 3 or 4 Poles
- Open type, NEMA 1, 3R, 4, 4X and 12
- Available to 600 VAC, 50 or 60 Hz
- Suitable for emergency and standby applications on all classes of load, 100% tungsten rated through 400 amps
- UL 1008 listed at 480 VAC
- CSA C22.2 No. 178 certified at 600 VAC
- IEC 947-6-1 listed at 480 VAC

Design and Construction Features:

- Electrically operated, mechanically held
- Segmented silver tungsten alloy contacts with separate arcing contacts on all sizes
- Arc quenching grids, enclosed arc chambers, and wide contact air gap
- Components accessible for inspection and maintenance without removal of the switch or the power conductors
- Standard annunciation and operational selection package for user interface
- Active control of the generator governor not required, but is available as an option



The world's first true ATS is here Introducing TruONE.

A critical breakthrough for critical power



What makes TruOne® unique

- One unit, One wire - just like an ATS should be
- Below 50 ms in-phase transfer
- IEC/UL1008 approved
- Overlapping neutral
- ABB Ability™: EDCS for cloud-based services
- Ekip Com modules for uniform platform
- Predictive maintenance
- Modular structure to simplify service

Automatic transfer switches - IEC

Ordering Information

Delayed transition – Open style, Level 2 DIP controls

I-O-II –operation with stable OFF position between positions I and II.

Delivery includes handle for manual operation, 2 m RJ45 connection cable between detachable HMI and ATS frame.

Terminal connection kits (bolts, nuts and washers) available as accessory.



OXB200...250E3X2Q



OXB315...400E3X2Q



OXB500...800E3X3Q



OXB1000...1600E3S2Q



OXB1000...1600E3X2Q

Bottom entry - Source 1 and Source 2 connections on bottom, load connections on top				
No. of poles	Rated current [A]	Type	Order number	L.P. (₹)
4	200	OXB200E3S2QB	1SCA153427R1001	Upon request
4	250	OXB250E3S2QB	1SCA153456R1001	
4	315	OXB315E3S2QB	1SCA153501R1001	
4	400	OXB400E3S2QB	1SCA153515R1001	
4	500	OXB500E3S2QB	1SCA151025R1001	
4	630	OXB630E3S2QB	1SCA151054R1001	
4	800	OXB800E3S2QB	1SCA150934R1001	
4	1000	OXB1000E3S2QB	1SCA153577R1001	
4	1250	OXB1250E3S2QB	1SCA153610R1001	
4	1600	OXB1600E3S2QB	1SCA153622R1001	

Delayed transition – Open style, Level 3 LCD controls

I-O-II –operation with stable OFF position between positions I and II.

Delivery includes handle for manual operation, 2 m RJ45 connection cable between detachable HMI and ATS frame.

Terminal connection kits (bolts, nuts and washers) available as accessory.

Bottom entry - Source 1 and Source 2 connections on bottom, load connections on top				
No. of poles	Rated current [A]	Type	Order number	L.P. (₹)
4	200	OXB200E3S3QB	1SCA153429R1001	Upon request
4	250	OXB250E3S3QB	1SCA152435R1001	
4	315	OXB315E3S3QB	1SCA152046R1001	
4	400	OXB400E3S3QB	1SCA153517R1001	
4	500	OXB500E3S3QB	1SCA151741R1001	
4	630	OXB630E3S3QB	1SCA151057R1001	
4	800	OXB800E3S3QB	1SCA149958R1001	
4	1000	OXB1000E3S3QB	1SCA153579R1001	
4	1250	OXB1250E3S3QB	1SCA153612R1001	
4	1600	OXB1600E3S3QB	1SCA152412R1001	

Delayed transition – Open style, Level 4 Touch controls

I-O-II –operation with stable OFF position between positions I and II.

Delivery includes handle for manual operation, 2 m RJ45 connection cable between detachable HMI and ATS frame.

Terminal connection kits (bolts, nuts and washers) available as accessory.

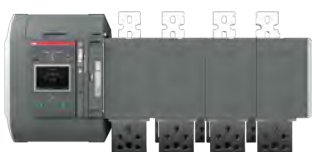

Bottom entry - Source 1 and Source 2 connections on bottom, load connections on top				
No. of poles	Rated current [A]	Type	Order number	L.P. (₹)
4	200	OXB200E3S4QB	1SCA153431R1001	Upon request
4	250	OXB250E3S4QB	1SCA152794R1001	
4	315	OXB315E3S4QB	1SCA153504R1001	
4	400	OXB400E3S4QB	1SCA152048R1001	
4	500	OXB500E3S4QB	1SCA150003R1001	
4	630	OXB630E3S4QB	1SCA151060R1001	
4	800	OXB800E3S4QB	1SCA149959R1001	
4	1000	OXB1000E3S4QB	1SCA151491R1001	
4	1250	OXB1250E3S4QB	1SCA153614R1001	
4	1600	OXB1600E3S4QB	1SCA152414R1001	

Enclosed automatic transfer switches - IEC

Ordering Information



Enclose TruOne ATS

Delayed transition - Enclosed style, Level 3 LCD controls

I-O-II –operation with stable OFF position between positions I and II.

Delivery includes steel sheet enclosure, handle for manual operation, PE-terminal, neutral bar (3 pole versions), transparent IP54 protection cover and bolt kit with nuts and washers for all terminals. Enclosure rating IP54 and 4 mounting brackets for wall mounting included in the delivery. Cable connections from the bottom, one large cable entry flange on bottom side, top side blank and door with 2 locks. Color RAL 7035. ATS manually operable without opening the door.

All cable entries from bottom - source 1, source 2 and load

No. of poles	Rated current [A]	Type	Order number	L.P. (₹)
4	200	OXB200E3S3Q54B	1SCA157160R1001	Upon request
4	250	OXB250E3S3Q54B	1SCA157162R1001	
4	315	OXB315E3S3Q54B	1SCA157163R1001	
4	400	OXB400E3S3Q54B	1SCA157165R1001	
4	630	OXB630E3S3Q54B	1SCA151056R1001	
4	800	OXB800E3S3Q54B	1SCA150936R1001	
4	1000	OXB1000E3S3Q54B	1SCA153649R1001	
4	1250	OXB1250E3S3Q54B	1SCA153653R1001	



Enclose TruOne ATS

Delayed transition - Enclosed style, Level 4 Touch controls

I-O-II –operation with stable OFF position between positions I and II.

Delivery includes steel sheet enclosure, handle for manual operation, PE-terminal, neutral bar (3 pole versions), transparent IP54 protection cover and bolt kit with nuts and washers for all terminals. Enclosure rating IP54 and 4 mounting brackets for wall mounting included in the delivery. Cable connections from the bottom, one large cable entry flange on bottom side, top side blank and door with 2 locks. Color RAL 7035. ATS manually operable without opening the door.

Bottom entry - Source 1 and Source 2 connections on bottom, load connections on top

No. of poles	Rated current [A]	Type	Order number	L.P. (₹)
4	200	OXB200E3S4Q54B	1SCA157161R1001	Upon request
4	250	OXB250E3S4Q54B	1SCA157010R1001	
4	315	OXB315E3S4Q54B	1SCA157164R1001	
4	400	OXB400E3S4Q54B	1SCA157011R1001	
4	630	OXB630E3S4Q54B	1SCA151059R1001	
4	800	OXB800E3S4Q54B	1SCA150936R1001	
4	1000	OXB1000E3S4Q54B	1SCA153650R1001	
4	1250	OXB1250E3S4Q54B	1SCA153654R1001	

Compact ATS

Automatic transfer switches, I - O - II operation

Supplied with bridging bars and direct mounted handle



Rated current In [A]	Pole	Description	Ordering code	L.P.(₹)
63	3	OTM63F3C20D400C	1SYN151423R1001	45,930
63		OTM63F3C21D400C	1SYN151423R1002	66,370
125		OTM125F3C20D400C	1SYN151423R1003	51,490
125		OTM125F3C21D400C	1SYN151423R1004	75,040



Rated current In [A]	Pole	Description	Ordering code	L.P.(₹)
40	4	OTM40F4C20D400C	1SYN151252R1001	45,680
40		OTM40F4C21D400C	1SYN151253R1001	69,380
40		OTM40F4CB21D400C	1SYN150580R1001	69,380
63		OTM63F4C20D400C	1SYN151254R1001	48,080
63		OTM63F4C21D400C	1SYN151255R1001	72,630
63		OTM63F4CB21D400C	1SYN150586R1001	72,630
125		OTM125F4C20D400C	1SYN151250R1001	56,640
125		OTM125F4C21D400C	1SYN151251R1001	82,050
125		OTM125F4CB21D230C	1SYN150574R1001	82,050

Note:

- For 2 pole requirement contact nearest sales office

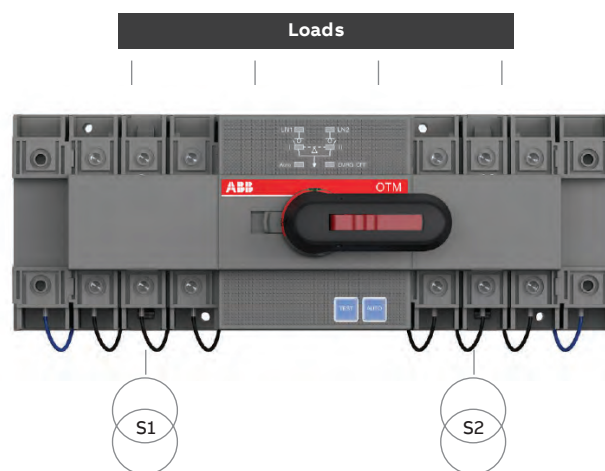

OTM_C20D:

- For Network/Network application
- Fixed version with pre-defined delay times and voltage thresholds

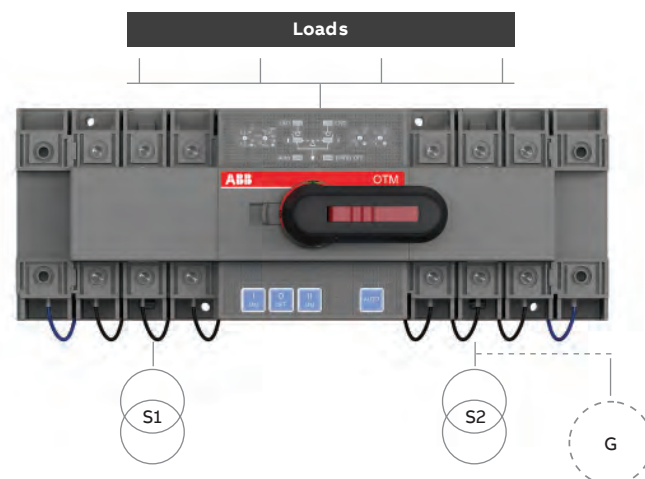

OTM_C21D

- For Network/Network and Network/Genset applications
- Adjustable version with configurable transfer and back-switching delays Adjustable over and under-voltage thresholds

OT automatic transfer switches



OMD300



OA1G10



OMZB



OTZC13...34



OTZC43...44
OTZC53...54

Automatic transfer switches, I - O - II operation

Supplied with bridging bars and handle

Automatic operation, equipped with OMD300 controller unit with integrated dual power supply

Rated current In [A]	Poles	Description	Ordering code	L.P.(₹)
160	4	OTM160E4C3D230C	1SYN106305R1001 ■ *	1,18,450
200		OTM200E4C3D230C	1SYN106309R1001 *	1,22,430
250		OTM250E4C3D230C	1SYN106313R1001 *	1,26,420
315		OTM315E4C3D230C	1SYN106317R1001 *	1,32,420
400		OTM400E4C3D230C	1SYN106318R1001 ■ *	1,39,730
630		OTM630E4C3D230C	1SYN108726R1001 *	1,86,310
800		OTM800E4C3D230C	1SYN108728R1001 *	2,46,200
1000		OTM1000E4C3D230C	1SYN112851R1001 *	2,66,170
1250		OTM1250E4C3D230C	1SYN112851R1001 *	3,06,080
1600		OTM1600E4C3D230C	1SYN112848R1001 *	3,99,230

* Automatic Transfer Switches 1SYN... code include the following:

- OTM160...1600_CM_ motorized change-over switch - 1 no.
- Bridging bar - 1 no.
- OMZB_ voltage sensing connectors - 1 no.
- OA1G10 auxiliary contacts - 2 no.
- OMD300E480C-A1 - 1 no.



OMD800



OA1G10



OMZB



OTZC13...34



OTZC43...44
OTZC53...54

Automatic operation, equipped with OMD800 controller unit with display

Rated current In [A]	Poles	Description	Ordering code	L.P.(₹)
160	4	OTM160E4C8D230C	1SYN101020R1001 *	1,59,690
200		OTM200E4C8D230C	1SYN101021R1001 *	1,66,350
250		OTM250E4C8D230C	1SYN101022R1001 *	1,73,010
315		OTM315E4C8D230C	1SYN101063R1001 *	1,79,650
400		OTM400E4C8D230C	1SYN101064R1001 *	1,99,610
630		OTM630E4C8D230C	1SYN108453R1001 *	2,19,590
800		OTM800E4C8D230C	1SYN108455R1001 *	2,66,170
1000		OTM1000E4C8D230C	1SYN112861R1001 *	3,39,350
1250		OTM1250E4C8D230C	1SYN112864R1001 *	3,72,630
1600		OTM1600E4C8D230C	1SYN112867R1001 *	4,65,780

* Automatic Transfer Switches 1SYN... code include the following:

- OTM160...1600_CM_ motorized change-over switch - 1 no.
- Bridging bar - 1 no.
- OMZB_ voltage sensing connectors - 1 no.
- OA1G10 auxiliary contacts - 2 no.
- OMD800E480C-A1 - 1 no.

Note:

- Motor voltage Ue 220-240 V AC
- For 3 pole requirement contact the nearest sales office
- For OMD800, consider accessory ODPS for dual power supply
- For mounting the OMD automatic control unit on the door. The type OMZD1 and OMZC2 must be ordered for mounting the control on the door (Refer to catalogue)

OT manual changeover switches

Manual changeover switches, I-O-II -operation

Supplied with extended shaft and IP 65 pistol type handle



Rated current In [A]	Poles	Description	Ordering code	L.P. (₹)
16	3	OT16F3C	1SYN104816R1001 ■	3,900
25		OT25F3C	1SYN104863R1001 ■	4,920
40		OT40F3C	1SYN104913R1001 ■	5,340
63		OT63F3C	1SYN105338R1001 ■	6,960
80		OT80F3C	1SYN105402R1001	7,660
100		OT100F3C	1SYN105008R1001 ■	10,240
125		OT125F3C	1SYN105037R1001 ■	10,730
16	4	OT16F4C	1SYN104831R1001	4,920
25		OT25F4C	1SYN104877R1001	5,110
40		OT40F4C	1SYN104934R1001 ■	5,640
63		OT63F4C	1SYN105369R1001 ■	7,880
80		OT80F4C	1SYN105418R1001 ■	8,280
100		OT100F4C	1SYN105019R1001	12,190
125		OT125F4C	1SYN105054R1001 ■	12,480
Supplied with bridging bars, extended shaft and IP 65 pistol type handle				
160	3	OT160E03CP	1SYN022772R6510 ■	14,830
200		OT200E03CP	1SYN022771R7520 ■	15,330
250		OT250E03CP	1SYN022771R3450 ■	18,430
315		OT315E03CP	1SYN022772R6780 ■	22,500
400		OT400E03CP	1SYN022771R8500 ■	26,590
630		OT630E03CP	1SYN022785R6050 ■	39,890
800		OT800E03CP	1SYN022785R6300	51,140
1000		OT1000E03CP	1SYN022872R1680 ■	1,38,080
1250		OT1250E03CP	1SYN022872R0790	1,53,420
1600		OT1600E03CP	1SYN022872R1840	1,89,210
2000		OT2000E03CP	1SYN103908R1001	2,86,400
2500		OT2500E03CP	1SYN105615R1001	3,11,960
3200	OT3200E03CP	1SYN129156R1001	4,50,030	
160	4	OT160E04CP	1SYN022775R9440 ■	17,390
200		OT200E04CP	1SYN022771R7280 ■	17,910
250		OT250E04CP	1SYN022775R4640 ■	19,940
315		OT315E04CP	1SYN022775R7150 ■	24,350
400		OT400E04CP	1SYN022771R8680 ■	28,650
630		OT630E04CP	1SYN022785R6130 ■	49,100
800		OT800E04CP	1SYN022785R6210 ■	59,320
1000		OT1000E04CP	1SYN022872R1500	1,58,530
1250		OT1250E04CP	1SYN022872R1250	1,65,700
1600		OT1600E04CP	1SYN022872R2310	2,04,560
2000		OT2000E04CP	1SYN103912R1001	3,68,200
2500		OT2500E04CP	1SYN103906R1001	4,09,130
3200	OT3200E04CP	1SYN129158R1001	5,36,980	

Note: Contact our nearest sales office

1. For 6 pole change over
2. For manual/motorized bypass switch
3. For manual closed transition
4. For wide phase manual change over

OT motorized changeover switches



Changeover switches, motor operation, I-O-II -operation

Supplied with bridging bars and handle

Rated current In [A]	Poles	Description	Ordering code	L.P.(₹)	Poles	Description	Ordering code	L.P.(₹)
40	3	OTM40F3CMA230V	1SYN120096R1001	32,050	4	OTM40F4CMA230V	1SYN120102R1001	34,510
63		OTM63F3CMA230V	1SYN120095R1001	33,880		OTM63F4CMA230V	1SYN120101R1001 ■	36,350
80		OTM80F3CMA230V	1SYN120093R1001	36,960		OTM80F4CMA230V	1SYN120100R1001	38,200
100		OTM100F3CMA230V	1SYN120071R1001	38,800		OTM100F4CMA230V	1SYN120098R1001 ■	39,440
125		OTM125F3CMA230V	1SYN120070R1001	40,040		OTM125F4CMA230V	1SYN120097R1001 ■	41,910
160		OTM160E3CM230C	1SYN022845R8610	49,570		OTM160E4CM230C	1SYN022848R1510 ■	51,860
200		OTM200E3CM230C	1SYN022845R960	50,230		OTM200E4CM230C	1SYN022846R1590 ■	52,110
250		OTM250E3CM230C	1SYN022845R9260	61,960		OTM250E4CM230C	1SYN022846R1910 ■	63,800
315		OTM315E3CM230C	1SYN022847R1210	62,620		OTM315E4CM230C	1SYN022847R2870 ■	65,130
400		OTM400E3CM230C	1SYN022847R1630	75,350		OTM400E4CM230C	1SYN022847R3250 ■	81,750
630		OTM630E3CM230C	1SYN103567R1001	88,790		OTM630E4CM230C	1SYN022873R1990 ■	91,640
800		OTM800E3CM230C	1SYN103570R1001	1,31,980		OTM800E4CM230C	1SYN022872R8340 ■	1,37,820
1000		OTM1000E3CM230C	1SYN112677R1001	1,96,710		OTM1000E4CM230C	1SYN112703R1001	1,99,870
1250		OTM1250E3CM230C	1SYN112676R1001	2,15,840		OTM1250E4CM230C	1SYN112702R1001	2,19,180
1600		OTM1600E3CM230C	1SYN112678R1001	2,59,560		OTM1600E4CM230C	1SYN112704R1001	2,68,780
2000		OTM2000E3CM230C	1SYN112709R1001	4,37,480		OTM2000E4CM230C	1SYN112712R1001	4,77,580
2500		OTM2500E3CM230C	1SYN112710R1001	4,80,520		OTM2500E4CM230C	1SYN112713R1001	5,21,020

Note:

Motor voltage Ue 110-240 V AC/DC (OTM40...125A)

Motor voltage Ue 220-240 V AC (OTM160...2500A)

OMD control units can be purchased separately for their motorized changeover switches in order to build an ATS by themselves. Contact nearest sales office for making selection.

Contact our nearest sales office:

- For motor voltage Ue 110...125 V AC/DC (160A-2500A)
- For motor voltage Ue = 48V DC (160A-2500A)

Accessories for changeovers (manual, motorized, ATS)

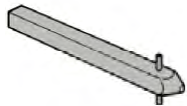

Shaft

Frame	Description	Ordering code	L.P. (₹)	Handle	Description	Ordering code	L.P. (₹)
OT16...125F_C	EXP6X170	1SCA108224R1001	390	OHB45J6E311	1SCA022817R2130 ■	2,470	
OT160...250_C	EXP6x161	1SCA022067R176 ■	390	OHB65J6E011	1SCA022383R2480 ■	2,750	
OT315...400_C	EXP12x166	1SCA022325R671	610	OHB95J12E011	1SCA022621R0760 ■	3,130	
OT630...800_C				OHB125J12E011	1SCA022589R3340 ■	3,470	
OT630...3200_C	EXP12x185	1SCA022325R710 ■	720	OHB200J12PE011	1SCA022873R4230	7,610	

Auxiliary contacts

Frame	Contact functions	Installation side	Description	Ordering code	L.P. (₹)
OT16...125F_C OTM40...125	1NO	Right	OA1G10	1SCA022353R497	620
	1NC	Right	OA8G01	1SCA022744R224 ■	1,110
	1NO	Left	OA7G10	1SCA022673R114 ■	980
	1NC	Left	OA1G01	1SCA022353R489	620
OT160...3200 OTM160...2500	1NO	Right	OA1G10	1SCA022353R4970	620
	1NC	Right	OA3G01	1SCA022456R7410	680

Phase barriers

3-pole change-overs need 8 barriers and 4-pole change-overs need 12 barriers for full protection.

Frame	Poles	Description	Ordering code	L.P. (₹)
OT160...800 OTM160...800	3	PB100 low	1SDA054970R1	1,120
	4	PB100 low	1SDA054971R1	1,620

Basic ATS controller for motorised change over

Frame	Description	Ordering code	L.P. (₹)
40...2500A	ODPS230	1SCA122946R1001 ■	14,350

Note: Contact our nearest sales office for more information

■ Stock items

Kabeldon low voltage switchgear system



Features of the Kabeldon IP-system are its simplicity and reliability. These are the most important factors when you want to achieve low operating costs and high delivery reliability in a distribution system.

- Busbars of continuously-extruded aluminium sections, insulated with a layer of polyamid.
- The busbar has a touch-proof contact slot.
- Blade fuses in all of the fuse-switch disconnectors.
- The switching devices can be arranged in any order, regardless of rated current.
- All parts, busbars and devices, fulfil IP2X protection in accordance with IEC 60529*).
- Switching devices 100-1600 A.
- It is easy to add new switching devices to existing distribution boards.
- Switching devices are mounted on and connected to the busbar system in the same operation.
- Switching devices can be connected when the system is live.
- Always voltage-free (“dead”) when changing fuses.
- Busbars are available with rated currents from 400 to 1600 A.
- Switching devices, connectors and busbars combine to form a modular system. Each module is 12.5 mm. The modular system makes planning easier.
- The compact design of the switching devices makes them suitable for use in many different types of distribution boards.
- All switching devices have a utilisation category.

ABB's comprehensive range of LV control products

The range of ABB control products ranks amongst the most extensive on the market with a full range of innovative solutions for control & protection, motor starting, intelligent motor management, measurement and monitoring and safety applications.

The business unit is comprised of 3 main product families:

- Control & protection
- Electronic relays
- Safety products

Our products

Our products are already among the most extensive in the market and we are constantly adding new products in order to meet ever changing customer needs.

Quality and reliability are built into every device to ensure total performance satisfaction, even in the most demanding applications.

We offer a very modern and competitive range of contactors, starters, manual motor starters, a wide range of electronic relays and overload relays, together with an extended of pilot devices.

Our offering

- Contactors
- Manual motor starters
- Thermal overload relays
- Electronic overload relays
- Intelligent motor management systems
 - Universal motor controllers
 - Communication fieldbus plugs
- Electronic products and relays
 - Timers
 - Measuring and monitoring relays
 - Power supplies
 - Interface relays & optocouplers
- Jokab safety systems
- Pilot devices
- Arc guard systems



Motor starting and protection

Keep things moving with protection and control - at every level.

Our broad portfolio of motor starting and protection solutions are fully scalable, allowing you to keep things moving whatever the extent of your operations.

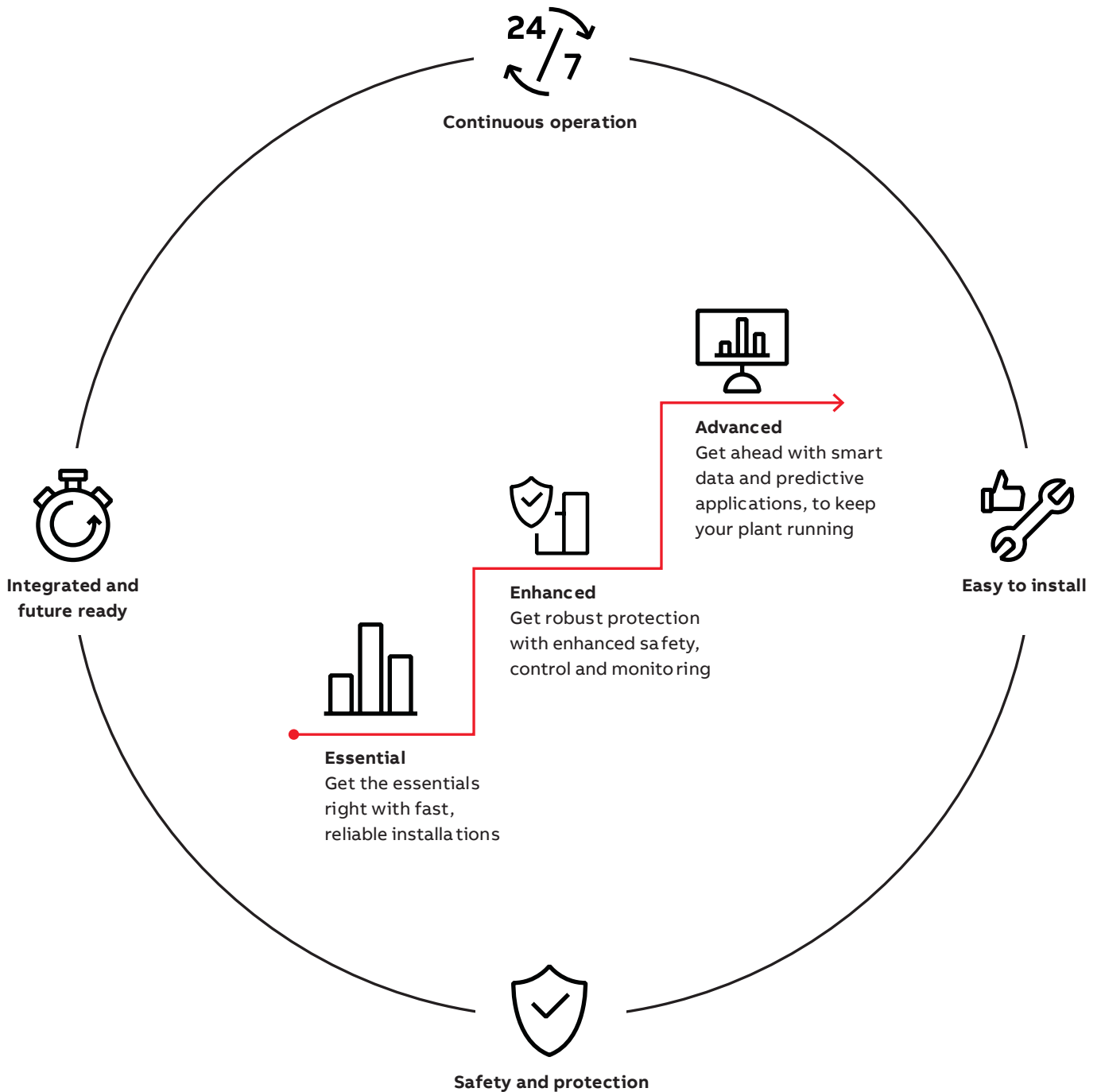

Enhanced solutions

Get robust protection with enhanced safety, control and monitoring

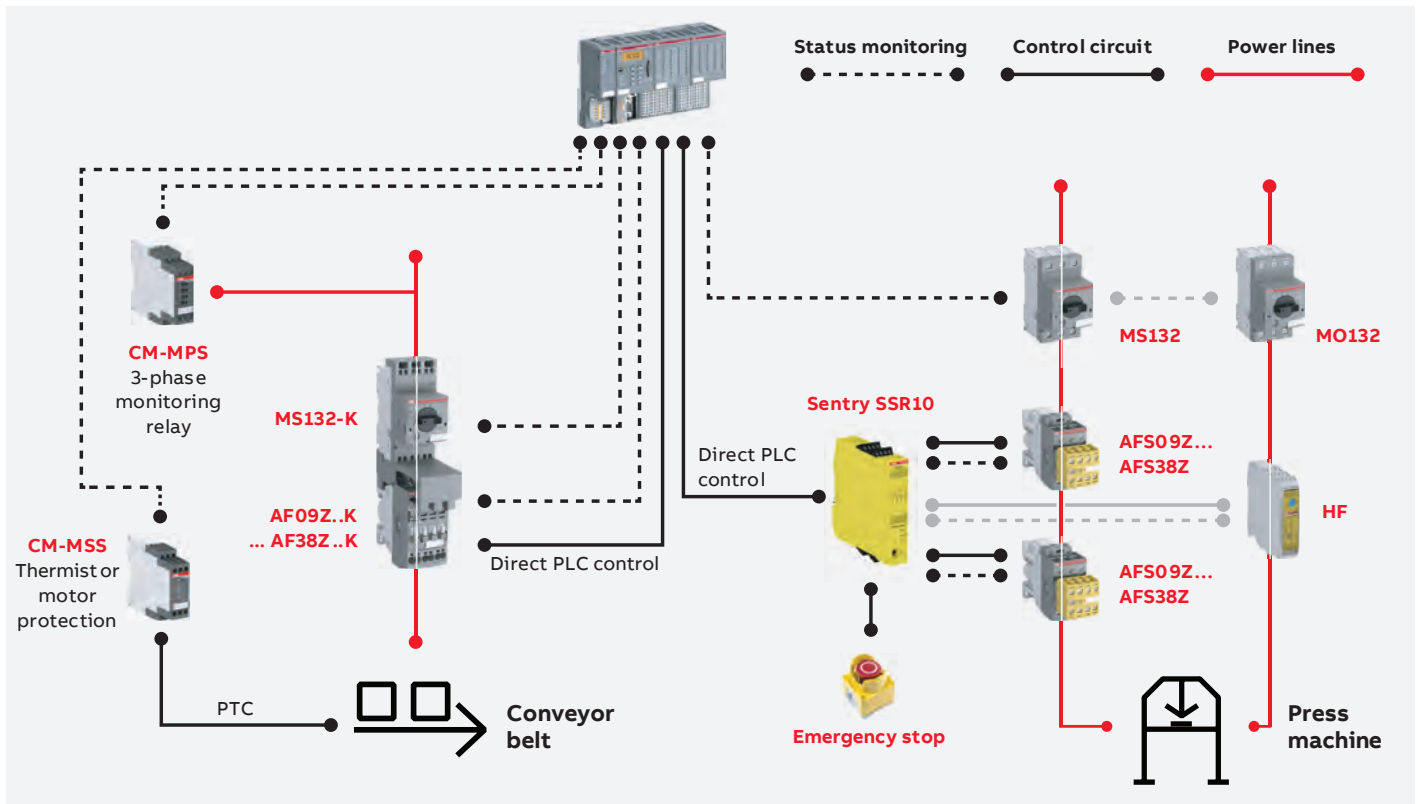

Safety and protection

Enhanced safety and protection for solutions with higher specification requirements.

- Integration in machine manufacturer's systems complying with main standards EN ISO 13849, EN 62061 and IEC / EN 61508
- Trouble-free and economic operation of machines and installations thanks to the monitoring of all important parameters in your three-phase network
- Prevent overheating, overload and insufficient cooling. Irregularities are signaled early to avoid plant downtime



Speed up your projects

Reduce time in planning, designing, assembly and delivery of custom panels to market.

- Use the same starters in Europe, Asia and North America as one contactor coil now handles 100 V – 250 V AC / DC, 50 / 60 Hz
- Push-in Spring allows you to insert both ferruled and rigid cables without the need to use any tools, boosting your productivity like never before
- With more than 1800 tested and validated coordination tables available in the SOC tool, you can quickly and easily choose the right ABB solution

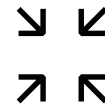

Space-saving

Space is usually very limited for control panels, but our compact solutions are designed to easily fit into your application.

- Motor starters can be controlled directly by PLC thanks to AF contactor versions with low consumption coil, external or built-in PLC interface. No need for interface relays, which requires extra space
- Motor starters up to 3 kW / 3 hp require 90 % less space thanks to ABB's HF electronic compact starter. At just 22.5 mm width, it still provides motor starting functionalities with embedded protection and safety

Advanced solutions

UMC100.3 application example

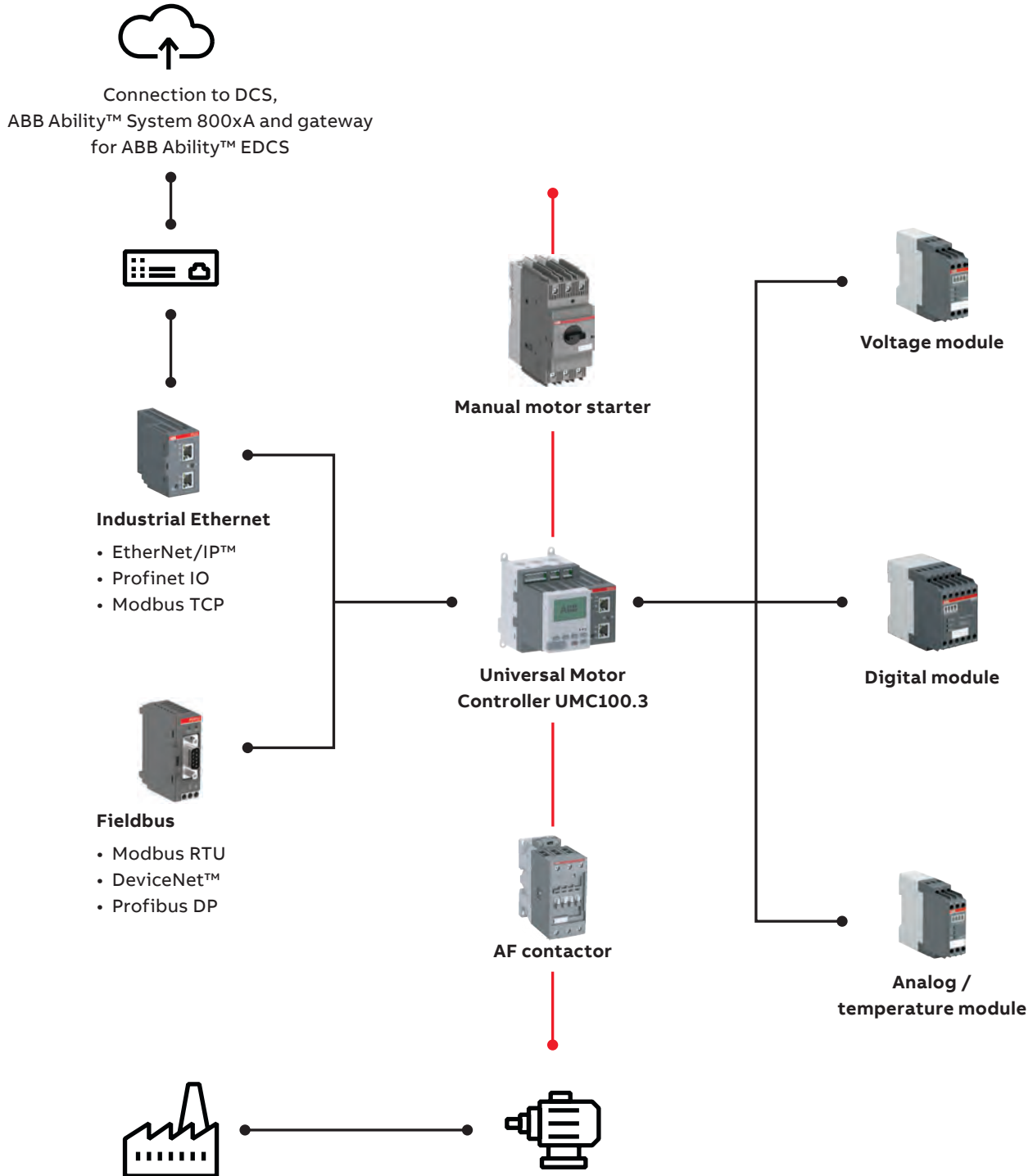

Complete solutions for control panels

ABB's broad portfolio offers all you need for your application, at every level.

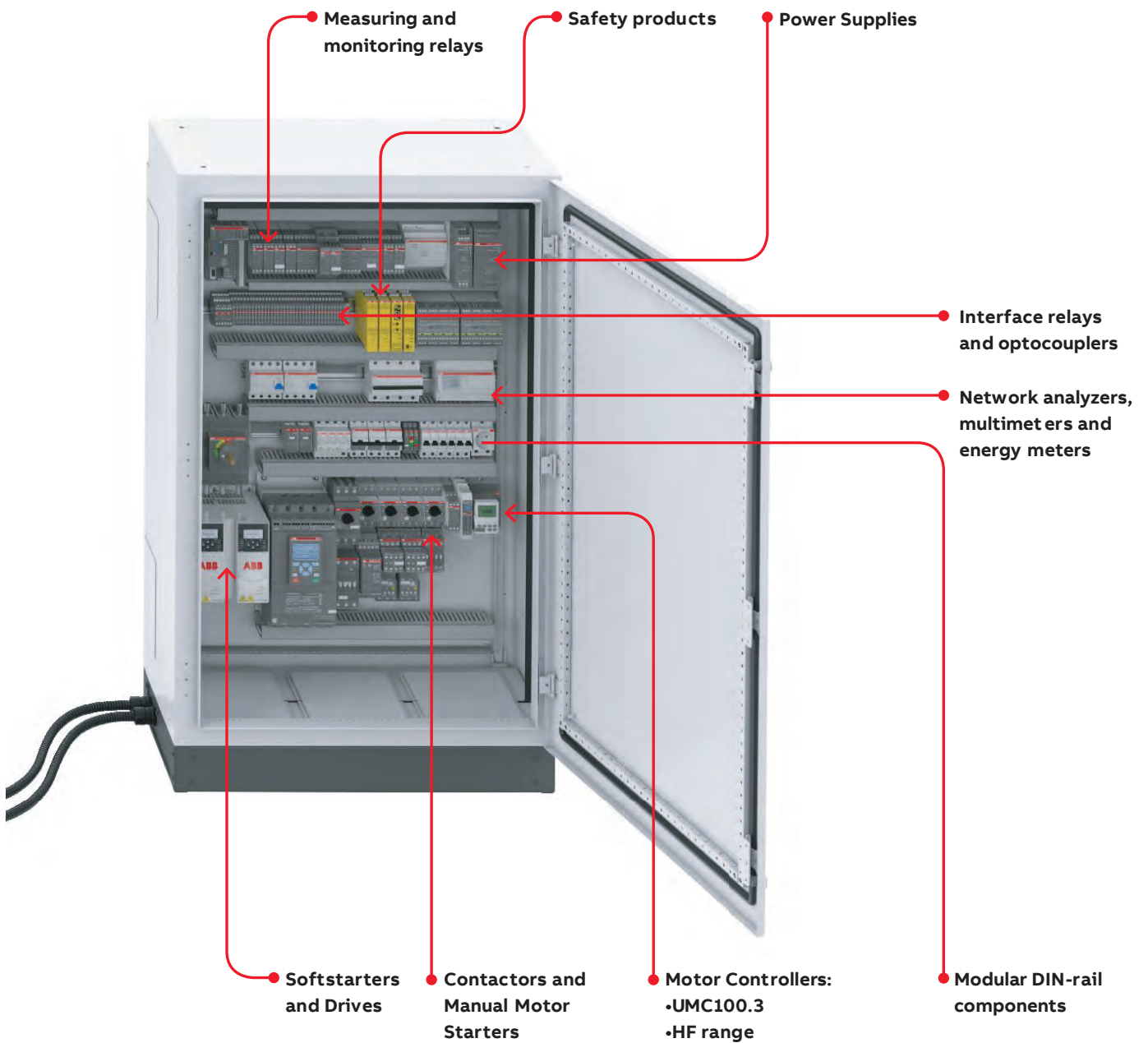

Auxiliary contactors



Standard control contactors

No. of contacts	Contact configuration		Type code reference	Ordering code	L.P.(₹)	Type code reference	Ordering code	L.P.(₹)
	NO	NC						
4	2	2	N22E **	1SBH141001R□□22 ■	1,450	NL22E **	1SBH143001R□□22 ■	2,210
4	3	1	N31E **	1SBH141001R□□31 ■		NL31E **	1SBH143001R□□31 ■	
4	4	0	N40E **	1SBH141001R□□40 ■		NL40E **	1SBH143001R□□40 ■	

Refer Page 93 for accessories

No. of contacts	Contact configuration		Type code reference	Ordering code	L.P.(₹)
	NO	NC			
4	2	2	NX22E	1SBH901074R□□22 ■	1,200
4	3	1	NX31E	1SBH901074R□□31 ■	
4	4	0	NX40E	1SBH901074R□□40 ■	

Refer Page 100 for accessories

Wide band AC / DC operated

No. of contacts	Contact configuration		Type code reference	Ordering code	L.P.(₹)
	NO	NC			
4	2	2	NF22E **	1SBH137001R□□22 ■	2,570
4	3	1	NF31E **	1SBH137001R□□31 ■	
4	4	0	NF40E **	1SBH137001R□□40 ■	

Refer coil voltage & codes mentioned below.

Wide band low power consumption

Type code reference #	Ordering code	L.P.(₹)
NFZ31E **	1SBH136001R□□31	
NFZ40E **	1SBH136001R□□40	

#Allows direct control by PLC output ≥ 24 V DC 500 mA

Coil voltages and codes

N & NX range (AC operated)

Voltage	Voltage	Code
V - 50Hz	V - 60Hz	□□
24	24	8 1 ■
110	110 ... 120	8 4 ■
220 ... 230	230 ... 240	8 0 ■
400 ... 415	415 ... 440	8 6 ■

NF range (AC/DC operated)

Voltage	Voltage	Code
V 50/60 Hz	V DC	□□
24...60	20...60	1 1 ■
48...130	48...130	1 2 ■
100...250	100...250	1 3 ■
250...500	250...500	1 4 ■

NL (DC operated)

Voltage V DC	Code
□□	□□
24	8 1 ■
48	8 3 ■
110	8 6 ■
240	8 9 ■

NFZ range (AC/DC operated)

Voltage	Voltage	Code
V 50/60 Hz	V DC	□□
-	12...20	2 0
24...60	20...60	2 1
48...130	48...130	2 2
100...250	100...250	2 3

■ Stock items

3 pole contactors: AX09...AX370 : AC operated



AX09



AX95



AX185



AX370

AX Contactor

AX contactors are mainly used for controlling 3-phase motors and power circuits up to 690 V AC. These contactors are of the block type design with:

- 3 main poles and built-in auxiliary contact
- Control circuit: AC operated
- Add-on auxiliary contact blocks for front or side mounting and a wide range of accessories

Contactors: 3-pole – AC operated

AC1 duty Amps	AC3 rating at 415V		Auxiliary contacts	Type code	Ordering code	L.P.(₹)
	Amps	kW				
22	9	4	1NO -	AX09-30-10	1SBL901074R□□10 ■	1200
22	9	4	- 1NC	AX09-30-01	1SBL901074R□□01 ■	1200
25	12	5.5	1NO -	AX12-30-10	1SBL911074R□□10 ■	1,330
25	12	5.5	- 1NC	AX12-30-01	1SBL911074R□□01 ■	1,330
27	18	9	1NO -	AX18-30-10	1SBL921074R□□10 ■	1,490
27	18	9	- 1NC	AX18-30-01	1SBL921074R□□01 ■	1,490
32	25	11	1NO -	AX25-30-10	1SBL931074R□□10 ■	2,020
32	25	11	- 1NC	AX25-30-01	1SBL931074R□□01 ■	2,020
55	32	15	1NO -	AX32-30-10	1SBL281074R□□10 ■	4,410
55	32	15	- 1NC	AX32-30-01	1SBL281074R□□01 ■	4,410
60	40	18.5	1NO -	AX40-30-10	1SBL321074R□□10 ■	6,520
60	40	18.5	- 1NC	AX40-30-01	1SBL321074R□□01 ■	6,520
100	50	25	1NO 1NC	AX50-30-11	1SBL351074R□□11 ■	8,600
115	65	30	1NO 1NC	AX65-30-11	1SBL371074R□□11 ■	11,710
125	80	37	1NO 1NC	AX80-30-11	1SBL411074R□□11 ■	14,020
145	96	45	1NO 1NC	AX95-30-11	1SFL431074R□□11 ■	17,110
160	115	55	1NO 1NC	AX115-30-11	1SFL981074R□□11 ■	21,650
190	150	75	1NO 1NC	AX150-30-11	1SFL991074R□□11 ■	28,420
250	185	90	1NO 1NC	AX185-30-11	1SFL491074R□□11 ■	33,350
275	205	110	1NO 1NC	AX205-30-11	1SFL501074R□□11 ■	39,360
400	265	132	1NO 1NC	AX260-30-11	1SFL547074R□□11 ■	51,950
500	305	160	1NO 1NC	AX300-30-11	1SFL587074R□□11 ■	60,950
600	370	200	1NO 1NC	AX370-30-11	1SFL607074R□□11 ■	77,410

Note: Complete the contactor code by replacing □□ with desired coil voltages as per above table.

Refer Page 94 for accessories

Coil voltages and codes AX range

Voltage	Voltage	Code
□□ V - 50Hz	□□ V - 60Hz	□□
24	24	8 1 ■
110	110	8 4 ■
220 ... 230	220 ... 230	8 0 ■
400 ... 415	400 ... 415	8 6 ■

■ Stock items

3 pole contactors: AC operated



Contactors: 3-pole – AC operated

AC1duty Amps	AC3 rating at 415V			Auxiliary contacts		Type code	Ordering code	L.P.(₹)
	Amps	hP	kW					
25	9	5.5	4	1NO	-	A09-30-10 **	1SBL141001R□□10 ■	1,350
25	9	5.5	4	-	1NC	A09-30-01 **	1SBL141001R□□01 ■	1,350
27	12	7.5	5.5	1NO	-	A12-30-10 **	1SBL161001R□□10 ■	1,520
27	12	7.5	5.5	-	1NC	A12-30-01 **	1SBL161001R□□01 ■	1,520
30	17	12.5	7.5	1NO	-	A16-30-10 **	1SBL181001R□□10 ■	1,710
30	17	12.5	7.5	-	1NC	A16-30-01 **	1SBL181001R□□01 ■	1,710
45	26	15	11	1NO	-	A26-30-10 **	1SBL241001R□□10 ■	2,360
45	26	15	11	-	1NC	A26-30-01 **	1SBL241001R□□01 ■	2,360
55	32	20	15	1NO	-	A30-30-10 **	1SBL281001R□□10 ■	4,780
55	32	20	15	-	1NC	A30-30-01 **	1SBL281001R□□01 ■	4,780
60	37	30	18.5	1NO	-	A40-30-10 **	1SBL321001R□□10 ■	7,370
60	37	30	18.5	-	1NC	A40-30-01 **	1SBL321001R□□01 ■	7,370
100	50	40	25	-	-	A50-30-00 **	1SBL351001R□□00 ■	9,180
115	65	50	37	-	-	A63-30-00 **	1SBL371001R□□00 ■	12,660
125	75	60	40	-	-	A75-30-00 **	1SBL411001R□□00 ■	15,900
145	96	70	55	1NO	1NC	A95-30-11**	1SFL431001R□□11 ■	20,550
160	110	75	59	1NO	1NC	A110-30-11**	1SFL451001R□□11 ■	26,380
250	145	100	75	1NO	1NC	A145-30-11**	1SFL471001R□□11 ■	33,670
275	185	115	90	1NO	1NC	A185-30-11**	1SFL491001R□□11 ■	41,610
350	205	150	110	1NO	1NC	AF205-30-11**	1SFL527002R□□11 ■	47,120
400	265	175	140	1NO	1NC	AF265-30-11**	1SFL547002R□□11 ■	55,450
500	305	215	160	1NO	1NC	AF305-30-11**	1SFL587002R□□11 ■	65,560
600	370	270	200	1NO	1NC	AF370-30-11**	1SFL607002R□□11 ■	80,830
600	400	300	220	1NO	1NC	AF400-30-11**	1SFL577001R□□11 ■	85,980
700	460	340	250	1NO	1NC	AF460-30-11**	1SFL597001R□□11 ■	1,14,830
800	580	470	355	1NO	1NC	AF580-30-11**	1SFL617001R□□11 ■	1,73,670
1050	750	570	425	1NO	1NC	AF750-30-11**	1SFL637001R□□11 ■	2,57,560
1260	-	-	-	1NO	1NC	AF1250-30-11**	1SFL647001R□□11	
1350	860	-	500	1NO	1NC	AF1350-30-11**	1SFL657001R□□11	
1650	1050	-	600	1NO	1NC	AF1650-30-11**	1SFL677001R□□11	
2050	-	-	-	1NO	1NC	AF2050-30-11**	1SFL707001R□□11	Upon request
2650	-	-	-	1NO	1NC	AF2650-30-11**	1SFL667001R□□11	
2850	-	-	-	1NO	1NC	AF2850-30-11**	1SFL687001R□□11	

Complete the contactor type code by replacing ** with desired coil voltage, AF contactors have advanced electronic coil interface with wideband AC/DC coil
Refer Page 93 and Page 100 for accessories

Coil voltages and codes: A09 ... A185 range

Voltage	Voltage	Code
□□ V - 50Hz	□□ V - 60Hz	□□
24	24	8 1 ■
110	110 ... 120	8 4 ■
220 ... 230	230 ... 240	8 0 ■
400 ... 415	415 ... 440	8 6 ■

New AF205...AF370 range (AC/DC operated)

Voltage	Voltage	Code
V 50/60 Hz	V DC	□□
24...60	20...60	1 1
48...130	48...130	1 2
100...250	100...250	1 3
250...500	250...500	1 4

AF400...AF1250 range (AC/DC operated)

Voltage	Voltage	Code
V 50/60 Hz	V DC	□□
-	24...60	6 8
48...130	48...130	6 9
100...250	100...250	7 0
250...500	250...500	7 1

AF1350...AF2850 range (AC/DC operated)

Voltage	Voltage	Code
V 50/60 Hz	DC	□□
100...250	100...250	7 0

Note: For non-standard coil voltage, other than this contact us for price.

4 pole contactors: AC operated



Contactors: 4-pole (AC operated)

Rating at 415V AC1 Amps	Main contact arrangement		Auxiliary contacts		Type code reference	Ordering code	L.P.(₹)
25	4NO	-	-	-	A09-40-00 **	1SBL141201R□□00 ■	1,740
25	2NO	2NC	-	-	A09-22-00 **	1SBL141501R□□00 ■	2,050
30	4NO	-	-	-	A16-40-00 **	1SBL181201R□□00 ■	1,830
30	2NO	2NC	-	-	A16-22-00 **	1SBL181501R□□00 ■	2,170
45	4NO	-	-	-	A26-40-00 **	1SBL241201R□□00 ■	3,230
45	2NO	2NC	-	-	A26-22-00 **	1SBL241501R□□00 ■	4,120
70	4NO	-	-	-	A45-40-00**	1SBL331201R□□00 ■	8,820
70	2NO	2NC	-	-	A45-22-00**	1SBL331501R□□00	12,370
100	4NO	-	-	-	A50-40-00**	1SBL351201R□□00 ■	12,840
125	4NO	-	-	-	A75-40-00**	1SBL411201R□□00 ■	17,080
125	2NO	2NC	-	-	A75-22-00**	1SBL411501R□□00	19,570
160	4NO	-	-	-	AF116-40-00	1SFL427102R□□00	28,270
200	4NO	-	-	-	AF140-40-00	1SFL447102R□□00	35,090
275	4NO	-	-	-	AF190-40-00	1SFL487102R□□00 ■	50,980
350	4NO	-	-	-	AF205-40-00	1SFL527102R□□00 ■	60,780
400	4NO	-	-	-	AF265-40-00	1SFL547102R□□00 ■	72,220
500	4NO	-	-	-	AF305-40-00	1SFL587102R□□00 ■	88,950
525	4NO	-	-	-	AF370-40-00	1SFL607102R□□00 ■	99,240
800	4NO	-	1NO	1NC	EK550-40-11 **	SK827041 - □□ ■	1,58,500
1000	4NO	-	1NO	1NC	EK1000-40-11 **	SK827044 - □□	2,20,530

Complete the contactor type code by replacing ** with desired coil voltage
Refer Pa e93 for accessories

Coil voltages and codes:

A09 ... A 75 range

Voltage	Voltage	Code
V - 50Hz	V - 60Hz	□□
24	24	8 1
110	110 ... 120	8 4
220 ... 230	230 ... 240	8 0
400 ... 415	415 ... 440	8 6

Coil voltages and codes:

New AF116 - AF370 (AC/DC operated)

Voltage	Voltage	Code
V 50/60 Hz	V DC	□□
24...60	20...60	1 1
48...130	48...130	1 2
100...250	100...250	1 3
250...500	250...500	1 4

Note: For non-standard coil voltage, other than this contact us for price.

Coil voltages and codes: EK550 ... EK1000

Voltage	Voltage	Code
V - 50Hz	V - 60Hz	□□
-	110	A E
110	120	A F
220 ... 230	*	A L ■
230 ... 240	-	A M
400 ... 415	-	A R

■ Stock items

3 pole contactors AL and TAL range: DC operated



AL contactors

AC 1 duty Amps	AC3 rating at 415V		Auxiliary contacts	Type code reference	Ordering code	L.P.(₹)	
	Amps	hP					kW
25	9	5	4	1NO -	AL9-30-10	1SBL143001R□□10 ■	2,140
25	9	5	4	- 1NC	AL9-30-01	1SBL143001R□□01 ■	2,140
27	12	7.5	5.5	1NO -	AL12-30-10	1SBL163001R□□10	2,390
27	12	7.5	5.5	- 1NC	AL12-30-01	1SBL163001R□□01	2,390
30	17	10	7.5	1NO -	AL16-30-10	1SBL183001R□□10 ■	2,910
30	17	10	7.5	- 1NC	AL16-30-01	1SBL183001R□□01	2,910
45	26	20	11	1NO -	AL26-30-10	1SBL243001R□□10 ■	4,400
45	26	20	11	- 1NC	AL26-30-01	1SBL243001R□□01	4,400
55	32	25	15	1NO -	AL30-30-10	1SBL283001R□□10	8,800
55	32	25	15	- 1NC	AL30-30-01	1SBL283001R□□01	8,800
60	37	30	18.5	1NO -	AL40-30-10	1SBL323001R□□10	11,050
60	37	30	18.5	- 1NC	AL40-30-01	1SBL323001R□□01	11,050

TAL contactors



AC 1 duty Amps	AC3 rating at 415V		Auxiliary contacts	Type code reference	Ordering code	L.P.(₹)	
	Amps	hP					kW
25	9	5	4	1NO -	TAL9-30-10	1SBL143061R□□10 ■	2,570
25	9	5	4	- 1NC	TAL9-30-01	1SBL163061R□□10 ■	2,570
27	12	7.5	5.5	1NO -	TAL12-30-10	1SBL163061R□□10	3,160
27	12	7.5	5.5	- 1NC	TAL12-30-01	1SBL163061R□□01	3,160
30	17	10	7.5	1NO -	TAL16-30-10	1SBL183061R□□10 ■	3,380
30	17	10	7.5	- 1NC	TAL16-30-01	1SBL183061R□□01 ■	3,380
45	26	20	11	1NO -	TAL26-30-10	1SBL243061R□□10 ■	4,800
45	26	20	11	- 1NC	TAL26-30-01	1SBL243061R□□01	4,800
55	32	25	15	1NO -	TAL30-30-10	1SBL283061R□□10	9,440
55	32	25	15	- 1NC	TAL30-30-01	1SBL283061R□□01	9,440
60	37	30	18.5	1NO -	TAL40-30-10	1SBL323061R□□10 ■	10,530
60	37	30	18.5	- 1NC	TAL40-30-01	1SBL323061R□□01	10,530

Coil voltages and codes: AL

Voltage	Code
V DC	□□
24	8 1
110	8 6 ■
240	8 9

Coil voltages and codes: TAL

Voltage	Code
V DC	□□
77...143	6 2 ■

Other voltages: contact nearest ABB sales office.
Refer Page 93 for accessories

Contactors for special application - capacitors switching



Contactors for capacitor switching: 3 pole – AC operated:

kVAR Rating at 415V	Auxiliary contacts	Type code reference	Ordering code	L.P.(₹)
Type UA..RA with in-built damping resistors:				
12.5	1NO	UA16-30-10RA **	1SBL181024R□□10 ■	2,970
22	1NO	UA26-30-10RA **	1SBL241024R□□10 ■	4,950
30	1NO	UA30-30-10RA**	1SBL281024R□□10 ■	5,670
40	--	UA50-30-00RA	1SBL351024R□□00 ■	15,690
50	--	UA63-30-00RA**	1SBL371024R□□00 ■	16,880
60	--	UA75-30-00RA**	1SBL411024R□□00 ■	19,550
70	--	UA95-30-00RA**	1SFL431024R□□00 ■	20,450
80	--	UA110-30-00RA**	1SFL451024R□□00 ■	24,470

Type UA..RA with in-built damping resistors

Complete the contactor type code by replacing ** with desired coil voltage.

Peak current $\hat{I} \leq 100$ times the rms current

kVAR rating at 415V	Max peak current \hat{I}	Auxiliary contacts fitted		Type	Ordering code	L.P.(₹)
		NO	NC			
kvar	kA					
12.5	1.8	1	0	UA16-30-10	1SBL181022R□□10 ■	2,560
20	3	1	0	UA26-30-10	1SBL241022R□□10 ■	3,170
27.5	33.5	1	0	UA30-30-10	1SBL281022R□□10 ■	5,450
33	5	0	0	UA50-30-00	1SBL351022R□□00 ■	12,230
45	6.5	0	0	UA63-30-00	1SBL371022R□□00 ■	12,880
50	7.5	0	0	UA75-30-00	1SBL411022R□□00 ■	15,390
65	9.3	1	1	UA95-30-11	1SFL431022R□□11 ■	19,320
75	10.5	1	1	UA110-30-11	1SFL451022R□□11 ■	24,290

Single step - Peak current $\hat{I} \leq 30$ times the RMS current

kVAR Rating at 415V	Type code	Ordering code	L.P.(₹)
60	A95-30-11**	1SFL431001R□□11 ■	20,550
70	A110-30-11**	1SFL451001R□□11 ■	26,380
90	A145-30-11**	1SFL471001R□□11 ■	33,670
110	A185-30-11**	1SFL491001R□□11 ■	41,610
130	AF205-30-11**	1SFL527002R□□11 ■	47,120
145	AF265-30-11**	1SFL547002R□□11 ■	55,450
165	AF305-30-11**	1SFL587002R□□11 ■	65,560
200	AF370-30-11**	1SFL607002R□□11 ■	80,830
210	AF400-30-11**	1SFL577001R□□11 ■	85,980
240	AF460-30-11**	1SFL597001R□□11 ■	1,14,830
285	AF580-30-11**	1SFL617001R□□11 ■	1,73,670
400	AF750-30-11**	1SFL637001R□□11 ■	2,57,560

Coil voltages and codes UA...RA & UA

Voltage	Voltage	Code
□□□ V - 50Hz	□□□ V - 60Hz	□□
24	24	8 1 ■
110	110 ... 120	8 4 ■
220 ... 230	230 ... 240	8 0 ■
400 ... 415	415 ... 440	8 6 ■

Note: Refer Page 96 for accessories

■ Stock items

Contactors for DC circuit switching: AC/DC operated

Coil	Current ratings at 440V DC			Type code reference	Ordering code	L.P.(₹)
	DC-1	DC-3	DC-5			
AC	100A	85A	50A	GA75-10-11 **	1SBL411025R□□11	Upon request
DC	100A	85A	50A	GAE75-10-11 **	1SBL419025R□□11	Upon request

Complete the contactor type code by replacing ** with desired coil voltage

Coil	Current ratings at 1000V DC		Type code reference	Ordering code	L.P.(₹)
	DC-1 L/R 1 ms				
AC/DC	275A		GAF185-10-11	1SFL497025R□□11	Upon request
	450A		GAF300-10-11	1SFL557025R□□11	
	700A		GAF460-10-11	1SFL597025R□□11	
	1050A		GAF750-10-11	1SFL637025R□□11	
	1250A		GAF1250-10-11	1SFL647025R□□11	
	1650A		GAF1650-10-11	1SFL677025R□□11	
	2050A		GAF2050-10-11	1SFL707025R□□11	

For DC3, DC5 ratings refer technical catalog

Coil voltages and codes:

GA 75

Voltage	Voltage	Code
□□□ V - 50Hz	□□□ V - 60Hz	□□
24	24	8 1
110	110 ... 120	8 4
220 ... 230	230 ... 240	8 0
400 ... 415	415 ... 440	8 6

Coil voltages and codes:

GAE 75

Voltage	Code
□□□ V d.c.	□□
12	8 0
24	8 2
42	8 1
110	8 6
240	8 9

Coil voltages and codes:

GAF range (AC/DC operated)

Voltage	Voltage	Code
V 50/60 Hz	V DC	□□
-	24...60	6 8
48...130	48...130	6 9
100...250	100...250	7 0
250...500	250...500	7 1

Accessories for contactors



Auxiliary contact block

Description	Mounting on contactors	Contact configuration		Type code reference	Ordering code	L.P.(₹)			
		NO	NC						
Front mounted single pole add-on blocks	A9...A110 AL9...AL40, TAL9...TAL40 N,NL &UA	1NO	-	CA5-10	1SBN010010R1010 ■	230			
		-	1NC	CA5-01	1SBN010010R1001 ■	230			
		4NO	-	CA 5-40 E	1SBN010040R1040				
		3NO	1NC	CA 5-31 E	1SBN010040R1031	1,060			
		2NO	2NC	CA 5-22 E	1SBN010040R1022 ■				
Side mounted 2 pole add-on blocks	A9...A75, AL9...AL40, TAL9...TAL40, N, NL & UA 16..75	1NO	1NC	CAL5-11	1SBN010020R1011 ■	780			
		A95...A185, UA95...UA110, AF400...AF2050	1NO	1NC	CAL18-11	1SFN010720R1011 ■	900		
			A145...A185	AF400...AF2050	1NO	1NC		CAL18-11B	1SFN010720R3311 ■
			AF205...AF370	1NO	1NC	CAL19-11		1SFN010820R1011 ■	
				1NO	1NC	CAL 19-11B		1SFN010820R3311	

Auxiliary contact blocks for EK range of contactors:

Description	Mounting on contactors	Contact configuration		Type code reference	Ordering code	L.P.(₹)
		NO	NC			
Side mounting Two pole auxiliary contact blocks	EK110 ... EK1000	1NO	1NC	CAL16-11A	SK829002-A ■	900
		1NO	1NC	CAL16-11B	SK829002-B ■	
		1NO	1NC	CAL16-11C	SK829002-C	
		1NO	1NC	CAL16-11D	SK829002-D	

* Refer technical catalogue for proper selection.

■ Stock items

Accessories for contactors



Auxiliary contact block

Description	Mounting on contactors	Contact configuration		Type code reference	Ordering code	L.P. (₹)
		NO	NC			
Front mounted single pole add-on blocks	AX09...AX150, NX 4-pole	1NO	-	CA5X-10	1SBN019010R1010 ■	220
		-	1NC	CA5X-01	1SBN019010R1001 ■	220
Front mounted Four pole add-on blocks	AX09...AX150, NX 4-pole	2NO	2NC	CA5X-22E	1SBN019040R1022 ■	800
		3NO	1NC	CA5X-31E	1SBN019040R1031	
		4NO	-	CA5X-40E	1SBN019040R1040	
		-	4NC	CA5X-04E	1SBN019040R1004	
Side mounted 2 pole add-on blocks	AX09...AX80, NX 4-pole	1NO	1NC	CAL5X-11	1SBN019020R1011 ■	710
		1NO	1NC	CAL18X-11	1SFN019820R1011 ■	720
	AX95...AX205	1NO	1NC	CAL18X-11B	1SFN019820R3311 ■	
		1NO	1NC	CAL19-11	1SFN010820R1011	
	AX260...AX370	1NO	1NC	CAL19-11B	1SFN010820R3311	

Surge suppressors



For contactor types	Voltage range	Type code reference	Ordering code	L.P. (₹)
AL9...AL40, TAL9...TAL40, NL	12...32 DC	RT5/32	1SBN050020R1000 ■	920
	25...65 DC	RT5/65	1SBN050020R1001	
	50...90 DC	RT5/90	1SBN050020R1002	
	77...150 DC	RT5/150	1SBN050020R1003 ■	
	150...264 DC	RT5/264	1SBN050020R1004	
A9...A110, AL9...AL40, TAL9...TAL40, N/NL AX09...AX150	24...50V AC/DC	RV5/50	1SBN050010R1000	920
	50...133V AC/DC	RV5/133	1SBN050010R1001	
	110...250V AC/DC	RV5/250	1SBN050010R1002	
	250...440V AC/DC	RV5/440	1SBN050010R1003	
A9...A40, N AX09...AX40	24...50V AC	RC5-1/50	1SBN050100R1000	920
	50...133V AC	RC5-1/133	1SBN050100R1001	
	110...250V AC	RC5-1/250	1SBN050100R1002 ■	
	250...440V AC	RC5-1/440	1SBN050100R1003 ■	
A45...A110 AX50...AX150	24...50V AC	RC5-2/50	1SBN050200R1000	920
	50...133V AC	RC5-2/133	1SBN050200R1001	
	110...250V AC	RC5-2/250	1SBN050200R1002 ■	
A145...A185, AX185...AX205	250...440	RC5-2/440	1SBN050200R1003 ■	1,280
	250...440	RC5-3/440	1SFN050300R1003 ■	
EK550...EK1000	48...110V/AC	RC-EH 800/110	SK829007-C	3,850
	220...600V/AC	RC-EH 800/600	SK829007-D	

■ Stock items

Accessories for contactors



VM5-1



VM300

Mechanical interlocks

For contactor types	Description	Type code reference	Ordering code	L.P.(₹)
A9...A40, AL9...AL40 AX09...AX40	Horizontal Mechanical Interlock	VM5-1	1SBN030100R1000 ■	610
A9...A40, AL9...AL40 AX09...AX40	Horizontal Mechanical & Electrical Interlock with 2NC contacts	VE5-1	1SBN030110R1000 ■	900
A30...A110 AX50...AX115	Horizontal Mechanical & Electrical Interlock with 2NC contacts	VE5-2	1SBN030210R1000 ■	1,760
A95...A185, AX185...AX205	Horizontal with 2NC contacts	VM300H	1SFN034700R1000	3,700
EK110...EK150	Horizontal Mechanical Interlock	VH145	SK829071-A	5,000
EK175...EK210	Horizontal Mechanical Interlock	VH300	SK829071-B	5,800
AF116...AF146 and AF190. AF205	Horizontal Mechanical Interlock	VM140/190	1SFN034403R1000 ■	3,820
AF190, AF205 and AF265 ... AF370	Horizontal Mechanical Interlock	VM205/265	1SFN035203R1000 ■	3,800
AF116...AF370 AX260...AX370	Horizontal Mechanical Interlock	VM19	1SFN030300R1000	4,000

Note: Refer technical catalogue for proper selection.

Mechanical latching units description

For converting standard contactors into latched contactors. The WB75-A block contains a mechanical latching device with electromagnetic impulse unlatching (AC or DC) or manual unlatching.

Ordering details



For contactors	Rated control circuit voltage Uc		Type	Ordering code	L.P.(₹)
	V 50 Hz or DC	V 60 Hz			
N, NL, A9-A75	24	24...28	WB75-A	FPTN372726R1001	6,650
	220...230	220...255	WB75-A	FPTN372726R1006	6,650

For contactors	Rated control circuit voltage Uc	Time ranges	Delay type	Auxiliary contacts	Type	Ordering code	L.P.(₹)
Separate mounting	24-240 V AC 24-48 V DC	0.05s - 100 h	ON-delay	1C/O	CT-ERC.12	1SVR508100R0000	2,360
			ON-delay	2C/O	CT-ERC.22	1SVR508100R0100	4,680
			OFF-delay	1C/O	CT-AHC.12	1SVR508110R0000	2,760
			OFF-delay	2C/O	CT-AHC.22	1SVR508110R0100	5,010

Electronic timers

Contactors: Wide band AC/DC operated AF technology

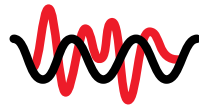

Conventional AC coil

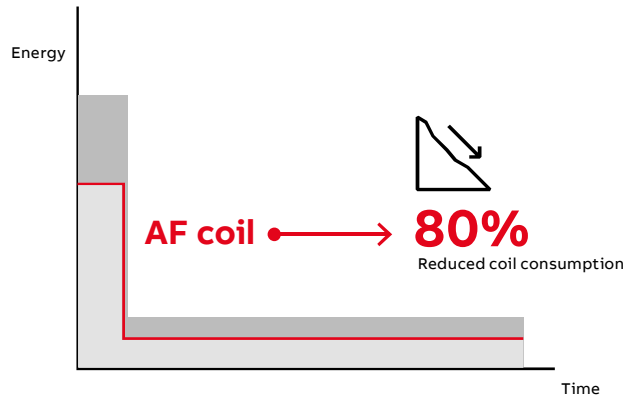

Reliable in all networks

The electronic system within the AF contactor continuously monitor the current and voltage apply to the coil. The contactor is safely operated in an always optimized condition and hum free.

Reduced coil consumption

AF coil and energy consumption is reduced up to 80%. This allows a reduction of the temperature rise, the size of control transformers and size of cabinets.



AF coil

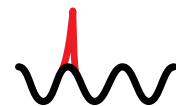
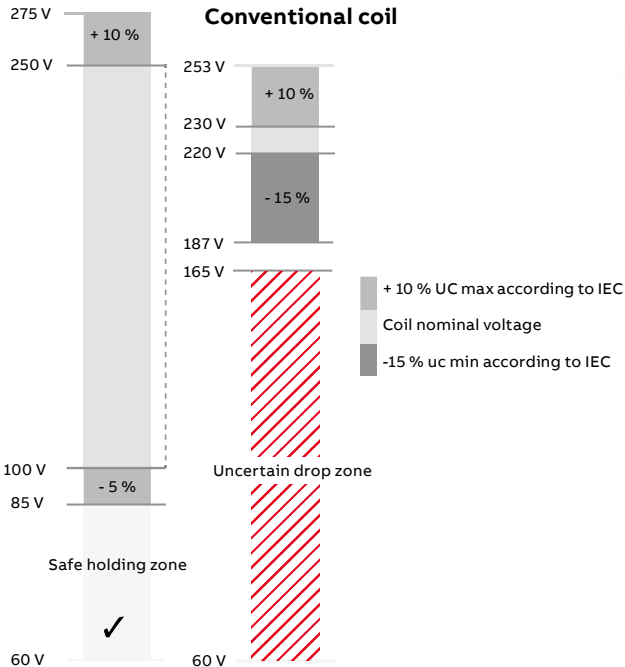

Wide control voltage range

With conventional contactor technology, different contactors are needed for different network voltages. Thanks to the wide operating range of the AF contactor, it can operate just as well in Europe as in Asia or North America. The core coil of the AF contactor range covers 100-250 V AC / DC, 50 / 60 Hz.

Built-in surge suppression

With conventional contactor technology, it is recommended to use an external surge suppressor, an accessory that could cost as much as half of the contactor. With the AF technology, the surges are handled by the contactor and never reach the control circuit. One less product and one less complication to worry about.

INTRODUCING **NEW**

Novolink™ – smart function and sensor modules for AF contactors

Integrated into the B&R X20 system



Digitalize one of the best motor starting portfolios on the market

You have the choice

Strongest contactor range on the market

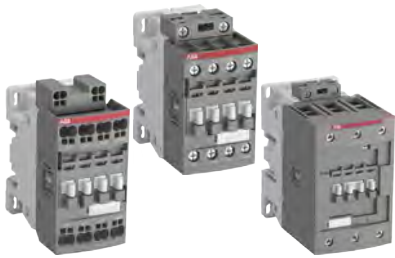

Novolink devices are compatible with 24 V DC coil contactors — from AF09 up to AF96 with screw terminal and AF09 up to AF38 with Push-in Spring terminals

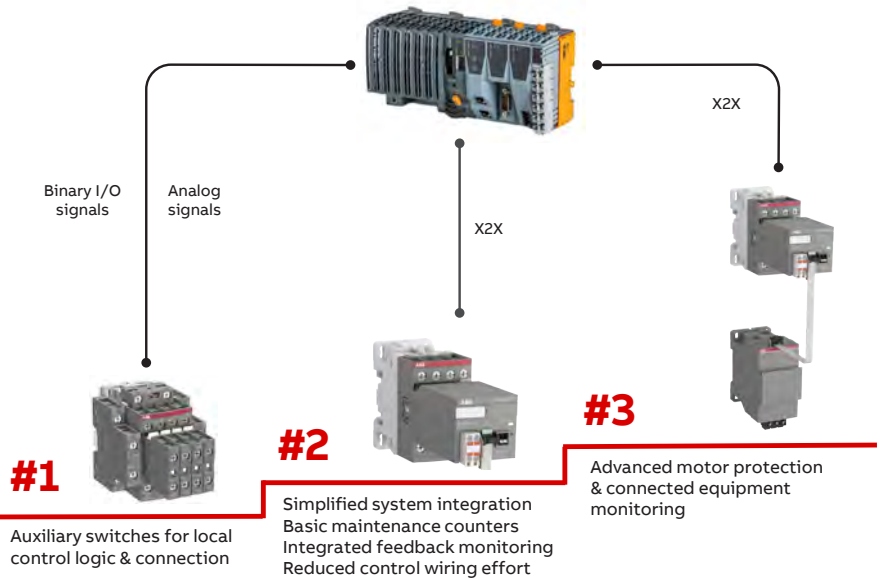

Ordering details

Type	Description	Order code	L.P.(₹)
SFM-CAB-RJTB.1-500	Connection cable RJ45 - X20 Terminal Block of X20BT9400, 5m	1SVM823000R0500	
SFM-CAB-S.1-50	Connection cable SFM to Sensor 0.5m	1SVM811000R0050	
SFM-CAB-S.1-25	Connection cable SFM to Sensor 0.25m	1SVM811000R0025	Upon request
SCV10-40.1	Current – Voltage Sensor	1SVM320010R0000	
SFM1-A11.1	Advanced Function Module with X2X	1SVM120012R0000	

3 pole contactors AF range: Wide band AC/DC operated

AF contactors are built in with:

- Universal coil operable on wide band AC / DC voltages
- Surge suppressors
- Low power consumption coil



AC1duty Amps	AC3 rating at 415V		Auxiliary contacts	Type code	Ordering code	L.P.(₹)	
	Amps	hP					kW
25	9	5.5	4	1NO -	AF09-30-10-□□	1SBL137001R□□10 ■	2,930
				- 1NC	AF09-30-01-□□	1SBL137001R□□01 ■	2,930
28	12	7.5	5.5	1NO -	AF12-30-10-□□	1SBL157001R□□10 ■	3,190
				- 1NC	AF12-30-01-□□	1SBL157001R□□01 ■	3,190
30	18	12.5	7.5	1NO -	AF16-30-10-□□	1SBL177001R□□10 ■	3,920
				- 1NC	AF16-30-01-□□	1SBL177001R□□01 ■	3,920
45	26	15	11	- -	AF26-30-00-□□	1SBL237001R□□00 ■	4,860
50	32	20	18	- -	AF30-30-00-□□	1SBL277001R□□00 ■	10,680
50	38	25	18.5	- -	AF38-30-00-□□	1SBL297001R□□00 ■	12,160
70	40	30	18.5	- -	AF40-30-00-□□	1SBL347001R□□00 ■	13,170
100	53	40	22	- -	AF52-30-00-□□	1SBL367001R□□00 ■	15,320
105	65	50	30	- -	AF65-30-00-□□	1SBL387001R□□00 ■	17,260
125	80	60	37	- -	AF80-30-00-□□	1SBL397001R□□00 ■	21,360
130	96	70	45	- -	AF96-30-00-□□	1SBL407001R□□00 ■	25,210
160	116	75	55	1NO 1NC	AF116-30-11-□□	1SFL427001R□□11 ■	28,530
200	140	100	75	1NO 1NC	AF140-30-11-□□	1SFL447001R□□11 ■	35,500
225	146	100	75	1NO 1NC	AF146-30-11-□□	1SFL467001R□□11 ■	36,510
275	190	120	90	1NO 1NC	AF190-30-11-□□	1SFL487002R□□11 ■	44,030
350	205	150	110	1NO 1NC	AF205-30-11-□□	1SFL527002R□□11 ■	47,120
400	265	175	140	1NO 1NC	AF265-30-11-□□	1SFL547002R□□11 ■	55,450
500	305	215	160	1NO 1NC	AF305-30-11-□□	1SFL587002R□□11 ■	65,560
600	370	270	200	1NO 1NC	AF370-30-11-□□	1SFL607002R□□11 ■	80,830
600	400	300	220	1NO 1NC	AF400-30-11**	1SFL577001R□□11	85,980
700	460	340	250	1NO 1NC	AF460-30-11**	1SFL597001R□□11	1,14,830
800	580	470	355	1NO 1NC	AF580-30-11**	1SFL617001R□□11 ■	1,73,670
1050	750	570	425	1NO 1NC	AF750-30-11**	1SFL637001R□□11 ■	2,57,560
1260	-	-	-	1NO 1NC	AF1250-30-11**	1SFL647001R□□11	
1350	860	-	500	1NO 1NC	AF1350-30-11**	1SFL657001R□□11	
1650	1050	-	600	1NO 1NC	AF1650-30-11**	1SFL677001R□□11	
2050	-	-	-	1NO 1NC	AF2050-30-11**	1SFL707001R□□11	Upon request
2650	-	-	-	1NO 1NC	AF2650-30-11**	1SFL667001R□□11	
2850	-	-	-	1NO 1NC	AF2850-30-11**	1SFL687001R□□11	

Complete the contactor type code by replacing ** with desired coil voltage, AF contactors have advanced electronic coil interface with wideband AC/DC coil

Coil voltages and codes:

New AF09...AF370 range (AC/DC operated)

Voltage	Voltage	Code
V 50/60 Hz	V DC	□□
24...60	20...60	1 1 ■
48...130	48...130	1 2 ■
100...250	100...250	1 3 ■
250...500	250...500	1 4 ■

AF400...AF1250 range (AC/DC operated)

Voltage	Voltage	Code
V 50/60 Hz	V DC	□□
-	24...60	6 8
48...130	48...130	6 9
100...250	100...250	7 0 ■
250...500	250...500	7 1 ■

AF1350...AF2850 range (AC/DC operated)

Voltage	Voltage	Code
V 50/60 Hz	DC	□□
100...250	100...250	7 0

Note: For non-standard coil voltage, other than this contact us for price.
Refer Page 100 and Page 101 for accessories

4 pole contactors: Wide band AC/DC operated

New AF Contactors: 4 pole – AC / DC Operated

Rating at 415V AC1 Amps	Main contact arrangement	Auxiliary contacts	Type code reference	Ordering code	L.P.(₹)
25	4NO - - -	AF09-40-00-□□	1SBL137201R□□00 ■	3,010	
	2NO 2NC - -	AF09-22-00-□□	1SBL137501R□□00	3,780	
30	4NO - - -	AF16-40-00-□□	1SBL177201R□□00	3,780	
	2NO 2NC	AF16-22-00-□□	1SBL177501R□□00 ■	4,630	
45	4NO - - -	AF26-40-00-□□	1SBL237201R□□00	5,730	
	2NO 2NC	AF26-22-00-□□	1SBL237501R□□00	7,090	
55	4NO - - -	AF38-40-00-□□	1SBL297201R□□00 ■	11,760	
	2NO 2NC - -	AF38-22-00-□□	1SBL297501R□□00	14,300	
70	4NO - - -	AF40-40-00-□□	1SBL347201R□□00	18,620	
	2NO 2NC - -	AF40-22-00-□□	1SBL347501R□□00	20,600	
100	4NO - - -	AF52-40-00-□□	1SBL367201R□□00 ■	19,360	
125	4NO - - -	AF80-40-00-□□	1SBL397201R□□00	23,530	
	2NO 2NC - -	AF80-22-00-□□	1SBL397501R□□00	26,370	
160	4NO - - -	AF116-40-00-□□	1SFL427102R□□00 ■	28,270	
200	4NO - - -	AF140-40-00-□□	1SFL447102R□□00 ■	35,090	
275	4NO - - -	AF190-40-00-□□	1SFL487102R□□00 ■	50,980	
350	4NO - - -	AF205-40-00-□□	1SFL527102R□□00 ■	60,780	
400	4NO - - -	AF265-40-00-□□	1SFL547102R□□00 ■	72,220	
500	4NO - - -	AF305-40-00-□□	1SFL587102R□□00 ■	88,950	
525	4NO - - -	AF370-40-00-□□	1SFL607102R□□00 ■	99,240	

Coil voltages and codes: New AF range (AC/DC operated)

Voltage V 50/60 Hz	Voltage V DC	Code □□
24...60	20...60	11 ■
48...130	48...130	12 ■
100...250	100...250	13 ■
250...500	250...500	14 ■

Accessories for AF contactors

Auxiliary contact block

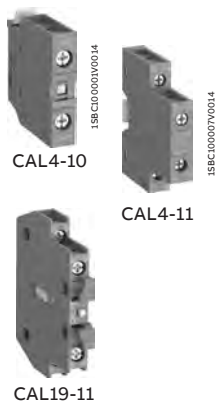

Description	Mounting on contactors	Contact configuration		Type code reference	Ordering code	L.P.(₹)
		NO	NC			
Front mounted 1 pole add-on blocks	AF09....AF96 / NF	1NO	-	CA4-10	1SBN010110R1010 ■	250
		-	1NC	CA4-01	1SBN010110R1001 ■	250
Front mounted 4 pole add-on blocks	AF09....AF80 / NF	4NO	-	CA4-40E	1SBN010140R1040 ■	1,050
		3NO	1NC	CA4-31E	1SBN010140R1031	1,050
		2NO	2NC	CA4-22E	1SBN010140R1022 ■	1,050
		-	4NC	CA4-04E	1SBN010140R1004	1,050
Side mounted 2 pole add-on blocks	AF09....AF96 / NF AF96...AF370	1NO	1NC	CAL4-11	1SBN010120R1011 ■	670
		1NO	1NC	CAL19-11	1SFN010820R1011 ■	900
		1NO	1NC	CAL19-11B	1SFN010820R3311 ■	

* Refer technical catalogue for proper selection.

■ Stock items

Accessories for AF contactors



Mechanical interlocks

Description	For contactor types	Type Code reference	Ordering code	L.P.(₹)
Horizontal Mechanical Interlock	AF09...AF38	VM 4	1SBN030105T1000	730
Horizontal Mechanical & Electrical Interlock	AF09...AF38	VEM 4	1SBN030111R1000	1,290
Horizontal Mechanical Interlock	AF40...AF96	VM96-4	1SBN033405T1000	2,640
Horizontal Mechanical Interlock	AF116...AF146 and AF190, AF205	VM140/190	1SFN034403R1000	3,820
Horizontal Mechanical Interlock	AF190, AF205 and AF265 ... AF370	VM205/265	1SFN034403R1000	3,820
Horizontal Mechanical Interlock	AF116...AF370	VM19	1SFN030300R1000	4,000

Note: Refer technical catalogue for proper selection.

Ordering details

For contactors	Rated control circuit voltage Uc	Type	Ordering code	L.P.(₹)
NF(Z),AF(Z)09....38,AF40...65	24V DC	WA4-10	1SBN040100R1010	2,860
NF(Z),AF(Z)09....38,AF40...65	24-60V50/60HZ-DC	WA4-11	1SBN040100R1011	2,860
NF(Z),AF(Z)09....38,AF40...65	48-130V50/60HZ-DC	WA4-12	1SBN040100R1012	2,860
NF(Z),AF(Z)09....38,AF40...65	100-250V50/60HZ-DC	WA4-13	1SBN040100R1013	2,860
NF(Z),AF(Z)09....38,AF40...65	250-500V50/60HZ-DC	WA4-14	1SBN040100R1014	2,860
AF80....96	24-60V50/60HZ-DC	WA4-96-11	1SBN040200R1011	2,860
AF80....96	48-130V50/60HZ-DC	WA4-96-12	1SBN040200R1012	2,860
AF80....96	100-250V50/60HZ-DC	WA4-96-13	1SBN040200R1013	2,860
AF80....96	250-500V50/60HZ-DC	WA4-96-14	1SBN040200R1014	2,860



Electronic timers

For contactor types	Time delay range selected by switch	Delay type	Auxiliary contacts	Type	Ordering code	L.P.(₹)
AF09 ... AF96	0.1...1 s 1...10 s 10...100 s	ON-delay	1NO + 1NC	TEF4-ON	1SBN020112R1000	6,920
		OFF-delay	1NO + 1NC	TEF4-OFF	1SBN020114R1000	6,580

Note: Rated control circuit voltage Uc 24...240 V 50/60 Hz or DC.

Connecting links with manual motor starters

For contactor types	Used with	Type	Ordering code	L.P.(₹)
AF09 ... AF16	MS116-0.16 ... MS116-25, MS132-0.16 ... MS132-25	BEA16-4	1SBN081306T1000	510
AF26 ... AF30	MS116-0.16 ... MS116-16, MS132-0.16 ... MS132-10	BEA26-4	1SBN082306T1000	580
	MS116-20 ... MS116-32, MS132-12 ... MS132-32	BEA38-4	1SBN082306T2000	630

Connection sets for reversing contactors

For contactor types	Type	Ordering code	L.P.(₹)
AF09 ... AF16	BER16-4	1SBN081311R1000	1,280
AF26 ... AF30	BER38-4	1SBN082311R1000	1,740
AF40 ... AF65	BER65-4	1SBN083411R1000	2,080
AF80 ... AF96	BER96-4	1SBN083911R1000	3,610

Connection sets for star-delta starting

For contactor types	Type	Ordering code	L.P.(₹)
AF09 ... AF16	BEY16-4	1SBN081313R2000	1,750
AF26 ... AF30	BEY38-4	1SBN082713R2000	2,700
AF40 ... AF65	BEY65-4	1SBN083413R2000	3,490
AF80 ... AF96	BEY96-4	1SBN083913R2000	4,470

AFC contactors for AC control applications NEW

Flexible and safe

Part of the AF platform

AFC contactors are an extension of the AF platform. Sharing same footprint and having equivalent electrical performance, installation design and maintenance are easier and faster. Protection devices (manual motor starters, overloads relays), accessories (auxiliary contacts, electronic timers, ...) and connection kits (direct-on-line, reversing, start delta) are common to the entire platform.



Great flexibility for coil terminal access and surge suppressor

AFC contactors offer free choice of coil terminal access from top, bottom or front. Surge suppressor can be mounted from top or bottom.

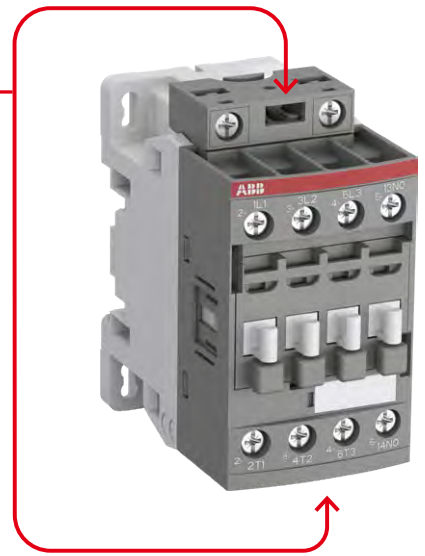
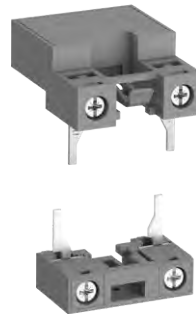
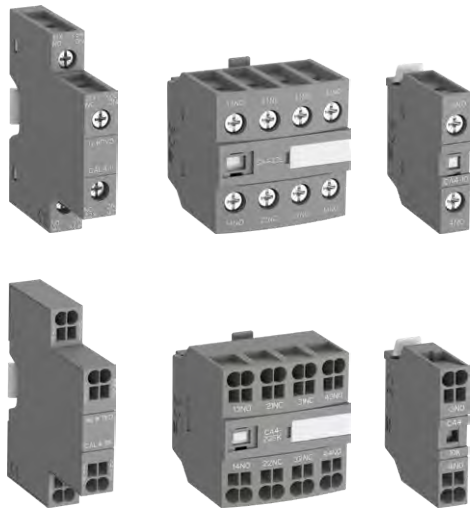

Compatible and easy to use accessories

1-pole, 2-pole and 4-pole auxiliary contact blocks (front or side mounted) are available with screw and Push-in Spring terminals: They can be mounted on every contactor of the AF platform, whatever its terminal connection type.



Easy, fast and secure starters assembly

The AF contactor range is perfect for motor starting applications and for solutions where space is limited. You can create any motor starting type and save assembly time with a complete range of accessories and connection sets.



Protect from overload in all conditions

Select thermal overload relays (trip class 10) or electronic overload relays (trip class 10E, 20E, 30E in the same product) to protect your motors against overload and phase failure.

AFC contactors: AC operated NEW



Contactors: 3-pole – AC operated

AC1 duty Amps	AC3 rating at 415V			Auxiliary contacts		Type code	Ordering code	L.P.(₹)
	Amps	hP	kW					
25	9	5.5	4	1NO	-	AFC09-30-10 **	1SBL131001R□□10 ■	Upon request
25	9	5.5	4	-	1NC	AFC09-30-01 **	1SBL131001R□□01 ■	
28	12	7.5	5.5	1NO	-	AFC12-30-10 **	1SBL151001R□□10 ■	
28	12	7.5	5.5	-	1NC	AFC12-30-01 **	1SBL151001R□□01 ■	
30	17	12.5	7.5	1NO	-	AFC16-30-10 **	1SBL171001R□□10 ■	
30	17	12.5	7.5	-	1NC	AFC16-30-01 **	1SBL171001R□□01 ■	
45	26	15	11	-	-	AFC26-30-00 **	1SBL231001R□□00 ■	
50	32	20	15	-	-	AFC30-30-00 **	1SBL271001R□□00 ■	
50	37	30	18.5	-	-	AFC40-30-00 **	1SBL291001R□□00 ■	

Contactors: 4-pole (AC operated)

Rating at 415V AC1 Amps	Main contact arrangement		Auxiliary contacts		Type code reference	Ordering code	L.P.(₹)
25	4NO	-	-	-	AFC09-40-00 **	1SBL131201R□□00 ■	Upon request
25	2NO	2NC	-	-	AFC09-22-00 **	1SBL131501R□□00 ■	
30	4NO	-	-	-	AFC16-40-00 **	1SBL171201R□□00 ■	
30	2NO	2NC	-	-	AFC16-22-00 **	1SBL171501R□□00 ■	
45	4NO	-	-	-	AFC26-40-00 **	1SBL231201R□□00 ■	
45	2NO	2NC	-	-	AFC26-22-00 **	1SBL231501R□□00 ■	
55	4NO	-	-	-	AFC38-40-00**	1SBL291201R□□00 ■	
55	2NO	2NC	-	-	AFC38-22-00**	1SBL291501R□□00 ■	

Auxiliary contactors

No. of contacts	Contact configuration		Type code reference	Ordering code	L.P.(₹)
	NO	NC			
4	2	2	NFC22E **	1SBH131001R□□22 ■	Upon request
4	3	1	NFC31E **	1SBH131001R□□31 ■	
4	4	0	NFC40E **	1SBH131001R□□40 ■	
8	4	4	NFC44E **	1SBH131001R□□44 ■	
8	5	3	NFC53E **	1SBH131001R□□53 ■	
8	6	2	NFC62E **	1SBH131001R□□62 ■	
8	7	1	NFC71E **	1SBH131001R□□71 ■	
8	8	0	NFC80E **	1SBH131001R□□80 ■	

Coil voltages and codes:

AFC09 ... AFC38/NFC range

Voltage	Voltage	Code
□□V - 50Hz	□□V - 60Hz	□□
24	24	8 1■
110	110 ... 120	8 4■
220 ... 230	230 ... 240	8 0■
400 ... 415	415 ... 440	8 6■

Note: For non-standard coil voltage, other than this contact us for price.

Accessories for AF contactors

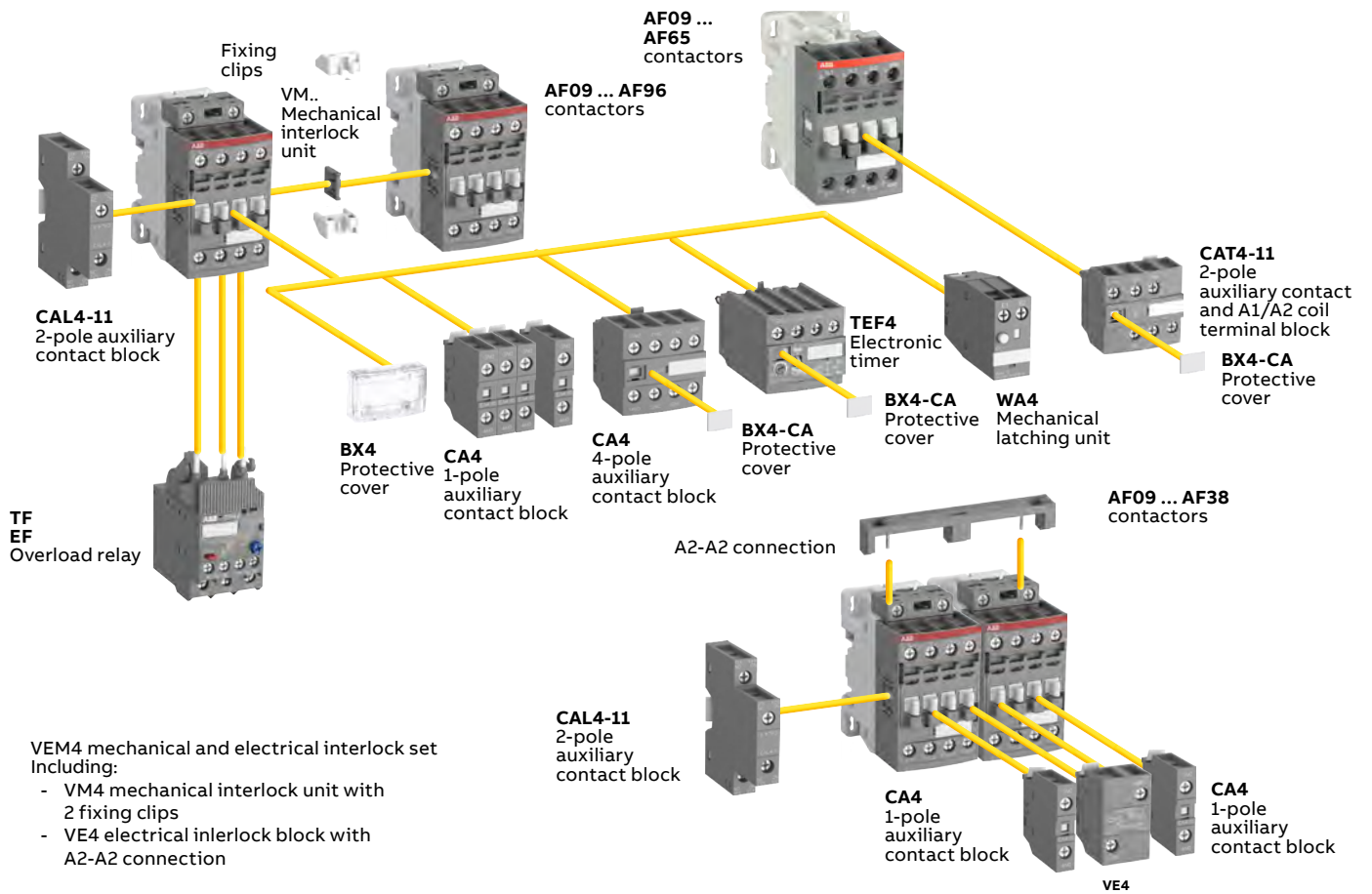

AF the premium range



The AF contactor is compact

The AF contactor is compact in size and has had its width reduced by up to 30% thanks to an 80% reduction of the coil's energy consumption.

The AF contactor is flexible

AF09...AF370 is perfect for motor starting applications and for solutions where space is limited. Interlocked reversing pairs require no spacing between contactors can fit more functions meaning you fit into cabinets or other small enclosures.



Powerful light switching made easy

ESB and EN installation contactors



ABB's hum-free installation contactor designs offer a wide range of ratings from 16 A to 100 A. With an innovative AC/DC coil design that eliminates hum, a broad selection of common accessories as well as manual and automatic versions, ESB..N contactors cover all your needs in both domestic and residential applications. Find out more at abb.com/lowvoltage



ESB and EN Installation contactors



Hum-free operation



Tool-free to save time



More choice,
less inventory



Comprehensive solution



Optimum interface



Easy to install



Group mounting
saves space



Global
availability



Easy identification

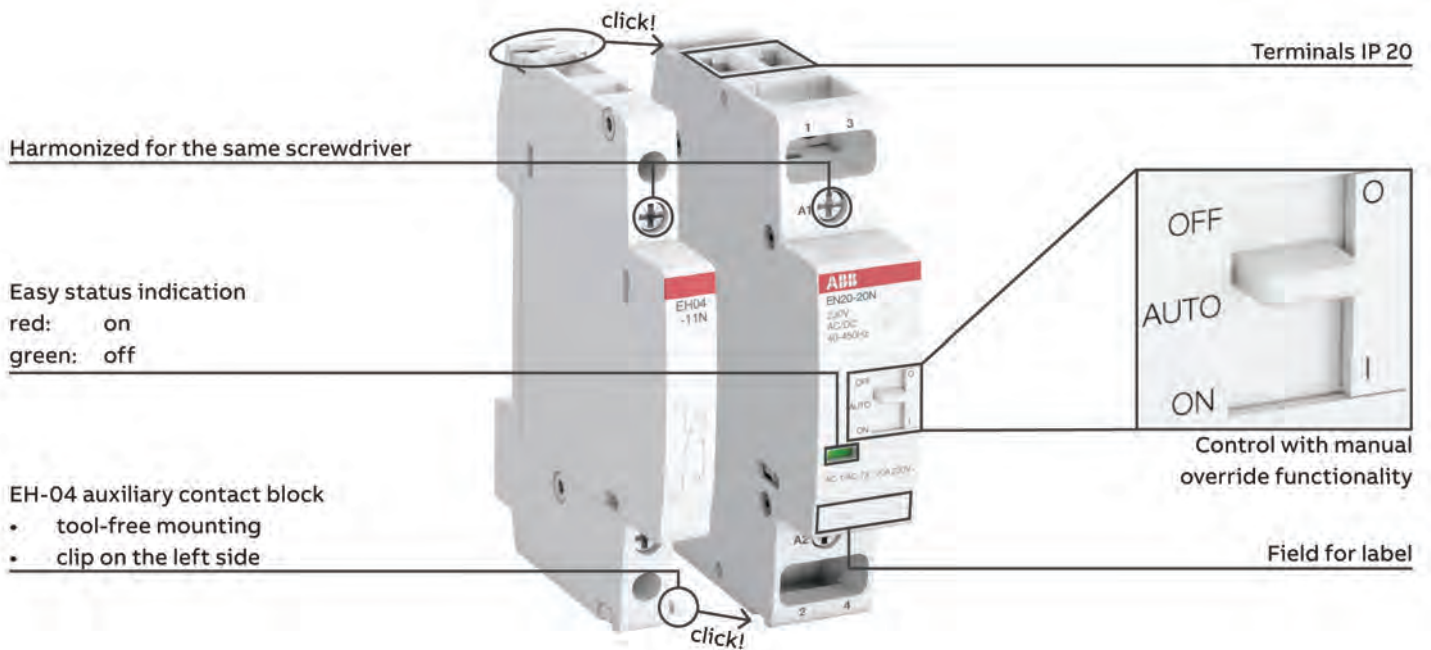

Harmonized for the same screwdriver

Easy status indication

red: on
green: off

EH-04 auxiliary contact block

- tool-free mounting
- clip on the left side

Terminals IP 20







OFF
AUTO
ON







Control with manual
override functionality











Field for label











ESB and EN Installation contactors







ABB's installation contactor range comes with a host of features to make installation and maintenance easier. A mechanical indicator shows the status in green or red color to make system diagnostics quicker. Some speciality types also feature a manual override functionality with a toggle switch providing independent control. Accessories such as auxiliaries, space holders, as well as safety covers can be mounted tool-free onto the contactor.





Main contacts	Width in number of modular spacings	Rated control circuit voltage ⁽¹⁾ V AC / DC	Type	Ordering code	L.P. (₹)
	1	24	ESB16-20N-01	1SBE11111R0120	3,030
	1	230	ESB16-20N-06	1SBE11111R0620	3,030
	1	24	ESB16-02N-01	1SBE11111R0102	3,170
	1	230	ESB16-02N-06	1SBE11111R0602	3,170
	1	24	ESB16-11N-01	1SBE11111R0111	3,090
	1	230	ESB16-11N-06	1SBE11111R0611	3,090

Main contacts	Width in number of modular spacings	Rated control circuit voltage ⁽¹⁾ V AC / DC	Type	Ordering code	L.P. (₹)
	1	24	ESB20-20N-01	1SBE12111R0120	3,360
	1	230	ESB20-20N-06	1SBE12111R0620	3,360
	1	24	ESB20-02N-01	1SBE12111R0102	3,510
	1	230	ESB20-02N-06	1SBE12111R0602	3,510
	1	24	ESB20-11N-01	1SBE12111R0111	3,390
	1	230	ESB20-11N-06	1SBE12111R0611	3,390

Main contacts	Width in number of modular spacings	Rated control circuit voltage ⁽¹⁾ V AC / DC	Type	Ordering code	L.P. (₹)
	2	24	ESB25-40N-01	1SAE23111R0140	3,420
	2	230 ... 240	ESB25-40N-06	1SAE23111R0640	3,420
	2	24	ESB25-04N-01	1SAE23111R0104	3,540
	2	230 ... 240	ESB25-04N-06	1SAE23111R0604	3,540
	2	24	ESB25-22N-01	1SAE23111R0122	3,540
	2	230 ... 240	ESB25-22N-06	1SAE23111R0622	3,540
	2	24	ESB25-31N-01	1SAE23111R0131	3,540
	2	230 ... 240	ESB25-31N-06	1SAE23111R0631	3,540
	2	24	ESB25-13N-01	1SAE23111R0113	3,540
	2	230 ... 240	ESB25-13N-06	1SAE23111R0613	3,540



Main contacts	Width in number of modular spacings	Rated control circuit voltage ⁽¹⁾ V AC / DC	Type	Ordering code	L.P. (₹)
	3	24	ESB40-40N-01	1SAE34111R0140	6,300
	3	230	ESB40-40N-06	1SAE34111R0640	6,300
	3	24	ESB40-22N-01	1SAE34111R0122	6,400
	3	230	ESB40-22N-06	1SAE34111R0622	6,400
	3	24	ESB40-31N-01	1SAE34111R0131	6,400
	3	230	ESB40-31N-06	1SAE34111R0631	6,400
	3	24	ESB40-30N-01	1SAE34111R0130	6,060
	3	230	ESB40-30N-06	1SAE34111R0630	6,060
	3	24	ESB40-20N-01	1SAE34111R0120	6,060
	3	230	ESB40-20N-06	1SAE34111R0620	5,840





Main contacts	Width in number of modular spacings	Rated control circuit voltage ⁽¹⁾ V AC / DC	Type	Ordering code	L.P. (₹)
	3	24	ESB63-40N-01	1SAE35111R0140	8,200
	3	230	ESB63-40N-06	1SAE35111R0640	8,200
	3	230	ESB63-31N-06	1SAE35111R0631	8,430
	3	230	ESB63-30N-06	1SAE35111R0630	7,980
	3	24	ESB63-20N-01	1SAE35111R0120	7,860
	3	230	ESB63-20N-06	1SAE35111R0620	7,860

Main contacts	Width in number of modular spacings	Rated control circuit voltage ⁽¹⁾ V AC / DC	Type	Ordering code	L.P. (₹)
	6	24	ESB100-40N-01	1SAE66111R0140	28,040
	6	230	ESB100-40N-06	1SAE66111R0640	28,040
	3	24	ESB100-20N-01	1SAE36111R0120	26,850
	3	230	ESB100-20N-06	1SAE36111R0620	26,850

ESB and EN Installation contactors

Main contacts	Width in number of modular spacings	Rated control circuit voltage ⁽¹⁾ V AC / DC	Type	Ordering code	L.P. (₹)
	1	24	EN20-20N-01	1SBE122111R0120	4,720
		230	EN20-20N-06	1SBE122111R0620	

Main contacts	Width in number of modular spacings	Rated control circuit voltage ⁽¹⁾ V AC / DC	Type	Ordering code	L.P. (₹)
	2	24	EN25-40N-01	1SAE232111R0140	14,100
		230 ... 240	EN25-40N-06	1SAE232111R0640	14,380
	2	24	EN25-31N-01	1SAE232111R0131	14,490
		230 ... 240	EN25-31N-06	1SAE232111R0631	14,490
	2	230 ... 240	EN25-30N-06	1SAE232111R0630	12,580

Main contacts	Width in number of modular spacings	Rated control circuit voltage ⁽¹⁾ V AC / DC	Type	Ordering code	L.P. (₹)
	3	24	EN40-40N-01	1SAE342111R0140	14,440
		230	EN40-40N-06	1SAE342111R0640	14,440
	3	24	EN40-31N-01	1SAE342111R0131	14,550
		230	EN40-31N-06	1SAE342111R0631	14,550
	3	230	EN40-30N-06	1SAE342111R0630	12,920
	3	230	EN40-20N-06	1SAE342111R0620	12,580

Auxiliary contact blocks

Auxiliary contacts	Suitable for	Type	Ordering code	L.P. (₹)
Single packaging				
	ESB16..N, ESB20..N, ESB25..N, ESB40..N, ESB63..N, ESB100..N, EN20..N, EN25..N, EN40..N	EHO4-11N	1SAE901901R1011	1,110
		EHO4-20N	1SAE901901R1020	1,110

Distant piece

Suitable for	Type	Ordering code	L.P. (₹)
Single packaging			
ESB25..N, ESB40..N, ESB63..N, EN25..N, EN40..N, ESB100..N, EN100..N	ESB-DIS	GHE3201902R0001	210

Mini contactors



Mini contactors with screw connection: 3 pole - AC operated

AC1 duty Amps	AC3 rating at 415V			Auxiliary contacts		Type code reference	Ordering code	L.P.(₹)
	Amps	hP	kW					
16A	9	5.5	4	1NO	-	B06-30-10 **	GJL1211001R□10□ ■	1,340
16A	9	5.5	4	-	1NC	B06-30-01 **	GJL1211001R□01□ ■	
20A	12	7.5	5.5	1NO	-	B07-30-10 **	GJL1311001R□10□ ■	1,460
20A	12	7.5	5.5	-	1NC	B07-30-01 **	GJL1311001R□01□ ■	

Complete the contactor type code by replacing ** with desired coil voltage

3 pole - DC operated

Type code reference	Ordering code	L.P.(₹)
BC6-30-10 **	GJL1213001R□10□ ■	1,840
BC6-30-01 **	GJL1213001R□01□ ■	
BC7-30-10 **	GJL1313001R□10□ ■	2,000
BC7-30-01 **	GJL1313001R□01□ ■	

Mini reversing contactors with screw connection:

3 pole - AC operated

AC1 duty Amps	AC3 rating at 415V			Auxiliary contacts		Type code reference	Ordering code	L.P.(₹)
	Amps	hP	kW					
16A	9	5.5	4	1NO	-	VB06-30-10 **	GJL1211901R□10□ □	3,920
16A	9	5.5	4	-	1NC	VB06-30-01 **	GJL1211901R□01□ □	3,920
20A	12	7.5	5.5	1NO	-	VB07-30-10 **	GJL1311901R□10□ □	4,130
20A	12	7.5	5.5	-	1NC	VB07-30-01 **	GJL1311901R□01□ □	4,130

Complete the contactor type code by replacing ** with desired coil voltage

3 pole - DC operated

Type code reference	Ordering code	L.P.(₹)
VBC6-30-10 **	GJL1213901R□10□ □	4,090
VBC6-30-01 **	GJL1213901R□01□ ■	4,090
VBC7-30-10 **	GJL1313901R□10□ □	4,380
VBC7-30-01 **	GJL1313901R□01□ □	4,380

Mini contactors are also available in 4 pole (4NO / 2NO + 2NC)

Mini auxiliary contactor 4 pole with screw connection

Control circuit	Contact configuration		Type code reference	Ordering code	L.P.(₹)
	NO	NC			
AC	2NO	2NC	K6-22Z**	GJH1211001R□22□ □	1,470
	3NO	1NC	K6-31Z **	GJH1211001R□31□ ■	
	4NO	-	K6-40E **	GJH1211001R□40□ □	
DC	2NO	2NC	KC6-22Z**	GJH1213001R□22□ ■	1,890
	3NO	1NC	KC6-31Z **	GJH1213001R□31□ □	
	4NO	-	KC6-40E **	GJH1213001R□40□ □	

Complete the contactor type code by replacing ** with desired coil voltage

Coil voltage for mini contactors

AC		DC	
50-60Hz	Code	DC V	Code
24	0 ... 1 ■	24	0 ... 1 ■
48	0 ... 3	110 ... 125	0 ... 4 ■
110 ... 127	8 ... 4 ■	220 ... 240	0 ... 5
220 ... 240	8 ... 0 ■		
380 ... 415	8 ... 5		

Auxiliary contact blocks for mini contactors

Ordering details

For contactor types	Auxiliary contacts	Type	Ordering code	L.P.(₹)
Front mounted instantaneous auxiliary contact blocks				
B6-, B7-30-10, BC6-, BC7-30-10	1NO + 1NC	CAF6-11M	GJL1201330R0003	780
VB6, VB7, VBC6, VBC7, VB6A, VB7A	2NO	CAF6-20M	GJL1201330R0007	
VBC6A, VBC7A	2NC	CAF6-02M	GJL1201330R0011	
Side mounted instantaneous auxiliary contact block				
B6-, B7-30-10, BC6-, BC7-30-10	1NO + 1NC	CA6-11M	GJL1201317R0003	780

Spares for contactors

Spare coils for A range

For contactor types	Type code reference	Ordering code	L.P.(₹)
N, A9.....A16, UA16..RA	ZA16 **	1SBN151410R□□06	940
A26..A40;UA26..UA30 RA	ZA40 **	1SBN152410R□□06	1,160
A45..A75;UA50..UA75 RA	ZA75 **	1SBN153510R□□06	3,650
A95..A110; UA95..UA110 RA	ZA110 **	1SFN154310R□□06	4,780
A145...A185	ZA185 **	1SFN154710R□□06	7,820
A210...A300	ZA300 **	1SFN155110R□□06	8,650

Spare coils for AF range

For contactor types	Type code reference	Ordering code	L.P.(₹)
AF45...AF75	ZAF75	1SBN153570R□□06	9,980
AF95...AF110	ZAF110	1SFN153370R□□06	13,400
AF145...AF185	ZAF185	1SFN154770R□□06	15,680
AF210,AF260 &AF300	ZAF300	1SFN155170R□□06	28,510
AF400...AF460	ZAF460**	1SFN155770R□□06	33,490
AF580...AF750**	ZAF750**	1SFN156170R□□06	43,470

Coil voltages & codes

N range, A09.....A300, UA.....RA, AX09...AX205			AF45...AF300			AF400...AF750		
Voltage V-50 Hz	Voltage V-60 Hz	Code	Voltage V-50/60 Hz	Voltage V..dc	Code	Voltage V-50/60 Hz	Voltage V..dc	Code
24	24	81		20....60	72*		24....60	68
110	110....120	84	48....130	48....130	69	48....130	48....130	69
220....230	230....240	80	100....250	100....250	70	100....250	100....250	70
400....415	415....440	86				250....500	250....500	71

* For contactor AF95...AF300

Spare contact sets for 3 pole

Description	For contactor types	Type code reference	Ordering code	L.P.(₹)
Contact set for 3 -pole contactors consisting of 6 fixed contacts, 3 moving contacts, springs and the required screws.	A/AF/AE/TAE50	ZL 50	1SBN163503R1000 ■	5,030
	A/AF/AE/TAE63	ZL 63	1SBN163703R1000 ■	7,300
	A/AF/AE/TAE75	ZL 75	1SBN164103R1000 ■	9,260
	A/AF/AE/TAE95	ZL 95	1SFN164303R1000 ■	12,050
	A/AF/AE/TAE110	ZL 110	1SFN164503R1000 ■	13,200
	A/AF145	ZL 145	1SFN164703R1000 ■	16,690
	A/AF185	ZL 185	1SFN164903R1000 ■	21,020
	A/AF210	ZL 210	1SFN165103R1000 ■	27,080
	A/AF260	ZL 260	1SFN165303R1000 ■	32,770
	A/AF300	ZL 300	1SFN165503R1000 ■	39,190
	AF400	ZL 400	1SFN165703R1000 ■	44,150
	AF460	ZL 460	1SFN165903R1000 ■	54,460
	AF 580	ZL 580	1SFN166103R1000 ■	91,670
	AF 750	ZL 750	1SFN166303R1000 ■	115,090
	UA 50	ZLU 50	1SBN163502R1000	5,790
	UA 63	ZLU 63	1SBN163702R1000	8,070
UA 75	ZLU 75	1SBN164102R1000	10,130	

Spare contact sets for 3 pole for AX

For contactor types	Type code reference	Ordering code	L.P.(₹)
AX50	ZLX50	1SBN163506R1000	4,650
AX65	ZLX65	1SBN163706R1000	6,180
AX80	ZLX80	1SBN164106R1000	8,050
AX95	ZLX95	1SFN164306R1000	9,380
AX115	ZLX115	1SFN169806R1000	11,410
AX150	ZLX150	1SFN169906R1000	15,140
AX185	ZLX185	1SFN164906R1000	17,820
AX205	ZLX205	1SFN165006R1000	21,670

Spare coils for AX range

For contactor types	Type code reference	Ordering code	L.P.(₹)
AX25	ZAX25	1SBN158910R□□36	860
AX40	ZAX40	1SBN152810R□□36	1,140
AX80	ZAX80	1SBN153510R□□36	3,560
AX150	ZAX150	1SFN159910R□□36	5,420
AX205	ZAX205	1SFN155010R□□36	7,690

Complete the contactor type code by replacing□□ with desired coil voltage from above mentioned table

* Consider Spare price list for other products.

■ Stock items

DOL and star delta starters



Direct on line starter:

Rating at 415V 50Hz		Back - up Fuse rating (A)	Type code reference	Ordering code	L.P.(₹)
HP	kW				
0.25	0.18	4A	MA-0.25 **	1SYN140318R□□25	3,720
0.50	0.37	4A	MA-0.50 **	1SYN140318R□□05	3,720
0.75	0.52	6A	MA-0.75 **	1SYN140318R□□75	3,720
1.00	0.75	6A	MA-1.00 **	1SYN140318R□□10 ■	3,720
1.50	1.10	10A	MA-1.50 **	1SYN140318R□□15	3,720
2.00	1.50	10A	MA-2.00 **	1SYN140318R□□20 ■	3,720
3.00	2.20	16A	MA-3.00 **	1SYN140318R□□30 ■	3,720
5.00	3.70	25A	MA-5.00 **	1SYN140318R□□50 ■	3,720
7.50	5.50	32A	MA-7.50 **	1SYN16018R□□75 ■	3,720
10.00	7.50	32A	MA-10.00 **	1SYN180318R□□10 ■	4,020



Fully automatic Star Delta starter:

Rating at 415V 50Hz		Type code reference	Ordering code	L.P.(₹)
HP	kW			
12.5	12.5/9.3	SDA-12.5 **	1SYN184322R□□00 ■	14,140
15	15/11	SDA-15 **	1SYN242322R□□00 ■	15,380
20	20/15	SDA- 20 **	1SYN244322R□□00 ■	17,840
25	25/18.5	SDA-25 **	1SYN246322R□□00	18,580
30	30/22	SDA-30 **	1SYN282322R□□00	22,450
35	35/26	SDA-35 **	1SYN284322R□□00	24,910
40	40/30	SDA-40 **	1SYN322322R□□00	30,230
50	50/37	SDA-50 **	1SYN352342R□□00	36,290
60	60/45	SDA-60 **	1SYN372342R□□00	46,680
75	75/55	SDA-75 **	1SYN412342R□□00	54,720

Complete the starter type code by replacing the ** with the desired coil voltage.

Voltage	Code
□□□	□□
220 ... 230 V coil	3 8
400 ... 415 V coil	8 6 ■

DOL Starter with IP65 enclosure



4KE 7.5KW 415V, IP65 compact plastic enclosure with double insulation



Description	Ordering code	L.P.(₹)
DRAS09-29P 4.0 kW 415V, 415V coil	1SBK104035R2900	7,300
DRAS12-29P 5.5 kW 415V, 415V coil	1SBK114035R2900	7,850
DRAS16-29P 7.5 kW 415V, 415V coil	1SBK124035R2900	10,550

Note: T16 OLR to be ordered separately. Plz refer page no. 120 for reference.

■ Stock items

Manual motor starter

With thermal and electromagnetic protection

MS116 Manual motor starters with short circuit, overload and phase loss protection



Rated power 415V KW	Ie current setting range Amp	S/C Icu breaking capacity kA	Type	Ordering code	L.P. (₹)
0.03	0.10 ... 0.16	50	MS116-0.16	1SAM250000R1001 ■	3,600
0.06	0.16 ... 0.25	50	MS116-0.25	1SAM250000R1002 ■	3,600
0.09	0.25 ... 0.40	50	MS116-0.4	1SAM250000R1003 ■	3,600
0.12	0.40 ... 0.63	50	MS116-0.63	1SAM250000R1004 ■	4,180
0.25	0.63 ... 1.00	50	MS116-1.0	1SAM250000R1005 ■	4,180
0.55	1.00 ... 1.60	50	MS116-1.6	1SAM250000R1006 ■	4,180
0.75	1.60 ... 2.50	50	MS116-2.5	1SAM250000R1007 ■	4,180
1.5	2.50 ... 4.00	50	MS116-4.0	1SAM250000R1008 ■	4,280
2.2	4.00 ... 6.30	50	MS116-6.3	1SAM250000R1009 ■	4,280
4.0	6.30 ... 10.0	50	MS116-10	1SAM250000R1010 ■	4,400
5.5	8.00 ... 12.0	25	MS116-12	1SAM250000R1012 ■	5,000
7.5	10.0 ... 16.0	16	MS116-16	1SAM250000R1011 ■	5,250
9.0	16.0 ... 20.0	15	MS116-20	1SAM250000R1013 ■	5,810
12.5	20.0 ... 25.0	15	MS116-25	1SAM250000R1014 ■	6,100
15.5	25.0 ... 32.0	10	MS116-32	1SAM250000R1015 ■	11,040

MS132 Manual motor starters with short circuit, overload and phase loss protection



Rated power 415V KW	Ie current setting range Amp	S/C Icu breaking capacity kA	Type	Ordering code	L.P. (₹)
0.03	0.10 ... 0.16	100	MS132-0.16	1SAM350000R1001	4,720
0.06	0.16 ... 0.25	100	MS132-0.25	1SAM350000R1002 ■	4,720
0.09	0.25 ... 0.40	100	MS132-0.4	1SAM350000R1003 ■	4,720
0.12	0.40 ... 0.63	100	MS132-0.63	1SAM350000R1004 ■	5,110
0.25	0.63 ... 1.00	100	MS132-1.0	1SAM350000R1005 ■	5,250
0.55	1.00 ... 1.60	100	MS132-1.6	1SAM350000R1006 ■	5,290
0.75	1.60 ... 2.50	100	MS132-2.5	1SAM350000R1007 ■	5,290
1.5	2.50 ... 4.00	100	MS132-4.0	1SAM350000R1008 ■	5,510
2.2	4.00 ... 6.30	100	MS132-6.3	1SAM350000R1009 ■	5,530
4.0	6.30 ... 10.0	100	MS132-10	1SAM350000R1010 ■	5,990
5.5	8.00 ... 12.0	100	MS132-12	1SAM350000R1012 ■	6,700
7.5	10.0 ... 16.0	100	MS132-16	1SAM350000R1011 ■	7,610
9.0	16.0 ... 20.0	100	MS132-20	1SAM350000R1013 ■	8,180
12.5	20.0 ... 25.0	50	MS132-25	1SAM350000R1014 ■	8,340
15.5	25.0 ... 32.0	50	MS132-32	1SAM350000R1015 ■	13,850

MS165 manual motor starters with short circuit, overload and phase loss protection



Ie current setting range Amp	S/C Icu breaking capacity kA	Type	Ordering code	L.P. (₹)
10 ... 16	100	MS165-16	1SAM451000R1011	13,150
14 ... 20	100	MS165-20	1SAM451000R1012	13,750
18 ... 25	100	MS165-25	1SAM451000R1013	14,090
23 ... 32	100	MS165-32	1SAM451000R1014 ■	15,100
30 ... 42	50	MS165-42	1SAM451000R1015 ■	15,680
40 ... 54	50	MS165-54	1SAM451000R1016 ■	19,050
52 ... 65	50	MS165-65	1SAM451000R1017 ■	20,270
62 ... 73	-	MS165-73	1SAM451000R1018	21,900
70 ... 80	-	MS165-80	1SAM451000R1019	23,600

■ Stock items

Manual motor starter

With thermal and electromagnetic protection

MO132 Manual motor starters with short circuit protection only



Rated power 415V KW	Rated operational current Amp	S/C Icu breaking capacity kA	Type	Ordering code	L.P. (₹)
0.03	0.16	100	MO132-0.16	1SAM360000R1001	4,570
0.06	0.25	100	MO132-0.25	1SAM360000R1002	4,570
0.09	0.40	100	MO132-0.4	1SAM360000R1003	4,570
0.12	0.63	100	MO132-0.63	1SAM360000R1004	5,150
0.25	1.0	100	MO132-1.0	1SAM360000R1005 ■	5,230
0.55	1.6	100	MO132-1.6	1SAM360000R1006 ■	5,230
0.75	2.5	100	MO132-2.5	1SAM360000R1007 ■	5,280
1.5	4.0	100	MO132-4.0	1SAM360000R1008 ■	5,340
2.2	6.3	100	MO132-6.3	1SAM360000R1009 ■	5,340
4.0	10	100	MO132-10	1SAM360000R1010 ■	5,520
5.5	12	100	MO132-12	1SAM360000R1012 ■	5,760
7.5	16	100	MO132-16	1SAM360000R1011 ■	5,760
9.0	20	100	MO132-20	1SAM360000R1013 ■	6,190
12.5	25	50	MO132-25	1SAM360000R1014 ■	6,410
15.5	32	50	MO132-32	1SAM360000R1015 ■	13,200

MO165 Manual motor starters with short circuit protection only



Rated operational current Amp	S/C Icu breaking capacity kA	Type	Ordering code	L.P. (₹)
16	100	MO165-16	1SAM461000R1011	13,350
20	100	MO165-20	1SAM461000R1012	14,020
32	100	MO165-32	1SAM461000R1014 ■	14,300
42	50	MO165-42	1SAM461000R1015	15,310
54	50	MO165-54	1SAM461000R1016 ■	15,950
65	50	MO165-65	1SAM461000R1017	16,570
73	30	MO165-73	1SAM461000R1018	20,050
80	30	MO165-80	1SAM461000R1019	21,990

MS132-T circuit breakers for transformer protection

Description

MS132-T Circuit breakers for transformer protection are electro-mechanical protection devices specially designed to protect control transformers on the primary side.

The short-circuit current setting is fixed to 20 times the operating current to handle the high inrush current generated by transformers.



Ie current setting range Amp	S/C Icu breaking capacity kA	Type	Ordering code	L.P. (₹)
0.10 ... 0.16	100	MS132-0.16T	1SAM340000R1001	5,530
0.16 ... 0.25	100	MS132-0.25T	1SAM340000R1002	5,530
0.25 ... 0.40	100	MS132-0.4T	1SAM340000R1003	5,530
0.40 ... 0.63	100	MS132-0.63T	1SAM340000R1004	6,010
0.63 ... 1.00	100	MS132-1.0T	1SAM340000R1005	6,060
1.00 ... 1.60	100	MS132-1.6T	1SAM340000R1006	6,340
1.60 ... 2.50	100	MS132-2.5T	1SAM340000R1007	6,340
2.50 ... 4.00	100	MS132-4.0T	1SAM340000R1008 ■	6,370
4.00 ... 6.30	100	MS132-6.3T	1SAM340000R1009 ■	6,460
6.30 ... 10.0	100	MS132-10T	1SAM340000R1010 ■	6,900
8.00 ... 12.0	100	MS132-12T	1SAM340000R1012	7,620
10.0 ... 16.0	100	MS132-16T	1SAM340000R1011 ■	7,620
16.0 ... 20.0	100	MS132-20T	1SAM340000R1013	9,200
20.0 ... 25.0	50	MS132-25T	1SAM340000R1014	9,220

■ Stock items

Manual motor starter

MS116, MS132, MO132, MS165 and MO165

General accessories

Description

With this solution of door coupling rotary mechanism it is possible to operate a Manual Motor Starter in the back of a switch cabinet from outside. The door coupling mechanism prevents opening of the door of a switch cabinet with the Manual Motor Starter in ON position. The complete mechanism includes handle, shaft, driver, shaft alignment ring and shaft supporter. All accessories fit for 6 mm shafts with a maximum length of 180 mm. The degree of protection for handles MSHD is IP64.

Ordering details

Frame	Description	Type	Ordering code	L.P.(₹)
	SHAFT - Shaft diameter 6 mm. Shaft extension for door coupling driver	OXS6X130	1SCA101655R1001	530
MS116	MSHD - Handle	MSHD-LB1	1SAM201920R1001	1,490
MS132		MSHD-LY2	1SAM201920R1002	1,490
MO132		MSHD-LTB3	1SAM201920R1011	1,490
MS165		MSHD-LTY3	1SAM201920R1012	1,490
MO165	MSMN- Driver	MSMN4	1SAM101923R0002	220
		MSMNO5	1SAM101923R0012	220
	MSH-AR Shaft alignment ring	MSH-AR	1SAM201920R1000	250
MS116, MS132	MSAH1-Shaft supporter	MSAH1	1SAM201909R1021	990

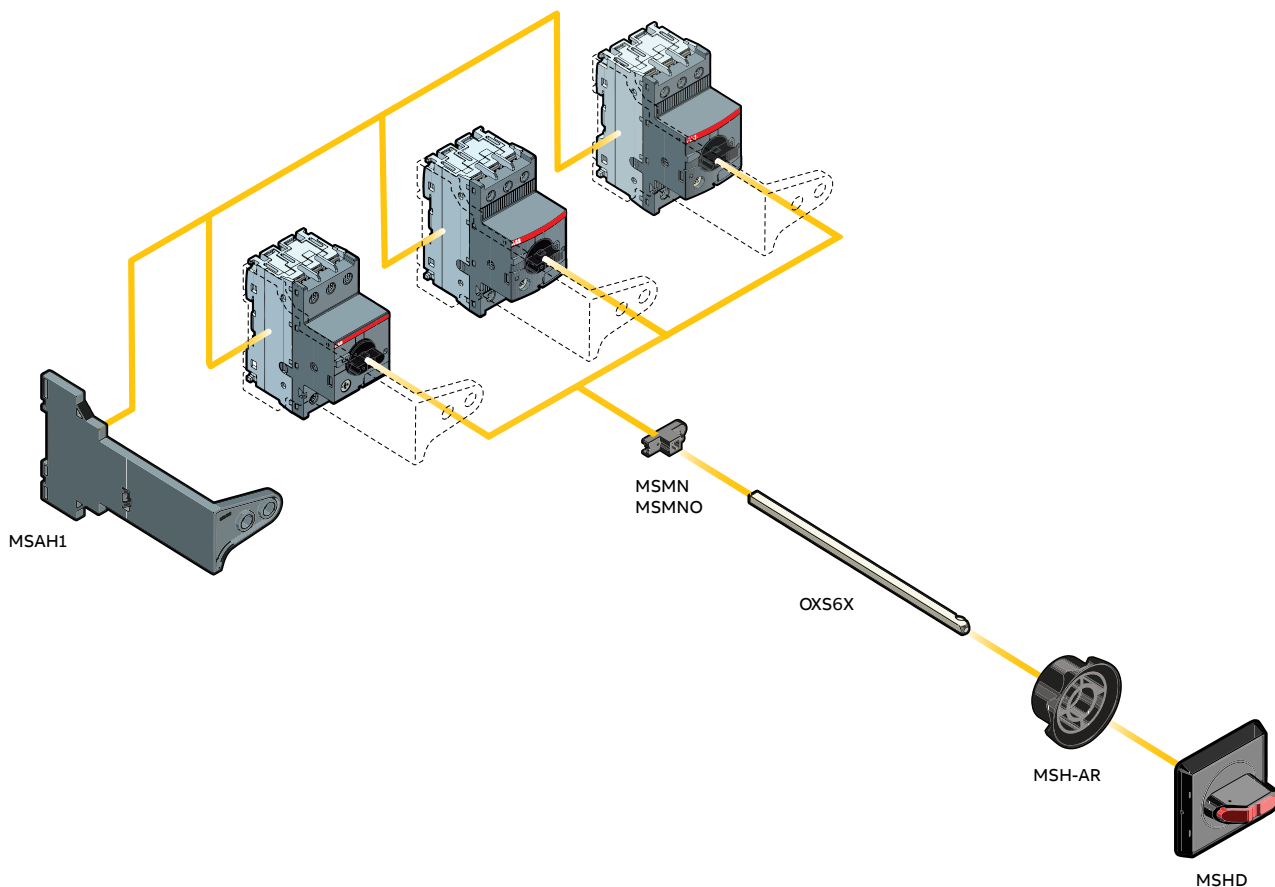

■ Stock items

Manual motor starter

Accessories for MS116, MS132, MO132, MS132-T, MS165, MO165



AA1-24

Shunt trip				
Suitable for	Rated voltage	Type	Ordering code	L.P.(₹)
MS116, MS132, MO132, MS132-T MS165 MO165	20 ... 24	AA1-24	1SAM201910R1001	3,910
	110	AA1-110	1SAM201910R1002 ■	3,910
	200-240	AA1-230	1SAM201910R1003 ■	3,910
	350-415	AA1-400	1SAM201910R1004	3,910
Undervoltage release				
MS116, MS132, MO132, MS132-T MS165 MO165	24	UA1-24	1SAM201904R1001	3,200
	110	UA1-110	1SAM201904R1004	3,200
	230	UA1-230	1SAM201904R1005	3,200
	415	UA1-415	1SAM201904R1007	3,200



HKF1-11

Auxiliary contacts – mountable on the front					
Suitable for	Aux contacts	Type	Ordering code	L.P.(₹)	
MS116, MS132, MO132, MS132-T MS165 MO165	1NO+1NC	HKF1-11	1SAM201901R1001 ■	790	
	2 NO	HKF1-20	1SAM201901R1002 ■	790	
	2NC	-	-	-	
	1NO	HKF1-10	1SAM201901R1003 ■	500	
MS116, MS132, MO132, MS132-T MS165 MO165	1NC	HKF1-01	1SAM201901R1004 ■	500	
	Auxiliary contacts – mountable on the right				
		HK1-11	1SAM201902R1001 ■	1,080	
		HK1-20	1SAM201902R1002 ■	1,080	
	HK1-02	1SAM201902R1003 ■	1,080		



SK1-11

CK1-11

Suitable for	Aux contacts	Type	Ordering code	L.P.(₹)
MS116, MS132, MO132, MS 165	1NO+1NC	SK1-11**	1SAM201903R1001 ■	1,430
MO 165 MS132-T	2 NO	SK1-20**	1SAM201903R1002 ■	1,430
MS132	2 NC	SK1-02**	1SAM201903R1003	1,430
MS132-T	1NO+1NC	CK1-11#	1SAM301901R1001 ■	2,000
MS165	2 NO	CK1-20#	1SAM301901R1002 ■	2,000
	2 NC	CK1-02#	1SAM301901R1003	2,000

**for tripped alarm, max 2 piece

#for short-circuit alarm, max. 2 pieces

Manual motor starter

Manual motor starters with short Circuit, overload and phase loss protection

MS49X range till stock available



MS495/MS497 Manual motor starters with short circuit, overload and phase loss protection**

Rated power 415V KW	Ie current setting range Amp	S/C Icu breaking capacity kA	Type	Ordering code	L.P. (₹)
37	57.0 ... 75.0	50	MS495-75	1SAM550000R1008	Upon request
45	70.0 ... 90.0	50	MS495-90	1SAM550000R1009	
55	80.0 100.0	50	MS495-100	1SAM550000R1010	
37	57.0 ... 75.0	100	MS497-75	1SAM580000R1008	
45	70.0 ... 90.0	100	MS497-90	1SAM580000R1009	
55	80.0 ... 100.	100	MS497-100	1SAM580000R1010	

Accessories for MS4xx**



HK4-11

Auxiliary contacts – mountable on the front

Suitable for	Aux contacts	Type	Ordering code	L.P. (₹)
MS49x, MO49x	1NO+1NC	HK4-11	1SAM401901R1001 ■	1,240

Auxiliary contacts – mountable on the right

Rated voltage	Type	Ordering code	L.P. (₹)
1NO+1NC	HKS4-11	1SAM401902R1001 ■	1,240
2 NO	HKS4-20	1SAM401902R1002 ■	1,240
2 NC	HKS4-02	1SAM401902R1003	1,240



AA4-24

Shunt trip units – mountable on the right

Suitable for	Rated voltage	Type	Ordering code	L.P. (₹)	Undervoltage release mountable on the right		
					Type	Ordering code	L.P. (₹)
MS49x, MO49x	20 ... 24	AA4-24	1SAM401907R1001	4,350	UA4-24	1SAM401905R1004	4,350
	110	AA4-110	1SAM401907R1002	4,350	UA4-110	1SAM401905R1001	4,350
	200-240	AA4-230	1SAM401907R1003	4,350	UA4-230	1SAM401905R1002	4,350
	350-415	AA4-400	1SAM401907R1004	4,350	UA4-415	1SAM401905R1002	4,350



SK4-11

Signaling contacts – mountable on the right*

Suitable for	Aux contacts	Type	Ordering code	L.P. (₹)
MS49x, MO49x	1NO+1NC	SK4-11	1SAM401904R1001 ■	2,230

*for tripped alarm, max 2 piece

**Till last stock

■ Stock items

Thermal overload relays



TA25, TA42 and TA75 relays

Relay range in Amps	Direct mounting on contactors	Type code reference	Ordering code	L.P.(₹)
0.1 ... 0.16		TA25DU 0.16M	1SAZ211201R2005 ■	1,730
0.16 ... 0.25		TA25DU 0.25M	1SAZ211201R2009 ■	1,730
0.25 ... 0.4		TA25DU 0.4M	1SAZ211201R2013 ■	1,730
0.4 ... 0.63		TA25DU 0.63M	1SAZ211201R2017 ■	1,730
0.63 ... 1.0		TA25DU 1.0M	1SAZ211201R2021 ■	1,730
1.0 ... 1.4		TA25DU 1.4M	1SAZ211201R2023 ■	1,730
1.3 ... 1.8		TA25DU 1.8M	1SAZ211201R2025 ■	1,730
1.7 ... 2.4		TA25DU 2.4M	1SAZ211201R2028 ■	1,730
2.2 ... 3.1	A9...A40	TA25DU 3.1M	1SAZ211201R2031 ■	1,730
2.8 ... 4.0	AX9...AX40	TA25DU 4.0M	1SAZ211201R2033 ■	1,730
3.5 ... 5.0	AL9...AL40	TA25DU 5.0M	1SAZ211201R2035 ■	1,730
4.5 ... 6.5	TAL9...TAL40	TA25DU 6.5M	1SAZ211201R2038 ■	1,730
6.0 ... 8.5		TA25DU 8.5M	1SAZ211201R2040 ■	1,730
7.5 ... 11.0		TA25DU 11M	1SAZ211201R2043 ■	1,730
10.0 ... 14.0		TA25DU 14M	1SAZ211201R2045 ■	1,730
13.0 ... 19.0		TA25DU 19M	1SAZ211201R2047 ■	2,140
18.0 ... 25.0		TA25DU 25M	1SAZ211201R2051 ■	2,140
24.0 ... 32.0		TA25DU 32M	1SAZ211201R2053 ■	2,140
TA42DU				
18.0 ... 25.0	A30,A40,	TA42DU 25	1SAZ311201R2001 ■	3,550
22.0 ... 32.0	AX32...AX40	TA42DU 32	1SAZ311201R2002 ■	3,860
29.0 ... 42.0	AL30,AL40, TAL30,TAL 40	TA42DU 42	1SAZ311201R2003 ■	3,860
TA75DU				
22 ... 32		TA75DU 32	1SAZ321201R2002 ■	4,460
29 ... 42		TA75DU 42	1SAZ321201R2003 ■	5,250
36 ... 52	A50...A75	TA75DU 52	1SAZ321201R2004 ■	5,250
45 ... 63	AX50...AX80	TA75DU 63	1SAZ321201R2005 ■	5,250
60 ... 80		TA75DU 80	1SAZ321201R2006 ■	5,620
TA80DU				
36 ... 52		TA80DU-52	1SAZ331201R1004 ■	6,450
45 ... 63	A95...A110,	TA80DU-63	1SAZ331201R1005 ■	6,450
60 ... 80	AX95...AX150	TA80DU-80	1SAZ331201R1006 ■	6,940

TA25/TA42/TA75/TA80/TA110/TA200 are direct operated relays with trip class 10A

TA110DU

66 ... 90	A95...A110,	TA110DU-90	1SAZ411201R1001 ■	10,760
80 ... 110	AX95...AX150	TA110DU-110	1SAZ411201R1002 ■	11,670

TA200DU

66 ... 90		TA200DU-90	1SAZ421201R1001 ■	12,380
80 ... 110		TA200DU-110	1SAZ421201R1002 ■	13,410
100 ... 135	A145...A185	TA200DU-135	1SAZ421201R1003 ■	14,300
110 ... 150	AX185...AX205	TA200DU-150	1SAZ421201R1004 ■	15,570
130 ... 175	AF190, AF205	TA200DU-175	1SAZ421201R1005 ■	16,210
150 ... 200		TA200DU-200	1SAZ421201R1006 ■	16,940

Accessories

Independent Mounting Kit	TA25DU0.16..25A	DB25/25	1SAZ201108R0001 ■	440
	TA25DU32	DB25/32	1SAZ201108R0002	940
	TA42DU,TA75DU, TA80DU	DB80	1SAZ301110R0001 ■	4,110
	TA110DU, TA200DU	DB200	1SAZ401110R0001 ■	4,260

■ Stock items

Thermal overload relays



TF42

T16 Relays

Relay range in Amps	Direct mounting on contactors	Type code reference	Ordering code	L.P. (₹)
0.10 ... 0.13		T16-0.13	1SAZ711201R1005	Upon request
0.13 ... 0.17		T16-0.17	1SAZ711201R1008	
0.17 ... 0.23		T16-0.23	1SAZ711201R1009	
0.23 ... 0.31		T16-0.31	1SAZ711201R1013	
0.31 ... 0.41		T16-0.41	1SAZ711201R1014	
0.41 ... 0.55		T16-0.55	1SAZ711201R1017	
0.55 ... 0.74		T16-0.74	1SAZ711201R1021	
0.74 ... 1.00	B6/BC6	T16-1.0	1SAZ711201R1023	
1.00 ... 1.30	B7/BC7	T16-1.3	1SAZ711201R1025	
1.30 ... 1.70	VB6/VBC6	T16-1.7	1SAZ711201R1028	
1.70 ... 2.30	VB7/VBC7	T16-2.3	1SAZ711201R1031	
2.30 ... 3.10	AS/ASL	T16-3.1	1SAZ711201R1033	
3.10 ... 4.20	DOL starter IP65	T16-4.2	1SAZ711201R1035	
4.20 ... 5.70		T16-5.7	1SAZ711201R1038 ■	
5.70 ... 7.60		T16-7.6	1SAZ711201R1040	
7.60 ... 10.0		T16-10	1SAZ711201R1043	
10.0 ... 13.0		T16-13	1SAZ711201R1045	
13.0 ... 16.0		T16-16	1SAZ711201R1047	

TF42 Relays

Relay range in Amps	Direct mounting on contactors	Type code reference	Ordering code	L.P. (₹)
0.10 ... 0.13		TF42-0.13	1SAZ721201R1005	Upon request
0.13 ... 0.17		TF42-0.17	1SAZ721201R1008	
0.17 ... 0.23		TF42-0.23	1SAZ721201R1009	
0.23 ... 0.31		TF42-0.31	1SAZ721201R1013	
0.31 ... 0.41		TF42-0.41	1SAZ721201R1014	
0.41 ... 0.55		TF42-0.55	1SAZ721201R1017	
0.55 ... 0.74		TF42-0.74	1SAZ721201R1021	
0.74 ... 1.00		TF42-1.0	1SAZ721201R1023	
1.00 ... 1.30		TF42-1.3	1SAZ721201R1025	
1.30 ... 1.70		TF42-1.7	1SAZ721201R1028 ■	
1.70 ... 2.30		TF42-2.3	1SAZ721201R1031 ■	
2.30 ... 3.10	AF09...AF38	TF42-3.1	1SAZ721201R1033 ■	
3.10 ... 4.20		TF42-4.2	1SAZ721201R1035 ■	
4.20 ... 5.70		TF42-5.7	1SAZ721201R1038 ■	
5.70 ... 7.60		TF42-7.6	1SAZ721201R1040 ■	
7.60 ... 10.0		TF42-10	1SAZ721201R1043	
10.0 ... 13.0		TF42-13	1SAZ721201R1045 ■	
13.0 ... 16.0		TF42-16	1SAZ721201R1047 ■	
16.0 ... 20.0		TF42-20	1SAZ721201R1049	
20.0 ... 24.0		TF42-24	1SAZ721201R1051	
24.0 ... 29.0		TF42-29	1SAZ721201R1052	
29.0 ... 35.0		TF42-35	1SAZ721201R1053	
35.0 ... 38.0/40.0		TF42-38	1SAZ721201R1055	

■ Stock items

Thermal overload relays



TF42

TF65/TF96/TF140 Relay

Relay range in Amps	Direct mounting on contactors	Type code reference	Ordering code	L.P. (₹)
22.0...28.0	AF40, AF52, AF65	TF65-28	1SAZ811201R1001	Upon request
25.0...33.0		TF65-33	1SAZ811201R1002	
30.0...40.0		TF65-40	1SAZ811201R1003	
36.0...47.0		TF65-47	1SAZ811201R1004	
44.0...53.0		TF65-53	1SAZ811201R1005	
50.0...60.0		TF65-60	1SAZ811201R1006	
57.0...67.0		TF65-67	1SAZ811201R1007	
40.0...51.0	AF80, AF96	TF96-51	1SAZ911201R1001	
48.0...60.0		TF96-60	1SAZ911201R1002	
57.0...68.0		TF96-68	1SAZ911201R1003	
65.0...78.0		TF96-78	1SAZ911201R1004	
75.0...87.0		TF96-87	1SAZ911201R1005	
84.0...96.0		TF96-96	1SAZ911201R1006	
66...90	AF116, AF140	TF140DU-90	1SAZ431201R1001	
80...110		TF140DU-110	1SAZ431201R1002	
100...135		TF140DU-135	1SAZ431201R1003	
110...142		TF140DU-142	1SAZ431201R1004	

For AF190 and AF205 use TA200DU OLR

Description	Type	Ordering code	L.P. (₹)
Separate mounting kit	DB16E	1SAX101110R0001 ■	Upon request
Separate mounting kit	DB42	1SAZ701902R0001 ■	
Separate mounting kit for TF65	DB65	1SAZ801901R1001	
Separate mounting kit for TF96	DB96	1SAZ901901R1001	

Electronic overload relays and suitable contactors

Suitable for Contactor	A9 ... A16 TAL9...TAL16	A26 ... A40	A50 ... A75	A95, A110	AF190, AF205			
EOLR	AL9 ... AL16	AL30 ... AL40	E16DU	E45DU	E80DU	E140DU	EF205	
Suitable for Contactor	AF400, AF460	AF580, AF750	AF1350, AF1650	B6/BC6	B7/BC7			
EOLR	EF460	EF750	E1250DU	E16DU, T16				
Suitable for Contactor	AF09 ... AF16	AF26, AF38	AF40, AF52, AF65	AF80, AF96	AF116, AF140, AF146	AF265, AF305, AF370	AF400, AF460,	AF580, AF750, AF1250
EOLR	EF19	EF45	EF65	EF96	EF146	EF370	EF460	EF750

■ Stock items

Electronic overload relays class 10, 20, 30



Electronic overload relays

Trip class 10, 20, 30 selectable

Setting range	Trip class	Type	Ordering code	L.P.(₹)	
0.1... 0.32A	Selecatable 10E, 20E and 30E	E16DU 0.32	1SAX111001R1101	9,590	
0.3 ... 1.0A		E16DU 1.0	1SAX111001R1102	9,590	
0.8 ... 2.7A		E16DU 2.7	1SAX111001R1103 ■	9,590	
1.9 ... 6.3A		E16DU 6.3	1SAX111001R1104 ■	10,590	
5.7... 18.9A		E16DU 18.9	1SAX111001R1105 ■	10,590	
9 ... 30A		E45DU 30	1SAX211001R1101 ■	13,650	
15 ... 45A		E45DU 45	1SAX211001R1102 ■	14,860	
27 ... 80A		E80DU 80	1SAX311001R1101 ■	19,510	
50 ... 140A		E140DU 140	1SAX321001R1101 ■	23,500	
63 ... 210A		EF205-210	1SAX531001R1101	Upon request	
115 ... 380A		EF370-380	1SAX611001R1101	Upon request	
150 ... 500A		EF460	1SAX721001R1101 ■	Upon request	
250 ... 800A		EF750	1SAX821001R1101	Upon request	
375 ... 1250A		E1250DU 375 - 1250 A	1SFA739001R1000	Upon request	
0.10...0.32A		Selecatable 10E, 20E and 30E	EF19-0.32	1SAX121001R1101	Upon request
0.30...1.00A			EF19-1.0	1SAX121001R1102	
0.80...2.70A	EF19-2.7		1SAX121001R1103 ■		
1.90...6.30A	EF19-6.3		1SAX121001R1104 ■		
5.70...18.9A	EF19-18.9		1SAX121001R1105 ■		
9.00...30.0A	EF45-30		1SAX221001R1101 ■		
15.0...45.0A	EF45-45		1SAX221001R1102 ■		
25...70A	EF65-70		1SAX331001R1101 ■		
36...100A	EF96-100		1SAX341001R1101 ■		
54...150A	EF146-150		1SAX351001R1101 ■		
63 ... 210A	EF205-210		1SAX531001R1101 ■		
115 ... 380A	EF370-380		1SAX611001R1101 ■		
150 ... 500A	EF460		1SAX721001R1101		
250 ... 800A	EF750		1SAX821001R1101		

Accessories

Description	Type	Ordering code	L.P.(₹)
Separate mounting kit	DB16E	1SAX101110R0001	3,070
Separate mounting kit - EF19	DB19EF	1SAX101910R1001 ■	3,100
Separate mounting kit - EF45	DB45EF	1SAX201910R0001 ■	4,960
Separate mounting kit	DB45E	1SAX201110R1001	4,960
Separate mounting kit	DB80E	1SAX301110R1001 ■	6,180
Separate mounting kit	DB140E	1SAX301110R1002	8,930

For suitable contactors refer page no. 101

■ Stock items

Just push it

Push-in Spring motor starting solution

- Faster than ever installation
- Easier than ever wiring
- Reliable as ever connections



Push-in Spring motor starting solution

Complete range, complete efficiency

With the new Push-in Spring motor starting solution, one push is all you need for extremely fast wiring. No tool is required, so you can save up to 50% wiring time with Push-in Spring compared to conventional spring solutions. And the connections are just as reliable. So for speed, ease and reliability, just push it.

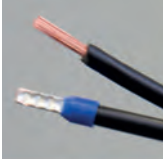

2-in-1

Benefit from both Push-in mode and Spring mode and use ferruled cables or cables without ferrules in the same terminal.



Compatible with screw range

Mount accessories for control circuits on the screw range up to 30 kW AC-3 400 V on manual motor starters and up to 45 kW AC-3 400 V, 130 A AC-1 on contactors.



Robust by design

Contact robustness by design, independent from operator.

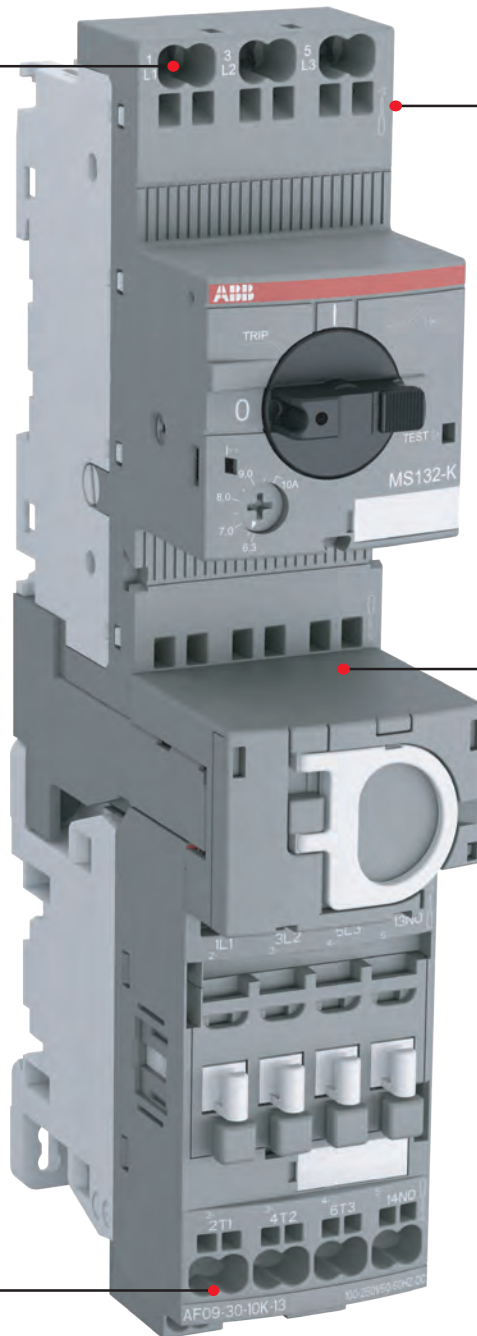

Just one tool for everything

You only need a 3 mm screwdriver in Spring mode as well as for de-wiring the complete solution.



Tool-less connecting links

100% tool-less mounting and dismantling connecting links.



Higher connecting capacity

The solution ranges up to 18.5 kW 400 V AC-3 and 50 A AC-1 (25 hp 480 V and 45 A 600 V general use).

Note: Contact our nearest sales office for more information

Softstarters **NEW**

ABB softstarters - The complete range



PSR - The compact range

PSR is our most compact softstarter with basic benefits and values. PSR can handle up to 100 starts per hour. Suitable for small motors.

PSE - The efficient range

The new generation PSE is a true general purpose softstarter. It's a perfect balance between high starting capacity and cost efficiency. Now featuring built-in fieldbus communication.

PSTX - The advanced range

PSTX is our most advanced softstarter with full control and motor protection built-in. PSTX is the most complete alternative for any motor starting application. Featuring built-in modbus and anybus modules that support all major communication protocols.

PSR	PSE	PSTX	* Standard, O Optional, - Not available
*	*	*	Built-in by-pass 1) on PSTB
-	-	*	Inside delta connection
-	*	*	Coated PCBs
-	*	*	Display and keypad,
-	*	*	Torque control / Pump control
-	*	*	Settable current limit function
-	*	*	Electronic motor overload protection
-	-	*	PTC input for motor protection
-	-	*	Phase imbalance protection
-	-	*	Phase reversal protection
-	*	*	Locked rotor protection
-	*	*	Thyristor overtemperature protection
-	*	*	Underload protection
-	-	*	UV/OV protection
-	-	*	Programmable warning functions
-	*	*	Analog output
O	* 1)	* 1)	FieldBus communication, 1) built in Modbus-RTU
-	O	*	Event log
-	O	* 1)	External keypad 1) detachable key pad
-	-	*	Motor heating
-	-	*	Pump cleaning
-	-	*	Limp mode
-	-	*	Network diagnostics

PSR18 - 600 -70

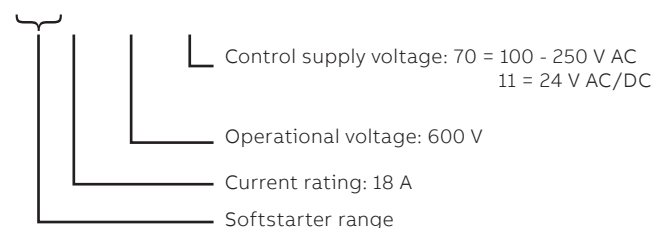

Softstarters selection **NEW**

ABB softstarters offering consists of three ranges, covering every need. The products help you secure motor reliability, improve installation efficiency and increase application productivity.



PSR – The compact range

- When soft start and stop benefits and values are requested
- When operating a small motor
- When up to 100 starts per hour are requested

PSE – The efficient range

- When there is limited space
- When common softstarter functions and protections are needed
- When communication is needed

PSTX – The advanced range

- When full control and motor protection is needed
- When an advanced softstarter with an extensive functionality is needed
- When motor is connected inside delta or in 690 V

Step	Process
1	Determine softstarter series First, determine the softstarter series that fulfill the needs of the application and motor. Use the guide on the left to explore the three series and the power range each one covers.
2	Match the softstarter size with the motor current When the softstarter series is selected, the correct size should now be determined. The selection of a softstarter is based on the current. Find the softstarter that corresponds to the motor current.
3	Fine tune and select the correct size The last step is to fine tune the selection, and there are three different factors to consider: <ol style="list-style-type: none"> Normal or a heavy load: If the load is characterized as a heavy load, select the next size softstarter in the series. High ambient temperature High altitude <p>Use the equations and the table on the right to find the correct de-rating equation.</p>

Note: If the application is more complicated and there are specific requirements on acceleration time, maximum starting current or many starts per hour, the software proSoft should be used for a fine tuned selection.

Altitude formula	
De-rate for altitudes between 1000-4000 m or 3280-13123 ft with the following equations for all softstarters:	
In meters: % of Ie = 100 – (x-1000)/150	
In feet: % of FLA = 100 – (y-3280)/480	
Where x/y is the actual altitude in m/ft	
Temperature equations	
PSTX and PSR In Celsius:	40...60 oC: Reduce Ie with 0.8%/°C
PSTX and PSR In Fahrenheit:	104...140 oF: Reduce FLA with 0.44%/°F
PSE In Celsius:	40...60 oC: Reduce Ie with 0.6%/°C
PSE In Fahrenheit:	104...140 oF: Reduce FLA with 0.33%/°F
Typical applications	
Normal duty start	Heavy duty
Bow thrusters	Centrifugal fan
Centrifugal pump	Conveyor belt (long)
Compressors	Crusher
Conveyor belt (short)	Stirrer
Elevator	Sawmill

Softstarters **NEW**

ABB softstarters - The complete range



PSR - The compact range

- Rated operational current: 3...105 A
- Operational voltage: 208...600 V AC
- Wide rated control supply voltage: 100...240 V AC, 50/60 Hz or 24 V AC/DC
- Two-phase controlled
- Soft start and soft stop with voltage ramp
- Built-in bypass for energy saving and easy installation
- Fieldbus communication with fieldbus plug adapter and the fieldbus plug

PSR3 ... PSR105

Rated operational voltage U_e, 208-600 V AC
Rated control supply voltage, U_s, 100 - 240 V AC



415V Pe kW"	IEC Max rated operational I _e A	Type	Order code	L.P. (₹)
1.5	3.9	PSR3-600-70	1SFA896103R7000	13,150
3	6.8	PSR6-600-70	1SFA896104R7000	15,050
4	9	PSR9-600-70	1SFA896105R7000	17,120
5.5	12	PSR12-600-70	1SFA896106R7000	20,330
7.5	16	PSR16-600-70	1SFA896107R7000	25,040
11	25	PSR25-600-70	1SFA896108R7000	27,650
15	30	PSR30-600-70	1SFA896109R7000	35,740
18.5	37	PSR37-600-70	1SFA896110R7000	44,920
22	45	PSR45-600-70	1SFA896111R7000	48,820
30	60	PSR60-600-70	1SFA896112R7000	65,350
37	72	PSR72-600-70	1SFA896113R7000	80,410
45	85	PSR85-600-70	1SFA896114R7000	90,770
55	105	PSR105-600-70	1SFA896115R7000	98,990

For rated control supply voltage, U_s, 24 V Dc replace R7000 by R1100



PSE - The efficient range

- Rated operational current: 18...370 A
- Operational voltage: 208...600 V AC
- Wide rated control supply voltage: 100...250 V AC, 50/60 Hz
- Voltage ramp and torque control for both start and stop
- Two-phase controlled, Current limit and Kick-start
- Built-in bypass for energy saving and easy installation
- External keypad rated IP66 (Type 1, 4X,12) as an option
- **NEW** Built-in modbus-RTU communication for monitoring and control
- Fieldbus communication with fieldbus plug adapter and the fieldbus plug
- Analog output for display of motor current
- Electronic overload, Underload and locked rotor protection

PSE18 ... PSE370

Normal starts, Class 10, In-Line

Rated operational voltage U_e, 208-600 V AC
Rated control supply voltage, U_s, 100 - 240 V AC

415V Pe kW	IEC Max rated operational I _e A	Type	Order code	L.P. (₹)
7.5	18	PSE18-600-70	1SFA897101R7000	57,670
11	25	PSE25-600-70	1SFA897102R7000	57,970
15	30	PSE30-600-70	1SFA897103R7000	61,010
18.5	37	PSE37-600-70	1SFA897104R7000	68,990
22	45	PSE45-600-70	1SFA897105R7000	75,250
30	60	PSE60-600-70	1SFA897106R7000	84,860
37	72	PSE72-600-70	1SFA897107R7000	96,990
45	85	PSE85-600-70	1SFA897108R7000	1,02,990
55	106	PSE105-600-70	1SFA897109R7000	1,16,710
75	143	PSE142-600-70	1SFA897110R7000	1,44,550
90	171	PSE170-600-70	1SFA897111R7000	1,65,760
110	210	PSE210-600-70-1	1SFA897112R7001	2,08,660
132	250	PSE250-600-70-1	1SFA897113R7001	2,27,360
160	300	PSE300-600-70-1	1SFA897114R7001	2,53,860
200	370	PSE370-600-70-1	1SFA897115R7001	2,77,200

For accessories consult

Softstarters

PSTX - The advanced range



- Rated operational current: 30 to 1250 A
- Three-phase controlled
- Operational voltage: 208 – 690 VAC
- Wide rated control supply voltage: 100 – 250 V, 50/60 Hz (inside-delta: 2160 A)
- Both in-line and inside-delta connection
- Coated circuit boards protecting from dust, moist and corrosive atmosphere
- Detachable keypad rated IP66 (4X outdoor)
- Built-in bypass for energy saving and easy installation
- Built-in Modbus RTU for monitoring and control
- Support for all major communication protocols
- Analog output for measurement of current, voltage, power factor etc.

PSTX30 ... PSTX370

Normal starts, class 10, in-line, ordering details

Rated operational voltage U_e , 208-600 V

Rated control supply voltage U_s , 100-250 V AC, 50/60 Hz



415V P_e kW	IEC Max rated operational I _e A	Type	Ordering code	L.P. (₹)
15	30	PSTX30-600-70	1SFA898103R7000	Upon request
18.5	37	PSTX37-600-70	1SFA898104R7000	
22	45	PSTX45-600-70	1SFA898105R7000	
30	60	PSTX60-600-70	1SFA898106R7000	
37	72	PSTX72-600-70	1SFA898107R7000	
45	85	PSTX85-600-70	1SFA898108R7000	
55	106	PSTX105-600-70	1SFA898109R7000	
75	143	PSTX142-600-70	1SFA898110R7000	
90	171	PSTX170-600-70	1SFA898111R7000	
110	210	PSTX210-600-70	1SFA898112R7000	
132	250	PSTX250-600-70	1SFA898113R7000	
160	300	PSTX300-600-70	1SFA898114R7000	
200	370	PSTX370-600-70	1SFA898115R7000	
250	470	PSTX470-600-70	1SFA898116R7000	
315	570	PSTX570-600-70	1SFA898117R7000	
400	720	PSTX720-600-70	1SFA898118R7000	
450	840	PSTX840-600-70	1SFA898119R7000	
560	1050	PSTX1050-600-70	1SFA898120R7000	
710	1200	PSTX1250-600-70	1SFA898121R7000	

Rated operational voltage U_e , 208-690 V

Rated control supply voltage U_s , 100-250 V AC, 50/60 Hz



690V P_e kW	IEC Max rated operational I _e A	Type	Ordering code	L.P. (₹)
25	30	PSTX30-690-70	1SFA898203R7000	Upon request
30	37	PSTX37-690-70	1SFA898204R7000	
37	44	PSTX45-690-70	1SFA898205R7000	
55	60	PSTX60-690-70	1SFA898206R7000	
59	72	PSTX72-690-70	1SFA898207R7000	
75	85	PSTX85-690-70	1SFA898208R7000	
90	106	PSTX105-690-70	1SFA898209R7000	
132	143	PSTX142-690-70	1SFA898210R7000	
160	171	PSTX170-690-70	1SFA898211R7000	
184	210	PSTX210-690-70	1SFA898212R7000	
220	250	PSTX250-690-70	1SFA898213R7000	
257	300	PSTX300-690-70	1SFA898214R7000	
355	370	PSTX370-690-70	1SFA898215R7000	
450	470	PSTX470-690-70	1SFA898216R7000	
560	570	PSTX570-690-70	1SFA898217R7000	
710	720	PSTX720-690-70	1SFA898218R7000	
800	840	PSTX840-690-70	1SFA898219R7000	
1000	1050	PSTX1050-690-70	1SFA898220R7000	
1200	1250	PSTX1250-690-70	1SFA898221R7000	



1SFC132053V0001

PSTX142 ... PSTX170

Softstarters

PSTX30 ... PSTX370

Normal starts, class 10, inside delta, ordering details

Rated operational voltage U_e , 208-600 V

Rated control supply voltage U_s , 100-250 V AC, 50/60 Hz



1SFC132058V0001

PSTX210 ... PSTX370

415V Pe kW	IEC Max rated operational Ie A	Type	Ordering code	L.P. (₹)
25	30	PSTX30-600-70	1SFA898103R7000	
30	37	PSTX37-600-70	1SFA898104R7000	
37	44	PSTX45-600-70	1SFA898105R7000	
55	60	PSTX60-600-70	1SFA898106R7000	
59	72	PSTX72-600-70	1SFA898107R7000	
75	85	PSTX85-600-70	1SFA898108R7000	
90	106	PSTX105-600-70	1SFA898109R7000	
132	143	PSTX142-600-70	1SFA898110R7000	
160	171	PSTX170-600-70	1SFA898111R7000	
184	210	PSTX210-600-70	1SFA898112R7000	Upon request
220	250	PSTX250-600-70	1SFA898113R7000	
257	300	PSTX300-600-70	1SFA898114R7000	
355	370	PSTX370-600-70	1SFA898115R7000	
450	470	PSTX470-600-70	1SFA898116R7000	
540	570	PSTX570-600-70	1SFA898117R7000	
710	720	PSTX720-600-70	1SFA898118R7000	
800	840	PSTX840-600-70	1SFA898119R7000	
1000	1050	PSTX1050-600-70	1SFA898120R7000	
1200	1250	PSTX1250-600-70	1SFA898121R7000	

Soft starter communication accessories



EtherNet/IP (2-port)
Modbus TCP (2-port)
Profinet (2-port)



EtherNet/IP (1-port)
Modbus TCP (1-port)



Profibus
Modbus-RTU

For communication protocol	Type	Ordering code	L.P. (₹)
Profibus	AB-PROFIBUS-1	1SFA899300R1001	
Devicenet	AB-DEVICENET-1	1SFA899300R1002	
Modbus-RTU	AB-MODBUS-RTU-1	1SFA899300R1003	
EtherNet/IP (1-port)	AB-ETHERNET-IP-1	1SFA899300R1005	Upon request
EtherNet/IP (2-port)	AB-ETHERNET-IP-2	1SFA899300R1006	
Modbus TCP (1-port)	AB-MODBUS-TCP-1	1SFA899300R1007	
Modbus TCP (2-port)	AB-MODBUS-TCP-2	1SFA899300R1008	
Profinet (2-port)	AB-PROFINET-2	1SFA899300R1010	

AFS contactors with front-mounted auxiliary contact blocks

Dedicated for safety applications

ABB's complete range of safety components make protection systems easier to build. Designed for machine safety applications, AFS contactors come with fixed front auxiliary

contact blocks, making them ideal for monitoring and controlling circuits. Mechanically linked and mirror contacts help make your system safer.



Safety and protection

Safety in all things

ABB's AFS contactors can be easily integrated in machine manufacturer's systems complying with main safety standards EN ISO 13849 and EN 62061 guaranteeing the safe use of your machinery and equipment. The AFS contactor range is an integral part of ABB's comprehensive range of safety products.



Continuous operation

Secure uptime

The AFS contactor secures system uptime. It allows direct control by relay outputs of safety PLCs and safety relays to ensure the safety performance customers require. A low energy auxiliary contact guarantees system status feedback.

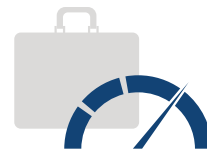

Speed up your projects

Simplify design

Perfect design makes integration easier. ABB's distinctive yellow auxiliary contact block makes identifying the right product quicker. By reducing the contactor coil's power consumption, panels can also be made smaller and transformers more compact. In addition, all the safety data for the contactors are readily available using safety design tools.

Note: Contact our nearest sales office for more information

M mini contactors and contactor relays **NEW**

Reliability, always



The M contactors range is a performance-dimension optimized solution for all the purposes. Its high reliability, even in extreme conditions, combined to the small sizes and the safe connections lead to easy design and compact panels.

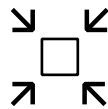

Space-saving

Small dimensions for big projects

The M range devices are a great solution when high performances are needed but the space is limited. The small dimensions of the products and the possibility to mount them side by side will maximize the cost efficiency of the cabinets without making compromises.



Reliability in extreme conditions

Made for all the applications

The technology used in the design of the contactors and the wide set of variants available guarantee reliability of operation with heavy working conditions as well. Instability of the network, high altitude and extreme temperatures will not be a limit anymore.



Optimum interface

Never without a solution

A wide set of coils is provided for matching all the requirements: pure AC or DC for very fast switching, with low energy consumption for direct control by PLC and with extended operating limits to face voltage fluctuations. A complete offer for realizing your projects.

M Mini contactors with screw connection

NEW

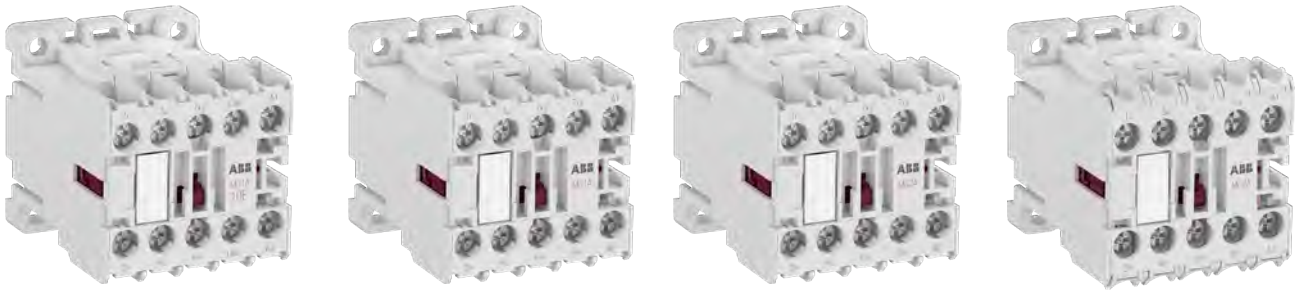

3 pole - AC operated

AC1 duty Amps	hP	kW	Aux Contacts	coil Voltage	Type code reference	Ordering code	L.P.(₹)	Coil Voltage	Type code reference	Ordering code	L.P. (₹)
20A	5	4	1NO	24	MC1A310AT1	1SAL102617R9901		12	MC1C310ATB	1SAL100210R9901	
20A	5	4	1NC	24	MC1A301AT1	1SAL102638R9901		12	MC1C301ATB	1SAL100220R9901	
20A	5	4	1NO	110..115	MC1A310ATJ	1SAL100213R9901		24	MC1C310ATD	1SAL100216R9901	
20A	5	4	1NC	110..115	MC1A301ATJ	1SAL100223R9901		24	MC1C301ATD	1SAL100226R9901	
20A	5	4	1NO	220..240	MC1A310ATN	1SAL100214R9901		24 with Diode	MC1C310ATDD	1SAL113312R9901	
20A	5	4	1NC	220..240	MC1A301ATN	1SAL100224R9901		24 with Diode	MC1C301ATDD	1SAL113328R9901	
20A	7.5	5.5	1NO	24	MC2A310AT1	1SAL103577R9902	Upon request	12	MC2C310ATB	1SAL103588R9902	Upon request
20A	7.5	5.5	1NC	24	MC2A301AT1	1SAL103569R9902		12	MC2C301ATB	1SAL103589R9902	
20A	7.5	5.5	1NO	110..115	MC2A310ATJ	1SAL103573R9902		24	MC2C310ATD	1SAL103584R9902	
20A	7.5	5.5	1NC	110..115	MC2A301ATJ	1SAL103565R9902		24	MC2C301ATD	1SAL103580R9902	
20A	7.5	5.5	1NO	220..240	MC2A310ATN	1SAL103574R9902		24 with Diode	MC2C310ATDD	1SAL101926R9902	
20A	7.5	5.5	1NC	220..240	MC2A301ATN	1SAL103566R9902		24 with Diode	MC2C301ATDD	1SAL101955R9902	

4 pole - AC operated

AC1 duty Amps	hP	kW	Main Pole	coil Voltage	Type code reference	Ordering code	L.P.(₹)	Coil Voltage	Type code reference	Ordering code	L.P. (₹)
20A	5	4	4NO	24	MC1A400AT1	1SAL102986R9901		24	MC1C400ATWD	1SAL220344R9901	
20A	5	4	2NO+2NC	24	MC1AB00AT1	1SAL103007R9901		24	MC1CB00ATWD	1SAL220345R9901	
20A	5	4	4NO	110..115	MC1A400ATJ	1SAL100363R9901		110	MC1C400ATWJ	1SAL220342R9901	
20A	5	4	2NO+2NC	110..115	MC1AB00ATJ	1SAL100373R9901		110	MC1CB00ATWJ	1SAL220343R9901	
20A	5	4	4NO	220..240	MC1A400ATN	1SAL100364R9901		220	MC1C400ATWN	1SAL220340R9901	
20A	5	4	2NO+2NC	220..240	MC1AB00ATN	1SAL100374R9901		220	MC1CB00ATWN	1SAL220341R9901	
20A	7.5	5.5	4NO	24	MC2A400AT1	1SAL101645R9902	Upon request	24	MC2C400ATWD	1SAL101961R9902	Upon request
20A	7.5	5.5	2NO+2NC	24	MC2AB00AT1	1SAL101648R9902		24	MC2CB00ATWD	1SAL101965R9902	
20A	7.5	5.5	4NO	110..115	MC2A400ATJ	1SAL116184R9902		110	MC2C400ATWJ	1SAL101963R9902	
20A	7.5	5.5	2NO+2NC	110..115	MC2AB00ATJ	1SAL110548R9902		110	MC2CB00ATWJ	1SAL101967R9902	
20A	7.5	5.5	4NO	220..240	MC2A400ATN	1SAL116177R9902		220	MC2C400ATWN	1SAL100445R9902	
20A	7.5	5.5	2NO+2NC	220..240	MC2AB00ATN	1SAL135699R9902		220	MC2CB00ATWN	1SAL101968R9902	

M Mini contactor relay **NEW**

MCRA/MCRC



4 pole - AC operated

4 pole - DC operated with extended operating limit

Contact configuration	coil Voltage	Type code reference	Ordering code	L.P.(₹)	Coil Voltage	Type code reference	Ordering code	L.P. (₹)
4NO	24	MCRA040AT1	1SAH102013R9900	Upon request	24	MCRC040ATWD	1SAH220410R9900	Upon request
3NO 1NC	24	MCRA031AT1	1SAH102034R9900		24	MCRC031ATWD	1SAH220409R9900	
2NO 2NC	24	MCRA022AT1	1SAH220438R9900		17..32	MCRC022ATWD	1SAH220408R9900	
4NO	110..115	MCRA040AT1	1SAH102013R9900		110	MCRC040ATWJ	1SAH220407R9900	
3NO 1NC	110..115	MCRA031AT1	1SAH102034R9900		110	MCRC031ATWJ	1SAH220406R9900	
2NO 2NC	110..115	MCRA022AT1	1SAH220438R9900		77..143	MCRC022ATWJ	1SAH107171R9900	
4NO	220..240	MCRA040AT1	1SAH102013R9900		220	MCRC040ATWN	1SAH220404R9900	
3NO 1NC	220..240	MCRA031AT1	1SAH102034R9900		220	MCRC031ATWN	1SAH220403R9900	
2NO 2NC	220..240	MCRA022AT1	1SAH220438R9900		220	MCRC022ATWN	1SAH220402R9900	

Auxiliary contact blocks for mini contactors

Ordering details

For contactor types	Auxiliary contacts	Type	Ordering code	L.P.(₹)
Front mounted instantaneous auxiliary contact blocks				
All MC1 and MC2 variants Contacts in accordance with EN 50012	1NO + 1NC	MACN211AT	1SAL100999R9906	Upon request
	2NO	MACN202AT	1SAL100998R9906	
	3NO + 1NC	MACN431AT	1SAL100995R9906	
	2NO + 2NC	MACN422AT	1SAL100996R9906	
	1NO + 3NC	MACN413AT	1SAL100997R9906	
Side mounted instantaneous auxiliary contact block				
All MC1 and MC2 variants Contacts in accordance with EN 50012	1NO	MACL110AT	1SAL100560R9906	Upon request
	1NC	MACL101AT	1SAL100561R9906	

For contactor types	Rated control circuit voltage	Type	Ordering code	L.P.(₹)
Surge suppressors for contactor coils				
All MC1 and MC2 variants	24-48 V AC / DC	MPODAE4	1SAL100536R9906	Upon request
	50-127 V AC / DC	MPODAE5	1SAL204848R9906	
	130-250 V AC / DC	MPODAE6	1SAL204849R9906	

For contactor types	Rated control circuit voltage	Time range	Type	Ordering code	L.P.(₹)
Electronic timers					
All MC1 and MC2 variants	24-250 V AC / DC	0.5 ... 60 sec.	MREBC10AC2	1SAL100541R9906	Upon request
		0.2 ... 24 sec.	MREBC20AC2	1SAL100542R9906	

Electronic compact starters: HF range

A compact solution with great functionality

ABB's electronic compact starter, up to 3 kW / 400 V, is a 22.5 mm wide product. Even though its compact, it has, direct-on-line, reversed starting, motor overload

protection, and emergency stop all included. It is well suited for paper machines, conveyors or machine tools.

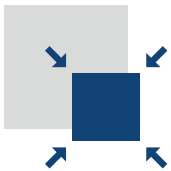

Space saving

Up to 90% less space required

Decrease your cabinet size. ABB's electronic compact starter is 22.5 mm wide while still containing motor starting functionalities and embedding motor protection and safety.



Safety and protection

Integrated safety function

Protect your personnel with emergency stop version complying with SIL3, PL e safety standards. Extend equipment life time and decrease maintenance cost as our starters service life is 10 times higher than electromechanical solutions.



Easy to install

Up to 75% reduced time in wiring

Wiring time upon installation is reduced to a minimum as motor protection, reversing function and emergency stop are already part of the product. Only one component to install reduces the risk of wiring errors.

Pilot devices

Pilot Devices Offering

ABB Pilot Devices offers both modular and compact range of pushbuttons. Both feature the same front-of-panel design and appear consistent when combined.

Modular range, features a wide range of operators that can be combined with high flexibility. The unique snap-on design promotes simple and fast assembly.

Compact range features an all-in-one construction and rugged design for added simplicity and ease of installation.



Modular range

Technical data compact range

Standard and approvals	
IEC / EN 60947-1	Low-voltage switchgear and controlgear - Part 1: General rules
IEC / EN 60947-5-1	Low-voltage switchgear and controlgear - Part 5-1: Control circuit devices and switching elements - Electromechanical control circuit devices
IEC / EN 60947-5-5	Low-voltage switchgear and controlgear - Part 5-5: Control circuit devices and switching elements - Electrical emergency stop device with mechanical latching function
IEC / EN 60073	Basic and safety principles for man-machine
IEC / EN 60529	Degrees of protection provided by enclosures (IP Code)
EN 50013	Low-voltage switchgear and controlgear for industrial use - Terminal marking and distinctive number for particular control switches
DIN 40050-9	Road vehicles; degrees of protection (IP-code); protection against foreign objects; water and contact; electrical equipment
UL 508	Industrial control equipment
CSA C22.2 No 14	Industrial control equipment

Environmental data

Degrees of protection

Pilot device:	IEC/EN DIN	UL/CSA
Pushbutton	IP66, IP67 and IP69K	Type 1, 3R, 4, 4X, 12, 13
Selector switch	IP66, IP67 and IP69K	Type 1, 3R, 4, 4X, 12, 13
Pilot light	IP66, IP67 and IP69K	Type 1, 3R, 4, 4X, 12, 13
Emergency stops	IP66, IP67 and IP69K	Type 1, 3R, 4, 4X, 12, 13
Terminals	IP20	

Temperature

Ambient temperature during operation	-25 to +70 °C
Storage temperature	-40 to +85 °C

Technical data

Cable connections

Operator	Cable terminal
Pushbutton	Plus-minus Pozidriv No. 2
Selector switch	Connectable area:
Emergency stop	min. 1 x 0.5 mm ² /1 x AWG22 max. 2 x 1.5 mm ² /2 x AWG14

Tightening torque

Operators, M22	Min. 2 Nm / Max. 2.3 Nm
Pushbutton and selector switch	Cable terminals M3, 0.8 Nm
Pilot light	Cable terminals M3.5, 0.9 Nm
Emergency stop	Cable terminals M3, 0.8 Nm

Electrical data

Electrical ratings

Contacts

Ratings as per IEC 60947-5-1

Rated insulation voltage, U _i	300 V	
Rated thermal current, I _{th}	5 A	
Rated operational current, I _e utilisation category AC-15	at: 240 V	1 A
Rated operational current, I _e utilization category DC-13,	at: 24 V	0.3 A
	at: 125 V	0.2 A

Ratings as per UL, CSA, NEMA

	C300 AC	R300 DC
Rated insulation voltage	250 V	250 V
Rated thermal current	2.5 A	1 A
Rated operational current	at: 120 V 1.5 A at: 125 V 0.75 A at: 240 V 0.75 A at: 250 V 0.11 A	0.22 A

Short circuit protection

Max. fuse at 1 kA	gG 10A
Make-and-break contacts	

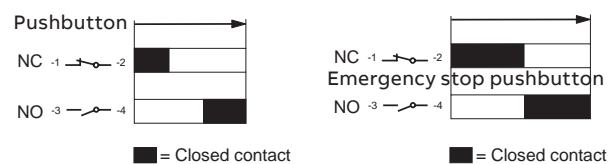

LEDs (for both compact and modular)

Service life for LED's means number of service hours until the brightness has been reduced down 50 %. Service life 50 000 h	
White LEDs	x=0.31 Y=3.2 means the position of color in the ICI Chromaticity Diagram
Over voltage on LEDs	10 % overvoltage is acceptable without affecting the service life
Voltage peaks on LEDs	Voltage peaks up to 1000 V Current peaks up to 500 mA during a few msec
Gloaming light	All integrated LEDs have a function built in to cut leakage currents

Mechanical data

Mechanical life

Pushbuttons, selector switches	500 000 operations
Emergency stop pushbutton	50 000 operations

Pilot devices

Compact range

Order example:

Ex 1: Type CP1-10 ■-10, to order color red replace ■ with R: CP1-10 R-10

Ex 2: Ordering code 1SFA619100R101 □ To order color red replace □ with 1: 1SFA619100R1011 ■

Color codes							
	Red ●	Green ●	Yellow ●	Blue ●	White ○	Black ●	Grey ●
Type ■	R	G	Y	L	W	B	U
Ordering code □	1	2	3	4	5	6	7



Non-illuminated flush Push-button with black plastic bezel

Non-illuminated flush pushbutton				
	Type	Pack size	Ordering code	L.P.(₹)
Momentary				
1 NO	CP1-10 □-10	1 X 10	1SFA619100R101 □	120
2 NO	CP1-10 □-20	1 X 10	1SFA619100R102 □	180
1 NC	CP1-10 □-01	1 X 10	1SFA619100R104 □	120
2 NC	CP1-10 □-02	1 X 10	1SFA619100R105 □	180
1 NO+1 NC	CP1-10 □-11	1 X 10	1SFA619100R107 □	180
Maintained				
1 NO	CP2-10 □-10	1 X 10	1SFA619101R101 □	170
2 NO	CP2-10 □-20	1 X 10	1SFA619101R102 □	200
1 NC	CP2-10 □-01	1 X 10	1SFA619101R104 □	160
2 NC	CP2-10 □-02	1 X 10	1SFA619101R105 □	200
1 NO+1 NC	CP2-10 □-11	1 X 10	1SFA619101R107 □	220



Non-illuminated extended Push-button with black plastic bezel

Non-illuminated extended pushbutton				
	Type	Pack size	Ordering code	L.P.(₹)
Momentary				
1 NO	CP3-10 ■-10	1 X 10	1SFA619102R101 □	140
2 NO	CP3-10 ■-20	1 X 10	1SFA619102R102 □	200
1 NC	CP3-10 ■-01	1 X 10	1SFA619102R104 □	150
2 NC	CP3-10 ■-02	1 X 10	1SFA619102R105 □	200
1 NO+1 NC	CP3-10 ■-11	1 X 10	1SFA619102R107 □	220
Maintained				
1 NO	CP4-10 ■-10	1 X 10	1SFA619103R101 □	170
2 NO	CP4-10 ■-20	1 X 10	1SFA619103R102 □	200
1 NC	CP4-10 ■-01	1 X 10	1SFA619103R104 □	170
2 NC	CP4-10 ■-02	1 X 10	1SFA619103R105 □	210
1 NO+1 NC	CP4-10 ■-11	1 X 10	1SFA619103R107 □	230

Pilot devices

Compact range



Pilot Light with intergrated LED, with leakage current protection



Pilot Light with intergrated LED, with leakage current protection



Pilot Light with intergrated LED, with leakage current protection

Color codes						
	Red ●	Green ●	Yellow ●	Blue ●	White ○	Amber ●
Type ■	R	G	Y	L	W	A
Ordering code □	1	2	3	4	5	9

Pilot light with integrated LED			
Type	Pack size	Ordering code	L.P.(₹)
24 V, AC/DC			
CL-502R	1 X 10	1SFA619402R5021 ■	
CL-502G	1 X 10	1SFA619402R5022 ■	170
CL-502Y	1 X 10	1SFA619402R5023 ■	
CL-502L	1 X 10	1SFA619402R5024 ■	320
CL-502W	1 X 10	1SFA619402R5025 ■	
CL-502A	1 X 10	1SFA619402R5029 ■	170
110-130 V, AC			
CL-513R	1 X 10	1SFA619402R5131 ■	
CL-513G	1 X 10	1SFA619402R5132 ■	170
CL-513Y	1 X 10	1SFA619402R5133 ■	
CL-513L	1 X 10	1SFA619402R5134 ■	320
CL-513W	1 X 10	1SFA619402R5135 ■	
CL-513A	1 X 10	1SFA619402R5139 ■	170
110-130 V, DC			
CL-515R	1 X 10	1SFA619402R5151 ■	
CL-515G	1 X 10	1SFA619402R5152 ■	170
CL-515Y	1 X 10	1SFA619402R5153 ■	
CL-515L	1 X 10	1SFA619402R5154 ■	320
CL-515W	1 X 10	1SFA619402R5155 ■	
CL-515A	1 X 10	1SFA619402R5159 ■	170
220 V, DC			
CL-520R	1 X 10	1SFA619402R5201 ■	
CL-520G	1 X 10	1SFA619402R5202 ■	170
CL-520Y	1 X 10	1SFA619402R5203 ■	
CL-520L	1 X 10	1SFA619402R5204 ■	320
CL-520W	1 X 10	1SFA619402R5205 ■	
CL-520A	1 X 10	1SFA619402R5209 ■	170
230 V, AC			
CL-523R	1 X 10	1SFA619402R5231 ■	
CL-523G	1 X 10	1SFA619402R5232 ■	170
CL-523Y	1 X 10	1SFA619402R5233 ■	
CL-523L	1 X 10	1SFA619402R5234 ■	320
CL-523W	1 X 10	1SFA619402R5235 ■	
CL-523A	1 X 10	1SFA619402R5239 ■	180

Note:

48 V AC/DC, 60 V AC/DC, 380 V AC and 415 V AC Pilot devices are available with ABB range of Pilot lamps L.P.(₹) will be available upon request

CL Range Pilot devices available till 31st March 2022

Pilot devices

Compact range



Non-illuminated black selector switch with plastic bezel

Selector switch				
	Type	Pack size	Ordering code	L.P. (₹)
Maintained / Two-positions				
1 NO	C2SS1-10B-10	1 X 10	1SFA619200R1016	280
2 NO	C2SS1-10B-20	1 X 10	1SFA619200R1026	310
1 NC	C2SS1-10B-01	1 X 10	1SFA619200R1046	280
2 NC	C2SS1-10B-02	1 X 10	1SFA619200R1056	310
1 NO+1 NC	C2SS1-10B-11	1 X 10	1SFA619200R1076	
Maintained / Two-positions				
1 NO	C2SS2-10B-10	1 X 10	1SFA619201R1016	280
2 NO	C2SS2-10B-20	1 X 10	1SFA619201R1026	310
1 NC	C2SS2-10B-01	1 X 10	1SFA619201R1046	280
2 NC	C2SS2-10B-02	1 X 10	1SFA619201R1056	310
1 NO+1 NC	C2SS2-10B-11	1 X 10	1SFA619201R1076	
Momentary / Two-positions				
1 NO	C2SS3-10B-10	1 X 10	1SFA619202R1016	270
2 NO	C2SS3-10B-20	1 X 10	1SFA619202R1026	310
1 NC	C2SS3-10B-01	1 X 10	1SFA619202R1046	270
2 NC	C2SS3-10B-02	1 X 10	1SFA619202R1056	310
1 NO+1 NC	C2SS3-10B-11	1 X 10	1SFA619202R1076	
Maintained / Three-positions				
2 NO	C3SS1-10B-20	1 X 10	1SFA619210R1026	310
2 NC	C3SS1-10B-02	1 X 10	1SFA619210R1056	
1 NO+1 NC	C3SS1-10B-11	1 X 10	1SFA619210R1076	
Momentary / Three-positions				
2 NO	C3SS2-10B-20	1 X 10	1SFA619211R1026	310
2 NC	C3SS2-10B-02	1 X 10	1SFA619211R1056	
1 NO+1 NC	C3SS2-10B-11	1 X 10	1SFA619211R1076	
Momentary / Three-positions				
2 NO	C3SS3-10B-20	1 X 10	1SFA619212R1026	310
2 NC	C3SS3-10B-02	1 X 10	1SFA619212R1056	
1 NO+1 NC	C3SS3-10B-11	1 X 10	1SFA619212R1076	



Non-illuminated emergency stop pushbutton, 30 mm



Non-illuminated emergency stop pushbutton, 40 mm

Emergency stop pushbutton				
Description	Type	Pack size	Ordering code	L.P.(₹)
● Twist release				
1 NC	∅ 30 mm CE3T-10R-01	1	1SFA619500R1041 ■	220
2 NC	∅ 30 mm CE3T-10R-02	1	1SFA619500R1051	280
1NO+1NC	∅ 30 mm CE3T-10R-11	1	1SFA619500R1071	270
Pull release				
2 NC	∅ 30 mm CE3P-10R-02	1	1SFA619501R1051	270
1NO+1NC	∅ 30 mm CE3P-10R-11	1	1SFA619501R1071	320
Key release: Ronis 455, key code 71				
2 NC	∅ 30 mm CE3K1-10R-02	1	1SFA619502R1051	830
1NO+1NC	∅ 30 mm CE3K1-10R-11	1	1SFA619502R1071	
Twist release				
1 NC	∅ 40 mm CE4T-10R-01	1	1SFA619550R1041 ■	230
2 NC	∅ 40 mm CE4T-10R-02	1	1SFA619550R1051 ■	290
1NO+1NC	∅ 40 mm CE4T-10R-11	1	1SFA619550R1071 ■	
Pull release				
2 NC	∅ 40 mm CE4P-10R-02	1	1SFA619551R1051 ■	290
1NO+1NC	∅ 40 mm CE4P-10R-11	1	1SFA619551R1071	
Key release: Ronis 455, key code 71				
2 NC	∅ 40 mm CE4K1-10R-02	1	1SFA619552R1051	890
1NO+1NC	∅ 40 mm CE4K1-10R-11	1	1SFA619552R1071	

Pilot devices

Compact range



Non-illuminated machine stop pushbutton, pull release, 30 mm



Non-illuminated machine stop pushbutton, push release, 30 mm

Machine stop					
Description	Type	Pack size	Ordering code	L.P.(₹)	
•	Twist release				
1NO+1NC Ø 30 mm	CE3T-10B-11	1	1SFA619500R1076	270	
	Pull release				
1NO+1NC Ø 30 mm	CE3P-10B-11	1	1SFA619501R1076	630	
	Key release: Ronis 455, Key code 71				
1NO+1NC Ø 30 mm	CE3K1-10B-11	1	1SFA619502R1076	880	
	Twist release				
1NO+1NC Ø 40 mm	CE4T-10B-11	1	1SFA619550R1076	270	
	Pull release				
1NO+1NC Ø 40 mm	CE4P-10B-11	1	1SFA619551R1076	630	
	Key release: Ronis 455, Key code 71				
1NO+1NC Ø 40 mm	CE4K1-10B-11	1	1SFA619552R1076	880	

Buzzer						
Description	Sound output	Rated current mA	Type	Pack size	Ordering code	L.P.(₹)
Rated voltage 24 V, AC/DC						
● Black	Continuous	40	CB1-620B	1	1SFA619600R6206	1,280
● Black	Pulsation	48	CB1-630B	1	1SFA619600R6306	
Rated voltage 230 V, AC						
● Black	Continuous	40	CB1-623B	1	1SFA619600R6236	1,280
● Black	Pulsation	40	CB1-633B	1	1SFA619600R6336	
Rated voltage 110-130 V, DC						
● Black	Continuous	15	CB1-622B	1	1SFA619600R6226	1,280
● Black	Pulsation	15	CB1-632B	1	1SFA619600R6326	
Rated voltage 110-130 V, AC						
● Black	Continuous	40	CB1-621B	1	1SFA619600R6216	1,280
● Black	Pulsation	45	CB1-631B	1	1SFA619600R6316	



Assembled compact emergency stop enclosures					
Description	Type	Pack size	Ordering code	L.P.(₹)	
1-seat plastic enclosure (yellow)					
■ □ Twist release. Red button 2 NC	CEPY1-1001	1	1SFA619821R1001	3,740	
■ □ Pull release. Red button 2 NC	CEPY1-1002	1	1SFA619821R1002		
Emergency stop enclosure with shroud					
■ □ Twist release. Red button 2 NC	CEPY1-2002	1	1SFA619821R2002	3,990	
■ □ Pull release. Red button 2 NC	CEPY1-2001	1	1SFA619821R2001		



Assembled compact emergency stop enclosures					
Description	Type	Pack size	Ordering code	L.P.(₹)	
1-seat plastic enclosure with black mushroom pushbutton (dark grey)					
■ □ Twist release. Black button 1 NO + 1 NC	CEP1-1001	1	1SFA619811R1001	3,150	
■ □ Pull release. Black button 1 NO + 1 NC	CEP1-1002	1	1SFA619811R1002	1,750	
Machine stop enclosure with shroud					
■ □ Twist release. Black button 1 NO + 1 NC	CEP1-2001	1	1SFA619811R2001	3,450	
■ □ Pull release. Black button 1 NO + 1 NC	CEP1-2002	1	1SFA619811R2002	2,060	



■ Stock items

Pilot devices

Technical data modular range

Standard and approvals	
IEC / EN 60947-1	Low-voltage switchgear and controlgear - Part 1: General rules
IEC / EN 60947-5-1	Low-voltage switchgear and controlgear - Part 5-1: Control circuit devices and switching elements - Electromechanical control circuit devices
IEC / EN 60947-5-5	Low-voltage switchgear and controlgear - Part 5-5: Control circuit devices and switching elements - Electrical emergency stop device with mechanical latching function
IEC / EN 60073	Basic and safety principles for man-machine interface, marking and identification - Coding principles for indicators and actuators
IEC / EN 60529	Degrees of protection provided by enclosures (IP Code)
EN 50013	Low-voltage switchgear and controlgear for industrial use - Terminal marking and distinctive number for particular control switches
UL 508	Industrial control equipment
CSA C22.2 No 14	Industrial control equipment

Environmental data		
Degrees of protection		
Operators	IEC/EN	UL/CSA
Pushbutton	IP 66	Type 1, 3R, 4, 4X, 12, 13
Double pushbutton	IP 66	Type 1, 3R, 4, 4X, 12, 13
Mushroom	IP 66	Type 1, 3R, 4, 4X, 12, 13
Emergency stop	IP 66	Type 1, 3R, 4, 4X, 12, 13
Selector switch	IP 66	Type 1, 3R, 4, 4X, 12, 13
Key operated selector switch	IP 66	Type 1, 3R, 4, 4X, 12
Toggle switch	IP 66	Type 1, 3R, 4, 4X, 12, 13
Extreme duty pushbutton	-	Type 1, 3R, 4, 4X
Reset button	IP 66	Type 1, 3R, 4, 4X, 12, 13
Joystick	IP 66, 67, 69K	Type 1, 4X (indoor), 12, 13
Pilot lights	IP 66	Type 1, 3R, 4, 4X, 12, 13
Buzzer	IP 65	Type 4X
Potentiometer	IP 66	Type 1, 3R, 4, 4X, 12, 13
Contact block and transformer block	IP 20	-
Plastic enclosures	IP 66	Type 1, 3R, 4, 4X, 12, 13
Metallic enclosures	IP 66, 67, 69K	-

Temperature	
Ambient temperature during operation	-25 to +70 °C
Storage temperature	-40 to +85 °C

Technical data	
Terminals	
Plus-minus Pozidriv No.2 screw with DIN-washer	
Connectable area	min. 1 x 0.5 mm ² AWG 20 max. 2 x 2.5 mm ² /2 x AWG14

Tightening torque	
Operators, M22	Min. 2 Nm / Max. 2.3 Nm
Cable terminals	0.9 Nm
Recommended maximum number of blocks: 6	

Electrical data	
Standards contact blocks	
Mechanical endurance	10 million operations
Self cleaning contacts of silver, NC contact with positive opening. At voltages and currents below 24 V and 5.6 mA we recommended our micro switch blocks or as an alternative, gold plated contacts.	

Ratings as per IEC 60947-5-1		
Rated insulation voltage, U _i	690 V	
Rated thermal current, I _{th}	10 A	
Rated operational current, I _e utilisation category AC 15,	at: 120 V	8 A
	at: 230 V	6 A
	at: 400 V	4 A
	at: 690 V	2 A
Rated operational current, I _e utilisation category DC 13,	at: 24 V	5 A
	at: 125 V	1.1 A
	at: 250 V	0.55 A

Ratings as per UL, CSA, NEMA				
	A600 AC	Q600 DC		
Rated insulation voltage	600 V	600 V		
Rated thermal current	10 A	2.5 A		
Rated operational current	at: 120 V	6 A	at: 125 V	0.55 A
	at: 240 V	3 A	at: 250 V	0.27 A
	at: 480 V	1.5 A	at: 480 V	0.10 A
	at: 600 V	1.2 A	at: 600 V	0.10 A

Contact resistance	< 25 mΩ
Compulsory function test	at: 5V, 16 mA

Micro switch block / ratings as per IEC 60947-5-1		
Rated insulation voltage, U _i	125 V	
Rated thermal current, I _{th}	3 A	
Rated operational current, I _e utilisation category AC 14,	at: 125 V	0.5 A
Rated operational current, I _e utilization category DC 13,	at: 24 V	0.3 A
Rated operational current, I _e utilization category DC 12,	at: 24 V	0.1 A
Minimum switching capacity	3 V DC	1 mA

Ratings as per UL 508		
	125 V AC	3 A
	60 V DC	0.2 A
	48 V DC	0.1 A

Short circuit protection	
Max. fuse at 1 kA	gG 16A
Note: LEDs see technical data compact range	

Mechanical data	
Mechanical life	
Pushbuttons, momentary mushroom	2 million operations
Selector switches. Present standard (no operation of center contact)	500 000 operations
With operation of center contact	250 000 operations
	150 000 operations
Maintained mushroom, pushbutton, key operated selector switch and double pushbutton	500 000 operations
Emergency stop	100 000 operations
Toggle switch	1 million operations

Pilot devices

Modular range



Modular product features

- Widest range of integrated LEDs on the market
- Parts of Range IP 66, 67, 69K
- All range & UL Type 1, 3R, 4, 4X, 12, 13
- Snap-on feature reduces installation time
- Quick release contact holder
- Several bezel colors
- Unique low energy solutions, including wiping action

How to order standard operators:

- Non-illuminated operator + holder
- + contact block(s)
- Illuminated operator + holder
- + contact block(s)
- + lamp block

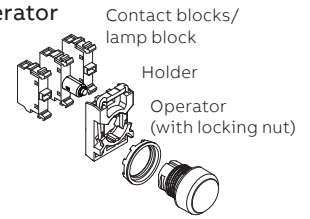

*Only for illuminated operator

How to order Bezel:

Bezel options	Type	Ordering code
Black plastic	MPX-10X	1SFA611 10X R1XXX

Color codes

	Red ●	Green ●	Yellow ●	Blue ●	White ○	Black ●	Grey ●
Type ■	R	G	Y	L	W	B	U
Ordering code □	1	2	3	4	5	6	7

Ordering example:

Ex 1: Type MP1-10 ■, to order color red replace ■ with R: MP1-10R

Ex 2: Ordering code 1SFA611100R1001 n, to order color red replace □ with 1: 1SFA619100R1001

Operator : Flush button Non-illuminated push button

	Type	Pack size	Ordering code	L.P. (₹)
Momentary	MP1-10 ■	1 X 10	1SFA611100R100 □	60
Maintained	MP2-10 ■	1 X 10	1SFA611101R100 □	90

Operator : Extended button Non-illuminated push button

Momentary	MP3-10 ■	1 X 10	1SFA611102R100 □	90
Maintained	MP4-10 ■	1 X 10	1SFA611103R100 □	90

Color codes

	Red ●	Green ●	Yellow ●	Blue ●	White ○	Black ●	Grey ●	Amber ●
Type ■	R	G	Y	L	W	B	U	AN
Ordering code □	1	2	3	4	5	6	7	9

	Type	Pack size	Ordering code	L.P. (₹)
--	------	-----------	---------------	----------

Operator : Flush button illuminated push button

Momentary	MP1-11 ■	1 X 10	1SFA611100R110 □	90
	MP1-11AN	1 X 10	1SIN611100R1109	90
Maintained	MP2-11 ■	1 X 10	1SFA611101R110 □	110
	MP2-11AN	1 X 10	1SIN611101R1109	110

Operator : Extended button illuminated push button

Momentary	MP3-11 ■	1 X 10	1SFA611102R110 □	110
	MP3-11AN	1 X 10	1SIN611102R1109	110
Maintained	MP4-11 ■	1 X 10	1SFA611103R110 □	110
	MP4-11AN	1 X 10	1SIN611103R1109	110

Note:

1. Integrated LED block to be considered from MLBL range of suitable voltage from page no. 109

Separate holder

Holders for three blocks	MCBH-00	1 X 10	1SFA611605R1100	30
Contact blocks only (without holder)				
1 NO	MCB-10	1 X 10	1SFA611610R1001 ■	70
1 NC	MCB-01	1 X 10	1SFA611610R1010 ■	70

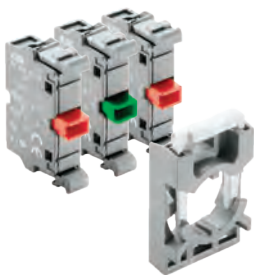

Blocks and holder

■ Stock items

Pilot devices

Modular range



LED lamp block with built in leakage curragge protection

Operator : Pilot lights				
	Type	Pack size	Ordering code	L.P.(₹)
● Red	ML1-100R	1 X 10	1SFA611400R1001 ■	70
● Green	ML1-100G	1 X 10	1SFA611400R1002 ■	
● Yellow	ML1-100Y	1 X 10	1SFA611400R1003 ■	
● Blue	ML1-100L	1 X 10	1SFA611400R1004	
○ White	ML1-100W	1 X 10	1SFA611400R1005	
● Amber	ML1-100AN	1 X 10	1SIN611400R1009	
Separate holder				
	Type	Pack size	Ordering code	L.P.(₹)
Holder for three blocks	MCBH-00	1 X 10	1SFA611605R1100 ■	30
Lamp blocks with integrated LED				
Rated voltage 24 V, AC/DC				
	Type	Pack size	Ordering code	L.P.(₹)
● Red	MLBL-01R	1 X 10	1SFA611621R1011 ■	160
● Green	MLBL-01G	1 X 10	1SFA611621R1012 ■	
● Yellow	MLBL-01YN	1 X 10	1SIN611621R1013	370
● Blue	MLBL-01L	1 X 10	1SFA611621R1014 ■	
○ White	MLBL-01W	1 X 10	1SFA611621R1015 ■	170
● Amber	MLBL-01A	1 X 10	1SFA611621R1016	
Rated voltage 110-130 V, AC				
	Type	Pack size	Ordering code	L.P.(₹)
● Red	MLBL-04R	1 X 10	1SFA611621R1041	160
● Green	MLBL-04G	1 X 10	1SFA611621R1042	
● Yellow	MLBL-04YN	1 X 10	1SIN611621R1043	350
● Blue	MLBL-04L	1 X 10	1SFA611621R1044	
○ White	MLBL-04W	1 X 10	1SFA611621R1045	170
● Amber	MLBL-04A	1 X 10	1SFA611621R1046	
Rated voltage 110-130 V, DC				
	Type	Pack size	Ordering code	L.P.(₹)
● Red	MLBL-05R	1 X 10	1SFA611621R1051	160
● Green	MLBL-05G	1 X 10	1SFA611621R1052	
● Yellow	MLBL-05YN	1 X 10	1SIN611621R1053	370
● Blue	MLBL-05L	1 X 10	1SFA611621R1054	
○ White	MLBL-05W	1 X 10	1SFA611621R1055	170
● Amber	MLBL-05A	1 X 10	1SFA611621R1056	
Rated voltage 220 V, DC				
	Type	Pack size	Ordering code	L.P.(₹)
● Red	MLBL-06R	1 X 10	1SFA611621R1061	160
● Green	MLBL-06G	1 X 10	1SFA611621R1062	
● Yellow	MLBL-06YN	1 X 10	1SIN611621R1063	360
● Blue	MLBL-06L	1 X 10	1SFA611621R1064	
○ White	MLBL-06W	1 X 10	1SFA611621R1065	160
● Amber	MLBL-06A	1 X 10	1SFA611621R1066	
Rated voltage 230 V, AC				
	Type	Pack size	Ordering code	L.P.(₹)
● Red	MLBL-07R	1 X 10	1SFA611621R1071	160
● Green	MLBL-07G	1 X 10	1SFA611621R1072 ■	
● Yellow	MLBL-07YN	1 X 10	1SIN611621R1073	360
● Blue	MLBL-07L	1 X 10	1SFA611621R1074 ■	
○ White	MLBL-07W	1 X 10	1SFA611621R1075	160
● Amber	MLBL-07A	1 X 10	1SFA611621R1076	

Note: 48 V AC/DC, 60 V AC/DC, 380 V AC and 415 V AC L.P.(₹)S will be available upon request

■ Stock items

Pilot devices

Modular range



Operator : Emergency stop pushbutton				
	Type	Pack size	Ordering code	L.P.(₹)
●				
Ø 30 mm / Non-illuminated				
Twist release	MPET3-10R	1	1SFA611520R1001	430
Pull release	MPEP3-10R	1	1SFA611521R1001	
Key release code 71/Ronis 455	MPEK3-11R	1	1SFA611522R1101	
Key release code 72/ Ronis 421	MPEK3-12R	1	1SFA611522R1201	820
Key release code 73/ Ronis 3433-E	MPEK3-13R	1	1SFA611522R1301	
Ø 40 mm / Non-illuminated				
Twist release	MPET4-10R	1	1SFA611523R1001	370
Pull release	MPEP4-10R	1	1SFA611524R1001	780
Key release code 71/Ronis 455	MPEK4-11R	1	1SFA611525R1101	800
Key release code 72/ Ronis 421	MPEK4-12R	1	1SFA611525R1201	
Key release code 73/ Ronis 3433-E	MPEK4-13R	1	1SFA611525R1301	
Ø 60 mm / Non-illuminated				
Twist release	MPMT4-10R	1	1SFA611513R1001	660
Pull release	MPMP4-10R	1	1SFA611514R1001	540
Ø 40 mm / Illuminated				
Twist release	MPMT3-11R	1	1SFA611510R1101 ■	630
Pull release	MPMP3-11R	1	1SFA611511R1101	510
Ø 60 mm / Illuminated				
Twist release	MPMT4-11R	1	1SFA611513R1101	860
Pull release	MPMP4-11R		1SFA611514R1101	690

Refer holder and contact block configuration for standard operator from page no. 110



Operator : Machine stop pushbutton				
	Type	Pack size	Ordering code	L.P.(₹)
●				
Ø 30 mm				
Twist release	MPET3-10B	1	1SFA611520R1006	430
Pull release	MPEP3-10B	1	1SFA611521R1006	
Key release	MPEK3-10B	1	1SFA611522R1106	
Ø 40 mm				
Twist release	MPET4-10B	1	1SFA611523R1006	430
Pull release	MPEP4-10B	1	1SFA611524R1006	

Refer holder and contact block configuration for standard operator from page no. 110



Operator : Double pushbutton				
	Type	Pack size	Ordering code	L.P.(₹)
● Upper				
● Lower				
Extended lower button / Non-illuminated				
I / O	MPD13-11B	1	1SFA611142R1106	450
START / STOP	MPD15-11B	1	1SFA611144R1106	
● Upper				
● Lower				
Extended lower button / Illuminated				
I / O	MPD13-11C	1	1SFA611142R1108	670
START / STOP	MPD15-11C	1	1SFA611144R1108	
● Upper				
● Lower				
○ Upper Extended lower button / ● Lower Non-illuminated				
I / O	MPD17-11B	1	1SFA611146R1106	450

Refer holder and contact block configuration for standard operator

Pilot devices

Modular range



Operator: non-illuminated black two-position selector switch

Type	Pack size	Ordering code	L.P.(₹)
Maintained / Short handle			
M2SS1-10B	1	1SFA611200R1006	300
Maintained / Short handle			
M2SS2-10B	1	1SFA611201R1006	300
Momentary / Short handle, spring return from C to B			
M2SS3-10B	1	1SFA611202R1006	310
Maintained / Long handle			
M2SS4-10B	1	1SFA611203R1006	900
Maintained / Long handle			
M2SS5-10B	1	1SFA611204R1006	900
Momentary / Long handle, spring return from C to B			
M2SS6-10B	1	1SFA611205R1006	920

Refer holder and contact block configuration for standard operator

Operator: non-illuminated black three-position selector switch

Type	Pack size	Ordering code	L.P.(₹)
Maintained / Short handle			
M3SS1-10B	1	1SFA611210R1006	300
Momentary / Short handle, spring return from A to B and C to B			
M3SS2-10B	1	1SFA611211R1006	310
Momentary / Short handle, spring return from C to B			
M3SS3-10B	1	1SFA611212R1006	310
Momentary / Short handle, spring return from A to B			
M2SS7-10B	1	1SFA611216R1006	310
Maintained / Long handle			
M3SS4-10B	1	1SFA611213R1006	900
Momentary / Long handle, spring return from A to B and C to B			
M3SS5-10B	1	1SFA611214R1006	920
Momentary / Long handle, spring return from C to B			
M3SS6-10B	1	1SFA611215R1006	1,160
Momentary / Long handle, spring return from A to B			
M2SS8-10B	1	1SFA611217R1006	840

Refer holder and contact block configuration for standard operator

Operator: non-illuminated black three-position selector switch with operation of center position

Type	Pack size	Ordering code	L.P.(₹)
Short handle			
M3SSC1-10B	1	1SFA611250R1006	
M3SSC2-10B	1	1SFA611251R1006	
M3SSC3-10B	1	1SFA611252R1006	330
M3SSC7-10B	1	1SFA611256R1006	
Long handle			
M3SSC4-10B	1	1SFA611253R1006	
M3SSC5-10B	1	1SFA611254R1006	950
M3SSC6-10B	1	1SFA611255R1006	

Refer holder and contact block configuration for standard operator

Pilot devices

Modular range



Operator : Key operated selector switch					
	Type		Pack size	Ordering code	L.P.(₹)
●	Maintained / Two positions (The key can be removed in both position)				
71/Ronis 455	M2SSK1-101		1	1SFA611280R1001	690
72/Ronis 421	M2SSK1-102		1	1SFA611280R1002	
73/Ronis 3433-E	M2SSK1-103		1	1SFA611280R1003	
Random selection*)	M2SSK1-104		1	1SFA611280R1004	
	Maintained / Two positions (The key can be removed in position B only)				
71/Ronis 455	M2SSK2-101		1	1SFA611281R1001	690
72/Ronis 421	M2SSK2-102		1	1SFA611281R1002	
73/Ronis 3433-E	M2SSK2-103		1	1SFA611281R1003	
Random selection*)	M2SSK2-104		1	1SFA611281R1004	
	Momentary / Two positions, spring return from C to B (The key can be removed in position B only)				
71/Ronis 455	M2SSK3-101		1	1SFA611282R1001	770
72/Ronis 421	M2SSK3-102		1	1SFA611282R1002	
73/Ronis 3433-E	M2SSK3-103		1	1SFA611282R1003	
Random selection*)	M2SSK3-104		1	1SFA611282R1004	

Refer holder and contact block configuration for standard operator

Operator : Key operated selector switch					
	Type		Pack size	Ordering code	L.P.(₹)
●	Maintained / Three positions (The key can be removed in both position)				
71/Ronis 455	M3SSK1-101		1	1SFA611283R1001	700
72/Ronis 421	M3SSK1-102		1	1SFA611283R1002	
73/Ronis 3433-E	M3SSK1-103		1	1SFA611283R1003	
Random selection*)	M3SSK1-104		1	1SFA611280R1004	
	Maintained / Three positions (The key can be removed in position B only)				
71/Ronis 455	M3SSK2-101		1	1SFA611284R1001	700
72/Ronis 421	M3SSK2-102		1	1SFA611284R1002	
73/Ronis 3433-E	M3SSK2-103		1	1SFA611284R1003	
Random selection*)	M3SSK2-104		1	1SFA611284R1004	
	Momentary / Three positions, spring return from C to B (The key can be removed in position B only)				
71/Ronis 455	M3SSK3-101		1	1SFA611285R1001	770
72/Ronis 421	M3SSK3-102		1	1SFA611285R1002	
73/Ronis 3433-E	M3SSK3-103		1	1SFA611285R1003	
Random selection*)	M3SSK3-104		1	1SFA611285R1004	

Refer holder and contact block configuration for standard operator

Potentiometer					
	Type		Pack size	Ordering code	L.P.(₹)
●	with resistor 5 kohm				
Black plastic	MT-105B		1	1SFA611410R1056	3,720
●	with resistor 10 kohm				
Black plastic	MT-110B		1	1SFA611410R1106	3,720
●	with resistor 50 kohm				
Black plastic	MT-150B		1	1SFA611410R1506	4,190

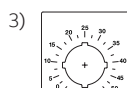
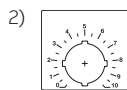

Toggle switch*					
	Type		Pack size	Ordering code	L.P.(₹)
●	Maintained / Two-positions				
Black plastic	MTS1-10B		1	1SFA611300R1006	660
●	Momentary / Three-positions				
Black plastic	MTS2-10B		1	1SFA611301R1006	850
●	Maintained / Three-positions				
Black plastic	MTS3-10B		1	1SFA611302R1006	660

Pilot devices

Modular range

• Joystick (holder included)
+ contact blocks

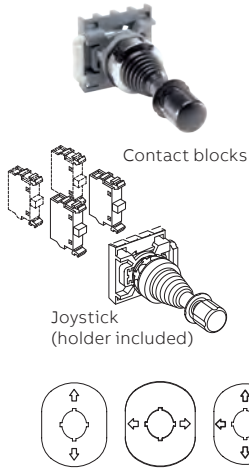

Joystick				
●	Type	Pack size	Ordering code	L.P.(₹)
Maintained				
2 - position	MJS1-60B	1	1SFA611701R6006	3,570
4 - position	MJS5-60B	1	1SFA611705R6006	3,920
Spring return				
2 - position	MJS2-60B	1	1SFA611702R6006	3,570
4 - position	MJS6-60B	1	1SFA611706R6006	3,920
Maintained / Latching function				
2 - position	MJS7-60B	1	1SFA611707R6006	3,920
4 - position	MJS11-60B	1	1SFA611711R6006	4,530
Spring return / Latching function				
2 - position	MJS8-60B	1	1SFA611708R6006	3,920
4 - position	MJS12-60B	1	1SFA611712R6006	4,530

Legend plates for joystick				
2 - position	MA6-1240	1	1SFA611930R1240	
2 - position	MA6-1241	1	1SFA611930R1241	310
4 - position	MA6-1242	1	1SFA611930R1242	

Refer holder and contact block configuration for standard operator

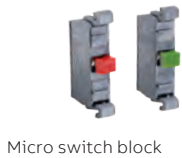

Micro switch blocks				
Description	Type	Pack size	Ordering code	L.P.(₹)
1 NO	MCBL-10	1	1SFA611612R1010	
1 NC	MCBL-01	1	1SFA611612R1001	550

Extreme duty pushbutton				
● ● ●	Type	Pack size	Ordering code	L.P.(₹)
For Ø 30 mm mounting hole				
● ● ●	KP6-40 ■	1	1SFA616105R400 □	1,520

Refer contact block configuration for standard operator



Reset pushbutton				
● ○	Type	Pack size	Ordering code	L.P.(₹)
With shaft				
No text	KPR3-100 ■	1	1SFA616162R100 □	470
Without shaft				
No text	KPR1-100 ■	1	1SFA616160R100 □	360
Accessories: Shaft (black)				
No text	KA1-8046	1	1SFA616920R8046	150



Accessories				
	Type	Pack size	Ordering code	L.P.(₹)
Mounting tool	MA1-8015	1	1SFA611920R8015	330
Membrane of silicone flush button	KA1-8052	1	1SFA611920R8052	210
Membrane of silicone extended button	KA1-8002	1	1SFA611920R8002	390
Locking nut	MA1-8019	1	1SFA611920R8019	250

*Spacer is needed when legendplates are not used in plastic enclosures

Pilot devices

Enclosures



Empty enclosures



Shroud



DIN-rail adaptor

Empty plastic enclosures for modular and compact range

Description	Type	Pack size	Ordering code	L.P.(₹)
■ □ 1-seat	MEPY1-0	1	1SFA611821R1000	1,890
■ □ 1-seat	MEP1-0	1	1SFA611811R1000	1,860
■ □ 2-seat	MEP2-0	1	1SFA611812R1000	1,720
■ □ 3-seat	MEP3-0	1	1SFA611813R1000	2,430
■ □ 4-seat	MEP4-0	1	1SFA611814R1000	3,300
■ □ 6-seat	MEP6-0	1	1SFA611816R1000	5,020

Shroud for modular range push button operator

■ Yellow	MA1-8053	1	1SFA611920R8053	540
■ Grey	MA1-8128	1	1SFA611920R8128	1,600

Empty enclosures for compact range

■ □ Yellow/Light grey	CEPY1-0	1	1SFA619821R1000	1,610
■ □ Dark grey/Light grey	CEP1-0	1	1SFA619811R1000	1,320

Shroud for compact range push buttons

■ Yellow	CA1-8053	1	1SFA619920R8053	340
■ Grey	CA1-8054	1	1SFA619920R8054	340

DIN-rail adaptor

DIN-rail adaptor	MA1-8131	1	1SFA611920R8131	900
------------------	----------	---	-----------------	-----

Signal towers and signal beacons*



* Price on request

Signal tower and beacons



KL70-401B

1SFC151507F0001



KL70-401Y

1SFC151508F0001



KA4-102...

1SFC151509F0001

Description					
Colors	● Red	● Green	● Yellow	● Blue	○ Clear
Replace ■ in type with	R	G	Y	B	C
Replace □ in Ordering code with	1	2	3	4	8

Description	Type	Ordering code	L.P.(₹)
Light element			
Available in red, green, yellow, blue and clear			
Permanent light, 12-240 V AC/DC For bulb BA 15d. Bulb not included	KL70-401 ■	1SFA616070R401 □	1,940
Blinking light, 24 V AC/DC with integrated LED	KL70-306 ■	1SFA616070R306 □	8,090
Flashing light, 24 V AC/DC with integrated xenon tube	KL70-203 ■	1SFA616070R203 □	11,200
Blinking light, 115 V AC with integrated LED	KL70-342 ■	1SFA616070R342 □	7,280
Flashing light, 115 V AC with integrated xenon tube	KL70-113 ■	1SFA616070R113 □	9,080
Blinking light, 230 V AC with integrated LED	KL70-352 ■	1SFA616070R352 □	8,090
Flashing light, 230 V AC with integrated xenon tube	KL70-123 ■	1SFA616070R123 □	8,690
LED permanent light, 24 V AC/DC with integrated LED	KL70-305 ■	1SFA616070R305 □	7,610
LED rotating light, 24 V AC/DC with integrated LED	KL70-307 ■	1SFA616070R307 □	17,090

Bulbs: Bulb Ba 15d, 42mm, max 7 W for permanent or blinking light			
24 V, 5 W, AC/DC	KA4-1021	1SFA616923R1028	160
115 V, 5 W, AC/DC	KA4-1118	1SFA616923R1118	240
230 V, 5 W, AC/DC	KA4-1148	1SFA616923R1148	250

LED bulbs Ba 15d, 40mA			
Available in red, green, yellow, blue and white			
24 V AC/DC	KA4-102 ■	1SFA616924R102 □	4,760

Audible modules buzzer element. 85 dB, continuous or pulsating tone, adjustable			
24 V AC/DC	KB70-3001	1SFA616071R3001	4,990
115 V AC	KB70-3101	1SFA616071R3101	5,700
115 V AC	KB70-1201	1SFA616071R1201	5,300



Signal towers



KT70-10...

1SFC151510F0001



KA70-1001

1SFC151511F0001



KA70-1034

1SFC151512F0001

Description	Type	Ordering code	L.P.(₹)
Siren element			
Multi function, 8 diff. Tones adjustable, volume adjustable 100 dB, 115 V AC	KS70-1104	1SFA616073R1104	8,350
Multi function, 8 diff. Tones adjustable, volume adjustable 100 dB, 230 V AC	KS70-1204	1SFA616073R1204	8,350
Multi function, 7 diff. Tones adjustable, volume adjustable, 100 dB, 24 V DC	KS70-2004	1SFA616073R2004	9,160
Multi function, 8 diff. Tones adjustable, volume adjustable 100 dB, 24 V AC/DC	KS70-3004	1SFA616073R3004	7,050
Continuous tone alternating 108 dB, 24 V DC	KS70-2002	1SFA616073R2002	5,420
Terminal elements			
For tube mounting, including cap	KT70-1001	1SFA616075R1001	2,850
For bracket or base, including cap	KT70-1002	1SFA616075R1002	2,850
Special parts			
Contact box			
Cable exit at side	KA70-1001	1SFA616077R1001	600
Magnetic base	KA70-1002	1SFA616077R1002	3,710
Base with tube			
D=25 mm L=110 mm	KA70-1011	1SFA616077R1011	1,510
Base for tube			
D=25 mm, plastic	KA70-1012	1SFA616077R1012	730
D=25 mm, metal	KA70-1013	1SFA616077R1013	2,270
Tube, anodized aluminum			
D=25 mm L=250 mm	KA70-1021	1SFA616077R1021	1,220
D=25 mm L=400 mm	KA70-1022	1SFA616077R1022	1,460
D=25 mm L=800 mm	KA70-1023	1SFA616077R1023	2,920
Bracket			
1-sided mounting	KA70-1031	1SFA616077R1031	1,060
2-sided mounting	KA70-1032	1SFA616077R1032	1,060
For tube mounting	KA70-1033	1SFA616077R1033	1,120
For surface mounting	KA70-1034	1SFA616077R1034	1,120

Signal beacons



KSB-401G

SFC151513F0001



KASB-100

SFC151514F0001

Description					
Colors	● Red	● Green	● Yellow	● Blue	○ Clear
Replace ■ in type with	R	G	Y	B	C
Replace □ in Ordering code with	1	2	3	4	8

Light element: Available in red, green, yellow, blue and clear

Permanent light, 12-240 V AC/DC. For Bulb BA 15dBulb not included	KSB-401 ■	1SFA616080R401 □	12,370
Flashing light, 24 V DC. With integrated xenon tube	KSB-203 ■	1SFA616080R203 □	12,430
Flashing light, 115 V AC. With integrated xenon tube	KSB-113 ■	1SFA616080R113 □	10,590
Flashing light, 230 V AC. With integrated xenon tube	KSB-123 ■	1SFA616080R123 □	10,590

Light element LED: Available in red, green and yellow

LED permanent light, 24 V AC/DC. With integrated LED	KSB-305 ■	1SFA616080R305 □	13,710
LED blinking light, 24 V AC/DC. With integrated LED	KSB-306 ■	1SFA616080R306 □	13,710
LED rotation light, 24 V AC/DC. With integrated LED	KSB-307 ■	1SFA616080R307 □	12,370

Special parts

Anti-twist device	KASB-100	1SFA616087R1000	480
-------------------	----------	-----------------	-----

Bulbs for signal beacons max 10 W. For permanent light Bulb Ba 15d, 52mm

12 V, 7 W, AC/DC	KA3-1018	1SFA616922R1018	180
24 V, 7 W, AC/DC	KA3-1028	1SFA616922R1028	250
115 V, 7 W, AC/DC	KA3-1118	1SFA616922R1118	290
220-260 V, 7-10 W, AC/DC	KA3-1148	1SFA616922R1118	300

Electronic products and relays

The product range



Time relays, CT range

Three ranges of electronic timers provide timing functions for all applications: the CT-D range with a width of just 17.5 mm; the CT-E and CT-C range, the ideal solution for serial applications; and the CT-S range that has two different types of connection terminals and is ideally suited for universal use. The CT range has a wide variety of timing functions (from ON or OFF delay to star-delta changeover). The time relays are available with output relays, solid-state outputs and precise direct time adjustment.

Measuring and monitoring relays, CM range

State-of-the-art monitors for single and three-phase systems. Monitoring of: voltage, current, frequency, power factor (motor load), thermistors, temperature, liquid level, insulation resistance, and grid feeding. ABB has one of the world's widest product ranges of measuring and monitoring relays. The CM range is a key product line of the EPR range.

Power supplies, CP range

Modern power supply units are a vital component in most areas of energy management and automation technology. As your global partner in this area, ABB pays close attention to corresponding requirements. Innovation is the key to the substantial enlargement of our power supply product range. ABB offers four different product lines for single and three-phase supplies, output voltages 5/12/24, and 48 VDC in plastic and metal enclosure, as well as various accessories.

Interface relays and optocouplers, CR range and R600

Interface relays and optocouplers are widely used in various industrial applications. As an interface, they link the controller, e.g. PLC (programmable logic controller), PC or field bus systems to the sensor/actuator level. Here, they have various functions: switching AC or DC loads with different resistive, inductive and capacitive parts, switching voltages from a few mV up to 250 V, switching currents from a few mA up to 16 A, amplification of weak control signals, electrical isolation of control and load circuits, and signal multiplying.

Temperature monitoring relays CM-TCS & CM-TCN monitor

over-temperature, under-temperature, or temperatures between two threshold values (window monitoring) with PT100 sensor. As soon as the temperature falls below or exceeds the threshold value the output relays change their positions according to the configured functionality and the front-face LEDs display the current status. Regardless of the selected configuration, the device is monitoring its measuring circuit for interrupted wires or short circuits.

Time relays

CT-C, CT-S and CT-D



CT-C range

Operating controls



Connection terminals

Wide terminal spacing makes wiring connections easier: 2 x 1.5 mm² (2 x 16 AWG) with wire end ferrules or 2 x 2.5 mm² (2 x 14 AWG) without ferrules.



Preselection of the time range



Direct reading scales

Direct setting of the time delay without any additional calculation provides accurate time delay adjustment.



Selection of the timing function

- ON-delay
- OFF-delay with aux. voltage
- Impulse-ON
- Impulse-OFF with aux. voltage
- Flasher starting with ON
- Flasher starting with OFF
- Pulse former

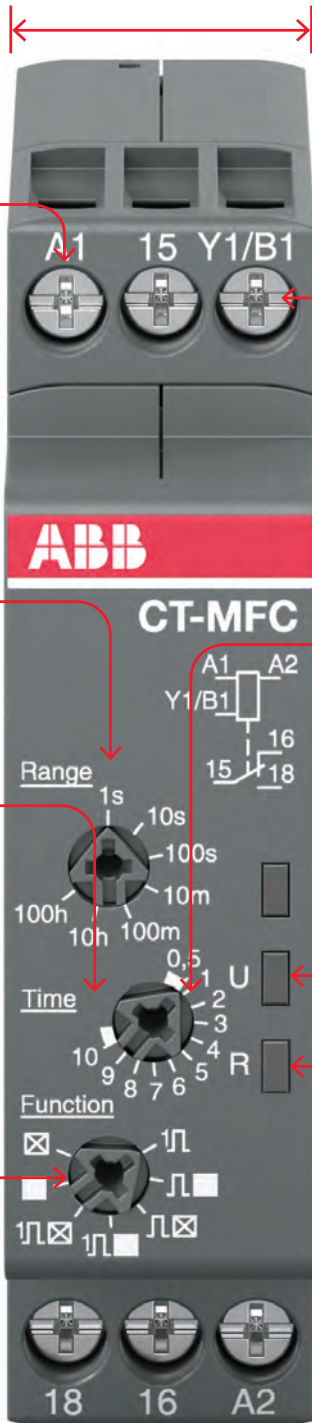

Width 17.5 mm

With a width of just 17.5mm, CT-C time relays are ideal for installations with limited space.

Control input to start timing



Fine adjustment of the time delay



LEDs for status indication

All actual operational states are displayed by front-facing LEDs, simplifying commissioning and troubleshooting.

- U - green LED: control supply voltage applied / timing
- R, R1, R2 - yellow LED: output relay energized

ABB CT-C Product Portfolio



CT-MFC.12

2CDC251030V0018



CT-ERC.22

2CDC251029V0018

*Control input with voltage-related triggering_No triggering

Ordering details

Timing function	Rated control supply voltage	Time ranges	Control input	Output	Type	Order code	LP.(₹)
Multi 1)	12-240 V AC/DC	7 (0.05 s - 100 h)	*	Solid State	CT-MKC.31	1SVR508010R1300	3,150
Multi 1)	24-240 V AC 24-48 V DC		*	1C/O	CT-MFC.12	1SVR508020R0000	2,870
Multi 1)	12-240 V AC/DC		*	2C/O	CT-MFC.21	1SVR508020R1100	8,020
Dual 2)	24-240 V AC 24-48 V DC	7 (0.05 s - 10 min)	-	1C/O	CT-ARC.12	1SVR508120R0000	3,880
ON-delay		7 (0.05 s - 100 h)	-	1C/O	CT-ERC.12	1SVR508100R0000	2,360
			-	2C/O	CT-ERC.22	1SVR508100R0100	4,680
OFF-delay			-	1C/O	CT-AHC.12	1SVR508110R0000	2,760
			-	2C/O	CT-AHC.22	1SVR508110R0100	5,010
Impulse- ON			*	1C/O	CT-VWC.12	1SVR508130R0000	4,160
Flasher 3)	24-240 V AC 24-48 V DC		*		CT-EBC.12	1SVR508150R0000	3,040
Pulse generator		2x7 (0.05 s - 100 h)	-		CT-TGC.12 4)	1SVR508160R0000	5,010
			-	2C/O	CT-TGC.22 4)	1SVR508160R0100	6,020
Star-delta changeover		2x7 (0.05 s - 100 h)	*	2N/O	CT-SDC.22 5)	1SVR508211R0100	3,150
			*		CT-SAC.22 6)	1SVR508210R0100	3,260

- 1) Functions: ON-delay, OFF-delay with auxiliary voltage, Impulse-ON, Impulse-OFF with auxiliary voltage, Flasher starting with ON, Flasher starting with OFF, Pulse former
- 2) OFF-delay without aux. voltage (True OFF-delay), True Impulse-OFF
- 3) Flasher starting with ON, Flasher starting with OFF
- 4) ON and OFF times adjustable independently: 2 x 7 time ranges 0.05 s - 100 h
- 5) Transition time 50 ms fixed
- 6) Transition time adjustable



ABB CT-S Product Portfolio

CT-MFS.21: ON-delay (accumulative), OFF-delay without aux., Symmetrical ON-delay and OFF-delay and Impulse-ON, ON/OFF function, pulse former, star-delta changeover with impulse, Flasher starting with OFF, Flasher starting with ON, impulse -OFF, 2 c/o



Type	Rated control supply voltage	Time range	Ordering code	L.P. (₹)
CT-MFS.21S	24-240 V AC/DC	10 (0.05 s - 300 h)	1SVR730010R0200	12,180

CT-ERS.22: ON-delay (accumulative), 2 c/o

Type	Rated control supply voltage	Time range	Ordering code	L.P. (₹)
CT-ERS.22S	24-48 V DC, 24-240 V AC	10 (0.05 s - 300 h)	1SVR730100R3300	7,460

Electronic products and relays

Measuring and monitoring relays



Single and three phase monitoring relays for phase failure detection

Type	Rated control supply voltage = measuring voltage	Ordering code	L.P.(₹)
With neutral monitoring			
CM-PBE	3x380-440 V AC, 220-240 V AC	1SVR550881R9400	6,180
Without neutral monitoring			
CM-PBE	3x380-440 V AC	1SVR550882R9500	6,180

Single and three phase monitoring relays for over / undervoltage and phase failure detection

Type	Rated control supply voltage = measuring voltage	Ordering code	L.P.(₹)
With neutral monitoring			
CM-PVE	3x320-460 V AC, 185-265 V AC	1SVR550870R9400 ■	6,180
Without neutral monitoring			
CM-PVE	3x320-460 V AC	1SVR550871R9500	6,180

Three phase monitoring relays for phase sequence monitoring and phase failure detection

Type	Rated control supply voltage = measuring voltage	Ordering code	L.P.(₹)
CM-PFS.S	3x200-500 V AC	1SVR730824R9300	4,560



Three phase monitoring relays for over and undervoltage with adjustable threshold values

Type	Rated control supply voltage = measuring voltage	Ordering code	L.P.(₹)
CM-PVS.31P	3x160-300 V AC	1SVR740794R1300	20,850
CM-PVS.31S		1SVR730794R1300	17,200
CM-PVS.41P	3x300-500 V AC	1SVR740794R3300	18,560
CM-PVS.41S		1SVR730794R3300	18,560

Three phase monitoring relays for phase unbalance

Type	Rated control supply voltage = measuring voltage	Ordering code	L.P.(₹)
CM-PAS.31P	3x160-300 V AC	1SVR740774R1300	19,830
CM-PAS.31S		1SVR730774R1300	17,200
CM-PAS.41P	3x300-500 V AC	1SVR740774R3300	19,830
CM-PAS.41S		1SVR730774R3300	17,200

Multifunctional three phase monitoring relays (phase failure detection, phase sequence monitoring, overvoltage, undervoltage, phase unbalance)

Type	Rated control supply voltage = measuring voltage	Ordering code	L.P.(₹)
With interrupted neutral monitoring			
CM-MPS.11P	3x90-170 V AC	1SVR740885R1300	20,640
CM-MPS.11S		1SVR730885R1300	19,250
CM-MPS.21P	3x180-280 V AC	1SVR740885R3300	19,940
CM-MPS.21S		1SVR730885R3300	18,930
Without interrupted neutral monitoring			
CM-MPS.41S	3x300-500 V AC	1SVR730884R3300 ■	8,380

Electronic products and relays

Measuring and monitoring relays

Three phase monitoring relays



Multifunctional three phase monitoring relays, automatic phase sequence correction and separate monitoring of over and undervoltage (window monitoring) configurable

Type	Rated control supply voltage = measuring voltage	Ordering code	L.P.(₹)
With interrupted neutral monitoring			
CM-MPS.23P	3x180-280 V AC	1SVR740885R4300	25,310
CM-MPS.23S		1SVR730885R4300	22,280
Without interrupted neutral monitoring			
CM-MPS.43P	3x300-500 V AC	1SVR740884R4300	24,410
CM-MPS.43S		1SVR730884R4300	20,210

Multifunctional three phase monitoring relays, automatic phase sequence correction and separate monitoring of over and undervoltage (window monitoring) configurable

Type	Rated control supply voltage = measuring voltage	Ordering code	L.P.(₹)
CM-MPN.52P	3x350-580 V AC	1SVR760487R8300	27,780
CM-MPN.52S		1SVR750487R8300	23,600
CM-MPN.62P	3x450-720 V AC	1SVR760488R8300	27,780
CM-MPN.62S		1SVR750488R8300	24,410
CM-MPN.72P	3x530-820 V AC	1SVR760489R8300	27,780
CM-MPN.72S		1SVR750489R8300 ■	24,410

Insulation monitors for unearthed supply systems



Type	Nominal voltage Un of the distribution system to be monitored	Rated control supply voltage	Ordering code	L.P.(₹)
CM-IWS.1P	0-250 V AC / 0-300 V DC	24-240 V AC/DC	1SVR740660R0100	31,840
CM-IWS.1S			1SVR730660R0100 ■	30,660
CM-IWS.2P	0-400 V AC	24-240 V AC/DC	1SVR740670R0200	28,220
CM-IWS.2S			1SVR730670R0200 ■	25,190
CM-IWN.1P	0-400 V AC / 0-600 V DC	24-240 V AC/DC	1SVR760660R0200	80,150
CM-IWN.1S			1SVR750660R0200	58,340
Coupling unit				
CM-IVN.S	Passive device, no control supply voltage needed	0-690 V AC / 0-1000 V DC	1SVR750669R9400 ■	30,510
CM-IVN.P			1SVR760669R9400	37,140

Thermistor motor protection relays



Type	Rated control supply voltage	Ordering code	L.P.(₹)
CM-MSE	24 V AC	1SVR550805R9300	6,760
	110-130 V AC	1SVR550800R9300 ■	5,140
	220-240 V AC	1SVR550801R9300 ■	6,760
CM-MSS.12S	24 V AC/DC	1SVR730700R0100	8,600
CM-MSS.12P	24 V AC/DC	1SVR740700R0100	9,070
CM-MSS.13S	110-130 V AC/220-240 V AC	1SVR730700R2100	8,100
CM-MSS.13P	110-130 V AC/220-240 V AC	1SVR740700R2100	9,070
CM-MSS.22S	24 V AC/DC	1SVR730700R0200	8,640
CM-MSS.22P	24 V AC/DC	1SVR740700R0200	9,930
CM-MSS.23S	110-130 V AC/220-240 V AC	1SVR730700R2200	8,640
CM-MSS.23P	110-130 V AC/220-240 V AC	1SVR740700R2200	9,930

■ Stock items

Electronic products and relays

Pluggable interface relays



CR-M

Ordering details - CR-M range without LED

Version	Outputs	Type	Ordering code	L.P.(₹)
12 V DC	2 c/o (SPDT)	CR-M012DC2	1SVR405611R4000	710
24 V DC		CR-M024DC2	1SVR405611R1000 ■	710
48 V DC		CR-M048DC2	1SVR405611R6000	710
60 V DC		CR-M060DC2	1SVR405611R4200	710
110 V DC		CR-M110DC2	1SVR405611R8000 ■	790
125 V DC		CR-M125DC2	1SVR405611R8200	780
220 V DC		CR-M220DC2	1SVR405611R9000	740
24 V AC		CR-M024AC2	1SVR405611R0000	740
48 V AC		CR-M048AC2	1SVR405611R5000	740
110 V AC		CR-M110AC2	1SVR405611R7000	740
120 V AC	CR-M120AC2	1SVR405611R2000	740	
230 V AC	CR-M230AC2	1SVR405611R3000 ■	820	
12 V DC	4 c/o (SPDT)	CR-M012DC4	1SVR405613R4000	710
24 V DC		CR-M024DC4	1SVR405613R1000 ■	710
48 V DC		CR-M048DC4	1SVR405613R6000	750
60 V DC		CR-M060DC4	1SVR405613R4200	720
110 V DC		CR-M110DC4	1SVR405613R8000 ■	820
125 V DC		CR-M125DC4	1SVR405613R8200 ■	830
220 V DC		CR-M220DC4	1SVR405613R9000 ■	870
24 V AC		CR-M024AC4	1SVR405613R0000	830
48 V AC		CR-M048AC4	1SVR405613R5000	780
110 V AC		CR-M110AC4	1SVR405613R7000 ■	830
120 V AC	CR-M120AC4	1SVR405613R2000	830	
230 V AC	CR-M230AC4	1SVR405613R3000 ■	870	

Ordering details - CR-M range with LED

Version	Outputs	Type	Ordering code	L.P.(₹)
12 V DC	2 c/o (SPDT)	CR-M012DC2L	1SVR405611R4100	710
24 V DC		CR-M024DC2L	1SVR405611R1100 ■	730
48 V DC		CR-M048DC2L	1SVR405611R6100	740
60 V DC		CR-M060DC2L	1SVR405611R4300	740
110 V DC		CR-M110DC2L	1SVR405611R8100	830
125 V DC		CR-M125DC2L	1SVR405611R8300	830
220 V DC		CR-M220DC2L	1SVR405611R9100	860
24 V AC		CR-M024AC2L	1SVR405611R0100	820
48 V AC		CR-M048AC2L	1SVR405611R5100	750
110 V AC		CR-M110AC2L	1SVR405611R7100	820
120 V AC	CR-M120AC2L	1SVR405611R2100	830	
230 V AC	CR-M230AC2L	1SVR405611R3100	870	
12 V DC	4 c/o (SPDT)	CR-M012DC4L	1SVR405613R4100	880
24 V DC		CR-M024DC4L	1SVR405613R1100 ■	880
48 V DC		CR-M048DC4L	1SVR405613R6100	880
60 V DC		CR-M060DC4L	1SVR405613R4300	780
110 V DC		CR-M110DC4L	1SVR405613R8100 ■	980
125 V DC		CR-M125DC4L	1SVR405613R8300	980
220 V DC		CR-M220DC4L	1SVR405613R9100 ■	1,030
24 V AC		CR-M024AC4L	1SVR405613R0100	980
48 V AC		CR-M048AC4L	1SVR405613R5100	980
110 V AC		CR-M110AC4L	1SVR405613R7100	980
120 V AC	CR-M120AC4L	1SVR405613R2100	890	
230 V AC	CR-M230AC4L	1SVR405613R3100 ■	1,030	



CR-M



CR-M45S

Ordering details - CR-M range accessories

Version	Type	Ordering code	L.P.(₹)
Standard socket for 2 c/o	CR-M2SS	1SVR405651R1000 ■	450
Standard socket for 2/4 c/o	CR-M4SS	1SVR405651R3000 ■	480
Plastic holder	CR-MH	1SVR405659R1000 ■	60
Metal holder	CR-MH1	1SVR405659R1100 ■	50

■ Stock items

Electronic products and relays

Pluggable interface relays

Ordering details - CR-MX range with LED



Version	Outputs	Type	Ordering code	L.P.(₹)	
12 V DC	2 c/o (SPDT), 250 V, 7 A	CR-MX012DC2L	1SVR405631R4100	290	
24 V DC		CR-MX024DC2L	1SVR405631R1100 ■	320	
48 V DC		CR-MX048DC2L	1SVR405631R6100	340	
110 V DC		CR-MX110DC2L	1SVR405631R8100 ■	320	
220 V DC		CR-MX220DC2L	1SVR405631R9100	570	
24 V AC		CR-MX024AC2L	1SVR405631R0100 ■	290	
110 V AC		CR-MX110AC2L	1SVR405631R7100	290	
230 V AC		CR-MX230AC2L	1SVR405631R3100 ■	340	
12 V DC		4 c/o (SPDT), 250 V, 5 A	CR-MX012DC4L	1SVR405633R4100	340
24 V DC			CR-MX024DC4L	1SVR405633R1100 ■	360
48 V DC	CR-MX048DC4L		1SVR405633R6100	370	
110 V DC	CR-MX110DC4L		1SVR405633R8100 ■	370	
220 V DC	CR-MX220DC4L		1SVR405633R9100	620	
24 V AC	CR-MX024AC4L		1SVR405633R0100 ■	370	
110 V AC	CR-MX110AC4L		1SVR405633R7100 ■	400	
230 V AC	CR-MX230AC4L		1SVR405633R3100 ■	400	

Ordering details - CR-MX range with Integrated LED & Test Button



Version	Outputs	Type	Ordering code	L.P.(₹)	
12 V DC	2 c/o (SPDT), 250 V, 7 A	CR-MX012DC2LT	1SVR405641R4100	360	
24 V DC		CR-MX024DC2LT	1SVR405641R1100 ■	380	
48 V DC		CR-MX048DC2LT	1SVR405641R6100	400	
110 V DC		CR-MX110DC2LT	1SVR405641R8100 ■	400	
220 V DC		CR-MX220DC2LT	1SVR405641R9100	630	
24 V AC		CR-MX024AC2LT	1SVR405641R0100 ■	400	
110 V AC		CR-MX110AC2LT	1SVR405641R7100	410	
230 V AC		CR-MX230AC2LT	1SVR405641R3100 ■	440	
12 V DC		4 c/o (SPDT), 250 V, 5 A	CR-MX012DC4LT	1SVR405643R4100	410
24 V DC			CR-MX024DC4LT	1SVR405643R1100 ■	430
48 V DC	CR-MX048DC4LT		1SVR405643R6100	440	
110 V DC	CR-MX110DC4LT		1SVR405643R8100 ■	450	
220 V DC	CR-MX220DC4LT		1SVR405643R9100	710	
24 V AC	CR-MX024AC4LT		1SVR405643R0100 ■	450	
110 V AC	CR-MX110AC4LT		1SVR405643R7100 ■	470	
230 V AC	CR-MX230AC4LT		1SVR405643R3100 ■	470	



CR-MX with Base and Holder

Ordering details - Accessories* - CR-MX range

Version	Type	Ordering code	L.P.(₹)
For 2 c/o (SPDT) contacts, black	CR-M2SFB	1SVR405651R1400 ■	160
For 2 or 4 c/o (SPDT) contacts, black	CR-M4SFB	1SVR405651R3400 ■	210
Metal holder	CR-MH1	1SVR405659R1100 ■	50

■ Stock items

Electronic products and relays

Power supplies

Overview

Modern power supply units are vital components in most areas of energy management and automation technology. ABB as your global partner in these areas pays the utmost attention to the resulting requirements. Innovation is the key to a substantial enlargement of our power supply product program:

CP-D

The CP-D range of power supply units in MDRC design (modular DIN rail components) fits into all domestic installation and distribution panels.

CP-E

The CP-E range offers enhanced functionality while the number of different types has been considerably reduced. Now all power supply units can be operated at an ambient temperature of up to +70 °C.

CP-T

The CP-T range of three-phase power supply units is ABB's youngest member of the power supply family.

CP-C.1

The CP-C.1 power supplies are ABB's high-performance and most advanced range. With excellent efficiency, high reliability and innovative functionality, it is prepared for the most demanding industrial applications. These power supplies have up to 50% integrated power reserve and operate at an efficiency of up to 94%. They are equipped with overheat protection and active power factor correction. Combined with a broad AC and DC input range and extensive worldwide approvals the CP-C.1 power supplies are the preferred choice for professional DC applications.



CP-E range

Rated I/P voltage	Rated O/P Voltage/Current	Type	Ordering code	L.P. (₹)
100-240 V AC	5 V DC / 3 A	CP-E 5/3.0	1SVR427033R3000	5,540
100-240 V AC	12 V DC / 2.5 A	CP-E 12/2.5	1SVR427032R1000 ■	5,730
115 / 230 V AC auto select	12 V DC / 10 A	CP-E 12/10.0	1SVR427035R1000 ■	10,550
100-240 V AC	24 V DC / 0.75 A	CP-E 24/0.75	1SVR427030R0000	4,240
100-240 V AC	24 V DC / 1.25 A	CP-E 24/1.25	1SVR427031R0000 ■	4,620
100-240 V AC	24 V DC / 2.5 A	CP-E 24/2.5	1SVR427032R0000 ■	4,760
115 / 230 V AC auto select	24 V DC / 5 A	CP-E 24/5.0	1SVR427034R0000 ■	8,600
115 / 230 V AC auto select	24 V DC / 10 A	CP-E 24/10.0	1SVR427035R0000 ■	12,480
115 / 230 V AC	24 V DC / 20 A	CP-E 24/20.0	1SVR427036R0000 ■	22,260
100-240 V AC	48 V DC / 0.625 A	CP-E 48/0.62	1SVR427030R2000	5,910
100-240 V AC	48 V DC / 1.25 A	CP-E 48/1.25	1SVR427031R2000	7,500
115 / 230 V AC auto select	48 V DC / 5 A	CP-E 48/5.0	1SVR427034R2000	15,170
115 / 230 V AC	48 V DC / 10 A	CP-E 48/10.0	1SVR427035R2000 ■	21,630

Note: Refer technical data sheet for DC voltage input range

CP-C.1

Input voltage range	Rated output Voltage/Current	Type	Ordering code	L.P. (₹)
100-240 V AC, 90-300 V DC	24 V DC / 5 A	CP-C.1 24/5.0	1SVR360563R1001	26,160
100-240 V AC, 90-300 V DC	24 V DC / 10 A	CP-C.1 24/10.0	1SVR360663R1001	41,560
100-240 V AC, 90-300 V DC	24 V DC / 20 A	CP-C.1 24/20.0	1SVR360763R1001	64,900

CP-T range

Rated I/P voltage	Rated O/P Voltage/Current	Type	Ordering code	L.P. (₹)
340-575 V AC / 480-820 V DC	24 V DC / 5 A	CP-T 24/5.0	1SVR427054R0000	14,900
340-575 V AC / 480-820 V DC	24 V DC / 10 A	CP-T 24/10.0	1SVR427055R0000	18,970
340-575 V AC / 480-820 V DC	24 V DC / 20 A	CP-T 24/20.0	1SVR427056R0000	23,530
340-575 V AC / 480-820 V DC	24 V DC / 40 A	CP-T 24/40.0	1SVR427057R0000	34,820
340-575 V AC / 480-820 V DC	48 V DC / 5 A	CP-T 48/5.0	1SVR427054R2000	20,620
340-575 V AC / 480-820 V DC	48 V DC / 10 A	CP-T 48/10.0	1SVR427055R2000	28,190
340-575 V AC / 480-820 V DC	48 V DC / 20 A	CP-T 48/20.0	1SVR427056R2000	41,240

■ Stock items

Smart temperature monitoring relay **NEW**

Reduced stocks, flexible adjustment
and easy setup: One relay for all applications.

One...



look

back-lit LCD for easy reading and setup



touch

NFC parametrization via smartphone



device

for a wide range of applications



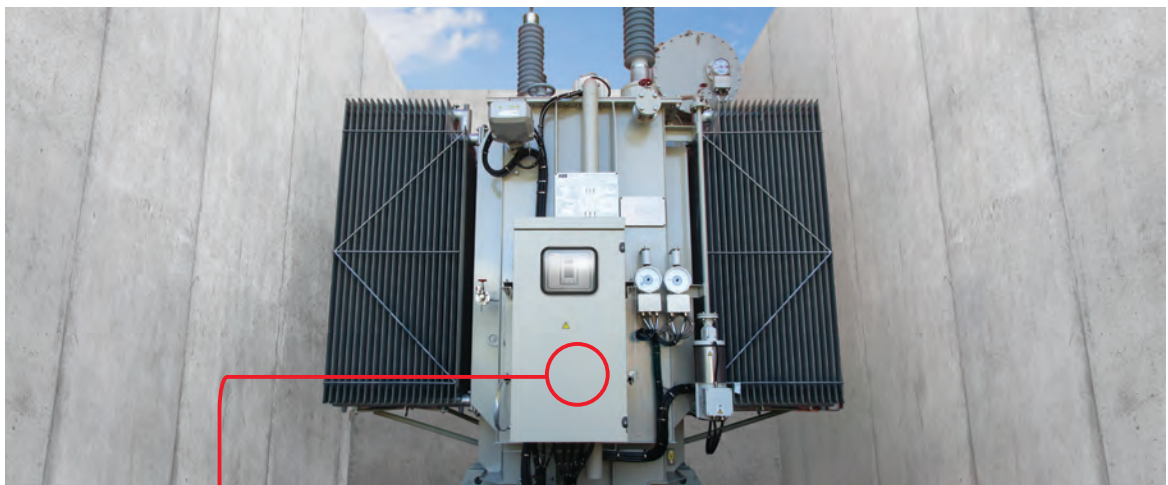
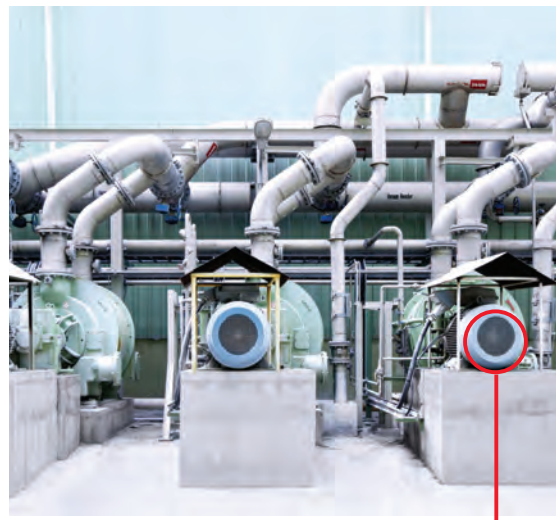

Temperature sensor, e.g. PT100



Smart temperature monitoring relay



ABB EPIC smartphone app

Description	Ordering code	L.P.(₹)
"Temperature monitoring relay CM-TCN.011S, Temp.-range -200..+850°C, width 45mm,digital adjustable, 3 thresholds, over temperature-, under temperature-, window monitoring, A1-A2=24-240V AC / DC, 3 c/o, Screw connection terminals"	1SVR750740R0110	32,000
"Temperature monitoring relay CM-TCN.011S, Temp.-range -200..+850°C, width 45mm, digital adjustable, 3 thresholds, over temperature-, under temperature-, window monitoring, A1-A2=24-240V AC / DC, 3 c/o, Pushing connection terminals"	1SVR760740R0110	33,000

Intelligent motor management system - UMC100.3

Ordering details - Universal Motor Controller UMC100.3



UMC100.3 DC

2CDC34106V0014



UMC100.3 UC

2CDC 341 007 V0014



UMC100-PAN

2CDC 341 008 V0014

Description

Intelligent motor management system for single and three-phase motors with $I_e = 0.24 - 63$ A in one single device. Compact housing with integrated current transformer for cable cross section up to 25 mm^2 (max. \varnothing with Insulation 11 mm). Higher currents with additional external current transformer. Thermal overload protection according to EN/IEC 60947-4-1, selectable trip classes 5E, 10E, 20E, 30E, 40E. Some functions require an additional expansion module.

- **Motor protection functions:**
Over-/underload, over-/undercurrent, over-/undervoltage, rotor blocking, phase failure/imbalance/sequence Earth fault detection integrated or with external sensor CEM11
Hot motor protection with thermistor or temperature measurement
- **Motor control functions:**
Easily configurable motor control functions: direct, reverse, star-delta starter, pole-changing, overload relay, actuator mode, softstarter mode. Additionally free programmable application specific logic with function blocks
- **Service and diagnostic data:**
Operating hours, number of motor starts and overload trips, energy, standstill and operation hours supervision, motor status, faults and warnings, fault history (16 events)
Motor current, phase voltages, thermal load, power factor (cos), active power, apparent power, energy, total harmonic distortion (THD).
- **Integrated I/Os:**
6 digital inputs, 1 PTC input, 4 digital outputs. Maximum number of I/Os with expansion modules:
14 digital inputs, 1 PTC input, 9 digital outputs, 6 analogue inputs, 1 analogue output
- **Communication interfaces for fieldbuses and ethernet networks, interface for operator panel UMC100-PAN, bus interface for connection of expansion modules**
- **Versions for supply voltage 24 V DC and 110 – 240 V AC/DC and with ATEX approval**

Ordering details

Designation	Supply voltage	Type	Ordering code	L.P. (₹)
Universal Motor Controller	24 V DC	UMC100.3 DC	1SAJ530000R0100	
Universal Motor Controller	110-240 V AC/DC	UMC100.3 UC	1SAJ530000R1100	
Universal Motor Controller, ATEX	24 V DC	UMC100.3 DC EX	1SAJ530000R0200	
Universal Motor Controller, ATEX	110-240 V AC/DC	UMC100.3 UC EX	1SAJ530000R1200	Upon request
Universal Motor Controller, DC, ATEX, Conformal Coating	24 V DC	UMC100.3 DC EX	1SAJ530000R0210	
Universal Motor Controller, UC, ATEX, Conformal Coating	110-240 V AC/DC	UMC100.3 DC EX	1SAJ530000R1210	

Operating panel UMC100-PAN

Operator panel for Universal Motor Controller UMC100. Backlit graphical and multilingual fulltext display, LEDs for status. Assembly directly on UMC100 or on the control cabinet door via extension cable and door mounting set.

Functions:

- **Monitoring:** Shows motor status and diagnostics
- **Operate:** Start, stop, fault reset
- **Parametrize:** Setting and changing of motor and fieldbus parameters (password protection possible)
- **Copy settings**
- **USB port for up/download of parameters and logic**

Supports 8 languages: English, French, German, Italian, Spanish, Polish, Portuguese, Russian
Replaces all former UMC100 operator panels

Ordering details

Designation	Type	Ordering code	L.P. (₹)
Operating panel	UMC100-PAN	1SAJ590000R0103	
0.7 m ext. cable with door mounting set	UMCPAN-CAB.070	1SAJ510003R0002	Upon request
1.5 m ext. cable with door mounting set	UMCPAN-CAB.150	1SAJ510004R0002	
3 m ext. cable with door mounting set	UMCPAN-CAB.300	1SAJ510002R0002	

Intelligent motor management system - UMC100.3

Ordering details - Expansion modules



DX111-FBP

2CDC 341 005 F0009

Description

Up to 4 expansion-modules can be connected to one UMC100.3

- 1 digital expansion module DX111 or DX122
- 1 voltage expansion module VI150 or VI155
- 2 analog/temperature expansion modules AI111 possible)

Supply voltage is 24 V DC; the 110-240 V AC/DC version of the UMC100.3 provides the 24 V DC supply for expansion modules



DX122-FBP

2CDC 341 004 F0009

DX111

I/O-expansion module with 8 digital inputs 24 V DC, 4 relay outputs, 1 analog output 0/4-20 mA or 0...10 V

DX122

I/O-expansion module with 8 digital inputs 110 / 230 V AC, 4 relay outputs, 1 analog output 0/4-0 mA or 0-10 V



VI150-FBP

2CDC 345 001 S0011

VI15x

Voltage modules for the determination of phase voltages, power factor ($\cos \phi$), apparent power, energy, total harmonic distortion (THD).

For use in grounded networks (VI150) or in all networks (VI155), 150-690 V AC

AI111

Analog / temperature expansion module, 3 inputs PT100, PT1000, KTY83, KTY84, NTC, 0-10 V, 0/4-20 mA

1 or 2 modules AI111 can be connected to an UMC100.3.



VI155-FBP

2CDC 345 002 S0011

Ordering details

Designation	Type	Ordering code	L.P.(₹)
I/O module for UMC100, 24 V DC digital input	DX111	1SAJ611000R0101	
I/O module for UMC100, 110 – 230 V AC digital input	DX122	1SAJ622000R0101	
3 phase voltage module for grounded networks	VI150	1SAJ650000R0100	
3 phase voltage module for all networks	VI155	1SAJ655000R0100	
Analog/temperature module 3 analogue inputs	AI111	1SAJ613000R0101	
Connection cable UMC100 - I/O module, length 0.30 m	UMCIO-CAB.030	1SAJ691000R0001	Upon request
Connection cable IO-module - IO-module, length 0,30 m	IOIO-CAB.030	1SAJ692000R0001	
Terminal set for UMC100.3 DC (spare parts)	UMCTB	1SAJ929160R0001	
Terminal set for UMC100.3 UC (spare parts)	UMCTB	1SAJ929160R0002	

Fieldbus interfaces

Ordering details



PDP32.0



MRP31.0



DNP31.0



PDR31.0

Description

Fieldbus communication interfaces enable the UMC100.3 to communicate via fieldbus. The interfaces can be used in two ways:

- Mounted directly on an UMC100.3 – the interface is supplied from the UMC100.3 and no additional accessory is required
- Mounted separately on a SMK3.0 adapter in the cable chamber of an MCC, the interface plugged on SMK3.0 requires a 24 V DC supply. Ready-made cables for applications in withdrawable systems are available, as well as terminal blocks for other cables:
CDP18.150: Cable for use inside the drawer CDP24.150: Cable from SMK3.0 to drawer outside

PDP32.0

- Communication interface for PROFIBUS DP; supports the protocols PROFIBUS DP/V0 and V1
- PNO-certified PROFIBUS slave
- Data transfer rate up to 12 Mbit/s
- Diagnostic LEDs
- Fieldbus connection via nine-pole Sub-D connector or terminal blocks
- GSD download from UMC100.3 webpage

MRP31.0

- Communication interface for Modbus RTU
- Data transfer rate up to 57.6 kbit/s
- Diagnostic LEDs
- Fieldbus connection via terminal blocks

DNP31.0

- Communication interface for DeviceNet
- ODVA-certified DeviceNet slave
- Data transfer rate up to 500 kbit/s
- Diagnostic LEDs
- Fieldbus connection via terminal blocks
- EDS download from UMC100.3 webpage

PDR31.0

- External active fieldbus termination for Profibus DP; the PDR31.0 needs to be mounted on a SMK3.0 adapter and supplied by 24 V DC

Description	Type	Order code	L.P. (₹)
Profibus DP communication interface	PDP32.0	1SAJ242000R0001	
Modbus RTU communication interface; terminal block for fieldbus connection included	MRP31.0	1SAJ251000R0001	
DeviceNet communication interface; terminal block for fieldbus connection included	DNP31.0	1SAJ231000R0001	Upon request
Profibus DP active bus termination	PDR31.0	1SAJ243000R0001	

Ethernet interfaces

Ordering details



MTQ22-FBP.0

Description

Ethernet communication interfaces enable the UMC100.3 to communicate via an Ethernet network. There are two types of interfaces:

Interfaces for the connection of one to four Universal Motor Controllers UMC100.3:

- MTQ22-FBP.0 for Modbus TCP
- PNQ22-FBP.0 for Profinet IO

Interface for a single universal motor controller UMC100.3:

- EIU32.0 for EtherNet/IP™



PNQ22-FBP.0

MTQ22-FBP.0

- Protocol Modbus TCP
- For one to four UMC100.3
- Master supervision with timeout control for up to four masters
- Micro USB-port for configuration via PC (configuration software downloaded from UMC100.3 webpage)
- Integrated Ethernet switch
- Supports all network topologies
- Ring topology with redundancy (MRP protocol)
- Easy to use in withdrawable applications
- No special Ethernet connectors required in MCCs
- 24 V DC supply voltage
- DIN-rail mounting



EIU32.0

PNQ22-FBP.0

- Protocol Profinet IO
- PNO-certified
- For one to four UMC100.3 devices
- Integrated Ethernet switch
- Supports all network topologies
- Ring topology with redundancy (MRP protocol)
- Easy to use in withdrawable applications
- No special Ethernet connectors required in MCCs
- Fully integrated into ABB 800xA
- Time-stamped events with ABB 800xA
- 24 V DC supply voltage
- DIN-rail mounting
- GSDML downloaded from UMC100.3 webpage

EIU32.0

- Protocol EtherNet/IP™
- ODVA-certified
- For one motor controller UMC100.3
- Mounting directly on an UMC100.3 (supplied by UMC100.3) or remotely on a SMK3.0 adapter (24 V DC supply required)
- Integrated Ethernet switch
- Supports all network topologies
- DLR (Device Level Ring) function for redundancy
- Easy to use in withdrawable applications
- No special Ethernet connectors required in MCCs
- EDS download from UMC100.3 webpage

Highlighted features:

- The PNU32.0 Ethernet adapter module provides Ethernet connectivity for the motor controller UMC100.3
- Through the PNU32.0 Ethernet Adapter module it is possible to:
 - give control commands to the device (Start, Stop, Auto, etc.). The commands' meaning depends on the connected device
 - read status information and actual values from the device
 - change parameter values
 - read maintenance counters
 - reset a trip
- The PNU32.0 supports the Profinet S2 redundancy function
- Configuration from within the control system by using start-up parameters (similar to block parameters of PROFIBUS)
- A built-in two-port switch allows the flexible usage in bus, star or ring network topologies
- The Media Redundancy Protocol (MRP) is implemented (client). MRP is standardized in IEC/EN 62439-2 and offers cable redundancy in case of a single failure
- Location supervision for the detection of interchanged drawers in withdrawable systems
- Time stamped diagnosis: ABB proprietary Sequence of Event (SoE) support (800xA)



PNU32



PNU32+SMK3.0

Designation	Type	Ordering code	L.P. (₹)
Ethernet Modbus TCP interface	MTQ22-FBP.0	1SAJ260000R0100	
Ethernet Profinet IO interface	PNQ22-FBP.0	1SAJ261000R0100	Upon request
EtherNet/IP™ interface	EIU32.0	1SAJ262000R0100	
Ethernet Profinet IO interface	PNU32.0	1SAJ263000R0100	

Adapter and accessories

Ordering details

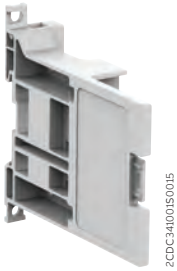

SMK3.0

2CDC34100150015



CDP18.150

2CDC341007F0018



PDP32.0 on SMK3.0

2CDC345008V0014



EIU32.0 on SMK3.0

2CDC341001V0018

Adapter and ready-made cables

Adapter SMK3.0 for external mounting of a fieldbus or EtherNet/IP™ interface EIU32.0 outside a drawer. SMK3.0 can be mounted on a DIN-rail or fixed by screws. 24 V DC supply is required. Ready-made cables for inside and outside the drawer, including a terminal block on one side and open end on the other. Terminal blocks are also separately available for making own cables.

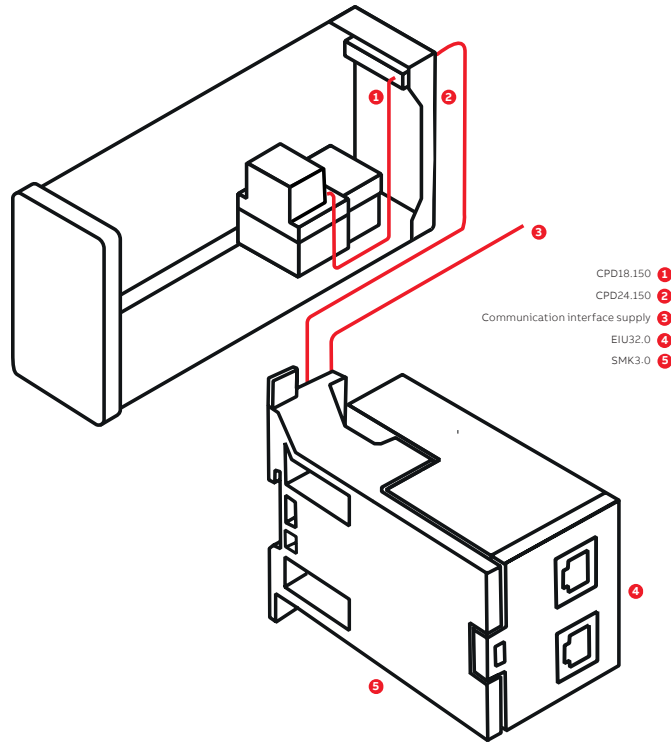

Separate wiring of the EtherNet/IP™ communication interface EIU32.0

Description	Type	Order code	L.P. (₹)
Adapter for separate mounting of a communication interface; terminal block for 24 V DC supply included	SMK3.0	1SAJ929600R0001	
Cable for use inside drawer, length 1.5 m	CDP18.150	1SAJ929180R0015	
Cable from SMK3.0 to drawer's outside, length 1.5 m	CDP24.150	1SAJ929240R0015	
Terminal block 2-pole for SMK3.0 supply (spare parts)	SMK3-X2.10	1SAJ929610R0001	
Terminal block 5-pole for SMK3.0 comm. (spare parts)	SMK3-X1.10	1SAJ929620R0001	
Cable for inside and outside drawer, length 1.5 m	CDP18.150	1SAJ929180R0015	Upon request
Cable Ethernet interface - UMC100.3, length 1.5 m	CDP23.150	1SAJ929230R0015	
Cable Ethernet interface - UMC100.3, length 3 m	CDP23.300	1SAJ929230R0030	
Cable from SMK3.0 to drawer's outside, length 1.5 m	CDP24.150	1SAJ929240R0015	
Terminal blocks for MTQ22/PNQ22 X1...X4	ETHTB-FBP.4	1SAJ929200R0001	
Terminal blocks for MTQ22/PNQ22 X1...X4	ETHTB-FBP.50	1SAJ929200R0002	

Earth fault monitors, current transformers

Ordering details



2CDC34501F0008

CEM11-FBP.xxx

Earth fault monitors CEM11-FBP.xxx for use with the Universal Motor Controller UMC100.3

The CEM11-FBP.xxx device monitors if the sum of the currents flowing through it is zero (factorial addition). If the sum is zero, no residual current is present. If the residual current is above an adjusted threshold value, the output signal of the CEM11-FBP.xxx changes. It can be used in motor feeders to detect leakage currents, as well as ground faults, caused for example by insulation breakdowns.

- CEM11-FBP.xxx is connected to a digital input of the UMC100.3
- Earth fault current threshold can be set in eight steps with a screwdriver
- Test position for easy control of the wiring

CEM11-FBP.xxx is delivered with adapters for DIN-rail or wall mounting.
CEM-11.FBP.120 is for wall-mounting only.



2CDC34001S0012

CT4L185R/4, CT4L310R/4

Earth fault currents [mA]	Through-hole diameter	Type	Order code	L.P. (₹)
80 ¹⁾ , 300, 550, 750, 1000, 1200, 1500, 1700	20 mm	CEM11-FBP.20	1SAJ929200R0020	Upon request
100 ¹⁾ , 500, 1000, 1400, 2000, 2400, 3000, 3400	35 mm	CEM11-FBP.35	1SAJ929200R0035	
120 ¹⁾ , 1000, 2000, 2800, 4000, 4800, 6000, 6800	60 mm	CEM11-FBP.60	1SAJ929200R0060	
300 ¹⁾ , 2000, 4000, 5600, 8000, 9600, 12000, 13600	120 mm	CEM11-FBP.120	1SAJ929200R0120	

¹⁾ Lower values have higher inaccuracy



2CDC34002S0012

CT5L500R/4, CT5L850R/4

Current transformers for use with the Universal Motor Controller UMC100.3

Linear type three-phase transformers, for use with the UMC100.3 and nominal motor currents >63 A. Terminal blocks for conductors Cu 2.5 mm² for wiring on the UMC100.3 side.

Description	Recommended current range	Type	Order code	L.P. (₹)
Current transformer	60...185 A AC	CT4L185R/4	1SAJ929500R0185	Upon request
Current transformer	180...310 A AC	CT4L310R/4	1SAJ929500R0310	
Current transformer	300...500 A AC	CT5L500R/4	1SAJ929501R0500	
Current transformer	500...850 A AC	CT5L850R/4	1SAJ929501R0850	

UMC100-FBP.0 and FBP system accessories are being phased out. Please contact your local ABB contact for spare parts or retrofit solutions.

Arc flash protection and mitigation solutions

Passive, active and preventive

Most short circuit faults in LV and MV switchgears are accompanied by an electric arc. An arc fault always leads to considerable damage to equipment and personnel unless it is distinguished very fast. The fault should be disconnected as fast as possible and in less than 0.1 s to avoid serious damages and give involved person a fair chance to survive the accident without severe damages. This is a demand found in the electrical safety rules in all CE countries, ref. IEC364-4-42.

The Arc Guard System TVOC-2 is an aid to quickly detect an arc fault and trip the incoming circuit-breaker. The main advantage with the Arc Guard System is that it can trip instantaneously, i.e. override other tripping functions.



LV distribution

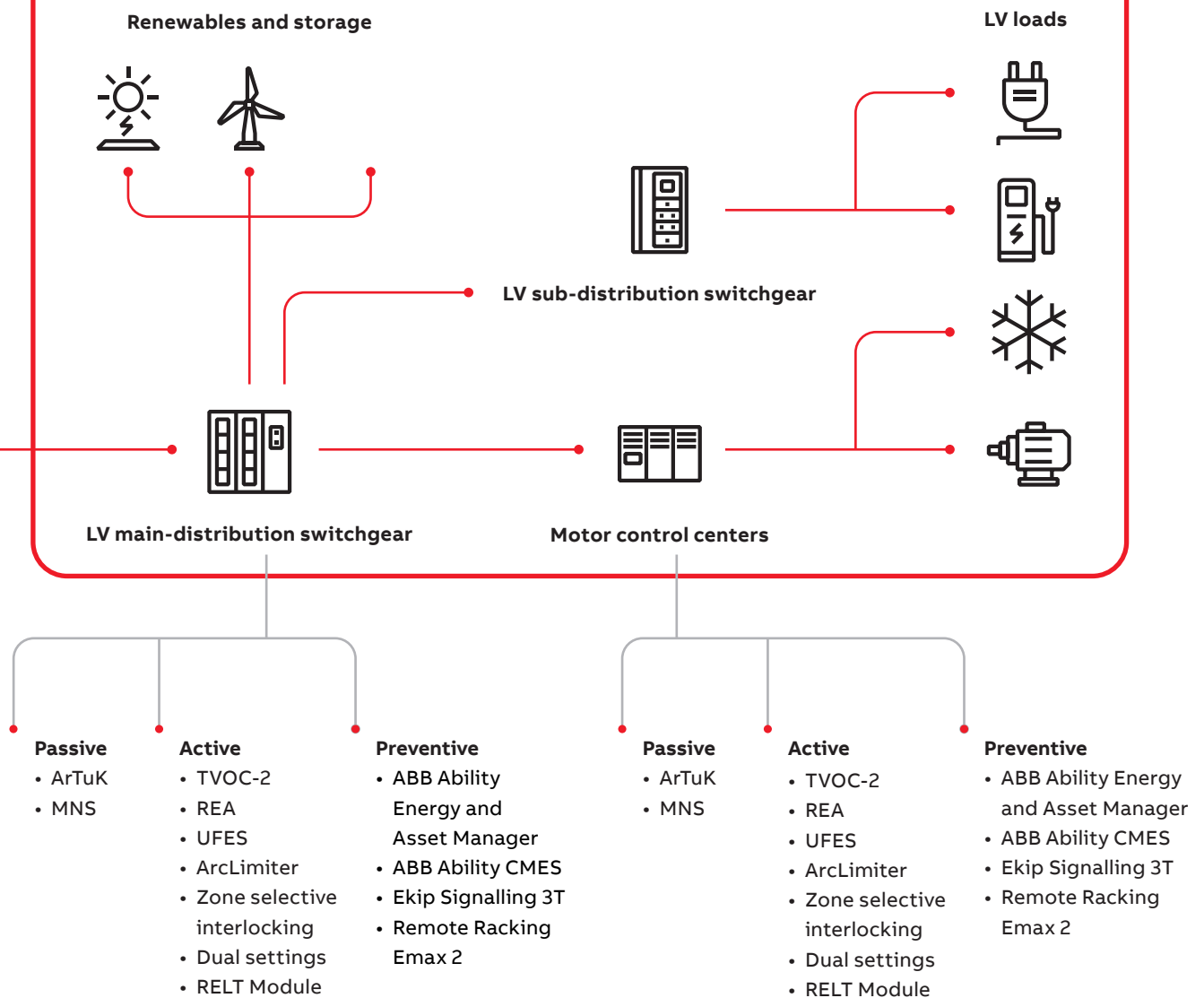

Arc Guard System TVOC-2



Arc Monitor with COM Module

1SFCT70011V0001



Arc Monitor with HMI

1SFCT70014V0001



Extension unit

1SFCT70012F0001



COM Module

1SFCT70009V0001



HMI

1SFCT70012V0001



Detector cable

1SFCT70011F0001



CSU-2LV

1SFCT70008V0001

Ordering details				
Description	Rated supply voltage	Type	Ordering code	LP.(₹)
Arc Monitor including one HMI and door mounting accessories	24...48V DC	TVOC-2-48	1SFA664001R1002	Upon request
	100...240V AC/ 100...250V DC	TVOC-2-240	1SFA664001R1001	
Arc Monitor including one COM Module and door mounting accessories	24...48V DC	TVOC-2-48-C	1SFA664001R1004	
	100...240V AC/ 100...250V DC	TVOC-2-240-C	1SFA664001R1003	

Accessories				
Extension-10 optical inputs		TVOC-2-E1	1SFA664002R1001	Upon request
Extension-10 optical inputs for cable TVOC-2-DP60 only		TVOC-2-E3	1SFA664002R3001	
HMI (Human machine interface)		TVOC-2-H1	1SFA664002R1005	
COM Module-with communication interface (Modbus RTU) and door mounting		TVOC-2-COM	1SFA664002R4001	

Detector				
Cable length	1 m	TVOC-2-DP1	1SFA664003R1010	Upon request
Cable length	2 m	TVOC-2-DP2	1SFA664003R1020	
Cable length	4 m	TVOC-2-DP4	1SFA664003R1040	
Cable length	6 m	TVOC-2-DP6	1SFA664003R1060	
Cable length	8 m	TVOC-2-DP8	1SFA664003R1080	
Cable length	10 m	TVOC-2-DP10	1SFA664003R1100	
Cable length	15 m	TVOC-2-DP15	1SFA664003R1150	
Cable length	20 m	TVOC-2-DP20	1SFA664003R1200	
Cable length	25 m	TVOC-2-DP25	1SFA664003R1250	
Cable length	30 m	TVOC-2-DP30	1SFA664003R1300	
Cable length (1)	60 m	TVOC-2-DP60	1SFA664003R3600	

Current sensing unit

NEW

Description	Type	Order code	Weight (1 pce) kg
Low voltage current sensing unit	CSU-2LV	1SFA664002R5001	0.420
Medium voltage current sensing unit	CSU-2MV	1SFA664002R8001	0.420

Diameter mm	Cable length	Type	Order code	Weight (1 pce) kg
-------------	--------------	------	------------	-------------------

Rogowski coil current sensors for low voltage applications

120	5	RC120-05	1SFA664005R1205	0.180
	10	RC120-10	1SFA664005R1210	0.180
	15	RC120-15	1SFA664005R1215	0.570
200	30	RC120-30	1SFA664005R1230	1.030
	5	RC200-05	1SFA664005R2005	0.210
	10	RC200-10	1SFA664005R2010	0.210
	15	RC200-15	1SFA664005R2015	0.600
	30	RC200-30	1SFA664005R2030	1.050

Note: For medium voltage application, use KECA and KEVCD current sensors types.

Please consult <https://new.abb.com/medium-voltage/apparatus/instrument-transformers-and-sensors-id/products/sensors-new>

Production-friendly safety systems from ABB Jokab Safety

Quick-Guard fencing system
to prevent unauthorised access



**Contactors and electronic
compacts starters**
to control power and motors



**Inca emergency stop
button**
for compact panel
mounting



MKey9 key switch
for safe locking of hatches and doors

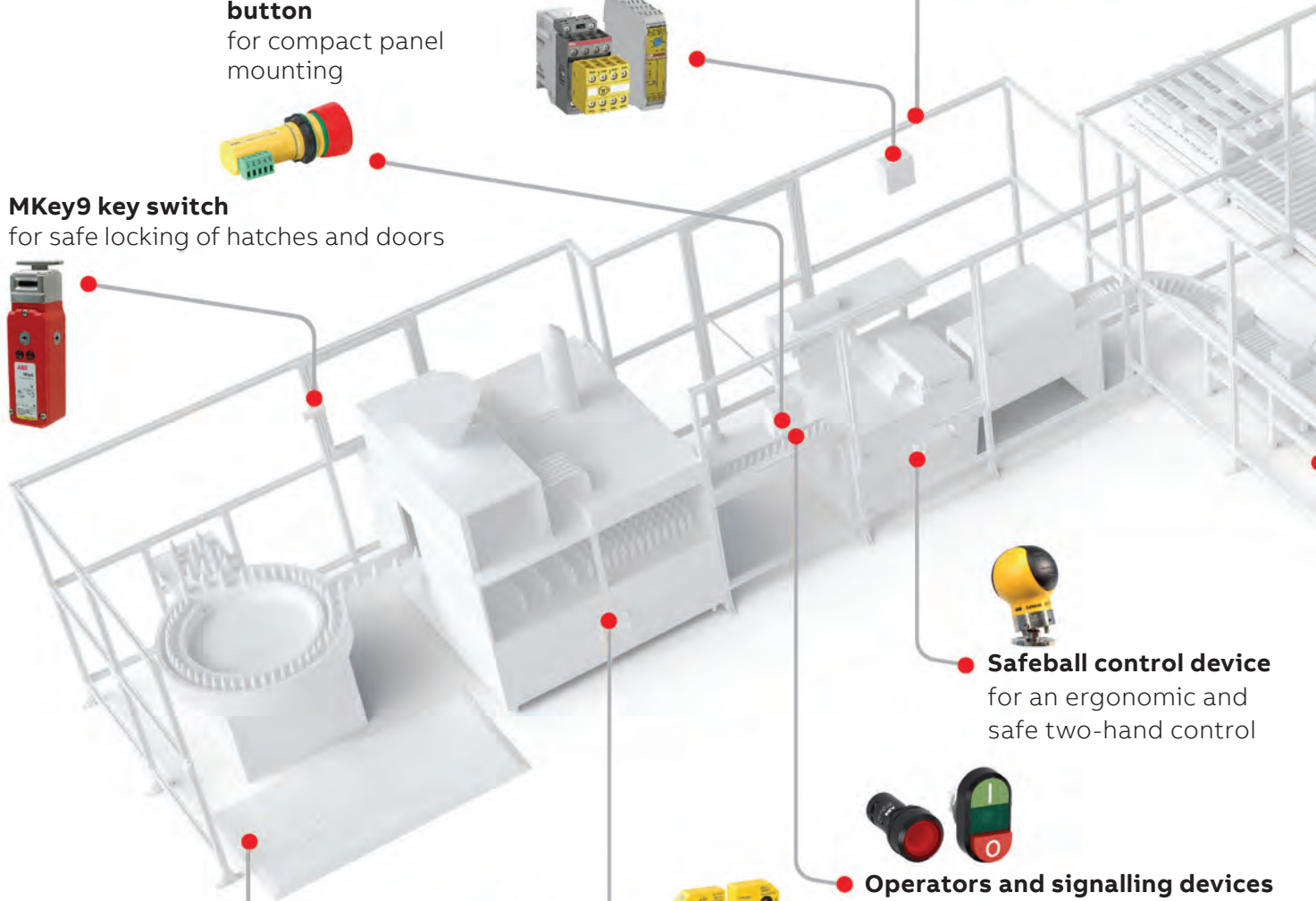

Safeball control device
for an ergonomic and
safe two-hand control



Operators and signalling devices
for control and indication

Mats, rails and bumpers
to detect the presence
of people

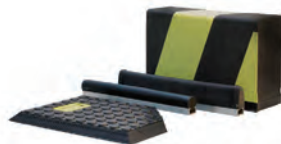

Eden sensor
for reliable non-contact monitoring of
doors and hatches



Magne magnetic lock
to keep doors and hatches
locked during a process



**Pluto programmable safety controller, B&R X20 safety PLC,
Vital safety controller and Sentry safety relays**
for flexible monitoring of safety devices



Smile emergency stop button
to safety stop machinery in hazardous
situations



Orion light guards
for a production friendly
safety detection



GKey safety lock
for safe locking of doors



JSDH4 three-position device
for safe and ergonomic
inspection and troubleshooting



**LineStrong pull wire
emergency stop switch**
for easy access of emergency stop
function



ABB jokab safety

Sentry safety relays

Expansion	Safety devices	Test/Reset	Safety relay outputs	Timer function	Feature	Power supply	Type	Ordering code	L.P.(₹)
Expansion of safety controller outputs	1 channel 2 channels with equivalent contacts 2 channels with antivalent contacts OSSD outputs / PNP outputs Contact mats, bumpers and safety edges ^{c)} Two-hand devices	Manual reset (all models have auto reset) Start/Test	3 NO + 1 NC 4 NO 2 NO + 2 delayed/delayable NO 4 NO + 1 NC	Off-delay 0.5 s Off-delay 1.5 s Advanced timer functions 0 – 999 s ^{d)}	Configurable with display	85-265 VAC / 120-375 VDC +24 VDC			
a)	● b)	●	●			●	BSR10	2TLA010040R0000	13,150
a)	● b)	●	●			●	BSR11	2TLA010040R0200	13,150
a)			●			●	BSR23 e)	2TLA010041R0600	11,450
●	● ● ●	●	●			●	SSR10	2TLA010050R0000	16,150
●	●	●	●			●	SSR10M	2TLA010050R0100	20,420
		●	●			●	SSR20	2TLA010051R0000	17,730
		●	●			●	SSR20M	2TLA010051R0100	22,650
	● ● ●	●	●	●		●	SSR32	2TLA010052R0400	25,800
	● ● ●	●	●	●		●	SSR42	2TLA010053R0400	25,800
●	● ● ●		●	● ● ● ●		●	TSR10	2TLA010060R0000	20,730
●	● ● ●		●	● ●		●	TSR20	2TLA010061R0000	20,730
●	●		●	● ●		●	TSR20M	2TLA010061R0100	20,420
	● ● ● ● ● ●	●	●	● ● ● ●		●	USR10	2TLA010070R0000	24,610
	● ● ● ● ● ●	●	●	● ● ● ●	●	●	USR22	2TLA010070R0400	34,350



- a) These models can also be used for expansion of Pluto safe transistor outputs (-24 VDC)
- b) No monitoring of two-channel fault, i.e. max Category 3 without fault exclusion.
- c) The safety relay detects a short-circuit, not a change in resistance.
- d) Off-delay, On-delay, Time bypass or Time reset.
- e) BSR23 must be monitored by another device in order to reach higher than Category 1/PL c according to EN ISO 13849-1, for example a safety relay, a safety PLC or an Orion light guard (EDM function).
- f) push in version also available.
- g) Please contact your local sales of ABB.



Safety controller

DYNlink circuits	Maximum DYNlink devices	Safe outputs	Type	Order code	L.P.(₹)
1	30	2 NO	Vital 1	2TLA020052R1000	35,410

ABB jokab safety

Programmable safety controller

Safety bus	Failsafe outputs a)	Failsafe inputs (max) b)	Analog inputs (max) b)	Fast counter inputs (max) b)	StatusBus inputs (max) b)	Non failsafe outputs (max) b)	Width mm	Type	Ordering code	L.P.(₹)
No	4	16	1 c)		4	8	45	Pluto S20	2TLA020070R4700	78,620
	6	40	3 c)		4	16	90	Pluto S46	2TLA020070R1800	1,11,850
Yes		22	1 c)		4	8	45	Pluto B22 e)	2TLA020070R4800	74,980
	2	4			2	2	45	Pluto O2 f)	2TLA020070R8500	67,790
	4	16	1 c)		4	8	45	Pluto A20 g)	2TLA020070R4500	1,07,560
								Pluto B20	2TLA020070R4600	98,800
			4 d) + 1 c)		4	8	45	Pluto D20	2TLA020070R6400	1,31,680
	6	40	3 c)		4	16	90	Pluto B46	2TLA020070R1700	1,31,680
		39	8 d)	4	4	15	90	Pluto D45	2TLA020070R6600	1,60,650

a) Failsafe outputs

2 failsafe outputs:

- 2 independent individually safe potential free relay outputs (Q0 and Q1) with 3 contacts each

4 failsafe outputs:

- 2 independent individually safe potential free relay outputs (Q0 and Q1)
- 2 independent individually safe transistor outputs (-24 VDC) (Q2 and Q3)

6 failsafe outputs:

- 2 independent individually safe potential free relay outputs (Q0 and Q1)
- 2 independent individually safe potential free relay outputs with common supply (Q4 and Q5)
- 2 independent individually safe transistor outputs (-24 VDC) (Q2 and Q3)

- b) -The number of failsafe inputs available decreases with the number of used non-failsafe outputs, analog inputs, fast counter inputs and StatusBus inputs.
 -The number of analogue inputs available decreases with the number of used fast counter inputs.
 -The number of non-failsafe outputs available decreases with the number of StatusBus inputs used.
 Check the Pluto hardware manual for more information.

c) 0-27 V analog inputs

d) 0-10 V/4-20 mA (high resolution) analog inputs

e) Expansion model with failsafe inputs and no failsafe outputs.

f) Expansion model with 2 failsafe outputs with 3 contacts each. Also possible to use as stand-alone unit.

g) Model with current monitoring



Gateway for communication

Fieldbus	Ethernet	Type	Ordering code	L.P.(₹)
CANopen		GATE-C2	2TLA020071R8100	32,320
DeviceNet		GATE-D2	2TLA020071R8200	38,350
PROFIBUS-DP		GATE-P2	2TLA020071R8000	38,350
EtherCAT	X	GATE-EC	2TLA020071R9100	48,800
Ethernet/IP	X	GATE-EIP	2TLA020071R9000	48,160
Modbus TCP	X	GATE-MT	2TLA020071R9400	48,800
PROFINET	X	GATE-PN	2TLA020071R9300	48,800



ABB jokab safety

Safety and process locks

Switches

Material (body)	Positions for pilot devices	Manual unlock	Type	Ordering code	L.P.(₹)
Die cast	4	Yes	GKey4 RU	2TLA050304R0002	85,860



Mounting plate with front handle

Type of handle	Material (mounting plates and sliding bolt)	Type	Ordering code	L.P.(₹)
Sliding	Die cast	FHS GKey4	2TLA050310R0032	27,350

Accessories - Rear handle and spring loaded catch

Type of handle	Material	Description	Type	Ordering code	L.P.(₹)
Sliding	Die cast	Rear handle	RHS GKey MKey	2TLA050040R0510	2,810
		Spring catch	SCS GKey MKey	2TLA050040R0511	2,810

Safety light curtains/Grids

Detection (Resolution mm)	Protected height mm	Type (Transmitter + receiver)	Ordering code	L.P.(₹)
Finger (14)	150	Orion1-4-14-015-B	2TLA022300R0000	78,850
	450	Orion1-4-14-045-B	2TLA022300R0200	1,40,780
	750	Orion1-4-14-075-B	2TLA022300R0400	1,98,880
	1050	Orion1-4-14-105-B	2TLA022300R0600	2,55,670
	1200	Orion1-4-14-120-B	2TLA022300R0700	2,84,930
	1050	Orion1-4-14-105-E	2TLA022301R0600	3,16,800
	1200	Orion1-4-14-120-E	2TLA022301R0700	3,48,000
	1500	Orion1-4-14-150-E	2TLA022301R0900	4,17,440



Safety light curtains/Grids

Detection (Resolution mm)	Protected height mm	Type (Transmitter + receiver)	Ordering code	L.P.(₹)
Hand (30)	450	Orion1-4-30-045-B	2TLA022302R0200	1,03,030
	750	Orion1-4-30-075-B	2TLA022302R0400	1,32,900
	1050	Orion1-4-30-105-B	2TLA022302R0600	1,63,410
	1200	Orion1-4-30-120-B	2TLA022302R0700	1,80,980
	1500	Orion1-4-30-150-B	2TLA022302R0900	2,10,960
	1800	Orion1-4-30-180-B	2TLA022302R1100	2,43,040
	1050	Orion1-4-30-105-E	2TLA022303R0600	2,23,960
	1200	Orion1-4-30-120-E	2TLA022303R0700	2,41,900
	1500	Orion1-4-30-150-E	2TLA022303R0900	2,88,710
	1800	Orion1-4-30-180-E	2TLA022303R1100	3,36,300



**Note:- for other variants please contact Local Sales of ABB.

ABB jokab safety



Orion 2 Base/Extended

Detection	Protected height mm	Type (Transmitter + receiver)	Ordering code	L.P.(₹)
Body	900 (4 beams)	Orion2-4-K2-090-B	2TLA022304R0200	1,12,330
	1200 (4 beams)	Orion2-4-K4-120-B	2TLA022304R0300	1,24,790
Body	500(2 beams)	Orion2-4-K2-050-E	2TLA022305R0000	97,910
	800 (3 beams)	Orion2-4-K2-080-E	2TLA022305R0100	1,14,770
	900 (4 beams)	Orion2-4-K2-090-E	2TLA022305R0200	1,29,190
	1200 (4 beams)	Orion2-4-K2-120-E	2TLA022305R0300	1,43,510



Orion 3 Base/Extended

Detection	Protected height mm	Active or passive Part	Type	Ordering code	L.P.(₹)
Body	500 (2 beams)	Active part	Orion3-4-K1C-050-B	2TLA022306R0000	55,720
		Passive part	Orion3-4-M1C-050	2TLA022306R1000	21,530
	800 (3 beams)	Active part	Orion3-4-K2C-080-B	2TLA022306R0100	73,220
		Passive part	Orion3-4-M2C-080	2TLA022306R1100	29,610
	900 (4 beams)	Active part	Orion3-4-K2C-090-B	2TLA022306R0200	80,220
		Passive part	Orion3-4-M2C-090	2TLA022306R1300	32,300
Body	1200 (4 beams)	Active part	Orion3-4-K2C-120-B	2TLA022306R0300	85,330
		Passive part	Orion3-4-M2C-120	2TLA022306R1400	40,920
	500 (2 beams)	Active part	Orion3-4-K1C-050-E	2TLA022307R0000	71,870
		Passive part	Orion3-4-M1C-050	2TLA022306R1000	21,530
	800 (3 beams)	Active part	Orion3-4-K2C-080-E	2TLA022307R0100	87,760
		Passive part	Orion3-4-M2C-080	2TLA022306R1100	29,610
900 (4 beams)	Active part	Orion3-4-K2C-090-E	2TLA022307R0200	95,020	
	Passive part	Orion3-4-M2C-090	2TLA022306R1300	32,300	
1200 (4 beams)	Active part	Orion3-4-K2C-120-E	2TLA022307R0300	1,04,170	
	Passive part	Orion3-4-M2C-120	2TLA022306R1400	40,920	

**Note:- for other variants please contact Local Sales of ABB.



Safeball JSTD1

Types of switches	Cable length	Type	Ordering code	L.P.(₹)
1 NO + 1 NC	2 m	JSTD1-A	2TLA020007R3000	13,970
	0.2 m	JSTD1-B	2TLA020007R3100	11,340
	10 m	JSTD1-C	2TLA020007R3200	17,010
2 NO	0.2 m	JSTD1-E	2TLA020007R3400	11,090



Two-hand control devices JSTD25

Extra feature	Connector male	Type	Ordering code	L.P.(₹)
None	M12-5	JSTD25F	2TLA020007R6000	39,900
	M12-8	JSTD25H	2TLA020007R6300	47,250
Pre-mounted Smile 10 EK emergency stop button	M12-8	JSTD25K	2TLA020007R6900	53,970

Accessories

Description	Type	Ordering code	L.P.(₹)
Mounting bracket for JSTD1 with orientation possibility (ball joint)	JSM C5	2TLA020007R0900	5,630
Suspension shelf for JSTD25F/H/K	JSM C7	2TLA020007R1200	5,990
coat for Safeball	Safeball coat	2TLA020007R1900	2,990



ABB jokab safety

Three positional safety device Complete list of JSHD4 models



Top Part Buttons and LEDs	Bottom part Feature	ID	Connection	Anti-tamper	Type	Ordering code	L.P.(₹)
JSHD4-1	Use your own cable	AA	Cable gland and 5 screw connections		JSHD4-1-AA	2TLA019995R0000	30,450
No LEDs No buttons	Cost effective and quick connection	AC	M12-5 male		JSHD4-1-AC	2TLA019995R0100	34,230
JSHD4-2	Cost effective and robust	AB	Cannon 12 male pins		JSHD4-2-AB	2TLA019995R0200	43,470
	Use your own cable, full pin connection	AJ	Cable gland and 16 screw connections	●	JSHD4-2-AJ-A	2TLA019995R1100	58,800
	Replacement of old units*	AK	Cannon 12 male pins		JSHD4-2-AK	2TLA019995R4800	41,580

HD5 ordering information



Emergency stop with LED	Home position sensor	Motion sensor	LED flashlight	Connector	Two top	Type	Ordering code	L.P.(₹)
No	No	No	No	M23-12	No	HD5-S-102	2TLA023001R0000	71,400
					Yes	HD5-S-104	2TLA023001R0200	84,000
Yes	Yes	Yes	Yes	M23-19	Yes	HD5-S-111	2TLA023001R0100	1,26,000

HD5 accessories



Description	Suitable for	Type	Ordering code	L.P.(₹)
Active holder (for home position sensor)	All models	HD5-M-001	2TLA920509R0001	5,150
Passive holder	All models	HD5-M-002	2TLA920509R0002	4,270
10 m cable with M23-12 female connector	HD5-S-102/104	JSD-TK10-12	2TLA930051R0000	40,110
5 m cable with M23-12 female connector	HD5-S-102/104	JSD-TK5-12	2TLA930050R0000	30,660
10 m spiral cable with M23-12 female connector	HD5-S-102/104	JSD-TK100S-12	2TLA930034R0000	73,500

Emergency Stop Sign

Panel mounting



IP rating	Depth	Connection type	Type of safety signal	Feature	Type	Ordering code	L.P.(₹)
IP65	26 mm	1 x M12-5 male	DYNlink	Status LED	Smile 11 EAR Tina	2TLA030050R0100	11,240
			2 NC	Status LED	Smile 11 EAR	2TLA030051R0100	9,770
			DYNlink	Status LED	INCA 1 Tina	2TLA030054R0000	11,760
Button IP65, connector IP20	53 mm	Removable terminal block		Status LED, StatusBus	INCA 1 EC Tina	2TLA030054R1400	13,130
			2 NC	Status LED	INCA 1	2TLA030054R0100	10,500

ABB jokab safety

Emergency Stop Button External mounting



Description	Type of safety signal	Connection type	Feature	Type	Ordering code	L.P.(₹)
Compact size Plastic housing IP65	DYNlink	1 m cable from bottom 1 x M12-5 male 1 x M12-5 male 2 x M12-5 male	Status LED	Smile 10 EA Tina	2TLA030050R0400	11,340
			Status LED	Smile 11 EA Tina	2TLA030050R0000	10,920
			Status LED, StatusBus	Smile 11 EC Tina	2TLA030050R0900	11,970
			Status LED	Smile 12 EA Tina	2TLA030050R0200	11,870
Plastic housing IP66, IP67 and IP69K	2 NC	1 m cable from bottom 1 m leads from bottom 1 x M12-5 male 2 x M12-5 male	Status LED	Smile 10 EA	2TLA030051R0400	9,870
			-	Smile 10 EK	2TLA030051R0600	7,350
			Status LED	Smile 11 EA	2TLA030051R0000	9,450
			Status LED	Smile 12 EA	2TLA030051R0200	10,400
Plastic housing IP66, IP67 and IP69K	2 NC*	2 x M20 conduits	-	CEPY1-1002 (Compact)	1SFA619821R1002	3,720
			With shroud	CEPY1-2002 (Compact)	1SFA619821R2002	3,990
Metal housing IP67 and IP69K	2 NO + 2 NC	3 x M20 conduits	Status LED	EStrongZ LED	2TLA050220R0222	28,350
			-	EStrongZ	2TLA050220R0020	25,620

* Can be adapted to DYNlink with Tina

Emergency stop grab wire safety switch



IP rating	Material	E-stop button	Contacts	Max. wire length (m)		Feature	Type	Ordering code	L.P.(₹)
				1 unit	2 units				
IP67	Yellow die cast aluminum alloy	No	2 NO + 2 NC	30	50	-	LineStrong1	2TLA050200R0030	19,130
				60	80	-	LineStrong2	2TLA050202R0332	27,290
		Yes	2 NO + 4 NC	100	125	Left hand	LineStrong3L	2TLA050206R0332	34,650
						Right hand	LineStrong3R	2TLA050208R0332	34,650
						200	325	Both sides	LineStrong3D
IP67, IP69K	Stainless steel 316	Yes	2 NO + 4 NC	100	125	-	LineStrong2Z	2TLA050202R0322	56,700
						Left hand	LineStrong3LZ	2TLA050206R0322	66,150
						Right hand	LineStrong3RZ	2TLA050208R0322	66,150
						200	325	Both sides	LineStrong3DZ

Safety bumper -ASB



Overtravel ^{a)} mm	Description	Material	Type	Ordering code	L.P.(₹)
60	60x100 mm bumper. Length in m needs to be specified on order.	Imitation leather	Bumper ASB 60-100 black/ yellow	2TLA076200R0500	Upon request
120	100x200 mm bumper. Length in m needs to be specified on order.	Imitation leather	Bumper ASB 100-200 black/yellow	2TLA076200R0600	
180	150x300 mm bumper. Length in m needs to be specified on order.	Imitation leather	Bumper ASB 150-300 black/yellow	2TLA076200R0700	
240	200x400 mm bumper. Length in m needs to be specified on order.	Imitation leather	Bumper ASB 200-400 black/yellow	2TLA076200R0800	

^{a)} 60% of bumper height at 10 mm/s

Production cost and cables

Description	Type	Ordering code	L.P.(₹)
Bumpers production cost, including aluminum rail and cables	Bumper production cost	2TLA076200R0000	Upon request

ABB jokab safety

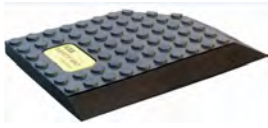

Safety mat ASK – standard sizes

Size mm	Description	Connectors	Type	Ordering code	L.P.(₹)
750x1000	750x1000 safety mat with molded ramp rail and two 5 m cables	1x M8 male 1x M8 female	Safety mat ASK T4 750x1000mm	2TLA076310R1000	Upon request
1000x1000	1000x1000 safety mat with molded ramp rail and two 5 m cables	1x M8 male 1x M8 female	Safety mat ASK T4 1000x1000mm	2TLA076310R1100	
1000x1500	1000x1500 safety mat with molded ramp rail and two 5 m cables	1x M8 male 1x M8 female	Safety mat ASK T4 1000x1500mm	2TLA076310R1200	

Safety mat ASK – custom sizes

Description	Connectors	Type	Ordering code	L.P.(₹)
Base price for custom made safety mat with molded ramp rail	–	Safety mat ASK CM T4, base price	2TLA076301R0200	Upon request
Order code for size (m2) and two 5 m cables. Specify dimensions (width x length in mm) in text.	1x M8 male 1x M8 female	Safety mat ASK CM T4	2TLA076301R0600	

Safety edge TT

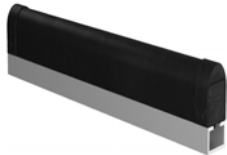

Overtravel ^{a)} mm	Description	Material	Type	Ordering code	L.P.(₹)
15	30 mm high safety edge with 25-14 aluminum rail. Length in m needs to be specified on order.	TPE	Safety edge TT 25-30 TPE	2TLA076025R3010	Upon request
22.7	45 mm high safety edge with 25-14 aluminum rail. Length in m needs to be specified on order.	TPE	Safety edge TT 25-45 TPE	2TLA076025R4510	

Production cost and cables

Length of cables m	Description	Type	Ordering code	L.P.(₹)
2.5	Production cost with a 2,5 m cable in each end.	Safety edge production cost 2,5m cable	2TLA076010R0100	Upon request
5	Production cost with a 5 m cable in each end.	Safety edge production cost 5,0m cable	2TLA076010R0500	
10	Production cost with a 10 m cable in each end.	Safety edge production cost 10,0m cable	2TLA076010R1000	

Eden sensors

Eva



Code description	Code level	Type	Ordering code	L.P.(₹)
General code. (Eva is interchangeable)	Low level	Eva General code	2TLA020046R0800	2,380
Unique code. (Prevents defeat/fraud)	High level	Eva Unique code	2TLA020046R0900	4,050

Adam



Type of safety controller	Status Bus	Info signal	Local reset	Series connection	Connector male	Type	Ordering code	L.P.(₹)
Pluto	x	x ¹⁾	x	x	M12-5	Adam DYN-Status M12-5	2TLA020051R5200	8,930
Pluto or Vital		x		x	M12-5	Adam DYN-Info M12-5	2TLA020051R5100	7,860
			x	x	M12-5	Adam DYN-Reset M12-5	2TLA020051R5300	10,400
OSSD compatible (incl. Pluto and Sentry)		x			M12-5	Adam OSSD-Info M12-5	2TLA020051R5400	6,770
			x		M12-5	Adam OSSD-Reset M12-5	2TLA020051R5600	9,180
		x	x	x	M12-8	Adam OSSD-Reset M12-8	2TLA020051R5900	11,240

ABB jokab safety

MKey ordering information

Locking function	Material housing	Material head	Holding force	Special feature	Type	Ordering code	L.P.(₹)
—	Plastic	Plastic	12 N		MKey5	2TLA050003R0100	5,580
			40 N		MKey5+	2TLA050003R0101	6,160
	Stainless steel	Stainless steel	12 N		MKey5 SSH	2TLA050003R0110	7,890
			40 N		MKey5+ SSH	2TLA050003R0111	8,750
Process lock (power to lock)	Plastic	Stainless steel	12 N	IP69K	MKey5Z	2TLA050003R0120	22,740
			40 N	IP69K	MKey5+Z	2TLA050003R0121	25,830
	Die cast	Die cast	1800 N		MKey9M 24VDC	2TLA050009R0112	30,450
			2000 N		MKey8M 24VDC	2TLA050013R0132	42,420
Safety lock (power to unlock)	Plastic	Stainless steel	1800 N		MKey9 24VDC	2TLA050007R0112	28,370
				No key supplied	MKey9 24VDC, No Key	2TLA050007R0012	27,720
	Die cast	Die cast	2000 N		MKey8 24VDC	2TLA050011R0132	39,270
				With escape release button	MKey8ER 24VDC	2TLA050015R0132	55,860
	Stainless steel	Stainless steel	2000 N	IP69K	MKey8Z 24VDC	2TLA050011R0122	61,950





We Develop Solutions To Move E-Mobility Forward

ABB lays the foundations for a future of smarter, reliable, and emission-free mobility, accessible by everyone, everywhere



- One stop provider for hardware, software, connectivity and services
- Tailor-made solutions in every scale. From chargers for private homes to public charging infrastructure.

We develop solutions to move you

Bring your challenges to us

ABB has years of experience in designing, manufacturing, installing, and maintaining electric vehicle charging infrastructure as a provider of one-stop, source-to-socket solutions.

Since 2010, ABB has been leading the e-mobility revolution with charging infrastructure suitable for any location combined with connectivity services. With over 100 years' experience in delivering critical grid connection and power distribution infrastructure, we develop smart solutions to move e-mobility forward.

We are at the forefront of EV charging technology, working in partnership with major vehicle manufacturers to develop the charging systems that will power the next generation of electric vehicles.

Whatever your needs, we provide tailor-made solutions scaled to suit your situation – from chargers for use in private homes and residential locations to public car-charging stations and heavy vehicle charging infrastructure.

That includes all the equipment you need to run a successful charging operation. We are your one-stop provider for hardware, software, connectivity, and related services.

Just bring your challenges to us. ABB is ideally positioned to address the intricacies and demands of each project. Our solutions will move you – both today and in the future.



Enabling your charging operation through intelligent connectivity

We develop solutions that offer simple and secure operation of infrastructure using a combination of local and cloud protocols

Cloud Connectivity

The ABB Ability™ Connected Services platform incorporates many years of experience in connecting thousands of chargers to the Internet. Connectivity helps EV charging network operators to optimize operations with deep insights and statistics on energy usage at the charger, site, and network level. The remote control OCPP IoT Ecosystem enables reduced total cost of ownership with 99%+ uptime through remote diagnostics and solution deployment.

Local Connectivity

On-site management of local assets, such as an energy storage system, can bring significant operational savings through balanced energy management. The EV chargers can be upgraded with features that enable connectivity via OPC UA. OPC UA is the most widely adopted interoperability standard for secure, reliable, and platform independent information exchange in the world, with thousands of OPC-compliant products available.

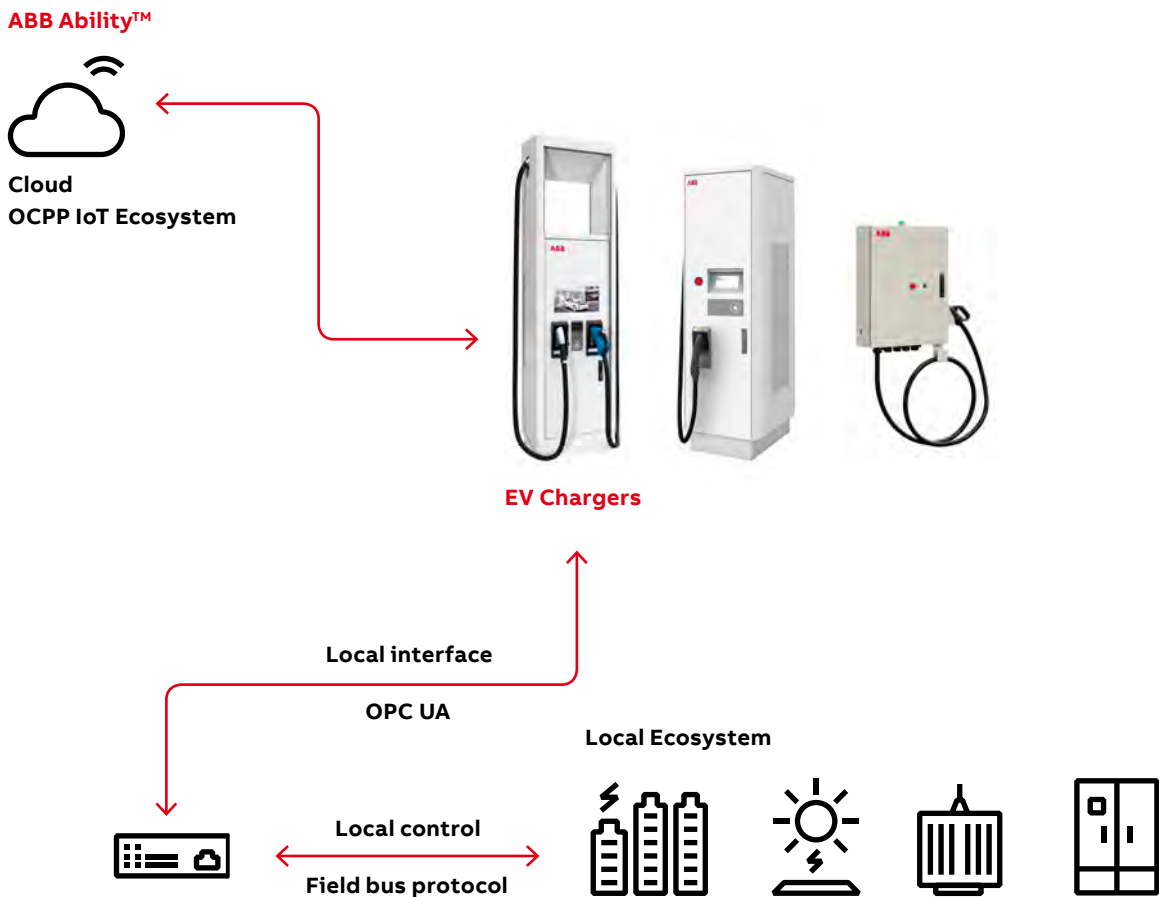

Public and commercial car charging

- Use cases

Charging service should match charging application and demand

Public and commercial EV Charging

AC destination	DC destination	DC Fast	DC High Power
3-22 kW	20-25 kW	50 to 150 kW	150 to 350 kW+
4-16 hours	1-3 hours	20-90 min	10-20 min



- Office, workplace
- Home
- Multi family housing
- Hotel and hospitality
- Overnight fleet
- Supplement at DC charging sites for PHEVs



- Office, workplace
- Hotel and hospitality
- Parking structures
- Dealerships
- Urban fleets
- Public or private campus
- Sensitive grid applications



- Retail, grocery, mall, big box, restaurant
- High turnover parking
- Convenience fueling stations
- Highway truck stops and travel plazas
- OEM R&D



- Highway corridor travel
- Metro 'charge and go'
- Highway rest stops
- Petrol station area's
- City ring service stations
- OEM R&D



Terra AC



Te DC Wallbox 24



Terra 54, Terra 94, Terra 124, Terra 184



Terra HP

Terra AC wallbox

To serve a growing market

Reducing cost of EVs

EVs will be cheaper than internal combustion engine (ICE) alternatives by the mid-to-late 2020s in almost every market

Global EV sales

Electric vehicles will represent 57% of global passenger car sales by 2040



Passenger EV sales

Passenger EV sales will rise to 28 million in 2030 and 56 million by 2040

Terra AC wallbox provides tailored, intelligent and networked charging solutions for any business, home or location.

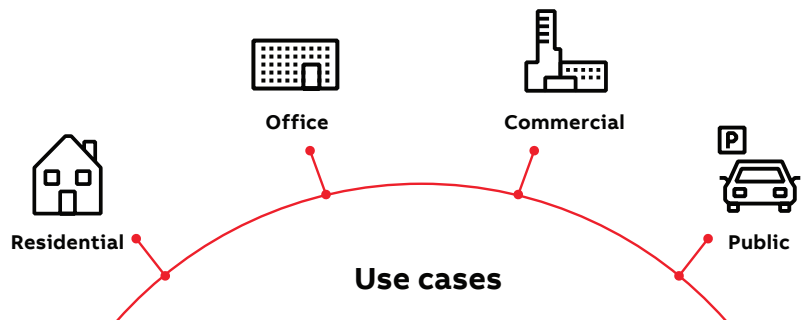

At home

From private homes to multi-tenant homes and residential communities

At work

From small offices to large offices, business parks and complexes

Commercial locations

From hotels to sports institutions and shopping centres

While parking

While on the street or in a car park

Terra AC wallbox benefits

High-value quality



The best value AC charger on the market, providing the exceptional quality expected of the world leader in EV charging.

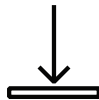

Enabled for remote software updates to ensure optimal performance while minimizing the need for onsite intervention.



Enabled for remote software updates to ensure optimal performance while minimizing the need for onsite intervention.

Futureproof flexibility



Smart functionality means the wallbox can adapt its power usage and provide optimal charging, today and into the future.



Set up for energy meter integration to provide dynamic load management, reducing energy costs and preventing nuisance tripping of distribution protective devices.



Dedicated App provides easy authentication and control of the AC charger, along with insight into charging status for users.

Terra AC wallbox benefits

Safety and protection



Evaluated and tested to the highest standards by independent, third party safety certification organizations.



Current limiting protection allows maximum charging power without nuisance tripping, aligned with the design of a given building's electrical distribution system.



Integrated protections including DC ground fault and over voltage protect both user and car.

India portfolio

AC charger for electric vehicles, type 2

Power supply network: 220 ... 240 V single phase and 380 ... 415 V three phase, 50 / 60 Hz



Rated Power (kW)	Max Current (A)	Socket outlet or connector type	Other features	Type	Order code	L.P. (₹)
Single phase						
3.7	16	Socket with shutter, type 2	-	TAC-W4-S-0	ABB6AGC082587	
3.7	16	Socket with shutter, type 2	RFID	TAC-W4-S-R-0	ABB6AGC085384	
7.4	32	Socket, type 2	RFID, 4G	TAC-W7-T-R-C-0	ABB6AGC085383	
7.4	32	Socket, type 2	RFID	TAC-W7-T-R-0	ABB6AGC085382	
7.4	32	Cable 5 m, type 2	RFID, 4G	TAC-W7-G5-R-C-0	ABB6AGC085385	
7.4	32	Socket, type 2	-	TAC-W7-T-0	ABB6AGC081278	
3.7	16	Socket with shutter, type 2	-	TAC-W4-S-0	ABB6AGC082587	Upon request
3.7	16	Socket with shutter, type 2	RFID	TAC-W4-S-R-0	ABB6AGC085384	
7.4	32	Socket, type 2	RFID, 4G	TAC-W7-T-R-C-0	ABB6AGC085383	
7.4	32	Socket, type 2	RFID	TAC-W7-T-R-0	ABB6AGC085382	
7.4	32	Cable 5 m, type 2	RFID, 4G	TAC-W7-G5-R-C-0	ABB6AGC085385	
7.4	32	Socket, type 2	-	TAC-W7-T-0	ABB6AGC081278	
		Cable 5 m, type 2	RFID	TAC-W7-G5-R-0	ABB6AGC082155	
Single phase with display and MID certification						
7.4	32	Socket, type 2	RFID, 4G	TAC-W7-T-RD-MC-0	ABB6AGC082174	Upon request
7.4	32	Cable 5 m, type 2	RFID, 4G	TAC-W7-G5-RD-MC-0	ABB6AGC085386	
Three phase						
11	16	Cable 5 m, type 2	RFID	TAC-W11-G5-R-0	ABB6AGC082156	
22	32	Socket, type 2	-	TAC-W22-T-0	ABB6AGC081279	
22	32	Socket, type 2	RFID	TAC-W22-T-R-0	ABB6AGC082152	
22	32	Socket, type 2	RFID, 4G	TAC-W22-T-R-C-0	ABB6AGC082153	
22	32	Socket with shutter, type 2	RFID	TAC-W22-S-R-0	ABB6AGC082589	Upon request
22	32	Socket with shutter, type 2	RFID, 4G	TAC-W22-S-R-C-0	ABB6AGC082154	
22	32	Cable 5 m, type 2	RFID, 4G	TAC-W22-G5-R-C-0	ABB6AGC082157	
Three phase with display and MID certification						
22	32	Socket, type 2	RFID	TAC-W22-T-RD-M-0	ABB6AGC081280	
22	32	Socket, type 2	RFID, 4G	TAC-W22-T-RD-MC-0	ABB6AGC081281	
22	32	Socket with shutter, type 2	RFID, 4G	TAC-W22-S-RD-MC-0	ABB6AGC081282	Upon request
22	32	Cable 5 m, type 2	RFID, 4G	TAC-W22-G5-RD-MC-0	ABB6AGC081285	

Terra DC wallbox

The smart e-mobility investment

Limited changes required to existing electrical infrastructure due to reduced power requirements

Increasing revenue opportunities for operators and owners by supporting current and future electric vehicles with high voltage charging



Enabled for smart charging via OCPP to balance load demands and reduce infrastructure costs

Developed with leading electric vehicle manufacturers, trusted by energy suppliers and governments, the Terra DC wallbox makes fast charging safe, smart and future-compatible

Terra DC wallbox is a future-proof investment supporting current and future EVs with high voltage charging, applicable to a wide variety of use cases, in an ultra-compact footprint, that is safe and reliable, for residential use too.

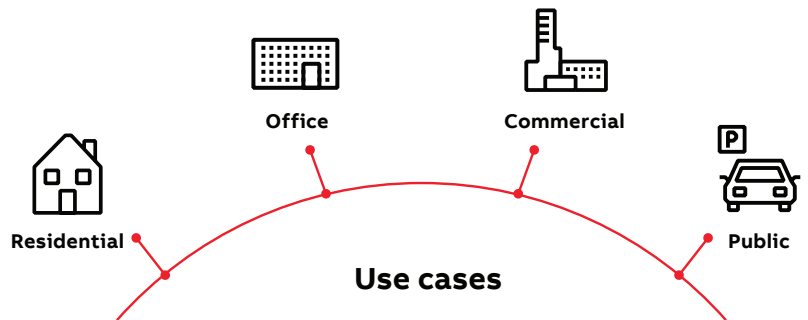

Residential
Multi-tenant homes, residential communities

Office
Small and large offices, business parks and complexes

Commercial
Hotels & hospitality sports institutions, shopping centres, commercial fleets, public or private campus, parking structures, car dealerships, race tracks

Public assets
Bus depots, utility, sensitive grid applications

Terra DC wallbox benefits

Intelligent design: compact, convenient, connected



The DC wallbox with **ultra-compact footprint** enables flexibility in installation to serve a variety of site conditions

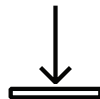

Intuitive interface with a **user-friendly 7-inch color touch screen** and easy-reach cables for convenient parking and charging



Broad range of connectivity options including **3G/4G modem, Ethernet and GSM for easy control** and integration with existing infrastructure

Terra AC wallbox benefits

Future-proof: ROI maximized



High voltage charging capabilities supporting the EVs from today and into the future



Enabled for smart charging via OCPP to balance load demands and reduce infrastructure costs



Connection to ABB Ability platform manages over-the-air-authentication and payment, remote diagnostics, software updates and asset **monitoring**

Safety: built-in protection



Evaluated and tested to the highest standards by independent, third party safety certification organizations



Certified with EMC Class B protection for safe use in residential areas



Integrated ground-fault and trip protection protect both user and car

India portfolio, three phase

Description

DC charger for electric vehicles, CCS2 and CHAdeMO

Power supply network: 3 phase 400 V AC +/-10 % (50/60 Hz)

Connectivity: Cellular connection, 3G / 4G, 2 port RJ45, Ethernet

Metal Connector/cable holders for inside use provided standard with the product



Rated continuous power (kW)	Rated peak power (kW)	Charging standard	EMC classification	Cable length (m / ft)	Type	Ordering code	L.P. (₹)
22.5	24	CCS2	Class A	3.5 / 12	TWB CE 24 C 0-7M-A-0	6AGC074509	
22.5	24	CCS2	Class A	7 / 23	TWB CE 24 C 7-7M-A-0	6AGC076048	
22.5	24	CCS2	Class B	3.5 / 12	TWB CE 24 C 0-7M-0-0	6AGC077815	
22.5	24	CCS2	Class B	7 / 23	TWB CE 24 C 7-7M-0-0	6AGC077816	
22.5	24	CHAdeMo / CCS2	Class A	3.5 / 12	TWB CE 24 CJ 0-7M-A-0	6AGC003683	Upon request
22.5	24	CHAdeMo / CCS2	Class A	7 / 23	TWB CE 24 CJ 7-7M-A-0	6AGC076046	
22.5	24	CHAdeMo / CCS2	Class B	3.5 / 12	TWB CE 24 CJ 0-7M-0-0	6AGC077814	
22.5	24	CHAdeMo / CCS2	Class B	7 / 23	TWB CE 24 CJ 7-7M-0-0	6AGC077817	

Terra 54 DC Fast Charger

The pillar of growth for smart, sustainable mobility

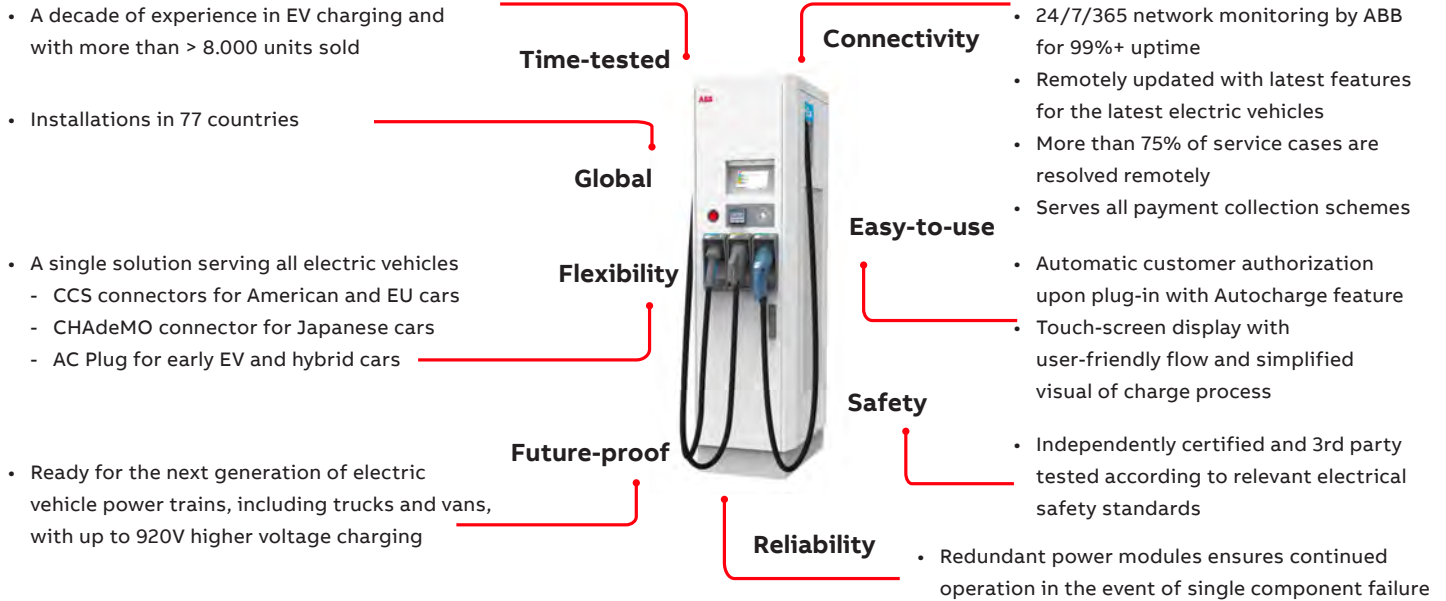

Configurations

Possible configurations

Terra 54 is available in the following configurations, all with CCS cable from left, and CHAdeMO cable (optional) from right side:

- Terra 54 CJG: CCS, CHAdeMO and (22 or) 43 kW AC connector
- Terra 54 CJT: CCS, CHAdeMO and 22 kW AC socket
- Terra 54 CJ: CCS and CHAdeMO
- Terra 54 CT: CCS and 22 kW AC socket

Applications

- Highway petrol / service stations
- Metropolitan / urban areas
- Commercial fleet operators
- EV infrastructure operators and service providers



Fast charging beyond 50 kW

City Charging Point

The Terra chargers can provide a quick refill adding 100 km or range in as little as 25 minutes (Terra 54) or 15 minutes (Terra 94).

Retail / Shopping Center

The Terra 124 charger can provide a full battery charge to two vehicles simultaneously by the time of a shopping errand, and recharge a third vehicle using the AC outlet.

Fast Charging Station

The higher power versions of the Terra chargers can add 100 km of range in as little as 8 minutes* and fast-charge two vehicles at the same time



one electric vehicle up to **90 kW**



one electric vehicles up to **120 kW**



two electric vehicles up to **60 kW**



one electric vehicle up to **180 kW**

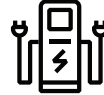

two electric vehicles up to **90 kW**



* actual charging speed depends on the electric vehicle model and charging condition

Value proposition

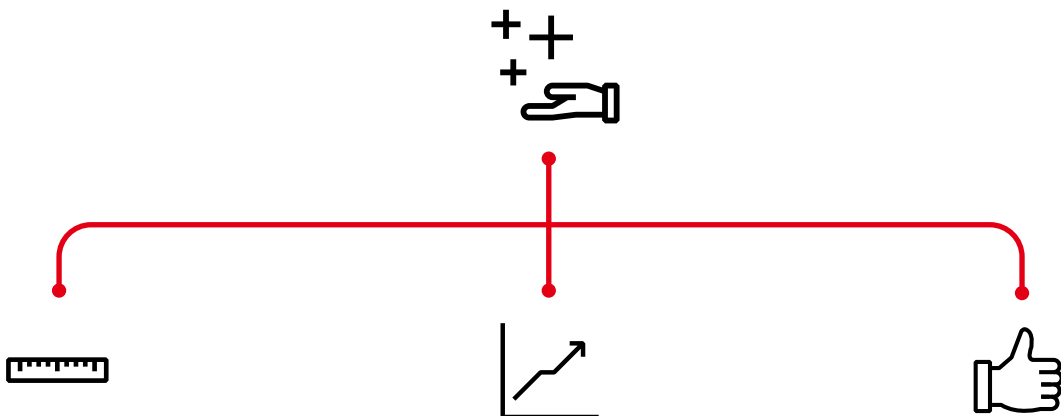

Compact footprint

- Small footprint makes it perfect for urban environments with limited available space
- No need for separate power cabinets, significantly reducing the installation costs versus other high power charging solutions.

Maximized revenue generation

- Supports all charging standards on the market and all battery sizes
- Can charge up to three vehicles at once (2 charging fast and 1 slow/ AC charging)
- Large number of customizations: credit card payment terminal, cable management system, customized screen and logos, branded cabinet

Future ready

- With output voltage up to 920 VDC it's ready to charge the next generation of EV's
- Supports future business needs with easy power upgrade up to 180kW

Ordering codes

Voltage level (Vdc)	Rated power (kW)	DC connector 1	DC connector 2	AC connector	Type	Order code
Low voltage power trains						
150-500	20	CCS-2		AC Type-2 socket (22 kW)	Terra CE 24 CT 0-7M-0-0	6AGC074672
		CCS-2		AC Type-2 cable (22 kW)	Terra CE 24 CG 22 0-7M-0-0	6AGC073442
		CCS-2	CHAdeMO		Terra CE 24 CJ 0-7M-0-0	6AGC073424
		CCS-2	CHAdeMO	AC Type-2 cable (43 kW) 50	Terra CE 24 CJG 0-7M-0-0	6AGC073423
	50	CCS-2			Terra CE 54 C 0-7M-0-0	6AGC075211
		CCS-2		AC Type-2 socket (22 kW)	Terra CE 54 CT 0-7M-0-0	6AGC071873
		CCS-2		AC Type-2 cable (43 kW)	Terra CE 54 CG 0-7M-0-0	6AGC066382
		CCS-2	(CHAdeMO as upgrade)	AC Type-2 cable (43 kW)	Terra CE 54 CG 0-7M-0-SLA	6AGC071786
		CCS-2		AC Type-2 cable (22 kW)	Terra CE 54 CG 22 0-7M-0-0	6AGC073428
		CCS-2	CHAdeMO		Terra CE 54 CJ 0-7M-0-0	6AGC063492
		CCS-2	CHAdeMO	AC Type-2 socket (22 kW)	Terra CE 54 CJT 0-7M-0-0	6AGC071512
		CCS-2	CHAdeMO	AC Type-2 cable (22 kW)	Terra CE 54 CJG 22 0-7M-0-0	6AGC071735
		CCS-2	CHAdeMO	AC Type-2 cable (43 kW)	Terra CE 54 CJG 0-7M-0-0	6AGC063056
Low and high voltage power trains						
150-920	50	CCS-2			Terra CE 54 HV C 0-7M-0-0	6AGC070818
		CCS-2		AC Type-2 socket (22 kW)	Terra CE 54 HV CT 0-7M-0	6AGC077783
		CCS-2		AC Type-2 cable (43 kW)	Terra CE 54 HV CG 0-7M-0-0	6AGC076835
		CCS-2		AC Type-2 cable (22 kW)	Terra CE 54 HV CG 22 0-7M-0-0	6AGC080559
		CCS-2	CHAdeMO		Terra CE 54 HV CJ 0-7M-0-0	6AGC076568
		CCS-2	CHAdeMO	AC Type-2 socket (22 kW)	Terra CE 54 HV CJT 0-7M-0-0	6AGC077781
		CCS-2	CHAdeMO	AC Type-2 cable (43 kW)	Terra CE 54 HV CJG 0-7M-0-0	6AGC066474
		CCS-2	CHAdeMO	AC Type-2 cable (22 kW)	Terra CE 54 HV CJG 22 0-7M-0-0	6AGC080560
	90	CCS-2			Terra CE 94 C 0-7M-0-0	6AGC080803
		CCS-2	CHAdeMO		Terra CE 94 CJ 0-7M-0-0	6AGC080805
		CCS-2	CCS-2		Terra CE 94 CC 0-7M-0-0	6AGC080804
		CCS-2	CHAdeMO	AC Type-2 socket (22 kW)	Terra CE 94 CJT 0-7M-0-0	6AGC080806
	120	CCS-2			Terra CE 124 C 0-7M-0-0	6AGC083318
		CCS-2	CHAdeMO		Terra CE 124 CJ 0-7M-0-0	6AGC082793
		CCS-2	CCS-2		Terra CE 124 CC 0-7M-0-0	6AGC082794
		CCS-2	CHAdeMO	AC Type-2 socket (22 kW)	Terra CE 124 CJT 0-7M-0-0	6AGC084095
		CCS-2	CCS-2	AC Type-2 socket (22 kW)	Terra CE 124 CCT 0-7M-0-0	6AGC082795
	150	CCS-2			Terra CE 154 C 0-7M-0-0	**
		CCS-2	CHAdeMO		180 kW Terra CE 154 CJ 0-7M-0-0	** **
		CCS-2	CCS-2		180 kW Terra CE 154 CC 0-7M-0-0	** **
		CCS-2	CHAdeMO	AC Type-2 socket (22 kW)	180 kW Terra CE 154 CJT 0-7M-0-0	** **
	180	CCS-2	CCS-2	AC Type-2 socket (22 kW)	180 kW Terra CE 154 CCT 0-7M-0-0	** **
		CCS-2			Terra CE 184 C 0-7M-0-0	6AGC080810
		CCS-2	CHAdeMO		Terra CE 184 CJ 0-7M-0-0	6AGC080812
		CCS-2	CCS-2		Terra CE 184 CC 0-7M-0-0	6AGC080811
		CCS-2	CHAdeMO	AC Type-2 socket (22 kW)	Terra CE 184 CJT 0-7M-0-0	**
		CCS-2	CCS-2	AC Type-2 socket (22 kW)	Terra CE 184 CCT 0-7M-0-0	**

ABB Heavy Commercial Vehicle charging

ABB offers a complete portfolio for charging electric Heavy Commercial Vehicles such as buses and trucks.

With increasing air pollution levels in cities and a stronger public commitment to cleaner transportation, electric city buses and trucks offer a great opportunity to reduce emissions in cities, while also reducing operational costs.

ABB offers a complete portfolio for charging electric Heavy Commercial Vehicles such as buses and trucks. Charging can be done during daily operation at any given stop or rest opportunity, charge time typically is between 3 and 6 minutes and requires an automated connection device and high power charging. This so called Opportunity Charging provides an ideal solution to ensure zero-emission public transport during the day without impacting the normal operation on the route.

Since most vehicles will return to a depot for overnight parking, this also provides an ideal moment to charge the vehicles up to 100% and to precondition the vehicle before it goes back into operation. Normally this requires lower charging powers and can be done by a connector or by automated connection devices and is called Overnight Charging. Different power levels and interfaces are available to either charge 1 vehicle per charger or to have sequential charging, which offers an efficient solution to charge up to 3 vehicles with 1 charger.

Charging powers start at 24 kW and can be extended up to 150 kW for overnight charging and up to 600 kW for opportunity charging. The following 3 interfaces are supported:

1. Connector – CCS1 or CCS2;
2. Pantograph Up - roof mounted pantograph;
3. Pantograph Down - pantograph mounted on the infrastructure.



ABB Heavy Commercial Vehicle charging



Flexibility

The Heavy Commercial Vehicle charging product line offers a wide range of chargers, providing maximum flexibility to the operator or fleet owner to electrify a single bus line up to a complete fleet of electric buses or trucks with the required power level.



Complies with international standards

ABB's high power chargers are designed to the highest international electrical, quality and safety standards, including IEC 61851-23, guaranteeing safe and reliable operation in public areas.



Future proof

ABB products support a wide output voltage range of 150 – 850 V DC and some products even up to 920 V DC, supporting today's and next generation of cars, buses and trucks.



Always connected – remote service & data management

ABB chargers come with an extensive suite of connectivity features including remote monitoring, remote management and smart software upgradeability. These advanced services enable high uptime of the equipment, a fast response to problems and provide owners of chargers with powerful insight into statistics of their charging operation.



Interoperability

Use the same charging infrastructure for different vehicle configurations and different vehicle makes.



ABB is your experienced partner

The new fast charging solution for Heavy Commercial Vehicles is based on ABB's solid experience in charging solutions for electric vehicles. Since early 2010, ABB has sold more than 10,500 fast charging systems for electric vehicles around the world and is a global leader in this market.



Modular design

The modular power cabinets can be expanded at any time, allowing customers to invest in increasing charging power in line with the emergence of higher-capacity in the (near) future.



HVC-150C with 150 kW power cabinet and three depot charge boxes with sequential charging

Pantograph up

Charge electric buses with a roof mounted pantograph



HVC-300PU with 300 kW power cabinet and slim design charge pole

ABB offers an ideal solution to charge electric buses that are equipped with a roof mounted pantograph. This allows to charge larger fleets of electric buses overnight in a range of 50-150 kW per vehicle and during the day with 150 kW up to 600 kW for opportunity charging.

Main features and key benefits:

- Voltage range from 150-850 V
- Power range of 50-100-150 kW for overnight charging
- Sequential charging with up to 3 outlets for overnight charging
- Power range of 150-300-450-600 kW for opportunity charging
- Safe and reliable fully automated connection
- Compliant with ISO 15118 / DIN 70121 / IEC 61851-23 & -24
- OCPP compliant
- Remote diagnostics and management tools

Pantograph down

Charge electric buses following the OppCharge protocol



HVC-450PD with 450 kW power cabinet and standard charge pole

ABB offers an ideal solution to charge electric buses fully automated following the OppCharge protocol. With typical charge times of 3 to 6 minutes the system can easily be integrated in existing operations, ensuring zero-emission public transit during the day without impacting on the normal operation of the route.

Main features and key benefits:

- Voltage range from 150-850 V
- Power range of 150-300-450-600 kW
- Charge in 3 to 6 minutes
- One charger can serve multiple vehicle types and brands
- Safe and reliable fully automated connection
- Compliant with OppCharge / IEC 61851-23
- OCPP compliant
- Remote diagnostics and management tools





Uninterruptible power supply systems

Standalone and modular
portfolio 1 kVA to 5 MVA

UPS product overview

1 kVA to 10 kVA

Single phase UPS



GENERAL DATA	PowerValue 11T	PowerValue 11 RT
UPS frame rated power	1 / 2 / 3 / 6 / 10 kVA	1 / 2 / 3 / 6 / 10 kVA
UPS module rated power	–	–
UPS output rated PF	0.9	1.0
Max. no of parallel frames	–	Up to 4 units (6 - 10kVA)
Max no of parallel modules across frames	–	–
Max system power	10 kW	40 kW
Wiring	1-ph + N + PE	1-ph +N+PE
UPS type	Standalone tower	Rack or tower convertible
Topology	Online double conversion	Online double conversion
INPUT		
Nominal input voltage	220/230/240 VAC (1–3 kVA) 208/220/230/240 VAC (6–10 kVA)	208, 220, 230, 240 VAC
Voltage range	100–300 VAC (1–3 kVA) 110–300 VAC (6–10 kVA)	120–300 VAC (1–3 kVA) 100–276 VAC (6–10 kVA)
Frequency range	45–55 Hz (1–3kVA) 46–54 Hz (6–10kVA)	45–55 Hz
Current THD at 100% load	12% with full resistive load (1–3 kVA) < 5% with full resistive load (6–10 kVA)	< 5%
Power factor at 100% load	≥0.95 (1–3 kVA) ≥0.99 (6–10 kVA)	≥ 0.99
OUTPUT		
Rated output voltage (load dependent)	220/230/240 VAC (1–3 kVA) 208/220/230/240 VAC (6–10 kVA)	
Voltage THD (with linear load)	< 3% linear load, < 6% non linear load (1–3 kVA) < 3% linear load, < 5% non linear load (6–10 kVA)	< 2% linear load, < 5% non linear load (1–3 kVA) < 2% linear load, < 4% non linear load (6–10 kVA)
Rated frequency	50 Hz	50 Hz
EFFICIENCY		
Line-interactive	–	–
Double conversion	Up to 90%(1-3 kVA) 92% for 6 kVA 93% for 10 kVA	Up to 92% (1–3 kVA); 94% (6–10 kVA)
Eco-mode	Up to 95% (1–3 kVA) Up to 98% (6–10kVA)	Upto 98%
COMMUNICATIONS		
User Interface	LCD	LCD
Communication ports	SNMP; ModBus; AS400; Environmental monitoring sensor probe	USB, RS-232, SNMP slot, potential-free contacts
Software	Monitoring and shutdown software available as option	

UPS product overview

10 kVA to 5 MVA

3 Phase Standalone UPS



GENERAL DATA	PowerScale 33 (Transformerless)	PowerWave 33 (Transformerless)	SG Series (Transformer based)
UPS frame rated power	10/15/20/25/30/40/50 kVA	60/80/100/120/160/200/ 250/300/400/500 kW	10–500 kVA
UPS module rated power	–	–	–
UPS output rated PF	0.9	1.0	0.9
Max. no of parallel frames	Up to 20 units	Up to 10 units	Up to 6 units
Max no of parallel modules across frames	–	–	–
Max system power	1000 kVA	5000 kW	3000 kVA
Wiring	3ph + N + PE	3ph + N + PE	3ph + N + PE
UPS type	Standalone tower	Standalone tower	Standalone tower
Topology	Online double conversion	Online double conversion	Online double conversion
INPUT			
Nominal input voltage	220 / 380, 230 / 400, 240 / 415 VAC	220 / 380, 230 / 400, 240 / 415 VAC	380/400/415 VAC 340–460 VAC
Voltage range	161/280 – 264/460 VAC	138/240 – 264/460 VAC	340–460 VAC
Frequency range	35 – 70 Hz	35 – 70 Hz	45–66 Hz
Current THD at 100% load	≤ 3%	≤ 4%	< 2%
Power factor at 100% load	≥ 0.99	≥ 0.99	0.99
OUTPUT			
Rated output voltage (load dependent)	220 / 380, 230 / 400, 240 / 415 VAC	220 / 380, 230 / 400, 240 / 415 VAC	3x 380/400/415 VAC
Voltage THD (with linear load)	< 2%	< 2%	< 1.5%
Rated frequency	50 or 60 Hz (selectable)	50 or 60 Hz (selectable)	50 or 60 Hz (selectable)
EFFICIENCY			
Line-interactive	–	–	–
Double conversion	Up to 95.5%	Up to 96%	up to 94.6%
Eco-mode	98%	99%	up to 98.7% (eBoost)
COMMUNICATIONS			
User Interface	LCD + mimic diagram	Graphical touch screen (optional on 160 – 200 kW), LCD+mimic diagram (on 60– 200 kW only)	System Graphical Display LCD
Communication ports	USB (optional), RS-232, SNMP slot, potential-free contacts (optional)	USB, RS-232, SNMP slot, potential-free contacts	RS232, SNMP (Modbus IP, RS232, RS485 & BacNet IP)
Software	Monitoring and shutdown software available as option		

UPS product overview

10 kVA to 1.5 MVA

3 phase Modular UPS



GENERAL DATA	DPA UPScale RI	DPA UPScale ST	ConceptPower DPA 250 S2	DPA 250 S4
UPS frame rated power	10/20/40/80 kW	40/60/80/120/200 kW	200 kW	300 kW
UPS module rated power	10/20 kW	10/20 kW	30/40/50 kW	50 kW
UPS output rated PF	1.0	1.0	0.8	1.0
Max. no of parallel frames	1 subrack	Up to 4 frames	Up to 6 frames	Up to 5 frames
Max no of parallel modules across frames	4 modules	20 modules	30 modules	30 modules
Max system power	80 kW	400 kW	1200 kW	1500 kW
Wiring	3ph + N + PE	3ph + N + PE	3ph + N + PE	3ph + N + PE
UPS type	Modular (DPA)	Modular (DPA)	Modular (DPA)	Modular (DPA)
Topology	Online double conversion	Online double conversion	Online double conversion	Online double conversion
INPUT				
Nominal input voltage	220/380, 230/400, 240/415 VAC	220/380, 230/400, 240/415 VAC	220/380, 230/400, 240/415 VAC	220/380, 230/400, 240/415 VAC
Voltage range	150/260 – 264/460 VAC	150/260 – 264/460 VAC	161/280 – 264/460 VAC	161/280 – 264/460 VAC
Frequency range	35 – 70 Hz	35 – 70 Hz	30 – 70 Hz	35 – 70 Hz
Current THD at 100% load	< 3%	< 3%	< 3%	< 3%
Power factor at 100% load	≥ 0.99	≥ 0.99	≥ 0.99	≥ 0.99
OUTPUT				
Rated output voltage (load dependent)	220/380, 230/400, 240/415 VAC	220/380, 230/400, 240/415 VAC	220/380, 230/400, 240/415 VAC	220/380, 230/400, 240/415 VAC
Voltage THD (with linear load)	< 1.5%	< 1.5%	< 2%	< 2%
Rated frequency	50 or 60 Hz (selectable)	50 or 60 Hz (selectable)	50 or 60 Hz (selectable)	50 or 60 Hz (selectable)
EFFICIENCY				
Line-interactive	–	–	–	–
Double conversion	Up to 96%	Up to 96%	Up to 95.5 %	Up to 97.6% module efficiency, up to 97.4% system efficiency
Eco-mode	98%	98%	98%	99%
COMMUNICATIONS				
User Interface	Module level LCD+mimic diagram, Remote system display optional	Module level LCD+mimic diagram, System graphical display	Module level LCD+mimic diagram, System graphical display	Module level LCD+mimic diagram, System graphical display
Communication ports	USB, RS-232, SNMP slot, potential-free contacts	USB, RS-232, SNMP slot, potential-free contacts	USB, RS-232, SNMP slot, potential-free contacts	USB, RS-232, SNMP slot, potential-free contacts
Software	Monitoring and shutdown software available as option			

UPS product overview

1 kVA to 6 MVA

3 phase Modular UPS



GENERAL DATA	Conceptpower DPA 500	MegaFlex DPA
UPS frame rated power	500 kW	1000/1500 kW
UPS module rated power	100 kW	250 kW
UPS output rated PF	1.0	1.0
Max. no of parallel frames	Up to 6 frames	Up to 4 frames
Max no of parallel modules across frames	30 modules	24 modules
Max system power	3000 kW	6000 kW
Wiring	3ph + N + PE	3ph + N + PE
UPS type	Modular (DPA)	Modular (DPA)
Topology	Online double conversion	Online double conversion
INPUT		
Nominal input voltage	220/380, 230/400, 240/415 VAC	220/380, 230/400, 240/415 VAC
Voltage range	161/280 – 264/460 VAC	161/280 – 264/460 VAC
Frequency range	35 – 70 Hz	40 – 70 Hz
Current THD at 100% load	< 3.5%	<4%
Power factor at 100% load	≥ 0.99	≥ 0.99
OUTPUT		
Rated output voltage (load dependent)	220/380, 230/400, 240/415 VAC	220/380, 230/400, 240/415 VAC
Voltage THD (with linear load)	< 2%	< 2%
Rated frequency	50 or 60 Hz (selectable)	50 or 60 Hz (selectable)
EFFICIENCY		
Line-interactive	-	-
Double conversion	Up to 96%	Up to 97.4%
Eco-mode	99%	99%
COMMUNICATIONS		
User Interface	Module level LCD+mimic diagram,	Module level LCD+mimic diagram,
Communication ports	System graphical display USB, RS-232, SNMP slot, potential-free contacts	System graphical display USB, RS-232, potential-free contacts, ABB network card
Software	Monitoring and shutdown software available as option	

Electrical installation solutions for buildings

A world of advantages

Miniature circuit-breakers

1 S200 Series
Circuit breakers up to 63 A
S200, S200M and S200P:
For residential, commercial and
industrial use up to 25 kA.
S200U, S200UP and SU200PR
with certification acc. to:
Certification UL489/CSA 22.2
No. 5 (US and Canada).

2 SN201 Series
SN201 series circuit breakers
including one pole and neutral
in one module width up to
40 A specific for household
applications and tertiary sector.

3 S800 Series
S800 circuit breakers with high
breaking capacity up to 125 A
S800B: 16 kA breaking capacity.
S800C: 25 kA breaking capacity.
S800N: 36 kA breaking capacity.
S800S: 50 kA breaking capacity.

Residual current protection

4 F200 Series
Residual current devices up to 125 A
F200: Residential, tertiary and industrial.

5 DDA200 and DDA800 Series
RCD blocks adaptable to the S200
and S800 circuit-breaker series up
to 63 A and 100 A respectively.

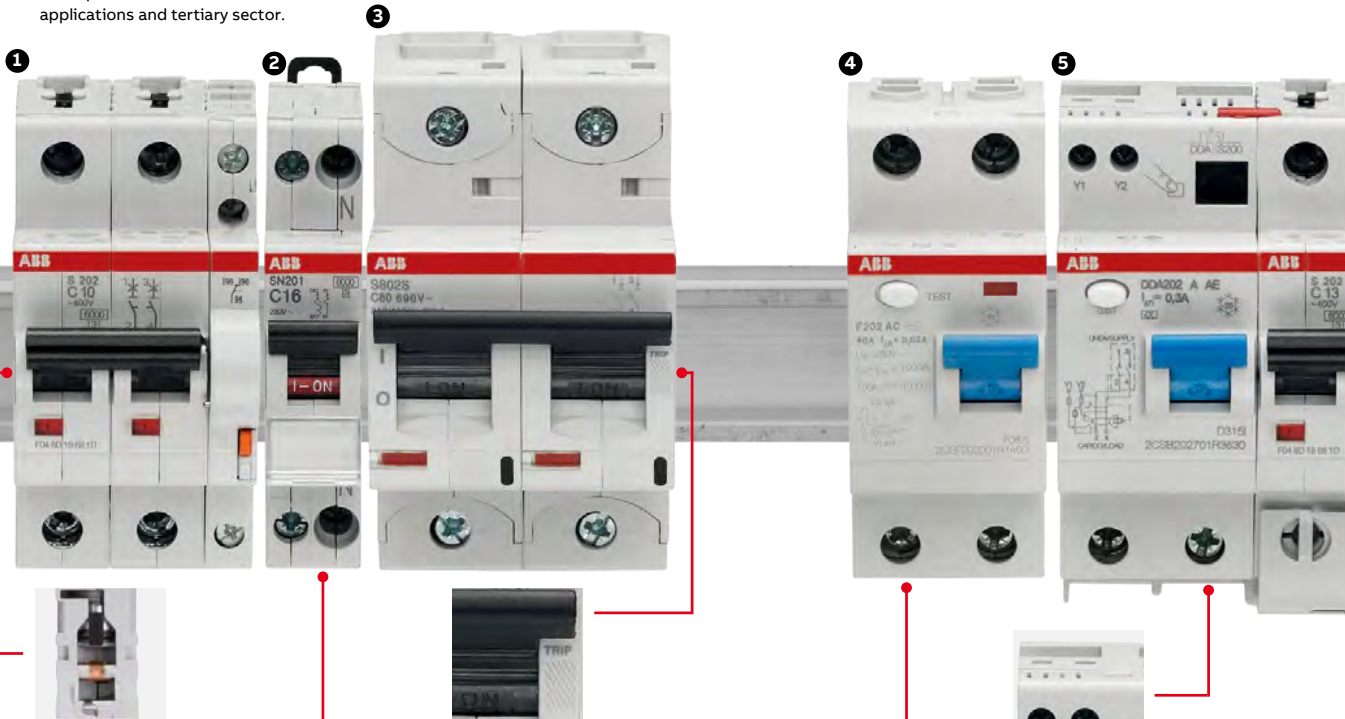

Increased terminal opening for higher wire gauges up to 35 mm². For conductors with or without connector sleeves. Fulfills still the requirements for protection degree IP20 (finger safe) acc. to IEC/EN 60529. Integrated plate protecting flexible cables from damage and homogenous pressure in the terminal opening.



Multiple certification marks visible on the upper and lower face of the S200 circuit breakers. Laser marking for reliable readability. Real contact position indication, directly connected to the moving contact, for more comfort and safety. Individual identification code for each MCB on the front.

Switch with intermediate trip position (TRIP). S800 circuit breakers differentiate manual actuation from over-current trip.



Label-holder built into SN200 circuit breakers. Easy identification of protected circuits. One pole plus neutral in a width of just 17.6 mm.



The green/red switch colour clearly indicates the connected/disconnected status.



Terminal on the front face for fail-safe function.



Failsafe bi-directional cylinder-lift terminal at top and bottom (available for the entire System pro M compact® range). Ideal for connection of cables and busbars simultaneously.



Electrical installation solutions for buildings

A world of advantages

6 DS200 Series

Overcurrent and residual current protection in a single device, just two modules width. Suitable for residential, tertiary and industrial applications.

7 RD3 residual current relays

Residual current relays with the possibility to set sensitivity and intervention time. Ideal to obtain time and sensitivity combinations and to achieve selectivity with other residual current devices.

Other protection devices

8 OVR series surge protective devices

Protection of electrical equipment against surges caused by lightning or other grid disruptions.

9 E90 fuseholders and fuse disconnectors

E90: Disconnecter series up to 32 A.
E90h: Compact series up to 32 A.
E90 50/125: Series up to 125 A.



Displays the cause of the trip of the DS200 residual current breaker. Blue (residual current) trip or black (over-current trip indications).



Includes Rfid label. Prevents forgeries through the inclusion of a serial number in compliance with the ISO/IEC FCD 15693-3 standard.



Contact position indicator visible on the front of the DS200 residual current breaker.

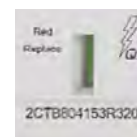

Visual indicator of the remaining life of the OVR surge protective device. Option to include remote signaling contacts of the OVR status.

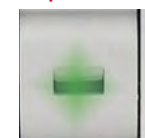

Blown fuse indicator light on the front part of the E90 fuseholder.

Electrical installation solutions for buildings

A world of advantages

Command and control

10 **Contactors, latching relays and installation relays**
 ESB/EN..N series installation contactors.
 E297 series installation relays.
 E290 and E260 series latching relays.

11 **Switch disconnectors**
 E200 series switch disconnectors
 From 1 to 4 poles.
 Up to 125 A.

 SD200 switch disconnectors
 From 1 to 4 poles.
 Up to 63 A.
 Fully compatible with MCB accessories.

12 **E210 series on-off switches, push buttons and indicator lamps**
 E211 and E218 series on-off switches.
 E213 series change over switches.
 E214 series group switches.
 E215 and E217 series push buttons.
 E219 series single, double and triple indicator lights.

13 **D-Line digital and AT analogue time switches**
 D1 and D2 weekly digital time switches.
 D365 yearly digital time switches.
 AT analogue time switches.

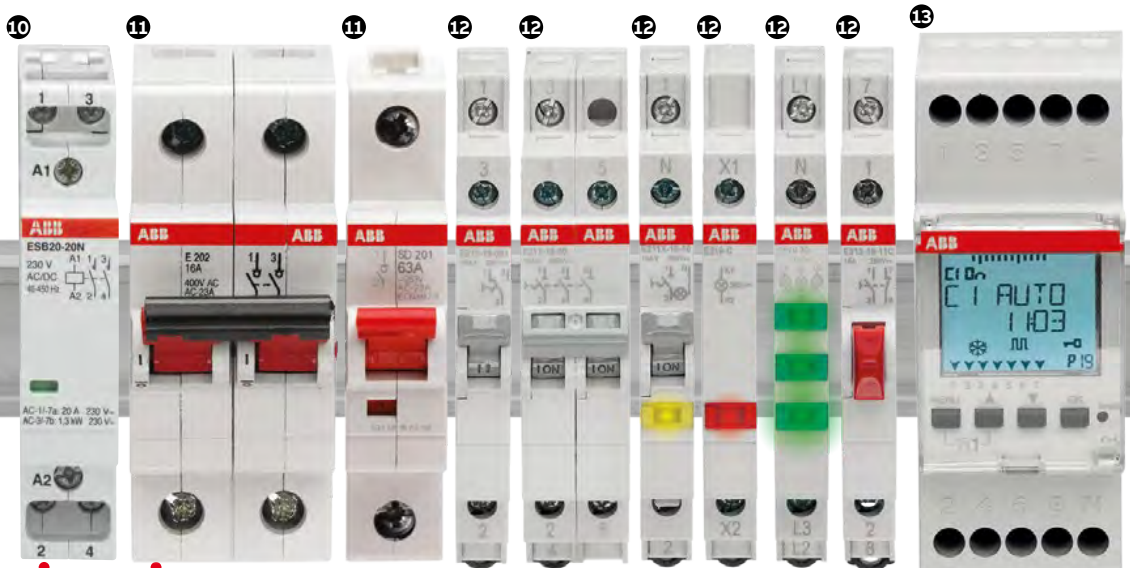

Currents up to 125 A.
 From 1 to 4 poles.
 Option to include an add-on of up to 3 auxiliary contacts.

Hum-free operation.
 Variety of control voltages.
 Multiple combinations of NO and NC contacts.
 Function modes selector:
 Automatic/Connected/Disconnected (EN series).

Multiple command and control functions in the ultra-compact design (9 mm width) of the E210 series.

Up to 3 E219 LED indicator lights in a width of just 9 mm. LED indicators guarantee an optimal illumination with very low consumption.

Electrical installation solutions for buildings

A world of advantages

14 TWA astronomical switches and TW twilight switches

TWA astronomical switches to activate lighting systems according to the rising and setting of the sun.
TW twilight switches to control lighting devices according to the level of the ambient light.

15 E234 series electronic timers and E232 series staircase switches

Wide range of E234.
E232 staircase timers for household applications.

16 CP-D primary switch mode power supplies

Optimized for world-wide applications with a wide AC and DC supply range and continuously adjustable output voltage. Additional redundancy unit CP-RUD available.

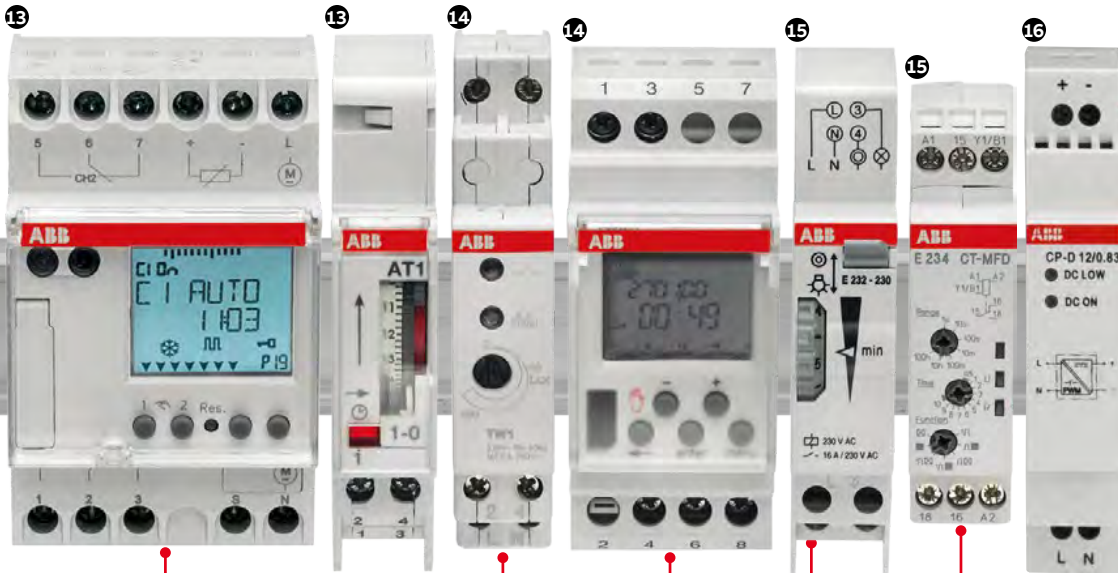

D-Line series weekly and annual digital time switches. Multiple communication options. Wide range of programs: standard, cyclic, casual and holiday. White backlit LCD display.

Connection and disconnection time delays. Continuous and impulse signals among multiple options.

Easy to program. Ideal for public lighting, stores lighting, monuments, etc.

Miniature Circuit Breaker SB200 M

The details make the difference

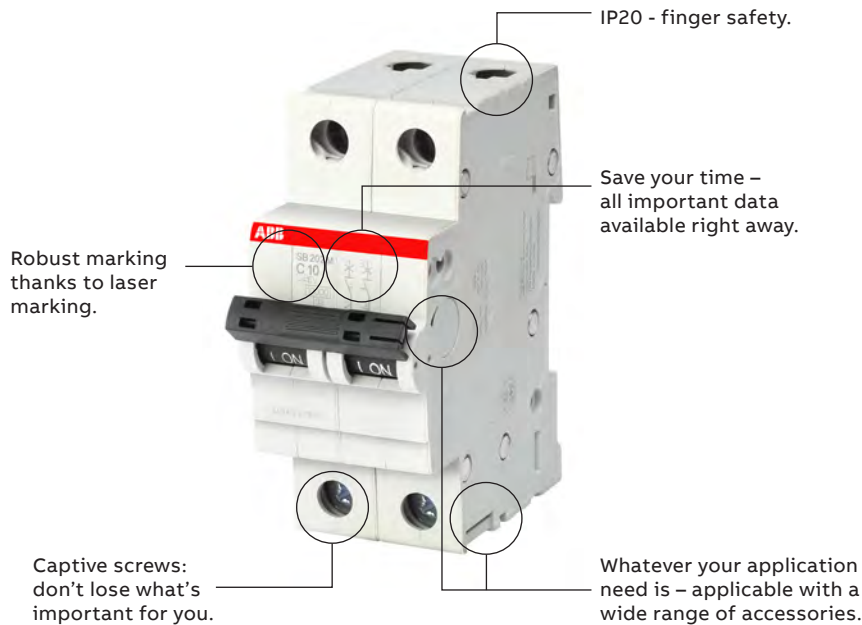

Technical Features

General data

Standards	IEC/IS 60898-1, IEC/IS 60947-2
Poles	B: 1P, 1P+N, 2P C: 1P, 2P, 3P, 4P, 1P+N, 3P+N D: 1P, 2P, 3P, 4P
Rated short-circuit capacity (Icn)	10 kA
Rated ultimate short-circuit breaking capacity Icu (acc.to IEC 60947-2)	15 kA
Tripping characteristics	B, C, D
Reference temperature for tripping characteristics	30°C
Energy limiting class (B-,C- Curve)	3
Rated voltage Ue	1P : 240/415 V AC 1P + N : 240 V AC 2...4P : 415 V AC 3P + N : 415 V AC
Rated current In	B: 6, 10, 16, 20, 25, 32, 40 A C&D: 0,5, 1, 1,6, 2, 3, 4, 6, 10, 16, 20, 25, 32, 40, 50, 63 A
Rated frequency	50 Hz
Max. Power frequency recovery voltage (Umax)	1P: 264 V AC; 60V DC; 1P+N:264 V AC; 2...4P : 457 V AC; 2P: 120V DC; 3P+N: 457 V AC
Min. operating voltage	12 V AC
Rated insulation voltage Ui acc. to IEC/EN 60664-1	250 V AC (phase to ground) , 440 V AC (phase to phase)
Rated impulse withstand voltage Uimp. (1.2/50µs)	4 kV (test voltage 6.2kV at sea level, 5kV at 2.000m)
Dielectric test voltage	2 kV (50 / 60Hz, 1 min.)
Overvoltage category	III
Pollution degree	3
Electrical endurance	In < 32A: 20.000 ops.(AC), In ≥ 32A: 10.000 ops.(AC); 1.000 ops. (DC); 1 cycle (2s - ON, 13s - OFF, In ≤ 32A), 1 cycle (2s - ON, 28s - OFF, In >32A)

MCB SB200 M

B characteristic



SB201 M B 16

SB200 M B characteristic

Function: protection and control of the circuits against overloads and short-circuits; protection for resistive and inductive loads with low inrush current.

Applications: residential, commercial and industrial.

Standard: IEC/IS 60898-1, IEC/IS 60947-2

Icn=10 kA

SB201 M B

Number of poles	Rated current In A	Order details		Standard pack	Unit MRP ₹
		Type code	Order code		
1P	6	SB201 M-B6	1SYS271012R0065 ■	12	335
	10	SB201 M-B10	1SYS271012R0105 ■	12	335
	16	SB201 M-B16	1SYS271012R0165 ■	12	335
	20	SB201 M-B20	1SYS271012R0205 ■	12	335
	25	SB201 M-B25	1SYS271012R0255 ■	12	335
	32	SB201 M-B32	1SYS271012R0325 ■	12	335
	40	SB201 M-B40	1SYS271012R0405 ■	12	665

SB201 M B NA

Number of poles	Rated current In A	Order details		Standard pack	Unit MRP ₹
		Type code	Order code		
1P+N	6	SB201 M-B6 NA	1SYS271112R0065 ■	6	950
	10	SB201 M-B10 NA	1SYS271112R0105 ■	6	950
	16	SB201 M-B16 NA	1SYS271112R0165 ■	6	950
	20	SB201 M-B20 NA	1SYS271112R0205 ■	6	950
	25	SB201 M-B25 NA	1SYS271112R0255 ■	6	950
	32	SB201 M-B32 NA	1SYS271112R0325 ■	6	950
	40	SB201 M-B40 NA	1SYS271112R0405 ■	6	1,545

SB202 M B

Number of poles	Rated current In A	Order details		Standard pack	Unit MRP ₹
		Type code	Order code		
2P	6	SB202 M-B6	1SYS272012R0065 ■	6	890
	10	SB202 M-B10	1SYS272012R0105 ■	6	890
	16	SB202 M-B16	1SYS272012R0165 ■	6	890
	20	SB202 M-B20	1SYS272012R0205 ■	6	890
	25	SB202 M-B25	1SYS272012R0255 ■	6	890
	32	SB202 M-B32	1SYS272012R0325 ■	6	890
	40	SB202 M-B40	1SYS272012R0405 ■	6	1,500

MCB SB200 M

C characteristic



SB201 M C 16

SB200 M C characteristic

Function: protection and control of the circuits against overloads and short-circuits; protection for resistive and inductive loads with low inrush current.

Applications: residential, commercial and industrial.

Standard: IEC/IS 60898-1, IEC/IS 60947-2

Icn=10 kA

SB201 M C

Number of poles	Rated current In A	Order details		Standard pack	Unit MRP ₹
		Type code	Order code		
1P	0.5	SB201 M-C0.5	1SYS271012R0984	12	555
	1	SB201 M-C1	1SYS271012R0014	12	555
	1.6	SB201 M-C1.6	1SYS271012R0974	12	555
	2	SB201 M-C2	1SYS271012R0024	12	485
	3	SB201 M-C3	1SYS271012R0034	12	485
	4	SB201 M-C4	1SYS271012R0044	12	485
	6	SB201 M-C6	1SYS271012R0064 ■	12	335
	10	SB201 M-C10	1SYS271012R0104 ■	12	335
	16	SB201 M-C16	1SYS271012R0164 ■	12	335
	20	SB201 M-C20	1SYS271012R0204 ■	12	335
	25	SB201 M-C25	1SYS271012R0254 ■	12	335
	32	SB201 M-C32	1SYS271012R0324 ■	12	335
	40	SB201 M-C40	1SYS271012R0404	12	665
	50	SB201 M-C50	1SYS271012R0504	12	665
	63	SB201 M-C63	1SYS271012R0634	12	665

SB201 M C NA

Number of poles	Rated current In A	Order details		Standard pack	Unit MRP ₹
		Type code	Order code		
1P+N	0.5	SB201 M-C0.5 NA	1SYS271112R0984	6	1,575
	1	SB201 M-C1 NA	1SYS271112R0014	6	1,575
	1.6	SB201 M-C1.6 NA	1SYS271112R0974	6	1,575
	2	SB201 M-C2 NA	1SYS271112R0024	6	1,370
	3	SB201 M-C3 NA	1SYS271112R0034	6	1,370
	4	SB201 M-C4 NA	1SYS271112R0044	6	1,370
	6	SB201 M-C6 NA	1SYS271112R0064 ■	6	950
	10	SB201 M-C10 NA	1SYS271112R0104 ■	6	950
	16	SB201 M-C16 NA	1SYS271112R0164 ■	6	950
	20	SB201 M-C20 NA	1SYS271112R0204 ■	6	950
	25	SB201 M-C25 NA	1SYS271112R0254 ■	6	950
	32	SB201 M-C32 NA	1SYS271112R0324 ■	6	950
	40	SB201 M-C40 NA	1SYS271112R0404 ■	6	1,545
	50	SB201 M-C50 NA	1SYS271112R0504 ■	6	1,545
	63	SB201 M-C63 NA	1SYS271112R0634 ■	6	1,545

■ Stock items

MCB SB200 M

C characteristic



SB202 M C 16

SB202 M C

Number of poles	Rated current In A	Order details		Standard pack	Unit MRP ₹
		Type code	Order code		
2P	0.5	SB202 M-C0.5	1SYS272012R0984	6	1,465
	1	SB202 M-C1	1SYS272012R0014	6	1,465
	1.6	SB202 M-C1.6	1SYS272012R0974	6	1,465
	2	SB202 M-C2	1SYS272012R0024	6	1,325
	3	SB202 M-C3	1SYS272012R0034	6	1,325
	4	SB202 M-C4	1SYS272012R0044	6	1,325
	6	SB202 M-C6	1SYS272012R0064 ■	6	945
	10	SB202 M-C10	1SYS272012R0104 ■	6	945
	16	SB202 M-C16	1SYS272012R0164 ■	6	945
	20	SB202 M-C20	1SYS272012R0204 ■	6	945
	25	SB202 M-C25	1SYS272012R0254 ■	6	945
	32	SB202 M-C32	1SYS272012R0324 ■	6	945
	40	SB202 M-C40	1SYS272012R0404 ■	6	1,500
	50	SB202 M-C50	1SYS272012R0504 ■	6	1,500
	63	SB202 M-C63	1SYS272012R0634 ■	6	1,500

SB203 M C

Number of poles	Rated current In A	Order details		Standard pack	Unit MRP ₹
		Type code	Order code		
3P	0.5	SB203 M-C0.5	1SYS273012R0984	4	2,250
	1	SB203 M-C1	1SYS273012R0014	4	2,250
	1.6	SB203 M-C1.6	1SYS273012R0974	4	2,250
	2	SB203 M-C2	1SYS273012R0024	4	2,060
	3	SB203 M-C3	1SYS273012R0034	4	2,060
	4	SB203 M-C4	1SYS273012R0044	4	2,060
	6	SB203 M-C6	1SYS273012R0064 ■	4	1,545
	10	SB203 M-C10	1SYS273012R0104 ■	4	1,545
	16	SB203 M-C16	1SYS273012R0164 ■	4	1,545
	20	SB203 M-C20	1SYS273012R0204 ■	4	1,545
	25	SB203 M-C25	1SYS273012R0254 ■	4	1,545
	32	SB203 M-C32	1SYS273012R0324 ■	4	1,545
	40	SB203 M-C40	1SYS273012R0404 ■	4	2,360
	50	SB203 M-C50	1SYS273012R0504 ■	4	2,360
	63	SB203 M-C63	1SYS273012R0634 ■	4	2,360

■ Stock items

MCB SB200 M

C characteristic

SB203M C NA

Number of poles	Rated current In A	Order details		Standard pack	Unit MRP ₹
		Type code	Order code		
3P+N	0.5	SB203 M-C0.5 NA	1SYS273112R0984	3	3,325
	1	SB203 M-C1 NA	1SYS273112R0014	3	3,325
	1.6	SB203 M-C1.6 NA	1SYS273112R0974	3	3,325
	2	SB203 M-C2 NA	1SYS273112R0024	3	2,920
	3	SB203 M-C3 NA	1SYS273112R0034	3	2,920
	4	SB203 M-C4 NA	1SYS273112R0044	3	2,920
	6	SB203 M-C6 NA	1SYS273112R0064 ■	3	2,105
	10	SB203 M-C10 NA	1SYS273112R0104 ■	3	2,105
	16	SB203 M-C16 NA	1SYS273112R0164 ■	3	2,105
	20	SB203 M-C20 NA	1SYS273112R0204 ■	3	2,105
	25	SB203 M-C25 NA	1SYS273112R0254 ■	3	2,105
	32	SB203 M-C32 NA	1SYS273112R0324 ■	3	2,105
	40	SB203 M-C40 NA	1SYS273112R0404 ■	3	2,975
	50	SB203 M-C50 NA	1SYS273112R0504 ■	3	2,975
63	SB203 M-C63 NA	1SYS273112R0634 ■	3	2,975	



SB204 M C 16

SB204 M C

Number of poles	Rated current In A	Order details		Standard pack	Unit MRP ₹
		Type code	Order code		
4P	0.5	SB204 M-C0.5	1SYS274012R0984	3	3,160
	1	SB204 M-C1	1SYS274012R0014	3	3,160
	1.6	SB204 M-C1.6	1SYS274012R0974	3	3,160
	2	SB204 M-C2	1SYS274012R0024	3	2,755
	3	SB204 M-C3	1SYS274012R0034	3	2,755
	4	SB204 M-C4	1SYS274012R0044	3	2,755
	6	SB204 M-C6	1SYS274012R0064 ■	3	1,995
	10	SB204 M-C10	1SYS274012R0104 ■	3	1,995
	16	SB204 M-C16	1SYS274012R0164 ■	3	1,995
	20	SB204 M-C20	1SYS274012R0204 ■	3	1,995
	25	SB204 M-C25	1SYS274012R0254 ■	3	1,995
	32	SB204 M-C32	1SYS274012R0324 ■	3	1,995
	40	SB204 M-C40	1SYS274012R0404 ■	3	3,050
	50	SB204 M-C50	1SYS274012R0504 ■	3	3,050
63	SB204 M-C63	1SYS274012R0634 ■	3	3,050	

■ Stock items

MCB SB200 M

D characteristic



SB202 M D 16

SB200 M D characteristic

Function: protection and control of the circuits against overloads and short-circuits; protection for resistive and inductive loads with low inrush current.

Applications: residential, commercial and industrial.

Standard: IEC/IS 60898-1, IEC/IS 60947-2

Icn=10 kA

SB201 M D

Number of poles	Rated current In A	Order details		Standard pack	Unit MRP ₹
		Type code	Order code		
1P	0.5	SB201 M-D0,5	1SYS271012R0981	12	630
	1	SB201 M-D1	1SYS271012R0011	12	630
	1.6	SB201 M-D1,6	1SYS271012R0971	12	630
	2	SB201 M-D2	1SYS271012R0021	12	550
	3	SB201 M-D3	1SYS271012R0031	12	550
	4	SB201 M-D4	1SYS271012R0041	12	550
	6	SB201 M-D6	1SYS271012R0061	12	445
	10	SB201 M-D10	1SYS271012R0101	12	445
	16	SB201 M-D16	1SYS271012R0161	12	445
	20	SB201 M-D20	1SYS271012R0201	12	445
	25	SB201 M-D25	1SYS271012R0251	12	445
	32	SB201 M-D32	1SYS271012R0321	12	445
	40	SB201 M-D40	1SYS271012R0401	12	750
	50	SB201 M-D50	1SYS271012R0501	12	750
	63	SB201 M-D63	1SYS271012R0631	12	750

SB202 M D

Number of poles	Rated current In A	Order details		Standard pack	Unit MRP ₹
		Type code	Order code		
2P	0.5	SB202 M-D0.5	1SYS272012R0981	6	1,735
	1	SB202 M-D1	1SYS272012R0011	6	1,735
	1.6	SB202 M-D1.6	1SYS272012R0971	6	1,735
	2	SB202 M-D2	1SYS272012R0021	6	1,510
	3	SB202 M-D3	1SYS272012R0031	6	1,510
	4	SB202 M-D4	1SYS272012R0041	6	1,510
	6	SB202 M-D6	1SYS272012R0061	6	1,080
	10	SB202 M-D10	1SYS272012R0101	6	1,080
	16	SB202 M-D16	1SYS272012R0161	6	1,080
	20	SB202 M-D20	1SYS272012R0201	6	1,080
	25	SB202 M-D25	1SYS272012R0251	6	1,080
	32	SB202 M-D32	1SYS272012R0321	6	1,080
	40	SB202 M-D40	1SYS272012R0401	6	1,775
	50	SB202 M-D50	1SYS272012R0501	6	1,775
	63	SB202 M-D63	1SYS272012R0631	6	1,775

MCB SB200 M

D characteristic



SB203 M D 16

SB203 M D

Number of poles	Rated current In A	Order details		Standard pack	Unit MRP ₹
		Type code	Order code		
3P	0.5	SB203 M-D0.5	1SYS273012R0981	4	2,675
	1	SB203 M-D1	1SYS273012R0011	4	2,675
	1.6	SB203 M-D1.6	1SYS273012R0971	4	2,675
	2	SB203 M-D2	1SYS273012R0021	4	2,340
	3	SB203 M-D3	1SYS273012R0031	4	2,340
	4	SB203 M-D4	1SYS273012R0041	4	2,340
	6	SB203 M-D6	1SYS273012R0061	4	1,765
	10	SB203 M-D10	1SYS273012R0101	4	1,765
	16	SB203 M-D16	1SYS273012R0161	4	1,765
	20	SB203 M-D20	1SYS273012R0201	4	1,765
	25	SB203 M-D25	1SYS273012R0251	4	1,765
	32	SB203 M-D32	1SYS273012R0321	4	1,765
	40	SB203 M-D40	1SYS273012R0401	4	2,785
	50	SB203 M-D50	1SYS273012R0501	4	2,785
63	SB203 M-D63	1SYS273012R0631	4	2,785	

SB204 M D

Number of poles	Rated current In A	Order details		Standard pack	Unit MRP ₹
		Type code	Order code		
4P	0.5	SB204 M-D0.5	1SYS274012R0981	3	2,925
	1	SB204 M-D1	1SYS274012R0011	3	2,925
	1.6	SB204 M-D1.6	1SYS274012R0971	3	2,925
	2	SB204 M-D2	1SYS274012R0021	3	3,075
	3	SB204 M-D3	1SYS274012R0031	3	3,075
	4	SB204 M-D4	1SYS274012R0041	3	3,075
	6	SB204 M-D6	1SYS274012R0061	3	2,440
	10	SB204 M-D10	1SYS274012R0101	3	2,440
	16	SB204 M-D16	1SYS274012R0161	3	2,440
	20	SB204 M-D20	1SYS274012R0201	3	2,440
	25	SB204 M-D25	1SYS274012R0251	3	2,440
	32	SB204 M-D32	1SYS274012R0321	3	2,440
	40	SB204 M-D40	1SYS274012R0401	3	3,220
	50	SB204 M-D50	1SYS274012R0501	3	3,220
63	SB204 M-D63	1SYS274012R0631	3	3,220	

Miniature Circuit Breaker SB200 DC

Right product for right application

The range impresses with its performance, approvals and high in-built short-circuit breaking capacity for

DC application. Can be used in SP version at 250V DC and DP version upto 500V DC.

Polarity marking.



IP20 - finger safety.

Captive screws: don't lose what's important for you.

Approvals and standard.

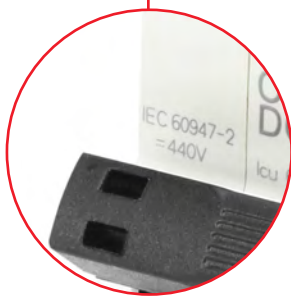

Whatever your application need is – applicable with a wide range of accessories.

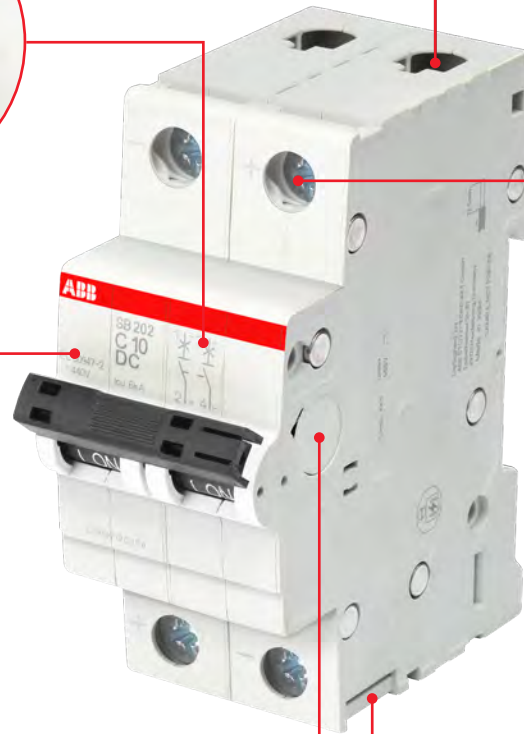



**State-of-the-art design
(Aesthetics & Ergonomics)**

Elegant in appearance and the knob is designed for easy operation.



Laser marking

All printing of the SB200 MCBs, like the approvals on the product identification, are printed by a laser. The laser printing ensures a friction, scratch and solvent resistant marking on the MCBs. Easy identification of the products in case of maintenance or replacement, due to safe laser printing.



Housing cover with fire retardant material

High performance 100% recyclable plastic material with fire retardant, high melting point, low water absorption & high dielectric strength properties. ABB is taking care of the environment... with the latest generation of thermoplastics, it is possible to recycle the MCBs – especially the thermoplastic housing material can be re-used. SB200 is 100% free of halogens.



IP20 protection

IP20 - finger safe terminals. The System pro M compact® MCBs are equipped with 25 mm² cylinder lift twin terminals, a well-proven and reliable technology - designed for sophisticated industrial use. The cross wiring can easily be done by inserting the System pro M compact® busbars into the rear terminal part and then the incoming wires into the front part of the terminal.



Labelling area

Provision for providing label enables easy identification and polarity marking of circuit during installation, operation & maintenance.



Accessories mountable

Wide range of add-on accessories having 30 different types of accessories. Max. possibility of mounting: 4 different accessories on the right side and 1 on the left side ensures highest flexibility of functions. Universal contact, motorised unique accessory like mechanical tripping devices available only with ABB.

MCB SB200 DC

C characteristic

SB200 DC characteristic

Function: protection and control of the circuits against overloads and short-circuits; protection for resistive and inductive loads with low inrush current.

Applications: residential, commercial and industrial.

Standard: IS/IEC 60947-2

I_{cn}=6 kA



SB201 C 6 DC

SB201 DC C

Number of poles	Rated current In A	Order details		Standard pack	L.P.(₹)
		Type code	Order code		
1P	1.6	SB201-C1.6DC	1SYS251067R0974	12	995
	2	SB201-C2DC	1SYS251067R0024	12	995
	3	SB201-C3DC	1SYS251067R0034	12	995
	4	SB201-C4DC	1SYS251067R0044	12	995
	6	SB201-C6DC	1SYS251067R0064	12	810
	10	SB201-C10DC	1SYS251067R0104	12	810
	16	SB201-C16DC	1SYS251067R0164	12	810
	20	SB201-C20DC	1SYS251067R0204	12	810
	25	SB201-C25DC	1SYS251067R0254	12	810
	32	SB201-C32DC	1SYS251067R0324	12	810
	40	SB201-C40DC	1SYS251067R0404	12	1,030
	50	SB201-C50DC	1SYS251067R0504	12	1,030
	63	SB201-C63DC	1SYS251067R0634	12	1,030



SB202 C 10 DC

SB202 DC

Number of poles	Rated current In A	Order details		Standard pack	L.P.(₹)
		Type code	Order code		
2P	1.6	SB202-C1.6DC	1SYS252067R0974	6	2,095
	2	SB202-C2DC	1SYS252067R0024	6	2,095
	3	SB202-C3DC	1SYS252067R0034	6	2,095
	4	SB202-C4DC	1SYS252067R0044	6	2,095
	6	SB202-C6DC	1SYS252067R0064	6	1,690
	10	SB202-C10DC	1SYS252067R0104	6	1,690
	16	SB202-C16DC	1SYS252067R0164	6	1,690
	20	SB202-C20DC	1SYS252067R0204	6	1,690
	25	SB202-C25DC	1SYS252067R0254	6	1,690
	32	SB202-C32DC	1SYS252067R0324	6	1,690
	40	SB202-C40DC	1SYS252067R0404	6	2,285
	50	SB202-C50DC	1SYS252067R0504	6	2,285
	63	SB202-C63DC	1SYS252067R0634	6	2,285



Miniature Circuit Breaker (MCB)

S200 series - 80, 100A



S201C

Features

- Breaking capacity - 6kA
- Tripping characteristics - C curve
- Suitable for -25..... +55 °C ambient temperatures
- Standards : Conforms to IEC60898, IEC60947-2

Description	Current rating (A)	Pack unit (Pc)	Ordering code	L.P.(₹)
Single pole				
S201-C80	80	1	2CDS251001R0804	3,095
S201-C100	100	1	2CDS251001R0824	3,620
Single pole & neutral				
S201-C80NA	80	1	2CDS251103R0804	6,470
S201-C100NA	100	1	2CDS251103R0824	7,725
Double pole				
S202-C80	80	1	2CDS252001R0804	6,065
S202-C100	100	1	2CDS252001R0824	7,005
Triple pole				
S203-C80	80	1	2CDS253001R0804	8,830
S203-C100	100	1	2CDS253001R0824	10,680
Triple pole & neutral				
S203-C80NA	80	1	2CDS253103R0804	13,270
S203-C100NA	100	1	2CDS253103R0824	15,820
Four pole				
S204-C80	80	1	2CDS254001R0804	12,400
S204-C100	100	1	2CDS254001R0824	13,405

High performance MCB

S800 series 80 to 125A



S801B C

Features

- Complies to standards IEC 60947-2 & EN 60898-1
- Compact size: One size up to 125A
- Compact performance: Selective and back-up characteristics
- Does not let go: The interchangeable terminal adapter. Cage terminals or ring lugs
- On the safe side: Operating status display.
- Simple and flexible: Accessories fitted by the customer
- Identical accessories for a broad range of applications

The S800 range

- S800S (50kA) upto 125A
- S800N (36kA) upto 125A
- S800C (25kA) upto 125A
- S800B (16kA) upto 125A
- S800PV-SP (upto 1500V DC & upto 125A)
- S800PV-M-H (upto 1500V DC & upto 125A)

S800B - 'C' Curve 16 kA as per IEC 60947-2

Single pole

Description	Current rating (A)	Pack unit (Pc)	Ordering code	L.P.(₹)
S801B-C32	32	1	2CCS811001R0324	3,080
S801B-C40	40	1	2CCS811001R0404	3,080
S801B-C50	50	1	2CCS811001R0504	3,235
S801B-C63	63	1	2CCS811001R0634	3,235
S801B-C80	80	1	2CCS811001R0804	3,775
S801B-C100	100	1	2CCS811001R0824	3,975
S801B-C125	125	1	2CCS811001R0844	4,175

Double pole

Description	Current rating (A)	Pack unit (Pc)	Ordering code	L.P.(₹)
S802B-C32	32	1	2CCS812001R0324	6,470
S802B-C40	40	1	2CCS812001R0404	6,470
S802B-C50	50	1	2CCS812001R0504	6,790
S802B-C63	63	1	2CCS812001R0634	6,790
S802B-C80	80	1	2CCS812001R0804	7,815
S802B-C100	100	1	2CCS812001R0824	8,355
S802B-C125	125	1	2CCS812001R0844	8,760

Triple pole

Description	Current rating (A)	Pack unit (Pc)	Ordering code	L.P.(₹)
S803B-C32	32	1	2CCS813001R0324	9,835
S803B-C40	40	1	2CCS813001R0404	9,835
S803B-C50	50	1	2CCS813001R0504	10,350
S803B-C63	63	1	2CCS813001R0634	10,350
S803B-C80	80	1	2CCS813001R0804	12,075
S803B-C100	100	1	2CCS813001R0824	12,720
S803B-C125	125	1	2CCS813001R0844	13,370

Four pole

Description	Current rating (A)	Pack unit (Pc)	Ordering code	L.P.(₹)
S804B-C32	32	1	2CCS814001R0324	13,240
S804B-C40	40	1	2CCS814001R0404	13,240
S804B-C50	50	1	2CCS814001R0504	13,910
S804B-C63	63	1	2CCS814001R0634	13,910
S804B-C80	80	1	2CCS814001R0804	16,225
S804B-C100	100	1	2CCS814001R0824	17,085
S804B-C125	125	1	2CCS814001R0844	17,965

Switch Disconnecter SDB200

The details make the difference

Easy product coding – easy identification: basic technical information already integrated into the name.

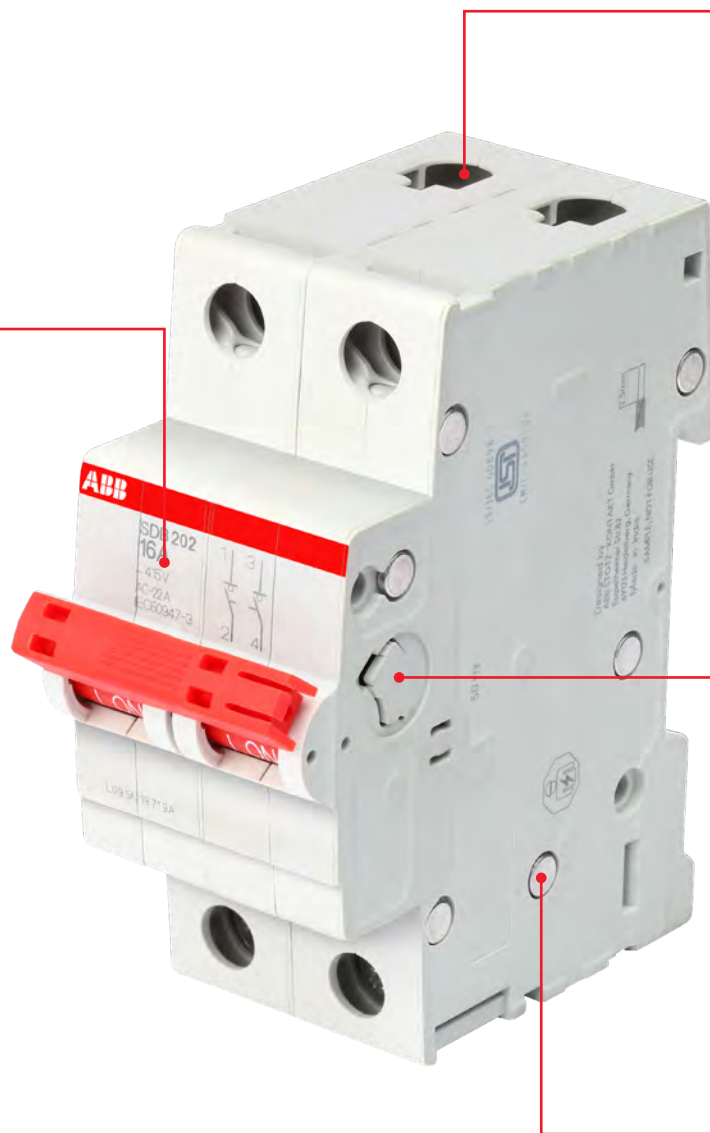

IP20 - finger safety.

Fully compatible with all System pro M devices and accessories.

Patented housing design: Environment-friendly and performance-optimized.



Patented housing design

By using state-of-the-art housing material, ABB is taking care of the environment. With the latest generation of halogen-free thermoplastics for SDB200, it is possible to recycle the switch disconnectors completely without environmental pollution. The material works for the stability.



Highest performance

With a rated voltage of 253/440 V AC, a rated conditional short-circuit current of 25 kA, terminals with protection from misconnection, a "Real CPI" switching position display, as well as full compatibility with all MCB accessories, the SDB200 is unique in its field of application. SDB200 complies with IEC/EN 60947-3.



IP20 protection

IP20 - finger safe terminals. The System pro M compact® MCBs are equipped with 25 mm² cylinder lift twin terminals, a well-proven and reliable technology - designed for sophisticated industrial use. The cross wiring can be easily done by inserting the System pro M compact® busbars into the rear terminal part and then the incoming wires into the front part of the terminal.

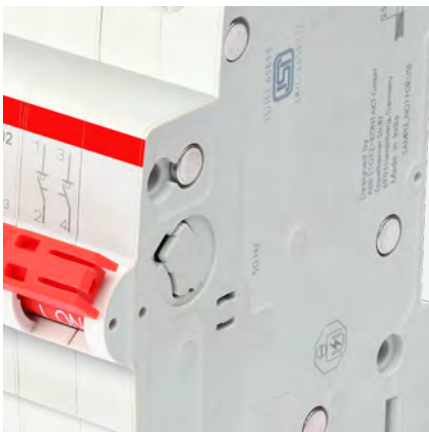

Laser printing

All labels on the SDB200, as the approvals on the dome, technical details and the product identification, are printed by a laser. The laser printing ensures a friction, scratch and solvent resistant marking on the switch disconnectors for easy identification in case of maintenance or replacement. For control and acceptance procedure, it is important to see all markings also in the mounted position.



ISI and CE marking

In addition to the International standards and markings IEC, the product is certified as per latest Indian Standards (ISI)



Wide range of accessories

SDB200 is fully compatible to the complete range of System pro M compact accessories like:

- Auxiliary contacts, to be mounted on the left side, the right side or bottom fitting
- Shunt trips
- Undervoltage release
- Motor operating devices

Switch Disconnecter

SDB200



SDB203 16 A

SDB202

Number of poles	Rated current In A	Order details		Standard pack	Unit MRP ₹
		Type code	Order code		
2P	40	SDB202/40	1SYD272115R0040 ■	6	745
	63	SDB202/63	1SYD272115R0063 ■	6	975

SDB203

Number of poles	Rated current In A	Order details		Standard pack	Unit MRP ₹
		Type code	Order code		
3P	40	SDB203/40	1SYD273115R0040 ■	4	1,270
	63	SDB203/63	1SYD273115R0063 ■	4	1,480

SDB204

Number of poles	Rated current In A	Order details		Standard pack	Unit MRP ₹
		Type code	Order code		
4P	40	SDB204/40	1SYD274115R0040 ■	3	1,580
	63	SDB204/63	1SYD274115R0063 ■	3	1,745

Note: Standard packing quantity for SDB switch Disconnecter: DP-6 Nos, TP-4 Nos, FP-3 Nos.

E200



E201

E200

Number of poles	Rated current In A	Order details		Standard pack	Unit L.P. ₹
		Type code	Order code		
Double pole					
2P	80	E202/80r	2CDE282001R0080	1	1,210
	100	E202/100r	2CDE282001R0100	1	1,910
	125	E202/125r	2CDE282001R0125	1	1,975
Triple pole					
3P	80	E203/80r	2CDE283001R0080	1	2,035
	100	E203/100r	2CDE283001R0100	1	2,230
	125	E203/125r	2CDE283001R0125	1	2,490
Four pole					
4P	80	E204/80r	2CDE284001R0080	1	2,290
	100	E204/100r	2CDE284001R0100	1	2,430
	125	E204/125r	2CDE284001R0125	1	2,710

Change over switch



E213

Description	Ordering code	L.P. (₹)
E213-16-002, double pole change over switch, 16 A (I-II)	2CCA703045R0001	2,765
E213-25-002, double pole change over switch, 25 A (I-II)	2CCA703046R0001	3,440
E214-16-202, group switch, 16 A (I-O-II)	2CCA703030R0001	3,115
E214-25-202, group switch, 25 A (I-O-II)	2CCA703031R0001	3,485

■ Stock items

Residual Current Circuit Breaker FB200

A range designed to ensure efficiency and protection

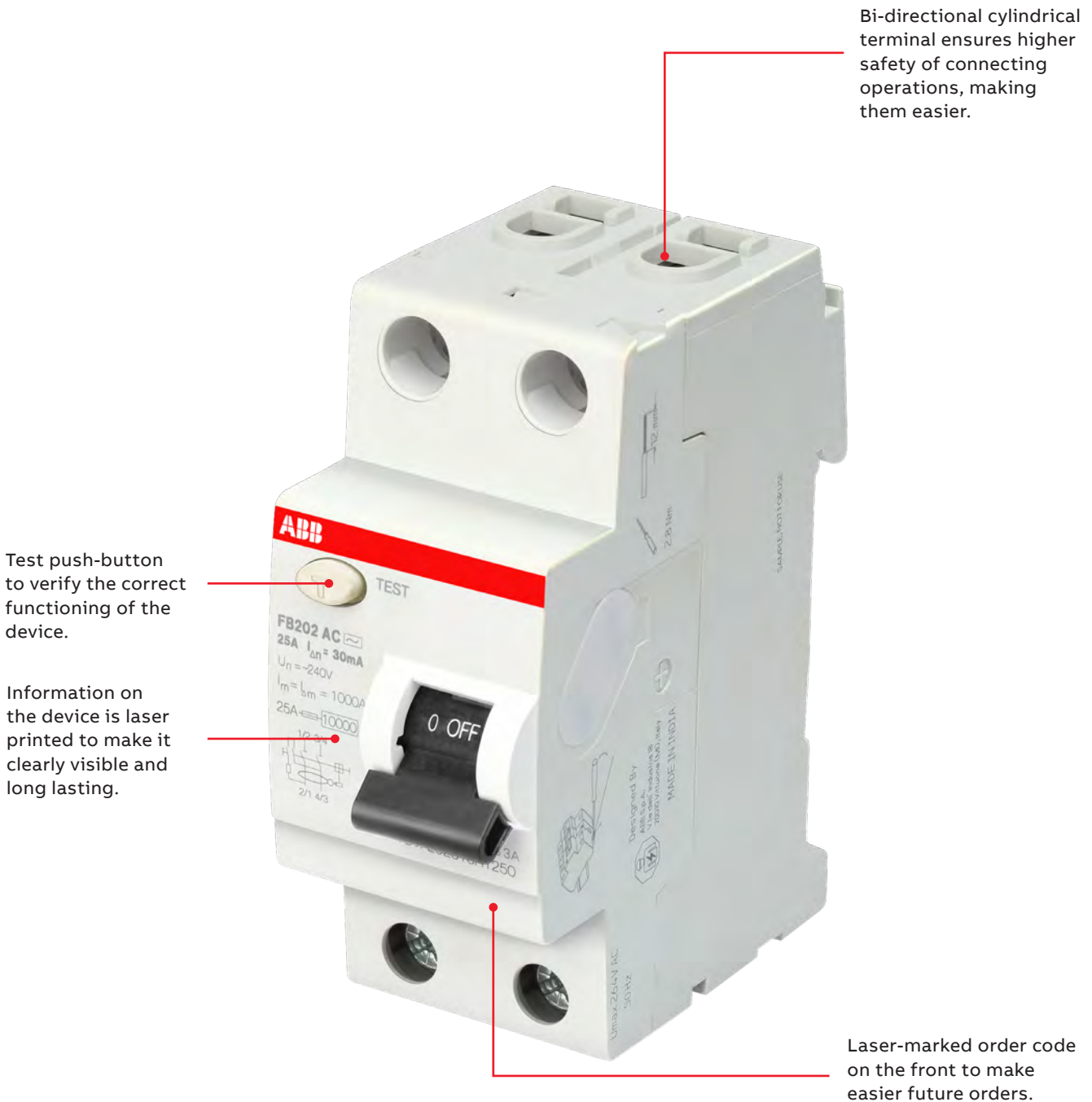



ISI and CE marking

In addition to the international standards and markings IEC, the product is certified as per latest Indian Standards (ISI).



High performance

- Rated breaking capacity and rated residual breaking capacity laser printed on the device:
 $I_m = I_{\Delta m} = 1000 \text{ mA}$
- Co-ordination with a 63 A rated current with conditional short-circuit capacity $I_{nc} = 10000 \text{ A}$.

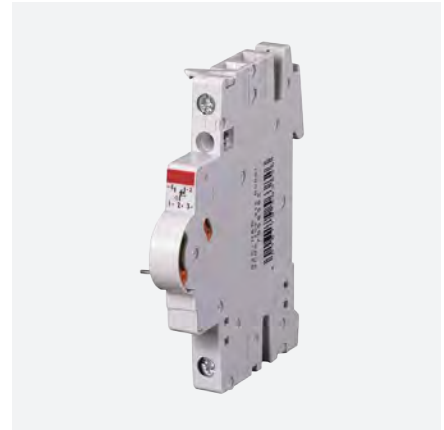

Accessories mountable

Wide range of add-on accessories having 30 different types of accessories. Max. possibility of mounting: 4 different accessories on the right side and 1 on the left side ensures highest flexibility of functions. Universal contact, motorised unique accessory like mechanical tripping devices available only with ABB.



Termination

The availability of two terminals offers different connection solutions, thanks to the possibility to connect two independent cables in the same device: the second terminal can be used for an auxiliary circuit or for the supply of devices with small section cables without connecting them together with the main circuit.



Auto reclosing

The FB200 can be coupled with the auto reclosing unit F2C-ARH in order to ensure continuity of service for the whole installation of your home, avoiding lack of supply.



Dual termination

Two terminals are available, the fore one for cables up to 25 mm², the back one for cables up to 10 mm² or for busbars.

RCCB FB200 and F200 higher rating

AC  type

FB200 AC and F200 type function: protection against the effects of sinusoidal alternating earth fault currents; protection against indirect contacts and additional protection against direct contacts (with $I_{\Delta n}=30$ mA).

Application: residential, commercial, industrial.

Standard: IEC/EN 61008-1; IEC/EN 61008-2-1

Marking: according to EN 61008-1; EN 61008-2-1



FB202 AC

FB202 AC

Number of poles	Rated current In A	Order details		Standard pack	Unit MRP ₹
		Type code	Order code		
2P	25	FB202 AC-25/0.03	1SYF202015R1250 ■	1	3,465
	25	FB202 AC-25/0.1	1SYF202015R2250 ■	1	3,625
	25	FB202 AC-25/0.3	1SYF202015R3250	1	3,650
	40	FB202 AC-40/0.03	1SYF202015R1400 ■	1	3,970
	40	FB202 AC-40/0.1	1SYF202015R2400 ■	1	4,160
	40	FB202 AC-40/0.3	1SYF202015R3400	1	4,280
	63	FB202 AC-63/0.03	1SYF202015R1630 ■	1	4,695
	63	FB202 AC-63/0.1	1SYF202015R2630 ■	1	4,855
	63	FB202 AC-63/0.3	1SYF202015R3630	1	4,940

F202 AC

Number of poles	Rated current In A	Order details		Standard pack	Unit L.P. ₹
		Type code	Order code		
2P	80	F202 AC-80/0,03	2CSF202005R1800	1	12,210
	80	F202 AC-80/0,1	2CSF202005R2800	1	12,105
	80	F202 AC-80/0,3	2CSF202005R3800	1	12,105
	100	F202 AC-100/0,03	2CSF202005R1900	1	10,935
	100	F202 AC-100/0,1	2CSF202005R2900	1	11,445
	100	F202 AC-100/0,3	2CSF202005R3900	1	12,405

FB204 and F204 AC

Number of poles	Rated current In A	Order details		Standard pack	Unit MRP ₹
		Type code	Order code		
4P	25	FB204 AC-25/0.03	1SYF204015R1250	1	4,605
	25	FB204 AC-25/0.1	1SYF204015R2250	1	4,815
	25	FB204 AC-25/0.3	1SYF204015R3250	1	5,000
	40	FB204 AC-40/0.03	1SYF204015R1400 ■	1	4,695
	40	FB204 AC-40/0.1	1SYF204015R2400 ■	1	4,725
	40	FB204 AC-40/0.3	1SYF204015R3400 ■	1	5,035
	63	FB204 AC-63/0.03	1SYF204015R1630 ■	1	5,320
	63	FB204 AC-63/0.1	1SYF204015R2630 ■	1	5,705
	63	FB204 AC-63/0.3	1SYF204015R3630 ■	1	5,760

F204 AC

Number of poles	Rated current In A	Order details		Standard pack	Unit MRP ₹
		Type code	Order code		
4P	80	F204 AC-80/0,03	2CSF204005R1800	1	12,945
	80	F204 AC-80/0,1	2CSF204005R2800	1	13,530
	80	F204 AC-80/0,3	2CSF204005R3800	1	13,670
	100	F204 AC-100/0,03	2CSF204005R1900	1	13,160
	100	F204 AC-100/0,1	2CSF204005R2900	1	14,640
	100	F204 AC-100/0,3	2CSF204005R3900	1	14,275
	125	F204 AC-125/0,03	2CSF204001R1950	1	Upon request
	125	F204 AC-125/0,1	2CSF204001R2950	1	
	125	F204 AC-125/0,3	2CSF204001R3950	1	

■ Stock items



Residual current circuit breaker with overcurrent protection

RCBO - DS200M series



DS201M 1P+N

Features

- Complies to standard to IEC/EN 61009
- DS201 available in 4.5kA,6kA & 10kA breaking capacity
- Available in AC, A and APR types to meet all protection needs
- B and C characteristics with rated current up to 40 A available on all the versions
- Contact position indicator (CPI) to indicate the exact information of the circuit-breaker status
- Equipped with an RFID tag according to standard ISO/IEC FCD 15693-3 to authenticate the product
- Bi-directional cylinder-lift terminals for easier parallel feed
- Flag indicators - Differential trip indicator - blue
- Contact position indicator - green / red

RCBO 10kA AC Type - DS200M

Description	Current rating (A)	Residual rated current (mA)	Pack unit (Pc)	Ordering code	L.P. (₹)
DS201 M C6 AC30	6	30	1	2CSR275080R1064	5,030
DS201 M C10 AC30	10	30	1	2CSR275080R1104	5,030
DS201 M C16 AC30	16	30	1	2CSR275080R1164	5,030
DS201 M C20 AC30	20	30	1	2CSR275080R1204	5,030
DS201 M C25 AC30	25	30	1	2CSR275080R1254 ■	5,030
DS201 M C32 AC30	32	30	1	2CSR275080R1324	5,465
DS201 M C40 AC30	40	30	1	2CSR275080R1404 ■	6,480
DS201 M C6 AC100	6	100	1	2CSR275080R2064	5,655
DS201 M C10 AC100	10	100	1	2CSR275080R2104	5,655
DS201 M C16 AC100	16	100	1	2CSR275080R2164	5,655
DS201 M C20 AC100	20	100	1	2CSR275080R2204	5,655
DS201 M C25 AC100	25	100	1	2CSR275080R2254 ■	5,655
DS201 M C32 AC100	32	100	1	2CSR275080R2324	5,850
DS201 M C40 AC100	40	100	1	2CSR275080R2404 ■	6,865
DS201 M C6 AC300	6	300	1	2CSR275080R3064	5,465
DS201 M C10 AC300	10	300	1	2CSR275080R3104	5,465
DS201 M C16 AC300	16	300	1	2CSR275080R3164	5,465
DS201 M C20 AC300	20	300	1	2CSR275080R3204	5,465
DS201 M C25 AC300	25	300	1	2CSR275080R3254	5,465
DS201 M C32 AC300	32	300	1	2CSR275080R3324	5,655
DS201 M C40 AC300	40	300	1	2CSR275080R3404	6,675

Residual current circuit breaker with overcurrent protection

RCD blocks - DDA200 + S200 M series (RCBO combinations)



DDA200

S200 M

DDA - 200 AC type

Function: RCD-block for assembly on site with MCBs S 200M series. Protection against the effects of sinusoidal alternating earth fault currents; protection against indirect contacts and additional protection against direct (with $I_{\Delta n}=30$ mA) contacts.

Standard: IEC/EN 61009 Ann. G



DDA202 AC

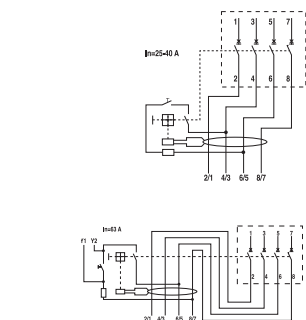
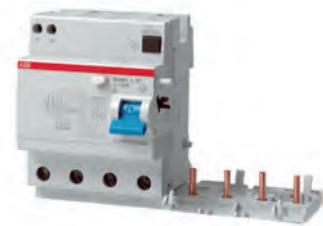
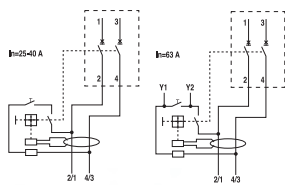

DDA 200 AC

Two pole

Description	Current rating (A)	Residual rated current (mA)	Pack unit (Pc)	Ordering code	L.P. (₹)
DDA202 AC-63/0.03*	63	30	1	2CSB202001R1630 ■	4,065
DDA202 AC-63/0.1*	63	100	1	2CSB202001R2630 ■	4,945
DDA202 AC-63/0.3*	63	300	1	2CSB202001R3630	4,965

* Consider S200 M double pole MCBs.

Four pole

Description	Current rating (A)	Residual rated current (mA)	Pack unit (Pc)	Ordering code	L.P. (₹)
DDA204 AC-25/0.03	25	30	1	2CSB204001R1250	3,810
DDA204 AC-25/0.1	25	100	1	2CSB204001R2250	4,240
DDA204 AC-25/0.3	25	300	1	2CSB204001R3250	4,350
DDA204 AC-40/0.03	40	30	1	2CSB204001R1400 ■	3,955
DDA204 AC-40/0.1	40	100	1	2CSB204001R2400 ■	4,500
DDA204 AC-40/0.3	40	300	1	2CSB204001R3400 ■	4,670
DDA204 AC-63/0.03	63	30	1	2CSB204001R1630 ■	4,180
DDA204 AC-63/0.1	63	100	1	2CSB204001R2630 ■	5,385
DDA204 AC-63/0.3	63	300	1	2CSB204001R3630 ■	5,465

* Consider S200 M four pole MCBs.

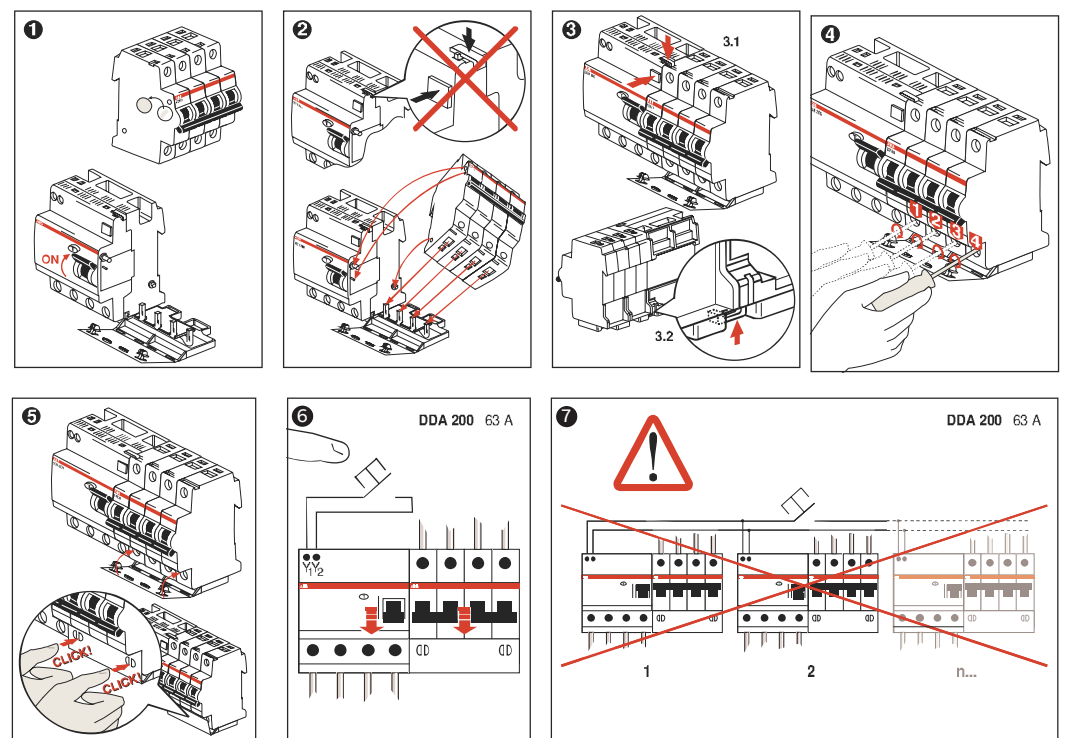

■ Stock items

Miniature circuit breaker (MCB)

S200M series

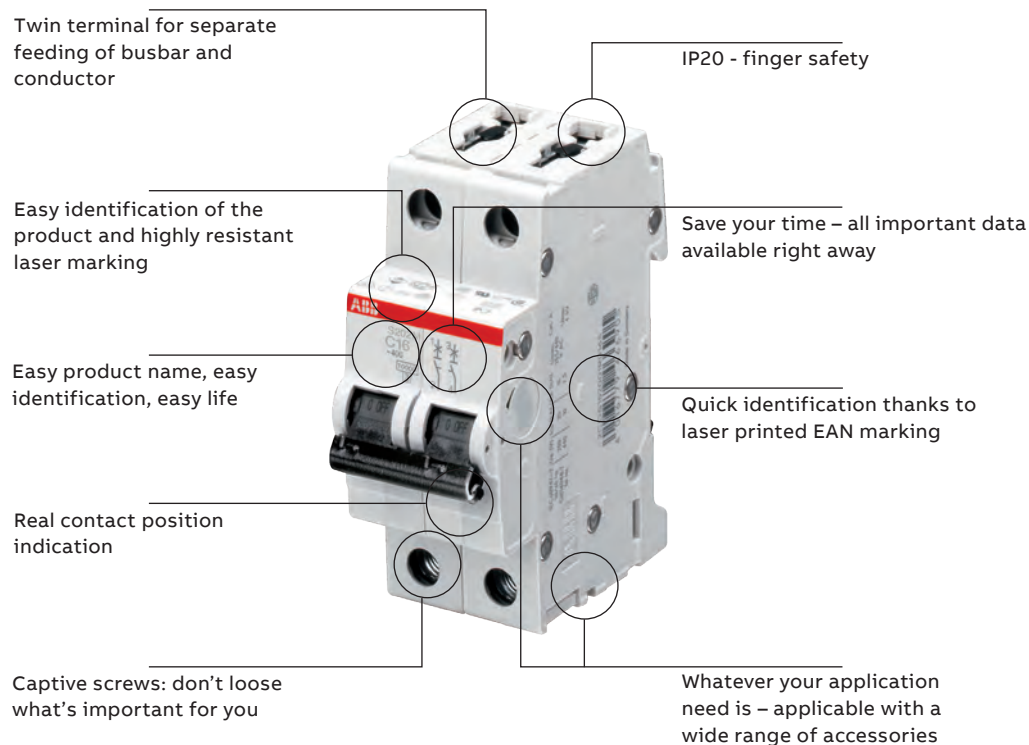

Technical features

Electrical data	S200 M	
Standards	IEC 60947-2, IS/IEC-60898-1	
Poles	1P, 2P, 3P, 4P, 1P +N, 3P +N	
Tripping characteristics	B, C, D	
Rated current	0.5A - 63 A	
Rated voltage	1P : 230 / 400 V AC	1P : 60 V DC
	1P + N : 230 V AC	2P : 120 V DC
	2...4P : 400 V AC	
	3P + N : 400 V AC	
Insulation voltage	250 V AC (Phase to ground)	
	500 V AC (Phase to phase)	
Max operating voltage	1P: 253 V AC 2...4P : 440 V AC	
Min operating voltage	12 V AC	
Rated frequency	50/60 Hz	
Rated short circuit capacity	10kA	
Energy limiting class (B, C upto 40 A)	3	
Over voltage category	III	
Pollution degree	3	
Rated impulse withstand voltage	4kV (Test Voltage 6.2kV at Sea Level, 5kV at 2,000 m)	
Dielectric test voltage	2kV (50/60 Hz, 1 min)	
Accessories mountable	Yes	
Cross-section of conductor (top / bottom)	35 mm ²	
Terminal	Fail safe bi-directional cylinder - lift terminal	
Contact position indication	Marking on toggle (1 ON / 0 OFF), Real CPI (red ON / green OFF)	
Real contact position indication	Red ON / green OFF	

S200M - MCBs, C characteristics - 10 kA



S202M-C

Double pole

Description	Current rating (A)	Pack unit (Pc)	Ordering code	Unit MRP (₹)
S202M-C 6	6	6	2CDS272001R0064 ■	1,165
S202M-C 10	10	6	2CDS272001R0104 ■	
S202M-C 16	16	6	2CDS272001R0164 ■	
S202M-C 20	20	6	2CDS272001R0204 ■	
S202M-C 25	25	6	2CDS272001R0254 ■	
S202M-C 32	32	6	2CDS272001R0324 ■	
S202M-C 40	40	6	2CDS272001R0404 ■	1,810
S202M-C 50	50	6	2CDS272001R0504 ■	
S202M-C 63	63	6	2CDS272001R0634 ■	

Note: Standard packing quantity for MCBs: SP - 12 Nos, SPN/DP - 6 Nos, TP - 4 Nos, TPN/FP - 3 Nos.



S204M-C

Four pole

Description	Current rating (A)	Pack unit (Pc)	Ordering code	Unit MRP (₹)
S204M-C 6	6	3	2CDS274001R0064 ■	2,320
S204M-C 10	10	3	2CDS274001R0104 ■	
S204M-C 16	16	3	2CDS274001R0164 ■	
S204M-C 20	20	3	2CDS274001R0204 ■	
S204M-C 25	25	3	2CDS274001R0254 ■	
S204M-C 32	32	3	2CDS274001R0324 ■	
S204M-C 40	40	3	2CDS274001R0404 ■	3,485
S204M-C 50	50	3	2CDS274001R0504 ■	
S204M-C 63	63	3	2CDS274001R0634 ■	

Note: Standard packing quantity for MCBs: SP - 12 Nos, SPN/DP - 6 Nos, TP - 4 Nos, TPN/FP - 3 Nos.

S200M - MCBs, D characteristics - 10 kA



S202M-D

Double pole

Description	Current rating (A)	Pack unit (Pc)	Ordering code	Unit MRP (₹)	
S202M-D 6	6	6	2CDS272001R0061	1,205	
S202M-D 10	10	6	2CDS272001R0101		
S202M-D 16	16	6	2CDS272001R0161		
S202M-D 20	20	6	2CDS272001R0201		
S202M-D 25	25	6	2CDS272001R0251		
S202M-D 32	32	6	2CDS272001R0321		
S202M-D 40	40	6	2CDS272001R0401		
S202M-D 50	50	6	2CDS272001R0501		2,095
S202M-D 63	63	6	2CDS272001R0631		

Note: Standard packing quantity for MCBs: SP - 12 Nos, SPN/DP - 6 Nos, TP - 4 Nos, TPN/FP - 3 Nos.



S204M-D

Four pole

Description	Current rating (A)	Pack unit (Pc)	Ordering code	Unit MRP (₹)
S204M-D 6	6	3	2CDS274001R0061	2,665
S204M-D 10	10	3	2CDS274001R0101	
S204M-D 16	16	3	2CDS274001R0161	
S204M-D 20	20	3	2CDS274001R0201	
S204M-D 25	25	3	2CDS274001R0251	
S204M-D 32	32	3	2CDS274001R0321	
S204M-D 40	40	3	2CDS274001R0401	
S204M-D 50	50	3	2CDS274001R0501	3,970
S204M-D 63	63	3	2CDS274001R0631	

Note: Standard packing quantity for MCBs: SP - 12 Nos, SPN/DP - 6 Nos, TP - 4 Nos, TPN/FP - 3 Nos.

Solution for unwanted tripping - AP-R type (high immunity) RCCB / RCBO

The ABB range of AP-R anti-disturbance residual current circuit-breakers and blocks was designed to overcome the problem of unwanted tripping due to overvoltages of atmospheric or operation origin.

The electronic circuit in these devices can distinguish between temporary leakage caused by disturbances on the mains and permanent leakage due to actual faults, only breaking the circuit in the latter case.

AP-R residual current circuit-breakers and blocks have a slight delay into the tripping time, but this does not compromise the safety limits set by the Standards in force (release time at $2 I_{\Delta n} = 150$ ms).

Compared with standard type breakers, AP-R residual current breakers are therefore characterised, for any given sensibility, by:

- Higher residual trip current
- Tripping time delay
- Better resistance to overvoltages, harmonics and impulse disturbances

Guaranteeing conventional residual current protection, their installation in the electrical circuit therefore allows any unwanted tripping to be avoided in domestic and industrial systems in which service continuity is essential.

This delay makes the AP-R residual current devices especially suited for installations involving motor starters/variable speed drives, fluorescent lamps or IT/electronic equipment.

The use of multiple electronic reactors for the supply of fluorescent lamps instead generates permanent leakage currents and inrush currents that can cause nuisance tripping of a standard residual current circuit breaker.

IT system loads and other electronic equipment (e.g. dimmers, computers, inverters) with capacitive input filters connected between the phases and ground can also generate permanent earth leakage currents whose sum may provoke the nuisance tripping of a standard residual current circuit breaker. For these situations, the AP-R breakers allow a greater number of devices to be connected to the installation.

Frequency converters include a rectifier section and an inverter section.

In case of fault within a single-phase frequency converter AP-R type RCDs provide complete protection, because an earth fault occurring downstream the inverter, produces an earth fault current with multi-frequency shape with high amount of harmonics.

While, in case of fault within a three-phase frequency converter, B type RCDs ensure complete protection because in case of insulation fault between the rectifier and the inverter or downstream the inverter we can have a smooth DC earth fault current.

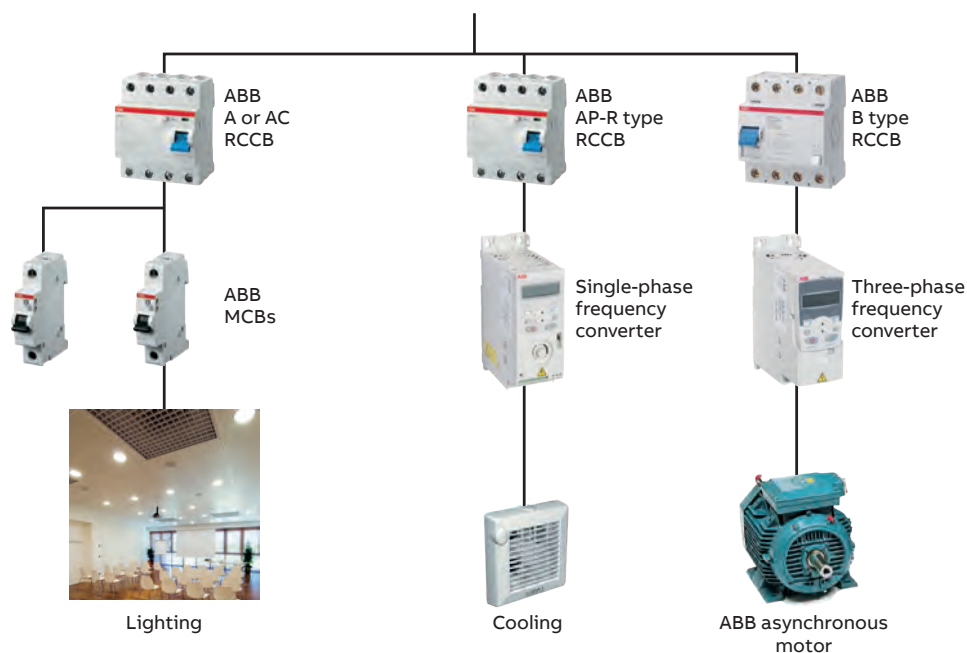

RCCB - F200 series: AP-R (high immunity)



F202A

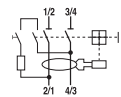

F204A

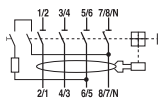

Function: protection against the effects of sinusoidal alternating and direct pulsating earth fault currents, providing the best compromise between safety and continuity in the service, thanks to the resistance to unwanted trippings; protection against indirect contacts and additional protection against direct ($I_{\Delta n}=30$ mA) contacts.

Application: residential, commercial, industrial Standard: IEC/EN 61008

Surge current resistance (wave 8/20)=3000 A Marking: according to EN 61008

RCCB - F200 series

Description	Current rating (A)	Residual rated current (mA)	Packing	Ordering code	L.P. (₹)
Two pole					
F202 A-25/0.03 AP-R	25	30	1	2CSF202401R1250	7,605
F202 A-40/0.03 AP-R	40	30	1	2CSF202401R1400	8,000
F202 A-63/0.03 AP-R	63	30	1	2CSF202401R1630	9,655
F202 A-80/0.03 AP-R	80	30	1	2CSF202401R1800	13,385
F202 A-100/0.03 AP-R	100	30	1	2CSF202401R1900	14,990

Four pole

F204 A-25/0.03 AP-R	25	30	1	2CSF204401R1250	9,345
F204 A-40/0.03 AP-R	40	30	1	2CSF204401R1400	9,615
F204 A-63/0.03 AP-R	63	30	1	2CSF204401R1630	10,905
F204 A-80/0.03 AP-R	80	30	1	2CSF204401R1800	16,370
F204 A-100/0.03 AP-R	100	30	1	2CSF204401R1900	18,040
F204 A-125/0.03 AP-R	125	30	1	2CSF204401R1950	Upon Request

RCBO - DS200 series APR type (high immunity)

Function: protection against the effects of sinusoidal alternating and direct pulsating earth fault currents, providing an optimal compromise between safety and continuity of service, thanks to the resistance to unwanted tripping; protection against indirect contact and additional protection against direct ($I_{\Delta n}=30$ mA) contact; protection and isolation of resistive and inductive loads.

Application: residential, commercial, industrial Standard: IEC/EN 61009

$I_{cn}=10$ kA



DS201M APR-1P+N

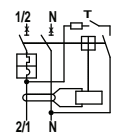

RCBO - DS200 series APR type

Description	Current rating (A)	Residual rated current (mA)	Packing	Ordering code	L.P. (₹)
DS201 M C6 APR30	6	30	1	2CSR275480R1064	8,675
DS201 M C10 APR30	10	30	1	2CSR275480R1104	8,675
DS201 M C16 APR30	16	30	1	2CSR275480R1164	8,675
DS201 M C20 APR30	20	30	1	2CSR275480R1204	8,675
DS201 M C25 APR30	25	30	1	2CSR275480R1254	8,675
DS201 M C32 APR30	32	30	1	2CSR275480R1324	8,970
DS201 M C40 APR30	40	30	1	2CSR275480R1404	9,155
DS201 M C6 APR100	6	100	1	2CSR275480R2064	10,955
DS201 M C10 APR100	10	100	1	2CSR275480R2104	10,955
DS201 M C16 APR100	16	100	1	2CSR275480R2164	10,955
DS201 M C20 APR100	20	100	1	2CSR275480R2204	10,955
DS201 M C25 APR100	25	100	1	2CSR275480R2254	10,955
DS201 M C32 APR100	32	100	1	2CSR275480R2324	12,360
DS201 M C40 APR100	40	100	1	2CSR275480R2404	12,610
DS201 M C6 APR300	6	300	1	2CSR275480R3064	10,735
DS201 M C10 APR300	10	300	1	2CSR275480R3104	10,735
DS201 M C16 APR300	16	300	1	2CSR275480R3164	10,735
DS201 M C20 APR300	20	300	1	2CSR275480R3204	10,735
DS201 M C25 APR300	25	300	1	2CSR275480R3254	10,735
DS201 M C32 APR300	32	300	1	2CSR275480R3324	12,120
DS201 M C40 APR300	40	300	1	2CSR275480R3404	12,360

System pro M

Accessories for MCB's-SB200 M/S200 M,
RCCB's- FB200/F200, Switch Disconnecter-
SDB200/E200, RCBO DS200

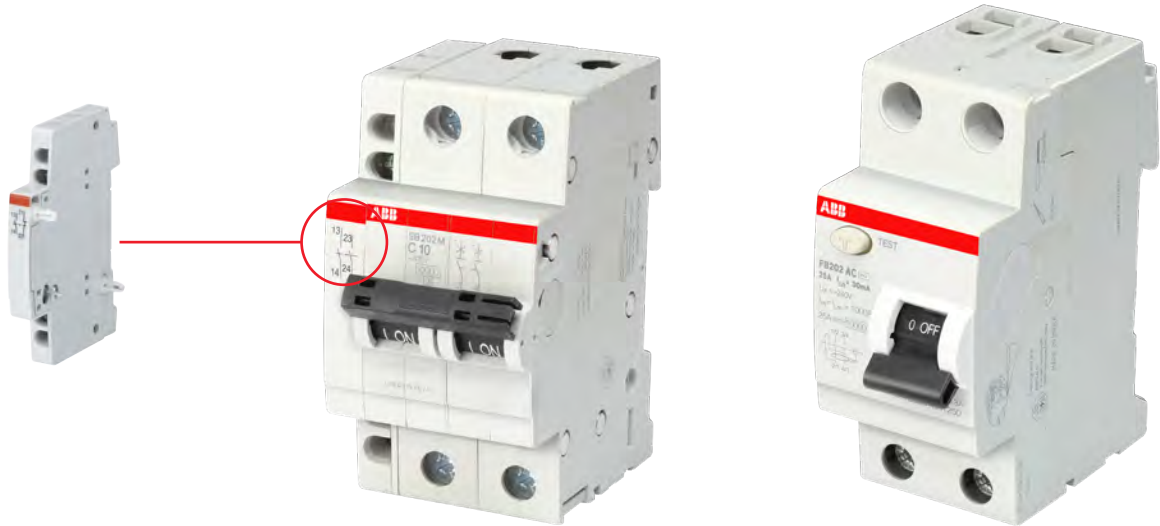

Thanks to the variety of control and monitoring accessories which enable you to build different monitoring control logics of the protection devices.



S2C-H6...
Auxiliary contact



S2C-S/H6R
Signal/auxiliary contacts



S2C-A
Shunt trip



S2C-UA
Under voltage release



S2C-OVP
Over voltage release



S2C-CM4
Motor operating device



S2C-BP
Mechanical tripping device

System pro M

Accessories for MCB's-SB200 M/SB200 DC/S200 M,
Switch Disconnecter SDB200/E200

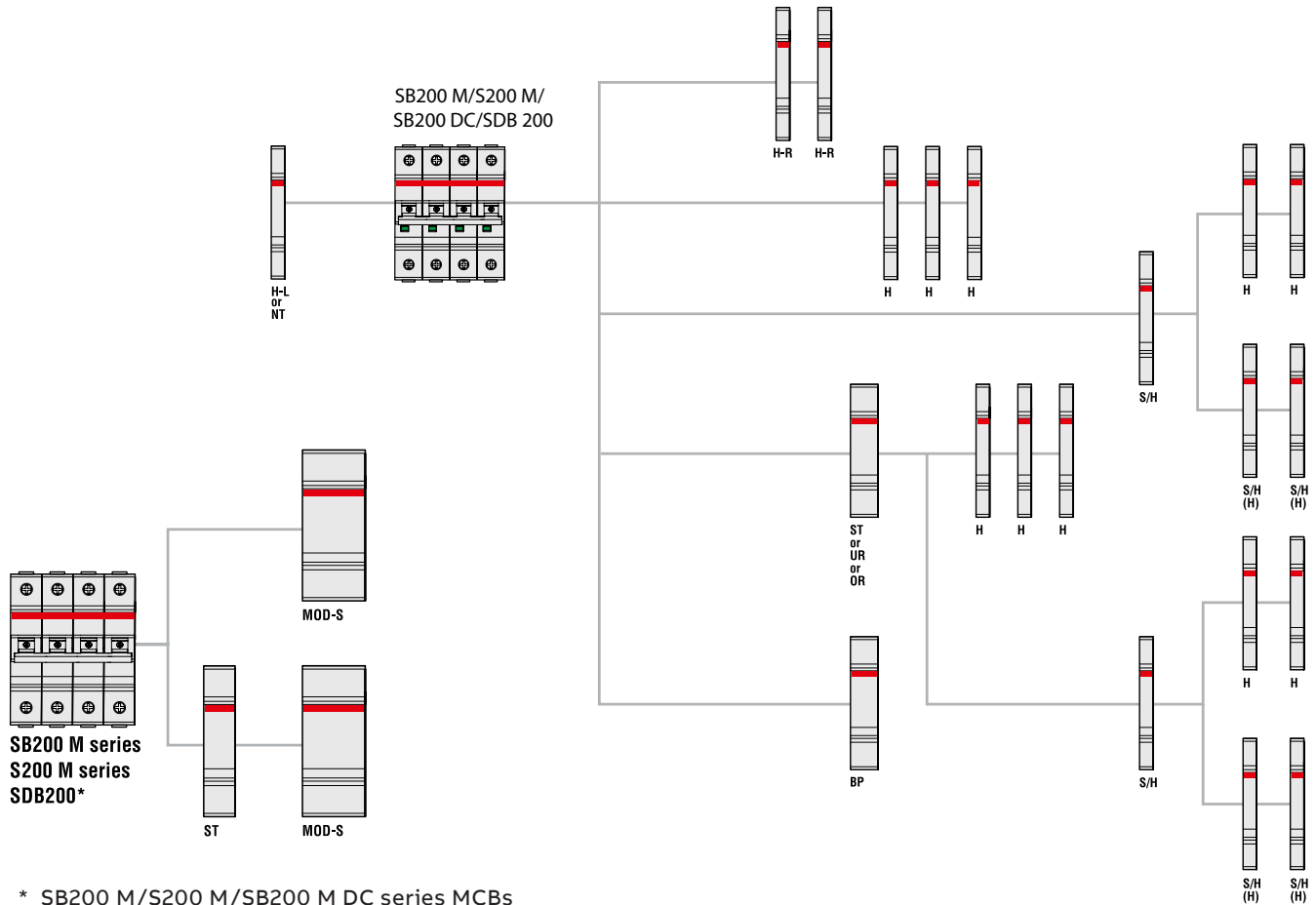

* SB200 M/S200 M/SB200 M DC series MCBs and SDB200 switch disconnectors up to 3P or 2P+ST can be coupled with MOD-S

H	Auxiliary contact	S2C-H6R
H-R	Auxiliary contact	S2C-H6-...R
S/H	Signal/Auxiliary contact	S2C-S/H6R
S/H (H)	Signal/Auxiliary contact used as auxiliary contact	S2C-S/H6R
ST	Shunt trip for SB200 MCB	S2C-A...
UR	Undervoltage release	S2C-UA
OR	Overvoltage release	S2C-OVP
ST-L	Shunt trip for SB200 MCBs to be mounted on the left	S2C-A...L
H-L	Auxiliary contact for SB200 MCBs to be mounted on the left	S2C-H...L
BP	Mechanical tripping device	S2C-BP
NT	Switched neutral	S2C-Nt

System pro M

Accessories for RCCB's FB200 and F200

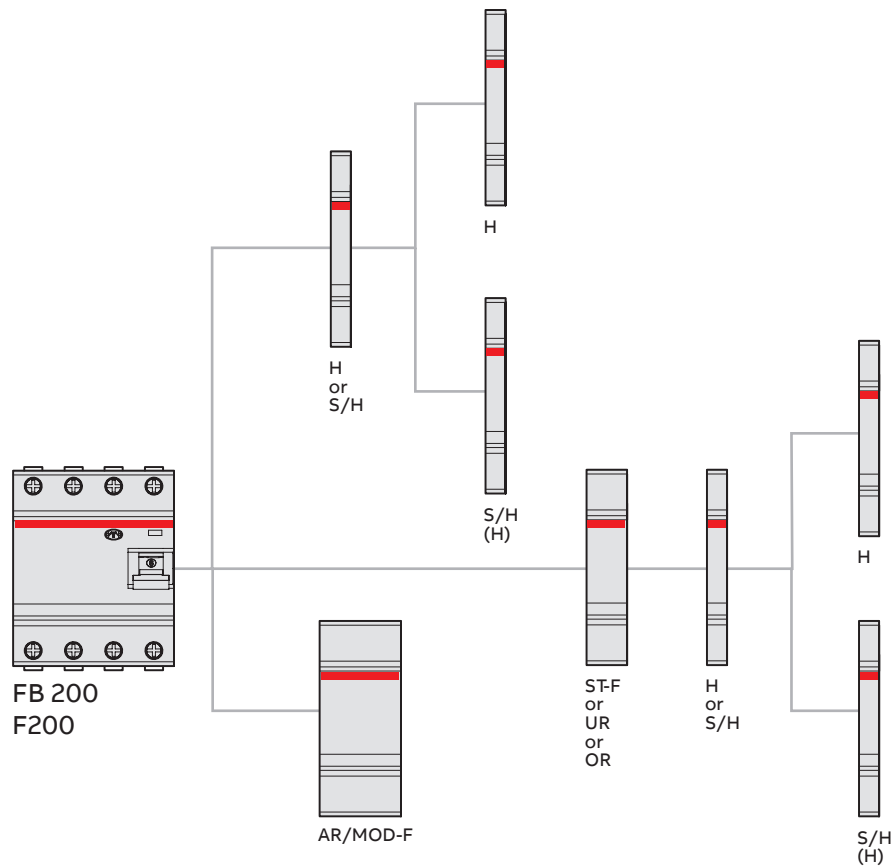

H	Auxiliary contact	S2C-H6R
S/H	Signal/Auxiliary contact	S2C-S/H6R
S/H (H)	Signal/Auxiliary contact used as auxiliary contact	S2C-S/H6R
UR	Undervoltage release	S2C-UA
OR	Overvoltage release	S2C-OVP
AR	Auto reclosing unit	F2C-ARI
MOD-F	Motor operating device	F2C-CM
ST-F	Shunt trip for FB200 RCCB	F2C-A

System pro M

Accessories for RCBO's DS201 M

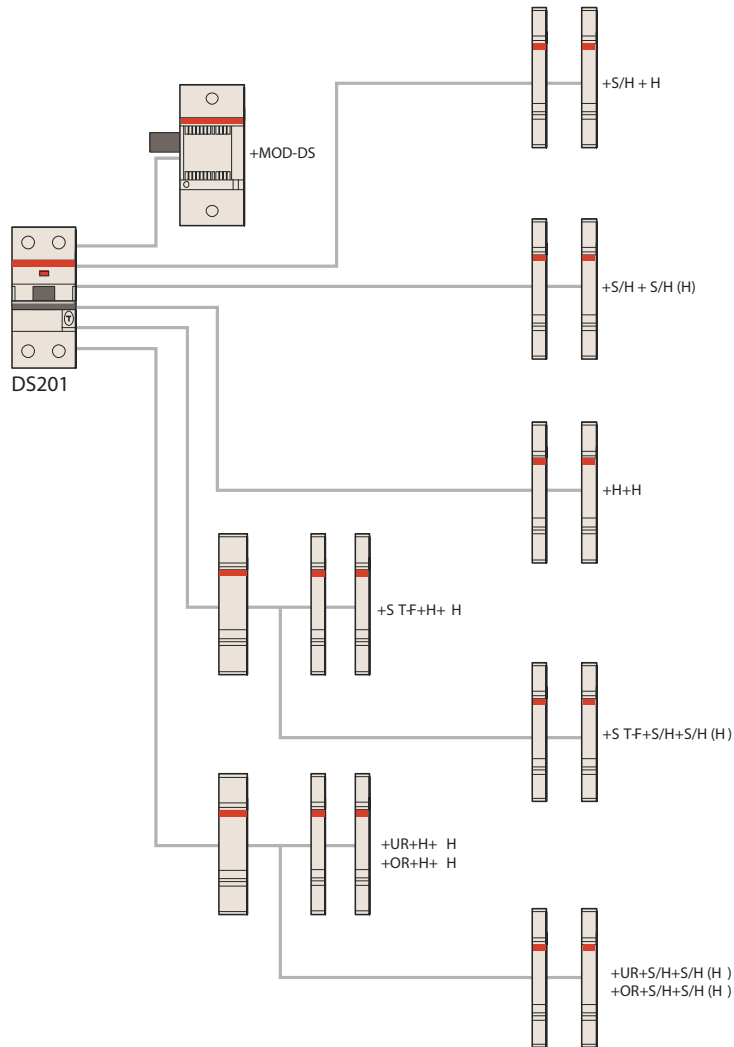

H	Auxiliary contact	S2C-H6R
S/H	Signal/Auxiliary contact	S2C-S/H6R
S/H (H)	Signal/Auxiliary contact used as auxiliary contact	S2C-S/H6R
ST-F	Shunt trip for DS201 RCCB	F2C-A
UR	Undervoltage release	S2C-UA
OR	Oversvoltage release	S2C-OVP
MOD-DS	Motor operating device	DS2C-CM

Accessories

for SB200 M/SB200 DC, switch disconnecter
SDB200/E200 RCBO DS201 M



SA 1

Locking device for MCBs and switches

Prevents unauthorised or dangerous operation of the operating lever. An adaptor makes it possible to block the operating lever whether switched ON or OFF. The lever is blocked with a padlock having a cross bar section of 3 or, as the case may be, 6 mm max. For multipole devices, one lock may be fitted per pole.

The lock adaptor can be used for all MCBs of the SB200 M, SB200 DC, switch disconnecter SDB200, RCBO DS201 M and E200.



SA 2

Description	Order details		Standard pack	L.P. ₹
	Type code	Order code		
Locking Device 3mm	SA 1	GJF1101903R0001	10	620
Lock Adaptor 6mm	SA 1E	GJF1101903R0004	10	615
Padlock with 2 keys	SA 2	GJF1101903R0002	10	1,990
Padlock, identical locking with 2 keys	SA 2 i	GJF1109999R0001	10	1,510
Lock adapto incl. padlock with 3 keys in transparent box	SA 3	GJF1101903R0003	10	1,890

Auxiliary elements for

MCB's SB200 M/SB200 DC/S200 M, switch disconnecter SDB200, RCCB-FB200/F200 and RCBO-DS201 M



2CSC400465F0201

S2C-S/H6R

Signal/auxiliary contacts

Signal contacts indicate if a device trips due to a failure (overcurrent/short-circuit for MCBs and RCBOs; earth fault for RCCBs and RCBOs). Auxiliary contacts indicate the position of the contacts, independent if a failure occurred or the device was operated manually.

S2C-S/H6R:

Choice through a selector between signal and auxiliary contact.

S2C-H6R and S2C-HxxR:

Auxiliary contacts with contact configuration according to the following table. All right-side mounted contacts are suitable for MCBs, RCDs, switch disconnectors SDB200 according to the "Selection tables" which are displayed at the beginning of chapter 4.



2CSC400465F0201

S2C-H6-...

S2C-HxxL:

Auxiliary contacts with contact configuration according to the following table. These contacts are left-side mounted and fit to SB200 MCBs and switch disconnectors SDB200 according to the "Selection tables". Especially when using a motor operating device this is a possibility to add a contact as the right side mounted ones do not fit within this combination.

Description	Bbn 4016779	Order details		Standard pack	L.P. ₹
	EAN	Type code	Order code		
Signal contact/ auxiliary switch 1CO	563819	S2C-S/H6R	2CDS200922R0001 ■	1	1,775
Auxiliary contact 1CO	563826	S2C-H6R	2CDS200912R0001 ■	1	990
Auxiliary contact 1NO/1NC	697941	S2C-H6-11R	2CDS200946R0001 ■	1	1,005
Auxiliary contact 2NO	697958	S2C-H6-20R	2CDS200946R0002	1	1,015
Auxiliary contact 2NC	697965	S2C-H6-02R	2CDS200946R0003	1	1,015

Auxiliary contacts mounting on the left side

Description	Bbn 4016779	Order details		Standard pack	L.P. ₹
	EAN	Type code	Order code		
Auxiliary contact 1 NO/1NC	648820	S2C-H11L	2CDS200936R0001	1	1,150
Auxiliary contact 2 NO	648837	S2C-H20L	2CDS200936R0002	1	1,125
Auxiliary contact 2 NC	648844	S2C-H02L	2CDS200936R0003	1	1,125

Auxiliary elements for

MCB's SB200 M, SB200 M DC, switch disconnecter SDB200/E200 and RCBO DS201 M



S2C-A

2CSC40041F0201

Shunt trips

Function: remote opening of the device when a voltage is applied. Suitable for MCBs SB200 series, RCBOs DS201 series, SDB200 switch disconnectors series.

Shunt trips use a coil like MCBs for tripping. To trip a shunt, it is necessary to choose the right voltage and make sure the corresponding I_{bmax} (as mentioned in the table above) is provided by the power supply used. If the power supply can provide higher currents the shunt trip will reduce the current to I_{bmax} due to its internal resistance.

As soon as the shunt trips, the contact inside is open – the electrical circuit is disconnected even if the shunt trip is still powered on. The free-tripping mechanism of the shunt trip allows a restart of the MCB only after the shunt trip gets no external release signal anymore.

Auxiliary contacts mounting on the left side

Rated voltage	Bbn 4016779	Order details		Standard pack	L.P. ₹
	EAN	Type code	Order code		
AC/DC 12...60 V	570992	S2C-A1	2CDS200909R0001 ■	1	4,435
AC 110...415 V/DC110...250 V	571005	S2C-A2	2CDS200909R0002 ■	1	

Auxiliary elements for

RCCB FB200 and F200



F2C-A

2CSS400013F0202

Shunt trips

Function: remote opening of the device when a voltage is applied. Suitable for RCCBs FB200, F200 series and RCBOs DS201.

Auxiliary contacts mounting on the left side

Rated voltage	Bbn 8012542	Order details		Standard pack	L.P. ₹
	EAN	Type code	Order code		
AC/DC 12...60V	974901	F2C-A1	2CSS200933R0011	1	5,405
AC 110...415V / DC 110...250V	975007	F2C-A2	2CSS200933R0012	1	

Auxiliary elements for

MCB's SB200 M, SB200 DC, switch disconnecter SDB200/E200, RCCB FB200, F200 and RCBO DS201 M



S2C-UA

2CSS400325F0201

Undervoltage releases

Function: protection of the load in the event of a voltage drop (between 70% and 35% of its rated value); positive safety (devices tripping when the voltage is disconnected) emergency stop by means of a button. Suitable for MCBs SB200 series, RCCBs FB200 series and RCBOs DS201, SDB200 switch disconnectors series.

Rated voltage	Bbn 8012542	Order details		Standard pack	L.P. ₹
	EAN	Type code	Order code		
12V DC	839705	S2C-UA 12 DC	2CSS200911R0001	1	5,690
24V AC	839804	S2C-UA 24 AC	2CSS200911R0002	1	
24V DC	896401	S2C-UA 24 DC	2CSS200911R0007	1	
48V AC	839903	S2C-UA 48 AC	2CSS200911R0003	1	
48V DC	896500	S2C-UA 48 DC	2CSS200911R0008	1	
110V AC	840008	S2C-UA 110 AC	2CSS200911R0004 ■	1	
110V DC	896609	S2C-UA 110 DC	2CSS200911R0009	1	
230V AC	840107	S2C-UA 230 AC	2CSS200911R0005 ■	1	
230V DC	896708	S2C-UA 230 DC	2CSS200911R0010	1	
400V AC	840206	S2C-UA 400 AC	2CSS200911R0006	1	

Overvoltage release

Function: monitoring voltage between the neutral and phase; when an overvoltage reaches the threshold value, the OVP device causes the tripping of the associated MCB or RCCB. Suitable for MCBs of the SB200 series up to 63 A, and RCCBs of the FB200 series up to 100 A and RCBOs DS201, Suitable for SDB200 switch disconnectors series.

Description	Bbn 8012542	Order details		Standard pack	L.P. ₹
	EAN	Type code	Order code		
Overvoltage release (max. tripping voltage AC: 275V)	748137	S2C-OVP1	2CSS200910R0005	1/5	6,785
Overvoltage release (max. tripping voltage AC: 290V)	952039	S2C-OVP2	2CSS200993R0005	1/5	



S2C-Nt

2CSS400055F0201

Hand operated neutral left side mounted

S2C-Nt		
Rated current	A	max. 40
Terminal	mm ²	10; cage terminal
Tightening torque	Nm	1.2
Dimensions (H x D x W)	mm	85 x 69 x 8.8

Hand operated neutral

The hand operated neutral has to be mounted to the left side of the MCB and be snapped onto the DIN rail. It is used for measuring duties where the neutral conductor must be in the open position. Due to the special design of the handle - when switching ON the MCB - the neutral will make before the MCB is closed. Suitable for SDB200 switch disconnecter series. The S2C - Nt is not to switch with a tool (screwdriver).

Description	Bbn 4016779	Order details		Standard pack	L.P. ₹
	EAN	Type code	Order code		
Max 40A	647625	S2C-Nt	2CDS200918R0001	1	1,015

Accessories

Rotary operating mechanism for SB200 M



S2C-DH

Rotary operating mechanism (usable just with SB200/S200 devices)

For the actuation of 2-, 3- or 4pole miniature circuit-breakers in closed distribution boards for driveaxles of 5 or 6 mm² (square)

Description	Bbn 4012233	Order details		Standard pack	L.P. ₹
	EAN	Type code	Order code		
Rotary operating mechanism	57960 5	S2C-DH	GHS2001901R0003	1	Upon request

Note: S2C-DH cannot be used on DS200

Handles

Handle IP 65, 65 x 65 mm, padlockable with max. 3 padlocks (bail diameter 5 - 8 mm), door interlock in ON-position, adjustable*



OH

Color	Suitable for switches	Bbn 4012233	Order details		Standard pack	L.P. ₹
		EAN	Type code	Order code		
Black	OT16...40F	40978 8	OHBS2AJ	1SCA105213R1001	1	Upon request
Yellow-red	OT16...40F	41226 9	OHYS2AJ	1SCA105296R1001	1	
Silver	OT16...40F	41199 6	OHSS2AJ	1SCA105278R1001	1	
Grey	OT16...40F	41186 6	OHGS2AJ	1SCA105265R1001	1	

Handle IP 65, 65 x 65 mm, padlockable with max. 3 padlocks (bail diameter 5 - 8 mm), door interlock in ON-position

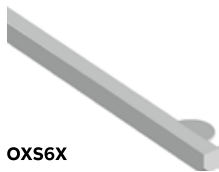

OXS6X

Color	Suitable for switches	Bbn 4012233	Order details		Standard pack	L.P. ₹
		EAN	Type code	Order code		
Black	OT16...40F	41140 8	OHBS2AJ1	1SCA105215R1001	1	Upon request
Yellow-red	OT16...40F	41227 6	OHYS2AJ1	1SCA105297R1001	1	
Silver	OT16...40F	41210 8	OHSS2AJ1	1SCA105279R1001	1	
Grey	OT16...40F	41187 3	OHGS2AJ1	1SCA105266R1001	1	

* OH_2_J enables selection of MCB behavior when opening panel door (remain switched on or switch off).
OH_2_J1 will cause MCB to switch off when opening panel door.

Axle extension

Type and order numbers are for one piece. For selector type handles. Shaft diameter 6 mm.

Length	Suitable for switches	Bbn 4012233	Order details		Standard pack	L.P. ₹
		EAN	Type code	Order code		
85	OT16...40F	36571 8	OXS6X85	1SCA101647R1001	10	Upon request
105	OT16...40F	42411 8	OXS6X105	1SCA108043R1001	10	
120	OT16...40F	36578 7	OXS6X120	1SCA101654R1001	10	
130	OT16...40F	36577 0	OXS6X130	1SCA101655R1001	10	
160	OT16...40F	36580 0	OXS6X160	1SCA101656R1001	10	
180	OT16...40F	36583 1	OXS6X180	1SCA101659R1001	10	
250	OT16...40F	36584 8	OXS6X250	1SCA101660R1001	10	
330	OT16...40F	36585 5	OXS6X330	1SCA101661R1001	10	

Auxiliary elements for

MCB's SB200 M, SB200 DC, switch disconnecter SDB200, RCCB's FB200, F200 and RCBO's DS201 M



F2C-ARI

Motor operating devices

Function: S2C-CM, F2C-CM and DS2C-CM allow the remote control (opening or closing) of the coupled device. Suitable for SB200 series MCBs and SDB200 switch disconnectors, FB200 RCCBs and RCBOs DS201.

Description	Bbn 8012542 EAN	Order details		Standard pack	L.P. ₹
		Type code	Order code		
Motor operating device for 1P S200 series MCBs and SD200 switch disconnectors	026259	S2C-CM1	2CSS201997R0013	1	Upon request
Motor operating device for 2P and 3P S200 series MCBs and SD200 switch disconnectors	026358	S2C-CM2/3	2CSS203997R0013	1	
Motor operating device for 4P S200P MCBs	026457	S2C-CM4	2CSS204997R0013	1	
Motor operating device for 2P and 4P F200 RCCBs	026556	F2C-CM	2CSF200997R0013	1	
Motor operating device for 1P+N and 2P DS201, DS202C RCBOs	135951	DS2C-CM	2CSR201997R0013	1	
Motor operating device for F200 125A RCCB	020721	F2-125A-24V-CM4	2CSF200997R1214	1	
Motor operating device for F200 125A RCCB	600626	F2-125A-230V-CM4	2CSF200997R1205	1	

Auto-reclosing units

Function: F2C-ARI and F2C-ARI30 allow the auto-reclosing of the coupled device in case of unwanted tripping. Suitable for F 200 RCCBs up to 100 A.

Description	Bbn 8012542 EAN	Order details		Standard pack	L.P. ₹
		Type code	Order code		
Auto-reclosing unit for 2P and 4P F200 RCCBs	026655	F2C-ARI	2CSF200996R0013	1	Upon request
Auto-reclosing unit for 2P and 4P F200 RCCBs (30")	064350	F2C-ARI30	2CSF200995R0013	1	

Auxiliary elements for RCCB's FB200 and F200



F2C-ARH

2CSF200992R0005

Home automatic resetting unit (for domestic and similar applications)

Function: it recloses the associated residual current device, only after having checked that there are no effective faults in the system protected by the RCCB.

Suitable for 2-pole RCCB series with 30 mA or 100 mA sensitivities, max 63 A

Description	Bbn 8012542	Order details		Standard pack	L.P. ₹
	EAN	Type code	Order code		
Home automatic resetting unit (30 mA)	732433	F2C-ARH	2CSF200992R0005	1	Upon request
Home automatic resetting unit (100 mA)	658535	F2C-ARH100	2CSF200990R0005	1	



F2C-ARH-T

2CSF200991R0005

Home automatic resetting unit with autotest (for domestic and similar applications)

Function: it recloses the associated residual current device, only after having checked that there are no effective faults in the system protected by RCCB.

Suitable for 2-pole RCCB series with 30 mA or 100 mA sensitivities, max 63 A.

F2C-ARH-T allows the RCCB automatic test every six months.

Description	Bbn 8012542	Order details		Standard pack	L.P. ₹
	EAN	Type code	Order code		
Home automatic resetting unit (30 mA) with RCCB autotest	733232	F2C-ARH-T	2CSF200991R0005	1	Upon request
Home automatic resetting unit (100 mA) with RCCB autotest	593836	F2C-ARH-T100	2CSF200989R0005	1	

Auxiliary elements for MCB's S800 series



S800-AUX

Auxiliary contact

Description	Order details	Packing	Ordering code	L.P. (₹)
Auxiliary contact	S800-AUX	1	2CCS800900R0011 ■	3,470



S800-AUX/ALT

Combined auxiliary and signal contact

Description	Order details	Packing	Ordering Code	L.P. (₹)
Auxiliary/signal contact	S800-AUX/ALT	1	2CCS800900R0021	4,145

■ Stock items

Wiring diagram

System Pro M

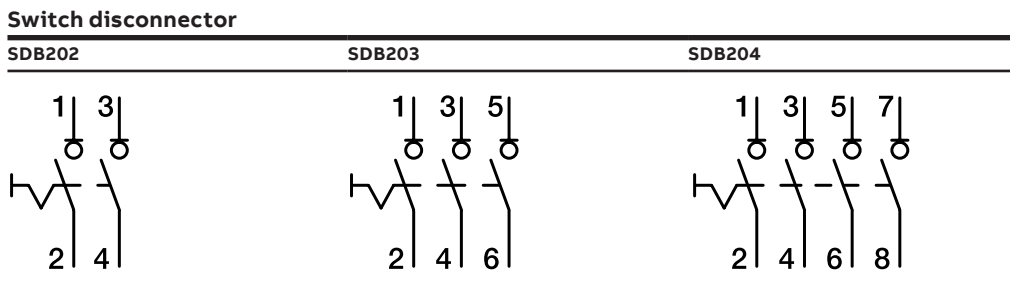
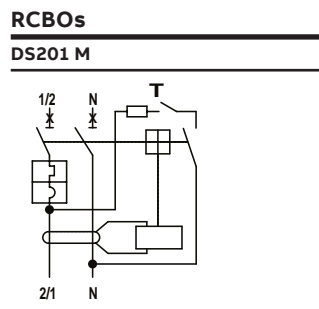
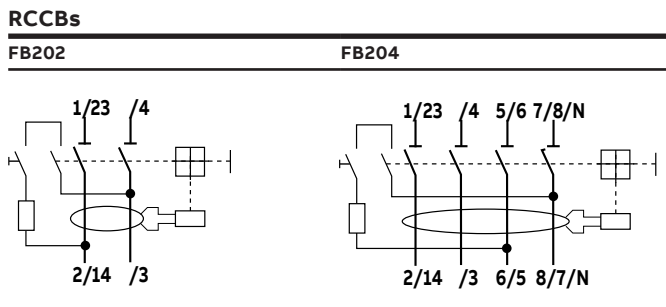
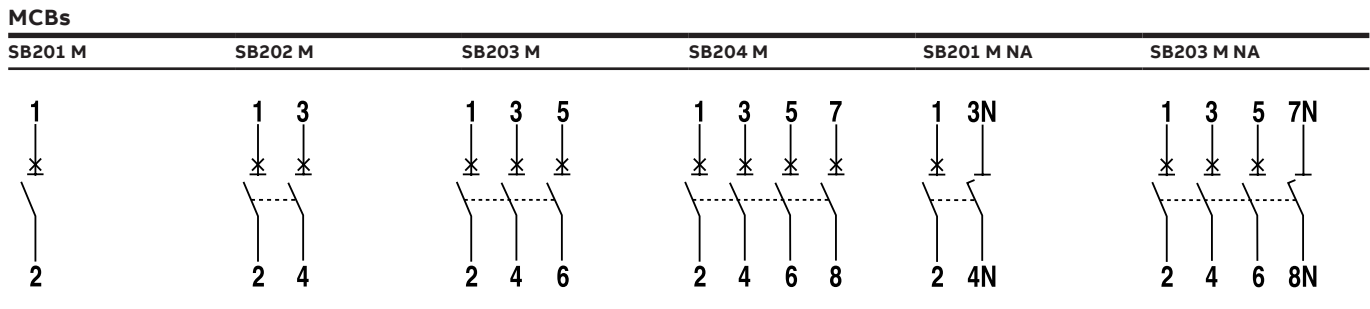

Wiring diagram

SB200 DC

Example for permissible voltages between the conductors depending on the number of poles and circuit layout:

voltage between conductors	U_n	250 V-	500 V-	500 V-	500 V-
voltage between conductors and earth	U_n	250 V-	250 V-	500 V-	250 V-
MCB		1-pole SB200 DC	2-pole SB200 DC	2-pole SB200 DC	2-pole SB200 DC
supply from below					
supply from above					

Supply and load connections

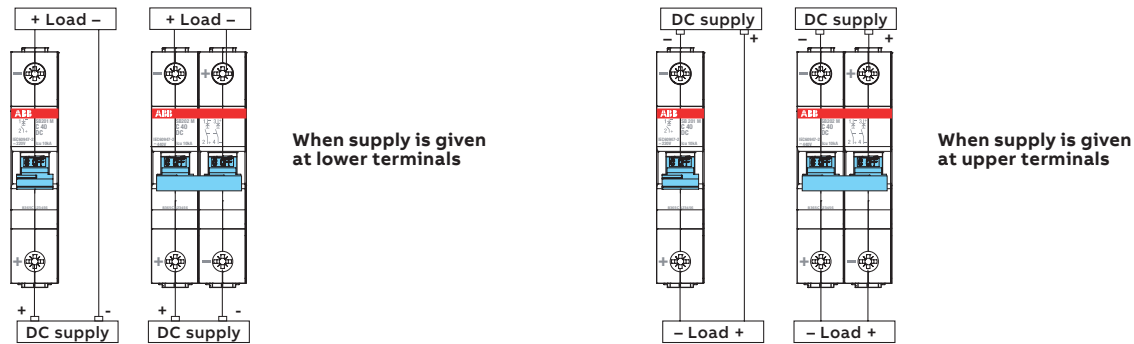

Auxiliary elements

S2C-S/H6R			S2C-H6R		S2C-H-11R		S2C-H6-20R	
Used as signal contact	Automatic opening	Manual opening	Used as auxiliary contact	Automatic opening	Used as auxiliary contact	Automatic opening	Used as auxiliary contact	Automatic opening

Auxiliary elements

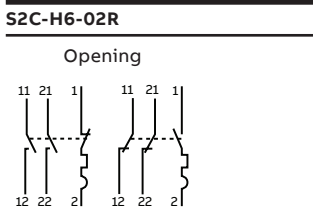

Overall dimensions

System Pro M

MCB SB200 M and Switch disconnecter SDB200

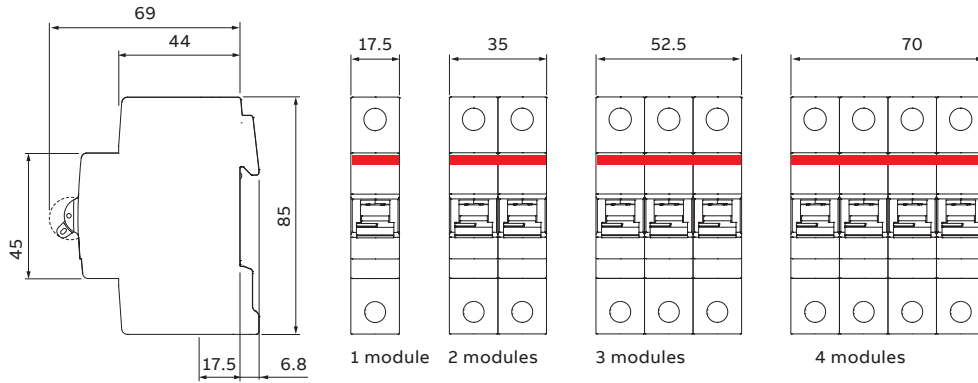

MCB SB200 DC

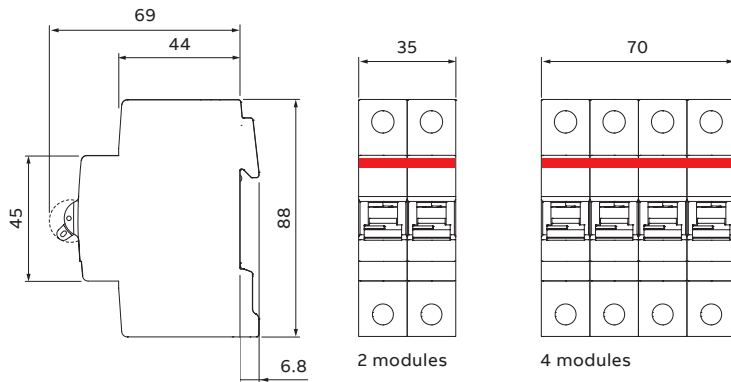

RCCB FB200

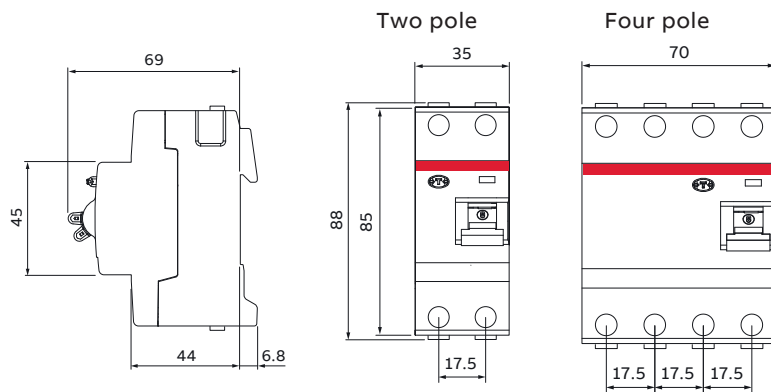

RCBO DS201 M

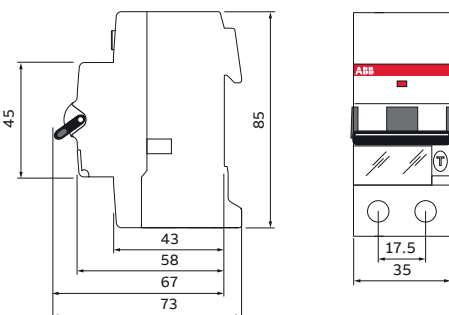

Overall dimensions

MCB - (S200 M and S200)

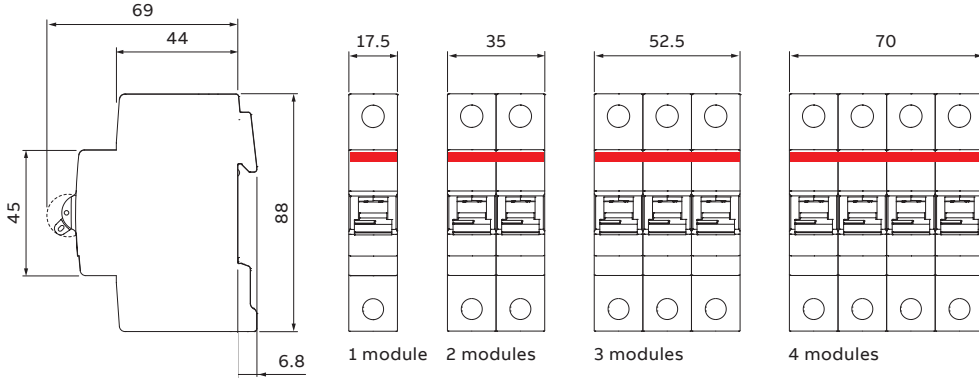

RCCB - (F200)

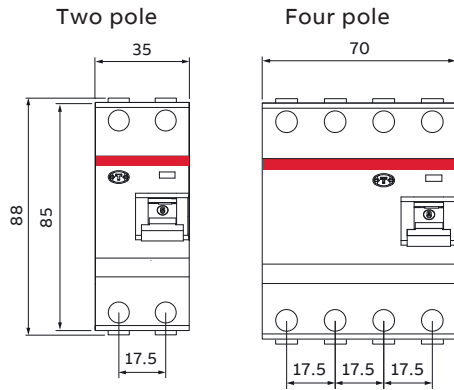
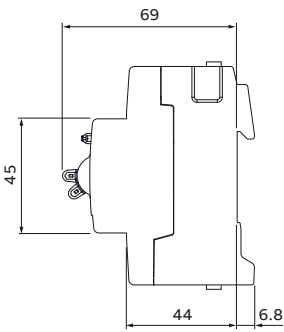

RCBO (DS200)

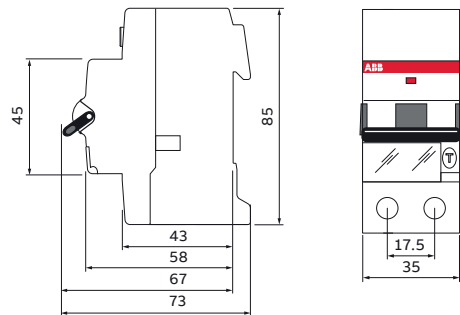

DDA 200

Two pole
In=25-63 A

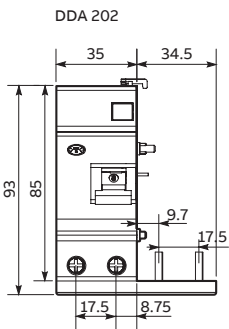

Four pole
In=25-40 A

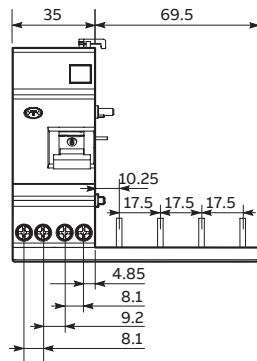

Four pole
In=63 A

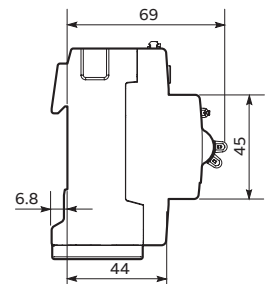
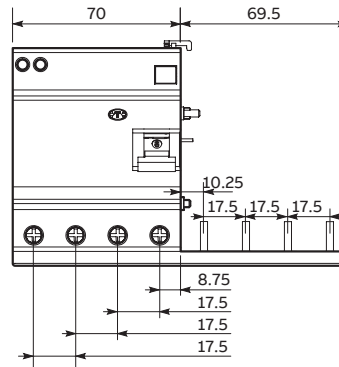

Surge protection devices - The new OVR QuickSafe®

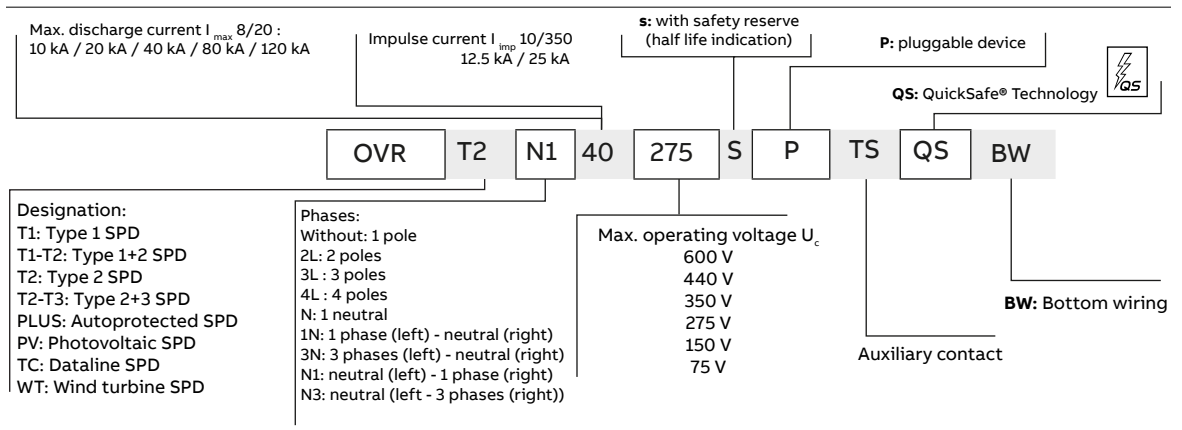

Type 1+2 - Metal oxide varistor

Type 1+2 surge protective devices are designed to discharge high current surges without any destruction of the installation. These surge protective devices are characterized by their capacity to withstand impulse current with 10/350 μ s wave form which simulate natural lightning current.

Three pole + neutral



OVR Type 1

Description	Max. continuous operating voltage U_c (V)	"I imp in kA (10/350us wave)"	"I max in kA (8/20us wave)"	Pole	No. of modules	Ordering code	L.P. (₹)
OVR T1-T2 3N 12.5-275s P QS	275	12.5	80	3+1	4	2CTB815710R1900 ■	26,265
OVR T1-T2 3N 12.5-275s P TS QS	275	12.5	80	3+1	4	2CTB815710R0700	30,215
OVR T1-T2 3N 12.5-440s P QS	440	12.5	80	3+1	4	2CTB815710R4800	31,525
OVR T1-T2 3N 12.5-440s P TS QS	440	12.5	80	3+1	4	2CTB815710R3600	36,245

Type 2 - Metal oxide varistor

Type 2 SPDs can be installed at the sub-distribution switch board for protection of electrical installation and equipments against indirect lightning and switching surges.

Single pole



OVR Type 2

Description	Max. continuous operating voltage U_c (V)	I max in kA (8/20us wave)	No. of Modules	Ordering code	L.P. (₹)
OVR T2 40-275 P QS	275	40	1	2CTB803871R2300 ■	4,445
OVR T2 40-275s P QS	275	40	1	2CTB815704R1200	6,580
OVR T2 40-275 P TS QS	275	40	1	2CTB803871R1700	5,670
OVR T2 40-440 P QS	440	40	1	2CTB803871R1200	4,540
OVR T2 40-440s P QS	440	40	1	2CTB815704R4100	6,250
OVR T2 80-275s P QS	275	80	1	2CTB815708R1200	6,800
OVR T2 80-275s P TS QS	275	80	1	2CTB815708R0000	8,375
OVR T2 80-440s P QS	440	80	1	2CTB815708R4100	6,155
OVR T2 80-440s P TS QS	440	80	1	2CTB815708R2900	7,715

Surge protection devices (OVR)



OVR Type 2

Single pole + neutral

Description	Max. continuous operating voltage U _c (V)	I max in kA (8/20us wave)	No. of Modules	Ordering code	L.P. (₹)
OVR T2 1N 40-275 P QS	275	40	2	2CTB803972R1100 ■	9,465
OVR T2 1N 40-275s P QS	275	40	2	2CTB815704R1400	11,935
OVR T2 1N 40-275 P TS QS	275	40	2	2CTB803972R0500	10,745
OVR T2 1N 40-275s P TS QS	275	40	2	2CTB815704R0200	13,060
OVR T2 1N 40-350 P QS	350	40	2	2CTB803982R1100	10,225
OVR T2 1N 40-350 P TS QS	350	40	2	2CTB803982R0500	11,610
OVR T2 1N 80-275s P QS	275	80	2	2CTB815708R1400	12,570
OVR T2 1N 80-275s P TS QS	275	80	2	2CTB815708R0200	13,870

Three pole + neutral



OVR Type 2

Description	Max. continuous operating voltage U _c (V)	I max in kA (8/20us wave)	No. of modules	Ordering code	L.P. (₹)
OVR T2 3N 40-275 P QS	275	40	4	2CTB803973R1100 ■	16,175
OVR T2 3N 40-275s P QS	275	40	4	2CTB815704R2000	23,055
OVR T2 3N 40-275 P TS QS	275	40	4	2CTB803973R0500	20,595
OVR T2 3N 40-275s P TS QS	275	40	4	2CTB815704R0800	27,015
OVR T2 3N 40-350 P QS	350	40	4	2CTB803983R1100	17,480
OVR T2 3N 40-350 P TS QS	350	40	4	2CTB803983R0500	26,225
OVR T2 3N 40-440 P QS	440	40	4	2CTB803973R1400	16,660
OVR T2 3N 40-440 P TS QS	440	40	4	2CTB803973R1500	20,850
OVR T2 3N 40-440s P TS QS	440	40	4	2CTB815704R3700	48,635
OVR T2 3N 80-275s P QS	275	80	4	2CTB815708R2000	24,100
OVR T2 3N 80-275s P TS QS	275	80	4	2CTB815708R0800	28,710
OVR T2 3N 80-440s P QS	440	80	4	2CTB815708R4900	21,030
OVR T2 3N 80-440s P TS QS	440	80	4	2CTB815708R3700	25,385

Surge arrester for data line protection (Pluggable)



OVR SL

Description	Max. continuous operating voltage U _c (V)	I max in kA (8/20us wave)	Width	Ordering code	L.P. (₹)
OVR SL06	7.79 V	10 kA	7mm	7TCA085400R0360	Upon request
OVR SL15	16.7 V	10 kA	7mm	7TCA085400R0361	
OVR SL30	36.7 V	10 kA	7mm	7TCA085400R0363	
OVR SL50	56.7 V	10 kA	7mm	7TCA085400R0364	
OVR SLTN	296 V	10 kA	7mm	7TCA085400R0323	

DBT Timer digital time switches **NEW**

An ideal range for automating the functions of the installation

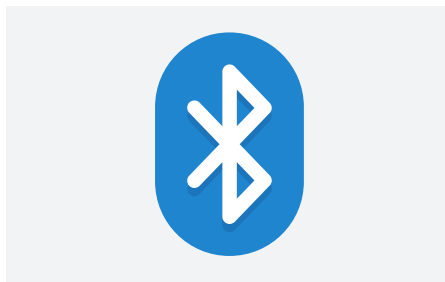
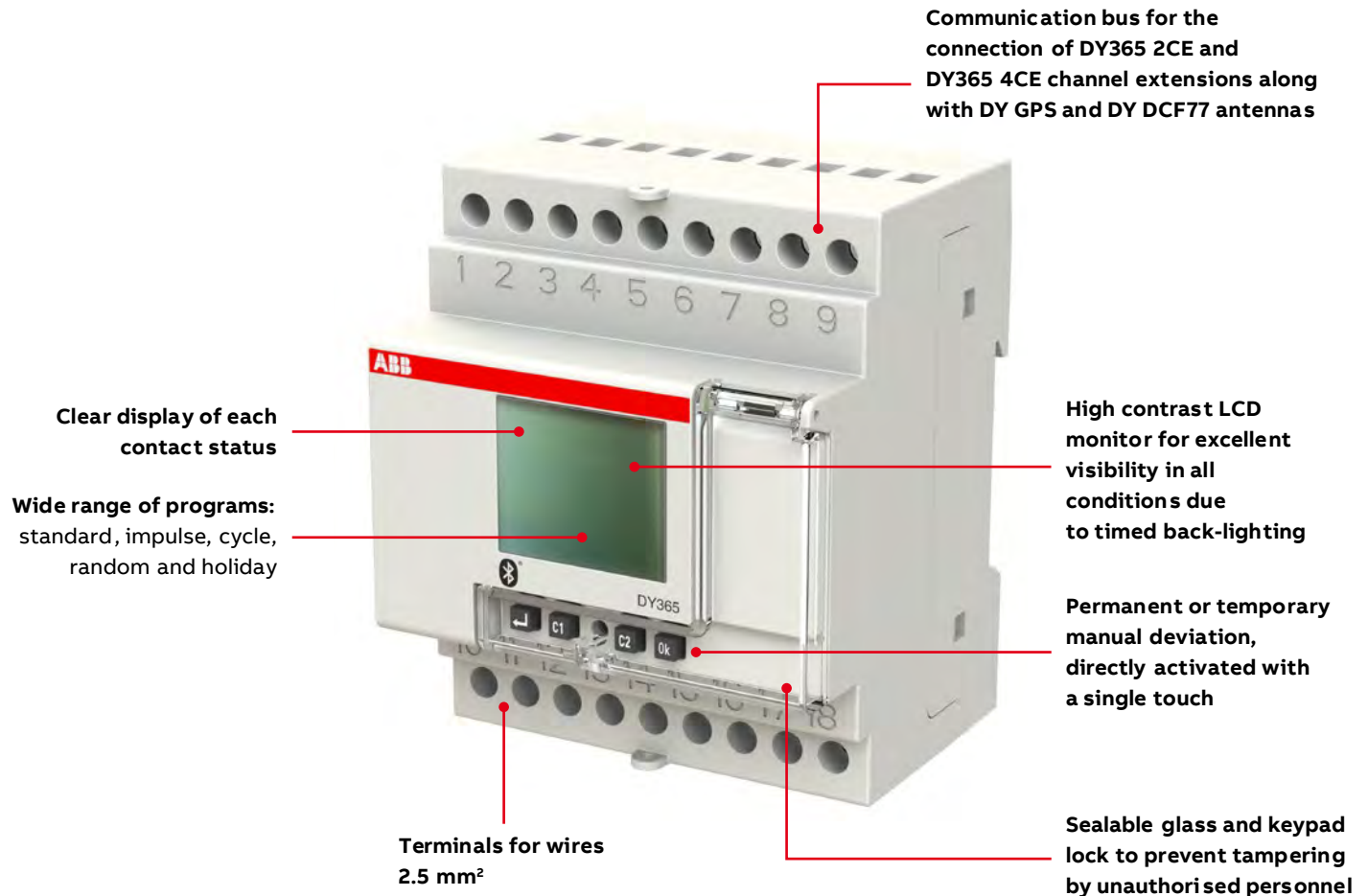

Wide range of programs: standard, impulse, cycle, random and holiday

- Permanent or temporary manual deviation, directly activated with a single touch
- LCD Display with back-lighting
- Up to 900 storable events
- Up to 400 pre-defined cities coordinates
- Accuracy of ± 0.5 seconds/24h
- Switching solar time/daylight saving time

Bluetooth communication combined with the DBT Timer APP available for Android and iOS ensure smart configuration and quick visualization. This functionality also allows to transfer programs from one device to another simply using the Smartphone.

Time synchronization via DY DCF77 or DY GPS antennas. The DY DCF77 antenna receives scheduled messages transmitted by the atomic clock installed c/o Mainflingen (Germany), near Frankfurt. Thanks to this signal, the time switches are automatically set to: hour, date and proper daylight saving time. The DY GPS antenna receives time from the Global Positioning System, providing an accurate location and time information for an unlimited number of people in all weathers, day or night, anywhere in the world.

DBT Timer digital time switches

An ideal range for automating the functions of the installation



DW1

Digital weekly time switch - DW

DW1 and DW2 are weekly digital time switches with 1 and 2 channels, respectively. They allow exclusion of the normal weekly program in every week with the same mode.

Description	Ordering code	L.P. (₹)
DW weekly digital time switches-DW1, 1 channel	2CSM222531R1000	10,355
DW weekly digital time switches-DW2, 2 channel	2CSM222521R1000	16,175



DWA1

Digital weekly astronomical time switch - DWA

The astronomical switches DWA1 and DWA2, respectively, with 1 and 2 channels, automatically control lighting circuits depending on the time of sunrise and sunset, greatly increasing energy efficiency. The programming is in fact based on a mathematical algorithm able to calculate the time of the rising and setting of the sun in a certain location for each day of the year. Once powered the device, simply insert date, time, geographical coordinates and time zone so that it is ready to work. These settings can also be automatically defined using the DBT Timer APP. The installation of astronomical digital time switches is particularly useful when using a twilight switch with external sensor is not recommended because it may be subject to malfunctions caused by air pollution, excessive brightness or vandalism. DWA1 and DWA2 are also indicated for the control of public lighting, shop windows of shops, neon signs, monuments, facades, illuminated fountains.

Description	Ordering code	L.P. (₹)
DWA twilight astronomical switches DWA-1, 1 channel	2CSM222511R1000	22,430
DWA twilight astronomical switches DWA-2, 2 channel	2CSM222501R1000	27,995



TL1

TL1 Pole

TL Line modular twilight switches

TL1 twilight switch allows to switch ON and switch OFF lighting devices according to a scheduled level of the ambient light. It is used in combination with an external sensor to detect if the ambient light is higher or lower than the set level. A switching delay prevents them from operating unnecessarily when the light intensity suddenly changes (e.g. lightning, moving vehicles, etc.). The TL1 twilight switch 1 channel is preset with a 10 LUX from factory and it is equipped with 2 signalling LEDs that indicate the setpoint value and display the status of the contact. The operating instructions are printed on the side of the product.

Description	Ordering code	L.P. (₹)
TL1 modular twilight switches 1 channel with external sensor TL1	2CSM229921R1341	9,230
TL1 pole twilight switches, installation on the pole/wall TL1 Pole	2CSM229911R1341	8,595



AD1CO-15m

AG Timer electro-mechanical time switches

These analog timers are designed for installation on DIN-rail. They control circuit opening and closing according to the scheduled program. Available both on daily and weekly versions and equipped with a 16 A contact. They can be set on the scheduled program or on the permanent ON-OFF function. The AD1NO-R-15m, AD1CO-R-15m, AW1CO-R-120m, AD1CO-R-30m, AW1CO-R-210m versions are equipped with a built-in battery, charged by the network voltage, which allows the devices to maintain the set time also in case of long (up to 150 h) power supply failures. The products fit applications such as control of lighting systems of shops or commercial buildings, heating and ventilation systems as well as control of automatic irrigation systems of private or external gardens.

Description	Ordering code	L.P. (₹)
AD1CO Daily time switch, running reserve 1NO/1NC, AD1CO-R-15m	2CSM208151R1000 ■	4,540

Control and automation components

Description	Ordering code	L.P. (₹)
E 232-230 staircase lighting time-delay switches, Staircase lighting time-delay switches are usually operated by pushbuttons, often fitted with a glow lamp. Switches are designed for a glow lamp current of up to 150 mA and thus perfectly suitable for installations in multi-storey buildings.	2CDE11000R0501	6,420
The E 232-230 staircase lighting time-delay switch includes an electro-mechanical timer with a synchronous motor drive to ensure high operational safety in whatever mounting position. The time range is adjustable in increments of 15 seconds from 1 to seven minutes. Resettable after 30 seconds	2CDE110003R0511	8,335



E200

■ Stock items

SMISLINE TP plug-in system

Changes have never been easier

SMISLINE TP ensures that load-free devices and components can be snapped on and off under voltage without the need for additional personal protective equipment to guard against electrical hazards.

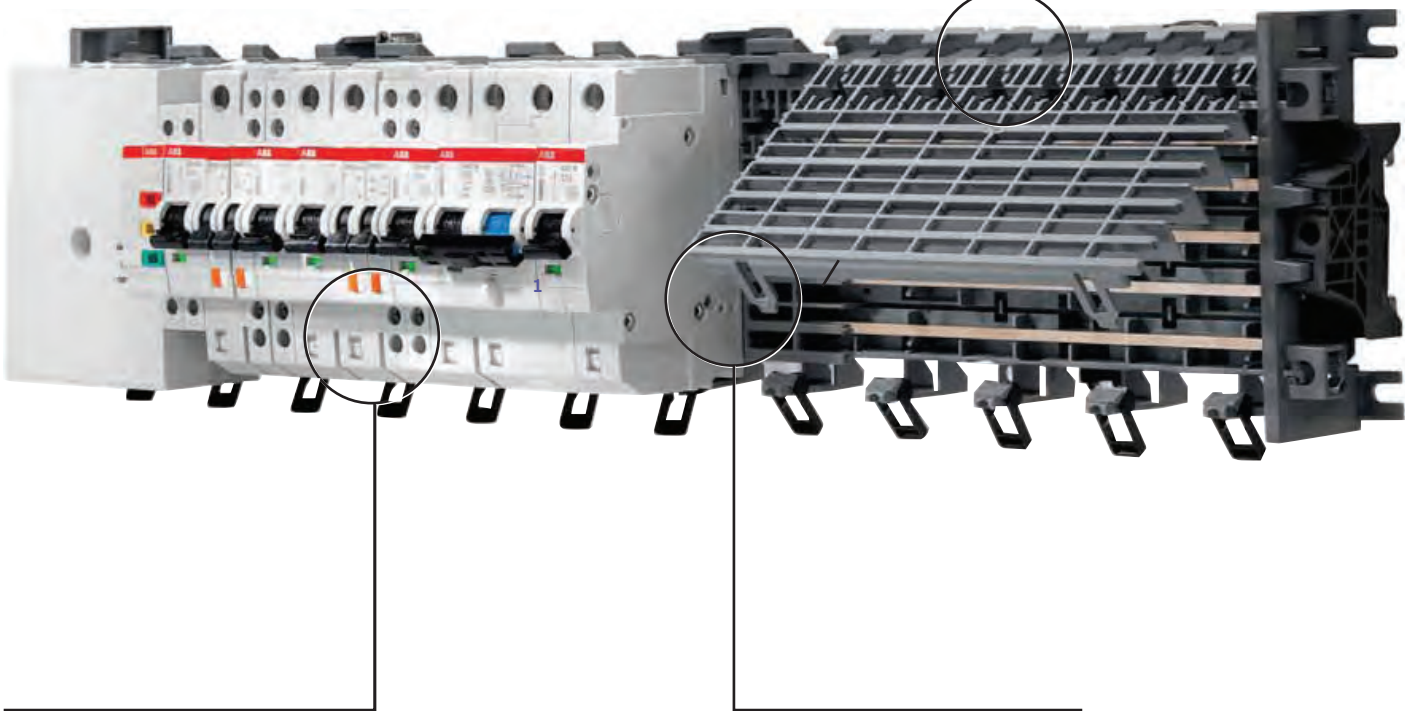

It opens up to completely new prospects for you when it comes to installation, operation and flexibility.

The world's first pluggable socket system.

SMISLINE TP plug-in system

Changes have never been easier



Even safer: protection against electrical hazards

We have upgraded our unique SMISLINE socket system even further through the addition of a pioneering innovation. With the new SMISLINE TP system, components can now be plugged in or unplugged load-free without any risk from electrical current running through the body.

The SMISLINE TP pluggable socket system is completely fingersafe (IP2XB) – when devices are plugged in and unplugged, the system is always touch-proof. This means that SMISLINE TP prevents any danger to personnel from switching arcs or accidental arcing.

Even more flexible: make additions and changes during on-going operation

Pluggable devices can be added and changed quickly, safely and simply during on-going operation. And this can be done without any need for personal protective equipment.

This means that you benefit from more flexibility, savings on installation and maintenance – and improved safety. SMISLINE TP provides greater availability and operating safety than conventional systems.

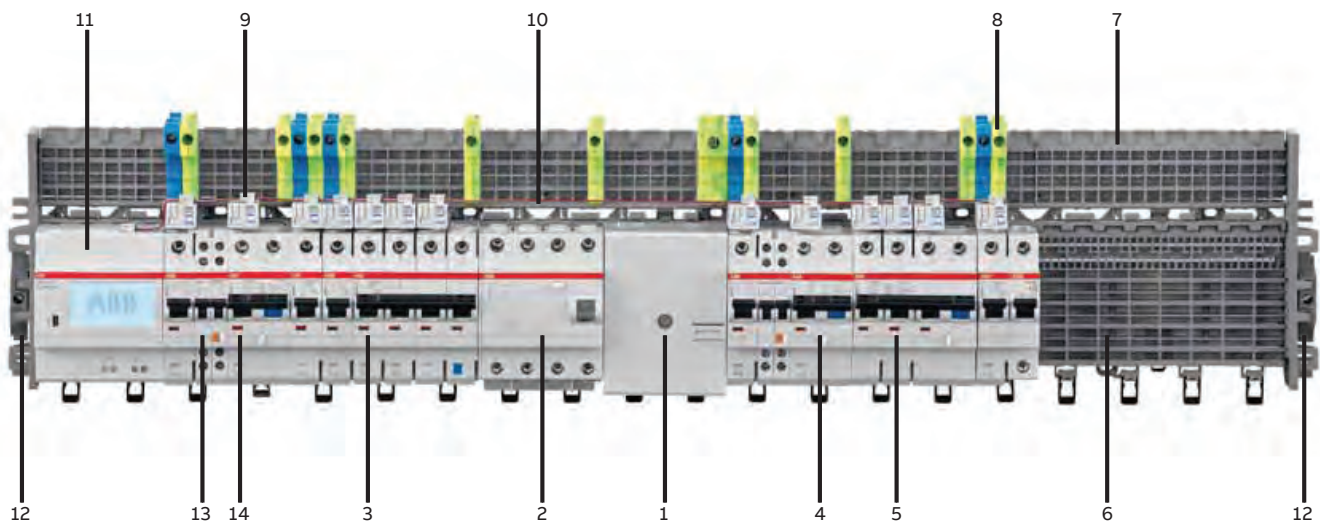

- | | | |
|------------------------------------|---|----------------------|
| 1 Supply terminal | 6 Socket IP20 | 11 Control unit CMS |
| 2 Surge arrester OVR404 | 7 Additional socket IP20 | 12 Socket end piece |
| 3 Miniature circuit breaker S403NP | 8 Terminals | 13 Auxillary contact |
| 4 RCBO FS401 | 9 Sensor for current measurement system | 14 Signal contact |
| 5 RCBO FS403 | 10 Cabel Bus system CMS | |

ELR, Earth leakage relay - (DIN & front panel mountable)



Front panel residual current relays are electronic devices used in combination with an external toroidal transformer. They are according to the protection standard IEC/EN 60947-2 Annex-M. The sensitivity can be set from 0.03 A to 30 A, while the tripping time from 0 to 5 seconds. Residual current relays are available in versions 48x48 mm, 72x72 mm, and 96x96 mm. The Fail Safe function is available for versions ELR48P, ELR72P and ELR96P: the contacts switch when there is no auxiliary power. The ELR96PF version is equipped with Fail Safe function, fault memory LED, and a frequency filter, that ensure continuity of service in the presence of harmonics. ELR96PD has (in addition to these functions) a digital display for an instantaneous view of the residual current $I_{\Delta n}$.

Description	Operating voltage	Pack	Ordering code	L.P.(₹)
ELR48P	110 V a.c./d.c. - 230 V a.c.	1	2CSG252211R1202	
ELR48V24P	24-48 V a.c./d.c.	1	2CSG452211R1202	
ELR72	110 V a.c./d.c. - 230 V a.c.	1	2CSG252120R1202	
ELR72V24	24-48 V a.c./d.c.	1	2CSG452120R1202	
ELR72P	110-230-400 V a.c.	1	2CSG152424R1202	
ELR72V24P	24-48 V a.c./d.c.	1	2CSG452424R1202	Upon request
ELR96	110-230-400 V a.c.	1	2CSG152130R1202	
ELR96V24	24-48 V a.c./d.c.	1	2CSG452130R1202	
ELR96P	110-230-400 V a.c.	1	2CSG152434R1202	
ELR96V24P	24-48 V a.c./d.c.	1	2CSG452434R1202	
ELR96PF	110-230-400 V a.c.	1	2CSG152435R1202	
ELR96PD	110-230-400 V a.c.	1	2CSG152436R1202	

RD3, residual current relays - (DIN rail mountable)

The RD3 family of electronic residual current relays provides residual current protection and monitoring functions according to IEC/EN 60947-2:2006 annex M and can be used in conjunction with all S 200 automatic devices and Tmax range moulded case devices up to T5, for industrial installations.

The RD3 residual current relays can provide status indications through two output contacts.



Description	Operating voltage	Pack	Ordering code	L.P.(₹)
RD3-48	12-48 a.c./d.c.	1	2CSJ201001R0001	
RD3	230-400 a.c.	1	2CSJ201001R0002	
RD3M-48	12-48 a.c./d.c.	1	2CSJ202001R0001	Upon request
RD3M	230-400 a.c.	1	2CSJ202001R0002	
RD3P-48	12-48 a.c./d.c.	1	2CSJ203001R0001	
RD3P	230-400 a.c.	1	2CSJ203001R0002	

Toroidal transformers

Description	Toriod useful diameter (mm)	Min. measureable current (mA)	Max. rated current ¹ (A)	Max. capacity ² (A)	Pack	Ordering code	L.P.(₹)
TRM	29 (modular version)	30	65	160	1	2CSM029000R1211	
TR1	35	30	75	250	1	2CSG035100R1211	
TR2	60	30	85	400	1	2CSG060100R1211	
TR3	80	100	160	800	1	2CSG080100R1211	
TR4	110	100	250	1,250	1	2CSG110100R1211	
TR4/A	110 (openable version)	300	250	1,250	1	2CSG110200R1211	Upon request
TR160	160	300	400	2,000	1	2CSG160100R1211	
TR160A	160 (openable version)	500	400	2,000	1	2CSG160200R1211	
TR5	210	300	630	3,200	1	2CSG210100R1211	
TR5/A	210 (openable version)	500	630	3,200	1	2CSG210200R1211	

¹ Shows toroidal transformers selection for use with ELR according to IEC/EN 60947-2 Annex M in combination with MCBs S200 range and MCCBs Tmax range upto T5

² Shows the technical features of the toroidal transformers



M1A and M1V

NEW

The M1 series is a single phase and three-phase digital panel meter for reliable and accurate true-RMS measurement of electrical parameters (voltage, current) for industrial and commercial applications.



Application

- Commercial and industrial sub-metering
- High and medium voltage switchgear panels
- Power control centre (PCC) panels
- Motor control centre (MCC) panels
- LV distribution panels
- Control and relay panels
- Automation and monitoring systems

Parameters	M1A	M1V
Auxiliary power supply	80V to 300 V AC or DC	80V to 300 V AC or DC
Frequency	50 - 60 Hz	50 - 60 Hz
Burden	5VA	5VA
Installation category CAT III	200mA	200mA
Protection fuse		
Measurement accuracy		Voltage $\pm 1,0\%$ (M1V1) / $\pm 0,5\%$ (M1V3)
Current $\pm 1,0\%$	Current $\pm 1,0\%$ (M1A1) / $\pm 0,5\%$ (M1A3)	
Voltage measurement inputs		40-300V AC (p-n)
Measurement category	CAT III	CAT III
Rated frequency [Hz]	50 - 60Hz	50 - 60Hz
Max. VT Primary [V]		999 Kv
Burden [VA]		0.2VA Max. per phase
Current measurement inputs	CT secondary 1A or 5A	
Measurement range	50mA - 6A ¹	
Max. CT Primary [A]	99 kA.	
Burden [VA]	0.2VA Max. per phase	
User Interface Access to device	2 pushbuttons	2 pushbuttons
Display type	LED display	LED display
LED Digit height [mm]	10	10
Mechanical characteristics Overall dimensions [mm]	96 x 96 x 58 (52mm depth inside the switchboard)	96 x 96 x 58 (52mm depth inside the switchboard)
IP degree of protection (IEC 60529)	IP51	IP51
Weight [kg]	0,300	0,300
Climatic conditions operating temperature	-10°C to +60°C ²	-10°C to +60°C ²
Storage temperature	-25°C to +70°C	-25°C to +70°C
Relative humidity	5% to 95% non condensing	5% to 95% non condensing
Pollution degree	2	2
Altitude	Below 2000ms	Below 2000ms
Standards Electrical safety	IEC 61010-1	IEC 61010-1

M1A and M1V

Ordering codes

NEW



M1A

M1A is a digital ammeter for current measurement, providing the measurement of the single-phase or three-phase electrical parameters and allowing easy replacement of different analogue meters.

Communication protocol and interface	Order details Type code	Order code	Pack unit pc.	L.P.(₹)
-	M1A 1-1 Ammeter 1Ph (Cl 1.0)	1SYG235145R4051 ■	1	1,130
-	M1A 3-1 Ammeter 3Ph (Cl 1.0)	1SYG235135R4051 ■	1	2,055
-	M1A 3-05 Ammeter 3Ph (Cl 0.5)	1SYG234905R4051 ■	1	1,780



M1V

M1V is a digital voltmeter for voltage (and Frequency) measurement, providing the measurement of the single-phase or three-phase Voltage as well as Frequency (for 3Ph Voltmeter) and allowing easy replacement of different analogue meters.

Communication protocol and interface	Order details Type code	Order code	Pack unit pc.	L.P.(₹)
-	M1V 3-05 Volt Meter 3Ph	1SYG233695R4051 ■	1	1,130
-	M1V 3-1 Volt Meter 3Ph	1SYG233955R4051 ■	1	2,055
-	M1V 1-1 Volt Meter 1Ph	1SYG233965R4051 ■	1	1,780

Coming soon*

M1M 11

M1M11 is a digital kWh meter for energy measurement, providing the measurement of the single-phase or three-phase energy consumption.

Order details Type code	Order code	Pack unit pc.	L.P.(₹)
M1M 11-1 Modbus kWh meter 1%	1SYG233685R4051	1	Upon request
M1M 11-05 Modbus kWh meter 0,5%	1SYG232395R4051	1	

* Availability from February 2022

Measurement devices **NEW**

M1M 10 and M1M 12

Intuitive visualization

Clear and simple reading of the measurement data for all 3 phases on the wide LED displays.

Compact design

Only 52mm inside the switchboard to ensure optimized logistics and reduced footprint in the panel



Electrical system monitoring

Complete electrical parameters measurement, from simple VAF (voltage, current, frequency) to power and energy monitoring

Easy to use

Simple front keypad to navigate in setup and menus.

Remote measurement

Availability of RS485 interface with the support of communication protocol Modbus RTU facilitating the communication and connection of the device with remote locations.

M1M 10 and M1M 12

Technical features

		M1M 10	M1M 12
Auxiliary power supply	Auxiliary Power Supply range	80V to 300 V AC or DC	
	Frequency	Hz	50 - 60
	Burden		5VA Max
	Installation category		CAT III
	Protection fuse		200mA
Measurement accuracy	Voltage		±1,0%
	Current		±1,0%
	Active Power (M1M 12)		±1,0%
	Active Energy (M1M 12)		±1,0%
Voltage measurement inputs	Measurement range	[V]	40-300V AC (p-n)
	Measurement category		CAT III
	Rated frequency	[Hz]	50 - 60Hz
	Max. VT Primary	[V]	999 Kv
	Burden	[VA]	0.2VA Max. per phase
Current measurement inputs	CT secondary		1A or 5A
	Measurement range		50mA - 6A ¹
	Max. CT Primary	[A]	99 kA.
	Burden	[VA]	0.2VA Max. per phase
User Interface	Access to device		2 pushbuttons
	Display type		LED display
	LED Digit height	[mm]	10
Communication protocol (M1M 12 Modbus)	RS-485		
	Protocol		Modbus RTU
	Communication interface		RS485 with optical isolation
	Baud rate		2400 bps to 19200 bps
	Parity number		Odd, Even, None
	Stop bit		1,2
	Address		1-247
Mechanical characteristics	Overall dimensions	[mm]	96 x 96 x 58 (52mm depth inside the switchboard)
	IP degree of protection (IEC 60529)		IP51
	Weight	[kg]	0,300
Climatic conditions	Operating temperature		-10°C to +60°C ²
	Storage temperature		-25°C to +70°C
	Relative humidity		5% to 95% non condensing
	Pollution degree		2
	Altitude		Below 2000ms
Standards	Electrical safety		IEC 61010-1
	EMC		IEC 61000 4-2,4-3,4-6,4-8,4-4,4-11; CISPR-22

¹ Below 250mA, additional error of 0.1% of full scale.

² Below 10°C, mean temperature coefficient is 0.15%/K

M1M 10 and M1M 12

Technical features



		M1M 10	M1M 12
Measured parameter	TRMS Voltage	■	■
	TRMS Current	■	■
	Frequency	■	■
	Power Factor		■
	Active Power		■
	Active Energy		■
	On Hours	■	■
	Load Hours		■
Communication interface	Serial port		RS-485
	Protocol		Modbus RTU

Overall dimensions

All measurements in mm

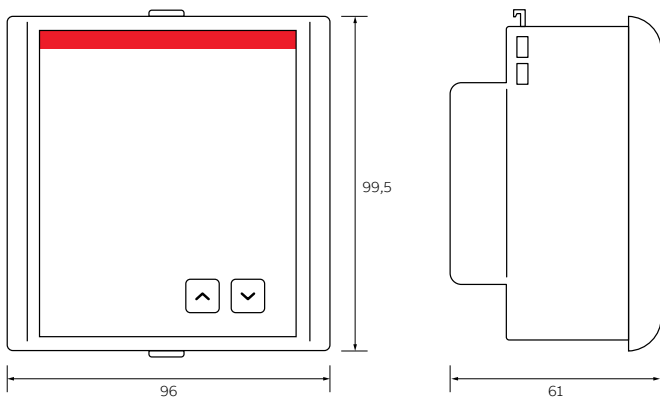

M1M 10 and M1M 12

Ordering codes



M1M 10

M1M 10

M1M 10 is a VAF meter for basic electrical system monitoring, providing the measurement of the main single-phase and three-phase electrical parameters and allowing easy replacement of different analogue meters.

Communication protocol and interface	Bbn 8012542 EAN	Order details Type code	Order code	Pack unit pc.	L.P.(₹)
-	350811	M1M 10	■	1	2,832



M1M 12

M1M 12

M1M 12 is a multi-function meter, providing what is needed to monitor the electrical system and allowing statistical metering of active energy consumption.

M1M 12 product range includes option with built-in communication protocol (Modbus RTU) through RS485 communication port, allowing easy integration with Modbus supervision systems.

Communication protocol and interface	Bbn 8012542 EAN	Order details Type code	Order code	Pack unit pc.	L.P.(₹)
-	075912	M1M 12	1SYG207591R4051 ■	1	9,108
Modbus RTU RS485	075813	M1M 12 Modbus	1SYG207581R4051 ■	1	10,094

M1M Power Meters

Introducing the new ABB dual source and power meters ranges M1M DS, M1M 20B and M1M 30B an easy solution for any standard application in buildings and industry.

M1M DS, M1M 20B and M1M 30B are the new ABB ranges of dual source and power meters, offering exactly what is needed to monitor the electrical system and analyze the power quality in a single device.

The new M1M power meters offer allows to easily and cost-effectively cover the main submetering and power quality monitoring requirements in commercial and industrial buildings, either small or mid/large-sized, e.g. inside power factor correction boards, motor control center or sub-distribution switchboards.

ABB's complete dual source, multifunction meters and network analyzers product line, now including

M1M and M4M ranges, are capable to cover all needs, from basic electrical parameters measurement to advanced power quality analysis.

ABB's power meters are simple to use, with a common and intuitive user experience from installation to operations, allowing to fully exploit the reliable, IEC-compliant measurements.

Thanks to their connectivity capabilities, M1M and M4M can get leverage on the integration in ABB scalable energy and asset management solutions to monitor, optimize and control the complete electrical system, such as System pro M compact® InSite and ABB Ability™ Energy and Asset Manager cloud-computing platform.

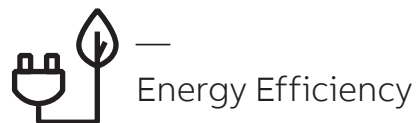
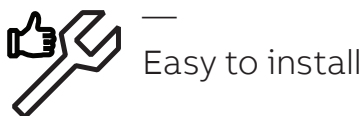

— Your benefits

For distributors

- Reduce selection time of the correct product thanks to reduced range complexity
- Manage a limited number of order codes from a single supplier
- Save space needed for internal stock
- Have the product on stock when needed and reduce delivery time

For panel builders

- 1 supplier only for all measurement products covering wide range of projects
- Increase competitiveness in projects
- Reduce time needed for product selection thanks to simple range composition
- Reduce time for installation and operations
- Minimum space requirements in the panel

M1M DS, 20B and 30B

Coming soon*

Ordering codes

M1M DS

M1M DS is a digital dual source meter along with power parameters for two source measurement for example EB/DG.

Order details Type code	Order code	Pack unit pc.	L.P.(₹)
M1M DS Dual source meter	1SYG232385R4051	1	Upon request
M1M DS Modbus Dual source meter	1SYG232375R4051	1	

M1M 20B

M1M 20 is a power meter including THD and import/export (4 quadrants) measurement for basic power quality analysis applications such as power factor management and local energy generation monitoring.

Order details Type code	Order code	Pack unit pc.	L.P.(₹)
M1M 20B-1 Modbus 1%	1SYG231445R4051	1	Upon request
M1M 20B-05 Modbus 0,5%	1SYG230355R4051	1	
M1M 20B-02 Modbus 0,2%	1SYG230295R4051	1	

M1M 30B

M1M 30 is a power meter providing complete features in terms of power quality analysis such as measurement up to 40th harmonic and internal memory for datalogging, allowing to target e.g. demand management applications.

Order details Type code	Order code	Pack unit pc.	L.P.(₹)
M1M 30B-05 Modbus	1SYG230185R4051	1	Upon request
M1M 30B-02 Modbus	1SYG229775R4051	1	

* Availability from February 2022

Measurement devices

M4M Network Analyzers



Full connectivity

Cloud-based power monitoring

Connectivity-based solutions increase awareness of resources and process behaviors: asset management can then be optimized through the control and monitoring of operations and costs.

M4M network analyzers ranges allow full connectivity and easy integration of submetering and power quality monitoring features, thanks to a complete set of communication protocols, matching high-accuracy standard requirements.

M4M exploits the scalability of the ABB solution, from stand-alone visualization and commissioning via HMI or EPiC mobile APP and desktop software, to monitoring, optimization and control of the complete electrical system via ABB Ability™.

At ABB we leverage internet of things' devices to drive digital transformation of buildings, by providing a scalable portfolio for energy and asset management.



Propose a single solution to optimize costs and energy needs thanks to M4M which is automatically integrated in ABB Ability™ EDCS cloud-computing platform, enabling real-time monitoring widgets, historical trend analysis and power quality reporting.



Propose projects compliant with energy efficiency regulations. High-accuracy network analyzers class 0,5 according to IEC 61557-12, connecting to the cloud complete set of electrical parameters and power quality KPIs: from THD to individual harmonics.

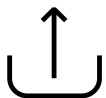

Rogowski coil acceptance to integrate measurement functionalities and power quality analysis in any existing installation, easily transmitted to the cloud also in brownfield projects.



**Scalable, fully connected,
unique ABB solution**



**Meet energy efficiency
requirements and
regulations**

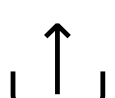

**Revamping of any
existing installation**

Explore the new ranges **NEW**

M4M network analyzers are available in two different versions which ensure all power monitoring needs, from basic to more complete power quality analysis.



EQUIPPED WITH GRAPHIC COLOR DISPLAY AND 5 PUSHBUTTONS KEYBOARD, M4M 20 RANGE ALLOWS COMPLETE MONITORING AND BASIC POWER QUALITY ANALYSIS.



EQUIPPED WITH TOUCHSCREEN COLOR DISPLAY, M4M 30 RANGE ALLOWS COMPLETE POWER QUALITY ANALYSIS AND ENERGY EFFICIENCY EVALUATIONS.

Graphic color display

M4M 20 and M4M 30 are equipped with a graphic color display and common app-based menu for an intuitive visualization.

Bluetooth-enabled

All M4M network analyzers are equipped with Bluetooth module for smart commissioning via mobile app.

Full communication

A complete set of embedded communication protocols, including Modbus RTU, Modbus TCP/IP, Profibus DP-V0 and BACnet/IP

Input/Output

Control on the system thanks to I/O options including digital outputs, programmable I/O or programmable analogue outputs.

Datalogger

Data logging features are available, from complete notification logs to flash memory and RTC for 1-year data logging of trends.

Rogowski version

M4M Rogowski versions are compatible with ABB's R4M Rogowski coils for easy retrofit in existing installations.



01

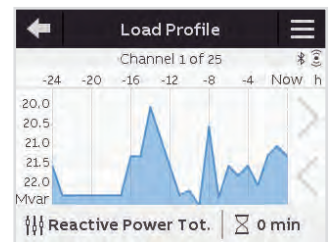

02



03

01 M4M Homepage

02 Trending graphs of load profiles

03 R4M Rogowski coils

M4M 20 and M4M 30

Technical data



M4M 20



M4M 30

Real-time		
TRMS current	•	•
TRMS voltage	•	•
Frequency	•	•
Active, Reactive and Apparent Power	•	•
Power Factor	•	•
Operating timer, countdown timer	•	•
Energy		
Active, Reactive and Apparent Energy	•	•
4 quadrants Energy (Import/Export)	•	•
Tariffs	/	•
Power Quality		
THD (I, VLN, VLL)	•	•
Individual Harmonics	/	40th
Unbalances (I, VLN, VLL)	/	•
Neutral current	Calculated	Measured
Phasors (I, VLN)	/	•
Waveforms (I, VLN, VLL)	/	•
Data recording and logs		
Single alarms	25	25
Warnings, alarms and errors logs	•	•
Complex alarms with logics	/	4
Demand values (average)	Basic	Advanced
Min/Max Demand values	Basic	Advanced
Energy Trending logs	/	•
RTC	/	•
HMI		
	Graphic color	Graphic color touchscreen
Graphs visualization	Basic	Advanced
Notifications	•	•
Homepage and favourite page	•	•
Password protection	•	•
Connectivity		
Automatic integration in ABB Ability™ EDCS	•	•
Bluetooth Low Energy	•	•
Communication Protocols	Modbus RTU, Modbus TCP/IP, Profibus DP-V0, BACnet/IP	Modbus RTU, Modbus TCP/IP, Profibus DP-V0, BACnet/IP
RJ45 Daisy Chain (Ethernet version)	/	•

M4M 20 and M4M 30

Ordering codes



M4M 20

M4M 20 is ABB's network analyzer range that provides complete and accurate electrical parameters monitoring and basic power quality analysis.

Equipped with graphic color display for advanced visualization of the measured parameters and Bluetooth module for smart commissioning.

Communication protocol	I/O	Bbn		Order details		Pack	L.P.(₹)
		8012542 EAN	Type code	Order code	Unit pc.		
BLE	2 Digital out	511519	M4M 20	2CSG251151R4051	1	Upon request	
BLE, Modbus RTU	2 Digital out	511410	M4M 20 Modbus	2CSG251141R4051	1		
BLE, Modbus TCP/IP	2 Digital out	044710	M4M 20 Ethernet	2CSG204471R4051	1		
BLE, Profibus DP-V0	2 Digital out	511311	M4M 20 Profibus	2CSG251131R4051	1		
BLE, BACnet/IP	2 Digital out	368311	M4M 20 Bacnet	2CSG236831R4051	1		
BLE, Modbus RTU	2 Progr. I/O, 2 Digital out, 2 Analogue out	511618	M4M 20 I/O	2CSG251161R4051	1		



M4M 20 - ROGOWSKI VERSION

M4M 20 is also available as compatible with ABB's R4M Rogowski coils for current measurement, increasing the flexibility of network analyzers offer and allowing retrofit in any existing installations.

M4M 20 Rogowski together with R4M Rogowski coils ensures the integration of basic power quality metering in any existing system with 0 downtime.

Communication protocol	I/O	Bbn		Order details		Pack	L.P.(₹)
		8012542 EAN	Type code	Order code	Unit pc.		
BLE, Modbus RTU	2 Digital Outputs	070818	M4M 20 Rogowski	2CSG207081R4051	1	Upon request	

M4M 20 and M4M 30

Ordering codes



M4M 30

M4M 30 is ABB's network analyzer range that allows complete power quality analysis and energy efficiency evaluations.

Equipped with touchscreen color display for simplified access to the device and with Bluetooth module for smart commissioning.

Communication protocol	I/O	Bbn		Order details		Pack	
		8012542 EAN	Type code	Order code	Unit pc.	L.P.(₹)	
BLE, Modbus RTU	4 Progr. I/O	747611	M4M 30 Modbus	2CSG274761R4051	1	Upon request	
BLE, Modbus TCP/IP	4 Progr. I/O	746812	M4M 30 Ethernet	2CSG274681R4051	1		
BLE, Profibus DP-V0	4 Progr. I/O	367918	M4M 30 Profibus	2CSG236791R4051	1		
BLE, BACnet/IP	4 Progr. I/O	024514	M4M 30 Bacnet	2CSG202451R4051	1		
BLE, Modbus RTU	6 Progr. I/O, 2 Analogue out	024712	M4M 30 I/O	2CSG202471R4051	1		



M4M 30 - ROGOWSKI VERSION

M4M 30 is also available as compatible with ABB's R4M Rogowski coils for current measurement, increasing the flexibility of network analyzers and allowing retrofit in any existing installations.

M4M 30 Rogowski together with R4M coils ensure integration of complete PQ analysis in any existing system with 0 downtime.

Communication protocol	I/O	Bbn		Order details		Pack	
		8012542 EAN	Type code	Order code	Unit pc.	L.P.(₹)	
BLE, Modbus RTU	4 Progr. I/O	024613	M4M 30 Rogowski	2CSG202461R4051	1	Upon request	



R4M ROGOWSKI COILS

R4M Rogowski coils are flexible current transformer based on Rogowski technology, ideal to retrofit existing installations up to 12kA. Available in two different sizes (80mm or 200mm diameters), R4M coils are directly equipped with pre-wired removable terminals that perfectly fit M4M 20 Rogowski (3 Rogowski coil inputs) and M4M 30 Rogowski (4 Rogowski coil inputs), with no need for external integrators.

Diameter (mm)	Bbn		Order details		Pack	
	8012542 EAN	Type code	Order code	unit pc.	L.P.(₹)	
80	021605	R4M-80	2CSG202160R1101	1	Upon request	
200	021506	R4M-200	2CSG202150R1101	1		

Complete integration in the ABB's scalable solutions for energy and asset management, to protect assets and optimize costs and energy needs

Full connectivity...

...for integration with ABB Ability™ system



Measurement devices

EQ matic energy meters selection table



	EQ meters C11	EQ meters C13	EQ meters B21	EQ meters B23	EQ meters B24
Overall dimensions	1 DIN module	3 DIN modules	2 DIN modules	4 DIN modules	4 DIN modules
Display	LCD	LCD	Backlit LCD	Backlit LCD	Backlit LCD
Operating voltage	230 V AC	3x230/400 V AC	220...240 V AC	3x220/380...240/415 V AC	
Frequency					50 / 60 Hz
Max current	40 A	40 A	65 A	65 A	6 A
CTVT connected	-	-	-	-	CT
Active energy					
Reactive energy	-	-			
Apparent energy	-	-	optional		
Accuracy	Cl. 1	Cl. 1 (B)	Cl. 1 (B)	Cl. 1 (B)	Cl. 1 (B), Cl. 0,5 S (C)
Tariff	-	-	optional		
Event log	-	-			
Maximum demand	-	-	-	-	-
Previous values	-	-	-	-	-
Load profiles	-	-	-	-	-
Harmonic analysis	-	-	-	-	-
Alarm function					
Voltage					
Current					
Power factor					
Frequency	-	-	optional		
Pulse output					
Outputs	-	-	optional		
Inputs	-	-			
Built-in serial communication	-	-	IR, M-Bus, RS-485		
Protocols	-	-	M-Bus, Modbus RTU, EQ bus		



EQ meters A41	EQ meters A42	EQ meters A43	EQ meters A44	EQ meters G13
4 DIN modules	4 DIN modules	7 DIN modules	7 DIN modules	4 DIN modules
Backlit Pixel (LCD)	Backlit Pixel (LCD)	Backlit Pixel (LCD)	Backlit Pixel (LCD)	No display
	57.7...288 V AC		3 x 57.7/100...288/500 V AC	100...240 V AC
				50 / 60 Hz
80 A	6 A	80 A	6 A	-
-	CTVT	-	CTVT	-
				-
			optional	-
Cl. 1 (B)	Cl. 1 (B), Cl. 0,5 S (C)	Cl. 1 (B)	Cl.1 (B), Cl. 0,5 S (C)	-
			optional	-
				-
				-
			optional	-
				-
				-
			optional	-
				-
			optional	-
				-
			IR, M-Bus, RS-485	IR, RS-485, M-Bus
			M-Bus, Modbus, EQ bus	EQ bus, M-Bus, JSON

Measurement devices

Circuit Monitoring System

The quality of a Circuit Monitoring System is dependent on the strengths of the individual components and how well they interact. ABB's CMS sets the bar particularly high. Regardless of whether we're talking compactness, technology,

measurement results, user friendliness or flexibility, every component and every feature of this CMS has been fully optimized in terms of practicality and functionality.

Example illustration:
Control Unit CMS-700 in combination with CMS open-core sensors



CMS-700

CMS bus interface
A bus interface allows up to 32 sensors to be connected to the Control Unit.

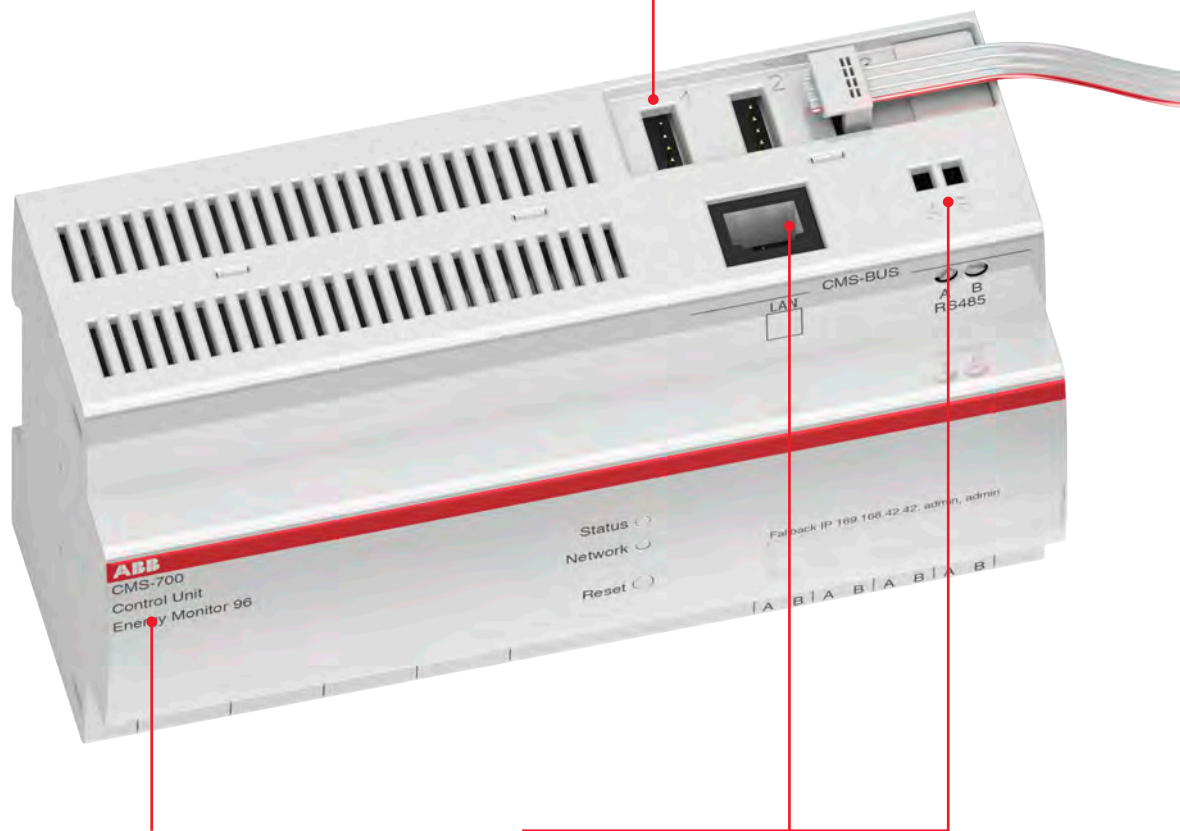

Control Units

The Control Unit is a kind of computing and communication center that, depending on the equipment connected to it, evaluates the different data picked up by the sensors and makes it available via the built-in interfaces.

You have a choice of three different units depending on your applications: CMS-600 and CMS-700.

Serial interfaces

Depending on the unit, numerous interfaces and protocols are available to ensure smooth network implementation: RS485 (Modbus RTU), LAN (TCP/IP and Modbus TCP), SNMP v1/v2 and encrypted v3.

Thanks to the built-in web server, an internet browser or a free Android or iOS app can be used to visualize the values measured. What's more, the measured values can also be exported to CSV files.

Integrate however you want, thanks to multiple mounting options.

Depending on the application, choose between up to four different mounting options to make integrating the CMS sensors in your installation as simple and as uncomplicated as possible.

Universally usable sensor designs



Mounting on a DIN rail
CMS-120DR, CMS-100DR, and CMS-200DR series sensors can be mounted on all DIN rails with the aid of a DIN rail mounting.



Cable tie mounting
If space is at a real premium, CMS-120CA, CMS-100CA, and CMS-200CA series sensors can be secured directly to the cable(s) to be measured by means of cable ties.

Tangible value addition for you ABB circuit monitoring pays off two-fold

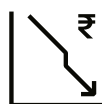

Early warning system (predictive maintenance) for increasing the availability of critical consumers
Continuous monitoring of the current flow at the circuit breaker makes it possible to detect overloaded lines before they lead to a service interruption. Apart from this, monitoring individual circuits indicates whether the loads are in the desired operating mode or not. In this way, system deviations can be ascertained instantaneously. What's more, the CMS can be used to detect unbalanced loads before they result in failure of the neutral conductor and consequently load failure.

Cost analysis to reduce and assign energy costs
The cost of energy will rise continuously. In order to cut costs, you first have to know where they arise. The Control Unit helps illustrate and analyze the instantaneous energy consumption levels. Furthermore, the calculated active energy can be used to roughly allocate the costs at the output level.

ABB ITUS

Performance redefined

At ABB we look at global trends along with advances in innovation, along the line of power enclosures. Keeping these factors in mind, using advanced techniques and vast domain expertise, we come up with products that are future ready.

Keeping pace with new requirements coupled with dynamic changes in the business space, our products are designed so that they meet multiple objectives and desires of our customers.

Our products are designed to give maximum convenience and customization options, providing a true sense of freedom and choice for all your wiring needs.



Suitable for installation in MiVan construction

- Inner/outer folded back box provided with regular cutout on the top portion to increase the mechanical strength of the DB
- DB Box provided with cement guard so that slurry doesn't enter the DB box during concreting
- Removable frame is provided to facilitate adjustments owing to civil work, like plastering
- Once plastering is completed, frame and door are installed. Since thickness of plaster itself is 8 mm to 10 mm, the screws used to fix frame with the DB box have to be long enough, Hence long screws are provided to meet the requirement.

Both ITUS and Elegance can be used as per customer taste and preference.



ITUS

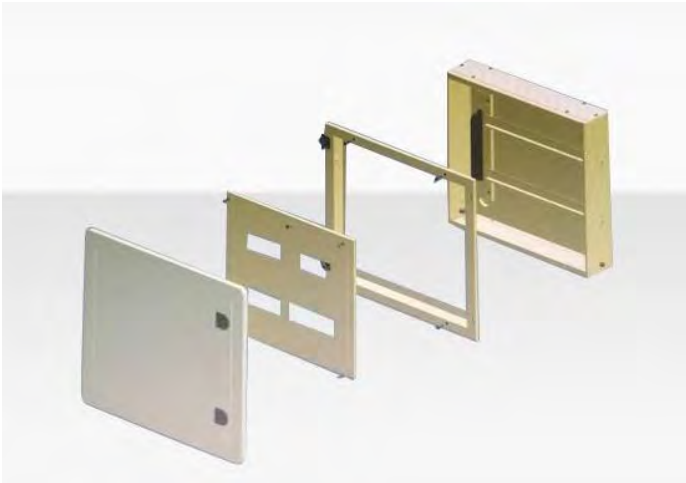

Elegance



ABB ITUS Distribution Enclosures

SPN-SHC

Horizontal single phase consumer unit with provision for 2 pole (MCB/Isolator/RCD) incoming and single phase outgoing. These distribution boards come with earth link, shrouded neutral link and tinned electrolytic copper insulated busbar. Top and bottom, removable gland plates with knockouts. Mounting of these boards can be flush or surface.

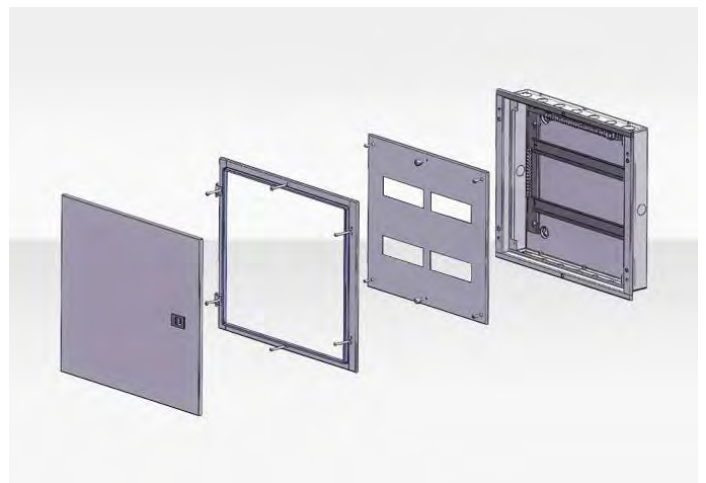

IP 30, IK 08 Without door

Product description	Product code	No. of ways	No. of modules	Unit MRP (₹)
I-SPN06 WAY WD DB	1SYM011506C0001 ■	6 way	6	1,728
I-SPN08 WAY WD DB	1SYM011508C0001 ■	8 way	8	2,018
I-SPN10 WAY WD DB	1SYM011510C0001	10 way	10	2,234
I-SPN12 WAY WD DB	1SYM011512C0001 ■	12 way	12	2,342
I-SPN14 WAY WD DB	1SYM011514C0001	14 way	14	2,690
I-SPN16 WAY WD DB	1SYM011516C0001	16 way	16	3,050
I-SPN18 WAY WD DB	1SYM011518C0001 ■	18 way	18	3,472
I-SPN22 WAY WD DB	1SYM011522C0001	22 way	22	3,556



IP 43, IK 09 With metal door

Product description	Product code	No. of ways	No. of modules	Unit MRP (₹)
I-SPN06 WAY MD DB	1SYM011606C0001 ■	6 way	6	2,566
I-SPN08 WAY MD DB	1SYM011608C0001 ■	8 way	8	2,946
I-SPN10 WAY MD DB	1SYM011610C0001	10 way	10	3,386
I-SPN12 WAY MD DB	1SYM011612C0001 ■	12 way	12	3,476
I-SPN14 WAY MD DB	1SYM011614C0001	14 way	14	4,064
I-SPN16 WAY MD DB	1SYM011616C0001	16 way	16	4,332
I-SPN18 WAY MD DB	1SYM011618C0001 ■	18 way	18	4,618
I-SPN22 WAY MD DB	1SYM011622C0001	22 way	22	5,336



IP 43, IK 09 Metal door with acrylic

Product description	Product code	No. of ways	No. of modules	Unit MRP (₹)
I-SPN06 WAY AD DB	1SYM011706C0001	6 way	6	3,802
I-SPN08 WAY AD DB	1SYM011708C0001	8 way	8	4,372
I-SPN10 WAY AD DB	1SYM011710C0001	10 way	10	4,618
I-SPN12 WAY AD DB	1SYM011712C0001	12 way	12	5,028
I-SPN14 WAY AD DB	1SYM011714C0001	14 way	14	5,450
I-SPN16 WAY AD DB	1SYM011716C0001	16 way	16	5,722
I-SPN18 WAY AD DB	1SYM011718C0001	18 way	18	6,276
I-SPN22 WAY AD DB	1SYM011722C0001	22 way	22	6,914



IP 54, IK 09 Metal door

Product description	Product code	No. of ways	No. of modules	Unit MRP (₹)
I-SPN06 WAY WP DB	1SYM011806C0001	6 way	6	6,242
I-SPN08 WAY WP DB	1SYM011808C0001	8 way	8	8,260
I-SPN10 WAY WP DB	1SYM011810C0001	10 way	10	8,356
I-SPN12 WAY WP DB	1SYM011812C0001	12 way	12	9,490
I-SPN14 WAY WP DB	1SYM011814C0001	14 way	14	9,890
I-SPN16 WAY WP DB	1SYM011816C0001	16 way	16	10,556
I-SPN18 WAY WP DB	1SYM011818C0001	18 way	18	11,086
I-SPN22 WAY WP DB	1SYM011822C0001	22 way	22	11,850

■ Stock items

ABB ITUS Distribution Enclosures

TPN-SHDB

Horizontal three phase distribution board with provision for incomer 8 pole (MCB/Isolator/RCD) and single phase outgoing. These distribution boards come with earth link, shrouded neutral link, tinned electrolytic copper insulated busbar and wire sets for cable management. Top and bottom, removable gland plates with knockouts. Mounting of these boards can be flush or surface.



IP 30, IK 08 Without door

Product description	Product code	No. of ways	No. of modules		Unit MRP (₹)
			I/C	O/G	
I-TPN04 WAY WD DB	1SYM021504C0001 ■	4 way	8	12	4,714
I-TPN06 WAY WD DB	1SYM021506C0001 ■	6 way	8	18	5,984
I-TPN08 WAY WD DB	1SYM021508C0001 ■	8 way	8	24	6,896
I-TPN12 WAY WD DB	1SYM021512C0001 ■	12 way	8	36	10,232



IP 43, IK 09 With metal door

Product description	Product code	No. of ways	No. of modules		Unit MRP (₹)
			I/C	O/G	
I-TPN04 WAY MD DB	1SYM021604C0001 ■	4 way	8	12	5,928
I-TPN06 WAY MD DB	1SYM021606C0001 ■	6 way	8	18	7,010
I-TPN08 WAY MD DB	1SYM021608C0001 ■	8 way	8	24	8,260
I-TPN12 WAY MD DB	1SYM021612C0001 ■	12 way	8	36	12,022

IP 43, IK 09 Metal door with acrylic

Product description	Product code	No. of ways	No. of modules		Unit MRP (₹)
			I/C	O/G	
I-TPN04 WAY AD DB	1SYM021704C0001	4 way	8	12	7,062
I-TPN06 WAY AD DB	1SYM021706C0001	6 way	8	18	8,726
I-TPN08 WAY AD DB	1SYM021708C0001	8 way	8	24	10,460
I-TPN12 WAY AD DB	1SYM021712C0001	12 way	8	36	16,040

IP 54, IK 09 Metal door

Product description	Product code	No. of ways	No. of modules		Unit MRP (₹)
			I/C	O/G	
I-TPN04 WAY WP DB	1SYM021804C0001	4 way	8	12	17,864
I-TPN06 WAY WP DB	1SYM021806C0001	6 way	8	18	21,352
I-TPN08 WAY WP DB	1SYM021808C0001	8 way	8	24	23,352
I-TPN12 WAY WP DB	1SYM021812C0001	12 way	8	36	32,906

ABB ITUS Distribution Enclosures

TPN-SHPPI per phase isolation

Horizontal per-phase isolation distribution board with provision for 8 pole (MCB/Isolator/RCD) as incomer, 3 DP MCB/Isolator/RCD as sub-incoming and SP MCBs as outgoing. These distribution boards come with separate shrouded neutral link for each phase, earthing link, tinned electrolytic copper insulated busbar and wire sets for cable management. Top and bottom removable gland plates with knockouts. Mounting of these boards can be flush or surface.



IP 43, IK 09 With metal door

Product description	Product code	No. of ways	No. of modules			Unit MRP (₹)
			I/C	Sub I/C	O/G	
I-HPPI06 WAY MD DB	1SYM031606C0001 ■	6 way	8	6	12	11,724
I-HPPI08 WAY MD DB	1SYM031608C0001 ■	8 way	8	6	18	13,902
I-HPPI12 WAY MD DB	1SYM031612C0001 ■	12 way	8	6	30	15,812

ABB ITUS Distribution Enclosures

TPN-SVDB per phase isolation

Vertical per-phase Isolation Distribution Board in 4-tier structure with provision for 8 pole (MCB/Isolator/ RCD) incomer and 2 pole (MCB/Isolator/RCD) as sub-incomer with single phase outgoing. These distribution boards come with separate shrouded neutral link for each phase, earthing link, tinned electrolytic copper insulated busbar and wire sets for cable management. Top and bottom removable gland plates with knockouts. Mounting of these boards can be flush or surface.



IP 43, IK 09 With metal door

Product description	Product code	No. of ways	No. of modules			Unit MRP (₹)
			I/C	Sub I/C	O/G	
I-VPPI06 WAY MD DB	1SYM041606C0001 ■	6 way	8	6	18	11,263
I-VPPI08 WAY MD DB	1SYM041608C0001 ■	8 way	8	6	24	13,354
I-VPPI12 WAY MD DB	1SYM041612C0001 ■	12 way	8	6	36	15,188

■ Stock items

ABB ITUS Distribution Enclosures

TPN-8 segment

Eight segment distribution board with phase segregation and separation between incoming and outgoing with provision for 4P+8P incomer (MCB/Isolator/RCD) and 4 pole sub-incomer (MCB/Isolator/RCD) with single phase outgoing. These distribution boards come with shrouded neutral bar, earthing link and wire sets for cable management for each compartment. Top and bottom, removable gland plates with knockouts. Mounting of these boards can be flush or surface.



IP 43, IK 09 With metal door

Product description	Product code	No. of ways	No. of modules			Unit MRP (₹)
			I/C	Sub I/C	O/G	
I-8SEG04 WAY MD DB	1SYM051604C0001 ■	4 way	4+8	12	12	15,674
I-8SEG06 WAY MD DB	1SYM051606C0001 ■	6 way	4+8	12	18	17,614
I-8SEG08 WAY MD DB	1SYM051608C0001 ■	8 way	4+8	12	24	19,630
I-8SEG12 WAY MD DB	1SYM051612C0001	12 way	4+8	12	36	24,414

ABB ITUS Distribution Enclosures

TPN-SVTDB MCB

Vertical three phase distribution board with provision for 8 pole (MCB/Isolator/RCD) incoming with three phase and single phase (TP/SP) outgoing. These distribution boards come with complete insulated busbar (tinned electrolytic copper) arrangement, shrouded neutral bar and earth bars. Top and bottom removable gland plates with knockouts. Mounting of these boards can be flush or surface.

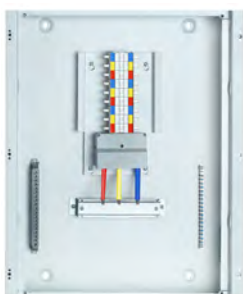

IP 43, IK 09 Metal door

Product description	Product code	No. of ways	No. of modules		Unit MRP (₹)
			I/C	O/G	
I-VTPN04 WAY MCB/IC MD DB	1SYM061604C0001 ■	4 way	8	12	14,954
I-VTPN06 WAY MCB/IC MD DB	1SYM061606C0001 ■	6 way	8	18	17,034
I-VTPN08 WAY MCB/IC MD DB	1SYM061608C0001 ■	8 way	8	24	18,480
I-VTPN12 WAY MCB/IC MD DB	1SYM061612C0001	12 way	8	36	25,262

ABB ITUS Distribution Enclosures

TPN-SVTDB XT1

Vertical three phase distribution board with provision for 4 pole MCCB (XT1) up to 160A as incomer with three phase and single phase (TP/SP) MCB outgoing. These distribution boards come with complete insulated busbar (tinned electrolytic copper) arrangement, shrouded neutral bar and earth bars. Top and bottom removable gland plates with knockouts. Mounting of these boards can be flush or surface.



IP 43, IK 09 Metal door

Product description	Product code	No. of ways	No. of modules		Unit MRP (₹)
			I/C	O/G	
I-VTPN04 WAY XT1/IC MD DB	1SYM071604C0001	4 way	XT1 160	12	17,282
I-VTPN06 WAY XT1/IC MD DB	1SYM071606C0001	6 way	XT1 160	18	19,552
I-VTPN08 WAY XT1/IC MD DB	1SYM071608C0001	8 way	XT1 160	24	21,374
I-VTPN12 WAY XT1/IC MD DB	1SYM071612C0001	12 way	XT1 160	36	28,124

ABB ITUS Distribution Enclosures

TPN-SVTDB XT3

Vertical three phase distribution board with provision for 4 pole MCCB (XT3) up to 250A as incomer with three phase and single phase (TP/SP) MCB outgoing. These distribution boards come with complete insulated busbar (tinned electrolytic copper) arrangement, shrouded neutral bar and earth bars. Top and bottom removable gland plates with knockouts. Mounting of these boards can be flush or surface.



IP 43, IK 09 Metal door

Product description	Product code	No. of ways	No. of modules		Unit MRP (₹)
			I/C	O/G	
I-VTPN04 WAY XT3/IC MD DB	1SYM081604C0001	4 way	XT3 250	12	30,038
I-VTPN06 WAY XT3/IC MD DB	1SYM081606C0001	6 way	XT3 250	18	31,686
I-VTPN08 WAY XT3/IC MD DB	1SYM081608C0001	8 way	XT3 250	24	34,964
I-VTPN12 WAY XT3/IC MD DB	1SYM081612C0001	12 way	XT3 250	36	36,674

ABB ITUS Distribution Enclosures

SVFLM flexi tier

Total flexibility as per site needs - configuration as per your choice of incomer and outgoing. Supply busbars need to be selected. These distribution boards come with shrouded neutral link, earthing link. Top and bottom, removable gland plates with knockouts. Mounting of these boards can be flush or surface.



IP 43, IK 09 Metal door

Product description	Product code	No. of ways	No. of rows	No. of modules	Unit MRP (₹)
I-2 ROW 13 MOD DB	1SYM101632C0001	2 Row of 13 Mod	2	26	6,896
I-2 ROW 14 MOD DB	1SYM101642C0001	2 Row of 14 Mod	2	28	7,952
I-3 ROW 13 MOD DB	1SYM101633C0001	3 Row of 13 Mod	3	39	8,380
I-3 ROW 14 MOD DB	1SYM101643C0001	3 row of 14 Mod	3	42	8,760
I-4 ROW 13 MOD DB	1SYM101634C0001	4 Row of 13 Mod	4	52	10,204
I-4 ROW 14 MOD DB	1SYM101644C0001	4 Row of 14 Mod	4	56	10,772

ABB ITUS Distribution Enclosures

SPVS phase selector

Phase selector distribution boards with in-built 3 numbers of selector switches and 3 numbers of piano switches as well as provision for 8 pole MCB/Isolator/RCD as incoming and SP MCBs as outgoing. These distribution boards come with earth link, shrouded neutral link, tinned electrolytic insulated copper busbar and wire sets for cable management. Top and bottom, removable gland plates with knockouts. Mounting of these boards can be flush or surface.



IP 43, IK 09 Metal door

Product description	Product code	No. of ways	No. of modules I/C	No. of modules O/G	Unit MRP (₹)
I-PS 63A04 WAY MD DB	1SYM091604C0001	4 way	8	12	19,666
I-PS 63A06 WAY MD DB	1SYM091606C0001	6 way	8	18	19,666
I-PS 63A08 WAY MD DB	1SYM091608C0001	8 way	8	24	21,602
I-PS 63A12 WAY MD DB	1SYM091612C0001	12 way	8	36	23,564

ABB ITUS Distribution Enclosures

SEN enclosures

Metal enclosures, universal mounting suitable for DP, FP, 6P and 8 pole arrangements.



IP 20, IK 08

Product description	Product code	No. of ways	No. of modules	Unit MRP (₹)
I- 2MOD Metal Enclosure	1SYM121502C0001 ■	2P enclosure	2	900
I- 4MOD Metal Enclosure	1SYM121504C0001 ■	4P enclosure	4	906
I- 6MOD Metal Enclosure	1SYM121506C0001 ■	6P enclosure	6	1,236
I- 8MOD Metal Enclosure	1SYM121508C0001 ■	8P enclosure	8	1,476

ABB ITUS Distribution Enclosures

P&S boards

This range offers a wide variety of plug & socket boards. These plugs & sockets can be used for single phase or three phase applications up to 30A along with MCB or RCBO with provision for universal mounting.



IP 20, IK 08

Product description	Product code	No. of ways	No. of modules	Unit MRP (₹)
I- 20A SP 2Pin P&S Enclosure	1SYM111520C0001 ■	1	2	2,314
I- 30A TP 3Pin P&S Enclosure	1SYM111530C0001 ■	1	4	4,948

ABB ITUS Distribution Enclosures

Cable end boxes

SPN-SHC

Product description	Product code	No. of ways	Unit MRP (₹)
I-SPN06 WAY MD CEB	1SYM140106C0001	6 way	824
I-SPN08 WAY MD CEB	1SYM140108C0001	8 way	1,002
I-SPN10 WAY MD CEB	1SYM140110C0001	10 way	1,058
I-SPN12 WAY MD CEB	1SYM140112C0001	12 way	1,176
I-SPN14 WAY MD CEB	1SYM140114C0001	14 way	1,272
I-SPN16 WAY MD CEB	1SYM140116C0001	16 way	1,440
I-SPN18 WAY MD CEB	1SYM140118C0001	18 way	1,724
I-SPN22 WAY MD CEB	1SYM140122C0001	22 way	1,826

TPN-SHDB

Product description	Product code	No. of ways	Unit MRP (₹)
I-TPN04 WAY MD CEB	1SYM140204C0001	4 way	1,238
I-TPN06 WAY MD CEB	1SYM140206C0001	6 way	1,724
I-TPN08 WAY MD CEB	1SYM140208C0001	8 way	3,002
I-TPN12 WAY MD CEB	1SYM140212C0001	12 way	4,094

TPN-SHPPI

Product description	Product code	No. of ways	Unit MRP (₹)
I-HPPI06 WAY MD CEB	1SYM140306C0001	6 way	1,724
I-HPPI08 WAY MD CEB	1SYM140308C0001	8 way	3,002
I-HPPI12 WAY MD CEB	1SYM140312C0001	12 way	4,094

TPN-SVDB

Product description	Product code	No. of ways	Unit MRP (₹)
I-VPPI06 WAY MD CEB	1SYM140406C0001	6 way	1,472
I-VPPI08 WAY MD CEB	1SYM140408C0001	8 way	1,472
I-VPPI12 WAY MD CEB	1SYM140412C0001	12 way	1,680

8 Segment

Product description	Product code	No. of ways	Unit MRP (₹)
I-8SEG04 WAY MD CEB	1SYM141013C0001	4 way	2,178
I-8SEG06 WAY MD CEB	1SYM141014C0001	6 way	3,354
I-8SEG08 WAY MD CEB	1SYM140600C0001	8 way	4,940
I-8SEG12 WAY MD CEB	1SYM140700C0001	12 way	6,820

SVTDB, XT1 & XT3

Product description	Product code	No. of ways	Unit MRP (₹)
I-VTPN MCB/IC MD CEB	1SYM140800C0001	For all SVTDB MCB I/C	2,812
I-VTPN XT1/IC MD CEB	1SYM140504C0001	For all SVTDB MCCB XT1 I/C	4,452
I-VTPN XT3/IC MD CEB	1SYM140506C0001	For all SVTDB MCCB XT3 I/C	4,452

SVFLM

Product description	Product code	No. of ways	Unit MRP (₹)
I-13 MOD CEB	1SYM140508C0001	13 module	1,826
I-14 MOD CEB	1SYM140512C0001	14 module	2,178

Busbars and blanking plate

Product description	Product code	No. of ways	No. of modules	Unit MRP (₹)
I-13 MOD Insulated Busbar	1SYM131514C0001	13		456
I-14 MOD Insulated Busbar	1SYM131500C0001	14		456
I-Blank Plate	1SYM131513C0001		1	23

Elegance series

Distribution boards

Elegance series (E-series) distribution boards are available in texture grey (color code - RAL7035)

Construction

Blending aesthetics, functionality and safety, the E-series of ABB distribution boards are manufactured with high precision, and high quality CRCA steel sheets. These distribution boards undergo a seven-tank phosphating process to ensure anti-rust conditioning, superior finish and lasting strength. Premier quality powder coating is applied using the latest techniques

Colour

ABB's E-series of distribution boards is available in texture grey (RAL 7035)

Installation

The E-series of ABB distribution boards are universal mounting type, hence can be flush or wall mounted. These distribution boards are provided with top and bottom removable gland plates with adequate no of knock outs, which enable easy installation and connection of conduits of sizes up to 32 mm dia knock out.

Protection

E-series distribution boards offer three types of protection- IP43 & IP54 degree with a metal door and IP30 degree without a door. The highest degree of attention has been paid to the safety aspect of the distribution boards, considering that they are installed in close proximity to people. An intermediate plate ensures total safety, as no live parts are exposed when the door is opened.



Elegance series

Distribution boards

SPN DB -E-SHC

Horizontal single phase consumer unit with provision for incoming 2 pole (MCB / Isolator / RCD) and single phase outgoing. Suitable for surface and flush mounting.

IP 30



Product description	Ordering code	No. of ways	No of modules	Unit MRP (₹)
E-SHC WD 4	1SYE011504C0001 ■	4 way	4+2	1,602
E-SHC WD 6	1SYE011506C0001	6 way	6+2	1,728
E-SHC WD 8	1SYE011508C0001 ■	8 way	8+2	2,070
E-SHC WD 10	1SYE011510C0001	10 way	10+2	2,172
E-SHC WD 12	1SYE011512C0001 ■	12 way	12+2	2,490
E-SHC WD 14	1SYE011514C0001	14 way	14+2	2,822
E-SHC WD 16	1SYE011516C0001 ■	16 way	16+2	3,214
E-SHC WD 20	1SYE011520C0001	20 way	20+2	3,620

IP 43 with metal door



Product description	Ordering code	No. of ways	No. of modules	Unit MRP (₹)
E-SHC M 4	1SYE011604C0001 ■	4 way	4+2	2,520
E-SHC M 6	1SYE011606C0001	6 way	6+2	2,714
E-SHC M 8	1SYE011608C0001 ■	8 way	8+2	3,134
E-SHC M 10	1SYE011610C0001	10 way	10+2	3,284
E-SHC M 12	1SYE011612C0001 ■	12 way	12+2	3,762
E-SHC M 14	1SYE011614C0001	14 way	14+2	4,012
E-SHC M 16	1SYE011616C0001 ■	16 way	16+2	4,520
E-SHC M 20	1SYE011620C0001	20 way	20+2	5,266

IP 43 Metal door with acrylic



Product description	Ordering code	No. of ways	No. of modules	Unit MRP (₹)
E-SHC P 4	1SYE011704C0001	4 way	4+2	2,896
E-SHC P 6	1SYE011706C0001	6 way	6+2	3,204
E-SHC P 8	1SYE011708C0001	8 way	8+2	3,386
E-SHC P 10	1SYE011710C0001	10 way	10+2	3,876
E-SHC P 12	1SYE011712C0001	12 way	12+2	4,246
E-SHC P 14	1SYE011714C0001	14 way	14+2	4,618
E-SHC P 16	1SYE011716C0001	16 way	16+2	5,170
E-SHC P 20	1SYE011720C0001	20 way	20+2	6,060

IP 54

Product Description	Ordering code	No. of ways	No. of modules	Unit MRP (₹)
E-SHC M WP 4	1SYE011804C0001	4 way	4+2	6,550
E-SHC M WP 6	1SYE011806C0001	6 way	6+2	7,102
E-SHC M WP 8	1SYE011808C0001	8 way	8+2	7,746
E-SHC M WP 10	1SYE011810C0001	10 way	10+2	8,162
E-SHC M WP 12	1SYE011812C0001	12 way	12+2	8,914
E-SHC M WP 14	1SYE011814C0001	14 way	14+2	9,080
E-SHC M WP 16	1SYE011816C0001	16 way	16+2	9,878
E-SHC M WP 20	1SYE011820C0001	20 way	20+2	10,568

■ Stock items

Elegance series

Distribution boards

TPN DB - E-SHDB

Horizontal three phase distribution board provision for incomer 8 pole (MCB / Isolator / RCD) and single phase outgoings suitable for both surface & flush mounting.



IP 30

Product description	Ordering code	No. of ways	No. of modules	Unit MRP (₹)
E-SHDB WD 4	1SYE021504C0001 ■	4 way	8+12	4,366
E-SHDB WD 6	1SYE021506C0001	6 way	8+18	4,924
E-SHDB WD 8	1SYE021508C0001 ■	8 way	8+24	5,792
E-SHDB WD 12	1SYE021512C0001 ■	12 way	8+36	8,498



IP 43 with metal door

Product description	Ordering code	No. of ways	No. of modules	Unit MRP (₹)
E-SHDB M 4	1SYE021604C0001 ■	4 way	8+12	5,870
E-SHDB M 6	1SYE021606C0001	6 way	8+18	6,658
E-SHDB M 8	1SYE021608C0001 ■	8 way	8+24	7,650
E-SHDB M 12	1SYE021612C0001 ■	12 way	8+36	11,132
E-SHDB M 16	1SYE021616C0001 ■	16 way	8+48	12,380



IP 43 with metal door with acrylic

Product description	Ordering code	No. of ways	No. of modules	Unit MRP (₹)
E-SHDB P 4	1SYE021704C0001	4 way	8+12	6,464
E-SHDB P 6	1SYE021706C0001	6 way	8+18	7,512
E-SHDB P 8	1SYE021708C0001	8 way	8+24	8,494
E-SHDB P 12	1SYE021712C0001	12 way	8+36	13,024

IP 54

Product description	Ordering code	No. of ways	No. of modules	Unit MRP (₹)
E-SHDB M WP 4	1SYE021804C0001	4 way	8+12	14,404
E-SHDB M WP 6	1SYE021806C0001	6 way	8+18	17,340
E-SHDB M WP 8	1SYE021808C0001	8 way	8+24	18,958
E-SHDB M WP 12	1SYE021812C0001	12 way	8+36	26,716

■ Stock items

Elegance series

Distribution boards



Per Phase Isolation DB -E-SHPPI

Horizontal per-phase Isolation distribution board with provision for 8 pole (MCB / Isolator / RCD) as incomer and single phase as outgoing with separate neutral and earth bars for per phase isolation.

IP 43 with metal door

Product description	Ordering code	No. of ways	No. of modules	Unit MRP (₹)
E-SHPPI M 6	1SYE031606C0001 ■	6 way	8+18	9,940
E-SHPPI M 8	1SYE031608C0001 ■	8 way	8+24	11,646
E-SHPPI M 12	1SYE031612C0001 ■	12 way	8+36	15,218
E-SHPPI M 16	1SYE031616C0001 ■	16 way	8+48	17,806



Per Phase Isolation DB -E-SVDB

Tier type per-phase isolation distribution board with provision for 8 pole (MCB / Isolator / RCD) incomer and provision for 2 pole (MCB / Isolator / RCD) as sub-incomers with single phase outgoing with separate neutral and earth bars for per phase Isolation.

IP 43 with metal door

Product description	Ordering code	No. of ways	No. of modules	Unit MRP (₹)
E-SVDB M 6	1SYE041606C0001 ■	6 way	8+6+18	11,286
E-SVDB M 8	1SYE041608C0001 ■	8 way	8+6+24	14,028
E-SVDB M 12	1SYE041612C0001 ■	12 way	8+6+36	16,468

Elegance series

Distribution boards



Vertical DB 8P I/C & SP/TP O/G - E-SVTDB

Vertical three phase distribution board with provision for 8 pole (MCB / Isolator / RCD) incoming with three phase and single phase (TP/SP) outgoing, complete with insulated busbar arrangement.

IP 43 with metal door

Product description	Ordering code	No. of ways	No. of modules	Unit MRP (₹)
E-SVTDB M 4	1SYE061604C0001	4 way	8+12	12,824
E-SVTDB M 6	1SYE061606C0001	6 way	8+18	14,848
E-SVTDB M 8	1SYE061608C0001	8 way	8+24	16,096
E-SVTDB M 12	1SYE061612C0001	12 way	8+36	20,754



Vertical DB 160 A MCCB I/C & SP/TP MCB O/G - E - SVTDB-XT1

Vertical three phase distribution board with provision for 4 pole MCCB (Tmax - XT1) upto 160A as incomer with three phase and single.

IP 43 with metal door

Product description	Ordering code	No. of ways	No. of modules	Unit MRP (₹)
E-SVTDB M 4XT1	1SYE071604C0001	4 way	Tmax XT1+12	14,420
E-SVTDB M 6XT1	1SYE071606C0001	6 way	Tmax XT1+18	16,804
E-SVTDB M 8XT1	1SYE071608C0001	8 way	Tmax XT1+24	19,374
E-SVTDB M 12XT1	1SYE071612C0001	12 way	Tmax XT1+36	24,036



Vertical DB 250 A MCCB I/C & SP/TP MCB O/G - E - SVTDB-XT3

Vertical three phase distribution board with provision for 4 pole MCCB (Tmax - XT3) upto 250A as incomer with three phase and single phase (TP/SP) outgoing, complete with insulated busbar arrangement.

IP 43 with metal door

Product description	Ordering code	No. of ways	No. of modules	Unit MRP (₹)
E-SVTDB M 4XT3	1SYE081604C0001	4 way	250A Tmax XT3+12	26,272
E-SVTDB M 6XT3	1SYE081606C0001	6 way	250A Tmax XT3+18	28,284
E-SVTDB M 8XT3	1SYE081608C0001	8 way	250A Tmax XT3+24	29,850
E-SVTDB M 12XT3	1SYE081612C0001	12 way	250A Tmax XT3+36	31,600



8 Segment DB - E-S8SEG - MCB I/C (Available also in RAL 9003 colour)

Eight segment distribution board with phase segregation and separation between incoming and outgoing with provision for 8P (MCB / Isolator / RCD) + 4P(ACCL provision) as incomer with single phase outgoing with complete wire sets.

IP 43 with metal door

Product description	Ordering code	No. of ways	No. of modules	Unit MRP (₹)
E-S8SEG M 4	1SYE051604C0001	4 way	8+12+12	12,974
E-S8SEG M 6	1SYE051606C0001	6 way	8+12+18	14,552
E-S8SEG M 8	1SYE051608C0001	8 way	8+12+24	16,200
E-S8SEG M 12	1SYE051612C0001	12 way	8+12+36	20,880
E-S8SEG M4 (RAL 9003)	1SYE151604C0001	4 way	8+12+12	Upon request
E-S8SEG M6 (RAL 9003)	1SYE151606C0001	6 way	8+12+18	
E-S8SEG M8 (RAL 9003)	1SYE151608C0001	8 way	8+12+24	
E-S8SEG M12 (RAL9003)	1SYE151612C0001	12 way	8+12+36	

Elegance series

Distribution boards



Phase Selector DB -E- SPVS

Phase selector DBs-SPVS with inbuilt 3 nos. piano switches and 3 nos. phase selector switch of 63A.

IP 43 with metal door

Product description	Ordering code	No. of ways	No. of modules	Unit MRP (₹)
E-SPVS M 4(63A)	1SYE091604C0001	4 way	8+12	19,312
E-SPVS M 6(63A)	1SYE091606C0001	6 way	8+18	19,312
E-SPVS M 8(63A)	1SYE091608C0001	8 way	8+24	20,314
E-SPVS M 12(63A)	1SYE091612C0001	12 way	8+36	21,820



Flexy tier DB - E-SVFL

Total flexibility as per site needs - configuration as per your choice of incomer & outgoings. Supply bus bars needs to be selected.

IP 43 with metal door

Product description	Ordering code	No. of ways	No. of modules	Unit MRP (₹)
E-SVFL M 132	1SYE101632C0001	2 row of 13mod	26	6,772
E-SVFL M 133	1SYE101633C0001 ■	3 row of 13mod	39	8,310
E-SVFL M 134	1SYE101634C0001 ■	4 row of 13mod	52	10,094
E-SVFL M 142	1SYE101642C0001	2 row of 14mod	28	7,284
E-SVFL M 143	1SYE101643C0001 ■	3 row of 14mod	42	8,390
E-SVFL M 144	1SYE101644C0001 ■	4 row of 14mod	56	10,716

Plug & Socket DB - E-SGK

Plug socket boards for single phase and three phase applications up to 63A (supplied completely with plug and socket).

Product description	Ordering code	No. of ways	No. of modules	Unit MRP (₹)
E-SGK 20 SP	1SYE111520C0001 ■	20A SP	1	2,144
E-SGK 30 TP	1SYE111530C0001 ■	30A TP	3	4,582
E-SGK 60 FP	1SYE111560C0001 ■	60A FP	4	17,254

Enclosure-E-SEN

Metal enclosures, universal mounting suitable for SP, DP, FP, 6 pole & 8 pole arrangement.

Product description	Ordering code	No. of ways	No. of modules	Unit MRP (₹)
E-SEN 2P	1SYE121502C0001 ■	2P Enclosure	2	832
E-SEN 4P	1SYE121504C0001 ■	4P Enclosure	4	838
E-SEN 6P	1SYE121506C0001 ■	6P Enclosure	6	1,146
E-SEN 8P	1SYE121508C0001 ■	8P Enclosure	8	1,368

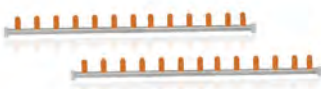

Busbar SP I/C & SP O/G

Product description	Ordering code	No. of ways	No. of modules	Unit MRP (₹)
13Mod Insulated Busbars	1SYE131514C0001 ■	13	13	478
14Mod Insulated Busbars	1SYE131500C0001 ■	14	14	478

Blanking plate

Product description	Ordering code	No. of ways	No. of modules	Unit MRP (₹)
Blank PL	1SYE131513C0001 ■		1	24

■ Stock items

Elegance series

Distribution boards

Cable end box

Product description	Ordering code	No. of ways	Unit MRP (₹)
SPN IP43 SHC			
E-SHC M 4/CEB	1SYE140104C0001	For 4 way SPN IP43 DB	645
E-SHC M 6/CEB	1SYE140106C0001	For 6 way SPN IP43 DB	675
E-SHC M 8/CEB	1SYE140108C0001	For 8 way SPN IP43 DB	785
E-SHC M 10/CEB	1SYE140110C0001	For 10 way SPN IP43 DB	755
E-SHC M 12/CEB	1SYE140112C0001	For 12 way SPN IP43 DB	895
E-SHC M 14/CEB	1SYE140114C0001	For 14 way SPN IP43 DB	880
E-SHC M 16/CEB	1SYE140116C0001	For 16 way SPN IP43 DB	1,010
E-SHC M 20/CEB	1SYE140120C0001	For 20 way SPN IP43 DB	1,125
TPN IP43 SHDB			
E-SHDB M 4/CEB	1SYE140204C0001	For 4 way TPN IP43 DB	1,125
E-SHDB M 6/CEB	1SYE140206C0001	For 6 way TPN IP43 DB	1,185
E-SHDB M 8/CEB	1SYE140208C0001	For 8 way TPN IP43 DB	1,480
E-SHDB M 12/CEB	1SYE140212C0001	For 12 way TPN IP43 DB	1,860
TPN IP43 SHPPI			
E-SHPPI M 6/CEB	1SYE140306C0001	For 6way PPI IP43 DB	1,345
E-SHPPI M 8/CEB	1SYE140308C0001	For 8way PPI IP43 DB	1,845
E-SHPPI M 12/CEB	1SYE140312C0001	For 12way PPI IP43 DB	2,655
TPN IP43 SVDB			
E-SVDB M 6/CEB	1SYE140406C0001	For 6way SVDB IP43 DB	1,175
E-SVDB M 8/CEB	1SYE140408C0001	For 8way SVDB IP43 DB	1,400
E-SVDB M 12/CEB	1SYE140412C0001	For 12way SVDB IP43 DB	1,610
Flexy DB IP43			
E-SVFL 13M/CEB	1SYE140508C0001	For all SVFL 13Mod DBs	1,470
E-SVFL 14M/CEB	1SYE140512C0001	For all SVFL 14Mod DBs	1,780
VTPN IP43 SVTDB			
E-SVTDB M/CEB	1SYE140800C0001	For all SVTDBs(IP43DBs)	2,705
VTPN IP43 XT1 160A			
E-SVTDB M XT1/CEB	1SYE140504C0001	For all SVTDB XT1 DBs(IP43DBs)	3,515
VTPN IP43 XT3 250A			
E-SVTDB MXT3CEB	1SYE140506C0001	For all SVTDB XT3 DBs(IP43DBs)	4,160
8 Segment			
E-S8SEG M4/CEB	1SYE14013C0001	For 4 way 8 Segment DB	2,065
E-S8SEG M6/CEB	1SYE14014C0001	For 6 way 8 Segment DB	2,420
E-S8SEG M8/CEB	1SYE140600C001	For 8 way 8 Segment DB	2,815
E-S8SEG M12/CEB	1SYE140700C001	For 12 way 8 Segment DB	3,455

Classic series

Distribution boards



SPN DB - SHC

IP 30



Product description	No. of ways	No. of modules	Ordering code	Unit MRP (₹)
SHC WD 4	4 way	4+2	1SYN869006R0001 ■	1,482
SHC WD 6	6 way	6+2	1SYN869007R0001	1,528
SHC WD 8	8 way	8+2	1SYN869008R0001 ■	1,846
SHC WD 10	10 way	10+2	1SYN869006R0010	2,000
SHC WD 12	12 way	12+2	1SYN869009R0001 ■	2,376
SHC WD 14	14 way	14+2	1SYN869010R0001	2,440
SHC WD 16	16 way	16+2	1SYN869006R0016 ■	3,020
SHC WD 20	20 way	20+2	1SYN869006R0020	3,704

IP 43 with metal door



Product description	No. of ways	No. of modules	Ordering code	Unit MRP (₹)
SHC M 4	4 way	4+2	1SYN869001R0001 ■	2,052
SHC M 6	6 way	6+2	1SYN869002R0001 ■	2,262
SHC M 8	8 way	8+2	1SYN869003R0001	2,668
SHC M 10	10 way	10+2	1SYN869004R0101	2,770
SHC M 12	12 way	12+2	1SYN869004R0001 ■	3,066
SHC M 14	14 way	14+2	1SYN869005R0001	3,568
SHC M 16	16 way	16+2	1SYN869001R0016 ■	3,716
SHC M 20	20 way	20+2	1SYN869001R0020	4,230

Classic series distribution boards are available in ivory color (color code - RAL9010)

■ Stock items

Classic series

Distribution boards



SPN DB - SHC

IP 43 metal door with acrylic

Product description	No. of ways	No. of modules	Ordering code	Unit MRP (₹)
SHC P 4	4 way	4+2	1SYN869011R0041	2,234
SHC P 6	6 way	6+2	1SYN869011R0042	2,536
SHC P 8	8 way	8+2	1SYN869013R0001	2,918
SHC P 10	10 way	10+2	1SYN869013R0002	3,294
SHC P 12	12 way	12+2	1SYN869015R0012	3,528
SHC P 14	14 way	14+2	1SYN869015R0001	3,978
SHC P 16	16 way	16+2	1SYN869011R0161	4,286
SHC P 20	20 way	20+2	1SYN869011R0201	4,874



IP 54

Product description	No. of ways	No. of modules	Ordering code	Unit MRP (₹)
SHC M WP 4	4 way	4+2	1SYN869002R0004	5,768
SHC M WP 6	6 way	6+2	1SYN869004R0020	6,218
SHC M WP 8	8 way	8+2	1SYN869002R0008	7,638
SHC M WP 10	10 way	10+2	1SYN869004R0021	7,854
SHC M WP 12	12 way	12+2	1SYN869002R0012	7,952
SHC M WP 14	14 way	14+2	1SYN869004R0022	8,408
SHC M WP 16	16 way	16+2	1SYN869004R0023	9,712
SHC M WP 20	20 way	20+2	1SYN869002R0013	9,314



TPN DB - SHDB

IP 30

Product description	No. of ways	No. of modules	Ordering code	Unit MRP (₹)
SHDB WD 4	4 way	8+12	1SYN869020R0001 ■	3,802
SHDB WD 6	6 way	8+18	1SYN869021R0001	4,452
SHDB WD 8	8 way	8+24	1SYN869022R0001 ■	5,290
SHDB WD 12	12 way	8+36	1SYN869023R0001 ■	8,146



IP 43 with metal door

Product description	No. of ways	No. of modules	Ordering code	Unit MRP (₹)
SHDB M 4	4 way	8+12	1SYN869016R0001 ■	4,806
SHDB M 6	6 way	8+18	1SYN869017R0001	5,672
SHDB M 8	8 way	8+24	1SYN869018R0001 ■	6,966
SHDB M 12	12 way	8+36	1SYN869019R0001 ■	10,106
SHDB M 16	16 way	8+48	1SYN869004R0025 ■	12,676



IP 43 metal door with acrylic

Product description	No. of ways	No. of modules	Ordering code	Unit MRP (₹)
SHDB P 4	4 way	8+12	1SYN869024R0001	5,380
SHDB P 6	6 way	8+18	1SYN869025R0001	6,686
SHDB P 8	8 way	8+24	1SYN869026R0001	7,586
SHDB P 12	12 way	8+36	1SYN869027R0006	10,580



IP 54

Product description	No. of ways	No. of modules	Ordering code	Unit MRP (₹)
SHDB M WP 4	4 way	8+12	1SYN869001R0004	12,722
SHDB M WP 6	6 way	8+18	1SYN869001R0006	15,316
SHDB M WP 8	8 way	8+24	1SYN869001R0008	16,770
SHDB M WP 12	12 way	8+36	1SYN869004R0027	23,768

■ Stock items

Classic series

Distribution boards



PER PHASE ISOLATION DB - SHPPI

IP 43 WITH METAL DOOR

Product description	No. of ways	No. of modules	Ordering code	Unit MRP (₹)
SHPPI M 6	6 way	8+18	1SYN8690100R0061	7,962
SHPPI M 8	8 way	8+24	1SYN8690100R0081	9,520
SHPPI M 12	12 way	8+36	1SYN8690100R0121	12,716
SHPPI M 16	16 way	8+48	1SYN8690100R0161	15,470



PER PHASE ISOLATION DB -SVDB

IP 43 WITH METAL DOOR

Product description	No. of ways	No. of modules	Ordering code	Unit MRP (₹)
SVDB M 6	6 way	8+6+18	1SYN869028R0001	10,192
SVDB M 8	8 way	8+6+24	1SYN869029R0001	12,016
SVDB M 12	12 way	8+6+36	1SYN869030R0001	13,874



IP 43 WITH METAL DOOR

Product description	No. of ways	No. of modules	Ordering code	Unit MRP (₹)
SVTDB M 4	4 way	8+12	1SYN869031R0001	11,486
SVTDB M 6	6 way	8+18	1SYN869032R0001	13,520
SVTDB M 8	8 way	8+24	1SYN869033R0001	15,344
SVTDB M 12	12 way	8+36	1SYN869034R0001	19,448



IP 43 WITH METAL DOOR

Product description	No. of ways	No. of modules	Ordering code	Unit MRP (₹)
SVTDB M 4XT1	4 way	Tmax XT1+12	1SYN8690VMXT104	13,464
SVTDB M 6XT1	6 way	Tmax XT1+18	1SYN8690VMXT106	15,408
SVTDB M 8XT1	8 way	Tmax XT1+24	1SYN8690VMXT108	16,576
SVTDB M 12XT1	12 way	Tmax XT1+36	1SYN8690VMXT112	21,284



IP 43 WITH METAL DOOR

Product description	No. of ways	No. of modules	Ordering code	Unit MRP (₹)
SVTDB M 4XT3	4 way	250A Tmax XT3+12	1SYN8690VMXT304	23,290
SVTDB M 6XT3	6 way	250A Tmax XT3+18	1SYN8690VMXT306	25,610
SVTDB M 8XT3	8 way	250A Tmax XT3+24	1SYN8690VMXT308	27,754
SVTDB M 12XT3	12 way	250A Tmax XT3+36	1SYN8690VMXT312	28,358

Classic series

Distribution boards

7 SEGMENT DB - S7SEG

IP43 WITH METAL DOOR



Product description	No. of ways	No. of modules	Ordering code	Unit MRP (₹)
S7SEG M 4	4 way	8+12+12	1SYN869058R0001	12,488
S7SEG M 6	6 way	8+12+18	1SYN869059R0001	14,040
S7SEG M 8	8 way	8+12+24	1SYN869060R0001	15,208
S7SEG M 12	12 way	8+12+36	1SYN869061R0001	17,916

PHASE SELECTOR DB - SPVS

IP43 WITH METAL DOOR



Product description	No. of ways	No. of modules	Ordering code	Unit MRP (₹)
SPVS M 4(63A)	4 way	8+12	1SYN869100R0001	18,138
SPVS M 6(63A)	6 way	8+18	1SYN869100R0002	18,912
SPVS M 8(63A)	8 way	8+24	1SYN869100R0003	19,454
SPVS M 12(63A)	12 way	8+36	1SYN869100R0004	21,632

FLEXY TIER DB - SVFL

IP43 WITH METAL DOOR



Product description	No. of ways	No. of modules	Ordering code	Unit MRP (₹)
SVFL M 132	2 row of 13mod	26	1SYN869004R0051	5,586
SVFL M 133	3 row of 13mod	39	1SYN869103R0001	6,806
SVFL M 134	4 row of 13mod	52	1SYN869103R0002	8,950
SVFL M 142	2 row of 14mod	28	1SYN869004R0052	6,440
SVFL M 143	3 row of 14mod	42	1SYN869004R0053	7,808
SVFL M 144	4 row of 14mod	56	1SYN869103R0012	9,064

Plug & Socket DB - SGK

Product description	No. of ways	No. of modules	Ordering code	Unit MRP (₹)
SGK 20 SP	20A SP	1	1SYN869043R0001 ■	1,846
SGK 30 TP	30A TP	3	1SYN869044R0001 ■	4,458
SGK 60 FP	60A FP	4	1SYN869053R0001 ■	16,958



Enclosure - SEN

Product description	No. of ways	No. of modules	Ordering code	Unit MRP (₹)
SEN 2P	2P Enclosure	2	1SYN869055R0001 ■	758
SEN 4P	4P Enclosure	4	1SYN869056R0001 ■	770
SEN 6P	6P Enclosure	6	1SYN869057R0001 ■	1,078
SEN 8P	8P Enclosure	8	1SYN869004R0029 ■	1,236



BUSBAR SP I/C & SP O/G, BLANKING PLATE

Product description	No. of ways	No. of modules	Ordering code	Unit MRP (₹)
13 Module Pin type Busbars	13	13	■	456
14 Module Pin type Busbars	14	14	1SYN869103R0013 ■	456

BLANKING PLATE

Product description	No. of ways	No. of modules	Ordering code	Unit MRP (₹)
Blank PL		1	1SYN869004R0059 ■	24

Classic series

Distribution boards

One way MCCB enclosures

XT1 MCCB ENCL

Product description	No. of ways	Ordering code	Unit MRP (₹)
XT1 TP MCCB Enclosure	3 pole	1SYT121503C0001	1,926
XT1 FP MCCB Enclosure	4 pole	1SYT121504C0001	2,194

XT3 MCCB ENCL

Product description	No. of ways	Ordering code	Unit MRP (₹)
XT3 TP MCCB Enclosure	3 pole	1SYT321503C0001	2,194
XT3 FP MCCB Enclosure	4 pole	1SYT321504C0001	2,456

A1 MCCB ENCL

Product description	No. of ways	Ordering code	Unit MRP (₹)
A1 TP MCCB Enclosure	3 pole	1SYA121503C0001	2,194
A1 FP MCCB Enclosure	4 pole	1SYA121504C0001	2,326

A2 MCCB ENCL

Product description	No. of ways	Ordering code	Unit MRP (₹)
A2 TP MCCB Enclosure	3 pole	1SYA221503C0001	2,326
A2 FP MCCB Enclosure	4 pole	1SYA221504C0001	2,394

Plug and Sockets in Metal Enclosure with MCB/RCCB Provision

Product Description	No of Ways	No of Modules	Product Code	Unit MRP (₹)
216RAUSPNE	16A 3 PIN (2P+E) Socket with Enclosure	2	1SYN880110R0001	Upon request
232RAUSPNE	32A 3 PIN (2P+E) Socket with Enclosure	2	1SYN880113R0001	
263RAUSPNE	63A 3 PIN (2P+E) Socket with Enclosure	2	1SYN880116R0001	
316RAU6TPE	16A 4 PIN (3P+E) Socket with Enclosure	3	1SYN880111R0001	
332RAU6TPE	32A 4 PIN (3P+E) Socket with Enclosure	3	1SYN880114R0001	
363RAU6TPE	63A 4 PIN (3P+E) Socket with Enclosure	3	1SYN880117R0001	
416RAU6TPNE	16A 5 PIN (4P+E) Socket with Enclosure	4	1SYN880112R0001	
432RAU6TPNE	32A 5 PIN (4P+E) Socket with Enclosure	4	1SYN880115R0001	
363RAU6TPE	63A 5 PIN (4P+E) Socket with Enclosure	4	1SYN880118R0001	

Classic series

Distribution boards

Cable end box

Product description	Ordering code	No. of ways	Unit MRP (₹)
SPN IP43 SHC			
SHC M 4/CEB	1SYN869103R0014	For 4 way SPN IP 43 DB	656
SHC M 6/CEB	1SYN869103R0015	For 6 way SPN IP43 DB	716
SHC M 8/CEB	1SYN869004R0082	For 8 way SPN IP43 DB	740
SHC M 10/CEB	1SYN869004R0083	For 10 way SPN IP43 DB	784
SHC M 12/CEB	1SYN869004R0084	For 12 way SPN IP43 DB	884
SHC M 14/CEB	1SYN869004R0085	For 14 way SPN IP43 DB	968
SHC M 16/CEB	1SYN869004R0086	For 16 way SPN IP43 DB	1,176
SHC M 20/CEB	1SYN869004R0087	For 20 way TPN IP43 DB	1,462
TPN IP43 SHDB			
SHDB M 4/CEB	1SYN869004R0088	For 4 way TPN IP43 DB	1,104
SHDB M 6/CEB	1SYN869004R0089	For 6 way TPN IP43 DB	1,132
SHDB M 8/CEB	1SYN869004R0090	For 8 way TPN IP43 DB	1,664
SHDB M 12/CEB	1SYN869004R0091	For 12 way TPN IP43 DB	1,832
TPN IP43 SHPPI			
SHPPI M 6/CEB	1SYN869004R0093	For 6 way PPI IP43 DB	1,276
SHPPI M 8/CEB	1SYN869004R0094	For 8 way PPI IP43 DB	1,758
SHPPI M 12/CEB	1SYN869004R0095	For 12 way PPI IP43 DB	2,520
SHPPI M 16/CEB	1SYN869004R0096	For 16 way PPI IP43 DB	2,732
TPN IP43 SVDB			
SVDB M 6/CEB	1SYN869004R0097	For 6 way SVDB IP43 DB	1,360
SVDB M 8/CEB	1SYN869004R0098	For 8 way SVDB IP43 DB	1,378
SVDB M 12/CEB	1SYN869004R0099	For 12 way SVDB IP43 DB	1,590
Flexy DB IP43			
SVFL 13M/CEB	1SYN869004R0103	For all SVFL 13Mod DBs	1,456
SVFL 14M/CEB	1SYN869004R0104	For all SVFL 14Mod DBs	1,770
VTPN IP43 SVTDB			
SVTDB M/CEB	1SYN869004R0100	For all SVTDBs(IP43DBs)	2,700
VTPN IP43 XT1 160A			
SVTDB M XT1 160/CEB	1SYN869004C0101	For all SVTDB XT1 160 DBs(IP43DBs)	3,422
VTPN IP43 XT3 250A			
SVTDB M XT3 250/CEB	1SYN869004C0103	For all SVTDB XT3 250 DBs(IP43DBs)	4,016
7 Segment CB			
S7SEG M4/CEB	1SYN141013C0001	For 4 way 7 SEG IP43 DB	2,066
S7SEG M6/CEB	1SYN141014C0001	For 6 way 7 SEG IP43 DB	2,414
S7SEG M8/CEB	1SYN140600C0001	For 8 way 7 SEG IP43 DB	2,816
S7SEG M12/CEB	1SYN140700C0001	For 12 way 7 SEG IP43 DB	3,456

Complete range

Customization in ABB Distribution Enclosures available on request*

- i) Enclosures-TV/TEL/IOT related backend devices
- ii) Enclosures-SPD provision
- iii) Pre-wired distribution boards
- iv) Indication lamps provision
- v) MCCB enclosures

Mistral IP 65 enclosures

A point of reference. For simplicity and effectiveness

A complete series, versatile and easy to install

Efficiency, safety, integration: the new System pro E comfort MISTRAL65 series rests on the strengths which have consolidated ABB's image over the years for its expertise and reliability in the area of products for protection, control, monitoring, measurement, safety and energy efficiency. These innovative IP65 rated consumer units complete

ABB's wide product range for the industrial sector. The result of constant research and constant attention paid to technological development, the System pro E comfort consumer units are designed to satisfy all requirements electrical installers might have.

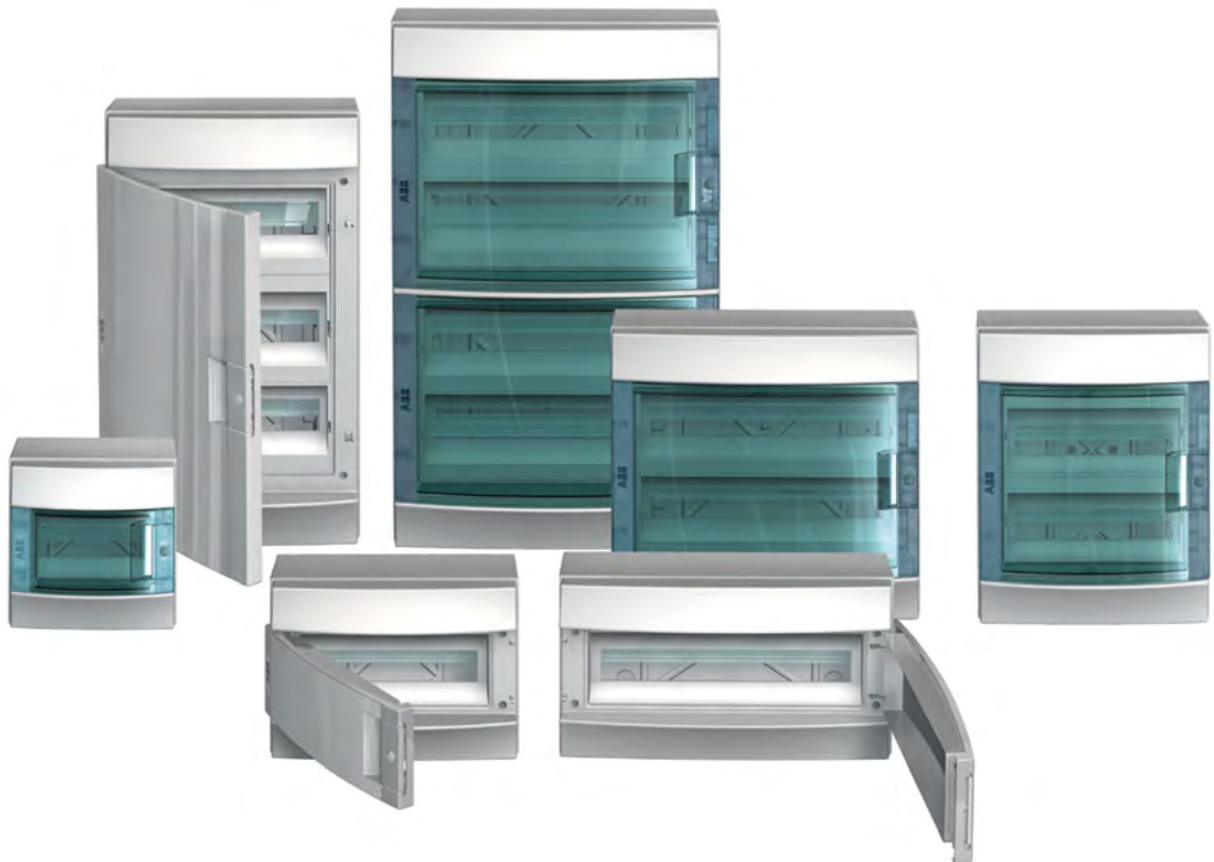

Description	No. modules	No. of rows	Dimensions WxHxD	Order code	L.P. (₹)
Mistral65 transparent door 4M	4	1	52x202x117	1SL1200A00	3,050
Mistral65 transparent door 8M	8	1	232x250x154	1SL1201A00	4,928
Mistral65 transparent door 12M	12	1	320x250x155	1SL1202A00	6,552
Mistral65 transparent door 18M	18	1	430x250x155	1SL1203A00	8,308
Mistral65 transparent door 24M	24	2	320x435x155	1SL1204A00	10,180
Mistral65 transparent door 36M 2F	36	2	430x435x155	1SL1205A00	16,214
Mistral65 transparent door 36M 3F	36	3	320x600x155	1SL1206A00	16,214
Mistral65 transparent door 54M	54	3	430x600x155	1SL1208A00	23,388

Gemini switchboard

Distribution boards

ABB SACE's Gemini range is revolutionizing the market of low voltage electric insulating switchboards. The reason for this is that it is the first switchboard made in thermoplastic material, to which the co-injection molding technique gives the same mechanical characteristics as polyester. This means that it is extremely sturdy, with its rigid covering and expanded internal

core. Moreover, it contains no fiber glass, a material that with time rises to the surface, jeopardizing the functioning and safety of switchboards made in polyester with which it is usually mixed. Available in 6 different sizes with transparent or opaque door, the Gemini switchboards are suitable for installation in any application context.



Compliance with standard	IEC60670, EN 50298, 60439-1, 62208, 61439 – 1 & 2
Rated service voltage	1000V AC
Degree of protection	IP 30 open door / IP66 closed door

* Details available on request

Millenium

Thanks to a combined system, the switches of the Millenium series provide a comprehensive range of solutions for single rooms or whole building concepts. The square and ultra slim switches do not only add quality and style to the overall building, but are also easy to install.



01



02

NEW

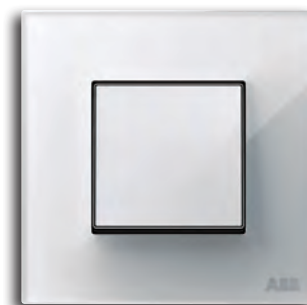

05

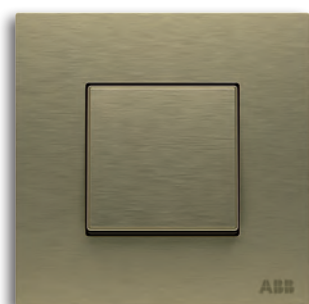

03

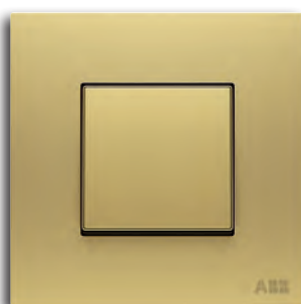

04

NEW



06



07



08



09



10

- 01 Stainless Steel
- 02 Silk Black *
- 03 Antique Gold
- 04 Matt Gold
- 05 White Glass **
- 06 Black Glass **
- 07 Stainless Steel and Silk Black
- 08 Silk Black and Stainless Steel
- 09 Antique Gold and Silk Black
- 10 Matt Gold and Silk Black

* Silk Black not suitable to installation outdoors
 ** Cover frame made of real glass



Modern and contemporary 4 finishes made in real stainless steel material AISI 304 and 2 finishes made in glass to complete the elegant finishes of Millennium: Stainless Steel, Silk Black, Antique Gold, and Matt Gold, White Glass and Black Glass.

Designed by the famous European designer Josep LLuscá.



Slim line design, only 4 mm high with straight and square lines at the forefront. Rocker with attractive chrome profile that gives a distinctive glance.

Range with wide rocker and metal finish. Screwless front plate ultra slim design.



Zenit

The highlight of modular series

Zenit is the most comprehensive modular range for all kind of homes and commercial buildings. A number of appreciated designs and beautiful finishes that add value to the facility, with advanced features that provide greater comfort and performance level. With Zenit you can make any type of installation, can enjoy benefit of technical advantages that make it easier and faster. This range has the guarantee of a brand renowned for its quality such as ABB.





Zenit

- BL White
- PL Silver
- AN Anthracite
- CV Champagne

Zenit Noble

- CB White Glass
- CN Black Glass
- CF Graphite Glass
- CH Champagne Glass
- CP Pearl Glass

- CC Coffee Glass
- OX Stainless Steel
- WG Wenge
- PZ Slate

AN

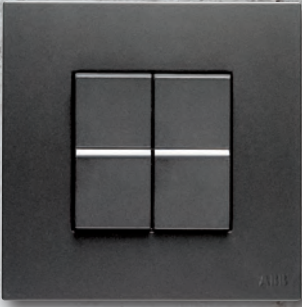

CV



CP



CF



CH



WG



PZ



Wiring accessories

IVIE

Switch to the future

IVIE is the latest premium modular range of wiring accessories designed to address various functionalities. These include basic switching, controlling, comfort and energy saving.

The IVIE range innovatively matches your interiors and aesthetically brings out the best in your comfort zone. The enhanced design for reliable performance of this range is for the passionate, compassionate, intuitive and magnetic personality within each one of us.

The IVIE range, includes the tastefully selected color options, caters to the needs of various segments like residential, commercial and hospitality.

IVIE with its ability to integrate home automation solutions in your existing switch box, makes the range future proof.

IVIE truly makes you want to switch to the future.

Sleek and convex design in different finishes

Thanks to the complete system, The IVIE series provides a comprehensive range of solutions for building concepts. The convex and sleek design not only provides quality and style to the overall building, but is easy to install.



01



02



03



04

Different finishes and combinations:

- 01 Anthracite grey mechanisms in Silver plate
- 02 Silver mechanisms in Anthracite Grey plate
- 03 Anthracite grey mechanisms in White plate
- 04 Anthracite grey mechanisms in Anthracite Grey plate

Flexibility in design which provides total control

The IVIE range is the first Indian range to incorporate wired and wireless home automation systems together. This range can be integrated with

ABB-free@home® home automation system, which is the most intelligent way of managing spaces with energy saving.



Great comfort, safety and energy efficiency for buildings

ABB-free@home® sensor for switching control, blind control, dimming and scene control.



IVIE complete range

IVIE mechanisms - White



1SYK100001A1001



1SYK100001A1007



1SYK100001A1008



1SYK100001 A1003 1SYK100001 A1005



1SYK100001A1028



1SYK100001A1023



2CLA218500 N1102 2CLA228500 N1102



1SYK100001A1041

Type reference and description	Number of modules	Std pack	Ordering code	Unit M.R.P.(₹)
Switch 6 A - 240 V ~				
IIS10610 BL - 6A 1 way switch	1	20/400	1SYK100001A1001 ■	160
IIS10620 BL - 6A 2 way switch	1	20/400	1SYK100001A1002 ■	287

Type reference and description	Number of modules	Std pack	Ordering code	Unit M.R.P.(₹)
Switch 16 A - 240 V ~				
IIS11610 BL - 16A 1 way switch	1	20/400	1SYK100001A1006 ■	370
IIS1161L BL - 16A 1 way switch with indicator	1	20/400	1SYK100001A1007 ■	442

Type reference and description	Number of modules	Std pack	Ordering code	Unit M.R.P.(₹)
Switch 32 A - 240 V ~				
IIS2321L BL - 32A, DP switch	2	10/200	1SYK100001A1008 ■	1,214

Type reference and description	Number of modules	Std pack	Ordering code	Unit M.R.P.(₹)
Bell Push				
IIS106B0 BL - 6A Bell switch	1	20/400	1SYK100001A1003 ■	318
IIS106BL BL - 6A Bell switch with indicator	1	20/400	1SYK100001A1004 ■	403
IIS206BL BL - 6A Mega Bell switch with indicator	2	10/200	1SYK100001A1005 ■	562

Type reference and description	Number of modules	Std pack	Ordering code	Unit M.R.P.(₹)
Sockets				
IIK20306 BL 6A 3Pin Socket	2	10	1SYK100001A1028 ■	390
IIK20616 BL - 6/16A socket	2	10/200	1SYK100001A1023 ■	551
N2238 BL - Euro-American earthed socket outlet, 125/250V AC, 15/16A, 2 P+E	2	10	2CLA223800N1102	Upon request
N2135 BL - Euro-American unearthed socket outlet, 125/250V AC, 15/16A, 2 P	1	20	2CLA213500N1102	
N2237 BL - British standard socket outlet, 250V AC, 13A, 2 P+E	2	10	2CLA223700N1102	

Type reference and description	Number of modules	Std pack	Ordering code	Unit M.R.P.(₹)
USB chargers				
N2185 BL - USB charger 0.75A, 100-240V	1	1	2CLA218500N1102	4,741
N2185.2 BL - USB charger 2A, 100-230V	1	1	2CLA218520N1102 ■	6,462
N2285 BL - USB charger 1.5A, 100-240V	2	1	2CLA228500N1102	5,544

Type reference and description	Number of modules	Std pack	Ordering code	Unit M.R.P.(₹)
Blank plates				
IIM1BLNK BL - blank plate	1	20/400	1SYK100001A1041 ■	71

■ Stock items

IVIE complete range

IVIE mechanisms - White



1SYK100001A1042



1SYK100001A1045



2CLA226020N1102



2CLA226030N1102



2CLA226080N1102



2CLA226090N1102

Type reference and description	Number of modules	Std pack	Ordering code	Unit M.R.P.(₹)
Dimmer & fan regulators				
IIM2FR05 BL - step fan regulator 5 step	2	5/100	1SYK100001A1042 ■	1,209
IIM1FR04 BL - step fan regulator 4 step	1	10/200	1SYK100001A1043 ■	1,050
IIM2D400 BL - dimmer 400 watt	1	10/200	1SYK100001A1045	1,404
N2260.2 BL - Universal rotatory/push dimmer, 230V • Rated voltage: 230 V AC • Max. power: incandescent: 500 Watt halogen lamp with electronic transformer: 500 VA • Halogen lamp with ferromagnetic transformer: 400 VA	2	1	2CLA226020N1102	
N2260.3 BL - LED rotatory/push dimmer, 230V • Rated voltage: 230 V AC • Nominal power: 250 W/VA Power (min./max load): LEDi: 2/100 W/VA (max. 10 lamps) • Dimmable energy saving lamps: 2/100 W/VA (max. 10 lamps) • LV LEDi with transformer (only type L or LC): 4/100 W/VA (max. 10 lamps) • Incandescent lamps: 10/250 W/VA • Halogen lamps: 10/250 W/VA • LV halogen with transformer (only type L or LC): 10/250 W/VA (max. 10 lamps) • 2 wire connection. Optional: auxiliary on/off with 2-way switch N2X02	2	1	2CLA226030N1102	Upon request
N2260.8 BL - LED rotatory/push dimmer • Rated voltage: 127 V AC, Frequency: 50/60 Hz (Nominal power: 140 W/VA) • Power (min./max load): LEDi: 2/55 W/VA (max. 10 lamps) • Dimmable energy saving lamps: 2/55 W/VA (max. 10 lamps) • LV LEDi with transformer (only type L or LC): 4/55 W/VA (max. 10 lamps) • Incandescent lamps: 10/140 W/VA • Halogen lamps: 10/140 W/VA • LV halogen with transformer (only type L or LC): 10/140 W/VA (max. 10 lamps)	2	1	2CLA226080N1102	
N2260.9 BL - 1-10V rotary dimmer • Rated voltage: 127 - 230 V AC/50 - 60 Hz • Max. power: 230 Vac: 700 VA • 127 V AC: 350 VA • Max. 6 ballasts per device	2	1	2CLA226090N1102	



1SYK100001A1047

Type reference and description	Number of modules	Std pack	Ordering code	Unit M.R.P.(₹)
Data & voice				
IIM1RJ11 BL - RJ11 Tel. jack 2 pin	1	20/400	1SYK100001A1047 ■	276
IIM1RJ45 BL - RJ45 Jack cat 6	1	20/400	1SYK100001A1048 ■	1,001



1SYK100001A1049

Type reference and description	Number of modules	Std Pack	Ordering code	Unit M.R.P.(₹)
TV Socket				
IIM1TVSK BL - TV co-axial socket	1	20/400	1SYK100001A1049 ■	281



1SYK100001A1051

Type reference and description	Number of modules	Std Pack	Ordering code	Unit M.R.P.(₹)
Starters				
IIM2ST20 BL - Single Phase Starter 20A	2	5/100	1SYK100001A1051	1,250
IIM2ST25 BL - Single Phase Starter 25A	2	5/100	1SYK100001A1052	1,300

■ Stock items

IVIE complete range

IVIE mechanisms - White



1SYK100001A1055



2CLA224450N1102 2CLA218050N1102
2CLA218040N1102



2CLA221410N1102



1SYK100001A1059



2CLA215520N1102 2CLA215530N1102



2CLA215540N1102 2CLA215560N1102



2CLA224100N1102



2CLA211900N1102 2CLA221900N1102



1SYK100001A1053

■ Stock items

Type reference and description	Number of modules	Std pack	Ordering code	Unit M.R.P.(₹)
DND & MMR				
IIM1DND5 BL - DND and MMR set internal & external	2+3	5/100	1SYK100001A1055	2,008
N2244.5 BL - DND and MUR 2-gang interlocked switch	2	5	2CLA224450N1102	
N2180.5 BL - LED MUR signaling light	1	5	2CLA218050N1102	6,297
N2180.4 BL - LED DND signaling light	1	5	2CLA218040N1102	

Type reference and description	Number of modules	Std pack	Ordering code	Unit M.R.P.(₹)
Key card switches				
N2214.1 BL - Card switch 1-gang, 1-way, DP	2	1	2CLA221410N1102	5,883

Type reference and description	Number of modules	Std pack	Ordering code	Unit M.R.P.(₹)
Down lighter				
IIM3DOWN BL-down lighter	3	5/100	1SYK100001A1059 ■	863

Type reference and description	Number of modules	Std pack	Ordering code	Unit M.R.P.(₹)
Audio & video connector				
N2155.2 BL - 2x RCA connection unit	1	1	2CLA215520N1102	
N2155.3 BL - 3x RCA connection unit	1	1	2CLA215530N1102	
N2155.4 BL - Mini-Jack connection unit	1	1	2CLA215540N1102	
N2155.5 BL - VGA connection unit	1	1	2CLA215550N1102	Upon request
N2155.6 BL - HDMI connection unit	1	1	2CLA215560N1102	
N2155.7 BL - HDMI female-female connection unit	1	1	2CLA215570N1102	
N2155.8 BL - USB connection unit	1	1	2CLA215580N1102	
N2155.9 BL - USB female-female connection unit	1	1	2CLA215590N1102	

Type reference and description	Number of modules	Std pack	Ordering code	Unit M.R.P.(₹)
Motion sensor				
N2241 BL - 110° motion sensor • Max. power: Incandescent: 1,800W @230V AC/1,000W @127V AC • Halogen with electronic or ferromagnetic transformer: 750VA @230V AC/400VA @127V AC - Fluorescent lamps or motors: 400VA @230V AC/200VA @127V AC • For automatic switching of devices dependent on motion and brightness • With integrated selector switch for automatic ON-OFF in the front side • Switch-off delay: 10 sec to 10 min or short-time pulse 1 sec adjustable (from the front side) • Detection range: 5 m radius • Adjustable light set point level for activation (from the front side) • Detection angle: 110° Mounting height: 1, 2 m Auxiliary control with N2X04.X push-buttons	2	1	2CLA224100N1102	Upon request

Type reference and description	Number of modules	Std pack	Ordering code	Unit M.R.P.(₹)
Buzzer & door bell				
IIM2BUZR BL - Buzzer	2	5/100		598
N2119 BL - Buzzer	1	1	2CLA211900N1102	
N2219 BL - Buzzer	2	1	2CLA221900N1102	Upon request
N2224 BL - Electronic door bell 230 V AC	2	1	2CLA222400N1102	

Type reference and description	Number of modules	Std pack	Ordering code	Unit M.R.P.(₹)
Indicator				
IIM1INDI BL - Indicator	1	20/400	1SYK100001A1053	427

IVIE complete range

IVIE mechanisms - White



2CLA218000N1602

Type reference and description	Number of modules	Std pack	Ordering code	Unit M.R.P.(₹)
Signaling light				
N2180 BL - LED white signaling light, Lamp: white LED Luminous flux: > 2 lumen at 1 meter, white diffuser	1	5	2CLA218000N1102	Upon request
N2180 RJ - LED red signaling light, Lamp: white LED Luminous flux: > 2 lumen at 1 meter, Red diffuser	1	1	2CLA218000N1602	
N2180 VD - N2180 VD, Lamp: white LED Luminous flux: > 2 lumen at 1 meter, Green diffuser	1	1	2CLA218000N1802	
N2280 BL - LED signaling light, Lamp: white LED Luminous flux: > 2 lumen at 1 meter, White diffuser	2	1	2CLA228000N1102	
N2281 BL - Beacon LED light, Lamp: white LED Luminous flux: > 2 lumen at 1 meter, white diffuser, Autonomy: 3 hours (1 hour at maximum illumination 2 hours with lower illumination), Battery: Ni-MH (estimated lifetime: 4 years)	2	1	2CLA228100N1102	



2CLA814050
A1002



2CLA224050
N1102

Type reference and description	Number of modules	Std pack	Ordering code	Unit M.R.P.(₹)
Thermostat				
8140.5 - Digital room thermostat • Maximum load: 3A cos = 0,5 • Output relay operation modes: Hysteresis: 0.5° C • Pulse-width modulation: with a ±4°C difference with the set-point temperature • Variable from 100% to 0% modulation • To be installed with N2240.5 cover plates	2	1	2CLA814050A1002	Upon request
N2240.5 BL - Cover plate for digital thermostat - 2M	2	1	2CLA224050N1102	



2CLA936810A1001



2CLA936820
A1001



2CLA225710
N1102

Type reference and description	Number of modules	Std pack	Ordering code	Unit M.R.P.(₹)
Sound				
9368.1 - Multiroom sound module	1	1	2CLA936810A1001	Upon request
9368.2 - Remote control for multiroom sound module	2	1	2CLA936820A1001	
N2268 BL - Cover plate for radio/remote control modules	-	1	2CLA226800N1102	
9368- FM - Radio and alarm module	2	1	2CLA936800A1001	
N2268 BL - Cover plate for radio/remote control modules	-	1	2CLA226800N1102	
9368.3 - Auxiliary module	2	1	2CLA936830A1001	
N2268.3 BL - Cover plate for I/O + USB + Bluetooth module	-	1	2CLA226830N1102	
N2257.1 BL - Speaker connection unit	2	1	2CLA225710N1102	

* More details will be provided upon request



15YK100001
A1071



15YK100001
A1072



15YK100001
A1073



15YK100001
A1074



15YK100001A1077



15YK100001A1079

Type reference and description	Number of modules	Std pack	Ordering code	Unit M.R.P.(₹)
White plate with frame				
IIP0133 BL - 1M plate	1	15/360	15YK100001A1071 ■	211
IIP0233 BL - 2M plate	2	15/360	15YK100001A1072 ■	227
IIPP343 BL - 3M plate power	3	10/240	15YK100001A1073 ■	238
IIP0343 BL - 3M plate	3	10/240	15YK100001A1074 ■	314
IIP0453 BL - 4M plate	4	10/190	15YK100001A1075 ■	341
IIP0683 BL - 6M plate	6	5/120	15YK100001A1076 ■	470
IIP0893 BL - 8M plate	8	5/120	15YK100001A1077 ■	551
IIP0855 BL - 8M plate square	8	5/95	15YK100001A1078 ■	627
IIP1286 BL - 12M plate	12	5/95	15YK100001A1079 ■	681
IIP1888 BL - 18M plate	18	5/40	15YK100001A1080 ■	1,075

■ Stock items

IVIE complete range

IVIE mechanisms - Anthracite Grey



1SYK100001A1201

Type reference and description	Number of modules	Std pack	Ordering code	Unit M.R.P.(₹)
Switch 6 A - 240 V ~				
IIS10610 AN - 6A 1 way switch	1	20/400	1SYK100001A1201 ■	220
IIS10620 AN - 6 A 2 way switch	1	20/400	1SYK100001A1202 ■	324



1SYK100001A1207

Type reference and description	Number of modules	Std pack	Ordering code	Unit M.R.P.(₹)
Switch 16 A - 240 V ~				
IIS11610 AN - 16A 1 way switch	1	20/400	1SYK100001A1206 ■	413
IIS1161L AN - 16A 1 way switch with ind.	1	20/400	1SYK100001A1207 ■	515



1SYK100001A1208

Type reference and description	Number of modules	Std pack	Ordering code	Unit M.R.P.(₹)
Switch 32 A - 240 V ~				
IIS2321L AN - 32A, DP switch	2	10/200	1SYK100001A1208	1,459



1SYK100001
A1203



1SYK100001
A1205

Type reference and description	Number of modules	Std pack	Ordering code	Unit M.R.P.(₹)
Bell Push - 240 V ~				
IIS106B0 AN - 6A Bell Switch	1	20/400	1SYK100001A1203	369
IIS106BL AN - 6A Bell Switch with ind.	1	20/400	1SYK100001A1204 ■	470
IIS206BL AN - 6A Mega Bell switch with ind.	2	10/200	1SYK100001A1205	659



1SYK100001A1128



1SYK100001A1223

Type reference and description	Number of modules	Std pack	Ordering code	Unit M.R.P.(₹)
Sockets - 240 V ~				
IIK20616 AN - 6/16A socket	2	10/200	1SYK100001A1223 ■	653
IIK20306 AN - 6A, 3Pin socket	2	10/200	1SYK100001A1228 ■	437
N2238 AN - Euro-American earthed socket outlet, Rated current: 15/16A, 2P+E/NEMA 5-15R	2	10	2CLA223800N1802	Upon request
N2135 AN - Euro-American unearthed socket outlet, Rated current: 15/16A, 2P (non-earthed)/NEMA 1-15R	1	20	2CLA213500N1802	
N2237 AN - British standard socket outlet, Rated current: 13A, 2P+E	2	10	2CLA223700N1302	



2CLA218500
N1802

Type reference and description	Number of modules	Std pack	Ordering code	Unit M.R.P.(₹)
USB chargers				
N2185 AN - USB charger 750mA, 1-gang	1	1	2CLA218500N1802	Upon request
N2185.2 AN - USB charger 2.000mA, 1-gang	1	1	2CLA218520N1802	
N2285 AN - USB charger 1.500mA, 2-gang	2	1	2CLA228500N1802	



1SYK100001A1241

Type reference and description	Number of modules	Std pack	Ordering code	Unit M.R.P.(₹)
Blank plates				
IIM1BLNK AN - Blank plate	1	20/400	1SYK100001A1241 ■	131

■ Stock items

IVIE complete range

IVIE mechanisms - Anthracite Grey



1SYK100001A1242



2CLA226020N1802



2CLA226030N1802



2CLA226080N1802



2CLA226090N1802



1SYK100001A1247



1SYK100001A1249



1SYK100001A1257



1SYK100001A1255



Type reference and description	Number of modules	Std pack	Ordering code	Unit M.R.P.(₹)
Motion sensor				
IIM2FR05 AN - Step fan regulator 5 step	2	5/100	1SYK100001A1242 ■	1,396
IIM1FR04 AN - Step fan regulator 4 step	1	10/200	1SYK100001A1243 ■	1,235
IIM1D400 AN - Dimmer 400 Watt	1	10/200	1SYK100001A1245	1,609
N2260.2 AN - Universal rotatory/push dimmer • Rated voltage: 230 V AC • Max. power: Incandescent: 500 W • Halogen lamp with electronic transformer: 500 VA • Halogen lamp with ferromagnetic transformer: 400 VA	2	1	2CLA226020N1802	
N2260.3 AN - LED rotatory/push dimmer • Rated voltage: 230 V AC • Nominal power: 250 W/VA • Power (min./max load): LEDi: 2/100 W/VA (max. 10 lamps). Dimmable energy saving lamps: 2/100 W/VA (max. 10 lamps) • LV LEDi with transformer (only type L or LC): 4/100 W/VA (max. 10 lamps) • Incandescent lamps: 10/250 W/VA • Halogen lamps: 10/250 W/VA • LV halogen with transformer (only type L or LC): 10/250 W/VA (max. 10 lamps) • 2 wire connection • Optional: auxiliary on/off with 2-way switch N2X02	2	1	2CLA226030N1802	Upon request
N2260.8 AN - LED rotatory/push dimmer • Rated voltage: 127 V AC • Frequency: 50/60 Hz (Nominal power: 140 W/ VA) • Power (min./max load): LEDi: 2/55 W/VA (max. 10 lamps) • Dimmable energy saving lamps: 2/55 W/VA (max. 10 lamps) • LV LEDi with transformer (only type L or LC): 4/55 W/VA (max. 10 lamps) • Incandescent lamps: 10/140 W/VA • Halogen lamps: 10/140 W/VA • LV halogen with transformer (only type L or LC): 10/140 W/VA (max. 10 lamps)	2	1	2CLA226080N1802	
N2260.9 AN - 1-10V rotary dimmer • Rated voltage: 127 - 230 V AC / 50 - 60 Hz • Max. power: 230 V AC: 700 VA • 127 V AC: 350 VA • Max. 6 ballasts per device	2	1	2CLA226090N1802	

Type reference and description	Number of modules	Std pack	Ordering code	Unit M.R.P.(₹)
Data & Voice				
IIM1RJ11 AN - RJ11 Tel. jack 2 pin	1	20/400	1SYK100001A1247 ■	330
IIM1RJ45 AN - RJ45 Jack cat 6	1	20/400	1SYK100001A1248	1,075

Type reference and description	Number of modules	Std pack	Ordering code	Unit M.R.P.(₹)
TV socket				
IIM1TVSK AN - TV co-axial socket	1	20/400	1SYK100001A1249 ■	392

Type reference and description	Number of modules	Std pack	Ordering code	Unit M.R.P.(₹)
Shaver socket				
IIM2SVSK AN - Shaver Socket	2	5/100	1SYK100001A1257	1,944

Type reference and description	Number of modules	Std pack	Ordering code	Unit M.R.P.(₹)
DND & MMR				
IIM1DNDS AN - DND and MMR set internal & external	2+3	5/100	1SYK100001A1255	2,249
N2244.5 AN - DND and MUR 2-gang interlocked switch	2	1	2CLA224450N1802	6,594
N2180.4 AN - LED MUR signaling light	1	1	2CLA218050N1802	6,297
N2180.4 AN - LED DND signaling light	1	1	2CLA218040N1802	6,297

Type reference and description	Number of modules	Std pack	Ordering code	Unit M.R.P.(₹)
Key card switches				
- Card switch 1-gang, 1-way, DP	2	1	2CLA221410N1802	5,988

■ Stock items

IVIE complete range

IVIE mechanisms - Anthracite Grey



1SYK100001A1259

Type reference and description	Number of modules	Std pack	Ordering code	Unit M.R.P.(₹)
Down lighter				
IIM3DOWN AN - Down lighter	3	5/100	1SYK100001A1259 ■	1,218



2CLA215520 N1802



2CLA215530 N1802

Type reference and description	Number of modules	Std pack	Ordering code	Unit M.R.P.(₹)
Audio & Video Connector				
N2155.2 AN - 2x RCA connection unit	1	1	2CLA215520N1802	Upon request
N2155.3 AN - 3x RCA connection unit	1	1	2CLA215530N1802	
N2155.4 AN - Mini-Jack connection unit	1	1	2CLA215540N1802	
N2155.5 AN - VGA connection unit	1	1	2CLA215550N1802	
N2155.6 AN - HDMI connection unit	1	1	2CLA215560N1802	
N2155.7 AN - HDMI female-female connection unit	1	1	2CLA215570N1802	
N2155.8 AN - USB connection unit	1	1	2CLA215580N1802	
N2155.9 AN - USB female-female connection unit	1	1	2CLA215590N1802	



2CLA215540 N1802



2CLA215550 N1802



2CLA215560 N1802



2CLA215580 N1802

Type reference and description	Number of modules	Std pack	Ordering code	Unit M.R.P.(₹)
Motion Sensor				
N2241 AN - 110° motion sensor • Max. power: Incandescent: 1.800W @230V AC/1.000W @127V AC • Halogen with electronic or ferromagnetic transformer: 750VA @230V AC/400VA @127V AC • Fluorescent lamps or motors: 400VA @230V AC/200VA @127V AC • For automatic switching of devices dependent on motion and brightness • With integrated selector switch for automatic ON-OFF in the front side • Switch-off delay: 10 sec. to 10 min. or short-time pulse 1 sec adjustable (from the front side) • Detection range: 5 m radius Adjustable light set point level for activation (from the front side) • Detection angle: 110° Mounting height: 1, 2 m auxiliary control with N2X04.X push-buttons	2	1	2CLA224100N1802	Upon request



2CLA211900 N1802



2CLA221900 N1802

Type reference and description	Number of modules	Std pack	Ordering code	Unit M.R.P.(₹)
Buzzer & Door Bell				
IM2BUZR AN - Buzzer	2	5/100	1SYK100001A1254	826
N2119 AN - Buzzer	1	1	2CLA211900N1802	Upon request
N2219 AN - Buzzer	2	1	2CLA221900N1802	
N2224 AN - Electronic door bell 230 V AC	2	1	2CLA222400N1802	

Type reference and description	Number of modules	Std pack	Ordering code	Unit M.R.P.(₹)
Indicator				
IIM1INDI AN - Indicator	1	20/400	1SYK100001A1253	471

Type reference and description	Number of modules	Std pack	Ordering code	Unit M.R.P.(₹)
Thermostat				
N2240.5 AN - Cover plate for digital thermostat	2	1	2CLA224050N1802	Upon request

IVIE complete range

IVIE mechanisms - Anthracite Grey

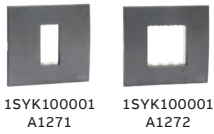

1SYK100001 A1271 1SYK100001 A1272



1SYK100001A1273



1SYK100001A1274



1SYK100001A1277

Type reference and description	Number of modules	Std pack	Ordering code	Unit M.R.P.(₹)
Anthracite plate with frame				
IIP0133 AN - 1M plate	1	15/360	1SYK100001A1271 ■	471
IIP0233 AN - 2M plate	2	15/360	1SYK100001A1272 ■	488
IIPP343 AN - 3M plate power	3	10/240	1SYK100001A1273 ■	556
IIP0343 AN - 3M plate	3	10/240	1SYK100001A1274 ■	664
IIP0453 AN - 4M plate	4	10/190	1SYK100001A1275 ■	834
IIP0683 AN - 6M plate	6	5/120	1SYK100001A1276 ■	1,044
IIP0893 AN - 8M plate	8	5/120	1SYK100001A1277 ■	1,208
IIP0855 AN - 8M plate square	8	5/95	1SYK100001A1278 ■	1,310
IIP1286 AN - 12M plate	12	5/95	1SYK100001A1279 ■	1,753
IIP1888 AN - 18M plate	18	5/40	1SYK100001A1280 ■	2,467

IVIE installation system

IVIE series is a grid type system enabling combination of colours and products of different dimensions and functionalities, together with ABB-free@home® sensors that have to be composed with the required frame, in order to have the right assortment of functionality and design.

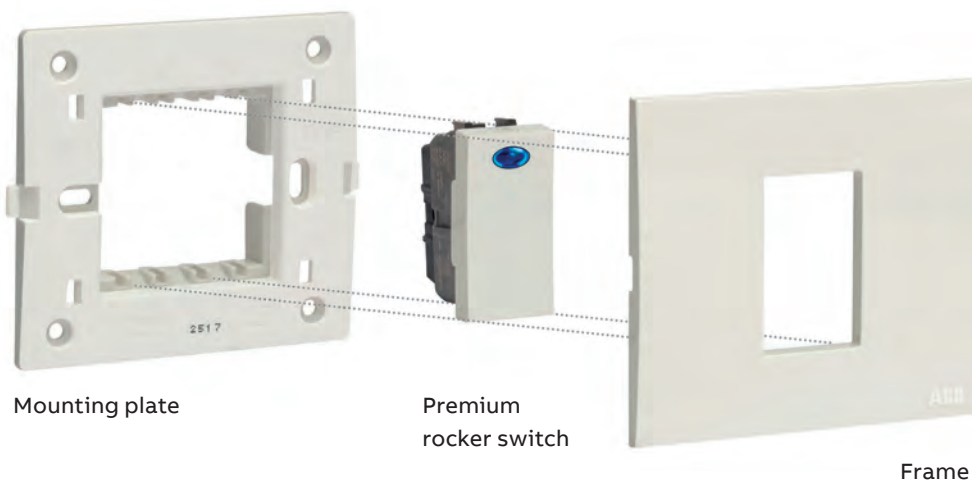

Mounting plate

Premium rocker switch

Frame

IVIE complete range

IVIE mechanisms - Silver



1SYK100001A1101



1SYK100001A1107



1SYK100001A1108



1SYK100001
A1003



1SYK100001
A1105



1SYK100001A1128



1SYK100001A1123



2CLA218500
N1302



2CLA228500
N1302

Type reference and description	Number of modules	Std pack	Ordering code	Unit M.R.P.(₹)
Switch 6 A - 240 V ~				
IIS10610 PL - 6A 1 way switch	1	20/400	1SYK100001A1101	220
IIS10620 PL - 6A 2 way switch	1	20/400	1SYK100001A1102	324

Type reference and description	Number of modules	Std pack	Ordering code	Unit M.R.P.(₹)
Switch 16 A - 240 V ~				
IIS11610 PL - 16A 1 way switch	1	20/400	1SYK100001A1106	413
IIS1161L PL - 16A 1 way switch with Ind.	1	20/400	1SYK100001A1107	515

Type reference and description	Number of modules	Std pack	Ordering code	Unit M.R.P.(₹)
Switch 32 A - 240 V ~				
IIS2321L PL - 32A, DP switch	2	10/200	1SYK100001A1108	1,445

Type reference and description	Number of modules	Std pack	Ordering code	Unit M.R.P.(₹)
Bell Push - 240 V ~				
IIS106B0 PL - 6A Bell Switch	1	20/400	1SYK100001A1103	369
IIS106BL PL - 6A Bell Switch with Ind.	1	20/400	1SYK100001A1104	470
IIS206BL PL - 6A Mega bell switch with Ind.	2	10/200	1SYK100001A1105	659

Type reference and description	Number of modules	Std pack	Ordering code	Unit M.R.P.(₹)
Sockets - 240 V ~				
IIK20616 PL - 6/16A socket	2	10/200	1SYK100001A1123	653
IIK20306 PL - 6A, 3Pin socket	2	10/200	1SYK100001A1128	437
N2238 PL - Euro-American earthed socket outlet, Rated voltage: 125/250 Vac, Rated current: 15/16A. 2P+E/ NEMA 5-15R	2	10	2CLA223800N1302	
N2135 PL - Euro-American unearthed socket outlet, Rated voltage: 125/250 V AC, Rated current: 15/16A. 2P (non-earthed)/NEMA 1-15R	1	20	2CLA213500N1302	Upon request
N2237 PL - British standard socket outlet, Rated current: 13A, 2P+E	2	10	2CLA223700N1802	

Type reference and description	Number of modules	Std pack	Ordering code	Unit M.R.P.(₹)
USB Chargers				
N2185 PL - USB charger 750mA, 1-gang	1	1	2CLA218500N1302	5,251
N2185.2 PL - USB charger 2.000mA, 1-gang	1	1	2CLA218520N1302	8,323
N2285 PL - USB charger 1.500mA, 2-gang	2	1	2CLA228500N1302	6,451

Type reference and description	Number of modules	Std pack	Ordering code	Unit M.R.P.(₹)
Blank Plates				
IIM1BLNK PL - Blank Plate	1	20/400	1SYK100001A1141	131

IVIE complete range

IVIE mechanisms - Silver



1SYK100001A1142



2CLA226030N1302



2CLA226030N1302



2CLA226080N1302



2CLA226090N1302

Type reference and description	Number of modules	Std pack	Ordering code	Unit M.R.P.(₹)
Dimmer & Fan Regulators				
IIM2FR05 PL - Step fan regulator 5 step	2	5/100	1SYK100001A1142	1,402
IIM1FR04 PL - Step fan regulator 4 step	1	10/200	1SYK100001A1143	1,232
IIM1D400 PL - Dimmer 400 Watt	1	10/200	1SYK100001A1145	1,609
N2260.2 PL - Universal rotatory/push dimmer • Rated voltage: 230 V AC • Max. power: Incandescent: 500 W • Halogen lamp with electronic transformer: 500 VA • Halogen lamp with ferromagnetic transformer: 400 VA.	2	1	2CLA226020N1302	
N2260.3 PL - LED rotatory/push dimmer 230 V AC • Rated voltage: 230 V AC, Nominal power: 250 W/VA • Power (min./max load): LEDi: 2/100 W/VA (max. 10 lamps) • Dimmable energy saving lamps: 2/100 W/VA (max. 10 lamps) • LV LEDi with transformer (only type L or LC): 4/100 W/VA (max. 10 lamps) • Incandescent lamps: 10/250 W/VA • Halogen lamps: 10/250 W/VA • LV halogen with transformer (only type L or LC): 10/250 W/VA (max. 10 lamps) • 2 wire connection • Optional: auxiliary on/off with 2-way switch N2X02	2	1	2CLA226030N1302	Upon request
N2260.8 PL - LED rotatory/push dimmer 127 V AC • Rated voltage: 127 V AC, Frequency: 50/60 Hz (Nominal power: 140 W/VA) • Power (min./max load): LEDi: 2/55 W/VA (max. 10 lamps) • Dimmable energy saving lamps: 2/55 W/VA (max. 10 lamps) • LV LEDi with transformer (only type L or LC): 4/55 W/VA (max. 10 lamps) • Incandescent lamps: 10/140 W/VA • Halogen lamps: 10/140 W/VA • LV halogen with transformer (only type L or LC): 10/140 W/VA (max. 10 lamps)	2	1	2CLA226080N1302	
N2260.9 PL - 1-10V rotary dimmer • Rated voltage: 127 - 230 V AC/50 - 60 Hz • Max. power: 230 Vac: 700 VA • 127 Vac: 350 VA • Max. 6 ballasts per device	2	1	2CLA226090N1302	



1SYK100001A1147



1SYK100001A1149

Type reference and description	Number of modules	Std pack	Ordering code	Unit M.R.P.(₹)
Data & Voice				
IIM1RJ11 PL - RJ11 Tel. jack 2 pin	1	20/400	1SYK100001A1147	330
IIM1RJ45 PL - RJ45 Jack cat 6	1	20/400	1SYK100001A1148	1,075



1SYK100001A1157

Type reference and description	Number of modules	Std pack	Ordering code	Unit M.R.P.(₹)
TV Socket				
IIM1TVSK PL - TV co-axial socket	1	20/400	1SYK100001A1149	392

Type reference and description	Number of modules	Std pack	Ordering code	Unit M.R.P.(₹)
Shaver Socket				
IIM2SVSK PL - Shaver Socket	2	5/100	1SYK100001A1157	1,944



2CLA218040N1302

Type reference and description	Number of modules	Std pack	Ordering code	Unit M.R.P.(₹)
DND & MMR				
IIM1DND5 PL - DND and MMR set internal & external	2+3	5/100	1SYK100001A1155	2,379
N2244.5 PL - DND and MUR 2-gang interlocked switch	1	1	2CLA224450N1302	
N2180.4 PL - LED DND signaling light	2	1	2CLA218040N1302	Upon request
N2180.4 BL - LED MUR signaling light	1	1	2CLA218050N1102	

IVIE complete range

IVIE mechanisms - Silver



2CLA221410N1302



1SYK100001A1159



2CLA215520
N1302



2CLA215530
N1302



2CLA215540
N1302



2CLA215550
N1302



2CLA215560
N1302



2CLA215580
N1302



2CLA211900
N1302



2CLA221900
N1302

Type reference and description	Number of modules	Std pack	Ordering code	Unit M.R.P.(₹)
Key Card Switches				
N2214.1 PL - Card switch 1-gang, 1-way, DP	2	1	2CLA221410N1302	6,705

Type reference and description	Number of modules	Std pack	Ordering code	Unit M.R.P.(₹)
Down Lighter				
IIM3DOWN PL - Down lighter	2	5/100	1SYK100001A1159	1,224

Type reference and description	Number of modules	Std pack	Ordering code	Unit M.R.P.(₹)
Audio & Video Connector				
N2155.2 PL - 2x RCA connection unit	1	1	2CLA215520N1302	Upon request
N2155.3 PL - 3x RCA connection unit	1	1	2CLA215530N1302	
N2155.4 PL - Mini-Jack connection unit	1	1	2CLA215540N1302	
N2155.5 PL - VGA connection unit	1	1	2CLA215550N1302	
N2155.6 PL - HDMI connection unit	1	1	2CLA215560N1302	
N2155.7 PL - HDMI female-female connection unit	1	1	2CLA215570N1302	
N2155.8 PL - USB connection unit	1	1	2CLA215580N1302	
N2155.9 PL - USB female-female connection unit	1	1	2CLA215590N1302	

Type reference and description	Number of modules	Std pack	Ordering code	Unit M.R.P.(₹)
Motion Sensor				
N2241 PL - 110° motion sensor Max. power: Incandescent: 1.800W @230V AC/1.000W @127V AC • Halogen with electronic or ferromagnetic transformer: 750VA @230V AC/400VA @127V AC - Fluorescent lamps or motors: 400VA @230V / 200VA @127Vac • For automatic switching of devices dependent on motion and brightness • With integrated selector switch for automatic ON-OFF in the front side, Switch-off delay: 10 sec to 10 min or short-time pulse 1 sec adjustable (from the front side) • Detection range: 5 m radius Adjustable light set point level for activation (from the front side) • Detection angle: 110° Mounting height: 1, 2 m Auxiliary control with N2X04.X push-buttons	2	1	2CLA224100N1302	Upon request

Type reference and description	Number of modules	Std pack	Ordering code	Unit M.R.P.(₹)
Buzzer & Door Bell				
IIM2BUZR PL - Buzzer	2	5/100	1SYK100001A1154	826
N2119 PL - Buzzer	1	1	2CLA211900N1302	Upon request
N2219 PL - Buzzer	2	1	2CLA221900N1302	
N2224 PL - Electronic door bell 230 V AC	2	1	2CLA222400N1302	

Type reference and description	Number of modules	Std pack	Ordering code	Unit M.R.P.(₹)
Indicator				
IIM1INDI PL - Indicator	1	20/400	1SYK100001A1153	485

Type reference and description	Number of modules	Std pack	Ordering code	Unit M.R.P.(₹)
Thermostat				
N2240.5 PL - Cover plate for digital thermostat	2	1	2CLA224050N1302	Upon request

IVIE complete range

IVIE mechanisms - Silver

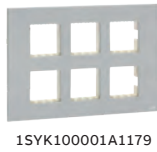
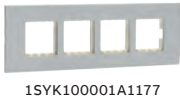
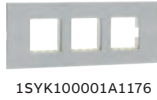
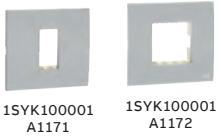

Plates

Type reference and description	Number of modules	Std pack	Ordering code	Unit M.R.P.(₹)
Silver plate with frame				
IIP0133 PL - 1M plate	1	15/360	1SYK100001A1171	471
IIP0233 PL - 2M plate	2	15/360	1SYK100001A1172	488
IIPP343 PL - 3M plate power	3	10/240	1SYK100001A1173	562
IIP0343 PL - 3M plate	3	10/240	1SYK100001A1174	664
IIP0453 PL - 4M plate	4	10/190	1SYK100001A1175	834
IIP0683 PL - 6M plate	6	5/120	1SYK100001A1176	1044
IIP0893 PL - 8M plate	8	5/120	1SYK100001A1177	1,208
IIP0855 PL - 8M plate square	8	5/95	1SYK100001A1178	1,310
IIP1286 PL - 12M plate	12	5/95	1SYK100001A1179	1,753
IIP1888 PL - 18M plate	18	5/40	1SYK100001A1180	2,467



Metal flush boxes

Type reference and description	Number of modules	Std pack	Ordering code	Unit M.R.P.(₹)
Flush boxes				
Metal Box 1-2M - CMBZ3302	1/2	108	1SYN880452R0001 ■	148
Metal Box 3M - CMBZ4303	3	82	1SYN880453R0001 ■	153
Metal Box 4-5M - CMBZ5305	4	60	1SYN880454R0001 ■	194
Metal Box 6M - CMBZ8306	6	40	1SYN880463R0001 ■	318
Metal Box 8M - CMBZ9308	8	39	1SYN880464R0001 ■	441
Metal Box 8MV - CMBZ5508V	8	26	1SYN880456R0001 ■	412
Metal Box 12M - CMBZ8612	12	16	1SYN880465R0001 ■	483

■ Stock items



Euro White



Anthracite Grey



Silver

ABB Tvisha

Wiring accessories

Switch on simplicity

ABB Tvisha is a range of wiring accessories with simple flat surface design that creates a trend on the wall with its elegant Euro white finish. The range covers a large variety of functionalities that caters to most of the applications beyond the normal switching functions like USB chargers, HDMI ports, communication sockets, foot lamps and dimmers. ABB Tvisha is ideal for residential and commercial requirements.

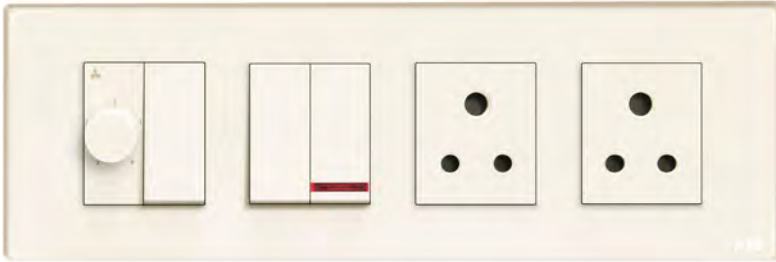

- Plastic parts which hold current carrying parts are made of PA6 20% glass filled rating upto 16A
- All switches are marked with IS 3854:1997
- Terminals are designed in such a way that wire is tightened without damage
- Bi-metal silver contact tips for less spark and longer life
- 6A & 6/16A marked with IS 1293, up to 16A
- Non-flammable thermoplastic resin parts and a very high insulating resistance after humidity test



Switches

Item description	Module size	Std pack	Ordering code	Unit M.R.P.(₹)
ITS10610 BL 6A 1 way switch	1 M	20	15YK100001A1501 ■	130
ITS1061L BL 6A 1 way switch with Ind.	1 M	20	15YK100001A1502	215
ITS10620 BL 6A 2 way switch	1 M	20	15YK100001A1503 ■	193
ITS106B0 BL 6A Bell switch	1 M	20	15YK100001A1504 ■	209
ITS106BL BL 6A Bell switch with Ind.	1 M	20	15YK100001A1505 ■	292
ITS11610 BL 16A 1 way switch	1 M	20	15YK100001A1506 ■	226
ITS1161L BL 16A 1 way switch with Ind.	1 M	20	15YK100001A1507 ■	275
ITS1201L BL 20A DP Switch 1 way with Ind.	1 M	20	15YK100001A1508 ■	622
ITS206BL BL 6A Bell Mega switch with Ind.	2 M	10	15YK100001A1509 ■	374
ITS2062L BL 6A 2 way Mega switch with Ind.	2 M	10	15YK100001A1510	443
ITS2162L BL 16A 2 way Mega switch with Ind.	2 M	10	15YK100001A1511	465
ITS2321L BL 32A 1 Way DP Mega switch with Ind.	2 M	10	15YK100001A1512 ■	622

Sockets

Item description	Module size	Std pack	Ordering code	Unit M.R.P.(₹)
ITK20306 BL 6A 3Pin Socket	2 M	10	15YK100001A1527 ■	200
ITK20616 BL 6/16A Socket	2 M	10	15YK100001A1523 ■	362

■ Stock items

Price list

Switches, sockets, plates and accessories



1SYK100001A1542



1SYK100001A1543



1SYK100001A1544



1SYK100001A1545



1SYK100001A1554



1SYK100001A1546



1SYK100001A1552



1SYK100001A1553

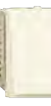

1SYK100001A1550



1SYK100001A1555

Support accessories

Item description	Module size	Std pack	Ordering code	Unit M.R.P. (₹)
ITM1BLNK BL Blank plate	1 M	20	1SYK100001A1541 ■	49
ITM2FR05 BL Fan regulator 5 step	2 M	5	1SYK100001A1542 ■	820
ITM1FR04 BL Fan regulator 4 step	1 M	10	1SYK100001A1543 ■	605
ITM1RJ11 BL RJ 11TEL 2 Pin	1 M	20	1SYK100001A1544 ■	189
ITM1RJ45 BL RJ 45 Jack CAT 6	1 M	20	1SYK100001A1545 ■	734
ITM1TVSK BL TV socket	1 M	20	1SYK100001A1546 ■	195
ITM1FLEX BL Flex outlet	1 M	20	1SYK100001A1547 ■	176
ITM2LDFL BL LED foot lamp	1 M	10	1SYK100001A1550 ■	616
ITM1INDI BL Indicator	2 M	5	1SYK100001A1551 ■	335
ITM1USBC BL USB Charger 1A	1 M	5	1SYK100001A1552 ■	1,280
ITM2USBC BL USB charger 2A	2 M	10	1SYK100001A1553 ■	2,265
ITM1HDMI BL HDMI Port 2.0	1 M	20	1SYK100001A1554 ■	1,832
ITM1D400 BL Dimmer 400W	1 M	20	1SYK100001A1548 ■	908
ITM2D1000 BL Dimmer 1000W	1 M	20	1SYK100001A1549 ■	1,150
ITM2MS20 BL Single Phase Starter 20A	2 M	5	1SYK100001A1555 ■	1,168
ITM2MS25 BL Single Phase Starter 25A	2 M	5	1SYK100001A1556 ■	1,270



1SYK100001A1571



1SYK100001A1572



1SYK100001A1573



1SYK100001A1574

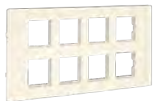

1SYK100001A1580

Plates

Item description	Module size	Std pack	Ordering code	Unit M.R.P. (₹)
ITP0133 BL 1 M Plate	1 M	15	1SYK100001A1571 ■	130
ITP0233 BL 2 M Plate	2 M	15	1SYK100001A1572 ■	130
ITPP343 BL 3 M Plate power	3 M	10	1SYK100001A1573 ■	168
ITP0453 BL 4 M Plate	4 M	10	1SYK100001A1574 ■	184
ITP0683 BL 6 M Plate	6 M	5	1SYK100001A1575 ■	309
ITP0893 BL 8 M Plate	8 M	5	1SYK100001A1576 ■	341
ITP0855 BL 8 M Plate square	8 M	5	1SYK100001A1577 ■	459
ITP1286 BL 12 M Plate	12 M	5	1SYK100001A1578 ■	562
ITP1696 BL 16M Plate	16 M	5	1SYK100001A1579 ■	642
ITP1888 BL 18M Plate	18 M	5	1SYK100001A1580 ■	743



1SYN880452R0001



1SYN880454R0001



1SYN880464R0001



1SYN880465R0001



1SYN880462R0001

Metal flush boxes

Type reference and description	Number of modules	Std pack	Ordering code	Unit M.R.P. (₹)
Flush boxes				
Metal Box 1-2M - CMBZ3302	1/2	108	1SYN880452R0001 ■	148
Metal Box 3M - CMBZ4303	3	82	1SYN880453R0001 ■	153
Metal Box 4-5M - CMBZ5305	4	60	1SYN880454R0001 ■	194
Metal Box 6M - CMBZ8306	6	40	1SYN880463R0001 ■	318
Metal Box 8M - CMBZ9308	8	39	1SYN880464R0001 ■	441
Metal Box 8MV - CMBZ5508V	8	26	1SYN880456R0001 ■	412
Metal Box 12M - CMBZ8612	12	16	1SYN880465R0001 ■	483
Metal Box 16M - CMBZ9616	12	15	1SYN880466R0001 ■	636
Metal Box 18M - CMBZ8824	18	10	1SYN880462R0001 ■	765

■ Stock items

ABB Tvisha (White)

Wiring accessories



1SYK100001A1801 1SYK100001A1804



1SYK100001A1805 1SYK100001A1809



1SYK100001A1808 1SYK100001A1812

Switches

Item description	Module size	Std pack	Ordering code	Unit M.R.P. (₹)
ITS10610 RW 6A 1 way switch	1 M	20	1SYK100001A1801	Upon request
ITS1061L RW 6A 1 way switch with Ind.	1 M	20	1SYK100001A1802	
ITS10620 RW 6A 2 way switch	1 M	20	1SYK100001A1803	
ITS106B0 RW 6A Bell Switch	1 M	20	1SYK100001A1804	
ITS106BL RW 6A Bell Switch with Ind.	1 M	20	1SYK100001A1805	
ITS11610 RW 16A 1 way switch	1 M	20	1SYK100001A1806	
ITS1161L RW 16A 1 way switch with Ind.	1 M	20	1SYK100001A1807	
ITS1201L RW 20A DP Switch 1 way with Ind.	1 M	20	1SYK100001A1808	
ITS206BL RW 6A Bell Mega Switch with Ind.	2 M	10	1SYK100001A1809	
ITS2062L RW 6A 2 way Mega Switch with Ind	2 M	10	1SYK100001A1810	
ITS2162L RW 16A 2 way Mega Switch with Ind	2 M	10	1SYK100001A1811	
ITS2321L RW 32A 1 Way DP Mega Switch with Ind.	2 M	10	1SYK100001A1812	



1SYK100001A1827 1SYK100001A1823

Sockets

Item description	Module size	Std pack	Ordering code	Unit M.R.P. (₹)
ITK20006 RW 6A 3 Pin Socket	2 M	10	1SYK100001A1827	Upon request
ITK20616 RW 6/16A Socket	2 M	10	1SYK100001A1823	



1SYK100001A1842 1SYK100001A1843



1SYK100001A1844 1SYK100001A1845

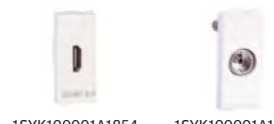

1SYK100001A1854 1SYK100001A1846



1SYK100001A1852 1SYK100001A1853



1SYK100001A1850 1SYK100001A1855

Support accessories

Item description	Module size	Std pack	Ordering code	Unit M.R.P. (₹)
ITM1BLNK RW Blank Plate	1 M	20	1SYK100001A1841	Upon request
ITM2FR05 RW Fan Regulator 5 Step	2 M	5	1SYK100001A1842	
ITM1FR04 RW Fan Regulator 4 Step	1 M	10	1SYK100001A1843	
ITM1RJ11 RW RJ 11TEL 2 Pin	1 M	20	1SYK100001A1844	
ITM1RJ45 RW RJ 45 Jack CAT 6	1 M	20	1SYK100001A1845	
ITM1TVSK RW TV Socket	1 M	20	1SYK100001A1846	
ITM1FLEX RW Flex outlet	1 M	20	1SYK100001A1847	
ITM1D400 RW Dimmer 400W	1 M	10	1SYK100001A1848	
ITM2D1000 RW Dimmer 1000W	2 M	5	1SYK100001A1849	
ITM2LDFL RW LED Foot Lamp	1 M	5	1SYK100001A1850	
ITM1INDI RW Indicator	2 M	10	1SYK100001A1851	
ITM1USBC RW USB Charger 1A	1 M	20	1SYK100001A1852	
ITM2USBC RW USB Charger 2A	1 M	20	1SYK100001A1853	
ITM1HDMI RW HDMI Port 2.0	1 M	20	1SYK100001A1854	
ITM2MS20 RW Motor Starter 20A	2 M	5	1SYK100001A1855	
ITM2MS25 RW Motor Starter 25A	2 M	5	1SYK100001A1856	

ABB Tvisha (White)

Wiring accessories



Plates

Item description	Module size	Std pack	Ordering code	Unit M.R.P. (₹)
ITP0133 RW 1 M Plate	1 M	15	1SYK100001A1871	
ITP0233 RW 2 M Plate	2 M	15	1SYK100001A1872	
ITPP343 RW 3 M Plate Power	3 M	10	1SYK100001A1873	
ITP0453 RW 4 M Plate	4 M	10	1SYK100001A1874	
ITP0683 RW 6 M Plate	6 M	5	1SYK100001A1875	Upon request
ITP0893 RW 8 M Plate	8 M	5	1SYK100001A1876	
ITP0855 RW 8 M Plate Square	8 M	5	1SYK100001A1877	
ITP1286 RW 12 M Plate	12 M	5	1SYK100001A1878	
ITP1696 RW 16M Plate	16 M	5	1SYK100001A1879	
ITP1888 RW 18M Plate	18 M	5	1SYK100001A1880	

ABB Tvisha

Anti-bacterial range

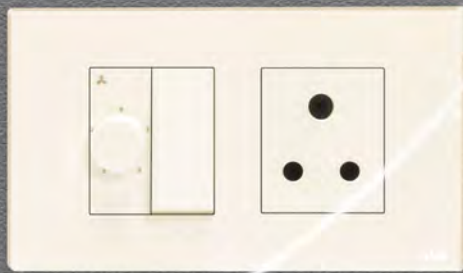

Switches with double shrouds



Socket with separate shutter



Frame with partition



Knobs with 360° rotation



*Ordering codes and prices on request

Snieo

Wiring accessories

Classic ideas never go out of style

Snieo combines modern design with high-performance materials such as premium thermoplastic resin. Our switches are made of fire retardant substances with superior electrical properties. Chamfered edges prevent dust accumulation and well crafted sockets provide an enduring grip for a variety of plugs.



Switch modules

Description	Module size	Std pack	Ordering code	Unit M.R.P. (₹)
6A 1 way switch - CPW10610	1	25	1SYN880676R0001 ■	143
6A 2 way switch - CPW10620	1	25	1SYN880677R0001 ■	200
6A Bell Push - CPW106B0	1	25	1SYN880676R0002 ■	215
6A 1 way switch LED - CPW1061L	1	25	1SYN880676R0003	237
6A Bell Push LED - CPW106BL	1	25	1SYN880676R0004 ■	313
16A 1 way switch - CPW11610	1	25	1SYN880676R0005 ■	212
16A 2 way switch - CPW11620	1	25	1SYN880677R0002 ■	345
16A 1 way switch with LED - CPW1161L	1	25	1SYN880676R0006 ■	276
20A DP Switch 1 way with LED - CPW1201L	1	20	1SYN880670R0001 ■	395
6A 1 way Mega switch with LED - CPW2061L	2	10	1SYN880652R0001	360
6A 2 way Mega switch with LED - CPW2062L	2	10	1SYN880652R0002	407
6A Mega Bell Push with LED - CPW206BL	2	10	1SYN880652R0003 ■	358
16A 1 way Mega switch with LED - CPW2161L	2	10	1SYN880653R0001	474
16A 2 way Mega switch with LED - CPW2162L	2	10	1SYN880653R0002	468
32A 1 way DP Switch with LED - CPW2321DPL	2	10	1SYN880655R0001 ■	530

Socket modules

Description	Module size	Std pack	Ordering code	Unit M.R.P. (₹)
6A 3 Pin Socket - 2 Module - CPWS2063	2	20	1SYN880690R0002 ■	204
6/16A Socket - 2 Module - CPWS2166	2	10	1SYN880393R0001 ■	324
6/16A Socket - CPWS3166	3	5	1SYN880122R0001 ■	426

Support modules

Description	Module size	Std pack	Ordering code	Unit M.R.P. (₹)
Fan Regulator - 1 Module - CPW1SFR4	1	20	1SYN880373R0002 ■	519
Fan Regulator - CPW2SFR5	2	10	1SYN880284R0003 ■	762
Dimmer 100W - 1 Module - CPW1D0400	1	20	1SYN880373R0011	666
Dimmer 400W - CPW2D0400	2	10	1SYN880400R0001	960
Dimmer 1000W - CPW1D1000	2	20	1SYN880500R0001	1,155
Blank Plate - CPW1BLNK	1	80	1SYN880182R0001 ■	54
TV Socket - CPW1TVSK	1	20	1SYN880175R0001 ■	179
RJ 11TEL 2 Pin - CPW1RJ11	1	20	1SYN880192R0001 ■	161
RJ 45 Jack CAT 6 - CPW1RJ45	1	20	1SYN880201R0001 ■	765
Flex Outlet - CPW1FLEX	1	20	1SYN880165R0001	209
Foot Lamp Grid - CPW4FLGD	4	10	1SYN880671R0001	374
Buzzer - CPW2BZR	2	10	1SYN880490R0001	382
Indicator - CPW1IND	1	20	1SYN880412R0004	347

■ Stock items

Snieo

Wiring accessories

Hospitality products

Description	Ordering code	Unit M.R.P. (₹)
Mechanical Keytag fitted with Lumina Plate & 20A DP Switch (3M) - CPW320MKT	1SYN880669R0001	1,271
DND/MMR Set - External - CPWDNDSET	1SYN880412R0005	1,075
Switch Ste DND/MMR - Internal - CPW2SET	1SYN880414R0001	715
Room Occupied - Internal - CPW1OQP	1SYN880412R0003	481
USB Charger 1Module 1000mA - 1 CPW1USBC	1SYN880417R0001	1,932
Charger 2Module 2000mA - 2 CPW2USBC	1SYN880418R0001	3,365

Snieo mounting plates

Description	Metal box size	Std Pack	Ordering code	Unit M.R.P. (₹)
1 M Plate - SNWP3301	3"x3"	25	1SYN880421R0001 ■	114
2 M Plate - SNWP3302	3"x3"	25	1SYN880422R0001 ■	114
3 M Plate - SNWP4303	4"x3"	20	1SYN880423R0001 ■	144
3 M Power Plate - SNWP4303S	4"x3"	20	1SYN880424R0001 ■	153
4 M Plate - SNWP5304	5"x3"	15	1SYN880425R0001 ■	171
5 M Plate - SNWP5305	5"x3"	15	1SYN880426R0001 ■	204
6 M Plate - SNWP8306	8"x3"	10	1SYN880427R0001 ■	263
8 M Plate - SNWP8308	8"x3"	10	1SYN880428R0001 ■	328
8 M Plate Square - SNWP5508	5"x5"	6	1SYN880430R0001 ■	370
10 M Plate - SNWP9310	9"x3"	15	1SYN880429R0001 ■	352
12 M Plate - SNWP8612	8"x6"	6	1SYN880431R0001 ■	450
16 M Plate - SNWP8616	8"x6"	6	1SYN880432R0001 ■	539

Metal flush boxes

Description	Metal box size	Std Pack	Ordering code	Unit M.R.P. (₹)
Metal Box 1-2M - CMBZ3302	3"x3"	108	1SYN880452R0001 ■	148
Metal Box 3M - CMBZ4303	4"x3"	82	1SYN880453R0001 ■	153
Metal Box 4-5M - CMBZ5305	5"x3"	60	1SYN880454R0001 ■	194
Metal Box 6-8MH - CMBZ8308	8"x3"	40	1SYN880455R0001 ■	324
Metal Box 9-10M - CMBZ9310	9"x3"	39	1SYN880457R0001 ■	453
Metal Box 8MV - CMBZ5508V	5"x5"	26	1SYN880456R0001 ■	412
Metal Box 12-16M - CMBZ8616	8"x6"	16	1SYN880458R0001 ■	483

Surface boxes

Description	Length	Height	Depth	Std Pack	Ordering code	Unit M.R.P. (₹)
Surface box 1-2M - SNBW3302	86.7	86.7	49.3	60	1SYN880351R0001	206
Surface box 3M - SNBW4303	115	87	50.8	45	1SYN880352R0001	233
Surface box 4M - SNBW5305	146	85.3	50.6	30	1SYN880353R0001	281
Surface box 6-8M - SNBW8308	220.3	85.9	50.5	20	1SYN880354R0001	389

■ Stock items

Busch-Presence detectors

Energy saving the easy way

Presence detectors automatically detect the presence of someone inside the room. Their precision is far superior to that of conventional movement detectors. Not only lighting systems but heating systems and air-conditioning systems can be controlled intelligently and efficiently with presence detectors. Empty rooms in which the lights are on and the air-conditioning runs at full power are now history. There is one presence detector for each need.



Office single



Office open plan /
with or without windows



Gym
Sport facilities



Toilets



6818 U-500

Description	Type	Ordering code	L.P. (₹)
Busch-Watchdog Presence tech BasicLINE mini - 6 Metres For switching lighting systems that depend on brightness and movement. Ceiling installation using integrated spring bracket. Switch-off delay: approx. 1 sec - 15 min or short-time pulse adjustable.	6811 EB-500	2CKA006800A2517	4,776
Busch-Watchdog Presence tech BasicLINE - 8 Metres For switching lighting systems that depend on brightness and movement. For semiautomatic and fully automatic operation. Ceiling installation using integrated spring bracket. Switch-off delay: approx. 5 sec - 30 min or short-timepulse adjustable.	6814 U-500	2CKA006800A2518	4,141
Busch-Watchdog Presence tech BasicLINE Corridor - 24 Metres For switching lighting systems that depend on brightness and movement. Ceiling installation using included dust protection socket. Switch-off delay: approx. 10 sec - 30 min or short-time pulse adjustable. Remote control possible via IR service remote control 6843. Use outdoors possible due to combination with surfacemounted housing 6888.	6818 U-500	2CKA006800A2519	9,556
Surface-mounting box -6818U For Busch-Watchdog Presence tech BasicLINE Corridor 6818 U-500. For surface mounting and increase of the protection type. Protection class (Device): IP 54	6888	2CKA006899A2305	1,652

Busch-Presence detectors

Energy saving the easy way



6817/32-24-500

Description	Type	Ordering code	L.P. (₹)
<p>Presence Comp. e-contact - 8 Metres Master presence detector with mixed light measurement. For switching lighting systems that depend on brightness and movement. Detection range (for installation height of 3 m): circular: Seated persons: up to Ø 6,5 m, walking persons: up to Ø 8 m. Ceiling installation using integrated spring bracket. Switch-off delay: approx. 1 min - 30 min or short-time pulse adjustable. Remote control possible via IR service remote control 6843. Suitable for false ceilings with a board thickness from 9 to 25 mm.</p>	6817/62-24-500	2CKA006800A2737	12,612
<p>Presence Uni. e-contact - 12 Metres Master presence detector with mixed light measurement. For switching lighting systems that depend on brightness and movement. Detection range (for installation height of 3 m): circular: Seated persons: up to Ø 10 m, walking persons: up to Ø 12 m. Ceiling installation using integrated spring bracket. Switch-off delay: approx. 1 min - 30 min or short-time pulse adjustable. Remote control possible via IR service remote control 6843. Suitable for false ceilings with a board thickness from 9 to 25 mm.</p>	6817/32-24-500	2CKA006800A2739	15,433
<p>Presence Uni. Bluetooth e-contact - 12 Metres Master presence detector with mixed light measurement. For switching lighting systems that depend on brightness and movement. Detection range (for installation height of 3 m): circular: Seated persons: up to Ø 10 m, walking persons: up to Ø 12 m. Ceiling installation using integrated spring bracket. Switch-off delay: approx. 1 min - 30 min or short-time pulse adjustable. With selectable dynamic switch-off delay. Suitable for false ceilings with a board thickness from 9 to 25 mm.</p>	6817/33-24-500	2CKA006800A2743	17,068



6819/51-24-500

Description	Type	Ordering code	L.P. (₹)
<p>Presence Comp. rel - 8 Meters Master presence detector with mixed light measurement. For switching lighting systems that depend on brightness and movement. With power relays for LED operation. Detection range (for installation height of 3 m): circular Seated persons: up to Ø 6.5 m, walking persons: up to Ø 8 m.</p>	6819/60-24-500	2CKA006800A2733	12,054
<p>Presence Uni. Rel - 12 Meters Master presence detector with mixed light measurement. For switching lighting systems that depend on brightness and movement. With power relays for LED operation. Detection range (for installation height of 3 m): circular Seated persons: up to Ø 10 m, walking persons: up to Ø 12 m.</p>	6819/30-24-500	2CKA006800A2735	14,699
<p>Presence Uni. rel. Bluetooth - 12 Metres Master presence detector with mixed light measurement. For switching lighting systems that depend on brightness and movement. With Bluetooth interface for parameterization and operation. Adjustment of all setting options via smartphone or tablet. Light control via smartphone or tablet app. With power relays for LED operation. Detection range (for installation height of 3 m): circular Seated persons: up to Ø 10 m, walking persons: up to Ø 12 m.</p>	6819/31-24-500	2CKA006800A2741	16,277
<p>Presence Corr. rel. Bluetooth - 20 Metres Master presence detector with mixed light measurement. For switching lighting systems that depend on brightness and movement. With Bluetooth interface for parameterization and operation. Adjustment of all setting options via smartphone or tablet. Light control via smartphone or tablet app. With power relays for LED operation. Detection range (for installation height of 3 m): rectangular Walking persons: crosswise to the detector 30 m x 3 m, frontal 20 m x 3 m. Extension of the detection range by means of master/slave combination. Mounting height 27 mm.</p>	6819/51-24-500	2CKA006800A2745	21,478
<p>Presence Uni. DALI Bluetooth -12 Metres Master presence detector with mixed light measurement. For regulating and switching of DALI operating devices that depend on brightness and movement. Suitable for up to 45 DALI operating devices. Detection range (for installation height of 3 m): circular Seated persons: up to Ø 10 m, walking persons: up to Ø 12 m.</p>	6819/35-24-500	2CKA006800A2747	20,742

Busch-Presence detectors

Energy saving the easy way



6819/50-24-500



6819/39-24-500



2069/21



2069/11-84

Description	Type	Ordering code	L.P. (₹)
Presence Corr. DALI Bluetooth - 30 Metres Master presence detector with mixed light measurement. For regulating and switching of DALI operating devices that depend on brightness and movement. . Detection range (for installation height of 3 m): rectangular Walking persons: crosswise to the detector 30 m x 3 m, frontal 20 m x 3 m.	6819/55-24-500	2CKA006800A2749	28,004
Presence Comp. Slave - 8 Metres Slave presence detector for extension of the detection range of master presence detectors. Detection range (for installation height of 3 m): circular Seated persons: up to Ø 6.5 m, walking persons: up to Ø 8 m. Visible height 23 mm.	6819/68-24-500	2CKA006800A2751	9,641
Presence Uni. Slave - 8 Metres Slave presence detector for extension of the detection range of master presence detectors. Detection range (for installation height of 3 m): circular Seated persons: up to Ø 10 m, walking persons: up to Ø 12 m. Visible height 23 mm.	6819/38-24-500	2CKA006800A2753	11,759
Presence Corr. Slave - 30 Metres Slave presence detector for extension of the detection range of master presence detectors. Detection range (for installation height of 3 m): rectangular Walking persons: crosswise to the detector 24 m x 3 m, frontal/lengthways to the detector 14 m x 3 m.	6819/58-24-500	2CKA006800A2755	15,876
Presence Uni. DALI Slave - 12 Metres DALI slave presence detector for extension of the detection range of DALI master presence detectors. For the supply of operating voltage via the DALI master. Power consumption on the DALI bus: max. 10 mA, corresponds to approx. 5 DALI operating devices. Detection range (for installation height of 3 m): circular Seated persons: up to Ø 10 m, walking persons: up to Ø 12 m. Visible height 23 mm.	6819/39-24-500	2CKA006800A2759	15,288
Presence Corr. DALI Slave - 30 Metres DALI slave presence detector for extension of the detection range of DALI master presence detectors. For the supply of operating voltage via the DALI master. Detection range (for installation height of 3 m): rectangular Walking persons: crosswise to the detector 24 m x 3 m, frontal/lengthways to the detector 14 m x 3 m. Mounting height 27 mm.	6819/59-24-500	2CKA006800A2761	15,876
Presence Corr. Rel - 30 Metres Master presence detector with mixed light measurement. For switching lighting systems that depend on brightness and movement. With power relays for LED operation. Detection range (for installation height of 3 m): rectangular Walking persons: crosswise to the detector 24 m x 3 m, frontal/lengthways to the detector 14 m x 3 m. Switch-off delay: approx. 1 min. - 30 min. or short-time pulse adjustable.	6819/50-24-500	2CKA006800A2797	19,845
IceLight set ceiling module, Busch-iceLight Consisting of LED/FM insert, power module (neutral white) 2067/12 U. Consisting of ceiling module, one light direction 2068/21. For ambient lightning. Light outlet downward. Not dimmable. Light intensity can be switched between 100% and 25% using front service switch. Colour temperature: 4,000 K (neutral white) System power consumption: 5 W Rated voltage: 230 V~, + 10% / - 10% Current consumption of LED: 350 mA (secondary) Secondary: SELV	2069/21	2CKA001510A0018	23,587
IceLight Night light set, studio white, Busch-iceLight Complete set consists flush-mounted LED insert Night light (cold white) 2067/14 U. Wall module with one lighting direction, design future® linear 2068/11-84. Cover frame design future® linear 1721-184K. With one lighting direction. Not dimmable. For low brightness (night light). Colour temperature 6,500 K (cold white) System power consumption: 0.15 W Rated voltage: 230 V~, + 10% / - 10% Current consumption of LED: 40 mA (secondary) Secondary: SELV	2069/11-84	2CKA001510A0015	11,227

Emergency lighting systems

Exit sign, light and battery system

The requirement for emergency lighting originates from the Fire Precautions Act, 1971 and was further enforced by the Fire Precautions (Workplace) Regulations, 1997 (Amended 1999).

The Emergi-Lite concept is clear and simple. Emergi-Lite offers you reliable total solutions for safe evacuation. The way in which we do this is what makes the difference. Emergi-Lite offers advantages to everybody involved in the construction process. That way, you know that Emergi-Lite is always the right choice, for both you and your customers.

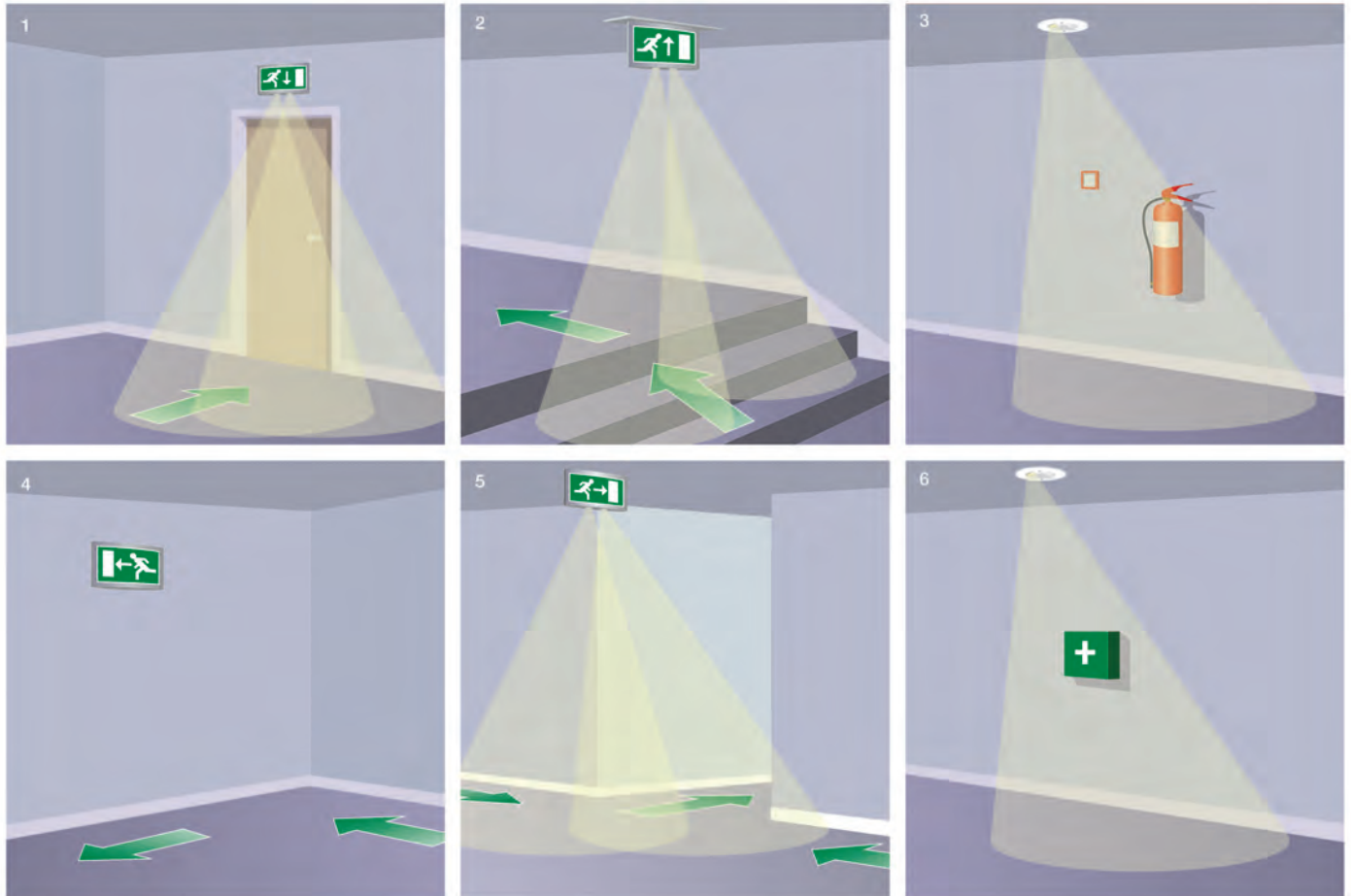

Industrial plugs and sockets

Wiring accessories

Reliable, durable and safe. Perfect for your application

These products are used for connection of equipment in all kind of applications where it needs to be possible to connect and disconnect. ABB industrial plugs and sockets are chosen when safety, reliability and durability are requested.

IEC 60309-2 "clock"

$I_e = 16\text{ A}, 32\text{ A}, 63\text{ A}, 125\text{ A}$
 $U_e = 50 \dots 1000\text{ V}$

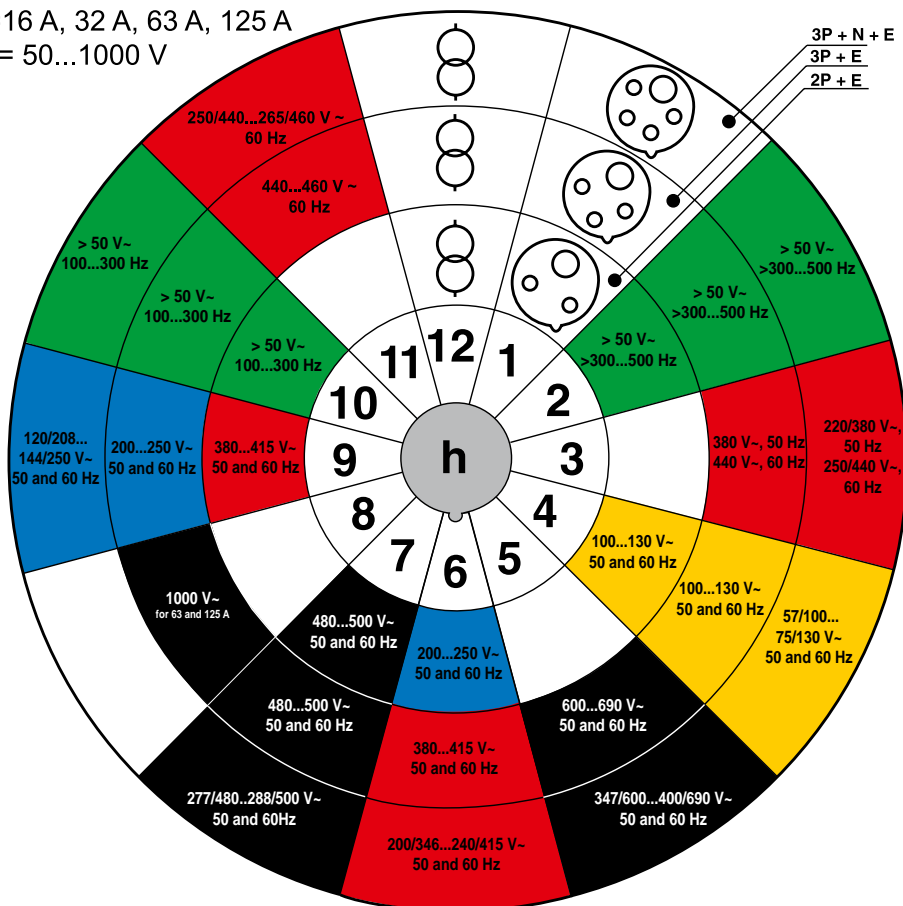

Standard voltages - Color codes according to IEC60309-1, -2

Position of earthing sleeve according to IEC 60309-2 (clock)	2P+E	3P+E	3P+N+E
1	<input type="checkbox"/> Optional voltage (not stated below)	<input type="checkbox"/> Optional voltage (not stated below)	<input type="checkbox"/> Optional voltage (not stated below)
2	■ >300...500 V~ >50 Hz	■ >300...500 V~ >50 Hz	■ >300...500 V~ >50 Hz
3	<input type="checkbox"/> Not used	■ 380 V~ 50 Hz, 440 V 60 Hz	■ 220/380 V~ 50 Hz, 250/440 V 60 Hz
4	■ 100...130 V~ 50 and 60 Hz	■ 100...130 V~ 50 and 60 Hz	■ 57/100...75/130 V~ 50 and 60 Hz
5	<input type="checkbox"/> Not used	■ 600...690 V~ 50 and 60 Hz	■ 347/600...400/690 V~ 50 and 60 Hz
6	■ 200...250 V~ 50 and 60 Hz	■ 380...415 V~ 50 and 60 Hz	■ 200/346...240/415 V~ 50 and 60 Hz
7	■ 480...500 V~ 50 and 60 Hz	■ 480...500 V~ 50 and 60 Hz	■ 277/480...288/500 V~ 50 and 60 Hz
8	<input type="checkbox"/> Not used	■ 1000 V~ (for 63 A and 125 A)	<input type="checkbox"/> Not used
9	■ 380...415 V~ 50 and 60 Hz	■ 200...250 V~ 50 and 60 Hz	■ 120/208...144/250 V~ 50 and 60 Hz
10	■ 100...300 V~ >50 Hz	■ 100...300 V~ >50 Hz	■ 100...300 V~ >50 Hz
11 Mainly for marine installations	<input type="checkbox"/> Not used	■ 440...460 V~ 60 Hz	■ 250/440...265/460 V~ 60 Hz
12 Supply from isolating transformer	<input type="checkbox"/> Supply from isolating transformer	<input type="checkbox"/> Supply from isolating transformer	<input type="checkbox"/> Supply from isolating transformer

Industrial plugs and sockets

Wiring accessories

Plugs



IP44 (2P+E)



IP44 (3P+E)



IP67 (3P+N+E)

Terminals / Pole	IP Protection	Color code	Voltage	Current rating (A)	Type	Ordering code	L.P. (₹)
3 (2P+E)	IP44	Blue	200...250	16	216-P6-I	2CMA100202R1000	535
		Blue	200...250	32	232-P6-I	2CMA100204R1000	811
		Blue	200...250	63	263P6	2CMA166742R1000	3,790
	IP67	Blue	200...250	16	216P6W	2CMA166460R1000	1,685
		Blue	200...250	32	232P6W	2CMA166722R1000	1,968
		Blue	200...250	63	263P6W	2CMA166776R1000	4,901
4 (3P+E)	IP44	Red	380...415	16	316-P6	2CMA193506R1000	717
		Red	380...415	32	332-P6	2CMA193515R1000	984
		Red	380...415	63	363P6	2CMA166752R1000	4,075
	IP67	Red	380...415	16	316P6W	2CMA166476R1000	1,754
		Red	380...415	32	332P6W	2CMA166738R1000	2,241
		Red	380...415	63	363P6W	2CMA166786R1000	4,997
5 (3P+N+E)	IP44	Red	346...415	16	416-P6-I	2CMA100203R1000	809
		Red	346...415	32	432-P6-I	2CMA100205R1000	824
		Red	346...415	63	463P6	2CMA166764R1000	4,101
	IP67	Red	346...415	16	416P6W	2CMA166494R1000	1,734
		Red	346...415	32	432P6W	2CMA166524R1000	2,483
		Red	346...415	63	463P6W	2CMA166798R1000	5,203
		Red	346...415	125	4125P6W	2CMA166828R1000	15,018

Connectors



IP44 (2P+E)



IP67 (3P+E)



IP67 (3P+N+E)

Terminals / Pole	IP Protection	Color code	Voltage	Current rating (A)	Type	Ordering code	L.P. (₹)
3 (2P+E)	IP44	Blue	200...250	16	216-C6-I	2CMA100206R1000	878
		Blue	200...250	32	232-C6-I	2CMA100208R1000	1,070
		Blue	200...250	63	263C6	2CMA166840R1000	5,083
	IP67	Blue	200...250	16	216C6W	2CMA166538R1000	2,088
		Blue	200...250	32	232C6W	2CMA166584R1000	2,772
		Blue	200...250	63	263C6W	2CMA166874R1000	6,078
4 (3P+E)	IP44	Blue	200...250	125	2125C6W	2CMA166918R1000	17,523
		Red	380...415	16	316-C6	2CMA193523R1000	910
		Red	380...415	32	332-C6	2CMA193529R1000	1,268
	IP67	Red	380...415	63	363C6	2CMA166850R1000	5,259
		Red	380...415	16	316C6W	2CMA166554R1000	2,376
		Red	380...415	32	332C6W	2CMA166604R1000	2,739
5 (3P+N+E)	IP44	Red	380...415	63	363C6W	2CMA166894R1000	6,190
		Red	380...415	125	3125C6W	2CMA166924R1000	18,018
		Red	346...415	16	416-C6-I	2CMA100207R1000	1033
	IP67	Red	346...415	32	432-C6-I	2CMA100209R1000	1,445
		Red	346...415	63	463C6	2CMA166862R1000	4,914
		Red	346...415	16	416C6W	2CMA166572R1000	2,337
IP67	Red	346...415	32	432C6W	2CMA166618R1000	3,061	
	Red	346...415	63	463C6W	2CMA166906R1000	6,378	
	Red	346...415	125	4125C6W	2CMA166936R1000	19,476	

Industrial plugs and sockets

Wiring accessories

Panel mounted socket - Unified angled flange

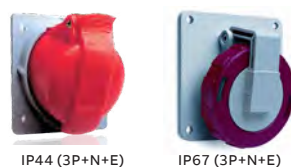
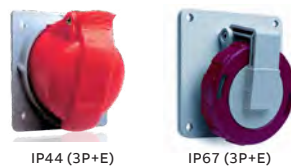

Terminals / Pole	IP Protection	Color code	Voltage	Current rating (A)	Type	Ordering code	L.P. (₹)
3 (2P+E)	IP44	Blue	200...250	16	216RAU6-I	2CMA100218R1000	824
		Blue	200...250	32	232RAU6-I	2CMA100220R1000	931
		Blue	200...250	63	263RAU6	2CMA167408R1000	3,907
	IP67	Blue	200...250	16	216RAU6W	2CMA166996R1000	1,515
		Blue	200...250	32	232RAU6W	2CMA166948R1000	1,839
		Blue	200...250	63	263RAU6W	2CMA167442R1000	4,599
4 (3P+E)	IP44	Red	380...415	16	316RAU6	2CMA193226R1000	869
		Red	380...415	32	332RAU6	2CMA193274R1000	1,160
		Red	380...415	63	363RAU6	2CMA167418R1000	4,294
	IP67	Red	380...415	16	316RAU6W	2CMA167012R1000	1,738
		Red	380...415	32	332RAU6W	2CMA166964R1000	2,261
		Red	380...415	63	363RAU6W	2CMA167452R1000	4,602
5 (3P+N+E)	IP44	Red	346...415	16	416RAU6-I	2CMA100219R1000	1001
		Red	346...415	32	432RAU6-I	2CMA100221R1000	1,242
		Red	346...415	63	463RAU6	2CMA167430R1000	4,246
	IP67	Red	346...415	16	416RAU6W	2CMA167030R1000	1,969
		Red	346...415	32	432RAU6W	2CMA166982R1000	2,333
		Red	346...415	63	463RAU6W	2CMA167464R1000	4,376

Panel mounted sockets - Unified straight flange

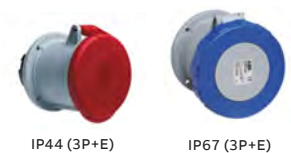

Terminals / Pole	IP Protection	Color code	Voltage	Current rating (A)	Type	Ordering code	L.P. (₹)
3 (2P+E)	IP44	Blue	200...250	16	216RU6-I	2CMA100210R1000	787
		Blue	200...250	32	232RU6-I	2CMA100212R1000	883
		Blue	200...250	63	263RU6	2CMA167510R1000	4,063
	IP67	Blue	200...250	63	263RU6W	2CMA167374R1000	4,715
		Blue	200...250	125	2125RU6W	2CMA167133R1000	15,782
		Red	380...415	16	316RU6	2CMA193178R1000	949
4 (3P+E)	IP44	Red	380...415	32	332RU6	2CMA193250R1000	1131
		Red	380...415	63	363RU6	2CMA167520R1000	4,199
		Red	380...415	63	363RU6W	2CMA167384R1000	4,721
	IP67	Red	380...415	125	3125RU6W	2CMA167136R1000	13,664
		Red	346...415	16	416RU6-I	2CMA100211R1000	878
		Red	346...415	32	432RU6-I	2CMA100213R1000	1065
5 (3P+N+E)	IP44	Red	346...415	63	463RU6	2CMA167532R1000	4,350
		Red	346...415	63	463RU6W	2CMA167396R1000	4,733
	IP67	Red	346...415	125	4125RU6W	2CMA167142R1000	14,994

Industrial plugs and sockets

Wiring accessories

Surface Sockets Outlet



Terminals / Pole	IP Protection	Color code	Voltage	Current rating (A)	Type	Ordering code	L.P. (₹)
3 (2P+E)	IP44	Blue	200...250	16	216RS6	2CMA193098R1000	915
		Blue	200...250	32	232RS6	2CMA193122R1000	1,248
		Blue	200...250	63	263RS6	2CMA167476R1000	4,744
	IP67	Blue	200...250	16	216RS6W	2CMA167149R1000	1,868
		Blue	200...250	32	232RS6W	2CMA167172R1000	2,659
		Blue	200...250	63	263RS6W	2CMA167306R1000	6,786
4 (3P+E)	IP44	Red	380...415	16	316RS6	2CMA193106R1000	1026
		Red	380...415	32	332RS6	2CMA193130R1000	1,309
		Red	380...415	63	363RS6	2CMA167498R1000	4,938
	IP67	Red	380...415	16	316RS6W	2CMA167157R1000	2,258
		Red	380...415	32	332RS6W	2CMA167180R1000	2,857
		Red	380...415	63	363RS6W	2CMA167316R1000	5,981
5 (3P+N+E)	IP44	Red	346...415	16	416RS6	2CMA193115R1000	1058
		Red	346...415	32	432RS6	2CMA193139R1000	1,348
		Red	346...415	63	463RS6	2CMA167484R1000	4,963
	IP67	Red	346...415	16	416RS6W	2CMA167166R1000	2,424
		Red	346...415	32	432RS6W	2CMA167189R1000	3,157
		Red	346...415	63	463RS6W	2CMA167328R1000	6,045
		Red	346...415	125	4125RS6W	2CMA167264R1000	19,520

Switched interlocked socket outlet - horizontal thermoplastic

Housing in plastic (PBT). Cable entry with knock-outs Ø 25 mm/M25. Cable area 1.5...4 mm²



Terminals / Pole	IP Protection	Color code	Voltage	Current rating (A)	Type	Ordering code	L.P. (₹)
3 (2P+E)	IP44	Blue	200...250	16	216MHS6	2CMA167623R1000	8,263
		Blue	200...250	32	232MHS6	2CMA167669R1000	9,642
		Blue	200...250	63	263MHS6	2CMA167715R1000	23,630
	IP67	Blue	200...250	16	216MHS6W	2CMA167801R1000	8,407
		Blue	200...250	32	232MHS6W	2CMA167848R1000	11,574
		Blue	200...250	63	263MHS6W	2CMA167894R1000	23,673
4 (3P+E)	IP44	Red	380...415	16	316MHS6	2CMA167631R1000	9,612
		Red	380...415	32	332MHS6	2CMA167677R1000	10,872
		Red	380...415	63	363MHS6	2CMA167721R1000	24,863
	IP67	Red	380...415	16	316MHS6W	2CMA167809R1000	10,832
		Red	380...415	32	332MHS6W	2CMA167856R1000	13,344
		Red	380...415	63	363MHS6W	2CMA167899R1000	25,882
5 (3P+N+E)	IP44	Red	346...415	16	416MHS6	2CMA167640R1000	9,747
		Red	346...415	32	432MHS6	2CMA167686R1000	11,688
		Red	346...415	63	463MHS6	2CMA167727R1000	24,781
	IP67	Red	346...415	16	416MHS6W	2CMA167818R1000	11,831
		Red	346...415	32	432MHS6W	2CMA167865R1000	13,936
		Red	346...415	63	463MHS6W	2CMA167905R1000	26,094

Installation products

Product brands overview

The acquisition of Thomas & Betts advances ABB's strategy of expanding its electrification products division into new geographies, sectors and products. The combination of Thomas & Betts' electrical components and ABB's low voltage protection, control and measurement products offer more of the components you need every day than any other single manufacturer in the world.

Our focus is on improving your business performance by providing practical, reliable electrical products and services that solve everyday problems in:

- Wire & cable management - cable ties, wiring ducts, accessories.
- Connectivity & grounding - connectors, terminals, earthing, lightning protection
- Cable protection systems - rigid and flexible conduit & fittings
- Lighting & systems - emergency lighting, lighting & battery systems
- Explosion protection - IECex, UL, CSA lighting, boxes and conduit systems
- Cable accessories and apparatus - MV and HV switches, cable accessories

Markets we protect & connect together.

- 1 Renewables
Wind, solar, water & bio
- 2 Utilities
Power generation, transmission & distribution, telecom & datacentre, water & waste
- 3 Extraction
Oil, gas, mining
- 4 Transportation & infrastructure
Rail, road, marine, aerospace, rail track, motorways, waterways
- 5 Commercial & institutional
Office & storage, retail & leisure, healthcare & education, Government
- 6 Residential
Residential towers & apartment blocks, housing development projects, HMOs & university accommodation
- 7 Industry processing chemicals, pharma, minerals, metals, materials, food & beverage, agriculture
- 8 Industry assembling & OEM
OEM equipment & devices, machinery, automation, robotics

Wire & cable management - Energy & data connection	Cable protection systems - Energy & data protection	Connectivity & grounding - Critical process protection	Lighting - Safety & explosion proof
 <p>Ty-Rap®</p> <p>Premium cable ties</p>	 <p>Adaptaflex</p> <p>Flexible conduit systems for critical power & data protection</p>	 <p>furse</p> <p>Earthing & lightning protection</p>	 <p>EMERGI-LITE</p> <p>Emergency lighting systems</p>
 <p>Ty-Met™</p> <p>Stainless steel cable ties</p>	 <p>KOPEX™</p> <p>Flexible conduit systems for hazardous areas</p>	 <p>elastimold</p> <p>Underground cable protection accessories</p>	 <p>EMERGI-LITE</p> <p>Emergency safety systems</p>
 <p>T&B CableTray</p> <p>Cable tray, ladder, support systems & wire duct</p>	 <p>PMA</p> <p>Cable protection systems</p>	 <p>JOSLYN</p> <p>Overhead products for electrical power systems</p>	 <p>ETS</p> <p>Explosion-proof lighting & emergency lighting</p>
 <p>E-Klips®</p> <p>Electrical & mechanical steel spring fasteners</p>	 <p>Harnessflex</p> <p>Automotive wiring harness protection</p>	 <p>Spec-Kon®</p> <p>Solderless crimp connectors</p>	 <p>ETS</p> <p>Custom built control panels for hazardous areas</p>

Flexible conduit system

Adaptaflex flexible conduit system

Adaptaflex is one of the market leading flexible conduit system brands that can be found all over the world. Combining innovative design with dedicated manufacture, it offers customers one of the world's broadest ranges of cable protection products and solutions. With a choice of over 6000 products, the range covers metallic and non-metallic flexible conduit systems for the protection of critical power and data cables.

The system solutions from Adaptaflex need to perform in a wide variety of environments from high temperature to freezing subzero conditions. The products are designed and tested to withstand constant vibrations, water ingress, offer corrosion resistance and are available in halogen free, low smoke and low toxicity materials. An extensive range of engineered solutions are designed to withstand the rigours of some of the most technically demanding markets. So whatever your project involves, our experience will provide the answer, helping you to specify the correct flexible conduit system.

Markets and industries

Adaptaflex flexible conduit systems used to protect critical power and data cabling are available throughout a wide range of markets including:

- Commercial contracting
- Machinery
- Rail / Infrastructure
- Marine
- Mechanical
- Security / CCTV
- Data cabling
- Critical power

Many components are designed specifically for a market solution. These products uniquely meet an industry's needs - solving a specific application requirement, providing product innovation, saving installation and component costs, improving the quality and the integrity of the end product. Wherever you need mechanical and electrical protection for your cables you can be confident in specifying Adaptaflex products.

Type PA - Polyamide (Nylon) 6 conduit

Type Code	Description	UOM	MOQ	SPQ	M.R.P.*
PAFL13/BL	13mm nominal dia Nylon conduit, black	mtr	50	50	Upon request
PAFL16/BL	16mm nominal dia Nylon conduit, black	mtr	50	50	
PAFL21/BL	21mm nominal dia Nylon conduit, black	mtr	50	50	
PACL28/BL	28mm nominal dia Nylon conduit, black	mtr	50	50	
PACL34/BL	34mm nominal dia Nylon conduit, black	mtr	50	50	
PACL42/BL	42mm nominal dia Nylon conduit, black	mtr	25	25	
PACL54/BL	54mm nominal dia Nylon conduit, black	mtr	25	25	
PACS80/BL	80mm nominal dia Nylon conduit, black	mtr	10	10	
PACS106/BL	106mm nominal dia Nylon conduit, black	mtr	10	10	

* Price per meter



Approvals



Temperature Range

Static applications: -40°C to +120°C

Moving applications: -5°C to +120°C

Flexibility & fatigue life

High flexibility - high fatigue life

Fire performance & EMI screen

Self extinguishing Halogen-free

UV resistance

Very high

Type S - Galvanised steel general purpose conduit

Type Code	Description	UOM	MOQ	SPQ	M.R.P.*
S16	16mm nominal dia steel conduit	mtr	10	10	Upon request
S20	20mm nominal dia steel conduit	mtr	10	10	
S25	25mm nominal dia steel conduit	mtr	10	10	
S32	32mm nominal dia steel conduit	mtr	10	10	
S40	40mm nominal dia steel conduit	mtr	10	10	
S50	50mm nominal dia steel conduit	mtr	10	10	
S63	63mm nominal dia steel conduit	mtr	10	10	
S75	75mm nominal dia steel conduit	mtr	10	10	

* Price per meter



Approvals



Temperature range

Static applications: -50°C to +300°C

Moving applications: -45°C to +250°C

Flexibility & fatigue life

High flexibility - High fatigue life

Fire performance & EMI screen

Self extinguishing Halogen-free

UV resistance

Very high



Type SP - Covered steel general purpose conduit

Type Code	Description	UOM	MOQ	SPQ	M.R.P.*
SP16/BL	BL 16mm nom. dia covered steel conduit, black	mtr	10	10	Upon request
SP20/BL	20mm nom. dia covered steel conduit, black	mtr	10	10	
SP25/BL	25mm nom. dia covered steel conduit, black	mtr	10	10	
SP32/BL	32mm nom. dia covered steel conduit, black	mtr	10	10	
SP40/BL	40mm nom. dia covered steel conduit, black	mtr	10	10	
SP50/BL	50mm nom. dia covered steel conduit, black	mtr	10	10	
SP63/BL	63mm nom. dia covered steel conduit, black	mtr	10	10	
SP75/BL	75mm nom. dia covered steel conduit, black	mtr	10	10	

* Price per meter



Approvals



Temperature range

Static applications: -25°C to +70°C

Moving applications: -5°C to +90°C

Flexibility & fatigue life

High flexibility - Medium fatigue life

Fire performance & EMI screen

Self extinguishing

UV resistance

Very high

For any other specification/requirement of conduits and accessories kindly contact local ABB sales office

External lightning protection

OPR - Optimized Pulse Rod

The OPR efficiency (ΔT)

Lightning is one of the most spectacular meteorological phenomena. Generated by the interaction of clouds elements (water and ice), it can kill, injure and damage. The unique efficiency of the OPR Early streamer emission is based on the difference (ΔT), measured in a laboratory, in between the emission time of the OPR and the one from a simple rod. The OPR ESE air terminal is composed of a striking point connected to a down conductor to conduct the lightning to the ground.

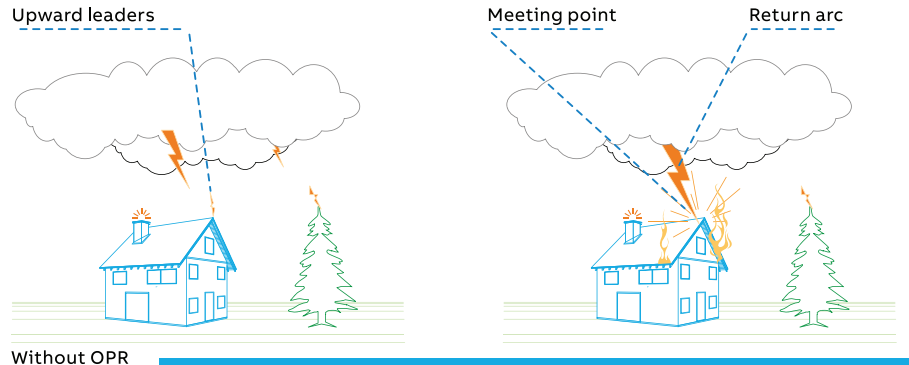

Complete autonomy

During a storm the ambient electric field may rise from 600 V to 10-20 kV/m. When the electric field reach this level representing a minimum risk for a lightning, the OPR begins to get activated and generates high voltage pulses, helping to create and propogating an upward leader. After a strike on the OPR, the lightning current is driven to ground by the down conductor to the earth termination system.

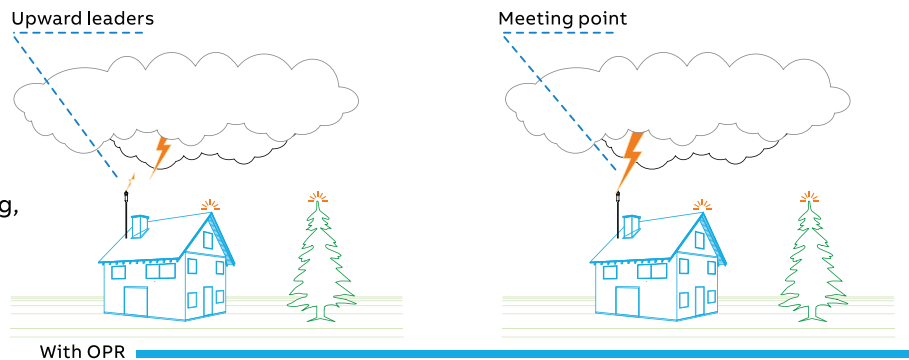

Radius of protection

The radius of protection (R_p) of the OPR is calculated according to the NF C 17-102 (edition 2011). It depends on the OPR efficiency (ΔT) expressed in micro-seconds. The maximum value for ΔT is 60 μs .

The risk assessment shall be calculated according to the NF C 17-102 Annex A / IEC 62305-2 and will define the protection level (LPL I, II, III or IV) which will be used in the determination of the OPR radius of protection.

Installing/testing

The installation and verification of lightning protection systems using one or more OPR units must be performed in accordance with the manufacturer's recommendations and to the NF C 17-102 standard.

Rp(h) : Protection radius at a given height (h)
 $R_p(h) = \sqrt{2rh - h^2 + \Delta(2r + \Delta)}$ (for $h \geq 5$ m)
 For $h < 5$ m, refer to the table below

h : Height of the OPR tip above the surface(s) to be protected

r(m) : Standardized striking distance

$\Delta(m)$ = $10^6 \cdot \Delta T$ (OPR efficiency)

OPR radius of protection

Protection level	I (r = 20 m)			II (r = 30 m)			III (r = 45 m)			IV (r = 60 m)		
	OPR 30	OPR 45	OPR 60	OPR 30	OPR 45	OPR 60	OPR 30	OPR 45	OPR 60	OPR 30	OPR 45	OPR 60
h (m)	Radius of protection Rp (m)											
2	19	25	31	22	28	35	25	32	39	28	36	43
3	29	38	47	33	42	52	38	48	58	43	57	64
4	38	51	63	44	57	69	51	65	78	57	72	85
5	48	63	79	55	71	86	63	81	97	71	89	107
6	48	63	79	55	71	87	64	81	97	72	90	107
8	49	64	79	56	72	87	65	82	98	73	91	108
10	49	64	79	57	72	88	66	83	99	75	92	109
15	50	65	80	58	73	89	69	85	101	78	95	111
20	50	65	80	59	74	89	71	86	102	81	97	113
45	43	65	76	58	75	89	75	90	105	89	104	119
50	40	65	74	57	75	88	75	90	105	89	104	120
55	36	65	72	55	75	86	74	90	105	90	105	120
60	30	65	69	52	75	85	73	90	104	90	105	120

External lightning protection

OPR - Optimized Pulse Rod

OPR Range

Type Code	Description	Length (m)	Weight (kg)	Time gain (µs)	Ordering code	M.R.P. (₹)
OPR 30	ESE Air terminal without mast	0.215	2.4	30	2CTB899800R7000	1,48,675
OPR 45	ESE Air terminal without mast	0.215	2.4	45	2CTB899800R7500	1,78,085
OPR 60	ESE Air terminal without mast	0.215	2.4	60	2CTB899800R7100	1,95,050

Accessories

Type Code	Description	Length (m)	Weight (kg)	Ordering code	M.R.P. (₹)
LS COUNTER	Lightning stroke counter	-	0.56	2CTH0CCF2004	52,940
MAST 2M30	Mounting Mast, 2m, 30mm dia	2	4.4	H00003002L	9,865
MAST 3M	Mounting Mast, 3m with guywire and base plate	3	6.5	H00003003LGB	19,525
CM015	25kg sack of bentonite moisture	-	25	7TCA083870R0030	
CM035	25kg sack of furse conductive	-	25	7TCA083870R1818	
RB335	3/4 (NOM)x3000mm extensible cu-bond	3	-	7TCA083120R0069	Upon request
CR315	1in (25mm) type e connector	-	-	7TCA083210R0014	
PT205	Lockable high performance poly	-	-	7TCA083320R0011	
TC030/50-IN	25x3mm cu-tape 50m furse coils	50	-	7TCA083010R0629	

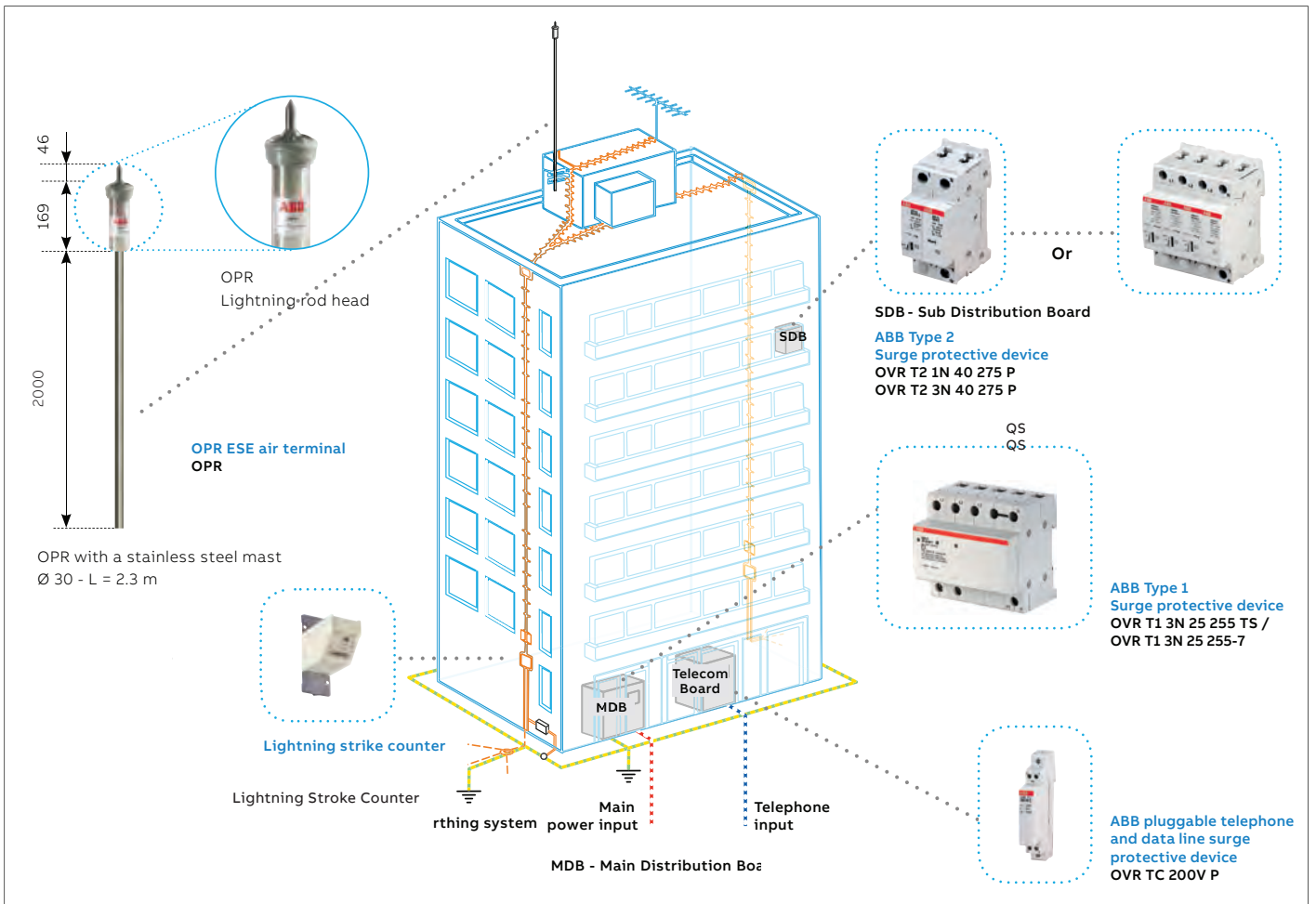

External lightning protection

Furse - Earthing and lightning protection

Furse provides world leading earthing, lightning and electronic systems protection from our own designed and manufactured products through to risk assessment and systems design advice.

Our renowned Furse range of earthing & lightning protection design services provide a unique total solution.

Expertise

Specialist advice from our fully qualified technical engineers - focusing on your earthing & lightning protection issues and concerns.

Experience

Experience to provide the optimum design - one that doesn't use more material than is necessary, saving you money.

Knowledge

Our knowledge of the latest products ensures a tailored design that can be installed using the most appropriate and up-to-date products.

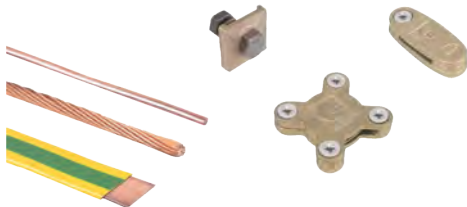

Structural lightning protection

From Furse air termination systems including air rods and strike plates to capture lightning strikes, through to our comprehensive range of down conductors and lightning protection components which channel lightning energy safely to a Furse earth termination network.

- Air termination systems
- Lightning protection conductors
- Conductor clips, clamps and holdfasts
- Bimetallic connection components



Electronic systems protection

Our exhaustive range of equipotential bonding and transient overvoltage SPDs providing fully co-ordinated protection against transient overvoltages on all incoming and outgoing metallic service lines including power, data, signal & telecoms.

- Lightning equipotential bonding SPDs
- Mains power transient overvoltage SPDs
- Data, signal & telecommunication lines SPDs
- DC power & photovoltaic SPDs

Compliance, now & in the future

Furse designs comply with all recognised standards - national and international. Our engineers actively contribute to national and harmonised European / international standards, ensuring we remain at the forefront of new developments.

- BS EN/IEC 62305 protection against lightning
- NFPA 780 Standard for the installation of lightning protection systems
- IEEE Std 80:2000 IEEE guide for safety in AC substation grounding
- ENA TS 41-24 guidelines for the design, installation, testing & maintenance of main earthing systems in substations
- BS EN 50522:2010 - earthing of power installations exceeding 1.k Vac
- IS/IEC 62305 - protection against lightning



Earthing

A combination of Furse earth electrodes, soil conditioning, conductors and equipotential bonding bars provide an effective, low resistance dissipation from the lightning protection system to earth.

- Earth rods and conductor systems
- Mechanical earth clamps and bonds
- Soil conditioning agents
- Earth bars and equipotential bonding



FurseWELD - Exothermic welding

FurseWELD exothermic welding is a cost-efficient, self-contained system that uses the high temperature reaction of powdered copper oxide and aluminium, within a mould, to form permanent electrical connections.

- Moulds
- Powder
- Handle clamps
- Accessories

Section I: Auxiliary relays, tripping relays and timers

Type	Technical description	Auxiliary voltage	Type of mounting	Contact configurations	Typical applications	L.P. (₹)
Auxiliary relays						
CV2DJ	Single element auxiliary relay, self reset contacts with operation indicator	24/30/48/110/220/250 V DC	Flush mounting	2NO+0NC/ 1NO+1NC	Contact multiplication, signalling	2,195
CV2AJ	Single element auxiliary relay, self reset contacts with operation indicator	110/240 V AC	Flush mounting	2NO+0NC/ 1NO+1NC	Contact multiplication, signalling	3,180
CV2D2J	Two element auxiliary relay, self reset contacts with operation indicator	24/30/48/110/220/250 V DC	Flush mounting	4NO+0NC/ 2NO+2NC/ 3NO+1NC	Contact multiplication, signalling	3,475
CV2A2J	Two element auxiliary relay, self reset contacts with operation indicator	110/240 V AC	Flush mounting	4NO+0NC/ 2NO+2NC/ 3NO+1NC	Contact multiplication, signalling	3,800
P8nCH2J	Single element auxiliary relay, self reset contacts with operation indicator	24/30/48/110/125//220/250 V DC	Flush mounting	7NO+0NC/ 6NO+1NC/ 5NO+2NC/ 4NO+3NC	Contact multiplication, signalling and tripping	4,225
P8nCH2J	Single element auxiliary relay, self reset contacts without operation indicator	110/240 V AC	Flush mounting	7NO+0NC/ 6NO+1NC/ 5NO+2NC/ 4NO+3NC	Contact multiplication, signalling and tripping	4,715
P8nAHX	Single element auxiliary relay, self reset contacts without operation indicator	24/30/48/110/125//220/250 V DC	Plug-in base mounting	7NO+0NC/ 6NO+1NC/ 5NO+2NC/ 4NO+3NC	Contact multiplication, signalling and tripping	4,660
RXP8n	Single element auxiliary relay, self reset contacts without operation indicator	24/30/48/110/220/250 V DC	Combiflex mounting*	7NO+0NC/ 6NO+1NC/ 5NO+2NC/ 4NO+3NC	Contact multiplication, signalling and tripping	3,820
Supervision relays						
PN8nCH2J	No volt relay with reverse flag, self reset contacts	24/30/48/110/220 V DC	Flush mounting	7NO+0NC/ 6NO+1NC/ 5NO+2NC/ 4NO+3NC	DC supply supervision	4,200
PN8nCH2J	No volt relay with reverse flag, self reset contacts	110/240 V AC	Flush mounting	7NO+0NC/ 6NO+1NC/ 5NO+2NC/ 4NO+3NC	AC supply supervision	4,575
TCS	Trip circuit supervision relay	24/30/48 V DC 110-125/220-250 V DC/AC	Flush mounting	1NO+1NC+2C/O	Trip circuit supervision	4,830
RXTCS	Trip circuit supervision relay	24/30/48 V DC 110-125/220-250 V DC/AC	Combiflex mounting*	1NO+1NC+2C/O	Trip circuit supervision	4,920
UVT92M	Fuse failure relay	110V AC, 50 Hz, 30/110/220 V DC	Flush mounting		Fuse failure supervision	10,700

*Combiflex accessories need to be ordered separately. Check with your local ABB office.

Section II: Electro-mechanical high speed tripping relays, Bi-stable relays and static relays

Type	Technical description	Auxiliary voltage	Type of mounting	Contact configurations	Typical applications	L.P. (₹)
High speed tripping relays						
PQ5nCH2J	High speed tripping relay, hand reset contacts with operation indicator	24/30/48/110/125//220/250 V DC	Flush mounting	4NO+0NC/ 3NO+1NC	Low burden tripping	4,050
PQ5nCH2J	High speed tripping relay, hand reset contacts with operation indicator	110/240 V AC	Flush mounting	4NO+0NC/ 3NO+1NC	Low burden tripping	4,580
PQ8nCH2J	High speed tripping relay, hand reset contacts with operation indicator	24/30/48/110/125//220/250 V DC	Flush mounting	7NO+0NC/ 6NO+1NC/ 5NO+2NC/ 4NO+3NC	Low burden tripping	4,630
PQ8nCH2J	High speed tripping relay, hand reset contacts with operation indicator	110/240 V AC	Flush mounting	7NO+0NC/ 6NO+1NC/ 5NO+2NC/ 4NO+3NC	Low burden tripping	5,000
PQ8nC2JW	High speed high burden tripping relay, hand reset contacts with operation indicator	24-30/48/110-125//220-250 V DC	Flush mounting	6NO+0NC/ 5NO+1NC/ 4NO+2NC	High burden tripping	4,630
RXPQ8n	High speed tripping relay, hand reset contacts with operation indicator	24/30/48/110/220/250 V DC	Combiflex mounting*	7NO+0NC/ 6NO+1NC/ 5NO+2NC/ 4NO+3NC	Low burden tripping	3,920
PSU14n-2X	High speed tripping relay, electrically reset contacts, with operation indicator	110/220 V DC	Plug-in base mounting	14NO+0NC/ 13NO+1NC/ 12NO+2NC/ 11NO+3NC/ 10NO+4NC/ 9NO+5NC/ 8NO+6NC/ 7NO+7NC	High burden tripping	14,000
RXPSU14n	High speed tripping relay, electrically reset contacts with operation indicator	110/220 V DC	Combiflex mounting*	14NO+0NC/ 13NO+1NC/ 12NO+2NC/ 11NO+3NC/ 10NO+4NC/ 9NO+5NC/ 8NO+6NC/ 7NO+7NC	High burden tripping	14,000
PSU6n-X	High speed trip relay without operation indicator	110/220 V DC	Plug-in base mounting	6NO+0NC 5NO+1NC 4NO+2NC 3NO+3NC	High burden tripping	8,500
RXPSU6n	High speed trip relay without operation indicator	110/220 V DC	Combiflex mounting*	6NO+0NC 5NO+1NC 4NO+2NC 3NO+3NC	High burden tripping	8,500
PSU14nCJW	High speed high burden tripping relay, hand/ electrical reset contacts with operation indicator	110/220 V DC	Flush Mounting	14NO+0NC 13NO+1NC/ 12NO+2NC/ 11NO+3NC/ 10NO+4NC/ 9NO+5NC/ 8NO+6NC/ 7NO+7NC	High burden tripping	15,015
PSU6nCJW	High speed high burden tripping relay, hand/ electrical reset contacts with operation indicator	110/220 V DC	Flush Mounting	6NO+0NC 5NO+1NC/ 4NO+2NC/ 3NO+3NC	High burden tripping	9,100

Section II: Electro-mechanical high speed tripping relays, Bi-stable relays and static relays

Type	Technical description	Auxiliary voltage	Type of mounting	Contact configurations	Typical applications	L.P. (₹)
Bi-stable relays						
PSU6n-X	Bi-stable relay, electrically reset contacts without operation indicator	24/30/48/110/125//220/250 V DC	Plug-in base mounting	6NO+0NC/ 5NO+1NC/ 4NO+2NC/ 3NO+3NC	CB/ Isolation/ Earth switch/ Contact multiplication/ Voltage selection/ CT switching	7,670
PSU14n-2X	Bi-stable relay, electrically reset contacts with operation indicator	24/30/48/110/125//220/250 V DC	Plug-in base mounting	14NO+0NC/ 13NO+1NC/ 12NO+2NC/ 11NO+3NC/ 10NO+4NC/ 9NO+5NC/ 8NO+6NC/ 7NO+7NC	CB/ Isolation/ Earth switch/ Contact multiplication/ Voltage selection/ CT switching	12,650
RXPSU6n	Bi-stable relay, electrically reset contacts without operation indicator	24/30/48/110/125//220/250 V DC	Combiflex mounting*	6NO+0NC/ 5NO+1NC/ 4NO+2NC/ 3NO+3NC	CB/ Isolation/ Earth switch/ Contact multiplication/ Voltage selection/ CT switching	7,670
RXPSU14n	Bi-stable relay, electrically reset contacts, with operation Indicator	24/30/48/110/125//220/250 V DC	Combiflex mounting*	14NO+0NC/ 13NO+1NC/ 12NO+2NC/ 11NO+3NC/ 10NO+4NC/ 9NO+5NC/ 8NO+6NC/ 7NO+7NC	CB/ Isolation/ Earth switch/ Contact multiplication/ Voltage selection/ CT switching	12,650
Static protection relay						
IRXm	Circulating current relay	24/30/48 V DC 110-125/220-250 V DC	Flush mounting	2NO+1NC	Restricted earth fault protection for generators and transformers, high impedance differential protection for motors, generators	11,200
VHXM22A	Under relay without time delay	63.5/110/240 V AC, 40-80%, 24/30/48/110/220 V DC	Flush mounting	6NO+0NC/ 3NO+3NC/	Under voltage protection/ Residual (dead bus) monitoring	9,890
VHXM22B	Under voltage relay with variable time delay	63.5/110/240 V AC, 40-80%, 0.1-1.0 sec/0.5-5.0 sec/1-10 sec, 24/30/48/110/220 V DC	Flush mounting	6NO+0NC/ 3NO+3NC/	Under voltage protection	13,520
VHXM23A	Over voltage relay without time delay	63.5/110/240 V AC, 80-140%, 24/30/48/110/220 V DC	Flush mounting	6NO+0NC/ 3NO+3NC/	Over voltage relay	9,890
VHXM23B	Over voltage relay with variable time delay	63.5/110/240 V AC, 80-140%, 0.1-1.0 sec/0.5-5.0 sec/1-10 sec, 24/30/48/110/220 V DC	Flush mounting	6NO+0NC/ 3NO+3NC/	Over voltage relay	13,520

*Combiflex accessories need to be ordered separately. Check with your local ABB office.

Section III: Numerical protection and control relays

Type	Product description	L.P. (₹)
Relion® 605 series		
REF601	Numerical feeder protection and control relay	Upon request
REJ601	Numerical feeder protection relay	
REM601	Numerical motor protection and control / Motor protection relay	
REJ603	Numerical self-powered feeder protection relay	
Relion® 611 series		
REF611	Numerical feeder protection and control relay	Upon request
REM611	Numerical motor protection and control relay	
REB611	Numerical busbar and multipurpose differential protection and control relay	
REU611	Numerical voltage protection and control relay	
Relion® 615 series		
REF615	Numerical feeder protection and control relay	Upon request
REM615	Numerical motor protection and control relay	
RED615	Numerical line differential protection and control relay	
RET615	Numerical transformer protection and control relay	
REV615	Numerical capacitor bank protection and control relay	
REU615	Numerical voltage protection and control relay	
REC615	Grid automation, numerical remote monitoring and control relay	
RER615	Grid automation, numerical recloser protection and control relay	
REG615	Numerical generator protection and control relay	
Relion® 620 series		
REF620	Numerical feeder protection and control relay	Upon request
RET620	Numerical transformer protection and control relay	
REM620	Numerical motor protection and control relay	
Relion® 630 series		
REF630	Numerical feeder protection and control relay	Upon request
RET630	Numerical transformer protection and control relay	
REG630	Numerical generator protection and control	
REM630	Numerical motor protection and control	
Relion® 640 series		
REX640	All-in-one protection for advanced power generation and distribution applications	Upon request

Visit "<http://new.abb.com/medium-voltage/distribution-automation>" for catalogues.
Prices "Upon request" for Numerical relays shall be provided as per the configuration requirement.

Section IV: Grid automation, FBT, arc protection, load shedding, engineering tools and miscellaneous items

Type	Product description	L.P. (₹)
RIO600	Remote I/O unit	
	Power supply module	
	Communication module	
	Digital input module with 8 inputs	
	Digital output module with 4 outputs	
	RTD/mA input module with 4 inputs	
	Analog output module with 4 outputs	
COM600	Grid automation controller	Upon request
PML630	Power management/Compact load-shedding solution	
REK510	Current injection device for rotor earth fault protection	
PCM600	Protection and control IED manager	
REA10	Arc fault protection system	
SUE3000	High speed transfer device (Fast bus transfer)	
RTU	RTU560/RTU511	
ARC600	Wireless controller for RMU/Feeder automation	
ARG600	Wireless gateway for connection over cellular network	
ARR600	Wireless I/O gateway for connection over cellular network	
ARM600 (M2M)	Communication server manages all arctic product family	

Visit "<http://new.abb.com/medium-voltage/distribution-automation>" for catalogues.

Prices "Upon request" for numerical relays shall be provided as per the configuration requirement.

Type 2 co-ordination

MS132/MS165 DOL-NS-IE1/IE2/IE3

SCPD type : MMS

Rated voltage : 400/415 V.

Short circuit current: 50 kA

Starting type : DOL-NS

Co-ordination type: IEC Type 2

Overload relay: embedded

Frequency: 50-60 Hz

Motor		Manual motor starter		Contactor	
Rated power	Rated current		Instantaneous tripping current	Current setting range	
[kW]	[A]	Type	[A]	[A]	
				Type	
0.06	0.2	MS132-0,25	2.44	0.16 - 0.25	A9
0.09	0.3	MS132-0,40	3.9	0.25 - 0.40	A9
0.12	0.44	MS132-0,63	6.14	0.40 - 0.63	A9
0.18	0.6	MS132-0,63	6.14	0.40 - 0.63	A9
0.25	0.85	MS132-1,0	11.5	0.63 - 1.00	A9
0.37	1.1	MS132-1,6	18.4	1.00 - 1.60	A9
0.55	1.5	MS132-1,6	18.4	1.00 - 1.60	A9
0.75	1.9	MS132-2,5	28.75	1.60 - 2.50	A9
1.1	2.7	MS132-4,0	50	2.50 - 4.00	A16
1.5	3.6	MS132-4,0	50	2.50 - 4.00	A16
2.2	4.9	MS132-6,3	78.75	4.00 - 6.30	A26
3	6.5	MS132-10	150	6.30 - 10.00	A26
4	8.5	MS132-10	150	6.30 - 10.00	A26
5.5	11.5	MS132-12	180	8.00 - 12.00	A26
7.5	15.5	MS132-16	240	10.00 - 16.00	A30
11	22	MS132-25	375	20.00 - 25.00	A30
15	29	MS132-32	480	25.00 - 32.00	A30
18.5	35	MS165-42	630	30.00 - 42.00	A63
22	41	MS165-54	810	40.00 - 54.00	A63
25	46.6	MS165-54	810	40.00-54.00	A75
30	45.5	MS165-65	975	52.00-65.00	A75

Type 2 co-ordination

MS132/MS165 SD-NS-IE1/IE2/IE3

Co-ordination type: IEC Type 2

SCPD type: MMS

Rated voltage : 400/415 V

Short circuit current: 50 kA.

Starting type : SD-NS

Overload relay: Embedded

Frequency : 50-60 Hz

Rated power [kW]	Rated current		Instantaneous tripping current [A]	Current setting range			
	[A]	Type		[A]	Line	Delta	Star
0.06	0.20	MS132-0,25	3.13	0.16 - 0.25	A9	A9	A9
0.09	0.30	MS132-0,40	5.0	0.25 - 0.40	A9	A9	A9
0.12	0.44	MS132-0,63	7.88	0.40 - 0.63	A9	A9	A9
0.18	0.60	MS132-0.63	7.88	0.40 - 0.63	A9	A9	A9
0.25	0.85	MS132-1,00	12.5	0.63 - 1.00	A9	A9	A9
0.37	1.10	MS132-1,60	20.0	1.00 - 1.60	A9	A9	A9
0.55	1.50	MS132-1,60	20.0	1.00 - 1.60	A9	A9	A9
0.75	1.90	MS132-2,50	31.25	1.60 - 2.50	A9	A9	A9
1.1	2.70	MS132-4,00	50	2.50 - 4.00	A26	A26	A26
1.5	3.60	MS132-4,00	50	2.50 - 4.00	A26	A26	A26
2.2	4.90	MS132-6,30	78.75	4.00 - 6.30	A26	A26	A26
3.0	6.5	MS132-10.00	150	6.30-10.00	A26	A26	A26
4.0	8.5	MS132-10.00	150	6.30-10.00	A26	A26	A26
5.5	11.5	MS132-16.00	240	10.00-16.00	A26	A26	A26
7.5	18.5	MS132-20.00	300	16.00-20.00	A30	A26	A26
11.0	22.0	MS132- 25.00	375	20.00-25.00	A30	A26	A26
15.0	29.0	MS132- 32.00	480	25.00-32.00	A30	A26	A26
15.0	29.0	MS165 -32.00	480	23.00-32.00	A40	A40	A40
18.5	35.0	MS165 -42.00	630	30.00-42.00	A40	A40	A40
22.0	41.0	MS165 -54.00	810	40.00-54.00	A50	A40	A40
25.0	46.6	MS165 -54.00	810	40.00-54.00	A63	A40	A40
30.0	55.0	MS165 -65.00	975	52.00-65.00	A63	A40	A40

Type 2 co-ordination

MCCB DOL-NS

SCPD type: MCCB

Rated voltage: 400/415 V

Short circuit current: 50 kA

Starting type: DOL-NS

Coordination type: IEC Type 2 / IE1 /IE2

Overload relay: TOL

Frequency: 50-60 Hz

Motor		Moulded case circuit breakers		Contactor		Overload relay
Rated power	Rated current	Instantaneous tripping current				Current setting range
[kW]	[A]	Type	[A]	Type	Type	[A]
0.37	1.1	XT2S160 MF 2	28	A9	TA25DU1.4	1 - 1.4
0.55	1.5	XT2S160 MF 2	28	A9	TA25DU1.8	1.3 - 1.8
0.75	1.9	XT2S160 MF 2	28	A9	TA25DU2.4	1.7 - 2.4
1.1	2.7	XT2S160 MF 4	56	A9	TA25DU4	2.8 - 4
1.5	3.6	XT2S160 MF 4	56	A16	TA25DU5	3.5 - 5
2.2	4.9	XT2S160 MF 8.5	120	A26	TA25DU6.5	4.5 - 6.5
3	6.5	XT2S160 MF 8.5	120	A26	TA25DU8.5	6 - 8.5
4	8.5	XT2S160 MF 12.5	175	A30	TA25DU11	7.5 - 11
5.5	11.5	XT2S160 MF 12.5	175	A30	TA25DU14	10 - 14
7.5	15.5	XT2S160 MA 20	210	A30	TA25DU19	13 - 19
11	22	XT2S160 MA 32	288	A30	TA42DU25	18 - 25
15	29	XT2S160 MA 52	392	A50	TA75DU42	29 - 42
18.5	35	XT2S160 MA 52	469	A50	TA75DU42	29 - 42
22	41	XT2S160 MA 52	547	A50	TA75DU52	36 - 52
30	55	XT2S160 MA 80	840	A63	TA75DU63	45 - 63
37	66	XT2S160 MA 80	960	A75	TA75DU80	60 - 80
45	80	XT2S160 MA 100	1200	A95	TA110DU110	80 - 110
55	97	XT3S250 MA 160	1440	A110	TA110DU110	80 - 110
75	132	XT3S250 MA 200	1800	A145	TA200DU175	130 - 175
90	160	XT3S250 MA 200	2400	A185	TA200DU200	150 - 200
110	193	T5S400 PR221-I In320	2720	AF205	EF205-210	63 - 210
132	230	T5S400 PR221-I In400	3200	AF265	EF370-380	115 - 380
160	280	T5S400 PR221-I In400	4000	AF305	EF370-380	115 - 380
200	350	T5S630 PR221-I In630	5040	AF370	EF370-380	115 - 380
250	430	T6S630 PR221-I In630	6300	AF460	EF460-500	150 - 500
290	520	T6S800 PR221-I In800	8000	AF580	EF750-800	250 - 800
315	540	T6S800 PR221-I In800	8000	AF580	EF750-800	250 - 800
355	610	T6S800 PR221-I In800	8000	AF750	EF750-800	250 - 800

Type 2 co-ordination

MCCB SD-NS

SCPD type: MCCB

Rated voltage: 400/415 V

Short circuit current: 50 kA

Starting type: SD-NS

Coordination type: IEC Type 2 / IE1 /IE2

Overload relay: TOL

Frequency: 50-60 Hz

Motor		MCCB		Contactor			Thermal release	
Pe [kW]	Ie [A]	Type	Im [A]	Line type	Delta type	Star type	Type	[A]
18.5	35	XT2S160 MA52	469	A50	A50	A26	TA75DU25	18-25
22	41	XT2S160 MA52	547	A50	A50	A26	TA75DU32	22-32
30	55	XT2S160 MA80	720	A63	A63	A30	TA75DU42	29-42
37	66	XT2S160 MA80	840	A75	A75	A30	TA75DU52	36-52
45	80	XT2S160 MA100	1050	A75	A75	A30	TA75DU63	45-63
55	97	XT2S160 MA100	1200	A75	A75	A40	TA75DU63	45-63
75	132	XT3S250 MA160	1700	A95	A95	A75	TA110DU90	66-90
90	160	XT3S250 MA200	2000	A110	A110	A95	TA110DU110	80-110
110	195	XT3S250 MA200	2400	A145	A145	A95	TA200DU135	100-135
132	232	T5S400 PR221-I In320	2880	A145	A145	A110	EF205-210	60-200
160	282	T5S400 PR221-I In400	3600	A185	A185	A145	EF205-210	60-200
200	350	T5S630 PR221-I In630	5040	AF265	AF265	AF190	EF370-380	115-380
250	430	T6S630 PR221-I In630	6300	AF265	AF265	AF190	EF370-380	115-380
290	520	T6S630 PR221-I In630	8000	AF580	AF580	AF400	EF750-800	250-800
315	540	T6S800 PR221-I In800	8000	AF580	AF580	AF400	EF750-800	250-800
355	610	T6S800 PR221-I In800	8000	AF580	AF580	AF400	EF750-800	250-800



ABB low voltage air circuit breakers

Service and retrofit solutions



ABB's circuit breaker retrofit solution is a cost-effective alternative to the complete replacement of existing low voltage switchgear. ABB Service experts conduct audits on existing installations to recommend the ideal solution and ensure the optimum return on investment. Retrofitting encompasses the replacement of phased-out devices with current technology air circuit breakers by adapting them both mechanically and electrically to suit the existing switchgear. The result is a major improvement in reliability, safety, and performance. ABB Service is a full system provider for retrofit solutions, from the initial recommendation and design, through manufacturing and testing, up to installation and commissioning.

www.abb.com/lowvoltage



Introduction

ABB Service

ABB Service is more than a simple Service!

ABB is a pioneering technology leader for utilities, industries, transportations and infrastructures.

The company was found in 1988 by the merger between ASEA and Brown Bover & Cie (BBC), two of the most important electrical companies of the last century.

ABB has extensively invested in Service developing advanced solutions aim to guarantee the continuous revamping of products and systems according to the technology progress.

Spare Parts

Spare Parts availability is the key of a successful Service!

A spare part is a replaceable product's component fundamental to ensure the functioning of the system to which it belongs.

Having original spare parts always at your disposal means guarantee of the highest level of performance to your plant, reducing significantly the risk of failure as well as the down-time due to the maintenance.

ABB guarantees 100 % of compatibility of all Spare Parts that are going to replace the defective components of your equipment.

All Spare Parts are equipped with instruction sheets to enable a correct and safety assembly and are delivered in short times in order to fulfill customer's needs.

Service portfolio

Life Cycle Management

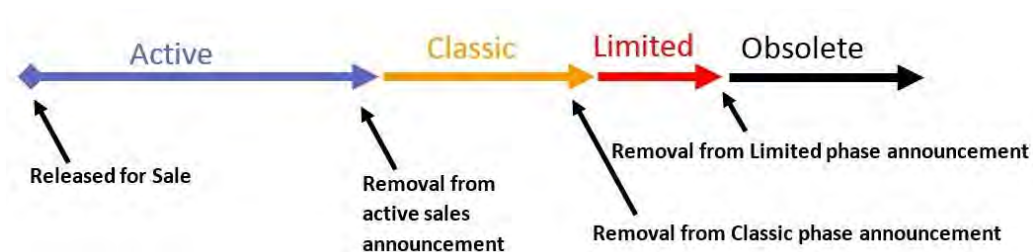

Active standard development, production and sale.

Classic maintenance phase of the product: spare parts availability is guaranteed for replacing in existing plants.

Limited spare parts are available. The production of the CB's whole range is not guaranteed, and the technical support is limited.

Obsolete technical support is no more guaranteed. The production of the CB's whole range has ended but spare parts might be available. Retrofit solutions are available.

Service portfolio

Low voltage products division delivers a vast range of services to cover the whole product lifecycle. The services offered by ABB's low voltage products and systems span the entire value chain, from the moment a customer makes the first enquiry to disposal and recycling of the product. Throughout the value chain, ABB provides training, technical support and customized contracts. All of this is supported by one of the most extensive country sales and service network.

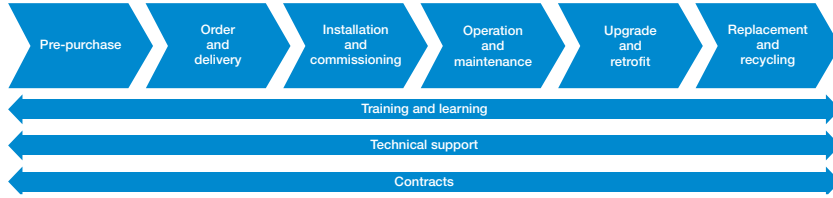

Installation and commissioning

ABB provides comprehensive installation and commissioning services to achieve a problem-free start up, by following installation and commissioning procedures. The use of service personnel from ABB LP service ensures that the switchgear is installed in a safe and correct way.

Operation and maintenance

ABB can guide the customer through a fast and efficient fault finding procedure as well as analyze the operation of the product and the customer's process. From site surveys to preventive, predictive maintenance and reconditioning, ABB has all the options covered to keep its customers' processes operational.

Upgrade and retrofits Upgrades

An existing ABB product can often be upgraded to the latest software or hardware to improve the performance of the application. Existing processes can be economically modernized by upgrading with the latest technology.

Retrofits

Replacing old LV Switchgear of any make with ABB's latest versions can be done using the ABB special conversion kits which enable quick installation without structural modifications to the original compartment. In addition complete "turnkey" solutions are available. Specific conversion kits have been developed in order to replace old components with new ones that can be found in the latest switchgears.

Replacement and Recycling

ABB can advise on the best replacement products while ensuring that the existing products are disposed of in a way that meets all local regulations.

Entire value chain services

The main services available throughout the entire value chain include:

Training and learning – Hands on

ABB LP service carries out training programs. Those trainings can be either general or bespoke and have the aim of providing the personnel in charge of management/maintenance with the necessary know-how to achieve an excellent level of operating ability in certain situations. The manager of an electrical site can find it convenient to have certain maintenance capabilities available within his own team.

The courses mainly cover:

- Operating equipment
- Maintenance principles
- Repairs for small faults

Technical support

At each stage of the value chain, an ABB expert is available to offer advice to keep the customer's process or plant operational.

Spare parts

Availability of original spare parts is essential for fast and efficient maintenance activities. This becomes even more critical when the product was produced some years ago and has components in it which are no longer in production. ABB LP service is the only one able to supply original and guaranteed spare parts. These can be easily selected and ordered through the authorized channel.

Maintenance contracts

In addition to the corrective maintenance of a faulty unit, which includes any type of emergency intervention, there is a complete preventive maintenance service package, ensuring those who manage the plant gain considerable advantages in terms of reliability, safety and reduction of costs. Also customized contracts can be devised between the customer and ABB. Depending on the severity of the intervention needed, it can often be done on-site by our skilled and experienced engineers and is a faster way of resolution. ABB LP service has an effective service network across the country and dedicated service workshops. For all your service requirements, contact our nearest Sales office.

Benefits of maintenance contracts

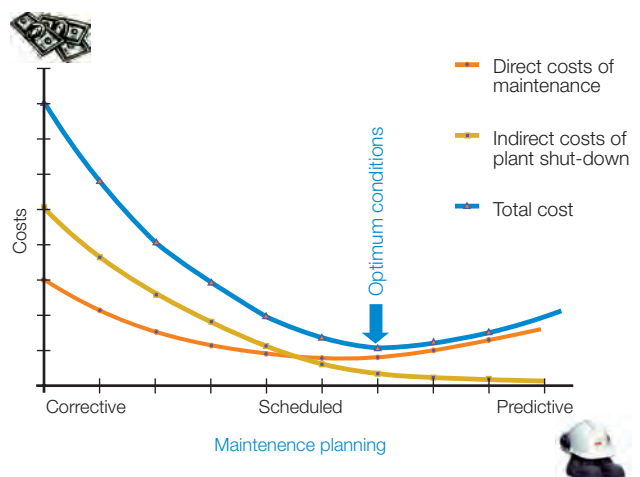

Materials

Technical material - SOC

Selected optimized coordination (SOC) tables

ABB provides coordination tables for the selection of low voltage equipment, specifically tested for starting and protecting IE3 motors in the SOC tool.

Essential, enhanced and advanced solutions as introduced in this brochure can be selected there. Product selection for different types of starting methods are available as well, including direct-on-line, star-delta and softstarters. Usage of coordination tables helps reduce the time for selection and design of solutions as well as the risk of unwanted downtime, e.g. caused by nuisance tripping. This provides protection and safety, further driving down the total cost of ownership

more than **1800**
tested and validated
coordination tables
available

You can find SOC tables [here](#)

SOC - SELECTED OPTIMIZED COORDINATION

Coordination tables for Motor protection

→ Info on IE3 Motors

→ UL Motor Coordinations BETA

Clear selection

Standard: IEC UL

Motor efficiency class: ANY IE1/IE2/IE3 N/H IE3 NE/HE

Motor Rated Power [kW]	Rated voltage	Short-Circuit Current [kA]	Starter Type	Coordination type	Protection device	Overload relay
0.06	208Vac	3	DOL-NS	IEC Type 1	ACB	Embedded
0.09	230Vac	5	DOL-HD	IEC Type 2	Fuses	TOL
0.12	240Vac	12	SD-NS		MCCB	EOL
0.18	400Vac	16	SD-HD		MMS	UMC
0.25	415Vac	20	SS-NS-IL			
0.37	440Vac	22	SS-NS-ID			
0.55	480Vac	25				
0.75	480Vac	27				
1.1	500Vac	30				
1.5	525Vac	35				

Search Export PDF

Results 1398 Internal use only records.

20 Number of Records to show

ACB, 415 Vac, 42 kA, DOL-NS, Coordination type : IEC Type 2, Overload relay : Embedded, Motor efficiency class IE1/IE2/IE3 N/H

Motor	SACE Emax Circuit Breaker	Inst.Trip.Current [A]	Max allowed load current [A]	Status	Table
Motor Rated Power [kW]	Rated Current (FLA) [A]	Type			

IE3/IE4 Motor **NEW**

SOC - Selected Optimized Coordination

Motor protection | Selectivity | Back-up | Other Devices protection

Standard: IEC UL

Starting type: Normal start Heavy duty

Motor Efficiency Class - Design: Any IE1/IE2/IE3/IE4 - N/H IE3/IE4 - NE/HE

Table status: Any Active Legacy

Starter Type	Rated voltage	Motor Rated Power	Short-Circuit Current	Coordination type	Protection device	Overload protection
Direct-on-line starter	230 V AC	0.06 kW	25 kA	IEC Type 1	Switch fuse	Embedded
Star-Delta starter	400 V AC	0.09 kW	35 kA	IEC Type 2	Molded case circuit-breaker	Thermal overload relay
	415 V AC	0.12 kW	36 kA		Manual motor starter	Electronic overload relay
	440 V AC	0.18 kW	42 kA			Universal motor controller
	500 V AC	0.25 kW	50 kA			
	525 V AC	0.37 kW	65 kA			
	690 V AC	0.55 kW	70 kA			

131 Coordination tables found

Export PDF PDF Books Reset filters

Materials

Technical material - e-Configure

e-Configure is a product and application configuration tool for low voltage products and solutions that provides customers a quick and easy configuration process.

- Browse for products by categories, product code or description
- Retrieve product related information (specs, prices, availability)
- Select and configure products and accessories
- Create, modify and order the bill of material
- Re-order custom configured units

You can find e-Configure [here](#)

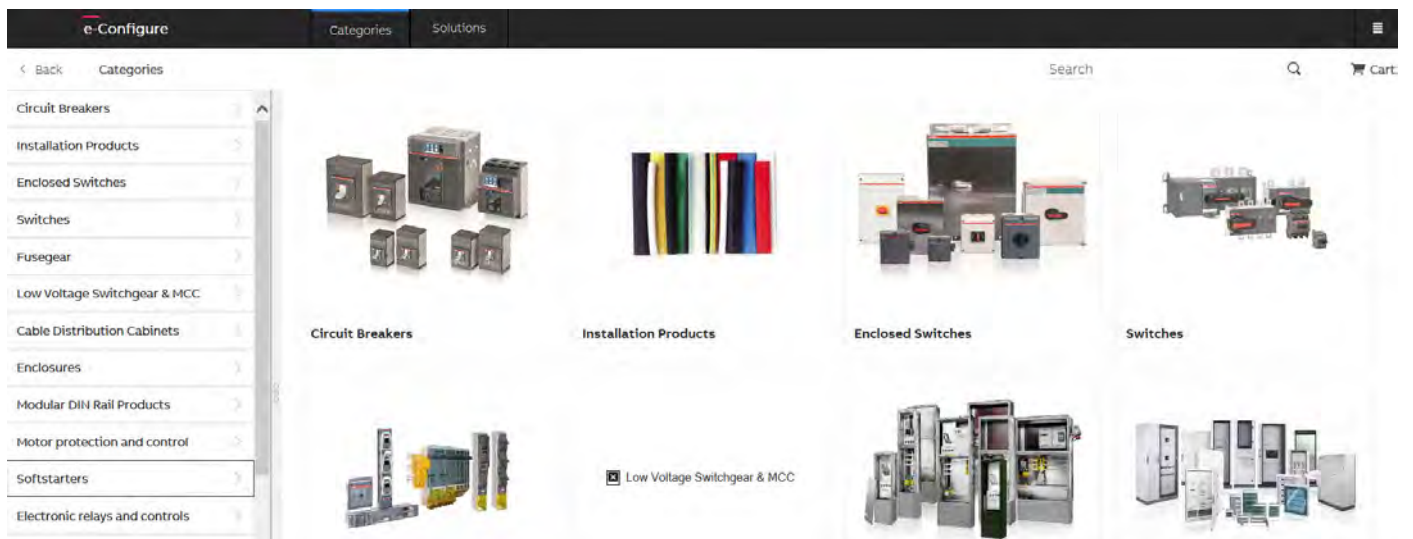
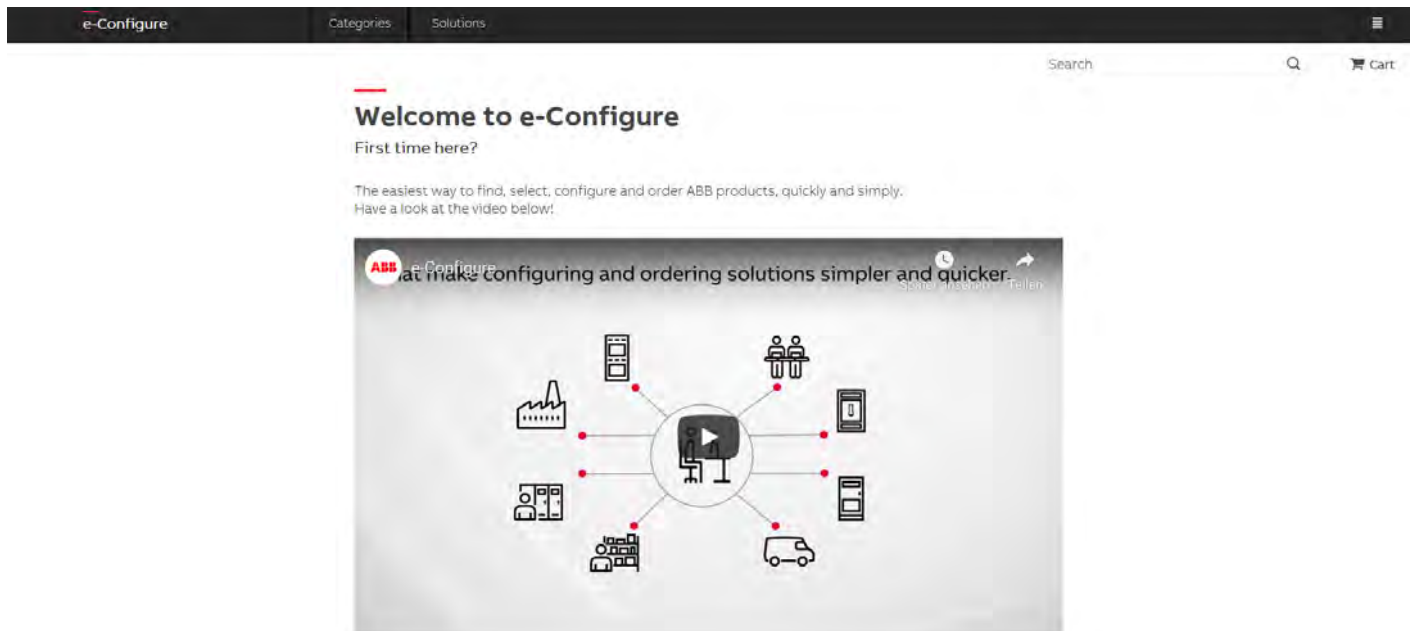

Materials

Technical material - 3D Portal

Cadenas provides 3D and 2D data for ABB Motor Starting & Safety products.

- Download CAD models in different file formats
- Generate Pdf data sheets

You can find 3D Portal [here](#)

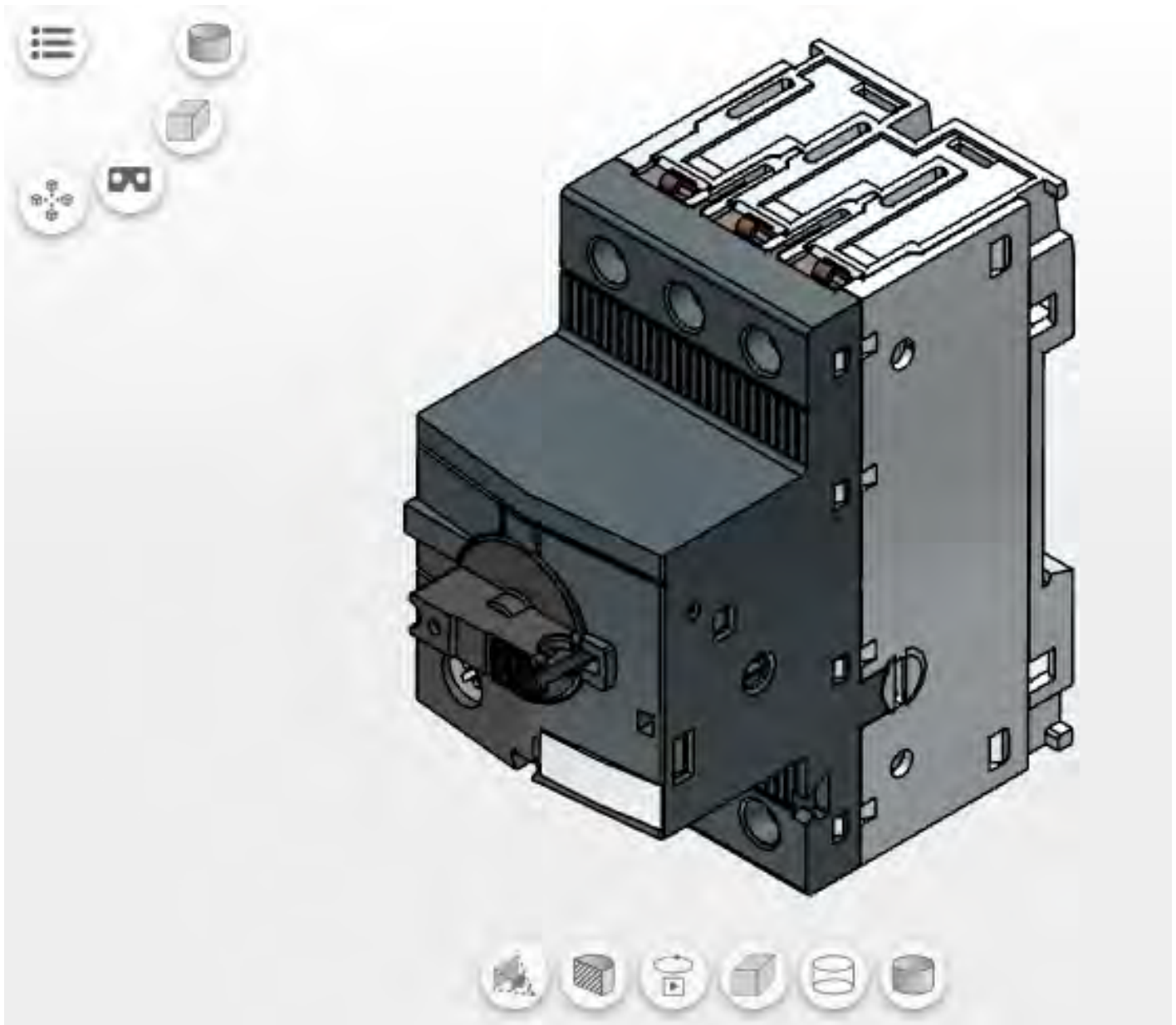

Electrification India has launched eMart, a B2B & B2C online marketplace in August 2020 for bringing ABB products and solutions closer and nearer to our customers than ever.

Customers will have easy access to more than 6,000 ABB home and industrial products and solutions in one of the fastest growing e-commerce markets in the world.

This unique B2B & B2C platform is the first of its kind in the industry, owing to its dynamic, price transparent model. It aims to provide an equally fair and favorable experience to both ABB distributors and customers. ABB eMart also provides a dynamic model to empower our partners to set their own competitive pricing for the products they sell on the platform, while simultaneously providing customers with a choice of the best deals to suit their specific needs.

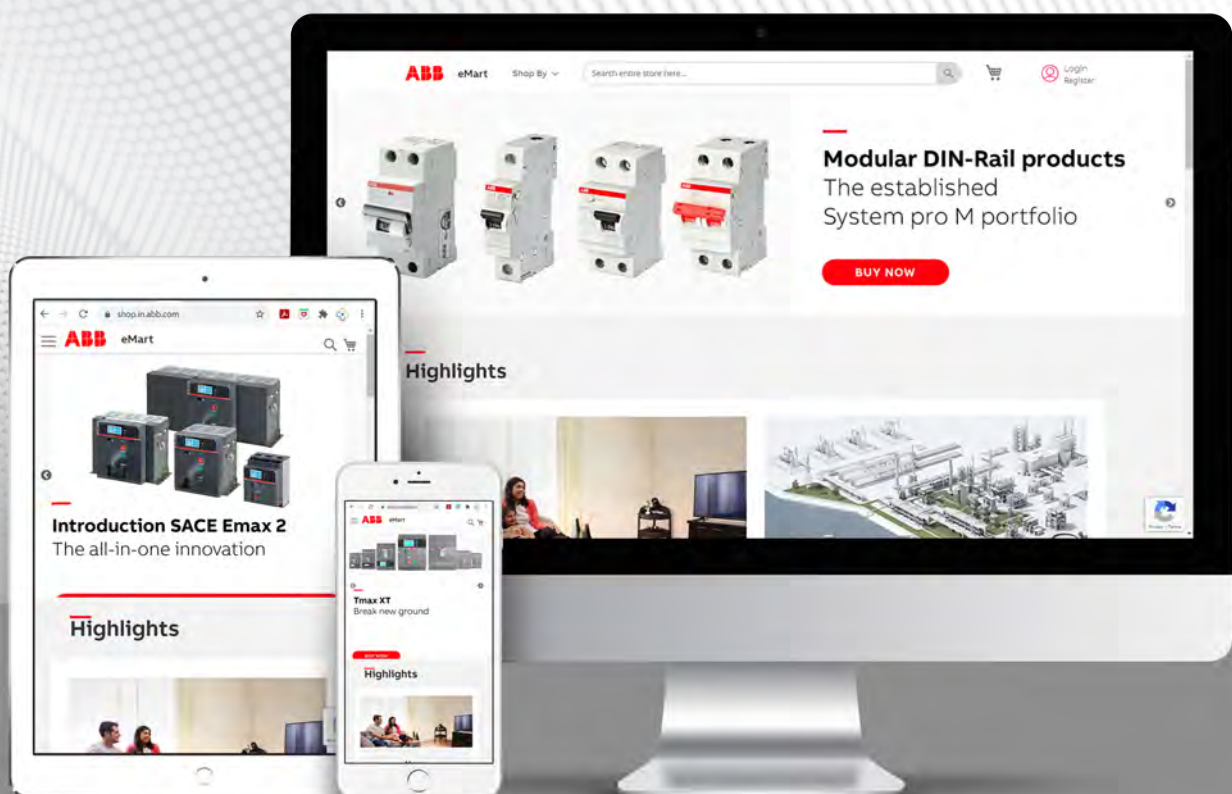

Click below to find offerings from eMart.



MCCB



Isolator



MCB



Meter



RCD



Switches, Sockets & Accessories



Fusegear



Transfer Switch



Switch Disconnecter



Industrial Plug & Socket



Contactor



Interface Products



Manual Motor Starters



Measuring and Monitoring Relays



Pilot Device



Power Supply



Safety Products



Time Relays



Universal Motor Controller



Overload Relays

General conditions of sale

General terms and conditions of sale:

- All prices mentioned in this price list are in Indian Rupees (INR) and this supersedes all previous price lists
- Prices are based on Ex-work basis
- Maximum retail prices (MRPs) mentioned in the publication are maximum recommended selling prices
- List prices (LPs) mentioned are exclusive of all taxes
- Prices are subject to revision without prior notice

Terms of delivery: Ex- work, Nelamangala or any other ABB warehouse in India

Standard delivery terms

Ex-stock or 30 working days

Address of Nelamangala warehouse

ABB INDIA LIMITED

#126, Hanchipura Village, Kasaba Hobli
Nelamangala Taluk, Bangalore-562 123

Tel: +91 80 2770 0081

Tel: +91 80 2770 0082

Tel: +91 80 2770 0083

Address of Works

Nelamangala

Survey No: 88/3, 88/4, Basavanhalli, Kasaba Hobli,
Nelamangala Taluk, Bangalore - 562 123

Karnataka, India

Tel: +91 80 2294 6618

Tel: +91 80 2294 6619

Fax: +91 80 2294 9999

Peenya

Plot No. 5 & 6, II Phase,
Peenya Industrial Area, Bangalore - 560 058

Karnataka, India

Tel: +91 80 22949354/9585

Fax: +91 80 22949389

Vadodara

Maneja Works, Maneja,
Vadodara - 390 013

Gujarat, India

E-mail: in-da.sales@abb.com

Tollfree No: 1800-4200-707

Warranty policy

ABB guarantees the supply according to the law. Upon expiration, the warranty expires even if the devices have not been operated for any reason. In the case of faults, as long as this does not depend on assembly errors by the customer or third parties, on incorrect use of the materials, lack of or incorrect maintenance, normal wear and tear, faults caused by inexperience or negligence by the purchaser or by transport, by the improper storage of the materials, or failure by the customer to adopt measures to reduce eventual dysfunction, overload with respect to the contractual limits, by unauthorized intervention, by tampering or action effected by the customer, to force majeure, ABB will, throughout the warranty period, repair or replace any defective part of supply free of charge, in the shortest possible time, at its premises. Where the repair cannot be executed at ABB premises, except as otherwise agreed, all the supplementary or relevant expenses shall be borne by the customer.

Repair or replacement will be executed only if the customer has performed all the obligations to that date. The customer may not suspend performance of the obligations in any case in which this warranty is invoked. The term for the repair or replacement of the faulty supply will be agreed by ABB and the customer. The shipment of any supply claimed to be faulty by the customer to ABB and subsequently by ABB to the customer, shall be at the risk and under the responsibility of the customer, who shall arrange adequate insurance coverage. The supply repaired or replaced is shipped at the expense and risk of the customer. Any dispute about a shipment has no effect on the remainder of the supply. The products replaced by ABB become the property of ABB.

General conditions of sale

Any claim regarding the supply, machinery, plant or components not compliant with the specifications or the contractual documentation must be raised in writing, within a maximum term of 8 days from delivery, when the time limit for action expires. In the case of systems, this term is 60 days from execution of the disputed service when the time limit for action expires.

In the case of latent defects, the terms indicated above run from the date of discovery. Once the warranty period has expired, claims are not accepted, even for latent defect. Where the claim is timely and justified, ABB's obligation is limited to replacement of the goods found not in compliance or repetition of execution of the non-compliant service, excluding all rights to the Customer to seek termination of the contract and/or compensation of damages.

With reference to the provision of spare parts, ABB reserves the right to provide materials either from the original supplier or from equivalent supplier.

Warranty period:

1. **Breakers & switches:** The warranty period is 12 months from the date of commissioning or 18 months from the date of ABB's invoice, whichever is earlier.
2. **Control products:** The warranty period is 12 months from the date of commissioning or 18 months from the date of ABB's invoice, whichever is earlier.
3. **Enclosures & Din Rail components:**
 - Components of SB200M and SDB200 will have 5 Years warranty from the date of ABB's invoice, if mounted inside the ABB Distribution boards. If non- ABB enclosure is used, Warranty period is 12 months from the date of commissioning or 18 months from the date of ABB's invoice, whichever is earlier.
 - All other range of products : 12 months from the date of commissioning or 18 months from the date of ABB's invoice, whichever earlier.

- If products are altered, dismantled, rectified or tampered. Warranty states is not company's entire liability. This does not extend to cover consequential losses or damage or installation cost arising from defective products. Since product improvement is a continuous process, the data furnished in this brochure may undergo revision. For the latest information, you may contact our nearest sales office.

4a. Wiring accessories:

- Standard Switches & Sockets (without LED Lamp) : 10 years from the date of ABB's invoice.
- Electronic Products (with LED Lamp) : 12 months from the date of commissioning or 24 months from the date of ABB's invoice, whichever earlier.
- ABB mounting boxes are not covered under warranty.
- Warranty for all the products will not be valid, If products are not used with original ABB mounting boxes.
- If products are altered, dismantled, rectified or tampered. Warranty states is not company's entire liability. This does not extend to cover consequential losses or damage or installation cost arising from defective products. Since product improvement is a continuous process, the data furnished in this brochure may undergo revision. For the latest information, you may contact our nearest sales office.

- 4b. **Plug & sockets:** The warranty period is 12 months from the date of commissioning or 18 months from the date of ABB's invoice, whichever is earlier.

Liability clause:

The manufacturer shall not be liable for any consequential loss, injury or damages attributable to defect or failure of its products.





ABB India Helpline.

Technical telephone support for customers
and channel partners.

Toll free: (BSNL) +91 1800 420 07 07

website: new.abb.com/low-voltage