

CONSTRUCTION NOTICE FOR STERLING STATION LINE EXTENSION PROJECT



PUCO Case No. 18-0848-EL-BNR

Submitted to:
The Ohio Power Siting Board
Pursuant to Ohio Administrative Code
Section 4906-6-05

Submitted by:
AEP Ohio Transmission Company, Inc.

May 23, 2018

CONSTRUCTION NOTICE

AEP Ohio Transmission Company, Inc.'s Sterling Station Line Extension Project

4906-6-05

AEP Ohio Transmission Company, Inc. ("AEP Ohio Transco") provides this Construction Notice ("CN") to the Ohio Power Siting Board ("OPSB") in accordance with the requirements of Ohio Administrative Code Section 4906-6-05.

4906-6-05(B) General Information

B(1) Project Description

The name of the project and applicant's reference number, names and reference number(s) of resulting circuits, a brief description of the project, and why the project meets the requirements for a Letter of Notification.

AEP Ohio Transco proposes the Sterling Station Line Extension Project ("Project"), located in Allen County, Ohio. Short extensions of the Lima-Sterling (0.05 miles), Sterling-South Kenton (0.04 miles), and Southwest Lima-Sterling 138kV (0.09 miles) Transmission Lines, totaling 0.18 miles, will be constructed to accommodate the expansion of a distribution substation. The entirety of the Project will be constructed on property owned by Ohio Power Company. This Project is referenced in the 2018 Long-Term Forecast Report (LTFR) submitted by AEP Ohio, in PUCO Form FE-T8, page 77 (Figure 6). The Project is listed by circuit names within the LTFR, with the Lima-Sterling 138kV line as the North Delphos-Sterling 138kV circuit, the Sterling-South Kenton 138kV line as the East Lima-Sterling circuit, and the Southwest Lima-Sterling 138kV line as the Ordnance Junction Switch-Sterling 138kV circuit. This Project was identified as part of PJM Reference Number S1206. The slides that were presented to PJM are attached as Figure 7.

The Project meets the requirements for a Construction Notice because it is within the types of projects defined by (1)(a) of Appendix A to Ohio Administrative Code Section 4906-1-01, *Application Requirement Matrix for Electric Power Transmission Lines*:

1. *New construction, extension, or relocation of single or multiple circuit electric power transmission line(s), or upgrading existing transmission or distribution line(s) for operation at a higher transmission voltage, as follows:*
 - (a) *Line(s) not greater than 0.2 miles in length.*

The Project has been assigned PUCO Case No. 18-0848-EL-BNR.

B(2) Statement of Need

If the proposed Letter of Notification project is an electric power transmission line or gas pipeline, a statement explaining the need for the proposed facility.

Transmission line connections terminating at Sterling Station will see entrance span modifications so that they may terminate at their new positions in the newly built distribution facility. The complete station rebuild is listed as a PJM supplemental project (S1206) driven by station rehabilitation needs in

which the majority of station equipment was determined to be in need of replacement. The rebuild of Sterling Station also addresses PJM identified baseline project needs (B1881 and B2820), calling for the replacement of some 138kV terminal equipment at the existing Sterling station. The rebuilt Sterling Station terminal equipment is designed to address these previously-identified needs. The transmission line extensions are to accommodate the components of the station expansion.

B(3) Project Location

The applicant shall provide the location of the project in relation to existing or proposed lines and substations shown on an area system map of sufficient scale and size to show existing and proposed transmission facilities in the Project area.

Figure 1 identifies the location of the Project in relation to existing and proposed transmission lines and substations.

B(4) Alternatives Considered

The applicant shall describe the alternatives considered and reasons why the proposed location or route is best suited for the proposed facility. The discussion shall include, but not be limited to, impacts associated with socioeconomic, ecological, construction, or engineering aspects of the project.

The proposed Project is to reconfigure transmission lines to accommodate an expansion of an existing distribution station on fallow land. As the transmission line extensions to accommodate this expansion is in close proximity to existing facilities, and will have minimal impacts associated with socioeconomic, ecological, construction, or engineering. AEP Ohio Transco chose this distribution site expansion based upon the suitable geography, proximity to existing transmission lines, and presence of road access for construction and maintenance crews. Upon review, AEP Ohio Transco's engineering and siting consultants concluded that the expanded Sterling Station site at the recommended location for the upgraded substation and reconfiguring the transmission line to accommodate, as illustrated in Figure 1, is the best option for the proposed Project.

Siting the Project on alternative sites in the region would have resulted in considerably more socioeconomic and environmental impacts because there would have been a need to re-route and extend various transmission lines in order to reach the new site. There is no such need within the Project area.

B(5) Public Information Program

The applicant shall describe its public information program to inform affected property owners and tenants of the nature of the project and the proposed timeframe for project construction and restoration activities.

Because the Project will be located fully on Ohio Power Company-owned Property, no other property owners or tenants will be affected. AEP Ohio Transco maintains a website (<http://aeptransmission.com/ohio/>) on which an electronic copy of this CN is available. A paper copy of the CN will be served to the public library in each political subdivision affected by this Project.

B(6) Construction Schedule

The applicant shall provide an anticipated construction schedule and proposed in-service date of the project.

Construction of the Project is planned to begin in the late third to fourth quarter of 2018, with an anticipated in-service date in the fourth quarter of 2020.

B(7) Area Map

The applicant shall provide a map of at least 1:24,000 scale clearly depicting the facility with clearly marked streets, roads, and highways, and an aerial image.

Figures 1 and 2 provide the proposed Project area on maps of 1:24,000-scale. Figure 1 provides the proposed Project area on the United States Geological Survey (USGS) 7.5-minute topographic maps of the Cridersville and Lima quadrangles. Figure 2 shows the Project area on recent aerial photography, as provided by Bing Maps. To access the Project location from Columbus, take I-70 West for approximately 5 miles. At exit 93, take the ramp right for I-270 North. After 9 miles, take exit 17B right for State Route 161 West/US-33 West toward Marysville and continue for 16 miles. Keep straight onto US 36 West/US 33 West for another 30.5 miles. Take ramp right toward Huntsville/Lima and bear right onto State Route 117. Continue on State Route 117 for 23 miles before turning left onto East Hanthorn Road. Follow East Hanthorn Road for 5.8 miles and turn left onto McClain Road. The station entrance is on the left after approximately 200 feet. The approximate address of Sterling Station is 12765 McClain Road, Lima, Ohio 45806 at latitude 40.701, longitude -84.108.

B(8) Property Agreements

The applicant shall provide a list of properties for which the applicant has obtained easements, options, and/or land use agreements necessary to construct and operate the facility and a list of the additional properties for which such agreements have not been obtained.

The proposed Project will be constructed on property currently under option for purchase by Ohio Power Company. The transmission line taps and relocations will extend from the existing adjacent ROW across the station site. After transfer of the station property, additional easements and/or land use agreements may be needed to construct and operate the facility.

B(9) Technical Features

The applicant shall describe the following information regarding the technical features of the project:

B(9)(a) Operating characteristics, estimated number and types of structures required, and right-of-way and/or land requirements.

The proposed Project will consist of four (4) 138kV conductors relocated into the new Sterling Station. Conductor for line one is one (1) –1033.5 kcmil ACSR 45/7 Ortolan conductor per phase with two (2) 7#8 Alumoweld overhead ground wires. Conductor for line two is two circuits of one (1) - 795 kcmil ACSR 26/7 Drake conductor per phase, with one (1) 159 ACSR Guinea overhead ground wire and one (1) 48 fiber OPGW. Conductor for line three is two circuits of one (1) - 1590 kcmil ACSR 45/7 Lapwing per phase, with one (1) 7#8 Alumoweld overhead ground wire. Conductor for line four is one (1) – 795 kcmil ACSR 45/7 Tern with one (1) 7#8 Alumoweld overhead ground wire. The insulator assemblies will consist of polymer

insulators. The replacement structures will be primarily galvanized steel single pole structures with davit arms.

The proposed Project will also consist of two (2) 34kV conductors relocated into the new Sterling Station. Conductor for line five is one (1) – 336 kcmil ACSR 18/1 Merlin conductor per phase with one (1) 7#10 Alumoweld overhead ground wire. Conductor for line six is two circuits of one (1) – 336 kcmil ACSR 18/1 Merlin conductor per phase, with one (1) 7#10 Alumoweld overhead ground wire. The insulator assemblies will consist of polymer insulators. The replacement structures will be primarily galvanized steel single pole structures with davit arms.

Sketches of the proposed structure types are included as Figures 4-1A through 4-1D.

B(9)(b) Electric and Magnetic Fields

For electric power transmission lines that are within one hundred feet of an occupied residence or institution, the production of electric and magnetic fields during the operation of the proposed electric power transmission line.

This section is not applicable. No occupied residences or institutions are located within 100 feet of the Project.

B(9)(b)(ii)(c) Project Cost

The estimated capital cost of the project.

The capital costs estimate for the proposed Project, comprised of applicable tangible and capital costs, is approximately \$4,000,000.

B(10) Social and Economic Impacts

The applicant shall describe the social and ecological impacts of the project:

B(10)(a) Operating Characteristics

Provide a brief, general description of land use within the vicinity of the proposed project, including a list of municipalities, townships, and counties affected.

An aerial photograph of the Project vicinity is provided as Figure 2. The Project site is currently an old field, vacant property, as observed during a March 20, 2017 site reconnaissance. A photo of the Project site is included as Figure 5. The Project is located in Perry Township, Allen County, Ohio.

B(10)(b) Agricultural Land Information

Provide the acreage and a general description of all agricultural land, and separately all agricultural district land, existing at least sixty days prior to submission of the application within the potential disturbance area of the project.

The Project site is approximately seven acres and is currently all old field, vacant land. The proposed Project is not located within agricultural district land based upon coordination with the Allen County Auditor.

B(10)(c) Archaeological and Cultural Resources

Provide a description of the applicant's investigation concerning the presence or absence of significant archaeological or cultural resources that may be located within the potential disturbance area of the project, a statement of the findings of the investigation, and a copy of any document produced as a result of the investigation.

In March 2017, AEP Ohio Transco's consultant completed a Phase I Cultural Resource Management Investigation for the Project. No cultural resources were identified during that investigation. No significant resources that are older than 50 years of age or older were identified within the Project area. The cultural report is presented as Appendix B. No further work is deemed necessary for this Project.

B(10)(d) Local, State, and Federal Agency Correspondence

Provide a list of the local, state, and federal governmental agencies known to have requirements that must be met in connection with the construction of the project, and a list of documents that have been or are being filed with those agencies in connection with siting and constructing the project.

A Notice of Intent will be filed with the Ohio Environmental Protection Agency for authorization of construction storm water discharges under General Permit OHC000004. There are no other known local, state, or federal requirements that must be met prior to commencement of the proposed Project.

B(10)(e) Threatened, Endangered, and Rare Species

Provide a description of the applicant's investigation concerning the presence or absence of federal and state designated species (including endangered species, threatened species, rare species, species proposed for listing, species under review for listing, and species of special interest) that may be located within the potential disturbance area of the project, a statement of the findings of the investigation, and a copy of any document produced as a result of the investigation.

AEP Ohio Transco's consultant prepared a Wetland Delineation and Stream Assessment report that included consultation and habitat review for special status species. That report is included as Appendix A. Lists of federal and state species of concern were reviewed to determine the threatened and endangered species currently known to occur in Allen County. Those lists identified Indiana bat (*Myotis sodalis*; federally and state listed endangered) and northern long-eared bat (*Myotis septentrionalis*; federally and state listed listed threatened) currently known in Allen County. The Indiana bat and northern long-eared bat are addressed in detail in Appendix A.

Coordination letters were submitted to the Ohio Department of Natural Resources – Division of Wildlife (“ODNR-DOW”), Ohio National Heritage Program (“ONHP”) and U.S. Fish and Wildlife Service (“USFWS”) seeking environmental review of the Project for potential impacts to threatened or endangered species. On March 13, 2017, the ONHP indicated that there are no records of state endangered or threatened species within the Project vicinity. On March 16, 2017, USFWS noted that the Project lies within the range of the Indiana bat and northern long-eared bat. USFWS recommends that should the proposed site contain trees ≥ 3 inches dbh, that trees be saved wherever possible. If tree clearing cannot be avoided, USFWS recommends that tree removal occur between October 1 and March 31. Due to the Project type, size, and location, USFWS does not anticipate adverse effects to any other federally endangered, threatened,

proposed, or candidate species. AEP Ohio Transco received comments from ODNR on May 3, 2017. In addition to similar Indiana and northern long-eared bat comments as those provided by USFWS, ODNR requested seasonal restrictions regarding impacts to grassland nesting habitat associated the upland sandpiper from April 15 to July 31.

B(10)(f) Areas of Ecological Concern

Provide a description of the applicant's investigation concerning the presence or absence of areas of ecological concern (including national and state forests and parks, floodplains, wetlands, designated or proposed wilderness areas, national and state wild and scenic rivers, wildlife areas, wildlife refuges, wildlife management areas, and wildlife sanctuaries) that may be located within the potential disturbance area of the project, a statement of the findings of the investigation, and a copy of any document produced as a result of the investigation.

No areas of ecological concern were identified within the Project area. AEP Ohio Transco's consultant prepared a Wetland Delineation and Stream Assessment Report, included as Appendix A.

B(10)(g) Unusual Conditions

Provide any known additional information that will describe any unusual conditions resulting in significant environmental, social, health, or safety impacts.

To the best of AEP Ohio Transco's knowledge, no unusual conditions exist that would result in significant environmental, social, health, or safety impacts.

G:\Cincinnati\DCS\GIS\ArcMap_GeoDB_Projects\ENV\60538242_AEP_SterlingStation_CAD-GIS\920-GIS or Graphics\SterlingStation_CN_Fig1.mxd Date: 5/10/2018

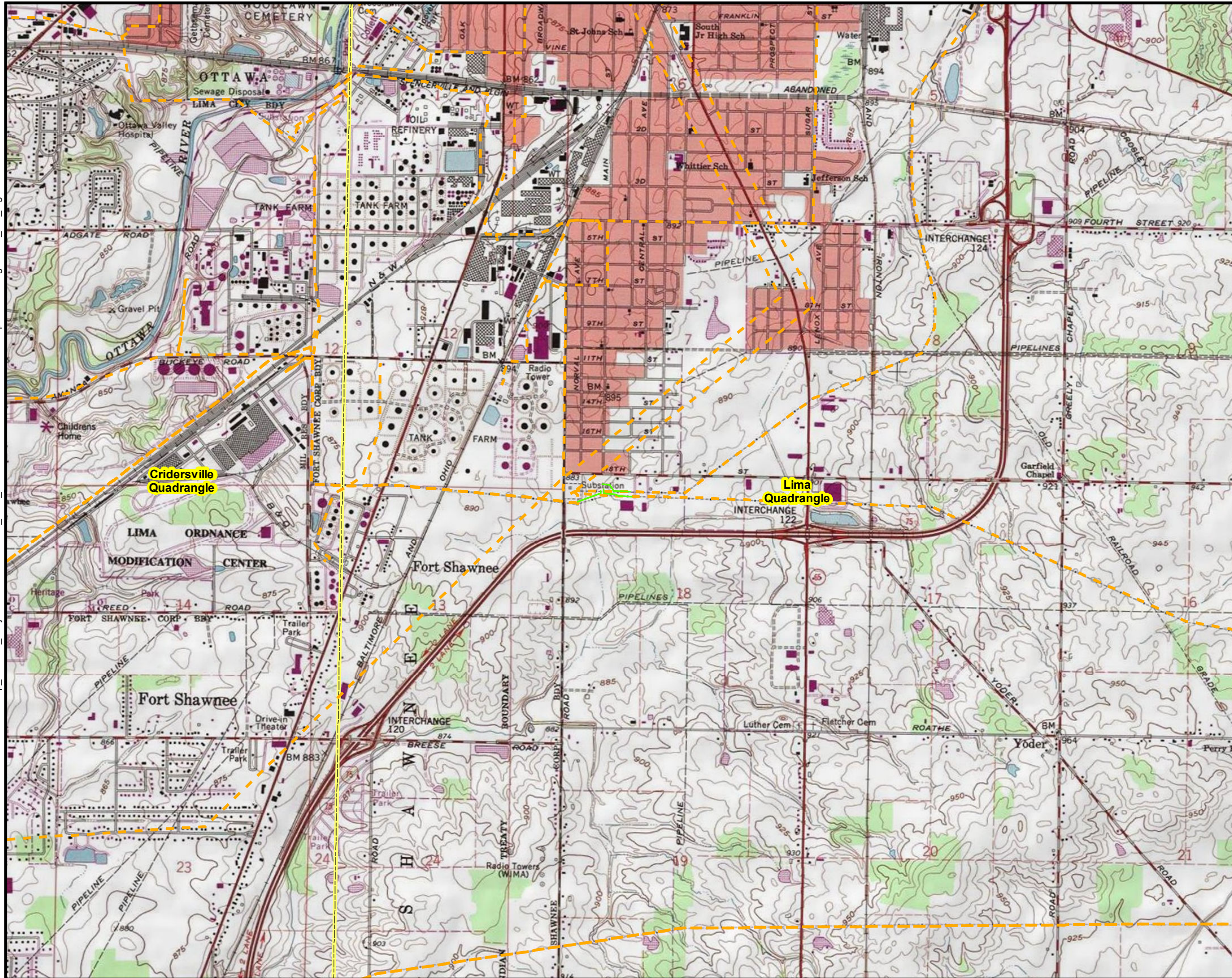

- LEGEND:
- Proposed Transmission Line Tap
 - - - Existing Transmission Line
 - USGS 7.5" Topographical Quadrangle

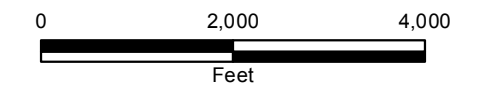

Base Map: http://goto.arcgisonline.com/maps/USA_Topo_Maps

AEP OHIO TRANSMISSION COMPANY Sterling Station Expansion

FIGURE 1
PROJECT OVERVIEW

Date Saved: 5/10/2018	SCALE: 1:24,000
CREATED BY: SJJ	CHECKED BY: AG
JOB NO: 60538242	AECOM

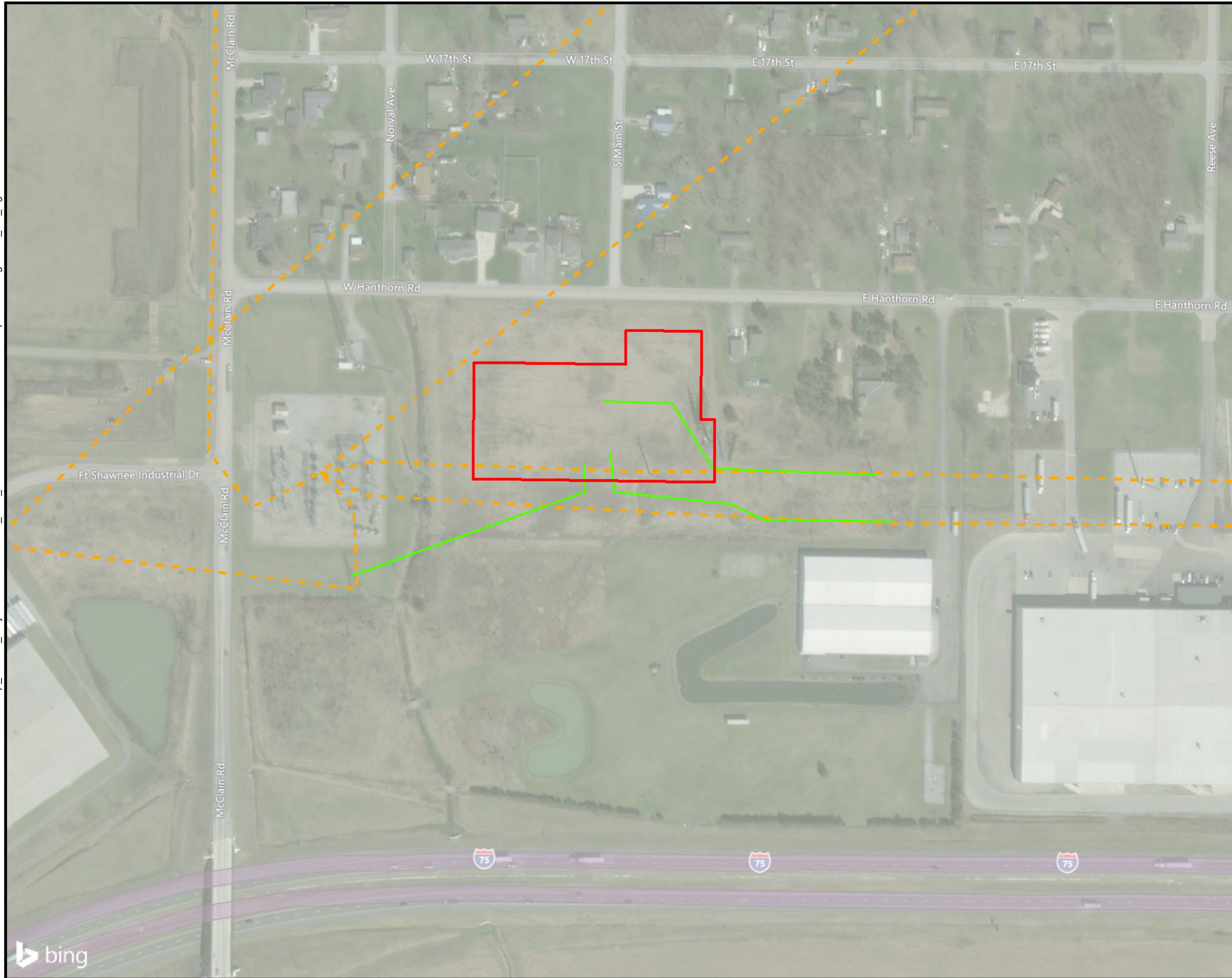

LEGEND:

- Proposed Expansion Area
- Proposed Transmission Line Tap
- Existing Transmission Line

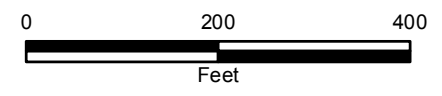

Base Map: http://goto.arcgisonline.com/maps/USA_Topo_Maps

AEP OHIO TRANSMISSION COMPANY Sterling Station Expansion

FIGURE 2
AERIAL PHOTOGRAPH OF
THE PROJECT VICINITY

Date Saved: 5/10/2018	SCALE: 1:2,400
CREATED BY: SJJ	CHECKED BY: AG
JOB NO: 60538242	AECOM

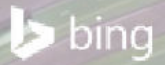

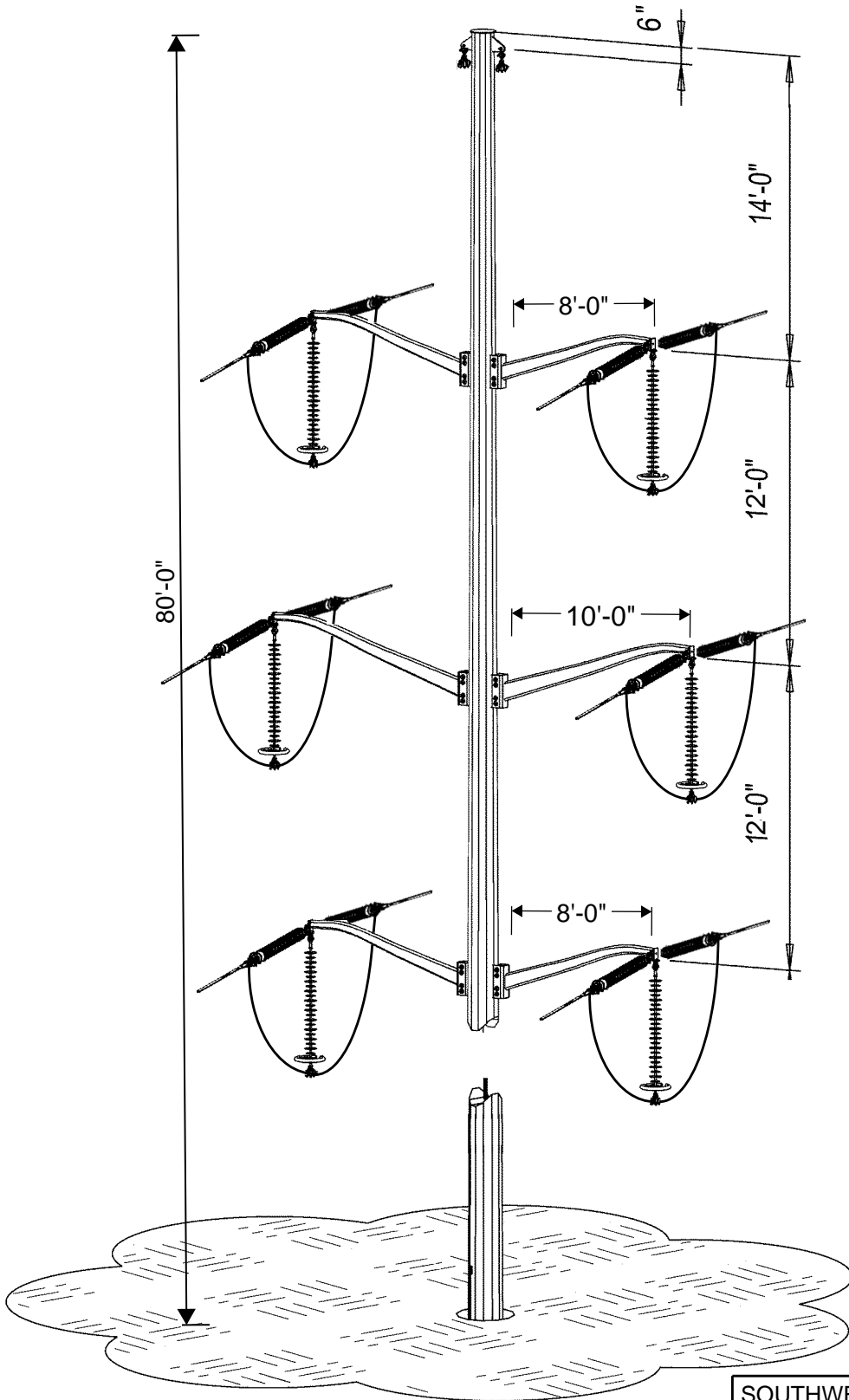

SOUTHWEST LIMA - STERLING 138KV LINE



TYPICAL 138KV DOUBLE CIRCUIT
STEEL DEAD END POLE

NOT TO SCALE

FIGURE 04-1A

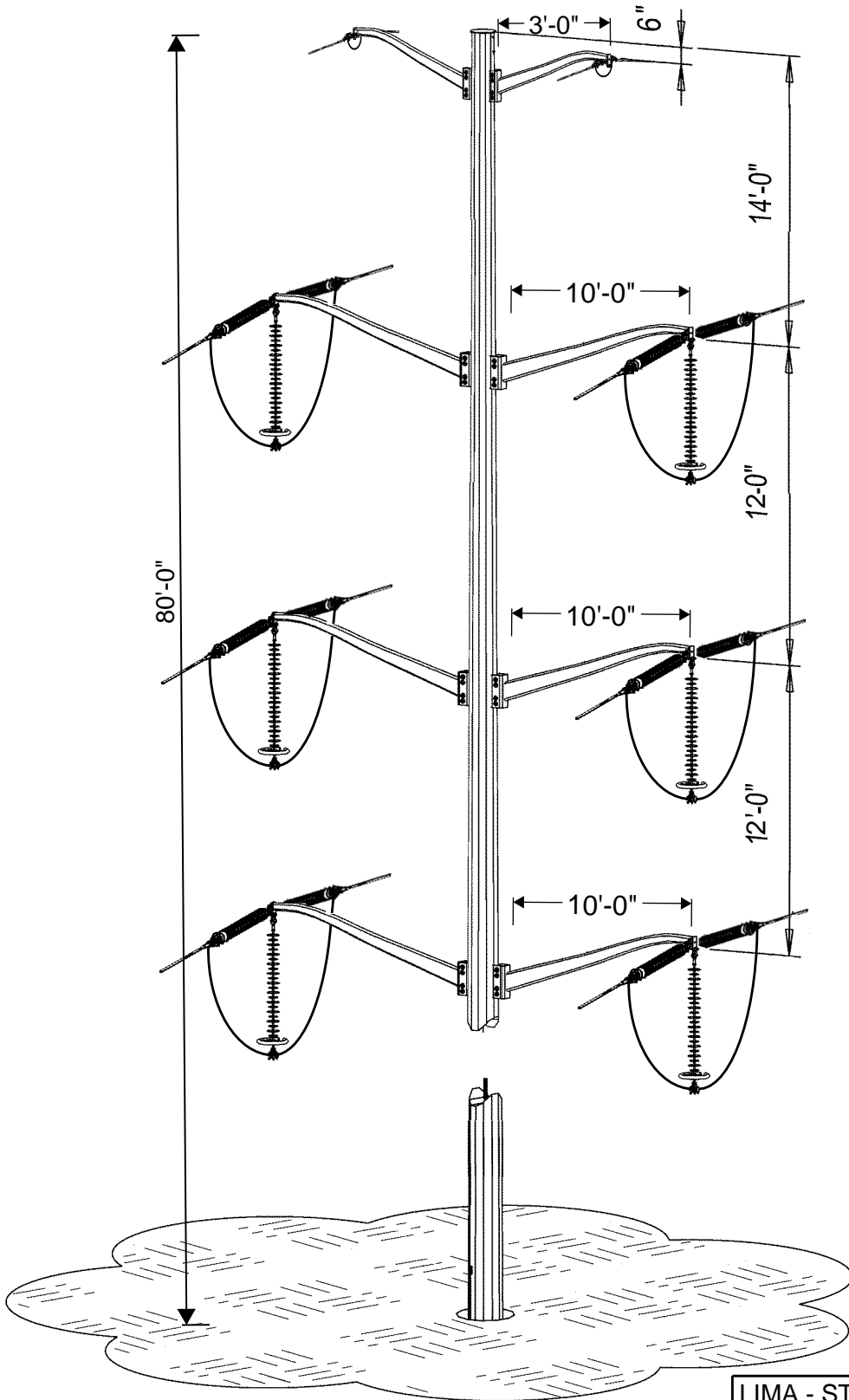

LIMA - STERLING 138KV LINE

AEP AMERICAN ELECTRIC POWER

TYPICAL 138KV DOUBLE CIRCUIT STEEL DEAD END POLE

NOT TO SCALE | FIGURE 04-1C

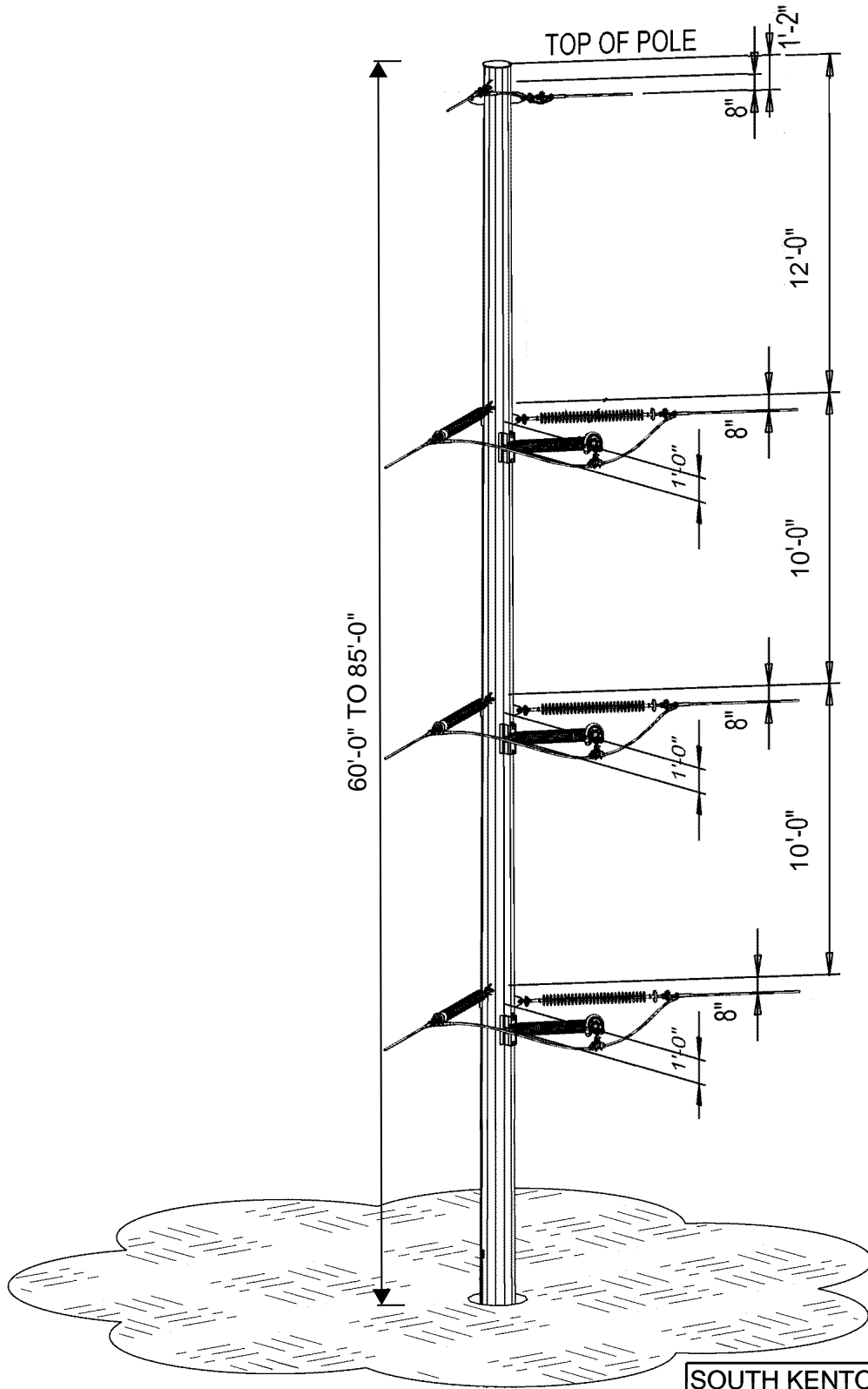

SOUTH KENTON - STERLING 138KV LINE
STERLING - FOUNDRY PARK 138KV LINE



TYPICAL 138KV SINGLE CIRCUIT STEEL
DEAD END POLE

NOT TO SCALE

FIGURE 04-1D

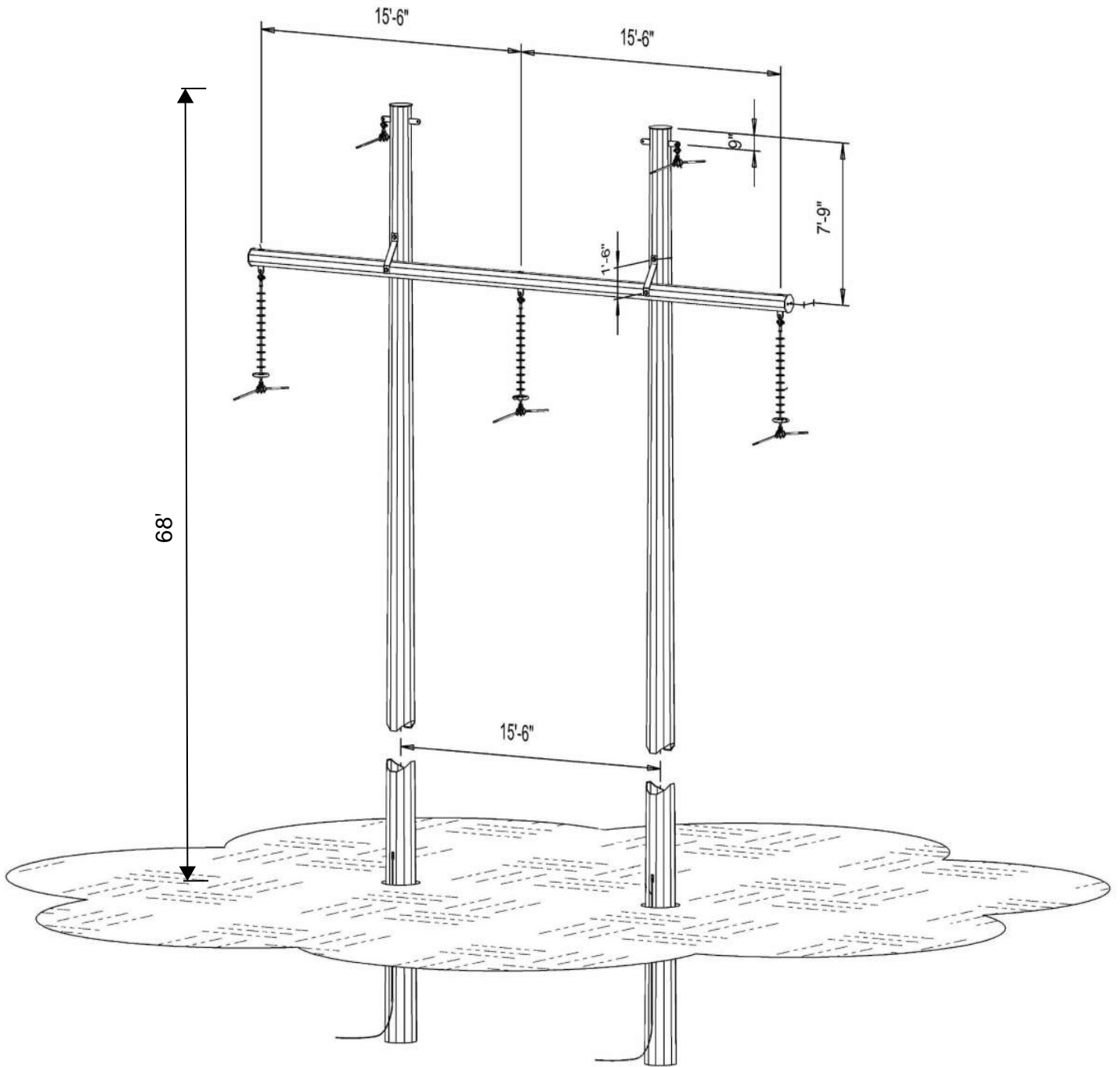

SOUTH KENTON - STERLING 138KV LINE



TYPICAL 138KV SINGLE CIRCUIT STEEL H-FRAME STRUCTURE

NOT TO SCALE

FIGURE 04-1F

PUCO FORM FE-T8
AEP OHIO
SUMMARY OF EXISTING SUBSTATIONS ON TRANSMISSION LINES

Substation Name	Type Distribution (D) Transmission (T)	Voltage(s) (kV)	Line Association (FE-T7 or FE-T9 Notation)	Notation	Line Existing or Proposed
SOUTH HICKSVILLE	T	138	Lockwood Road - Robison Park	771	E
SOUTH KENTON	T	138	East Lima - South Kenton	700	E
SOUTH KENTON	T	138	South Kenton - West Mount Vernon	748	E
SOUTH LANCASTER	T	138	Crooksville - South Lancaster	696	E
SOUTH LANCASTER	T	138	South Lancaster - West Lancaster	751	E
SOUTH LUCASVILLE	D	138	North Portsmouth - South Lucasville	21537	E
SOUTH LUCASVILLE	D	138	Don Marquis - South Lucasville	21538	E
SOUTH MILLERSBURG	T	138	Ohio Central - West Millersburg	12478	E
SOUTH POINT	T	138	Apple Grove - South Point	184	E
SOUTH POINT	T	138	South Point - Tri State	2845	E
SOUTH POINT	T	138	Millbrook Park - South Point	726	E
SOUTH TIFFIN	T	138	Melmore - West End Fostoria	22940	E
SOUTH TORONTO	T	138	*South Toronto - Weirton (FE) - Wylie Ridge (FE)	614	E
SOUTHEAST CANTON	T	138	Canton Central - Southeast Canton 138 kV	689	E
SOUTHEAST CANTON	T	138	South Canton - Southeast Canton 138 kV	744	E
SOUTHEAST CANTON	T	138	Southeast Canton - Sunnyside	749	E
SOUTHEAST CANTON	T	138	Southeast Canton - Timken	750	E
SOUTHEAST CANTON	T	345	Canton Central - Southeast Canton 345 kV	14378	E
SOUTHEAST CANTON	T	345	South Canton - Southeast Canton 345 kV	14857	E
SOUTHWEST LIMA	T	138	Southwest Lima - West Moulton	4842	E
SOUTHWEST LIMA	T	138	Ordnance Junction Sw. - Southwest Lima	741	E
SOUTHWEST LIMA	T	138	Southwest Lima - West Lima	752	E
SOUTHWEST LIMA	T	345	*Shelby (DP&L) - Southwest Lima	559	E
SOUTHWEST LIMA	T	345	East Lima - Southwest Lima	582	E
SOUTHWEST LIMA	T	345	Marysville - Southwest Lima	585	E
SPENCER RIDGE SWITCH	T	138	Crooksville - Poston Strouds Run	594	E
SPRING ROAD SWITCH	T	138	Genoa - Karl Road - Morse Road	639	E
STELZER	T	138	Mifflin - Stelzer	5941	E
STELZER	T	138	Morse Road - Stelzer	664	E
STERLING	T	138	East Lima - Sterling	2043	E
STERLING	T	138	North Delphos - Sterling	24279	E
STERLING	T	138	Ordnance Junction Sw. - Sterling	740	E
STRASBURG	D	138	Philo Sw. - South Canton	742	E
STROUDS RUN	T	138	Crooksville - Poston Strouds Run	594	E
SUGARCREEK TERMINAL	D	138	Philo Sw. - South Canton	742	E



AEP Transmission Zone

Supplemental Project

Problem Statement:

PJM originally identified an overload on the Lincoln – Sterling 138 kV line in the 2012 RTEP analysis (b1881). AEP identified the overloaded elements as terminal equipment at Sterling station. During the detailed scoping and engineering stage of the baseline project, it was determined to rebuild the entire station in the clear to help alleviate aging infrastructure concerns with other existing station equipment at Sterling. Sterling station houses transformers from 1947 and 1951 that leak oil and seven circuit breakers dating from between 1952 and 1955 that have no spare parts and are no longer supported by the vendor. The station was constructed in 1943 and the majority of the station structures are original.

Recommended Transmission Solution:

Rebuild Sterling 138kV station in the clear. (S1206)

Transmission Alternates Considered:

No good alternates. The station is in extremely poor condition and any attempt to upgrade the terminal equipment will be short lived. Also, workers will be exposed to unsafe conditions due to poor station records pertaining to live cables buried at the station in the early 1940s.

Estimated Transmission Cost: \$9.0M

Projected IS Date: 11/1/2018

Status: Engineering

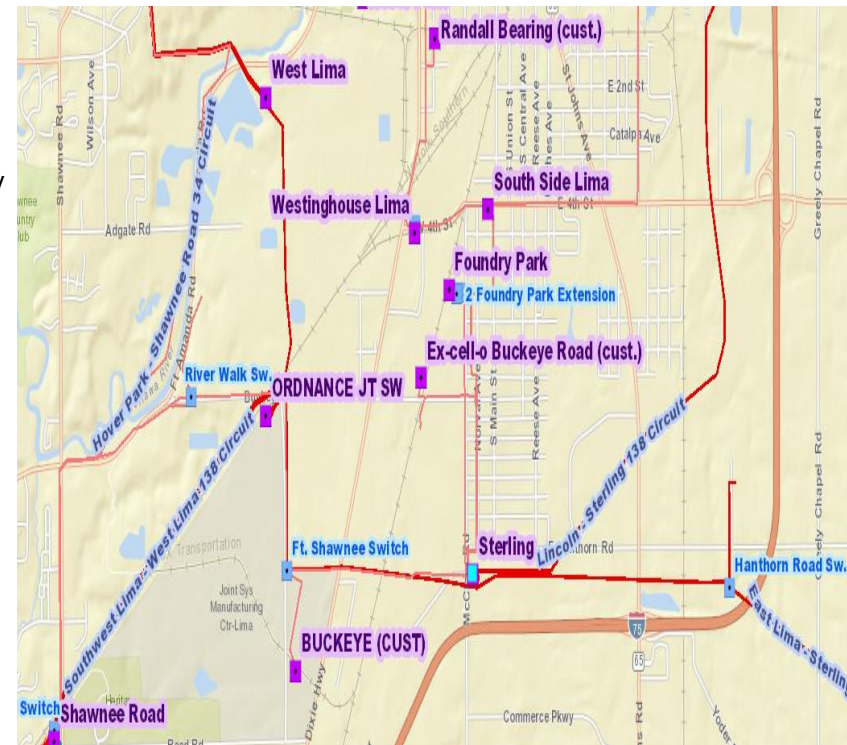

Appendix A Wetland Delineation and Stream Assessment Report

STERLING STATION EXPANSION PROJECT, ALLEN COUNTY, OHIO

WETLAND DELINEATION AND STREAM ASSESSMENT REPORT

Prepared for:

American Electric Power Ohio Transmission Company
700 Morrison Road
Gahanna, Ohio 45230



Prepared by:

AECOM
525 Vine Street, Suite 1800
Cincinnati, Ohio 45202

Project #: 60538242

January 2018

TABLE OF CONTENTS

1.0	INTRODUCTION.....	1
2.0	METHODOLOGY.....	1
2.1	WETLAND DELINEATION.....	1
2.1.1	SOILS.....	2
2.1.2	HYDROLOGY.....	2
2.1.3	VEGETATION.....	3
2.2	STREAM CROSSINGS.....	5
2.2.1	OEPA QUALITATIVE HABITAT EVALUATION INDEX.....	5
2.2.2	OEPA PRIMARY HEADWATER HABITAT EVALUATION INDEX.....	6
3.0	RESULTS.....	7
3.1	WETLAND DELINEATION.....	7
3.1.1	PRELIMINARY SOILS EVALUATION.....	7
3.1.2	NATIONAL WETLAND INVENTORY MAP REVIEW.....	8
3.1.3	DELINEATED WETLANDS.....	9
3.2	STREAM CROSSINGS.....	9
3.3	PONDS.....	10
3.4	VEGETATIVE COMMUNIT IES WITHIN THE PROJECT SURVEY AREA.....	10
3.5	THREATENED AND ENDANGERED SPECIES AGENCY COORDINATION.....	11
4.0	SUMMARY.....	16
5.0	REFERENCES.....	18

TABLES**Number**

TABLE 1	SOIL MAP UNITS AND DESCRIPTIONS WITHIN THE STERLING STATION EXPANSION PROJECT SURVEY AREA
TABLE 2	DELINEATED WETLANDS WITHIN THE STERLING STATION EXPANSION PROJECT SURVEY AREA
TABLE 3	VEGETATIVE COMMUNITIES WITHIN THE PROJECT AREA
TABLE 4	ODNR AND USFWS LISTED SPECIES WITHIN THE PROJECT AREA

FIGURES**Number**

FIGURE 1	Overview Map
FIGURE 2	Soil Map Unit and National Wetland Inventory Map
FIGURE 3	Wetland Delineation and Stream Assessment Map
FIGURE 4	Vegetative Communities Assessment Map

APPENDICES**Number**

APPENDIX A	U.S. Army Corps of Engineers Wetland Forms
APPENDIX B	OEPA Wetland ORAM Forms
APPENDIX C	OEPA HHEI Stream Form
APPENDIX D	Delineated Features Photographs
APPENDIX E	Correspondence Letters from USFWS and ODNR

LIST OF ACRONYMS and ABBREVIATIONS

AEP Ohio Transco	American Electric Power Ohio Transmission Company
FAC	Facultative
FACU	Facultative upland
FACW	Facultative wetland
GPS	Global Positioning System
IBI	Index of Biotic Integrity
NRCS	Natural Resources Conservation Service
NWI	National Wetlands Inventory
OBL	Obligate wetland
ODNR	Ohio Department of Natural Resources
OEPA	Ohio Environmental Protection Agency
OHWM	Ordinary high water mark
ONHD	Ohio Natural Heritage Database
QHEI	Qualitative Habitat Evaluation Index
ROW	Right-of-way
UPL	Upland
U.S.	United States
USACE	United States Army Corps of Engineers
USDA	United States Department of Agriculture
USFWS	United States Fish and Wildlife Service
USGS	United States Geological Survey

1.0 INTRODUCTION

American Electric Power Ohio Transmission Company's (AEP Ohio Transco) is proposing to expand its existing Sterling Station in Allen County, Ohio. AEP requested that AECOM survey approximately 18 acres that includes the existing station and adjacent areas, although the expansion is not expected to extend across the entire survey area. The existing fenced area of the station is approximately 2 acres. The proposed Project is illustrated on Figure 1.

Land uses within the Project survey area were assigned a general classification based upon the principal land characteristics of the location as observed through aerial photography review and observations during the field surveys. The general land use type in within the proposed Project area included: old field, existing transmission station, and maintained transmission line right-of-way (ROW).

2.0 METHODOLOGY

The purpose of the field survey was to assess whether wetlands and other "waters of the U.S." exist within the approximately 18-acre Project survey area. Prior to conducting field surveys, digital and published county Natural Resources Conservation Service (NRCS) soil surveys, U.S. Fish and Wildlife Service (USFWS) National Wetland Inventory (NWI) maps, and U.S. Geological Survey (USGS) 7.5-minute topographic maps were reviewed as an exercise to identify the occurrence and location of potential wetland areas.

On March 20th, 2017, and January 22, 2018, AECOM ecologists walked the Project survey area to conduct a wetland delineation and stream assessment. During the field survey, the physical boundaries of observed water features were recorded using sub-decimeter accurate Trimble Global Positioning System (GPS) units. The GPS data was imported into ArcMap GIS software, where the data was then reviewed and edited for accuracy.

2.1 WETLAND DELINEATION

The Project survey area was evaluated according to the procedures outlined in the U.S. Army Corps of Engineers (USACE) 1987 Wetland Delineation Manual (1987 Manual) (Environmental Laboratory, 1987) and the Regional Supplement to the Corps of Engineers Wetland Delineation Manual: Midwest Region (Version 2.0) (Regional Supplement) (USACE, 2010). The Midwest Regional Supplement was released by the USACE in August 2010 to address regional wetland characteristics and improve the accuracy and efficiency of wetland delineation procedures. This 1987 Manual and Regional Supplement define wetlands as areas that have positive evidence of three environmental parameters: hydric soils, wetland hydrology, and hydrophytic vegetation. Wetland boundaries are placed where one or more of these parameters give way to upland characteristics.

Since quantitative data were not available for any of the identified wetlands, AECOM utilized the routine delineation method described in the 1987 Manual and Regional Supplements that consisted of a pedestrian site reconnaissance, including identifying the vegetation communities, soils identification, a geomorphologic assessment of hydrology, and notation of disturbance. The methodology used to examine each parameter is described in the following sections.

2.1.1 SOILS

Soils were examined for hydric soil characteristics using a spade shovel to extract soil samples. A *Munsell Soil Color Chart* (Kollmorgen Corporation, 2010) was used to identify the hue, value, and chroma of the matrix and mottles of the soils. Generally, mottled soils with a matrix chroma of two or less, or unmottled soils with a matrix chroma of one or less are considered to exhibit hydric soil characteristics (Environmental Laboratory, 1987). In sandy soils, mottled soils with a matrix chroma of three or less, or unmottled soils with a matrix chroma of two or less are considered to be hydric soils.

2.1.2 HYDROLOGY

The *1987 Manual* requires that an area be inundated or saturated to the surface for an absolute minimum of five percent of the growing season (areas saturated between five percent and 12.5 percent of the growing season may or may not be wetlands, while areas saturated over 12.5 percent of the growing season fulfill the hydrology requirements for wetlands). The *Regional Supplement* states that the growing season dates are determined through onsite observations of the following indicators of biological activity in a given year: (1) above-ground growth and development of vascular plants, and/or (2) soil temperature (12-in. depth) is 41 degree Fahrenheit (°F) or higher as an indicator of soil microbial activity. Therefore, the beginning of the growing season in a given year is indicated by whichever condition occurs earlier, and the end of the growing season by whichever persists later.

The *Regional Supplement* also states that if onsite data gathering is not practical, the growing season can be approximated by the number of days between the average (five years out of ten, or 50 percent probability) date of the last and first 28°F air temperature in the spring and fall, respectively. The National Weather Service WETS data obtained from the NRCS National Water and Climate Center reveals for Allen County that in an average year, this period lasts from April 10 to November 2, or 206 days. In the Project area, five percent of the growing season equates to approximately ten days.

The soils and ground surface were examined for evidence of wetland hydrology in lieu of detailed hydrological data. This is an acceptable approach according to the *1987 Manual* and the *Regional Supplements*. Evidence indicating wetland hydrology typically includes primary indicators such as surface water, saturation, water marks, drift deposits, water-stained leaves, sediment deposits and oxidized rhizospheres on living roots; and secondary indicators such as drainage patterns, geomorphic position, micro-topographic relief, and a positive Facultative (FAC)-neutral test (USACE, 2010).

2.1.3 VEGETATION

Dominant vegetation was visually assessed for each stratum (tree, sapling/shrub, herb and woody vine) and an indicator status of obligate wetland (OBL), facultative wetland (FACW), facultative (FAC), facultative upland (FACU), and/or upland (UPL) was assigned to each plant species based on the U.S. Army Corps of Engineers *2016 National Wetland Plant List: Midwest Region*, which encompasses the area of the Project. An area is determined to have hydrophytic vegetation when, under normal circumstances, 50 percent or more of the composition of the dominant species are OBL, FACW and/or FAC species. Vegetation of an area was determined to be non-hydrophytic when more than 50 percent of the composition of the dominant species was FACU and/or UPL species. In addition to the dominance test, the FAC-Neutral test and prevalence tests are used to determine if a wetland has a predominance of hydrophytic vegetation. Recent USACE guidance indicates that to the extent possible, the hydrophytic vegetation decision should be based on the plant community that is normally present during the wet portion of the growing season in a normal rainfall year (USACE, 2010).

Vegetation sampling for wetland delineation can be challenging when some plants die back due to freezing temperatures or other factors (USACE, 2010). The end of the growing season is indicated when woody deciduous species lose their leaves or the last herbaceous plants cease flowering and their leaves become dry or brown, whichever occurs latest. The wetland delineation field work within the Project area was conducted after the occurrence of these events and therefore, outside the normal growing season. Conducting a wetland delineation outside the normal growing season can make identifying the wetland/upland boundary more challenging and may require further assessment during the next growing season.

2.1.4 WETLAND CLASSIFICATIONS

Wetlands were classified based on the naming convention found in *Classification of Wetlands and Deepwater Habitats of the United States* (Cowardin et al, 1979). The identified wetlands within the survey area were classified as a freshwater, Palustrine system, which includes non-tidal wetlands dominated by trees, shrubs, emergents, mosses, or lichens. One palustrine wetland class was identified within the Project survey area:

- **PEM** – Palustrine emergent wetlands are characterized by erect, rooted, herbaceous hydrophytes, excluding mosses and lichens. This vegetation is present for most of the growing season in most years. These wetlands are usually dominated by perennial plants.

2.1.5 OHIO RAPID ASSESSMENT METHOD v. 5.0

The Ohio Environmental Protection Agency (OEPA) Ohio Rapid Assessment Method for Wetlands v. 5.0 (ORAM) was developed to determine the relative ecological quality and level of disturbance of a particular

wetland in order to meet requirements under Section 401 of the Clean Water Act. Wetlands are scored on the basis of hydrology, upland buffer, habitat alteration, special wetland communities, and vegetation communities. Each of these subject areas is further divided into subcategories under ORAM v. 5. 0 resulting in a score that describes the wetland using a range from 0 (low quality and high disturbance) to 100 (high quality and low disturbance). Wetlands scored from 0 to 29.9 are grouped into "Category 1", 30 to 59.9 are "Category 2" and 60 to 100 are "Category 3". Transitional zones exist between "Categories 1 and 2" from 30 to 34.9 and between "Categories 2 and 3" from 60 to 64.9. However, according to the OEPA, if the wetland score falls into the transitional range, it must be given the higher Category unless scientific data can prove it should be in a lower Category (Mack, 2001).

Category 1 Wetlands

Category 1 wetlands support minimal wildlife habitat, hydrological and recreational functions, and do not provide for or contain critical habitats for threatened or endangered species. In addition, Category 1 wetlands are often hydrologically isolated and have some or all of the following characteristics: low species diversity, no significant habitat for wildlife use, limited potential to achieve wetland functions, and/or a predominance of non-native species. These limited quality wetlands are considered to be a resource that has been severely degraded or has a limited potential for restoration, or is of low ecological functionality.

Category 2 Wetlands

Category 2 wetlands "...support moderate wildlife habitat, or hydrological or recreational functions," and as wetlands which are "...dominated by native species but generally without the presence of, or habitat for, rare, threatened or endangered species; and wetlands which are degraded but have a reasonable potential for reestablishing lost wetland functions." Category 2 wetlands constitute the broad middle category of "good" quality wetlands, and can be considered a functioning, diverse, healthy water resource that has ecological integrity and human value. Some Category 2 wetlands are lacking in human disturbance and considered to be naturally of moderate quality; others may have been Category 3 wetlands in the past, but have been degraded to Category 2 status.

Category 3 Wetlands

Wetlands that are assigned to Category 3 have "...superior habitat, or superior hydrological or recreational functions." They are typified by high levels of diversity, a high proportion of native species, and/or high functional values. Category 3 wetlands include wetlands which contain or provide habitat for threatened or endangered species, are high quality mature forested wetlands, vernal pools, bogs, fens, or which are scarce regionally and/or statewide. A wetland may be a Category 3 wetland because it exhibits one or all of the above characteristics. For example, a forested wetland located in the flood plain of a

river may exhibit “superior” hydrologic functions (e.g., flood retention, nutrient removal), but not contain mature trees or high levels of plant species diversity.

2.2 STREAM CROSSINGS

Regulatory activities under the Clean Water Act provide authority for states to issue water quality standards and “designated uses” to all waters of the U.S. upstream to the highest reaches of the tributary streams. In addition, the Federal Water Pollution Control Act of 1972 and its 1977 and 1987 amendments require knowledge of the potential fish or biological communities that can be supported in a stream or river, including upstream headwaters. Streams were identified by the presence of a defined bed and bank, and evidence of an ordinary high water mark (OHWM). The USACE defines OHWM as “that line on the shore established by the fluctuations of water and indicated by physical characteristics such as a clear, natural line impressed on the bank, shelving, changes in the character of soil, destruction of terrestrial vegetation, the presence of litter and debris, or other appropriate means that consider the characteristics of the surrounding areas” (USACE, 2005).

Stream assessments were conducted using the methods described in the OEPA’s Methods for Assessing Habitat in Flowing Waters: Using OEPA’s *Qualitative Habitat Evaluation Index* (Rankin, 2006) and in the OEPA’s Field Evaluation Manual for Ohio’s Primary Headwater Habitat Streams (Ohio EPA, 2012).

2.2.1 OEPA QUALITATIVE HABITAT EVALUATION INDEX

The qualitative habitat evaluation index (QHEI) is designed to provide a rapid determination of habitat features that correspond to those physical factors that most affect fish communities and which are generally important to other aquatic life (e.g., macroinvertebrates). The quantitative measure of habitat used to calibrate the QHEI score are Indices (or Index) of Biotic Integrity (IBI) for fish. In most instances the QHEI is sufficient to give an indication of habitat quality, and the intensive quantitative analysis used to measure the IBI is not necessary. It is the IBI, rather than the QHEI, that is directly correlated with the aquatic life use designation for a particular surface water.

The QHEI method is generally considered appropriate for waterbodies with drainage basins greater than one square mile, if natural pools are greater than 40 cm, or if the water feature is shown as blue-line waterways on USGS 7.5-minute topographic quadrangle maps. In order to convey general stream habitat quality to the regulated public, the OEPA has assigned narrative ratings to QHEI scores. The ranges vary slightly for headwater streams (H are those with a watershed area less than or equal to 20 square miles) versus larger streams (L are those with a watershed area greater than 20 square miles). The Narrative Rating System includes: Very Poor (<30 H and L), Poor (30 to 42 H, 30 to 44 L), Fair (43 to 54 H, 45 to 59 L), Good (55 to 69 H, 60 to 74 L) and Excellent (70+ H, 75+ L).

2.2.2 OEPA PRIMARY HEADWATER HABITAT EVALUATION INDEX

Headwater streams are typically considered to be first-order and second-order streams, meaning streams that have no upstream tributaries (or “branches”) and those that have only first-order tributaries, respectively. The stream order concept can be problematic when used to define headwater streams because stream-order designations vary depending upon the accuracy and resolution of the stream delineation. Headwater streams are generally not shown on USGS 7.5-minute topographic quadrangles and are sometimes difficult to distinguish on aerial photographs. Nevertheless, headwater streams are now recognized as useful monitoring units due to their abundance, widespread spatial scale and landscape position (Fritz, et al. 2006). Impacts to headwater streams can have a cascading effect on the downstream water quality and habitat value. The headwater habitat evaluation index (HHEI) is a rapid field assessment method for physical habitat that can be used to appraise the biological potential of most Primary Headwater Habitat (PHWH) streams. The HHEI was developed using many of the same techniques as used for QHEI, but has criteria specifically designed for headwater habitats. To use HHEI, the stream must have a “defined bed and bank, with either continuous or periodically flowing water, with watershed area less than or equal to 1.0 mi² (259 ha), and a maximum depth of water pools equal to or less than 15.75 inches (40 cm)” (Ohio EPA, 2012).

Headwater streams are scored on the basis of channel substrate composition, bankfull width, and maximum pool depth. Assessments result in a score (0 to 100) that is converted to a specific PHWH stream class. Streams that are scored from 0 to 29.9 are typically grouped into "Class 1 PHWH Streams", 30 to 69.9 are "Class 2 PHWH Streams", and 70 to 100 are "Class 3 PHWH Streams". Technically, a stream can score relatively high, but actually belong in a lower class, and vice-versa. According to the OEPA, if the stream score falls into a class and the scorer feels that based on site observations that score does not reflect the actual stream class, a decision-making flow chart can be used to determine appropriate PHWH stream class using the HHEI protocol (Ohio EPA, 2012). Evidence of anthropogenic alterations to the natural channel will result in a “Modified” qualifier for the stream.

Class 1 PHWH Streams: Class 1 PHWH Streams are those that have “normally dry channels with little or no aquatic life present” (Ohio EPA, 2012). These waterways are usually ephemeral, with water present for short periods of time due to infiltration from snowmelts or rainwater runoff.

Class 2 PHWH Streams: Class 2 PHWH Streams are equivalent to "warm-water habitat" streams. This stream class has a "moderately diverse community of warm-water adapted native fauna either present seasonally or on an annual basis" (Ohio EPA, 2012). These species communities are composed of vertebrates (fish and salamanders) and/or benthic macroinvertebrates that are considered pioneering, headwater temporary, and/or temperature facultative species.

Class 3 PHWH Streams: Class 3 PHWH Streams usually have perennial water flow with cool-cold water adapted native fauna. The community of Class 3 PHWH Streams is comprised of vertebrates (either cold water adapted species of headwater fish and or obligate aquatic species of salamanders, with larval stages present), and/or a diverse community of benthic cool water adapted macroinvertebrates present in the stream continuously (on an annual basis).

2.3 Threatened and Endangered Species

AECOM conducted a rare, threatened, and endangered species review and general field habitat surveys within areas crossed by the Project survey area. This report will be used to assist AEP Ohio Transco's efforts to avoid impacts to threatened and endangered species potentially present in the survey area during construction activities. The first phase of the survey involved a review of online lists of federal and state species of concern. In addition to the review of available literature, AECOM submitted a request to Ohio Department of Natural Resources (ODNR) Ohio Natural Heritage Database (ONHD) for Geographical Information System (GIS) records of species of concern that were reported within close proximity to the Project. AECOM also submitted coordination letters to the USFWS, ODNR – Division of Wildlife (DOW), and ODNR – Division of Soil and Water Resources (DSWR) soliciting comments on the Project. Agency-identified species and available species-specific information was reviewed to identify the various habitat types that listed species are known to frequent. AECOM field ecologists conducted a general habitat survey in conjunction with the stream and wetland field survey on March 20th, 2017 and January 22, 2018.

3.0 RESULTS

Within the Project survey area, AECOM delineated two wetlands and one stream. No ponds were identified within the Project survey area. The assessed features are discussed in detail in the following sections.

3.1 WETLAND DELINEATION

3.1.1 Preliminary Soils Evaluation

Soils in the delineated wetland were observed and documented as part of the delineation methodology. According to the USDA/NRCS Web Soil Surveys of Allen County, Ohio (NRCS 2017) and the NRCS Hydric Soils Lists of Ohio, five soil series are mapped within the Project survey area (NRCS 2017). Within these soil series, six soil map units are listed as hydric. Table 1 provides a detailed overview of all soil series and soil map units within the Project survey area. Soil map units located within the Project survey area are shown on Figure 2.

**TABLE 1
SOIL MAP UNITS AND DESCRIPTIONS WITHIN THE STERLING STATION EXPANSION
PROJECT SURVEY AREA**

Soil Series	Symbol	Map Unit Description	Topographic Setting	Hydric	Hydric Component (%)
Blount	Blg1A1	Blount silt loam, ground moraine, 0 to 2 percent	Ground moraines	Yes	Pewamo, ground moraine (9)
	Blg1B1	Blount silt loam, ground moraine, 2 to 4 percent slopes	Ground moraines	Yes	Pewamo, ground moraine (9)
Blount-Urban	BsA	Blount-Urban land complex, 0 to 2 percent slopes	Till plains	Yes	Typic Endoaquents, till substratum (6)
Glynwood	Gwg1B1	Glynwood silt loam, ground moraine, 2 to 6 percent slopes	Ground moraines	Yes	Pewamo (6)
Pewamo	PmA	Pewamo silty clay loam, 0 to 1 percent slopes	Depressions	Yes	Pewamo (85), Minster (6)
Udorthents	UdA	Udorthents, loamy, 12 to 25 percent slopes	Depressions	Yes	Poorly drained soils at the centers of cloverleaves (10)

NOTES:

(1) Data sources include:

[USDA, NRCS. 2017 Soil Survey Geographic \(SSURGO\) Database. Available online at: http://soildatamart.nrcs.usda.gov/](http://soildatamart.nrcs.usda.gov/)
[USDA, NRCS. December 2015. National Hydric Soils List by State. Available online at: http://www.nrcs.usda.gov/wps/portal/nrcs/main/soils/use/hydric/](http://www.nrcs.usda.gov/wps/portal/nrcs/main/soils/use/hydric/)

3.1.2 National Wetland Inventory Map Review

National Wetland Inventory (NWI) wetlands are areas of potential wetland that have been identified from USFWS aerial photograph interpretation which have typically not been field verified. Forested and heavy scrub/shrub wetlands are often not shown on NWI maps as foliage effectively hides the visual signature that indicates the presence of standing water and moist soils from an aerial view. The USFWS website states that the NWI maps are not intended or designed for jurisdictional wetland identification or location. As a result, NWI maps do not show all the wetlands found in a particular area nor do they necessarily provide accurate wetland boundaries. NWI maps are useful for providing indications of potential wetland areas, which are often supported by soil mapping and hydrologic predictions, based upon topographical analysis using USGS topographic maps.

According to the NWI maps of the Lima, Ohio quadrangle, the Project survey area does not contain any mapped NWI wetlands.

3.1.3 Delineated Wetlands

AECOM identified two wetlands totaling 0.15 acre within the Project survey area. Both wetlands were identified as Category 1, PEM wetlands with scores of 18.5 (Wetland 01) and 21.5 (Wetland 02). These wetlands generally exhibited narrow to medium upland buffers and moderately high to high intensive surrounding land use (residential, urban, industrial, etc.), exhibited very limited plant community development with nearly absent to sparse percentage of invasive species, and characteristically had habitat and hydrology in the early stages of recovering from previous manipulation due to mowing and sedimentation. A summary of the delineated wetlands within the Project survey area is provided in Table 2.

No Category 2 or Category 3 wetlands were identified by AECOM within the Project survey area.

The locations of the wetlands identified within the Project survey area is shown on Figure 3. Completed USACE and ORAM wetland delineation forms are provided in Appendices A and B, respectively. Color photographs taken of the wetlands are provided in Appendix D.

**TABLE 2
DELINEATED WETLANDS WITHIN THE STERLING STATION EXPANSION PROJECT SURVEY AREA**

Wetland Name	Latitude	Longitude	Cowardin Wetland Type ^a	ORAM Score	ORAM Category	Acreage within Project Survey Area
Wetland 01	40.7009	-84.1033	PEM	18.5	Category 1	0.03
Wetland 02	40.7009	-84.1039	PEM	21.5	Category 1	0.12
Total: 2 Wetlands						0.15

Cowardin Wetland Type^a: PEM = palustrine emergent,

3.2 STREAM CROSSINGS

AECOM identified one intermittent stream, totaling 663 linear feet, within the Project survey area. This stream (Stream 1) was assessed using the HHEI methodology (drainage area less than 1 mi²). The stream was identified as “modified Class 2” stream and received an HHEI score of 68. The substrates were generally dominated by silt and leaf pack/wood debris. The stream showed evidence of stream channel modification (e.g., channelization, culverting, etc.) that resulted in the stream receiving a Modified Class 2 designation. The maximum pool depths ranged was 11 inches, and average bankfull width was 15 feet. The stream’s location within the Project survey area is shown on Figure 3. A completed HHEI form is provided in Appendix C. Color photographs taken of the stream are provided in Appendix D.

AECOM has preliminarily determined that the assessed stream within the Project survey area appears to be jurisdictional (i.e., waters of the U.S.), as it appears to be a tributary that flows into or combines with other streams (waters of the U.S).

3.3 PONDS

No ponds were identified by AECOM with in the Project survey area.

3.4 VEGETATIVE COMMUNITIES WITHIN THE PROJECT SURVEY AREA

AECOM field ecologists conducted a general habitat survey in conjunction with the stream and wetland field survey on March 20th, 2017, and January 22, 2018. Portions of the Project survey area were identified as existing transmission station (urban area), landscaped areas, stream/wetland areas and old field. Habitat descriptions, applicable to the Project, and details on the expected impacts of construction are provided below. Vegetated land cover can be seen visually from aerial photography provided on Figure 4.

**TABLE 3
VEGETATIVE COMMUNITIES WITHIN THE PROJECT AREA**

Vegetative Community	Description	Approximate Acreage Within the Project Survey Area	Approximate Percentage within the Project Survey Area
Landscaped Area	Landscaped areas, including residential properties and commercial properties, were observed within the Project vicinity. These landscaped areas within the Project survey area and adjacent areas are frequently mowed grasses and forbs.	3.7	21%
Old Field	Scrub-shrub habitats represent the successional stage between old-field and second growth forest, and often emerge in recently harvested forests responding to the lightness of the removed canopy. Dominant species consist of herbaceous communities similar to that of old field habitat with a few woody species, to a community dominated by forest herbs and woody species.	10.5	59%
Urban	Urban areas are areas developed with residential and commercial land uses, including roads, buildings and parking lots. These areas are generally devoid of significant woody and herbaceous vegetation.	3.2	18%
Stream/Wetland	Wetlands and a Stream and wetlands were observed within the Project survey area	0.5	2%
Totals:		17.9	100%

3.5 THREATENED AND ENDANGERED SPECIES AGENCY COORDINATION***Protected Species Agency Consultation –***

AECOM conducted a rare, threatened, and endangered species review for areas crossed by the Project survey area. The first phase of the evaluation involved a review of online lists of federal and state species of concern. In addition to the review of available literature, a request was submitted to ODNR Ohio Natural Heritage Database for records of species of concern that were reported within close proximity to the Project. Coordination letters to the USFWS, ODNR – DOW, and ODNR – DSWR soliciting comments on the project were also submitted. A summary of the agency coordination is provided below. Correspondence letters from the USFWS and ODNR are included as Appendix E. Table 4 provides a list of these species of concern identified in the Project area during the rare, threatened, and endangered species review.

TABLE 4
ODNR AND USFWS LISTED SPECIES WITHIN THE PROJECT AREA

Common Name (Scientific Name)	State Status	Federal Status	Habitat Description	Potential Habitat Observed in the Project Survey Area	Impact Assessment	Agency Comments
Mammals						
Indiana bat (<i>Myotis sodalis</i>)	Endangered	Endangered	Winter Indiana bat hibernacula include caves and mines, while summer habitat typically includes tree species exhibiting exfoliating bark or cavities that can be used for roosting. The 8- to 10-inch diameter size classes of several species of hickory (<i>Carya</i> spp.), oak (<i>Quercus</i> spp.), ash (<i>Fraxinus</i> spp.), birch (<i>Betula</i> spp.), and elm (<i>Ulmus</i> spp.) have been found to be utilized by the Indiana bat. These tree species and many others may be used when dead, if there are adequately sized patches of loosely-adhering bark or open cavities. The structural configuration of forest stands favored for roosting includes a mixture of loose-barked trees with 60 to 80 percent canopy closure and a low density sub-canopy (less than 30 percent between about 6 feet high and the base canopy). The suitability of roosting habitat for foraging or the proximity to suitable foraging habitat is critical to the evaluation of a particular tree stand. An open subcanopy zone, under a moderately dense canopy, is important to allow maneuvering while catching insect prey. Proximity to water is critical, because insect prey density is greater over or near open water.	No	No woodlots were observed within the Project survey area.	USFWS commented that due to the project type, size, and location, plus the project proposal for seasonal cutting tree cutting between October 1 and March 31, there should be no expected impacts to the Indiana bat. ODNR requested that suitable Indiana bat habitat should be conserved or cut between October 1 and March 31.

TABLE 4
ODNR AND USFWS LISTED SPECIES WITHIN THE PROJECT AREA

Common Name (Scientific Name)	State Status	Federal Status	Habitat Description	Potential Habitat Observed in the Project Survey Area	Impact Assessment	Agency Comments
Northern long-eared bat (<i>Myotis septentrionalis</i>)	Threatened	Threatened	Winter hibernacula include caves and mines, while summer habitat typically includes tree species exhibiting exfoliating bark or cavities that can be used for roosting. The 8- to 10-inch diameter size classes of several species of hickory (<i>Carya</i> spp.), oak (<i>Quercus</i> spp.), ash (<i>Fraxinus</i> spp.), birch (<i>Betula</i> spp.), and elm (<i>Ulmus</i> spp.) have been found to be utilized by northern long-eared bats. These tree species and many others may be used when dead, if there are adequately sized patches of loosely-adhering bark or open cavities. The structural configuration of forest stands favored for roosting includes a mixture of loose-barked trees with 60 to 80 percent canopy closure and a low density sub-canopy (less than 30 percent between about 6 feet high and the base canopy). The suitability of roosting habitat for foraging or the proximity to suitable foraging habitat is critical to the evaluation of a particular tree stand. An open subcanopy zone, under a moderately dense canopy, is important to allow maneuvering while catching insect prey. Proximity to water is critical, because insect prey density is greater over or near open water. Northern long-eared bats have also been found, albeit rarely, roosting in structures like barns and sheds.	No	No woodlots were observed within the Project survey area	USFWS commented that due to the project type, size, and location, plus the project proposal for seasonal cutting tree cutting between October 1 and March 31, there should be no expected impacts to the northern long-eared bat.
Mussels						
Clubshell (<i>Pleurobema clava</i>)	Endangered	Endangered	This mussel prefers clean, loose sand and gravel in medium to small rivers and streams. This mussel will bury itself in the bottom substrate to depths of up to four inches.	Yes	No in-water work is planned as part of the Project. No impacts to mussel species and their habitat are anticipated.	ODNR stated that due to the location, and that there is no in-water work proposed in a perennial stream, this project is not likely to impact these species.

TABLE 4
ODNR AND USFWS LISTED SPECIES WITHIN THE PROJECT AREA

Common Name (Scientific Name)	State Status	Federal Status	Habitat Description	Potential Habitat Observed in the Project Survey Area	Impact Assessment	Agency Comments
Pondhorn (<i>Uniomerus tetralasmus</i>)	Threatened	None	This mussel prefers ponds, small creeks, and the headwaters of larger streams in mud and sand. This mussel can withstand periods of desiccation and is often present in areas where few other mussels are found.	Yes	No in-water work is planned as part of the Project. No impacts to mussel species and their habitat are anticipated.	ODNR stated that due to the location, and that there is no in-water work proposed in a perennial stream, this project is not likely to impact these species.
Northern Riffleshell (<i>Epioblasma torulosa rangiana</i>)	Endangered	Endangered	This mussel prefers stable, undisturbed habitat and a sufficient population of host fish to complete the mussel's larval development. Adult mussels require gravel and sand habitat.	Yes	No in-water work is planned as part of the Project. No impacts to mussel species and their habitat are anticipated.	ODNR stated that due to the location, and that there is no in-water work proposed in a perennial stream, this project is not likely to impact these species.
Fish						
Greater redbhorse (<i>Moxostoma valenciennesi</i>)	Threatened	Species of Concern	Found in medium to large rivers in the Lake Erie drainage system. Only found in limited portions of the Sandusky, Maumee, and Grand River systems. Greater redbhorse are typically found in pools with clean sand or gravel substrate, but are intolerant of pollution and turbid water.	Yes	No in-water work is planned as part of the Project. No impacts to fish species and their habitat are anticipated.	ODNR stated that due to the location, and that there is no in-water work proposed in a perennial stream, this project is not likely to impact these species.
Birds						
Upland sandpiper (<i>Bartramia longicauda</i>)	Endangered	None	Nesting upland sandpipers utilize dry grasslands including native grasslands, seeded grasslands, grazed and ungrazed pasture, hayfields, and grasslands established through the Conservation Reserve Program (CRP).	Yes	Some potentially suitable habitat is present within the Project area (old field; pasture; emergent wetland habitats).	If grassland habitat will be impacted, ODNR requests construction should be avoided in this habitat during the species' nesting period of April 15 to July 31. If this type of habitat will not be impacted, this project is not likely to impact this species.

ODNR-DOW Coordination –

Coordination with the ODNR-DOW was initiated during the planning stages of the Project to obtain ONHD records located in the vicinity of the project. On March 13, 2017, the ODNR-DOW replied to an e-mailed request for records of protected species within an extended area around the Project site. The ONHD indicated that there are no records of state endangered or threatened plants or animals within the Project vicinity. In a letter dated May 3, 2017, the ODNR-DOW provided comments on the Project with regard to state and/or federally-listed threatened and endangered species that may occur within the Project vicinity (Table 4).

ODNR noted that the Project is within the range of three state-listed mussel species (clubshell (*Pleurobema clava*), the northern riffleshell (*Epioblasma torulosa rangiana*), and the pondhorn (*Unio merus tetralasmus*)) and one state-listed fish species (greater redhorse (*Moxostoma valenciennesi*)). ODNR indicated that due to the location, and that there is no in-water work proposed in a perennial stream, this Project is not likely to impact these species.

The ODNR-DOW listed the upland sandpiper as being potential species found within the vicinity of the Project area; however, based on the ODNR's state listed wildlife species for Allen County, Ohio, the upland sandpiper has never been recorded in the county. ODNR-DOW has also indicated that the potential habitat ground cover types that are smaller than one acre in size and commercial or residential landscaped areas do not constitute adequate nesting habitat for this species.

AECOM ecologists walked the Project survey area to classify the general vegetative communities crossed by the Project. The field survey was supplemented through the review of aerial photography. Based on ODNR-DOW guidance and the field survey, upland sandpiper nesting habitat within areas crossed by the Project were identified. Approximately half of the Project area is not suitable for upland sandpiper nesting habitat. Landscaped areas and urban areas are frequently mechanically maintained and do not provide suitable grassland habitat for nesting. These areas were observed to be disturbed and devoid of grasses or maintained such that grasses were too short to provide nesting habitat.

One old field totaling approximately 10.5 acres (59% of the survey area) was observed, and appears to be suitable upland sandpiper nesting habitat. At the time of the field surveys, this old field exhibited tall grasses. It appears likely that grassy vegetation remains high enough to support upland sandpiper nesting. The potentially suitable nesting habitat areas are shown on Figure 4. If access road or work pad construction will occur within these areas during the upland sandpiper's nesting window of April 15th to July 31st a presence/absence survey based on the ODNR-DOW survey protocol for each species may be warranted.

USFWS Coordination –

In a letter dated March 16, 2017, the USFWS provided comments on the Project with regard to federally-listed threatened and endangered species that may occur within the project vicinity. The USFWS indicated that there are no Federal wildlife refuges, wilderness areas, or critical habitat within the vicinity of the Project.

The USFWS noted that the Project lies within the range of the federally endangered Indiana bat (*Myotis sodalis*), and the federally threatened northern long-eared bat (*Myotis septentrionalis*). USFWS recommends that should the proposed site contain trees ≥ 3 inches dbh, that trees be saved wherever possible. If tree clearing cannot be avoided, USFWS recommends that tree removal occur between October 1 and March 31 avoid adverse effects to Indian bats and northern long-eared bats during the brood-rearing months. Due to the project type, size, and location, the USFWS does not anticipate adverse effects to any other federally endangered, threatened, proposed, or candidate species.

4.0 SUMMARY

The ecological survey of the Project survey area identified a total of two wetlands and one stream. The two wetlands delineated within the Project survey area were both identified as PEM, Category 1 wetlands.

The intermittent stream identified within the Project survey area (Stream 1) was assessed using the HHEI methodology (drainage area less than 1 mi²) and was identified as a “modified Class 2” stream.

With regard to state and/or federally-listed threatened and endangered species that may occur within the Project vicinity, seven state listed species were listed by the ODNR or USFWS including the following: Indiana bat, northern long-eared bat, clubshell, northern riffleshell, pondhorn, greater redhorse and upland sandpiper. Based on agency responses and/or no proposed in-water work, the Project is not likely to impact the clubshell, northern riffleshell, pondhorn or greater redhorse. USFWS indicated that the Project lies within the range of the Indiana bat and northern long-eared bat. Based on general observations during the ecology survey, the Project survey area did not contain any potential summer habitat for the Indiana bat and the northern long-eared bat. USFWS stated that they do not anticipate impacts to the species due to the project type, size, location, and proposed implementation of seasonal tree cutting (during October 1st and March 31st).

ODNR commented that if impact to grasslands is to occur as a result of construction, this activity should be conducted outside of the upland sandpiper’s nesting window of April 15th to July 31st. If these habitats will not be impacted, the Project is not likely to impact the species. Based on general observations during the ecology survey, approximately 10.5 acres of the Project survey area contained potential grassland habitat for the upland sandpiper. If access road or work pad construction will occur within these areas

during the upland sandpiper's nesting window of April 15th to July 31st, a presence/absence survey based pm the ODNR-DOW upland sandpiper survey protocol may be warranted.

The reported results of the ecological survey conducted by AECOM on this Project are limited to the areas within the Project survey boundary provided in Figure 3: Wetland Delineation and Stream Assessment Map. Areas that fall outside of the Project survey boundary, including any portion of work pads or access roads, were not evaluated in the field and are not included in the reporting of this survey.

The information contained in this wetland delineation report is for a study area that may be much larger than the actual Project limits-of-disturbance; therefore, lengths and acreages listed in this report may not constitute the actual impacts of the Project defined in subsequent permit applications. If necessary, a separate report that identifies the actual Project impacts will be provided with agency submittals.



The field survey results presented herein apply to the existing and reasonably foreseeable site conditions at the time of our assessment. They cannot apply to site changes of which AECOM is unaware and has not had the opportunity to review. Changes in the condition of a property may occur with time due to natural processes or human impacts at the project site or on adjacent properties. Changes in applicable standards may also occur as a result of legislation or the expansion of knowledge over time. Accordingly, the findings of this report may be invalidated, wholly or in part, by changes beyond the control of AECOM.

5.0 REFERENCES

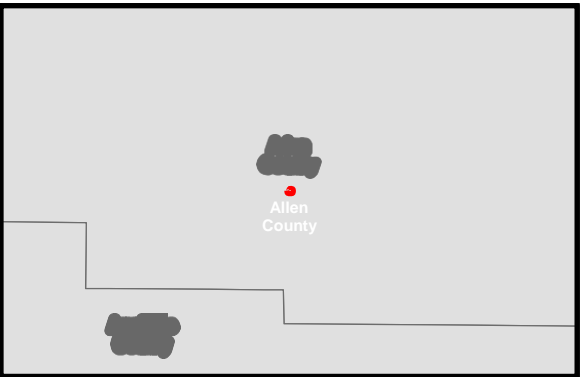
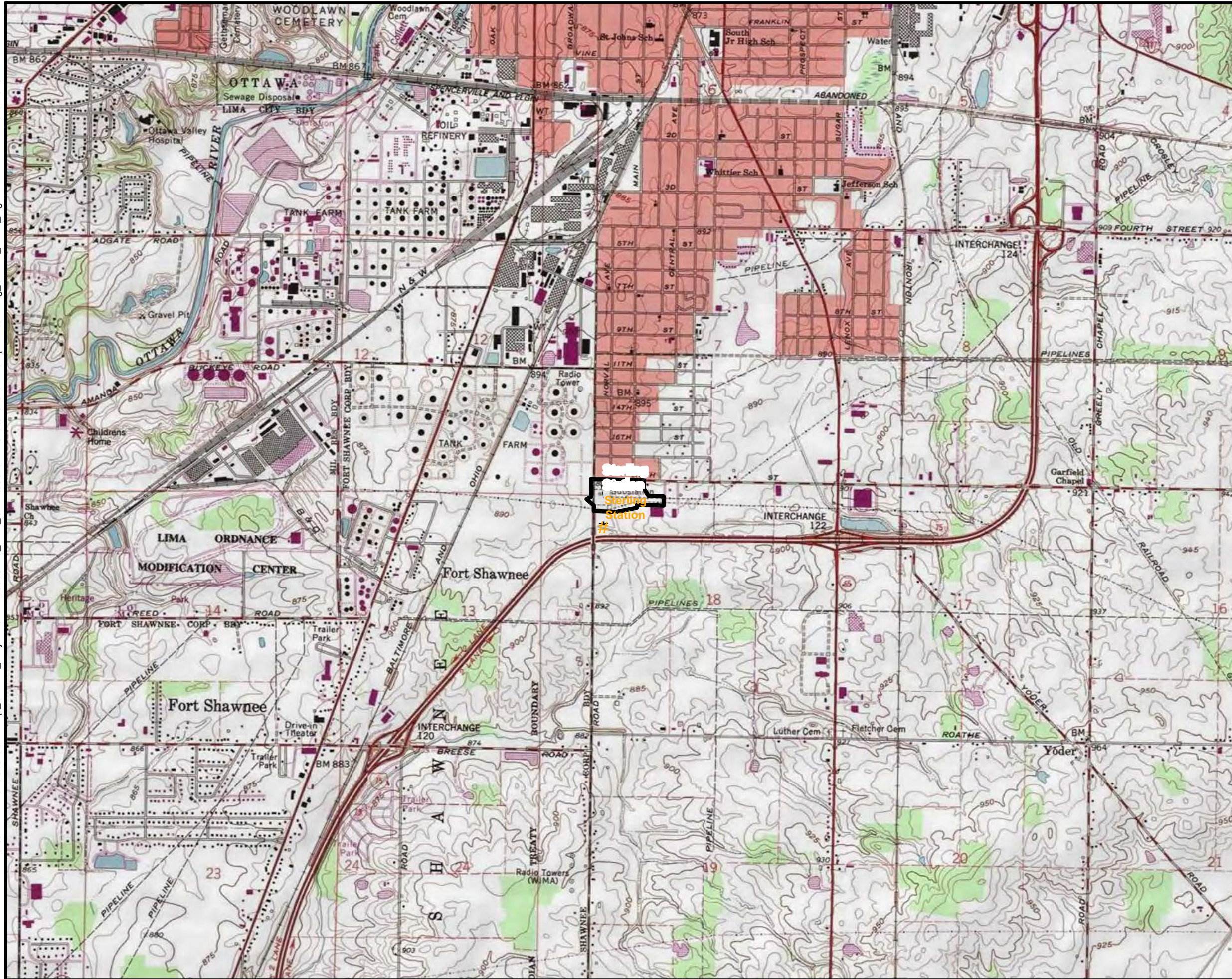
- Cowardin, L.M., V. Carter, F.C. Golet and E.T. LaRoe. 1979. *Classification of Wetlands and Deepwater Habitats of the United States*. Office of Biological Services, U.S. Fish and Wildlife Service, Washington, D.C.
- Environmental Laboratory. 1987. *U.S. Corps of Engineers Wetlands Delineation Manual*. Technical Report Y-87-1, U.S. Army Engineer Waterways Experiment Station: Vicksburg, Mississippi.
- Fritz, K.M., B.R. Johnson, and D.M. Walters. 2006. *Field Operations Manual for Assessing the Hydrologic Permanence and Ecological Condition of Headwater Streams*. EPA/600/R-06/126. U.S. Environmental Protection Agency, Office of Research and Development, Washington DC.
- Kollmorgen Corporation. 2010. *Munsell Soil Color Charts*. Baltimore, Maryland.
- Lichvar, R.W., D.L. Banks, W.N. Kirchner, and N.C. Melvin. 2016. *The National Wetland Plant List: 2016 wetland ratings*. *Phytoneuron* 2016-30: 1-17. Published 28 April 2016. ISSN 2153 733X
- Mack, John J. 2001. *Ohio Rapid Assessment Method for Wetlands v. 5.0, User's Manual and Scoring Forms*. *Ohio EPA Technical Report WET/2001-1*. Ohio Environmental Protection Agency, Division of Surface Water, 401/Wetland Ecology Unit, Columbus, Ohio.
- Ohio EPA, 2012. *Field Evaluation Manual for Ohio's Primary Headwater Habitat Streams*. Version 3.0. Ohio EPA Division of Surface Water, Columbus, Ohio. 117 pp.
- Rankin, Edward T. 2006. *Methods for Assessing Habitat in Flowing Waters: Using the Qualitative Habitat Evaluation Index (QHEI)*. Ohio EPA Ecological Assessment Section, Division of Surface Water, Columbus, Ohio.
- U.S. Army Corps of Engineers. 2005. *Regulatory Guidance Letter No. 05-05: Guidance on Ordinary High Water Mark Identification*.
- U.S. Army Corps of Engineers. 2010. *Regional Supplement to the Corps of Engineers Wetland Delineation Manual: Midwest Region (Version 2.0)*, ed. J. S. Wakely, R. W. Lichvar, and C. V. Noble. ERDC/EL TR-10-16. Vicksburg, MS: U.S. Army Engineer Research and Development Center.
- U.S. Department of Agriculture, Natural Resources Conservation Service. 2015. *National Hydric Soils List*. <http://www.nrcs.usda.gov/wps/portal/nrcs/main/soils/use/hydric/>. Accessed 3/06/17.
- U.S. Department of Agriculture, Natural Resources Conservation Service. 2017. *National Weather Service- Wetland Climate Evaluation Database (WETS Table)*. <http://www.wcc.nrcs.usda.gov/climate/wetlands.html>. Accessed 3/06/17.
- U.S. Department of Agriculture, Natural Resources Conservation Service. 2016. *Web Soil Survey (GIS Shapefile)*. <http://websoilsurvey.sc.egov.usda.gov/App/HomePage.htm>. Accessed 3/06/17.
- U.S. Fish and Wildlife Service. 2017. *National Wetlands Inventory Classification De-coder*. Available online at <https://fwsmapservices.wim.usgs.gov/decoders/SWL.aspx>. Accessed 03/17/17.



LEGEND:

-  Station
-  Project Survey Area

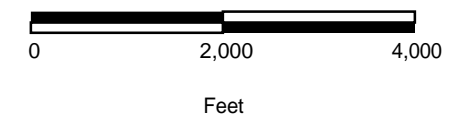

BASE MAP SOURCE:
Copyright © 2013 National Geographic Society, i-cubed
OHIO TRANSMISSION COMPANY

*Sterling Station
Expansion Project*

FIGURE 1
OVERVIEW MAP



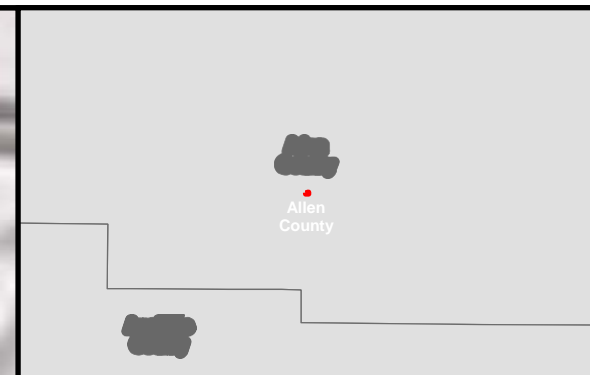
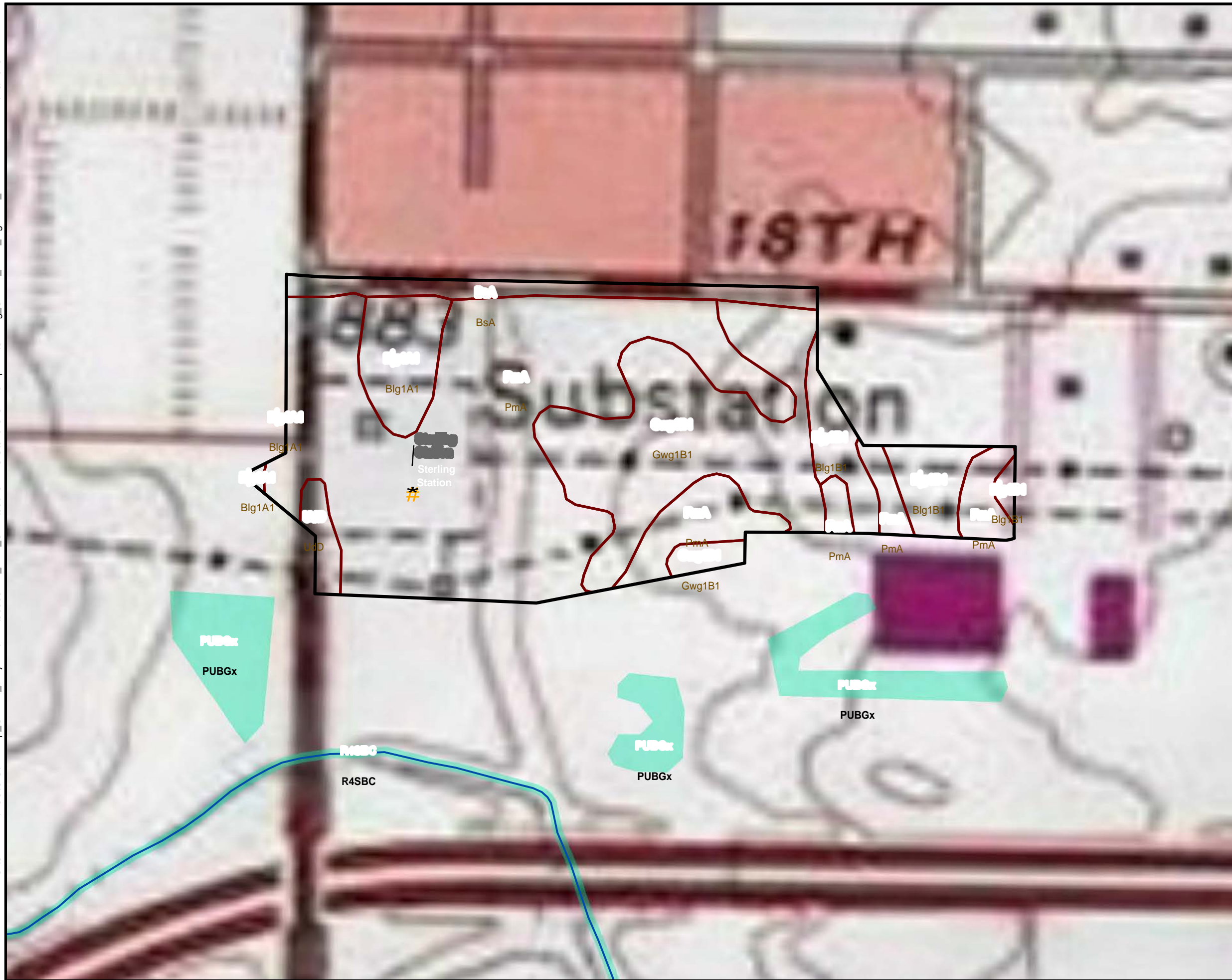

LEGEND:

- Station
- Project Survey Area
- NHD Stream
- NWI Wetland
- Soil Map Unit

Soil Map Unit Symbol

- Blg1A1
- Blg1B1
- BsA
- Gwg1B1
- PmA
- UdD

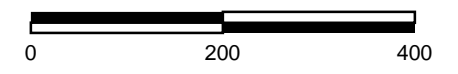

BASE MAP SOURCE:

Copyright © 2013 National Geographic Society, i-cubed
 OHIO TRANSMISSION COMPANY

Sterling Station Expansion Project

FIGURE 2
 SOIL MAP UNIT AND NATIONAL WETLAND INVENTORY MAP



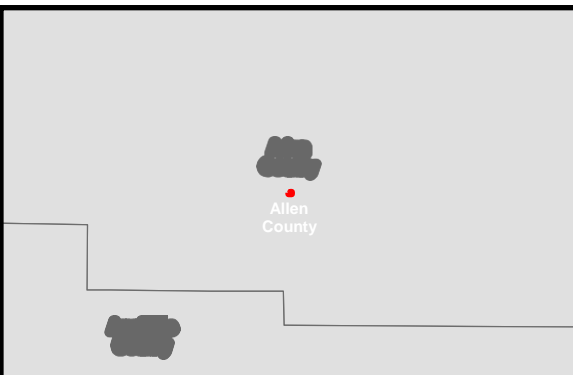
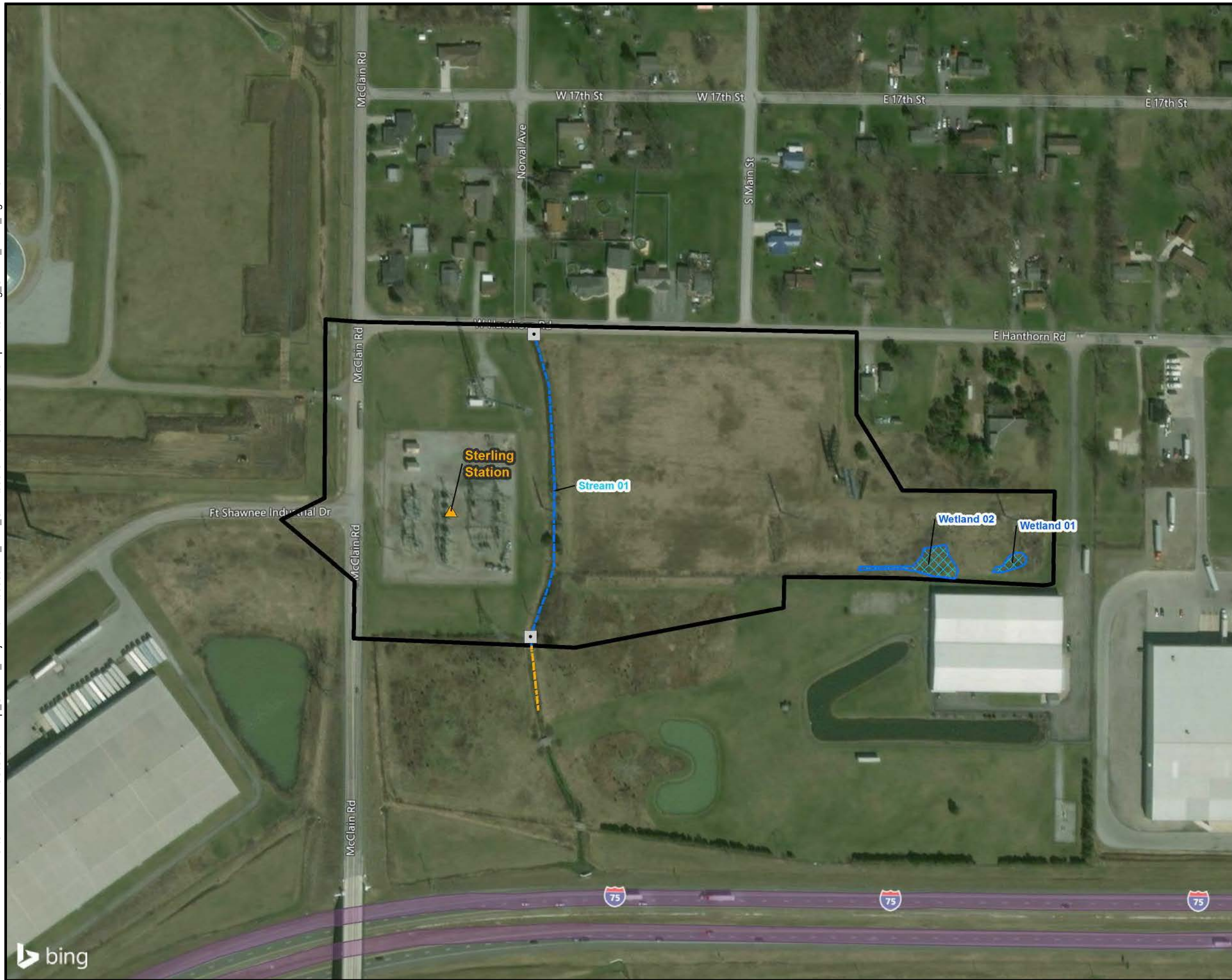

- Legend**
- Existing Station
 - Existing Culvert
 - Project Survey Area
 - Delineated Wetland
 - Delineated Intermittent Stream
 - Approximate Stream Location

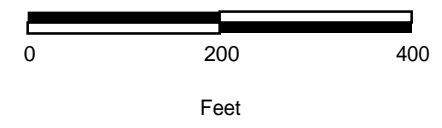

BASE MAP SOURCE:
 © 2018 Microsoft Corporation © 2018 DigitalGlobe
AEC OHIO TRANSMISSION COMPANY

Sterling Station Expansion Project

FIGURE 3
WETLAND DELINEATION AND
STREAM ASSESSMENT MAP

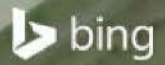

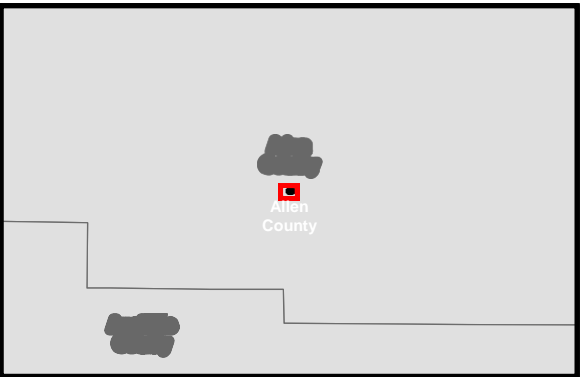
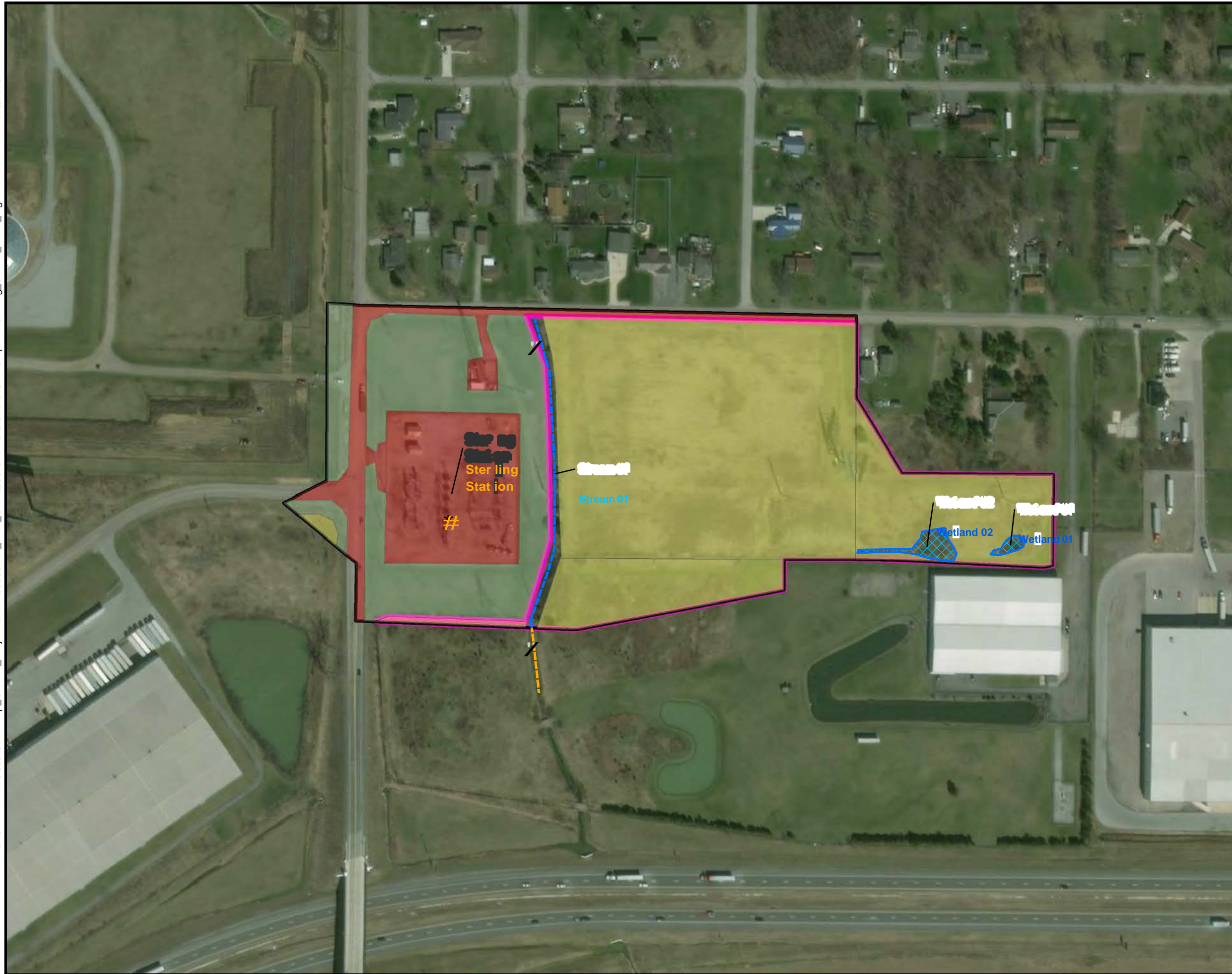

LEGEND:

- Existing Station
- Existing Culvert
- Project Survey Area
- Delineated Intermittent Stream
- Approximate Stream Location
- Delineated Wetland
- Landscaped Area
- Old Field
- Urban
- Potential Upland Sandpiper Habitat

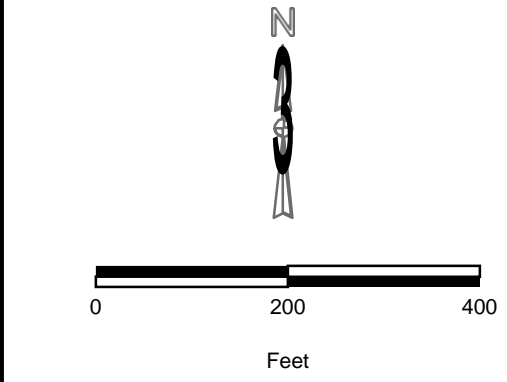

BASE MAP SOURCE:
 Sources: Esri, HERE, DeLorme, USGS, Intermap,
AECOM
OHIO TRANSMISSION COMPANY
 Sterling Station
 Expansion Project

FIGURE 4
VEGETATIVE COMMUNITIES
ASSESSMENT MAP

APPENDIX A

U.S. ARMY CORPS OF ENGINEERS WETLAND FORMS

WETLAND DETERMINATION DATA FORM - Midwest Region

Project/Site: Sterling Station City/County: Allen Sampling Date: 22-Jan-18
 Applicant/Owner: AEP State: oh Sampling Point: w-jbl-012218-01
 Investigator(s): jbl_jtt Section, Township, Range: S 18 T 4S R 7E
 Landform (hillslope, terrace, etc.): Lowland Local relief (concave, convex, none): concave
 Slope: 0.0% 0.0° Lat.: 40.700899 Long.: -84.103214 Datum: NAD 83
 Soil Map Unit Name: PmA, Blg1B1 NWI classification: N/A

Are climatic/hydrologic conditions on the site typical for this time of year? Yes No (If no, explain in Remarks.)
 Are Vegetation , Soil , or Hydrology significantly disturbed? Are "Normal Circumstances" present? Yes No
 Are Vegetation , Soil , or Hydrology naturally problematic? (If needed, explain any answers in Remarks.)

SUMMARY OF FINDINGS - Attach site map showing sampling point locations, transects, important features, etc.

Hydrophytic Vegetation Present? Yes <input checked="" type="radio"/> No <input type="radio"/> Hydric Soil Present? Yes <input checked="" type="radio"/> No <input type="radio"/> Wetland Hydrology Present? Yes <input checked="" type="radio"/> No <input type="radio"/>	Is the Sampled Area within a Wetland? Yes <input checked="" type="radio"/> No <input type="radio"/>
Remarks:	

VEGETATION - Use scientific names of plants.

Tree Stratum (Plot size: _____)	Absolute % Cover	Rel.Strat. Cover	Indicator Status	
1. _____	0	<input type="checkbox"/> 0.0%		
2. _____	0	<input type="checkbox"/> 0.0%		
3. _____	0	<input type="checkbox"/> 0.0%		
4. _____	0	<input type="checkbox"/> 0.0%		
5. _____	0	<input type="checkbox"/> 0.0%	0	
	0	= Total Cover		
Sapling/Shrub Stratum (Plot size: _____)				
1. <u>Rhamnus cathartica</u>	10	<input checked="" type="checkbox"/> 76.9%	FAC	
2. <u>Cornus amomum</u>	3	<input checked="" type="checkbox"/> 23.1%	FACW	
3. _____	0	<input type="checkbox"/> 0.0%		
4. _____	0	<input type="checkbox"/> 0.0%		
5. _____	0	<input type="checkbox"/> 0.0%		
	13	= Total Cover		
Herb Stratum (Plot size: _____)				
1. <u>Juncus tenuis</u>	30	<input checked="" type="checkbox"/> 29.1%	FAC	
2. <u>Cyperus esculentus</u>	15	<input checked="" type="checkbox"/> 14.6%	FACW	
3. <u>Carex annectens</u>	8	<input type="checkbox"/> 7.8%	FACW	
4. <u>Persicaria pensylvanica</u>	20	<input checked="" type="checkbox"/> 19.4%	FACW	
5. <u>Cirsium arvense</u>	10	<input type="checkbox"/> 9.7%	FACU	
6. <u>Apocynum cannabinum</u>	12	<input type="checkbox"/> 11.7%	FAC	
7. <u>Solidago gigantea</u>	8	<input type="checkbox"/> 7.8%	FACW	
8. _____	0	<input type="checkbox"/> 0.0%		
9. _____	0	<input type="checkbox"/> 0.0%		
10. _____	0	<input type="checkbox"/> 0.0%		
	103	= Total Cover		
Woody Vine Stratum (Plot size: _____)				
1. <u>Toxicodendron radicans</u>	15	<input type="checkbox"/> 100.0%	FAC	
2. _____	0	<input type="checkbox"/> 0.0%		
	15	= Total Cover		

Dominance Test worksheet:

Number of Dominant Species That are OBL, FACW, or FAC: 6 (A)

Total Number of Dominant Species Across All Strata: 6 (B)

Percent of dominant Species That Are OBL, FACW, or FAC: 100.0% (A/B)

Prevalence Index worksheet:

Total % Cover of:		Multiply by:	
OBL species	<u>0</u>	x 1 =	<u>0</u>
FACW species	<u>54</u>	x 2 =	<u>108</u>
FAC species	<u>67</u>	x 3 =	<u>201</u>
FACU species	<u>10</u>	x 4 =	<u>40</u>
UPL species	<u>0</u>	x 5 =	<u>0</u>

Prevalence Index = B/A = 2.664 (B)

Hydrophytic Vegetation Indicators:

1 - Rapid Test for Hydrophytic Vegetation

2 - Dominance Test is > 50%

3 - Prevalence Index is ≤ 3.0¹

4 - Morphological Adaptations¹ (Provide supporting data in Remarks or on a separate sheet)

Problematic Hydrophytic Vegetation¹ (Explain)

¹ Indicators of hydric soil and wetland hydrology must be present, unless disturbed or problematic.

Hydrophytic Vegetation Present? Yes No

Remarks: (Include photo numbers here or on a separate sheet.)

*Indicator suffix = National status or professional decision assigned because Regional status not defined by FWS

SOIL

Sampling Point: **W-jbl-012218-01**

Profile Description: (Describe to the depth needed to document the indicator or confirm the absence of indicators.)

Depth (inches)	Matrix		Redox Features				Texture	Remarks	
	Color (moist)	%	Color (moist)	%	Type ¹	Loc ²			
0-3	10YR	3/3	100				Clay Loam		
3-12	10YR	4/2	98	10YR	4/4	2	C	M	Clay Loam

¹ Type: C=Concentration, D=Depletion, RM=Reduced Matrix, CS=Covered or Coated Sand Grains. ²Location: PL=Pore Lining, M=Matrix.

Hydric Soil Indicators:

Histosol (A1) Sandy Gleyed Matrix (S4)

Histic Epipedon (A2) Sandy Redox (S5)

Black Histic (A3) Stripped Matrix (S6)

Hydrogen Sulfide (A4) Loamy Mucky Mineral (F1)

Stratified Layers (A5) Loamy Gleyed Matrix (F2)

2 cm Muck (A10) Depleted Matrix (F3)

Depleted Below Dark Surface (A11) Redox Dark Surface (F6)

Thick Dark Surface (A12) Depleted Dark Surface (F7)

Sandy Muck Mineral (S1) Redox Depressions (F8)

5 cm Mucky Peat or Peat (S3)

Indicators for Problematic Hydric Soils³:

Coast Prairie Redox (A16)

Dark Surface (S7)

Iron Manganese Masses (F12)

Very Shallow Dark Surface (TF12)

Other (Explain in Remarks)

³ Indicators of hydrophytic vegetation and wetland hydrology must be present, unless disturbed or problematic.

Restrictive Layer (if observed):

Type: _____

Depth (inches): _____

Hydric Soil Present? Yes No

Remarks:

HYDROLOGY

Wetland Hydrology Indicators:

Primary Indicators (minimum of one is required; check all that apply)

Surface Water (A1) Water-Stained Leaves (B9)

High Water Table (A2) Aquatic Fauna (B13)

Saturation (A3) True Aquatic Plants (B14)

Water Marks (B1) Hydrogen Sulfide Odor (C1)

Sediment Deposits (B2) Oxidized Rhizospheres on Living Roots (C3)

Drift Deposits (B3) Presence of Reduced Iron (C4)

Algal Mat or Crust (B4) Recent Iron Reduction in Tilled Soils (C6)

Iron Deposits (B5) Thin Muck Surface (C7)

Inundation Visible on Aerial Imagery (B7) Gauge or Well Data (D9)

Sparsely Vegetated Concave Surface (B8) Other (Explain in Remarks)

Secondary Indicators (minimum of two required)

Surface Soil Cracks (B6)

Drainage Patterns (B10)

Dry Season Water Table (C2)

Crayfish Burrows (C8)

Saturation Visible on Aerial Imagery (C9)

Stunted or Stressed Plants (D1)

Geomorphic Position (D2)

FAC-Neutral Test (D5)

Field Observations:

Surface Water Present? Yes No Depth (inches): 2

Water Table Present? Yes No Depth (inches): _____

Saturation Present? Yes No Depth (inches): _____

(includes capillary fringe)

Wetland Hydrology Present? Yes No

Describe Recorded Data (stream gauge, monitoring well, aerial photos, previous inspections), if available:

Remarks:

WETLAND DETERMINATION DATA FORM - Midwest Region

Project/Site: Sterling Station City/County: Allen Sampling Date: 22-Jan-18
 Applicant/Owner: AEP State: oh Sampling Point: w-jbl-012218-02
 Investigator(s): jbl_jtt Section, Township, Range: S 18 T 4S R 7E
 Landform (hillslope, terrace, etc.): Lowland Local relief (concave, convex, none): concave
 Slope: 0.0% 0.0 ° Lat.: 40.700883 Long.: -84.103878 Datum: NAD 83
 Soil Map Unit Name: PmA, Blg1B1 NWI classification: N/A

Are climatic/hydrologic conditions on the site typical for this time of year? Yes No (If no, explain in Remarks.)
 Are Vegetation , Soil , or Hydrology significantly disturbed? Are "Normal Circumstances" present? Yes No
 Are Vegetation , Soil , or Hydrology naturally problematic? (If needed, explain any answers in Remarks.)

SUMMARY OF FINDINGS - Attach site map showing sampling point locations, transects, important features, etc.

Hydrophytic Vegetation Present? Yes <input checked="" type="radio"/> No <input type="radio"/> Hydric Soil Present? Yes <input checked="" type="radio"/> No <input type="radio"/> Wetland Hydrology Present? Yes <input checked="" type="radio"/> No <input type="radio"/>	Is the Sampled Area within a Wetland? Yes <input type="radio"/> No <input checked="" type="radio"/>
Remarks:	

VEGETATION - Use scientific names of plants.

Tree Stratum (Plot size: _____)	Absolute % Cover	Dominant Species? Rel.Strat. Cover	Indicator Status	
1. _____	0	<input type="checkbox"/> 0.0%		
2. _____	0	<input type="checkbox"/> 0.0%		
3. _____	0	<input type="checkbox"/> 0.0%		
4. _____	0	<input type="checkbox"/> 0.0%		
5. _____	0	<input type="checkbox"/> 0.0%		
	0	= Total Cover		
Sapling/Shrub Stratum (Plot size: _____)				
1. _____	0	<input type="checkbox"/> 0.0%		
2. _____	0	<input type="checkbox"/> 0.0%		
3. _____	0	<input type="checkbox"/> 0.0%		
4. _____	0	<input type="checkbox"/> 0.0%		
5. _____	0	<input type="checkbox"/> 0.0%		
	0	= Total Cover		
Herb Stratum (Plot size: _____)				
1. <i>Agrostis stolonifera</i>	15	<input checked="" type="checkbox"/> 14.6%	FACW	
2. <i>Carex annectens</i>	15	<input checked="" type="checkbox"/> 14.6%	FACW	
3. <i>Scirpus atrovirens</i>	8	<input type="checkbox"/> 7.8%	OBL	
4. <i>Cyperus esculentus</i>	18	<input checked="" type="checkbox"/> 17.5%	FACW	
5. <i>Juncus torreyi</i>	15	<input checked="" type="checkbox"/> 14.6%	FACW	
6. <i>Carex lurida</i>	5	<input type="checkbox"/> 4.9%	OBL	
7. <i>Setaria pumila</i>	12	<input type="checkbox"/> 11.7%	FAC	
8. <i>Juncus tenuis</i>	10	<input type="checkbox"/> 9.7%	FAC	
9. <i>Apocynum cannabinum</i>	5	<input type="checkbox"/> 4.9%	FAC	
10. _____	0	<input type="checkbox"/> 0.0%		
	103	= Total Cover		
Woody Vine Stratum (Plot size: _____)				
1. _____	0	<input type="checkbox"/> 0.0%		
2. _____	0	<input type="checkbox"/> 0.0%		
	0	= Total Cover		

Dominance Test worksheet:

Number of Dominant Species That are OBL, FACW, or FAC: 4 (A)

Total Number of Dominant Species Across All Strata: 4 (B)

Percent of dominant Species That Are OBL, FACW, or FAC: 100.0% (A/B)

Prevalence Index worksheet:

Total % Cover of:		Multiply by:	
FACW species	<u>63</u>	x 2 =	<u>126</u>
FAC species	<u>27</u>	x 3 =	<u>81</u>
FACU species	<u>0</u>	x 4 =	<u>0</u>
UPL species	<u>0</u>	x 5 =	<u>0</u>

Prevalence Index = B/A = 2.136 (B)

Hydrophytic Vegetation Indicators:

1 - Rapid Test for Hydrophytic Vegetation

2 - Dominance Test is > 50%

3 - Prevalence Index is ≤ 3.0¹

4 - Morphological Adaptations¹ (Provide supporting data in Remarks or on a separate sheet)

Problematic Hydrophytic Vegetation¹ (Explain)

¹ Indicators of hydric soil and wetland hydrology must be present, unless disturbed or problematic.

Hydrophytic Vegetation Present? Yes No

Remarks: (Include photo numbers here or on a separate sheet.)

*Indicator suffix = National status or professional decision assigned because Regional status not defined by FWS

SOIL

Sampling Point: **w-jbl-012218-02**

Profile Description: (Describe to the depth needed to document the indicator or confirm the absence of indicators.)

Depth (inches)	Matrix			Redox Features					Texture	Remarks
	Color (moist)		%	Color (moist)	%	Type ¹	Loc ²			
0-7	10YR	4/2	97	10YR	4/6	3	C	M	Clay Loam	
7-14	10YR	4/1	95	10YR	4/6	5	C	M	Clay Loam	

¹ Type: C=Concentration, D=Depletion, RM=Reduced Matrix, CS=Covered or Coated Sand Grains. ²Location: PL=Pore Lining, M=Matrix.

Hydric Soil Indicators:

Histosol (A1) Sandy Gleyed Matrix (S4)

Histic Epipedon (A2) Sandy Redox (S5)

Black Histic (A3) Stripped Matrix (S6)

Hydrogen Sulfide (A4) Loamy Mucky Mineral (F1)

Stratified Layers (A5) Loamy Gleyed Matrix (F2)

2 cm Muck (A10) Depleted Matrix (F3)

Depleted Below Dark Surface (A11) Redox Dark Surface (F6)

Thick Dark Surface (A12) Depleted Dark Surface (F7)

Sandy Muck Mineral (S1) Redox Depressions (F8)

5 cm Mucky Peat or Peat (S3)

Indicators for Problematic Hydric Soils³:

Coast Prairie Redox (A16)

Dark Surface (S7)

Iron Manganese Masses (F12)

Very Shallow Dark Surface (TF12)

Other (Explain in Remarks)

³ Indicators of hydrophytic vegetation and wetland hydrology must be present, unless disturbed or problematic.

Restrictive Layer (if observed):

Type: _____

Depth (inches): _____

Hydric Soil Present? Yes No

Remarks:

HYDROLOGY

Wetland Hydrology Indicators:

Primary Indicators (minimum of one is required; check all that apply)

Surface Water (A1) Water-Stained Leaves (B9)

High Water Table (A2) Aquatic Fauna (B13)

Saturation (A3) True Aquatic Plants (B14)

Water Marks (B1) Hydrogen Sulfide Odor (C1)

Sediment Deposits (B2) Oxidized Rhizospheres on Living Roots (C3)

Drift Deposits (B3) Presence of Reduced Iron (C4)

Algal Mat or Crust (B4) Recent Iron Reduction in Tilled Soils (C6)

Iron Deposits (B5) Thin Muck Surface (C7)

Inundation Visible on Aerial Imagery (B7) Gauge or Well Data (D9)

Sparsely Vegetated Concave Surface (B8) Other (Explain in Remarks)

Secondary Indicators (minimum of two required)

Surface Soil Cracks (B6)

Drainage Patterns (B10)

Dry Season Water Table (C2)

Crayfish Burrows (C8)

Saturation Visible on Aerial Imagery (C9)

Stunted or Stressed Plants (D1)

Geomorphic Position (D2)

FAC-Neutral Test (D5)

Field Observations:

Surface Water Present? Yes No Depth (inches): _____

Water Table Present? Yes No Depth (inches): _____

Saturation Present? (includes capillary fringe) Yes No Depth (inches): _____

Wetland Hydrology Present? Yes No

Describe Recorded Data (stream gauge, monitoring well, aerial photos, previous inspections), if available:

Remarks:

WETLAND DETERMINATION DATA FORM - Midwest Region

Project/Site: Sterling Station City/County: Allen Sampling Date: 22-Jan-18
 Applicant/Owner: AEP State: oh Sampling Point: upl-jbl-012218-01
 Investigator(s): jbl_jtt Section, Township, Range: S 18 T 4S R 7E
 Landform (hillslope, terrace, etc.): Flat Local relief (concave, convex, none): flat
 Slope: 0.0% 0.0 ° Lat.: 40.700946 Long.: -84.103466 Datum: NAD 83
 Soil Map Unit Name: Blg1B1 NWI classification: N/A

Are climatic/hydrologic conditions on the site typical for this time of year? Yes No (If no, explain in Remarks.)
 Are Vegetation , Soil , or Hydrology significantly disturbed? Are "Normal Circumstances" present? Yes No
 Are Vegetation , Soil , or Hydrology naturally problematic? (If needed, explain any answers in Remarks.)

SUMMARY OF FINDINGS - Attach site map showing sampling point locations, transects, important features, etc.

Hydrophytic Vegetation Present? Yes <input type="radio"/> No <input checked="" type="radio"/> Hydric Soil Present? Yes <input type="radio"/> No <input checked="" type="radio"/> Wetland Hydrology Present? Yes <input type="radio"/> No <input checked="" type="radio"/>	Is the Sampled Area within a Wetland? Yes <input type="radio"/> No <input checked="" type="radio"/>
Remarks:	

VEGETATION - Use scientific names of plants.

Tree Stratum (Plot size: _____)	Absolute % Cover	Dominant Species? Rel.Strat. Cover	Indicator Status	Dominance Test worksheet:
1. _____	0	<input type="checkbox"/> 0.0%	_____	Number of Dominant Species That are OBL, FACW, or FAC: <u>1</u> (A) Total Number of Dominant Species Across All Strata: <u>3</u> (B) Percent of dominant Species That Are OBL, FACW, or FAC: <u>33.3%</u> (A/B)
2. _____	0	<input type="checkbox"/> 0.0%	_____	
3. _____	0	<input type="checkbox"/> 0.0%	_____	
4. _____	0	<input type="checkbox"/> 0.0%	_____	
5. _____	0	<input type="checkbox"/> 0.0%	_____	
= Total Cover				
Sapling/Shrub Stratum (Plot size: _____)				Prevalence Index worksheet: Total % Cover of: Multiply by: FACW species <u>0</u> x 2 = <u>0</u> FAC species <u>27</u> x 3 = <u>81</u> FACU species <u>83</u> x 4 = <u>332</u> UPL species <u>0</u> x 5 = <u>0</u> Prevalence Index = B/A = <u>3.755</u> (B)
1. <i>Juniperus virginiana</i>	10	<input checked="" type="checkbox"/> 83.3% FACU	_____	
2. <i>Cornus drummondii</i>	2	<input type="checkbox"/> 16.7% FAC	_____	
3. _____	0	<input type="checkbox"/> 0.0%	_____	
4. _____	0	<input type="checkbox"/> 0.0%	_____	
5. _____	0	<input type="checkbox"/> 0.0%	_____	
= Total Cover				
Herb Stratum (Plot size: _____)				Hydrophytic Vegetation Indicators: <input type="checkbox"/> 1 - Rapid Test for Hydrophytic Vegetation <input type="checkbox"/> 2 - Dominance Test is > 50% <input type="checkbox"/> 3 - Prevalence Index is ≤3.0 ¹ <input type="checkbox"/> 4 - Morphological Adaptations ¹ (Provide supporting data in Remarks or on a separate sheet) <input type="checkbox"/> Problematic Hydrophytic Vegetation ¹ (Explain) ¹ Indicators of hydric soil and wetland hydrology must be present, unless disturbed or problematic.
1. <i>Festuca arundinacea</i>	15	<input type="checkbox"/> 15.3% FACU	_____	
2. <i>Juncus tenuis</i>	25	<input checked="" type="checkbox"/> 25.5% FAC	_____	
3. <i>Cirsium arvense</i>	25	<input checked="" type="checkbox"/> 25.5% FACU	_____	
4. <i>Dipsacus fullonum</i>	18	<input type="checkbox"/> 18.4% FACU	_____	
5. <i>Solidago altissima</i>	15	<input type="checkbox"/> 15.3% FACU	_____	
6. _____	0	<input type="checkbox"/> 0.0%	_____	
7. _____	0	<input type="checkbox"/> 0.0%	_____	
8. _____	0	<input type="checkbox"/> 0.0%	_____	
9. _____	0	<input type="checkbox"/> 0.0%	_____	
10. _____	0	<input type="checkbox"/> 0.0%	_____	
= Total Cover				
Woody Vine Stratum (Plot size: _____)				Hydrophytic Vegetation Present? Yes <input type="radio"/> No <input checked="" type="radio"/>
1. _____	0	<input type="checkbox"/> 0.0%	_____	
2. _____	0	<input type="checkbox"/> 0.0%	_____	
= Total Cover				

Remarks: (Include photo numbers here or on a separate sheet.)

*Indicator suffix - National status or professional decision assigned because Regional status not defined by FWS.

SOIL

Sampling Point: upl-jbl-012218-01

Profile Description: (Describe to the depth needed to document the indicator or confirm the absence of indicators.)

Depth (inches)	Matrix		Redox Features				Texture	Remarks
	Color (moist)	%	Color (moist)	%	Type ¹	Loc ²		
0-7	10YR	4/3	100				Clay Loam	
7-13	10YR	4/4	99	10YR	4/6	1	Clay Loam	

¹ Type: C=Concentration, D=Depletion, RM=Reduced Matrix, CS=Covered or Coated Sand Grains. ²Location: PL=Pore Lining, M=Matrix.

Hydric Soil Indicators:

<input type="checkbox"/> Histosol (A1)	<input type="checkbox"/> Sandy Gleyed Matrix (S4)	Indicators for Problematic Hydric Soils³:
<input type="checkbox"/> Histic Epipedon (A2)	<input type="checkbox"/> Sandy Redox (S5)	
<input type="checkbox"/> Black Histic (A3)	<input type="checkbox"/> Stripped Matrix (S6)	
<input type="checkbox"/> Hydrogen Sulfide (A4)	<input type="checkbox"/> Loamy Mucky Mineral (F1)	
<input type="checkbox"/> Stratified Layers (A5)	<input type="checkbox"/> Loamy Gleyed Matrix (F2)	
<input type="checkbox"/> 2 cm Muck (A10)	<input type="checkbox"/> Depleted Matrix (F3)	
<input type="checkbox"/> Depleted Below Dark Surface (A11)	<input type="checkbox"/> Redox Dark Surface (F6)	
<input type="checkbox"/> Thick Dark Surface (A12)	<input type="checkbox"/> Depleted Dark Surface (F7)	
<input type="checkbox"/> Sandy Muck Mineral (S1)	<input type="checkbox"/> Redox Depressions (F8)	
<input type="checkbox"/> 5 cm Mucky Peat or Peat (S3)		

Coast Prairie Redox (A16)
 Dark Surface (S7)
 Iron Manganese Masses (F12)
 Very Shallow Dark Surface (TF12)
 Other (Explain in Remarks)

³ Indicators of hydrophytic vegetation and wetland hydrology must be present, unless disturbed or problematic.

Restrictive Layer (if observed):

Type: _____

Depth (inches): _____

Hydric Soil Present? Yes No

Remarks:

HYDROLOGY

Wetland Hydrology Indicators:

Primary Indicators (minimum of one is required; check all that apply)		Secondary Indicators (minimum of two required)
<input type="checkbox"/> Surface Water (A1)	<input type="checkbox"/> Water-Stained Leaves (B9)	<input type="checkbox"/> Surface Soil Cracks (B6)
<input type="checkbox"/> High Water Table (A2)	<input type="checkbox"/> Aquatic Fauna (B13)	<input type="checkbox"/> Drainage Patterns (B10)
<input type="checkbox"/> Saturation (A3)	<input type="checkbox"/> True Aquatic Plants (B14)	<input type="checkbox"/> Dry Season Water Table (C2)
<input type="checkbox"/> Water Marks (B1)	<input type="checkbox"/> Hydrogen Sulfide Odor (C1)	<input type="checkbox"/> Crayfish Burrows (C8)
<input type="checkbox"/> Sediment Deposits (B2)	<input type="checkbox"/> Oxidized Rhizospheres on Living Roots (C3)	<input type="checkbox"/> Saturation Visible on Aerial Imagery (C9)
<input type="checkbox"/> Drift Deposits (B3)	<input type="checkbox"/> Presence of Reduced Iron (C4)	<input type="checkbox"/> Stunted or Stressed Plants (D1)
<input type="checkbox"/> Algal Mat or Crust (B4)	<input type="checkbox"/> Recent Iron Reduction in Tilled Soils (C6)	<input type="checkbox"/> Geomorphic Position (D2)
<input type="checkbox"/> Iron Deposits (B5)	<input type="checkbox"/> Thin Muck Surface (C7)	<input type="checkbox"/> FAC-Neutral Test (D5)
<input type="checkbox"/> Inundation Visible on Aerial Imagery (B7)	<input type="checkbox"/> Gauge or Well Data (D9)	
<input type="checkbox"/> Sparsely Vegetated Concave Surface (B8)	<input type="checkbox"/> Other (Explain in Remarks)	

Field Observations:

Surface Water Present?	Yes <input type="radio"/> No <input checked="" type="radio"/>	Depth (inches): _____	Wetland Hydrology Present? Yes <input type="radio"/> No <input checked="" type="radio"/>
Water Table Present?	Yes <input type="radio"/> No <input checked="" type="radio"/>	Depth (inches): _____	
Saturation Present? (includes capillary fringe)	Yes <input type="radio"/> No <input checked="" type="radio"/>	Depth (inches): <u>12</u>	

Describe Recorded Data (stream gauge, monitoring well, aerial photos, previous inspections), if available:

Remarks:

WETLAND DETERMINATION DATA FORM - Midwest Region

Project/Site: Sterling Station City/County: Allen Sampling Date: 22-Jan-18
 Applicant/Owner: AEP State: oh Sampling Point: upl-jbl-012218-02
 Investigator(s): jbl_jtt Section, Township, Range: S 18 T 4S R 7E
 Landform (hillslope, terrace, etc.): Flat Local relief (concave, convex, none): none
 Slope: 0.0% 0.0 ° Lat.: 40.701055 Long.: -84.104010 Datum: NAD 83
 Soil Map Unit Name: PmA NWI classification: N/A

Are climatic/hydrologic conditions on the site typical for this time of year? Yes No (If no, explain in Remarks.)
 Are Vegetation , Soil , or Hydrology significantly disturbed? Are "Normal Circumstances" present? Yes No
 Are Vegetation , Soil , or Hydrology naturally problematic? (If needed, explain any answers in Remarks.)

SUMMARY OF FINDINGS - Attach site map showing sampling point locations, transects, important features, etc.

Hydrophytic Vegetation Present? Yes <input type="radio"/> No <input checked="" type="radio"/> Hydric Soil Present? Yes <input type="radio"/> No <input checked="" type="radio"/> Wetland Hydrology Present? Yes <input type="radio"/> No <input checked="" type="radio"/>	Is the Sampled Area within a Wetland? Yes <input type="radio"/> No <input checked="" type="radio"/>
Remarks:	

VEGETATION - Use scientific names of plants.

	Absolute % Cover	Rel.Strat. Cover	Indicator Status	
Tree Stratum (Plot size: _____)				
1. _____	0	<input type="checkbox"/> 0.0%		
2. _____	0	<input type="checkbox"/> 0.0%		
3. _____	0	<input type="checkbox"/> 0.0%		
4. _____	0	<input type="checkbox"/> 0.0%		
5. _____	0	<input type="checkbox"/> 0.0%		
	0	= Total Cover		
Sapling/Shrub Stratum (Plot size: _____)				
1. _____	0	<input type="checkbox"/> 0.0%		
2. _____	0	<input type="checkbox"/> 0.0%		
3. _____	0	<input type="checkbox"/> 0.0%		
4. _____	0	<input type="checkbox"/> 0.0%		
5. _____	0	<input type="checkbox"/> 0.0%		
	0	= Total Cover		
Herb Stratum (Plot size: _____)				
1. <u>Dipsacus fullonum</u>	40	<input checked="" type="checkbox"/> 40.0%	FACU	
2. <u>Solidago altissima</u>	30	<input checked="" type="checkbox"/> 30.0%	FACU	
3. <u>Juncus tenuis</u>	15	<input type="checkbox"/> 15.0%	FAC	
4. <u>Festuca arundinacea</u>	15	<input type="checkbox"/> 15.0%	FACU	
5. _____	0	<input type="checkbox"/> 0.0%		
6. _____	0	<input type="checkbox"/> 0.0%		
7. _____	0	<input type="checkbox"/> 0.0%		
8. _____	0	<input type="checkbox"/> 0.0%		
9. _____	0	<input type="checkbox"/> 0.0%		
10. _____	0	<input type="checkbox"/> 0.0%		
	100	= Total Cover		
Woody Vine Stratum (Plot size: _____)				
1. _____	0	<input type="checkbox"/> 0.0%		
2. _____	0	<input type="checkbox"/> 0.0%		
	0	= Total Cover		

Dominance Test worksheet:

Number of Dominant Species That are OBL, FACW, or FAC: 0 (A)

Total Number of Dominant Species Across All Strata: 2 (B)

Percent of dominant Species That Are OBL, FACW, or FAC: 0.0% (A/B)

Prevalence Index worksheet:

Total % Cover of:		Multiply by:	
FACW species	<u>0</u>	x 2 =	<u>0</u>
FAC species	<u>15</u>	x 3 =	<u>45</u>
FACU species	<u>85</u>	x 4 =	<u>340</u>
UPL species	<u>0</u>	x 5 =	<u>0</u>

Prevalence Index = B/A = 3.850 (B)

Hydrophytic Vegetation Indicators:

1 - Rapid Test for Hydrophytic Vegetation

2 - Dominance Test is > 50%

3 - Prevalence Index is ≤3.0¹

4 - Morphological Adaptations¹ (Provide supporting data in Remarks or on a separate sheet)

Problematic Hydrophytic Vegetation¹ (Explain)

¹ Indicators of hydric soil and wetland hydrology must be present, unless disturbed or problematic.

Hydrophytic Vegetation Present? Yes No

Remarks: (Include photo numbers here or on a separate sheet.)

*Indicator suffix = National status or professional decision assigned because Regional status not defined by FWS

SOIL

Sampling Point: upl-jbl-012218-02

Profile Description: (Describe to the depth needed to document the indicator or confirm the absence of indicators.)

Depth (inches)	Matrix		Redox Features				Texture	Remarks
	Color (moist)	%	Color (moist)	%	Type ¹	Loc ²		
0-10	10YR	4/3	100				Loam	

¹ Type: C=Concentration, D=Depletion, RM=Reduced Matrix, CS=Covered or Coated Sand Grains. ²Location: PL=Pore Lining, M=Matrix.

Hydric Soil Indicators: <input type="checkbox"/> Histosol (A1) <input type="checkbox"/> Histic Epipedon (A2) <input type="checkbox"/> Black Histic (A3) <input type="checkbox"/> Hydrogen Sulfide (A4) <input type="checkbox"/> Stratified Layers (A5) <input type="checkbox"/> 2 cm Muck (A10) <input type="checkbox"/> Depleted Below Dark Surface (A11) <input type="checkbox"/> Thick Dark Surface (A12) <input type="checkbox"/> Sandy Muck Mineral (S1) <input type="checkbox"/> 5 cm Mucky Peat or Peat (S3)		<input type="checkbox"/> Sandy Gleyed Matrix (S4) <input type="checkbox"/> Sandy Redox (S5) <input type="checkbox"/> Stripped Matrix (S6) <input type="checkbox"/> Loamy Mucky Mineral (F1) <input type="checkbox"/> Loamy Gleyed Matrix (F2) <input type="checkbox"/> Depleted Matrix (F3) <input type="checkbox"/> Redox Dark Surface (F6) <input type="checkbox"/> Depleted Dark Surface (F7) <input type="checkbox"/> Redox Depressions (F8)	Indicators for Problematic Hydric Soils³: <input type="checkbox"/> Coast Prairie Redox (A16) <input type="checkbox"/> Dark Surface (S7) <input type="checkbox"/> Iron Manganese Masses (F12) <input type="checkbox"/> Very Shallow Dark Surface (TF12) <input type="checkbox"/> Other (Explain in Remarks)
--	--	--	---

³ Indicators of hydrophytic vegetation and wetland hydrology must be present, unless disturbed or problematic.

Restrictive Layer (if observed): Type: _____ Depth (inches): _____	Hydric Soil Present? Yes <input type="radio"/> No <input checked="" type="radio"/>
---	---

Remarks:

HYDROLOGY

Wetland Hydrology Indicators: Primary Indicators (minimum of one is required; check all that apply)		Secondary Indicators (minimum of two required)
<input type="checkbox"/> Surface Water (A1) <input type="checkbox"/> High Water Table (A2) <input type="checkbox"/> Saturation (A3) <input type="checkbox"/> Water Marks (B1) <input type="checkbox"/> Sediment Deposits (B2) <input type="checkbox"/> Drift Deposits (B3) <input type="checkbox"/> Algal Mat or Crust (B4) <input type="checkbox"/> Iron Deposits (B5) <input type="checkbox"/> Inundation Visible on Aerial Imagery (B7) <input type="checkbox"/> Sparsely Vegetated Concave Surface (B8)	<input type="checkbox"/> Water-Stained Leaves (B9) <input type="checkbox"/> Aquatic Fauna (B13) <input type="checkbox"/> True Aquatic Plants (B14) <input type="checkbox"/> Hydrogen Sulfide Odor (C1) <input type="checkbox"/> Oxidized Rhizospheres on Living Roots (C3) <input type="checkbox"/> Presence of Reduced Iron (C4) <input type="checkbox"/> Recent Iron Reduction in Tilled Soils (C6) <input type="checkbox"/> Thin Muck Surface (C7) <input type="checkbox"/> Gauge or Well Data (D9) <input type="checkbox"/> Other (Explain in Remarks)	<input type="checkbox"/> Surface Soil Cracks (B6) <input type="checkbox"/> Drainage Patterns (B10) <input type="checkbox"/> Dry Season Water Table (C2) <input type="checkbox"/> Crayfish Burrows (C8) <input type="checkbox"/> Saturation Visible on Aerial Imagery (C9) <input type="checkbox"/> Stunted or Stressed Plants (D1) <input type="checkbox"/> Geomorphic Position (D2) <input type="checkbox"/> FAC-Neutral Test (D5)

Field Observations: Surface Water Present? Yes <input type="radio"/> No <input checked="" type="radio"/> Depth (inches): _____ Water Table Present? Yes <input type="radio"/> No <input checked="" type="radio"/> Depth (inches): _____ Saturation Present? (includes capillary fringe) Yes <input type="radio"/> No <input checked="" type="radio"/> Depth (inches): _____	Wetland Hydrology Present? Yes <input type="radio"/> No <input checked="" type="radio"/>
--	---

Describe Recorded Data (stream gauge, monitoring well, aerial photos, previous inspections), if available:

Remarks:

APPENDIX B
OEPA WETLAND ORAM FORMS

Wetland 01

Site: AEP Sterling Station Rater(s): J. Lubbers; J. Tucker Date: 1/22/2018

0 0

Metric 1. Wetland Area (size).

Field Id:
w-jbl-012218-01

max 6 pts. subtotal

- Select one size class and assign score.
- >50 acres (>20.2ha) (6 pts)
 - 25 to <50 acres (10.1 to <20.2ha) (5 pts)
 - 10 to <25 acres (4 to <10.1ha) (4 pts)
 - 3 to <10 acres (1.2 to <4ha) (3 pts)
 - 0.3 to <3 acres (0.12 to <1.2ha) (2pts)
 - 0.1 to <0.3 acres (0.04 to <0.12ha) (1 pt)
 - <0.1 acres (0.04ha) (0 pts)

acres

3 3

Metric 2. Upland buffers and surrounding land use.

max 14 pts. subtotal

- 2a. Calculate average buffer width. Select only one and assign score. Do not double check.
- WIDE. Buffers average 50m (164ft) or more around wetland perimeter (7)
 - MEDIUM. Buffers average 25m to <50m (82 to <164ft) around wetland perimeter (4)
 - NARROW. Buffers average 10m to <25m (32ft to <82ft) around wetland perimeter (1)
 - VERY NARROW. Buffers average <10m (<32ft) around wetland perimeter (0)

- 2b. Intensity of surrounding land use. Select one or double check and average.
- VERY LOW. 2nd growth or older forest, prairie, savannah, wildlife area, etc. (7)
 - LOW. Old field (>10 years), shrubland, young second growth forest. (5)
 - MODERATELY HIGH. Residential, fenced pasture, park, conservation tillage, new fallow field. (3)
 - HIGH. Urban, industrial, open pasture, row cropping, mining, construction. (1)

6.5 9.5

Metric 3. Hydrology.

max 30 pts. subtotal

3a. Sources of Water. Score all that apply.

- High pH groundwater (5)
- Other groundwater (3)
- Precipitation (1)
- Seasonal/Intermittent surface water (3)
- Perennial surface water (lake or stream) (5)

3c. Maximum water depth. Select one.

- >0.7 (27.6in) (3)
- 0.4 to 0.7m (15.7 to 27.6in) (2)
- <0.4m (<15.7in) (1)

3e. Modifications to natural hydrologic regime. Score one or double check and average.

- None or none apparent (12)
- Recovered (7)
- Recovering (3)
- Recent or no recovery (1)

3b. Connectivity. Score all that apply.

- 100 year floodplain (1)
- Between stream/lake and other human use (1)
- Part of wetland/upland (e.g. forest), complex (1)
- Part of riparian or upland corridor (1)

3d. Duration inundation/saturation. Score one or dbl check.

- Semi- to permanently inundated/saturated (4)
- Regularly inundated/saturated (3)
- Seasonally inundated (2)
- Seasonally saturated in upper 30cm (12in) (1)

Check all disturbances observed

- ditch
- tile
- dike
- weir
- stormwater input
- point source (nonstormwater)
- filling/grading
- road bed/RR track
- dredging
- Other:

7 16.5

Metric 4. Habitat Alteration and Development.

max 20 pts. subtotal

4a. Substrate disturbance. Score one or double check and average.

- None or none apparent (4)
- Recovered (3)
- Recovering (2)
- Recent or no recovery (1)

4b. Habitat development. Select only one and assign score.

- Excellent (7)
- Very good (6)
- Good (5)
- Moderately good (4)
- Fair (3)
- Poor to fair (2)
- Poor (1)

4c. Habitat alteration. Score one or double check and average.

- None or none apparent (9)
- Recovered (6)
- Recovering (3)
- Recent or no recovery (1)

Check all disturbances observed

- mowing
- grazing
- clearcutting
- selective cutting
- woody debris removal
- toxic pollutants
- shrub/sapling removal
- herbaceous/aquatic bed removal
- sedimentation
- dredging
- farming
- nutrient enrichment

16.5

subtotal this page ORAM v. 5.0 Field Form Quantitative Rating

Wetland 01

Site: AEP Sterling Station | Rater(s): J. Lubbers; J. Tucker | Date: 1/22/2018

16.5

subtotal this page

0 | **16.5**

max 10 pts.

subtotal

Metric 5. Special Wetlands.

Check all that apply and score as indicated.

- Bog (10)
- Fen (10)
- Old growth forest (10)
- Mature forested wetland (5)
- Lake Erie coastal/tributary wetland-unrestricted hydrology (10)
- Lake Erie coastal/tributary wetland-restricted hydrology (5)
- Lake Plain Sand Prairies (Oak Openings) (10)
- Relict Wet Prairies (10)
- Known occurrence state/federal threatened or endangered species (10)
- Significant migratory songbird/water fowl habitat or usage (10)
- Category 1 Wetland. See Question 5 Qualitative Rating (-10)

2 | **18.5**

max 20pts.

subtotal

6a. Wetland Vegetation Communities.

Score all present using 0 to 3 scale.

- Aquatic bed
- 1 Emergent
- Shrub
- Forest
- Mudflats
- Open water
- Other

6b. horizontal (plan view) Interspersion.

Select only one.

- High (5)
- Moderately high(4)
- Moderate (3)
- Moderately low (2)
- Low (1)
- None (0)

6c. Coverage of invasive plants. Refer

Table 1 ORAM long form for list. Add or deduct points for coverage

- Extensive >75% cover (-5)
- Moderate 25-75% cover (-3)
- Sparse 5-25% cover (-1)
- Nearly absent <5% cover (0)
- Absent (1)

6d. Microtopography.

Score all present using 0 to 3 scale.

- 1 Vegetated hummocks/tussucks
- Coarse woody debris >15cm (6in)
- Standing dead >25cm (10in) dbh
- 1 Amphibian breeding pools

Field Id:

w-jbl-012218-01

Vegetation Community Cover Scale

- | | |
|---|---|
| 0 | Absent or comprises <0.1ha (0.2471 acres) contiguous area |
| 1 | Present and either comprises small part of wetland's 1 vegetation and is of moderate quality, or comprises a significant part but is of low quality |
| 2 | Present and either comprises significant part of wetland's 2 vegetation and is of moderate quality or comprises a small part and is of high quality |
| 3 | Present and comprises significant part, or more, of wetland's 3 vegetation and is of high quality |

Narrative Description of Vegetation Quality

Low spp diversity and/or predominance of nonnative or low disturbance tolerant native species

Native spp are dominant component of the vegetation, mod although nonnative and/or disturbance tolerant native spp can also be present, and species diversity moderate to moderately high, but generally w/o presence of rare threatened or endangered spp to

A predominance of native species, with nonnative spp high and/or disturbance tolerant native spp absent or virtually absent, and high spp diversity and often, but not always, the presence of rare, threatened, or endangered spp

Mudflat and Open Water Class Quality

- | | |
|---|---|
| 0 | Absent <0.1ha (0.247 acres) |
| 1 | Low 0.1 to <1ha (0.247 to 2.47 acres) |
| 2 | Moderate 1 to <4ha (2.47 to 9.88 acres) |
| 3 | High 4ha (9.88 acres) or more |

Microtopography Cover Scale

- | | |
|---|--|
| 0 | Absent |
| 1 | Present very small amounts or if more common of marginal quality |
| 2 | Present in moderate amounts, but not of highest quality or in small amounts of highest quality |
| 3 | Present in moderate or greater amounts and of highest quality |

Category 1

18.5 GRAND TOTAL(max 100 pts)

Wetland 02

Site: AEP Sterling Station Rater(s): J. Lubbers; J. Tucker Date: 1/22/2018

1 **1**

Metric 1. Wetland Area (size).

Field Id:
w-jbl-012218-02

max 6 pts. subtotal

- Select one size class and assign score.
- >50 acres (>20.2ha) (6 pts)
 - 25 to <50 acres (10.1 to <20.2ha) (5 pts)
 - 10 to <25 acres (4 to <10.1ha) (4 pts)
 - 3 to <10 acres (1.2 to <4ha) (3 pts)
 - 0.3 to <3 acres (0.12 to <1.2ha) (2pts)
 - 0.1 to <0.3 acres (0.04 to <0.12ha) (1 pt)
 - <0.1 acres (0.04ha) (0 pts)

acres

6 **7**

Metric 2. Upland buffers and surrounding land use.

max 14 pts. subtotal

2a. Calculate average buffer width. Select only one and assign score. Do not double check.

- WIDE. Buffers average 50m (164ft) or more around wetland perimeter (7)
- MEDIUM. Buffers average 25m to <50m (82 to <164ft) around wetland perimeter (4)
- NARROW. Buffers average 10m to <25m (32ft to <82ft) around wetland perimeter (1)
- VERY NARROW. Buffers average <10m (<32ft) around wetland perimeter (0)

2b. Intensity of surrounding land use. Select one or double check and average.

- VERY LOW. 2nd growth or older forest, prairie, savannah, wildlife area, etc. (7)
- LOW. Old field (>10 years), shrubland, young second growth forest. (5)
- MODERATELY HIGH. Residential, fenced pasture, park, conservation tillage, new fallow field. (3)
- HIGH. Urban, industrial, open pasture, row cropping, mining, construction. (1)

6.5 **13.5**

Metric 3. Hydrology.

max 30 pts. subtotal

3a. Sources of Water. Score all that apply.

- High pH groundwater (5)
- Other groundwater (3)
- Precipitation (1)
- Seasonal/Intermittent surface water (3)
- Perennial surface water (lake or stream) (5)

3c. Maximum water depth. Select one.

- >0.7 (27.6in) (3)
- 0.4 to 0.7m (15.7 to 27.6in) (2)
- <0.4m (<15.7in) (1)

3e. Modifications to natural hydrologic regime. Score one or double check and average.

- None or none apparent (12)
- Recovered (7)
- Recovering (3)
- Recent or no recovery (1)

3b. Connectivity. Score all that apply.

- 100 year floodplain (1)
- Between stream/lake and other human use (1)
- Part of wetland/upland (e.g. forest), complex (1)
- Part of riparian or upland corridor (1)

3d. Duration inundation/saturation. Score one or dbl check.

- Semi- to permanently inundated/saturated (4)
- Regularly inundated/saturated (3)
- Seasonally inundated (2)
- Seasonally saturated in upper 30cm (12in) (1)

Check all disturbances observed

- | | |
|---|---|
| <input checked="" type="checkbox"/> ditch | <input type="checkbox"/> point source (nonstormwater) |
| <input type="checkbox"/> tile | <input checked="" type="checkbox"/> filling/grading |
| <input type="checkbox"/> dike | <input type="checkbox"/> road bed/RR track |
| <input type="checkbox"/> weir | <input type="checkbox"/> dredging |
| <input type="checkbox"/> stormwater input | <input type="checkbox"/> Other: |

6 **19.5**

Metric 4. Habitat Alteration and Development.

max 20 pts. subtotal

4a. Substrate disturbance. Score one or double check and average.

- None or none apparent (4)
- Recovered (3)
- Recovering (2)
- Recent or no recovery (1)

4b. Habitat development. Select only one and assign score.

- Excellent (7)
- Very good (6)
- Good (5)
- Moderately good (4)
- Fair (3)
- Poor to fair (2)
- Poor (1)

4c. Habitat alteration. Score one or double check and average.

- None or none apparent (9)
- Recovered (6)
- Recovering (3)
- Recent or no recovery (1)

Check all disturbances observed

- | | |
|---|---|
| <input checked="" type="checkbox"/> mowing | <input checked="" type="checkbox"/> shrub/sapling removal |
| <input type="checkbox"/> grazing | <input type="checkbox"/> herbaceous/aquatic bed removal |
| <input checked="" type="checkbox"/> clearcutting | <input type="checkbox"/> sedimentation |
| <input checked="" type="checkbox"/> selective cutting | <input type="checkbox"/> dredging |
| <input type="checkbox"/> woody debris removal | <input type="checkbox"/> farming |
| <input type="checkbox"/> toxic pollutants | <input type="checkbox"/> nutrient enrichment |

19.5

subtotal this page ORAM v. 5.0 Field Form Quantitative Rating

Wetland 02

Site: AEP Sterling Station | Rater(s): J. Lubbers; J. Tucker | Date: 1/22/2018

Field Id:
w-jbl-012218-02

19.5

subtotal this page

0 | 19.5

max 10 pts.

subtotal

Metric 5. Special Wetlands.

Check all that apply and score as indicated.

- Bog (10)
- Fen (10)
- Old growth forest (10)
- Mature forested wetland (5)
- Lake Erie coastal/tributary wetland-unrestricted hydrology (10)
- Lake Erie coastal/tributary wetland-restricted hydrology (5)
- Lake Plain Sand Prairies (Oak Openings) (10)
- Relict Wet Prairies (10)
- Known occurrence state/federal threatened or endangered species (10)
- Significant migratory songbird/water fowl habitat or usage (10)
- Category 1 Wetland. See Question 5 Qualitative Rating (-10)

2 | 21.5

max 20pts.

subtotal

6a. Wetland Vegetation Communities.

Score all present using 0 to 3 scale.

- Aquatic bed
- 1 Emergent
- Shrub
- Forest
- Mudflats
- Open water
- Other

6b. horizontal (plan view) Interspersion.

Select only one.

- High (5)
- Moderately high(4)
- Moderate (3)
- Moderately low (2)
- Low (1)
- x None (0)

6c. Coverage of invasive plants. Refer

Table 1 ORAM long form for list. Add or deduct points for coverage

- Extensive >75% cover (-5)
- Moderate 25-75% cover (-3)
- Sparse 5-25% cover (-1)
- x Nearly absent <5% cover (0)
- Absent (1)

6d. Microtopography.

Score all present using 0 to 3 scale.

- 1 Vegetated hummocks/tussucks
- Coarse woody debris >15cm (6in)
- Standing dead >25cm (10in) dbh
- Amphibian breeding pools

Vegetation Community Cover Scale

- | | |
|---|---|
| 0 | Absent or comprises <0.1ha (0.2471 acres) contiguous area |
| 1 | Present and either comprises small part of wetland's 1 vegetation and is of moderate quality, or comprises a significant part but is of low quality |
| 2 | Present and either comprises significant part of wetland's 2 vegetation and is of moderate quality or comprises a small part and is of high quality |
| 3 | Present and comprises significant part, or more, of wetland's 3 vegetation and is of high quality |

Narrative Description of Vegetation Quality

- | | |
|---|---|
| 0 | Low spp diversity and/or predominance of nonnative or low disturbance tolerant native species |
| 1 | Native spp are dominant component of the vegetation, mod although nonnative and/or disturbance tolerant native spp can also be present, and species diversity moderate to moderately high, but generally w/o presence of rare threatened or endangered spp to |
| 2 | A predominance of native species, with nonnative spp high and/or disturbance tolerant native spp absent or virtually absent, and high spp diversity and often, but not always, the presence of rare, threatened, or endangered spp |

Mudflat and Open Water Class Quality

- | | |
|---|---|
| 0 | Absent <0.1ha (0.247 acres) |
| 1 | Low 0.1 to <1ha (0.247 to 2.47 acres) |
| 2 | Moderate 1 to <4ha (2.47 to 9.88 acres) |
| 3 | High 4ha (9.88 acres) or more |

Microtopography Cover Scale

- | | |
|---|--|
| 0 | Absent |
| 1 | Present very small amounts or if more common of marginal quality |
| 2 | Present in moderate amounts, but not of highest quality or in small amounts of highest quality |
| 3 | Present in moderate or greater amounts and of highest quality |

Category 1

21.5 GRAND TOTAL(max 100 pts)

APPENDIX C
OEPA HHEI STREAM FORMS



Primary Headwater Habitat Evaluation Form

68

HHEI Score (sum of metrics 1, 2, 3) :

SITE NAME/LOCATION **AEP Sterlina Station**

hh-jbl-032017-01 SITE NUMBER **01** RIVER BASIN _____ DRAINAGE AREA (mi²) _____

LENGTH OF STREAM REACH (ft) _____ LAT. **40.70149** LONG. **-84.10676** RIVER CODE _____ RIVER MILE _____

DATE **03/20/17** SCORER **jbl,pjr** COMMENTS **intermittent**

NOTE: Complete All Items On This Form - Refer to "Field Evaluation Manual for Ohio's PWHH Streams" for Instructions

STREAM CHANNEL NONE / NATURAL CHANNEL RECOVERED RECOVERING RECENT OR NO RECOVERY

MODIFICATIONS: channelized, culverted, and riparian vegetation has been cleared

1. SUBSTRATE (Estimate percent of every type of substrate present. Check ONLY two predominant substrate TYPE boxes (Max of 32). Add total number of significant substrate types found (Max of 8). Final metric score is sum of boxes A & B.

TYPE	PERCENT	TYPE	PERCENT
<input checked="" type="checkbox"/> <input checked="" type="checkbox"/> BLDR SLABS [16 pts]	0%	<input checked="" type="checkbox"/> <input checked="" type="checkbox"/> SILT [3 pt]	70%
<input type="checkbox"/> <input type="checkbox"/> BOULDER (>256 mm) [16 pts]	0%	<input type="checkbox"/> <input checked="" type="checkbox"/> LEAF PACK/WOODY DEBRIS [3 pts]	30%
<input type="checkbox"/> <input type="checkbox"/> BEDROCK [16 pt]	0%	<input type="checkbox"/> <input type="checkbox"/> FINE DETRITUS [3 pts]	0%
<input type="checkbox"/> <input type="checkbox"/> COBBLE (65-256 mm) [12 pts]	0%	<input type="checkbox"/> <input type="checkbox"/> CLAY or HARDPAN [0 pt]	0%
<input type="checkbox"/> <input type="checkbox"/> GRAVEL (2-64 mm) [9 pts]	0%	<input type="checkbox"/> <input type="checkbox"/> MUCK [0 pts]	0%
<input type="checkbox"/> <input type="checkbox"/> SAND (<2 mm) [6 pts]	0%	<input type="checkbox"/> <input type="checkbox"/> ARTIFICIAL [3 pts]	0%

Total of Percentages of Bldr Slabs, Boulder, Cobble, Bedrock **0.00%** (A)

Substrate Percentage Check (B)

SCORE OF TWO MOST PREDOMINATE SUBSTRATE TYPES: **6**

TOTAL NUMBER OF SUBSTRATE TYPES: **2**

HHEI Metric Points

Substrate Max = 40

8

A + B

2. Maximum Pool Depth (Measure the maximum pool depth within the 61 meter (200 ft) evaluation reach at the time of evaluation. Avoid plunge pools from road culverts or storm water pipes) (Check ONLY one box):

<input type="checkbox"/> > 30 centimeters [20 pts]	<input type="checkbox"/> > 5 cm - 10 cm [15 pts]
<input checked="" type="checkbox"/> > 22.5 - 30 cm [30 pts]	<input type="checkbox"/> < 5 cm [5 pts]
<input type="checkbox"/> > 10 - 22.5 cm [25 pts]	<input type="checkbox"/> NO WATER OR MOIST CHANNEL [0 pts]

COMMENTS _____ MAXIMUM POOL DEPTH (Inches): **11.00**

Pool Depth Max = 30

30

3. BANK FULL WIDTH (Measured as the average of 3-4 measurements) (Check ONLY one box):

<input checked="" type="checkbox"/> > 4.0 meters (> 13') [30 pts]	<input type="checkbox"/> > 1.0 m - 1.5 m (> 3' 3" - 4' 8") [15 pts]
<input type="checkbox"/> > 3.0 m - 4.0 m (> 9' 7" - 13') [25 pts]	<input checked="" type="checkbox"/> 1.0 m (<= 3' 3") [5 pts]
<input type="checkbox"/> > 1.5 m - 3.0 m (> 9' 7" - 4' 8") [20 pts]	

COMMENTS _____ AVERAGE BANKFULL WIDTH (Feet): **15.00**

Bankfull Width Max=30

30

This information must also be completed

RIPARIAN ZONE AND FLOODPLAIN QUALITY (NOTE: River Left (L) and Right (R) as looking downstream't

RIPARIAN WIDTH	FLOODPLAIN QUALITY
(Per Bank)	(Most Predominant per Bank)
<input checked="" type="checkbox"/> <input checked="" type="checkbox"/> Wide >10m	<input checked="" type="checkbox"/> <input checked="" type="checkbox"/> Mature Forest, Wetland
<input type="checkbox"/> <input type="checkbox"/> Moderate 5-10m	<input type="checkbox"/> <input type="checkbox"/> Immature Forest, Shrub or Old Field
<input checked="" type="checkbox"/> <input checked="" type="checkbox"/> Narrow <5m	<input type="checkbox"/> <input checked="" type="checkbox"/> Residential, Park, New Field
<input type="checkbox"/> <input type="checkbox"/> None	<input type="checkbox"/> <input checked="" type="checkbox"/> Fenced Pasture
COMMENTS _____	<input type="checkbox"/> <input type="checkbox"/> Conservation Tillage
	<input type="checkbox"/> <input type="checkbox"/> Urban or Industrial
	<input type="checkbox"/> <input type="checkbox"/> Open Pasture, Row Crop
	<input type="checkbox"/> <input type="checkbox"/> Mining or Construction

FLOW REGIME (At Time of Evaluation) (Check ONLY one box):

Stream Flowing Moist Channel, isolated pools, no flow (Intermittent)

Subsurface flow with isolated pools (Interstitial) Dry channel, no water (Ephemeral)

COMMENTS rain earlier today

SINUOSITY (Number of bends per 61 m (200 ft) of channel) (Check ONLY one box):

None 1.0 2.0 3.0

0.5 1.5 2.5 >3

STREAM GRADIENT ESTIMATE

Flat (0.5 ft/100 ft) Flat to Moderate Moderate (2 ft/100 ft) Moderate to Severe Severe (10 ft/100 ft)

ADDITIONAL STREAM INFORMATION (This Information Must Also be Completed):

QHEI PERFORMED? Yes No QHEI Score (If Yes, Attach Completed QHEI Form)

DOWNSTREAM DESIGNATED USE(S)

<input type="checkbox"/> D	WWH Name:	<input type="text"/>	Distance from Evaluated Stream	<input type="text"/>
<input type="checkbox"/> D	CWH Name:	<input type="text"/>	Distance from Evaluated Stream	<input type="text"/>
<input type="checkbox"/> D	EWH Name:	<input type="text"/>	Distance from Evaluated Stream	<input type="text"/>

MAPPING: ATTACH COPIES OF MAPS, INCLUDING THE ENTIRE WATERSHED AREA. CLEARLY MARK THE SITE LOCATION

USGS Quadrangle Name: NRCS Soil Map Page: NRCS Soil Map Stream Order
 County: **Allen** Township / City:

MISCELLANEOUS

Base Flow Conditions? (Y/N): Y Date of last precipitation: **03/20/17** Quantity:
 Photograph Information:
 Elevated Turbidity? (Y/N): N Canopy (% open): **100%**
 Were samples collected for water chemistry? (Y/N): N (Note lab sample no. or id. and attach results) Lab Number:
 Field Measures: Temp (°C) Dissolved Oxygen (mg/l) pH (S.U.) Conductivity (µmhos/cm)
 Is the sampling reach representative of the stream (Y/N) Y If not, please explain:
 Additional comments/description of pollution impacts:

BIOTIC EVALUATION

Performed? (Y/N): N (If Yes, Record all observations. Voucher collections optional. NO TE: all voucher samples must be labeled with the site ID number. Include appropriate field data sheets from the Primary Headwater Habitat Assessment Manual)
 Fish Observed? (Y/N) N Voucher? (Y/N) N Salamanders Observed? (Y/N) N Voucher? (Y/N) N
 Frogs or Tadpoles Observed? (Y/N) N Voucher? (Y/N) N Aquatic Macroinvertebrates Observed? (Y/N) N Voucher? (Y/N) N
 Comments Regarding Biology:

DRAWING AND NARRATIVE DESCRIPTION OF STREAM REACH (This must be completed):

Include important landmarks and other features of interest for site evaluation and a narrative description of the stream's location

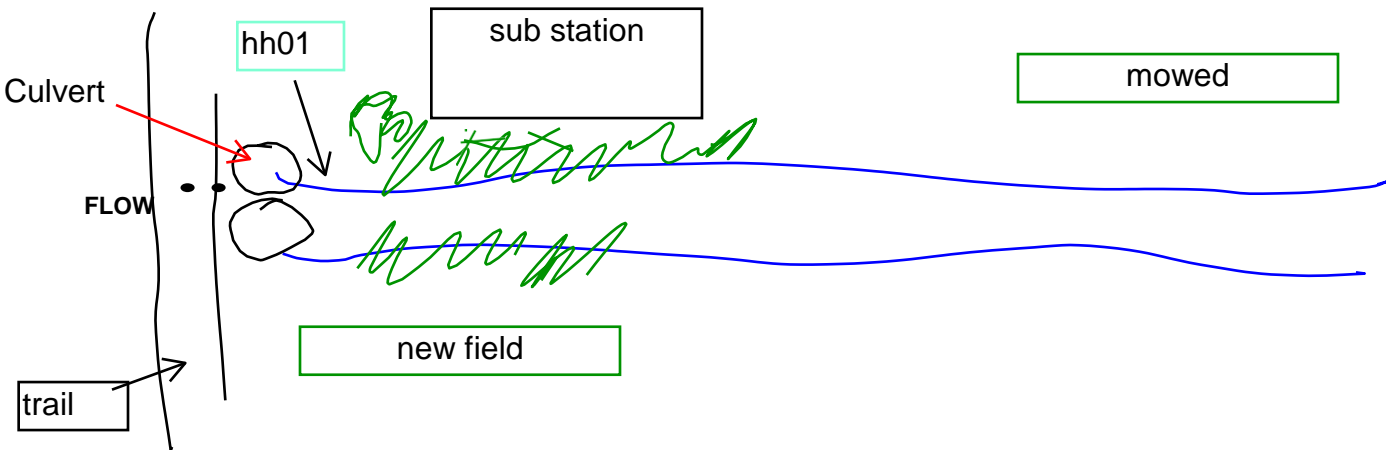

APPENDIX D
DELINEATED FEATURES PHOTOGRAPHS

Client Name:
AEP

Site Location:
Sterling Station Expansion Project

Project No.
60538242

Photo No. 1

Date:
January 22, 2018

Description:
Wetland 01
PEM wetland
Category 1



East



North



West



South



Soil Pit

Client Name:
AEP

Site Location:
Sterling Station Expansion Project

Project No.
60538242

Photo No. 2

Date:

January 22, 2018

Description:

Wetland 02

PEM wetland

Category 1



East



North



West



South



Soil Pit

Client Name: AEP	Site Location: Sterling Station Expansion Project	Project No. 60538242
----------------------------	---	--------------------------------

Photo No. 3	
Date: March 20, 2017	
Description: Stream 1 HHEI Stream Intermittent stream Facing upstream	

Photo No. 4	
Date: March 20, 2017	
Description: Stream 1 HHEI Stream Intermittent stream Facing downstream	

Client Name: AEP	Site Location: Sterling Station Expansion Project	Project No.: 60538242
----------------------------	---	---------------------------------

Photo No. 5	
Date: March 20, 2017	
Description: General view of eastern portion of Project survey boundary. Old Field Habitat Facing East	

Photo No. 6	
Date: March 20, 2017	
Description: General view of southern portion of Project survey boundary. Old Field Habitat Facing south	

APPENDIX E

CORRESPONDENCE LETTERS FROM USFWS AND ODNR



Ohio Department of Natural Resources

JOHN R. KASICH, GOVERNOR

JAMES ZEHRINGER, DIRECTOR

Ohio Division of Wildlife
Raymond W. Petering, Chief
2045 Morse Rd., Bldg. G
Columbus, OH 43229-6693
Phone: (614) 265-6300

13 March 2017

Jason Tucker
AECOM
525 Vine St.
Cincinnati, OH 45202

Dear Mr. Tucker,

After reviewing the Natural Heritage Database, I find the Division of Wildlife has no records of rare or endangered species in the Sterling Station Expansion project area, including a one-mile radius, in Perry Township, Allen County, Ohio. We are unaware of any unique ecological sites, geologic features, animal assemblages, scenic rivers, state wildlife areas, nature preserves, parks or forests, national wildlife refuges, parks or forests or other protected natural areas within a one-mile radius of the project area.

Our inventory program has not completely surveyed Ohio and relies on information supplied by many individuals and organizations. Therefore, a lack of records for any particular area is not a statement that rare species or unique features are absent from that area. This letter only represents a review of rare species and natural features data within the Ohio Natural Heritage Database. It does not fulfill coordination under the National Environmental Policy Act (NEPA) or the Fish and Wildlife Coordination Act (48 Stat. 401, as amended; 16 U.S. C. 661 et seq.) and does not supersede or replace the regulatory authority of any local, state or federal agency nor relieve the applicant of the obligation to comply with any local, state or federal laws or regulations.

Please contact me at 614-265-6818 if I can be of further assistance.

Sincerely,

A handwritten signature in blue ink that reads "Debbie Woischke".

Debbie Woischke
Ohio Natural Heritage Database Program

From: susan_zimmermann@fws.gov on behalf of Ohio, FW3 <ohio@fws.gov>
Sent: Thursday, March 16, 2017 11:48 AM
To: Tucker, Jason
Cc: nathan.reardon@dnr.state.oh.us; kate.parsons@dnr.state.oh.us
Subject: AEP Sterling Station Expansion Project, Allen Co. OH



UNITED STATES DEPARTMENT OF THE INTERIOR
U.S. Fish and Wildlife Service
Ecological Services Office
4625 Morse Road, Suite 104
Columbus, Ohio 43230
(614) 416-8993 / Fax (614) 416-8994



TAILS# 03E15000-2017-TA-0939

Dear Mr. Tucker,

We have received your recent correspondence requesting information about the subject proposal. There are no federal wilderness areas, wildlife refuges or designated critical habitat within the vicinity of the project area. The following comments and recommendations will assist you in fulfilling the requirements for consultation under section 7 of the Endangered Species Act of 1973, as amended (ESA).

The U.S. Fish and Wildlife Service (Service) recommends that proposed developments avoid and minimize water quality impacts and impacts to high quality fish and wildlife habitat (e.g., forests, streams, wetlands). Additionally, natural buffers around streams and wetlands should be preserved to enhance beneficial functions. If streams or wetlands will be impacted, the Corps of Engineers should be contacted to determine whether a Clean Water Act section 404 permit is required. Best management practices should be used to minimize erosion, especially on slopes. All disturbed areas should be mulched and revegetated with native plant species. Prevention of non-native, invasive plant establishment is critical in maintaining high quality habitats.

FEDERALLY LISTED SPECIES COMMENTS: All projects in the State of Ohio lie within the range of the federally endangered **Indiana bat** (*Myotis sodalis*) and the federally threatened **northern long-eared bat** (*Myotis septentrionalis*). In Ohio, presence of the Indiana bat and northern long-eared bat is assumed wherever suitable habitat occurs unless a presence/absence survey has been performed to document absence. Suitable summer habitat for Indiana bats and northern long-eared bats consists of a wide variety of forested/wooded habitats where they roost, forage, and travel and may also include some adjacent and interspersed non-forested habitats such as emergent wetlands and adjacent edges of agricultural fields, old fields and pastures. This includes forests and woodlots containing potential roosts (i.e., live trees and/or snags ≥ 3 inches diameter at breast height (dbh) that have any exfoliating bark, cracks, crevices, hollows and/or cavities), as well as linear features such as fencerows, riparian forests, and other wooded corridors. These wooded areas may be dense or loose aggregates of trees with variable amounts of canopy closure. Individual trees may be considered suitable habitat when they exhibit the characteristics of a potential roost tree and are located within 1,000 feet (305 meters) of other forested/wooded habitat. Northern long-eared bats have also been observed roosting in human-made structures, such as buildings, barns, bridges, and bat houses; therefore, these structures should also be considered potential summer habitat. In the winter, Indiana bats and northern long-eared bats hibernate in caves and abandoned mines.

Should the proposed site contain trees ≥ 3 inches dbh, we recommend that trees be saved wherever possible. If any caves or abandoned mines may be disturbed, further coordination with this office is requested to determine if fall or spring portal surveys are warranted. If no caves or abandoned mines are present and trees ≥ 3 inches dbh cannot be avoided, we recommend that removal of any trees ≥ 3 inches dbh only occur between October 1 and March 31. Seasonal clearing is being recommended to avoid adverse effects to Indiana bats and northern long-eared bats. While incidental take of northern long-eared bats from most tree clearing is exempted by a 4(d) rule (see <http://www.fws.gov/midwest/endangered/mammals/nleb/index.html>), incidental take of Indiana bats is still prohibited without a project-specific exemption. Thus, seasonal clearing is recommended where Indiana bats are assumed present.

If implementation of this seasonal tree cutting recommendation is not possible, summer surveys may be conducted to document the presence or probable absence of Indiana bats within the project area during the summer. If a summer survey documents probable absence of Indiana bats, the 4(d) rule for the northern long-eared bat could be applied. Surveys must be conducted by an approved surveyor and be designed and conducted in coordination with the Endangered Species Coordinator for this office. Surveyors must have a valid federal permit. Please note that summer surveys may only be conducted between June 1 and August 15.

If there is a federal nexus for the project (e.g., federal funding provided, federal permits required to construct), no tree clearing should occur on any portion of the project area until consultation under section 7 of the ESA, between the Service and the federal action agency, is completed. We recommend that the federal action agency submit a determination of effects to this office, relative to the Indiana bat and northern long-eared bat, for our review and concurrence.

Due to the project type, size, and location, we do not anticipate adverse effects to any other federally endangered, threatened, proposed, or candidate species. Should the project design change, or during the term of this action, additional information on listed or proposed species or their critical habitat become available, or if new information reveals effects of the action that were not previously considered, consultation with the Service should be initiated to assess any potential impacts.

These comments have been prepared under the authority of the Fish and Wildlife Coordination Act (48 Stat. 401, as amended; 16 U.S.C. 661 et seq.), the ESA, and are consistent with the intent of the National Environmental Policy Act of 1969 and the Service's Mitigation Policy. This letter provides technical assistance only and does not serve as a completed section 7 consultation document. We recommend that the project be coordinated with the Ohio Department of Natural Resources due to the potential for the project to affect state listed species and/or state lands. Contact John Kessler, Environmental Services Administrator, at (614) 265-6621 or at john.kessler@dnr.state.oh.us.

If you have questions, or if we can be of further assistance in this matter, please contact our office at (614) 416-8993 or ohio@fws.gov.

Sincerely,

Dan Everson
Field Office Supervisor

cc: Nathan Reardon, ODNR-DOW
Kate Parsons, ODNR-DOW



Ohio Department of Natural Resources

JOHN R. KASICH, GOVERNOR

JAMES ZEHRINGER, DIRECTOR

Office of Real Estate
Paul R. Baldrige, Chief
2045 Morse Road – Bldg. E-2
Columbus, OH 43229
Phone: (614) 265-6649
Fax: (614) 267-4764

May 3, 2017

Jason Tucker
AECOM
525 Vine Street, Suite 1800
Cincinnati, Ohio 45202

Re: 17-206; Sterling Station Expansion Project

Project: The proposed project involves the expansion of the existing AEP Sterling Station.

Location: The proposed project is located in the City of Lima, Allen County, Ohio.

The Ohio Department of Natural Resources (ODNR) has completed a review of the above referenced project. These comments were generated by an inter-disciplinary review within the Department. These comments have been prepared under the authority of the Fish and Wildlife Coordination Act (48 Stat. 401, as amended; 16 U.S.C. 661 et seq.), the National Environmental Policy Act, the Coastal Zone Management Act, Ohio Revised Code and other applicable laws and regulations. These comments are also based on ODNR's experience as the state natural resource management agency and do not supersede or replace the regulatory authority of any local, state or federal agency nor relieve the applicant of the obligation to comply with any local, state or federal laws or regulations.

Natural Heritage Database: The Natural Heritage Database has no records at or within a one-mile radius of the project area.

A review of the Ohio Natural Heritage Database indicates there are no records of state endangered or threatened plants or animals within the project area. There are also no records of state potentially threatened plants, special interest or species of concern animals, or any federally listed species. In addition, we are unaware of any unique ecological sites, geologic features, animal assemblages, scenic rivers, state wildlife areas, state nature preserves, state or national parks, state or national forests, national wildlife refuges, or other protected natural areas within the project area. The review was performed on the project area you specified in your request as well as an additional one mile radius. Records searched date from 1980.

Please note that Ohio has not been completely surveyed and we rely on receiving information from many sources. Therefore, a lack of records for any particular area is not a statement that rare species or unique features are absent from that area. Although all types of plant communities have been surveyed, we only maintain records on the highest quality areas.

Fish and Wildlife: The Division of Wildlife (DOW) has the following comments.

The DOW recommends that impacts to streams, wetlands and other water resources be avoided and minimized to the fullest extent possible, and that best management practices be utilized to minimize erosion and sedimentation.

The project is within the range of the Indiana bat (*Myotis sodalis*), a state endangered and federally endangered species. The following species of trees have relatively high value as potential Indiana bat roost trees to include: shagbark hickory (*Carya ovata*), shellbark hickory (*Carya laciniosa*), bitternut hickory (*Carya cordiformis*), black ash (*Fraxinus nigra*), green ash (*Fraxinus pennsylvanica*), white ash (*Fraxinus americana*), shingle oak (*Quercus imbricaria*), northern red oak (*Quercus rubra*), slippery elm (*Ulmus rubra*), American elm (*Ulmus americana*), eastern cottonwood (*Populus deltoides*), silver maple (*Acer saccharinum*), sassafras (*Sassafras albidum*), post oak (*Quercus stellata*), and white oak (*Quercus alba*). Indiana bat roost trees consists of trees that include dead and dying trees with exfoliating bark, crevices, or cavities in upland areas or riparian corridors and living trees with exfoliating bark, cavities, or hollow areas formed from broken branches or tops. However, Indiana bats are also dependent on the forest structure surrounding roost trees. If suitable habitat occurs within the project area, the DOW recommends trees be conserved. If suitable habitat occurs within the project area and trees must be cut, the DOW recommends cutting occur between October 1 and March 31. If suitable trees must be cut during the summer months, the DOW recommends a net survey be conducted between June 1 and August 15, prior to any cutting. Net surveys should incorporate either nine net nights per square 0.5 kilometer of project area, or four net nights per kilometer for linear projects. If no tree removal is proposed, this project is not likely to impact this species.

The project is within the range of the clubshell (*Pleurobema clava*), a state endangered and federally endangered mussel, the northern riffleshell (*Epioblasma torulosa rangiana*), a state endangered and federally endangered mussel, and the pondhorn (*Uniomerus tetralasmus*), a state threatened mussel. Due to the location, and that there is no in-water work proposed in a perennial stream, this project is not likely to impact these species.

The project is within the range of the greater redhorse (*Moxostoma valenciennesi*), a state threatened fish. Due to the location, and that there is no in-water work proposed in a perennial stream, this project is not likely to impact this species.

The project is within the range of the upland sandpiper (*Bartramia longicauda*), a state endangered bird. Nesting upland sandpipers utilize dry grasslands including native grasslands, seeded grasslands, grazed and ungrazed pasture, hayfields, and grasslands established through the Conservation Reserve Program (CRP). If this type of habitat will be impacted, construction should be avoided in this habitat during the species' nesting period of April 15 to July 31. If this type of habitat will not be impacted, this project is not likely to impact this species.

Due to the potential of impacts to federally listed species, as well as to state listed species, we recommend that this project be coordinated with the U.S. Fish & Wildlife Service.

Water Resources: The Division of Water Resources has the following comment.

The local floodplain administrator should be contacted concerning the possible need for any floodplain permits or approvals for this project. Your local floodplain administrator contact information can be found at the website below.

http://water.ohiodnr.gov/portals/soilwater/pdf/floodplain/Floodplain%20Manager%20Community%20Contact%20List_8_16.pdf

ODNR appreciates the opportunity to provide these comments. Please contact John Kessler at (614) 265-6621 if you have questions about these comments or need additional information.

John Kessler
ODNR Office of Real Estate
2045 Morse Road, Building E-2
Columbus, Ohio 43229-6693
John.Kessler@dnr.state.oh.us

Appendix B Cultural Report



In reply refer to
2017-ALL - 39845

August 30, 2017

Mr. Ryan J. Weller
Weller & Associates, Inc.
1395 West Fifth Avenue
Columbus, Ohio 43212

RE: Sterling Station Rebuild Project, Shawnee and Perry Township, Allen County, Ohio

Dear Mr. Weller:

This letter is in response to the correspondence received on August 25, 2017 regarding the proposed Sterling Station Rebuild Project, Shawnee and Perry Townships, Allen County, Ohio. We appreciate the opportunity to comment on this project. The comments of the Ohio State Historic Preservation Office (SHPO) are submitted in accordance with the provisions of Section 106 of the National Historic Preservation Act of 1966, as amended (16 U.S.C. 470 [36 CFR 8001]).

The following comments pertain to the *Phase I Cultural Resource Management Investigations for American Electric Power's 6.5 ha (16 ac) Sterling Station Rebuild Project in Shawnee and Perry Townships, Allen County, Ohio* by Weller & Associates, Inc. (2017).

A literature review, visual inspection, shovel probe excavation, and shovel test unit excavation was completed as part of the investigations. No previously identified archaeological sites are located within the project area. No archaeological sites were identified during this survey. Based on the information provided, we agree with your determination of no historic properties affected and no further archaeological work is necessary.

No properties over 50 years of age were identified in the study area. Therefore, we agree that the project as proposed will have no effect on historic properties.

Based on the information provided, we agree the project will not affect historic properties. No further coordination with this office is necessary, unless the project changes or unless new or additional historic properties are discovered during implementation of this project. In such a situation, this office should be contacted.

If you have any questions, please contact me at (614) 298-2022, or by e-mail at khorricks@ohiohistory.org. Thank you for your cooperation.

Sincerely,

A handwritten signature in blue ink, appearing to read "Krista Horrocks", is written over a light blue circular stamp.

Krista Horrocks, Project Reviews Manager
Resource Protection and Review

cc: Ron Howard, AEP (rmhoward@aep.com)

RPR Serial No: 1070226



**Phase I Cultural Resource Management Investigations for
American Electric Power's 6.5 ha (16 ac) Sterling Station
Rebuild Project in Shawnee and Perry Townships, Allen
County, Ohio**

Ryan J. Weller

March 13, 2017

1395 West Fifth Ave.
Columbus, OH 43212
Phone: 614.485.9435
Fax: 614.485.9439
Website: www.wellercrm.com

**Phase I Cultural Resource Management Investigations for
American Electric Power's 6.5 ha (16 ac) Sterling Station
Rebuild Project in Shawnee and Perry Townships,
Allen County, Ohio**

By

Ryan J. Weller

Submitted By:

**Ryan J. Weller, P.I.
Weller & Associates, Inc.
1395 West Fifth Ave.
Columbus, OH 43212
Phone: 614.485. 9435 Fax: 614.485. 9439
Website: www.wellercrm.com**

Prepared For:

**American Electric Power
700 Morrison Road
Gahanna, OH 43230**



Ryan Weller, P.I.

March 13, 2017

Abstract

In March of 2017, Weller & Associates, Inc. conducted Phase I Cultural Resource Management Investigations for American Electric Power's 6.5 ha (16 ac) Sterling Station Rebuild Project in Shawnee and Perry Townships, Allen County, Ohio. The work was conducted under contract with American Electric Power (AEP) for submittal to the Ohio Power Siting Board. These investigations were conducted for a rebuilding project associated with an existing electric substation and including an expanded area. The project area is located in the southern part of the City of Lima. The field investigations involved visual inspection and subsurface testing. The fieldwork did not result in the identification of any cultural materials; the project area, being located in an industrial setting, is consistent and not aberrant to the surrounding setting.

The project area is located in the southern part of the City of Lima. This part of Lima is a mixture of single-family housing lots, but is mostly affiliated with industrial types of development. This is an upland setting where the terrain is gently undulating to nearly level. The project area is located mostly to the east of McClain Road, south of East Hanthorn Road, and north of I-75. The project plans are to rebuild the existing Sterling 138kV Substation and expand the facilities to the east.

A literature review conducted prior to the field investigations determined that there are few sites recorded in the vicinity of the project as well as the uplands in these areas. There are no previously recorded cultural resources identified within the study area. The westernmost aspect of the project, the part that extends west of McClain Road, was previously investigated (Schuck 1999). This survey involves a very small aspect of the project area and did not identify any sites.

There were no cultural resources identified during these investigations. There are no significant resources that are older than 50 years of age or older identified within what is regarded as the APE. No further work is deemed necessary for this project.

Table of Contents

Abstract	i
List of Tables and Figures	iii
Introduction	1
Environmental Setting	1
Cultural Setting	4
Research Design	12
Literature Review	14
Fieldwork Results	16
APE Definition and NRHP Determination	17
Recommendations	18
References Cited	19
Figures	23

List of Tables

1. Soils in the Project.

List of Figures

1. Political map of Ohio showing the approximate location of the project.
2. Portion of the USGS *1994 Lima, Ohio 7.5 Minute Series (Topographic)* map indicating the location of the project and previously recorded resources in the study area.
3. Aerial map indicating the location of the project.
4. Portion of the USGS *1906 Lima, Ohio 15 Minute Series (Topographic)* map indicating the approximate location of the project.
5. Fieldwork results and photo orientation map.
6. The existing substation within the western portion of the project.
7. View of the disturbed conditions west of McClain Rd.
8. More disturbed conditions west of McClain Rd.
9. View of the disturbed conditions just east of McCain Rd.
10. Typical disturbed conditions within the northern portion of the project.
11. The shovel tested area within the eastern portion of the project.
12. View of the southern portion of the project.
13. The disturbed ditch area in the center of the project.
14. Conditions within the northwestern portion of the project.
15. A disturbed shovel probe from the project.
16. A typical shovel test unit excavated within the project.

Introduction

In March of 2017, Weller & Associates, Inc. (Weller) Phase I Cultural Resource Management Investigations for American Electric Power's 6.5 ha (16 ac) Sterling Station Rebuild Project in Shawnee and Perry Townships, Allen County, Ohio (Figures 1-3). The work was conducted under contract with American Electric Power (AEP) pursuant to documentary requirements for the Ohio Power Siting Board (OPSB). These investigations were conducted in a manner reflective of the survey and report format established in *Archaeology Guidelines* (Ohio Historic Preservation Office 1994). The work efforts evaluated cultural resources similar to methods that are reflective of the National Register of Historic Places (NRHP) pursuant to Section 106 of the National Historic Preservation Act of 1966, as amended (16 U.S.C. 470 [36 CFR 800]). This report summarizes the results of the fieldwork and literature review. The work includes a literature review/background documentation, archaeological field investigations, and visual inspection of the Area of Potential Effects (APE).

Chad Porter completed the literature review on March 8, 2017. The field investigations for this project were conducted in March of 2017. The field crew included Josh Engle, Justin Fryer, Dakota Martinez, and Seth Cooper. Ryan Weller served as the Principal Investigator. Jackie Lehmann conducted the investigations for the history/architecture component of this project.

Project Description

The project will include the rebuilding of the existing Sterling 138kV Station in the City of Lima, Allen County, Ohio. The project area is located mostly north and west of the I-75 and McClain Road intersection. This is an area that has been highly developed with residences and industry. The project will include tap lines that are less than 305 m (1,000 ft) long. The overall project includes an area that is about 6.5 ha (16 ac) in size and this includes the existing station. This is an urban/industrial environment and it is expected that subsurface testing would be necessary throughout the areas where construction is not already extant. Since this is new construction an architectural survey of the immediate area around the proposed substation is necessary.

Environmental Setting

Climate

Allen County, like all of Ohio, has a continental climate with hot and humid summers and cold winters. Most of precipitation falls in June, and the smallest amount falls in February. The average annual temperature in Allen County is 11°C. Precipitation is favorably distributed for the production of crops (United States Department of Agriculture, Soil Conservation Service [USDA, SCS] 1965 (2017)).

Physiography, Relief, and Drainage

The southern part of Allen County, including the project area, is located in the

Central Ohio Clayey Till Plain region (Brockman 1998). There are end moraine deposits that extend in a general east-west manner through Allen County (Pavey et al. 1999). The majority of the project area is nearly level to gently rolling till plains. The project area is drained by an unnamed tributary of the Ottawa River; this part of the Auglaize-Maumee River watershed.

Geology

The underlying bedrock throughout Allen County is affiliated with Silurian age materials (Brockman 1998). The Silurian System consists of sedimentary rocks, mainly of dolomite, anhydrite, gypsum, salt, and shale.

Soils

The soils that are in this part of Allen County part of the project area is contained in nearly homogeneous till plain terrain. The soils series types that are present within the project are indicative of upland till plain settings that are lacking any noticeably distinct features/topography. There are five soil series types present within the project area (Table 1). The Pewamo series soils are indicative of poorly drained, low-lying situations. Udorthents are indicative of severely disturbed conditions (USDA, SCS 1965 (2017)) (Table 1).

Table 1. Soils in the Project.			
Soil Symbol	Soil Name	% Slope	Location
PmA	Pewamo silty clay loam	0-1	Drainageways, flats, and depressions
Blg1A1	Blount silt loam	0-2	Till plains, slight rises
Blg1B1	Blount silt loam	2-4	Till plains, slight rises
Gwg1B1	Glynwood silt loam	2-6	Till plains, slight rises
UdD	Udorthents, loamy	12-25	Made-land, disturbance

Flora

There was, and continues to be, great floral diversity in Ohio. This diversity is relative to the soils and the terrain that generally includes the till plain, lake plain, terminal glacial margins, and unglaciated plateau (Forsyth 1970). Three major glacial advances, including the Kansan, Illinoian, and Wisconsinan, have affected the landscape of Ohio. The effects of the Wisconsin glaciation are most pronounced and have affected more than half of the state (Pavey et al. 1999). The following is to provide comparison of the different floral regions of Ohio relative to this project.

The least diverse part of Ohio extends in a belt from the northeast below the lake-affected areas through most of western Ohio (Gordon 1966). These areas are part of the late Wisconsin ground moraine and lateral end moraines. It is positioned between the lake plains region and the terminal glacial moraines. This area included broad forested areas of beech maple forests interspersed with mixed oak forests in elevated terrain or where relief is greater (Forsyth 1970; Gordon 1966). Prairie environments such as those

in Wyandot and Marion County areas would contain islands of forests, but were mostly expansive open terrain dominated by grasses.

The northwestern Ohio terrain is nearly flat because of ancient glacial lakes and glaciation, which affected the flora. However, the vegetation was more diverse than the till plain to the south and east because of the variety of factors that contributed to its terrain. Forests within the Black Swamp were generally comprised of elm/ash stands; however, dissected areas along drainages and drier, elevated areas from beach deposits would contain mixed forests of oak and hickory (Gordon 1966, 1969). There was little upland floral diversity in the lake plains (Black Swamp region) except for the occasional patches of oak and hickory. Floral variety was most evident in narrow sleeves along larger stream valleys where there is relief.

The most biological diversity in Ohio is contained within the Allegheny Plateau, which encompasses the southeastern two-thirds of the state (Sheaffer and Rose 1998). Because this area is higher and has drier conditions, it is dominated by mixed oak forests. Some locations within the central part of this area contain beech and mixed mesophytic forests. There are large patches of oak and sugar maple forests to the south of the terminal moraine from Richland to Mahoning County (Gordon 1966).

Southwestern Ohio from about Cincinnati to Bellefontaine east to the Scioto River historically contained a very diverse floral landscape. This is an area where moraines from three glacial episodes are prevalent (Pavey et al. 1999). Forests in this area include elm-ash swamp, beech, oak-sugar maple, mixed mesophytic, prairie grasslands, mixed oak, and bottomland hardwoods (Core 1966; Gordon 1966, 1969). These forest types are intermingled with prairies being limited to the northern limits of this area mostly in Clark and Madison Counties.

Generally, beech forests are the most common variety through Ohio and could be found in all regions. Oak and hickory forests dominated the southeastern Ohio terrain and were found with patchy frequency across most of northern Ohio. Areas that were formerly open prairies and grasslands are in glacial areas, but are still patchy. These are in the west central part of the state. Oak and sugar maple forests occur predominantly along the glacial terminal moraine. Elm-ash swamp forests are prevalent in glaciated areas including the northern and western parts of Ohio (Gordon 1966; Pavey et al. 1999).

Central Allen, including the project area, are generally within what is considered to be a beech and elm-ash swamp forest area (Gordon 1966).

Fauna

The upland forest zone offered a diversity of mammals to the prehistoric diet. This food source consisted of white-tailed deer, black bear, Eastern cottontail rabbit, opossum, a variety of squirrels, as well as other less economically important mammals. Several avian species were a part of the upland prehistoric diet as well (i.e. wild turkey, quail, ruffed grouse, passenger pigeon, etc.). The lowland zone offered significant

species as well. Raccoon, beaver, and muskrat were a few of the mammals, while wood duck and wild goose were the economically important birds. Fishes and shellfish were also an integral part of the prehistoric diet. Ohio muskellunge, yellow perch, white crappie, long nose gar, channel catfish, pike, and sturgeon were several of the fish, whereas, the Ohio naiad mollusc, butterfly's shell, long solid, common bullhead, knob rockshell, and cod shell were the major varieties of shellfish. Reptiles and amphibians, such as several varieties of snakes, frogs, and turtles, were also part of the prehistoric diet (Trautman 1981; Lafferty 1979; Mahr 1949).

Cultural Setting

The first inhabitants of Ohio were probably unable to enter this land until the ice sheets of the Wisconsin glacier melted around 14,000 B.C. Paleoindian sites are considered rare due to the age of the sites and the effects of land altering activities such as erosion. Such sites were mostly used temporarily and thus lack the accumulation of human occupational deposits that would have been created by frequent visitation. Paleoindian artifact assemblages are characteristic of transient hunter-gatherer foraging activity and subsistence patterns. In Ohio, major Paleoindian sites have been documented along large river systems and near flint outcrops in the Unglaciated Plateau (Cunningham 1973). Otherwise, Paleoindian sites in the glaciated portions of Ohio are encountered infrequently and are usually represented by isolated finds or open air scatters.

The Paleoindian period is characterized by tool kits and gear utilized in hunting Late Pleistocene megafauna and other herding animals including but not limited to short-faced bear, barren ground caribou, flat-headed peccary, bison, mastodon, giant beaver (Bamforth 1988; Brose 1994; McDonald 1994). Groups have been depicted as being mobile and nomadic (Tankersley 1989); artifacts include projectile points, multi-purpose unifacial tools, burins, graters, and spokeshaves (Tankersley 1994). The most diagnostic artifacts associated with this period are fluted points that exhibit a groove or channel positioned at the base to facilitate hafting. The projectiles dating from the late Paleoindian period generally lack this trait; however, the lance form of the blade is retained and is often distinctive from the following Early Archaic period (Justice 1987).

The Archaic period has been broken down into three sub-categories, including the Early, Middle, and Late Archaic. During the Early Archaic period (ca. 10,000-8000 B.P.), the environment was becoming increasingly arid as indicated by the canopy (Shane 1987). This period of dryness allowed for the exploitation of areas that were previously inaccessible or undesirable. The Early Archaic period does not diverge greatly from the Paleoindian regarding the type of settlement. Societies still appear to be largely mobile with reliance on herding animals (Fitting 1963). For these reasons, Early Archaic artifacts can be encountered in nearly all settings throughout Ohio. Tool diversity increased at this time including hafted knives that are often re-sharpened by the process of beveling the utilized blade edge and intense basal grinding (Justice 1987). There is a basic transition from lance-shaped points to those with blades that are triangular. Notching becomes a common hafting trait. Another characteristic trait occurring almost exclusively in the Early and Middle Archaic periods is basal bifurcation and large blade serrations. Tool forms begin to vary more and may be a reflection of differential resource

exploitation. Finished tools from this period can include bifacial knives, points, drills/perforators, utilized flakes, and scrapers.

The Middle Archaic period (8000-6000 B.P.) is poorly known or understood in archaeological contexts within Ohio. Some (e.g., Justice 1987) regard small bifurcate points as being indicative of this period. Ground stone artifacts become more prevalent at this time. Other hafted bifaces exhibit large side notches with squared bases, but this same trait can extend back to the Paleoindian period. The climate at this time is much like that of the modern era. Middle Archaic period subsistence tended to be associated with small patch foraging that involved a consistent need for mobility with a shift towards stream valleys (Stafford 1994). Sites encountered from this time period throughout most of Ohio tend to be lithic scatters or isolated finds. The initial appearance of regional traits may be apparent at this time.

The Late Archaic period in Ohio (ca 6000-3000 B.P.) diverges from the previous periods in many ways. Preferred locations within a regional setting appear to have been repeatedly occupied. The more intensive and repeated occupations often resulted in the creation of greater social and material culture complexity. The environment at this time is warmer and drier. Most elevated landforms in northeastern Ohio have yielded Archaic artifacts (Prufer and Long 1986: 7), and the same can be stated for the remainder of Ohio.

Various artifacts are diagnostic of the Late Archaic period. Often, burial goods provide evidence that there was some long-distance movement of materials, while lithic materials used in utilitarian assemblages are often from a local chert outcrop. There is increased variation in projectile point styles that may reflect regionalism. Slate was often used in the production of ornamental artifacts. Ground and polished stone artifacts reached a high level of development. This is evident in such artifacts as grooved axes, celts, bannerstones, and other slate artifacts.

It is during the Terminal Archaic period (ca 3500-2500 B.P.) that extensive and deep burials are encountered. Cultural regionalism within Ohio is evident in the presence of Crab Orchard (southwest), Glacial Kame (northern), and Meadowood (central to Northeastern). Along the Ohio River, intensive occupations have been placed within the Riverton phase. Pottery makes its first appearance during the Terminal Late Archaic.

The Early Woodland period (ca 3000-2100 B.P.) in Ohio is often associated with the Adena culture and the early mound builders (Dragoo 1976). Early and comparably simple geometric earthworks first appear with mounds more spread across the landscape. Pottery at this time is thick and tempered with grit, grog, or limestone; however, it becomes noticeably thinner towards the end of the period. There is increased emphasis on gathered plant resources, including maygrass, chenopodium, sunflower, and squash. Habitation sites have been documented that include structural evidence. Houses that were constructed during this period were circular, having a diameter of up to 18.3 m (Webb and Baby 1963) and often with paired posts (Cramer 1989). Artifacts dating from this period include leaf-shaped blades with parallel to lobate hafting elements, drilled

slate pieces, ground stone, thick pottery, and increased use of copper. Early Woodland artifacts can be recovered from every region of Ohio.

In northwest and north-central Ohio, there are not very many mounds or village sites that indicate an Early Woodland occupation. Artifacts from these areas often are reflective of seasonal hunting excursions. Adena-like bifaces and tools are commonly found in river and stream valleys that drain into Lake Erie as well as in the uplands. It is assumed that Early Woodland inhabitants used these areas for little more than a transient hunting-collecting subsistence. One of the best-known Early Woodland sites is the Leimbach site. This site is located where the Huron River empties into Lake Erie (Shane 1975). Early Woodland ceramics and lugged vessels have been recovered from this site. Evidence of Early Woodland activity, such as ceramics, has been encountered infrequently at locations across north-central and northwestern Ohio.

The Middle Woodland period (ca 2200-1600 B.P.) is often considered to be equivalent with the Hopewell culture. The largest earthworks in Ohio date from this period. There is dramatic increase in the appearance of exotic materials that appear most often in association with earthworks and burials. Artifacts representative of this period include thinner, grit-tempered pottery, dart-sized projectile points (Lowe Flared, Steuben, Snyders, and Chesser) [Justice 1987], exotic materials (mica, obsidian, and marine shell, etc.). The points are often thin, bifacially beveled, and have flat cross sections. There seems to have been a marked increase in the population as well as increased levels of social organization. Middle Woodland sites seem to reflect a seasonal exploitation of the environment. There is a notable increase in the amount of Eastern Agricultural Complex plant cultigens, including chenopodium, knotweed, sumpweed, and little barley. This seasonal exploitation may have followed a scheduled resource extraction year in which the populations moved camp several times per year, stopping at known resource extraction loci. Middle Woodland land use appears to center on the regions surrounding earthworks (Dancey 1992; Pacheco 1996); however, there is evidence of repeated occupation away from earthworks (Weller 2005). Household structures at this time vary with many of them being squares with rounded corners (Weller 2005). Exotic goods are often attributed to funerary activities associated with mounds and earthworks. Utilitarian items are more frequently encountered outside of funerary/ritual contexts. The artifact most diagnostic of this period is the bladelet, a prismatic and thin razor-like tool, and bladelet cores. Middle Woodland remains are more commonly recovered from central Ohio south and lacking from most areas in the northern and southeastern part of the state.

Little information is known about the Middle Woodland period of western and northwestern Ohio. This may be due to a poor representation of artifacts from this period or because the area is not directly associated with the Hopewell culture. The loosely associated patterns of earthworks to habitation sites that have been identified in central and southern Ohio areas are not present in this region. Sites associated with this period have been identified along the south and western shores of Lake Erie, but they are not common (Stothers et al. 1979; Stothers 1986).

The Late Woodland period (ca A.D. 400-900) is distinct from the previous period in several ways. There appears to be a population increase and a more noticeable aggregation of groups into formative villages. The villages are often positioned along large streams, on terraces, and were likely seasonally occupied (Cowan 1987). This increased sedentism was due in part to a greater reliance on horticultural garden plots, much more so than in the preceding Middle Woodland period. The early Late Woodland groups were growing a wide variety of crop plants that are collectively referred to as the Eastern Agricultural Complex. These crops included maygrass, sunflower, and domesticated forms of goosefoot and sumpweed. This starch and protein diet was supplemented with wild plants and animals. Circa A.D. 800 to 1000, populations adopted maize agriculture, and around this same time, shell-tempered ceramics appear. Other technological innovations and changes during this time period included the bow and arrow and changes in ceramic vessel forms.

Evidence suggests that the Late Woodland occupations in northern Ohio developed from the Western Basin Middle Woodland tradition. The Late Woodland period in northern Ohio is best defined by ceramic traditions. Western Basin Late Woodland sites have been identified in most of the river valleys in northwestern Ohio such as the Maumee, Auglaize, and the Sandusky Rivers. Radiocarbon dating establishes this Late Woodland occupation at the first century B.C. to A.D. 500 (Pratt and Bush 1981: 88). The Western Basin tradition consists of three primary phases, which include the Riviere au Vase, the Younge (Fitting 1965), and the Springwells phase. Influence from the Cole complex may extend into the area from the south, but this remains theoretical and not well researched.

The Late Prehistoric period in northwest and northern Ohio is often associated with an intensification of the use of plant resources, the presence of large villages, and a steady population increase. Permanent villages were associated with a heavy dependence on farming. These villages were often located on the meander belt zones of river valleys (Stothers et al. 1984: 6). Subsistence of these farming communities relied upon maize, beans, and squash as the major cultigens. Villages were often strategically located on bluff tops. There is a change in social structure to a chiefdom-based society. The Late Prehistoric period in northwest Ohio has been segregated into the Sandusky tradition and smaller phases based largely on age and ceramic assemblage traits.

The Sandusky tradition has been broken up into four phases. These phases are identified (in chronological order) as Eiden, Wolf, Fort Meigs, and Indian Hills. These are often associated with a style of ceramic referred to as Mixer Tool Impressed, Mixer Dentate, Mixer Cordmarked, and Parker Festooned. The Eiden and Wolf phases show a dependence upon fishing, and villages are usually associated with large cemeteries (Schneider 2000; Shane 1967).

The Fort Meigs and Indian Hills phases occur late in the Late Prehistoric period. The Fort Meigs phase may be related to the Wolf phase in that the pottery is similar. Fort Meigs phase occupations are identified by specific rim and neck motifs that are applied to their pottery. The Indian Hills phase is associated with shell-tempered pottery. Some

villages show evidence of defensive features such as stockade lines, ditches, or earthen walls (Pratt and Bush 1981: 155). There is little evidence to support inter-village relationships, such as trade; this lack may have been due to competition for localized resources.

Protohistoric to Settlement

By the mid-1600s, French explorers traveled through the Ohio country as trappers, traders, and missionaries. They kept journals about their encounters and details of their travels. These journals are often the only resource historians have regarding the early occupants of seventeenth century Ohio. The earliest village encountered by the explorers in 1652 was a Tionontati village located along the banks of Lake Erie and the Maumee River. Around 1670, it is known that three Shawnee villages were located along the confluence of the Ohio River and the Little Miami River. Because of the Iroquois Wars, which continued from 1641-1701, explorers did not spend much time in the Ohio region, and little else is known about the natives of Ohio during the 1600s. Although the Native American tribes of Ohio may have been affected by the outcome of the Iroquois Wars, no battles occurred in Ohio (Tanner 1987).

French explorers traveled extensively through the Ohio region from 1720-1761. During these expeditions, the locations of many Native American villages were documented. In 1751, a Delaware village known as Maguck existed near present-day Chillicothe. In 1758, a Shawnee town known as 'Lower Shawnee 2' existed at the same location. The French also documented the locations of trading posts and forts, which were typically established along the banks of Lake Erie or the Ohio River (Tanner 1987).

While the French were establishing a claim to the Ohio country, many Native Americans were also entering new claims to the region. The Shawnee were being forced out of Pennsylvania because of English settlement along the eastern coast. The Shawnee created a new headquarters at Shawnee Town, which was located at the mouth of the

Scioto River. This headquarters served as a way to pull together many of the tribes which had been dispersed because of the Iroquois Wars (Tanner 1987).

Warfare was bound to break out as the British also began to stake claims in the Ohio region by the mid-1700s. The French and Indian War (1754-1760) affected many Ohio Native Americans; however, no battles were recorded in Ohio (Tanner 1987). Although the French and Indian War ended in 1760, the Native Americans continued to fight against the British explorers. In 1764, Colonel Henry Bouquet led a British troop from Fort Pitt, Pennsylvania to near Zanesville, Ohio.

In 1763, the Seven Years' War fought between France and Britain, also known as the French and Indian War ended with The Treaty of Paris. In this Peace of Paris, the French ceded their claims in the entire Ohio region to the British. When the American Revolution ended with the Second Treaty of Paris in 1783, the Americans gained the entire Ohio region from the British; however, they designated Ohio as Indian Territory.

Native Americans were not to move south of the Ohio River but Americans were encouraged to head west into the newly acquired land to occupy and govern it (Tanner 1987).

By 1783, Native Americans had established fairly distinct boundaries throughout Ohio. The Shawnee tribes generally occupied southwest Ohio, while the Delaware tribes stayed in the eastern half of the state. Wyandot tribes were located in north-central Ohio, and Ottawa tribes were restricted to northeast Ohio. There was also a small band of Mingo tribes in eastern Ohio along the Ohio River, and there was a band of Mississauga tribes in northeastern Ohio along Lake Erie. The Shawnee people had several villages within Ross County along the Scioto River (Tanner 1987). Although warfare between tribes continued, it was not as intense as it had been in previous years. Conflicts were contained because boundaries and provisions had been created by earlier treaties.

In 1795, the Treaty of Greenville was signed as a result of the American forces defeat of the Native American forces at the Battle of Fallen Timbers. This allocated the northern portion of Ohio to the Native Americans, while the southern portion was opened for Euro-American settlement. Although most of the battles which led up to this treaty did not occur in Ohio, the outcome resulted in dramatic fluctuations in the Ohio region. The Greenville Treaty line was established, confining all Ohio Native Americans to northern Ohio, west of the Tuscarawas River (Tanner 1987).

Ohio Native Americans were again involved with the Americans and the British in the War of 1812. Unlike the previous wars, many battles were fought in the Ohio country during the War of 1812. By 1815, peace treaties began to be established between the Americans, British, and Native Americans. The Native Americans lost more and more of their territory in Ohio. By 1830, the Shawnee, Ottawa, Wyandot, and Seneca were the only tribes remaining in Ohio. These tribes were contained on reservations in northwest Ohio. By the middle 1800s, the last of the Ohio Native Americans signed treaties and were removed from the Ohio region.

Allen County History

The history of white occupation in Allen County begins with the War of 1812. In that year, a detachment of General Harrison's troops under the leadership of Col. Thomas Poague built a military base in what would one day become Allen County along the west bank of the Auglaize River. Poague named this fort for his wife, Fort Amanda. Here his men kept a garrison and built boats for river transport from the vast woodland. There was also a hospital and cemetery opened there for the military personnel. After the close of the war in 1815, the fort was abandoned, fell into disrepair, and was destroyed by vandals and probably its timber used by others as expedient material. One-hundred years later, in 1915, the state set a marble memorial at the site of the fort to commemorate its importance in the war effort (Howe 1888; Knapp 1872; Leeson 1885; Miller 1906; Rusler 1921; Winter 1917).

After the war, in 1817, Andrew Russell became the first permanent settler in Allen County. Soon after, perhaps in the same year, Peter Diltz and William Van Ansdall joined him. Logically, their settlements were very near the previously established, yet abandoned fort. At that time, the nearest neighbors were the Indians in Shawneetown. This was after the peace treaty, but before the Federal purchase of the final Indian Territories and the subsequent removal of the Indians to Kansas. Therefore, it will be noted that portions of modern Allen County were part of the Indian Lands. The Indians left the county in 1831. In the same year, Allen County was separated out as its own county (Howe 1888; Knapp 1872; Leeson 1885; Slocum 1905; Winter 1917).

The county had already been organized in 1820, but had been attached to Mercer County because of the complexities surrounding the Indian Lands and legal settlement. In 1824, Christopher Wood came to the county and served in many local government roles including a commissioner in charge of locating a county seat. He also organized the first Sunday School and worked as the county's first tanner. He and the other commissioners settled on the site of Lima for the county seat in 1831, facilitating the separation of Allen as its own county. W. L. Henderson laid it out. The US land office moved there in 1834 from Wapakoneta. It became an organized town in 1842 and a city near the turn of the century. At the formation of Auglaize County in 1848, the final boundaries of Allen County were set (Harrison 1880; Howe 1888; Knapp 1872; Leeson 1885; Miller 1906; Slocum 1905; Winter 1917).

German Catholics, Mennonites, and Welsh were among the early settlers of the area. The early structures reflect this as do the systems they put in place and the general attitudes within the region. John Cunningham operated the first school from 1834 to 1838. Robert Finley led the Methodists into the first organized church in 1829; but religious sentiment had come with the first settlers and all the major denominations were soon to follow with church organizations and buildings of their own (Howe 1888; Knapp 1872; Leeson 1885; Winter 1917).

The Crawford Mill and Samuel Burch's Sugar Creek Gristmill were both open to serve the county in 1830. This was the first real industry of the county, agriculture having been the foremost occupation of the settlers. With the opening of the Miami & Erie Canal in 1843 and 1845, growth came to the county in the form of new towns, new industry, and new opportunities. Delphos and Spencerville were both built in 1845 and owe their existence to the canal. Both became small manufacturing and shipping towns. They were overtrumped when the railroad came in the 1850s and bolstered the importance of Lima. Unquestionably, the oil business has been the largest industry in this county. The Lima oil field from the 1880s to the early 1900s was the largest discovered oil field in the world. Drilling and refining became big businesses for Allen County and though the field has mostly dried up, refining still plays a part of the local economy. Since those days, agriculture has re-emerged as the staple occupation of the Allen County resident outside the cities of Lima and Delphos, and the villages of Beaverdam, Bluffton, Cairo, Elida, Fort Shawnee, Harrod, Lafayette, and Spencerville (Howe 1888; Knapp 1872; Leeson 1885; Miller 1906; Rusler 1921; Winter 1917).

Perry Township History

Perry Township was established in 1833 by the County Board and organized at the house of Joseph Crossley in April 1834. Hugh Skilling, Sr., John Ridenour and Joseph Crossley were elected the first trustees. Moses McDonald was the justice of the peace and James Chenoweth was elected clerk. By 1885 the population of the township was 1,465. The concentrations of population are mostly in the southern aspect of the township in the cities of Warsaw, south Warsaw, and Amherst. The Lutheran and Methodist communities built churches in the township (Warner, Beers, & Co. 1885).

Early pioneers date from 1830 when John Ridenour first arrived. At that time the Shawnee Indians occupied most of the area along Hog Creek, and Ridenour reported seeing a few white settlers in the village within Shawnee Township. Ridenour built a cabin and settled there making many friends with the Shawnee including chief Quilna and other influential Shawnee such as Pht. The Shawnee left the area in 1832 and the area continued to grow with settlers who cleared land and made farms (Howe 1854).

In 1835 the first school house was built on the Budd farm which was section 8. The first teacher was Leonard Skilling, and the second teacher was John Terry who taught at a second school house in 1844. That school was built on section 25. The first mill in the area was in Auglaize Township however pioneers went to Cherokee to mill. When the South Warsaw Village was platted in section 27 were the first post office was established. The village didn't grow very large but several churches and small neighborhoods were built (Warner, Beers, & Co. 1885).

Shawnee Township History

American Township was organized in the year 1834. It is located in the south-central portion of Allen County. Neighboring townships include American to the north, Bath and Perry to the east, Auglaize County to the south and Amanda to the west. The topography in American Township is primarily level with little to no rolling or hilly areas. The native Shawnee had only recently completely left the area the when the township formed. Before 1832, the Shawnee, organized under Chief Pht, owned a large part of the township and had cabins, large farms and orchards. Some Shawnee later returned to the area to visit graves or hunt until about 1843. The first settler in the township was Griffith Breese in 1832 (Harrison and Engel 1880; Howe 1854).

Before the arrival of European influence, American Township was populated with dense forests. Thousands of acres were removed in order to clear land for agriculture and construction purposes. The timber was used for building homes, barns, schools, shops and other various crafting. The first mill in the township was built in 1835 by Daniel Hindel and Abel Tompkins. Many of the early European settlers immigrated from neighboring states and were of German descent (Harrison and Engel 1880; Howe 1854).

A rich and fertile soil make up the area. Agriculture was the leading industry during the infancy of Shawnee Township. The main products were corn, wheat and

beans. Children would often stay home from school in order to help their families with household duties (Miller 1906). The first schoolhouse was built in the township in 1835. Schoolhouses during this period were typically one room log constructions with multiple windows and a fireplace. Due to the lack of funding, the windows were made from wax paper. By 1885, the township had nine schoolhouses. The schoolhouses also served as a place of worship. The primary denomination is Methodist. Gatherings at the church gave residents the opportunity to discuss local issues and organize community events. The early preachers were circuit preachers. The first church building in the township was a Lutheran church on the banks of Little Hog Creek (Harrison and Engel 1880; Howe 1906).

Hume Village was established in the southwest of the township as a railroad town by the Lake Erie & Western Railroad. Other railroads in the township included the Dayton & Michigan and the Chicago & Atlantic. Today, the township is a mix of suburban housing and farmland. In the southeast corner of the township is the suburban community of Fort Shawnee. The village formed in 1960 and dissolved its village status in 2012 (Harrison and Engel 1880; Howe 1906).

Research Design

The purpose of this Phase I survey is to locate and identify cultural resources that will be affected by the planned construction activities. This includes archaeological deposits as well as architectural properties that are older than 50 years regarded as being in the APE. Once these resources are identified, they are evaluated for their eligibility to the NRHP. The literature review aspect of these investigations is to answer or address the following questions:

- 1) Did the literature review reveal anything that suggests the project area had been previously surveyed, and what is the relationship of previously recorded properties to the project area?
- 2) Are cultural resources likely to be identified in the project area?

Archaeological Field Methods

The survey conducted for this project used several methods of sampling/testing to identify and evaluate cultural resources. These included shovel probes, surface collection, and visual inspection. Aspects of the project were photographically documented to demonstrate conditions. The following describes the survey methods:

Shovel test unit excavation. Shovel test units were placed at 15-m intervals where adequate surface visibility was lacking. These measure 50 cm on a side and are excavated to 5 cm below the topsoil/subsoil interface. Individual shovel test units are documented regarding their depth, content and color (Munsell). Wherever sites are encountered, Munsell color readings are taken per shovel test unit. All of the undisturbed soil matrices from shovel test units are screened using .6 cm hardware mesh. When sites are identified, additional shovel test units will be

excavated at 7.5 m intervals extending on grid and in the four cardinal directions from the positive locations.

Shovel probe excavation. The excavation of shovel probes is reserved for locations where severe disturbance was prevalent, but not obvious on the surface. These will be initially excavated in a manner similar to a shovel test unit and to a depth that was usually to the subsoil or about 20 cm below the ground surface. This will be accomplished to better understand the nature of the disturbance and verify that intact deposits are lacking. These are spaced at no further than 30 m intervals. If intact soils are identified, the shovel probe will be treated as a shovel test unit.

Visual inspection. This method is conducted to document the nature of the project area and its conditions, disturbed setting, general nature of the area, and presence of any unmarked buildings. This method is used to verify the absence or likelihood of any cultural resources within and around the project area to assist in defining the APE.

The application of the resulting field survey methods was documented in field notes, field maps, and project plan maps.

Architectural Field Methods

This survey was conducted following the guidelines established in *Archeology and Preservation: Secretary of the Interior's Standards and Guidelines* (National Park Service 1983) and *Guidelines for Local Surveys: A Basis for Preservation Planning. National Register Bulletin No. 24* (National Park Service 1997). When properties are identified, they are subjected to the guidelines outlined in *National Register Bulletin 15, How to Apply the National Register Criteria for Evaluation* (National Park Service 1996).

There are four criteria for eligibility to be listed in the National Register of Historic Places (NRHP). Only one of these criteria must be met to be considered eligible for listing; however, oftentimes more than one of the criteria is met. The criteria for significance include:

- A. Association with historic events or patterns of events;
- B. Association with persons important to our past;
- C. Exceptional or important architectural characteristics; and/or
- D. Data potential.

Architectural properties typically qualify under Criteria A, B, or C. Criterion D is typically reserved for archaeological sites.

In addition to meeting at least one of the established criteria, the appropriate integrity must also be retained by the resource. There must be integrity of location, design, workmanship, setting, materials, feeling, and association.

Prior to commencing fieldwork, a literature review was conducted to determine if any previously recorded architectural properties, NRHP properties, or Ohio Genealogical Society cemeteries were present within the APE. Historic maps were also reviewed to aid in guiding the fieldwork and detecting the possible presence of properties 50 years of age or older within the APE. Background research was also conducted in order to establish a historic context of the region.

The field survey included a systematic approach to identifying all properties 50 years of age or older within the APE that is within the viewshed of the proposed project. Each property identified within the viewshed was photographed and annotated on appropriate mapping and included in the report. The approach was to identify those properties with NRHP potential, followed by a more intensive documentation and evaluation of those potentially eligible aboveground resources. The comprehensive survey involved recording of each property 50 years of age or older to a baseline level of documentation.

A summary and analysis of the field data detailing the overall architectural character of the APE is included as a narrative in the report. Weller historians analyzed the data and identified properties that are clearly not eligible for the NRHP due to a lack of significance or loss of integrity, as well as identified potential NRHP properties and advanced them to a more advanced level of documentation and evaluation.

Definitions

Within this report, an *architectural resource* is defined as aboveground buildings or structures that are 50 years of age or older. A *historic property* is defined as a building, structure, object, or site that is listed in, or considered eligible for listing in, the NRHP. An *effect* is defined as an activity associated with the project that alters a characteristic of a historic property that qualified it for inclusion in the NRHP.

Curation

No cultural materials were identified in this project.

Literature Review

The literature review study area is defined as a 305 m (1,000 ft) area extending from the centerline of the project area (Figure 2). In conducting the literature review, the following resources were consulted at the Ohio State Historic Preservation Office (SHPO) and the State Library of Ohio:

- 1) *Archeological Atlas of Ohio* (Mills 1914);

- 2) SHPO United States Geological Survey (USGS) 7.5' series topographic maps;
- 3) Ohio Archaeological Inventory (OAI) files;
- 4) Ohio Historic Inventory (OHI) files;
- 5) National Register of Historic Places (NRHP) files;
- 6) SHPO consensus Determinations of Eligibility (DOE) files;
- 7) SHPO CRM/contract archaeology files;
- 8) Allen County atlases, histories, historic USGS 15' series topographic map(s), and current USGS 7.5' series topographic map(s); and
- 9) Online and genealogical cemetery resource data.

A review of the *Atlas* (Mills 1914) was conducted and there are no sites indicated near the project area according to this resource.

There are few recorded archaeological sites in Allen County. There are no archaeological sites recorded in the study area for this project.

The OHI files indicated no previously recorded OHI properties located in the project or its study area.

A review of the NRHP files and SHPO consensus DOE files was conducted. There are no NRHP or DOE properties within the project area or study area.

A review of the CRM/contract files indicates that there was one survey conducted that is mostly to the west of the project area, but includes a small part of the area. This survey (Schuck 1999) did not identify any cultural materials.

Historical atlases were reviewed for this project. The USGS *1906 Lima, Ohio 15 Minute Series (Topographic)* map does not indicate any buildings or structures within or near the project area. The project is near an area that was pocked with oil tanks (Figure 4). Inspection of the *USGS 1994 Lima, Ohio 7.5 Minute Series (Topographic)* map depicts buildings, residences, tanks, and industrial development in the surrounding area with a substation in the western part of the project (Figure 2).

There are no cemeteries located in the project or study area.

Evaluation of Research Questions 1 and 2

There were two questions presented in the research design that will be addressed at this point. These are:

- 1) Did the literature review reveal anything that suggests the project area had been previously surveyed?
- 2) Are cultural resources likely to be identified in the project area?

The literature review for this project did not identify any sites or buildings involved in this project. There was a survey conducted for an industrial development that

is to the west of the project and includes a very small part of the current project area (i.e., Schuck 1999). This survey did not result in the identification of any cultural materials. The project area is located in a nearly homogeneous upland setting that is surrounded and includes industrial developments. This is not a typical type of setting where intact cultural materials would be expected.

Fieldwork Results

The Phase I field investigations for this project were conducted on March 9, 2017 (Figures 5-16). The weather at the time of survey was not a hindrance; it was sunny and Fahrenheit temperatures were in the upper 40s. The field investigations involved visual inspection and subsurface testing. Subsurface testing methods were applicable in the locations that were not clearly and severely disturbed and with dense ground cover. Most of the project area that is outside of the station is contained in manicured lawn conditions. These investigations were conducted for the construction/access easements for pole replacements relative to their proposed areas of ground utilization and disturbance. This work was conducted in an upland glaciated, till plain setting that is in the southcentral Allen County and within the City of Lima. There were no cultural materials identified during these investigations.

Shovel test unit (n=160) and shovel probe (n=19) excavation was conducted in non disturbed for this project (Figures 5-16). Shovel probing along the eastern limits of the area identified disturbed, graded conditions; otherwise, disturbed situations were spotty in the project. Shovel testing identified brown (10YR4/3) silt loam topsoil/plowzone that extended to an average depth of 32 cm below ground surface. The topsoil/subsoil interface is clear and abrupt, further suggesting formerly plowed or agricultural conditions. The subsoil has an increased amount of clay contained within it and is dark yellowish brown (10YR4/6) in hue; it is similar to lacustrine depositional soils. There were few rocks or gravelly materials identified during the subsurface testing. There were no cultural materials identified during this testing.

A small portion of the project area was subject to previous professional investigations. Ray Schuck (1999) conducted investigations for a gas/oil related facility that incorporates the westernmost aspect of the current project. This pertains to the area that is west of McClain Road. There were no cultural resources identified by this previous survey.

Visual inspection and photographic documentation of the conditions within the project area was completed. Severe disturbances were evident as were caused by grading activity for the existing electric station as well as for drainage. A small stream extends in a north-south manner and along the eastern side of the station. There is an underground pipeline that is located in the southeastern/southern part of the project area. Most of the disturbances were associated with grading activity for the extant facility and the abutting road rights-of-ways.

Fieldwork Summary

There were no archaeological or architectural resources identified during these investigations. Archaeological sites were not expected as this is a nearly level to homogenous setting that is unlikely to contain such deposits. Previous inspection of the project area first suggested that it would be severely disturbed. However, the testing did identify intact soil deposits that had high amounts of clay. The lack of cultural materials from this area is what would be expected from conditions and locations such as the project area.

Architectural Survey Results

The project APE was dominated by a rural agricultural landscape. The buildings/residences that are in the vicinity and regarded as being within the APE were predominantly modern structures. The surrounding setting is associated with industrial development. The survey focused on those above ground resources that were located within 1,000 feet of the proposed station expansion. The planned expansion and upgrade of the existing Sterling Station is not considered to be aberrant. There are no significant resources considered within the APE.

APE Definition and NRHP Determination

The APE is a term that must be applied on an individual project basis. The nature of the project or undertaking is considered in determining the APE. This may include areas that are off the property or outside of the actual project's boundaries to account for possible visual impacts. For example, when the construction is limited to underground activity, the APE may be contained within the footprint of the project. The APE for this project includes the footprint of the proposed access/construction easements and temporary construction easements. The project area involves an approximately 6.5 ha (16 ac) area for the expansion of the existing Sterling Substation.

This prospective undertaking is mostly located within an industrial setting on the south side of the City of Lima. This is an area that has been previously and continuously involved in the gas and oil industry with stations and tanks densely positioned in the surroundings. The station is existing and an expansion to this facility will not impact or involve any significant cultural resources.

There are no buildings or sites that are 50 years of age or older identified within what is regarded as the APE. This project will not impact or involve any historic properties or landmarks.

Recommendations

In March of 2017, Weller & Associates, Inc. (Weller) Phase I Cultural Resource Management Investigations for American Electric Power's 6.5 ha (16 ac) Sterling Station Rebuild Project in Shawnee and Perry Townships, Allen County, Ohio. The archaeological fieldwork involved subsurface testing, visual inspection, and photographic documentation. The work was conducted in an upland, till plain setting that is within an industrially developed part of south Lima. There were no resources that are regarded as being significant archaeological deposits or landmarks in the project or study area. No further cultural resource management work is deemed necessary for this project.

References Cited

Bamforth, D.

1988 *Ecology and Human Organization on the Great Plains*. Plenum, New York.

Brose, D. S.

1994 "Archaeological Investigations at the Paleo Crossing Site, a Paleoindian Occupation in Medina County, Ohio." In: *The First Discovery of America: Archaeological Evidence of the Early Ohio Area*, edited by W. S. Dancey, pp. 61-76. The Ohio Archaeological Council, Columbus.

Cowan, W. C.

1987 *First Farmers of the Middle Ohio Valley: Fort Ancient Societies, A.D. 1000-1670*. The Cincinnati Museum of Natural History, Cincinnati.

Cramer, A.

1989 *The Dominion Land Company Site: An Early Adena Mortuary Manifestation in Franklin County, Ohio*. M.A. Thesis, Kent State University, Kent, Ohio.

Cunningham, R. M.

1973 "Paleo Hunters along the Ohio River." In: *Archaeology of Eastern North America* 1(1): 116-118. Eastern States Archeological Federation, Bethlehem, Connecticut.

Dancey, W. S.

1992 "Village Origins in Central Ohio: The Results and Implications of Recent Middle and Late Woodland Research." In: *Cultural Variability in Context: Woodland Settlements of the Mid-Ohio Valley*, edited by M. F. Seeman, pp. 24-29. Special Papers 7, *Midcontinental Journal of Archaeology*, Kent State University Press, Kent, Ohio.

Dragoo, D.

1976 "Some Aspects of Eastern North American Prehistory: A Review 1975." In: *American Antiquity* 41(1):3-27. The Society for American Archaeology, Washington, DC.

Fitting, J. E.

1965 "Late Woodland Culture in Southeastern Michigan." In: *Anthropological Papers, the Museum of Anthropology*, No. 24, University of Michigan, Ann Arbor.

1963 "The Hi-Lo Site: A Paleo-Indian Site in Western Michigan." In: *Wisconsin Archaeologist* 44:87-96. Wisconsin Historical Society, Madison, Wisconsin.

Fuller, J.

1981 "Developmental Change in Prehistoric Community Patterns: The Development of Nucleated Village Communities in Northern West Virginia." Unpublished Ph.D. Dissertation, Department of Anthropology, University of Washington, Seattle.

Harrison, R. H.

1880 *Atlas of Allen County, Ohio*. R. H. Harrison, Philadelphia.

Howe, H.

1888 *Historical Collections of Ohio, Vol. I*. H. Howe & Son, Columbus.

1854 *Historical Collections of Ohio*. E. Morgan & Co's. Cincinnati

Justice, N.

1987 *Stone Age Spears and Arrow Points of the Midcontinental and Eastern United States*. Indiana University Press, Bloomington and Indianapolis.

Knapp, H. S.

1872 *History of the Maumee Valley: Commencing with its Occupation by the French in 1680*. Slade Mammoth Printing and Publishing House, Toledo, Ohio.

Leeson, M. A.

1885 *History of Allen County, Ohio*. Warner, Beers, & Co., Chicago.

McDonald, H.

1994 "The Late Pleistocene Vertebrate Fauna in Ohio: Coinhabitants with Ohio's Paleoindians." In: *The First Discovery of America: Archaeological Evidence of the Early Ohio Area*, edited by W. S. Dancey, pp. 23-41. The Ohio Archaeological Council, Columbus.

Miller, C. C.

1906 *History of Allen County, Ohio, and Representative Citizens*. Richmond and Arnold, Chicago.

Pacheco, P.

1996 "Ohio Hopewell Regional Settlement Patterns." In: *A View From The Core: A Synthesis of Ohio Hopewell Archaeology*, edited by P. Pacheco, pp. 16-35. The Ohio Archaeological Council, Columbus.

Pollack, D. and A. Henderson

2000 "Insights into Fort Ancient Culture Change: A View from South of the Ohio River." In: *Cultures Before Contact: The Late Prehistory of Ohio and Surrounding Regions*, edited by R. Genheimer, pp. 194-227. The Ohio Archaeological Council, Columbus.

Pratt, G. M., and D. R. Bush

1981 *Archaeological Resource Management in Ohio: A State Plan for Archaeology (Draft)*. Copy available for review at the Ohio Historic Preservation Office, Columbus.

Prufer, O. H., and D. A. Long

1986 "The Archaic of Northeastern Ohio." In: *Kent Research Papers in Archaeology, No. 6*, Kent State University Press, Kent, Ohio.

Slocum, C. E.

1905 *History of the Maumee River Basin: from the earliest account to its organization into counties*. Bowen & Slocum, Indianapolis & Toledo.

Schneider, A. M.

2000 "Archaeological Reflections of the Western Basin Tradition in the Maumee River Valley of Western Lake Erie, with Special Emphasis on Ceramic Analysis." Unpublished master's thesis, The University of Toledo, Toledo, Ohio.

Schuck, R.

1999 *Archaeological Report of the Allen County Industrial Park West Project, Shawnee Township, Allen County, Ohio*. Allen County Museum. Copy available for review at Ohio History Connection.

Shane, L.

1987 "Late-glacial Vegetational and Climatic History of the Allegheny Plateau and the Till Plains of Ohio and Indiana, U.S.A." In: *Boreas* 16:1-20. The Boreas Collegium, Blackwell Publishing Ltd., Edinburgh.

Shane, O. C., III

1975 "The Mixer Site: A Multicomponent Locality in Erie County, Ohio." In: *Studies in Ohio Archaeology* (rev. ed.), edited by O. H. Prufer. Kent State University Press, Kent, Ohio.

1967 "The Leimbach Site." In: *Studies in Ohio Archaeology*, edited by O. H. Prufer, pp. 98-120. The Press of Western Reserve University, Cleveland.

Slocum, C. E.

1905 *History of the Maumee River Basin: from the earliest account to its organization into counties*. Bowen & Slocum, Indianapolis & Toledo.

Stafford, R.

1994 "Structural Changes in Archaic Landscape Use in the Dissected Uplands of Southwestern Indiana." In: *American Antiquity*, 59:219-237. The Society for American Archaeology, Washington, DC.

Stothers, D.

1986 "The Western Basin Middle Woodland: Fact or Fiction?" Paper presented at the Midwest Archaeological Conference, Columbus.

- Stothers, D., G. Pratt and O. C. Shane III
1979 "The Western Basin Middle Woodland." In: *Hopewell Archaeology*, edited by D. Brose and N. Greber. The Kent State University Press, Kent, Ohio.
- Stothers, D. M., J. R. Graves, and B. G. Redmond
1984 "The Sandusky and Western Basin Traditions: A Comparative Analysis of Settlement-Subsistence Systems." In: *Toledo Area Aboriginal Research Society Bulletin* 7 (1&2): 1-73. Toledo Area Aboriginal Research Society, Toledo, Ohio.
- Tankersley, K.
1994 "Was Clovis a Colonizing Population in Eastern North America?" In: *The First Discovery of America: Archaeological Evidence of the Early Ohio Area*, edited by W. S. Dancey, pp. 95-116. The Ohio Archaeological Council, Columbus.
- 1989 "Late Pleistocene Lithic Exploitation and Human Settlement Patterns in the Midwestern United States." Unpublished Ph.D. dissertation, Department of Anthropology, Indiana University, Bloomington.
- Tanner, H.
1987 *Atlas of Great Lakes Indian History*. University of Oklahoma Press, Norman.
- Warner, Beers, & Co.
1885 *History of Allen County Ohio*. Warner, Beers, & Co. Chicago.
- Webb, W. S., and R. S. Baby
1963 *The Adena People No. 2*. The Ohio Historical Society, The Ohio State University Press, Columbus.
- Weller, R. J.
2005 *Data Recovery at the Haven Site (33DL1448) Located in Liberty Township, Delaware County, Ohio*. Weller & Associates. Submitted to the Delaware County Sanitary Engineer's Office. Copy available for review at the Ohio Historic Preservation Office, Columbus.
- Winter, N. O.
1917 *A History of Northwest Ohio*. The Lewis Publishing Company, Chicago and New York.

Figures

C:\Users\ChadPorter\Desktop\Fig 01 O-H-I-O.mxd LS:(2/24/2017 - ChadPorter) - LP:6/7/2016 12:39:06 PM - LExported:3/8/2017 1:37:16 PM

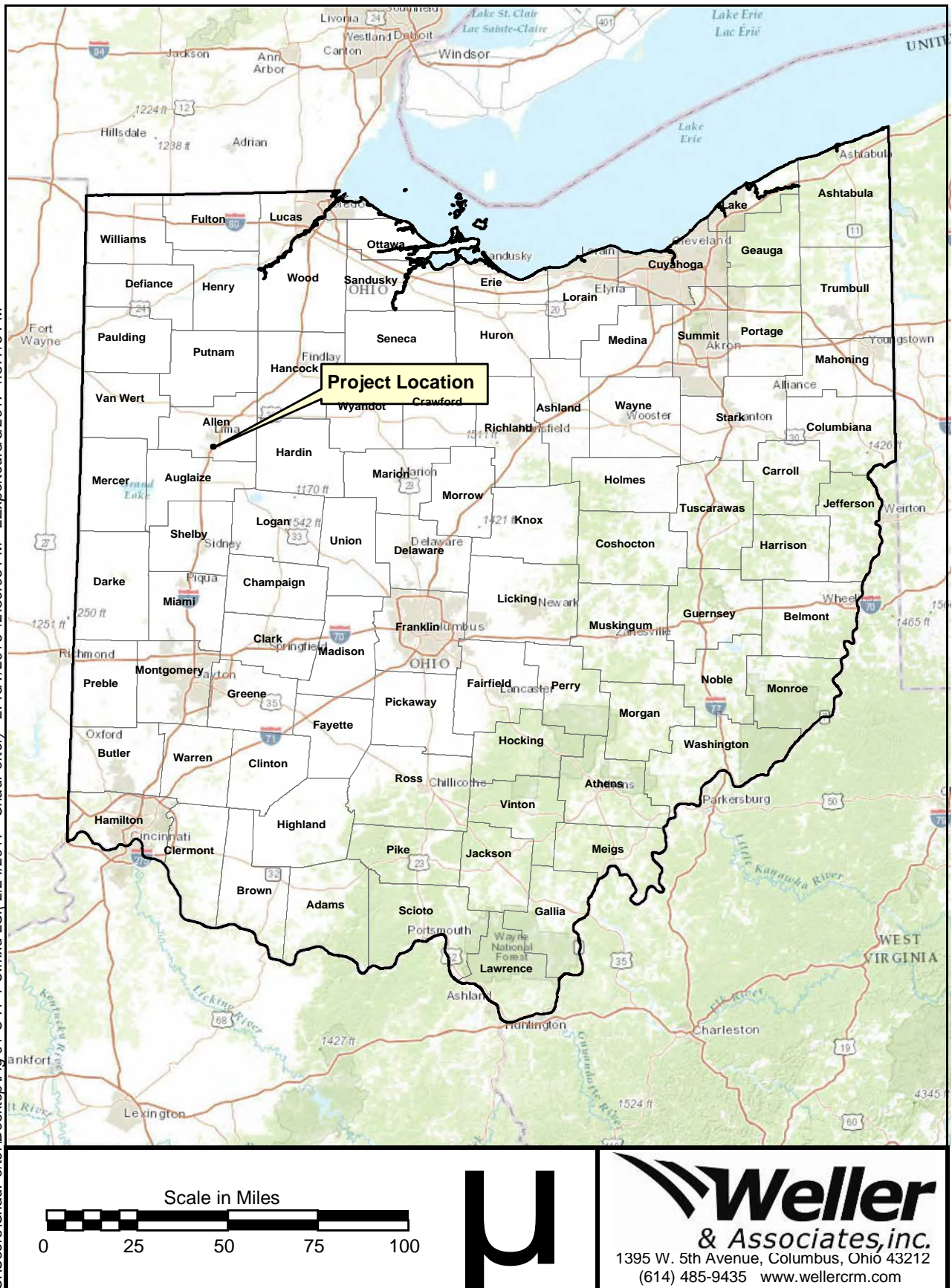

Figure 1. Political map of Ohio showing the approximate location of the project.

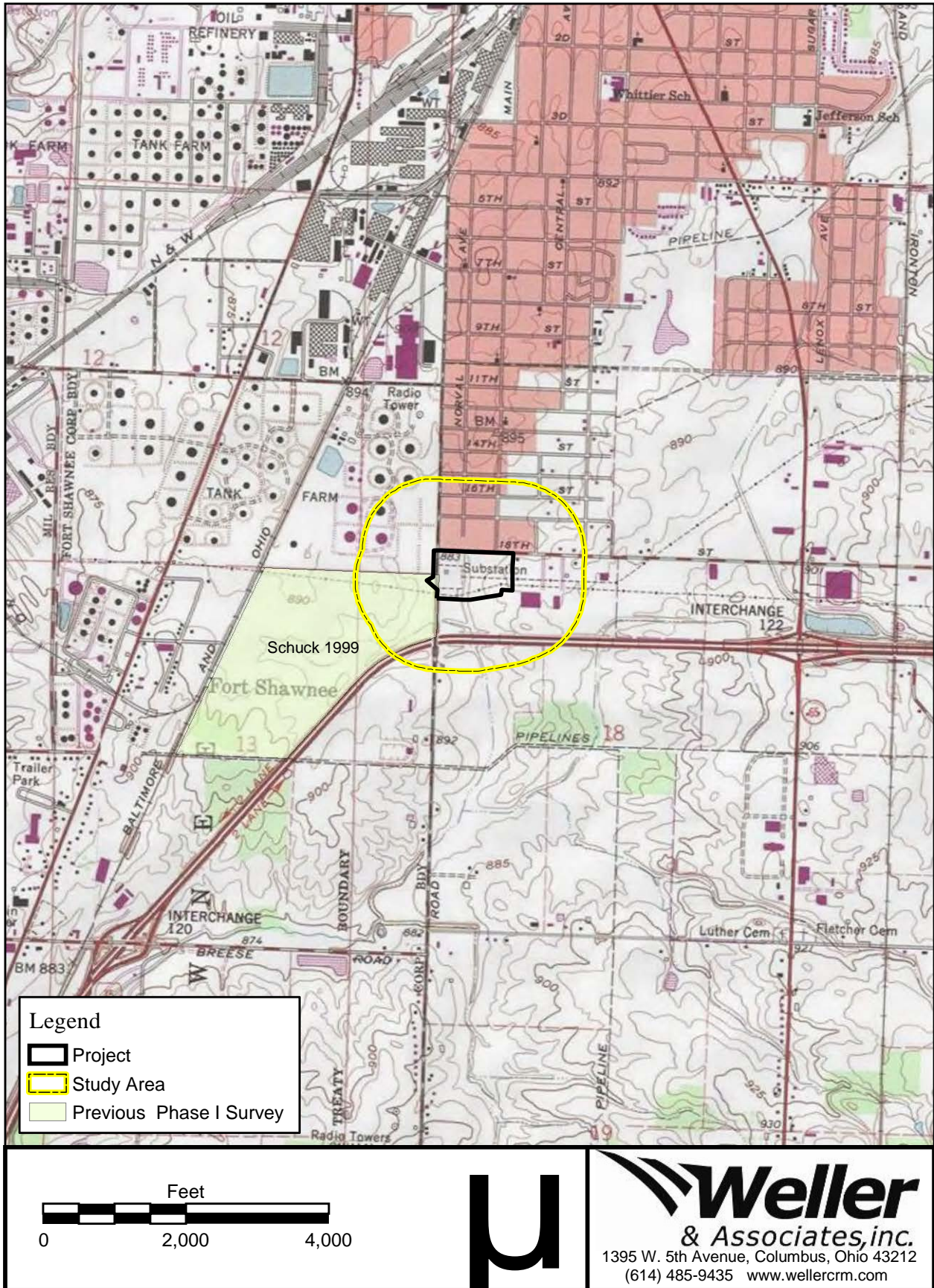

Figure 2. Portion of the USGS 1994 Lima, Ohio 7.5 Minute Series (Topographic) map indicating the location of the project and previously recorded resources in the study area.

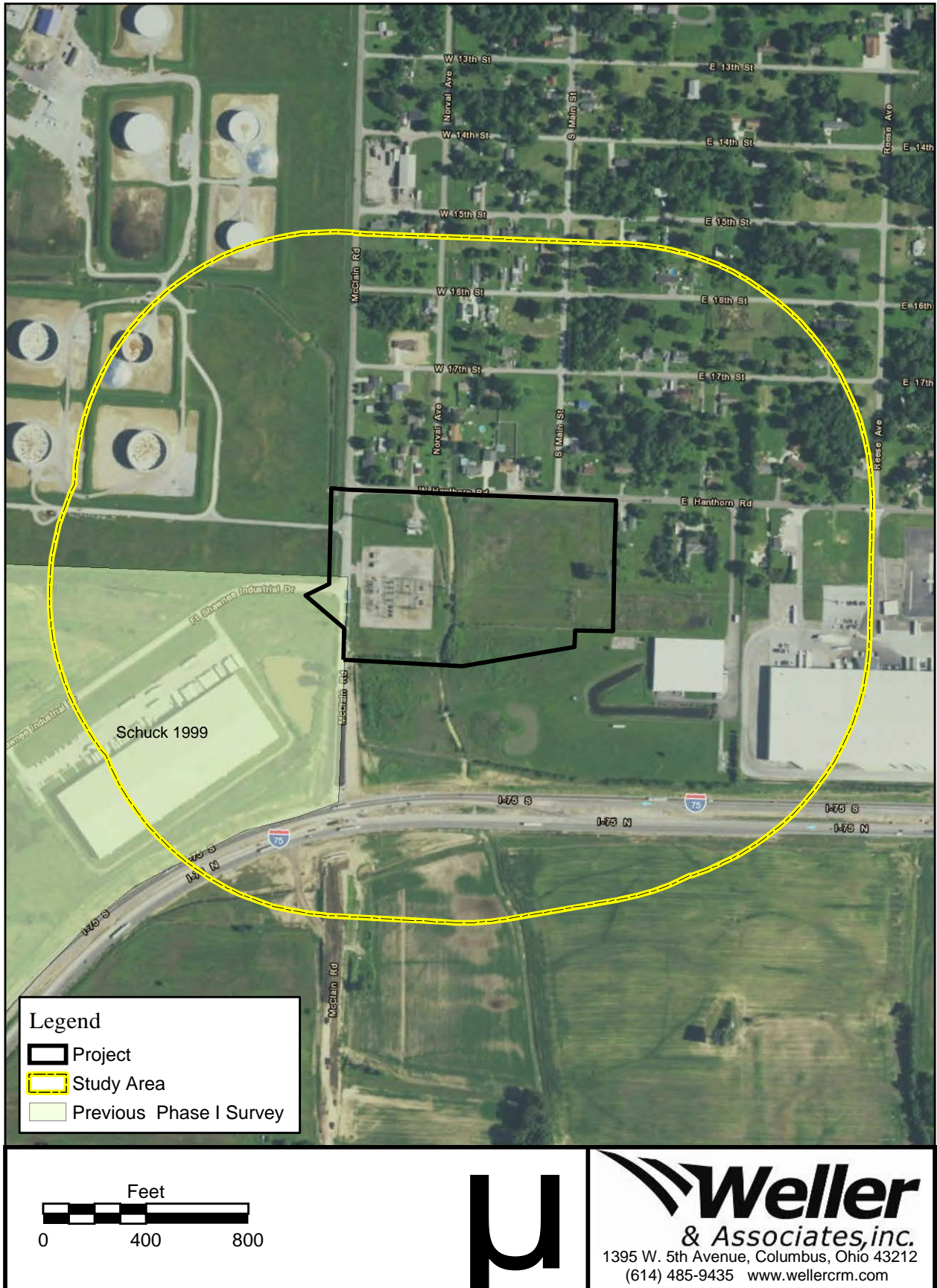

Figure 3. Aerial map indicating the location of the project.

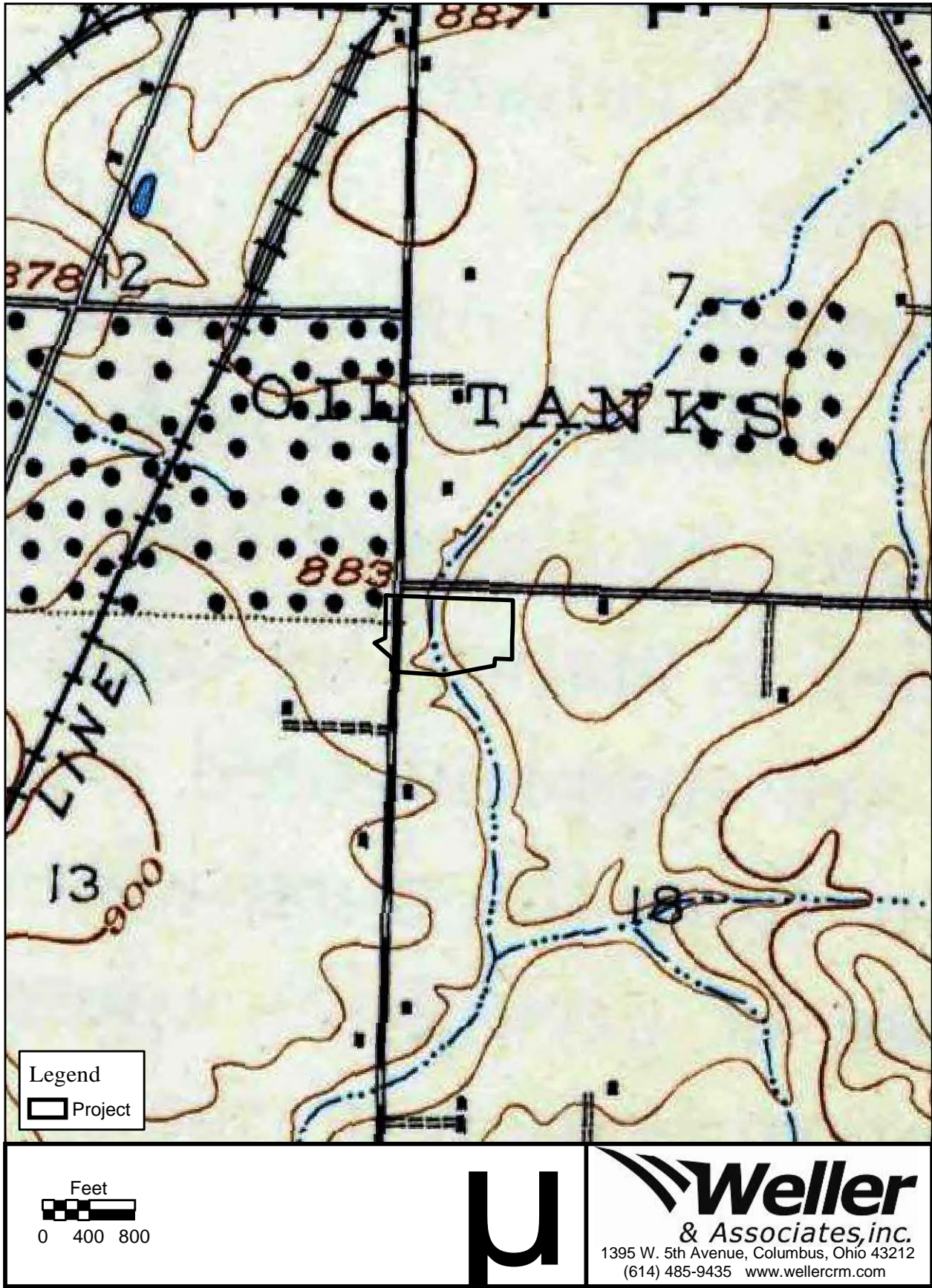

Figure 4. Portion of the USGS 1906 Lima, Ohio 15 Minute Series (Topographic) map indicating the approximate location of the project.

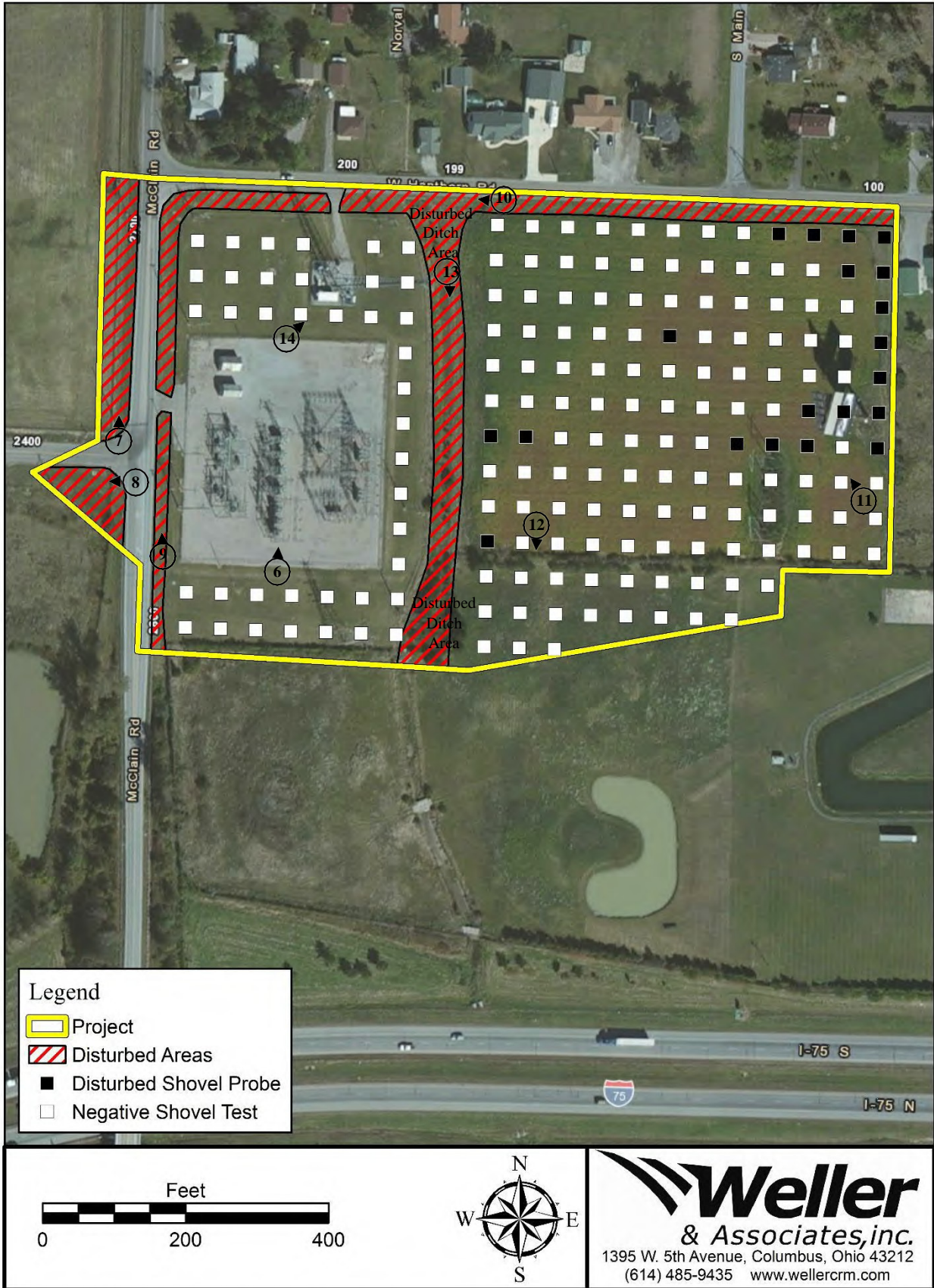

Figure 5. Fieldwork results and photo orientation map.



Figure 6. The existing substation within the western portion of the project.



Figure 7. View of the disturbed conditions west of McClain Rd.



Figure 8. More disturbed conditions west of McClain Rd.



Figure 9. View of the disturbed conditions just east of McCain Rd.



Figure 10. Typical disturbed conditions within the northern portion of the project.



Figure 11. The shovel tested area within the eastern portion of the project.



Figure 12. View of the southern portion of the project.



Figure 13. The disturbed ditch area in the center of the project.



Figure 14. Conditions within the northwestern portion of the project.



Figure 15. A disturbed shovel probe from the project.

Schematic of a Test Unit Profile

Blount Silt Loam (Blg1A1)

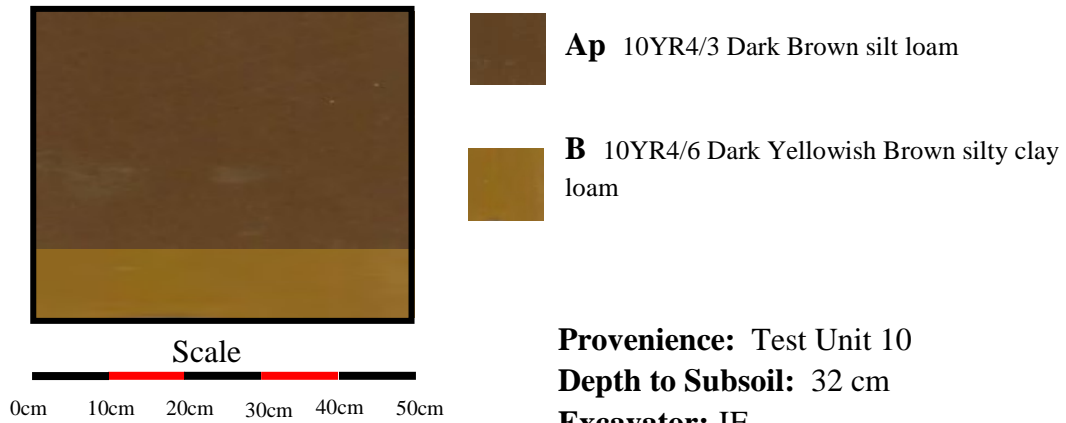

Provenience: Test Unit 10

Depth to Subsoil: 32 cm

Excavator: JE



Figure 16. A typical shovel test unit excavated within the project.