

AD-A198 648

12



US Army Corps of Engineers  
Committee on Water Quality

# WATER QUALITY '88

## Seminar Proceedings

DTIC  
S E D  
JUL 22 1988  
H

23 - 25 February 1988  
Charleston, South Carolina

DISTRIBUTION STATEMENT A

Approved for public release  
Distribution Unlimited

8 1 2 3 4 5 6 7 8 9 10 11 12

# Water Quality '88

## Seminar Proceedings

23-25 February 1988  
Charleston, South Carolina

U. S. ARMY CORPS OF ENGINEERS  
COMMITTEE ON WATER QUALITY  
WASHINGTON, D. C.

FOREWORD

A three-day seminar titled "Water Quality '88" was held on 23-25 February 1988. The purpose of the seminar was to provide a forum for Corps of Engineers personnel who are routinely involved in water quality and water control work.

Topics addressed during the seminar and included in these proceedings include twenty-one papers on Reservoir and Riverine Case Studies and sixteen papers on Coastal and Estuarine Case Studies. An appendix is also included which contains ten abstracts by those displaying materials during the poster session.

The seminar was co-sponsored by the Hydrologic Engineering Center and the Committee on Water Quality. This seminar proceedings, in addition to the general seminar coordination, was organized by Mr. R. G. Willey of the Hydrologic Engineering Center. Valuable assistance was graciously provided for coordination of the separate sessions by Mr. Dave Buelow and Ms. Lynn Lamar, HQUSACE; Messrs. Jeff Holland, Bill Rushing, and Dr. Robert Engler, WES; Mr. Dave Cowgill, NCD; Mr. Mike Koryak, Pittsburgh District; and Mr. Dennis Barnett, SAD. The conference rooms, individual rooms and all local arrangements were organized by Mr. Dennis Barnett, SAD and Ms. Carol Todd, Charleston District.

An optional field trip was arranged by Ms. Todd for 25 February. The trip included a boat tour of Charleston Harbor and the mouth of the Cooper River.

The views and conclusions expressed in these proceedings are those of the authors and are not intended to modify or replace official guidance or directives such as engineering regulations, manuals, circulars, or technical letters issued by the HQUSACE.

R. G. Willey  
Editor

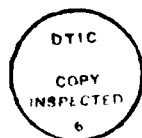

Accession For	
NTIS GRA&I	<input checked="" type="checkbox"/>
DTIC TAB	<input type="checkbox"/>
Unannounced	<input type="checkbox"/>
Justification	
By	<i>perform 50</i>
Distribution/	
Availability Codes	
Dist	Avail and/or Special
<i>A-1</i>	

COMMITTEE MEMBERS

Dr. Mark Anthony	Ohio River Division
Dennis Barnett	South Atlantic Division
Dave Buelow	HQUSACE
John Bushman	HQUSACE
David Cowgill	North Central Division
Dr. Robert Engler	Waterways Experiment Station
James Farrell	Lower Mississippi Valley
James Gottesman	HQUSACE
Jeff Holland	Waterways Experiment station
Lynn Lamar	HQUSACE
Dr. James Maragos	Pacific Ocean Division
Morton Markowitz	South Pacific Division
David Mathis	HQUSACE
Dr. Ike McKim	Cold Regions Research and Engineering Laboratory
Warren Mellema	Missouri River Division
Andrew Petallides	North Pacific Division
Charles Sullivan	Southwestern Division
Dr. Bolyvong Tanovan	North Pacific Division
Charles Wener	New England Division
Robert G. Willey	Hydrologic Engineering Center

SEMINAR SPEAKERS

John R. Adams	Buffalo District
Ken Avery	North Pacific Division
Robert Bank	Baltimore District
Townsend G. Barker	New England Division
Tim Bartish	Walla Walla District
Pam Bedore	Detroit District
David P. Bierl	Rock Island District
Sandra L. Bird	Waterways Experiment Station
Jackson K. Brown	Nashville District
Jim Brannon	Waterways Experiment Station
Darryl Calkins	Cold Regions Research & Engineering Lab
Joan U. Clark	Waterways Experiment Station
Russell L. Davidson	Portland District
Tom M. Dillon	Waterways Experiment Station
Thom Donaldson	Missouri River Division
Robert Engler	Waterways Experiment Station
Diane I. Findley	Mobile District
David T. Ford	Hydrologic Engineering Center
Thomas J. Fredette	New England Division
Robert F. Gaugush	Waterways Experiment Station
James D. Graham	Portland District
Douglas Gunnison	Waterways Experiment Station
Tom L. Hart	Waterways Experiment Station
Dennis D. Holme	St. Paul District
Stacy E. Howington	Waterways Experiment Station

SEMINAR SPEAKERS, cont.

F. Dewayne Imsand	Mobile District
David R. Johnson	Vicksburg District
Robert Kennedy	Waterways Experiment Station
Braxton Kyzer	Charleston District
James F. LaBounty	US Bureau of Reclamation
Douglas W. Larson	Portland District
Kenneth S. Lee	Baltimore District
Richard Leonard	Buffalo District
Ike McKim	Cold Regions Research & Engineering Lab
Andrew P. Murphy	US Bureau of Reclamation
Tommy E. Myers	Waterways Experiment Station
R. Douglas Nester	Mobile District
A. Susan Portzer	Waterways Experiment Station
Richard E. Price	Waterways Experiment Station
Richard E. Punnett	Huntington
Harold T. Sansing	Nashville District
Robert Sneed	Nashville District
Helene Takemoto	Pacific Ocean Division
Bolyvong Tanovan	North Pacific Division
Henry E. Tatem	Waterways Experiment Station
John F. Tavolaro	New York District
A. Rudder Turner, Jr.,	Portland District
Frank Urabeck	Seattle District
Steven C. Wilhelms	Waterways Experiment Station
Marc J. Zimmerman	Waterways Experiment Station

SEMINAR ATTENDEES

<u>Participants</u>	<u>Office</u>	<u>Phone Number</u>
John Adams	Buffalo	716 876-5454
Chandra Alloju	Fort Worth	817 334-2219
Dr. John Andersen	Omaha	402 221-4622
Edward Andrews	North Atlantic	212 264-7459
Dr. Mark Anthony	Ohio River	513 684-3070
Jeff Atkins	Memphis	901 521-3391
Ken Avery	North Pacific	503 221-3750
Robert Bank	Baltimore	301 962-4893
Townsend Barker	New England	617 647-8631
Dennis Barnett	South Atlantic	404 331-4580
Timothy Bartish	Walla Walla	509 522-6629
Clinton Beckert	Rock Island	309 788-6361
M. Pam Bedore	Detroit	313 226-2384
Robert A. Biel	Louisville	502 582-5640
David Bierl	Rock Island	309 788-6361
Boniface Bigornia	Los Angeles	213 894-6916
Sandra Bird	Waterways Experiment Station	601 634-3783
Robbin Blackman	Charleston	803 724-4116
LTC Bornhaft	Charleston	803 724-4344
David Bowman	Detroit	313 226-2223
James Brannon	Waterways Experiment Station	601 634-3725
Robert Brazeau	New England	617 752-1095
Jack Brown	Nashville	615 736-2020
David Buelow	Headquarters	202 272-8512

<u>Participants</u>	<u>Office</u>	<u>Phone Number</u>
Eugene Buglewicz	Lower Mississippi Valley	601 634-5856
Dr. John Bushman	Headquarters	202 272-0132
Darryl Calkins	Cold Regions Res & Engr Lab	603 646-4304
Richard Cassidy	Portland	503 221-6472
Joan Clarke	Waterways Experiment Station	601 634-2954
Carol A. Coch	New York	212 264-5621
David Cowgill	North Central	312 353-6354
Russell Davidson	Portland	503 221-6478
Kenneth Day	Mobile	205 694-3724
Lewis Decell	Waterways Experiment Station	601 634-3494
Thomas Dillon	Waterways Experiment Station	601 634-3922
Thomas Donaldson	Missouri River	402 221-7236
John Dorkin	Chicago	312 886-0451
Mark Dortch	Waterways Experiment Station	601 634-3517
Earl Eiker	Headquarters	202 272-8500
Dr. Robert Engler	Waterways Experiment Station	601 634-3624
James Farrell	Lower Mississippi Valley	601 634-5990
Diane Findley	Mobile	205 694-3857
David Ford	Hydrologic Engineering Center	916 551-1748
Thomas Fredette	New England	617 647-8057
Thomas Furdek	St. Louis	314 263-4008
Steve Garbaciak	Chicago	312 353-0789
Robert Gaugush	Waterways Experiment Station	601 634-3626
Harvey Geitner	USDI, Fish & Wildlife	803 724-4707
James Gottesman	Headquarters	202 272-0243
James Graham	Portland	503 294-5110
Douglas Gunnison	Waterways Experiment Station	601 634-3873
Billy Hanna	Mobile	205 690-3385



<u>Participants</u>	<u>Office</u>	<u>Phone Number</u>
Tom Hart	Waterways Experiment Station	601 634-3449
Paul Hein	Pittsburgh	412 644-6960
Herbert Hereth	Sacramento	916 551-2286
Bill Hicks	New Orleans	504 862-1933
Tim Higgs	Nashville	615 736-2020
Jeff Holland	Waterways Experiment Station	601 634-2644
Dennis Holme	St. Paul	612 220-0614
Stacy Howington	Waterways Experiment Station	601 634-2939
William Hubbard	New England	617 647-8236
Ron Hudson	Los Angeles	213 894-0245
Dewayne Imsand	Mobile	205 694-3858
Richard Jackson	Charleston	803 724-4248
David Johnson	Vicksburg	601 634-7221
Pete Juhle	Baltimore	301 926-4893
Dr. Robert Kennedy	Waterways Experiment Station	601 634-3659
Mike Koryak	Pittsburgh	412 644-6831
Braxton Kyzer	Charleston	803 724-4365
James LaBounty	Bureau of Reclamation	303 236-6002
Lynn Lamar	Headquarters	202 272-8513
Douglas Larson	Portland	503 221-6471
Kenneth Lee	Baltimore	301 962-4893
Michael Lee	Pacific Ocean	808 438-9258
Richard Leonard	Buffalo	716 876-5454
Rodney Mach	New Orleans	504 862-2443
Vince Marchese	Huntington	304 529-5134
Morton Markowitz	South Pacific	415 556-6210
David Mathis	Headquarters	202 272-8843
Gary Mauldin	Savannah	912 944-5515

<u>Participants</u>	<u>Office</u>	<u>Phone Number</u>
Mark McKeivitt	Savannah	912 944-5389
Dr. Harlan McKim	Cold Regions Res & Engr Lab	603 646-4479
Warren Mellema	Missouri River	402 221-7363
Tommy Meyers	Waterways Experiment Station	601 634-3939
Jan Miller	Chicago	312 353-6518
Jerry Miller	Vicksburg	601 634-7130
Stephen Morrison	Charleston	803 724-4614
Andrew Murphy	Bureau of Reclamation	303 236-4293
Patrick L. Neichter	Louisville	502 582-6739
Douglas Nester	Mobile	205 694-3854
George Nichol	Sacramento	916 551-2510
Rudy Nyc	South Atlantic	404 331-4619
Lawrence Oliver	New England	617 647-8347
Phil Payonk	Wilmington	919 343-4589
Andrew Petallides	North Atlantic	212 264-7459
Glenn Pickering	Waterways Experiment Station	601 634-3344
Allen Piner	Wilmington	919 343-4762
Susan Portzer	Waterways Experiment Station	601 634-2804
Dr. Richard Price	Vicksburg	601 634-2667
Dr. Richard Punnett	Huntington	304 529-5604
Mark Rosenthal	New England	802 886-8111
Col. Richard Rothblum	Water Resources Support Center	703 552-2250
Richard Ruane	Tennessee Valley Authority	615 751-7323
Bill Rushing	Headquarters	202 272-0257
Harold Sansing	Nashville	615 736-5675
Robert W. Schmitt	Pittsburgh	412 644-6951
Glenn Singleton	Seattle	206 764-3544
Dean Smith	San Francisco	415 974-0418

<u>Participants</u>	<u>Office</u>	<u>Phone Number</u>
John Smutz	North Atlantic	212 264-7534
Robert Sneed	Nashville	615 763-2020
Dr. Ann Strong	Waterways Experiment Station	601 634-2726
Robert Stuart	Los Angeles	213 894-3001
Charles Sullivan	Southwestern	214 767-2388
Michael Sydow	Savannah	912 944-5512
Helene Takemoto	Pacific Ocean	808 439-8877
Dr. Bolyong Tanovan	North Pacific	503 221-3764
Henry Tatem	Waterways Experiment Station	601 634-3695
John Tavolaro	New York	212 264-5620
Ed Theriot	Waterways Experiment Station	601 634-2678
Rudd Turner	Portland	503 221-6401
Frank Urabeck	Seattle	206 764-3708
LTC Kit Valentine	Headquarters	202 272-0166
Raymond Vandenberg	Kansas City	816 374-3773
Wayne Wagner	Seattle	206 764-3542
Steve Wilhelms	Waterways Experiment Station	601 634-2475
R.G. Willey	Hydrologic Engineering Center	916 551-1748
Tom Wright	Waterways Experiment Station	601 634-3708
Frank Yelverton	Wilmington	919 343-4640
Marc Zimmerman	Waterways Experiment Station	601 634-3784

CONTENTS

I. Reservoir and Riverine Case Studies

WATER QUALITY MANAGEMENT FOR RESERVOIRS AND TAILWATERS:  
A WOTS DEMONSTRATION

Robert H. Kennedy  
Research Limnologist

Robert C. Gunkel  
Biologist

Robert R. Gaugush  
Hydrologist  
Waterways Experiment Station . . . . . 2

MICROCOMPUTER SOFTWARE FOR THE ANALYSIS OF WATER  
QUALITY SAMPLING DESIGN

Robert F. Gaugush  
Hydrologist  
Environmental Laboratory  
Waterways Experiment Station . . . . . 9

USE OF REMOTE SENSING TECHNIQUES TO ENHANCE IN SITU  
WATER QUALITY MONITORING

David P. Bierl  
Hydrologist, Water Quality and Sedimentation Section  
Rock Island District . . . . . 17

MULTI-PORTED, SINGLE WET-WELL INTAKE STRUCTURE OPERATION  
IN A STRATIFIED RESERVOIR

Stacy E. Howington  
Research Hydraulic Engineer  
Hydraulics Laboratory  
Waterways Experiment Station . . . . . 32

REAERATION AT LOW-HEAD STRUCTURES: PRELIMINARY RESULTS

Steven C. Wilhelms  
Research Hydraulic Engineer  
Hydraulics Laboratory  
Waterways Experiment Station . . . . . 39

CONTENTS

I. Reservoir and Riverine Case Studies, cont.

MODELING WATER QUALITY IMPACTS OF HYDROPOWER RETROFITTING  
ON LOCKS AND DAMS OF THE LOWER OHIO RIVER

Marc J. Zimmerman  
Hydrologist  
Environmental Laboratory  
Waterways Experiment Station . . . . . 48

DISSOLVED OXYGEN STUDIES BELOW WALTER F. GEORGE DAM

Diane I. Findley  
Ecologist  
  
Kenneth Day  
Park Manager  
Mobile District . . . . . 52

COORDINATING THE WATER QUALITY ACT OF 1987

Harold T. Sansing  
Chief, Water Quality Section  
Nashville District . . . . . 61

LAKE CHICOT: THE FINAL CHAPTER

David R. Johnson  
Chief, Water Quality Section  
Vicksburg District . . . . . 67

CUMBERLAND BASIN WATER QUALITY MODEL

Jackson K. Brown  
Hydraulic Engineer, Water Quality Section  
Nashville District . . . . . 77

WATER QUALITY EVALUATION OF PROPOSED OUTLETS FROM  
DEVILS LAKE NEAR DEVILS LAKE, ND

Dennis D. Holme  
Physical Scientist, Water Quality Unit  
St. Paul District . . . . . 83

THERMAL STRATIFICATION IN MILL CREEK RESERVOIR

Tim Bartish  
Limnologist, Environmental Resources Branch  
Walla Walla District . . . . . 95

CONTENTS

I. Reservoir and Riverine Case Studies, cont.

POSTERUPTION LIMNOLOGY OF SPIRIT LAKE, MOUNT  
ST. HELENS, WASHINGTON, 1980-1986: LIMNOLOGICAL  
RESPONSE TO ACCELERATED LAKE DRAWDOWN VIA TUNNEL  
DISCHARGE, WITH EMPHASIS ON OXYGEN

Douglas W. Larson  
Limnologist, Hydraulics and Hydrology Branch  
Portland District . . . . . 104

WINTER WATER QUALITY IN LAKES AND STREAMS

Darryl J. Calkins  
Chief, Geological Sciences Branch

George D. Ashton  
Research Physical Scientist, Snow and Ice Branch  
Cold Regions Research and Engineering Laboratory . . 117

UNDER-ICE HYDRODYNAMICS AT TIOGA LAKE, PA

Kenneth S. Lee  
Environmental Engineer, Water Control Management  
Section

Robert A. Bank  
Hydraulic Engineer, Water Control Management  
Section  
Baltimore District . . . . . 125

TOWN BROOK RELIEF TUNNEL DESIGNING FOR ANOXIA AND  
H<sub>2</sub>S GENERATION

Townsend G. Barker  
Hydraulic Engineer, Hydraulics and Water Quality  
Section  
New England Division . . . . . 153

APPLICATIONS OF MIXERS AND AERATORS FOR RESERVOIR  
IMPROVEMENT

Richard E. Price  
Physical Scientist, Reservoir Water Quality Branch

Jeffery P. Holland  
Supervisory Research Hydraulics Engineer  
Reservoir Water Quality Branch  
Hydraulics Laboratory  
Waterways Experiment Station . . . . . 161

CONTENTS

I. Reservoir and Riverine Case Studies, cont.

DEVELOPING AN OPERATIONAL WATER TEMPERATURE MODEL  
FOR THE COLUMBIA RIVER SYSTEM

Bolyvong Tanovan  
Chief, Water Quality Section  
North Pacific Division

R. G. Willey  
Hydraulic Engineer  
Hydrologic Engineering Center . . . . . 170

DESTRATIFICATION OF BEECH FORK LAKE

Richard E. Punnett  
Hydraulic Engineer  
Huntington District . . . . . 185

UTILIZING THE STATISTICAL ANALYSIS SYSTEM FOR WATER  
QUALITY DATA BASE MANAGEMENT

James D. Graham  
Portland District . . . . . 195

GROUND-WATER MANAGEMENT PLAN FOR THE CONSTRUCTION OF  
THE BONNEVILLE NAVIGATION LOCK

James D. Graham  
Portland District

David Scofield  
Portland District

Saleem Farooqui  
Cornforth Consultants, Inc.

Steve Sagstad  
Sweet, Edwards, and Associates, Inc.

Kevin Foster  
Geotechnical Resources, Inc. . . . . 203

CONTENTS

II. Coastal and Estuarine Case Studies

SEDIMENT-WATER INTERACTIONS AND CONTAMINANT PROCESSES

Douglas Gunnison  
Research Microbiologist

James M. Brannon  
Research Chemist  
Environmental Laboratory  
Waterways Experiment Station . . . . . 216

CONTAMINANT MODELING FOR CORPS ACTIVITIES

S. L. Bird  
Civil Engineer  
Environmental Laboratory  
Waterways Experiment Station . . . . . 223

ADVANCES IN LABORATORY TESTING TO QUANTITATIVELY  
DESCRIBE SEDIMENT-WATER INTERACTIONS

James M. Brannon  
Research Chemist

Tommy E. Myers  
Environmental Engineer  
Environmental Laboratory  
Waterways Experiment Station . . . . . 228

AN APPROACH FOR ASSESSING IMPACTS OF IN-PLACE  
CONTAMINATED SEDIMENTS ON WATER QUALITY

T. L. Hart  
Supervisory Research Biologist

D. Gunnison  
Research Microbiologist

J. M. Brannon  
Research Chemist  
Environmental Laboratory  
Waterways Experiment Station . . . . . 242



CONTENTS

II. Coastal and Estuarine Case Studies, cont.

EVALUATING BIOAVAILABILITY OF NEUTRAL ORGANIC  
CHEMICALS IN SEDIMENTS - A CONFINED DISPOSAL  
FACILITY CASE STUDY

Joan U. Clarke  
Statistician (Biology), Ecosystem Research and  
Simulation Division

Victor A. McFarland  
Aquatic Biologist, Ecosystem Research and  
Simulation Division  
Environmental Laboratory  
Waterways Experiment Station

John Dorkin  
Fisheries Biologist, Environmental and Social  
Analysis Branch  
Chicago District . . . . . 251

USE OF DAPHNIA MAGNA AND MYSIDOPSIS ALMYRA TO ASSESS  
SEDIMENT TOXICITY

Henry E. Tatem  
Biologist  
Environmental Laboratory  
Waterways Experiment Station . . . . . 269

DREDGED-MATERIAL DISPOSAL PLANNING PROGRAMS

David T. Ford  
Hydrologic Engineer, Planning Division  
Hydrologic Engineering Center . . . . . 282

RELATIONSHIP BETWEEN SUBSURFACE GEOHYDROLOGIC  
INVESTIGATIONS AND SITING OF UPLAND DISPOSAL  
SITES/DEWATERING SITES FOR USE OF DREDGED MATERIAL  
AS SANITARY LANDFILL COVER

Carol A. Coch  
Oceanographer, Water Quality Compliance Branch

John F. Tavolaro  
Chief, Water Quality Compliance Branch  
New York District . . . . . 289

CONTENTS

II. Coastal and Estuarine Case Studies, cont.  
RECENT DEVELOPMENTS IN ESTIMATING POLYCHLORINATED BIPHENYL  
(PCB) LOSSES FROM CONFINED DISPOSAL FACILITIES

Tommy E. Myers  
Environmental Engineer  
Waterways Experiment Station

Jan A. Miller  
Environmental Engineer  
Chicago District

Frank L. Snitz  
Physical Scientist  
Detroit District . . . . . 312

EROSION AND RESUSPENSION EFFECTS OF HURRICANE GLORIA AT  
LONG ISLAND SOUND DREDGED MATERIAL DISPOSAL SITES

Thomas J. Fredette  
New England Division

W. Frank Bohlen  
Avery Point Marine Sciences Department  
University of Connecticut

Donald C. Rhoads  
Avery Point Marine Sciences Department  
University of Connecticut

Robert W. Morton  
Science Applications International Corporation  
Newport, Rhode Island . . . . . 323

USE OF SPOT HRV DATA IN THE CORPS OF ENGINEERS  
DREDGING PROGRAM

Carolyn J. Merry  
Harlan L. McKim  
Nancy LaPotin  
Cold Regions Research and Engineering Laboratory

John R. Adams  
New York District . . . . . 335

A TIERED APPROACH FOR EVALUATING SEDIMENT QUALITY AT  
MULTIPLE COASTAL AND RIVERINE DREDGING PROJECTS

A. Rudder Turner, Jr.  
Environmental Specialist, Advance Planning Branch  
Portland District . . . . . 350

CONTENTS

II. Coastal and Estuarine Case Studies, cont.

SURFACE AND GROUNDWATER MONITORING AT TIMES BEACH  
CONFINED DISPOSAL FACILITY, BUFFALO, NEW YORK

Richard P. Leonard  
Environmental Scientist, Water Quality Section  
Buffalo District . . . . . 362

THIN-LAYER DISPOSAL - A MODIFICATION OF CONVENTIONAL  
OVERBOARD DISPOSAL OF DREDGED MATERIAL

R. Douglas Nester  
Biologist, Coastal Environment Section  
Mobile District . . . . . 390

MOBILE HARBOR, ALABAMA, DUMP SCOW OVERFLOW TEST  
PRELIMINARY REPORT OF FINDINGS

F. Dewayne Imsand  
Environmental Engineer, Coastal Environment  
Section  
Mobile District . . . . . 398

MANAGEMENT OF DREDGED MATERIAL DISPOSAL AREAS

I. Braxton Kyzer  
Chief, Dredging Management Branch  
Charleston District . . . . . 410

Appendix. Poster Abstracts

SEDIMENTATION IN THE BALTIMORE DISTRICT

Robert A. Bank  
Civil Engineer, Water Control Management Section  
Baltimore District . . . . . 415

A HISTORY OF THE NORTH PACIFIC DIVISION'S DISSOLVED GAS  
MONITORING PROGRAM IN THE COLUMBIA/SNAKE RIVER BASINS

Ken Avery  
Hydrologist, Water Management Branch  
North Pacific Division . . . . . 416

CONTENTS

Appendix. Poster Abstracts, cont.

A CONCEPTUAL MODEL FOR EVALUATING WATER QUALITY IMPACTS  
OF STREAMBANK PROTECTION PROGRAM

Russell L. Davidson  
Civil Engineer/Water Resource Planner  
Planning Division  
Portland District . . . . . 417

BIOACCUMULATION OF CONTAMINANTS FROM BLACK ROCK HARBOR  
SEDIMENT BY NEREIS VIRENS

A. Susan Portzer  
Biologist  
Environmental Laboratory  
Waterways Experiment Station . . . . . 418

OPERATIONAL MONITORING OF CONFINED DISPOSAL FACILITIES  
IN HARBORS ALONG THE UPPER GREAT LAKES

M. Pam Bedore  
Physical Scientist  
Detroit District . . . . . 419

FIELD TESTING OF LOCALIZED MIXING SYSTEM - J. PERCY PRIEST  
LAKE, TENNESSEE

Robert B. Sneed  
Hydraulic Engineer, Water Quality Section  
Nashville District . . . . . 420

STUDIES ON THE CHEMICAL REDUCTION OF THE SELENATE  
ION IN WATER

Andrew P. Murphy  
Chemist  
U.S. Bureau of Reclamation . . . . . 421

THE INFLUENCE OF NITROGEN SUPERSATURATION ON THE ECOLOGY  
OF THE BIGHORN RIVER, MONTANA

James F. LaBounty  
U.S. Bureau of Reclamation . . . . . 422

CONTENTS

Appendix. Poster Abstracts, cont.

OXIDATION OF WASTE AQUEOUS FORMALDEHYDE SOLUTIONS TO  
CARBON DIOXIDE

A. P. Murphy  
Chemist

W. J. Boegli  
Civil Engineer

M. K. Price  
Chemical Engineer

U.S. Bureau of Reclamation . . . . . 423

THE USE OF A NEW TAGGING AGENT TO IDENTIFY SEEPING  
PROBLEMS ON BUREAU DAMS

Andrew P. Murphy  
Chemist

U.S. Bureau of Reclamation . . . . . 424

SECTION I  
RESERVOIR AND RIVERINE CASE STUDIES

WATER QUALITY MANAGEMENT FOR RESERVOIRS AND TAILWATERS:  
A WOTS DEMONSTRATION

by

Robert H. Kennedy, Robert C. Gunkel, and Robert F. Gaugush<sup>1</sup>

INTRODUCTION

The US Army Corps of Engineers (CE) is responsible for the construction, operation, and maintenance of water resource projects throughout major portions of the continental United States. These water resource projects have been authorized by Congress for a variety of purposes including flood control, hydroelectric power generation, navigation, flow regulation, irrigation, water supply, fish and wildlife habitat, and recreation. To date, approximately 783 projects having a total surface area of nearly 27,000 square kilometers have been completed to meet these purposes.

Growing public concern over the quality of freshwater resources and the desire to ensure responsible management of the valuable environmental resource provided by its water resource projects, led the CE to institute the Environmental and Water Quality Operational Studies (EWQOS) Program (Keeley et al., 1978). The purposes of this research program were to improve the understanding of limnological processes in reservoirs and to develop the technology to address water quality problems. As a continuing effort, the CE has established the Water Operations Technical Support (WOTS) Program as a means of maintaining and distributing water quality information and technology. A recent addition to the WOTS Program has been the Water Quality Management for Reservoirs and Tailwaters (WQMRT) Demonstration initiated in 1987. The objectives of the demonstration, which is a three-year effort sponsored by the Office, Chief of Engineers (OCE), are to:

- a. Identify water quality enhancement needs
- b. Inventory existing management technologies
- c. Develop a protocol for establishing and implementing water quality management plans

The identification of water quality enhancement needs is being accomplished through the use of a comprehensive questionnaire and by retrieving water quality information from STORET (US Environmental Protection Agency, 1979). Questionnaires solicit detailed information concerning project operation and are designed to allow district personnel to subjectively grade each project's water quality attributes. Additional

<sup>1</sup>Research Limnologist, Biologist, and Hydrologist, respectively, Environmental Laboratory, WES.

information has already been obtained from the CE National Inventory of Dams database (US Army Corps of Engineers, 1980), Annual Water Quality Reports compiled by each division, and the Simplified Techniques database developed during the EWQOS Program (Walker, 1981). When completed, the combined database is expected to contain over five million observations describing the physical, operational, and water quality attributes of 783 CE projects. The geographic distribution of these projects is presented in Figure 1.

Information describing various water quality enhancement techniques applicable to CE projects is also being solicited through the use of the above mentioned questionnaire. Supplemental information will be gained through a literature review. This information will be inventoried, screened for applicability and effectiveness, and placed in a readily-available format for use by district water quality personnel. To date, a draft report describing several in-reservoir methods for water quality enhancement has been prepared. The report also discusses methods for detecting and evaluating eutrophication-related water quality problems. Subsequent reports will describe techniques involving operational and structural modifications. Together, these reports will provide a wealth of current and authoritative water quality enhancement information to district personnel.

A major objective of WQMRT will be the formulation of a protocol for addressing water quality management issues and identifying appropriate mitigating methodologies. Since this will require technical input from and close coordination with FOA personnel, an advisory group composed of district personnel with long experience in water quality activities has been formed. This group will provide information on district water quality management practices and procedures, recommend research directions, and review and evaluate results.

#### DEVELOPMENT OF A MANAGEMENT PROTOCOL

Decision-making should progress in an orderly, directed fashion following clearly defined and interrelated steps. These steps, the definition of which is independent of the nature of the problem addressed, logically lead the manager from problem identification to problem solution. Six basic steps in this process are; (1) identification of issues, (2) collection and analysis of data, (3) formulation of management goals and objectives, (4) evaluation of management alternatives, (5) implementation of the selected alternative(s), and (6) post-implementation evaluation.

The identification of water quality issues is an important, yet often overlooked, step in the development of management approaches. In some cases, problems are identified based on monitoring activities designed to gauge current water quality conditions against commonly held expectations of water quality, without complete regard to project uses. In other cases, problems are only identified when use impairment occurs. These extreme approaches to defining issues can be ineffective, provide misleading information and/or lead to excessive and misdirected expenditures of money and manpower. A more logical approach would be to first determine user needs, then identify water quality conditions which adversely impact the



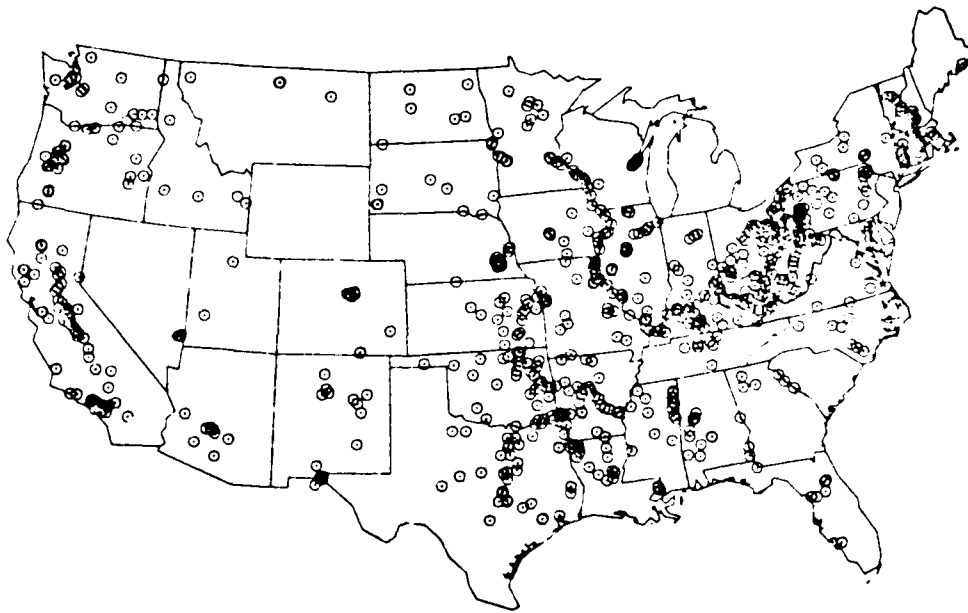

Figure 1. Geographic distribution of CE water resource projects.



Figure 2. Geographic distribution of a ten percent, stratified, random sample of CE projects for which questionnaires have been received.

fulfillment of these needs. Such an approach would allow the design and implementation of more efficient and cost-effective data collection and analyses programs.

Once water quality issues are defined and appropriate diagnostic data collected, management goals and objectives can be identified. These, in turn, would lead water quality personnel to identify, and eventually select and implement appropriate enhancement methodologies. The final step would involve post-implementation monitoring to determine management effectiveness.

#### PRELIMINARY SURVEY OF CE-WIDE WATER QUALITY ENHANCEMENT NEEDS

As mentioned previously, water quality enhancement needs or problems are being described directly through the use of the questionnaire and indirectly through the retrieval of water quality data stored in STORET. Later, relations between the perception of water quality problems, based on subjective responses obtained through the use of the questionnaire, and the quantification of that problem using STORET-derived data will be evaluated. Knowledge of such relations will increase our understanding of reservoir water quality problems and aid in the establishment of realistic and attainable water quality management goals. This section briefly describes the current status of this aspect of the WQMRT.

To date, water quality data have been retrieved for nearly 500 projects and approximately 470 questionnaires have been received. Since the establishment of a database containing this information has yet to be completed, a sample of questionnaires was randomly drawn and analyzed for the purpose of this report. The sample size was set at 10 percent (46 projects) and samples were drawn from strata based on project type (reservoir, lock and dam, and dry dam) and CE district. The geographic locations of sampled projects are presented in Figure 2 for comparison with the distribution of all CE projects (Figure 1). Results presented below are based on these analyses.

Figure 3 presents frequently cited water quality problems in tailwaters below CE projects. Most prevalent were problems associated with the seasonal occurrence of hypolimnetic anoxia in impounded waters. High concentrations of iron and manganese, low dissolved oxygen concentrations, and the presence of hydrogen sulfide are direct consequences of reducing conditions in hypolimnetic waters. Extreme and/or fluctuating discharge temperatures, which potentially impact downstream fisheries, are often associated with projects exhibiting marked thermal stratification and having bottom or near-bottom discharges.

An evaluation of water quality conditions in pools, also based on responses to the questionnaire, is presented in Figure 4. Most prevalent were problems related to the eutrophication process. These included excessive nutrient concentrations, algal blooms, macrophyte infestations, and the loss of dissolved oxygen in bottom waters. Other problems of concern included turbidity, excessive concentrations of reduced iron and manganese in bottom waters, and the accumulation of sediment and contaminants.

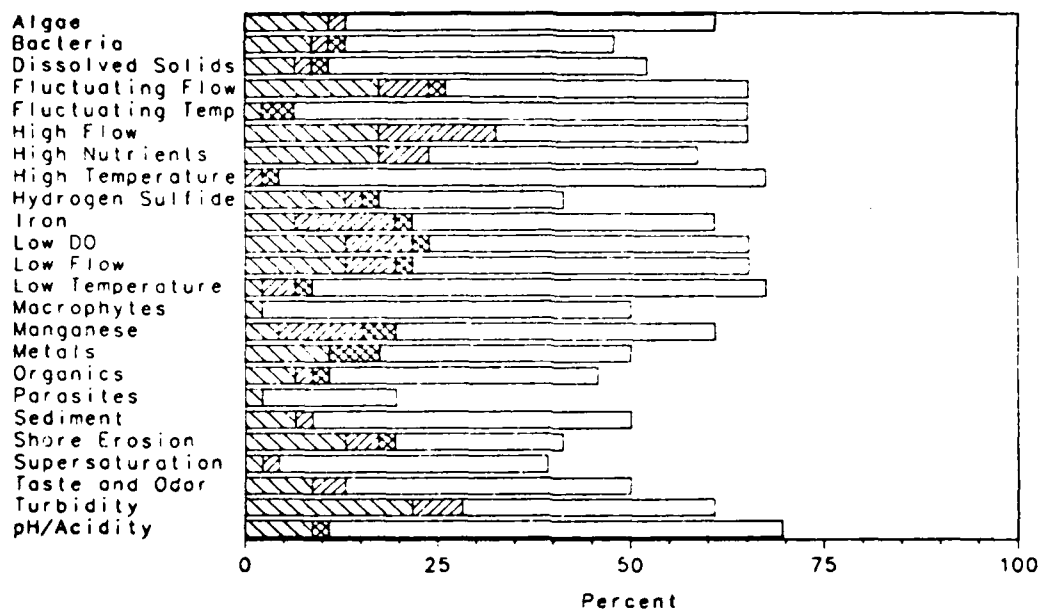

Figure 3. Frequency of occurrence of occasionally problematic (coarse hatching), intermittently problematic (fine hatching), chronically problematic (cross hatching), and non-problematic (no hatching) water quality conditions in tailwaters. Difference between accumulative frequency and 100 percent indicates percentage of projects for which no evaluation was made.

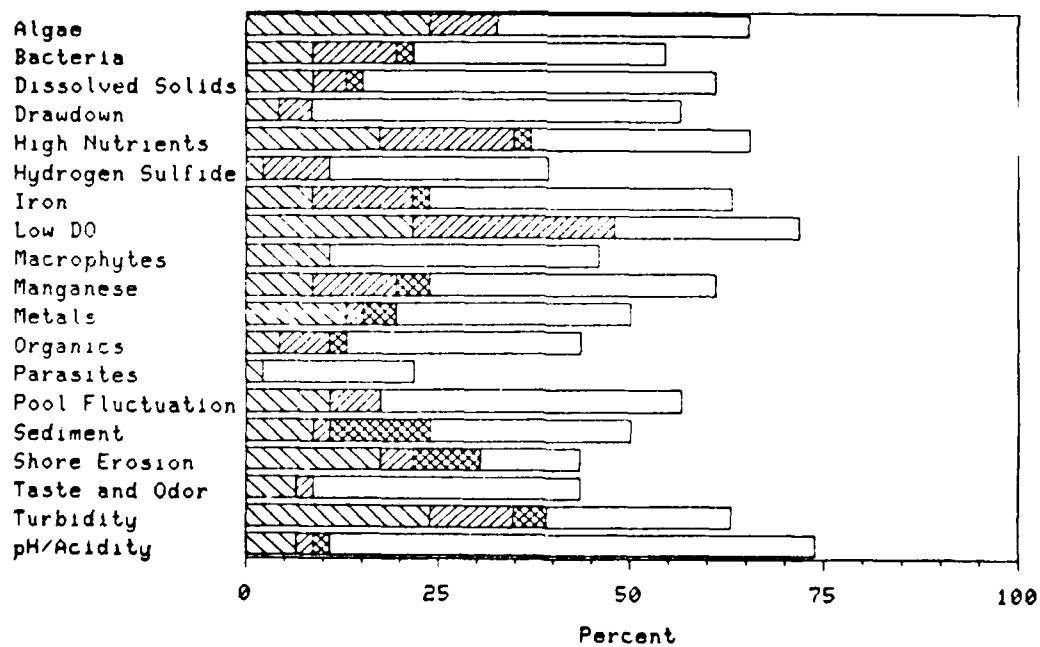

Figure 4. Frequency of occurrence of occasionally problematic (coarse hatching), intermittently problematic (fine hatching), chronically problematic (cross hatching), and non-problematic (no hatching) pool water quality conditions. Difference between accumulative frequency and 100 percent indicates percentage of projects for which no evaluation was made.

Impacts on user benefits associated with these water quality problems are presented in Figure 5 (tailwater) and Figure 6 (pool). Not unexpectedly, impacts are most frequently cited in relation to eutrophication-related problems. These include reduced benefits due to high nutrient concentrations, low dissolved oxygen, turbidity, and excessive algal growth. For tailwaters, losses in user benefits are often related to project operation. Water quality conditions leading to these reductions include high, low, or fluctuating flow, low dissolved oxygen, and elevated metal concentrations.

#### SUMMARY

The WQMRT Demonstration represents the CE's first, major effort to develop a sound protocol for the CE-wide management of its water resource projects. The assessment of current water quality conditions and enhancement needs is an important initial step. Data collected and analyzed to date indicate the occurrence of eutrophication-related problems, and the need to formulate approaches for the enhancement of water quality in tailwaters.

The compilation of water quality management technologies and the formulation of a framework within which to develop and implement water quality management plans will insure that the CE will continue to reach its water quality goals.

#### REFERENCES

Keeley, J. W., J. L. Mahloch, J. W. Barko, D. Gunnison, and J. D. Westhoff. 1978. "Reservoirs and Waterways: Identification and Assessment of Environmental Quality Problems and Research Program Development," Technical Report E-78-1, US Army Engineer Waterways Experiment Station, Vicksburg, Miss.

US Army Corps of Engineers. 1980. "National Inventory of Dams," Office, Chief of Engineers, Washington, D.C.

US Environmental Protection Agency. 1979. Water Quality Control Information STORET, User Handbook, Office of Water and Hazardous Materials, Washington, D.C.

Walker, W. W. 1981. "Empirical Methods for Predicting Eutrophication in Impoundments, Report 1, Phase I: Data Base Development," Technical Report E-81-9, US Army Engineer Waterways Experiment Station, Vicksburg, Miss.

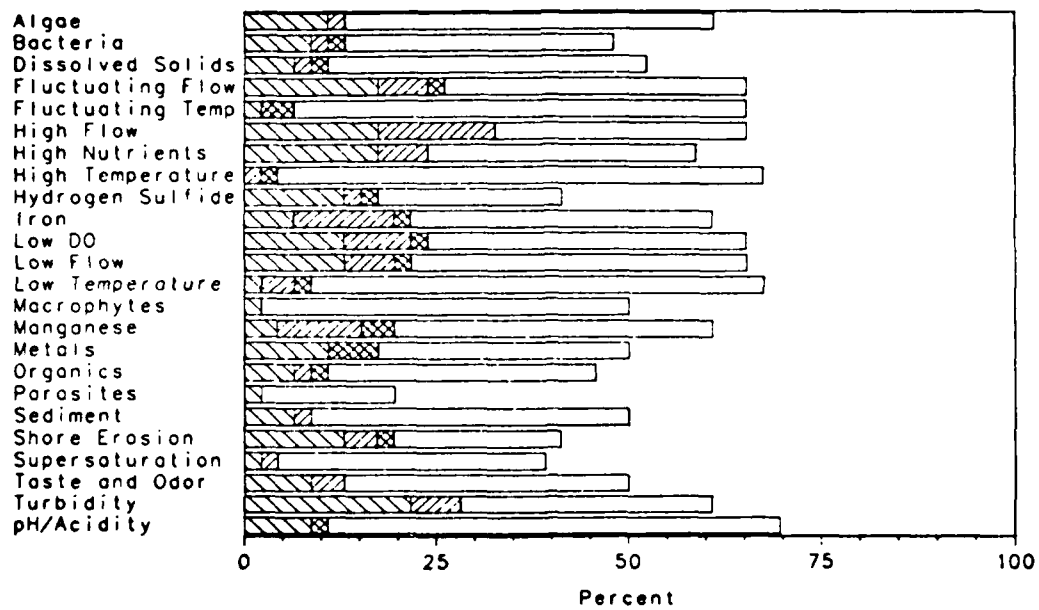

Figure 5. Frequency of occurrence of minor (coarse hatching), significant (fine hatching), severe (cross hatching), and non-existent (no hatching) impacts on user benefits associated with each water quality condition in tailwaters. Difference between accumulative frequency and 100 percent indicates percentage of projects for which no evaluation was made.

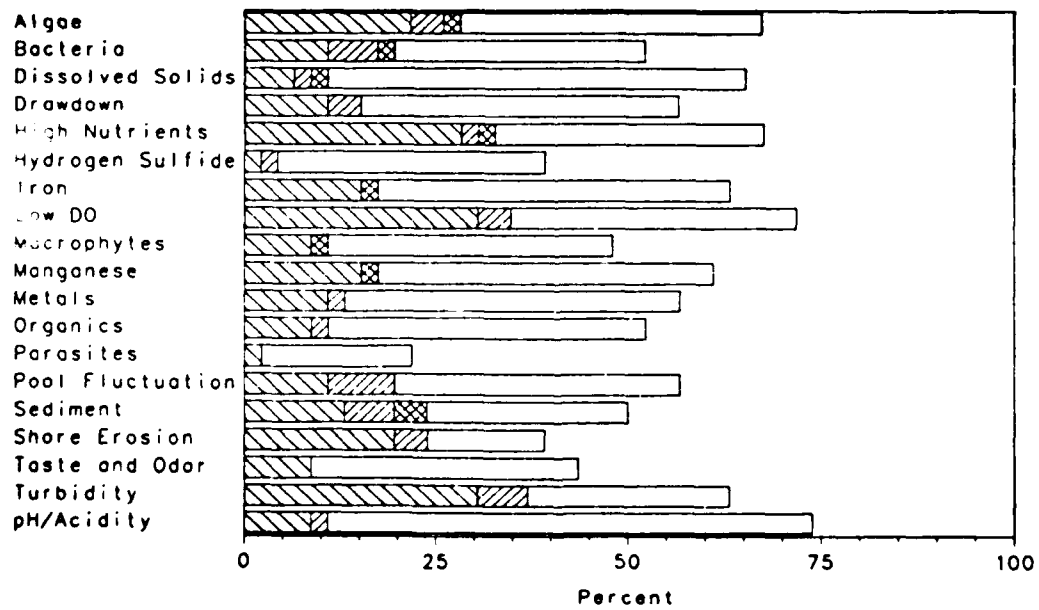

Figure 6. Frequency of occurrence of minor (coarse hatching), significant (fine hatching), severe (cross hatching), and non-existent (no hatching) impacts on user benefits associated with each water quality condition in project pools. Difference between accumulative frequency and 100 percent indicates percentage of projects for which no evaluation was made.

# MICROCOMPUTER SOFTWARE FOR THE ANALYSIS OF WATER QUALITY SAMPLING DESIGN

by

Robert F. Gaugush, PhD<sup>1</sup>

## INTRODUCTION

Once the data have been collected from a reservoir water quality monitoring program, the data analysis phase of the study can be initiated. There are fundamentally two types of data analysis: (a) analysis directed at characterizing the reservoir's water quality and (b) analysis with the objective of analyzing the effectiveness of the sampling design. The second type of data analysis is rarely considered. Evaluation of the sampling design is an important task because if the design is to be used again (as in an ongoing monitoring program), it is essential to determine if the design can be improved to increase the precision of the estimates or reduce the cost of sampling. Even if the sampling will not be repeated, it is worthwhile to evaluate the effectiveness of the design to aid the development of future sampling programs. Microcomputer software has been developed to aid in the evaluation of sampling design. The software addresses three important questions about the effectiveness of the sampling design and provides a corresponding method to answer each of the questions:

1. How well does the sampling design "explain" or account for the observed variance?

Method: Variance component analysis

2. Are there redundancies in the data that can be removed to improve the sampling design?

Method: Cluster analysis

3. Can the sampling design be modified to improve the precision of the estimates?

Method: Error analysis

The software was developed and compiled using Turbo Pascal and will run on any microcomputer using the MS-DOS operating system.

## VARIANCE COMPONENT ANALYSIS

Variance component analysis is a technique for quantifying the sources of variability in the data from a given sampling design. The analysis results in the determination of each design component's contribution to the overall

<sup>1</sup> Hydrologist, Environmental Laboratory, U.S. Army Engineer Waterways Experiment Station.

variance. Based on the results of a variance component analysis, sampling effort in a given stratum can be reduced or even eliminated. A good introduction to variance component analysis and the computational steps involved can be found in Winer (1971).

The variance component analysis program is called VARCOM and can address sampling designs with up to three factors and a total number of observations up to a maximum of 3500. As an example of the use of variance component analysis, consider a sampling program directed at estimating the epilimnetic chlorophyll concentration during the growing season (May - September). Samples at three stations at depths of 0, 1, 2, and 3 meters were taken at approximately two week intervals. The results of the variance component analysis are presented in Table 1.

Two observations are readily apparent from the distribution of variance among the components. First, almost 26 percent of the variance is not accounted for by the design used. Second, the station component accounted for less than 4 percent of the total variance. These findings suggest that the design could be improved by dropping two of the three stations because they do not account for a large fraction of the variance. Samples that were allocated to these stations could be used to increase the sampling frequency because most of the variance is associated with time effects. By dropping two stations and increasing sampling frequency, error variance should be reduced without increasing sample size or cost.

#### CLUSTER ANALYSIS

Cluster analysis is a multivariate classification technique that may be used to group or identify similar objects. In the more typical data analysis situation, cluster analysis might be used to group a set of reservoirs according to their trophic state or by the composition of their phytoplankton. The use of cluster analysis in a typical data analysis mode can be found in Gaugush (1986). In the evaluation of a sampling design, cluster analysis can be used to identify redundancy in the design. For example, if a stratified random design requires the collection of samples from a number of strata, cluster analysis may be able to identify groups of strata that can be combined to reduce sampling effort.

The clusters, or groups of similar observations, can be identified by a number of criteria, but in most applications the criterion is either the correlation between groups of observations or the similarity of their means. This criterion is based on a "distance" function, and clusters are defined on the basis of the "distance" between observations. The Euclidean distance function is typically used, and it defines distance as the sum of squared differences between observations. With this criterion, observations that are "close" to each other will be grouped in the same cluster. The grouping of observations into clusters is hierarchical. The "hierarchical" nature of the analysis implies that at the start of the analysis each observation is in a separate cluster. At each step in the analysis, clusters are joined based on their similarity or distance until all of the observations are included in a single cluster.

Three clustering methods (centroid, Ward's, and average linkage) are included in the sampling design software. The centroid method joins clusters based on the distance between the mean or centroid of each cluster. At each step, the two clusters that are separated by the smallest distance (i.e., most similar) are joined. Ward's method is based on the sum of squared deviations from the cluster mean. At each step of the analysis, Ward's method examines every possible combination, and the new cluster is the one with the smallest sum of squared deviations. The average linkage method uses the average distance between pairs of observations within a given cluster. As with Ward's method, the average linkage method examines every possible combination at each step, and the new cluster is the one with the minimum average distance.

Given that cluster analysis will produce a set of clusters from one (all observations in a single cluster) to a maximum where each observation forms a separate cluster, how does one determine the number of clusters that best describes the data? The cubic clustering criterion (CCC) is a method that provides an indication of the number of clusters that best represents groupings within the data set (Sarle, 1983). A more complete introduction to cluster analysis for sampling design analysis can be found in Gaugush (1987), and the computational details of the technique can be found in Anderberg (1973).

The cluster analysis program is called CLUSTER and has a maximum problem size of 150 observations and up to 10 variables. As an example of how CLUSTER might be used, consider the following sampling design. A stratified random sampling program was used to estimate the annual mean concentrations of chlorophyll a, total phosphorus, total nitrogen, total organic carbon, and dissolved silica. The epilimnion, metalimnion, and hypolimnion were chosen as the vertical strata, and the months of the year were chosen as the temporal strata. One randomly selected sample was taken from each combination of depth and time strata for a total sample size of 36. Cluster analysis can identify the number of clusters between 1 (i.e., all observations are similar) and 36 (i.e., all observations are dissimilar). It should be obvious that if the analysis finds a number of clusters less than 36 that can adequately describe the data, a reduction in future sampling effort can result. For the sake of the example, assume that the CCC has identified eight clusters as an acceptable grouping of the data.

The results of the analysis can be depicted graphically by displaying the location of the clusters with respect to depth and time (Figure 1, upper). The clusters appear to fall into logical groupings when one considers typical spatial and temporal patterns in water quality. The clusters for winter (Jan - Mar), spring mixing (Apr), fall turnover (Oct), and late fall (Nov - Dec) indicate that sampling with respect to depth is unnecessary during these periods of the year. The situation during the growing season is less clear, but it is apparent that sampling with respect to depth is necessary and that the stratified period may have to be split into early (May - Jun) and late (Jul - Sep) stratified periods. The results of the cluster analysis can be used to define new strata (Figure 1, lower) for any future sampling programs. Cluster analysis indicates that it may be possible to reduce the number of strata from 36 to 11. With this considerable reduction, it may also be possible to increase the total sample size, allocate more than one sample per stratum, and increase the precision of the estimates without increasing costs.



## ERROR ANALYSIS

Error analysis is a method for the improvement of the sampling design based on the observed distribution of variance. The results of an error analysis can suggest a redistribution of sampling effort to produce estimates with minimum variance (i.e., lower uncertainty). This method can use data collected using a stratified sampling design or data that have been subjected to post-stratification. Post-stratification involves assigning data collected from a non-stratified design (either a random or systematic design) to strata based on temporal or spatial criteria. For example, data taken at biweekly intervals (i.e., a systematic design) could be assigned to temporal strata based on the season of the year (i.e., spring, summer, fall, and winter).

The method of error analysis centers on the error variance of the stratified sample mean, the contribution of each stratum to the error variance, and the distribution of sampling effort among the strata. Given this information, the optimal distribution of sampling effort and the error variance of the optimal design can be determined. The optimal distribution of sampling effort is based on a consideration of both stratum size (i.e., relatively more samples are taken from larger strata) and stratum variance (i.e., strata with greater variance are sampled more). The expected error variance that will result with the application of the optimal design is primarily a function of the ratio of the actual sampling effort in a stratum to the optimal sampling effort. The computational details of error analysis can be found in Gaugush (1987).

The error analysis program is called ERROR and can handle up to 25 strata. As an example of the use of error analysis to re-distribute sampling effort, consider the following. A study was conducted with the objective of estimating the annual mean epilimnetic chlorophyll a concentration. A seasonal stratification scheme was used with the strata defined by the duration of spring mixing, summer stratification, fall mixing, and winter stratification. A proportional allocation of 25 samples was used because variance within the specified strata was not known. The results of this study are presented in Table 2. The distribution of sampling effort, error variance, and optimal sampling effort is shown in Table 3. An examination of the disparity between the actual distribution of samples and the distribution of the error variance indicates there is considerable room for improvement of the sampling design. For example, the spring stratum was allocated only 16 percent of the samples, and yet it contributed over 80 percent of the error variance. The optimal distribution of sampling effort which considers both stratum size and the contribution to error variance suggests that just over 50 percent of the samples should be allocated to the spring stratum. Error analysis also provides an estimate of the resultant error variance if, in the future, samples are allocated according to the optimal distribution. In this example, the optimal design results in an expected error variance of 19.28, whereas the existing design resulted in an error variance of 37.47. It is apparent that error analysis can lead to a significant reduction in error variance (i.e., a reduction in uncertainty) without an increase in cost.

## SUMMARY

Three microcomputer programs have been developed as an aid in the analysis of water quality sampling design. These programs are: 1) VARCOM, a variance component analysis program to identify the sources of variance in a sampling design; 2) CLUSTER, a cluster analysis program to identify sources of redundancy in a sampling design; and 3) ERROR, an error analysis program to reduce the error variance of a sampling design by optimally distributing sampling effort. These programs can be executed on any microcomputer capable of handling the MS-DOS operating system. The software will be made available on the Waterways Experiment Station microcomputer bulletin board (contact author for details of access).

## ACKNOWLEDGEMENT

Information presented herein, unless otherwise noted, were obtained from research conducted under the Environmental and Water Quality Operational Studies Program of the United States Army Corps of Engineers by the USAE Waterways Experiment Station. Permission was granted by the Chief of Engineers to publish this information.

## REFERENCES

- Anderberg, M.R. Cluster Analysis for Applications, Academic Press, New York, 1973.
- Gaugush, R.F., tech. ed. "Statistical Methods for Reservoir Water Quality Investigations," Instruction Report E-86-2, US Army Engineer Waterways Experiment Station, Vicksburg, Miss., 1986.
- Gaugush, R.F. "Sampling Design for Reservoir Water Quality Investigations," Instruction Report E-87-1, US Army Engineer Waterways Experiment Station, Vicksburg, Miss., 1987.
- Sarle, W.S. "Cubic Clustering Criterion," SAS Technical Report A-108, SAS Institute Inc., Cary, NC, 1983.
- Winer, B.J. Statistical Principles in Experimental Design, McGraw-Hill, Inc., New York, 1971.

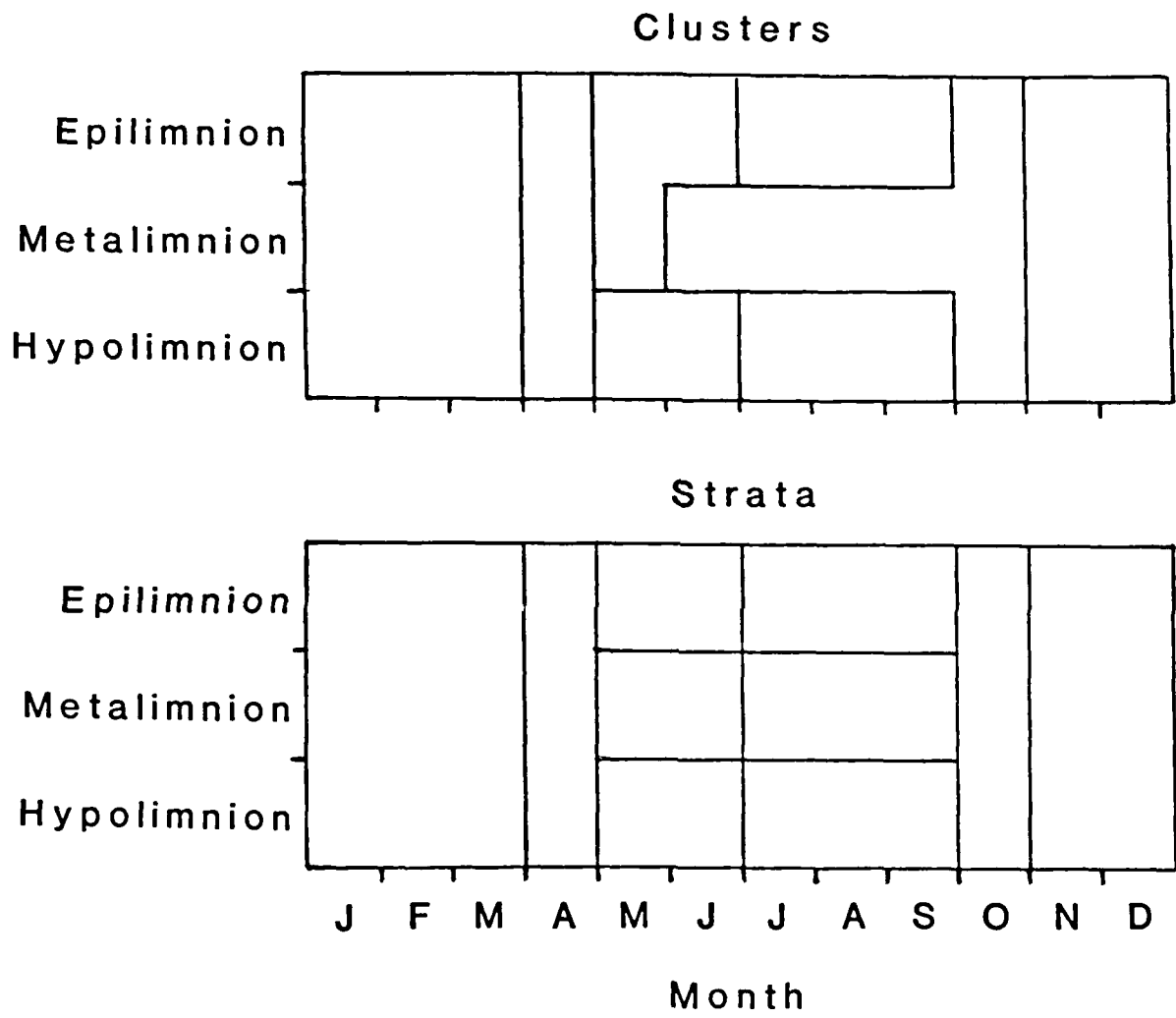

Figure 1. Location of the the eight clusters identified by cluster analysis (upper) and location of the ten strata of the improved sample design (lower) suggested by the results of the cluster analysis.

Table 1. Variance estimates and percentage contribution to the total variance resulting from the variance component analysis.

Source	Variance Estimate	Percent Total Variance
Station	30.6	3.6
Day	471.0	54.8
Depth	136.6	15.9
Error	221.9	25.8

Table 2. Sampling statistics for the strata used to estimate epilimnetic chlorophyll concentrations.

Stratum	n	Weight	Mean	Variance	Error Variance
Spring	4	0.16	73.30	4852.65	1213.16
Summer	9	0.36	41.81	341.80	37.98
Fall	4	0.16	31.93	45.08	11.27
Winter	8	0.32	13.93	93.41	11.68

Table 3. Distribution of sampling effort, error variance, and optimal sampling effort (expressed as percentages) for the chlorophyll data of Table 2.

Stratum	Actual Sampling Effort	Variance	Optimal Sampling Effort
Spring	16.0	82.9	50.8
Summer	36.0	13.1	30.3
Fall	16.0	0.8	4.9
Winter	32.0	3.2	14.1

USE OF REMOTE SENSING TECHNIQUES TO ENHANCE IN SITU  
WATER QUALITY MONITORING

by

David P. Bierl <sup>1</sup>

INTRODUCTION

The Rock Island District, U.S. Army Corps of Engineers, and the U.S. Army Cold Regions Research and Engineering Laboratory are currently participating in the Office of the Chief of Engineers' sponsored Remote Sensing Demonstration Program for Inland Waterways. The major objectives of this five-year (FY 86-FY 90) program are: (1) to demonstrate the use of aerial and satellite images in water resources activities, including comparison of the reliability, information content, and cost of acquiring and analyzing such data, and (2) to demonstrate the use of state-of-the-art environmental and hydrometeorological sensors which telemeter data via Geostationary Operational Environmental Satellite and other data relay systems.

Three application areas have been identified as candidates for remote sensing demonstrations: engineering, planning and operations. The engineering application area includes flood/drought operations, water quality data collection, emergency management/dam safety, and seepage monitoring. The planning application area includes flood damage assessment, cultural resources monitoring, habitat monitoring, and wetland identification/mapping. The operations application areas are shoreline monitoring and channel scour monitoring.

Remote sensing in the planning application area involves the use of Landsat Thematic Mapper satellite digital data and the French System Probatoire d'Observation de la Terre High Resolution Visible satellite digital data. Engineering and operations application areas involve the use of in situ sensors to measure numerous hydrological, geological and meteorological parameters, and include water quality sensors for the following: pH, dissolved oxygen, temperature, conductivity, ammonia and nitrate.

As part of the five-year program, Rock Island District Water Quality and Sedimentation Section personnel are testing and comparing various water quality probes. Corps District and Division offices and numerous water quality instrumentation manufacturers were surveyed to determine the availability of various water quality probes. The survey results assisted Rock Island District personnel in determining which probes to test and compare.

<sup>1</sup> Hydrologist, Water Quality and Sedimentation Section, Rock Island District.

The accomplishments to date, particularly the descriptions of, and preliminary results from, the testing of three dissolved oxygen probes, are presented. A brief overview of dissolved oxygen probes in general, and future plans for the water quality portion of the demonstration program are also discussed.

## WATER QUALITY INSTRUMENTATION SURVEYS

### Division and District Survey

In December of 1986, a survey was sent to Corps Division and District offices concerning the use of in situ water quality probes. The main purpose of this survey was to determine the types of probes being used by each office, and their satisfaction with these probes. Each office was asked to comment on the water quality probes they currently use and also to provide information on other water quality probes they may have had experience with, or be knowledgeable of. The water quality probes of concern were temperature, pH, conductivity, dissolved oxygen and total dissolved gasses. Respondents were asked to reply to the following questions concerning each type of probe:

1. How long has the probe been in service?
2. What is the frequency of standardization?
3. Is the probe currently in use?
4. What is the estimated price of the probe?
5. What is the probes method of interfacing?
6. What is your overall satisfaction with each probe?

The results of the survey assisted Rock Island District personnel in determining which water quality probes would be tested and compared.

### Manufacturer Survey

More than 100 water quality equipment manufacturers were contacted concerning the availability of water quality instrumentation. The information received from a number of these manufacturers has been reviewed by Rock Island District personnel to determine which water quality instruments warranted further investigation.

## DISSOLVED OXYGEN PROBES

The survey results helped Rock Island District personnel choose several dissolved oxygen probes for testing. A brief discussion of dissolved oxygen probes in general is presented, followed by a more specific discussion on three probes tested by the District.

### Dissolved Oxygen Probes - A Brief Overview

Membrane-covered electrodes have been used to measure dissolved oxygen in natural waters since the early 1960's. Membrane-covered galvanic dissolved oxygen probes were becoming popular for use in water pollution control programs at this time (Mancy and Westgarth, 1962). On November 17, 1959, L. C. Clark (1959) received a patent for a membrane-covered polarographic dissolved oxygen probe. Most probes used for dissolved oxygen measurements in natural waters since this time have been of either the galvanic or polarographic type. The basic difference between a polarographic and a galvanic type probe is that the former relies on an external voltage to polarize the indicator electrode, while in the latter, oxygen is a reactant at one of a pair of electrodes, thereby generating an electrical current without the aid of an electromotive force (Mancy and Jaffe, 1966). According to Quinby-Hunt et al. (1986), the operation of either type of membrane-covered probe involves the following steps:

1. Molecular oxygen from the sample passes through the membrane.
2. The molecular oxygen travels through the electrolyte solution between the membrane and the electrodes.
3. Molecular oxygen is reduced at the cathode, thereby generating a current equivalent to the quantity of oxygen reaching its surface.

In taking measurements with either type of probe, it is essential that there is adequate flow across the surface of the membrane. If the flow is inadequate, depletion of oxygen in the test solution close to the membrane occurs, the effective diffusion layer is increased, and the current decreases (Hitchman, 1978).

A frequently reported problem with membrane covered dissolved oxygen probes is biological fouling of the membrane (Bark et al., 1986, Wernke and Tenney, 1987, and Crumpton and Tikkanen, 1987). Fouling of the membrane effectively increases the membrane thickness; therefore, decreasing the rate of oxygen diffusion. Once the membrane is fouled, cleaning or recalibration is necessary.

Several dissolved oxygen probes developed in recent years have been designed to overcome the flow requirement and membrane biological fouling problems discussed previously. Optional stirring mechanisms are available for many probes. These devices usually fit over the membrane portion of the probe and continuously replenish the sample at the surface of the membrane.



Self-cleaning mechanisms are also available on some dissolved oxygen probes. The Zullig dissolved oxygen sensor utilizes a rotating grindstone which continually moves across the electrodes to remove fouling deposits. This sensor does not have a membrane or electrolyte solution. Royce Instrument Corporation manufactures a dissolved oxygen sensor which produces a biocidal gas which makes the membrane surface unattractive to microorganisms.

A pulsed dissolved oxygen sensor manufactured by Endeco virtually eliminates the need for sample flow across the membrane surface. In this type of polarographic sensor, the cathode is polarized for short, pulsed durations, as opposed to the continual polarization of the cathode in most polarographic probes. According to Langdon (1986), appropriate selection of pulse duration and pulse repetition can reduce oxygen consumption to the point that the sensor becomes insensitive to sample flow rate.

A dissolved oxygen probe has been developed by Leeds and Northrup Instruments in which there is no net consumption of oxygen. As oxygen is consumed by the cathode, an equal amount is produced by the anode. According to Wernke and Tenney (1987), since there is no net oxygen consumption, measurements are independent of flow and fouling; however, fouling can increase the sensor response time.

The dissolved oxygen sensors discussed previously are only a small portion of those currently available. A discussion of all the dissolved oxygen sensors currently available is beyond the scope of this paper. Preliminary tests have been performed on three of the sensors mentioned previously. These three sensors are described in more detail along with a discussion of the preliminary test results.

#### Leeds and Northrup Dissolved Oxygen Probe

The Leeds and Northrup dissolved oxygen probe (Cat. No. 7931-30) consists of three electrodes and a thermistor for temperature compensation. Two of the electrodes are connected as cathode (platinum) and anode (platinum) and are covered with electrolyte. The third electrode (silver chloride reference electrode) is mounted in the center of the supporting substrate and is also in contact with the electrolyte. The electrolyte in the probe is permanent and is contained within an expansion chamber to compensate for pressure changes. A permanent gas-permeable membrane, protected by a heavy-duty silicone rubber cover, holds the electrolyte around the electrodes. Oxygen generation and reduction functions are performed at the anode and cathode, while the reference electrode maintains the correct electrochemical potential.

Oxygen, which diffuses through the gas-permeable membrane, is reduced at the cathode, and at the same time, an equal amount of oxygen is generated at the anode. The diffusion continues until the partial pressure of oxygen on both sides of the membrane is equal. The current necessary to maintain this equilibrium is converted by the electrical circuitry to read out the dissolved oxygen concentration.

According to the manufacturer, since there is no oxygen diffusion or transport at equilibrium, and no net reaction at the electrodes, there are significant advantages to their probe:

1. There is no flow requirement because oxygen transport ceases after equilibrium and therefore, there is no depletion layer.
2. There is no contamination of the electrolyte by the electrodes, and there is no consumption of electrolyte.
3. The electrodes are not subject to plating or etching.
4. The measurement is independent of inert membrane fouling.
5. Air calibration can be performed without drying the probe.

#### Zullig Dissolved Oxygen Sensor

The Zullig dissolved oxygen sensor (Model 5141DO) is a galvanic-type probe consisting of an iron anode, a silver amalgam cathode, and a thermistor for temperature compensation. When the electrodes are immersed in a solution, a current passes between the electrodes. The concentration of oxygen dissolved in the solution, among other factors, determines the magnitude of the current.

The sensor consists of a plastic tube fitted with two concentric, spring-loaded, metal electrode rings. The rotary action of a grindstone, which is driven by an A.C. motor attached to the sensor, continually polishes the electrode surfaces. The electrodes are enclosed within a chamber which oscillates vertically and serves as a pump to continuously change the water which comes in contact with the electrodes. The chamber also protects the electrodes from direct contact with air bubbles and suspended material. The sensor has no membranes to replace and no filling solutions.

Advantages of the Zullig dissolved oxygen sensor, according to the corporation that markets the probe (Great Lakes Instruments), include the following:

1. The electrodes are self-cleaning, utilizing a grindstone mechanism.
2. No membranes or filling solutions are required.
3. The continual sample change minimizes electrode fouling.
4. Since the system does not rely on diffusion through a membrane, its response time is relatively fast.
5. The sensor is less sensitive to flow compared to membrane-type probes.

### Royce Dissolved Oxygen Sensor

The Royce Model 90 dissolved oxygen sensor is a galvanic-type probe consisting of a lead anode, a platinum cathode, and an automatic temperature compensator. A gas-permeable membrane is positioned over the cathode and separates the sensing mechanism from the solution being measured. Oxygen in the measured solution diffuses through the membrane to the platinum cathode where it is reduced. Diffusion through the membrane occurs only because of the partial pressure of oxygen in the measured solution. The partial pressure of oxygen inside the membrane is essentially zero as all the oxygen gas is reduced. When oxygen is reduced at the cathode, a current is developed which is directly proportional to the concentration of dissolved oxygen in the solution.

The Royce sensor has a self-cleaning system which utilizes a biocidal gas. The sensor is sold with a meter which houses the electronic components that initiate a timed (every two hours) electrochemical reaction within the sensor body to form free chlorine gas. The gas migrates through the membrane and makes it unattractive to microorganisms. At the same time, a number of minerals responsible for clogging the pores of the membrane are dissolved. The chlorine gas is produced from the potassium chloride electrolyte used in the sensor.

For use in quiescent waters, Royce recommends the use of an optional agitator which is easily coupled to the sensor and allows for adequate flow across the membrane.

According to Royce, advantages of the Model 90 sensor include the following:

1. The sensor utilizes a non-mechanical, non-hydraulic cleaning action.
2. The sensor has a quick, stable dissolved oxygen response.
3. It is the lowest priced self-cleaning dissolved oxygen sensor on the market.

### PRELIMINARY TEST RESULTS AND DISCUSSION

#### Leeds and Northrup Dissolved Oxygen Probe

The Leeds and Northrup probe was tested in the laboratory by Rock Island District personnel from March 18, 1987, through April 8, 1987, to determine how dissolved oxygen concentrations determined with the Leeds and Northrup meter compared with those determined by the azide modification of the Winkler method (APHA et al., 1985). The probe was air calibrated on March 18, 1987, and placed in a tank containing Mississippi River water. The probe was not recalibrated or cleaned during the entire 20-day test period. A bilge pump was used at times to circulate the water in the tank.

The results of the laboratory test are shown in Figure 1. During days one through ten, the Winkler values and Leeds and Northrup meter values were very close. The average difference of the five values determined during this period was 0.12 mg/l. On day nine, organic matter was added to the tank to lower the dissolved oxygen concentration. On day 13, the meter read zero, while the Winkler value was 0.40 mg/l. At this time, the water in the tank was aerated to raise the dissolved oxygen concentration. On day 14, the meter reading (6.60 mg/l) was still relatively close to the Winkler value (6.75 mg/l); thereafter, however, the differences between the two values tended to be greater. From day 15 through day 20, the average difference of the four values compared during this period was 0.48 mg/l. For the entire 20-day period, the average difference between meter and Winkler values was 0.28 mg/l.

The Leeds and Northrup probe was also tested in the field. On August 3, 1987, the probe was placed in a tank located inside a U.S. Geological Survey gaging station on the Des Moines River, downstream from Saylorville Reservoir, just north of Des Moines, Iowa. The probe was calibrated using a dissolved oxygen concentration determined by an air calibrated YSI dissolved oxygen meter. River water was pumped continuously to the tank by means of a submersible pump. The probe was left in the tank for 146 days, until January 26, 1988. The probe was not recalibrated during this entire period; however, it was cleaned on November 3, 1987.

The results of the field test are shown in Figure 2. From August 3, 1987, through August 25, 1987, the meter and Winkler values were relatively close; however, from September 8, 1987, through January 26, 1988, the values were significantly different. Between the August 25, 1987, and September 8, 1987, readings, the probe "lost" calibration. On November 3, 1987, the probe was cleaned. This resulted in an increase in the Leeds and Northrup meter readings, although these readings were still considerably lower than the dissolved oxygen concentrations determined by the Winkler method.

One limitation of the Leeds and Northrup probe is that it cannot be air calibrated when ambient air temperatures are below freezing. Also, the probe's membrane is very delicate and must not be allowed to dry out. Extreme care should be used when cleaning the membrane. If the membrane is punctured, the entire probe must be replaced.

#### Zullig Dissolved Oxygen Sensor

The Zullig sensor was field-tested from August 17-27, 1987. The sensor was positioned and calibrated in a manner similar to the Leeds and Northrup probe. A continuous flow of river water was supplied to the tank by means of a submersible pump. The sensor was not recalibrated or cleaned during the 11-day period.

Field-test results for the Zullig sensor are shown in Figure 3. A problem with the submersible pump limited the test to 11 days. The decrease in dissolved oxygen concentrations beginning on the fifth day of the test were probably related to an insufficient amount of flow being supplied to the tank by the submersible pump. On day 11, when Rock Island District personnel

# LEEDS AND NORTHRUP PROBE (LAB)

18 MAR 87 - 6 APR 87

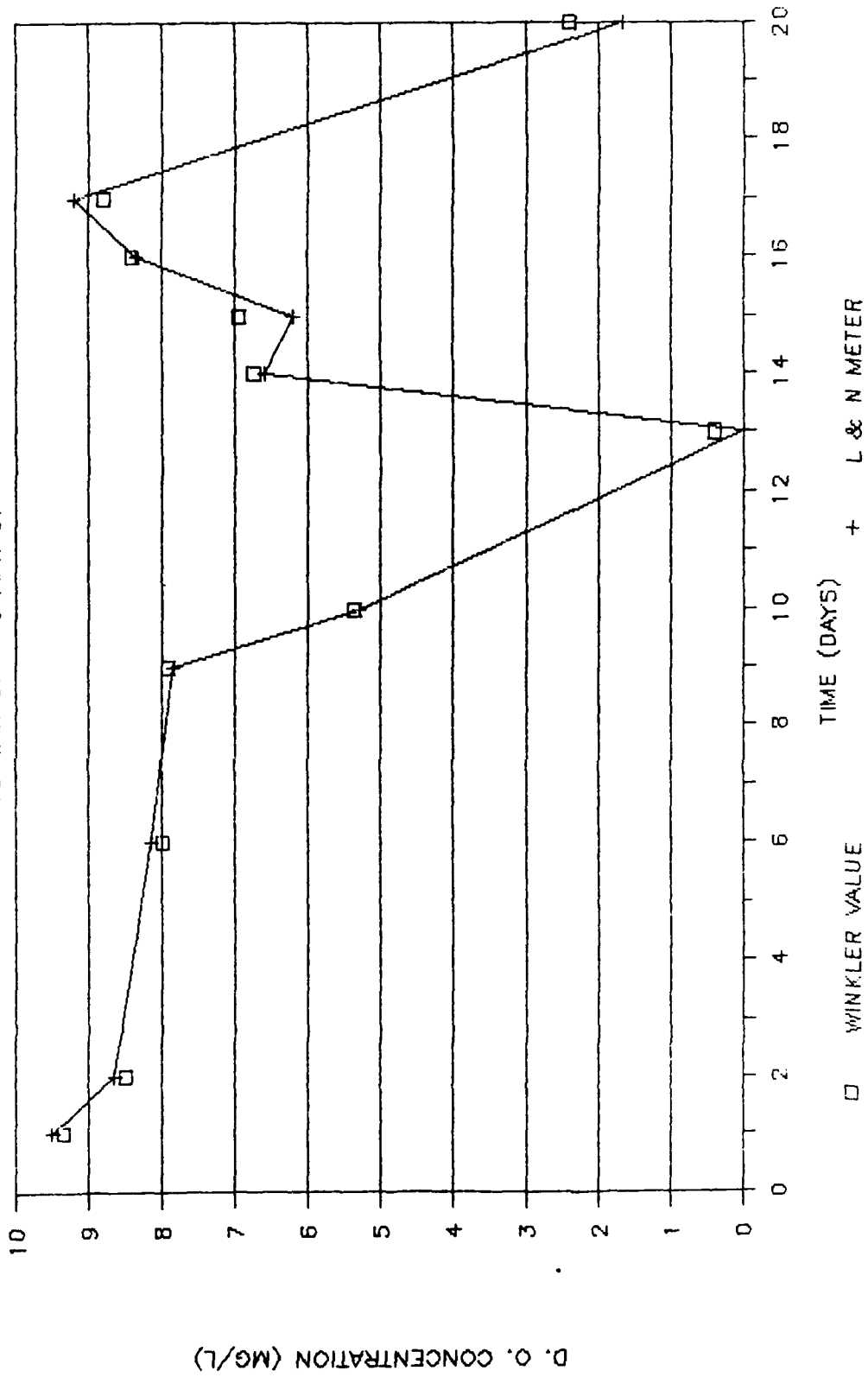

Figure 1. Laboratory test dissolved oxygen concentrations comparing Leeds and Northrup meter readings to Winkler values.

# LEEDS AND NORTHRUP PROBE (FIELD)

3 AUG 87 - 26 JAN 88

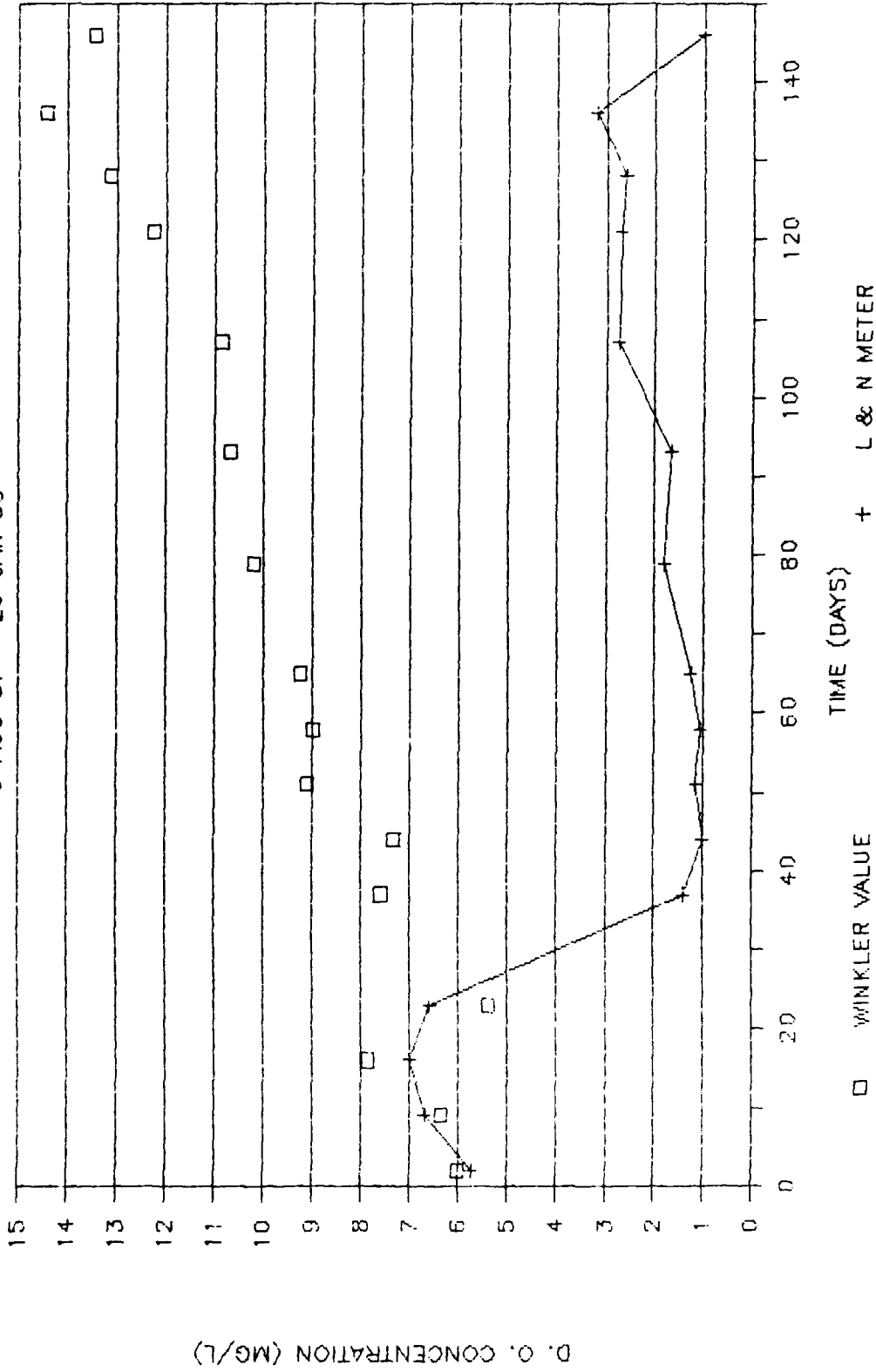

Figure 2. Field test dissolved oxygen concentrations comparing Leeds and Northrup meter readings to Winkler values.

# ZULLIG SENSOR (FIELD)

17 AUG 87 - 27 AUG 87

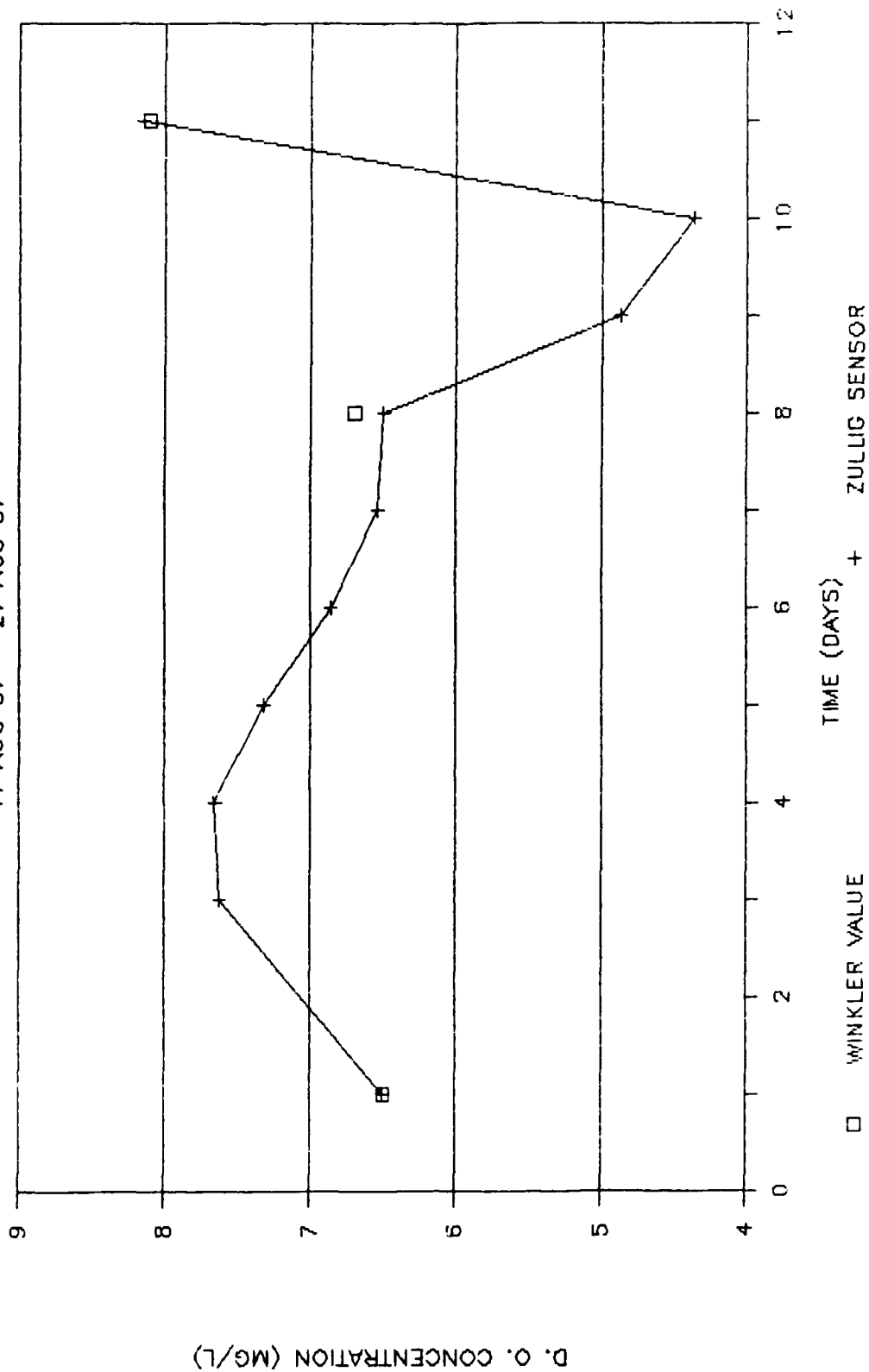

Figure 3. Field test dissolved oxygen concentrations comparing Zullig sensor readings to Winkler values.

inspected the tank, the flow of river water into the tank was quite low. The dissolved oxygen readings on this day were taken after the tank was drained, cleaned, and allowed to refill, thus explaining the higher concentrations. The three dissolved oxygen concentrations determined by Winkler titration over the 11-day test period were very close to the concentrations determined by the Zullig sensor. In fact, the average difference between the Zullig values and Winkler values was only 0.08 mg/l.

The Zullig sensor is limited in that a minimum solution conductivity of 300 micromhos/cm is required for proper sensor operation. Also, the manufacturer suggests not using the sensor in waters with a pH below 6.5. The Zullig sensor cannot be air calibrated. Since the Zullig probe has no membrane, it may be more sensitive to interferences such as hydrogen sulfide and free chlorine.

#### Royce Dissolved Oxygen Sensor

From December 1, 1987, through January 28, 1988, the Royce sensor was tested in the laboratory. The sensor was placed in a tank containing Mississippi River water. A bilge pump was used to circulate the water in the tank. The sensor was air calibrated on December 1, 1987, and was not recalibrated or cleaned for the remainder of the test period. Shortly after the test began, it was noticed that the dissolved oxygen concentrations given by the Royce meter peaked after each cleaning cycle. The sensor undergoes a 15-minute cleaning cycle every two hours during which a biocidal gas is produced. The first minute of the cleaning cycle involves production of chlorine gas which migrates through the membrane. The final 14 minutes of the cycle is a "clean-up" period during which any remaining chlorine gas is electrochemically removed from the sensor. According to the manufacturer, the peaks observed after each cleaning cycle were probably due to incomplete removal of chlorine gas from the sensor. Chlorine gas acts on the sensor in a manner similar to oxygen, thus leading to false high dissolved oxygen readings. Figure 4 shows a typical pattern of dissolved oxygen readings determined by the Royce sensor over a 7-hour period. The four peaks seen in the graph occurred immediately after cleaning cycles. It appears that the sensor required 45 to 60 minutes after each cleaning cycle to remove the residual chlorine gas from the system before the readings stabilized. The manufacturer suggested replacing a microchip in the meter to allow for a 20-minute cleaning cycle. The manufacturer felt that the additional five minutes of "clean-up" would remove the residual chlorine gas from the system. The new microchip will be placed in the meter and tested when it is received.

Results of laboratory testing of the Royce sensor over a 59-day period are shown in Figure 5. All readings plotted on this graph were taken immediately prior to a cleaning cycle, therefore helping assure that the Royce meter readings had stabilized. Known dissolved oxygen concentrations were determined with an air calibrated YSI probe on days 2 through 14. On the remaining days the known dissolved oxygen values were determined by Winkler titration. From day 2 through day 46, 11 known dissolved oxygen concentrations were determined. The average difference between these values and the 11 values read from the Royce meter was 0.21 mg/l. Organic matter was added to the tank on day 46 to lower the dissolved oxygen concentration. Soon



# ROYCE SENSOR (LAB)

23 DEC 87 (0848 - 1558)

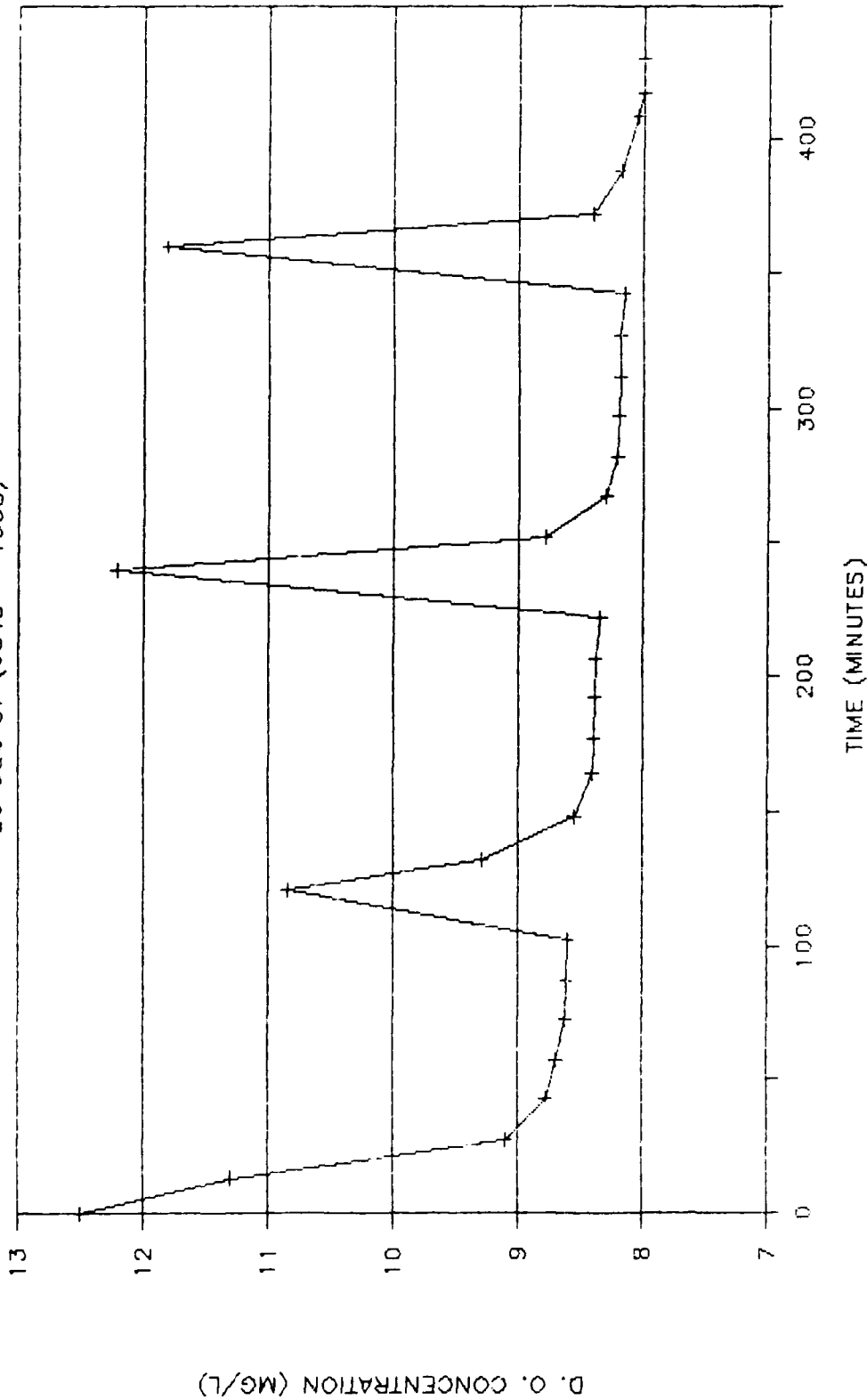

Figure 4. Laboratory dissolved oxygen concentrations over a 7-hour period from a Royce sensor utilizing a 15-minute cleaning cycle every two hours.

# ROYCE SENSOR (LAB)

01 DEC 87 - 28 JAN 88

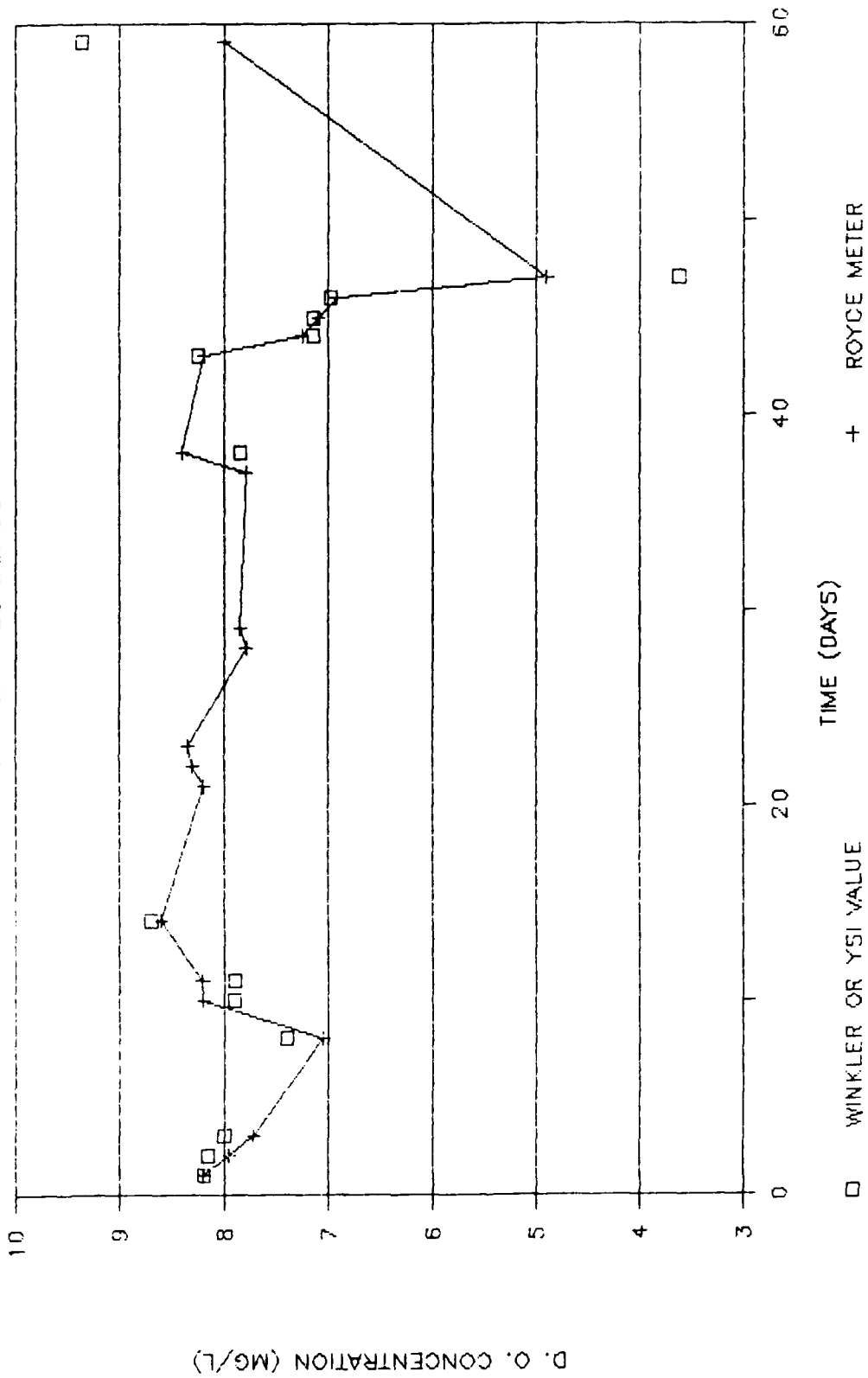

Figure 5. Laboratory test dissolved oxygen concentrations comparing Royce meter readings to Winkler values.

after this (day 47), the sensor appeared to "lose" calibration. On day 59, the sensor was placed in aerated tap water and shortly thereafter the Royce meter reading (8.00 mg/l) was still significantly different from the Winkler value (9.36 mg/l). The Royce meter readings determined on day 47 and day 59 varied an average of 1.32 mg/l from the Winkler values.

The Royce sensor appeared to be quite sensitive to flow. The model tested did not have a stirring mechanism; however, an optional agitator is available from the manufacturer. As stated previously, the dissolved oxygen readings peaked after each 15-minute cleaning cycle. According to the manufacturer, a 20-minute cleaning cycle should help alleviate this problem. A microchip that will allow for a 20-minute cleaning cycle will be placed in the meter and tested when it is received.

#### FUTURE CONSIDERATIONS

Future plans for the water quality portion of the Remote Sensing Demonstration Program for Inland Waterways call for the testing of several probes. The District has procured conductivity and pH probes from both McNab, Inc., and Great Lakes Instruments, Inc. Additional dissolved oxygen probes being considered for testing include those manufactured by Orbisphere Laboratories, Endeco, Inc., and Capital Controls Company. Also, further tests will be performed on the Leeds and Northrup, Zullig and Royce sensors. Multiparameter probes manufactured by Hydrolab Corporation and Martek Instruments, Inc., are also being considered for testing.

In addition to testing various probes, the District is attempting to develop signal conditioners which will allow certain water quality probes to be interfaced directly with Sutron data collection platforms without the use of the manufacturer's meter.

When testing is complete, the results of all findings will be disseminated to District and Division Offices.

## REFERENCES

- American Public Health Association, American Water Works Association, Water Pollution Control Federation, Standard Methods for the Examination of Water and Wastewater, Sixteenth Edition, APHA, AWWA, WPCF, Washington, D.C., 1985, 1,268 pp.
- Bark, A. W., D. W. Cartwright, C. S. Lovatt, and J. M. Watts, "A Simple and Inexpensive Monitor for Recording Oxygen and Temperature in Lakes and Reservoirs," Water Research, Vol. 20, No. 8, 1986, pp. 1005-1010.
- Clark, L. C., "Electrochemical Device for Chemical Analysis," U.S. Patent 2,913,386, issued Nov. 17, 1959.
- Crumpton, W. G., and C. Tikkanen, "Testing of Remote Water Quality Sensors: Sensors for Dissolved Oxygen, Ammonium, and Nitrate," Water Quality Studies - Red Rock and Saylorville Reservoirs, Des Moines River, Iowa, Iowa State University Engineering Research Institute Report No. 87185, 1987, pp. 363-415.
- Hitchman, M. L., Measurement of Dissolved Oxygen, John Wiley and Sons, New York, 1978, 255 pp.
- Langdon, C., "Pulsing Technique for Improved Performance of Oxygen Sensors," presented at the September, 1986, Oceans '86 Conference, held at Washington, D.C.
- Mancy, K. H., and T. Jaffe, Analysis of Dissolved Oxygen in Natural and Waste Waters, U.S. Department of Health, Education, and Welfare, Cincinnati, 1966, 94 pp.
- Mancy, K. H., and W. C. Westgarth, "A Galvanic Cell Oxygen Analyzer," Journal of the Water Pollution Control Federation, Vol 34, 1962, p. 1037.
- Quinby-Hunt, M. S., et al., Instrumentation for Environmental Monitoring, Volume 2, John Wiley and Sons, New York, 1986, 982 pp.
- Wernke, A. C., and A. S. Tenney, "Stream Monitoring with an Equilibrium Dissolved Oxygen Sensor," 1987 Environmental Conference, TAPPI Proceedings, 1987, pp. 349-351.

MULTI-PORTED, SINGLE WET-WELL INTAKE STRUCTURE OPERATION  
IN A STRATIFIED RESERVOIR

by

Stacy E. Howington<sup>1</sup>

BACKGROUND

Many reservoirs develop significant water temperature stratification during the summer months. Upper-level waters of a reservoir capture a large portion of the heat influx across the water surface, causing them to become less dense than the cooler bottom waters. Vertical transport and, therefore, exchange among the horizontal strata are inhibited by the buoyancy effects of the different water densities thereby promoting vertical stratification of many other water quality constituents within the reservoir. Therefore, the water column in the reservoir may be composed of a variety of water qualities.

Withdrawal from a density stratified reservoir can often be made from a limited vertical range. This practice, known as selective withdrawal (Davis et al. 1987), is made possible by the limited movement imposed by the density stratification and may permit release of a controllable quality of water. Operation of a single port using selective withdrawal is often adequate to meet a release water quality objective. However, due to resource limitations, it is frequently necessary to withdraw from multiple ports at different elevations and mix the different water qualities to achieve the desired result. Dual wet-well, dual flow-control reservoir intake structures have served this purpose in the past. Traditionally, in this type of structure, one port in each wet well has been opened. The amount of flow that passed through each of the ports was easily managed by the flow-controlling service gates at the exit from each wet well. Mixing of the different water qualities occurred downstream of the service gates.

Operating in a dual wet-well, dual flow-control mode is not always possible. For example, in recent years the addition of hydropower to existing dams has become an attractive source of renewable energy. This process very often involves the placement of hydroturbines at the downstream end of the existing release conduit. This normally requires the relocation of the point of flow control from the service gates at the exit from the wet wells to the hydroturbines. The amount of flow through each of multiple, open ports upstream is no longer strictly definable, and the different water qualities withdrawn are mixed above the point of flow control. Operation of multiple

---

<sup>1</sup> Research Hydraulic Engineer, Reservoir Water Quality Branch, Hydraulic Structures Division, Hydraulics Laboratory, US Army Engineer Waterways Experiment Station, Vicksburg, Miss.

ports with a common downstream flow control, which will be referred to as blending for the remainder of this paper, allows density differences between the port elevations to influence the distribution of flow among the open ports.

Single wet-well structures must blend to withdraw from multiple reservoir levels simultaneously, regardless of the presence or absence of downstream hydropower. Still, these types of structures are increasing in popularity for several reasons. Among these are potential economic savings over dual wet-well structure construction and the impracticality of establishing individual flow control on each potential level of simultaneous withdrawal. Examples of the latter might include selective withdrawal structure addition at existing hydropower projects and projects where more than two levels of simultaneous withdrawal are necessary.

#### THEORETICAL BASIS

Theoretical work has been concentrated on the most geometrically simple, but perhaps the most hydrodynamically complex situation: the multi-ported, single wet-well reservoir intake structure. However, the resulting concepts should be easily adaptable to a dual wet-well, single flow-control situation. The following theoretical descriptions were derived from Howington (1987).

The blending process is both flow and stratification dependent. In Figure 1, the density stratification buoys the lighter surface water both inside and outside the single wet well. This buoyancy prevents flow through the upper port at very low discharges. Less energy expenditure is required to withdraw all the water through the lower port than to overcome the buoyant forces. This condition is referred to as density blockage. The total discharge at which these buoyant forces are offset by the energy lost through the lower port is termed critical discharge. Discharges larger than the critical discharge will withdraw some flow through each of the two ports. However, the flow distribution among the ports may still be significantly impacted by the density stratification.

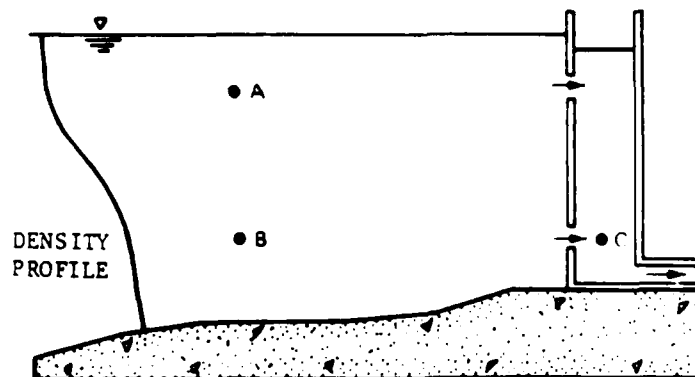

Figure 1. Blending in a single wet-well structure

A simple analytical approach may be taken to approximate the blending process. Bernoulli's equation, as seen in Brater and King (1976), may be employed. For flows less than or equal to critical discharge, this equation is applied across the lower port (point B to point C in Figure 1). At critical discharge, the analytical result of this application is given in Equation 1. The energy loss across the lower port at critical discharge is

$$HL_{B-C} = \frac{-1}{\rho_L} * \int_B^A (\rho(z) - \rho_u) dz \quad (1)$$

where

$HL_{B-C}$  = head lost from point B to point C, m

$\rho_L$  = density of water withdrawn through lower port,  $kg/m^3$

$\rho(z)$  = density as a function of elevation,  $kg/m^3$

$\rho_u$  = density of water which would be withdrawn through upper port,  $kg/m^3$

$z$  = elevation referenced to datum, m

equal to the potential energy of the stratification (represented by the right hand side of Equation 1). Knowing the hydraulic characteristics of the port, this head loss can be translated into discharge, yielding critical discharge.

For larger-than-critical discharges, the same technique applied simultaneously across both open ports produces Equation 2. The lower port application of the Bernoulli equation is from point B to point C as before and the upper port application is from point A to point C. The head loss from point A to point C is not stratification dependent and is approximately equal to the water-surface differential between the reservoir and the wet well.

$$HL_{B-C} = \frac{-1}{\rho_L} * \int_B^A (\rho(z) - \rho_u) dz + \frac{HL_{A-C} * \rho_u}{\rho_L} \quad (2)$$

where

$HL_{A-C}$  = head lost from point A to point C, m

A similar approach can be taken when more than two ports are open in a single wet-well structure. The resulting algorithm requires an iterative solution technique. It is potentially applicable to any number of simultaneously open ports and any stratification condition. The formulation is given in Equation 3. The head-loss term in this equation is similar to the form seen in Equations 1 and 2

$$Q = \sum_{n=1}^{NP} \sqrt{\frac{2g * A_n^2 * HL_n}{k_n}} \quad (3)$$

where

$Q$  = total structure discharge,  $m^3/sec$

$NP$  = number of simultaneous withdrawal levels

$g$  = acceleration due to gravity,  $m/sec^2$

$A_n$  = area of port level  $n$  opening,  $m^2$

$HL_n$  = head loss across port  $n$ ,  $m$

$k_n$  = head-loss coefficient across port  $n$

That is, it contains the computation of the density influences between levels of withdrawal. The algorithm in Equation 3 effectively minimizes the total energy loss for the system. Once the head loss for each port has been computed, the individual port discharge is easily determinable.

In the algorithm development, several assumptions were made. The application of Bernoulli's equation along streamlines required the assumption that the flow was steady and incompressible. Another assumption was that the turbulence of the water entering the lower port and possibly impinging on the backwall of the wet well did not significantly influence the blending process. The last major assumption was that the frictional losses associated with flow downward inside the wet well between the withdrawal levels were insignificant by comparison to the entrance losses. These assumptions have proven, thus far, to be appropriate.

#### RESEARCH RESULTS

The effects of density stratification on port flow distribution can be illustrated by Figure 2. This figure shows the flow through the upper port of a two-port, single wet-well structure in relation to the total discharge from the structure for two stratification conditions and three port openings. This figure was developed using two ports of equal area and constant, equal head-loss coefficients. For this example, the density withdrawn through the ports was assumed to be the density of the water in the reservoir at the center-line elevation of the individual ports.

In Figure 2, the three horizontal lines labeled "no stratification" indicate constant flow ratios between the two ports for the homogeneous density condition at all discharges. The three curves represent operation in a density stratified environment. The middle curve was developed with both the upper and lower ports fully open. The uppermost curve represents upper port flow with the upper port fully open and the lower port throttled (partially closed) by 50 percent. The lower curve represents upper port flow with the lower port fully open and the upper port throttled by 50 percent.

Figure 2 clearly demonstrates that the effects of density stratification on flow distribution are greatest at the lower discharges and smallest at the higher discharges. At low discharges, density blockage (represented in the figure by 0 percent flow through the upper port) is possible. As the discharge increases, the impacts of density become smaller until, at high discharges, the unstratified and stratified conditions converge to the same percentage flow distributions.



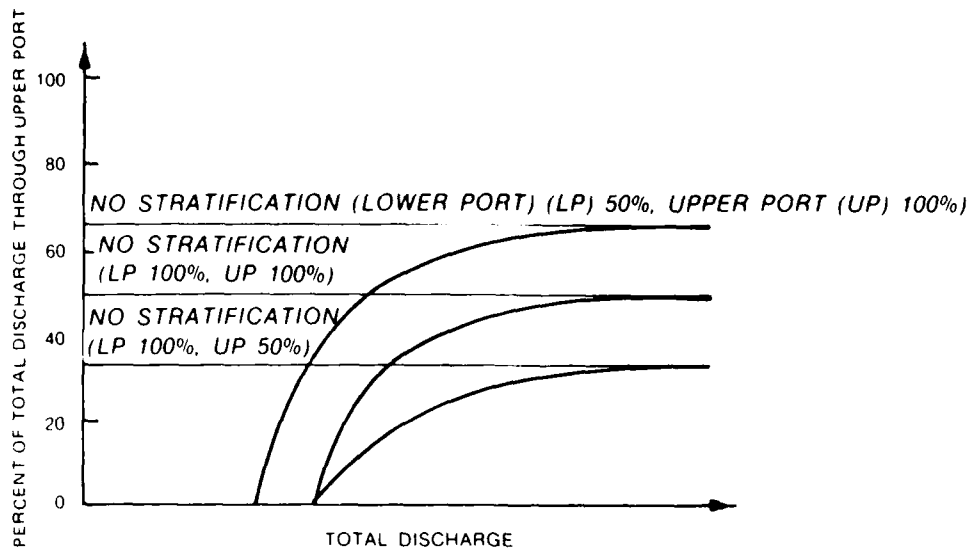

Figure 2. The percentage of total flow through the upper port for two stratification conditions and three port configurations

The figure also illustrates the dramatic impact of port throttling on the flow distribution in both the stratified and unstratified environments. Critical discharge, shown by the discontinuous point at 0 percent flow through the upper port for each of the stratified condition curves, is markedly decreased by the throttling of the lower port. Throttling the upper port, however, has no influence on critical discharge since, in the blocked situation, no flow enters the upper port. Throttling either port has a significant impact on the flow distribution for all but the very small discharges.

The influences of port throttling on flow distribution provide an opportunity for enhanced release water quality control. Port gate settings might be predicted to provide the desired flow distribution among the open ports in order to achieve the release objective. Therefore, unlimited throttling capability would provide the ability to achieve a multitude of feasible release objectives by mixing the individual port release qualities in the proper proportions. However, unlimited port throttling capability is not realistic as hydraulic and structural constraints will exist that preclude it.

#### APPLICATION

Although several data sets from diverse sources have been compared against the blending algorithm with very favorable correlation between predictions and observations, the discussion herein will be limited to the Elk Creek Dam physical model data and the Warm Springs Dam prototype data. The Elk Creek Dam physical model is a 1:20-scale replica of the proposed reservoir intake structure. The proposed structure would have two large ports (1.52 m wide and 3.05 m tall) at each of the four withdrawal levels. The wet well

would be 2.13 m deep and 6.4 m wide. The small flow capacity (maximum 14.16 m<sup>3</sup>/sec) of this relatively large intake structure resulted in low velocities which, in turn, produced small hydraulic entrance losses. Therefore, under very strong stratification conditions, density blockage of the uppermost ports was observed over virtually the entire range of release flow rates. However, this structure was designed with throttling capability on all ports, allowing density blockage to be easily overcome and providing great flexibility in meeting the desired flow ratios between the port elevations. The blending algorithm, when applied to the model results, accurately predicted the individual withdrawal level contributions for a variety of discharges, stratification conditions, and port configurations.

A different situation was encountered at the Warm Springs Dam, where a field study was conducted in 1986. The intake structure is located within a hillside. The three water quality intake conduits, which are about 1.52 m in diameter, extend a considerable distance from the reservoir to the single, 1.83-m-diameter wet well. Under moderately strong stratification conditions, density blockage was observed at only the smallest discharge tested, 0.792 m<sup>3</sup>/sec, which is well below the minimum discharge established for the system's normal operation. Blockage was less prevalent at this site than in the Elk Creek model because of the high hydraulic losses associated with the intake conduits. Even at low discharges, the losses were usually adequate to offset or surpass the potential energy associated with the stratification. A comparison of predicted and observed release temperatures is given in Figure 3.

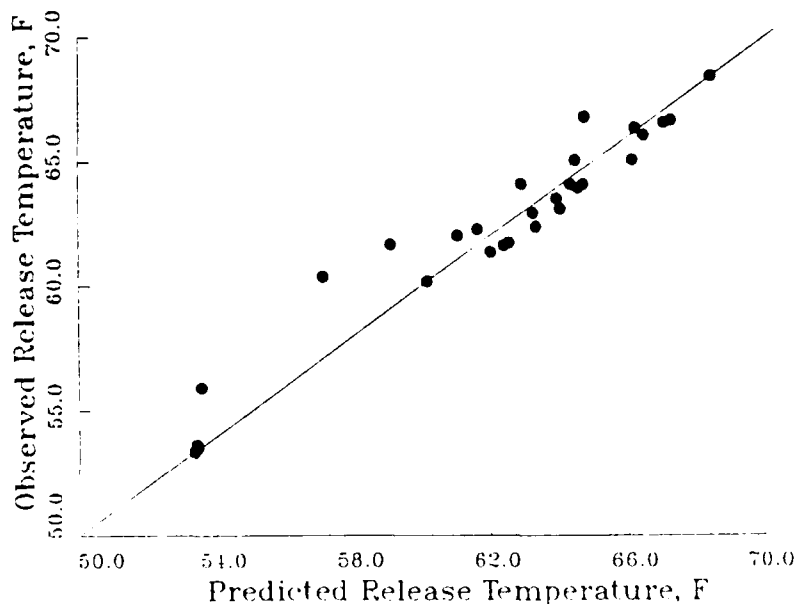

Figure 3. Predicted and observed release water temperatures during multi-port operations at Warm Springs Dam

## CONCLUSIONS

A multi-port, single-flow-control blending algorithm has been developed that has tested well in all cases thus far. These cases include a variety of sizes and shapes of single wet-well intake structures. All of the evaluations made to date have been in a quantitative fashion with good agreement between predictions and observations. The algorithm has been incorporated into two one-dimensional, mathematical reservoir models that employ the selective withdrawal technology. This has provided a means of operating these types of reservoir intake structures in a more predictable and controllable manner.

## ACKNOWLEDGMENT

The results reported herein were conducted under funding from the Water Quality Research Program of the US Army Engineer Waterways Experiment Station, Vicksburg, MS. Permission was granted by the Chief of Engineers to publish this information.

## REFERENCES

- Brater, E. F., and King, H. W. 1976. Handbook of Hydraulics, McGraw-Hill, New York.
- Howington, S. E. 1987. "Simultaneous Releases From a Stratified Reservoir," Proceedings of the 1987 National Conference on Hydraulic Engineering, American Society of Civil Engineers, pp. 42-47.
- Davis J. E., Holland, J. P., Schneider, M. L., and Wilhelms, S. C. 1987. "SELECT: A Numerical, One-Dimensional Model for Selective Withdrawal," Instruction Report E-87-2, US Army Engineer Waterways Experiment Station, Vicksburg, Mississippi.

# REAERATION AT LOW-HEAD STRUCTURES: PRELIMINARY RESULTS

By

Steven C. Wilhelms<sup>1</sup>

## INTRODUCTION

Reaeration or dissolved oxygen (DO) uptake at hydraulic structures can be a major source of water quality maintenance or improvement in our Nation's inland waters. Consequently, it is very important to understand the reaeration characteristics of the various types of hydraulic structures. For example, an understanding of the reaeration properties of a hydropower facility is essential to evaluate the potential impacts of proposed hydropower installations. The same is true for the other types of hydraulic structures such as a gated sills, gated spillways, a gated conduit, or overflow weir. The capability to compare the characteristics of the different structures is required if one structure is proposed to replace another, i.e., hydropower retrofit into a spillway or gated conduit. Further, the effects of structure operations must be identified to permit selected operational changes for enhancement of in-river DO.

In the Environmental and Water Quality Operational Studies (EWQOS) Research Program, gated-conduit outlet works were analyzed on the basis of existing DO data (Wilhelms and Smith 1981) and specifically tested (Tate 1982) to describe their gas transfer characteristics. Navigation locks were also tested (Wilhelms 1985) to determine the impact that their operation could potentially have on downstream water quality. Several alternatives for improving the release DO of high-head hydropower facilities were also identified (Bohac, et al. 1983) and tested (Wilhelms, et al. 1987) during the EWQOS program.

Past reaeration work has focused on relatively high head projects. There is a particular shortfall in understanding the gas transfer characteristics of low-head projects. Consequently, as a part of the ongoing Water Quality Research Program (WQRP) and with support from several field offices, a research effort was launched to fill part of the informational void around low-head projects. This paper presents some of the interim results of this effort.

## RESEARCH EFFORT

The objective of the research effort is to characterize reaeration at low-head structures and identify and develop methods for improving the DO content of releases from these projects. Subsequently, predictive tools and guidance will be developed that can be used in evaluating the effectiveness of various alternatives for release improvement.

---

<sup>1</sup> Research Hydraulic Engineer, Reservoir Water Quality Branch, Hydraulic Structures Division, Hydraulics Laboratory, US Army Engineer Waterways Experiment Station, Vicksburg, Mississippi

The approach taken in this research effort was to initially survey Corps of Engineers' (CE) district offices (FOA's) to identify the number and location of low-head projects, particularly low-head hydropower facilities. Simultaneously, selected field offices were contacted to help identify specific problems and potential solutions most often encountered at low-head projects. Based on this information, candidate sites for field tests would be selected. Through a coordinated effort with district offices, short-term intensive studies at these sites would provide a data base for developing and verifying mathematical descriptions of reaeration at low-head structures. With an understanding of the existing reaeration processes, alternative methods for improving release DO would be developed and demonstrated in conjunction with one or more FOA's. This information and guidance will be made available to FOA's through the Information Bulletin of the Water Operations Technical Support (WOTS) program and technical reports from the Waterways Experiment Station.

#### INTERIM RESULTS

Survey Results. Seven of the CE divisions in the continental United States responded to the initial survey about low-head hydropower projects. Low-head, in this context, referred to the type of turbine employed at the facility. A Kaplan or propeller type turbine, including tube and bulb turbines, were considered low-head turbines. Thirty-seven existing hydropower projects in 14 districts were identified. Most of these were Federally owned; however, at some CE flood-control or navigation projects, a private entity or local government agency may own the hydropower facility. Subsequent to the survey, several CE districts identified projects where non-Federal developers have proposed the retrofit installation of hydropower.

As expected, discussions with FOA's confirmed that release DO was the most common water quality concern related to low-head structures. Specific problems related to DO were identified as follows: (a) no capability to predict release DO (effects of reaeration) from low-head structures, and thus, (b) no capability to evaluate the effects of hydropower retrofit, (c) no capability to address the impact of multiple hydropower retrofits on one river system, (d) no guidance on the impacts of operational changes on release DO, and (e) no guidance on alternatives to improve release DO from low-head hydropower and non-hydropower projects. Hopefully, results of this work unit in the WQRP will address many of these concerns and problems.

Field Tests. As discussed previously, short-term field tests are a necessary part of developing an understanding of the physical processes that govern reaeration. These studies provide controlled evaluations of the hydraulic and geometric parameters that impact gas transfer. In these tests, the prototype structures become the laboratory from which gas transfer observations can be used to understand the relationships between reaeration and the hydraulic and geometric conditions that exist. Ultimately, these observations will lead to the development of a mathematical description of these relationships.

Important Parameters and Concepts. Tsivoglou and Wallace (1972) showed that reaeration in streams is a function of the energy loss in a stream reach. Using this concept, Wilhelms and Smith (1981) developed a relationship describing reaeration at gated-conduit outlet structures as a function of the head loss through the structure. However, for low-sill, high-tailwater structures, which are typical of low-head navigation spillways, an additional consideration for the downstream submergence of the discharge must be included. Conceptually, gas transfer should decrease as tailwater submergence increases. Further, as will be shown from field observations, reaeration at a structure is influenced by the discharge per unit length of structure. Thus, head loss, unit discharge, and submergence are considered the important parameters that significantly influence reaeration at low-head spillways.

To provide a logical framework in which field observations can be analyzed, the mathematical relationship between the parameters must be postulated and then field data used to substantiate or refine the relationship. Equation 1 shows the model form of this relationship.

$$\frac{D_d}{D_u} = \frac{C_s - C_d}{C_s - C_u} = \text{EXP}\left(-a_{20} \frac{\Delta h q}{s}\right) \quad (1)$$

where

- $D_d, D_u$  = downstream and upstream DO deficits, respectively, mg/l
- $C_d, C_u$  = downstream and upstream DO concentrations, respectively, mg/l
- $C_s$  = saturation concentration for ambient water temperature, mg/l
- $\Delta h$  = difference in pool and tailwater elevations at structure, ft
- $a_{20}$  = coefficient for 20° C water temperature, sec/ft<sup>3</sup>
- $s$  = gate lip submergence, ft
- $q$  = unit discharge through gates, ft<sup>3</sup>/sec/ft

Two of these parameters are defined in Figure 1.

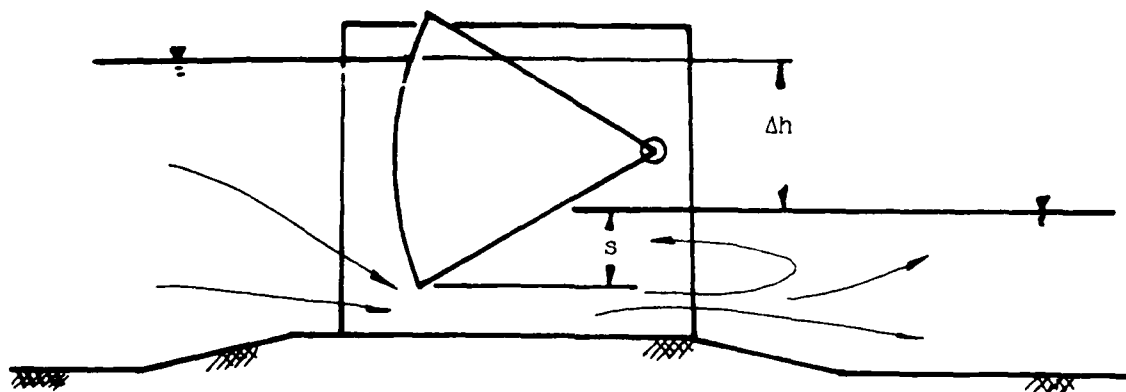

Figure 1. Definition sketch

Important in the development of Equation 1 are the controllable hydraulic or geometric parameters, such gate opening, which actually determines the gate

discharge. Only by varying such parameters over a relatively wide range of operating conditions can the relationships discussed earlier be discerned and confidence developed in the mathematical description. Obviously, it is not practical to control all the hydraulic variables at a single structure that could impact reaeration. For instance, modifying the head loss across a structure is usually not a feasible alternative because of the potential adverse impacts of significantly raising or lowering the tailwater or upstream pool. Therefore, to understand the effects of head differential on reaeration, several similar structures may have to be studied to see the impact of a range of structure head losses.

Measurement Techniques. Direct measurement of DO uptake through a structure is the most efficient way of determining reaeration characteristics. The data required to achieve the goal of the field study are water temperature and DO concentrations upstream and downstream of the structure, difference in pool and tailwater elevations (head across the structure), and the discharge through the single gate or portion of structure being tested. DO meters with polarographic probes or other comparable or more sophisticated water quality monitors can provide the in-situ measurements needed. However, the success of these measurements is predicated on the existence of a DO deficit upstream and downstream of the structure.

In some instances, a river may not experience a DO deficit sufficient to permit an accurate analysis of direct measurements of DO uptake. For this case, a "tracer gas" is required for determining reaeration. The United States Public Health Service (Tsivoglou et al. 1965, 1968) pioneered the use of tracer gases for reaeration measurements by employing krypton-85 (a radioisotope) gas. As an alternative to the radioactive tracer technique, the United States Geological Survey (USGS) (Rathbun et al. 1977, 1978) developed the use of propane (or other hydrocarbon gases) as a tracer gas to determine reaeration. The use of a tracer gas is based on the concept that the rate at which a water-borne tracer gas is transferred to the atmosphere is related to the rate at which oxygen is transferred from the atmosphere to the water. Propane tracer gas was selected for application testing in this research effort. The theory and application of tracer gases are discussed in greater detail by Tsivoglou (1967) and Wilhelms (1980, 1987).

Oxygen Measurements on the Ouachita and Red Rivers. In conjunction with the Vicksburg District, oxygen-uptake tests were conducted at three low-head spillways on the Ouachita and Red Rivers. Preliminary analysis indicated that substantially more reaeration was occurring at Red River Lock and Dam No. 1 (RR1), particularly for the higher discharges tested, than at either Columbia or Jonesville Locks and Dams (Figure 2). A review of their respective designs indicated that baffle blocks had been included in the stilling basin design on RR1, but were not part of the stilling basins at Columbia or Jonesville. Because of this dissimilarity and the resulting difference in hydraulic action in the stilling basin, it was considered inappropriate to group these structures together in a single analysis. Therefore, the analysis reported herein only included data from the Columbia and Jonesville structures.

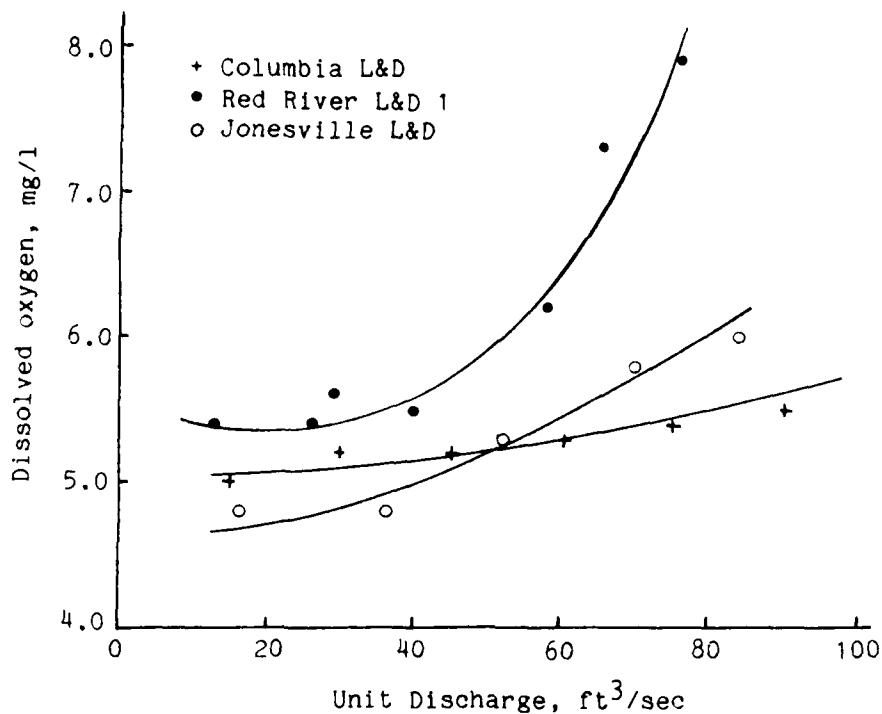

Figure 2. Release dissolved oxygen versus release flow rate.

Because gas transfer is affected by ambient water temperature, the deficit ratios observed at Columbia and Jonesville were adjusted (Tsvoglou and Wallace 1972) to reflect a 20° C water temperature with

$$\left(\frac{D_d}{D_u}\right)_{20^\circ} = \text{EXP} \left( \frac{\ln \left( \frac{D_d}{D_u} \right)_T}{1.024 (T-20)} \right) \quad (2)$$

where

$$\left(\frac{D_d}{D_u}\right)_{20^\circ} = \text{deficit ratio for water temperature of } 20^\circ \text{ C}$$

$$\left(\frac{D_d}{D_u}\right)_T = \text{deficit ratio for ambient water temperature}$$

T = ambient water temperature, °C

A regression analysis was performed on the adjusted deficit ratios as the dependent variable and head loss ( $\Delta h$ ), submergence (s), and unit discharge (q) as the independent variables. The form of the equation used for the regression was Equation 1. Results of the regression analysis indicated a value for  $a_{20}$  of 0.000797 with an additional regression coefficient of -0.188. The mathematical description takes the form

$$\frac{D_d}{D_u} = \text{EXP}(-0.000797 \frac{\Delta h q}{s} - 0.188) \quad (3)$$



Analysis of variance for the regression indicated that about 70 percent of the data variation ( $R$ -square = 0.70) was explained with this description. Figure 3 show a semi-log plot of the data and regression equation.

It is believed that this relationship can be used to evaluate the reaeration structures similar to those from the Ouachita River used in this analysis. There are, however, limitations on the range of the variable that can be used in the description because of its mathematical form, e.g.,

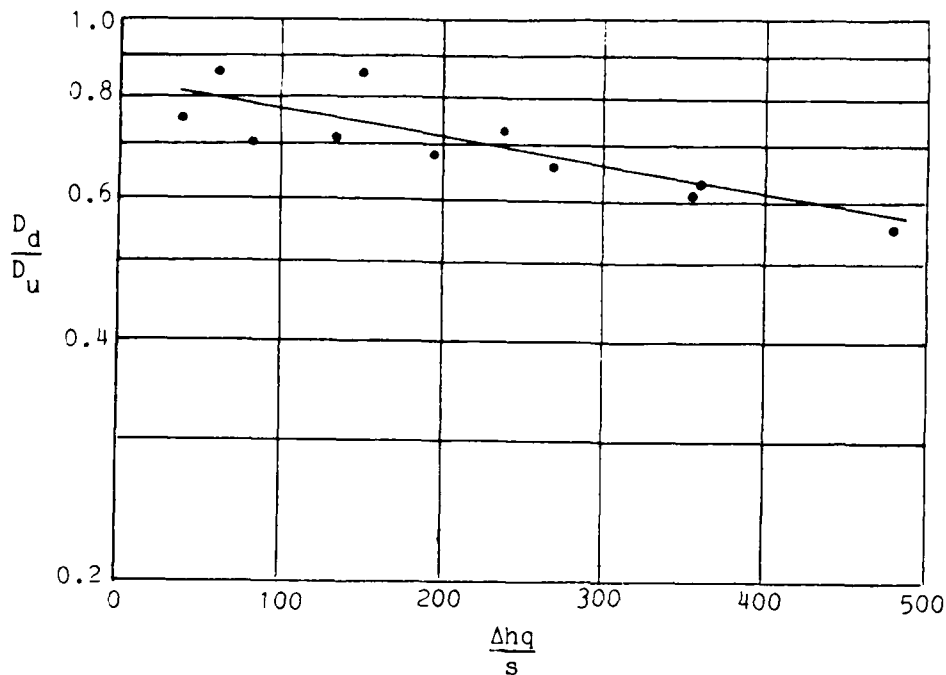

Figure 3. Deficit ratio versus combination of key parameters.

submergence cannot be equal to 0.0, since the quotient in the exponent of Equation 3 would be undefined. Thus, an added recommendation would be to limit the range of  $s$  to values greater than 1.0-2.0 ft.

In addition to the reaeration at the spillways of the Columbia and Jonesville projects, significant oxygen uptake was occurring at their overflow weirs. DO uptakes of about 3 mg/l and 2.5 mg/l were measured at the Columbia and Jonesville overflow weirs, respectively. This resulted in the downstream DO saturation levels ranging from about 85 to 95 percent. In general, it could be concluded that the overflow weirs aerated the discharge much more effectively than the low-sill spillway. Thus, if operationally feasible, improved release DO could be achieved by passing more discharge over the weirs.

Tracer Study at Smithland Locks and Dam. In conjunction with the Louisville District, the hydrocarbon (propane) tracer technique was applied to the spillway at the Smithland navigation project on the Ohio River. Two methods were attempted at Smithland to employ the hydrocarbon technique: (a) steady-state injection of propane gas and (b) single-dose injection. Although

neither technique yielded the desired results, much was learned regarding the application of the hydrocarbon technique to large hydraulic structures.

The steady-state propane injection system was installed upstream of the spillway. The purpose of the injection system was to provide a well-mixed steady inflow of water into the structure, "tagged" with dissolved propane gas. The loss of propane from upstream to downstream of the structure could be related to the potential for oxygen uptake. However, this technique was found infeasible for application to large structures such as those on the Ohio River. The flow field upstream of a single gate was highly dependent on structure operation and ambient meteorological conditions. It would be necessary, although impractical, to inject propane into the entire river flow to assure that steady well-mixed condition existed just upstream of the structure.

The single-dose technique appeared to be the more attractive alternative. However, this technique had limitations because of the logistics of handling a dose large enough to meet detection threshold requirements. A 55-gallon dose was considered a manageable dose size. This placed a limitation on the amount of dilution that could be tolerated as the dose passed through the structure. Based on the results obtained at Smithland, the dilution factor would have to be less than  $10^6$  to permit use of the 55-gal. dose. Unfortunately, the dilution factor at Smithland was greater than this limit, thereby precluding use of the single-dose technique also.

DO measurements were made in conjunction with the tracer testing. Although the DO in the Ohio River is usually near saturation, during this field study, the upstream DO was about 3.7 mg/l. For a 1-ft gate opening, a DO uptake of 0.2 mg/l was observed; for a 2-ft gate opening, an uptake of about 0.5 mg/l was measured. These measurements parallel the trends observed on the Red and Ouachita Rivers.

#### RECOMMENDATIONS

To improve release DO, two operational recommendations can be made based on the field observations discussed herein: (a) overflow weir discharge should be maximized relative to discharge through the low-sill spillway and/or (b) the unit (single-gate) discharge should be maximized. However, for any of these operations, hydraulic feasibility must be considered. Further, limits may occur in the effectiveness of these operational alternatives as discharge becomes very large. The single-dose tracer gas technique is an applicable technology, but with the limitation relative to structure flow characteristics. The dilution factor of flow through the structure must be less than  $10^6$ . Within the scope of the discussed research effort, there are plans to develop a description for dilution factor as a function of structure geometry and flow conditions. Additional field testing and data analysis are planned to further the understanding of reaeration through gate structures as well as overflow weirs.

## ACKNOWLEDGMENT

The results reported herein were conducted under funding from the Water Quality Research Program of the US Army Engineer Waterways Experiment Station, Vicksburg, MS. Permission was granted by the Chief of Engineers to publish this information.

## REFERENCES

- Bohac, C. E., Boyd, J. W., Harshbarger, E. D., and Lewis, A. R. 1983 (Feb). "Techniques for Reaeration of Hydropower Releases," Technical Report E-83-5, US Army Engineer Waterways Experiment Station, Vicksburg, Miss.
- Rathbun, R. E., Shultz, D. J., Stephens, D. W., and Tai, D. Y. 1977. "Experimental Modeling of the Oxygen Absorption Characteristics of Streams and Rivers," Proceedings: Seventeenth Congress of the International Association for Hydraulic Research, 15-19 August, Baden Baden, Federal Republic of Germany.
- Rathbun, R. E., Stephens, D. W., Shultz, D. J., and Tai, D. Y. 1978 (Apr). "Laboratory Studies of Gas Tracers for Reaeration," Journal of the Environmental Division, Proceedings of the American Society of Civil Engineers, Vol 104, No. EE2, pp 215-229.
- Tate, C. H., Jr. 1982 (Feb). "Reaeration Tests, Enid Lake Outlet Works," Technical Report E-82-2, US Army Engineer Waterways Experiment Station, Vicksburg, Miss.
- Tsivoglou, E. C., O'Connell, R. L., Walter, C. M., Godsil, P. J., and Logsdon, G. S. 1965 (Oct). "Tracer Measurement of Atmospheric Reaeration. I. Laboratory Studies," Journal of the Water Pollution Control Federation, Vol. 37, No. 10, pp 1343-1362.
- Tsivoglou, E. C. 1967 (Jun). "Tracer Measurement of Stream Reaeration," Federal Water Pollution Control Administration, US Department of the Interior, Washington, D.C.
- Tsivoglou, E. C., Cohen, J. B., Shearer, S. D., and Godsil, P. J. 1968 (Feb). "Tracer Measurement of Stream Reaeration. II. Field Studies," Journal of the Water Pollution Control Federation, Vol 40, No. 2, pt 1, pp 285-305.
- Tsivoglou, E. C. and Wallace, J. R. 1972. "Characterization of Stream Reaeration Capacity," Report No. EPA-R3-72-012, US Environmental Protection Agency, Washington, D.C.
- Wilhelms, S. C. 1980 (Dec). "Tracer Measurement of Reaeration: Application to Hydraulic Models," Technical Report E-80-5, US Army Engineer Waterways Experiment Station, Vicksburg, Miss.
- Wilhelms, S. C. 1985 (Jan). "Reaeration at Navigation Locks," Technical Report E-85-1, US Army Engineer Waterways Experiment Station, Vicksburg, Miss.

Wilhelms, S. C. 1987 (Oct). "Summary of Reaeration Testing at Smithland Locks and Dam," Memorandum for Record dated 8 October 1987, US Army Engineer Waterways Experiment Station, Vicksburg, Miss.

Wilhelms, S. C., Schneider, M. L., and Howington, S. E. 1987 (Mar). "Improvement of Hydropower Release Dissolved Oxygen with Turbine Venting," Technical Report E-87-3, US Army Engineer Waterways Experiment Station, Vicksburg, Miss.

Wilhelms, S. C. and Smith, D. R. 1981 (Mar). "Reaeration Through Gated-Conduit Outlet Works," Technical Report E-81-5, US Army Engineer Waterways Experiment Station, Vicksburg, Miss.

# MODELING WATER QUALITY IMPACTS OF HYDROPOWER RETROFITTING ON LOCKS AND DAMS OF THE LOWER OHIO RIVER

by

Marc J. Zimmerman\*

## INTRODUCTION

While the number of dam and reservoir projects under construction has decreased, attempts are being made to increase benefits obtained from existing ones. In particular, many projects are now being considered for hydropower retrofit or increased generation capacity. The potential for add-on hydropower for locks and dams on the Ohio River is being considered by the Louisville District (ORL) as part of its Lower Ohio River Multipurpose Study (LORMS). Water quality impacts of hydropower retrofitting to locks and dams have been the focus of a modeling study performed by the USAE Waterways Experiment Station, Environmental Laboratory, Water Quality Modeling Group (WQMG) for ORL.

The modeling study consists of four phases. The first phase leads to a model calibrated specifically for LORMS. In the second phase, the model's validity is confirmed using data representing flow and water quality conditions in the study reach during a year other than that used in the calibration. The project's third phase consists of performing computer simulations using proposed operation schedules and hydrodynamic data incorporating hydropower retrofitting at one or more of six locks and dams. The final phase of the study examines and evaluates potential water quality impacts revealed by the modeling study. This paper documents the first, or model calibration, phase of the study.

## STUDY REACH

The study reach extends approximately 500 miles from Meldahl Dam (RM 436.2) at the upstream end to Smithland Dam (RM 918.5), the downstream boundary. Between the system boundaries lie Markland, McAlpine, Cannelton, Newburgh, and Uniontown locks and dams. Using the seven locks and dams, the study reach was divided into six segments. Major riparian metropolitan centers include Cincinnati, Louisville, and Evansville. Several river tributaries feed into the Ohio along the study reach, but none of their flows contribute significantly to the flow of the river during the calibration period.

---

\* Hydrologist, USAE Waterways Experiment Station, Environmental Laboratory, Vicksburg, Miss.

## MODEL AND DATA SELECTION

Addition of hydropower to projects is expected to diminish reaeration associated with passage through the existing locks and dams. If several projects in a system have hydropower added, the impact may be compounded.

In order to study impacts of hydropower retrofitting on water quality, summer conditions were selected. Summertime dissolved oxygen (DO) concentrations and river flows are generally expected to be a year's lowest. Thus, if retrofitting has a negative impact on water quality, this is the time period when these effects can be expected to create the worst conditions. Flow data from July-August 1977 were selected for use in model calibration.

Because of the variability of flows on the river and the effect of add-on hydropower production when the locks and dams are retrofitted, use of an unsteady flow model was appropriate for this study. Normally, a study such as this would exclusively use CE-QUAL-RIV1 (Bedford et al., 1983), a one-dimensional, riverine water quality model, comprised of a stand-alone hydrodynamic code, RIV1H, and a water quality code, RIV1Q, driven by output from RIV1H. However, ORL had already been using DWOPER (Fread, 1982), another hydrodynamic code, and its output was readily adaptable as input to RIV1Q.

In order to expedite adaptation of DWOPER output to RIV1Q input and to simplify model hydraulic calibration, it was initially assumed that tributaries and waste discharges had insignificant effects on Ohio River flow. Thus, at first, calibration studies assumed the study reach was composed of the Ohio River channel alone, with all water quality constituents and flows entering through the upstream boundary, Meldahl lock and dam. As the calibration procedure evolved, additional data were incorporated to account for waste discharges.

RIV1Q, originally intended to simulate effects of wastewater or pollutant loadings, can calculate 10 water quality variables. This study focused on variables likely to affect dissolved oxygen concentrations in the lower Ohio River; in addition to dissolved oxygen, they included carbonaceous biochemical oxygen demand and ammonia nitrogen. Effects of algae and sediment oxygen demand were also incorporated into calculations of dissolved oxygen in the river.

ORL obtained water quality data for the calibration period from STORET records. These data revealed that water temperature changed by only 2 or 3° F over the 500-mile study reach during the simulation period. On this basis, the decision was made not to calculate water temperature, but, rather, to input it as a constant in each of the six river segments. This decision simplified and accelerated the simulation process by obviating the need to calculate temperature at each of the 100 cross sections that segmented the river for simulation purposes.

## MODEL CALIBRATION

Initial calibration testing revealed that dissolved oxygen simulations consistently overestimated observed concentrations. Standard calibration procedures, such as manipulation of rate coefficients, did not completely clear up these discrepancies. This led to an investigation of possible deficiencies in the data used and model formulation. In particular, concern focused on including impacts of loadings from sewage treatment plants and sediment oxygen demand.

First, attention was paid to waste discharges. While it was a relatively simple matter to determine that these flows did not comprise a significant proportion of total flow, the same judgment could not be made about the water quality characteristics of those inflows. Additional data were sought from sewage treatment plant managers to supplement ORSANCO data. These data revealed that sewage treatment facilities provided a significant input of oxygen demand to the river at the Cincinnati, Louisville, and Evansville metropolitan areas. Moreover, the main Louisville treatment plant was new in 1977 and had been releasing raw sewage into the Ohio River for the first six months of the year. The ORSANCO water quality monitoring station at Kosmosdale, which consistently reported low DO, was located a few miles downstream of this outfall.

While inclusion of point sources of oxygen demand from waste discharges improved the fit of predictions with observed data throughout the study reach, calculated dissolved oxygen concentrations downstream of Louisville remained high. These depressed DO concentrations were attributed to oxygen demand persisting from the raw sewage release. To account for this effect, a sediment oxygen demand term was added to the model and applied to the reach below Louisville. Again, an improved correspondence was seen between observed and predicted DO, especially at the downstream end of the McAlpine-Cannelton segment. However, predicted DO concentrations in the vicinity of the Kosmosdale station remained slightly high.

## CONCLUSIONS

This phase of the modeling study has produced a calibrated model that can account for changes in water quality brought about by add-on hydropower at any of the locks and dams located in the study reach. Before we can feel satisfied with the calibration results, a confirmation of the model must be performed using flow and water quality data from another year to demonstrate that assumptions made for 1977 are equally valid for other years and conditions. Following model confirmation, conditions with hydropower will be tested by suppressing reaeration at the dams.

This study has pointed to several shortcomings. First, a need exists to have a full inventory of waste discharges that may affect water quality. While the data from major sewage treatment plants were obtained,

other less obvious inputs may have been overlooked. Furthermore, data defining sediment oxygen demand would provide helpful information for this study.

#### ACKNOWLEDGEMENTS

The tests described and the resulting data presented herein, unless otherwise noted, were obtained from a reimbursible study conducted by WES for the US Army Engineer District, Louisville. Permission was granted by the Chief of Engineers to publish this information.

#### REFERENCES

Bedford, K. W., Sykes, R. M., and Libicki, C., 1983, "Dynamic Advective Water Quality Model for Rivers," J. Environmental Engineering Div., ASCE, Vol. 109, pp. 535-554.

Fread, D. L., National Weather Service Dynamic Wave Operational Model, Hydrologic Research Laboratory, U.S. National Weather Service, Silver Spring, Maryland, 1982.



## DISSOLVED OXYGEN STUDIES BELOW WALTER F. GEORGE DAM

Diane I. Findley, PhD<sup>1</sup> and Kenneth Day<sup>2</sup>

### INTRODUCTION

#### Project Location And Description

The Walter F. George (WFG) Lake is formed along the Chattahoochee River by the WFG Lock and Dam (L&D), which is located near Fort Gaines, Georgia. The impounding structure consists of a concrete dam, a fourteen-gated spillway and single lift lock. The WFG Lock is the second highest lift east of the Mississippi River. The WFG Powerhouse with four generating units is located on the opposite bank from the lock. The lake is 121 km (75 mi) from the mouth of the river, has a surface area of 18 292 ha (45 181 ac), and is 28.3 m (93.0 ft) at the deepest point. Normal pool elevation is 57.9 m (190.0 ft) National Geodetic Vertical Datum (NGVD). Authorized primarily for navigation and hydroelectric power generation, associated purposes include flood control, streamflow regulation to provide a nine-foot navigation channel, outdoor recreation and fish and wildlife conservation. The WFG Powerhouse is operated as a peaking facility. Characteristically, hydroelectric power is generated 3 to 6 hours (hr) daily, Monday through Friday. The turbine intake gates are located on the bottom of the lake and are approximately 7.5 m (24.8 ft) high.

Approximately 47 river km (29 river mi) downstream of WFG L&D is the George W. Andrews (GWA) L&D. This structure consists of a concrete dam with a fixed spillway and a single lift lock. The GWA L&D is a single purpose navigation project intended only to provide sufficient depth for authorized navigation. The lake created by GWA L&D has a surface area of 623 ha (1 540 ac).

#### History Of The Problem

Construction of both the WFG and the GWA projects was essentially complete in 1963. Problems with fish kills in the WFG tailrace area during periods of stratification soon followed. A number of interim measures have been implemented to combat the problems. The first of these measures, Standard Operating Procedures (SOP), was developed in 1970. Basic provisions of this SOP were to provide for water releases through spillway gates when fish were observed distressed or dying, to monitor conditions for indications of causal effects and to verify that corrective actions were effective.

<sup>1</sup>Ecologist, US Army Corps of Engineers, Mobile District

<sup>2</sup>Park Manager, US Army Corps of Engineers, Mobile District

In 1972 an automatic water quality monitor was installed downstream of WFG Lock and Dam. This monitor, which is presently located about 457 m (1 500 ft) below the dam on the west bank of the river, monitors dissolved oxygen (DO), pH, temperature, and conductivity.

The same basic provisions of the 1970 SOP were incorporated into a subsequent SOP and revision, both of which were implemented in 1982. On 30 July 1985, a major fish kill occurred, affecting approximately 100,000 fish as estimated by State of Alabama fisheries personnel. As a result of this 1985 fish kill, another SOP was implemented later that year that contained the basic provision of releasing water from the spillway gates once conditions deteriorated. There were, however, some provisions of note in this procedure. The SOP was prepared recognizing that although the problem had existed for several years, little was actually known about the cause. In an attempt to better understand the problem, the 1985 SOP contained significantly increased monitoring requirements. Notable among these was the direct transmittal of the monitor's DO information to a digital display in the WFG Powerhouse and the inclusion of measures to provide for spillway releases prior to visible fish distress or fish kill.

Some of the provisions for increased monitoring contained in the 1985 SOP were revised as more was learned about the situation and to accommodate the need to reduce the overwhelming burden it placed on field personnel. The latest revision is dated June 1987. This SOP reflects recommendations developed from an intensive dissolved oxygen (DO) study that was conducted in August 1986.

#### METHODS

Investigations into DO problems at WFG were conducted in two phases. Phase I was conducted from 13-19 August 1986 to better describe the effects of operational procedures such as generation startup sequences, spillway releases and lock discharges on DO and temperature in the immediate tailrace and at locations farther downstream. It was anticipated that data from this portion of the study would identify operational regimes which when combined with the naturally occurring processes would achieve the highest possible DO levels.

A temperature and DO profile was measured at midstream and at the right and left quarter points of the channel, except as indicated below, at each of the following stations. The depth intervals for each profile ranged from 0.2 m (0.5 ft) to 1.0 m (3.0 ft) at all stations, except Station 1. At Station 1 in WFG Lake, the data were collected at 1.5 m (5.0 ft) or 3.0 m (10.0 ft) intervals through the 28.3 m (93.0 ft) depth of the lake. Pool elevation during the study averaged 56.2 m (184.5 ft) NGVD.

- Station 1 - 244 m (800 ft) upstream of WFG L&D (single point vertical profile)
- Station 1A - 8 m (25 ft) downstream of WFG L&D at powerhouse draft tube exit area (single point vertical profile)
- Station 1B - 122 m (400 ft) downstream of WFG L&D (single point vertical profile)
- Station 2 - 244 m (800 ft) downstream of WFG L&D
- Station 3 - 457 m (1 500 ft) downstream of WFG L&D at water quality monitor

- Station 3A - 579 m (1 900 ft) downstream of WFG L&D (single point vertical profile)
- Station 4 - 2.4 km (1.5 mi) downstream of WFG L&D
- Station 5 - 26.6 km (16.5 mi) downstream of WFG L&D
- Station 6 - 42.3 km (26.3 mi) downstream of WFG L&D

Stations 1, 2, 3, 4, 5, and 6 were sampled until 1400 hr August 15. With the understanding acquired from these initial tests, Stations 4, 5, and 6 were relocated closer to the dam (Stations 1A, 1B, and 3A) for the remainder of the study.

Measurements were taken using Yellow Springs Instruments (YSI) DO meters. Air calibration of the meters was verified with the azide-modified Winkler titration technique. Temperature readings were verified with mercury thermometers. In addition to the YSI meters, a Hydrolab water quality monitor was used at selected locations to measure temperature, DO, pH, conductivity, and oxidation-reduction potential. Generally, data at each station were collected for at least one hour prior to operational changes, such as generation startup, and continued until the transient hydraulic effects of the event had dissipated. Data were collected at 20-minute intervals for all the tests except the 24-hour test period on August 15-16 when the frequency for collection varied depending on project operations but provided as a minimum one profile per hour. Station 1 profiles were collected generally once per hour.

Phase II was conducted from 9-10 September 1987. This phase focused on identifying the source of the low DO water observed in the tailrace during the Phase I portion of the study. Dissolved oxygen concentrations were monitored following generation under standard conditions when tailgates remained in the up or ready position, and again with the tailgates lowered to prevent flow of water through the powerhouse. It was hypothesized that gate leakage through water passages in the powerhouse was the primary source of low DO water observed in the tailrace. If this hypothesis were correct, it would be expected that low DO readings observed when the tailgates are in the standard position would not be detected when the gates are lowered.

An initial temperature and DO profile was measured in the lake at Station 1 to determine if the lake was stratified and to record the DO reading near the bottom for comparison with tailrace readings. All other measurements were taken in the immediate tailrace at Station 1A. A YSI, calibrated as in Phase I, was used to collect data at 20-minute intervals.

## DISCUSSION OF RESULTS

### Phase I Study

Data from Station 1 were typical for large stratified bodies of water (Wetzel, 1975). During the study, surface readings varied from 6.0 to 8.0 mg/l, mid-depth readings ranged from 3.0 to 4.0 mg/l and to below 1.0 mg/l at 15.2 m (50.0 ft) and continued to drop until readings were virtually 0 mg/l from 21.3 m (70.0 ft) to 28.3 m (93.0 ft), the lake bottom. Figure 1 illustrates the effects at mid-depth at Station 1, and surface changes at Stations 2 and 3, when each of the three functional turbines were brought on-

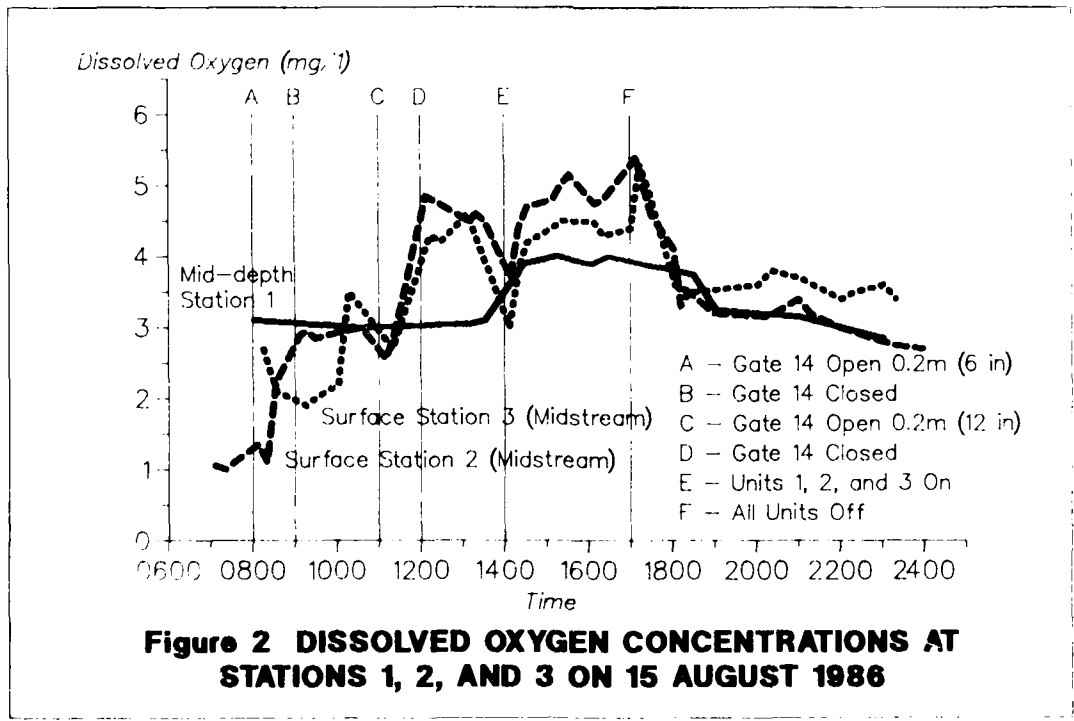
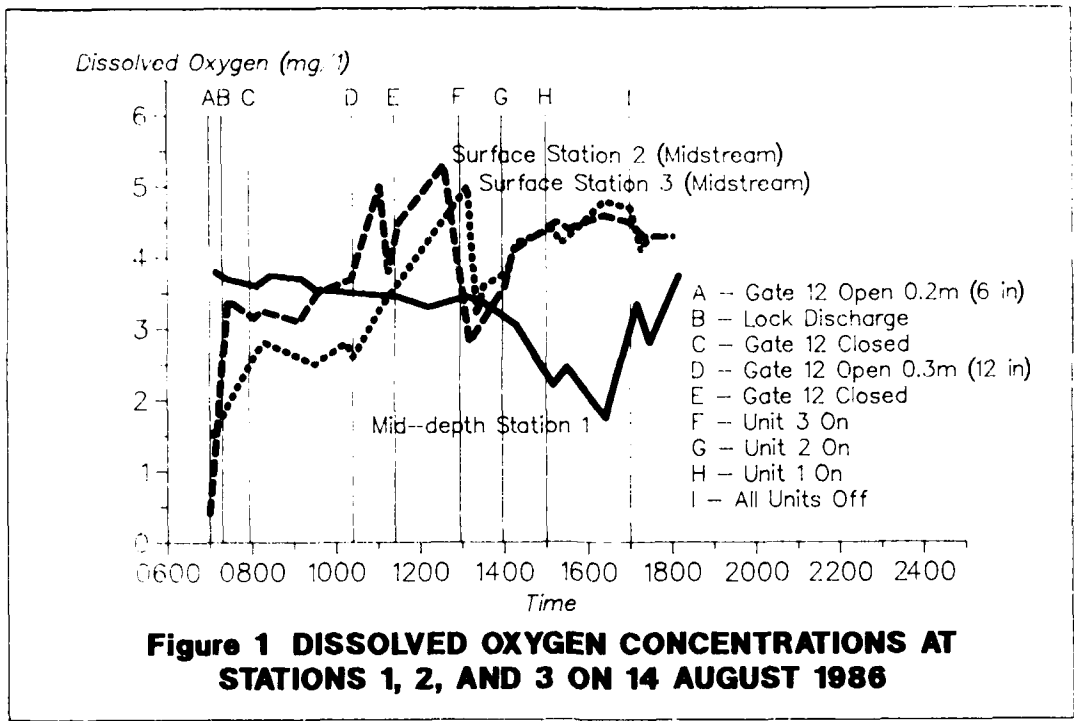

line in one-hour intervals. (Turbine 4 was nonfunctional due to servicing.) The DO level at mid- depth of Station 1, a point approximately 6.7 m (22.0 ft) above the turbine intake area, showed an appreciable decrease after the second turbine was brought on-line. DO levels continued to fall until the units were turned off at 1700 hr. DO soon recovered to pregeneration concentrations at Station 1.

Releases from spillway gate 12, which originate from a depth of 9.1 m (30.0 ft) in the lake, had no effect on the mid-depth DO concentration at Station 1. However, as shown in Figure 1, the surface DO readings at Stations 2 and 3 displayed immediate increases that continued after the gate was closed. It should be noted that the initial increases in tailwater DO from extremely low concentrations achieved with a gate opening of 0.2 m (0.5 ft) were much more dramatic than the increases achieved from a 0.3 m (1.0 ft) gate opening after the DO level had reached 3.0 mg/l.

Stations 2 and 3 displayed a sharp drop in DO levels when the first turbine was brought on-line followed by a gradual increase as the two remaining units were brought on-line. However, the DO never completely recovered to the pregeneration concentrations observed after releases were made from gate 12.

Generally, variations in DO concentrations observed at the upper tailrace stations were observable at Station 4. DO changes noted at Station 4, however, were not as dramatic and were shifted with respect to time and rate of discharge. Fluctuations in DO readings at Stations 5 and 6 could not be specifically attributed to operational discharges as they were at stations in the immediate tailrace area. It was noted that DO at Station 6 was higher than upstream stations by as much as 2.0 mg/l during the mid-day hours and extremely low readings (<2.0 mg/l) were not observed during the study. This correlates with Strain (1980).

Approximately two hours after generation ceased on August 14, DO and temperature readings were measured in the draft tube exit area immediately below the powerhouse. These measurements revealed that DO ranged from 3.0 mg/l at the surface to 2.0 mg/l or less from 3.0 m (10.0 ft) below the surface to 11.0 m (36.0 ft), the bottom. Based on the previous experience of the technical advisor from the Waterways Experiment Station, Mr. Steven C. Wilhelms, at Mark Twain Lake, Missouri, it was hypothesized that the cause of the low DO water in the tailrace was due to leakage through the turbines during nongeneration periods. This poor quality water would gradually displace the water from generation in the tailrace and would rove downstream. Therefore, testing and data collection were oriented toward testing this hypothesis beginning 15 August at 1700 hours through the remainder of the study. A test of an interim procedure as a means of preventing the buildup of extremely low DO water was conducted. This procedure provided spillway releases overnight from 1500 to 0700 hours and indicated good effectiveness. At Station 2 following an overnight release of 0.1 m (0.25 ft) from gate 12, DO readings were between 3.0 to 4.0 mg/l at all depths compared to readings of 1.0 mg/l or less when the releases were not provided. Lower readings of 1.0 mg/l or less, however, were measured directly in front of the turbine discharge bays.

Figure 2 depicts DO changes in the three upper stations resulting from spillway releases from gate 14, which was opened to a height of 0.2 m (0.5 ft) and 0.3 m (1.0 ft). For the purpose of the study, gate 14 had been modified by inserting stoplogs on the upstream side of the gate to a depth of 1.8 m (6.0 ft) from the surface. These stoplogs created a weir effect and allowed gate 14 to discharge surface water rather than water from the depth of the gate opening, 9.1 m (30.0 ft). The effects of discharges from gate 14 on DO paralleled data collected during discharges from the unmodified gate 12 (Figure 1).

Figure 2 also depicts generation startup with all three functional turbine units started sequentially within minutes of one another. This startup began at approximately 1400 hours and shows that DO at the mid-depth of Station 1 registered a corresponding rise over the duration of the generation period. This rise seemingly is due to an expanded withdrawal zone that encompasses more highly oxygenated water closer to the lake surface. Over the same period the surface DO at Stations 2 and 3 showed an immediate but short-lived sag of about 1.0 mg/l followed by an equally sudden rise of about 2.0 mg/l. Stations 2 and 3 also registered a general improvement in DO over the 3-hour generation period (to approximately 5.0 mg/l) followed by a drop of about 2.0 mg/l after generation ceased. Continued monitoring at these stations through 0800 hours on 16 August revealed a progression of low DO readings (<1.0 mg/l) from near the bottom at Station 1A both up through the water column and downstream. By the end of the monitoring period, this slug of low DO water had reached to the surface at Stations 1A and 2, and to mid-depth at Station 3.

#### Phase II Study

The DO and temperature profile taken at Station 1 in WFG Lake prior to testing in the tailrace indicated a weak chemical stratification. Temperature ranged from 28.5 degrees Celsius to 27.1 degrees Celsius from top to bottom, and DO ranged from 9.4 mg/l to 3.6 mg/l. Conditions were such that the slightest disturbance, wind or a drop in air temperature could have resulted in destratification.

Data collected in the tailrace on 9 September 1987 followed trends observed during the Phase I study conducted 13-19 August 1986. Soon after generation ceased at 2000 hours, lower DO concentrations were detected, first near the bottom and later progressing toward the surface. Figure 3 shows the decline in DO concentrations over several profiles taken during the course of the evening.

During the second night of monitoring, it was anticipated that if leakage through the powerhouse was the source of low DO water, then concentrations would remain constant due to lowering the tailgates. DO profiles over the course of the second evening are presented in Figure 4. DO concentrations recorded on 10 September started slightly lower than initial readings taken the previous evening. As the night progressed, the pattern of declining DO concentrations occurring first near the bottom and progressing toward the surface was noted. The pattern tended to progress much more rapidly than was observed on 9 September. And finally, at some depths the second night, DO concentrations declined below all previous readings taken either in the tailrace or readings recorded in the lake profile.

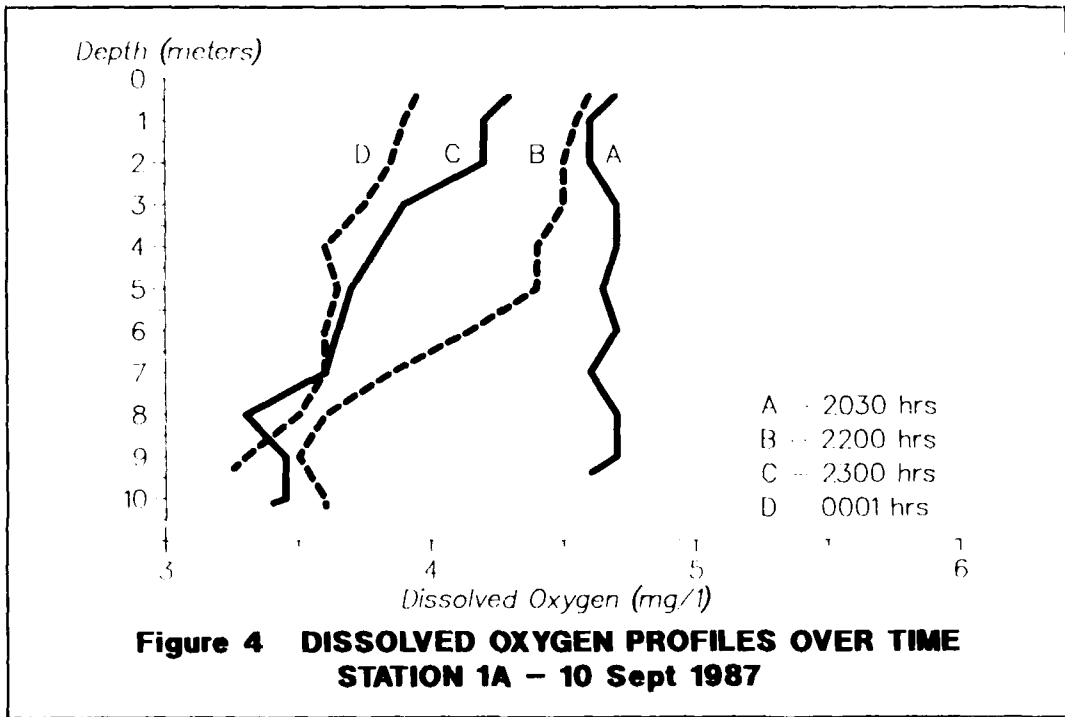
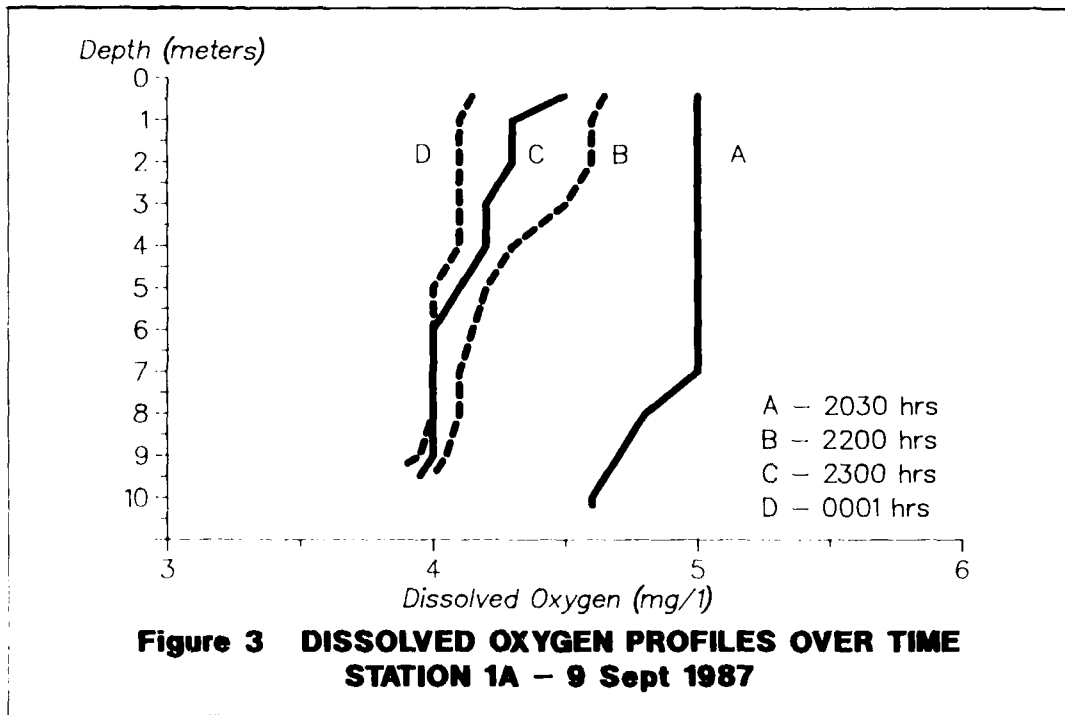

## CONCLUSIONS

### Phase I Study

Observations at the mid-depth of Station 1 and the surface at Stations 2, 3, and 4 during the startup of generation indicated that irrespective of the startup sequence, there is an initial drop in DO levels in the immediate tailrace associated with the start of hydropower production. The severity and duration of this DO drop is influenced by the startup procedure. Data indicate that compressed starting of the generators, i.e., all units sequentially within minutes of one another, minimizes both the acuteness and the duration of the DO drop. This seems to be due to the increased expansion of the zone of withdrawal within the lake, thus capturing more of the epilimnetic waters.

Data collected during spillway gate openings indicated that comparatively there is no difference between releases from gate 14 modified with stoplogs and other gates. Additionally, the data indicated that when DO levels were severely depressed, the spillway releases resulted in more dramatic improvements compared to releases when tailwater DO was 3.0 mg/l or better. Manipulations with spillway gate heights indicate that releases result in improvements in DO without respect to gate height; however, these improvements occur more rapidly with increased discharges either through increased gate heights or by opening additional gates. Data collected during spillway discharges indicate that the slug of low DO water that accumulates in the immediate tailrace is apparently pushed downstream by releases, and DO is not significantly improved. Further, overnight releases through the spillway gates seem to prevent significant accumulations of low DO water and instead both mixes and transports this water downstream except in a very localized area in the vicinity of the turbine discharge bays.

Intensive monitoring in the tailrace area substantiated the hypothesis that extremely low DO water moved into the downstream area from the turbine discharge bays. Using conductivity as a conservative tracer, data collected with the Hydrolab in the lake clearly showed that the low DO water being observed in the tailrace during nongeneration periods was available at the elevation of the powerhouse intakes. Conductivity and pH were measured at the draft tube exits and were found to be identical to those values measured in the lake at the intakes. Further, data collected during the study indicated that the extremely low DO water accumulates in the tailrace at varying rates. During an overnight monitoring period, the slug of low DO water had moved downstream only to the mid-depth at Station 3. On other occasions when monitoring began in the early morning, results indicated that the low DO water was uniformly distributed throughout the water column at Station 3 and had moved farther downstream.

### Phase II Study

A comparative analysis of data collected for both days of the test failed to show a correlation between DO readings when the tailgates were lowered and those measured when the gates were raised. This suggests that the passageways controlled by the tailgates are not the conduits by which low DO water reaches the tailrace. Further, DO readings measured the second night of the study



declined to concentrations that were lower than those observed during the first night, or those observed in the lake. A deterioration in lake conditions or discharges from underground wells, which are common in the vicinity, may account for the lower DO readings the second night.

#### ACKNOWLEDGMENTS

The authors wish to express their appreciation to the personnel from the US Geological Survey offices in Tuscaloosa, Cullman, and Montgomery, Alabama, for the professional manner in which they performed the field work during Phase I of the study. The technical advice and participation in the study through the WOTS Program of Mr. Steven C. Wilhelms from Waterways Experiment Station was an invaluable aid. Personnel from the WFG Powerhouse, Lock, and Resource Manager's Office provided assistance and support throughout the study. Engineering Technician, Mr. Terry Williams, from the Planning Division, Mobile District, furnished logistical help that was a major contribution to the successful completion of the study as did Mr. Joe Hand, who was working under the Cooperative Education Program during the Phase II Study.

#### REFERENCES

Strain, G. M., "Environmental Aspects of Reservoir Releases," Proceedings of a Seminar on Water Quality Evaluation, 22-24 January 1980, Tampa, Florida, Army Corps of Engineers, Committee on Water Quality, Washington, D.C., Paper 13, 1980.

Wetzel, R. G., Limnology, W. B. Saunders Co., 1975.

COORDINATING THE WATER QUALITY ACT OF 1987

by

Harold T. Sansing<sup>1</sup>

In December 1987, the Environmental Protection Agency (EPA) issued two guidance documents (among others) for states to follow in implementing Section 314, the Clean Lakes Program (CLP), and Section 319, the Nonpoint Source (NPS) Pollution Program, of the Water Quality Act (WQA) of 1987. The WQA of 1987 states:

"...it is the national policy that programs for the control of nonpoint sources of pollution be developed and implemented in an expeditious manner so as to enable the goals of this Act to be met through the control of both point and nonpoint sources of pollution."

The CLP and NPS are closely interrelated with other targeted areas specified by the WQA. The other areas, although providing separate EPA guidance, will obviously lead to overlaps in identifying strategies for water quality management of the Nation's water resources. Although the present focus is on the NPS program, the CLP is an integral part of the total "systems" management and must sooner or later be equally addressed within a state's clean water strategy.

Section 319 provides for the authorization of financial assistance to states for the implementation of the NPS program. This assistance includes the development of two reports required by the WQA, as well as implementation of a State NPS management program. A State Assessment Report and a State Management Program Report are required initially. The latter requires a detailed strategy for addressing NPS problems projected through the next four fiscal years. In essence, the WQA (through the EPA) is encouraging states to develop "state clean water strategies" (SCWS) that must take into account the interrelated system impacts of pollution sources on all water resources programs.

EPA guidance provides that an SCWS be developed in a three-tiered process: completing an assessment of the State's waters; identify best management practices for protecting water resources; and develop strategic management plans. States are encouraged to include in their SCWS the assessment requirements of the other sections of the WQA. The advantages of combining these should be obvious to water resource managers, who so often must interface and compete for funding in basic programs. This approach encourages multi-agency coordination of water resources programs, hopefully leading to a comprehensive management effort to control water pollution. The guidance specifically encourages states to coordinate NPS programs with other Federal Agencies.

---

<sup>1</sup>Chief, Water Quality Section, Nashville District

The EPA's NPS guidance document provides the following definition:

"Nonpoint Source (NPS) Pollution: NPS pollution is caused by diffuse sources that are not regulated as point sources and normally is associated with agricultural, silvicultural and urban runoff, runoff from construction activities, etc. Such pollution results in the human-made or human-induced alteration of the chemical, physical, biological, and radiological integrity of water. In practice terms, nonpoint source pollution does not result from a discharge at a specific, single location (such as a single pipe) but generally results from land runoff, precipitation, atmosphere deposition, or percolation. It must be kept in mind that this definition is necessarily general; legal and regulatory decisions have sometimes resulted in certain sources being assigned to either the point or nonpoint source categories because of considerations other than their manner of discharge. For example, irrigation return flows are designated as "nonpoint sources" by section 402(1) of the Clean Water Act, even though the discharge is through a discrete conveyance."

As stated previously, EPA encourages states to integrate NPS programs with related programs, e.g., Clean Lakes, Estuaries, Stormwater Permits, Groundwater, Toxics Control, State Revolving Funds and Wetlands and "complement and increase the effectiveness of State and local NPS programs already underway." As state assessments within the above guidelines are completed, priority differences by state and by watershed will likely emerge. Identified NPS problems may be regional in nature, such as coal mining vs. agriculture vs. urban development vs. land disposal, etc., each having priorities assigned relative to the perception of each state's assessment.

The State of Tennessee completed a preliminary draft assessment under Section 319 guidelines in September 1987. The program is being managed under the Division of Construction Grants and Loans within the Tennessee Department of Health and Environment. The State contacted the Nashville District advising us of the establishment of an interagency Management Advisory Group (MAG) for nonpoint pollution and invited our participation. At this time we are serving on three separate technical committees within the MAG.

Tennessee's draft assessment has identified seven major pollutant categories of nonpoint source pollution. Following is a listing with brief definitions:

Agriculture (AG), including: sediment from eroding cropland, contamination from in-stream livestock watering, feedlots, animal holding/management areas, and pesticides/herbicides.

Resource Extraction (RE), including: surface mining, subsurface mining, placer mining, dredge mining, petroleum activities, mill tailings, and mine tailings.

Forestry (FR), including: harvesting, reforestation, residue management, forest management, and road construction/maintenance.

Urban Runoff (UR), including: surface runoff from "first flush" type storm events in expanding urban areas, impacts from development, building construction, utility/sewer line emplacement, and highway/road construction.

Hydrologic Modification (HM), including: stream channelization, construction of dams, impoundments, reservoirs, dam tailwaters, sedimentation, thermal alterations, low dissolved oxygen concentrations, unnatural changes in the quantity of flow, dredging, removal of riparian vegetation, and streambank modification or destabilization.

Land Disposal (LD), including: sludge, wastewater, landfills, industrial land treatment, on-site wastewater systems (septic tanks, etc.) and hazardous waste.

Other (OT), including: waste storage/storage tank leaks, spills, in-place contaminants, marinas, natural sources, barge discharges, and application of aquatic herbicides/pesticides.

Section 319 requires that the state's assessment be completed by April, 1988 and the nonpoint source management program by August, 1988. There are three sections of information to be included in the management program. These are: to define existing conditions regarding the degree of water pollution associated with nonpoint sources; to define best management practices to diminish pollution by source category; and to define interagency programs with specific responsibility for reducing or quantifying nonpoint source pollution.

The state's draft NPS assessment is presently in the review process within the committees established under the Management Advisory Group. The State has asked each agency to supply specific information regarding the assessment of watersheds within the State. This includes: provide additional information that will supplement present drafts; identify where information is missing; evaluate the scope of the information presented; provide suggestions for improvement; and maintain an open technical dialogue with the NPS staff.

The Nashville District's response to the draft assessment has been mainly directed at the Hydrologic Modifications category of NPS. The District manages a multiple-purpose system of ten dams and reservoirs. Purposes include navigation, flood control, hydropower, recreation and water quality. The following points were communicated to the State in a letter response. These points concern the interpretation of the impacts of HM.

1. The quality of "lakes" is tied to hydrologic events and reflect land use activities upstream, including point and nonpoint sources of "pollution." However, in a developed river basin there are other considerations that are important in the development of a management plan for nonpoint sources. For instance, there are major significant differences between man-made and natural lakes. Man-made lakes, from the smallest mill pond to the largest individual multiple-development projects, have one thing in common. They are formed by placing a control structure in a natural drainage so that a flowing stream is converted into a "lake." In a system of lakes and reservoirs, such as the Cumberland River, flows characteristically enter each project near the surface of the more shallow upstream end and are routed through and discharged from the bottom in the deeper downstream end at the control structure that forms each lake. In the case of large multiple-use water resources development projects, here is a high degree of control over the routing of water through the system on an annual basis. This control, of course, is very basic to the concept, design and management of man-made lakes.
  
2. These basic characteristics of man-made lakes are in sharp contrast to what is found in natural lakes. The most significant aspect of the operational control in man-made lakes is that, as a part of the concept of multiple-use water resources development of a basin, measurable benefits are realized. These can include, as in the Cumberland Basin, navigation, flood control, hydropower, recreation, lake and tailwater fisheries, and reliable water supplies to users and consumers alike.
  
3. The management of a large multiple-use water resources development system is not without inherent problems. At present, a conflict exists between "standards" implemented for streams and those that are virtually non-existent for lakes or reservoirs, even though both receive "pollutants" from point or nonpoint sources. Until this is resolved, there will always be a problem in the development of management strategies for these man-made bodies of water. Similarly, a conflict exists between the systems' present operational criteria, which were developed very early primarily for the management of water quantity, and their apparent impacts on water quality, which presently lack completed operations criteria. The Corps of Engineers identified the need to resolve the latter conflict several years ago. The Nashville District has since proceeded with developing alternative management strategies, tailored to address quality and quantity in future operations.

4. The District's water quality program monitors the quality of inflows, attempts to define any inflake changes attributed to the effects of impoundment, and monitors the quality of water discharged into other river reaches or reservoirs of the Cumberland. The information gained from this effort has allowed us to identify and analyze specific problem areas, which should ultimately lead to refinements in the management of the water quality of the system. For example, it has made it possible for us to quantify, in specific water quality terms, the "system effects" of operating the Cumberland River projects. We are presently examining these effects and are proceeding with the development of mathematical tools to improve on present operational management. The basic concept is to have day-to-day capability for routing quality that supplements our present operations for routing quantity.
5. The District, in concert with technology transfer from our research laboratories, is developing more detailed lake and reservoir water quality simulation models. These models are being developed for the specific purpose of addressing project and system response to changes in economic development and/or land uses within the basin. When these become operational, they will provide a significant tool in Tennessee's Nonpoint Source Management Program.
6. In light of the function and operation of man-made lakes, the District has suggested a very critical technical review of the Hydrologic Modification category of Tennessee's nonpoint assessment program and how it relates to other categories. HM is a product of legitimate water resources development, although there exist inherent environmental problems in same. This can also be stated for the management of other categories of nonpoint sources including agriculture, resource extraction, forestry, urban runoff, and land disposal. There is a difference, however, in that HM receives the water quality output ("pollution") from these other management "systems," and depending upon management perspective, may or may not react in a negative manner. In a real sense, HM "processes" the water quality output from these activities. The reaction of HM may or may not lead ultimately to a situation considered detrimental to other water quality management goals.

At the present time, the District has representatives on three committees within Tennessee's Management Advisory Group. As mentioned previously, the committees are responsible for both assessment and development of Best Management Practices. These committees include Hydrologic Modifications, Dredge Mining, and the assessment of Wetlands.

The Nashville District's management responsibilities overlap several States including those in the Tennessee River Valley. We have not been approached by these other States at this time. If they elect to develop their clean water strategies, it will mean a considerable amount of work is yet to be accomplished.

There is probably sufficient background and technical information available at this time to define many of the NPS problems and evaluate alternative solutions. It will require daring, innovation and creativeness, however, to examine them objectively, especially in light of the many cross-impacts emerging from implementation of the Act. Also, limited funding may impact future efforts to implement the WQA of 1987.

## Lake Chicot: The Final Chapter

By

David R. Johnson\*

The water quality problems of Lake Chicot, Arkansas, and the method selected to improve those problems were introduced at the last Water Quality Conference. The Lake Chicot project is unique in the Vicksburg District in that water quality and not flood control is the primary project purpose. Congress authorized an investigation of the water quality problems in 1963. The implemented solution is one that was mutually agreed upon by the U.S. Fish and Wildlife Service (FWS), the Arkansas Game and Fish Commission, and the Corps of Engineers. The solution required the construction of three hydraulic structures: the 6500 cfs Lake Chicot Pump Plant; the Connerly Bayou Dam; and the Ditch Bayou Dam (Figure 1). The pump plant diverts sediment-laden runoff into the Mississippi River, while the control structures help maintain lake level and prevent excess runoff from entering Lake Chicot.

Lake Chicot is the largest natural lake in Arkansas. It was formed about 600 years ago when the Mississippi River changed course and cut off this bendway. In the early part of this century, the lake was renowned for its excellent fishing. The fishing declined steadily after completion of the Mississippi River mainline levees in 1920. The decline is the result of two factors, both related to the completion of the levees.

The first factor is the following sequence of events that contributed to the deterioration of this lake's recreational and aesthetical value. Prior to 1920, Lake Chicot had no inflows and was protected by natural levees. Cypress Gap, which provided natural drainage of the land north of Lake Chicot into the Mississippi River, was closed in 1920. This caused the drainage of the land to be redirected into Macon Lake, through Lake Chicot and into Bayou Macon (Figure 1). A local drainage project consisting of several drainage ditches was to reroute the runoff into Bayou Macon before it entered Lake Chicot. During the 1927 flood the Arkansas River overtopped its levees and much of the land in the basin was inundated. The local drainage project had not been completed and the flood waters, trying to find an escape, enlarged Connerly Bayou and forced the runoff throughout Lake Chicot. The suspended sediment in the runoff formed a sand bar in Lake Chicot just north of the Connerly Bayou inflow, effectively cutting the lake in two. This sandbar was enlarged by locals to provide a road. Finally, the state installed gates in the dam and improved the road further. Because of the dam, all the basin runoff flows into the lower lake, while the upper lake is isolated and remains much like it was prior to the construction of the mainline levees. Construction of the mainline levees had irreversibly changed the drainage pattern of the area, greatly increasing the Lake Chicot drainage basin.

\*Chief, Water Quality Section, Vicksburg District



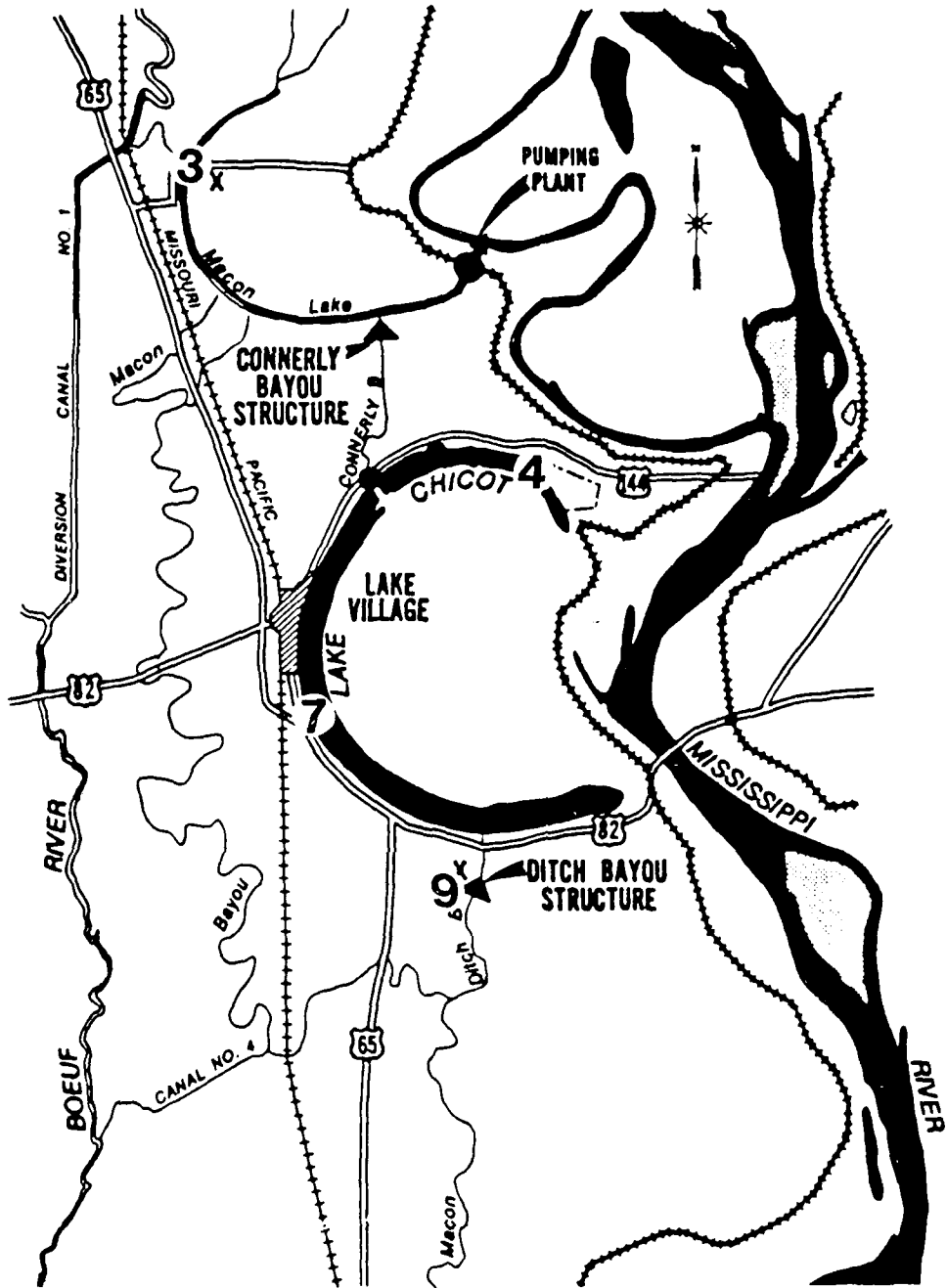

**LEGEND**

- EXISTING LEVEE
- ⬆️ PUMPING PLANT
- ▲ DAM
- WATER QUALITY STATION
- X GOES PLATFORM STATION

**OVER LEVEE PUMP PLAN**

**Figure 1. Lake Chicot Project area**

The second factor in the decline of the lake's water quality was a change in the land use of the basin. There was a steady clearing of the land for agricultural purposes. In 1915, 15 percent of the land was cleared for agricultural purposes, and by 1959, 68 percent of the land had been cleared. As the land was cleared, the sediment load in the drainage ditches and bayous increased. After World War II, the rate of land clearing accelerated and the water quality and fisheries in Lake Chicot deteriorated further. The situation attracted enough attention that Congress authorized a study in 1963. The study was performed by the FWS. They concluded that the fisheries could return to former levels if the lake remained clear 5 out of 6 years. The project as constructed is designed to keep the lake clear 6 out of 7 years, thus meeting the FWS criteria.

The Lake Chicot Project was completed in 1985. The project was designed to reduce the heavy suspended sediment loads to the lake by diverting inflows greater than 400 cfs to the Mississippi River. Prior to project completion, the lake was plagued with high suspended solid levels for 6 to 8 months of the year (annual mean = 350 mg/l). Coupled with the high sediment load was high nutrient loading. In spite of high nutrient levels in the lower lake, chlorophyll A levels are low due to small secchi depths resulting from the high suspended solids levels. The once good fishing had declined to very poor levels by the 1970's. The upper lake, which was isolated by the sand bar, continued to enjoy the good fishing and clear water that the entire lake had enjoyed prior to the construction of the Mississippi River mainline levees.

Additional background relating to the water quality and the lake fishery was provided by a primary productivity study conducted by the University of Arkansas in the mid-1970's. This study classified upper Lake Chicot as hyper-eutrophic and lower Lake Chicot as eutrophic. The annual primary productivity rates of the two lakes were determined to be 438 gC/m<sup>2</sup>/yr for the upper lake and 145 gC/m<sup>2</sup>/yr for the lower lake. A value between 75 and 250 gC/m<sup>2</sup>/yr indicates a eutrophic lake. This study also showed that there was a correlation between turbidity and primary productivity. The upper lake, which enjoys clear water most of the year, has primary productivity levels which are among the highest ever measured in the world. Its winter rates exceed the summer rates of most lakes in North America. The lower lake has primary productivity rates in late summer and fall, when it is clear, that are similar to the upper lake's rates. However, when turbid, its rates are near zero, even though it has very high nutrient levels. This study showed that if the lower lake would have its turbidity reduced the primary productivity of the lower lake would likely equal that of the upper lake.

Has the project been successful in reclaiming the water quality of Lake Chicot? The water quality of Lake Chicot basin has been measured on a routine basis since 1976. Originally 9 sampling sites were used, but three have been discontinued. The comparison of 4 of the remaining sites will provide a clear understanding of how the water quality has changed since the project was completed in April of 1985. These sites are: Macon Lake, the inflow to Lake Chicot designated station 3; Upper Lake Chicot, designated station 4; Lower Lake Chicot designated station 7 and Ditch Bayou, the outflow designated station 9. Stations 3 and 4 represent the extreme conditions and are the stations which should be unaffected by the project. Stations 7 and 9 represent the stations where the greatest changes should be detected if the project has been successful.

Eight water quality parameters were selected to evaluate the effectiveness of the project. They were turbidity, secchi depth, total solids, suspended solids, nitrate, chlorophyll A, orthophosphorus, and total phosphorus. Figures 2 through 9 plot the concentrations of these parameters at Macon Lake, Upper and Lower Lake Chicot (Stations 3, 4, and 7, respectively). For most of these parameters the post-project changes are clear and marked. Measured levels in the lower lake of both solids, turbidity, total phosphorus and nitrate drop sharply in early 1985, while the levels at the other two stations are more constant. Chlorophyll A and secchi depth values go up at Station 7 and remain relatively constant at the other two. The changes in orthophosphorus are less clear, but the baseline levels go down at station 7 in early 1985.

In order to test whether the apparent differences are significant, an analysis of variance (ANOVA) was performed for the above parameters at Stations 3, 4, 7, and 9. The results are tabulated in Table 1. The means at each station are ranked and grouped. The grouping was done using Duncan's Multiple Range Test. Means in the same group (the same letter) are not significantly different. Each station was treated as a different station pre- and post-project. Thus, all stations are compared to each other and to themselves pre- and post-project. The changes in the mean values of turbidity and those parameters directly related to turbidity (secchi depth and both solids) will be examined first. The station means for turbidity were divided into two clearly different groups. Stations 3, 7, 9, and post-3 were significantly higher than the means from Station 4 and post-project 4, 7, and 9. The mean at Station 7, lower Lake Chicot, dropped from 148 to 12 NTU's. As the target level was 50 NTU's, the project criteria has been met. (The FWS set a turbidity goal of 35 mg/l SiO<sub>2</sub>. They agreed to 50 NTU's as no conversion between units was possible. The state water quality criterion is 25 NTU's.) The results for total and suspended solids are similar. As with turbidity, these post-project means from Stations 7 and 9 group with the means from Station 4 (pre- and post-project) and are significantly lower than their pre-project means and the station 3 means. The secchi depth means group with Stations 3, 3-P, 7, and 9 significantly lower than all other stations. Additionally, the post-project mean at Station 7 (lower Lake Chicot) is significantly higher than all other stations. This indicates that the clarity at this station is greater than at all other stations.

Spatial and temporal differences in the station means for nutrients and chlorophyll A were less distinct. This is because temporal differences are evident for nitrate and chlorophyll in upper Lake Chicot, and for nitrate at Macon Lake. Significant decreases in the means of both nitrate and orthophosphorus in the Lower Lake Chicot and Ditch Bayou are evident. Similarly, significant increases in the means of chlorophyll A at those stations are also evident. A significant drop in nitrate at the inflow (Macon Lake) grouped its post-project mean with the other post-project stations and the pre-project upper lake. These anomalies may be real or they could be due to the lack of sufficient data from the post-project conditions. There were 10 years of pre-project data, but only 2 years of post-project data used in the analysis of variance. Lower Lake Chicot and Ditch Bayou displayed significant temporal differences for all eight parameters tested. Thus, it is clearly evident that the Lake Chicot Project has been successful in improving the water quality in Lake Chicot.

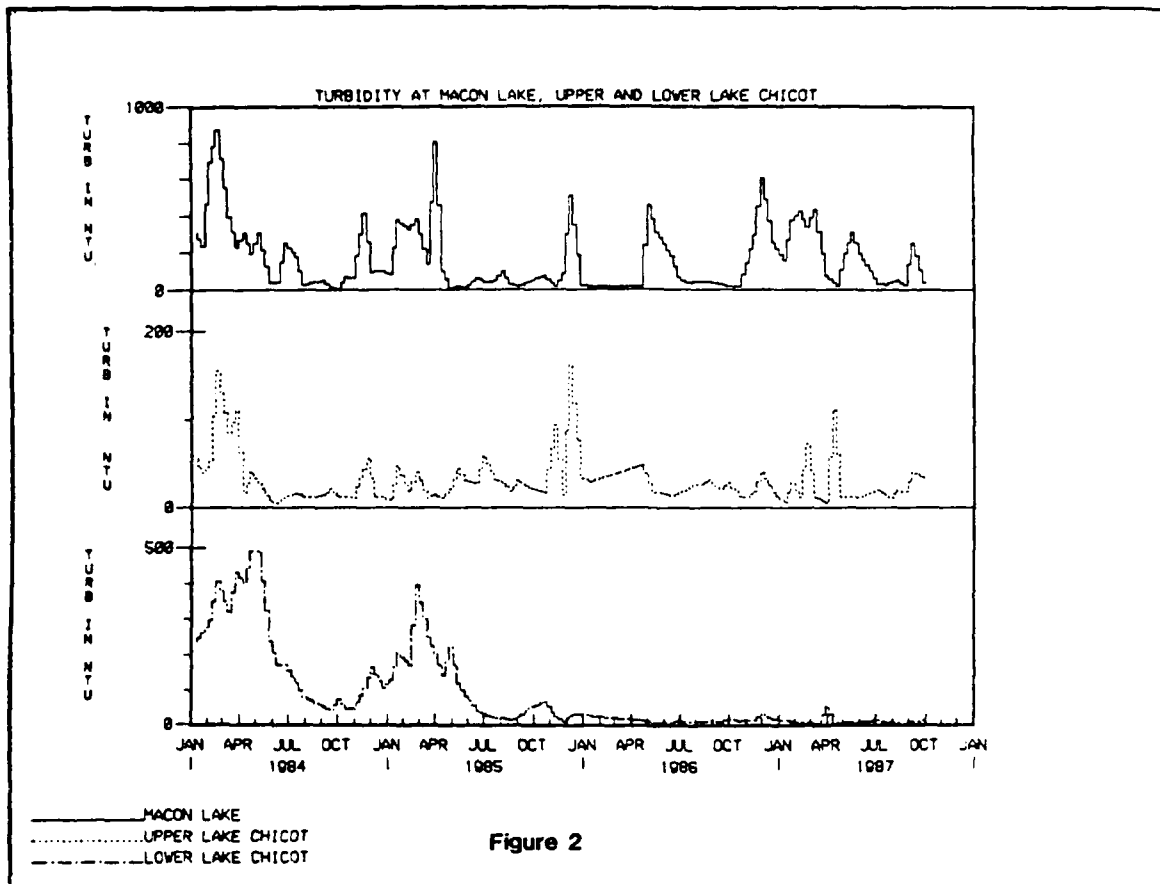

Figure 2

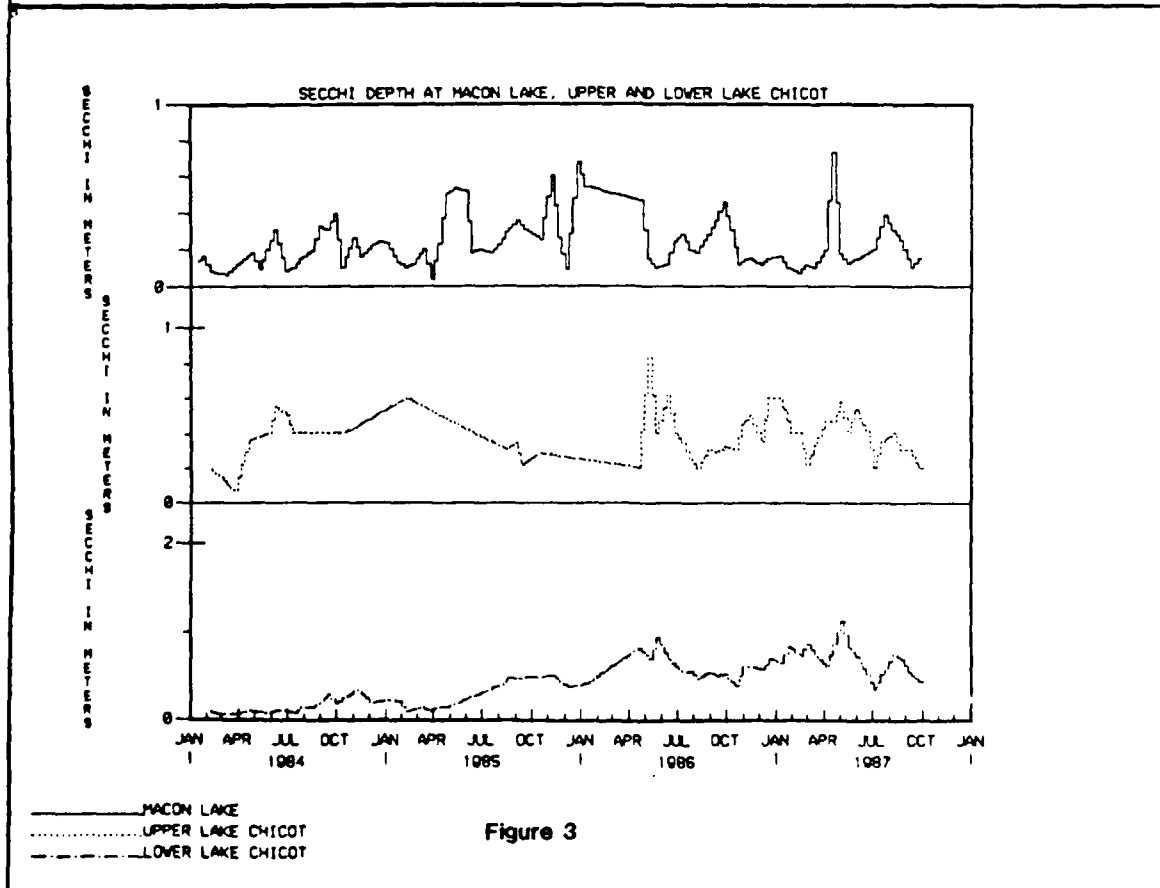

Figure 3

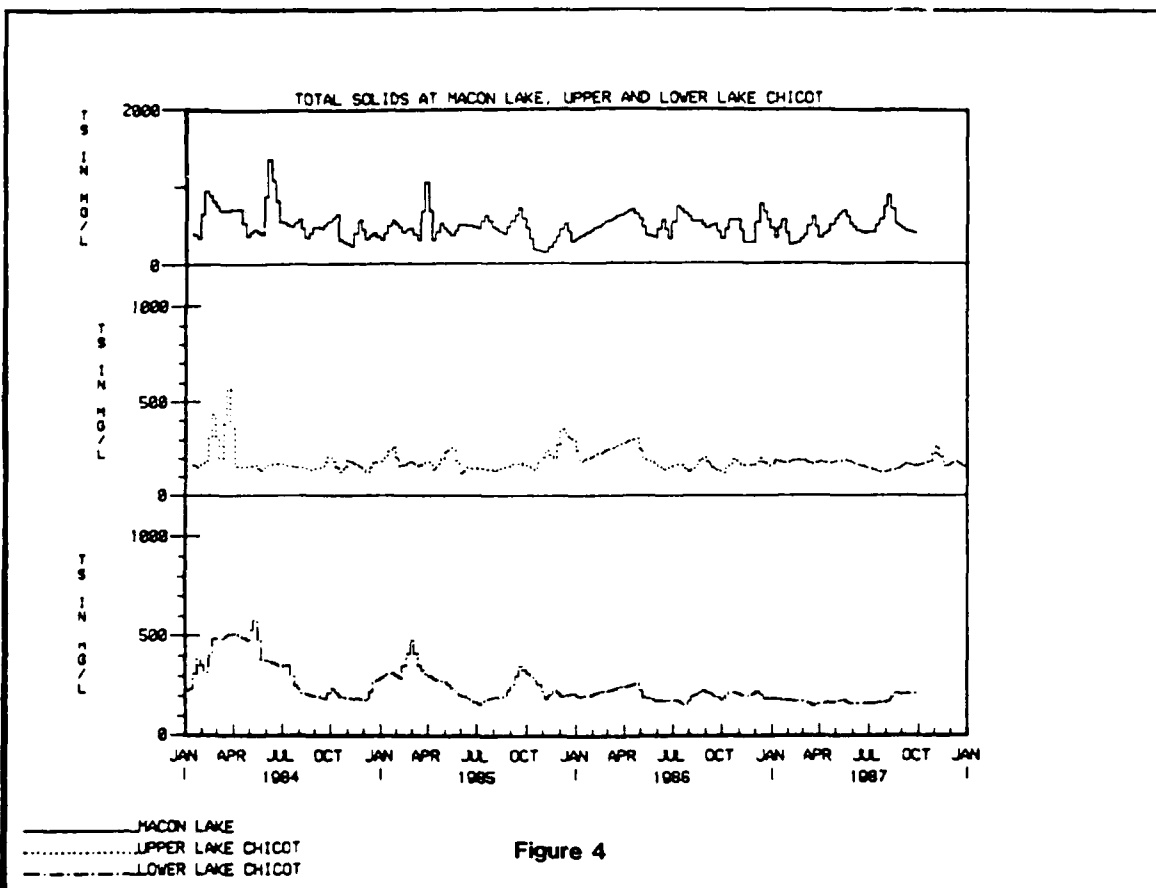

Figure 4

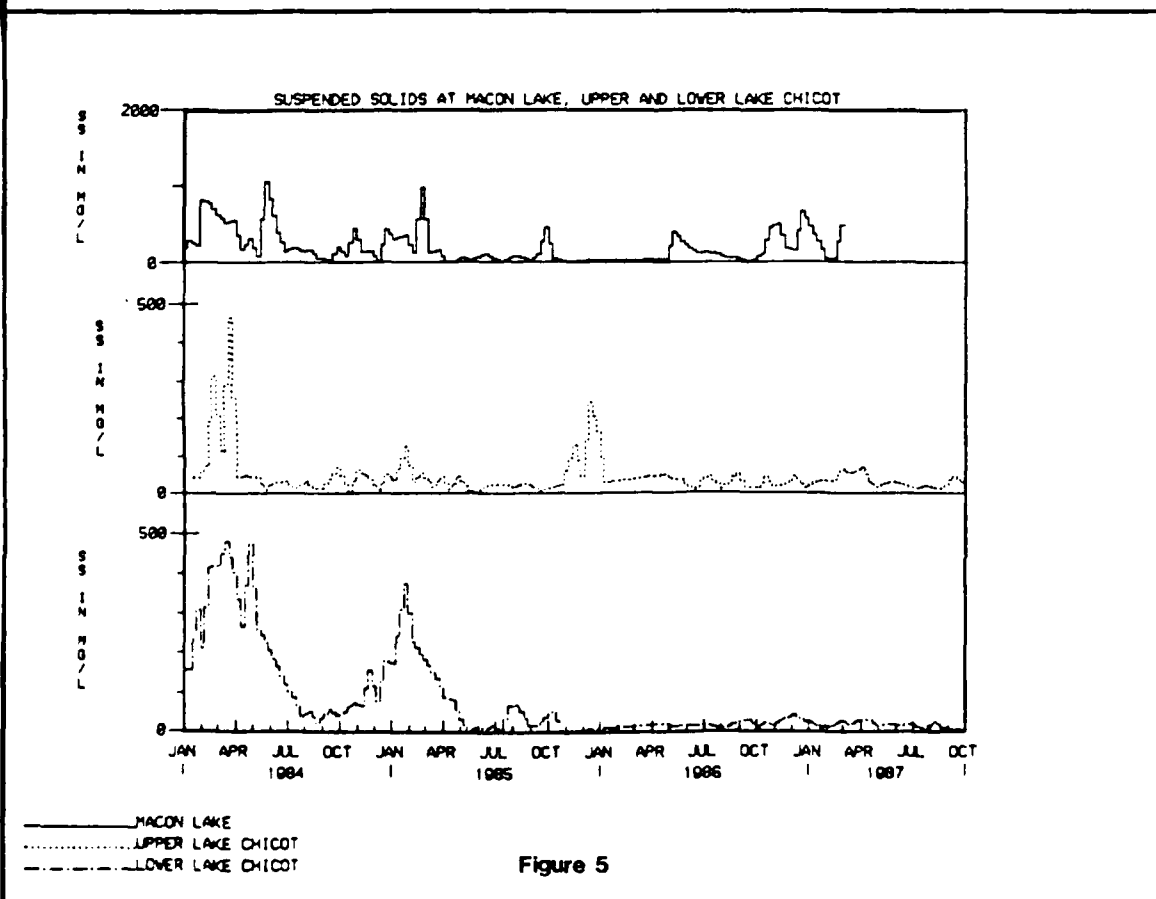

Figure 5

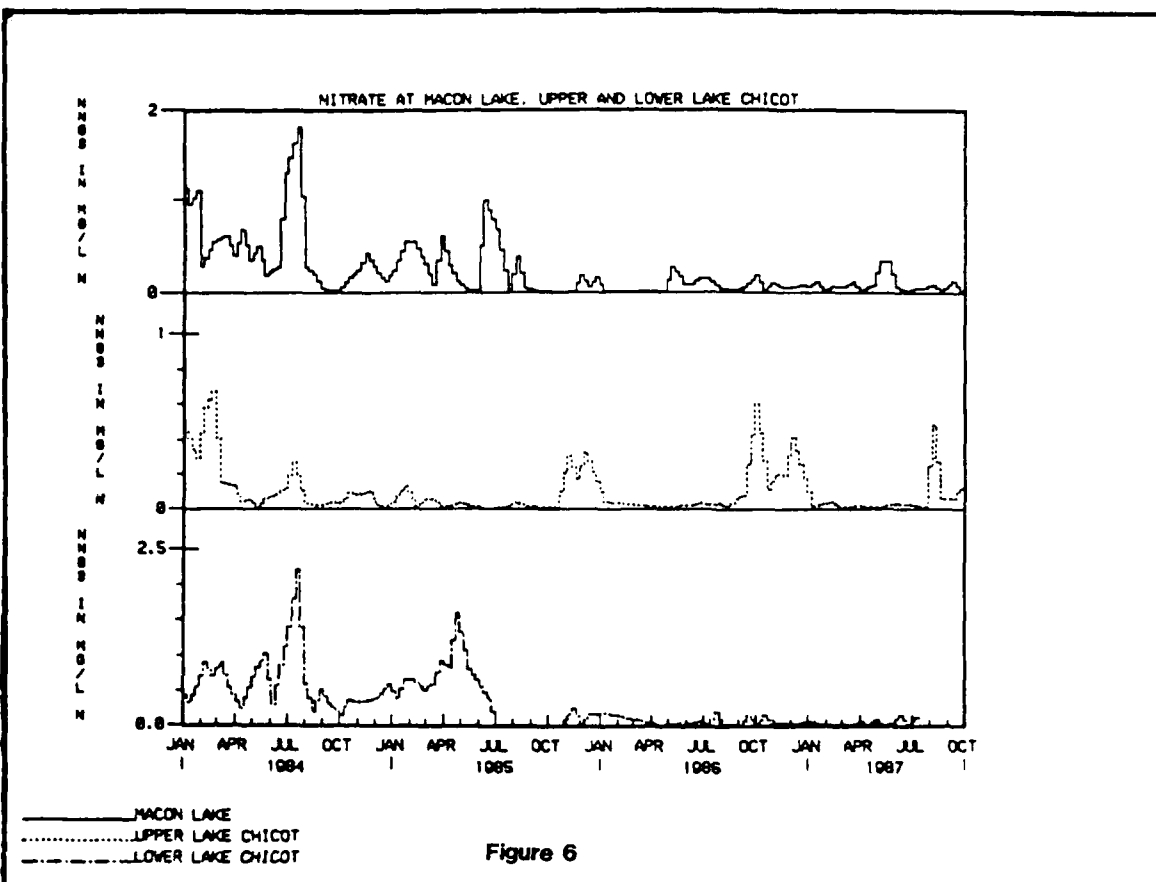

Figure 6

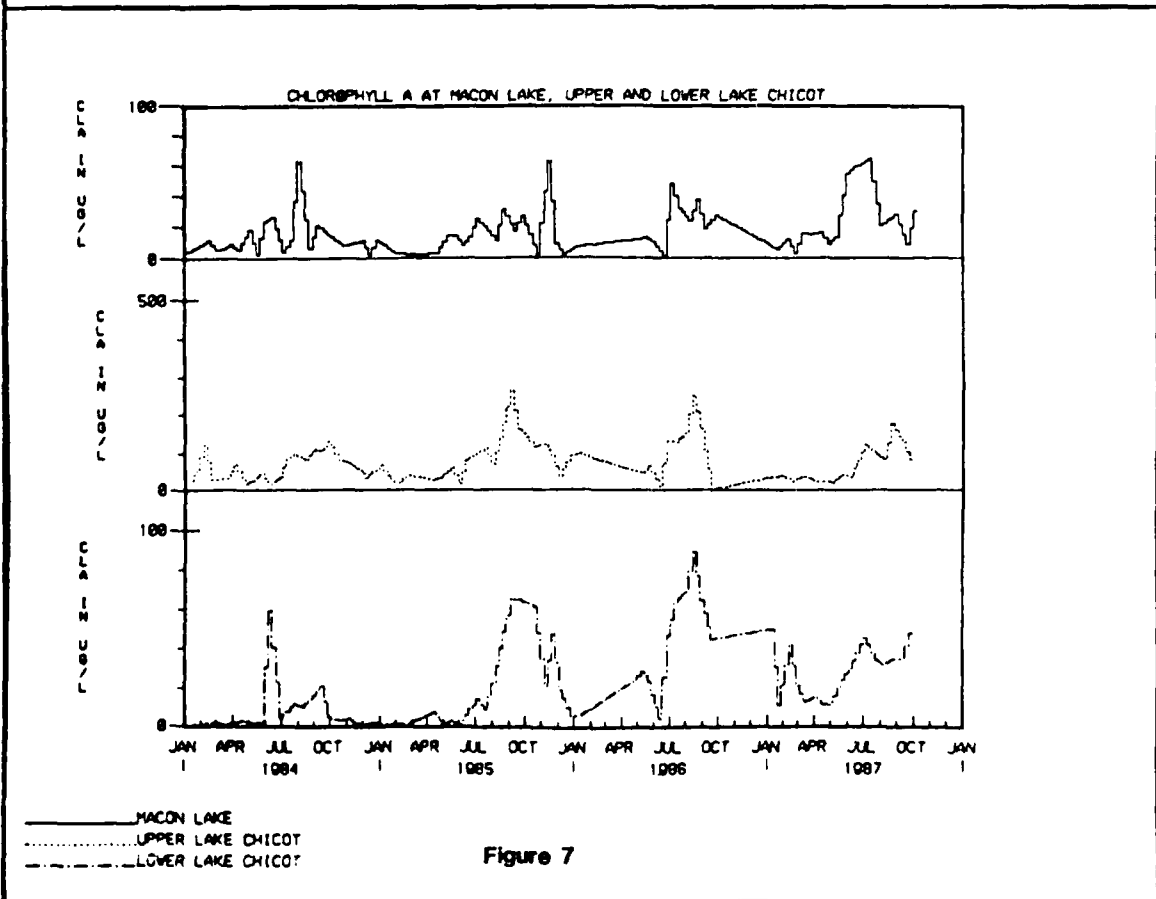

Figure 7

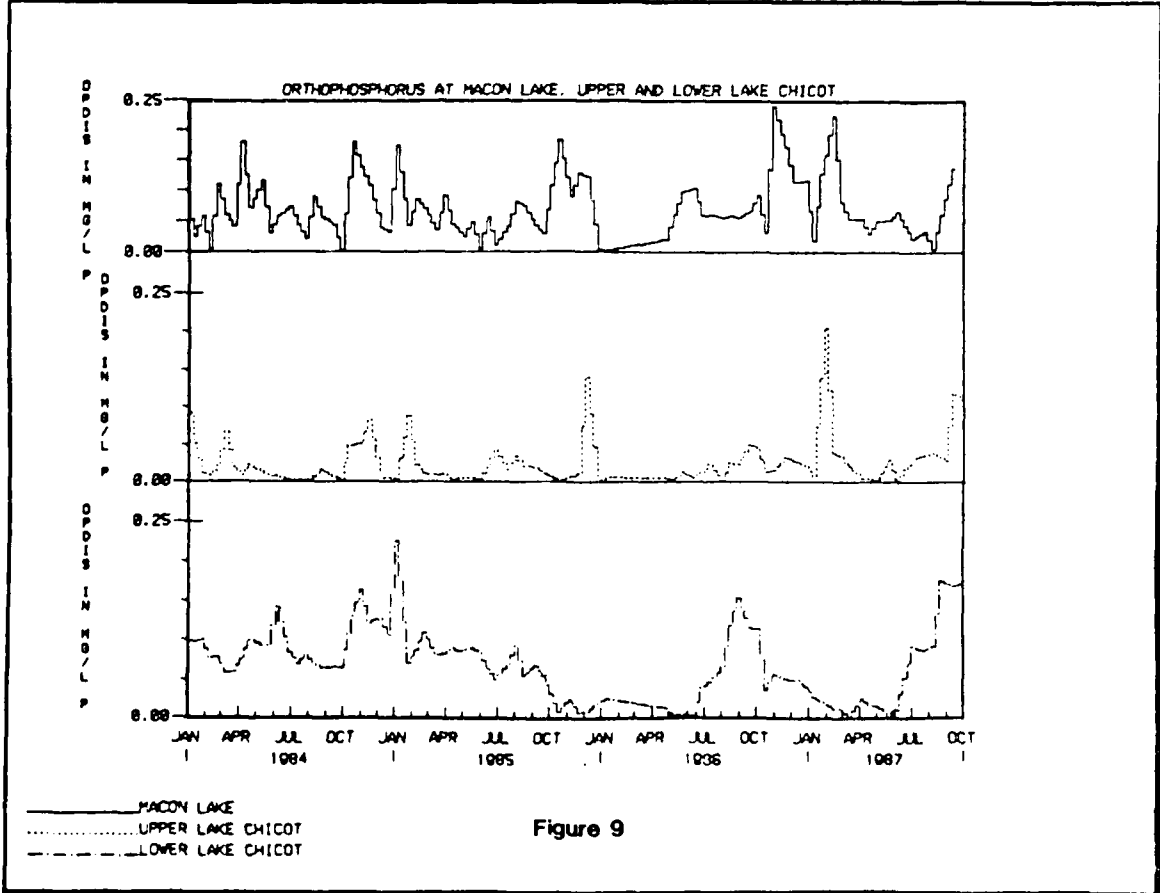
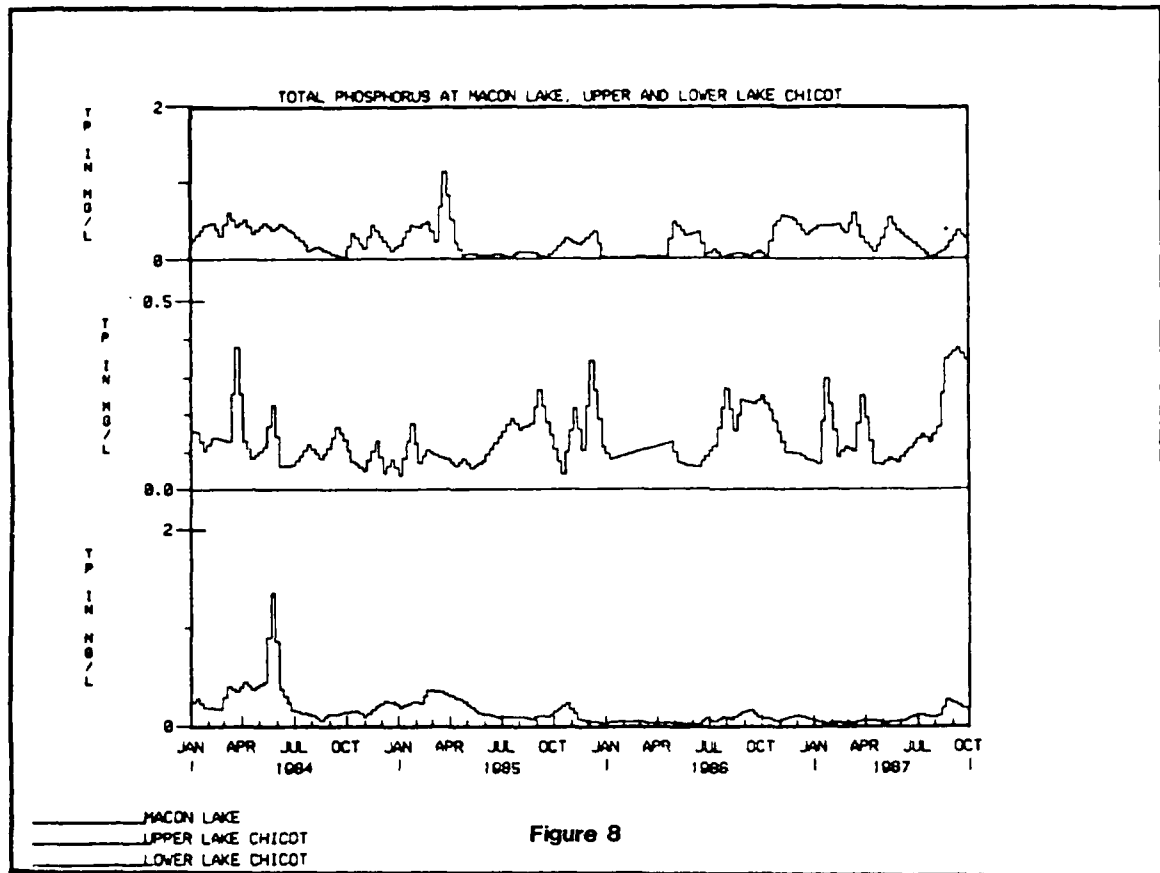

TABLE 1  
RESULTS OF THE ONE-WAY ANALYSIS OF VARIANCE  
COMPARING SAMPLING LOCATIONS

<u>Turbidity</u>			<u>Secchi Depth</u>		
Group	Mean	Station	Group	Mean	Station
A	182	3	A	.65	7-P
A	152	9	B	.45	9-P
A	152	3-P	C B	.38	4-P
A	148	7	C	.37	4
B	37	4	D	.26	3-P
B	28	4-P	D	.25	7
B	25	9-P	D	.22	3
B	12	7-P	D	.20	9

<u>Total Solids</u>			<u>Suspended Solids</u>		
Group	Mean	Station	Group	Mean	Station
A	474	3	A	203	3
A	455	3-P	A B	165	3-P
B	347	7	A B	142	7
C	280	9	B	131	9
D	189	9-P	C	45.9	4
D	185	7-P	C	33.7	4-P
D	172	4-P	C	26.1	9-P
D	167	4	C	17.2	7-P

<u>Nitrate</u>			<u>Chlorophyll A</u>		
Group	Mean	Station	Group	Mean	Station
A	.534	7	A	80.5	4-P
A	.521	9	B	56.5	4
A	.457	3	C	35.7	7-P
B	.147	4	C D	30.4	9-P
B	.134	3-P	E D	20.3	3-P
B	.124	9-P	E	13.8	3
B	.074	4-P	E	11.6	7
B	.044	7-P	E	8.9	9

<u>Total Phosphorus</u>			<u>Orthophosphorus</u>		
Group	Mean	Station	Group	Mean	Station
A	.574	3	A	.091	9
B	.430	9	A B	.082	7
B	.355	7	A B C	.072	3-P
C	.222	3-P	B C	.066	3
C	.145	4-P	C	.059	7-P
C	.140	4	D C	.052	9-P
C	.102	9-P	D E	.036	4
C	.083	7-P	E	.029	4-P

Station 3 = Macon Lake  
Station 7 = Lower Lake Chicot

Station 4 = Upper Lake Chicot  
Station 9 = Ditch Bayou

P = post project



Other indications of the success of the project are the doubling of land values around Lake Chicot, the increase in tourism in Chicot County and a request by the local authorities to have the dam isolating the upper lake breached.

#### REFERENCES

- Bacon, E.J., 1978, Primary Productivity, Water Quality, and Limiting Factors in Lake Chicot, Arkansas Water Resources Research Center, Fayetteville, Arkansas. Publ. No. 56.
- Cooper, C.M., E.J. Bacon, 1981, "Effects of Suspended Sediments on Primary Productivity in Lake Chicot, Arkansas," Proc., Sym. On Surface Water Impoundments, June, 1980, St. Paul, Minnesota, publ. by American Society of Civil Engineers.
- Ouachita Baptist University, 1985, "Physical, Chemical and Bacteriological Water Quality Monitoring at Lakes DeGray, Ouachita, Greeson and Chicot, Arkansas," Arkadelphia, Arkansas.
- U.S. Army Engineer District, Vicksburg, Vicksburg, Mississippi, 1966, Review Report, Lake Chicot, Arkansas.
- U.S. Department of Agriculture Sedimentation Laboratory, 1976-1984, Quarterly Progress Reports, "An Assessment of and Evaluation of Hydrological, Chemical and Microbiological Regimes of Lake Chicot Arkansas," Oxford, Mississippi.
- Price, R.E., 1986, "Water Quality Control of Lake Chicot, Arkansas," Proceedings of a Seminar on Water Quality R & D: Successful Bridging Between Theory and Applications, Ed. R.G. Willey, Washington, D.C.

## CUMBERLAND BASIN WATER QUALITY MODEL

By

Jackson K. Brown<sup>1</sup>

The purpose of this paper is to describe the efforts of the Nashville District to develop a system model to simulate water quality conditions in the Cumberland Basin. The Cumberland Basin, which lies in Tennessee and Kentucky, has a drainage area of 18,000 square miles. The Nashville District operates ten dams within the basin. The system model involves operations at eight of these projects. Four of the projects are classified as tributary storage impoundments and the remainder are classified as main stem navigation impoundments. The projects are listed and statistics are provided in Tables 1 and 2. A schematic drawing showing the relationship of the projects to each other is shown on Figure 1. All eight projects produce hydropower.

The sum of the drainage areas of the four storage projects comprises 55% of the total drainage area of the Cumberland Basin and 75% of the drainage area upstream of metropolitan Nashville. During the summer and fall low flow periods, which are of greatest concern from a water quality standpoint, flows through the main stem projects are almost completely controlled through the regulation of the tributary projects. The primary goal of our water quality modeling activities is to develop the capability to forecast impacts of proposed operations on downstream water quality conditions so that solutions to potential problems can be developed.

The need for this capability first became apparent in the mid-1970's. At this time extensive repair work was being performed on the foundation of Wolf Creek Dam, our largest storage project, and the level of Lake Cumberland was held to near the minimum power pool. Normally, inflows would have been stored in the spring and released later in the year. Since we were not able to store water in the spring, the volume of summer and fall releases from Wolf Creek was significantly below normal, causing low flows throughout the system of navigation projects. As a result, the outflow D.O. concentration dropped to 5 mg/l at Cordell Hull and to 2 mg/l at Old Hickory. Fortunately, this trend did not continue through Cheatham, the next downstream project. (Cheatham Lake exhibits only weak intermittent stratification in its most downstream reaches. Reaeration processes in the Cheatham pool caused the D.O. to increase, despite the significant organic loading from metropolitan Nashville.) From this it is obvious that the critical control point for D.O. in the system of navigation projects is the Old Hickory outflow.

At the time, we knew so little about cause and effect relationships in the system that we were completely surprised by this problem. It was obvious that we needed to define the most important of these relationships to be able to determine the causes of the problem. In subsequent studies one of the

---

1. Hydraulic Engineer, Water Quality Section, Nashville District

first and most important relationships we found was the relationship between flow and outflow D.O. Other pertinent factors we identified included inflow D.O. concentration, water temperature, epilimnion D.O. concentration in the forebay, shape of the withdrawal zone and turbine reaeration characteristics. Once relationships for these factors were established, we combined them in a series of equations which were initially solved manually. To speed this process up, the equations were later incorporated into a computer program or model named DORM (Dissolved Oxygen Routing Model).

DORM is essentially a 1-D model. It takes an inflow slug at a given D.O. concentration, computes the detention time of the water in the hypolimnion (a function of flow and hypolimnion volume), and decreases the D.O. by means of a bulk depletion rate expressed in mg/l per day. This gives the D.O. concentration in the hypolimnion at the dam. Water withdrawn from the hypolimnion comprises the major portion of turbine releases. The remaining computations use the withdrawal zone and turbine reaeration characteristics with a specified epilimnion D.O. value to determine outflow D.O.

To date, DORM has been used primarily for real time forecasts of D.O. conditions 5-10 days in the future. It has also been applied for long range forecasts of several months to assess the adequacy of water in storage to prevent D.O. problems in the main stem projects, and to develop potential operational schemes to prevent or minimize these problems. In practical use we have found the model is generally successful in determining when we are likely to experience problems with low D.O. levels in the Old Hickory releases.

To reduce the input requirements and, hopefully, improve the accuracy of our predictions, we have recently developed a 2-D version of DORM named DORMII. Like DORM, DORMII is essentially an empirical model which relies on bulk D.O. depletion computations and the assumption of slug flow. Any number of longitudinal segments can be specified; however, the model has only two vertical layers, the epilimnion and the hypolimnion. In addition to D.O., the model also performs routing computations for temperature. Because the model calculates temperature and the D.O. in the epilimnion, it requires less daily input data than DORM.

Unlike DORM, which assumes a constant stratification pattern, DORMII has an algorithm which computes stratification as a function of the densimetric Froude number. Thus, the model has the capability to destratify and restratify as flow and water temperature conditions vary. DORMII also computes reaeration within the impoundment being simulated. The model has thus far been calibrated to only one project, Cordell Hull, and we have had no opportunity to use it in a practical application.

As stated previously, both DORM and DORMII rely on a bulk depletion coefficient for D.O. computations. This catch-all term accounts for such factors as inflow BOD, biological fallout, sediment oxygen demand, and, in the case of DORM, reaeration in the upstream reaches of the impoundment. In making forecasts, inflow D.O. values and the bulk depletion rate are specified and the models compute daily outflow D.O. values. During calibration, after all other coefficients are established, the bulk depletion rate which produces the least standard error in calculating outflow D.O. is determined through a trial and error process. This term is useful not only in making forecasts, but is also an excellent water quality index for comparing the organic loading

between similar projects and different years at an individual project.

Unfortunately, the bulk depletion approach does not allow impacts of individual point and non-point source loadings to be determined. This requires a more sophisticated model with nutrient and D.O. budgets. The two models of this type which we are working with on our main stem projects are CE-QUAL-W2 and BETTER. To date, we have applied CE-QUAL-W2 to Cordell Hull and BETTER to Old Hickory. The former application was made by Mr. Stacy Howington of the Hydraulics Laboratory at WES and the latter by Dr. Russ Brown of Tennessee Tech. University. Work is currently underway through a contract with Tennessee Tech to apply BETTER to the remaining two main stem projects, Cheatham and Barkley. These models will give us the capability to define cause and effect relationships from various loadings and other pertinent factors, and to estimate resulting impacts on water quality.

With our real time models we currently have the technological capability to develop operational schemes to prevent or minimize D.O. problems in our main stem projects. However, the regulations and guidelines which we operate under require such schemes to be feasible not only from a technological standpoint, but also from an economic standpoint. Any change to the normal operational pattern requested for water quality control which does not coincide with the power schedule is interpreted as a conflict with hydropower production, an authorized project purpose. The hydropower interests have developed economic relationships which translate such conflicts into monetary losses. To offset these losses, which may or may not be real, we are expected to show monetary benefits associated with improved water quality conditions. Thus far, we have been unable to do this and, as a result, have been completely unsuccessful in implementing operational changes for water quality control in either our navigation projects or the tailwaters of our storage projects.

As water resources engineers charged with the management of the system of dams and reservoirs in the Cumberland Basin, our primary operational objective should be to maximize benefits for all project purposes. These purposes should include not only those stated in project authorization documents (navigation, flood control and hydropower), but also recreation and water quality. As long as the problem is perceived as hydropower versus water quality, we have little hope of impacting project operations.

To develop the capability to evaluate and maximize benefits from our reservoir system, we have recently initiated an optimization model study with the Environmental Lab at WES. This study will include the development of simplified flow routing techniques and economic relationships for water quality, recreation, hydropower and, if necessary, other project purposes. (Some of these needed relationships are already available in programs such as HEC-5Q and will be used whenever possible.) The flow routing techniques and economic relationships will be combined with DORMII to form a system model of the Cumberland Basin. Thus, the system model will actually consist of a series of relatively small models and programs capable of rapid execution on a PC. This compartmentalized approach should allow a great deal of flexibility in employing new programs and models, as they become available. Once the system model is operational, WES will attempt to apply an optimization routine to aid in evaluating our management of the projects. This study is being performed primarily by Mr. Don Hayes and is scheduled for completion in September 1989.

In summary, we are developing models to simulate water quality conditions in the system of main stem reservoirs in the Cumberland Basin and techniques to estimate the monetary value associated with improvements in water quality. By establishing the optimization of overall project benefits as our goal in the management of our water resources projects, we hope to be able to incorporate water quality control as an objective in our reservoir regulation activities.

TABLE 1  
STORAGE PROJECT DATA

<u>Project</u>	<u>Drainage Area (Sq. Mi.)</u>	<u>Surface Area (Acres)</u>	<u>Volume (Ac.-Ft.)</u>	<u>Maximum Depth (Feet)</u>
Wolf Creek	5800	50,000	4,000,000	155
Dale Hollow	900	28,000	1,400,000	155
Center Hill	2200	18,000	1,300,000	175
J. Percy Priest	900	14,000	400,000	100

TABLE 2  
NAVIGATION PROJECT DATA

<u>Project</u>	<u>Length of Backwater (Miles)</u>	<u>Surface Area (Acres)</u>	<u>Volume (Ac.-Ft.)</u>	<u>Maximum Depth (Feet)</u>	<u>Avg. Ann. Discharge (CFS)</u>
Cordell Hull	72	12,000	260,000	80	15,000
Old Hickory	97	22,000	420,000	70	19,000
Cheatham	67	7,000	100,000	40	23,000
Barkley	118	58,000	870,000	75	36,000

# FIGURE 1

## CUMBERLAND BASIN SYSTEM MODEL

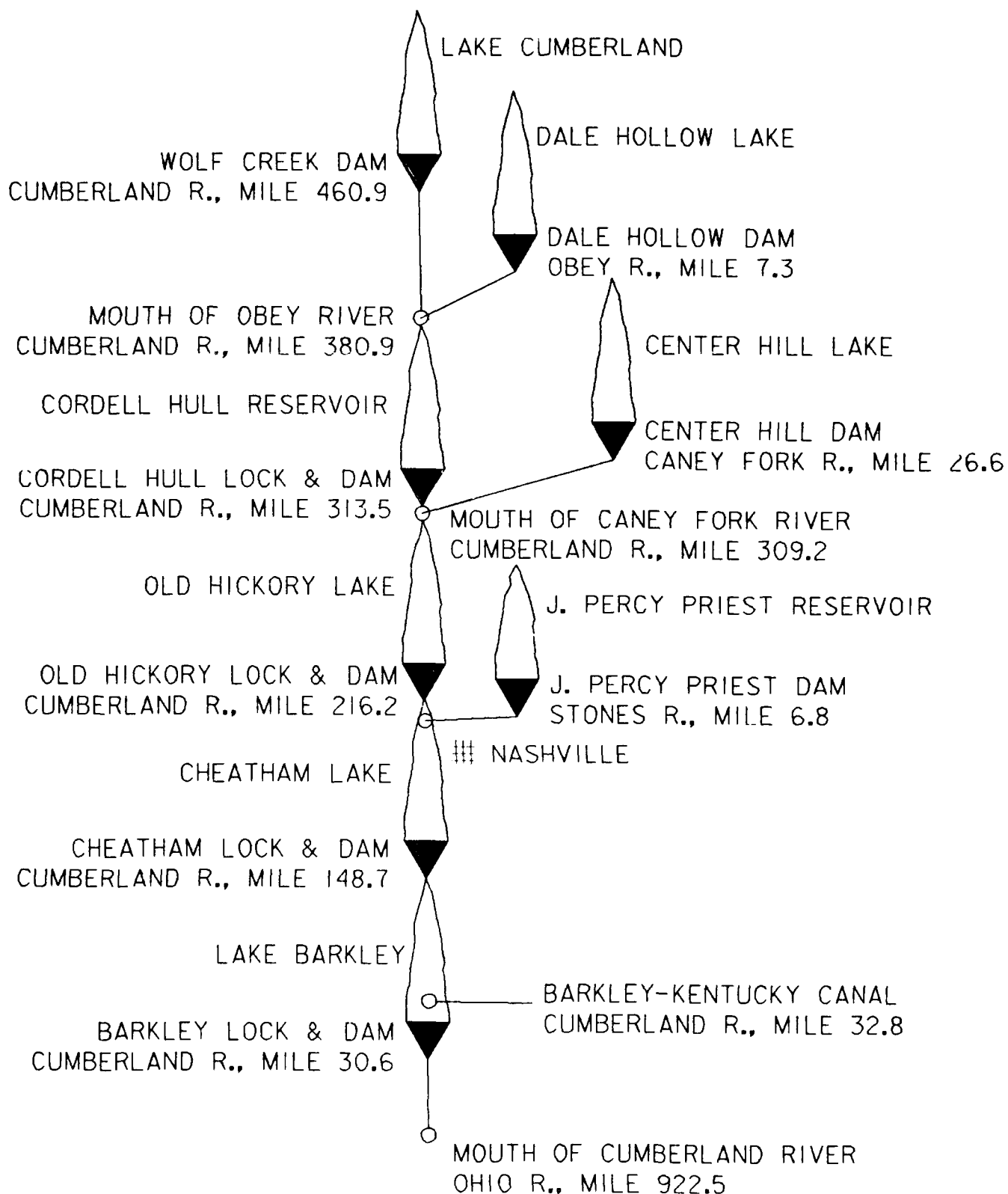

WATER QUALITY EVALUATION OF PROPOSED OUTLETS  
FROM DEVILS LAKE NEAR DEVILS LAKE, ND

by  
Dennis D. Holme<sup>1</sup>

INTRODUCTION

The St. Paul District is conducting feasibility studies for flood damage reduction and other purposes in the Devils Lake basin, a closed subbasin of the Red River Of The North watershed in northeastern North Dakota (Figure 1). The threat of flood damage stems from the recent climatic trend and other factors that have produced a 28-foot rise in the lake level since 1940. Among the alternatives considered were several possible outlet alignments that would permit controlling the upper limit of the lake surface at some desirable elevation by creating an outlet to the Sheyenne River. Some of the possible alignments were eliminated due to economic or political infeasibility. The feasibility of the remaining outlet alternatives will be determined largely on the basis of water quality considerations because Devils Lake is salty.

This paper describes the Devils Lake dissolved mineral dynamics with respect to recent lake level fluctuations and describes the formulation of models used for predicting the effects of a continued lake-level rise and the routing of Devils Lake releases through a downstream river and reservoir system.

DEVILS LAKE BASIN CHARACTERISTICS

The Devils Lake Basin possesses some unique hydrologic and water quality characteristics, which are the result of landforms created by large-scale sub-ice shearing of late Wisconsinan glaciation (Alstine and Bruce 1980). The southern border of the basin is a well-developed moraine made up of material displaced from the depression occupied by the Devils Lake chain and the Stump lakes. A lesser-developed formation, the Sweetwater Moraine, divided the basin laterally and impounded the Sweetwater chain of lakes, which contributes to Devils Lake at the western end during wet periods. The natural outlet of the Devils Lake chain is through East Stump Lake into the Sheyenne River. Devils Lake would have to rise to an elevation of 1450 feet msl to West Stump Lake and to 1457 feet to discharge into the Sheyenne River. Although there is no historical evidence of overflow into the Stump Lake basin, the high salt content of East Stump Lake strongly suggests that such overflows have occurred. The Stump lakes water levels, which are currently more than 28 feet lower than Devils Lake, have not been affected by the

<sup>1</sup>Physical Scientist, Water Quality Unit, St. Paul District



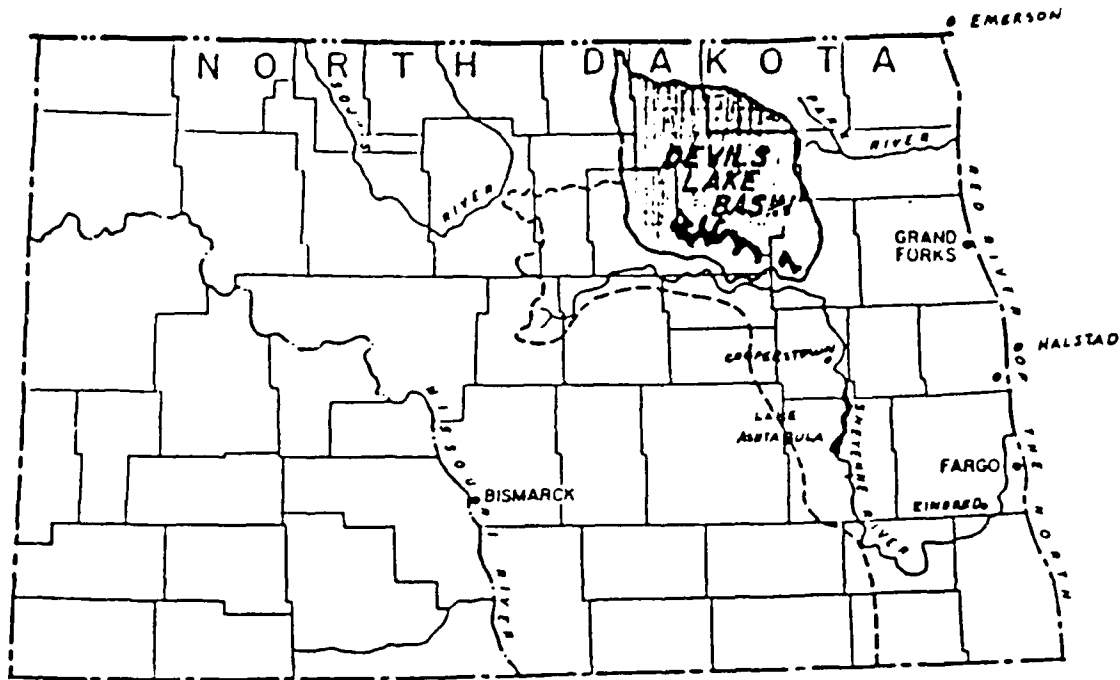

FIGURE 1 - STUDY AREA LOCATION MAP, DEVILS LAKE BASIN

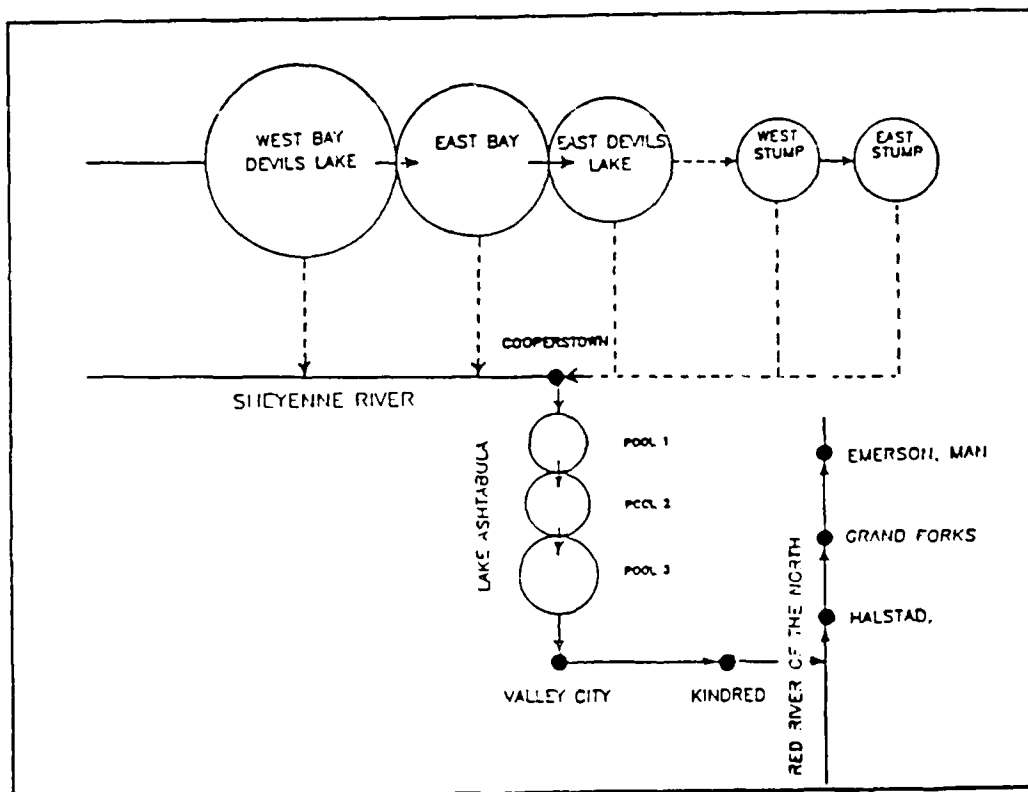

FIGURE 2 - DEVILS LAKE - SHEYENNE RIVER - RED RIVER OF THE NORTH MODEL CONFIGURATION

factors contributing to Devils Lake's recent rise. The total dissolved solids (TDS) concentration of East Stump Lake often exceeds 150,000 mg/l. More than 70% of its mineral content is sulfate.

The lake levels and mineral content of the Sweetwater group, which feeds Devils Lake through Mauvais Coulee, are controlled largely by seasonal inflow and outflow. The water is relatively fresh (less than 500 mg/l TDS), and fluctuations in lake levels and total dissolved solids (TDS) concentrations occur seasonally.

In contrast, the levels and mineral content of the Devils Lake chain are controlled largely by long-term climatic variation and evaporation. The water is highly mineralized because with no outlet the dissolved solids accumulate. The lake levels and TDS concentrations vary dramatically over periods measured in decades rather than seasons. Most of the inflow to Devils Lake enters at the western end of the chain from Mauvais Coulee. Water evaporating throughout the chain is replaced by water flowing in from the west carrying progressively concentrated solutions of dissolved solids. This perennial eastward transport of dissolved solids is never reversed. This accounts for the high TDS concentrations of East Bay (5200 mg/l) and East Devils Lake (8200 mg/l).

According to accounts of early settlers of the region, the elevation of Devils Lake was about 1446 feet msl in 1830. During the middle 1800's, a northern pike fishery flourished until the lake level dropped below 1430 feet in 1889. At that time the pike disappeared entirely due to increasing or fluctuating mineral concentrations. By 1940 the lake level had dropped to its historic low of 1402 feet. The TDS concentration of the Main Bay at that time was greater than 25,000 mg/l. At its present elevation of 1428 feet with a TDS concentration of about 1900 mg/l, the local economy again enjoys a thriving sport fishery tempered by the threats of flood damages if the lake continues to rise and by increasing salinity if it declines.

#### STUDY OBJECTIVES

The water quality study has focused primarily on predicting TDS and sulfate concentrations in the lake chain and downstream under various outlet operating scenarios. It involved the development of three mass-balance models for: (1) predicting the in-lake freshening effects of an indefinite continuation of the recent rising trend with and without the operation of an outlet, (2) routing of Devils Lake discharges through Lake Ashtabula Reservoir to Kindred, ND, on the Sheyenne River, and (3) routing the affected Sheyenne River water down the Red River of the North to Emerson, Manitoba. Figure 2 describes the configuration of the models.

#### THE DEVILS LAKE MODEL

The Devils Lake model represents the lake chain as a series of five basins including Main Bay, East Bay, East Devils Lake, West Stump Lake, and East Stump Lake. The first three basins are considered to be hydraulically

contiguous. The Stump Lake basins are considered to be connected to East Devils Lake by a lift station and excavated channel. Each basin operates under a separate set of elevation-storage and elevation-area functions, and each is assigned an initial condition for storage and TDS mass based on 1978 field data. Inflow volume (annual) entering the Main Bay is allocated among the contiguous basins according to their respective surface areas. The connecting flows are then calculated based on that allocation. TDS loading is calculated based on the connecting flow volume and the TDS concentration of the respective upstream basin as computed during the previous iteration. The volume of each basin is then reduced according to surface areas and a specified rate of net annual evaporation. Finally, the updated water surface elevations, surface areas, and TDS concentrations are computed based on the updated volumes. When a specified target elevation is reached, excess volume (with its TDS load) is discharged from East Devils Lake into West Stump Lake or into the Sheyenne River from one of the alternative outlet locations, or both.

The Devils Lake Model was used to predict the in-lake effects of an indefinite continuation of the average inflow conditions of the past 20 years with and without an outlet to control the lake level. The outlet scenarios included numerous combinations of Devils Lake and Stump Lake target elevations with discharges from the five alternative outlets. The program operates interactively, prompting the user for the above variables.

#### THE SHEYENNE RIVER MODEL

The Sheyenne River model is a mass-balance routing program that computes TDS concentrations at the Cooperstown gage, three segments of Lake Ashtabula Reservoir, and at the Kindred gage, located about 100 miles downstream of Baldhill Dam (Valley City). Cooperstown is considered to be the point of confluence with Devils Lake outflows and the point of inflow to Lake Ashtabula. Lake Ashtabula is represented as a series of three pools separated at the two reservoir crossings, Keyes Crossing and Ashtabula Crossing. The reservoir width is constricted to the width of the bridge openings, 125 ft. and 160 ft., respectively, at those locations. Thus, each crossing is represented as a dam with an outlet structure, and the inflow quantities for each pool are determined by modeled upstream conditions. The reason for segmenting the reservoir in this way is so that the spatial as well as temporal effects of reservoir storage could be represented. The effect is that a seasonally variable TDS gradient can be seen over the length of the reservoir. Mass quantities at Kindred are computed by adding estimated local and tributary quantities to the computed Baldhill Dam outflow with a nine-day shift to allow for travel time.

The Cooperstown data set includes daily flow and TDS data (computed from specific conductance) from the USGS gage for the period June 1981 through August 1982. The record was then extended by repeating the 1981 and 1982 data so that possible cumulative effects due to reservoir storage could be observed. Initial conditions for TDS in the three pools of Lake Ashtabula are from U.S. Geological Survey (USGS) measurements made in June 1981. Baldhill Dam and Kindred flow data are from USGS records at the respective gages. The

TDS concentrations of the estimated local flow between the dam and Kindred were assumed to be equal to those measured at Cooperstown.

The daily reservoir hydraulic routing is solved by computing the total reservoir change-in-storage based on inflow and outflow, allocating the change-in-storage among the three pools proportionally according to surface areas of the pools, and calculating the connecting flow rates at the crossings according to that allocation. The TDS load to each segment is then computed based on the respective inflows. TDS mass is assumed to be homogeneously distributed within each segment upon each daily update. The Sheyenne River model program operates interactively, prompting the user for Devils Lake outflow and TDS quantities.

#### THE RED RIVER MODEL

The Red River model extends the results of the Sheyenne River at Kindred predictions down the Red River Of The North, predicting TDS concentrations at Halstad, ND, Grand Forks, MN, and Emerson, Manitoba. The program is a simplified version of the Sheyenne River program in that it uses a monthly rather than daily computation interval and does not allow for time-of-travel down the Red River.

The program combines the mean monthly flow and TDS load at Kindred with an estimated local and tributary flow and TDS load between Kindred and Halstad, computing the resulting TDS concentration at Halstad. The procedure is then repeated for the Grand Forks and Emerson segments. The local and tributary flows were estimated by taking the difference between historical mean monthly flows at the two stations.

#### RESULTS

The Devils Lake model produced output describing 80 years of operations under 26 different scenarios for each of the five lake segments. The complete results are reported in "Feasibility Study and Environmental Impact Statement, Flood Control and Related Purposes, Devils Lake Basin, North Dakota, Volume 1B: Water Quality, April 1987 (Draft)." The results described below illustrate some of the many possibilities for in-lake water quality impacts depending on the location of the outlet channel along the lake chain.

Figures 3 and 4 describe the future without an outlet, assuming that the average annual inflow trend of the past 20 years (79,000 ac-ft) will continue over the next 80 years. As the lake level approaches 1440 feet msl, the marginal evaporation, a function of increasing surface area, approaches the inflow volume, and no further rise occurs. Figure 4 shows the future concentration trends of the three major bays. West Bay and East Bay would probably continue to freshen somewhat during the next 40 years but would begin to concentrate again after that. The current concentrating trend of East Devils Lake would continue indefinitely.

FIGURE 3  
 DEVILS LAKE ELEVATION PROJECTION  
 WITH NO OUTLET

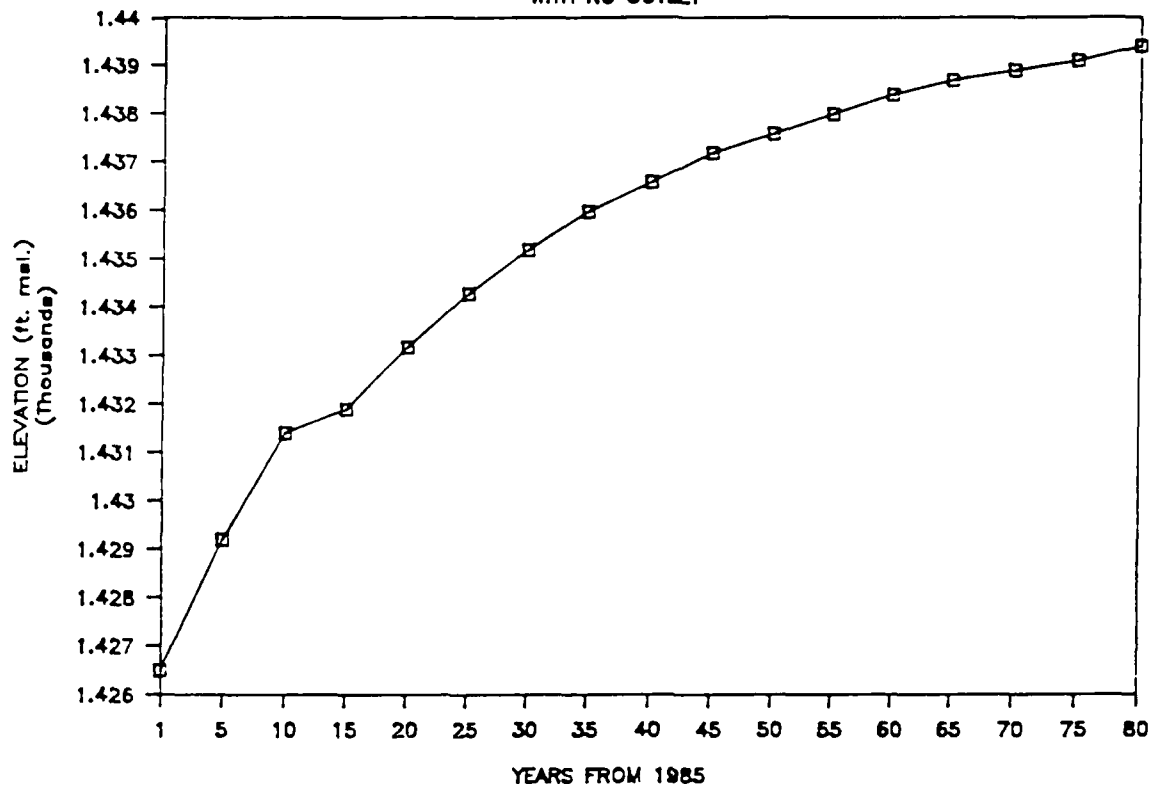
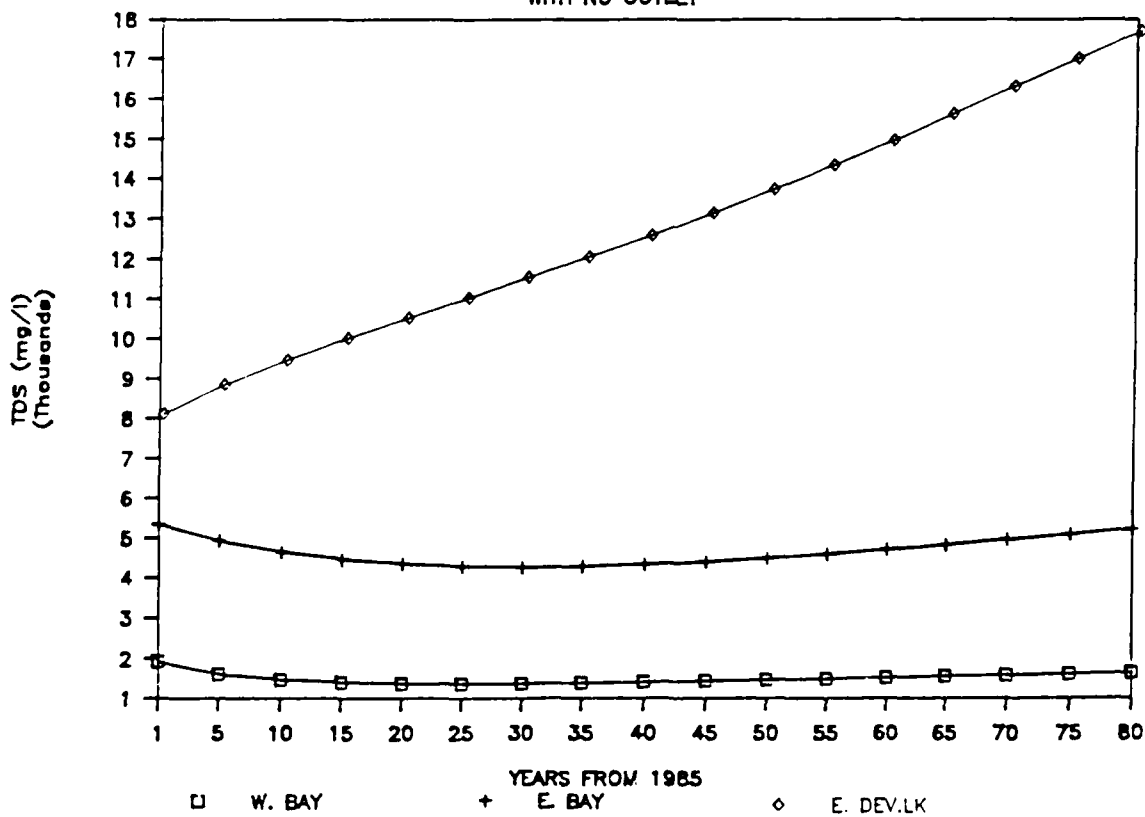

FIGURE 4  
 DEVILS LAKE TDS PROJECTIONS  
 WITH NO OUTLET



The future trends described above would be substantially altered by limiting the lake's rise to elevation 1435 by discharging excess volume to the Sheyenne River. The future concentrating trend of West Bay (Figure 5) would be attenuated regardless of the outlet location. The future concentrating trend of East Bay (Figure 6) would be increased by operating an outlet from the West Bay or reversed by operating an outlet from East Devils Lake. The future concentrating trend of East Devils Lake (Figure 7) would likewise be increased with a western outlet or reversed with an Eastern outlet.

The Sheyenne River model produced output describing the impact of Devils Lake outflow under numerous operating scenarios and outflow quality conditions. Figure 8 shows a simulation of the baseline condition in three segments of Lake Ashtabula Reservoir using historical 1981-1982 tributary and reservoir operation data. The plots illustrate the effects of seasonally variable inflow quality and the attenuation of concentration extremes in the lower pool by the dilution effect of storage in the successive upstream pools. Figure 9 shows the result of releasing Devils Lake water from West Bay Devils Lake (1500 mg/l TDS) using a release schedule designed to minimize the downstream impact. This is the most optimistic scenario. Releasing from East Bay and East Devils Lake resulted in TDS concentrations in Lake Ashtabula exceeding 4000 mg/l and 8000 mg/l, respectively. These high TDS concentrations are of particular concern considering that nearly 50% of the Devils Lake TDS is sulfate. The North Dakota state standard for sulfate on the Sheyenne River is 450 mg/l.

Figures 10 and 11 compare the Devils Lake effects at Valley City and at Kindred with the baseline simulation. Another consideration at Kindred (not apparent in the monthly mean plots shown) is that extreme short term variations occur due to local runoff events and Baldhill Dam operations.

Figures 12 - 13 compare the Devils Lake outlet effects on the Red River Of The North at Halstad, MN, and Emerson, Man., with the simulated baseline conditions. The State of Minnesota's water quality standard for TDS on the Red River Of The North is 500 mg/l. The Province of Manitoba also uses 500 mg/l as an objective or "alert level" for TDS. The Red River of the North already exceeds that concentration during some low-flow periods, but the simulations show that Devils Lake operations would increase both the magnitude and duration of those exceedances.

#### REFERENCE

Alstine, Van and James Bruce, Postglacial Ostracod Distribution and Paleocology, Devils Lake Basin, Northeastern North Dakota, University Microfilms International, Ann Arbor, Michigan, 1980.

FIGURE 5  
 WEST BAY TDS PROJECTION  
 WITH AND WITHOUT AN OUTLET

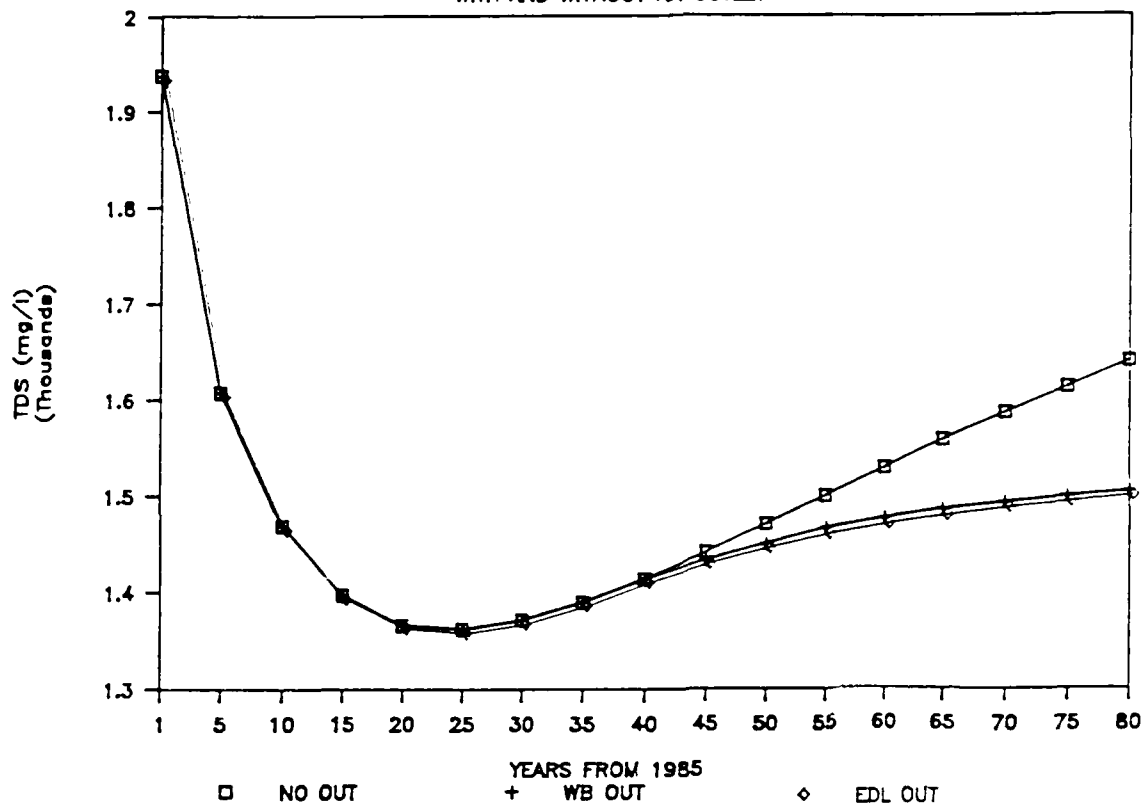

FIGURE 6  
 EAST BAY TDS PROJECTIONS  
 WITH AND WITHOUT AN OUTLET

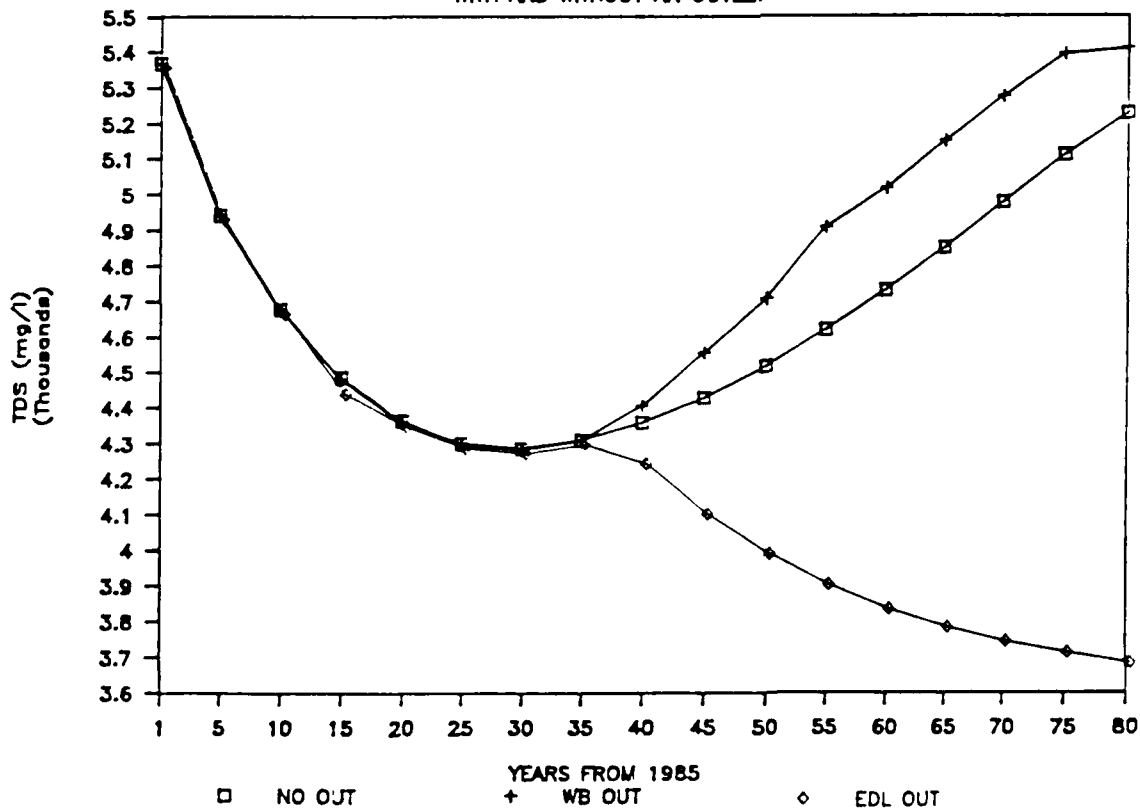

FIGURE 7  
EAST DEVILS LAKE TDS PROJECTIONS  
WITH AND WITHOUT AN OUTLET

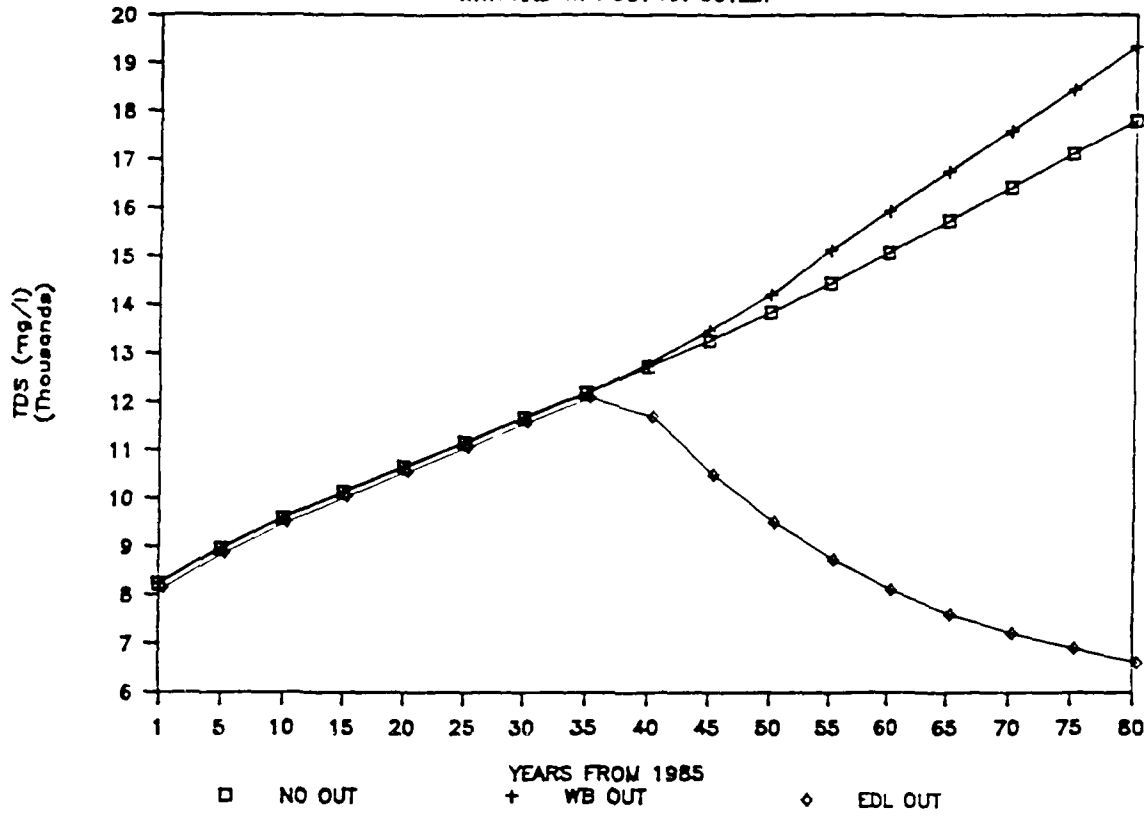



FIGURE 8  
LAKE ASHTABULA TDS ROUTING

BASELINE CONDITION

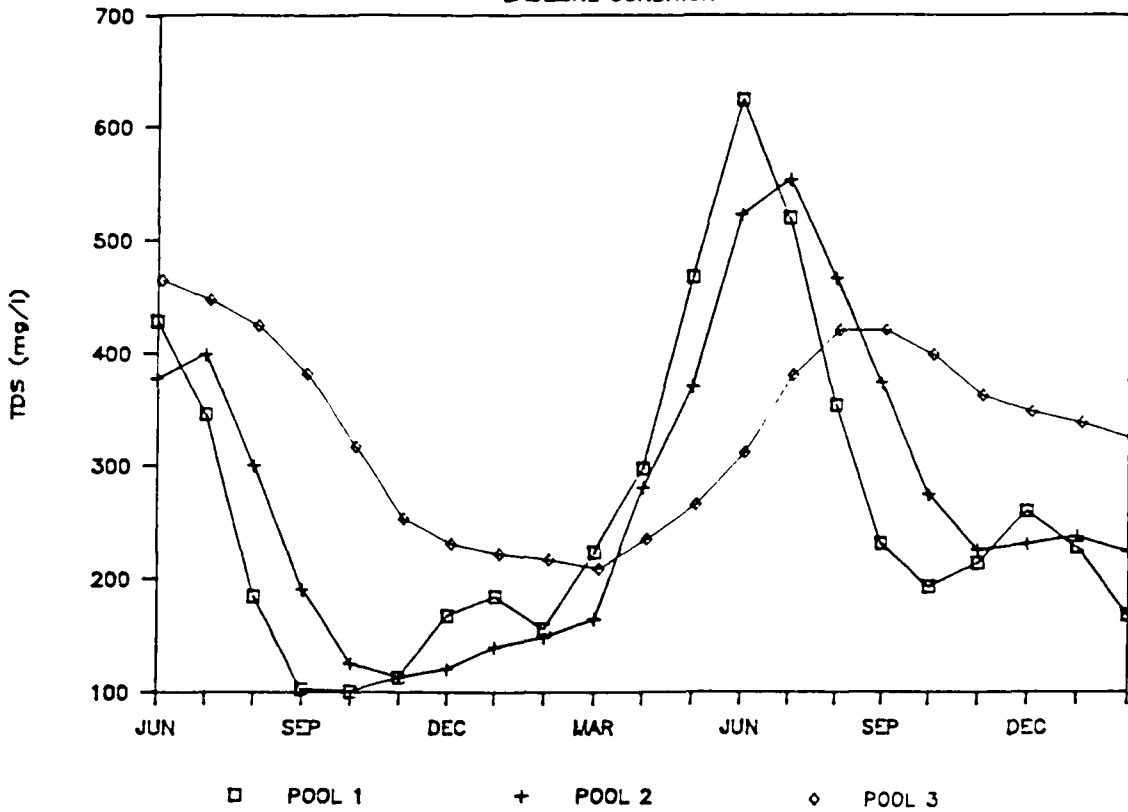

FIGURE 9

LAKE ASHTABULA TDS ROUTING

VARIABLE DL OUTFLOW 1500 mg/l

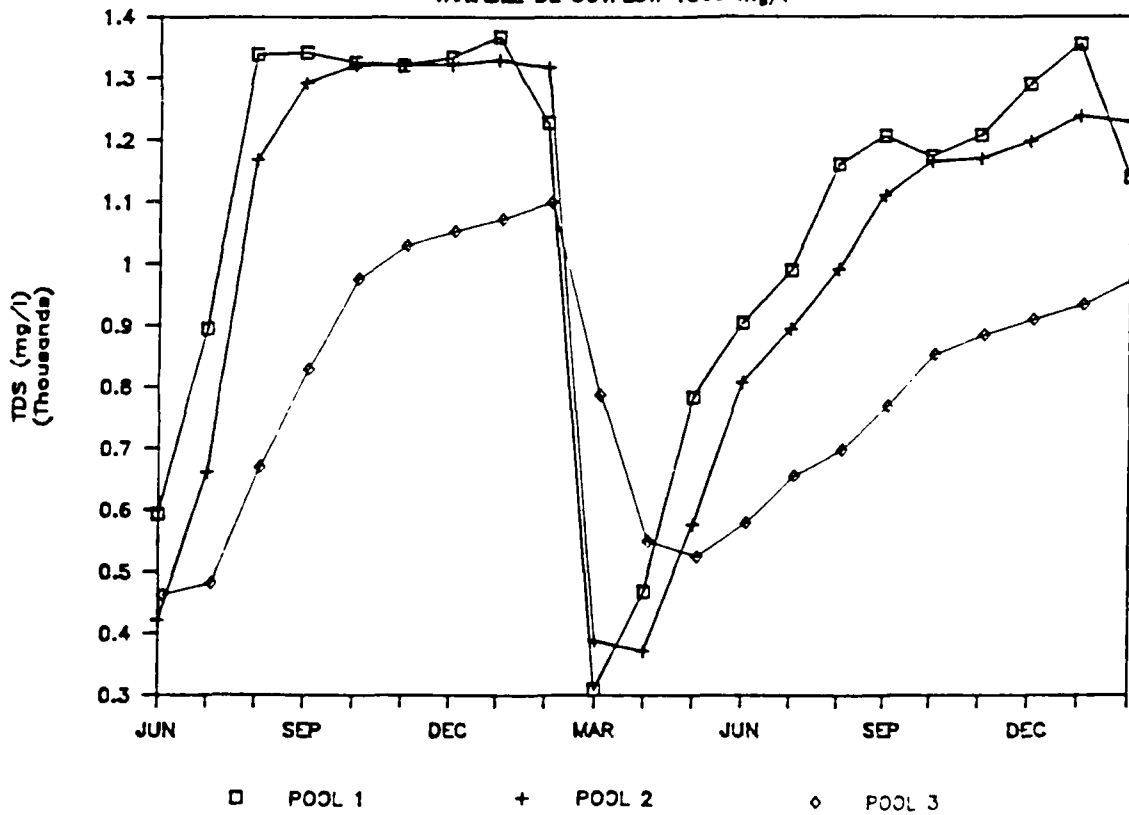

FIGURE 10  
 SHEYENNE R. AT VALLEY CITY, ND  
 VARIABLE DL OUTFLOW 1500 mg/l

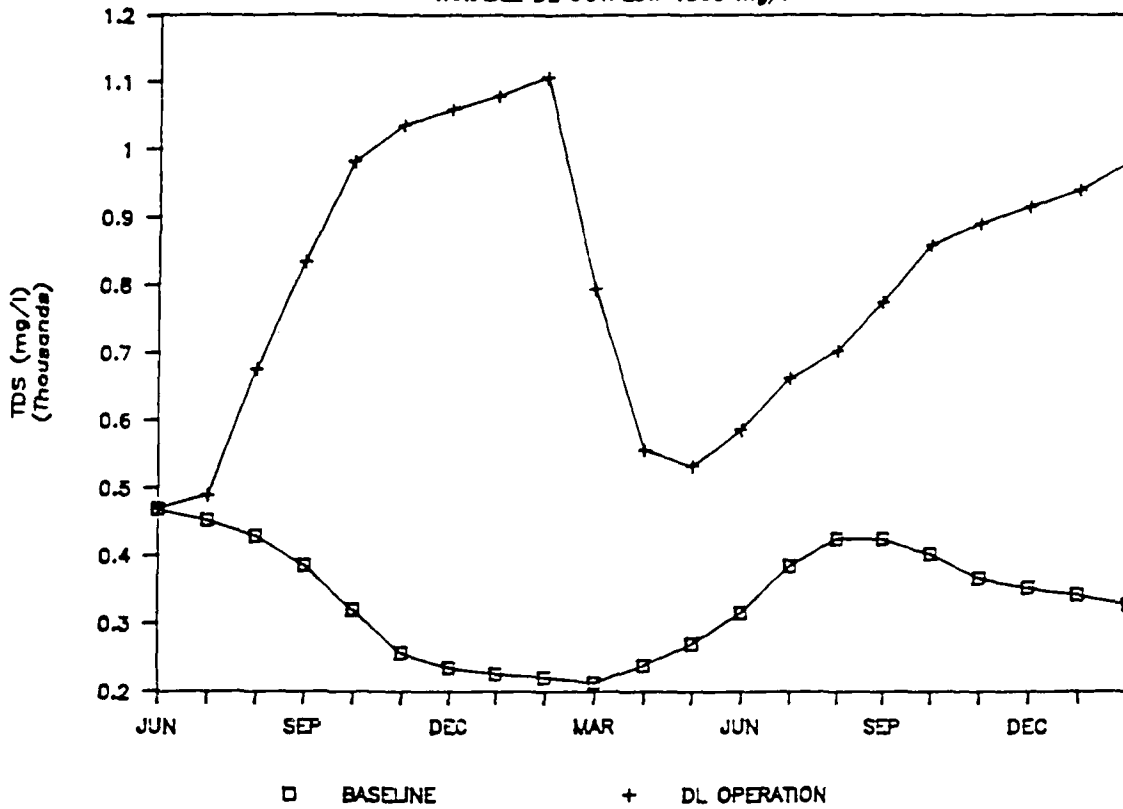

FIGURE 11  
 SHEYENNE R. AT KINDRED, ND  
 VARIABLE DL OUTFLOW 1500 mg/l

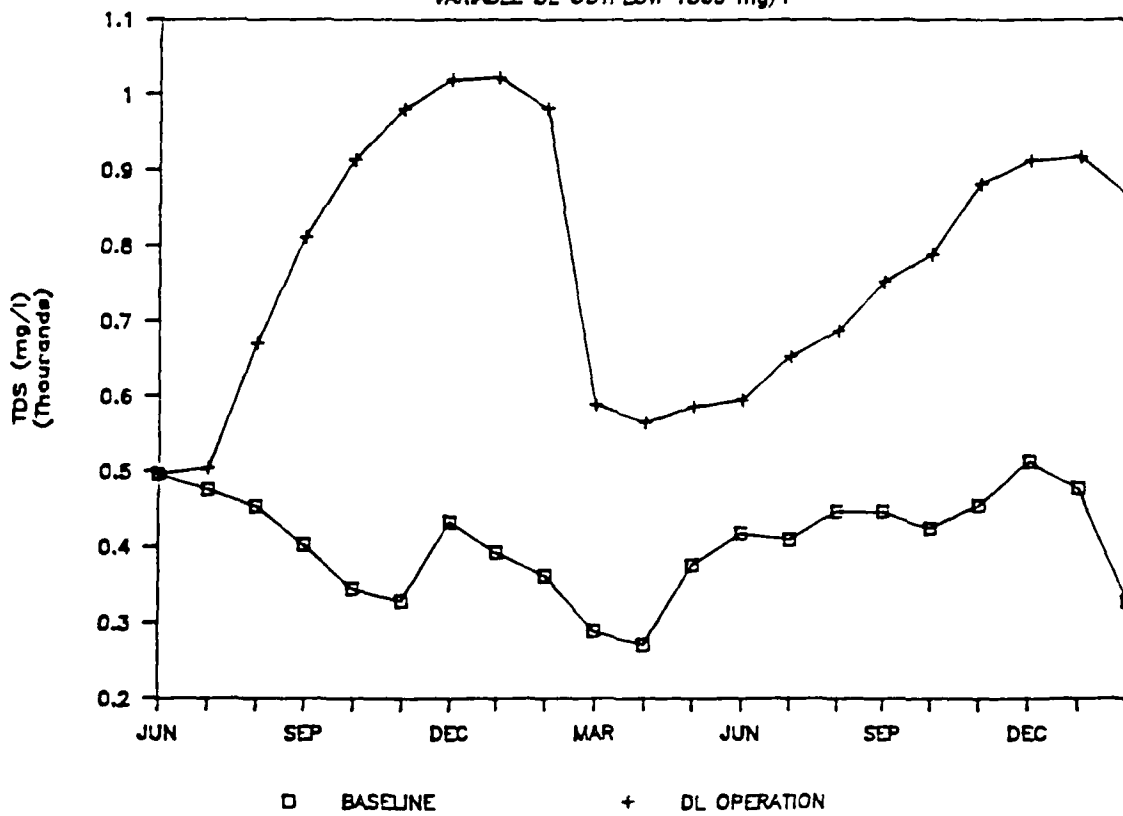

FIGURE 12

RED RIVER OF THE NORTH AT HALSTAD, ND

VARIABLE DL OUTFLOW 1500 mg/l

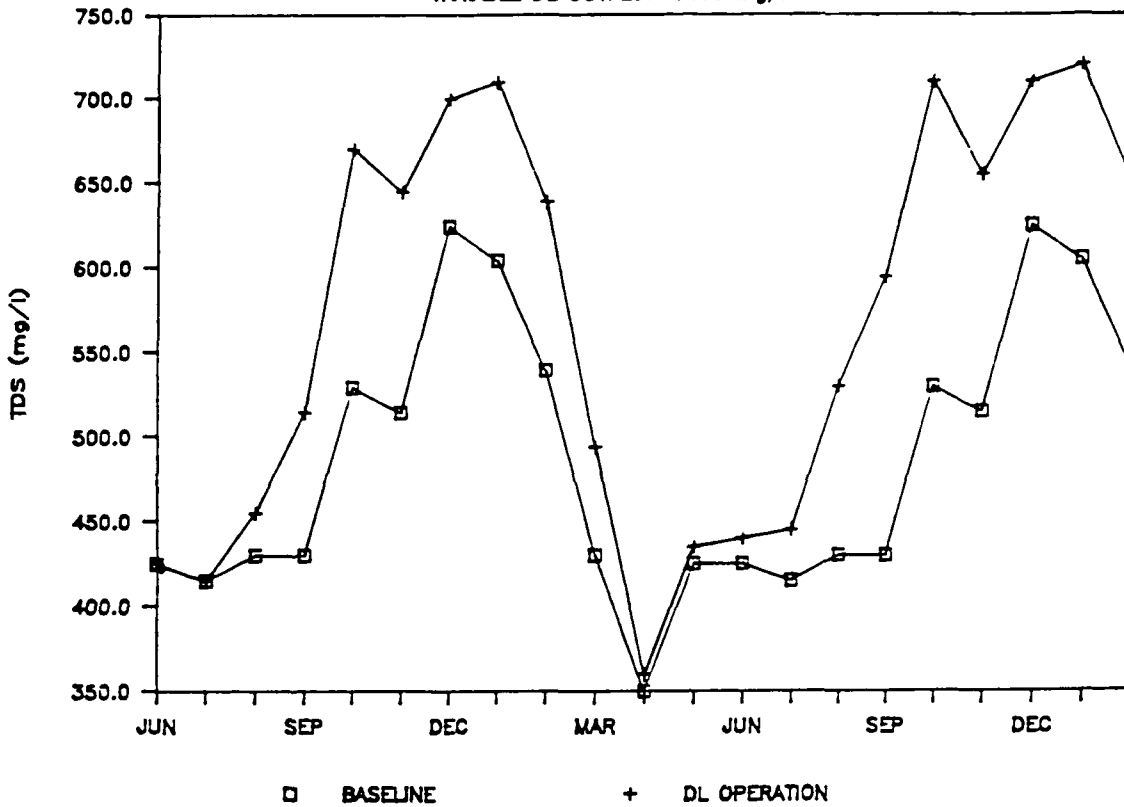
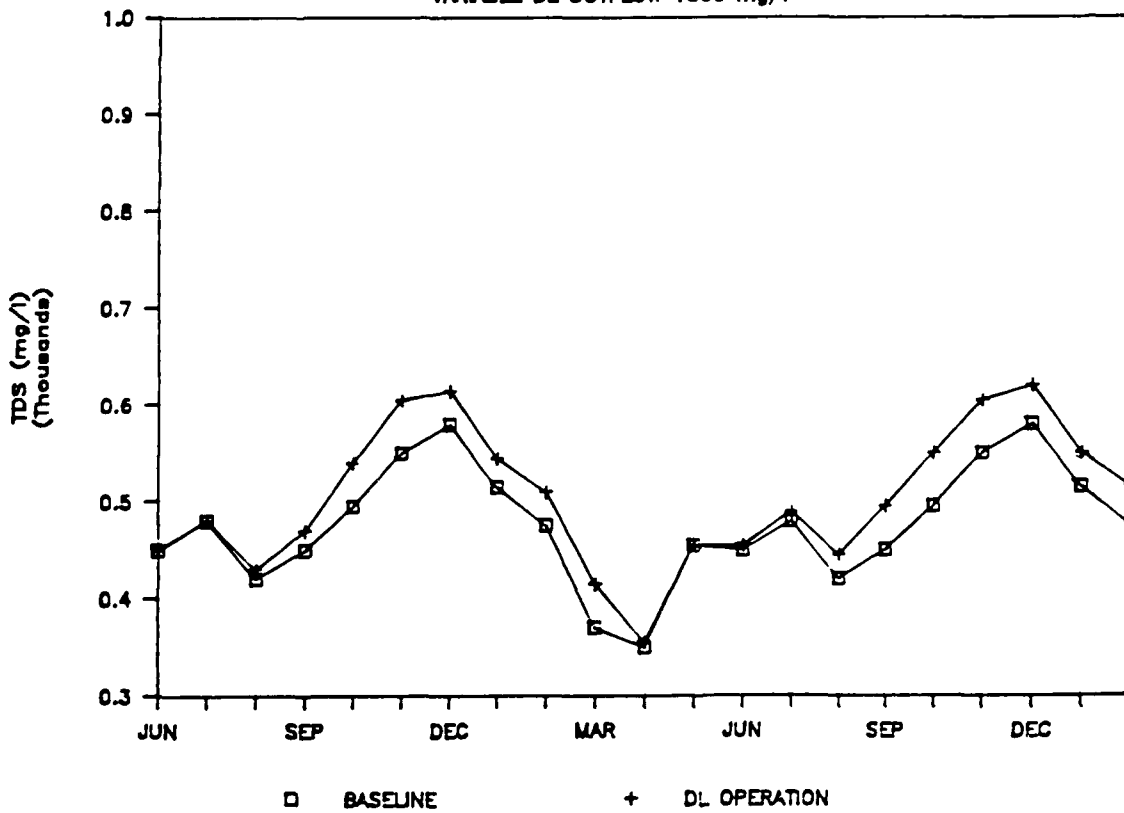

FIGURE 13

RED RIVER OF THE NORTH AT EMERSON, MAN

VARIABLE DL OUTFLOW 1500 mg/l



# THERMAL STRATIFICATION IN MILL CREEK RESERVOIR

By

Tim Bartish <sup>1</sup>

## INTRODUCTION

Despite its shallow depth, thermal stratification and associated reductions in water quality (anoxia, hydrogen sulfide production) have been occurring in Mill Creek reservoir since 1970. Because the reservoir is highly managed and is very small, these processes presently do not have significant ramifications to the overall quality of the system. Although not a serious concern to the District, nor having wide-reaching applications to other systems due to the uniqueness of the reservoir's structure and hydrology, this discussion is an attempt to document and quantify the conditions present in the reservoir, to focus attention on the problems, especially in light of proposed actions to occur, and to consider some of the potential measures to optimize water quality.

## PHYSICAL FEATURES

Mill Creek reservoir is a small, off-stream flood-control reservoir, created in 1941 to provide flood protection to the town of Walla Walla in southeast Washington. Spring runoff flood waters in flows of greater than 1400 cfs are shunted to this reservoir at a diversion dam structure 3 miles upstream of Walla Walla (Figure 1). The reservoir provides for 8300 acre-feet of storage for flood control purposes. Typically, flood waters diverted to the reservoir are rapidly evacuated from the reservoir via an outlet structure (intake tower, Figure 1) and various return canals. This water then enters one of two creeks which bypass Walla Walla to the south and flow to the Walla Walla River. Following high flow conditions in Mill Creek and reduction of volume in the reservoir to approximately 1300 acre-feet, no further discharge of water is allowed from the reservoir. On the average, Mill Creek flows exceed 1400 cfs and necessitate the use of the reservoir every 3 to 5 years.

Since 1953, the District has attempted to maintain a conservation pool of 1205 feet msl for recreational purposes. Water has been diverted to the reservoir annually, regardless of flow conditions, to fill the reservoir and provide recreational benefits. During non-flood years, the outlet structure was not used and no discharge of water from the reservoir occurred. Annual filling during both flood and non-flood-condition years was accomplished during the spring runoff (March through early May). During non-flood years, actual filling occurred shortly after the peak flows subsided. Reservoir elevations were typically at 1190 feet msl prior to the annual filling, thus requiring diversion of at least 500-800 acre-feet.

<sup>1</sup> Limnologist, Environmental Resources Branch, Walla Walla District

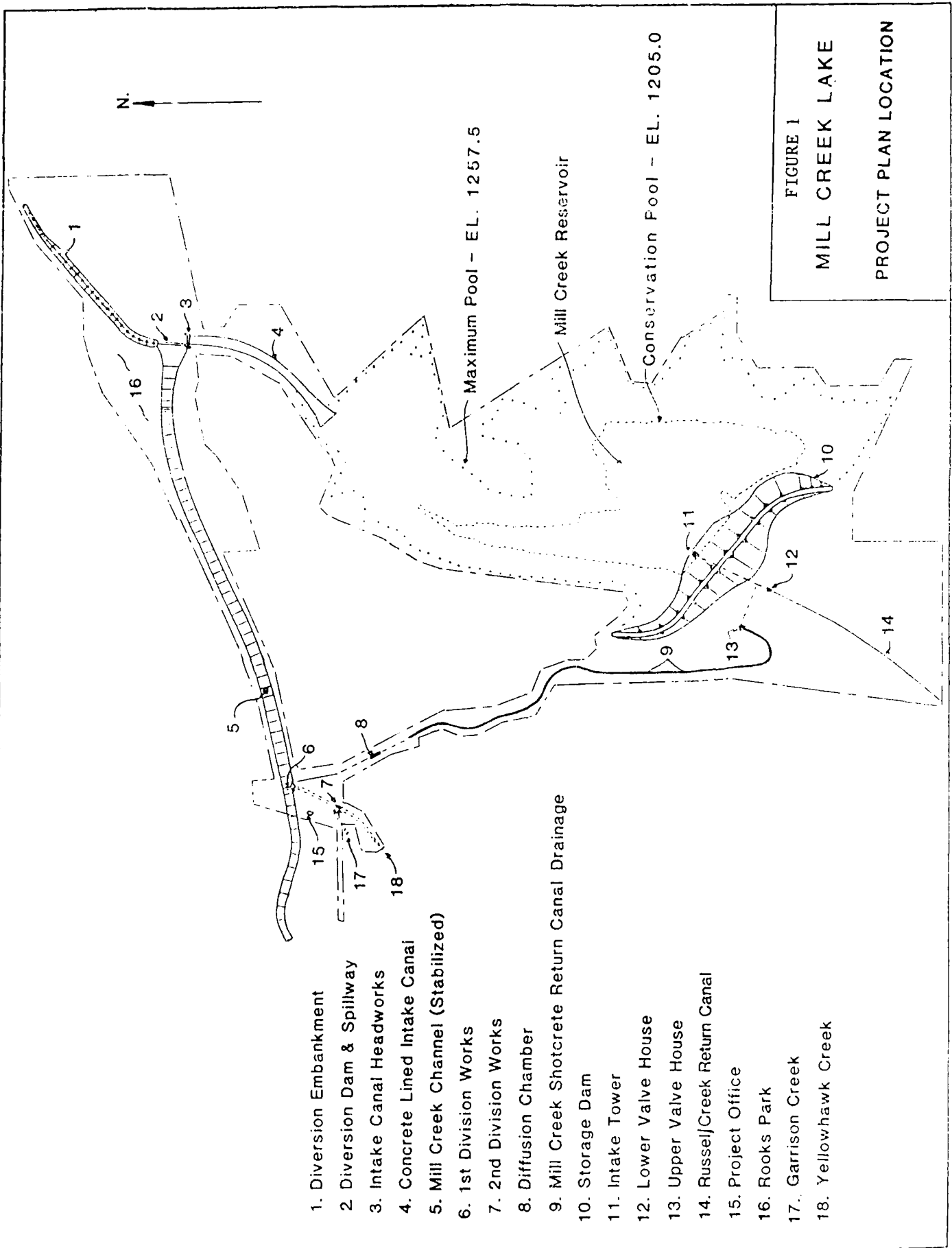

- 1. Diversion Embankment
- 2. Diversion Dam & Spillway
- 3. Intake Canal Headworks
- 4. Concrete Lined Intake Canal
- 5. Mill Creek Channel (Stabilized)
- 6. 1st Division Works
- 7. 2nd Division Works
- 8. Diffusion Chamber
- 9. Mill Creek Shotcrete Return Canal Drainage
- 10. Storage Dam
- 11. Intake Tower
- 12. Lower Valve House
- 13. Upper Valve House
- 14. Russell/Creek Return Canal
- 15. Project Office
- 16. Rooks Park
- 17. Garrison Creek
- 18. Yellowhawk Creek

Maximum Pool - EL. 1257.5

Mill Creek Reservoir

Conservation Pool - EL. 1205.0

FIGURE 1  
MILL CREEK LAKE  
PROJECT PLAN LOCATION

Although no discharge of water from the reservoir occurs below elevation 1212 feet msl, the water level drops substantially below this elevation due to seepage. This seepage has been occurring since the creation of the structure, although in 1981 a cutoff wall was installed into the foundation of the dam. Presently, seepage occurs around the cutoff wall structure. The foundation of the reservoir is highly pervious and seepage occurs at an estimated rate of up to 10 cfs, depending on the water surface elevation. Most of the seepage occurs through the slopes of the reservoir and not through the bottom, as seepage ceases once the reservoir elevation falls below about 1190 feet msl (bottom of the reservoir is at 1175 feet msl). At this elevation, the volume in the reservoir consists of 200-400 acre feet and the surface area is 40 acres. In order to offset this drawdown and maintain a recreational pool, additional low volume diversions of water from Mill Creek to the reservoir are necessary. These additional diversions are conducted during discrete periods, not continuously, and cease once the irrigation season commences downstream on Mill Creek, normally in late April/early May. Subsequently, the water level continues to drop until it reaches its typical winter elevation of 1190-1195 feet. The reservoir seldom goes completely dry.

Thus, in essence, Mill Creek reservoir is a pond: surface recharge to the reservoir occurs during discrete (and controllable) intervals; other drainage to the reservoir and inflow resulting from precipitation is insignificant, and; discharge of water is strictly through seepage and evaporation as no surface discharge occurs (outside of flood periods).

#### WATER QUALITY FEATURES

There have historically been few water quality problems associated with Mill Creek reservoir. Monitoring was conducted from 1970 to 1979, with the greatest problem being excessively high turbidity (Morency and Funk, 1975). Otherwise, Mill Creek reservoir received attention solely due to the seepage of its waters around the dam structure. Several efforts were conducted to solve this problem to no avail. In 1986, a plan was developed to use a polyethylene material to line the entire reservoir. Because of this, water quality monitoring on the reservoir was resumed late in 1986 to obtain background information pending environmental evaluations of the impacts of such an action.

Water quality conditions in Mill Creek reservoir are typically eutrophic. Input to the reservoir consists of water from the spring snow-melt event. As such, it is high in suspended solids, most of which are fine silts and clays, and associated nutrients. Although the reservoir appears to be an extremely low energy environment with little turbulent mixing, turbid conditions often continue through the summer period. Secchi disk transparency as low as 2 inches (Corps of Engineers, 1975) and turbidity levels as high as 300 NTU's have been documented, prompting an earlier study of the use of alum flocculants to precipitate the suspended material (Morency and Funk, 1975). A significant amount of resuspension of the soft bottom sediments within the reservoir may also contribute to the turbidity. However, even during periods

of distinct thermal stratification (indicating quiescent conditions), turbidity is still high. Dissolved oxygen is usually at or near saturation in the surface waters and nutrient levels are sufficient to sustain substantial algal growth (less than 0.03 to 0.25 mg/L phosphate, 1.0 to 5.0 mg/L nitrate). Conductivity values are similar to those in Mill Creek (60 to 80 umhos/cm), although definite increases are observed in bottom waters during stratification and anoxia. Sediments are predominantly composed of silts and clays and are high in organic content.

Productivity in the reservoir is moderate. Algal blooms occur but are not commonly observed, due possibly to the limited light penetration associated with the high suspended solids concentrations. Phytoplankton growth is dominated (in summer) by *Aphanizomenon*. Benthic organisms are dominated by those species of oligochaetes and chironomids which are tolerant of the frequent periods of anoxia occurring in the sediments and bottom waters. Mayflies (*Hexagenia* sp.) are abundant in the creek, but have not been observed in the reservoir samples. The reservoir supports a resident population of largemouth bass and crappie, and rainbow trout occur in the reservoir as a put-and-take fishery program.

Although limnological conditions in Mill Creek reservoir are exclusively dependent on those occurring in Mill Creek itself during diversion and filling, reservoir water quality is distinctly different from that in Mill Creek. This reflects a change to a lentic environment, conditions in Mill Creek during filling (i.e., high flow and high suspended solids), and substantial internal loading of suspended particulates and nutrients. No significant changes in water quality have occurred since the reservoir was first monitored in 1970.

#### THERMAL CONDITIONS

Occurrences of fairly well-developed thermal stratification in Mill Creek reservoir are common, in spite of the shallow depths (typically between 4 and 7 meters). Thermoclines have been observed from 2 to 4 meters deep and frequently involved temperature gradients of up to 8 degrees centigrade in 2 meters. The configuration of the surrounding shoreline, with the high-walled dam blocking prevailing winds, limits the amount of wind energy actually reaching the water surface. Earlier beliefs were that stratification was unstable and short-lived, with relatively minor winds easily disrupting the stability of the water column (Corps of Engineers, 1975). However, no consistent pattern of stratification occurs: occasionally, the above applies; in some years, no evidence of stratification occurs; and in other years, a distinct thermocline is present throughout the season, as occurred in 1987 (Figure 2). In that year, the water column displayed the typical late spring/early summer development of thermal gradients and establishment of a thermocline, which persisted throughout the summer and withstood significant wind forcing.

Although thermal stratification is not uncommon in shallow impoundments, especially those protected from significant wind activity (Dion et al., 1980), the finding of stable stratification in Mill Creek reservoir was surprising.

# MILL CREEK RESERVOIR TEMPERATURE PROFILES 1987

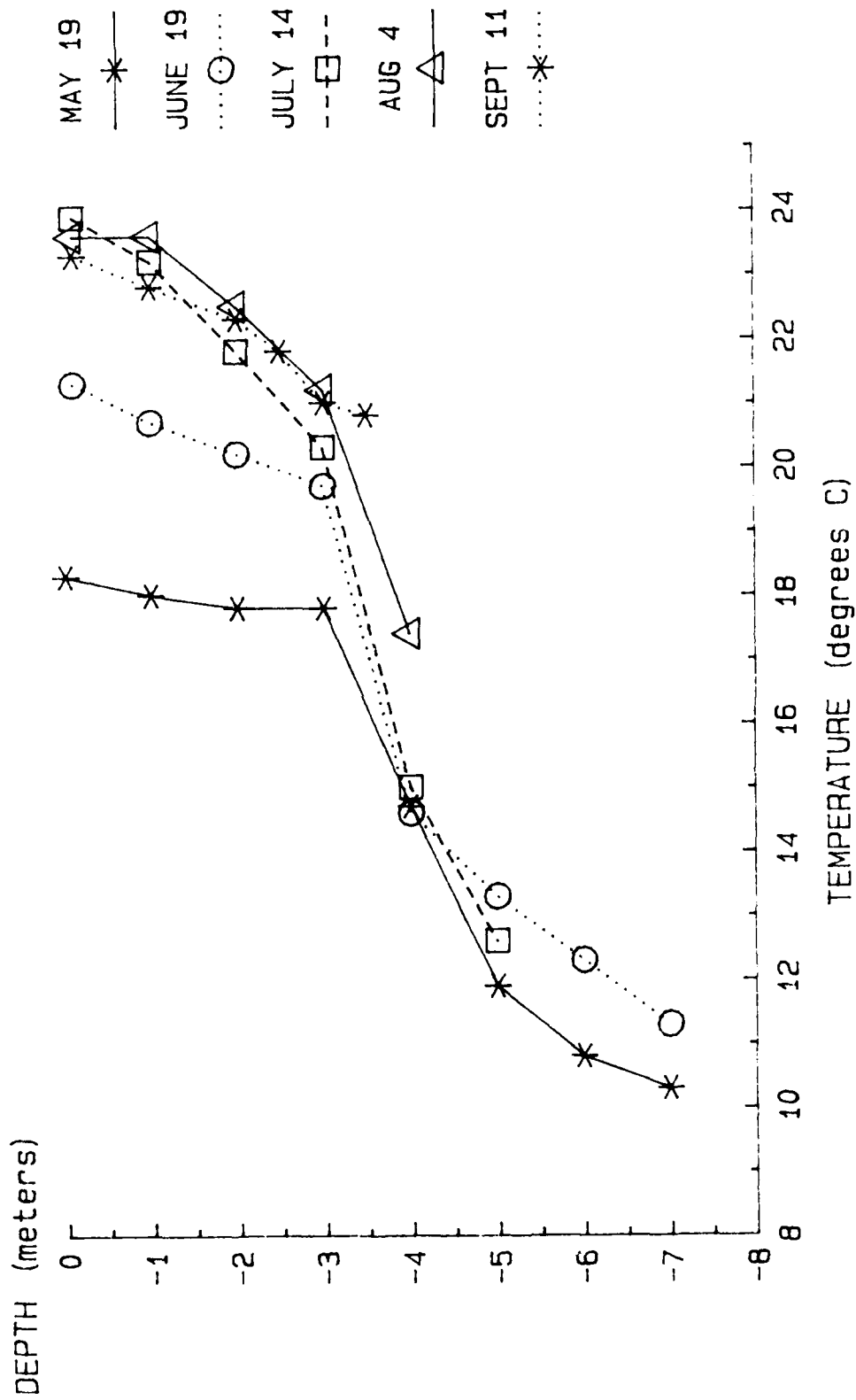

FIGURE 2



Historically, reports of excessive turbidity following wind events were common, leading one to suspect that wind-generated turbulence was occurring to mix the entire water column and resuspend sediments. Several conditions in the reservoir interact to rapidly create steep thermal gradients. The primary influence on the system is the lack of hydraulic flow-through: inflow is a short-term process, and outflow is diffused over a wide area (through seepage) at a rate of about 5 cfs. Since seepage occurs through the sides of the reservoir and not the bottom, withdrawal is mostly from surface waters. No gravity-driven currents or mixing patterns develop. In addition, high summer air temperatures and solar radiation rapidly warm the surface water layer. The high content of suspended material in the water accelerates this warming by absorbing radiation from the sun and warming the surrounding water. The turbid conditions also rapidly attenuate radiative penetration to the bottom layers. With limited wind energy to mix the water column, thermal gradients are established and mixing between the upper and lower layers ceases. As expected in stratified shallow-water bodies, thermocline development commences at higher water column temperatures (8 to 10 degrees C) when the density differential is greater. The bottom water mass being of low volume in relation to the surface waters, subsequent warming is appreciable, with bottom water temperatures reaching up to 18 degrees C prior to late-summer overturn.

Rapid depletion of dissolved oxygen occurs during stratification and frequently results in anoxia in the bottom waters. The high organic content of the sediments, the low water volume available in the bottom lens of water, and the relatively high water temperatures (10-15 degrees C) of the bottom water mass accelerate oxygen depletion. Concurrent with dissolved oxygen depletion are the expected increases in conductivity and turbidity, indicative of a change in oxidation state in the bottom water layer and regeneration of suspended and dissolved solids from the sediments. Eventually, production of hydrogen sulfide occurs.

Filling of the reservoir well after the flood peak results in reduced nutrient and organic material loading, followed by lower productivity and increased light penetration in the reservoir. On one occasion in 1987, photosynthesis was occurring below the thermocline, as indicated by an increase in dissolved oxygen concentrations from the anoxic conditions existing previously. Filling of the reservoir with flood waters results in high nutrient and organic loading, and subsequently anoxia.

#### IMPACTS

Very little regard is given to the prevalence of thermal stratification, anoxia, and hydrogen sulfide production in Mill Creek reservoir, as there exists low potential for significant impacts and there is low visibility of these problems. There occur no surface water problems (other than occasionally high turbidity) resulting from thermal stratification. Surface waters are fairly well mixed and seldom stagnant. Little infringement on the beneficial uses of the reservoir from nuisance aquatic plants or algal production occurs. Although conditions are not favorable for trout, this resource is annually replenished by stocking. Seldom are bacterial levels

in excess of primary contact standards. No use of the water for drinking or irrigation occurs, and no downstream targets are to be met.

However, because of the secondary uses of recreation, this reservoir has become an important site to the local residents. It is one of the few local bodies of water, parks, hiking areas, and the only local lake-type fishing area. Despite its small surface area at recreational pool (40 acres), boating, fishing, and swimming activities are widespread. The State of Washington plants approximately 25,000 rainbow trout in the reservoir each year, and fishing effort, especially prior to the general season opening in surrounding streams, is heavy. Approximately 60,000 user days are spent at the reservoir per year, with more than half of that centering around fishing, swimming, and boating.

Improvements to the water quality of the reservoir, by alleviating anoxia and/or thermal stratification, could result in a healthier and higher quality fishery, a more diverse and desirable benthic population, reduced eutrophication through reductions in internal nutrient loading, reduced frequency and intensity of algal blooms, and possibly a reduction in internally generated turbidity. Obviously, these limited benefits do not warrant, at this time, significant expenditures for alleviation of the stratification/anoxia occurring in the reservoir.

#### FUTURE CONSIDERATIONS

The Walla Walla District is currently proposing two options to eliminate or reduce water seepage through the dam which will impact the water quality of the reservoir. The first option is to limit the use of the reservoir to flood control only, no longer maintaining a recreational pool. Under this option, complete drying of the reservoir could occur between flood years.

The second option would be to line the entire reservoir with a high-density polyethylene membrane, covered with a layer of material for seating, protection, and aquatic habitat. The conservation pool elevation would then be increased from 1205 feet to 1212 feet msl. Only minor decreases in elevation (from evaporation) would subsequently occur during the year.

The increased depth and volume associated with the liner will not significantly change the tendency of the reservoir to stratify or develop anoxia in the bottom waters. Dynamic processes will remain similar (although without seepage-related outflow) and the overall water quality conditions would continue to be dependent on conditions of the creek during inflow and local climatic conditions. Higher water levels would probably increase the thickness of the lens of water below the thermocline, and as a result of the increased volume of this layer, the dissolved oxygen depletion rate could decrease slightly, possibly forestalling the onset of anoxia.

With the proposed liner and successful elimination of seepage, there exists the potential of incorporating low-cost, simple operational/structural

modifications that could minimize the occurrences of stratification and potentially improve water quality. These modifications include diverting water to the reservoir throughout the summer and using coarse-grained sediments of low organic content.

Without the water loss that presently occurs to seepage, water could be diverted continually to the reservoir and returned via the surface outlet (elevation 1212 feet msl) to Mill Creek, thus preserving water rights. Continual diversions of water would establish a hydraulic flow-through, creating additional turbulence and potentially inhibiting the development of thermal stratification. A continuous flow-through would also have the advantage of flushing extremely turbid water (found when the reservoir is filled for flood control purpose) through the reservoir and maintaining a water column of low particulate and low nutrient concentrations. Although it would be most beneficial to withdraw water from the deep outlet (EL 1187 feet), this outlet does not return to Mill Creek and imposes on water rights.

The use of coarse-grained materials (sand and gravel) having low organic content as new sediment to cover the liner will result in much lower oxygen consumption in the sediments as compared to that presently occurring. The very high rates of sediment oxygen depletion are responsible for the rapid development of anoxia that presently occurs with stratification. The coarse sediment material will also be less likely to be resuspended, thus internally-generated turbidity and loading of organics and nutrients will be reduced. In addition, large cobbles and gravels could be placed along the shoreline to reduce the amount of shoreline erosion and accompanying suspended solids and nutrient loading to the lake.

Thus, with the increase in reservoir volume, maintenance of low turbidity water, hydraulic flow-through, and low organic content of the sediments, it is possible that water quality conditions in the reservoir will improve significantly in regards to thermal stratification and dissolved oxygen depletion. These efforts to manage for water quality could also be accomplished with minimal expenditures.

## CONCLUSIONS

Unless extremely low-cost alternatives or operational modifications can be identified, under the present operation of Mill Creek reservoir, the benefits to be gained from alleviating seasonal anoxia are not warranted. However, with a pool elevation raise as proposed to solve the seepage problem, some simple operational/structural modifications could be implemented to improve water quality conditions.

## LITERATURE CITED

Corps of Engineers, 1975. Mill Creek Environmental Impact Statement. Walla Walla District, June 1975.

Dion, N.P., G.C. Bortelson, and J.K. Innes, 1980. Data on selected lakes in Washington-Part 6. Washington Department of Ecology, Water-Supply Bulletin 42, Part 6.

Morency, D.M. and W.H. Funk, 1975. Preliminary investigation into the possible reduction of turbidity in Mill Creek reservoir by the application of aluminum sulfate. Prepared by Washington State University Civil and Environmental Engineering Department for the Walla Walla District, Order No. DACW-76M-1924. November 1975, 23pp.

POST-ERUPTION LIMNOLOGY OF SPIRIT LAKE, MOUNT ST. HELENS,  
WASHINGTON, 1980-1986: LIMNOLOGICAL RESPONSE TO ACCELERATED  
LAKE DRAWDOWN VIA TUNNEL DISCHARGE, WITH EMPHASIS ON OXYGEN

by

Douglas W. Larson, Ph.D.<sup>1</sup>

INTRODUCTION

The catastrophic volcanic eruption of Mount St. Helens, Washington, on 18 May 1980, filled nearby Spirit Lake (Figure 1) with timber and volcanic debris and completely blocked the lake's natural outlet (Rosenfeld, 1980; Kerr, 1980). The lake (elevation about 975 meters [National Geodetic Vertical Datum, NGVD]), which its natural outlet had previously kept in hydrologic balance, was thereafter impounded in a closed, hydrologically unstable basin by a debris dam 150 to 180 meters (m) thick (Jennings *et al.*, 1981). This volcanic event greatly altered the limnology of Spirit Lake and created extremely poor lake water quality conditions (Dion and Embrey, 1981).

The limnological recovery of Spirit Lake, studied in detail by Portland District, Corps of Engineers, between 1983 and 1986 (Larson and Glass, 1987), was defined by Dahm *et al.* (1981) as the "return to oxygenated water year-round at all depths." In this paper I briefly describe the lake's oxygen recovery and report on how reoxygenation was possibly affected by accelerated lake drawdown via tunnel discharges.

PRE-ERUPTION LIMNOLOGY OF  
SPIRIT LAKE

The limnology of Spirit Lake was studied very little prior to the May 1980 eruption of Mount St. Helens. The lake was first surveyed limnologically in July 1937 by fisheries biologists from the State of Washington's Department of Game (WDG), who studied the lake's capacity to sustain fish populations, chiefly rainbow and brook trout, which had been planted in the lake beginning in 1913. WDG found that Spirit Lake was high in quality, but that essential "fish food" organisms, such as plankton and benthic invertebrates, were sparse. WDG thus concluded that the lake's potential for fish production was relatively small, probably less than 1 pound of fish per acre per year. Nevertheless, WDG stocked Spirit Lake with 40,000 legal-sized rainbow trout annually between 1951 and 1979 (Crawford, 1986).

Subsequent limnological reports published in the 1970's (Wolcott, 1973; Bortleson *et al.*, 1976) generally described Spirit Lake as a pristine, oligotrophic, and relatively large alpine body of water. Maximum depth reached 58 m, and the lake's surface area was 5.3 kilometer<sup>2</sup> (km<sup>2</sup>). The lake was surrounded by steep, rugged, heavily timbered mountain slopes except on the southwest shore facing Mount St. Helens; lakeshore

<sup>1</sup> Limnologist, Reservoir Regulation and Water Quality Section, Hydraulics and Hydrology Branch, Portland District, Corps of Engineers.

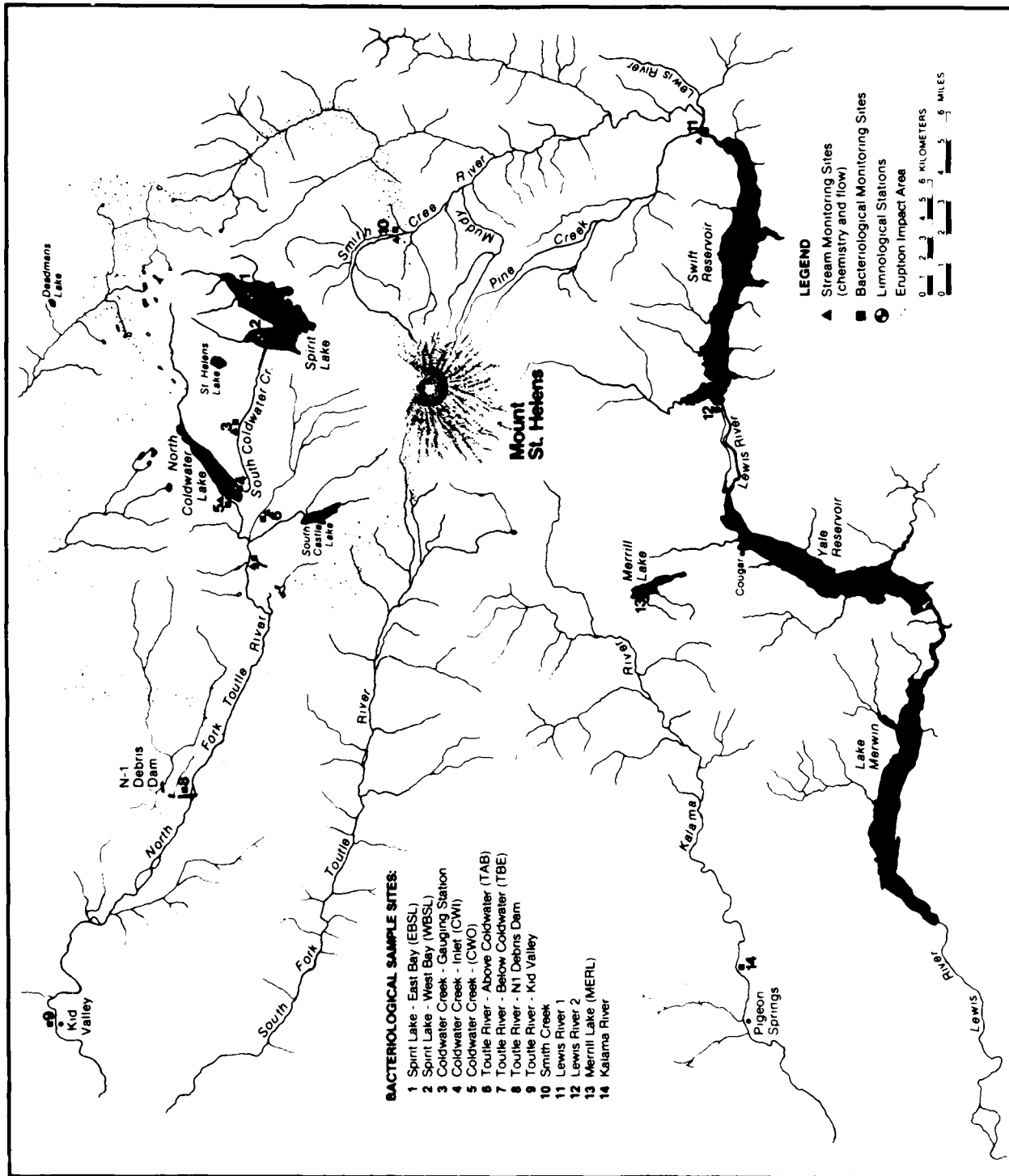

Figure 1. Map of Spirit Lake and Mount St. Helens, Washington. Location is approximately 96 km northeast of Portland, Oregon.

recreational development was minimal. Lake recreational activities took place mostly during the summer months, and even then, for example, only five to ten anglers typically fished the lake daily (Crawford, 1986). This limited use of Spirit Lake, in addition to its remote, alpine location in a national forest, helped preserve it as a pristine, oligotrophic environment. Indeed, nearly 40 years after the original study, Bortleson et al. (1976) found that the high quality of Spirit Lake had not diminished, as evidenced by extremely low concentrations of most dissolved and particulate organic substances, exceptional lake water clarity, and trace quantities of planktonic chlorophyll a.

Wissmar et al. (1982a, b) obtained limnological data for Spirit Lake on 4 April 1980, shortly before Mount St. Helens erupted. They, too, reported extremely low values for most lake water ionic constituents. Of the 13 metallic ions tested for in Spirit Lake, seven could not be detected, even with precise highly sensitive analytical techniques. Wissmar et al. (1982b) stated that surface waters in Spirit Lake were "supersaturated" with dissolved oxygen, but offered no measurements; they reported the surface temperature to be 4°C.

#### INITIAL POST-ERUPTION LIMNOLOGICAL CONDITIONS

Spirit Lake received enormous quantities of debris avalanche materials, timber, pyrolyzed forest vegetation, and minerals of magmatic and lithic origin. This influx greatly increased lake water concentrations of inorganic chemical constituents, as well as dissolved and particulate organic matter. Much of the deposited organic material was incorporated in the lake's new sediment layer, which was roughly 50 to 60 m thick. The lake was also the depository for high-temperature pyroclastic flows and mudflows, ashfall, and geothermal waters, which increased lake water temperatures to 33°C or higher (Dion and Embrey, 1981).

Unusually warm lake waters, acting in concert with the massive inorganic and organic loadings to Spirit Lake, prompted the lake's bacteria to proliferate rapidly: by 30 June 1980, aggregate bacteria in surface waters numbered  $4.9 \times 10^6$  cells per milliliter (ml), of which about  $1 \times 10^4$  cells per ml were viable heterotrophic bacteria (Staley et al., 1982). These latter bacteria proceeded to decompose and oxidize organic matter found abundantly in the lake's water column and sediments. This process soon depleted the lake's supply of dissolved oxygen, except in the uppermost 1 to 2 meters where wind-driven surface aeration maintained a relatively small concentration of dissolved oxygen (i.e., 2.35 mg/l) as late as 30 June 1980 (Wissmar et al., 1982b). Shortly after that date, however, the lake became completely anoxic and remained so until at least 21 October 1980 (Dahm et al., 1982; Larson and Geiger, 1982). Consequently, when all dissolved oxygen had been depleted, the only organisms capable of surviving in Spirit Lake were obligately or facultatively anaerobic microorganisms (Dahm et al., 1982). The fate of other biological components of the lake's pre-eruption ecosystem, such as protozoans, phytoplankton, periphyton, zooplankton, aquatic insects, fish, and amphibians, is largely unknown, although

protozoans and some phytoplankton were collected or observed at Spirit Lake during the late summer and fall of 1980 (Larson and Geiger, 1982; Ward et al., 1983).

#### THE NEED FOR ARTIFICIAL LAKE STABILIZATION

The quantity of incoming volcanic debris was sufficient to displace the lake's surface elevation upward by about 60 m over the pre-eruption level. The sum effect of this deposition was to produce a shallower, expanded basin with its storage capacity reduced by 10 percent or more, but its surface area increased by 80 percent from pre-eruption conditions. Subsequently, as lake water elevation and volume steadily increased from inflow, so did the possibility that the lake eventually would breach or overtop the debris dam. Either of these possibilities might, in turn, have caused the dam to fail entirely, in which case a substantial portion of the lake would have escaped, perhaps suddenly, downstream into the North Fork Toutle River.

The U.S. Army Corps of Engineers, at the request of the Federal Emergency Management Agency (FEMA), initiated temporary pumping operations in November 1982 to stabilize the lake surface elevation until a permanent solution to the problem could be devised. This pumping, by which approximately  $111 \times 10^6$  cubic meters (90,000 acre-feet) of water were removed from the lake during the first 10 months of operation, held the lake level to about 1,056 m NGVD. If the lake had not been pumped, its surface elevation would have reached 1,079 m NGVD by August 1983 (Figure 2). At this elevation, well above the Corps' recommended safe level of 1,049 m NGVD (U.S. Army Corps of Engineers, 1984), the lake would have overtopped the debris dam if it had not already breached the dam at a lower elevation. According to estimates by the Corps and the U.S. Geological Survey (USGS), there was a high probability for dam failure if lake levels were allowed to rise above 1,055 m NGVD (U.S. Army Corps of Engineers, 1984). Thus, pumping operations through the 18 to 20 months following November 1982 were aimed at holding the lake below this critical level (Figure 2).

Meanwhile, plans for a long-term solution to this problem, including permanent tunnels or outlet channels that would connect Spirit Lake to either the Lewis River or Toutle River drainages (Figure 1) were being studied by the Corps. Various alternative strategies for lake stabilization were considered and are outlined in Portland District's Environmental Impact Statement (EIS) for the proposed Spirit Lake Project (U.S. Army Corps of Engineers, 1984). Based on recommendations and comments received from Federal and State agencies and the general public, the Corps elected to construct a tunnel outlet connecting Spirit Lake to the North Fork Toutle River via South Coldwater Creek (Figure 1). This tunnel, 2,592 m (8,500 feet) long, was constructed between June 1984 and April 1985 at a cost of about \$14 million. Tunnel operation now permits excess water accumulated during high-inflow events to be drained safely from the lake basin, rather than allowing that water to rise beyond stable storage capacity (Figure 2).



# Spirit Lake Storage: 1980-1986

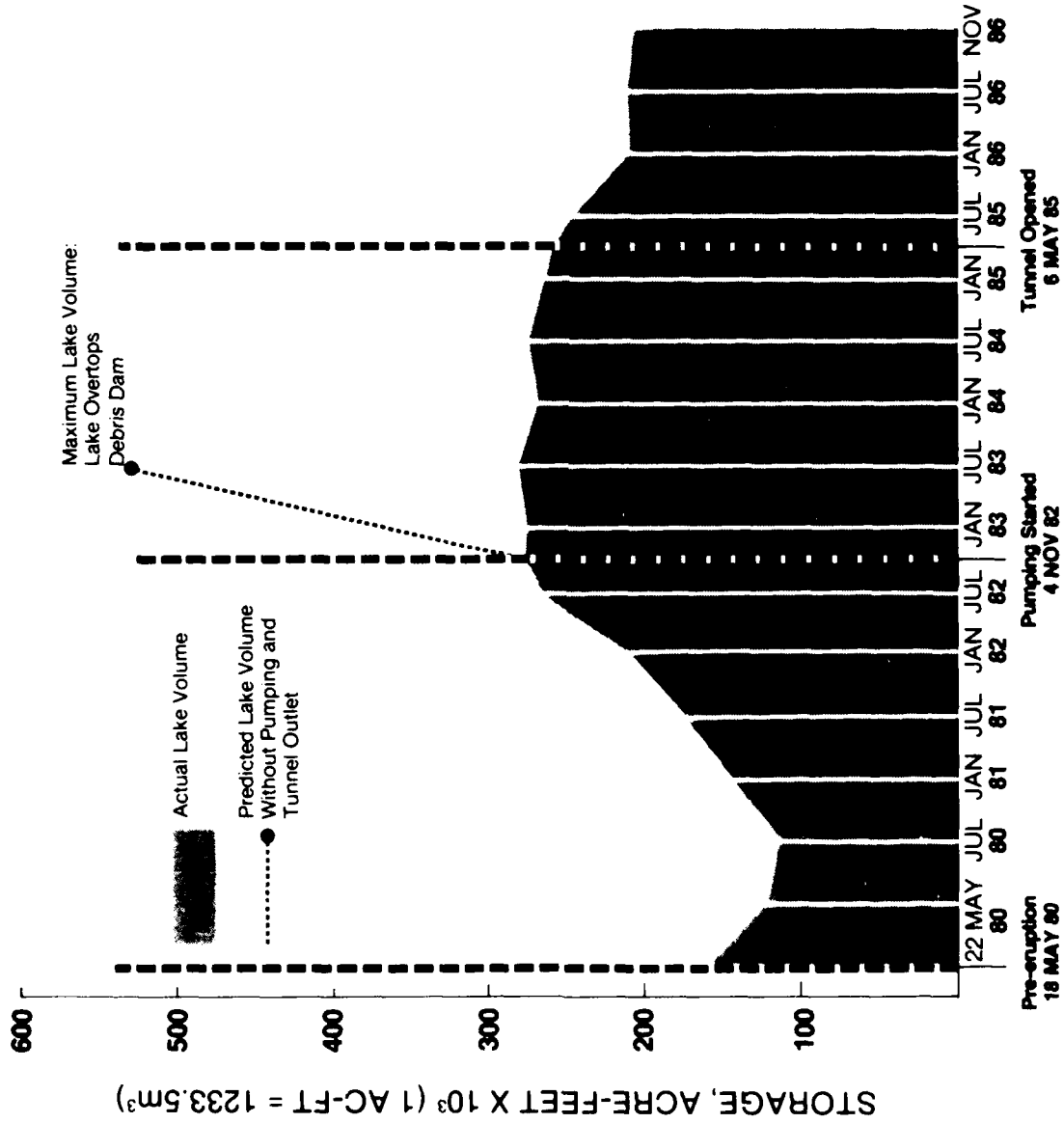

Figure 2. Lake volume (storage), Spirit Lake, Washington, 1980-1986.

## SUBSEQUENT POST-ERUPTION OXYGEN CONDITIONS: 1981-1982

Winter storms typical of the Pacific Northwest brought heavy precipitation to the Spirit Lake watershed beginning in late October 1980. Between 1 November 1980 and 1 April 1981, precipitation runoff into Spirit Lake increased the lake's volume by nearly 30 percent, i.e., from 152,664 to 193,690  $\text{m}^3 \times 10^3$  (123,765 to 157,025 acre-feet) (Meyer and Carpenter, 1983).

Precipitation runoff diluted Spirit Lake's chemically enriched waters and restored lake oxygen content to some extent. Concentrations of dissolved oxygen, measured on 30 April 1981, ranged from 8.8 mg/l at the lake's surface to 5.8 mg/l near the lake's bottom at 20 m. This oxygen restoration is attributable largely to autumnal lake turnover and subsequent continuous vertical mixing, or free circulation, of the lake during winter. Other factors contributing to lake reoxygenation included reduced water temperatures, lake water dilution from rain and snowfall, and diminished bacteriological activity.

In spite of these improved water quality conditions, Spirit Lake still retained substantial quantities of dissolved inorganic and organic materials. Concentrations of dissolved organic carbon, for example, which had reached more than 50 mg/l in August 1980 from pre-eruption levels of less than 1 mg/l, were still 16 to 18 mg/l during the spring and summer of 1981. These materials provided a rich energy source for oxygen-consuming bacteria, which proliferated anew in the lake. Consequently, oxygen concentrations began to diminish rapidly between April and June 1981. By 31 August 1981, the lake was once more anoxic except in surface waters.

The volume of Spirit Lake continued to increase over the following year, reaching 326,384  $\text{m}^3 \times 10^3$  (264,600 acre-feet) by 1 August 1982 (Meyer and Carpenter, 1983). Concomitantly, Spirit Lake water underwent further dilution, as evidenced by diminishing values for alkalinity, dissolved organic carbon, and various metallic and inorganic nonmetallic water constituents. Nevertheless, lake waters were still strongly enriched chemically, with all measured chemical variables remaining well above their respective pre-eruption levels. Also, the summertime oxygen depletion appeared to have slackened somewhat. Relatively large concentrations of dissolved oxygen were still present in the lake's upper 10 m as late as 27 July 1982, i.e., 8.0 and 4.3 mg/l, at lake surface and 10 m, respectively.

## CONTINUED LAKE-OXYGEN IMPROVEMENT AND POSSIBLE EFFECTS OF LAKE DRAWDOWN: 1983-1986

The strong improvement in the oxygen content of Spirit Lake between 1980 and 1982 was previously discussed. This improvement has been reflected differentially in the water column. Oxygen profiling, initiated in 1981 by Dahm *et al.* (1981), has shown that while epilimnetic oxygen content has changed little since 1983, hypolimnetic oxygen during summer thermal stratification has become progressively less depleted each year (Figure 3). This trend toward improved summertime hypolimnetic oxygen content is indicated further by areal hypolimnetic oxygen deficits (AHOD) computed for

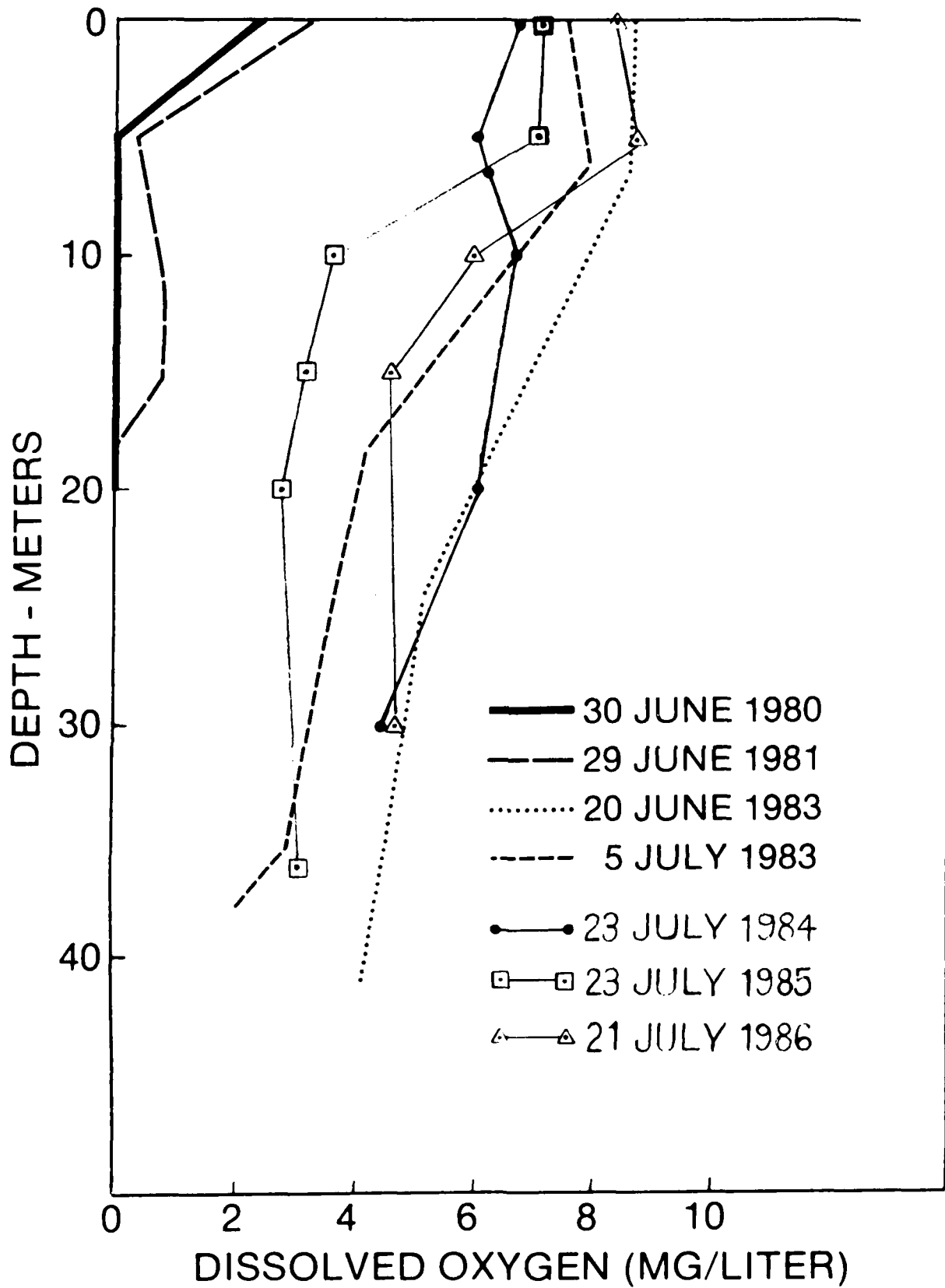

Figure 3. Lake recovery as indicated by the improvement in dissolved oxygen content (diminished oxygen consumption rates) of Spirit Lake since 1980.

years 1983 through 1986 (Table 1). AHOD is defined generally as the quantity of oxygen needed to restore hypolimnetic oxygen, depleted during summer thermal stratification, to saturation levels per unit of hypolimnetic surface area, i.e., the horizontal plane of the hypolimnion at roughly the thermocline (Hutchinson, 1957; Brock, 1985).

Thus, on this basis and as shown in Table 1, the summertime removal of hypolimnetic oxygen in Spirit Lake was less severe in 1986 than in previous years. The larger AHOD in 1985, which was a reversal in the year-to-year trend toward hypolimnetic oxygen improvement (Table 1), may well have resulted from the abrupt lake drawdown via tunnel discharge. This drawdown had reduced the volume of hypolimnetic waters by about 25 percent in the 76 days between 10 June and 25 August 1985 (Figure 4). Assuming that this reversal was indeed due to drawdown, it is uncertain precisely how that drawdown through the tunnel affected AHOD. Possibly the force of lake water withdrawal created turbulent currents along the lake bottom, particularly in the lake's west bay near the tunnel intake. If so, lake sediments would have been disturbed and perhaps mixed into near-bottom waters, with a resulting increase in hypolimnetic oxygen demand. Additionally, drawdown had definitely exposed myriad geothermal seeps and vast areas of lake bottom sediments along the lake's southwest shore. Seepwaters and surface runoff from these sites either collected in lakeside potholes, forming isolated peripheral ponds, or flowed directly into the lake. These waters were highly enriched with both organic and inorganic chemicals. Dr. James Sedell of the U.S. Forest Service (pers. comm.) characterized the lake's southwest shore as an extremely rich "upwelling area," supplying the lake with nutrients and other materials essential for bacterial and algal growth and production. This nutrient loading from seeps and exposed lakebeds may soon have increased the lake's biological productivity, but there is doubt whether it caused the lake's increased AHOD in summer 1985. There is also some doubt whether or not marked changes in hypolimnetic volume strongly influenced AHOD. For instance, the lake's AHOD in 1986 was smaller than in previous years, despite the fact that its hypolimnetic volume in summer 1986 was 25 to 30 percent less than it had been in 1983 and 1984, prior to lake drawdown (Figure 4). This suggests that the relatively poor hypolimnetic oxygen conditions observed in 1985 (Figure 4), while the lake was being rapidly drawn down, were probably due more to the hydromechanical effects of manipulating the lake level, i.e., drawing it down, than related to the volume of the hypolimnion.

Even though AHOD values for Spirit Lake have diminished since 1983, the 1986 AHOD value was still more than twice the AHOD standard arbitrarily set as the lower limit for eutrophic lakes. These standards are presented in Table 1.

Spirit Lake may never fully "recover," so to speak, if the criterion specified for recovery is that the hypolimnion is to be well-oxygenated, i.e., showing an orthograde oxygen profile, even during the period of summer thermal stratification. Pre-eruption oxygen profiles for Spirit Lake, obtained between 7 August and 9 October 1974 (Bortleson et al., 1976), show that near-bottom waters (50 to 52 meters) were considerably undersaturated; levels of only 16 to 27 percent oxygen-saturated waters were observed. If

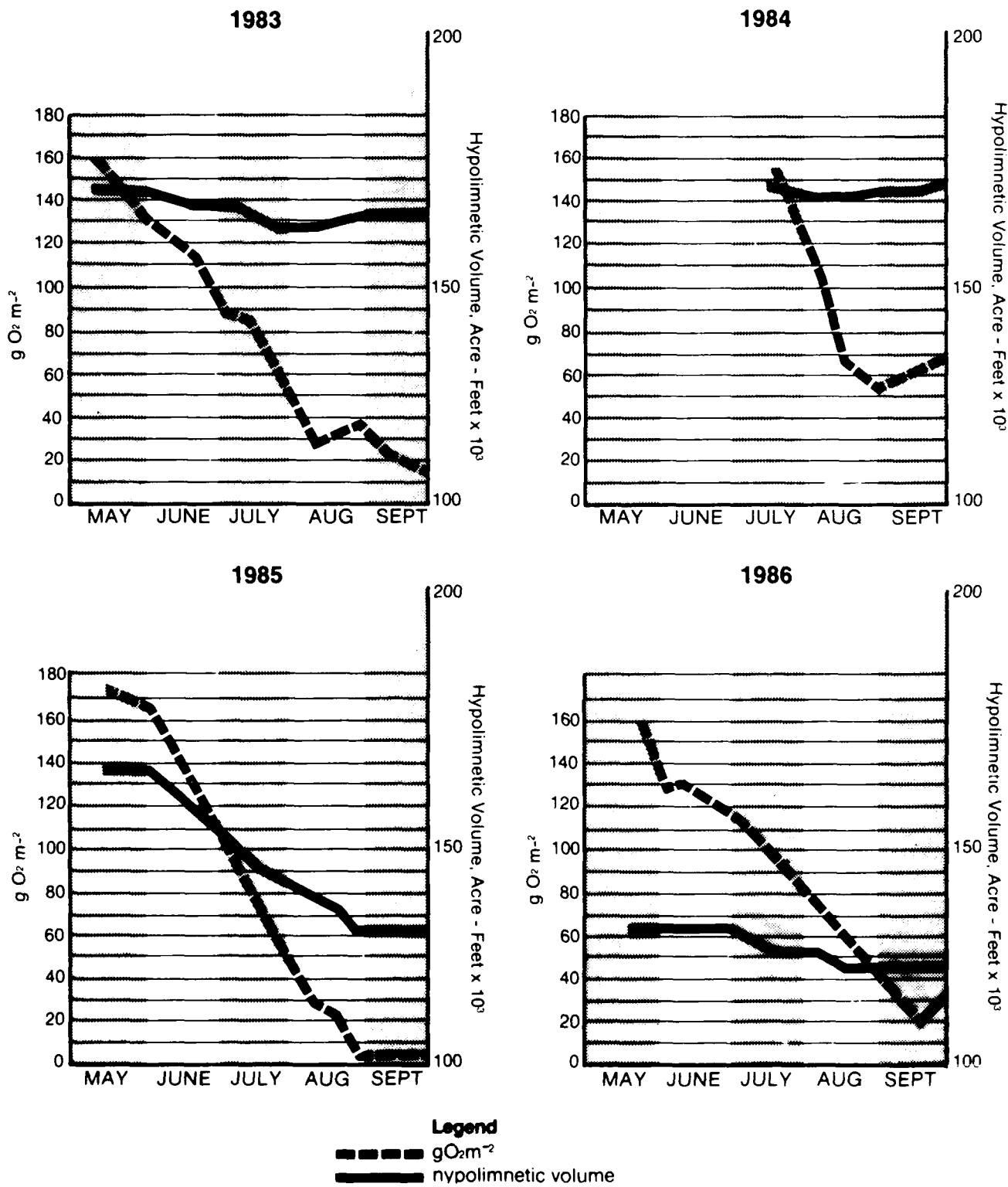

Figure 4. Hypolimnetic oxygen consumption versus reduction of hypolimnetic volume, Spirit Lake, Washington, 1983-1986.

the lake had been 20 meters shallower in 1974, its hypolimnetic oxygen would likely have been depleted much as it has been since 1983.

#### SUMMARY

The oxygen supply in Spirit Lake was rapidly and totally consumed by extraordinarily intense microbial activity during the summer of 1980, shortly after the eruption of Mount St. Helens. This condition of whole-lake anoxia lasted for several months until autumnal lake turnover reoxygenated, to some extent, the lake's entire water column.

The rate of oxygen depletion in Spirit Lake was less severe during the summer of 1981 (Dahm et al., 1981). Dissolved oxygen was still present to a depth of 18 meters on 29 June, although these remnant concentrations soon fell to zero. Oxygen persisted in surface waters, however, which were about 50 percent oxygen-saturated as late as 31 August 1981.

The oxygen content of Spirit Lake was measured only twice in 1982. Both profiles were abbreviated, but they indicated that: (1) the lake's epilimnion remained fairly well-oxygenated over much of the summer, at least until 27 July; and (2) hypolimnetic oxygen persisted long into the period of summer thermal stratification. These changes represented a marked improvement over summertime oxygen conditions observed in 1980 and 1981 (Larson and Glass, 1987).

Since 1983, hypolimnetic oxygen consumption has continued to proceed at fairly high rates during summer and fall while the lake is thermally stratified. The rate of oxygen consumption increases toward the lake bottom and is most intense at the sediment-water interface. Each summer, normally in late August or September, much of the hypolimnion becomes anoxic. Possibly, the entire hypolimnion becomes anoxic by the end of thermal stratification, usually in late October. But once the upper portion of the lake begins to cool rapidly, thermal stratification lessens, and complete vertical mixing, or lake turnover, commences. This process of autumnal lake turnover, allowing the lake to circulate throughout during winter and early spring, restores dissolved oxygen to the hypolimnion and maintains nearly isothermal conditions.

Finally, rates of hypolimnetic oxygen consumption have diminished year after year, except during summer 1985 when Spirit Lake was rapidly drawn down by tunnel releases. This is part of a larger body of evidence (Larson and Glass, 1987) indicating that Spirit Lake continues to recover limnologically.

Table 1. Areal Hypolimnetic Oxygen Deficits (AHOD) for Spirit Lake, Washington, and for Lakes in General.

Spirit Lake	<u>AHOD, gO<sup>2</sup>/m<sup>2</sup>/day</u>
1983	1.022
1984	1.024
1985	1.325
1986	1.008
 Oligotrophic Lakes	 0.033 - 0.33 <sup>1</sup>
Mesotrophic Lakes	0.33 - 0.50 <sup>1</sup>
Eutrophic Lakes	> 0.50 <sup>1</sup>

<sup>1</sup> Hutchinson, 1957, as cited in Wetzel, 1975.

## REFERENCES

- Bortleson, G.C., N.P. Dion, J.B. McConnell, and L.M. Nelson. 1976. Reconnaissance data on lakes in Washington. Vol. 4. Washington Department of Ecology Water-Supply Bull. 43, Olympia (Washington):1-197.
- Brock, T.D. 1985. A eutrophic lake. Ecological Studies 55, Springer-Verlag, New York, 308p.
- Crawford, B.A. 1986. Recovery of game fish populations impacted by the May 18, 1980 eruption of Mount St. Helens. Part II. Recovery of surviving fish populations within the lakes in the Mount St. Helens National Volcanic Monument and adjacent areas. Fishery Management Report 85-9B, State of Washington Department of Game, Vancouver. 134p.
- Dahm, C.N., J.A. Baross, A.K. Ward, M.D. Lilley, R.C. Wissmar, and A. Devol. 1981. North Coldwater Lake and vicinity: Limnology, chemistry, and microbiology. Final Report to the U.S. Army Corps of Engineers, Portland District. 49p.
- \_\_\_\_\_, \_\_\_\_\_, \_\_\_\_\_, \_\_\_\_\_, and J.R. Sedell. 1982. Lakes in the blast zone of Mount St. Helens: Chemical and microbial responses following the May 18, 1980 eruption, Pp. 98-137. In Conference on Mount St. Helens: Effects on water resources. Symp. Proc., Rept. No. 41, Washington State Univ., Pullman.
- Dion, N.P. and S.S. Embrey. 1981. Effects of Mount St. Helens eruption on selected lakes in Washington. U.S. Geological Circular 850-G. 25p.
- Hutchinson, G.E. 1957. A treatise on limnology. Vol. 1: Geography, physics, and chemistry. Wiley, New York, 1015p.
- Jennings, M.E., V.R. Schneider, and P.E. Smith. 1981. Emergency assessment of Mount St. Helens: Post-eruption flood hazards, Toutle and Cowlitz rivers, Washington. U.S. Geological Survey Circular 850-I. 17p.
- Kerr, R.A. 1980. Mount St. Helens: An unpredictable foe. Science 208:1446-1448.
- Larson, D.W. and N.S. Geiger. 1982. Existence of phytoplankton in Spirit Lake near active volcano Mt. St. Helens, Washington, U.S.A.: Post-eruption findings. Arch. Hydrobiol. 93(3):375-380.
- \_\_\_\_\_ and M.W. Glass. 1987. Spirit Lake, Mount St. Helens, Washington: Limnological and Bacteriological Investigations, Final Report, U.S. Army Corps of Engineers. Portland District, Oregon. 447p. (two volumes).
- Meyer, W. and P.J. Carpenter. 1983. Filling of Spirit Lake, Washington, May 18, 1980, to July 31, 1982. U.S. Geological Survey Open-File Report 82-771. 19p.
- Rosenfeld, C.L. 1980. Observations on the Mount St. Helens eruption. Am. Sci. 68:494-509.



- Staley, J.T., L.G. Lehmicke, F.E. Palmer, R.W. Peet, and R.C. Wissmar. 1982. Impact of Mount St. Helens eruption on bacteriology of lakes in the blast zone. *Appl. Environ. Microbiol.* 43(3):664-670.
- U.S. Army Corps of Engineers. 1984. Alternative strategies for a permanent outlet for Spirit Lake near Mount St. Helens, Washington. Environmental Impact Statement. U.S. Army Corps of Engineers, Portland District.
- Ward, A.K., J.A. Baross, C.N. Dahm, M.D. Lilley, and J.R. Sedell. 1983. Qualitative and quantitative observations on aquatic algal communities and recolonization within the blast zone of Mt. St. Helens, 1980 and 1981. *J. Phycol.* 19:238-247.
- Wetzel, R.G. 1975. *Limnology*. W.B. Saunders, Philadelphia, 743p.
- Wissmar, R.C., A.H. Devol, A.N. Nevissi, and J.R. Sedell. 1982a. Chemical changes of lakes within the Mount St. Helens blast zone. *Science* 216:175-178.
- \_\_\_\_\_, \_\_\_\_\_, J.T. Staley, and J.R. Sedell. 1982b. Biological responses of lakes in the Mount St. Helens blast zone. *Science* 216:178-181.
- Wolcott, E.E. 1973. *Lakes of Washington*. Vol. 1. Western Washington. Washington Department of Ecology Water-Supply Bull. 14, Olympia (Washington):1-619.

# WINTER WATER QUALITY IN LAKES AND STREAMS

by

Darryl J. Calkins<sup>1</sup> and George D. Ashton<sup>2</sup>

## INTRODUCTION

While the winter is often considered a dormant period from the water quality viewpoint, there are some fish and wildlife life cycles that rely heavily on adequate winter water quality. The physical processes that affect water quality in winter include ice effects on fish and wildlife habitat, changes in dissolved oxygen evolution, general changes in water chemistry as a result of near-freezing temperatures, natural or induced low-pH inputs, and natural or induced changes in water temperature.

The potential impacts, both beneficial and detrimental, of winter water releases from reservoirs on downstream wildlife or aquatic habitats have not been addressed in many studies. This paper highlights the experiences the authors have had over the past few years in the course of responding to requests for help in assessing the impact of physical processes during the winter on various fish and wildlife habitats.

One of the biggest obstacles to assessing these impacts is the lack of basic data (water temperature, dissolved oxygen content, water chemistry parameters, ice conditions, etc.). Often data are routinely gathered during the summer but discontinued during the winter. Dissolved oxygen, specific conductance, alkalinity, and other water chemistry parameters are frequently measured beneath lake ice covers, but rarely under river ice. The U.S. Geological Survey, for example, discontinues water temperature measurements in some rivers during the winter months because river ice may damage the sensors.

## THE WINTER PERIOD

In this paper the winter season is defined as the period during which an ice cover forms on river or lake surfaces. The meteorological, hydraulic and mechanical processes governing the formation, thickening, and breakup of river and lake ice are complex. Ashton (1986) has summarized the state-of-the-art in engineering applications that must consider these processes.

The ice conditions in a stream are determined by its hydraulic channel characteristics, the flow discharge, the thermal input from groundwater sources or springs, and the meteorological conditions that affect heat loss from the surface. The channel characteristics and flow discharge determine the depth, velocity and width in the stream, while the surface heat loss and water temperature determine whether or not ice is produced. The type of ice

---

<sup>1</sup> Chief, Geological Sciences Branch, USACRREL

<sup>2</sup> Research Physical Scientist, Snow and Ice Branch, USACRREL

generated is generally controlled by the surface velocity and rate of heat loss, while the initial thickness (surface ice cover) is controlled by velocity and river width. Subsurface ice accumulation is usually referred to as anchor ice, and it is primarily formed by the accumulation of frazil particles generated in sub-cooled open water reaches.

#### WINTER IMPACTS

The hydrologic input can also be critical to the winter water quality. The thermal input of the incoming groundwater is extremely important in that it helps provide good spawning conditions. The "acidity" of the snowpack is a factor; during the initial snowmelt period, the increase in hydrogen ion content of the runoff can be detrimental to the developing eggs of fall spawners. Likewise, the addition or diversion of flow from streams can have either a beneficial or negative impact, depending on its influence on the thermal regime and the effect on the ice conditions.

#### Ice Cover Effects on Dissolved Oxygen

The formation of an ice cover on a river quite obviously cuts off the exchange of oxygen from the atmosphere to the water, and as a consequence dissolved oxygen (DO) levels often become very low during the winter. Streams with high organic concentrations will exhibit a more severe oxygen depletion (Whitfield and McNaughton, 1986). While there have been few comprehensive studies of DO during the winter, we feel the essential behavior seems to be as follows:

Simultaneously with the formation of a complete ice cover the inflows to rivers become dominated by groundwater contributions. These, already low in DO, are not subject to re-aeration by surface exchange and hence stay low throughout most of the period of ice cover. Sometime just before breakup, increased (above freezing) air temperatures result in surface runoff which has been exposed to the air and this surface runoff contribution increases the DO in the rivers as the discharge rises just prior to causing breakup of the ice cover.

Occurring simultaneously with the above-described DO behavior is the biochemical oxygen demand (BOD) loading of the river. The decrease in flow typical of most rivers during the winter lowers their dilution ability, and while low temperature slows the assimilation of BOD, it does not cause it to cease altogether.

The above description is qualitative in nature, but there have been quantitative measurements. In at least one case (Ranjie and Huimin, 1987) field measurements, together with an empirical analysis within the framework of the processes described above, have been used to set guidelines for the amount of pollutants that can be introduced into a river during the period of ice cover.

### Natural or Man-made Low-pH Inputs

It is well known that low-pH rain and snow (<5.0) fall in the eastern United States and Canada. The impact of low-pH precipitation on aquatic and vegetative cover has been documented in Scandinavia and western Europe, and similar trends are now appearing in eastern North America.

During the winter the low-pH snow accumulates, and because its impurities are released first during the snowmelt period, a slug containing up to 70% of the accumulated hydrogen ion content in the snowpack can be released during the first significant snowmelt. This slug of H<sup>+</sup> can have a significant impact on developing eggs or embryos, and its entry into ice-covered lakes can lead to fish kills.

Runoff containing acids from open pit mining and tailing operations has also been documented. The impacts of strip mining on fish habitat have been addressed in conferences associated with fisheries management. Gold dredging operations (placer mining) in many Alaska streams are being regulated more closely with respect to maintaining low levels of turbidity and suspended sediments so as to minimize the impact on instream resources.

### Effects of Flow Diversion on Habitat Availability

A frequently recurring question related to the winter regime of rivers and streams deals with the effect of flow diversion to or from a stream. Particularly for smaller or shallower streams the effect can only be assessed by careful examination of the site in question, both with respect to the physical effects, such as reduced water levels or changes in velocity, and with respect to the thermal regime. To give an example, if a reach of stream is receiving inflow from groundwater, that inflow may act to elevate the water temperature sufficiently to reduce the extent and the location of ice formation. Withdrawal of the groundwater then not only reduces the flow but also subtracts the thermal energy that was being added via groundwater influx. Thus, a gravel bed with a small input of groundwater through it will remain locally ice-free, while withdrawal of water through that same substrate from a nearby well may result in ice formation on it in the form of anchor ice deposits. Reducing the water level by diversion may cause the surface ice to thicken to the bottom and freeze the bottom materials, with serious consequences for the biota that reside in them (Walsh and Calkins, 1986). Again, we are not able as yet to give generalized guidance and must examine the sites in question and obtain at least some winter period observations and measurements before being able to pass judgment on the effects of flow alteration.

### Constraints on Targeted Temperatures

It is generally accepted that a fishery can be affected by a change in the natural water temperature regime. Over the years various constraints have been placed by regulatory agencies on the amount of temperature change that can be tolerated. The typical constraint is in the form of an allowable deviation from the natural regime by a fixed increment. Generally, the constraint limits the raising of water temperature. At times the winter

period poses special problems in this regard, because of the peculiar density-temperature relationship of water in the vicinity of 0 to 8 degrees C and of the simple fact that the temperature decrease is limited at 0 degrees C by the formation of ice.

Some examples will illustrate the situation. At a reservoir in the Northwest, the objective is to release water in such a way that the natural seasonal temperature regime is maintained. A fairly elaborate multiple withdrawal structure has been installed for that purpose. In winter the natural regime in the river below the reservoir is near 0 degrees C. However, the reservoir, having a substantial amount of thermal inertia, never cools all the way down to 0 degrees C in the winter. To meet the downstream criteria would require addition of colder water, which is impossible except, of course, by completely rerouting the incoming flows around the reservoir, which does not appear to be feasible.

Sometimes the problem is the application of a rule or constraint formulated for summer conditions that does not make much sense during winter. The Dresden nuclear plant in Illinois uses a cooling pond for its heat sink, but supplements it by taking water from the Kankakee River, passing it through the plant, and discharging it back to the river. The constraint consists of a limit on the increase in the receiving water temperature. But that constraint has been imposed in terms of an allowable withdrawal flow that is inversely proportional to the difference between the return temperature and the natural temperature. This difference is large in winter, and hence the allowable cooling water discharge is smaller than in summer. However, during the winter, when ice is present, the discharged water acts not so much to raise the water temperature in the river as it does to melt the ice. Thus, greater releases would not raise the temperature more but rather would melt more ice, which would seem to be beneficial to everyone, including the resident wildlife. But ice is not considered in the regulation.

#### FISH AND WILDLIFE CASE STUDIES

Calkins and Foley (1988) have recently summarized previous work on the winter habitat of four species of salmonids: Atlantic salmon and brook, brown and rainbow trout. Few studies have been performed, and the majority of these have failed to document the physical conditions of the ice cover that change as a result of the freezing air temperatures and subsequent cooling of the river water and ice formation. The chemical and biological processes have been the major focus of many studies, but it is being recognized that multidisciplinary teams are needed to adequately cover the various processes encountered in ecological investigations (Cunjak, 1986).

Recently the Detroit District completed an environmental review of the potential impact of extended season navigation on the Great Lakes. Fisheries, wildlife and waterfowl studies were performed on the connecting channels in an attempt to answer some of the questions regarding the winter environment.

## Salmonids and Water Quality

Atlantic salmon and brook, brown and rainbow trout require water of high quality during the winter period. It has been shown that the eggs of Atlantic salmon suffer high mortality in low-pH (<5.0) water (Lacroix, 1985). Water low in dissolved oxygen concentration (<6.0 mg/L) is also detrimental to the incubating eggs of Atlantic salmon residing in the gravels. Chemical toxicity may also be a problem when pH mobilization of aluminum creates some degree of aqueous aluminum toxicity due to a short-term change to a lower pH during spring melt. Streams with a high silt load are also undesirable because the fines clog the gravels where spawning occurs.

Winter water quality in trout streams is affected by the groundwater flow and its water chemistry, the ice conditions, the river geomorphology and the snowpack runoff. The relative significance of each factor will vary from basin to basin, depending upon the climate, the surficial geology and the vegetative cover.

The snowpack provides runoff for spring ice cover decay or breakup and water for groundwater recharge. The quality of the snowmelt is important. If the snowpack contains a high hydrogen ion (H<sup>+</sup>) concentration, then a slug of low-pH water can be expected during the early melt period. The short-term change to a lower pH can be lethal to embryos and possibly to eggs and young fry.

The spatial and temporal distribution of groundwater flow to trout streams is extremely important. The relative contribution of the groundwater flow to the total flow becomes less as the stream size increases. However, its initial entry to the stream provides for relatively constant flow, temperature and dissolved oxygen content. The distribution of groundwater flow to streams is difficult to measure, but its temperature and dissolved oxygen content will be relatively constant during the winter period in the temperate zones. Streams with good groundwater flow conditions will minimize ice cover effects because of their relatively "warm" waters, i.e. 4-5 degrees C. The low dissolved oxygen will immediately increase because the ice cover will be absent due to the warm water.

The surface ice cover can have negative impacts on salmonids:

- a) Depression of dissolved oxygen
- b) Freezing of river bed in shallow areas
- c) Fluctuating water levels during freeze-up
- d) Spring breakup that induces high velocity flows

Sub-surface ice accumulation on the river bed can also be detrimental:

- a) Cutoff of the interchange of surface water and intergravel water
- b) Release of anchor ice, carrying with it bed material, which can expose deposited eggs in the redds

- c) Acceleration of the growth of the solid ice cover
- d) Creation of excessive stage heights at freeze-up in small streams, which often fall rapidly, stranding fish in dewatered "side channels"

### Winter Swan Habitat

Trumpeter swans winter on Henry's Fork of the Snake River in Idaho, downstream of Island Pond Reservoir. The reservoir was operated in a "fill and spill" mode prior to 1968, with little release during the winter periods. As a consequence the wintering area was often iced-over, preventing the swans from bottom feeding, and the population was in steady decline. After 1968, releases were increased during the winter, thus mitigating the icing, and since then the population has dramatically increased. Hydropower is now being contemplated for the dam, and the question of what release is appropriate in winter has been raised. A one-dimensional thermal model has been applied to the site and appears to do a reasonable job of predicting when the swan habitat will ice over, which, of course, depends on the air temperature and the release flow and its temperature. Some calibration is required; when that is completed, the model will provide a means of determining the releases so as to conserve water for power and irrigation while maintaining the swan habitat substantially ice-free.

### OVERVIEW OF MODELING CAPABILITIES IN WINTER

Among the tools used to manage water quality are models of rivers, reservoirs and lakes that predict their physical and thermal behavior. The models developed for non-winter periods are generally applicable to the winter period with some additional work to incorporate the effects of ice and the density inversion of water that occurs around 4 degrees C. However, these effects are not always obvious, are often complicated, and until very recently have not been considered from a water quality viewpoint. We will briefly outline the major uncertainties in models for two cases: reservoir temperature modeling and river ice and temperature modeling.

### Reservoir Temperature Modeling in Winter

Fox et al. (1979) performed a review of literature on northern lake modeling and, among other conclusions, noted that most available models cannot describe lake processes during the winter and spring ice periods. More recently, Harleman (1986) reviewed hydrothermal modeling of reservoirs in winter and noted that there is a severe lack of field data. The writers' own attempts to include ice in reservoir water quality models met with considerable difficulty in determining at what point the ice cover becomes complete. This is particularly important since the ice cover, once complete, essentially traps the thermal reserve associated with the water temperature at the time of freeze-over. While it is a common view that the water beneath an ice cover is all at the 4-degree C temperature of maximum density, this is rarely the case, and more typically it is of the order of 1 to 2 degrees C. For larger lakes and reservoirs it may be much closer to the freezing point of 0 degrees C. As an example, typical outflows from Oahe Reservoir (160 feet deep) in South Dakota are of the order of 0.4 to 1 degree

C, depending on the particular sequence of meteorological events at the time of freeze-over. In the spring period of ice dissipation, there is similar uncertainty because of the propensity for the ice to deteriorate or "rot" while still retaining significant thickness but not structural integrity. Once rotting has progressed, a wind event acts to cause the final clearing.

### River Modeling in Winter

Rivers are more complicated than reservoirs or lakes in winter, primarily because of the diversity of ice types and processes that occur. Relatively straightforward thermal models (Ashton, 1979; 1982) are capable of estimating the extent of open water downstream of a thermal input in response to the driving air temperature but still generally need some calibration against field data at each site. These have not as yet been coupled with unsteady hydraulic models, although efforts are beginning in that direction. The process of freeze-up jamming can be modeled reasonably well if the point of initiation of the ice accumulation is known. Breakup jams are much more difficult to model, although there has been some progress and we can estimate maximum stages. From a water quality standpoint, however, these models are very crude and do not consider the variations in ice processes and accumulations on the scale associated with habitat characterization. Particularly for smaller streams there has been little effort to characterize the ice behavior that occurs on the scale that fish and other wildlife care about.

### SUMMARY

This paper has highlighted some examples of the need to focus on winter water quality concerns for aquatic resources when reservoir operations or channel modifications are being considered. To our knowledge the existing Corps water quality models are not able to simulate the winter regimes of rivers or lakes with an ice cover present, although models do exist which can perform reservoir simulations (Harleman, 1986). There is a clear need for interdisciplinary teams to work on the complex physical, chemical and biological processes associated with the winter environment because of the interaction of all three processes with each other.

### REFERENCES

- Ashton, G.D., River and Lake Ice Engineering, Water Resources Publications, Littleton, CO, 1986.
- Ashton, G.D., "River Ice Suppression by Thermal Effluents," CRREL Report 79-30, 23p., Dec. 1979.
- Ashton, G.D., "Theory on Thermal Control and Prevention of Ice in Rivers and Lakes," In: Advances in Hydrosciences, Academic Press, Vol. 13, pp. 131-185, 1982.



Calkins, D. and Joann Foley, "Literature Review and Assessment of Winter Habitat of Atlantic Salmon, and Brook, Brown, and Rainbow Trout," Contract Report to USFS and CRREL Special Report, in review, 1988.

Cunjak, R.A. and G. Power, "Winter Habitat Utilization by Stream Resident Brook Trout (Salvelinus fontinalis) and Brown Trout (Salmo trutta)," Can. J. Fish. Aquatic Sci., Vol. 43, pp. 1970-1981, 1986.

Fox, P.M., J.D. Laperriere, and R.F. Carlson, "Northern Lake Modeling: A Literature Review," Water Resources Research, Vol. 15, No. 5, pp. 1065-1072, 1979.

Harleman, Donald R.F., "Hydrothermal Modeling of Reservoirs in Cold Regions: Status and Research Needs," In: Proceedings of Cold Regions Hydrology Symposium, D.L. Kane, editor, American Water Resources Association, 5410 Grosvenor Lane, Suite 220, Bethesda, MD, pp. 39-50, 1986.

Lacroix, Gilles L., "Survival of Eggs and Alevins of Atlantic Salmon (Salmo salar) in Relation to the Chemistry of Interstitial Water in Redds in Some Acidic Streams of Atlantic Canada," Can. J. Fish. Aquatic Sci., Vol. 42, pp. 292-299, 1985.

Ranjie, H. and L. Huimin, "Modelling of BOD-DO Dynamics in an Ice Covered River in Northern China," Water Research, Vol. 21, No. 3, pp. 247-251, 1987.

Walsh, M. and D. Calkins, "River Ice and Salmonids," Proceedings 4th Workshop on Hydraulics of River Ice, Montreal, pp. D4.1-D4.26, June 1986.

Whitfield, Paul H. and B. McNaughton, "Dissolved-Oxygen Depressions Under Ice Cover in Two Yukon Rivers," Water Resources Research, Vol. 22, No. 12, pp. 1675-1679, Nov. 1986.

# UNDER-ICE HYDRODYNAMICS AT TIOGA LAKE, PA

by

<sup>1</sup> Kenneth S. Lee and <sup>2</sup> Robert A. Bank

## I. INTRODUCTION:

### A. Project Description

Tioga-Hammond Lakes are located in north-central Pennsylvania (Figure 1). The project consists of two man-made lakes, linked by a connecting channel cut through the drainage divide between the two basins. The connecting channel makes it possible to share a common flood control outlet on the Tioga side, and a common emergency spillway on the Hammond side. A weir in the connecting channel separates the good quality Hammond waters from the degraded Tioga waters. Flows from Hammond are released through a gate structure in the weir, or through a small, limited capacity (100 CFS) outlet through Hammond Dam into Crooked Creek and thence back into the Tioga River. During flood events, the lakes can rise above the weir and become a single lake that is managed by the Tioga outlet works or the Hammond emergency overflow spillway.

The gate structure of the Tioga outlet works contains two flood gates and two low flow gates with four intake portals. For water quality (low flow) releases, the intake tower employs the four water quality ports, which are located at separate elevations (port 1, EL. 1039; port 2, EL. 1049; port 3, EL. 1059; port 4, EL. 1069). Water is drawn from the portals into a pair of hydraulically independent wetwells (2 ports per wetwell) and discharged into the outlet tunnel. This allows water of unlike quality from different levels of the lake to be blended to achieve a desired outflow quality. Ports 1 and 3 are controlled by the QC1 gate, and ports 2 and 4 are controlled by the QC2 gate.

The Hammond outlet works (connecting channel gates), the Tioga selective withdrawal intake tower, the Crooked Creek outlet works, and the connecting weir are the physical elements of the project that affect water quality.

The Tioga River above Tioga Lake is degraded by acid mine drainage entering the stream near Blossburg, Pennsylvania (Figure 2). For natural flows without the dam, the Tioga River generally carries a pH in the range of 4.0 to 6.3. A pH of 5.5 or less is generally considered very hazardous to aquatic life. The Pennsylvania State standard for this stream is pH 6.5-8.0. Tioga Lake controls a drainage area of 280 square miles and has a normal pool of 9,500 acre-feet at elevation 1081.0 MVD.

<sup>1</sup>

Environmental Engineer, Baltimore District, Water Control Management Section

<sup>2</sup>

Hydraulic Engineer, Baltimore District, Water Control Management Section

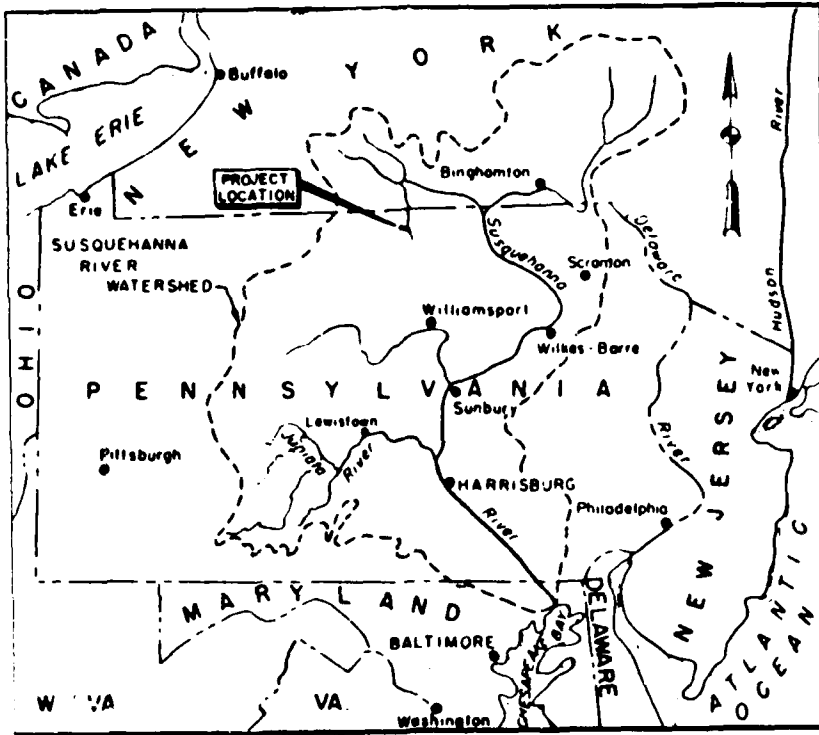

Figure 1, Vicinity Map

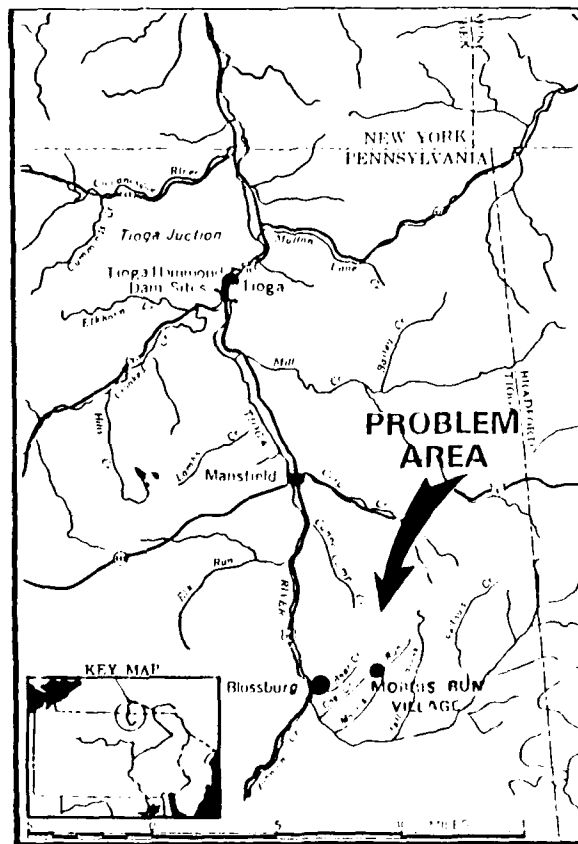

Figure 2, Tioga River Watershed and Problem Area

Crooked Creek above Hammond Lake is a mildly alkaline stream, and its pH generally ranges between 6.4 and 8.2. Hammond Lake controls a 122 square mile drainage area and has a normal pool of 8,500 acre-feet at elevation 1086.0 NVGD.

#### B. Overview of WQ Problems

Tioga-Hammond Lakes were completed in November 1978 and were filled in May 1981. The primary project purpose is flood control, and the secondary purpose is recreation. The project was constructed to accommodate water quality and is operated in accordance with Corps of Engineers environmental policies. During the planning stages, poor water quality in Tioga Lake was anticipated due to acid mine drainage. Fish were not expected to survive in Tioga Lake, and occasional downstream fish kills were expected. However, there are fish living in Tioga Lake, supplied through the connecting channel from Hammond, as well as from Mill Creek. A productive fishery has also established itself in the Tioga tailwater, supplied by tributary streams below the dam and escape through the Tioga and Crooked Creek outlet works.

Fish in the tailwater are prevented from moving upstream by the dams and congregate at the Tioga outlet. Water quality at the tailwater is usually adequate to sustain the fish life. If the quality suddenly drops after a prolonged period of adequate water quality releases, a serious fish kill results. Fish kills of various magnitudes (from a few fish to tens of thousands) on the Tioga River have occurred as far downstream as Lawrenceville, Pennsylvania. In-lake fish kills of unknown magnitude have also occurred under the ice in Tioga Lake.

The worst water quality conditions in Tioga Lake were expected at the end of low flow periods since low flow presents the worst water quality, and a prolonged drought would fill the lake with poor quality water. Although low flow periods have reduced water quality in the lake, quality has consistently remained above survival levels throughout summer and fall low flow periods. Instead, problems have occurred after ice formation in winter. Although inflow quality does not change significantly before or after ice cover formation, the water in the lake does not mix after ice covers the lake, and poor quality inflows travel directly along the old Tioga River channel to the outlet, resulting in poor quality downstream.

Fish kills in the Tioga River generally occur during the first winter runoff, when inflows are high. Highly acidic hypolimnetic Tioga water apparently surges up the face of the dam, rendering the selective withdrawal tower useless, and causing outflow quality to collapse. After a short period of severely depressed quality, the quality at the tower may soar to the point where no acidic water can be found for a short time, and then the water turns acidic again. This apparent seiche may continue for several cycles. Once the spring thaw melts the ice, water quality quickly returns to normal, and operation for quality control is no longer as difficult.

There are several reasons for the quality problems in Tioga Lake:

1. When the mildly alkaline waters of Hammond Lake are released through the connecting channel and the Tioga pool is steady or rising, the release forms a jet that travels across the lake and pools on the right bank. This water then cannot be utilized in the Tioga release.

2. During low flow periods, and after ice formation, Crooked Creek flow often drops off more rapidly than Tioga River flow, and less Hammond water is available for neutralization.

3. The complex under ice hydrodynamics of Tioga lake are compounded by the denial of wind mixing due to ice cover. Alkaline inputs to the system from Mill Creek and Hammond do not mix well in Tioga Lake and, therefore, cannot help neutralize the acidic Tioga River flows; this is especially true when the Tioga pool is steady or rising.

## II. WINTER OPERATIONS AND WATER QUALITY RESULTS:

Each year a different operational mode, within given constraints, was attempted to prevent fish kills at the Tioga-Hammond project. Discussion of winter operational modes and their effects on water quality follows.

### A. 1980-1981 Winter

This was the first year of winter operation at Tioga Lake. The initial filling of Tioga and Hammond Lakes started in March 1980, and the lakes attained elevation 1070 in Tioga and elevation 1075 in Hammond during the summer. Neither reservoir reached its summer pool because of filling restrictions such as outflow quality, minimum outflows and filling rate. Tioga and Hammond Lakes were originally designed for seasonal pools (winter pools: 1060 in Tioga and 1075 in Hammond; summer pools: 1081 in Tioga and 1086 in Hammond). Both reservoirs were lowered to their winter pools at the end of October. However, Tioga Lake was later raised to elevation 1070 for the winter because of an unexpected connecting channel gate freezing problem.

The basic constraints for Tioga-Hammond operation were maintaining a constant pool, maintaining a minimum release from the Crooked Creek outlet works (10 CFS), maximizing utilization of Hammond water through the Hammond outlet works for neutralization and maintaining proper combinations of portal openings. Lake water quality was fair to good in the summer; however, acid water was found on the bottom from time to time. Before the lake was ice covered, the quality in the lake was good. On December 10, the pH in the lake ranged from 6.5 to 6.8 from the top to the bottom. The objective pH for Tioga Junction, the downstream control point (see Figure 2), was set at 6.7.

When ice formed on Tioga Lake, water quality at the lower levels of the lake began to decline rapidly. This low quality water accumulated to higher and higher levels, toward the surface of the lake. Inflow water quality had not significantly changed before or after the lake was covered by ice. Figures 3 through 6 show the pH profiles in front of the tower. With the increasing volume of low quality water, Ports 1 and then 2 were closed or partially closed to maintain the downstream objective pH. As a result of closing the lower port, the accumulation of the low quality water continued. This phenomenon apparently reached a peak on February 2 just before the first winter runoff event. To neutralize the acidic Tioga water, Hammond water was dumped into Tioga through the connecting channel.

Figure 7 shows the inflow and outflow quality at Mansfield and Tioga Junction. When port 2 was partially closed on Julian day 4 (Figure 8), pH at Tioga Junction showed rapid improvement. Figure 9 shows the connecting channel flow in the 1980-81 winter. The connecting channel flows on Julian day 5 and 17 were to improve water quality in Tioga Lake. Even though Hammond water was dumped into Tioga on Julian day 5, the outflow quality (pH) continued to decline. The Hammond water dumping did not cause downstream quality improvement. Crooked Creek outflow was maintained at about 13 CFS until Julian day 5.

After Hammond water was dumped, Crooked Creek outflow was reduced to 8 CFS. Crooked Creek outflow was reduced further to 5 CFS when the pH at Tioga Junction rose to its objective on Julian day 15. The first winter runoff occurred on Julian day 33. Tioga inflow increased from 30-40 CFS to 800 CFS within a day; however, Hammond inflow did not increase as significantly. To maintain a constant pool, Tioga Lake discharges had to be increased, but Hammond Lake maintained the same outflow to hold its constant pool (Figure 10). The Tioga project made discharges of 800 CFS through ports 2 and 3 (maximum discharge of 400 CFS through each Quality Control (QC) gate). Crooked Creek outflow was increased from 5 CFS to 20 CFS (Figure 11). This operation resulted in a sudden pH drop at Tioga Junction on Julian day 35 (Figure 7). When the second winter runoff occurred on Julian day 41, Tioga outflow was limited to 70 CFS through port 2 and port 3. Most of the inflow was stored temporarily in the lake. The Crooked Creek outlet was fully opened (maximum discharge of about 100 CFS). During this event, Tioga inflow was again greater than Hammond inflow, and the Tioga pool rose higher than the Hammond pool. There was then no outlet for Hammond water except through the Crooked Creek outlet works. After waiting three days for mixing between the acid Tioga Lake water and the better-quality inflow water, a careful release was made through ports 2 and 3 to meet the objective pH. When the Tioga Lake elevation fell to equal the Hammond elevation, the connecting channel gates were fully opened, and Tioga releases were made through the flood gates. At that time the lake water quality near the intake tower rapidly improved from the top to the bottom, but continuously changed from good to bad and back again. When the connecting channel gates were opened, Crooked Creek outflow was limited to 10-20 CFS, and the excess Hammond waters were discharged into Tioga Lake through the connecting channel.

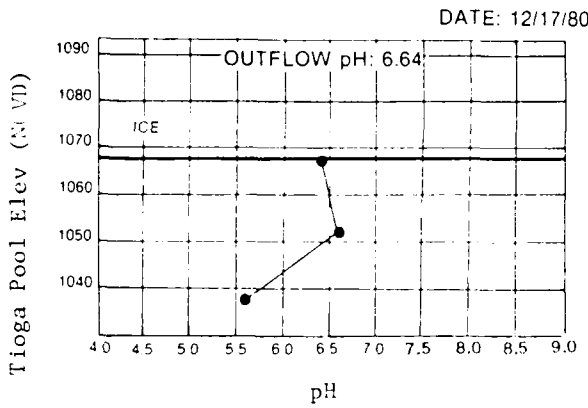

Figure 3, pH Profile in Front of the Intake Tower

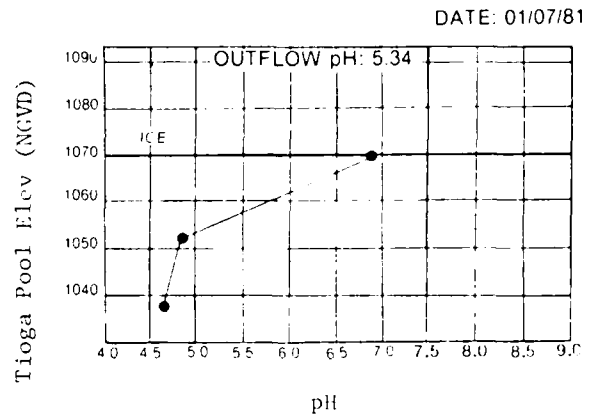

Figure 4, pH Profile in Front of the Intake Tower

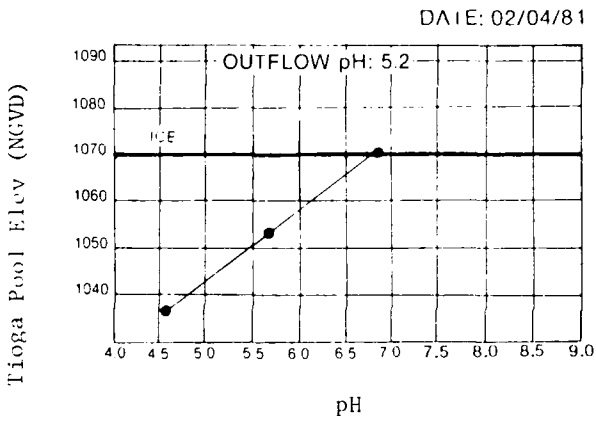

Figure 5, pH Profile in Front of the Intake Tower

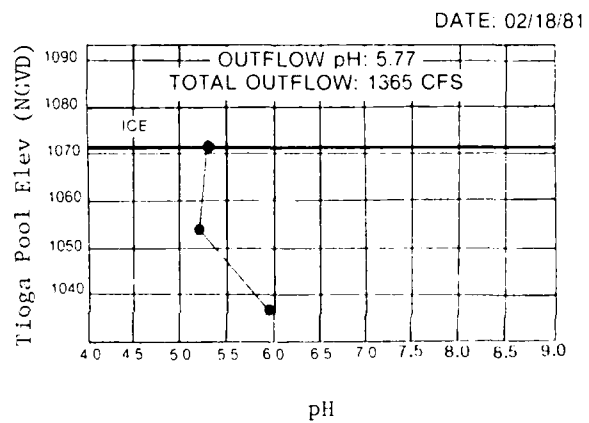

Figure 6, pH Profile in Front of the Intake Tower

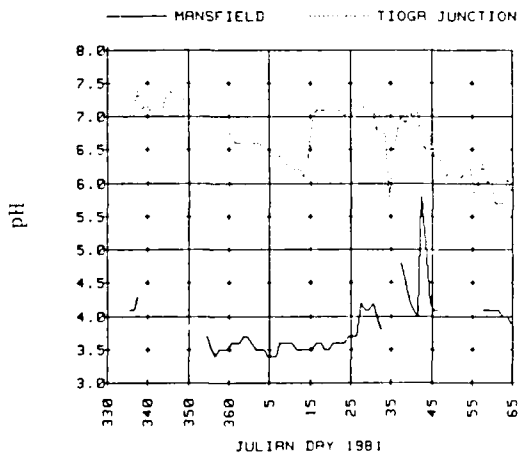

Figure 7, Inflow and Outflow pH in 1980-81 Winter

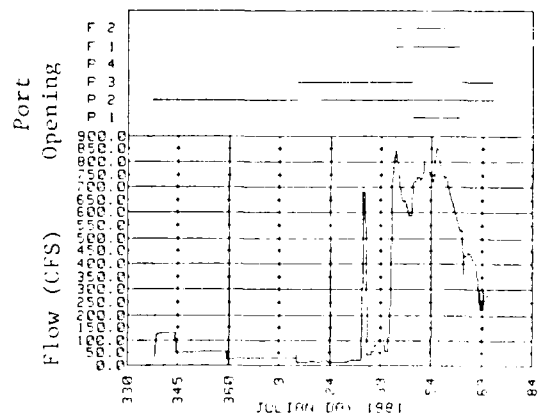

Figure 8, Discharge from Tioga QC Gate and Portal Opening in 1980-81 Winter

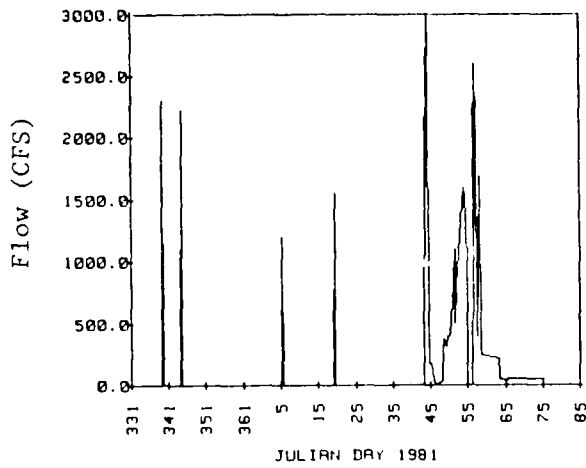

Figure 9, Discharge from Connecting Channel Gates in 1980-81 Winter

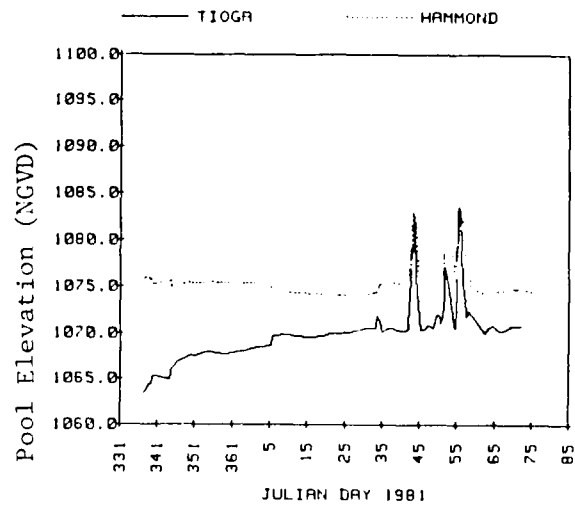

Figure 10, Pool Elevations in 1980-82 Winter

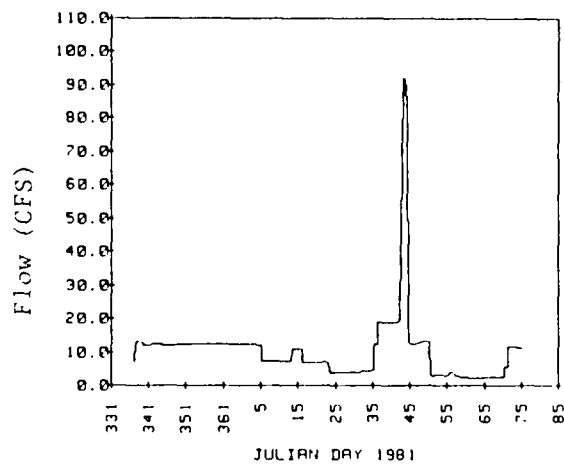

Figure 11, Discharge from Crooked Creek Outlet Works 1980-81 Winter

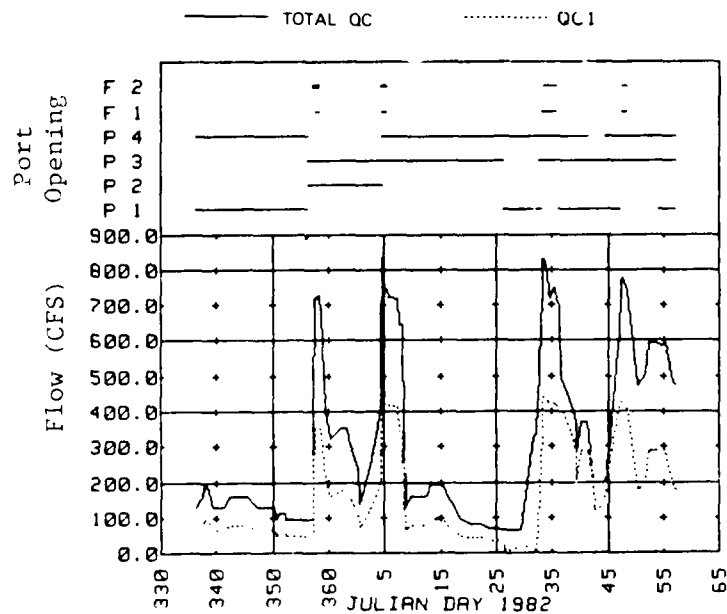

Figure 12, Discharge from Tioga QC and Portal Opening in 1981-82 Winter



The first year's experience taught us that Tioga inflow has to be stored in the reservoir for two to three days to allow mixing to take place at the beginning of the winter runoff. The mixing within Tioga Lake improved the water quality. We assumed that low inflow quality caused the quality problem under the ice cover. This assumption was probably only partially correct, as we would learn in later years. An extensive water quality data collection plan was planned for 1981-82 winter.

#### B. 1981-1982 Winter

The seasonal pool concept was eliminated for the 81-82 winter due to the freezing problem with the Hammond gates, and a year-round pool was adopted. The year-round pools for Tioga and Hammond are 1081 and 1086, respectively. The 1081 Tioga pool had a volume 4 times greater than the originally established winter pool, and more than 1 3/4 times greater than the pool maintained during the 80-81 winter. The additional volume increased the buffering capacity of Tioga Lake.

After the first winter's experience, the operational plan for the 81-82 winter was slightly modified from the 80-81 plan. The differences were:

1. Minimum discharge from the Crooked Creek outlet works was increased from 15 CFS to 30-40 CFS during low inflow periods to assure meeting the objective pH at Tioga Junction.
2. Tioga pool was temporarily raised about 5-6 feet for 2 to 3 days at the beginning of the first winter runoff to increase mixing.
3. Hammond water was to be dumped into Tioga Lake one or two days before the first winter runoff occurred.
4. A near-term water quality management plan was adopted, to maintain the objective pH.

During the summer of 1981, water quality conditions at Tioga Lake had been good. Tioga tailwater was reported as one of the best fishing spots in Pennsylvania. Before ice formed, Tioga Lake water quality conditions were still good (especially pH). By early December, in-lake water quality conditions were still good (pH was 6.5 from the top to the bottom), and ports 1 and 4 were opened (Figure 12). The 1981-1982 winter was wet. Two high runoff events occurred in early winter (December 28 and January 5) and two more occurred in February. Discharges greater than 800 CFS (the maximum selective withdrawal capacity) were made, both the flood gates and the selective withdrawal system were opened. During the December runoff, ports 2 and 3 were opened along with the flood gates because lake quality had declined slightly. When the lake quality declined further, ports 3 and 4 were opened.

The discharge ratio between the ports was changed from time to time depending upon lake water quality at the intake tower. When the quality on the bottom was worse, more water was released through the higher ports. Even though most releases were made from the top port around Julian day 20, the pH at Tioga Junction fell below the objective. To meet the objective pH, Crooked Creek outflow was increased from 40 CFS to 100 CFS (Figure 13). During a period of low Tioga inflow in January (less than 40 CFS), pH at Tioga Junction was maintained at the objective by use of the Tioga selective withdrawal tower and the Crooked Creek outlet works (Figure 14). However, the depletion of good quality water in Tioga Lake due to the near-term water quality management objective resulted in low quality in the Tioga stilling basin by the end of January. The Crooked Creek release still maintained the quality at Tioga Junction.

When the first winter runoff was expected, Hammond water was dumped into Tioga (Figure 15). During the first under-ice runoff period (Julian day 34), Tioga inflows were stored until Tioga Lake rose about 5-6 feet (Figure 16). Outflow was limited to 100-300 CFS, and the lake rose 6 feet in one day. The most difficult time for downstream water quality control was at the beginning of the lake rise. The first fish kill was reported at the Tioga stilling basin during the beginning of the high runoff operation. Seicheing water quality in front of the tower made quality control impossible. pH fluctuations at Tioga Junction from Julian day 35 to 65 resulted from pH seicheing in the lake. The near-term management plan appeared to cause a greater water quality problem and resulted in fish kills. The results of the data collection during the winter showed that inflow quality became worse after ice formation. As soon as the ground froze, inflow acidity increased to about 100 mg/l. We assumed that the decreased inflow quality was due to dumping of untreated mine wastes into the river; however, this was never confirmed.

#### C. 1982-1983 Winter

To clean up sediment and trash at the boat ramp and headwater areas, Tioga and Hammond Lakes were lowered to 1075 and 1078, respectively, in the fall. Due to a prolonged drought during the fall and early winter months, the lakes were not back to conservation pools before freezing. Whenever inflows were greater than the minimum allowed outflow, excess inflows were stored under the ice to fill the lakes. Tioga Lake attained conservation pool in early January, and Hammond during the first winter runoff on Julian day 35 (Figure 17). The operational plan was similar to the 1981-1982 plan. The differences were that Crooked Creek outflows were reduced from 40 CFS to 20 CFS, and the release of Hammond water through the connecting channel was limited because little Hammond water was available.

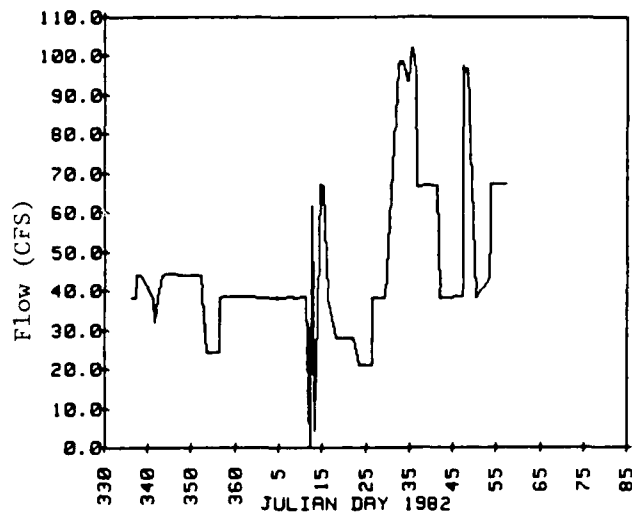

Figure 13, Discharge from Crooked Creek Outlet Works in 1981-82 Winter

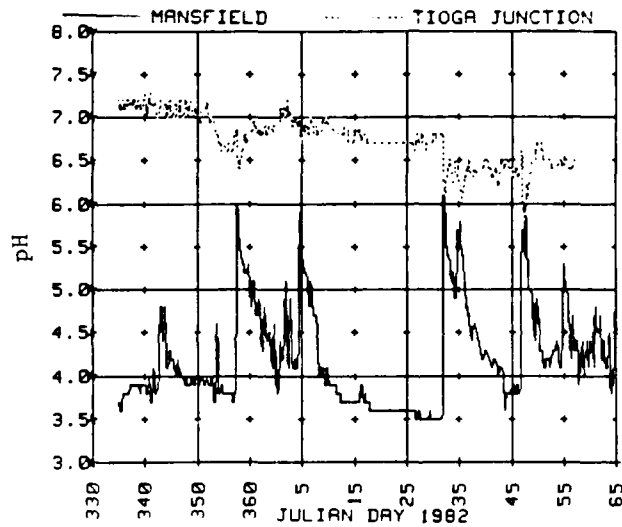

Figure 14, Inflow and Outflow pH in 1981-82 Winter

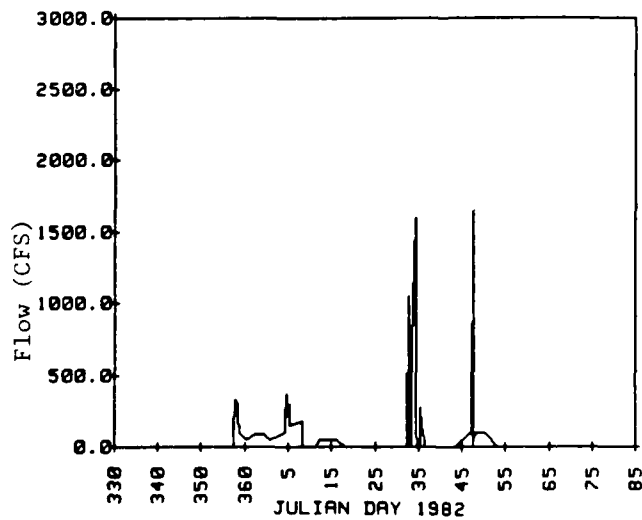

Figure 15, Discharge from Connecting Channel Gates in 1981-82 Winter

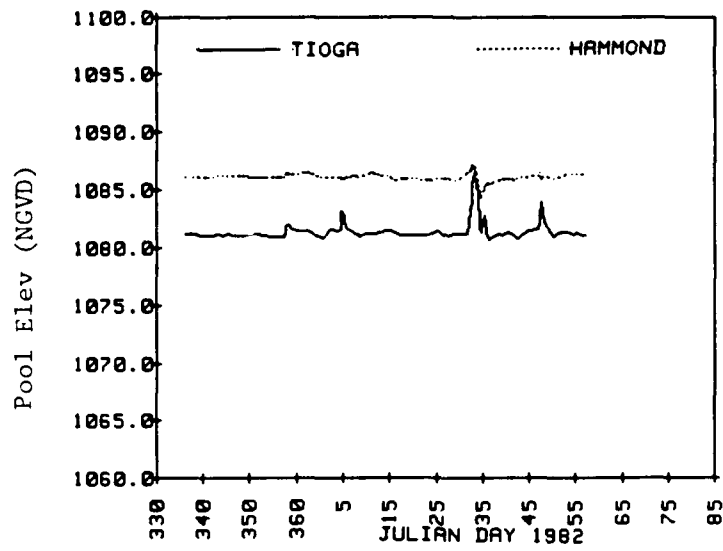

Figure 16, Pool Elevations in 1981-82 Winter

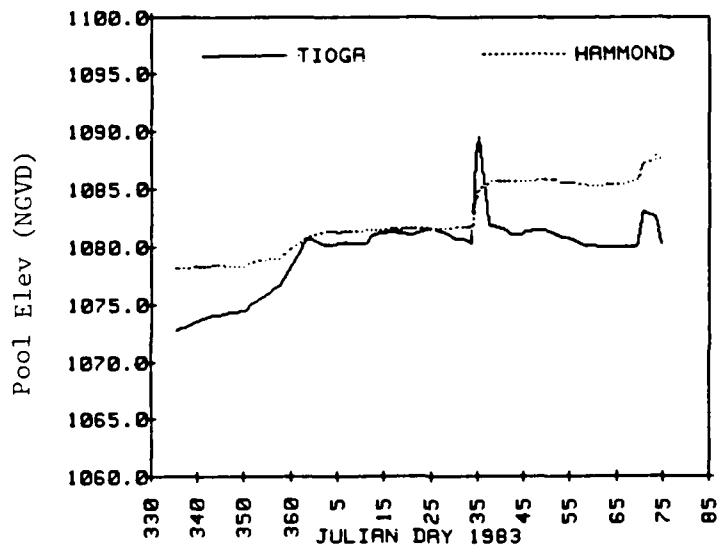

Figure 17, Pool Elevations in 1982-83 Winter

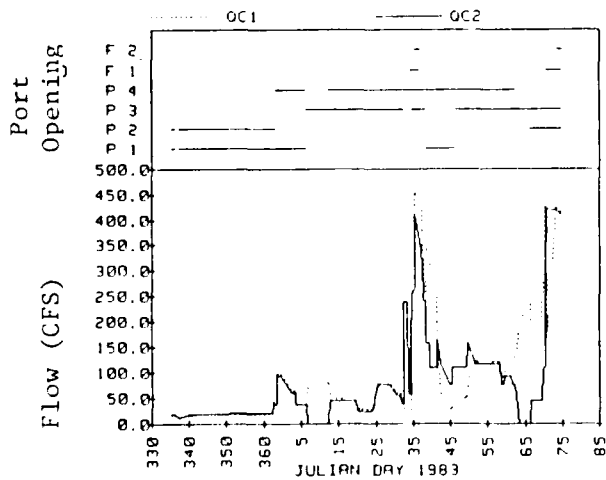

Figure 18, Discharge from Tioga QC Gates and Portal Opening in 1982-83 Winter

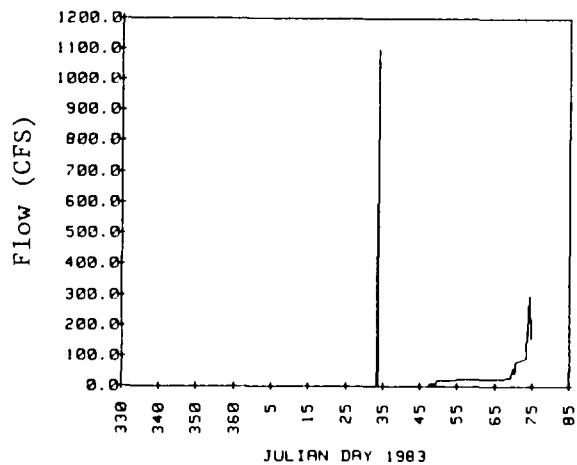

Figure 19, Discharge from Connecting Channel in 1982-83 Winter

Figures 17 through 20 show pool elevations, portal openings, discharge from connecting channel gates, and Crooked Creek outflows. During the under-ice conditions at the beginning of the first winter runoff (Julian day 34), Hammond water was dumped into Tioga, temporarily raising the pool. Water quality problems under the ice repeated. Figure 21 shows pH at Tioga Junction and Mansfield. A serious fish kill occurred at the beginning of the release during the first winter runoff. This fish kill extended downstream to Lawrenceville, Pennsylvania, at the confluence of the Cowanesque and Tioga Rivers. Again, after ice formed on the surface in the lake, lake quality in front of the intake tower rapidly declined with time. The regulation efforts were not successful in preventing a fish kill.

During the 1982-83 winter, an extensive lake water quality sampling program was carried out, and an alkaline water pocket near the Mill Creek arm of the lake was discovered. Figure 22 shows the pH profile in Tioga Lake on Julian day 55. It appeared that Mill Creek water had flowed upstream on the surface, and poor quality Tioga inflows with higher density traveled directly along the old river channel to the outlet.

To understand the effects of the mixing of Hammond water in Tioga Lake, a dye test was performed in the fall. It concluded that outflow quality improvement due to small volumes of Hammond water released through the connecting channel into Tioga Lake was minor. The direction that Hammond water flowed and the mixing pattern in Tioga Lake not conclusively determined.

It was hypothesized that the apparent seiching of water quality in Tioga Lake is caused by a sudden change of flow into or out of the lake. For instance, sudden high inflow or a sudden increase or decrease in discharge from Tioga Lake could generate a wave and cause the seiching. This hypothesis was confirmed by a laboratory test by the Baltimore District and a review of lake hydrodynamics literature.

#### D. 1983-1984 Winter

The Corps' Committee on Water Quality was asked in May 1983 to provide assistance in evaluating the water quality problems at Tioga Lake. The Committee met with the Baltimore District in June 1983 and provided a reply in November 1983. Based on their evaluation, the Committee concluded that the under ice problem is very complex and poorly understood, and that "except for periodic under-the-ice events, existing lake regulation appears to be very closely approaching reliable year-round control of acid pollution from the tributary basin of Tioga Lake." Committee suggestions included closely monitoring under ice water quality conditions with an intensive wintertime sampling program, and to detain under-ice acid slugs to improve mixing and neutralization. Unfortunately, the intensive winter sampling program was not executed because of lack of funding.

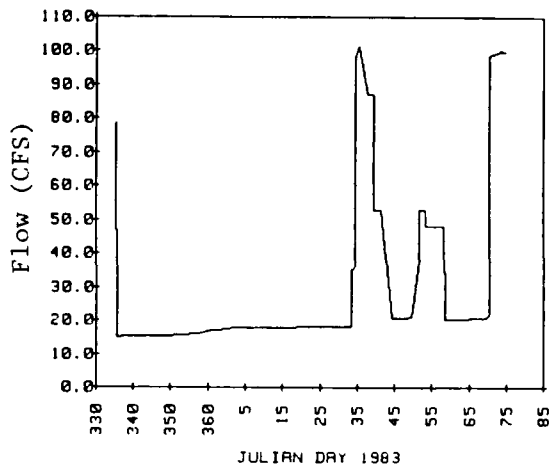

Figure 20, Discharge from Connecting Channel Gates in 1982-83 Winter

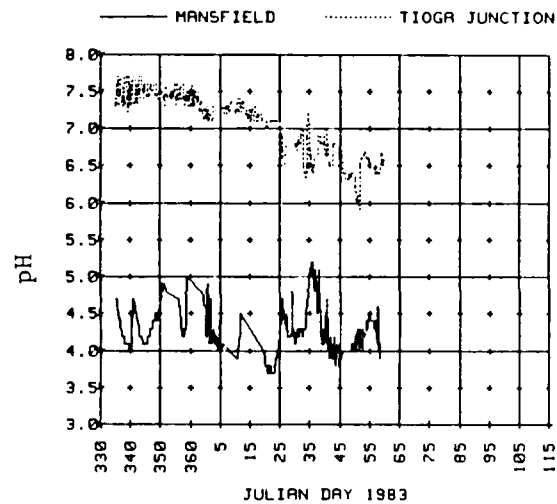

Figure 21, Inflow and Outflow pH in 1982-83 Winter

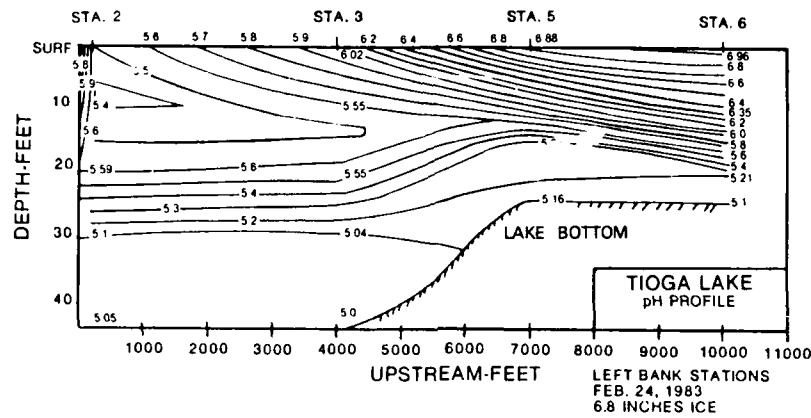

Figure 22, pH Profile in Tioga Lake

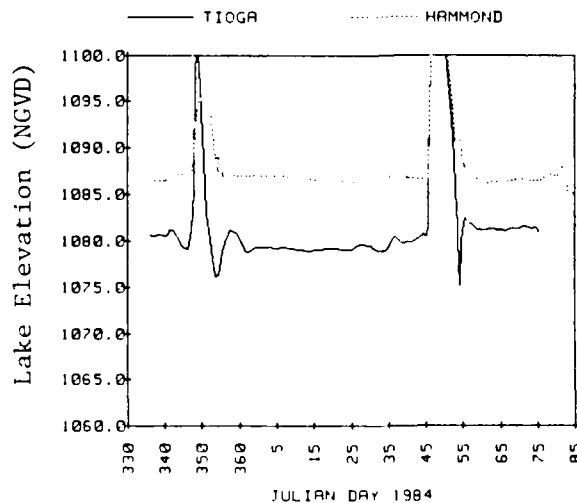

Figure 23, Lake Elevations in 1983-84 Winter

The past operational experiences seemed to indicate that the Tioga-Hammond project could not meet the objective downstream pH during under ice conditions. This was due to limited wind mixing and formation of the alkaline pocket near the Mill Creek arm area. The 1983-84 winter operational plan was modified from the 1982-83 operational plan as follows:

1. The objective pH at Tioga Junction was lowered from 6.7 to 6.0.
2. Bottom water was always released either through the bottom port or through the flood gates during under-ice conditions.
3. Ice-covered Tioga Lake was not allowed to rise until the first runoff.
4. Immediately following high runoff, Tioga Lake was lowered about 5-6 feet, and Hammond water was dumped into Tioga Lake, refilling it with good quality water.

In the fall of 1983, lake quality was poor (around pH 5.5). A high runoff event occurred in mid-December, when Tioga Lake was not ice covered. Tioga Lake almost reached the connecting channel weir crest (elevation of pool 1101), and Hammond Lake reached 1096. Immediately following the high runoff, Tioga Lake was lowered to elevation 1076 (Figure 23), and Hammond water was dumped into Tioga Lake to provide good quality water before freezing (Figure 24). After the high runoff, Tioga discharges were made through the uppermost port (port 4) and the lowest port (port 1) (Figure 25). The discharge ratio utilized varied with the resultant pH at Tioga Junction. Ice began to form on Julian day 10. Figures 26 through 28 show the pH profile in front of the intake tower before and after under ice formation. Even though Hammond water was dumped into Tioga in December, the lake quality exhibited low pH (5.0) below 10 feet from the surface on Julian day 5 (Figure 26), before the ice formed. The lake quality gradually improved by Julian day 12 (Figure 27). On Julian day 32 the lake showed good quality on the surface (Figure 28). The unpredictable variance of quality conditions in front of the intake tower resulted in wide pH fluctuation at Tioga Junction (Figure 29). Figures 30 and 31 show the lake pH at different times.

The alkaline water pocket near the Mill Creek arm area had just begun to form a week after freezing (Figure 30). As time passed, the alkaline water pocket became larger (Figure 31). Acid bottom waters were continuously released through port 1. Crooked Creek outlet releases were 20-40 CFS with one minor variance. The minor flow change was made to improve pH at Tioga Junction. Before the first snowmelt runoff occurred about Julian day 45, Hammond water was dumped into Tioga to improve lake water quality (Figure 24); however, the under-ice water quality problems repeated. No downstream fish kills were reported, probably because no fish were living in the Tioga River below the dam due to poor quality outflows since fall. A hypothetical under-ice flow pattern based on knowledge acquired through winter 83-84 appears as Figure 41.

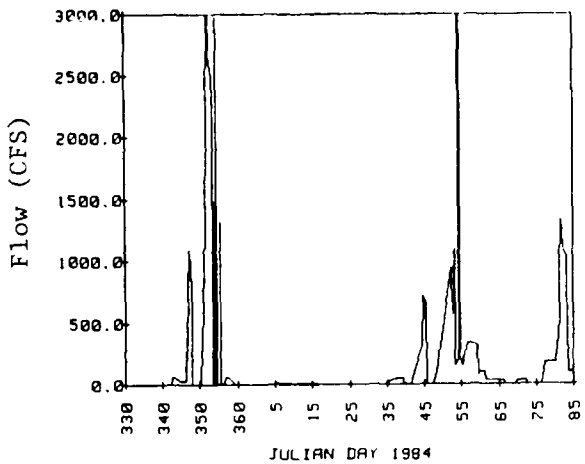

Figure 24, Discharge from Connecting Channel Gates in 1983-84 Winter

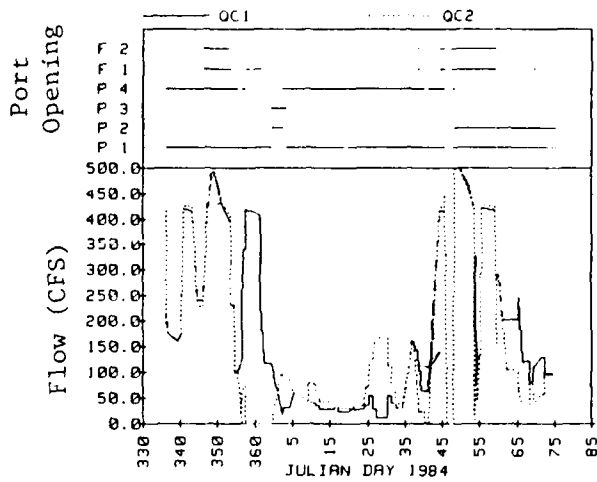

Figure 25, Discharge from Tioga QC Gates and Portal Opening

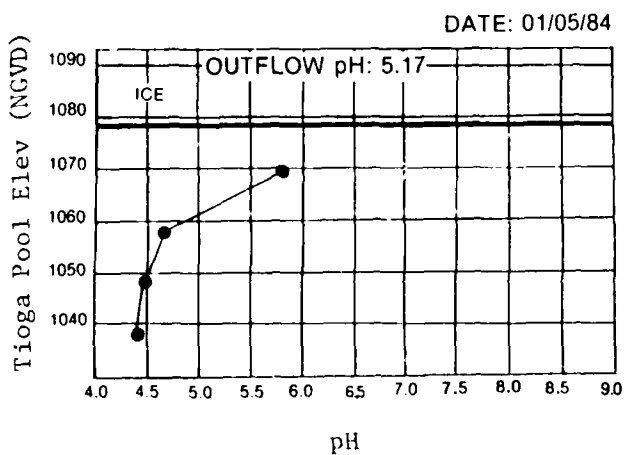

Figure 26, pH Profile in Front of the Intake Tower

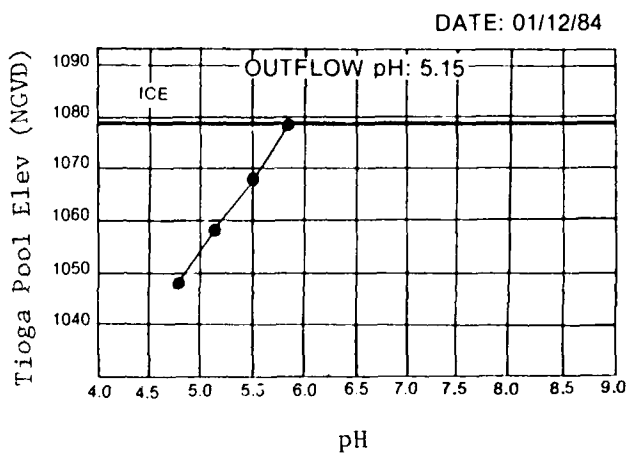

Figure 27, pH Profile in Front of the Intake Tower

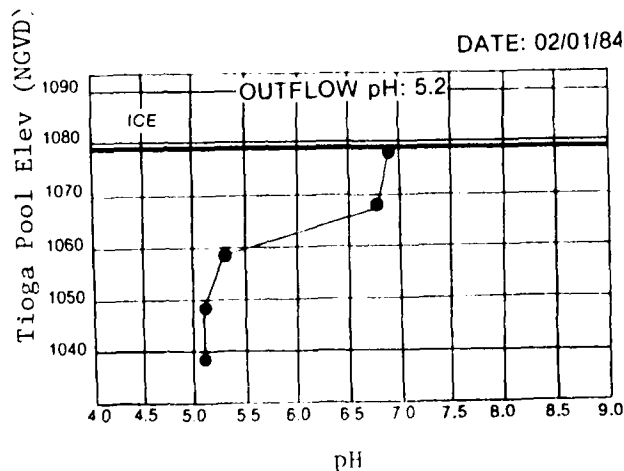

Figure 28, pH Profile in Front of the Intake Tower



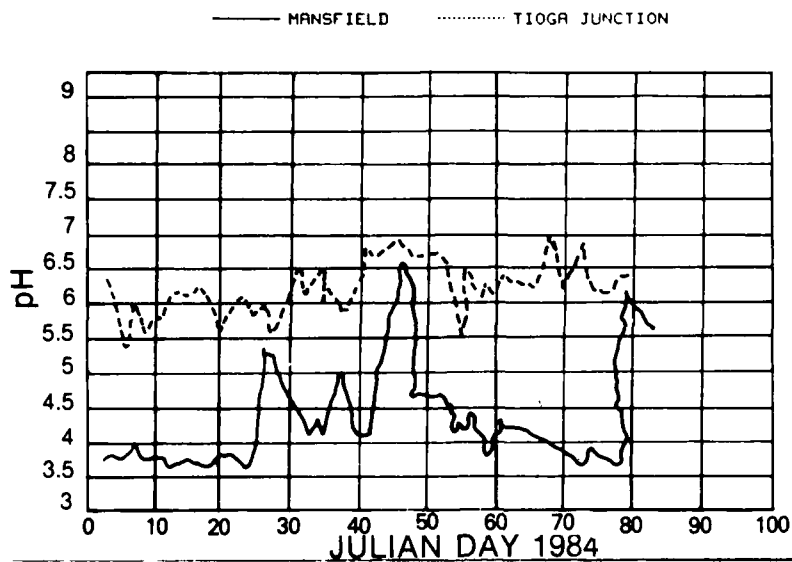

Figure 29, Inflow and Outflow pH in 1983-84 Winter

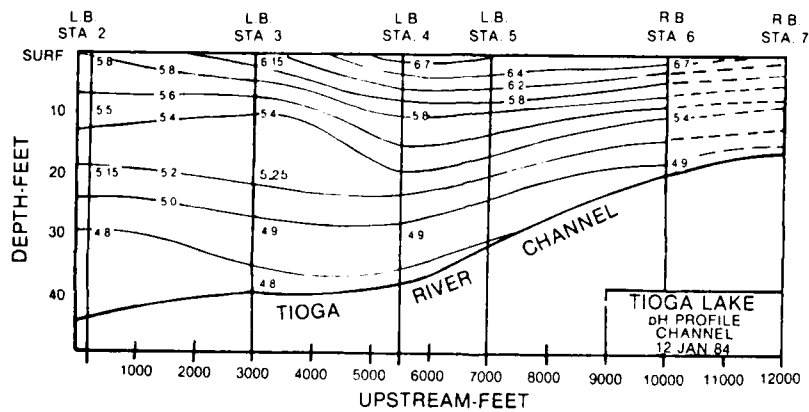

Figure 30, pH Profile in Tioga Lake

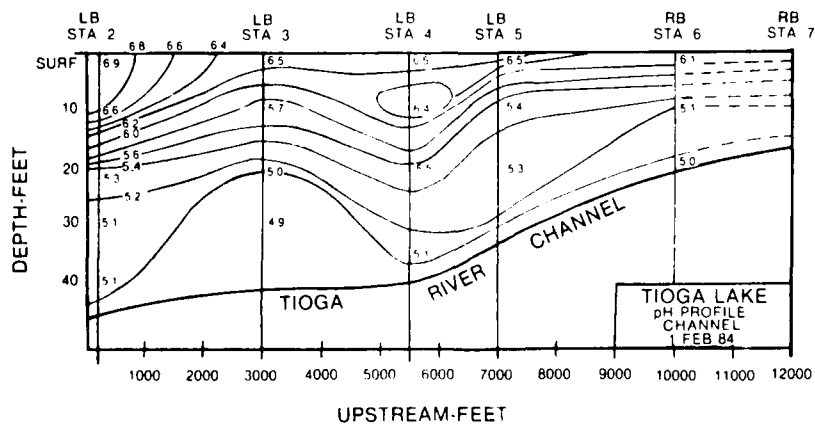

Figure 31, pH Profile in Tioga Lake

## E. 1984-1985 Winter

Past experience indicated that we apply a much more radical water quality management plan to maximize use of all available resources. For the last four years, Tioga regulation constraints had seriously limited water quality management. Use of existing physical elements (Tioga selective withdrawal system, Crooked Creek outlet works and Hammond outlet works) had been maximized but had been unsuccessful. However, the available resources could never not be fully utilized since both pools were always maintained nearly flat. For the winter of 84-85, we proposed fluctuation of Hammond Lake level to provide additional water to neutralize acidic Tioga water in times of greatest need. This plan was rejected because of its impact on recreation; therefore, the regulation plan for winter 1984-85 was modified only slightly in its water quality management aspect. The modified plan differed from the previous regulation plans in that water quality conditions in the reach between Tioga Dam and the river's confluence with Crooked Creek were artificially made worse to prevent the accumulation of acid water in front of the Tioga intake tower. An extensive sampling program was again planned, and dye tests were performed under the ice.

Figures 33 through 36 show the discharges from the Tioga selective withdrawal intake, the connecting channel gates, and Crooked Creek outlet works, and Tioga and Hammond pool elevations, respectively. Figures 37 through 39 show pH profiles in the lake. These figures show the development of alkaline water pocket near the Mill Creek arm.

This regulation plan resulted in the most uniform downstream quality (Figure 40). Minimum pH at Tioga Junction was 6.17. However, a very severe fish kill occurred as far downstream as Lawrenceville, Pennsylvania (confluence of Tioga and Cowanesque Rivers). This fish kill occurred at normal low discharges whereas past fish kills had occurred at the beginning of large releases. The causes of this fish kill are unknown; however, toxicity of heavy metals in the water is suspected. Water quality problems under the ice (alkaline water pocket formation and accumulation of acid water in front of the intake tower) persisted during the winter.

Based on operational experience, the following conclusions were made:

1. Fish kills will repeat every year unless wide latitude in operational flexibility of Tioga and Hammond Lakes is allowed.
2. The use of existing physical project elements and water quality management can only reduce the severity and frequency of fish kills, not avoid them.
3. The application of some type of treatment for acid neutralization and/or a mechanical mixing device may be necessary to prevent fish kills.
4. Toxicity of unknown heavy metals may cause fish kills.

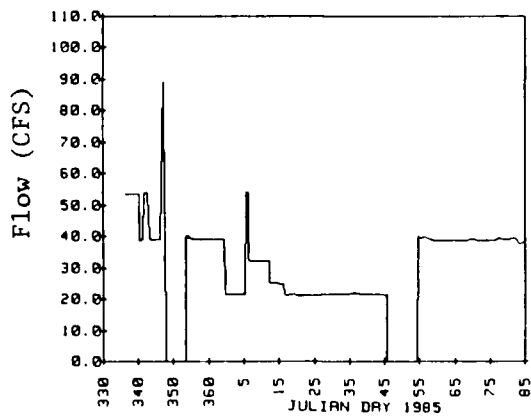

Figure 32, Discharge from Crooked Creek Outlet Works 1984-85 Winter

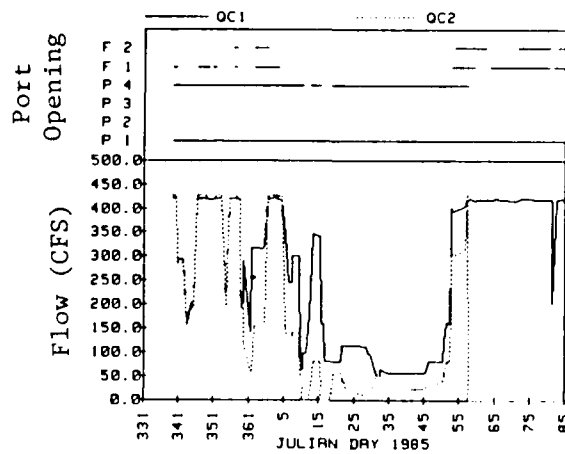

Figure 33, Discharge from Tioga QC Gates and Portal Opening in 1984-85 Winter

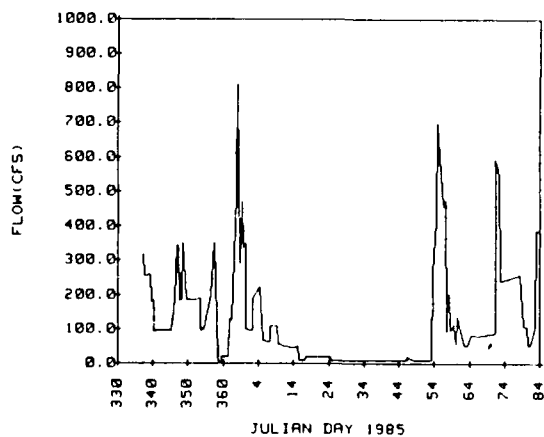

Figure 34, Discharge from Connecting Channel Gates in 1984-85 Winter

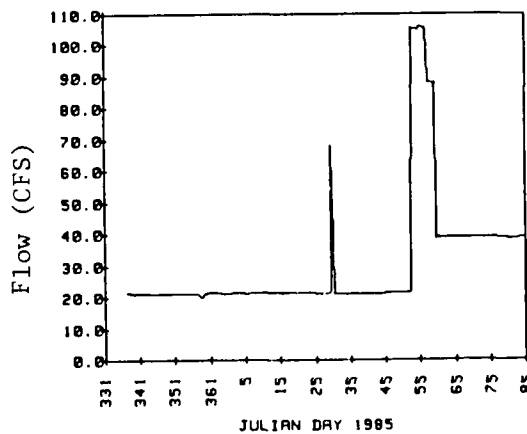

Figure 35, Discharge from Crooked Creek Outlet Works in 1984-85 Winter

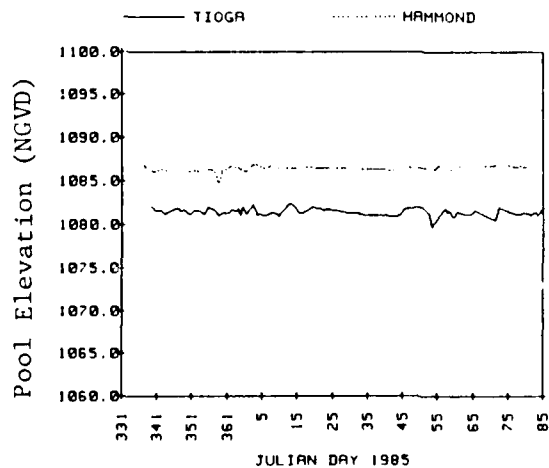

Figure 36, Pool Elevations in 1984-85 Winter

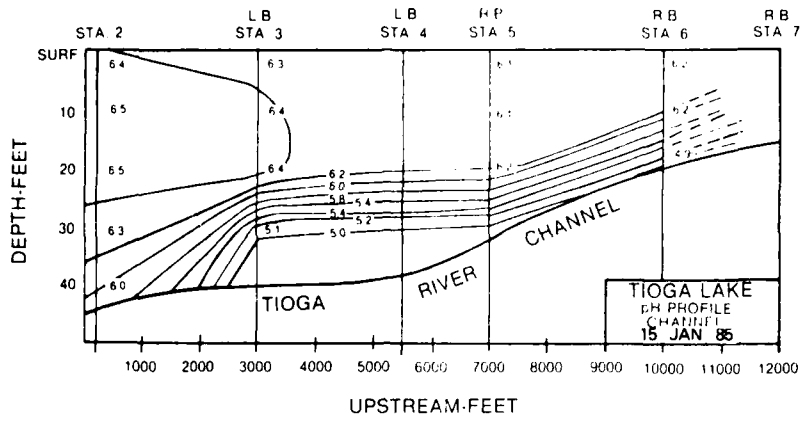

Figure 37, pH Profile in Tioga Lake

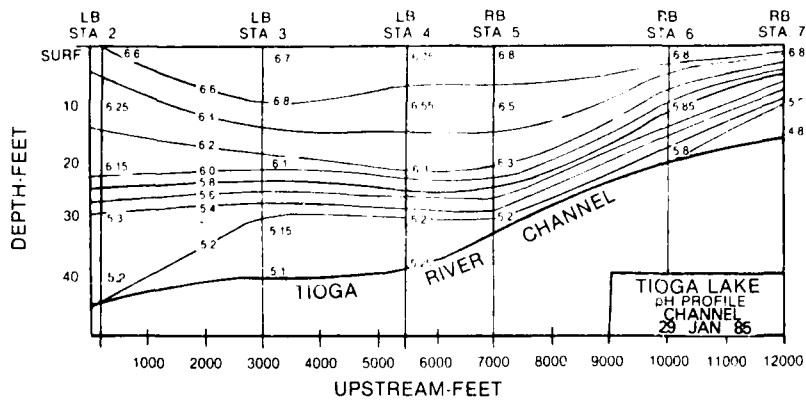

Figure 38, pH Profile in Tioga Lake

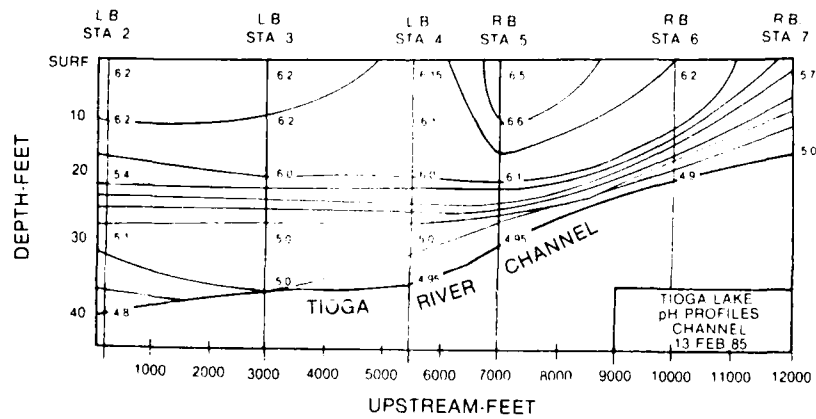

Figure 39, pH Profile in Tioga Lake

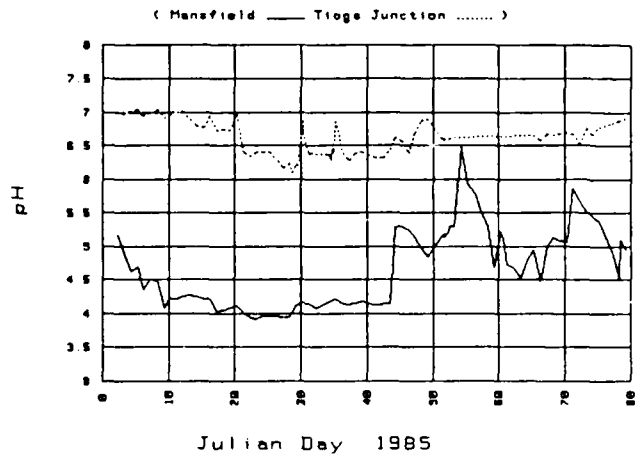

Figure 40 , Inflow and Outflow pH in 1984-85 Winter

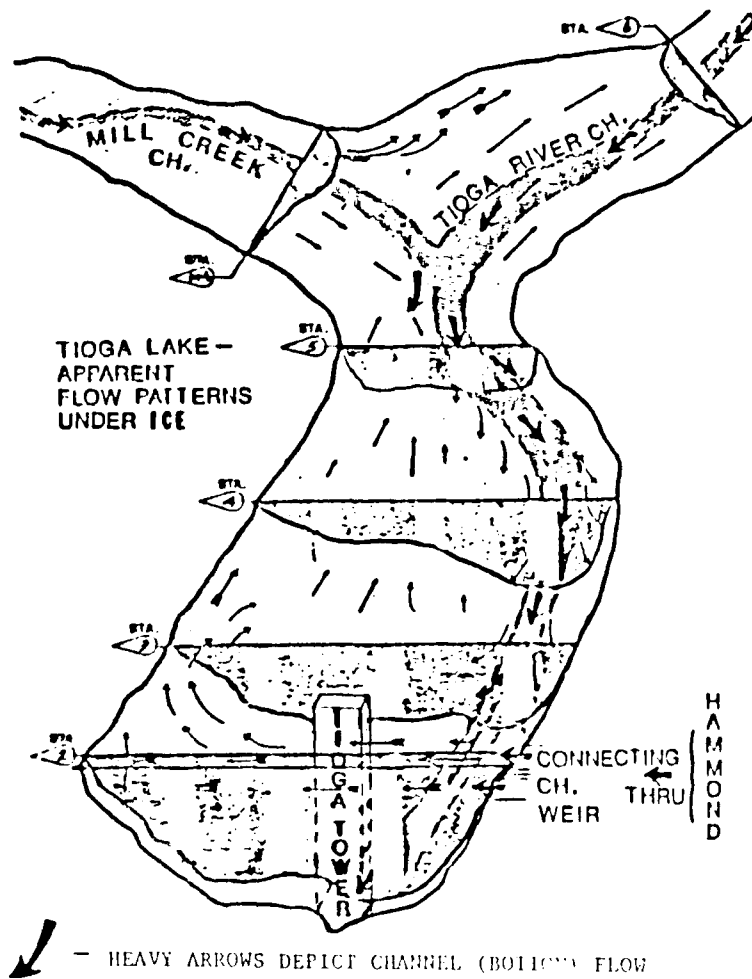

Figure 41, Hypothesized Flow Patterns in Tioga Lake During Under-ice Conditions

An under-ice dye test was performed to determine the flow patterns within the lake. At the time, the ice was partially covered by snow, and we could not trace the dye on the bottom. The surface flow pattern was similar to the previously hypothesized flow direction shown in Figure 41. Surface water was moving approximately 2 feet/minute upstream in the Mill Creek arm area.

Inflow quality in winter 84-85 did not change significantly. Jones and Bragg Mining Co. (the only active mine operation) closed their operations within the Tioga watershed in 1983; inflow quality has remained relatively constant ever since.

#### F. 1985-86 winter

Having exhausted all operational schemes within the constraints imposed on project operations, it became obvious that wider operation latitude and/or some form of treatment would be necessary at Tioga Lake. A thorough reevaluation of Tioga-Hammond Lakes was performed during 1985. Following are the study results showing the causes and possible solutions regarding water quality problems during under-ice conditions.

##### 1. Causes:

- a. Acid influx from Tioga watershed.
- b. Lack of neutralizing capacity.
- c. Limited wind mixing.
- d. Unknown hydrodynamics during under ice conditions.
  - (1) Acid water accumulation in front of the intake tower.
  - (2) Formation of alkaline water pocket near Mill Creek arm area.
  - (3) Unknown flow patterns of Hammond water in Tioga Lake during under-ice conditions.

##### 2. Possible Solutions:

- a. Upstream cleanup.
- b. Provision for neutralizing acid water.
  - (1) Chemical treatment.
  - (2) Hammond water.
- c. Mixing improvement.
  - (1) Mechanical mixing.
  - (2) Pool fluctuation.
- d. Water quality control management.
  - (1) Varying water quality objectives.
  - (2) Maximum utilization of physical project elements affecting water quality.

Various alternatives to improve water quality were considered based on the study results. Twenty-one options were presented to the Corps' Committee on Water Quality for evaluation in four categories: (1) pool elevation alternatives, (2) management alternatives, (3) chemical treatment, and (4) physical modifications.

The following options were evaluated.

1. Pool Level Alternatives:

- a. Maintain constant pools with minor fluctuation (Tioga: 1081±0.5, Hammond: 1086±0.5);
- b. Maintain constant pools (Tioga: 1081, Hammond: 1086);
- c. Drain both Tioga and Hammond in fall and refill in spring;
- d. Drain Tioga Lake in fall and refill in spring and maintain constant Hammond Lake pool (1086);
- e. Partially drain Tioga Lake in fall and refill in spring and maintain constant Hammond pool (1086);
- f. Partially drain both Tioga and Hammond Lakes in fall and refill in spring;
- g. Allow pools in Tioga and Hammond to fluctuate between elevation 1075 and 1084 in Tioga and 1080 and 1088 in Hammond for environmental enhancement from Labor Day until Memorial Day;
- h. Allow pool in Tioga to fluctuate between elevation 1075 and 1084 and fix Hammond pool (1086);
- i. Maintain Tioga and Hammond Lakes with no head differential and connecting channel gates fully opened at all times (1086 pools).

2. Management alternatives:

- a. Manage Tioga Lake for prevention of fishery in the lake and downstream;
- b. Manage for near term best quality with no regard for future conditions;
- c. Manage for far term water quality conditions.

3. Chemical treatment:

- a. Lime treatment at headwater area;
- b. Lime treatment at Tioga stilling basin;
- c. Lime treatment at Hammond outlet works stilling basin;
- d. Phosphate treatment at Tioga stilling basin.

4. Physical modifications:

- a. Remove end-wall and baffle blocks in Tioga side of Hammond outlet works stilling basin;
- b. Install a mechanical mixing device in Tioga Lake to induce mixing during ice-cover conditions;
- c. Install fish avoidance structures in connecting channel and downstream;

- d. Install a siphon pipe system from Hammond Lake to the Tioga stilling basin to directly withdraw Hammond waters;
- e. Transport fish.

5. Combinations of above options:

In the past, operational constraints (limited pool fluctuation) prevented maximum use of resources already available at the project to improve water quality. The committee recommended removing these constraints, thereby allowing the lakes to fluctuate to help control water quality.

The 1985-86 winter regulation plan was formulated to incorporate options from the pool level and management alternative categories. The plan included freedom for pool fluctuation and a far-term management objective to prevent excessive build up of acid water in Tioga Lake.

Experiments utilizing releases through the Hammond gates to help determine flow patterns in Tioga Lake were conducted by the Baltimore District in April 1984. From these experiments and data from previous years, it was conclusively determined that when the Tioga pool is rising or held steady, Tioga River flows tend to short-circuit the main body of the lake and travel directly along the old river channel to the Tioga outlet tower. Hammond releases cross Tioga Lake and either pool along the right bank or flow upstream along the right bank away from the Tioga outlet tower, which is located near the left bank of Tioga Lake. Also, Mill Creek water pools and moves upstream away from the outlet. When the Tioga pool is falling, Hammond connecting channel releases, Mill Creek waters, and Tioga inflows tend to travel together to the Tioga outlet tower.

Placing Tioga Lake into a slow fall results in better mixing of the lake by drawing all of the water downstream towards the dam. This discourages formation of the alkaline water pocket while the lake is covered by ice. Allowing Hammond Lake to fluctuate provides additional storage of alkaline water, which can be released through the connecting channel as needed to neutralize Tioga Lake waters. The steady lowering of Tioga Lake ensures that the connecting channel releases are drawn through the Tioga outlet to provide adequate downstream water quality. Under the new regulation plan, Tioga Lake is allowed to fluctuate between 1075 and 1084, and Hammond Lake between 1080 and 1088, for environmental enhancement between Labor Day and Memorial Day.

New operational procedures were also instituted to prevent in-lake acid slugs caused by high winter inflows. Poor quality water tends to accumulate near the headwaters of the lake, upstream of Mill Creek. When high inflows come, the upstream acid water is pushed rapidly towards the dam. In the past, when this under-ice slug of acid water reached the tower, control of outflow quality became impossible, resulting in fish kills. To remedy this situation, whenever high under-ice inflows are expected, Tioga outflow is increased to keep the pool falling and move the accumulated acid water towards the dam while connecting channel releases are increased to neutralize the acid water. After the initial surge of acid water, the high inflows bring in good quality water, and the lake is allowed to rise. Outflow quality then becomes easier to control.



The fish kill during the 84-85 winter occurred during low outflow with relatively good quality. Causes of the fish kill are unknown; however, it has been hypothesized that heavy metal toxicity may have killed the fish. Heavy metal concentrations in the lake are greatest at in the deepest areas of the lake, and bottom withdrawals release these waters. In response, the Pennsylvania Department of Environmental Resources' Bureau of Water Quality Management (PENNDER) initiated a cooperative 85-86 winter sampling program at Tioga-Hammond Lakes to monitor metals concentrations. PENNDER has noted effluent permit violations by an upstream foundry. Violations such as these may be contributing factors to possible metal toxicity related fish kills. Monitoring by PENNDER will continue, and we will continue to analyze the data.

The 1985-86 winter operation utilized Hammond water to further neutralize Tioga outflows to yield good downstream water quality. Figure 42 shows the required amount of Hammond water with pH at Tioga stilling basin. Maintaining pH 6.0 or above at Tioga stilling basin requires about 3,000 acre-feet of Hammond water (5 feet of elev.). The objective pH at Tioga stilling basin was established at 5.8 for the 1985-86 winter operation.

The proportion of Hammond water required to maintain the objective pH was determined by titration. Lake profile and connecting channel samples were periodically taken. These samples were combined in different proportions to construct operational titration curves. Figures 43 and 44 show two titration curves made during winter 1985-86.

The new operational mode was tested during the in 1985-86 winter, a period of wet hydrologic conditions. In early December when inflow quality was good, the lakes were raised: Tioga to 1084.5 and Hammond to 1087.5 (Figure 45). When inflow quality dropped after the lake froze, Tioga was lowered 0.05-0.1 foot per day. During lowering periods, the discharge ratio was set at 70-60% bottom and 30-40% top releases (Figure 46), depending on quality conditions. Connecting channel outflows were 5-30% of the total Tioga outflow depending upon Tioga Lake quality conditions and titration results (Figure 47).

Discharge from the Crooked Creek outlet was about 20 CFS throughout the winter (Figure 48). Pool fluctuation due to winter water quality operation was 6 feet (1085 to 1079) in Tioga and 2.5 feet (1087.5 to 1085) in Hammond. Around 1,700 acre-feet of Hammond water was used to neutralize acid water in 1985-86 winter. The wet hydrological conditions resulted in better inflow quality and required less Hammond water.

The operational mode instituted in winter 85-86 was completely successful in maintaining good quality water in-lake and downstream. No fish kills were reported, and the objective pH 6.0 at Tioga Junction was exceeded at all times (Figure 49). Figures 50 and 51 show typical pH profiles during winter 85-86, illustrating the absence of the alkaline water pocket by the Mill Creek arm. The operational method of pool fluctuation had reduced the extent of alkaline water pocket formation and increased mixing during under-ice conditions.

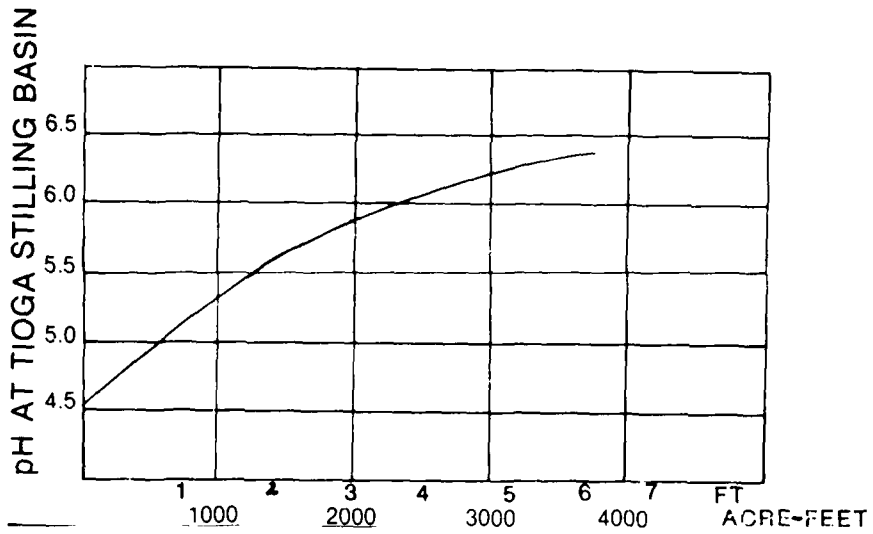

Figure 42, Require Amount of Hammond Water to Neutralize Tioga Acid Water

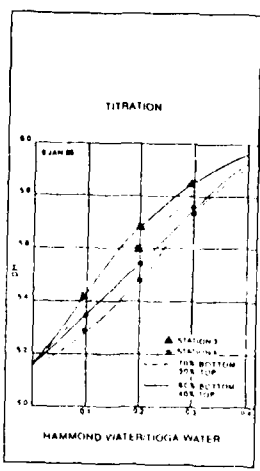

Figure 43, Titration Result Tioga vs. Hammond at Different Stations

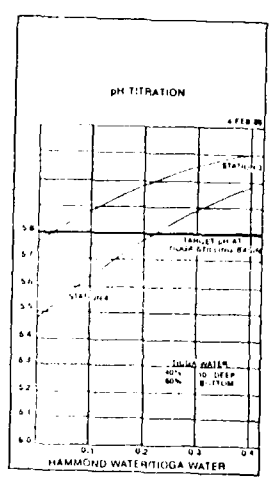

Figure 44, Titration Result Tioga Water vs. Hammond Water

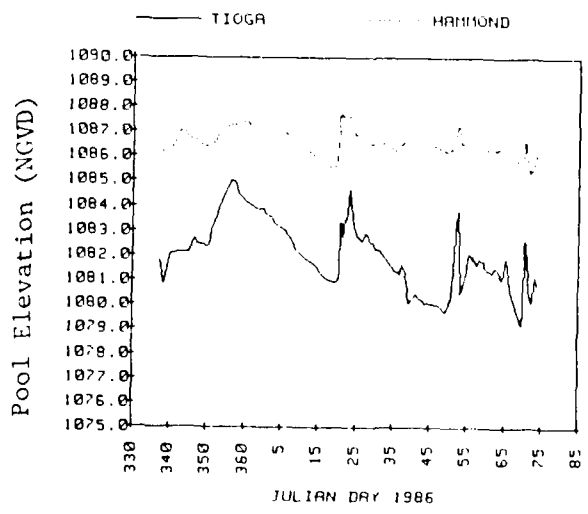

Figure 45, Pool Elevations in 1985-86 Winter

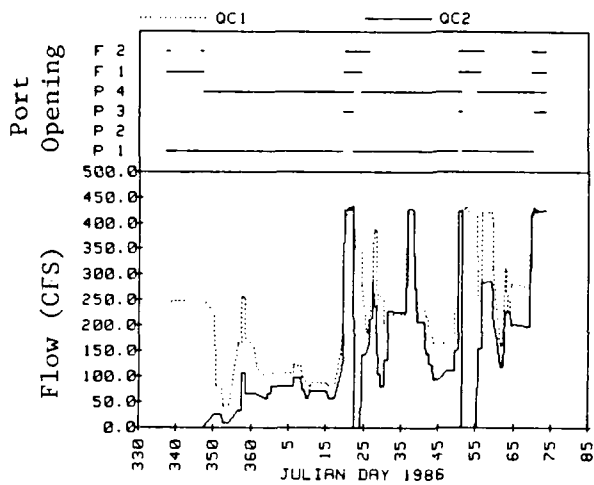

Figure 46, Discharge from Tioga QC Outlet Works and Portal Opening in 1985-86 Winter

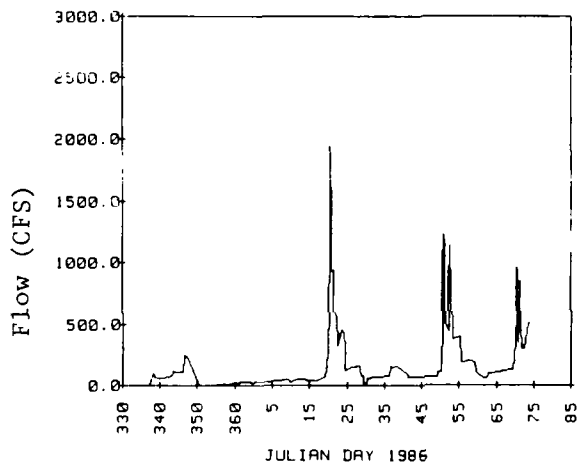

Figure 47, Discharge from Connecting Channel Gate in 1985-86 Winter

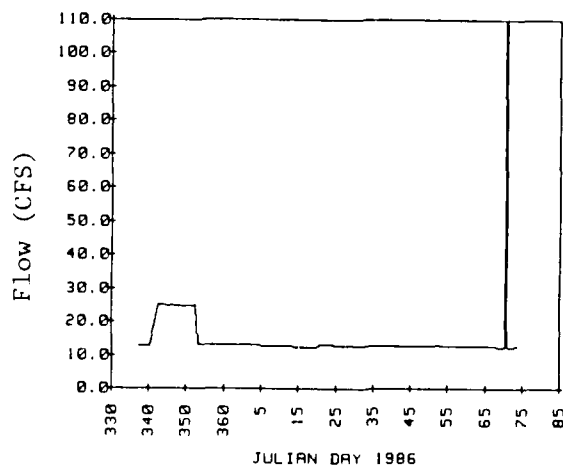

Figure 48, Discharge from Crooked Creek Outlet Works in 1985-86 Winter

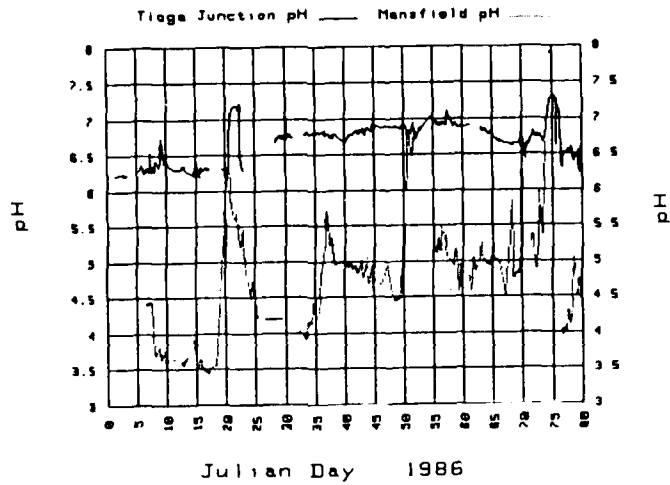

Figure 49, Inflow and Outflow pH in 1985-86 Winter

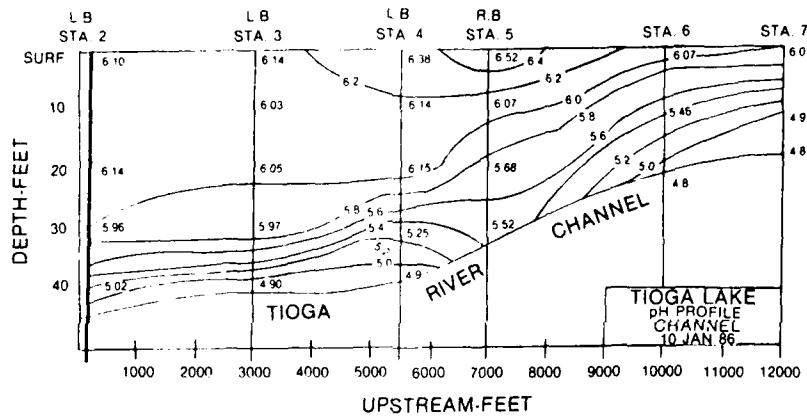

Figure 50, pH Profile in Tioga Lake

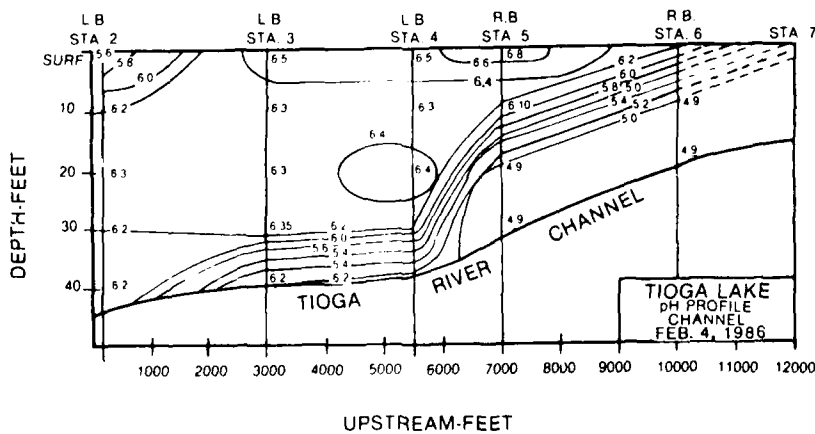

Figure 51, pH Profile in Tioga Lake

Several conclusions can be drawn from the successful new Tioga winter operating plan. Under-ice flow and circulation patterns in Tioga Lake can be altered by pool fluctuations. Since there is no accumulation of acid water by the tower and no alkaline water pocket, the overall in-lake pH is improved. This results in less Hammond water required to yield good downstream quality. However, without Hammond water, Tioga Lake does not have sufficient neutralization capacity, and quality control is difficult, if not impossible, even using the selective withdrawal system and a water quality management plan.

### III. CONCLUSIONS:

The flexible mode of operation instituted at Tioga Lake during the 1985-86 winter was successful in preventing downstream fish kills. Results of under ice water quality samples taken five times during the winter season indicate that the water in Tioga Lake was mixed during the 1985-86 winter. Profiles from previous years indicated that an alkaline water pocket formed near Mill Creek. This pocket caused the neutralizing effects of the alkaline Mill Creek water to be wasted. With a mixed lake due to the slow lowering of the pool, water quality control is facilitated. However, use of Hammond waters is necessary to further neutralize Tioga Lake outflows to yield good downstream winter water quality, achievable most of the time.

The flexible mode of Tioga-Hammond winter operation is a classic case of conflicting project objectives. Flat pools were maintained in the past for ease of recreational access for winter ice fishing. However, reevaluation of project objectives clearly determined that the small inconvenience to ice fishermen is far outweighed by the water quality benefits derived by pool fluctuation.

Although fish kills have occurred in and below Tioga Lake in the past, they are a good sign. They are indications that water quality had improved there to the point where fish life could be sustained a majority of the the time, and natural fisheries are thriving.

While operational procedures may help prevent water quality related fish kills at Tioga Lake, the only true solution would be to attack the root of the problem - acid mine drainage. Cleanup of abandoned coal mines in the Blossburg area upstream of Tioga Dam would not only improve water quality in Tioga Dam, but would restore the polluted Tioga River. With cleanup, the Tioga River upstream of the dam and Tioga Lake could one day become untainted, productive natural fisheries and a credit to the mine cleanup program.

### REFERENCES

U.S. Army Corps of Engineers, Tioga Lake, Pennsylvania; Investigation of Under-Ice Hydrodynamics and Water Quality, U.S. Army Corps of Engineers, Baltimore District, Baltimore, MD, 1987.

## TOWN BROOK RELIEF TUNNEL DESIGNING FOR ANOXIA AND H<sub>2</sub>S GENERATION

By

Townsend G. Barker<sup>1</sup>

The Town Brook Relief Tunnel is unique. Nothing with this sort of potential water quality problems has been built by the Corps of Engineers. It is a 12 foot diameter inverted siphon 4,060 feet long which carries excess flows from urban areas of Quincy into tidal reaches of Town River Bay. When urban runoff meets saltwater in a closed container 160 feet below ground, the result will be rapid dissolved oxygen (DO) depletion and the generation of hydrogen-sulfide gas. If this were not bad enough, there is the additional effect of 160 feet of hydrostatic head, which will allow the hydrogen-sulfide to build to supersaturated levels. When a storm flushes the tunnel's anaerobic, super-saturated hydrogen-sulfide waters into Town River Bay - probably during a smelt run and in any case into the shellfish beds - the results would be unacceptable at best. In order to prevent such occurrences, an imaginative water quality maintenance scheme has been proposed. That is the subject of my presentation.

The Town Brook tunnel is part of the larger Town Brook Local Protection Project which is located in eastern Massachusetts in the cities of Quincy and Braintree just south of Boston. This project is very unusual for the Corps of Engineers because of the tiny size of the watershed - only 4.5 square miles total drainage area. It is also quite complex involving improvements to Old Quincy Reservoir Dam and the construction of various improved culverts and conduits. Essential to all parts of the project is the tunnel, a 12 foot diameter inverted siphon; it carries the excess flows drained from the upper reaches of the watershed under the city of Quincy into Town River Bay. Figure 1 shows the layout of the various components of the Town Brook project.

The Town Brook tunnel is a relief tunnel designed to carry excess flows; it does not have water flowing through it at all times. During normal flow periods, water will bypass the tunnel and proceed on down Town Brook, only during floods will excess water spill over a set of weirs in the tunnel entrance structure and enter the tunnel itself. This is important to understanding the water quality effects of this project; it means that not only is the tunnel water stagnant for significant periods of time, but also that the initial part of storm flows will bypass the tunnel.

The 11-acre-foot volume of the relief tunnel is too small to have an effect on water quality in Town River Bay. However, it is large enough to affect water quality in Town River between the tunnel outlet and Town River Bay. The tunnel discharges into a saltmarsh with a high tide volume of about 30 acre-feet. Flow through the saltmarsh goes into a channel with a volume of about 23 acre-feet which leads into the wide areas of Town River Bay proper. It is in the relatively confined areas of the saltmarsh-estuary and channel that the tunnel discharges have the potential to affect water quality conditions.

The source of the anticipated water quality problems in the tunnel is somewhat complex. During storm events, runoff will wash street litter and other debris into the brook and into the tunnel. There are bar-racks to keep large debris out and grit chambers to keep sand out of the tunnel, but much organic BOD is expected to enter with storm flows. Most of this organic matter is expected to be contained in the initial part of the runoff hydrograph - the so-called 'first flush.' During small storms, there should be no problem since flow will bypass the tunnel. During large storms, there again may be no

<sup>1</sup> Hydraulic Engineer, Hydraulics and Water Quality Section, NED.

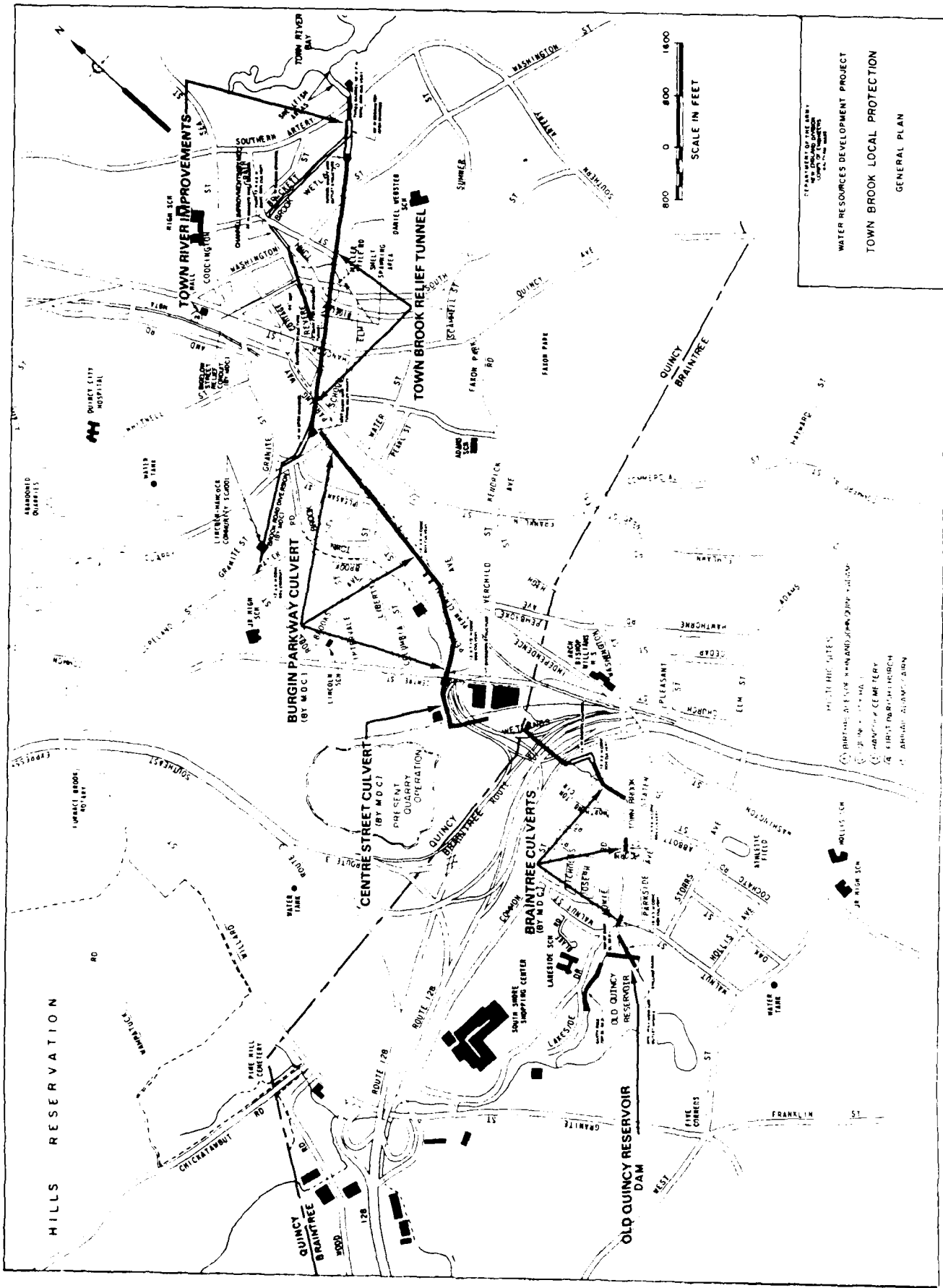

WATER RESOURCES DEVELOPMENT PROJECT  
 TOWN BROOK LOCAL PROTECTION  
 GENERAL PLAN

Figure 1

problem because the large amount of flow will wash the first flush through the tunnel. The worst situation will occur with an intermediate-sized storm which just fills the tunnel with runoff containing most of the organic material carried off in the first flush.

After the storm subsides, the runoff in the tunnel will mix with seawater. The outlet to the tunnel has an invert elevation of 2 ft NGVD, which is below the mean high tide level of 4.8 ft NGVD. Consequently, during every tide cycle, saltwater will enter the tunnel through the outlet and mix with and displace the lighter freshwater in the tunnel. After a few cycles, the tunnel and outlet shaft will be filled with seawater and the organic solids washed into the tunnel during the last storm.

This will make for a potent brew. Seawater left in a closed container will go anaerobic. Seawater with the additional organic material washed in by storms will not only go anaerobic, but will generate significant amounts of hydrogen-sulfide. This hydrogen-sulfide has the potential to be washed into the estuary when a storm flushes the tunnel.

Hydrogen-sulfide levels in the tunnel discharge are important for two reasons: first, because they are toxic to aquatic life, and, second, because their DO demand will greatly influence the duration of low DO levels in the tunnel discharge after mixing with the waters of Town River and Town River Bay.

We did quite a bit of work trying to quantify the time it would take the tunnel to go anaerobic and the amount of hydrogen-sulfide that would be generated. Data on the estuarine water quality were collected during different tide cycles and gave a good idea of the conditions of the seawater. However, estimating the condition of the storm water was much more difficult, not only because of its high variability, but also because construction in the watershed on the conduits and other improvements that were part of the Town Brook project had begun and would influence the results of any storm water monitoring program. Instead of trying to sample storm flows in Town Brook, we contacted engineers throughout the country who had collected storm water through the national urban runoff studies. It was important to find studies which included sampling at multiple points on the runoff hydrograph as this would permit an estimation of the water quality of that part of the storm which would enter the tunnel. We were able to find enough sites with watersheds similar in size to ours to get satisfactory estimates of the range of expected storm water runoff conditions at Town Brook.

A flood flow frequency analysis determined that storms with enough runoff to replace the tunnel's contents would occur an average of two to three times per year. The storm water analyses indicate that about half the storms contained a 5-day BOD load equal to or greater than the mean DO in Town Brook, which was the expected initial DO in the tunnel at the end of a storm. On this basis we estimated that half the storms would cause anaerobic conditions in 5 days. A further statistical analysis of the storm water variability showed that 80 percent would contain enough BOD to deplete the DO in 20 days.

Next we tried to calculate the maximum hydrogen-sulfide levels that could be generated. Hydrogen-sulfide estimates were made using the stoichiometric relationship that, after the onset of anaerobic conditions, 1 mole of sulfate is reduced for every two moles of carbon oxidized (1). This was adjusted to account for the greater energy in the denitrification reaction and the precipitation of metallic sulfides (2). Assuming seawater intrusion at the tunnel outlet caused the tunnel to contain a mixture of 50 percent fresh and 50 percent saltwater, and assuming mean levels of DO, an ample supply of metals in the seawater and a storm with the statistically determined worst case (99th percentile) ultimate BOD of 163 mg/l, a theoretical maximum of 39 mg/l of hydrogen-sulfide could be



produced. At the mean pH observed of 7.6, 20 percent of 7.8 mg/l would be in the form of dissolved (undissociated) hydrogen-sulfide gas and the rest would be in the form of dissociated hydrogen-sulfide (3). However, undissociated hydrogen-sulfide is highly toxic to sulfur bacteria (4,5). The buildup of hydrogen-sulfide in the water would poison the bacteria and prevent the theoretically possible high levels of hydrogen-sulfide from actually occurring. This same self-poisoning phenomenon is found in alcohol fermentation from sugar. An alcohol level of about 20 percent poisons the yeast and prevents further alcohol production even though more sugar is available. A literature search (6,7,8) found that the maximum hydrogen-sulfide level that was reported as nontoxic to fish for more than a few hours, was 1 mg/l. Using 1 mg/l undissociated hydrogen-sulfide as the toxic limit for sulfur bacteria, a maximum total hydrogen-sulfide level of 7 to 8 mg/l could occur at pH 7.8, the upper limit of pH levels expected in the Town Brook relief tunnel. This agrees with studies by the Massachusetts Division of Water Pollution Control (MDWPC) of a saline wedge of water at the bottom of the polluted Charles River basin (9). The situation in the Charles River basin is similar to the worst case expected for the Town Brook tunnel in that there was abundant BOD, sulfate, and time. Also, the pH levels in the Charles River basin are within the range expected in the Town Brook relief tunnel. In a 1974 survey, the MDWPC found a maximum of 8 mg/l of hydrogen-sulfide in this saline wedge.

Using a Streeter-Phelps method, we routed what we figured was a worst case (99th percentile BOD load) tunnel discharge through the Town River and into Town River Bay. The results indicated that an anaerobic plume could persist for 3 hours and another 2 hours could be required to restore conditions to the levels required by State standards - 6 mg/l DO. This was considered unacceptable.

The primary goal of the water quality maintenance plan is to prevent hydrogen-sulfide; the secondary goal is to prevent low DO or anaerobic discharge. There are a number of ways this could be accomplished. These fall into three general categories: flushing the tunnel, pumping the tunnel dry between runoff events, or mechanically aerating the tunnel.

The initially preferred plan involved flushing the tunnel with seawater using the power of the tides which have a mean range of 9.5 feet in this area. Figure 2 illustrates this scheme. A rising tide would fill the tunnel outlet with seawater; during a falling tide the water would drain through the low level outlet pipe. Because the outlet pipe withdraws water from the upstream end of the tunnel, a flushing of the entire tunnel could be accomplished. A tide gate on the end of the outlet pipe prevents a flow reversal during a rising tide.

Unfortunately, the excavation required to install the flushing pipes in the tunnel and the wetland out to the low tide level was too expensive, and with great reluctance we were forced to drop this plan.

Pumping the tunnel dry between runoff events was infeasible in part because of the cost, but also because it would require installing stoplogs in the tunnel outlet to keep out seawater. These stoplogs would have to be removed before storms or the tunnel would not perform its flood control function. Murphy's Law ensures that the stoplogs would be in place during a major flood.

This left only tunnel aeration as a viable means of preventing the potential adverse effects of tunnel discharges. Figure 3 illustrates the adopted plan. The proposed aeration method uses an air compressor to pump air into the outlet shaft through a coarse-bubble diffuser. This diffuser will be placed on one side of the outlet so that the rising bubbles

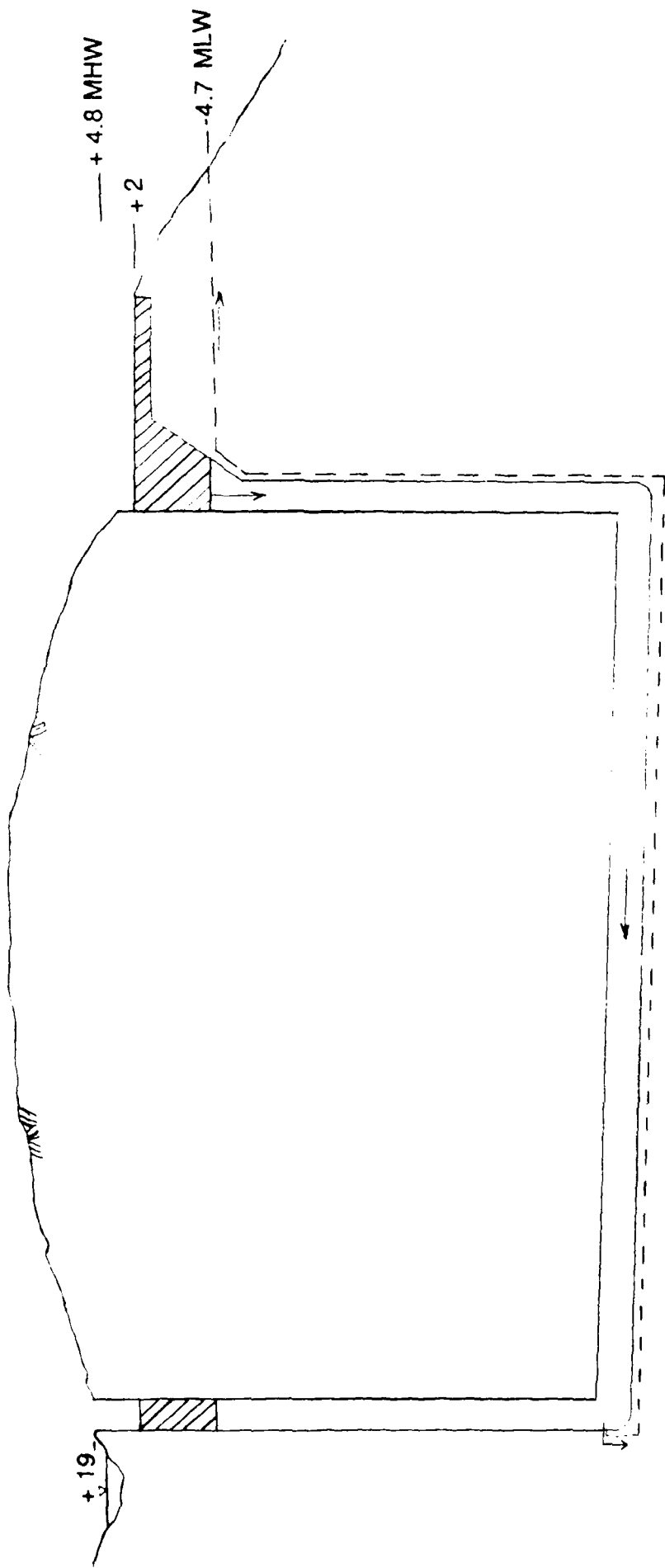

TOWN BROOK  
LOCAL PROTECTION  
PROJECT  
TIDAL FLUSHING  
PLAN

--- Circulation Pipe  
 Flush-water

Not to Scale

Figure 2

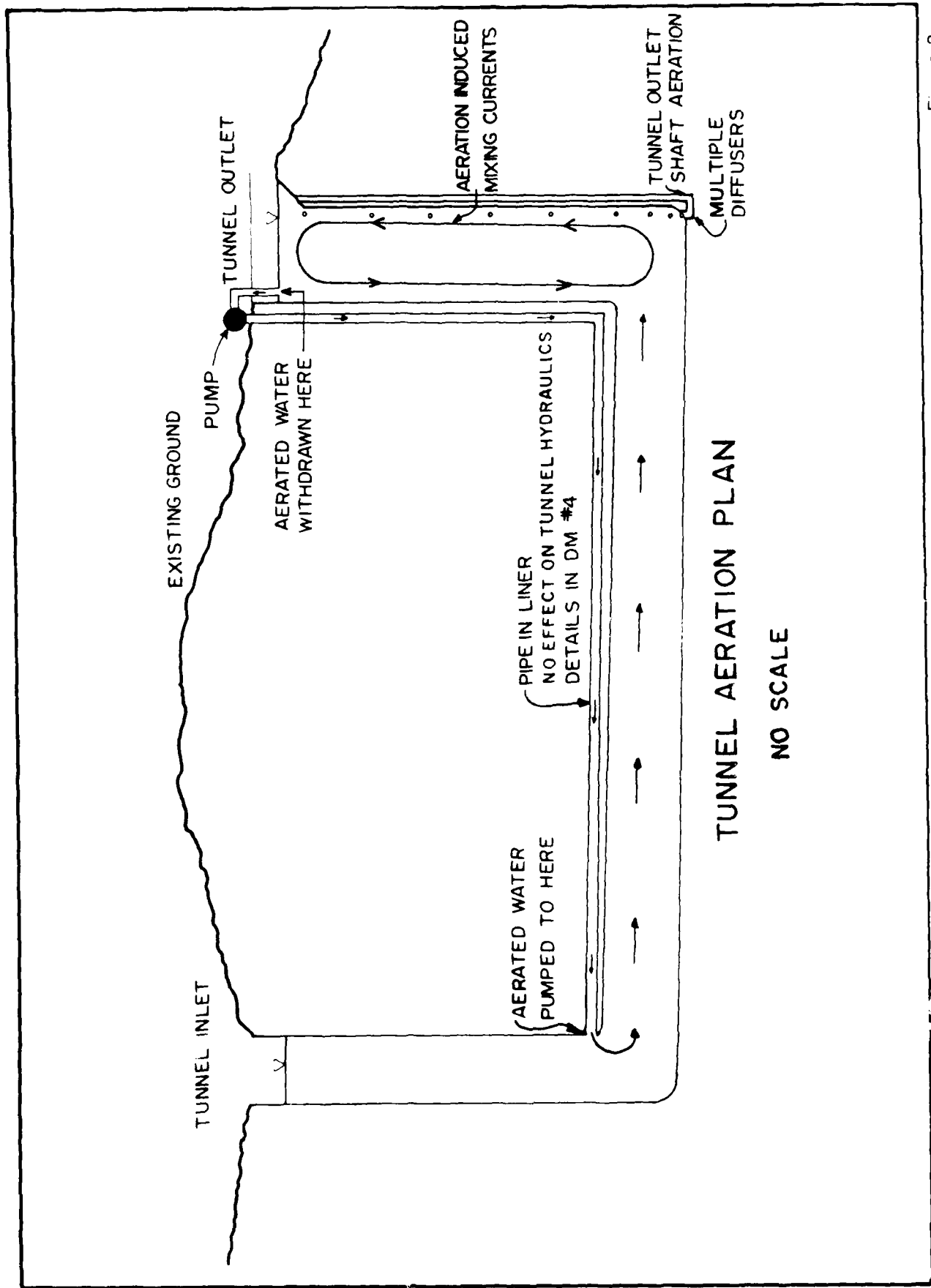

Figure 3

will keep the shaft aerated and mixed. The rising bubbles will cause the aerated water to rise to the surface so that gaseous exchange can occur with the atmosphere and prevent dissolved gas supersaturation. A pump will move the aerated outlet water at a rate of 1,000 gpm through 6-inch diameter pipes to the tunnel inlet shaft to get circulation throughout the tunnel. This system will circulate the tunnel's contents every 2.6 days.

The aeration system is designed to keep the outlet shaft at a minimum DO of 6 mg/l. A 2.6 day circulation time in the tunnel will have the effect of an input of 6 mg/l of DO to the tunnel every 2.6 days or 11.5 mg/l every 5 days, which is slightly greater than the estimated median 5-day BOD of 10.9 mg/l. For storms with BOD levels less than or equal to the estimated median level, the DO in the tunnel will drop, but will not go anaerobic, and will recover to 6 mg/l in one to two weeks. For storms which wash unusually high BOD loads into the tunnel, it could take up to a month or more for the tunnel to recover completely. However, since tunnel-flushing storms are expected only about three times per year, there will usually be time for the tunnel to recover.

On the rare occasions when a second intermediate storm hits before the tunnel has had time to recover fully from the first, the aeration system will offer some mitigation. Because of the high rate of conversion of hydrogen- sulfide to sulfate in the presence of aerated seawater, the first effect of the aeration will be to prevent the formation of hydrogen-sulfide. Therefore, the discharged water should be free of that problem. Aeration of the outlet shaft during discharges will help to raise the DO in the discharge and decrease the duration of the anaerobic or low DO plume.

Air demand for the mitigation system was computed using the equation

$$Q_a = 3.53 \times 10^{-3} \frac{Q(C_s)}{E(1.024)^{T-20}} \ln \left[ \frac{C_s - C_i}{C_s - C_o} \right]$$

where:  $Q_a$  = required air flowrate, m<sup>3</sup>/s  
 $Q$  = water flowrate in m<sup>3</sup>/s  
 $E$  = efficiency of gas transfer  
 $C_s$  = DO saturation at 20°C in mg/l  
 $C_i$  = initial DO level in mg/l  
 $C_o$  = final DO level in mg/l

from Wastewater Engineering (10).

Using the mean 5-day BOD of 13.3 mg/l gave a DO consumption rate of 2.7 mg/l/day. Using this consumption rate and a DO transfer efficiency of 20 percent, an air demand of 61 lb/hour was computed. Actual transfer efficiencies are likely to be better than 20 percent at the 160-foot depth that the air will be injected. However, assuming a low transfer efficiency will cause the system to have greater capacity than is required just for oxygen transfer, this will reduce the chances for dissolved gas supersaturation. Studies of nitrogen gas supersaturation caused by artificial aeration in reservoirs (11) have shown that supersaturation problems can occur if the air injection is not sufficient to bring the upwelled water to the surface or if the air is injected into low DO water. Aeration in low DO waters causes the oxygen to be brought out of the bubbles, causing an increase in the partial pressure of nitrogen gas in the bubbles. This causes a greater tendency to nitrogen gas supersaturation in the surrounding water. Sizing the aeration equipment to introduce more air than is required for oxygen transfer alone will prevent nitrogen gas supersaturation by reducing the tendency for supersaturation to occur and bringing aerated water to the surface where supersaturated gas can be released to the atmosphere.

Using two 6-inch fiberglass pipes to get a low friction factor (Hazen- Williams "C" of 140) and 5,000 feet of pipe gives a headloss of 110 feet for a flow of 500 gpm. To pump this flow against this head would require two 25 horsepower pumps, assuming 60 percent efficiency in the pumps. These pipes were originally to be placed in the tunnel liner as they would cause unacceptable hydraulic head losses if they were hung in the tunnel. However, in the end it proved cheaper to enlarge the tunnel and hang the pipes from the walls.

There will be times when an unusual combination of storms causes the tunnel to discharge anaerobic waters which could persist for up to several hours before being completely dissipated; however, these would be exceptionally rare occurrences. On the whole, the Town Brook Relief Tunnel as designed will maintain acceptable water quality in Town River and Town River Bay.

#### REFERENCES

1. Sawyer, C.N. and P.L. McCarty, Chemistry for Environmental Engineering, 3rd Ed, McGraw-Hill Book Company, NY, NY, 1978.
2. Stumm, W. and J.J. Morgan, Aquatic Chemistry, John Wiley & Sons, NY, NY, 1981.
3. APHA, AWWA and WPCF, Standard Methods for the Examination of Water and Wastewater, 15th Ed, 1981.
4. Hutchinson, E., A Treatise on Limnology, Vol 1, Part 2, John Wiley & Sons, NY, NY, 1975.
5. Colwell, R.R. and R.Y. Morita, Effect of the Ocean Environment on Microbial Activities, University Park Press, Baltimore, MD, 1974.
6. National Academy of Sciences - National Academy of Engineering, Water Quality Criteria 1972, Washington, D.C., 1972.
7. U.S. Environmental Protection Agency, Quality Criteria for Water, July 1976, U.S. Government Printing Office, Washington D.C.
8. McKee, J.E. & H.W. Wolfe, Water Quality Criteria, The Resources Agency of California, State Water Resources Control Board, 1963.
9. Massachusetts Division of Water Pollution Control, Charles Basin 1974 Water Quality Survey Data, Westborough, Massachusetts, February 1975.
10. Metcalf & Eddy Inc., Wastewater Engineering: Treatment Disposal, Reuse, McGraw-Hill Book Company, NY, NY, 1979.
11. Fast, A.W. and R.G. Hulquist, Supersaturation of Nitrogen Gas Caused by Artificial Aeration in Reservoirs, EWQOS Technical Report E-82-9, U.S. Army Waterways Experiment Station, Vicksburg, Mississippi, September 1982.

# APPLICATIONS OF MIXERS AND AERATORS FOR RESERVOIR IMPROVEMENT

by

Richard E. Price<sup>1</sup> and Jeffery P. Holland<sup>2</sup>

## INTRODUCTION

Most Corps of Engineers (CE) reservoirs undergo some degree of thermal stratification on an annual basis. This stratification, which is a result of insolation, usually begins in the late spring of each year. As air temperature increases, the surface water begins to warm. Circulation, both wind generated and convective, begins to mix the surface water with deeper water. As the surface continues to warm, the energy for mixing is insufficient for total water column mixing. Therefore, a surface mixed region called the epilimnion is formed. The zone immediately below this region, which is characterized by rapid temperature changes with depth, is called the thermocline or metalimnion. As the insolation increases into the summer, the region moves down in the water column, with a corresponding increase in the thickness of the epilimnion. The region below the thermocline, characterized by relatively uniform temperature, is termed the hypolimnion.

This stratification pattern, although set up by meteorological conditions, is naturally controlled by the corresponding density of the water. The density of water decreases as the temperature increases above 4° C. Thus, the density difference between 19° and 20° C is 20 times more than between 4° and 5° C. As the insolation decreases during the summer and into the fall, the thermal stratification continues to strengthen into mid-summer usually as a result of air temperature which lags behind the insolation. The corresponding stability of stratification increases, reflecting the effect of density. In late summer and early fall, the stability of this stratification then begins to decline with a corresponding loss of heat at the reservoir surface. Rapid cooling in the fall begins to reduce the surface water temperature and corresponding density. Complete water column mixing, termed fall overturn, results in uniform temperature and density throughout the reservoir and a loss of stability of stratification.

---

<sup>1</sup> Physical Scientist, Reservoir Water Quality Branch, Hydraulic Structures Division, Hydraulics Laboratory, US Army Engineer Waterways Experiment Station, Vicksburg, MS.

<sup>2</sup> Supervisory Research Hydraulics Engineer, Reservoir Water Quality Branch, Hydraulic Structures Division, Hydraulics Laboratory, US Army Engineer Waterways Experiment Station, Vicksburg, MS.

This stratification cycle effectively prevents circulation or mixing between the epilimnion and hypolimnion during the stratified period for many reservoirs. The hypolimnion, which usually has a larger biochemical oxygen demand due to settling of decaying organisms and sediment, is thus subject to loss of dissolved oxygen (DO). Once the hypolimnion becomes anaerobic, reduction of iron, manganese, and sulfate can occur. These compounds are undesirable in solution because of their toxic effects to aquatic organisms and, upon release downstream, create stain and odor problems. These processes are usually aggravated by eutrophication of the reservoir.

CE reservoirs designed for hydropower and/or flood control are often equipped with low-level releases. Even if the center-line elevation of these releases is located near the elevation of the thermocline, the withdrawal zone will typically extend well into the hypolimnion. Therefore, releases from these projects during the stratified periods may be low in DO and contain excessive levels of iron, manganese and hydrogen sulfide. Although there are a number of structural and downstream alternatives that are designed to deal with these types of water quality problems in the releases, the in-reservoir alternatives that utilize artificial methods of destratification and aeration are the subject of this paper. These alternatives in concept either effectively mix the hypolimnion and epilimnion to achieve a near uniform vertical thermal profile in front of the release structure, pump epilimnetic water into the withdrawal zone to dilute the release, or circulate the hypolimnion in the presence of air.

In-reservoir artificial circulation alternatives can be categorized by the region of the reservoir to be mixed. Total lake destratification involves the mixing of most or all of the volume of the lake to prevent significant thermal stratification. This is usually done to minimize effects of eutrophication of the reservoir. Localized mixing is essentially a smaller version of the total lake destratification. This technique is used to destratify a specific region in the lake, usually a well defined area in front of the release structure. The limits of the local mixing region are usually defined in terms of the volume of water being released. By design, impacts to the reservoir due to localized mixing are minimal. The last category is the hypolimnetic aeration, which involves either circulation of the hypolimnion through a closed conduit type device to the surface and return to the hypolimnion or with diffusers which aerate with air or oxygen without destratification of the reservoir. This technique, like total destratification, is used to mitigate eutrophic effects in the reservoir but also minimizes release problems. Total lake destratification and hypolimnetic aeration are also similar in that the design of destratification (using the total lake volume) and hypolimnetic aeration systems (using only the hypolimnetic volume) are both handled as simple mixed tank reactors. Computations are based on the volume and time of treatment for reaeration. However, the localized mixing technique, since it is usually used in conjunction with a release structure, may be significantly impacted by the withdrawal zone during releases.

Therefore, a two-dimensional aspect is involved in this technique in that the horizontal currents of the withdrawal zone may impact the vertical currents of the destratification device.

## BACKGROUND ON DEVICES

There are two major categories of artificial circulation (destratification) devices: (a) mechanical mixers that usually produce a hydraulic (water) jet; and (b) air diffuser systems that use air bubbles released near the bottom to induce mixing. Hypolimnetic aeration systems are variations of either mechanical or air-diffuser systems that only affect the hypolimnion, thereby preserving the general stratification pattern.

### Mechanical Mixers

There are two basic types of mechanical mixers used in reservoirs. Both develop a jet of water which is usually forced from the epilimnion downward to mix with the hypolimnion. The first type is an axial flow design based on the work of Quintero and Garton (1973). These types of pumps utilize large diameter impellers (1 to 2 meters in diameter) rotating at relatively low speeds (i.e., 50 rpms) to generate a hydraulic jet in the epilimnion. This jet is then forced down through the thermocline. Most of these applications, both total lake destratification and localized mixing, have been successful in relatively small lakes (Pastorok et al. 1982) but are less effective in deeper lakes. Recently, Mobley and Harshbarger (1987) have installed axial flow pumps in front of the hydropower intakes on Douglas Reservoir to improve reservoir releases. The Huntington District is currently using a Garton type pump to destratify Beech Fork Lake.

The second type of mechanical mixer that utilizes propellers, impellers or water jets to move water from one layer to another has received less attention. However, the success of these types of devices is reported to be quite good (Pastorok et al. 1982). An excellent review of mechanical pumps and water jet destratification devices appears in Pastorok et al. (1982). Additional guidance on hydraulic destratification of reservoirs for CE applications was published by Holland and Dortch (1984). Design criteria for localized mixing using mechanical pumps was also developed by Holland (1984). These design parameters were formulated for a surface mixer that jets a stream of epilimnetic water into the hypolimnion. Unlike the axial flow pump, these pumps entrain considerable volumes of epilimnetic water prior to crossing the thermocline. Thus, these pumps may be more effective in mixing but require more power than axial flow pumps. The higher velocity of these pumps makes response time much shorter than axial flow pumps for the same application.

### Diffusers

Pneumatic diffusers (diffused air systems) generally consist of an air compressor or blower that forces air through a diffuser located on or near the



lake bottom. Arrangement of the diffuser, which is composed of porous media or simple holes in a pipe, is usually site specific. The air bubbles released from the diffuser induce vertical currents as they rise to the surface, creating a circulation cell as the entrained water returns to the hypolimnion. Kobus (1968) determined that the air release depth and flow rate are the primary parameters in determining the induced water flow rate. An excellent discussion of applications of air diffusers prior to 1981 is given in Pastorok et al. (1982). Although diffuser systems are reported to be easier to operate and less expensive than mechanical devices (Lorenzen and Fast, (1977)), Dortch (1979) concluded hydraulic destratification was potentially more efficient with regard to mixing an entire reservoir.

Although there are a number of examples of hydraulic and pneumatic mixing devices, little actual field experience on their use for CE-sized reservoirs exists. This need within the CE for predictive techniques to investigate the feasibility of aeration and mixing devices has led to the initiation of a work unit in the Water Quality Research Program that will develop evaluation, design and operational criteria for hydraulic and pneumatic mixing and aeration devices for CE reservoirs. Since this is a new work unit, no new products as yet exist for field use. However, numerous tools from previous research, which were developed mostly from laboratory experience, can be used to provide initial design and operational guidance for these systems. Installation and testing of these designs can then further quantify their use. An example of this is given below.

#### EXAMPLE OF MIXER APPLICATION

J. Percy Priest (JPP) Lake, located east of metropolitan Nashville, TN, on the Cumberland River, was constructed for flood control, hydropower and recreation. With the onset of thermal stratification in the spring, the hypolimnetic DO begins to decline. By late August, the hypolimnion is usually devoid of oxygen. This steady decline creates release water quality problems through the stratified period, roughly May through October annually. These releases, which are infrequent during this period due to minimal inflow into the project, high evaporation loss, and maintenance of a stable pool for recreation, are withdrawn from a mid-pool level penstock for hydropower. The single Francis turbine is normally operated at its maximum capacity of 4,600 cfs when releases are scheduled. Thus, during operation the withdrawal zone extends from the surface to the bottom. Subsequent withdrawal of hypolimnetic water, which is low in DO with concentrations of reduced metals and hydrogen sulfide, results in release of poor water quality. Therefore, the Nashville District (ORN) attacked this problem by utilizing a release enhancement system designed specifically to:

- a. Improve the quality of the hydropower releases by maintaining release DO at or near 5 mg/l, thereby reducing concentrations of iron, manganese and hydrogen sulfide in solution.

b. Operate only when the infrequent hydropower releases are made from the project. The system should be easy to implement, operate, secure, and be operable in a minimum amount of time.

c. Enhance only the volume of water being released, not a sizable portion of the forebay region. Benefits to improvement of hypolimnetic quality in the lake are considered to be minimal.

#### Alternative Evaluation

There are a number of alternatives to improve the release quality (specifically DO) that may meet some of the criteria listed above. Hypolimnetic aeration/oxygenation, which utilizes mechanical or aeration devices to increase the hypolimnetic DO without destratifying, would increase the DO but would require treatment of a large area in the forebay. In addition, the system would have to be operated for a considerable period prior to hydropower generation to allow sufficient contact time. Other in-structure alternatives, such as penstock aeration, selective withdrawal or draft tube aeration, would require considerable modification of the hydropower facility. However, localized mixing meets the requirements given above in that it treats only the water being released. It also meets the operational criteria of only being operated during hydropower generation and requires a minimal amount of time to implement using commercially-available equipment.

There are a number of devices that can be used to destratify the area in front of the dam. Diffused air systems have been used at Eufaula Reservoir (Leach 1970) and Allatoona Reservoir (USAE 1973); however, these systems required treatment of a large area of the forebay to provide adequate contact time for absorption of the oxygen. Dortch and Wilhelms (1978) were successful in improving the release DO from Okattibbee Reservoir using an axial-flow (Garton) pump to destratify in front of the release structure. Response time for an increase in release DO was short (within 15 minutes of initiation of pumping), and the area impacted by the pump was less than 100 ft from the structure. However, this was for a relatively low discharge (45 cfs). The discussion above about mixers indicated two major types of pumps. The axial flow or Garton pump has been used in a number of applications; however, these devices are designed and constructed on a case-by-case basis. A key factor in the decision to use localized mixing at JPP was the short response time associated with these systems. The use of an axial flow pump would require design and construction since these pumps are used only in reservoir applications and, currently, no manufacturer mass produces these pumps. However, direct-drive surface mixers used in water supply applications are readily available. Therefore, the decision was made to use direct drive surface mixers in this localized mixing application.

## System Design

The key parameters used in the design of a localized mixing system are based on dilution of the release with epilimnetic water (Holland 1984). The volume of epilimnetic water to be pumped down into the withdrawal zone is based on the desired release DO. For a release at JPP of 4,600 cfs during an average August with a surface DO of 8.0 mg/l and a hypolimnetic DO of 0.1 mg/l, 2,875 cfs of epilimnetic water is required to produce a release DO of 5 mg/l. Once this is determined, the depth of penetration of the downward mixing jet required for its withdrawal must be determined. In this example, the withdrawal zone extended approximately 100 ft from the surface to the bottom indicating that the depth of penetration should be near the bottom without disturbing the sediments. Disturbance of the sediments may result in release of DO demanding materials and suspended sediment downstream. Based on Holland (1984), the depth of penetration into the hypolimnion is a function of the densimetric Froude number. Using the average density difference between the epilimnion and hypolimnion and the diameter and velocity of the jet at the thermocline, the volume flux across the thermocline as well as the depth of penetration can be computed. Since more energy is required for the jet to penetrate to the desired depth for stronger stratification patterns, the strongest observed normal stratification pattern (August) was used in design of the system. In this design, a surface temperature of approximately 27° C and a hypolimnetic temperature of 11° C were used as indicators of the strongest stratification. This corresponds to a density difference of 0.0029 g/cc. A manufacturer of surface mixers supplied initial jet velocity, diameter, and discharge that were then used for depth of penetration calculations. Using a range of pumps from 3 to 40 Hp, depth of penetration ranged from 17 to 71 ft below the thermocline. Since the thermocline was observed to be at a depth of approximately 25 ft, the 40 Hp unit was computed to provide the optimum depth of penetration of approximately 96 ft.

Selection of the appropriately powered mixer for depth of penetration is followed by determination of the number of mixers required to achieve the desired volume flux across the thermocline. The volume flux at the thermocline can be computed using the initial jet volume flux, distance from the pump outlet to the thermocline, and the initial jet diameter. For a 40-Hp unit with the above described stratification, the volume flux at the thermocline would be 220 cfs. If all of the water pumped from the epilimnion is entrained in the withdrawal zone and released (100 percent efficiency), 13 pumps would be required to bring the DO in the release from 0.1 to 5.0 mg/l.

## Field Tests

The design of the localized mixing system was based on depth of penetration and required dilution of the release. Other parameters for which no design guidance existed, such as spacing between pumps or their distance in front of the dam, had to be determined by prototype tests. To determine these

parameters, as well as the effectiveness of the surface mixers in improving release quality, ORN leased three direct-drive surface mixers commonly used in sewage lagoon and hydraulic mixing applications. Each of the 40-Hp units was tested in a variety of configurations in front of the hydropower intake for three test periods. For each test, observations were made of the optimum pump location and spacing for maximum dilution of the release. Complete results of these tests are presented in the poster session of these proceedings. These tests also provided the opportunity to verify the design calculations in a prototype environment. The dilution factor, which is a ratio of the epilimnetic volume flux to the total volume flux in the release, was computed for each test, and comparisons among individual tests were made to determine the maximum dilution factor achieved.

The change in release water density from before to after the pumps were turned on was used to determine the observed dilution factor while the computed epilimnetic volume flux across the thermocline was used to evaluate the predicted dilution factor (DF). Comparison of the observed with predicted DF follows:

<u>Test</u> <u>Date</u>	<u>Observed DF</u>	<u>Predicted DF</u>
2 Sep	0.171	0.173
24 Sep	0.244	0.202
22 Oct	0.540	0.260

The trends in these factors are explained below. The observed DF increased with weakening stratification in late September and October. The equations used to predict epilimnetic flux were based on two-layer stratification, much like the strong stratification observed in the late summer. As the observed stratification weakened, the entrainment of the jet increased, thus increasing the epilimnetic volume flux across the thermocline. Even though the epilimnetic volume flux is dependent on the depth of the thermocline, examination of the thermal profiles for the three test periods indicated the thermocline only moved from a depth of 25 to 35 ft. Still, for the stronger stratification patterns of 2 and 24 September, the existing guidance did a good job of predicting the DF. Given that the predictive equations were developed for strong, two-layer-like stratifications (in order to ensure a system design that would be effective for the entire stratification season), it was not surprising that their predictive capability broke down for the weaker stratification patterns.

#### CONCLUSIONS

The results of the example at J. Percy Priest Lake indicated that a direct-drive surface mixer can be used successfully in a localized mixing application to increase the DO in the release. The design criteria developed by previous research accurately predicted the depth of penetration and epilimnetic volume flux, resulting in an accurate prediction of the DF for the

strong stratification; however, the equations used in the prediction became very conservative as the stratification weakened. Based on the analysis above, more guidance is needed on operation of these systems for weaker stratifications and for positioning of the pumps relative to the withdrawal zone and to each other. In addition, investigation of the effects of modifications to these pumps, such as variation in the pump speed (hence discharge) or installation of an elbow, on the pump outlet that angles the jet should be conducted.

#### ACKNOWLEDGMENT

The results reported herein were conducted under funding from the Water Quality Research Program of the US Army Engineer Waterways Experiment Station, Vicksburg, MS. Permission was granted by the Chief of Engineers to publish this information.

#### REFERENCES

- Dortch, M. S. 1979 (Apr). "Artificial Destratification of Reservoirs; Hydraulic Laboratory Investigation," Technical Report E-79-1, US Army Engineer Waterways Experiment Station, Environmental and Water Quality Operational Studies.
- Dortch, M. S. and Wilhelms, S. C. 1978 (Jan). "Enhancement of Releases from a Stratified Impoundment by Localized Mixing, Okatibbee Lake, Mississippi," Miscellaneous Paper H-78-1, US Army Engineer Waterways Experiment Station, Vicksburg, Miss.
- Holland, J. P. 1984 (Jun). "Parametric Investigation of Localized Mixing in Reservoirs," Technical Report E-84-7, US Army Engineer Waterways Experiment Station, Environmental and Water Quality Operational Studies.
- Holland, J. P. and Dortch, M. S. 1984 (Aug). "Design Guidance on Hydraulic Destratification," Information Exchange Bulletin Vol E-84-4, Environmental and Water Quality Operational Studies, US Army Engineer Waterways Experiment Station, Vicksburg, Miss.
- Kobus, H. E. 1968. "Analysis of the Flow Induced by Air Bubble System," Coastal Engineering Conference, London, 2:1016-1031.
- Leach, L. E. 1970. "Eufaula Reservoir Aeration Research - 1968," Proceedings: Oklahoma Academy of Sciences, 49:174-181.
- Lorenzen, M. W. and Fast, A. W. 1977. "A Guide to Aeration/Circulation Techniques for Lake Management," Ecol. Res. Ser., EPA-600/3-77-004, US Environmental Protection Agency.

Mobley, M. H. and Harshbarger, E. D. 1987 (Jul). "Epilimnetic Pumps to Improve Reservoir Releases," Proceedings: CE Workshop on Reservoir Releases, Miscellaneous Paper E-87-3, US Army Engineer Waterways Experiment Station, Vicksburg, Miss. pp 133-135.

Pastorok, R. A., Lorenzen, M. W. and Ginn, T. C. 1982 (May). "Environmental Aspects of Artificial Aeration and Oxygenation of Reservoirs: A Review of Theory, Techniques, and Experiences," Technical Report E-82-3, prepared by Robert A. Pastorok, Marc W. Lorenzen, and Thomas C. Ginn, Tetra Tech, Inc., Bellevue, Washington, for the US Army Engineer Waterways Experiment Station, Vicksburg, Miss.

Quintero, J. E. and Garton, J. E. 1973. "A Low Energy Lake Destratifier," Transactions: American Society of Agricultural Engineers, 16:973-978.

US Army Corps of Engineers. 1973. "Allatoona Lake, Destratification Equipment Test Report," US Army Engineer District, Savannah, Savannah, Georgia.

DEVELOPING AN OPERATIONAL WATER TEMPERATURE MODEL  
FOR THE COLUMBIA RIVER SYSTEM

by

Bolyvong Tanovan<sup>1</sup> and R.G. Willey<sup>2</sup>

1. INTRODUCTION

This paper is not about another mathematical modeling success story. Rather, it is a narrative of the painstaking steps taken to overcome real-life problems in developing an operational water temperature model (COLTEMP) for the relatively complex Columbia and Snake River mainstem, under stringent modeling requirements and a scarcity of data. It is nonetheless an encouraging story in that it proves that significant accomplishments can be made despite the usual shortcomings, thanks to the Corps' immense resources and the ingenuity of its staff.

2. BACKGROUND

The combined mainstems of the Columbia and Snake Rivers span almost 2,000 miles of stream in Canada and the Pacific Northwest (Figure 1). The oldest dam on these rivers, Rock Island Dam, was constructed in 1932 on the Columbia River and the last one, Lower Granite Dam, was completed in 1975 on the Snake River. There is a total of 33 Corps reservoirs and 110 other non-Corps projects scattered throughout the entire basin, with a total active storage in excess of 60 million acre-feet. Over 60 percent of these projects have active storage capacities in excess of 100,000 acre-feet each. Despite their respectable sizes, the overwhelming majority of the impoundments are well mixed. Summer temperature differentials are generally less than 3 degrees F between surface and bottom layers. Only a few reservoirs (e.g., Mica, Revelstoke, Arrow, Libby, Grand Coulee, Brownlee, Hells Canyon and Dworshak) show any potential for stratification.

Average and maximum water temperatures of tributaries west of the Cascade Range are 70 and 82 degrees F, respectively. East of the Cascade Range, the temperature range increases to between 80 and 90 degrees F. The highest water temperatures occur in July and August. They normally increase in the flow direction because of solar radiation at the exposed reservoirs and valley-floor stream channels. At The Dalles (RM 191), the August water temperature ranges from 71 to 81 degrees F, averaging 75 degrees F. As expected, large reservoirs in the Pacific Northwest tend to decrease water temperatures in the summer, and to increase them in the fall and winter. Run-of-the-river impoundments, on the other hand, tend to cause water temperature to increase in the summer. Figures 2, 3 and 4 provide some ideas on Columbia and Snake River water temperatures recorded in the dry summer of 1985.

-----  
1. Chief, Water Quality Section, North Pacific Division, Portland, OR  
2. Hydraulic Engineer, Hydrologic Engineering Center, Davis, CA

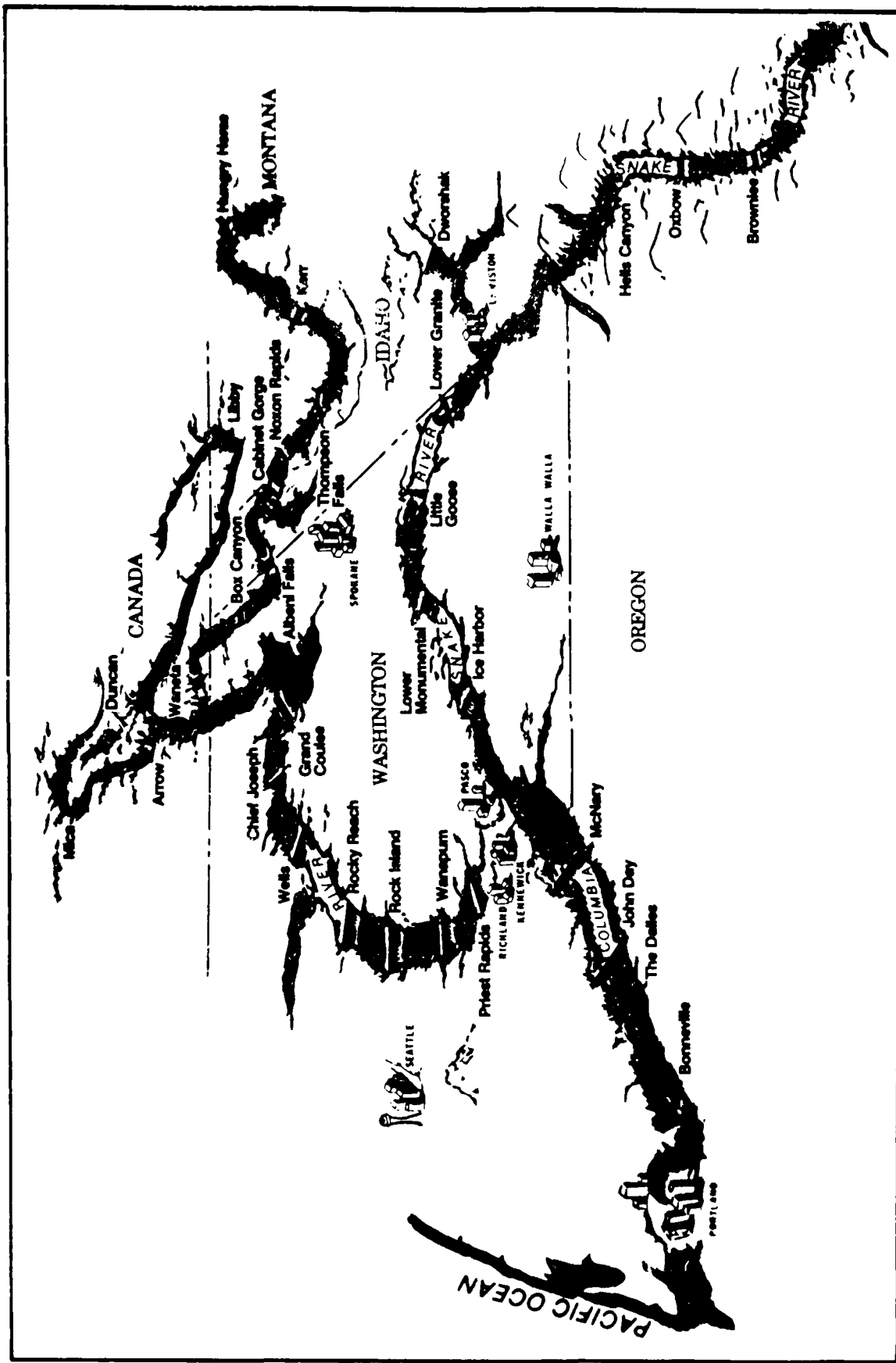

Figure 1. Location of Mainstem Columbia River Projects



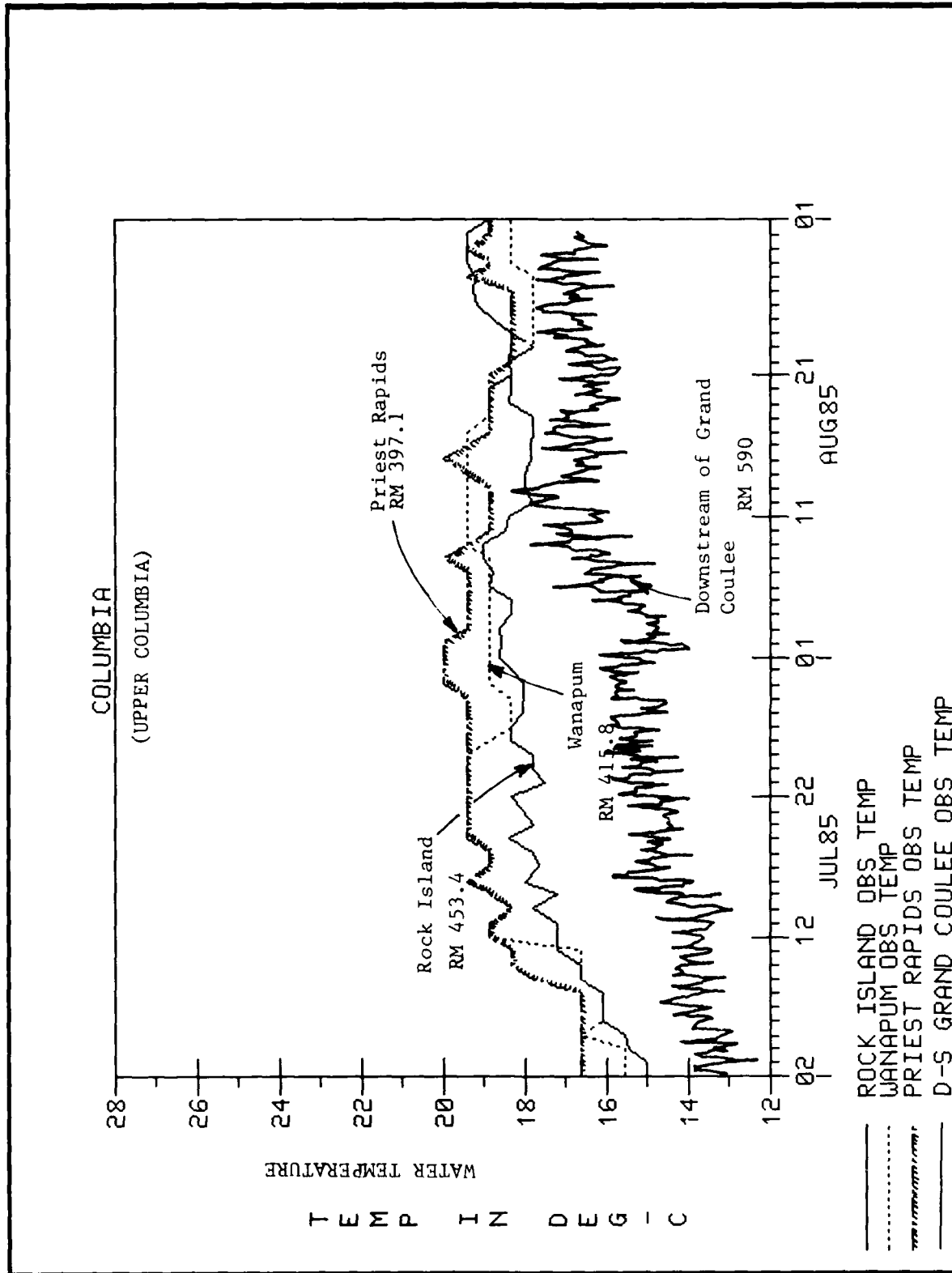

Figure 2. Water Temperature : Upper Columbia River (1985)

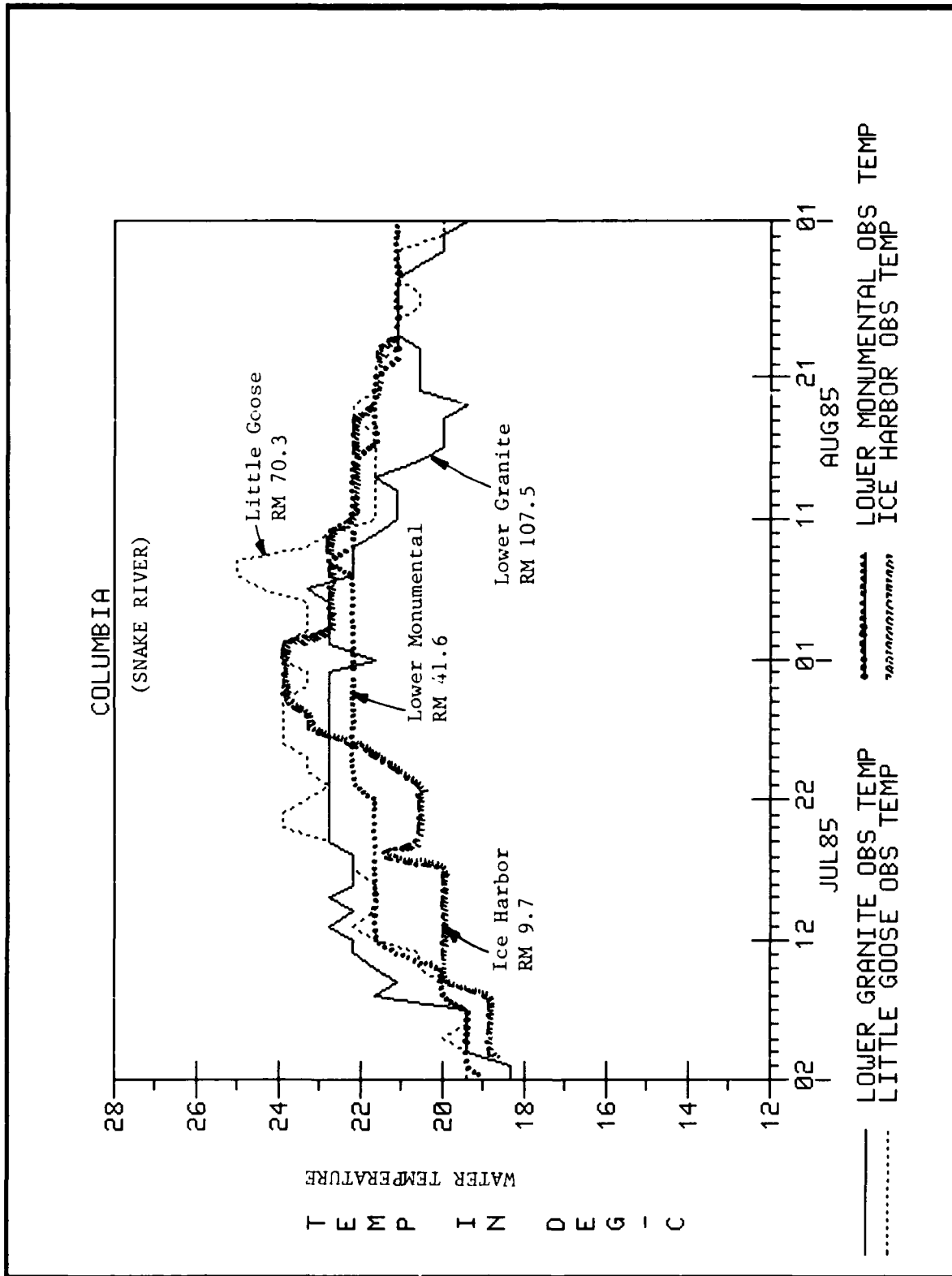

Figure 3. Water Temperature : Snake River (1985)

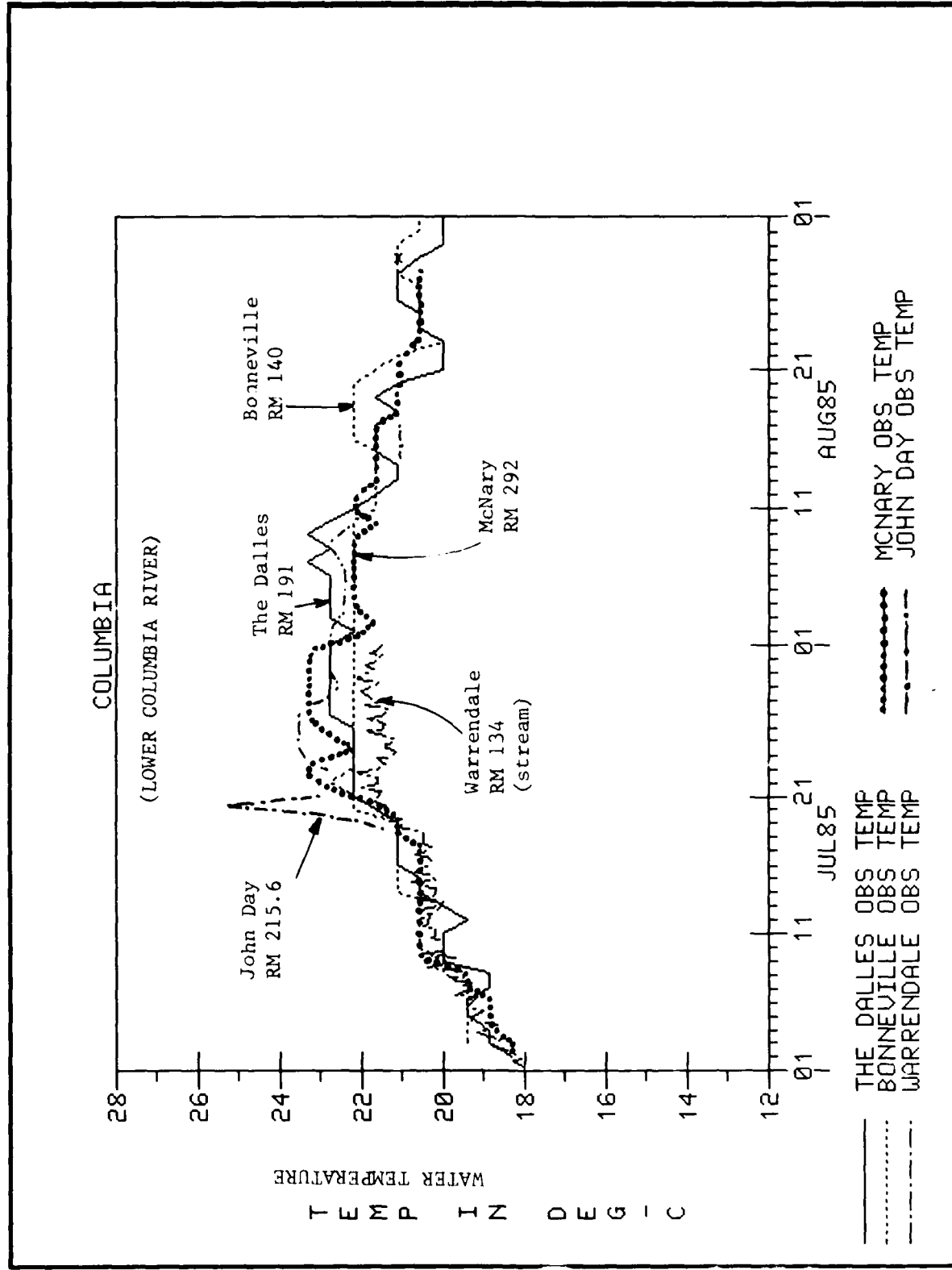

Figure 4. Water Temperature : Lower Columbia River (1985)

Particularly noteworthy is the fact that during certain months, Snake River water is warmer at Lower Granite Dam (RM 107.5) than at Ice Harbor Dam (RM 9.7), some 100 miles further downstream. Likewise, Columbia River water temperature is sometimes higher at McNary Dam (RM 292) than it is at Bonneville Dam (RM 140). This apparent contradiction can be explained. In the first case, the waters from the upper Snake River, warmed by high air temperature, are entering relatively cool reservoirs. The warming trend due to solar radiation did occur but was not enough to offset the colder waters initially stored in the downstream impoundments. In the second case, waters cool off when they travel from McNary Dam to Bonneville Dam due to less intense solar heating on the west side of the Cascade Range, colder tributary waters and relatively cold, well sheltered downstream reservoirs.

### 3. PAST WATER TEMPERATURE STUDIES

Past studies have established that the water temperatures of the Columbia River and its tributaries have been increased by the construction and operations of dams and reservoirs, irrigation diversions and point-source heat discharges. These studies have also concluded that there was little potential for thermal management of the river -- the few deep reservoirs that could have been used for this purpose are located too far from the temperature problem-prone areas. Under normal conditions a block of water released from Grand Coulee Reservoir, for example, would have reached the ambient temperature before it reached McNary Dam 240 miles away. Therefore, it appears that an inordinate amount of release water would be needed in most cases to achieve a measurable impact. This conclusion explains the limited past efforts involved in attempting to effect downstream temperature control from any Columbia River reservoir, large or small.

Furthermore, most past water temperature and temperature-related system studies were planning oriented and generally addressed long-term issues. Models used for investigating the feasibility of selective withdrawal facilities at Grand Coulee Dam, the impacts of the cooling waters at the Hanford Works and the Trojan Nuclear Plant, the downstream effects of cool water release from the Canadian storage projects, etc., used calculation time steps in the order of a day or more. Once they have met their needs, these models would be typically shelved and/or disbanded. Therefore, even if some of them could have been modified for use as an operational tool, none of them is readily available for all practical purposes.

### 4. NEED FOR OPERATIONAL SYSTEM MODELING CAPABILITY

The need for system water temperature modeling capability for operational purposes has, however, been recognized since the mid-1960's. The Columbia Basin Inter-Agency Committee included development of an operational water temperature modeling tool in their list of recommended research topics for 1966. The Committee specifically called for a "comprehensive water temperature model" capable of determining the effect of each element upon the system and of providing a management tool for exercising temperature control over the entire system." This recommendation has never been implemented because of funding, immediate needs and priority considerations.

The concept of downstream water temperature control resurfaced with more vigor following the enactment of the Northwest Power Act of 1980 and the subsequent creation of a new regional body, the Northwest Power Planning Council. The Council's Fish and Wildlife Program to "protect, mitigate and enhance fish and wildlife resources affected by hydroelectric development in the Columbia River Basin" considers more drastic and more original measures than had been contemplated before. One of the new Program elements is based on the concept that one or two degrees F can make the difference between life and death for the juvenile anadromous fish when water temperature is at or near the life-threatening threshold. Therefore, the primary objective is no longer sustained temperature control over an extended period of time but rather, at a control limited in magnitude as well as in duration. A well planned reservoir release, taking into account the diurnal variation of solar radiation, streamflow projections, project releases, location of juvenile fish runs and conditions of reservoir water temperature, could conceivably provide that limited but critical control during the two to three warmest hours of the day.

Another factor currently supporting development of an operational water temperature model is related to the summertime operations of the Lower Snake River projects. Four Corps projects are involved that may have an impact on the movement and survival of outmigrant juvenile fish. These projects had been occasionally shut down for the night during the summer. Sometimes, powerhouses were closed off, leaving only spillways to pass some flows. In other instances, the entire project was shut off with the exception of sluiceways, fish ladders, navigation locks, etc. The effects of that "zero" or "close to zero" nighttime flow on downstream water temperature are not very well known nor can they be predicted with reasonable accuracy by any of the existing models. For that and other reasons, such an operation has often been vigorously contested by the fishery agencies.

There is no doubt that a reliable prediction model that can investigate the impacts of a wide range of release schedules on water temperature would increase project operational flexibility. It would have been very useful during the past few years when warm water and considerably below average flows caused smolt mortalities in the McNary Dam fish collection facilities. During the summer of 1985, for example, water temperatures reached historically high levels for July at lower Columbia and Snake River projects. In the McNary Dam's reservoir forebay in particular, end of July water temperature readings exceeded 75 degrees F between July 28 and July 30, 1985 -- almost two to three weeks ahead of the previous year's peak period. The early summer spell might have prompted the juvenile fish to start their ocean-bound migration early, at a time when there might not be enough food available along their migration routes and when the smolt themselves might not be biologically ready. Water temperatures in 1985 bordered the danger zone for fish, but reservoir managers were not quite sure how they could have averted or mitigated the problem. To this date, the physical and economic feasibility of using upstream storage releases to mitigate the downstream impacts of low flow and high water temperature has not yet been fully assessed. Similarly, precise downstream impacts of water temperature due to partial or complete nighttime project shut down along the Lower Snake River are not known.

## 5. MODEL SELECTION

Some of the mathematical models used in earlier studies, if they can be found, could have been adapted for use in simulating the water temperature of the Columbia River. None of those, unfortunately, are readily available. At any rate, program refurbishing and/or adaptation of the older models to current conditions and objectives would have to be accomplished first because earlier models simulated steady-state flow conditions and used long time steps.

Furthermore, to model diurnal temperature fluctuations, short duration temperature blockage and the unusual thermal conditions previously mentioned require the dual capability of simulating both reservoir and riverine flow conditions. A run-of-the-river model alone would theoretically largely show a warming trend for water parcels moving from one location to the next, barring large influx of cold tributary waters. As described earlier, some of the Columbia and Snake River reaches experience just the opposite. Conversely, a reservoir model used by itself would not be adequate in view of the many run-of-the-river projects that exist in the Columbia River Basin.

At a consultative session with WES and HEC staff, these modeling requirements were weighed against the capabilities of three of the most readily available Corps models -- CE-QUAL-RIV1, CE-QUAL-R1, and HEC-5Q. All three are 1-D models, are based on comparable water quality simulation concepts, and use separate quantity and quality components. RIV1 and R1, of course, are specific to river reaches and reservoirs, respectively, which they simulate one by one, from the first to the last time step. R1 can provide detailed answers on selective withdrawal facilities sizing and operations. A combination of these two models, appropriately defined in a job stream, could simulate the entire Columbia River system. From a practical standpoint, however, HEC-5Q appears to be easier to handle, given the large configuration of the prototype and the need for system optimization capability. For each time step, HEC-5Q computes the entire system in one pass, before moving on to the next time step.

Obviously, known limitations to the model have to be addressed first. These include capability to (1) handle short calculation time steps and large number of projects involved, and (2) simulate the 2-D flow conditions of the McNary Reservoir with two different inflow qualities. HEC-5Q also needs to be made operational on NPD's AMDAHL computer, which is different from the HARRIS computer.

Reprogramming for short time step calculation and large number of projects operating both in tandem (series) and in parallel was subsequently carried out by a contractor to HEC, using funds provided by HQUSACE and NPD. Simulation of the McNary Reservoir was done empirically for the time being using a combination of 1-D models, one for the mid-Columbia River and the other one for the Snake River. The two models are joined together below McNary Dam at a point where it is believed that full mixing of Columbia and Snake River waters has materialized. The use of a more sophisticated 2-D model for the McNary Reservoir is being investigated by WES. Conversion of HEC-5Q to run on the AMDAHL is in progress.

## 6. INPUT PREPARATION

A substantial part of the input preparation work was carried out by HEC with support from NPD staff, following a start-up session held in Portland. Basic data requirements include cross sections for stream reaches; storage/area/elevation characteristics for all reservoirs modeled; location and capacity of spillways and outlets; and flow, pool elevations, water temperatures and weather data for the simulation period. The required information was gathered to cover a system that presently starts at Grand Coulee Reservoir on the Columbia River and at Brownlee Reservoir on the Snake River. The deep, large Dworshak Reservoir located on a tributary of the Snake River was also included. The most downstream location covered by the model is Vancouver, WA, located 60 miles downstream from Bonneville Dam.

Cross-sectional data were extracted from earlier dam-break study files compiled by the NPD office and Walla Walla District. They consist mainly of top widths for various elevations at several locations between the Pacific Ocean and the upper end of Lower Granite Reservoir on the Snake River, and Grand Coulee Dam on the mid-Columbia River. Auxiliary programs were developed to convert these data into the "GR" format used by HEC-5Q.

Storage/area/elevation and other project characteristics were excerpted from water control manuals or through direct telephone inquiries with the project personnel involved. Project data such as inflows, power releases, diversions, spill, total outflows and reservoir pool elevation data came directly from the files of the Columbia Reservoir's Operational HydroMet System (CROHMS). Information on 4-hour water temperatures recorded at 10-20 feet below the surface came from the Dissolved Gas Monitoring Program files. Additional records of daily water temperature data measured at the power intakes were also available from the project log books, through the Columbia Teletype System.

Finally, basic hydromet data were obtained from NOAA's National Weather Office (through the U.S. Air Force Environmental Technical Applications Center) in Ashville, NC. These included dry bulb temperature, dew point temperature, cloud cover and wind speed at several Pacific Northwest weather stations. Both flow and weather time series data refer to the July-August 1985 period, which has been selected as the simulation period. Four weather stations -- Boise, Lewiston, Spokane and Portland -- were chosen as index stations. Data were accordingly extracted for those stations from the NOAA magnetic tapes, reformatted by WEATHER and processed through a newly created HEC auxiliary program called EQTEMP. Since the selected time step was 4 hours, linear interpolation was used to develop the 4-hour weather and other input data required by the HEC-5Q model from daily values.

Segmentation of the model generally followed project location and confluence of major tributaries (Figure 5). During early model development, the three sub-models -- mid-Columbia, Lower Snake and Lower Columbia -- were treated separately. These submodels will continue to operate separately as long as HEC-5Q is run on the HARRIS computer. Although the critical problem area is in the McNary Reservoir, control points were spread throughout the entire system.

# Columbia River Operational System Water Temperature Model

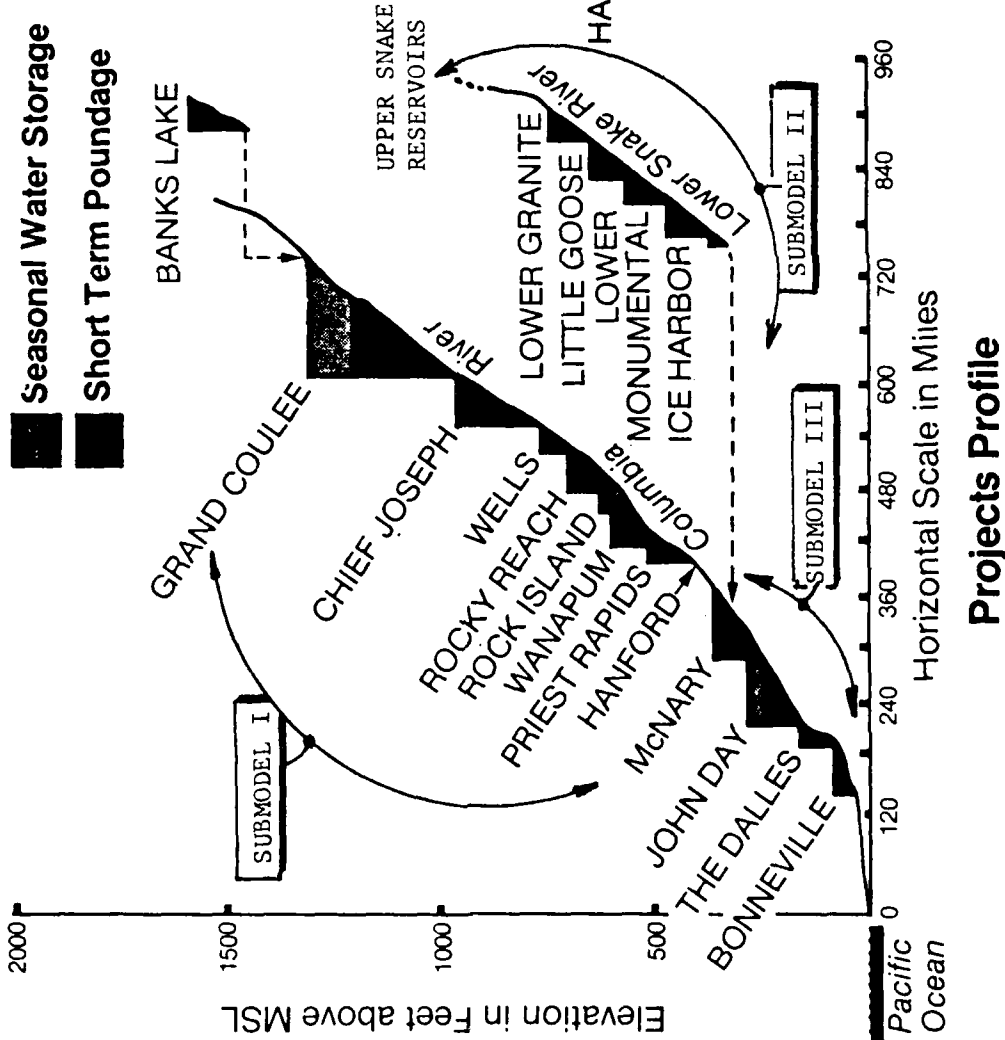

## Model Schematic

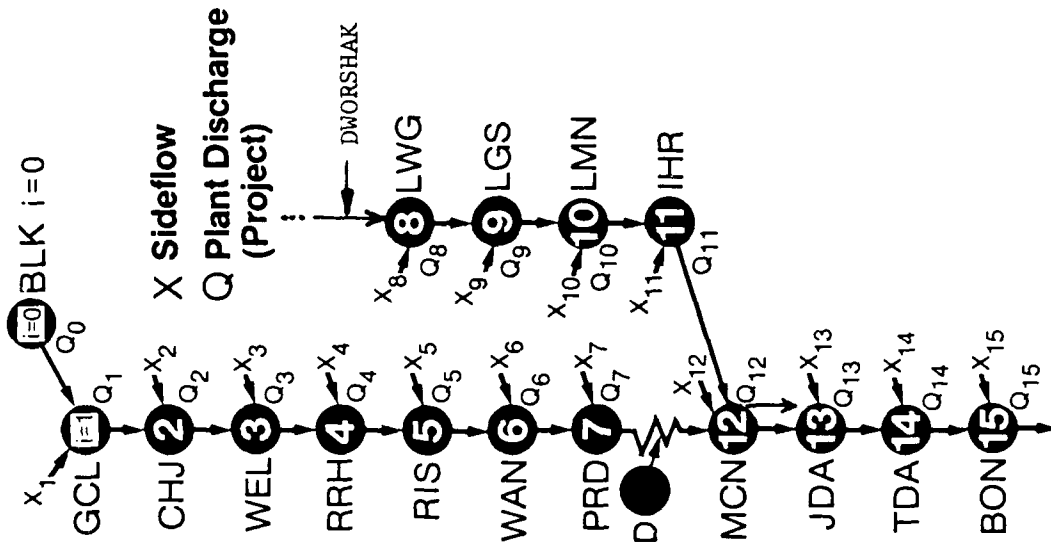

Figure 5. Columbia River Operational System Water Temperature Model



## 7. MODEL CALIBRATION

Model calibration was performed in two steps, using the newly developed hourly version of HEC-5Q. The first step involved setting a correct water accounting for the model and reconstituting the observed pool elevations at all reservoirs, given the specified inflows to and outflows from the projects. The second step was aimed at reproducing observed temperature profiles in the reservoirs and stream channels.

Water accounting should be a generally straightforward exercise if all the relevant input data are available and correct. Unfortunately, that has not always been the case because of missing information, typing errors during data entry, and discrepancies in the ways inflows and outflows have been historically determined. Storage curves below normal pools, for instance, are not always available for determining water temperature profiles below some depths. Minor manual adjustments of discharges and/or evaporation rates were needed to minimize errors in reproducing the observed reservoir pool elevations. Detailed model outputs are particularly helpful for this purpose since they include information on the computed local inflows and reservoir elevation differences between computed and observed values. Flags are distinctly visible when there is rationing of release discharges or when the pool exceeds the top of the dams. With some fine-tuning, most of the observed reservoir pool elevations were replicated to within one half of a foot.

The McNary Reservoir required special treatment. Even though there is no complete chemical mixing of the water because of density differences, there is complete hydraulic mixing. This means that the reservoir pool reflects the sum of the two inflows, the outflow and the change in storage. Therefore, one has to ensure that the pool elevations at each of the two fictitious reservoirs used to impound Columbia and Snake River waters are identical.

Quality model calibration was based on adjustments of reservoir diffusion coefficients and the three factors that affect light penetration: Secchi disk, solar radiation absorbed near surface and its associated depth. Temperatures of the tributaries were also adjusted to reproduce observed water temperatures.

At the time of this writing, fairly satisfactory results have been achieved for 1985 data, both for the quantity and the quality model calibrations. Reconstitution results are shown in Figures 6, 7 and 8 for water temperature simulation in the three sub-models. Essentially, vertical water temperature profiles (caused by the absence of stratification) were also calculated as expected for most reservoirs. These profiles are not shown, however, in any of the figures produced in this paper.

## 8. CONCLUSIONS

Development of the COLTEMP model is an important step toward systematic evaluation of thermal control opportunities present at Columbia River projects. Once fully calibrated (using a few more years of data to strengthen model predictivity), the model could be used to investigate

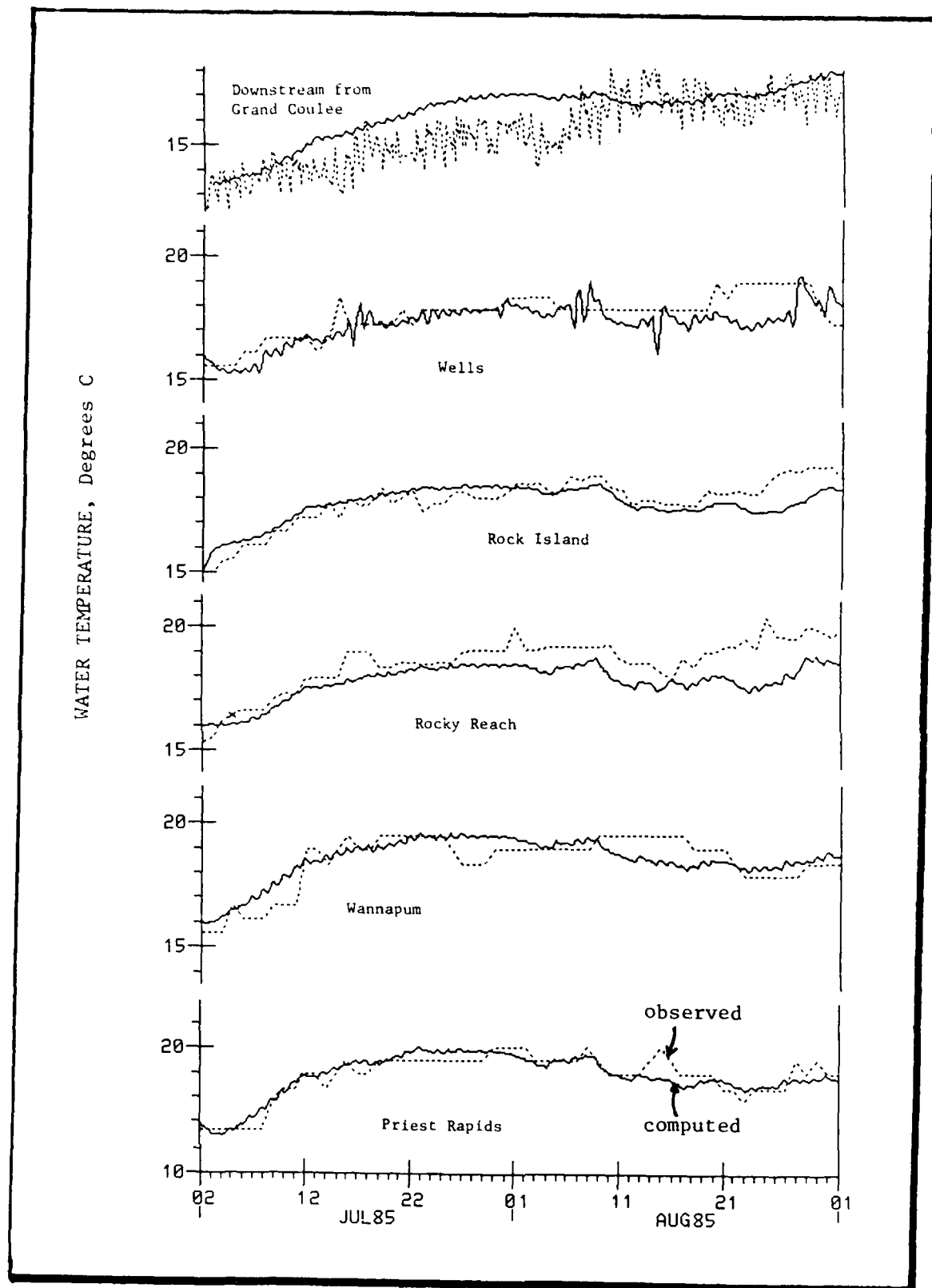

Figure 6. Model Calibration for 1985: Upper Columbia

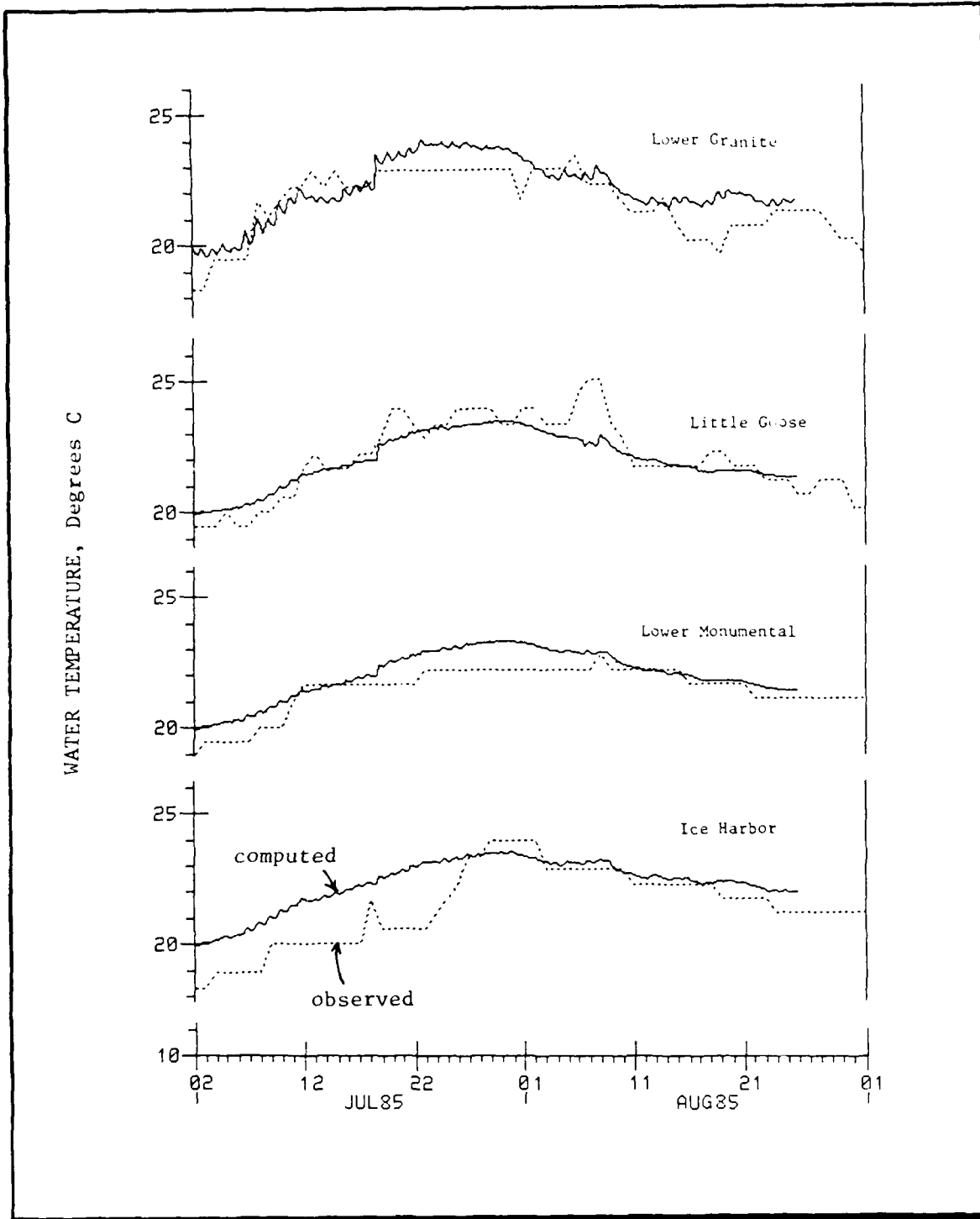

Figure 7. Model Calibration for 1985 : Snake

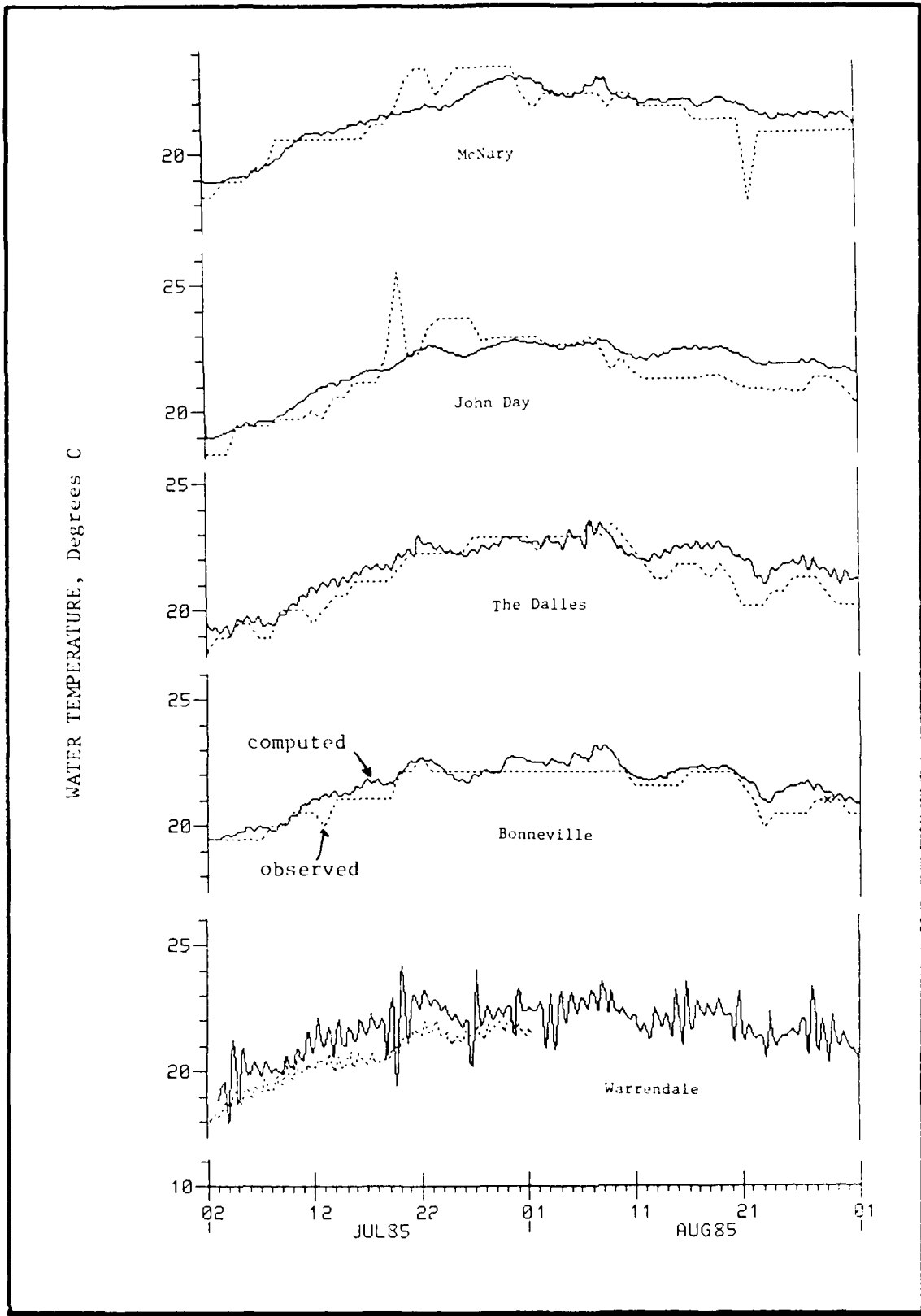

Figure 8. Model Calibration for 1985 : Lower Columbia

the impacts of various reservoir regulation patterns on water temperatures at several critical locations along the River. It could also be used to determine the best overall water temperature conditions for the system and how each reservoir should and could contribute to achieving that optimum. Ultimately, an economic evaluation could also be attempted to assign a price tag to various levels of water temperature improvement and their resulting benefits. This is a challenging study program and a good test of fire for the newly developed hourly version of HEC-5Q. Its success will depend on continued close cooperation between HEC and NPD, sustained efforts by the study team, and strong interest and support from management.

# DESTRATIFICATION OF BEECH FORK LAKE

by

RICHARD E. PUNNETT, Ph.D.<sup>1</sup>

## ABSTRACT

Four Garton-type pumps were used to destratify a 720 ac, 35 ft deep lake in West Virginia. Each pump had a capacity of about 75 cfs, a power requirement of 1.1 hp, and a six-bladed, 6.0 ft diameter impeller. Temperature, dissolved oxygen, conductivity, pH, transmittance, and some aquatic organisms were monitored. The normal stratification period of 1987 was studied. This paper presented some of the findings of the study which were related directly to the effectiveness of the destratification effort. Future reports were planned to discuss water quality impacts.

## INTRODUCTION

Seasonal thermal-density stratification in lakes is a naturally occurring process that prevents the surface to bottom mixing of the water. In the spring, the lake surface warms faster than the bottom water and is more buoyant. Throughout the summer period, the surface and bottom waters remain as separate layers unless a mixing force is introduced. In the fall, the surface waters cool until the lake assumes an isothermal condition. Additional cooling of the surface results in surface water "sinking" to the bottom and creating natural lake mixing (commonly referred to as a lake turnover).

In most lakes, the bottom water has an oxygen consumption rate that results in a complete loss of dissolved oxygen soon after thermal-density stratification is established. When oxygen depletion occurs, there is a severe reduction in water quality. Although there is oxygen consumption in the surface water, the oxygen production exceeds the demand and sustains good quality.

Fish respond to the changes in water quality (induced by stratification) by residing in the layers that have sufficient dissolved oxygen. In Beech Fork Lake, the fish typically resided in about the upper seven feet during the stratification period. In order to increase the habitat of the fish, a destratification project was planned. The major objective of the destratification project was to increase the epilimnion. The two basic methods to achieve destratification are pumping and air-bubbling. The method used depends primarily upon lake characteristics and cost considerations. In most cases, air-bubbling is required for lakes deeper than about 50 feet. For lakes less than 50 feet, pumping generally is more desirable.

---

<sup>1</sup>Hydraulic Engineer, Huntington District, U.S. Army Corps of Engineers, West Virginia.

When pumping is initiated for destratification, whole lake mixing occurs as a result of density currents moving through the lake. When the warm surface water is pumped downward, it mixes with the cold bottom water and produces a volume of "cooled" water. The cooled water moves throughout the lake as a layer in the thermocline regime. As pumping continues, this layer increases in length and thickness until both the warm and cold water is mixed and the lake is destratified (isothermal).

#### METHOD AND EQUIPMENT

Pumping was the preferred method at Beech Fork Lake since the lake was shallow and funding was limited. Four axial flow pumps, generally referred to (in research literature) as Garton pumps (Figure 1a), were used. The basic components are a floatation platform, gearbox, motor, shaft and bearings, and impeller. A six-bladed, six foot diameter impeller was used to pump the water (Figure 1b). The pumping rate was about 75 cfs per pump and the average velocity through the pump was about 2.7 fps. Although 3.0 hp motors were installed, the power requirement was about 1.1 hp per pump at the blade setting used. The total daily power expense was about \$4.50. The pumps were constructed by B & Q Machine in Leon, West Virginia. The cost of the four pumps was about \$24,000. Additional parts (i.e., anchors, cables, fencing, warning signs, and electrical supplies) were required.

The pumps were delivered intact, lacking only the electrical connections. A crane was used to lift each pump from a flatbed truck and then place the pumps into the lake near the outlet works (Figure 1a). The pumps were floated into position (about 100 feet from the outlet works) over the deepest part of the lake and anchored. The four pumps were clustered together at one location. About nine man-days of effort (three actual days) were required to begin pumping operations.

#### LOCATION AND SAMPLING STATIONS

Beech Fork Lake is located in northwestern West Virginia. Flood control, recreation, and fish and wildlife enhancement were the development purposes of the lake. The watershed covers 78 sq mi, at summer pool the maximum depth is 35 ft and the surface area is 720 ac. The lake shape is bifurcated and dendritic (Figure 2) and therefore not particularly suited for lake mixing from a single location.

Although several sampling sites were studied, only four were discussed in this paper (Figure 2). Station A, the main lake station, was about 100 feet from the pumps. Station B was located about 1.5 miles from the pumps on the Beech Fork arm. Station C was located about 2.0 miles from the pumps on the Millers Fork arm. Station D was located about 200 feet downstream of the dam. The depths at Station A, B, C and D were normally about 32, 20, 17, and 2 feet, respectively.

Profile data of temperature, dissolved oxygen (DO), pH, and conductivity were taken at each station. Phytoplankton, zooplankton, periphyton, and benthic macroinvertebrates were collected at Stations B, C, and D. A



Figure 1a. Garton Pump Being Lowered Into Lake

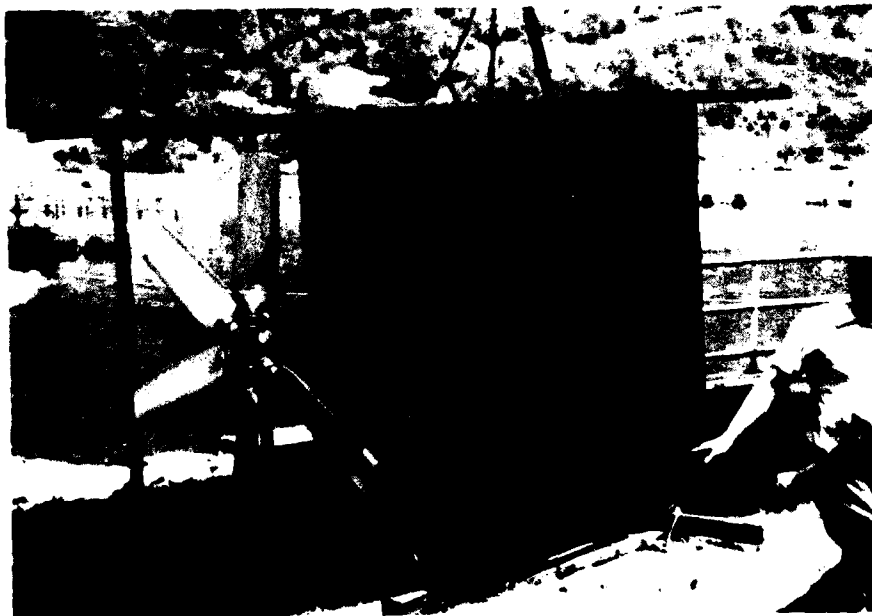

Figure 1b. Pump Impeller



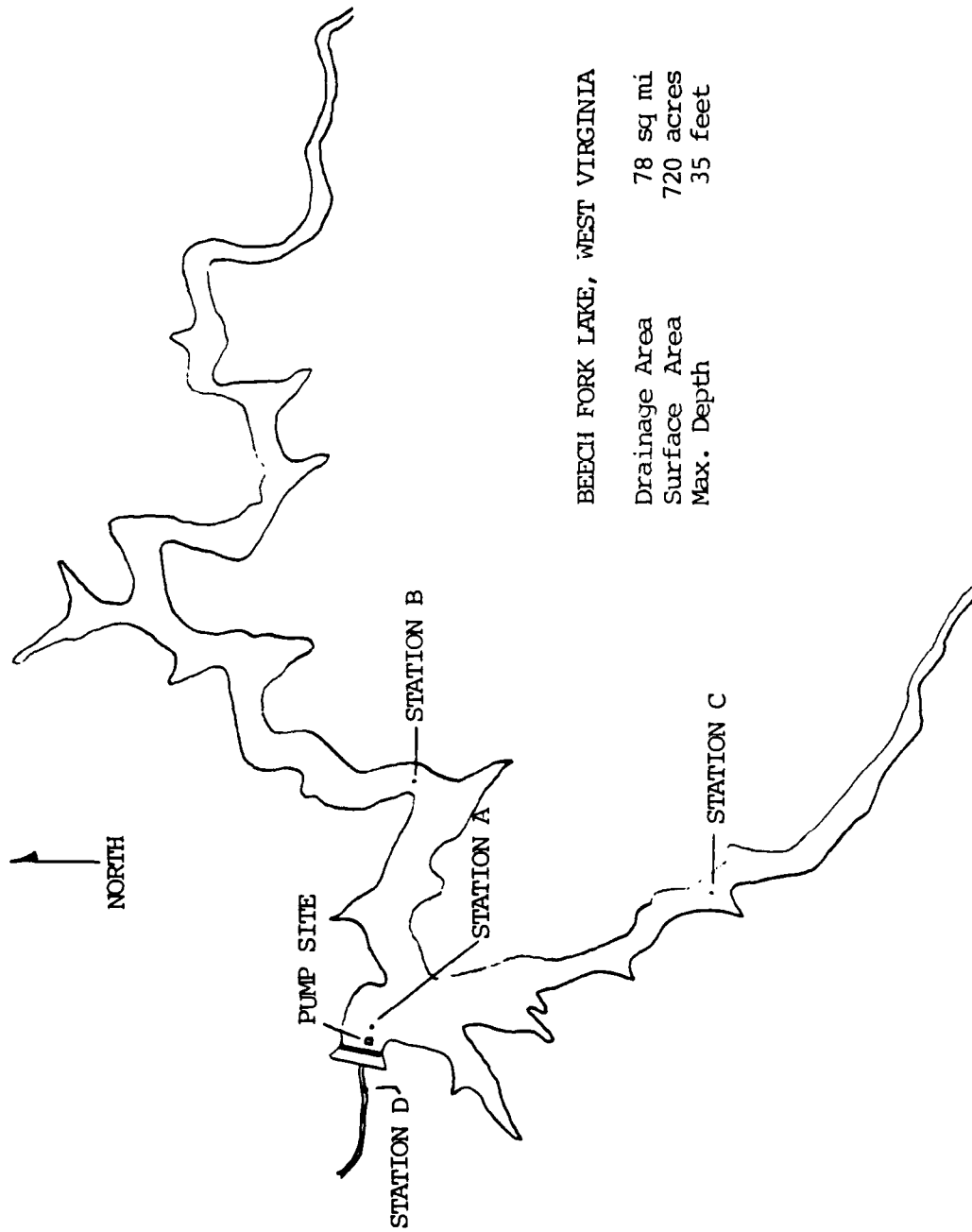

Figure 2. Beech Fork Lake

fish study was initiated to document the existing conditions and monitor changes. Since this paper reports primarily on the destratification effectiveness, the discussion will be limited principally to changes in the temperature and DO profiles.

#### DISCUSSION

The pumps began operation at noon on May 17, 1987. The initial stratification pattern showed a 17°C difference from surface to bottom; the typical difference was about 10°C. The DO had not depleted in the bottom zone, but it was significantly reduced. Within 7 days, the lake area between the pump and the dam was destratified and remained nearly isothermal for the rest of the year. The destratification of the rest of the lake took longer.

To illustrate the effectiveness of the destratification effort, Figures 3 through 5 were developed. The figures show the temperature and DO at five foot intervals in the lake over the normal stratification period. Both 1986 (a non-pumping year) and 1987 data were presented.

In Figure 3a, a typical stratification pattern can be seen at Station A (main lake). The surface temperature was about 22°C, and the bottom was about 10°C. The DO ranged from about 7 mg/l at the surface to about 1 mg/l at the bottom with significant depletion occurring below 10 feet. By early June, DO had depleted between 5 and 10 feet deep and remained anoxic until November. The thermocline, the zone between the warm surface and the colder bottom water, was between 5 and 10 feet in mid-May and just below 10 feet by late July. In August, the surface water began cooling until fall turnover in November.

In Figure 3b, the effects of the pumping on the temperature pattern can be seen. The surface water was about 25°C and the bottom water was about 9°C when pumping began on May 17, 1987. The bottom water began warming to near surface temperatures when pumping started. By mid-June, the temperature difference was about 6°C from top to bottom and the difference was about 3°C by mid-July. In August the lake was essentially destratified (isothermal) and cooling. On August 18, three pumps were turned off and one pump was left running to maintain the isothermal condition. On September 29, the last pump was turned off.

Also in Figure 3b, the effects of pumping on the DO pattern can be seen. The DO was about 9 mg/l at the surface in May and typically decreased through the season until surface cooling began in August. The DO at 5 feet was about 6 mg/l when pumping began and reduced to about 4 mg/l in July until improvement began in August. The DO from the surface to 25 feet did not go anoxic during the pumping year. The zone below 25 feet (less than 1% of the lake volume) was anoxic for a short period of time in July. As isothermal conditions occurred in August, the DO at all depths began significant improvement. Typically, DO in the lake did not significantly improve until November when turnover occurred.

Figures 4a and b show the destratification effect at about two miles from the pumping site for 1986 (non-pumping year) and 1987. The patterns (and

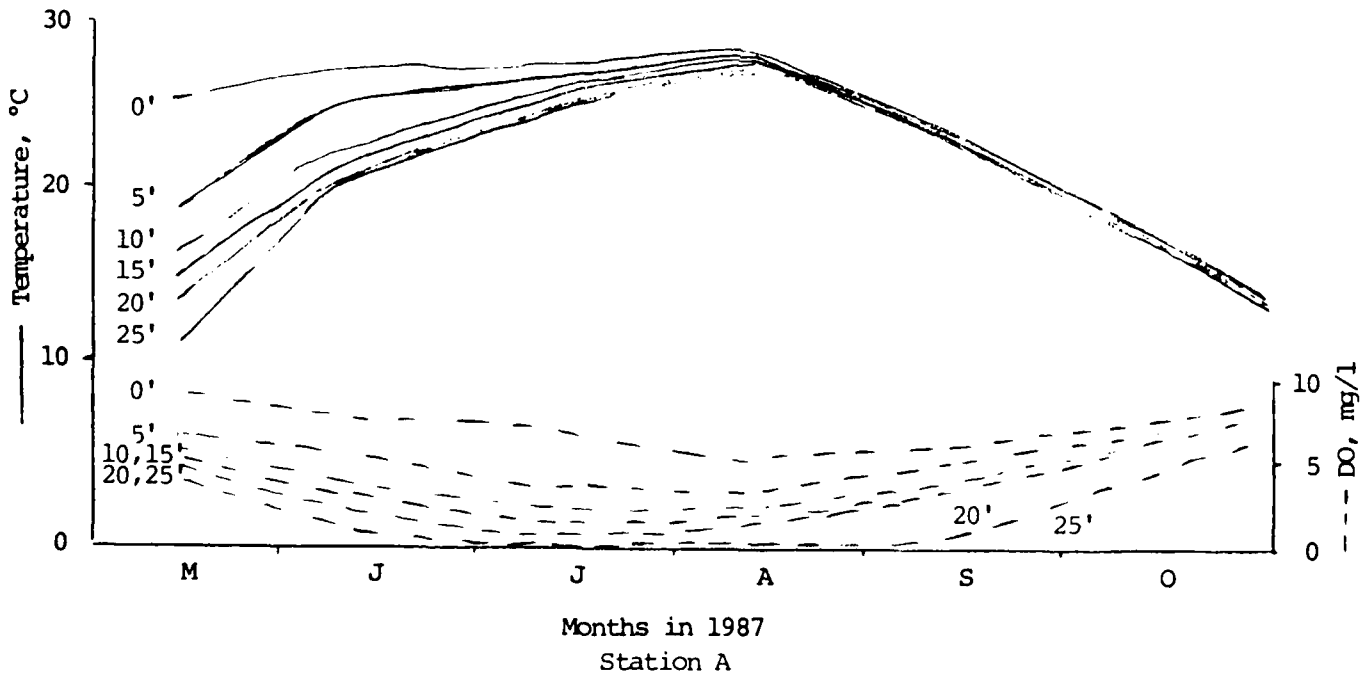
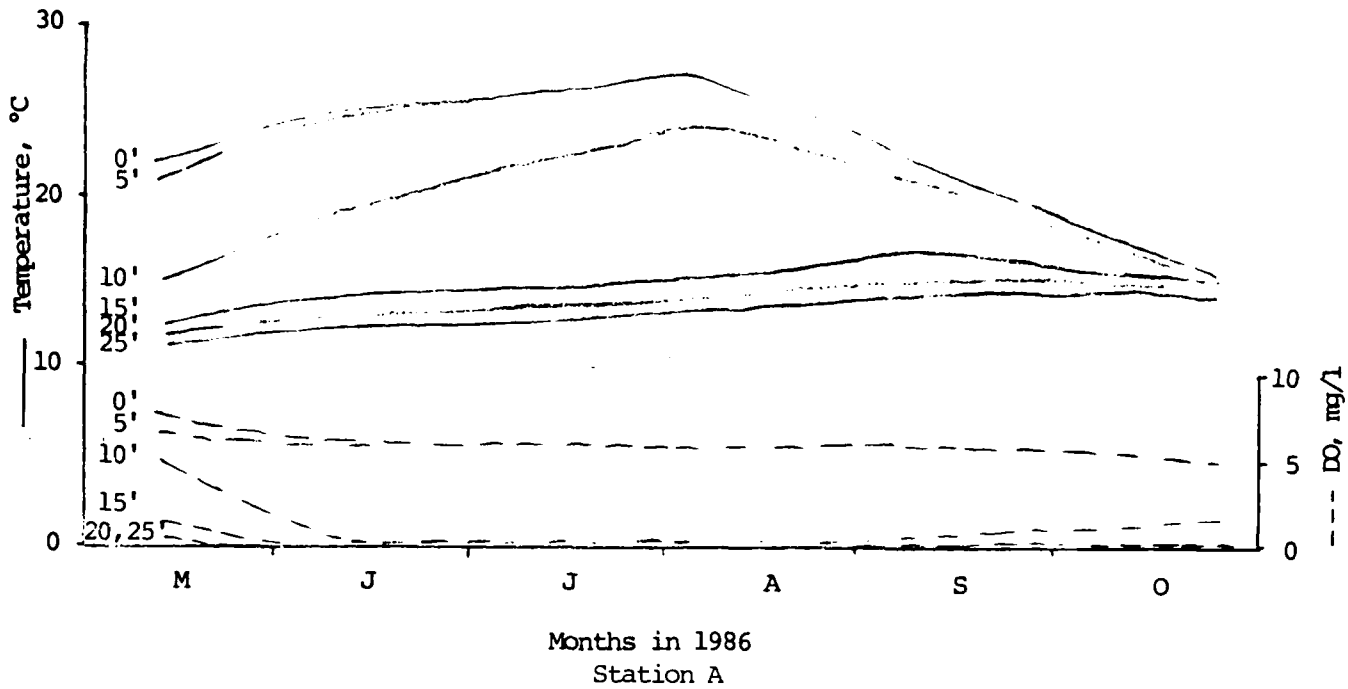

Beech Fork Lake  
Temperature and DO at Given Depths

Figure 3a. (upper)  
Figure 3b. (lower)

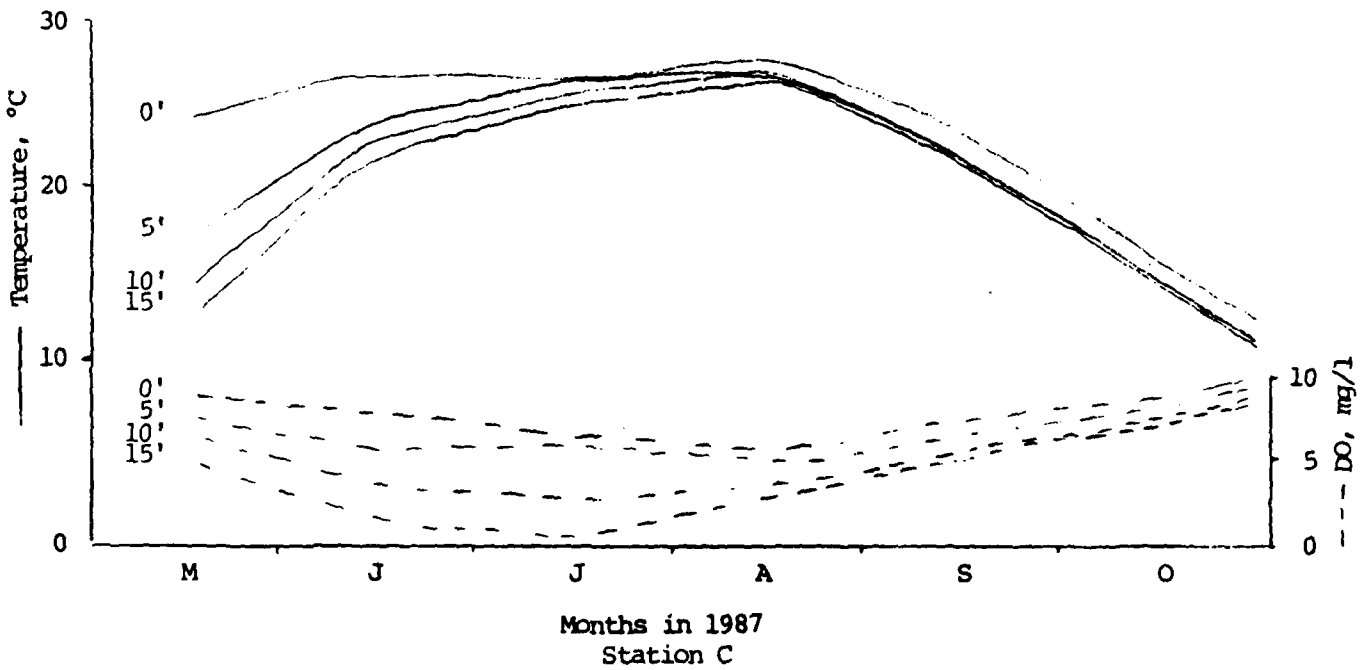
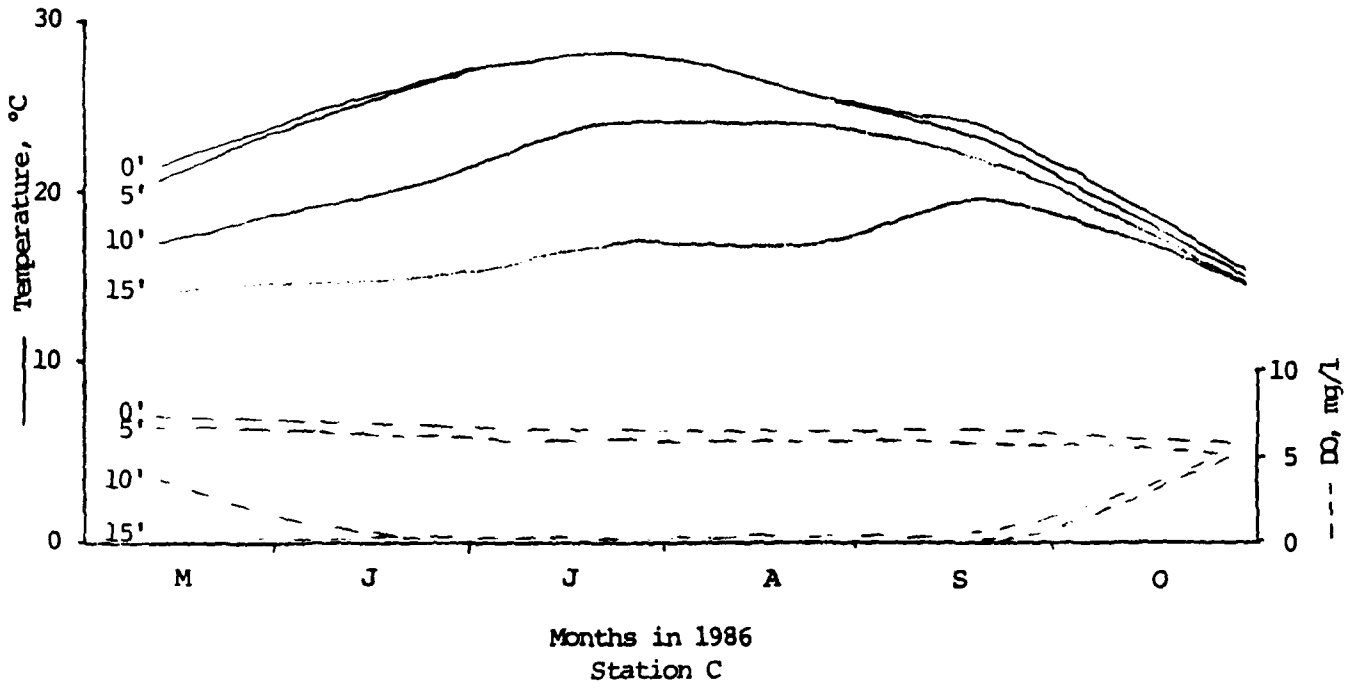

Beech Fork Lake  
Temperature and DO at Given Depths

Figure 4a. (upper)  
Figure 4b. (lower)

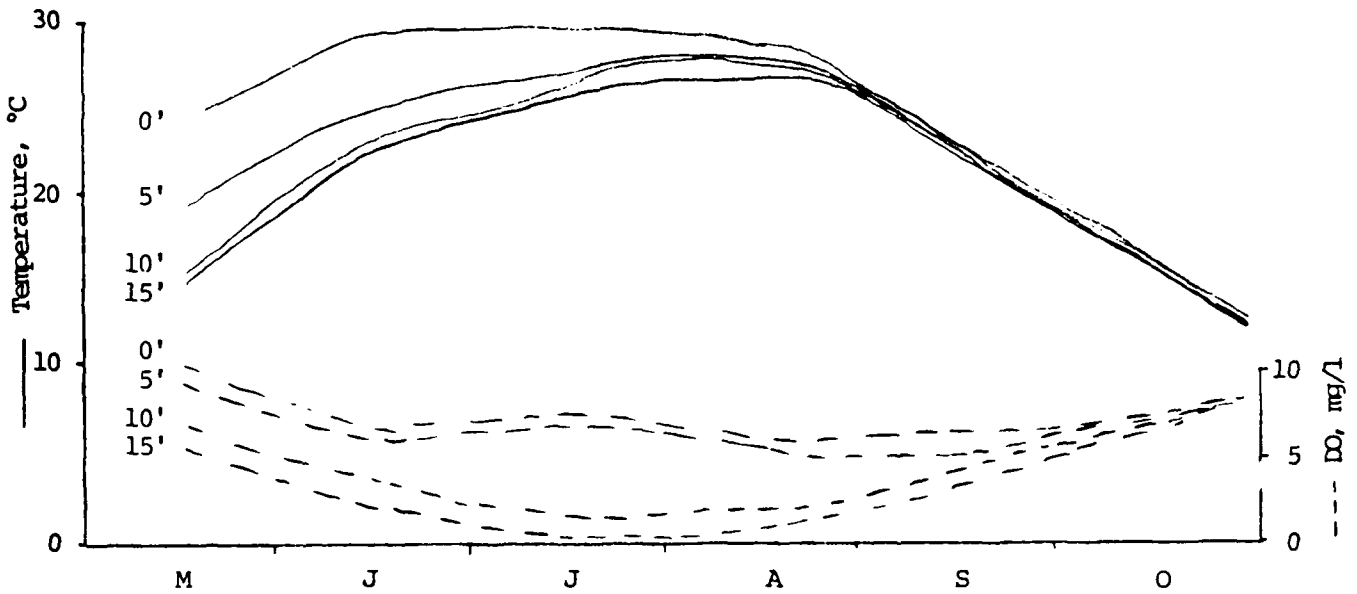

Months in 1986  
 Temperature and DO at Given Depths  
 Station B

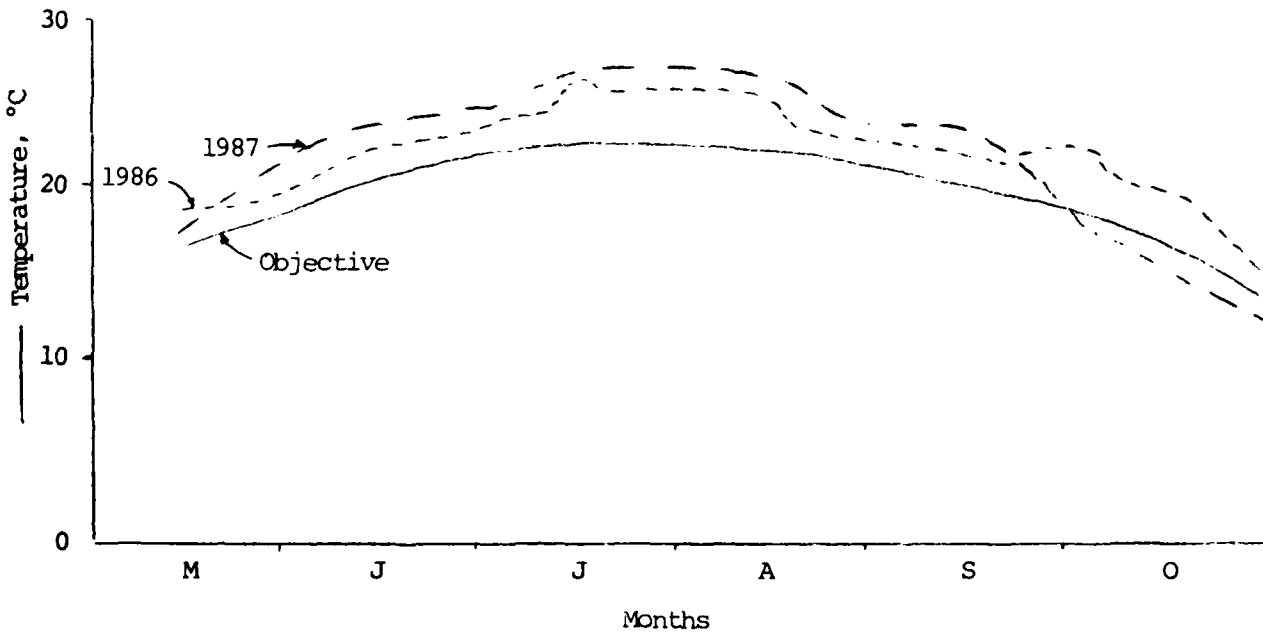

Beech Fork Lake  
 Outflow Temperatures

Figure 5a. (upper)  
 Figure 5b. (lower)

the resulting discussion) were essentially the same as Station A (Figure 3a) except that the site was shallower (17 feet). Similarly, Figure 5a shows the same destratification effects at Station B. Clearly the destratification effect of the pumps was a lake-wide phenomenon even though the pumps were located in a single location near the dam.

The outflow temperatures were also monitored since, under a destratified condition, temperature regulation was not possible. Figure 5b shows the objective and outflow temperatures for 1986 and 1987. Clearly, the destratified conditions resulted in warmer than normal conditions in the tailwater for June through mid-September. However, the temperature values did not exceed warm water fishery acceptable limits. In normal years, the ability of the intake structure to meet the outflow temperature objective was dependent upon the location of the thermocline and the lake elevation. Although conditions in 1986 were not favorable to meeting the outflow temperature objective, most years match the objectives fairly well.

Typically, in late summer releases, only the upper intake gate is used since the lower gates are in the hypolimnion layer. If possible, releases from the hypolimnion are avoided for water quality reasons. However, during the 1987 period, the water quality was suitable for release from any gate since anoxia (and the resulting degradation) did not occur in the area around the intake structure.

Normally, the fall turnover occurs in mid-November at Beech Fork Lake. As a result of the destratification project, the lake was fully mixing (turned over) by late August.

#### CONCLUSIONS

Considering the temperature and DO profiles as the major indicators of destratification effectiveness, several conclusions were evident.

1. The epilimnion was increased (the major objective).
2. The pumps were sufficient for destratifying Beech Fork Lake even though a strong thermal-density difference existed prior to the start of pumping.
3. Mixing occurred throughout the lake even though the shape of the lake did not appear to be suited to mixing and pumping was conducted at only one location.
4. The water in the vicinity of the dam did not become anoxic. Although at times the overall DO was low, only less than one percent of the lake volume became anoxic for a short period.

#### FUTURE PLANS

The destratification project will be continued. In 1988, pumping is planned to start no later than the first of April (prior to the

establishment of a strong stratification pattern). Data collection and evaluation will be continued. Additional reports on the destratification effects on aquatic organisms will be written.

# UTILIZING THE STATISTICAL ANALYSIS SYSTEM FOR WATER QUALITY DATA BASE MANAGEMENT

by

James D. Graham, P.G.<sup>1</sup>

## ABSTRACT

Water quality data has been collected by numerous people for a myriad of uses. This data can be found on a variety of computer storage devices such as tapes, disks, and floppies. Analysis of this data is challenging because the concentration of chemical constituents in water may vary both spatially and temporally. A variety of techniques, including analytical and statistical, is necessary for analysis. As a result, to be useful for water quality analysis, computer software must be powerful, flexible, and capable of producing high quality graphics.

Within the Corps of Engineers, water quality data has been analyzed by a variety of people with different hardware (micros to mainframes) and software (LOTUS, D-Base, SAS, SPSS, etc.). As a result, many of the programs written are incompatible with other users' programs, and there is a great deal of duplication of effort. In this paper, I have reviewed the capabilities of the statistical Analysis System (SAS) for water quality analysis and its potential application as a standard system for the Corps of Engineers.

## INTRODUCTION

The Corps of Engineers offers extensive technical training programs for scientists and engineers. The Corps does not, however, provide standard training in data base management and analysis. Data base training should include basic data base management (compiling and organizing data into a rational relationship), data base analysis (statistical treatment of data), and data base presentation (graphics and reports). Without a standard system of analysis and training, a user may not have the time to learn a complicated system, whereas a simple system may be inappropriate for analysis. Frustration is particularly noticable in water quality data base management, where an end user may need to evaluate a vast quantity of data in varying formats and quality and perform complicated statistical analysis.

When faced with somewhat similiar problems of not having software to do certain tasks, the Corps of Engineers' response has often been to try and develop its own software packages (such as HEC-1 to HEC-6, DSS, CEEG, etc.). Some of these programs may be doomed to failure due to a lack of flexibility of the software packages, the limited number of hardware drivers, and lack of software maintenance. When the packages do not meet the needs of the end user, he/she will often proceed with independent methods. Such has been the case in water quality data base management.

.....  
<sup>1</sup>Portland District, Army Corps of Engineers



As a result, there are numerous people in several Corps offices that have written water quality programs that basically do the same thing.

At NPD, we are fortunate (through the use of our Amdahl mainframe) to have access to what, I consider, is an excellent data analysis system, SAS. This system is available to some mainframe operating systems such as TSO and CMS. It is not, however, available to Harris users, and has just recently been made available to micro users. Because of the restrictions in operating systems support, SAS cannot be considered (at this time) to be the answer for the Corps data management problems. SAS can be used, however, as a standard to judge a Corps wide data analysis system.

Below are my requirements for a water quality data base management system based on my experiences with SAS, LOTUS, D-Base, and INFO, and my conclusions about how a system like SAS could be integrated into the entire Corps of Engineers.

#### CRITERIA FOR A WATER QUALITY DATA BASE MANAGEMENT SYSTEM

During the past 20 years, the magnitude and complexity of water quality data collection have increased to the point that traditional means of data analysis have become increasingly unproductive. Water quality data bases that formerly filled a page are now occupying tracks and cylinders and filling up floppies and hard disks. Many types of computer software have been developed as a result of the pressing need for easier and more powerful tools for data analysis. To be effective, these software packages must allow the user to read, manage, analyze and graph data with a minimum of programming skills, or the software will not be used. This software should be available to both micro and mainframe users and should be capable of producing graphics and reports on a variety of hardware.

#### Operating Systems Requirements

There are many different kinds of micros available that utilize operating systems such as MS-DOS and UNIX. Mainframes may utilize TSO, CMS, or other operating systems. My required water quality data base management system is one that will support these major operating systems on both micros and mainframes. This requirement will be easier to meet after the Corps decides on a Corps-wide mainframe under the CEAT procurement.

#### Software Requirements

Gaugush (1986) illustrated some of the the most common statistical methods used by water quality researchers. These techniques included one- and two-sample hypothesis, analysis of variance, cluster analysis, and regression. Useful presentation of data included scatter, histograms, box, and stem and leaf plots. These techniques, although useful, do not fully describe what is available for data analysis, including time-series, trend surface, and non-normal distribution analyses. Water quality graphics must include three dimensional plots and contouring with CADD enhancement, regression, and time series plots. For example, in several of the water quality reports that have been done

by the Portland District there has been a wide variety of statistical and graphical analyses employed that are less common than those mentioned by Gaughsh.

#### WHAT IS SAS?

SAS was originally developed to meet statistical needs. It grew into an all purpose data analysis system in response to the users' need for one software package that could provide for data storage, retrieval, modification, and programming, and produce written reports and graphics products. Other useful tools of the system include spread sheets, project management, and time series analysis (SAS, 1985). The system runs on IBM 370 series computers and compatibles, in batch and interactive modes under the OS, DOS/VS, VM/CMS, OS/VSE, SSX, and TSO operating systems. In addition to these mainframe applications, SAS has been compartmentalized to run on micro computers.

#### Data Storage and Retrieval

SAS can read data in virtually any format from cards, disks, and tapes. The data is then organized into SAS data sets. Once the data is in a SAS data set, it is formatted in such a way that it is easily handled by SAS. This procedure speeds up computer processing time. An analogy to FORTRAN's users is that the SAS data has been processed by a read statement and is ready for manipulation. SAS data sets are self-documenting in that they contain both the data values and their descriptions. The description, which can include a variable name and a label, allows the user or other users to understand the meaning and data structure of the SAS data set.

#### Data Modification and Programming

A complete set of programming tools is available to the SAS programmer. Powerful programming tools that are available include DO/END and IF-THEN/ELSE, which follow FORTRAN's programming structure, error checking, and accumulating totals. In addition, FORTRAN's subroutines can be called within a SAS program. As a result, it is possible to write complex programs using the SAS language. In addition, previously programmed FORTRAN subroutines can be incorporated for additional flexibility.

#### Report Writing

There are virtually no limits to the types of data and reports that SAS can write. In addition to preformatted reports, the user can produce reports that include such niceties as page numbering, and line and column control. For interaction with other programs, SAS can also output data in binary or hexadecimal.

#### Statistical Analysis

SAS was originally conceived as a statistical package and that feature is still the strongest aspect of the system. Statistical techniques range

from simple descriptive techniques to multi-variate and matrices analyses. These statistical procedures are, administratively, easy to call and link with data to be analyzed. Like all complex analysis, however, SAS relies on the judgment of the user for proper application.

#### File Handling

It is often necessary to combine values and observations from many different data sets for analysis. SAS has tools for subsetting, merging, and concatenating data sets so that the user has control over multiple input files, and several different reports can be generated with one pass of the data.

### USES OF SAS IN WATER QUALITY DATA ANALYSIS

Gunkel (1984) generically described how SAS was utilized to manage water quality data for the Corps of Engineers Reservoir Field Team. In the following sections I will give specific examples in ways that SAS could be used to analyze water quality data.

#### Data Management

Water quality data is available from a variety of sources: Governmental agencies, universities, consultants, and individuals. Often the data analyst has no control over the quantity, format, or variables of data that he/she receives from these sources. The data may arrive with only two variables, such as depth and water temperature in a reservoir, or may include the concentration of all of the EPA priority pollutants for a site over a 10-year period. The data may have to be merged from several different files for later analysis. For example, there may be several different contractors or consultants that have worked on a project, or different water chemistry tests may be done by different labs. If the data sets are large, a significant amount of time is spent on reading, sorting, merging, and rereading, resorting, and remerging data when mistakes are made in programming, or different programs are applied to the same data. Poor documentation can make the best programs worthless if new personnel must analyze previously compiled data without the original user's familiarity with the data.

SAS can allow a user to do an excellent job of data management with very little experience. Data can be read with a simple input list, or can be rigidly formatted from several lines of data. A single observation, such as a single water sample, can be described with up to 4,000 variables (such as date of sample, water temperature, arsenic concentration, etc.), and there is no limit to the number of observations (except time, money, and memory constraints) that can be processed. The data can be easily merged with other data sets by powerful SAS procedures, called PROCs, such as "PROC SORT" and by data step applications such as "MERGE." By putting the data into a SAS data set, the data is ready to be processed without rereading and is properly documented. For example, after running a "PROC CONTENTS" on a SAS data set, the user knows the variable name, location, and format, and as many as 40 characters of description of each variable.

## Data Analysis

There are many types of water quality data that lend themselves to statistical analysis; examples include metal concentration profiles in a reservoir or the bacteria count in a well observed over time. If the quantity of data is limited, a computer solution may not be appropriate. However, if the data base is large, complex, or is not normally distributed (the bane to statisticians everywhere), a computer solution is in order and may be essential to preserve the sanity of the analyst. Even the example of the count of bacteria mentioned above is not clear cut. If some of the sample counts are near the detection limit, normality may not be assumed, and a different technique such as the Gamma distribution may be in order (Haan, 1977). SAS is capable of analyzing data utilizing many different non-normal distributions.

Other types of statistics can help in many applications of water quality data analysis. Using techniques such as trend surface analysis or time-series analysis, it is possible to extrapolate data over time and space with a statistically defensible confidence at a much more reasonable cost than by an analytical or numerical modeling solution (Koch and Link, 1970).

Figure 1 shows a trend surface analysis of a groundwater contaminant plume extrarapolated some 20,000 to 30,000 feet past the limits of the groundwater model.

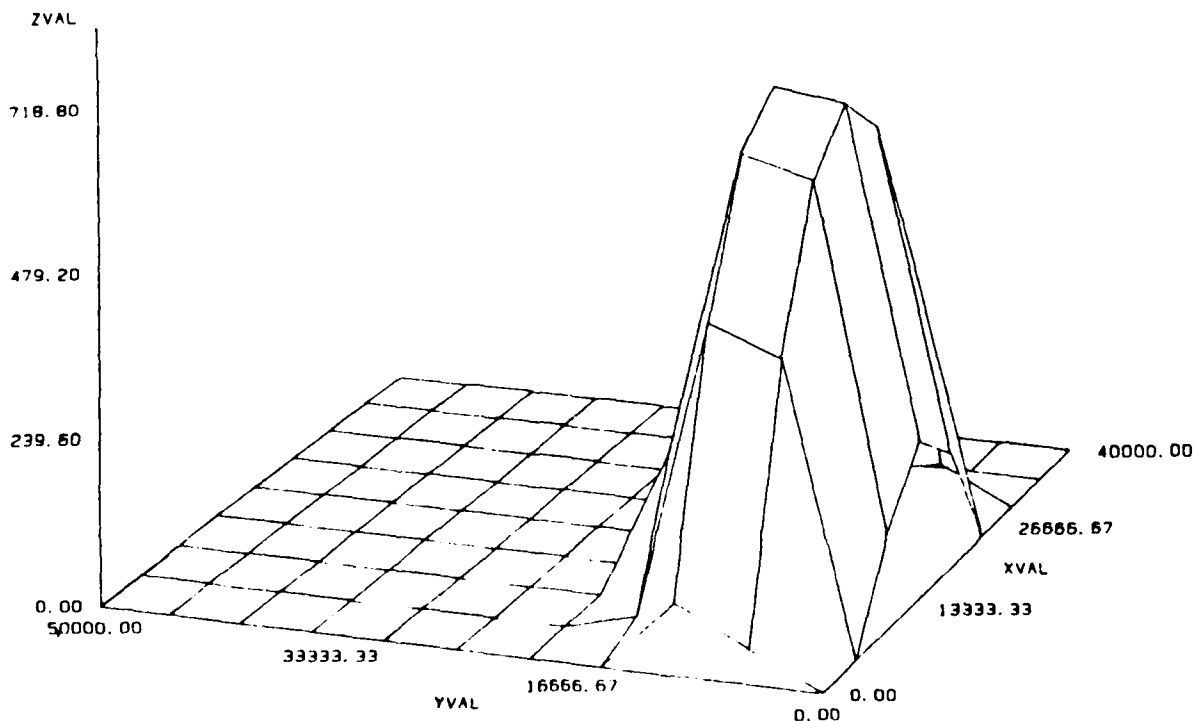

Figure 1. A SAS 3-D graphic of a trend surface model using a quadratic, multiple regression equation. The ZVAL shows estimated concentrations of a constituent extrapolated beyond the boundary conditions of the model.

In the case of figure 1, plume concentration was computed from 0 to 20,000 feet in the x direction (XVAL) and from 0 to 16,000 feet in the y direction (YVAL) using the SUTRA model (Voss, 1984). The contaminant plume was a model of the Rocky Mountain Arsenal hazardous waste site. The concentration values for a time step of the model were extrapolated using a multiple regression quadratic equation of the form:

$$ZVAL=(XVAL)*A+(XVAL*XVAL)*B+(YVAL)*C+(YVAL*YVAL)*D+(XVAL*YVAL)*E$$

Where: A, B, C, D, E, and F were supplied by SAS based on the principles of least squares.

Figure 1 is an example of a three-dimensional graphic generated from a trend surface model using a quadratic, multiple regression equation. The ZVAL shows estimated concentrations of a constituent extrapolated beyond the boundary conditions of the model. Several different trend surface models could be applied and evaluated based on their r squared estimate. In addition, the predicted concentration at a particular location over time could have been developed based on the model's simulation and regression or time series analysis. A statistical model, in this case, would be much faster and may be just as valid as the generation of a new numerical model grid and simulation.

#### Data Reporting

One very important, but commonly forgotten, aspect of data management and analysis is that no matter how good, the analysis must be sold to others, in the forms of engineering reports, scientific papers, etc., to be useful. The inability to generate a report means that the study probably should not have been done in the first place. Conversely, a researcher can write around the tables and graphics of a study, and a successful report can be produced. With the SAS system, tables of data can be generated by preformatted reports such as "PROC PRINT" and "PROC MEANS" or by user programmed printing. A user, after merging several data sets, performing complex analysis, etc., can output his/her data accurately, neatly, and correctly formatted (with column, line, and page control) with a minimum effort. SAS can produce graphics such as pie, bar, and X-Y charts, as well as other more complex graphics such as contouring and three-dimensional graphics (figure 1). In addition, SAS can produce these graphics on a variety of common and not-so-common graphic devices (device intelligent graphics), thus solving any problems of noncompatible programs and graphics devices. For an organization that has a variety of terminal and plotter types, this SAS feature is very desirable.

#### Side Benefits of SAS

There are many side benefits to using SAS as a data analysis tool. There are virtually no limits to the types of analysis that can be done using SAS. In general there is no need to learn another software system, just learn more SAS. Because the system is so all-encompassing, the data and techniques are transportable throughout SAS. Therefore, data that has been read and massaged in SAS Basic can be analyzed with SAS Statistics or Operations Research, reported on SAS Basic, and plotted by using SAS Graph, all without a hitch. If problems with the system arise, there is

a SAS hotline, where almost any kind of question can be answered by SAS hardware and software consultants.

I have found SAS to be very useful in doing technical studies in general. SAS has been very helpful in interpreting and plotting data that has come from several different types of data collection and storage devices. Several of these devices pack and store their data using binary or hexadecimal format. SAS, with the ability to read and interpret these machine languages, has been a valuable asset.

In almost every kind of study, there is a time when plotting summarizing data is needed. I have found SAS to be an excellent secondary tool for numerical modeling, by allowing me to plot and analyze the enormous volumes of output from numerical models. Figure 2, for example, shows a plot of a water quality concentration map generated by the SUTRA numerical model. This kind of plotting capability can save many hours of hand plotting during the course of a study.

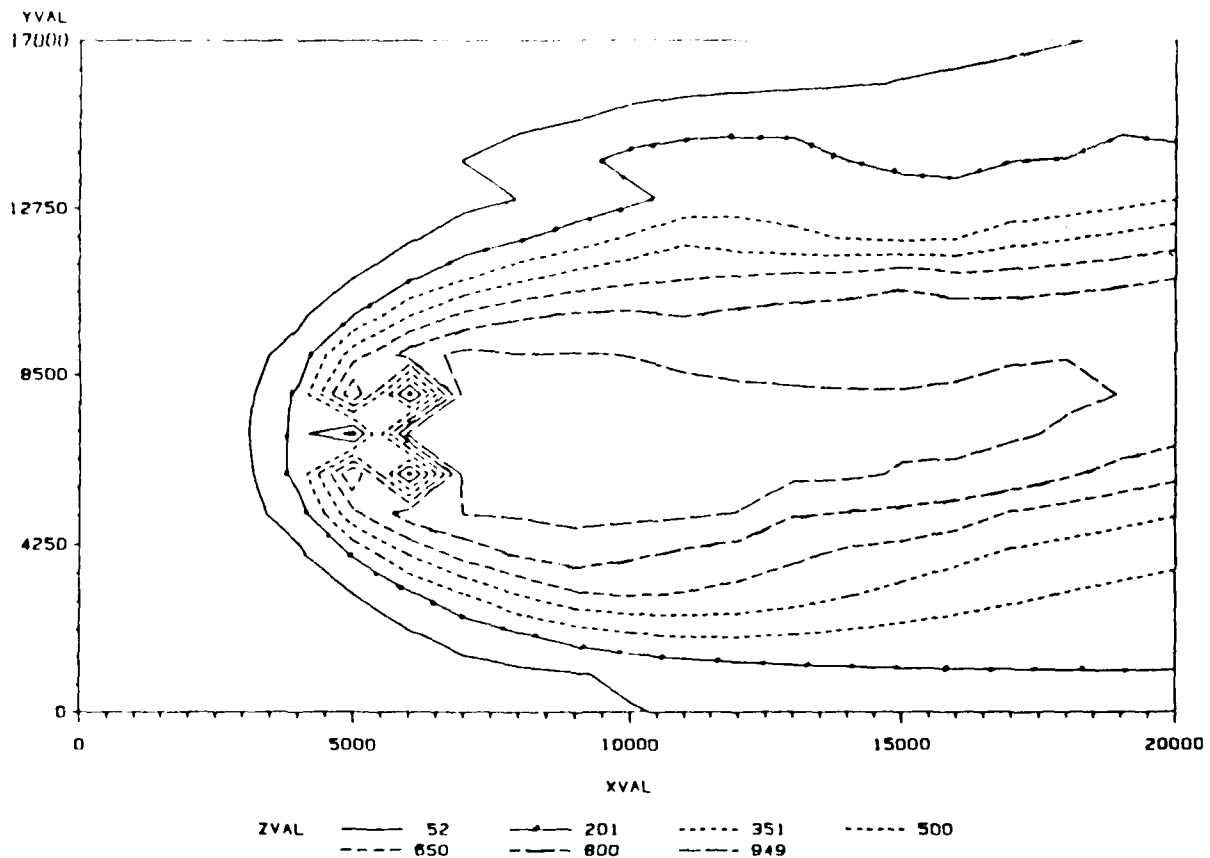

Figure 2. A SAS contour plot of concentrations of a constituent generated by the SUTRA model (Voss, 1984.) Scale and contour values were default values but could have been specified by the user.

In figure 2, scale and contour values were default values, but could have been specified by the user.

## CONCLUSIONS AND RECOMMENDATIONS

I have found SAS to be a very useful tool in the analysis of water quality data. The system is not devoid of faults, but I have found it to be one software package that has met all of my data analysis needs: data management, analysis, and presentation. I have and will continue to recommend this software for those in need of a powerful and generic data analysis package.

Water quality data base management in the Corps of Engineers is in a morass. Our problems, which are largely self-generated, are caused by a lack of data base management training for key personnel and the variety of incompatible computer approaches for data base management. Clearly, the Corps can do better by promoting a Corps-wide water quality data management system with micro and mainframe compatibility, computer training for water quality personnel, and compilation of a library clearing-house for water quality computer programs. By utilizing a standard system with the capabilities of SAS, the Corps of Engineers will benefit from better, more defensible and timely reports, and the taxpayers' money will be better spent.

## CITED REFERENCES

- Gaugush, R.F., 1986. Statistical Methods for Reservoir Water Quality Investigations. Instruction Report E-86-2. Department of the Army, Waterways Experiment Station, Corps of Engineers, PO Box 631, Vicksburg, Mississippi 39180-0631.
- Gunkel, R.C., 1984. A Water Quality Database Management System. Proceedings of a Seminar on Applications in Water Quality Control. U.S. Army Corps of Engineers. p. 45-49.
- Haan, C.T., 1977. Statistical Methods in Hydrology. The Iowa State University Press, Ames, Iowa. 378 pp.
- Koch, G.S., and R.L. Link, 1970. Statistical Analysis of Geologic Data. Dover Publications, New York. 917 pp.
- SAS, 1985. SAS User's Guide. SAS Institute, Cary, N.C.
- Voss, C., 1984. SUTRA, A Finite-Element Simulation Model for Saturated-Unsaturated, Fluid Density-Dependent Ground-Water Flow with Energy Transport or Chemically-Reactive Single-Species Solute Transport. U.S. Geological Survey, Water Resources Investigations Report 84-4369.

GROUND WATER MANAGEMENT PLAN  
FOR THE CONSTRUCTION OF THE BONNEVILLE NAVIGATION LOCK

By

James D. Graham, P.G.<sup>1</sup>  
David Scofield, P.G.<sup>1</sup>  
Saleem Farooqui, P.G.<sup>2</sup>  
Steve Sagstad, P.G.<sup>3</sup>  
Kevin Foster, C.E.G.<sup>4</sup>

ABSTRACT

The new navigation lock at Bonneville Dam on the Columbia River is being built because the present lock is obsolete in that it is unable to handle the present and projected barge sizes and volume of shipping. The location of the new lock and approach channel will necessitate the removal of the present Bonneville Fish Hatchery (BFH) well field and installation of a new well field. In addition, lock construction will also require extensive dewatering of the same Pre-Slide Alluvium aquifer (PSA) that is used to supply water to the BFH. To reconcile the potential problems of the two major well fields and the limited sustained yield potential of the PSA, the Portland District Geology Section and ground-water consultants have developed a ground-water management plan for the construction of the navigation lock. The purpose of the plan is to ensure the continued supply of high quality ground water to the fish hatchery while achieving construction dewatering for the navigation lock. Conceptual aspects and activities planned to further quantify and implement the plan are discussed.

INTRODUCTION

The new navigation lock for Bonneville Dam was authorized by the Supplemental Appropriations Act of 1985, PL 99-88. The BFH was expanded during 1974 as an environmental mitigation measure for the John Day Dam (the second project upstream of Bonneville Dam on the Columbia River). The BFH is located on an alluvial terrace on the Oregon shore at Bonneville Dam, about 42 miles east of Portland, Oregon. The terrace is aligned in a northeast-southwest direction and is bordered by the Columbia River to the north and west, intrusive rock to the east, and bedrock and landslide slopes to the south. The surface of the terrace lies at approximately elevation (El.) +55. The water level of the Columbia River varies between El. +7 and +37. Bonneville Pool, behind the dam and first powerhouse to the east of the terrace, has a water level elevation of about +72. The existing navigation lock and most of the first powerhouse are founded on intrusive rock, which virtually cuts off recharge from the pool to the terrace aquifers.

-----  
<sup>1</sup>Portland District, Corps of Engineers

<sup>2</sup>Cornforth Consultants, Inc.

<sup>3</sup>Sweet, Edwards, and Associates, Inc.

<sup>4</sup>Geotechnical Resources, Inc.



The maximum water requirements of 17,500 gallons per minute (gpm) for the fish hatchery are currently met by five large production wells located on the terrace about 500 feet north of the fish hatchery. The wells are in, but do not fully penetrate the PSA aquifer, the bottom of which is estimated to be near El. -200 mean sea level (MSL). The locations of the existing facilities and new navigation lock are shown on figure 1.

The BFH requires a water temperature between 47° and 53° Fahrenheit (F). Any deviation from this range of temperature could cause a reduction in hatchery production due to slower growth rates or an increased chance of disease. Other water quality criteria for Oregon fish hatcheries closely parallel Federal water quality criteria for the protection of freshwater aquatic life. For some water quality constituents the requirements for a fish hatchery exceed those for municipal drinking water (EPA, 1986).

As shown on figure 1, all of the existing water supply wells are within the new downstream approach channel for the navigation lock. Wells within the approach channel excavation will be inundated by tailrace water. Therefore, the well field must be relocated on the terrace to provide an uninterrupted water supply that will meet the water quantity needs and quality criteria of the fish hatchery.

#### GEOLOGY AND GROUND WATER HYDROLOGY

The terrace area consists of Quaternary to Recent alluvial deposits overlying Tertiary volcanoclastic and sedimentary bedrock. A geological map of the area is presented on figure 2. The oldest and stratigraphically lowest rock underlying the project area is the Tertiary Age Weigle formation, which consists of relatively impermeable sedimentary bedrock. Within the cliff walls of the surrounding Columbia River Gorge are exposures of younger Tertiary volcanoclastic and volcanic rocks that overlie the Weigle formation. These exposures include the Eagle Creek formation and the Columbia River basalt group. The bedrock units are intruded by an irregularly shaped diabase, the Bonney Rock intrusion, that is exposed in a south-southwest-trending ridge across the alignment of the new navigation lock. The Tanner Creek landslide and Tooth Rock landslide are also present in the project area. The Quaternary alluvial terrace deposits consist of heterogeneous, stratified sediments and reworked slide debris. The alluvial deposits are thought to have accumulated in a plunge pool formed on the downstream side of Bonney Rock during the Pleistocene Age high water known as the Missoula Floods. The deposits have been subdivided into units that generally correspond to distinct aquifers within the alluvial sequence: Recent River Deposits (RD); Reworked Slide Debris (RSD); Blue Clay (BC); Mica Sand (MS); and Pre-Slide Alluvium (PSA). A generalized geologic cross section, figure 3, shows the stratigraphy of the alluvial terrace.

The lock area appears to include at least four distinct ground-water systems: alluvial terrace deposits, Bonney Rock, and the Tooth Rock and Tanner Creek slide deposits. The most productive aquifers occur within the alluvial deposits system, which contains both confined and unconfined aquifers. All aquifers within the alluvial deposits are hydraulically connected to the Columbia River.

The PSA, which supplies all of the water to the BFH and is the main aquifer to be depressurized during construction of the navigation lock, consists of sandy, medium to coarse gravel, and medium to coarse open-work gravel with little or no sand. Some silt and sand beds are found interspersed throughout the sequence. Similar gravel was encountered across the river at the second powerhouse excavation and downstream of the second powerhouse at Hamilton Island. The PSA overlies the tuffaceous siltstone and sandstone of the Weigle formation, occupying a broad, southwest-trending erosion channel. The deepest portion of the PSA is at a depth of more than 250 feet (El. -200) but becomes shallower to the north where the base may be less than 200 feet in depth (El. -150). The bedrock floor rises sharply to the south, truncating the southern extent of the unit.

General hydrogeologic characteristics of the PSA aquifer were developed from the subsurface distribution and lithologic characteristics of the PSA and overlying units. Specific hydraulic parameters for the PSA aquifer were developed in August and September 1986, from three aquifer pump tests performed in well A-2 (WW 1805) and hatchery wells H-3 and H-4. The locations of the pump test wells are shown on figure 1. Details of these pump tests are presented in a pump test data report (Cornforth, 1986). The pump test data were analyzed by the Stallman, Theis, and Jacobs semi-log method (Cornforth, 1986). The procedures used consisted of plotting and analyzing drawdown or recovery in each well by curve matching or standard numerical methods. The results indicate that the PSA aquifer is confined and highly productive. Transmissivity, T, ranged from 150,000 to more than 300,000 gpd/foot; hydraulic conductivity, K, ranged from 0.5 to 1.0 foot/min; and the storage coefficient, S, ranged from  $1 \times 10^{-3}$  to  $1 \times 10^{-4}$ . The variation in computed properties is believed to be due to zones of higher and lower transmissivity that occur within the aquifer. The calculated values for transmissivity show good correlation between the methods of analyses.

The PSA aquifer is generally recharged from the Columbia River by leakage from overlying aquifers, but may also be recharged directly from the Columbia River. Because the Bonney Rock intrusion provides a natural ground-water cutoff between the upstream channel area and downstream approach channel, only the downstream dewatering will directly affect hydrostatic levels within the downstream alluvial aquifer system.

#### DOWNSTREAM AREA DEWATERING

The ground-water dewatering design is presented in the Bonneville Navigation Lock Excavation Plans and Specifications (USACOE, 1987b). In the downstream area, ground-water levels must be lowered to El. -42, which is 5 feet below the subgrade of the deep Downstream Minimum Excavation (DME). Assuming an average static ground-water level at El. +26, the ground-water level must be dropped a total of 68 feet. As shown on the stratigraphic cross sections, figure 3, the DME will extend through the units of RD and BC, and will bottom in the MS and Bonney Rock intrusive. Downstream dewatering must address dewatering of the RD, MS, and PSA aquifers. Cornforth (1986) estimated the pumping requirements for the three aquifers at 20,000 gpm for the RD aquifer, 3,500 gpm for the MS aquifer, and 30,000 gpm for the PSA aquifer, for a total dewatering requirement of 53,500 gpm in the downstream area.

Downstream dewatering will be accomplished by four deep, large-diameter wells, eight shallow wells, and a system of well points. Although not included in the dewatering design, fish hatchery wells are expected to contribute to PSA aquifer dewatering while fulfilling hatchery water requirements. The lock excavation contractor will have to operate the downstream well points, plus the shallow and deep wells as necessary to maintain the potentiometric level of the PSA aquifer between 5 and 10 feet below the excavation grade. This level must be held to maintain a dry excavation and to prevent the formation of quicksand in the excavation area. The locations of deep and shallow downstream wells are shown on figure 1. Shallow downstream wells will be used to dewater the MS and RD aquifers during and after overburden excavation. Deep downstream wells will be used to lower the potentiometric level of the PSA aquifer and provide supplemental water for the fish hatchery when necessary.

While supplying water for the fish hatchery needs, potentiometric levels may drop more than 10 feet below the excavation grade. The excavation contractor will be responsible for continuous ground-water monitoring and for keeping the Navigation Lock Resident Engineer's Office updated with ground-water levels to prevent conflicts in water user demands. Weekly coordination meetings will be held with the Resident Engineer's Office and fish hatchery representatives to ensure the successful operation of the downstream dewatering system without unplanned or unintentional interruption of the hatchery's water supply. Additional meetings will be held as necessary.

#### WATER QUALITY IMPACTS DUE TO DEWATERING

The proximity of the navigation lock construction to the new BFH well field may have some short-term effects on the quantity and quality of the water supply. The increased water withdrawal caused by the dewatering may have some effects on the limited water supply capability of the PSA.

Temperature impacts to the PSA aquifer may result from two different sources: the decrease in flow path length caused by the excavation and the increased head gradient across the BC aquitard, causing additional leakage and increased thermal conductivity.

Sagstad, et al. (1987), calculated a horizontal short-flow-path temperature impact from Columbia River water to the PSA aquifer. The conclusion of that analysis was that at a temperature of 60°F, the Columbia River could cause ground-water temperatures in the water supply to rise above 53°F after 3 months. An analysis of temperature and drawdown data obtained during early stages of the dewatering will be necessary to assess the impact of possible increased direct river recharge to the PSA aquifer.

An increase in head gradient is important because the shallower aquifers within the alluvial sequence experience significant recharge from the river. As a result, they have experienced larger fluctuations in ground-water temperatures than does the PSA, and the warmer waters can be transmitted to the PSA at a higher flow rate because of the increased leakage. Shallow wells that tap aquifers within the MS show temperatures as high as 70°F.

In addition to potential water quantity and temperature problems, excavation of overburden in the approach channel and the downstream excavation will expose the BC and MS, increasing the possibility of near-surface contamination of the ground water within these units.

The possibility of thermal pollution and cross contamination of aquifers during dewatering will be increased during periods of the greatest drawdown. Thermal and contaminant effects will not be uniform throughout the aquifer. At present, the major cation and anion concentrations suggest that the PSA aquifer ground water is older or more mature in the vicinity of wells to the north and east. This conclusion is demonstrated by higher sulfate and chloride and lower dissolved oxygen concentrations in wells A-2, C, D, H-3, H-4, and H-5 as compared with well H-1. This fact suggests that well H-1 is in the vicinity of a more direct recharge source from either the Columbia River or the shallow ground-water aquifer. This assumption is further supported by temperature trends noted during the 1987 monitoring period. It must be emphasized, however, that this is a discernible but not conclusive trend due to the limited quantity of data. Long-term thermal effects to the PSA aquifer could be caused by a direct, undetected breach of the BC aquitard.

#### DEVELOPMENT OF A CONSTRUCTION, DEWATERING, AND FISH HATCHERY WATER USE SCHEDULE

Hatchery water supply requirements range from a minimum of 8,750 gpm during summer months, to a maximum of 17,500 gpm supply during fall, winter, and spring months. Water supply is variable in the PSA, however, and depends on factors such as Columbia River tailwater elevations and water temperature. The projected average, minimum, and maximum hatchery water requirements during the period of lock construction have been developed based on past and expected water usage.

Figure 4 graphically depicts the Portland District ground-water management plan for average conditions. Plans based on minimum and maximum water supply have also been developed but are not included. The lower half of figure 4 provides a graphical summary of the relationship and effect of fish hatchery water supply need, and excavation dewatering on the PSA aquifer during the lock construction period. The DME grade profile shows the excavation being lowered in two phases, with the deepest portion of the excavation scheduled for the winter 1989-90. As previously discussed, the deep excavation is scheduled to coincide with the months that the PSA aquifer and Columbia River temperatures are closest, thereby minimizing temperature changes in the PSA aquifer during a period of potentially increased river recharge. The dashed line immediately below the DME grade contour (figure 4) indicates the maximum allowable ground-water elevation as the excavation progresses.

The tailrace elevation profile (USACOE, 1987a) is projected across the excavation profile. Piezometric data (USACOE, 1987a) indicate that unpumped potentiometric levels in the PSA aquifer closely track tailrace elevations. Shaded areas below the tailrace/PSA aquifer level profile, as defined on the figure legends, indicate potentiometric drawdown in the PSA aquifer resulting from aquifer pumping for fish hatchery water supply and excavation dewatering requirements.

Wavy dashed lines below the PSA aquifer drawdown patterns show estimated water levels in the hatchery wells during pumping. The well levels reflect the effects of the hatchery water demands, as well as concurrent pumping of deep dewatering wells for excavation dewatering requirements. Near the bottom of the plate, minimum allowable water levels in the hatchery wells during pumping are shown for the existing and new hatchery wells. These levels are located 20 feet above the top of the pump bowls in the existing hatchery wells and 20 feet above the estimated top of pump bowl assemblies for the new hatchery wells. To assure the hatchery wells have the priority on available water, dewatering wells will be shut down when water levels fall below the minimum pumping levels.

Estimates of PSA aquifer drawdown, hatchery well drawdown, and lock excavation dewatering requirements are based on average potentiometric drawdowns that occurred in PSA piezometers and existing hatchery wells during hatchery well pump tests conducted in 1974 (Cornforth, 1986). Hatchery well discharge was divided by average drawdown to obtain the approximate values of 450 gpm per foot drawdown in the PSA aquifer: 400 gpm per foot drawdown in existing hatchery wells H-3, H-4, and H-5; and 225 gpm per foot drawdown in existing hatchery wells H-1 and H-2. An average rate of 300 gpm per foot drawdown is assumed for the new hatchery wells, which is about the average of the drawdown rates in the five existing hatchery wells.

Based on the above, the effects of lock construction dewatering on the PSA aquifer were analyzed for various tailrace elevations and fish hatchery water supply requirements. The results of these studies are shown on figure 4, which assumes average excavation dewatering requirements that result from conditions of average hatchery water supply requirements and average tailrace elevations. The primary purpose of these analyses is to identify the times that especially close coordination between fish hatchery water supply and dewatering activities will be necessary. The drawdown curves are intended for planning and coordination purposes only. Actual water level drawdown and excavation dewatering requirements are likely to vary from estimated values. To illustrate how the information presented on figure 4 may be used, water supply and dewatering requirements are evaluated on two dates: November 1, 1988 and November 1, 1989.

Figure 4 indicates that on November 1, 1988, under average conditions, the hatchery water requirements are 17,500 gpm and the tailrace elevation, or PSA aquifer potentiometric surface, is at El. +13. The DME grade will be at El. +10, with the maximum potentiometric elevation of the PSA aquifer required at +5 feet for dewatering. In response to the fish hatchery water demand, the PSA aquifer is drawn down 38 feet to El. -25. The water supply requirement for the fish hatchery has drawn the potentiometric surface of the PSA aquifer well below the required excavation dewatering elevation, which indicates that additional dewatering will not be required by deep dewatering wells. During this time the water levels inside wells H-1 and H-2 will remain above their safe operating levels. Consequently, no water shortage would be anticipated at the fish hatchery.

On November 1, 1989, under average conditions, the hatchery water requirements and the PSA aquifer potentiometric surface are the same as for November 1, 1988. The DME grade is now at El. -37, however, with the maximum potentiometric elevation of the PSA aquifer required for dewatering.

at -42 feet. Drawdown in the aquifer water supplied to the hatchery will be equivalent to that on November 1, 1988, lowering the potentiometric surface of the PSA aquifer to El. -25. An additional 17 feet of drawdown will be required in deep dewatering wells to bring the PSA aquifer to the required elevation of -42 feet for excavation dewatering. The rate of additional dewatering may be estimated by multiplying the 30 feet of required drawdown by the assumed aquifer drawdown response rate of 450 gpm/feet, for a 7,650 gpm dewatering requirement.

#### EMERGENCY ALTERNATE WATER SUPPLY FOR THE BFH

During conditions of minimum tailrace elevation and maximum hatchery water supply needs, it is possible that total water requirements for the fish hatchery may not be met. Under these conditions, or if the PSA aquifer experiences thermal or contaminant pollution, existing hatchery wells H-1, H-2, and H-3 may be shut down in the fall of 1988 due to low aquifer levels. Although dewatering wells may replace some of the lost hatchery water supply, water supply from the PSA aquifer to the hatchery may fall short of the desired levels during this period. In situations of insufficient water to meet all demands, pumping rates and water priorities will be made by the Resident Engineer in coordination with the fish hatchery and the Portland District Office, and that information will be passed on to the Contractor.

In the event of inadequate water supply from the PSA aquifer, thermal degradation, or contamination of the aquifer, an alternative water supply may be necessary. Three possible sources have been identified, including Tanner Creek, the RD aquifer, and the Tanner Creek and Tooth Rock landslide aquifers. Limited water quality data are available for these alternative sources.

Tanner Creek was used as the primary water supply for the hatchery prior to installation of the ground-water supply system in the early 1970's. Apparently, during the colder winter months, Tanner Creek occasionally froze, which required supplying the hatchery with Columbia River water via the Mitchell Creek Slough.

The RD aquifer is assumed to be recharged from the Columbia River, Tanner Creek, and the upland area to the south, possibly including the Tanner Creek landslide aquifer. The variety of water sources apparently produces a variability in water quality, reflected in temperature data and chemical data for the "D" wells which are screened in this shallow aquifer. Water from the Columbia River should be considered unacceptable as a recharge source for the aquifer, however, certain sections of the aquifer, probably near the mouth of Tanner Creek, appear to have acceptable water quality. Pump testing would be necessary to determine if this area could sustain a high production rate without intrusion of Columbia River water.

The Tooth Rock and Tanner Creek landslide aquifers are located south and east of the hatchery site. The annual water temperature variation from these two aquifers is between 48° and 54°F, which would be acceptable for hatchery operations most of the year. Available water quality analyses also suggest compliance with hatchery requirements. Unfortunately, the productivity of both of these aquifers is limited. If further development

techniques could produce acceptable yields, these aquifers might be a suitable alternative water source. An additional contingency would be to install filters, temperature controls, and other equipment to regulate the fish hatchery water supply. This equipment would allow use of most nearby water sources, however, this approach was not considered as a practical alternative due to the high capital and maintenance costs.

#### CONCLUSIONS AND FURTHER STUDY

The Portland District and ground-water consultants have developed a plan to maintain the continued supply of water to the BFH while achieving the goals of the dewatering program. The plan has been based on studies of the geology and ground-water hydrology of the PSA aquifer to determine the sustained water yield of the aquifer under various potential conditions. Provisions have been made in the plan for an emergency water supply in the event of contamination, but careful construction and inspection practices during the Bonneville Navigation Lock construction will minimize those risks.

Future studies will analyze the existing data and develop a three dimensional heat and contaminant model of the area. The model will help in planning future activities during construction and may eventually be used in an operational mode.

#### REFERENCES

- Cornforth Consultants, Inc., 1986. Conceptual Dewatering Considerations, Bonneville Navigation Lock Site, Columbia River, Oregon.
- Cornforth Consultants, Inc., 1987. Fish Hatchery Water Supply, Bonneville Navigation Lock Site, Columbia River, Oregon.
- Portland District, Corps of Engineers, 1987a. Detailed Scope of Work for Bonneville Navigation Lock, Design Memorandum No. 9, Fish Hatchery Water Supply System Geotechnical Sections.
- Portland District, Corps of Engineers, 1987b. Bonneville Navigation Lock Plans and Specifications, Amendment 4.
- Sagstad, S.R., Farooqui, S. and Scofield, D., 1987. Dewatering and Water Supply Considerations: New Bonneville Navigation Lock. In: Proceedings of the NWWA Focus Conference on Northwestern Ground Water Issues, pp. 73-96.
- U.S. Environmental Protection Agency, 1986. RCRA Ground-Water Monitoring and Enforcement Guidance Document. U.S. Government Printing Office: 1986 O-172-437, pp. 117-120.

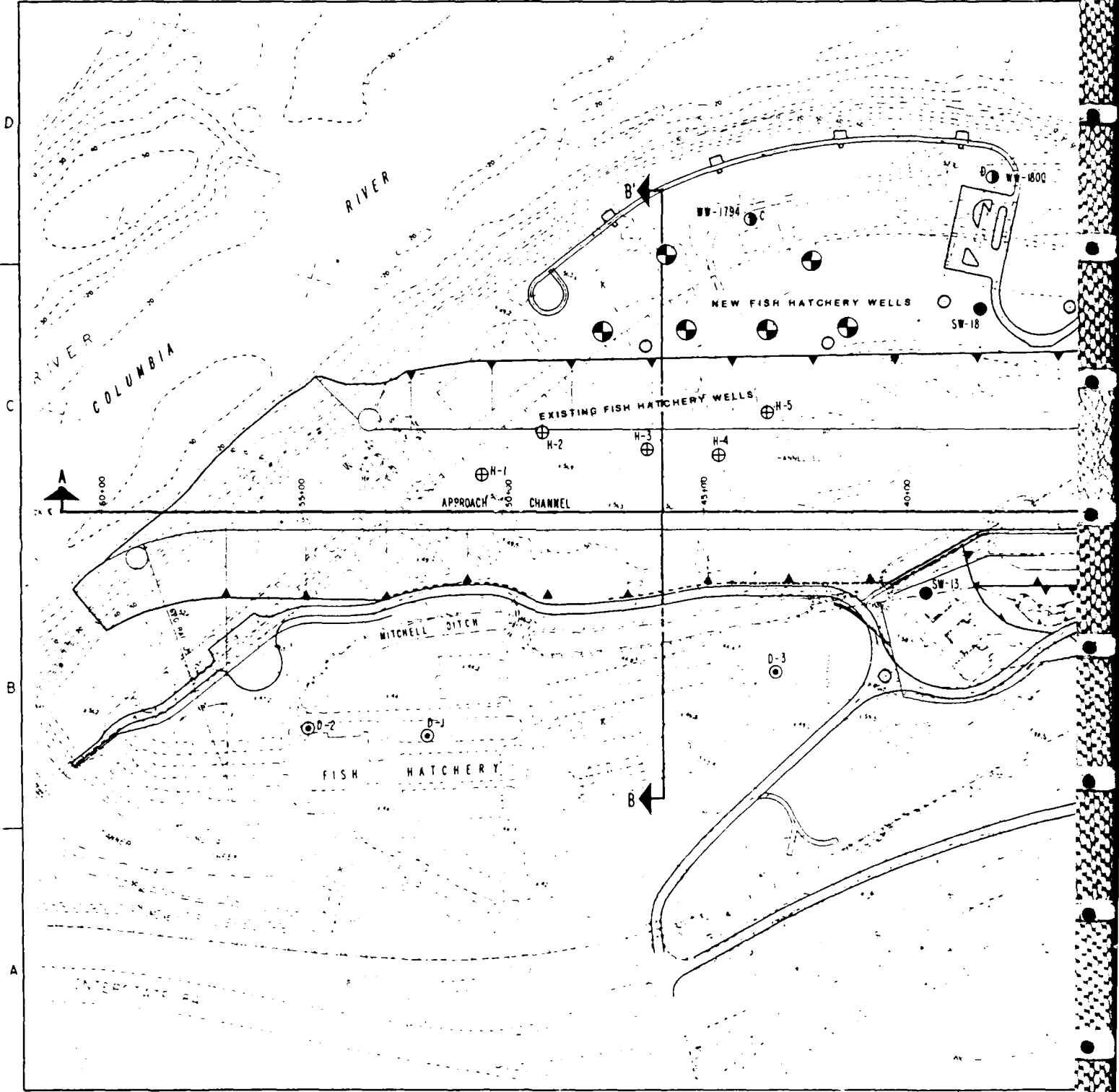

1083



4

3

2

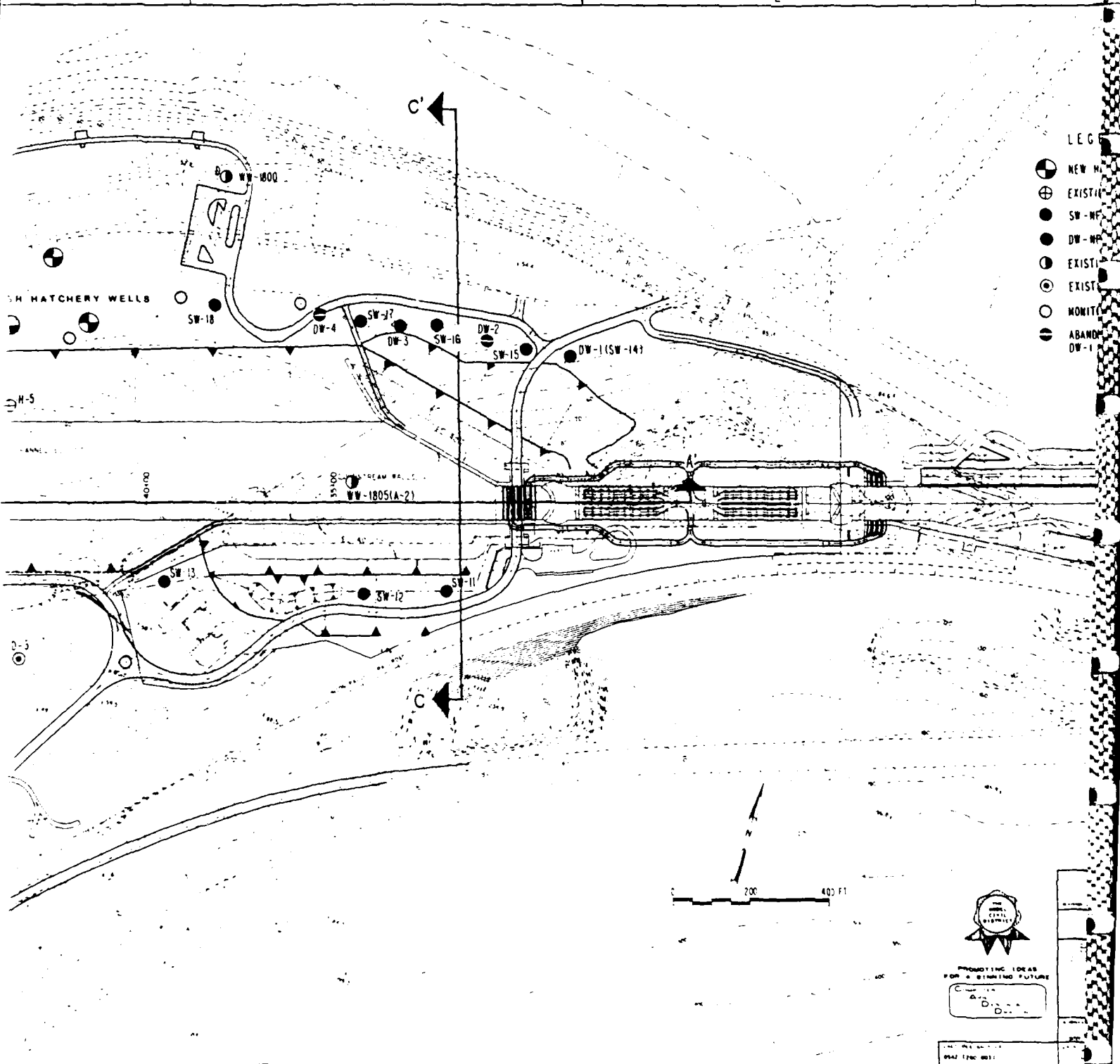

210

2

1

U.S. ARMY

LEGEND

- ⊕ NEW HATCHERY WELLS
- ⊕ EXISTING HATCHERY WELLS
- SW-NEW SHALLOW DEWATERING WELLS
- DW-NEW DEEP DEWATERING WELLS
- ⊙ EXISTING DEEP WELL (1805(A-2),C,D)
- ⊙ EXISTING SHALLOW WELL (D-1,D-2,D-3)
- MONITORING PIEZOMETER
- ⊖ ABANDONED DEEP DEWATERING WELLS  
DW-1, DW-2, DW-4

D

C

B

Figure 1:

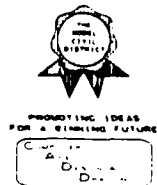

U.S. ARMY ENGINEER DISTRICT, PORTLAND			
BONNEVILLE NAVIGATION LOCK			
EXISTING FACILITIES/		NEW NAVIGATION LOCK LOCATION	
DATE	BY	APP'D	CHK'D
29 FEB 88			DHL
SCALE (1:50,000)	DATE	PROJECT	NO.
	29 FEB 88	BD-20-90/1	1

A

303

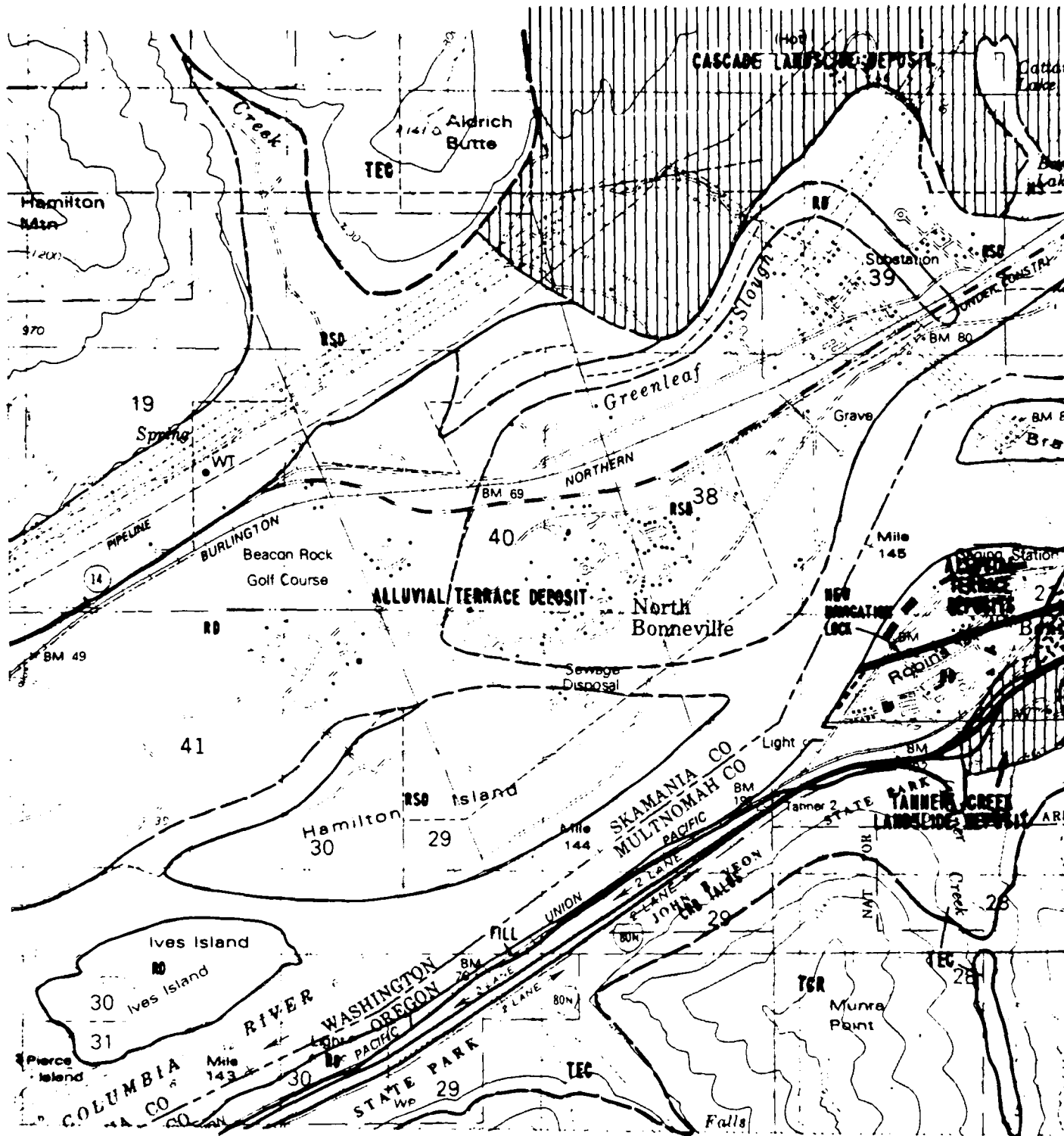

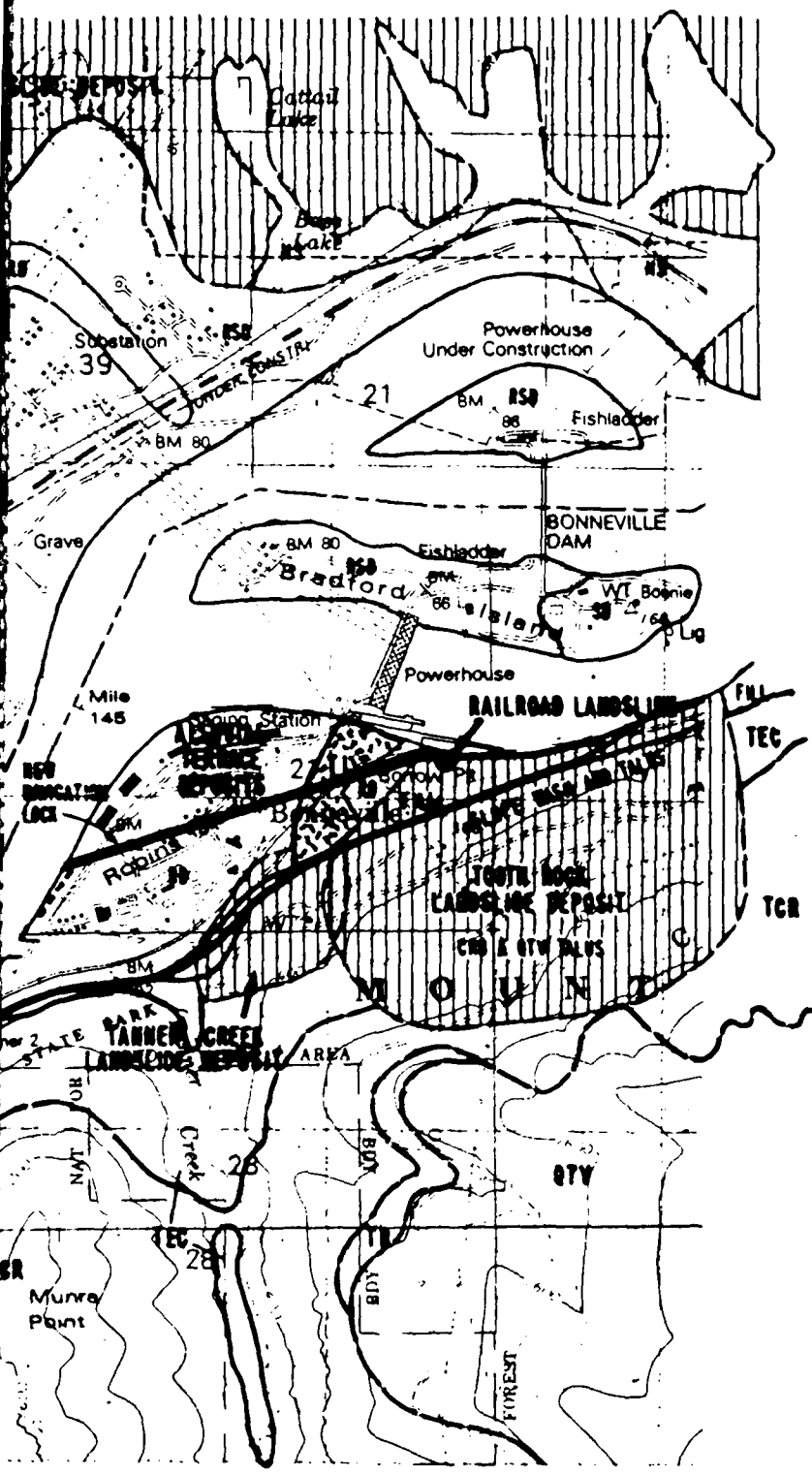

SOURCE: ADAPTED FROM U.S. ARMY CORPS OF ENGINEERS, 1974

**SOIL UNITS**

- RD** Recent Columbia River Alluvium. Includes stratified sand, gravel, cobbles, and boulders deposits with occasional silt and clay layers. Coarse fraction typically rounded consisting of Columbia River basalt and lesser amounts of olivine basalt. Also contains metamorphic and granitic "exotics" and white mica derived from the Idaho batholith area. RD unit is generally present below EL 100 ft. However, a silty, gravelly sand deposit with exotics is present on the EL 400 bench west of Tanner Creek. This deposit may be related to the Missoula Flood.
- RSD** Reworked Slide Debris. Forms unconsolidated "outwash" deposits down stream of the slide areas. Incorporates varying amounts of both alluvial and slide derived- materials.
- Talus** Angular rock fragments of predominantly Columbia River basalt with locally minor olivine basalt forms deposits of GP or GM at the base of steep TCR cliffs.
- Slope Wash and Talus** Brown to red-brown silty sand to sandy silt deposits. Unstratified, forms a thin cover over much of the area below the talus deposits. May contain varying amounts of angular rock fragments.
- MS** Unconsolidated fine to medium sand deposits with white mica. Forms unstratified deposits in depressions and channels in the Cascade landslide. MS unit is present in lesser amounts in the Tooth Rock landslide area.
- SD** Slide Debris. Unconsolidated slide materials ranging to 10 ft in size.

**LANDSLIDE DEPOSITS**

- Tanner Creek Landslide.** Last movement in 1960 during construction of I-84.
- Cascade Landslide.** No known recent activity. Wood fragments from slide dated at 750 years.
- Tooth Rock Landslide.** No known recent activity. Slide estimated to be 10,000 to 20,000 years old. Local unstable materials at toe failed in 1936 during construction of Bonneville Dam.

**BEDROCK UNITS**

- QTC** Boring Formation. Consists of olivine basalt lava flows, flow breccias, and related clastic rocks.
- TR** Rhododendron Formation. Consists of horizontal beds of volcanic conglomerate, tuff breccia, tuff, ash, and stratified mica sand.
- TCR** Columbia River Basalt Group. Consists of horizontal basalt lava flows and flow breccias with local soil interbeds between flows.
- TEC** Eagle Creek Formation. Consists of volcanic conglomerate and volcanic sandstones poorly bedded with local siltstone and sandstone interbeds. Maximum inplace dip is 15 degrees.
- TI** Bonney Rock Intrusive. Consists of columnar-jointed, fine- to medium-grained diabase. May be same age as olivine basalt.

Figure 2.

U.S. ARMY ENGINEER DISTRICT, PORTLAND			
BONNEVILLE NAVIGATION LOCK			
COLUMBIA RIVER OREGON - WASHINGTON NAVIGATION LOCK			
SURFACE GEOLOGY MAP			
SUBMITTED BY:	DESIGNED:	DRAWN:	CHECKED:
STEVEN L. STOCKTON, P.E.			DHJ
DATE:	PROJECT:		
29 FEB. 88	BD-20-90/2		

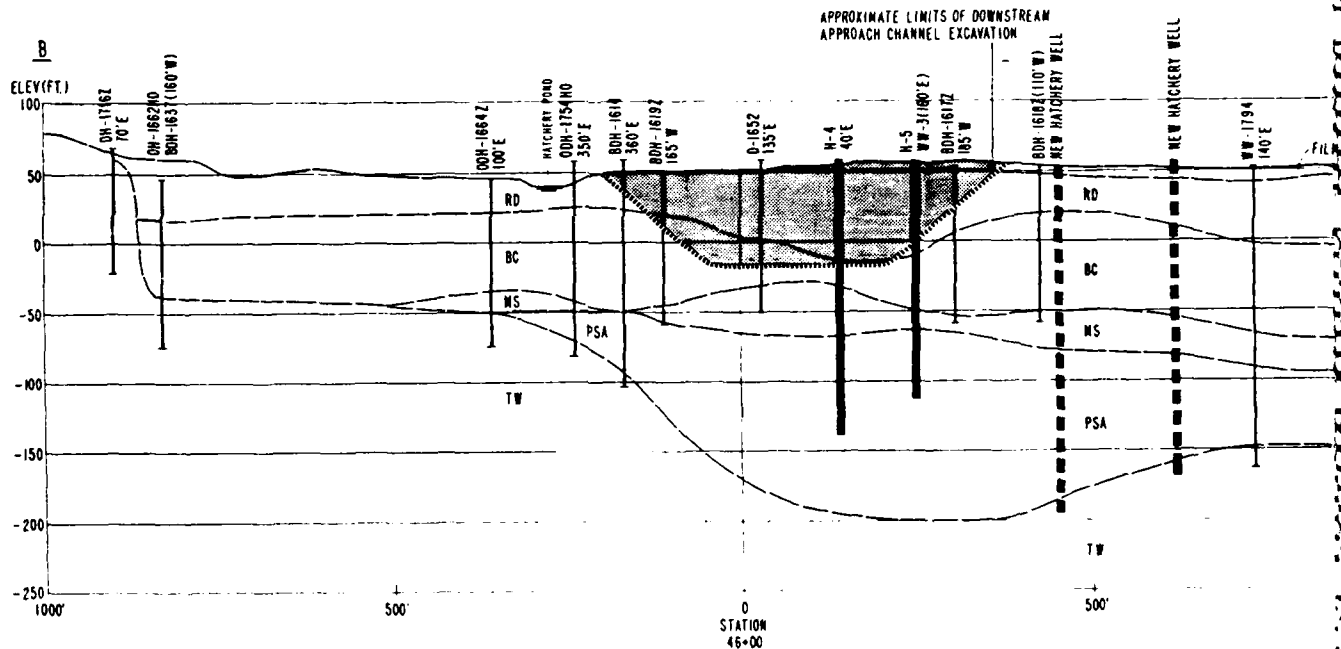
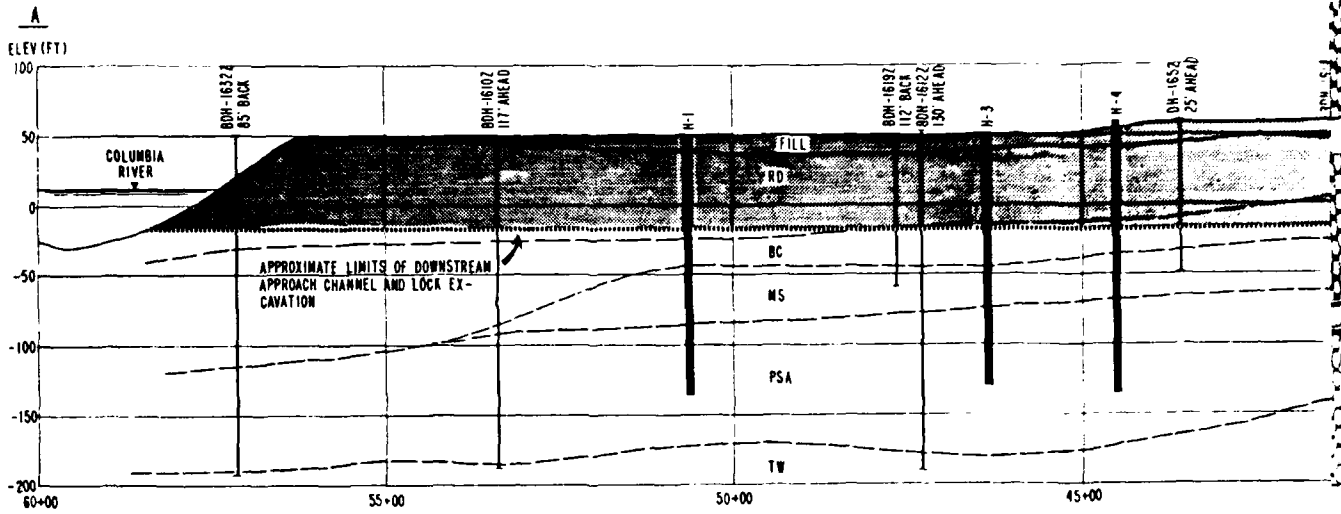

SECTION B-B'

HORIZONTAL SCALE  
0 100 200 FT

VERTICAL SCALE  
0 50 100 FT

SEE PLATE I FOR LOCATIONS OF PROFILES

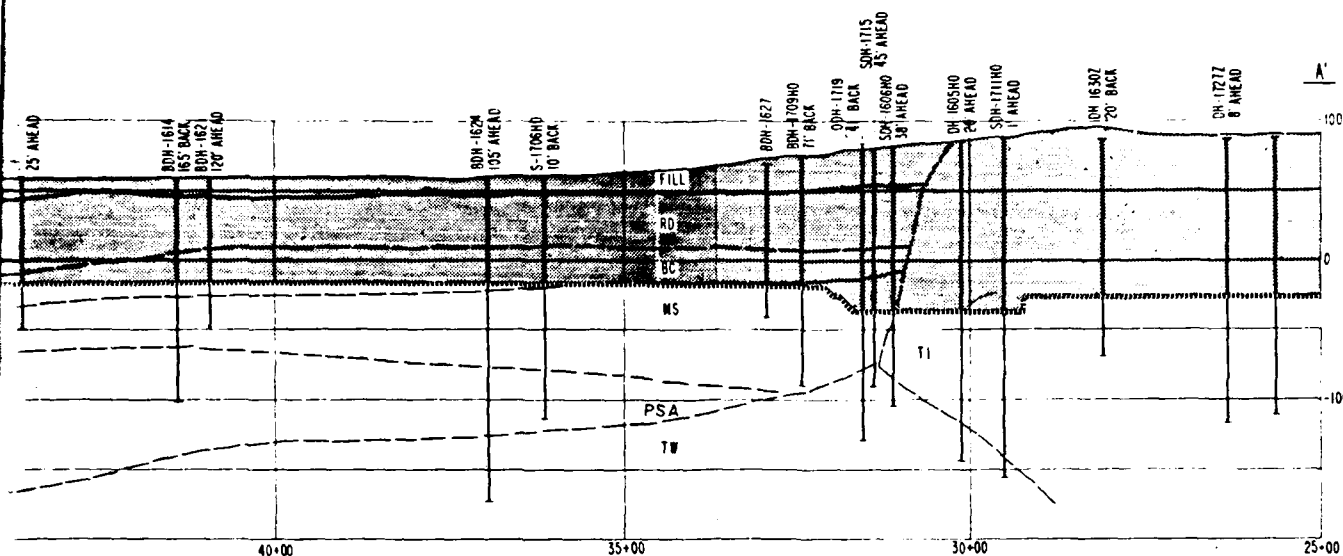

SECTION A-A'

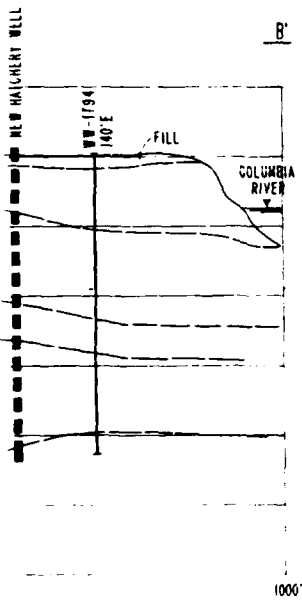

LEGEND

- RD RECENT RIVER DEPOSITS
- BC BLUE CLAY
- MS MICA SAND
- PSA PRE-SLIDE ALLUVIUM
- TW WEIGLE FORMATION

NOTE: THE SUBSURFACE PROFILE WAS DEVELOPED BY INTERPOLATING BETWEEN THE EXPLORATIONS SHOWN. DASHED LINES SEPARATING STRATIGRAPHIC UNITS INDICATE APPROXIMATE OR GENERALIZED DIVISIONS BETWEEN GRADATIONAL OR INTERFINGING UNITS. IT IS ACKNOWLEDGED THAT OTHER INTERPRETATIONS ARE POSSIBLE. THE DISCUSSION IN SECTION IV IS NECESSARY FOR A PROPER UNDERSTANDING OF THE SUBSURFACE CONDITIONS SHOWN ON THIS PLATE



Figure 3.

REVISION	DATE	DESCRIPTION
U. S. ARMY ENGINEER DISTRICT, PORTLAND		
BONNEVILLE NAVIGATION LOCK COLUMBIA RIVER OREGON - WASHINGTON		
GEOLOGIC CROSS-SECTIONS A-A' AND B-B' WITH LOCK EXCAVATION AND WELL LOCATIONS		
DATE	BY	PLT
29 FEB 88		
BD-20-90/3		3

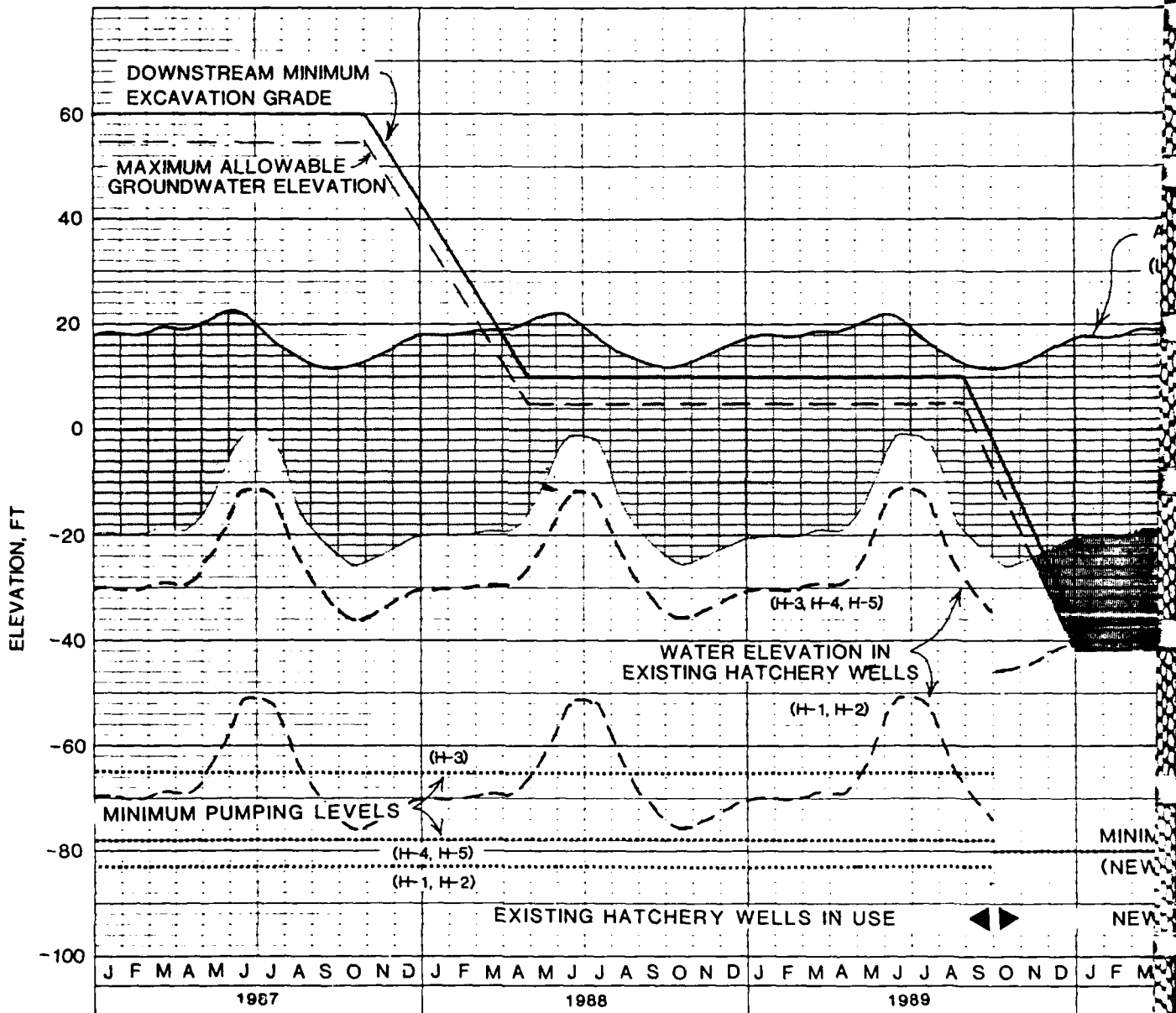
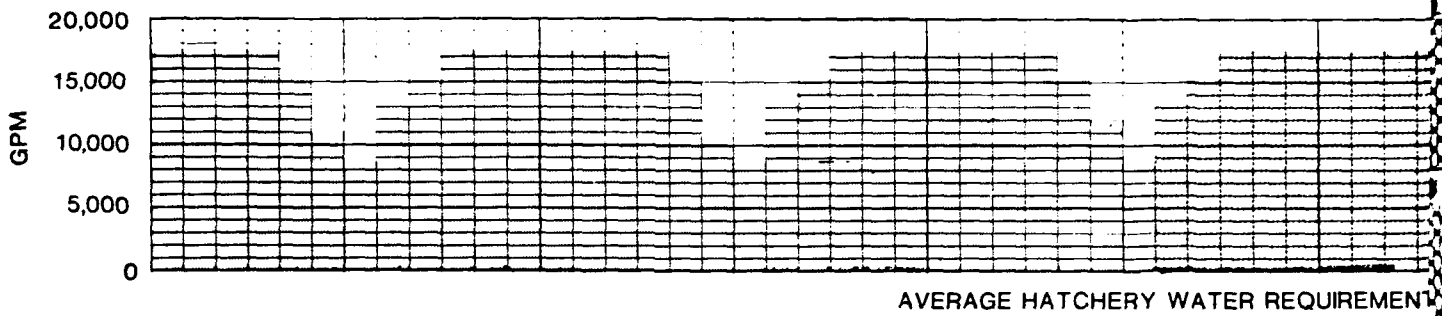
202



LEGEND

-  Drawdown in PSA aquifer resulting from average fish hatchery water supply requirements
-  Drawdown required in PSA aquifer to lower groundwater level to 5 ft below downstream minimum excavation grade
-  Minimum pumping levels provide 20 ft of water above the pump intake

REQUIREMENTS

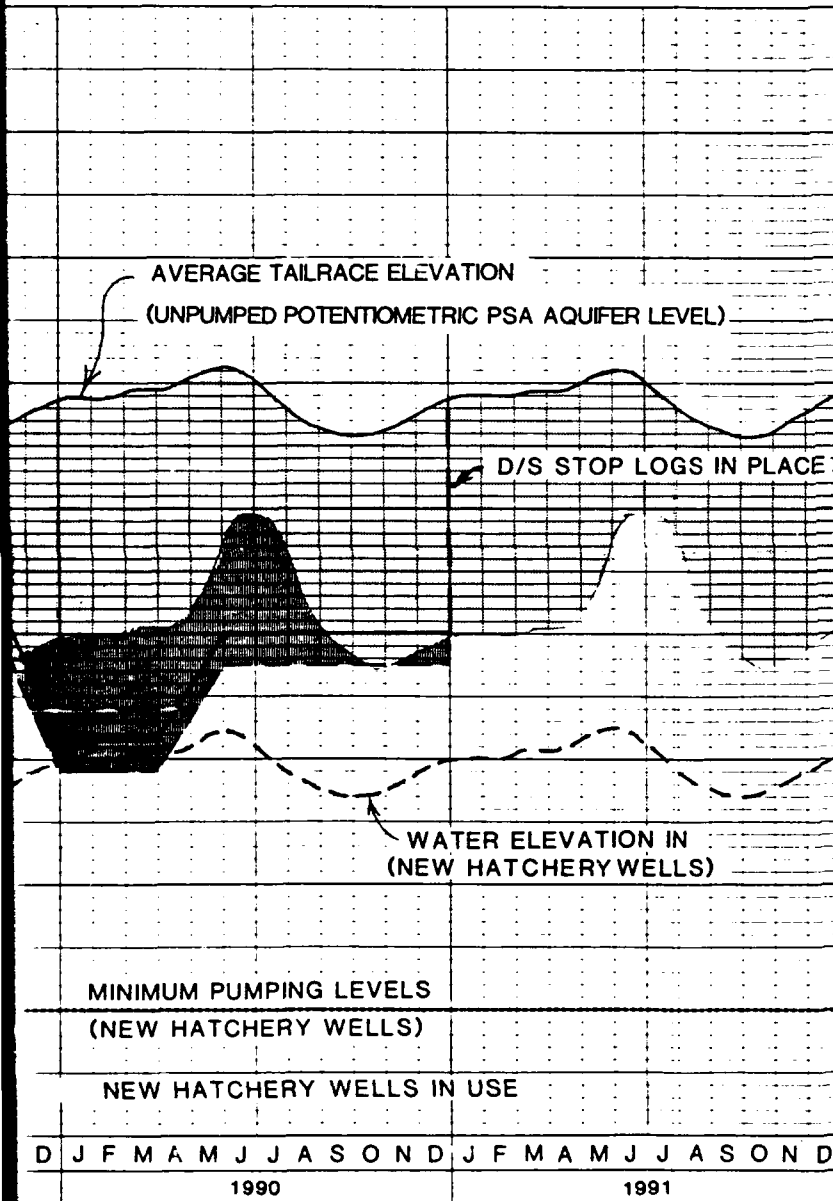

Figure 4.

U. S. ARMY ENGINEER DISTRICT, PORTLAND			
BONNEVILLE NAVIGATION LOCK COLUMBIA RIVER OREGON - WASHINGTON			
EXCAVATION AND WATER PROFILES (AVERAGE DEWATERING REQUIREMENTS)			
<i>[Signature]</i>		M KELLY	DMS
29 FEB 88		BD-20-90/7	7



SECTION II  
COASTAL AND ESTUARINE CASE STUDIES

# SEDIMENT-WATER INTERACTIONS AND CONTAMINANT PROCESSES

by

Douglas Gunnison and James M. Brannon\*

## Introduction

The presence of contaminants in Corps of Engineers (CE) water resources projects has caused problems in the past and resulted in increased costs associated with project operation. Increasing public awareness of environmental issues, such as the potential for carcinogen formation *in situ*, acid rain, acid mine drainage, the presence of pesticides, etc., also increase the likelihood that the CE will experience more problems with contaminants in reservoirs and their releases. In addition, the occurrence of contaminants in projects has resulted in increased operational costs and/or the short or long-term loss of certain project benefits. Examples include closing of reservoir fisheries due to the presence of pesticides in fish tissue, curtailment of body contact recreation because of elevated fecal coliform counts, and increased treatment costs for use of project waters as a water supply.

In addition to difficulties arising from regulatory requirements, some problems with contaminants in water resources projects are directly attributable to the biological and chemical properties of the contaminants. Many contaminants exhibit toxicity at low concentrations to fish and wildlife. Some compounds, particularly some of the lipophilic organochlorines, are biologically accumulated from the sediment or water column and can then undergo biomagnification in food chains. Other compounds may exhibit low toxicity or mobility in the form in which they enter a project. However, such substances may be microbiologically transformed into more toxic/more mobile forms. A prime example is elemental mercury which can be microbiologically transformed to the more mobile, more toxic dimethylmercury form (see discussions by Thayer 1973). In other cases, there may be a series of complex interactions between contaminants. Acid rain, for example, may leach metals from soil resulting in acid water and metals entering project waters.

Thus, contaminants cause operations and maintenance problems for CE water resources projects in several ways. These include curtailment of project benefits, impairment of project purposes, and conflicts with state or Federal water quality standards. Interactions between contaminants and other components of the aquatic environment, such as suspended and bottom sediments, within the context of project operation are unknown. Evaluation of the impacts of contaminated sediment loads on project water quality is impossible. Therefore, contaminant problems in reservoirs and their releases are difficult to manage or control. Such difficulties have been experienced by CE Districts. For example, a district submitted an

\* Research Microbiologist and Research Chemist, Environmental Laboratory, U.S. Army Engineer Waterways Experiment Station

"R and D Target" to the CE Committee on Water Quality Work Group. The target called for development of analytical and forecasting methodologies for evaluating impacts of contaminated sediment loads. The following sections provide background information on the reservoir contaminant problem area and describe an ongoing Water Quality Research Program Work Unit that is addressing the district R and D target.

### Reservoir Contaminants

For purposes of this paper, the term "contaminant" is defined as any chemical or microbiological substance which, when present in excessive levels, interferes with the use of a project. In practical terms, contaminants occur as one of the following classes of materials: acidity, heavy metals and sulfides, organic substances [organochlorine compounds: pesticides, herbicides, polychlorinated biphenyls (PCBs), polynuclear aromatic hydrocarbons (PAHs), plus petroleum and petroleum products], pathogenic and nonpathogenic microorganisms, and turbidity-producing substances.

We have assembled a partial listing of general contaminant-related problems (Table 1) based on the information obtained to date from examination of recent Annual Division Water Quality Reports, our own experience with problems in various sections of the country, the scientific literature, and conversations with CE District representatives. This list is far from complete and presents contaminant-related conditions, rather than specific contaminants. For example, acidity resulting from acid mine drainage and acid rain is a condition (see Lundgren et al. 1972, Mills and Herlihy 1985). There are normally certain contaminants (metals) associated with acidity; however, the specific suite of metallic contaminants present may vary from project to project. Agricultural and industrial pollution are also conditions, as are the development of anoxic hypolimnions, or the contamination of projects with high levels of dissolved solids or salinity. Thus, individual chemical compounds involved in contaminant problems are often quite site specific, although contaminant-related conditions often exhibit common features.

From our examination of information from the Districts to date, the principal contaminants of concern appear to be heavy metals, especially arsenic, iron, manganese, and mercury, and organic substances, especially pesticides, herbicides, and to a lesser extent, PCBs, petroleum and petroleum products. It is important to point out that refractory organic compounds (substances requiring prolonged periods for microbial degradation) are often the organic compounds most likely to cause problems in the environment. Our list of pertinent contaminants will be revised as additional information is obtained.

Many problems with contaminants in reservoirs are a consequence of the interactions between contaminants and sediment. Many contaminants have a high affinity for sediments and are rapidly sorbed to them. Many highly insoluble contaminants are transported with sediments, either being drawn through or retained in the projects according to the disposition of the sediments. Contaminants become associated with sediment components, generally within the smaller sediment particles (clay size fraction). The settling of specific sediment fractions to which contaminants are bound can determine the location of the contaminant in the project.

A number of sediment-water interactions exert important influences on contaminants. Factors controlling these interactions include sediment composition and concentration, adsorption/desorption processes, and microbial transformation kinetics. Sediment properties having a dominant influence on sediment-water interactions include oxidation-reduction potential, pH, alkalinity, organic carbon, iron, aluminum and manganese oxides, and sediment surface area. The nature and concentration of the contaminant itself are also important, particularly with regard to the affinity of the contaminant for sediment, water, or aquatic biota, and the behavior of the contaminant under varying environmental conditions.

The composition and concentration of suspended sediments determine the sediment surface area available to interact with contaminants. Suspended sediment adsorption-desorption processes determine the mass of contaminants released or adsorbed by sediment particles. Bottom sediment has only a limited surface area exposed to the water column. Interactions between water and sediment below the surface of bottom sediments depend upon slow diffusion processes to supply or remove contaminants.

Microbial processes are important because they can alter the structure of contaminants, degrade the contaminant to non-toxic forms, or increase the toxicity of the contaminant. Five microbial processes are particularly important to contaminant interactions with the environment. Transformations include addition reactions, molecular conjugation, and complex formation; each involves conversion of substrates into more complex forms (Alexander 1977). These reactions may substantially alter the mobility of the contaminant, usually through increases in solubility. Also included in this category are activation reactions involving conversion of nontoxic substrates into toxic forms. Microbial biodegradation reactions involve conversion of substrates from complex forms into simpler products (Alexander 1972, 1977); products are sometimes more mobile than the original substrate (Alexander 1977). Microbial uptake and bioconcentration mechanisms are processes involved in cellular accumulation of contaminants within the microorganisms themselves.

Sediment properties influencing sediment-water interactions include oxidation-reduction (redox) potential, pH, alkalinity, total organic carbon (TOC), and contents of iron, aluminum, and manganese oxides.

Redox potential is particularly important for the mobilization of metallic contaminants. Microbial consumption of dissolved oxygen followed by reduction and/or methylation of metallic contaminants often transform insoluble forms of these metals into reduced and/or methylated forms that are soluble. In like manner, the presence of oxidizing conditions results in the chemical and microbial oxidation of metallic contaminants, often forming insoluble oxides that precipitate. Redox conditions may also influence the solubility of certain organic contaminants; however, this area is just beginning to receive attention and is, therefore, not well-defined.

Adsorption-desorption of contaminants is strongly influenced by the pH of the water column and interstitial water. The pH affects the formation of ionized soluble or unionized insoluble species of many contaminants and also influences the adsorption-desorption properties of the sediment surface.

Alkalinity, the capacity of water to accept protons, is usually imparted to water by bicarbonate, carbonate, and hydroxide components of a natural or treated water supply. Alkalinity is important because it contributes to the buffering capacity of water - i.e., the ability of water to resist a change in pH in the face of such phenomena as acid mine drainage and acid rain. The higher the alkalinity, the more resistant the water is to changes induced by acidity. In addition, certain components of alkalinity - carbonates and hydroxides - are capable of interacting with some metallic contaminants to form insoluble precipitates. This strongly influences the tendency of the contaminant to be removed from solution and become part of the sediment.

Organic carbon (OC) can affect mobilization and binding of contaminants, and soluble OC can transport associated contaminants. Particulate substances can do likewise if resuspended. In contrast, sedimentary organic carbon may bind contaminants and hold them in the sediments.

Iron, aluminum, and manganese when present in high levels can be contaminants. In addition, their oxides, by virtue of their ability to serve as sorptive surfaces, can exert significant influences over contaminant mobility. In addition, each of these substances is a natural component of soils and sediments. Reduction of iron and manganese oxides produces soluble, mobile forms of these metals and simultaneously releases any other adsorbed metals. Further, oxidation of iron and manganese oxides results in formation of oxyhydroxides; these are highly sorptive materials which can sorb contaminants.

#### The Sediment-Water Interactions and Contaminant Processes Work Unit

This work was undertaken to address the concerns raised in the "R and D Target" described above. The objective of this work is to develop methods to quantify contaminant problems. This information will also be used as input in the development of project management and control strategies for contaminants at CE reservoir projects. To achieve this

objective, existing information on abiotic and microbiological processes relating to contaminant interactions with sediment and water will be examined. From this information, which will eventually include state-of-the-art descriptive models and contaminant management and control strategies, methods for determining the impacts of sediment-water interactions on reservoir water quality and contaminant fate will be selected and developed.

At the present time, contaminant problems and contaminants of major importance are being determined for CE reservoir water projects. Several such contaminants and groups of contaminants have been identified through use of the Annual Division Water Quality reports. These findings are being confirmed and further elucidated through other sources of information. One such source is the survey being conducted by Dr. Robert Kennedy as part of the Water Quality Management for Reservoirs and Tailwaters Demonstration sponsored by the Water Operations Technical Support (WOTS) Program. District personnel familiar with contaminant problems in reservoirs are also being contacted to obtain additional details about specific contaminants and individual reservoir projects. The literature on sediment-water interactions and contaminants is also being examined to identify those mechanisms most likely to be operative for major contaminant groups.

The first task is to limit the contaminants investigated to those substances causing major problems in CE reservoirs. Because of cost constraints it will be impossible to examine all known contaminants. Therefore, organic compounds will be selected for study whose behavior is typical of a class of compounds. For example, if PCBs are determined to be a major problem worthy of detailed investigation (not a foregone conclusion at this time), then a few selected congeners from among the 209 congeners that constitute PCBs would be selected for study.

The second task will be to assess the affect of environmental variables including redox potential, pH, alkalinity, and total organic carbon on contaminant adsorption/desorption processes. Contaminant adsorption/desorption kinetic and equilibrium tests will be important for determining the fate of contaminants associated with suspended sediment. As a part of this task, the effect of sediment properties on contaminant adsorption/desorption is being investigated to determine if simplifying assumptions are warranted. For example, it is known that organic carbon associated with sediment particles is responsible for much of the adsorption/desorption behavior of hydrophobic organic compounds. Such interdependence between contaminants and a specific sediment component will allow development of generalizations and predictions for all reservoir sediments, rather than predictive methods restricted to site specific testing.

Once existing information is condensed and synthesized, the experimental design and testing protocol will be finalized, and studies will be conducted with sediments from individual CE reservoir projects. Studies will be geared to provide a detailed understanding of the fate and effects of contaminants in individual reservoirs. Information obtained from these studies will add to the data needed to develop generalizations

and testing procedures and may limit the amount of site specific testing needed by the CE. One result of such studies will be development of testing procedures to determine the impact of sediment-water interactions and microbial degradation on water quality in a CE reservoir.

Results of these studies will be integrated with ongoing mathematical water quality models and other available methods to provide Districts with an improved understanding of the impacts of sediment-water interactions on contaminant problems in reservoirs. In addition, specific testing procedures applicable under the conditions prevalent in CE reservoirs will be developed, and an improved understanding of contaminants in reservoirs will be available for District personnel. These products will be in the form of tools that will allow CE District personnel to quantitatively evaluate contaminant management strategies for reservoirs.

The procedures and models developed in this program will be applied to field investigations. Hopefully, the field studies will take the form of a series of cooperative studies with various CE Districts. Cooperative studies for reservoir projects having serious contaminant problems would develop management options for these projects, while simultaneously field verifying the test procedures developed.

#### ACKNOWLEDGEMENTS

This research was supported by the Water Quality Research Program of the U.S. Army Corps of Engineers. Permission was granted by the Chief of Engineers to publish this information.

#### REFERENCES

Alexander, M., "Microbial Degradation of Pesticides," Proceedings of the U.S.-Japanese Conference on Environmental Toxicology of Pesticides, F. Matsumura, ed., Academic Press, Inc., New York, 1972, pp. 365-383.

Alexander, M., Introduction to Soil Microbiology, John Wiley and Sons, Inc., New York, 1977.

Lundgren, D. G. et al, "The Microbiology of Mine Drainage Pollution," Water Pollution Microbiology, R. Mitchell, ed., Wiley-Interscience, New York, 1972, pp. 69-88.

Mills, A. L. and A. T. Herlihy, "Microbial Ecology and Acidic Pollution of Impoundments," Microbial Processes in Reservoirs, D. Gunnison, ed., Dr. W. Junk, Publishers, The Hague, 1985, pp. 169-189.

Thayer, J. S., "Biological Methylation - Its Nature and Scope," Journal of Chemical Education, Vol. 50, No. 6, 1973, pp. 390-391.

Table 1. Tentative Summary of Contaminant Problems Occurring in Various Regions

Region	Distribution of Problems with Contaminants and the Major Contaminants of Concern in Some Lakes and Reservoir Projects
New England and Middle Atlantic Region as far West as Ohio	Reported problems often tend to be associated with acid mine drainage and acid rain. Contaminants found in association with acidity are primarily metals. Other problems with urbanization and industrial pollution.
Central Midwest	When reported, contaminants often result from agricultural pollution (pesticides and herbicides, cattle wastes) in rural areas, and from urbanization and industrial pollution in urban areas. Beginnings of indication of acidity in some projects.
Southeast	Reported problems often involve production of iron, manganese, and sulfide resulting from microbial reduction processes occurring in warm hypolimnions that become anoxic in summer months. Problems exacerbated by high productivity which fuels reduction processes in many lakes. Other problems involve urbanization and industrial pollution in urban areas.
Southwest	Problems with salinity and high levels of dissolved solids. Other problems involve urbanization and industrial pollution in urban areas.
Northwest	Few problems due to nature of projects (water supply and hydropower projects located in mountains and having little or no anthropocentric activity in headwaters).



# CONTAMINANT MODELING FOR CORPS ACTIVITIES

by

S. L. Bird\*

## INTRODUCTION

The presence of toxic contaminants in the aquatic environment, the increased public concern over effects of these contaminants, and the increased regulatory restrictions on disposal of contaminated materials complicate various USACE activities including dredging, disposal of dredged material, and management of Corps reservoirs. A variety of chemical fate models may be useful to managers when the presence of toxic substances complicate project operations. This paper surveys available computer models, outlines processes incorporated in each, offers guidance for applying these models to Corps activities, and assesses data requirements and complexity of these models.

Two different categories of modeling will be considered in this discussion: (1) simplified screening techniques and (2) high resolution models. Simplified screening techniques require little field data and could be applied with less than one man month worth of effort and could typically be applied within the context of a DOTS or WOTS request. Although these techniques offer limited resolution and typically supply an order of magnitude type analysis, their application can provide guidance in the identification of potential problems, sensitivity of the system to particular parameters, and direction for future data collection efforts. The high resolution models offer more detailed system resolution, require months to years of effort for application, and typically involve substantial field data collection for meaningful model implementation.

## SIMPLIFIED SCREENING MODELS

This discussion of screening tools and simplified techniques includes available methodologies as well as available computer codes. All of these simplified techniques are adaptable to PC's, and many are available as simple FORTRAN, BASIC, or PC spread sheet codes. These simplified techniques can give a rapid preliminary analysis of a system and provide useful insight into the dominant processes controlling system response. Gross impacts of alterations in system loadings due to changes in watershed uses or cessation of pollutant loadings can be rapidly evaluated.

One broad and useful tool available to Corps personnel is a U.S. Environmental Protection Agency procedures manual, "Water Quality Assessment: A Screening Procedure..." (Mills et al., 1985), which offers detailed guidance to performing screening calculations using hand calculator methods. This publication provides brief and clear process descriptions; useful tables of information for specific compounds, processes, and environmental factors; and

---

\*Civil Engineer, USAE Waterways Experiment Station, Environmental Laboratory, Vicksburg, MS.

step by step calculation procedures including sample calculations. A PC version of these procedures was developed by the authors but is not presently released to the public. This manual includes methods for estimating system loadings from runoff, point sources, and ground water as well as computations for transport and transformation of organic compounds and metals in streams, lakes, and estuaries.

Several simplified techniques utilize steady state and/or mixed volume assumptions to model compounds which partition between sediments and the water column. Mixed volume models are most appropriate to determine lake response to pollutant loadings (Chapra and Reckhow, 1983; DiToro et al., 1982). The water column is treated as a single mixed layer interacting with one or multiple sediment layers. Contaminants are modeled as absorbed or dissolved fractions. Equilibrium between particulate bound and dissolved contaminant is assumed. Losses due to the processes of microbial degradation, photolysis, hydrolysis and volatilization are lumped as a single first order decay rate for the dissolved and bound fractions separately. In the Simplified Lake and Stream Analysis model (SLSA) (DiToro et al., 1982), a simplified lake modeling approach was extended to describe longitudinal distribution of toxics for steady uniform flow and steady loadings in a river.

The model MICHIV provides a more flexible and less simplified evaluation of contaminant distribution in streams and rivers than the SLSA model. MICHIV allows the user to divide the river into successive reaches with different flow rates and geometric characteristics. In addition, MICHIV predicts solids concentration in the water column rather than requiring it as a constant input data parameter. This model can be set up rapidly, and data requirements are relatively limited.

Another type of modeling providing useful insight with limited effort is phase equilibria calculations for priority metal pollutants. Metals may be present in many forms, i.e., as free ions or complexes in the dissolved state, absorbed to surfaces, or as precipitates. The form of the metal is dependent on environmental variables such as pH, electron concentration, dissolved ions and temperature. MINTEQ (Felmy et al., 1984) is a well-documented and supported model which calculates aqueous geochemical phase equilibria for seven priority metal pollutants (arsenic, cadmium, copper, lead, nickel, silver and zinc). MINTEQ is a mixed reactor or 0-dimensional model, i.e., there is no spatial resolution of the system modeled. MINTEQ is strictly an equilibrium model and cannot provide information about time or spatially varying processes. However, the metal speciation information and the extent to which the metal may adsorb or precipitate due to environmental parameters provides important insight into potential problems for Corps projects. This model might be used to evaluate impacts of potential change in acidity, dissolved oxygen, alkalinity or dissolved ions on mobility or toxicity of these metals in a water body. Screening for potential problems when dredged sediments contaminated with heavy metals are placed in a new aquatic environment is another potential use for this type of model.

The most advanced type of screening model is the EXAMS/MEXAMS set of models. The Exposure Analysis Modeling System (EXAMS) (Burns and Cline, 1985), a steady-flow compartment model, calculates the concentration and distribution of organic compounds in a system under a given pollutant load; EXAMS further determines the persistence of compounds in the system after the loading is removed. This model is fundamentally a steady state model but can be applied to systems where flows and loadings vary slowly. Spatial resolution in 1, 2, or 3 dimensions can be obtained with EXAMS depending on the number and arrangement of the compartments. EXAMS requires input of flow distribution within the system and calculates flow through the compartments based on volume conservation. EXAMS calculates dissolved and sediment bound contaminant concentrations in both the water column and benthic layers. A major technical strength of this model is its handling of chemical kinetic processes such as hydrolysis, photolysis, biodegradation and volatilization. EXAMS has been designed to screen the behavior of numerous organic compounds and can be run interactively for rapid evaluation of scenarios. EXAMS is user friendly and provides on-line "help" to explain command options and input requirements.

The Metal Exposure Analysis Modeling System (MEXAMS) (Felmy et al., 1982), combines the metal equilibrium model of MINTEQ with the transport structure of EXAMS, allowing calculation of the distribution of heavy metal species throughout a waterbody and persistence in the system after removal of the loading.

EXAMS/MEXAMS could be useful in screening for the presence of various contaminants in the sediments of lakes or streams with known or suspected loadings or in calculating contaminant concentrations downstream from a disposal facility. Applications to estuaries is possible if tidally averaged values for the flow are considered.

#### HIGH RESOLUTION MODELS

The models considered under in the second category (i.e., applications which require extensive levels of effort) typically attempt to give increased spatial resolution, operate in a time-varying mode, require detailed system hydrodynamics and model sediment transport. Simulation of multidimensional hydrodynamics and sediment transport even without considering the contaminant fate calculations requires a major commitment of manpower and data collection. These modeling efforts attempt to address questions such as where in a system a contaminant is likely to accumulate or how structural and operational changes might effect distribution of a contaminant.

The Hydrologic Simulation Program - FORTRAN (HSPF) (Donigan et al., 1984), a one-dimensional model for nontidal rivers and unstratified lakes, is coupled with a watershed hydrologic model and non-point source runoff algorithms. HSPF simulates organic pollutants in a time-varying mode. Sediment transport is calculated for three particle sizes (sand, silt, and clay). HSPF has been used to evaluate best management practices for

controlling non-point source pollution from surface runoff (i.e., to determine impacts on receiving water quality from changes in watershed land use). This model may prove useful in examining effects of different watershed land use options on sediment quality or on sediment contributions to water quality problems.

The Toxics Water Analysis Simulation Program (TOXIWASP) (Ambrose et al., 1983), is a time-varying, multi-dimensional, box model for simulating transport and fate of toxic organic chemicals in rivers, lakes, estuaries, or coastal waters. TOXIWASP segments can be arranged in a 0-, 1-, 2-, or 3-dimensional configuration to achieve any required spatial resolution. Time-varying or steady state flows can be used in WASP simulations and must be supplied to the model as input. For complex multi-dimensional waterbody applications, a separate hydrodynamic model simulation would be required in conjunction with the TOXIWASP applications. Three different size classes of sediment and contaminant concentration for each class is simulated in the most recent release version of the model. TOXIWASP simulates multiple bed layers and allows net deposition or erosion of the bed surface and removal of contaminant from the system through burial.

Investigators at Batelle-Pacific Northwest Laboratories have developed and applied a series of finite element models combining sediment and contaminant transport and fate. These include a 1-dimensional (longitudinal) model TODAM, a 2-dimensional (longitudinal and lateral) model FERTRA, and a 2-dimensional (longitudinal and vertical) model SERATRA. All of these models must be coupled to an external hydrodynamic model and contain sophisticated or, at any rate, complex sediment transport routines and second order contaminant kinetics.

#### CONCLUSIONS

Time-varying multidimensional contaminant modeling requires not only extensive effort for model application, but field data requirements because a well validated application can be prohibitively expensive. In addition to data required as model input, calibration/verification data will be required for system hydrodynamics, sediment transport, and contaminant distribution through space and time. Although significant effort has been expended in this field, this type of modeling is in a highly developmental stage.

Although a few highly sensitive projects may require the effort required by the second type of model, evaluation of a far larger number of projects using the simplified techniques and screening models would be beneficial. Expanded use of the simplified approaches by field personnel would yield the greatest benefit with the least cost in the area of contaminant fate modeling.

## ACKNOWLEDGEMENTS

This work was funded by the Office, Chief of Engineers, US Army, as part of the Dredging Operations Technical Support (DOTS) program. Permissions was granted by the Chief of Engineers to publish this information. I thank Dr. Marc Zimmerman and Mr. Ross W. Hall for their review and comments on this manuscript.

## REFERENCES

- Ambrose, R. B., Jr., Hill, S. I., and Mulkey, L. A., 1983, "Users' Manual for the Chemical Transport and Fate Model Toxiwasp - Version I," U.S. Environmental Protection Agency, 600/3-83/005, Athens, GA, pp. 1-175.
- Burns, L. A. and Cline, D. M., 1985, "Exposure Analysis Modeling System: Reference Manual for Exams II," U.S. Environmental Research Laboratory, 600/3-85/038, Athens, GA, pp. 1-84.
- Chapra, S. C. and Reckhow, K. H., 1983, "Engineering Approaches for Lake Management, Volume 2: Mechanistic Modeling," Butterworth Publishers, Boston, MA.
- DiToro, D. M., O'Connor, D. J., Thomann, R. V., and St. John, J., 1982, "Simplified Model of the Fate of Partitioning Chemicals in Lakes and Streams" in Modeling the Fate of Chemicals in the Aquatic Environment, Ann Arbor Science, Ann Arbor, MI.
- Donigan, A. S., Imhoff, J. C., Bicknell, B. R., and Kittle, J. L., 1984, "Application Guide for Hydrological Simulation Program - FORTRAN (HSPF), U.S. Environmental Protection Agency, 600/3-84/065, Athens, GA, pp. 1-177.
- Felmy, A. R., Brown, S. M., Onishi, Y., Argo, R. S., and Yabusaki, S. B., 1982, "MEXAMS - The Metals Exposure Analysis Modeling System," U.S. Environmental Protection Agency, 68/03/3089, Athens, GA, pp. 1-148.
- Felmy, A. R., Girvin, D. C., and Jenne, E. A., 1984, "MINTEQ - A Computer Program for Calculating Aqueous Geochemical Equilibria," U.S. Environmental Protection Agency, 600/3-84/032, Athens, GA, pp. 1-86.
- Mills, W. B., Porcella, D. B., et. al., 1985, "Water Quality Assessment: A Screening Procedure for Toxic and Conventional Pollutant in Surface and Ground Water, Parts 1 and 2," U.S. Environmental Protection Agency, 600/6-85/002a-b, Athens, GA.

ADVANCES IN LABORATORY TESTING TO QUANTITATIVELY DESCRIBE  
SEDIMENT-WATER INTERACTIONS

by

James M. Brannon and Tommy E. Myers\*

INTRODUCTION

To determine the impact that contaminants associated with sediment may have on the environment, laboratory testing of sediment is often conducted. Over the years these tests have taken many forms, such as the elutriate test (Keeley and Engler 1974), column tests (Brannon et al. 1980), and bioassays. The elutriate test and many of the tests used today to test sediments and solid wastes are batch tests. A batch test is a procedure whereby a sediment is agitated with a liquid such as water under conditions that relate to site specific characteristics such as the presence or absence of air. Batch tests are quick and generally simple to perform and require minimal equipment. Batch test results are commonly reported in terms of the concentrations of chemicals analyzed in the aqueous phase (leachate). These results require manipulation before they can be applied to models or equations requiring steady state or rate inputs.

Batch leaching tests in combination with column leaching tests are currently being investigated at the Waterways Experiment Station (WES) as a means of providing planning level assessments of leachate quality in confined disposal facilities containing contaminated dredged material. This paper examines the theory of contaminant partitioning, the current state of development of batch test procedures used for obtaining distribution coefficients, and some uses for the distribution coefficients.

CONTAMINANT PARTITIONING THEORY

Current contaminant partitioning theory was developed to describe the adsorption of contaminants and other compounds of interest on soils, sediments, and other solid phases. Adsorption of many chemicals, especially hydrophobic organic compounds, can be described by the equilibrium partitioning of contaminant between sediment solids and water in contact with the sediment. In real world systems involving more than one adsorbing chemical, contaminants are distributed between solids and water according to a distribution coefficient,  $K_d$ , defined as follows (Thibodeaux 1979):

$$K_d = X_s/X_w = q/C \quad (1)$$

\*Research Chemist and Environmental Engineer, Environmental Laboratory, U.S. Army Engineer Waterways Experiment Station

where  $X_s$  is the contaminant mass fraction in the solid phase;  $X_w$  is the contaminant mass fraction in the aqueous phase;  $q$  is the contaminant concentration in the sediment solids (mg/kg); and  $C$  is the contaminant concentration in the aqueous phase (mg/l). The partitioning coefficient is probably the single most important parameter for predicting the fate and transport of most contaminants (Jaffe and Ferrara 1984). Distribution coefficients are usually determined using laboratory batch tests.

Sediment adsorption isotherms are determined in the laboratory by contacting varying quantities of sediment with aliquots of fluid containing the contaminant or by contacting a set quantity of sediment with aliquots of fluid containing varying amounts of contaminant. At equilibrium, each sample will have a different aqueous phase concentration and a different sorbed concentration. Consequently, a table of values may be generated for the mass of sorbate per mass of sorbent,  $q$ , versus the aqueous phase concentration,  $C$ . If the table values are plotted, a curve similar to Figure 1 is usually obtained. It may be observed from the figure that the sorbent loading asymptotically approaches a limiting value as aqueous phase concentrations become large. The approach to a limiting value occurs when the amount of contaminant adsorbed by a sediment approaches the adsorption capacity of the sediment.

In many situations important to the Corps of Engineers (CE), contaminants of interest are associated with the sediment. Testing to assess the mobility of the contaminant and its partitioning behavior, therefore, require desorption testing rather than adsorption testing. Desorption isotherms can be obtained by sequential batch leaching of contaminated sediment or by varying the sediment-water ratio. However, there are problems with using varying sediment-water ratios that may greatly complicate interpretation of isotherms derived in such a manner (Voice et al. 1983; Gschwend and Wu 1985). When steady state conditions are reached, the sorbed and aqueous phases are separated and analyzed. The sediment is then challenged by a new (clean) aliquot of leaching medium until steady-state conditions are again reached. By repeating this procedure, a table of values can be generated for the mass of contaminant per mass of sediment,  $q$ , versus the aqueous phase concentration,  $C$ . If the table of values is plotted, a desorption-dominated isotherm will result. Like the adsorption isotherm, the desorption isotherm describes an equilibrium-controlled process.

If adsorption- and desorption-dominated processes take place under constant conditions, the desorption of a contaminant back into the aqueous phase should follow the reverse of the curve provided by adsorption and trace it exactly. However, adsorption and desorption processes are not identical (Mustafa and Gamer 1972, DiToro and Horzempa 1982, Corwin and Farmer 1984), so that slopes of adsorption and desorption isotherms are rarely identical. This phenomenon is called hysteresis and means that a unique set of sorption coefficients applicable to both phenomena is unlikely. An idealized adsorption and subsequent desorption isotherm for a sediment is shown in Figure 2. The two desorption lines shown in Figure 2 represent the reported dependency of desorption processes on the initial solid phase concentration (Corwin and Farmer 1984).

The desorption isotherms shown in Figure 2 can be extended to intercept the sorbent concentration axis. This intercept has been interpreted as

irreversibly adsorbed material that is resistant to leaching (Crawford and Donigian 1973; Van Genuchten, Davidson, and Wierenga 1974; DiToro et al. 1982; Isaacson and Frink 1984). A term for a strongly or irreversibly adsorbed fraction that does not leach,  $q_r$ , can be added to equation (1) to yield

$$q - q_r = KdC \quad (2)$$

The existence of a contaminant fraction resistant to leaching becomes especially important when metals are considered. For example, it has been shown that varying fractions of metals in dredged material exist in sediment geochemical phases that are not mobile (Brannon et al. 1980). Therefore, the entire concentration of metal measured in a total sediment analysis cannot be assumed to be available for release.

## BATCH TESTING

### Development

In the past, batch testing has taken many forms. Vessels such as mason jars, agitation tanks, separatory funnels, and Erlenmeyer flasks have been used as batch reactors. Mixing has been provided by electric mixers, mechanical shakers of various configurations, and simple manual shaking. Solvents utilized as the extractant have included tap water, deionized water, and additives for pH adjustment such as hydrochloric acid, carbon dioxide, acetic acid, glycol, glycerine, and caustic. Reaction periods varying from 30 min to 24 hr have been used, usually at ambient temperature. Batch testing procedures evolved for almost a decade before standardization was attempted. The Japanese government appears to have been the first to adopt batch testing (Lowenbach 1978, Perket and Webster 1981) for evaluation of solid waste. The Corps of Engineers developed a batch procedure known as the Elutriate Test for the assessment of dredged material disposal under open water conditions (Lee and Plumb 1974). Several states have also developed their own batch test procedures (Lowenbach 1978). The first attempt to develop a standard test method for hazardous waste was carried out at the University of Wisconsin on behalf of the US Environmental Protection Agency (USEPA) (Ham et al. 1979). From this work came the Standard Leach Test (SLT) which evolved into the Toxic Extraction Procedure (EP) (USEPA 1980), which is used to classify wastes as hazardous or nonhazardous based upon their leaching potential under standard conditions. For a detailed overview of batch tests, see Lowenbach (1978) or Perket and Webster (1981). The USEPA is now preparing to replace the EP with the Toxicity Characteristic Leach Procedure (TCLP). The TCLP differs from the EP in that more contaminants are covered, grinding procedures are standardized, buffer systems are optional depending upon waste characteristics, shaking is limited to tumbling in zero head space containers, liquid/solid separation is by filtration through Whatman GF/F glass fiber filters, and the time of shaking is reduced. However, classification procedures for determining if a waste is hazardous or nonhazardous are unchanged.



## Batch Testing Problems

All batch test procedures have received criticism (Conway and Malloy 1981, Conway and Gullledge 1983). Lee and Jones (1981) have criticized the EP procedure on the basis of inattention to oxidation-reduction potential. Lee and Jones (1981) contend that most of the batch procedures used are not responsive to site-specific factors that are important in field applications. However, even though test conditions such as pH, oxidation-reduction potential, solid/liquid ratio, and type of extractant affect the outcome of a test, field extrapolation of batch test results involves more than selection of test conditions. There must be a technical basis, either empirical or deterministic, on which to extrapolate to the field situation. In an empirical approach, laboratory data are compared directly to field data. The necessary adjustments are made in the important parameters of the laboratory test until the data generated in the laboratory begin to agree with the field data. In a deterministic approach, a test is designed to reveal important information about the physical-chemical laws governing a system. This information is then used in a mathematical description of the problem to predict the field situation. Comparison is made between predicted and observed, and the theoretical model is either refined or abandoned.

The EP and TCLP tests fall somewhere between these two approaches. They are criteria-comparison type tests developed out of regulatory necessity for fast, uncomplicated, standardized procedures. Such tests, however, cannot provide information on leaching kinetics or on equilibrium desorption coefficients for the solid and aqueous phases. The elutriate test is similar to the EP or the TCLP in that it is a standardized procedure that is fast and uncomplicated. Unlike the EP and the TCLP, however, it was designed to simulate a specific disposal situation for a specific type of dredged material. Therefore, elutriate data can be extrapolated to the field situation on the basis that the test simulates critical field parameters involved in contaminant mobility during disposal operations. However, a single batch test cannot provide the information needed for predicting contaminant leaching using a mass transport equation. Leaching of contaminants through sediment is a complex process involving convection, dispersion, and contaminant transfer from the dredged material solids into the aqueous phase. Because of the complexity of the system, it is highly unlikely that a single batch test could adequately simulate the process.

## Batch Testing Kinetics

Equilibrium batch testing is based on the assumption that equilibrium is reached during the test. However, true equilibrium, which denotes dynamic balance between opposing reactions, is rarely ever reached (Stumm and Morgan 1981) and could take extended periods of time in a sediment-water system (Karickhoff and Morris 1985). Therefore, for real world situations, steady-state conditions, which occur when leachate concentrations do not change appreciably with time, are the closest practicable approach to equilibrium.

The time to reach steady state conditions during adsorption studies is relatively rapid and usually does not exceed 24 hours. The time necessary for

desorption to attain steady state conditions is not as firmly established. During desorption testing of dredged materials at this laboratory, two desorption trends have been noted. As illustrated in Figure 3 for As and Cd, steady state conditions for As were attained following 24 hours of shaking, after which no statistically significant increase in As concentration was observed. Alternatively, for Cd, the highest concentration reached was noted following 24 hours of shaking. Following the peak concentration noted at 24 hours and at 48 hours, contaminant concentrations then decreased. Other metals have shown peak concentrations following 24 hours of shaking followed by an immediate decrease in concentration at 48 hours. In such a case, sampling following 24 hours of shaking would reflect worst case leachate concentrations.

### Sequential Batch Leaching Procedures

Batch tests are rapid compared to column tests because the renewal rate of leachant at the sediment surface in a batch test is virtually infinite compared to renewal rate in a column test. By relating the volume of liquid used in a batch test to the percolation rate in a confined disposal facility, sequential batch extractions can be the basis of an accelerated testing protocol (Houle and Long 1980; Van der Sloot, Piepers and Kok 1984). Sequential batch leaching consists of challenging a sediment sample with successive aliquots of distilled water or other leaching solution. Phase separation is accomplished by centrifuging the sample, followed by filtration through glass fiber filters for organic constituents and through a membrane filter for metals prior to chemical analysis of the leachate. In recent sequential batch tests conducted at WES, a modification of the sequential batch testing approach of Houle and Long (1980) and Garret et al. (1984) has been used for obtaining steady-state distribution coefficients for use in the source term of mass transport equations. The assumption is made that contaminant leaching is equilibrium controlled for contaminants that are not solubility limited. This assumption is justified on the basis that the rates at which desorption proceed are rapid relative to the rate at which water percolates through the sediment. The procedure uses the same volume of leachant for successive extractions, rather than increasing the water-to-sediment ratio with each successive extraction (grading). This procedure will directly infer the long-term leaching response afforded by the approach of Houle and Long (1980), but will avoid changes in water-to-sediment ratios that can adversely affect the field applicability of laboratory-derived distribution coefficients.

The sequential batch leaching tests described previously have been applied to sediments from Indiana Harbor, IN, and Everett Harbor, WA (Environmental Laboratory 1987; Palermo et al. 1988) and are presently being applied to sediment from New Bedford Harbor, MA. An integrated approach, using results from batch tests, column tests, and a permeant-porous media equation, is being used to test the hypothesis that contaminant interphase transfer can be described as equilibrium-controlled, linear desorption. The permeant-porous media equation is a one-dimensional partial differential equation that mathematically describes contaminant leaching as water percolates through a column of dredged material or sediment (Hill, Myers, and Brannon 1988; Curl and Keoleian 1984; Grove and Stollenwerk 1984; Rao et al. 1979). Biological degradation is not included in the equation.

The integrated approach for leachate testing involving batch and column leach tests and a mass transport equation appears to be a useful tool for investigating the processes that govern contaminant leaching from sediment solids. An example is shown in Figures 4 and 5. In Figure 4 the desorption isotherm for arsenic in anaerobic Indiana Harbor sediment is presented. Based on a distribution coefficient ( $K_d$ ) obtained from a similar isotherm and column testing data, Figure 5 was developed. Figure 5 shows predicted concentrations of PCB in the column tests plotted for two conditions. The first assumes that contaminant leaching in the column tests is governed by equilibrium-controlled, linear desorption and that the equilibrium distribution is adequately described by the  $K_d$  obtained using sequential batch leach tests. The second condition assumes that desorption does not occur. That is,  $K_d$  is equal to zero. In both cases the interstitial water concentrations measured during batch testing were used as the initial pore water concentrations. The data presented in Figure 5 showed that there was some PCB desorption, but not as much as predicted. Overall, however, for this contaminant in this particular sediment, prediction was adequate. Other parameters in this and other sediments tested behaved in a manner that suggests non-constant partitioning. Such behavior can be traced to the sediment, the leachate, or both. If non-constant partitioning is caused by the sediment, it will probably be due to changes in phase association or the agent binding the metal or organic contaminant to the sediment. For example, Brannon and Patrick (1987) have shown that the sediment components binding As change during leaching. It is likely that such processes also affect other contaminants, although the manner in which this occurs has not been examined.

At present, applicability is limited to estimation of leachate quality in dredged material. In the future, batch testing and mass transport equations may be developed to address contaminant transport through dikes and the ability of clean material codisposed with contaminated material to adsorb contaminants released from the contaminated material.

## REFERENCES

- Brannon, J. M. and W. H. Patrick, Jr., "Fixation, Transformation, and Mobilization of Arsenic in Sediments," Environmental Science and Technology, Vol. 21, No. 5, 1987, pp 450-459.
- Brannon, J. M., R. H. Plumb, Jr., and I. Smith, Jr., "Long-Term Release of Heavy Metals from Sediments," Contaminants and Sediments, Ann Arbor Science Publishers, Inc., Ann Arbor, Michigan, Vol. 2, 1980, pp. 221-266.
- Conway, R. A. and W. P. Gullledge, Hazardous and Industrial Solid Waste Testing, 2nd Symposium, ASTM STP 805, American Society for Testing Materials, Philadelphia, PA, 1983.
- Conway, R. A. and B. C. Malloy, Hazardous Solid Waste Testing: First Conference, ASTM STP 760, American Society for Testing and Materials, Philadelphia, PA, 1981.
- Corwin, D. L. and W. J. Farmer, "Nonsingle-Valued Adsorption-Desorption of Bromacil and Diquat by Freshwater Sediments," Environmental Science and Technology, Vol. 18, No. 7, 1984, pp. 507-514.
- Crawford, N. H. and A. S. Donigan, Jr., "Pesticide Transport and Runoff Model for Agricultural Lands," EPA-660/2-74-013, US Environmental Protection Agency, Washington, DC, 1973.
- Curl, R. L. and G. A. Keoleian, "Implicit-Adsorbate Model for Apparent Anomalies with Organic Adsorption on Natural Sediments," Environmental Science and Technology, Vol. 18, No. 12, 1984, pp. 916-922.
- DiToro, D. M. and L. M. Horzempa, "Reversible and Resistant Components of PCB Adsorption-Desorption: Isotherms," Environmental Science and Technology, Vol. 16, No. 9, 1982, pp. 594-602.
- Environmental Laboratory, "Disposal Alternatives for PCB-Contaminated Sediments from Indiana Harbor, Indiana," Miscellaneous Paper EL-87-9, US Army Engineer Waterways Experiment Station, Vicksburg, MS, 1987.
- Garrett, B. C., et al. "Solid Waste Leaching Procedure," Draft Technical Resource Document Cn 68-03-2970, Municipal Environmental Research Laboratory, Office of Research and Development, US Environmental Protection Agency, Cincinnati, Ohio, 1984 (March).
- Grove, D. B. and K. G. Stollenwerk, "Computer Model of One-Dimensional Equilibrium Controlled Sorption Process," Water Resources Investigations Report 84-4059, US Geological Survey, Denver, Colo., 1984.
- Gschwend, P. M. and S. Wu, "On the Constancy of Sediment-Water Partition Coefficients of Hydrophobic Organic Pollutants," Environmental Science and Technology, Vol. 19, No. 1, 1985, pp. 90-96.
- Ham, R. K., et al., "Comparison of Three Waste Leaching Tests," EPA 600/2-79-071, US Environmental Protection Agency, Cincinnati, Ohio, 1979.

Hill, D. O., Myers, T. E., and J. M. Brannon, "Development and Application of Techniques for Predicting Leachate Quality in Confined Disposal Facilities: Background and Theory," Miscellaneous Paper D-88-1, US Army Engineer Waterways Experiment Station, Vicksburg, MS, 1988.

Houle, M. J. and D. E. Long, "Interpreting Results from Serial Batch Extraction Tests of Waster and Soils," Disposal of Hazardous Waste; Proceedings of the Sixth Annual Research Symposium, EPA-600/9-80-010, US Environmental Protection Agency, Cincinnati, Ohio, 1980, pp. 60-81.

Isaacson, P. J. and C. R. Frink, "Nonreversible Sorption of Phenolic Compounds by Sediment Fractions: The Role of Sediment Organic Matter," Environmental Science and Technology, Vol. 18, No. 1, 1984, pp. 43-48.

Jaffe, P.W. and Ferrara, R. A., "Modeling Sediment and Water Column Interactions for Hydrophobic Pollutants," Water Research, Vol. 18, No. 9, 1984, pp. 1169-1174.

Karickhoff, S. W. and K. R. Morris, "Sorption Dynamics of Hydrophobic Pollutants in Sediment Suspensions," Environmental Toxicology and Chemistry, Vol. 4, 1985, pp. 469-479.

Keeley, J. W. and R. M. Engler, "Discussion of Regulatory Criteria for Ocean Disposal of Dredged Materials: Elutriate Test Rationale and Implementation Guidelines," Miscellaneous Paper D-74-14, US Army Engineer Waterways Experiment Station, Vicksburg, MS, 1974.

Lee, G. F. and R. A. Jones, "Application of Site-Specific Hazard Assessment Testing to Solid Wastes," Hazardous Solid Waste Testing: First Conference, R. A. Conway and B. C. Malloy, eds., ASTM STP 760, American Society for Testing Materials, Philadelphia, PA, 1981.

Lee, G. F. and R. H. Plumb, Jr., "Literature Review on Research Study for the Development of Dredged Material Disposal Criteria," Contract Report D-74-1, US Army Engineer Waterways Experiment Station, Vicksburg, MS, 1974.

Lowenbach, W., "Compilation and Evaluation of Leaching Test Methods," EPA-600/2-78-095, US Environmental Protection Agency, Cincinnati, Ohio, 1978.

Mustafa, M. A. and Y. Gamer, "Adsorption and Desorption of Diuron as a Function of Soil Properties," Soil Science Society of America Proceedings, Vol. 36, 1972, pp. 561-565.

Palermo, M. R. et al., "Technical Supplement to Evaluation of Dredged Material Disposal Alternatives, U. S. Navy Homeport at Everett, Washington," Miscellaneous Paper in Preparation, US Army Engineer Waterways Experiment Station, Vicksburg, MS, 1988.

Perket, C. L. and W. C. Webster, "Literature Review of Batch Laboratory Leaching and Extraction Procedures," Hazardous Soils Waste Testing: First Conference, R. A. Conway and B. C. Malloy, eds., ASTM STP 760, American Society for Testing Materials, Philadelphia, Pa., 1981.

Rao, P. S. C., et al., "Evaluation of Conceptual Models for Describing Nonequilibrium Adsorption-Desorption of Pesticides During Steady-Flow in Soils," Soil Science Society of America Journal, Vol. 43, 1979, pp. 22-28.

Stumm, W. and J. J. Morgan, Aquatic Chemistry, 2nd ed., John Wiley and Sons, New York, 1981.

Thibodeaux, L. J. Chemodynamics, John Wiley and Sons, New York, 1979.

US Environmental Protection Agency, "Testing Requirements for Toxic Extraction Procedure," Federal Register, Vol. 45, No. 98 (19 May), 1980, pp. 33147.

Van der Sloot, H. A., O. Piepers, and A. Kok, "A Standard Leaching Test for Combustion Residues", BEOP-25, Bureau Energie Onderzoek Projecten, Studiegroep Ontwikkeling Standaard Uitloogtesten Verbrandingsresiduen, Stichting Energieonderzoek Centrum Nederland, translation by Koninklijke Shell-Laboratorium, Amsterdam 1984.

Van Genuchten, M. T., J. M. Davidson, and P. J. Wierenga, "An Evaluation of Kinetic and Equilibrium Equations for the Prediction of Pesticide Movement Through Porous Media, Soil Science Society of America Proceedings, Vol. 38, 1974, pp. 29-35.

Voice, T. C., C. P. Rice, and W. J. Weber, Jr., "Effect of Solids Concentration on the Sorptive Partitioning of Hydrophobic Pollutants in Aquatic Systems," Environmental Science and Technology, Vol. 17, No. 9, 1983, pp. 513-518.

#### ACKNOWLEDGEMENTS

This research was supported by the Long-Term Effects of Dredging Operations (LEDO) Program and the Chicago District of the U.S. Army Corps of Engineers. Analytical support was provided by the Analytical Laboratory Group, Waterways Experiment Station. Permission was granted by the Chief of Engineers to publish this information.

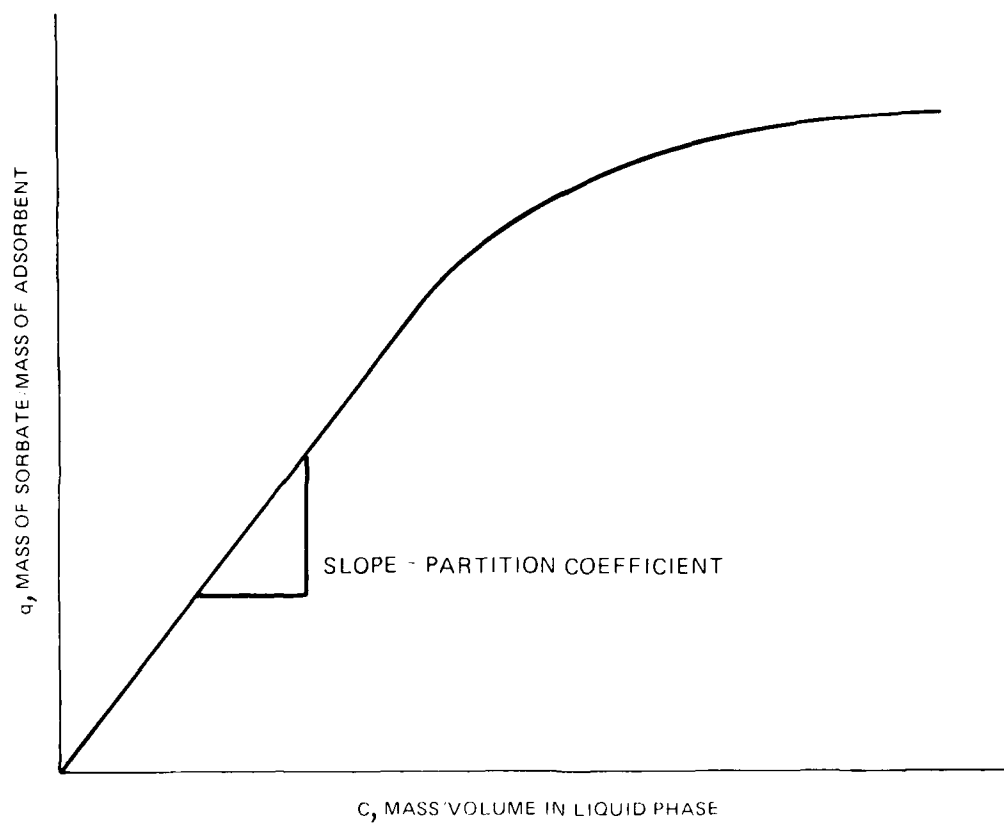

Figure 1. Adsorption Equilibrium Curve

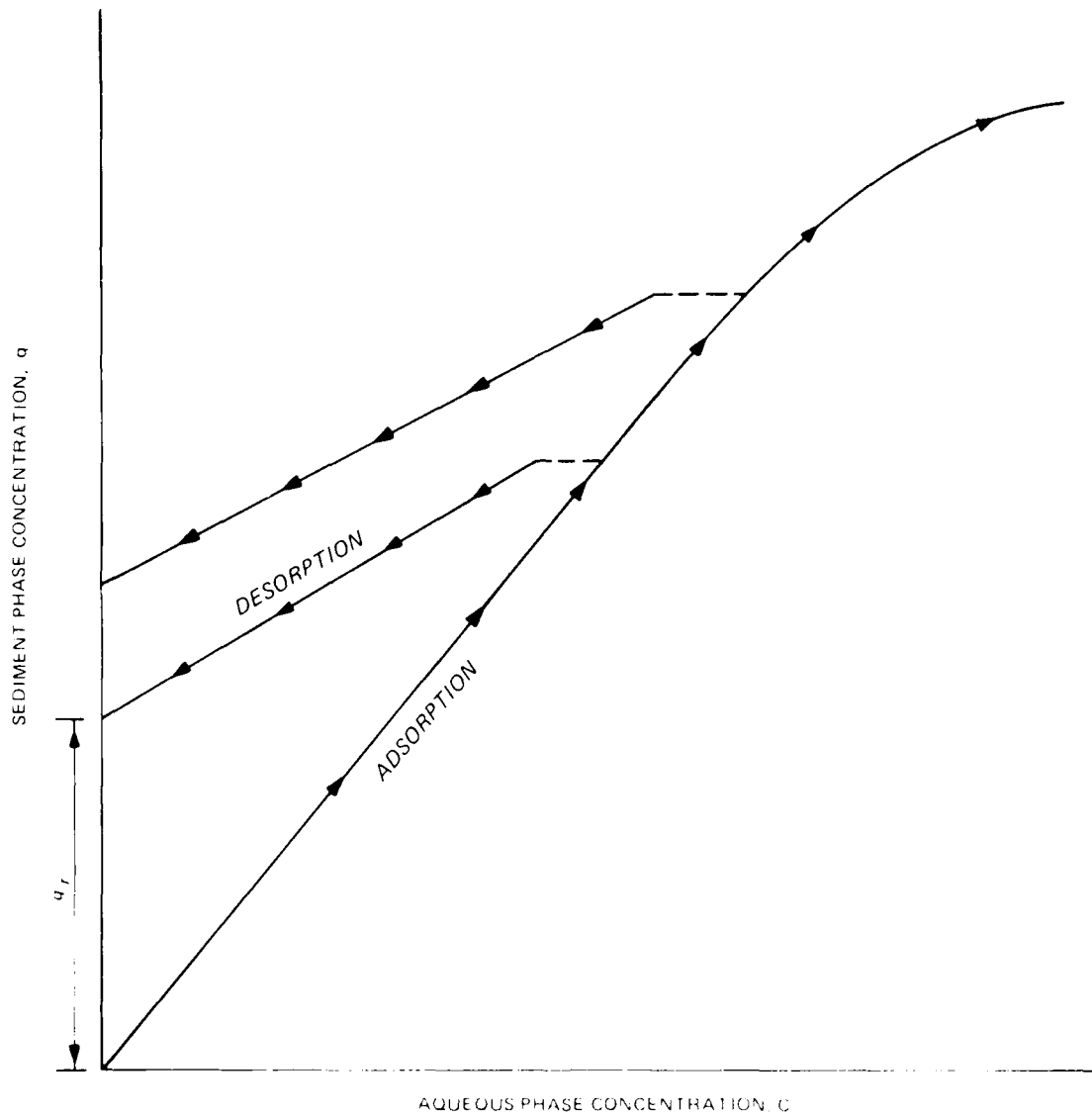

Figure 2. Adsorption/Desorption Plot



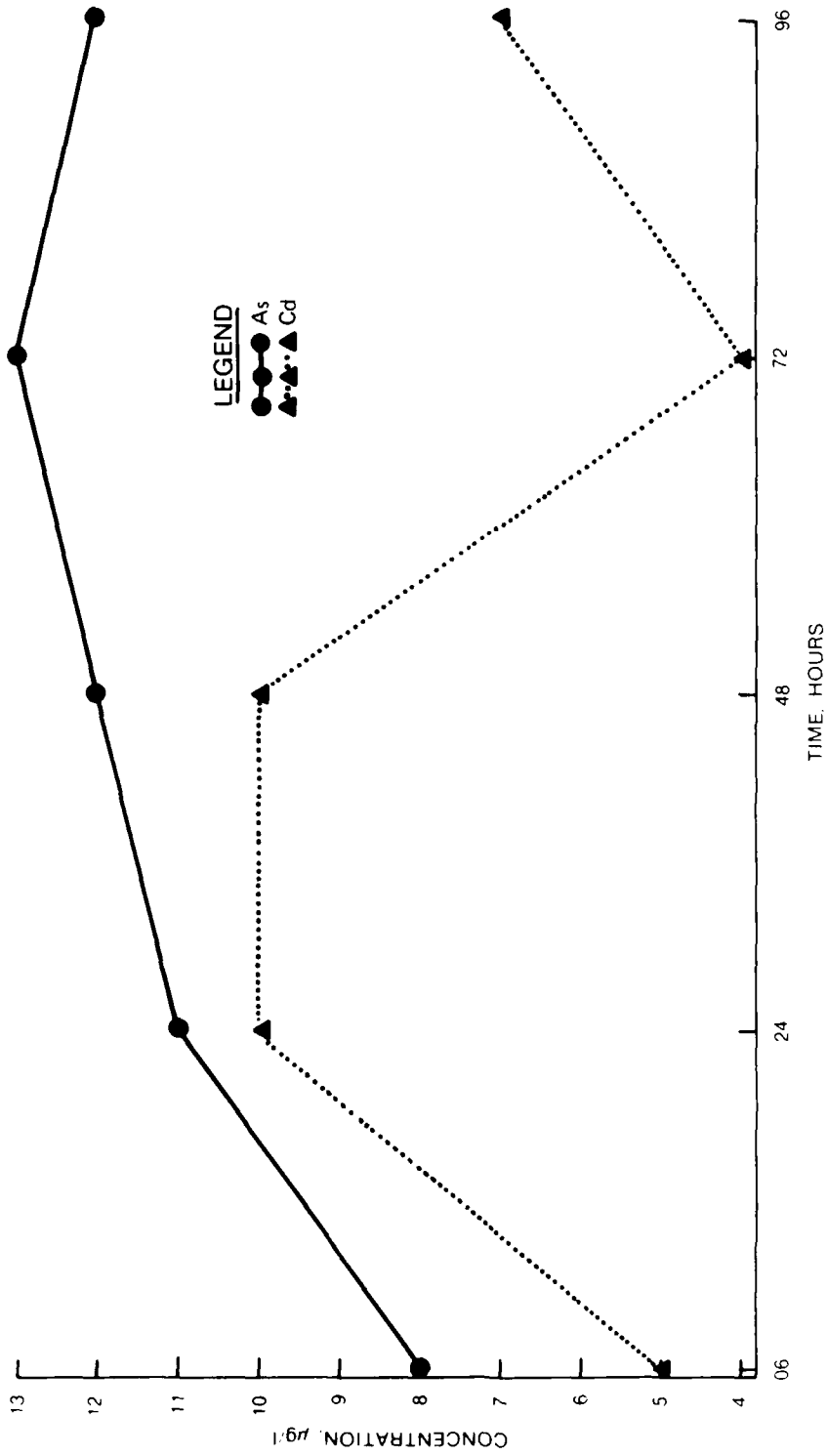

Figure 3. Leadate Concentration Changes as a Function of Shaking Time

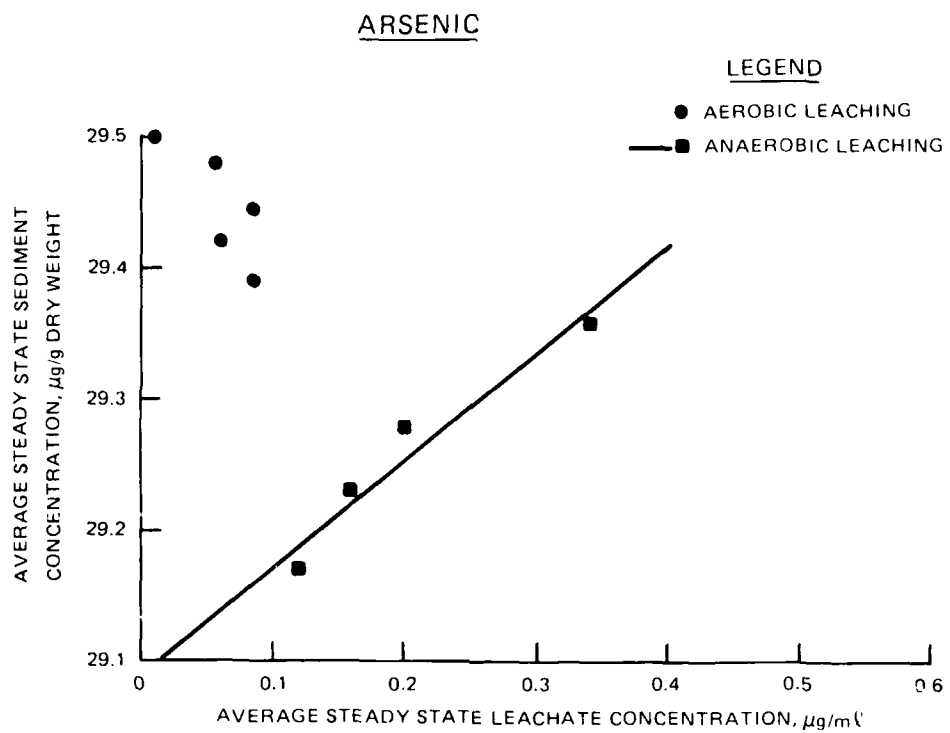

Figure 1. Desorption Isotherms for Arsenic In Indiana Harbor Sediment

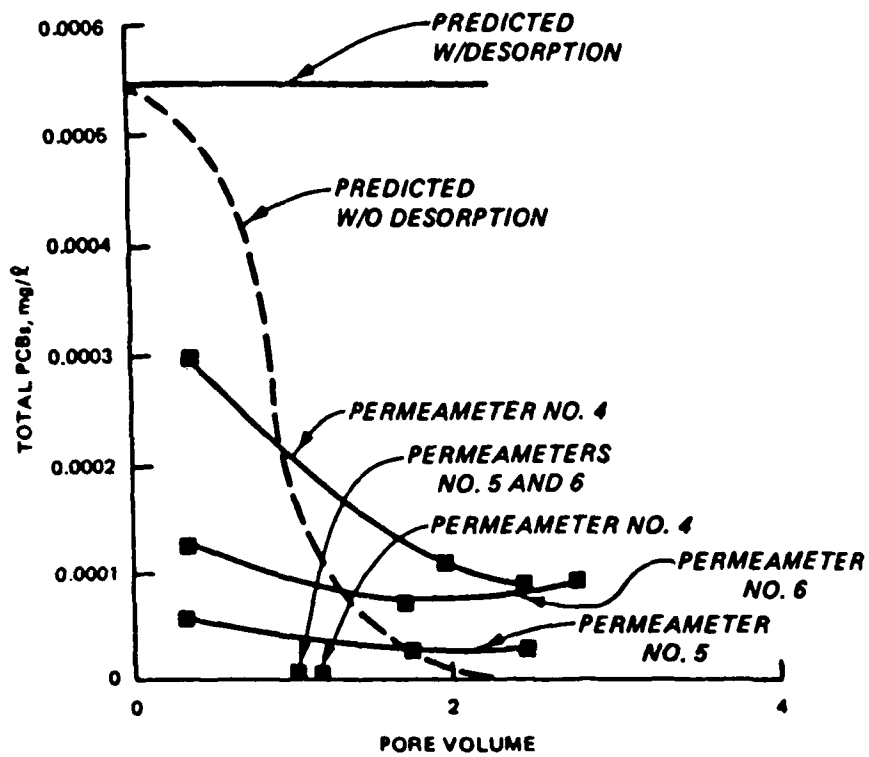

Figure 5. Total PCB Concentrations in Anaerobic Permeameter Leachate

AN APPROACH FOR ASSESSING IMPACTS OF IN-PLACE CONTAMINATED  
SEDIMENTS ON WATER QUALITY

by

T. L. Hart, D. Gunnison, and J. M. Brannon\*

INTRODUCTION

Strong public opinion is often expressed against the removal and disposal of contaminated sediments. These objections are based on the belief that the environmental consequence of sediment removal and subsequent disposal exceed the social and economic benefits gained from the project. Although polluted sediments are often located in highly industrial and urban areas, they are neither stationary nor inert. These sediments continue to exert an influence on the water quality of the waterway through oxygen demand and release of nutrients and toxic substances, as well as supporting only a limited pollutant tolerant community of poor species diversity. Further, the resuspension of these sediments by natural or man-induced causes will not only affect the overlying water column, but may also impact water quality for miles outside the immediate area of concern.

Polluted sediments are not confined to Federal channels and major harbors in our urban and industrial areas. Spills from chemical and petroleum barges and small chemical and petroleum terminals have resulted in localized pockets of contaminated sediments in areas far removed from our major metropolitan areas. Runoff from agricultural and timberlands also introduces pesticides and nutrients to the Nation's waters, often resulting in river, reservoir, and estuary sediments becoming contaminated. Point discharge from feedlots, chemical companies, and city sewage treatment plants has also been a source of nutrients and contaminants that have affected sediments. Many of these polluted sediments are located within Federal water resource projects built and maintained by the U.S. Army Corps of Engineers (CE). The affects of these sediments on the continued operation and maintenance of these projects, as well as proposed modifications to current use, can be significantly affected by the presence of contaminated sediments.

For a more complete assessment of cost vs benefits associated with maintaining specific water resource projects, the impacts of in-place sediments on the environment must be considered. If the CE can determine and quantify the impacts, the "true" cost of the project's social, economic, and environmental attributes can be determined.

This paper reviews an approach that can be used in the assessment of water resource projects to evaluate the environmental impact of contaminated sediments on water quality. The approach has been presented at the Thirteenth Experts Meeting on Management of Bottom Sediments Containing Toxic Substances in Baltimore, Maryland, in November 1987. However, to ensure those individuals

\*Supervisory Research Biologist, Research Microbiologist, and Research Chemist, Environmental Laboratory, U.S. Army Engineer Waterways Experiment Station

within the CE that have the responsibility for planning and/or assessment of water resource projects are cognizant of the recent work in assessing in-place sediments, the approach is being presented at this meeting. The approach has been used to assist the Chicago District in evaluating the impacts of bottom sediments from the Grand Calumet River and Indiana Harbor Canal, Indiana, USA, on water quality. Results of this study will be presented to demonstrate the approach as well as to indicate its limitations and strengths.

#### LEGAL CONSIDERATIONS

One major portion of the CE planning effort in maintaining Federal channels is compliance with Federal and state environmental legislation and implementing agency regulations. Often for Federal navigation projects, the major concern is with the requirements of Sections 401 and 404 of the Clean Water Act of 1977 (CWA) and Sections 102 and 103 of the Marine Protection, Research and Sanctuaries Act of 1972 (MPRSA). Each of these sections deal with the disposal of dredged material and associated potential environmental impacts. Under Section 404 an evaluation of the effects of dredged material discharge into navigable waters of the United States is made based on the U.S. Environmental Protection Agency 404(b)1 guidelines. For certain situations a water quality certification (Section 401) from the affected state is required. This certification insures that the project meets state water quality requirements. For those projects where disposal of dredged material will take place in the ocean, the requirements of Sections 102 and 103 of the MPRSA must be met. These, like the requirements of the CWA, are concerned with the environmental impacts due to the disposal of the dredged material. Neither of these Federal Acts specifically deals with the environmental impacts from in-place sediments, only the impacts associated with their disposal. However, for Federal projects the National Environmental Policy Act (NEPA) and the Council on Environmental Quality (CEQ) implementing regulations require, in the evaluation process, identification and assessment of reasonable and feasible alternatives. This assessment must include an evaluation of the existing condition and the consequences of the no action alternative.

Due to public concern, the major areas of emphases under these regulations have been on the short-term impacts of dredging on water quality and the adjacent areas and the impact of disposal of sediments on the terrestrial or aquatic environment. The cost and benefits associated with removal of sediments have dealt with social and economic issues, since they are easily obtained from the project sponsor. The environmental impacts, both positive and negative, of removing sediments have not been assessed due to the lack of a documented process that allows for a quantification of impacts. As a result, environmental documentation has generally only addressed the environmental cost to the project of sediment disposal. Although this addresses the public concern and meets the legislative requirements, the long-term environmental benefits that may be incurred from the removal of contaminated sediments are not factored into the project's cost vs benefit ratio. For Federal projects that require mitigation under NEPA, the lack of considering the benefits gained by removing a contaminated source may result in unnecessarily increasing the economic cost of the project.

## BASIC CONCEPT

The basic idea is to allow the project planner the ability to identify and quantify environmental impacts from in-place sediments on the water quality of the waterbody, thereby allowing for an accurate evaluation of the project cost vs benefits from removing the existing sediments. Various factors will influence this assessment; these include sediment characteristics, concentration and type of contaminants in the sediments, system hydrodynamics, contaminant sources, and existing and proposed uses of the waterbody. These and other factors will significantly affect the identification and quantification of impacts. Although many of these factors can be determined through existing data and information, others will require data collection and analysis. Without a delineated approach that provides a logical and systematic procedure to assess in-place sediments, the results may be of limited value due to misdirected efforts or inadequate data and analyses.

## ACTIVITIES

Assessment of in-place contaminated sediments has a number of applications. Listed are five potential applications where the CE has direct responsibility or is involved as a cooperating agency. Also included is a short description of the issues that can be addressed for each activity. Without exception, the evaluation of in-place contaminated sediments as part of the project's environmental studies would enhance the database for evaluating the existing conditions and the proposed action(s).

Federal Operation and Maintenance Navigation - For those maintenance dredging activities that involve contaminated sediments, the benefits gained are currently calculated in economic terms. However, disposal of this material is based on both environmental and economic considerations. Due to Federal environmental legislation, environmental issues normally govern the means of disposal. Therefore, the analysis conducted is based on meeting Federal requirements (404/103) for disposal of the dredged material. Currently the assessment does not address the influence of in-place sediments on the water column, and therefore, the database for evaluating baseline conditions is restricted to the disposal site(s). With a better understanding of existing sediment conditions, not only economic factors, but also environmental benefits from removing and isolating these sediments can be calculated and used in evaluating the project cost vs benefit ratio.

Permit Activities - The CE as a regulatory agency is required under the CWA and MPRSA to evaluate and permit the disposal of dredged material within the navigable waters of the United States. A major component of this process is evaluating those environmental factors delineated under the two Acts, including determining the need for the proposed activity. Including in the assessment an evaluation of in-place contaminated sediments would enhance the CE's ability to weigh the need for the project as well as the environmental cost and benefits.

Superfund Sites - For those sites classified as Superfund sites, the presence of a known contaminant(s) at a certain concentration has been deemed harmful to humans. As a result, actions to reduce or eliminate these contaminants have been deemed necessary. However, for many of the aquatic Superfund sites, data on the impacts of in-place sediments are limited to bulk

sediment contaminant concentrations. Data are lacking to: (a) provide a means to evaluate the benefits from alternative cleanup measures; (b) define clean (e.g., what are acceptable levels of contaminants in the sediments); and (c) determine the impact of the sediments on the environment if no action occurs. To quantify the impacts of in-place contaminated sediments, a database to address items a-c is required.

Reservoirs - Many of the Nation's reservoirs have received materials that contain high concentrations of nutrients and toxic materials from the surrounding watershed. The increase of nutrients through runoff from man-altered environments has had a significant effect on the levels of nutrients in reservoir sediments. With the development of anoxic conditions in the reservoir, many of these nutrients are released and can provide conditions conducive to noxious algal blooms. With the accumulation and release of nutrients over a period of years, the reservoir will become eutrophic, and this process may adversely affect the existing and proposed uses of the lake. Restrictions on water contact sports, fishing, and domestic water supply are only a few of the consequences resulting from the presence of elevated nutrients in the sediments. Also reservoirs can be a receiving body for toxic materials discharged by industry or man-modified lands. Through identification of these man-induced materials and assessment of their impact, remedial actions, if necessary, can be determined and evaluated as to their effectiveness.

Toxic Spills and Hotspots - As a regulatory agency, the CE must evaluate and authorize dredging and disposal activities in the navigable waters of the United States. For those situations where toxic materials may have been introduced into the aquatic environment, it is important to determine the environmental impacts from the presence of these materials. Without this information, delineating a remedial action is at best difficult. Both economic and environmental cost and benefits must be considered to determine the most appropriate cleanup measure.

#### BENEFITS

There are five basic benefits that can be incurred from the assessment of in-place sediments. These benefits, although not associated with each of the above-cited activities will provide for an improvement in the CE's ability to construct and maintain water resource projects. Five basic benefits are:

- a. Quantification of existing conditions, thereby providing a baseline for decision-making.
- b. Provide a baseline to assess the potential benefits and cost associated with each proposed alternative.
- c. Quantify project benefits incurred from removal or modification of in-place contaminated sediments.
- d. Provide for quantification of project cost and benefits gained for the proposed action.
- e. Provide a baseline for not only assessing short-term but long-term benefits and cost from various long-term management strategies.

## APPROACH

The conceptual process of developing and implementing an assessment protocol for in-place sediments is presented as a three-phase approach. Each phase consists of a series of steps or essential activities that lead to the development of specific data and information necessary to determine the impact of the sediments on water quality. The intent of this process is to quantify cost and benefits associated with specific alternatives as they relate to impacts from in-place contaminated sediments.

Phase I - Phase I is intended to serve as the first level of assessment. At a minimum, this phase requires the defining of assessment objectives (e.g., cleanup and alternative evaluation), thereby determining the level of data requirement and analyses for decision-making. Once the objectives for the assessment are defined, the next step is the identification and collection of existing data. There is usually a wealth of information available from various Federal and state sources. The intent under Phase I is to minimize field data collection activities, so a decision is needed as to the sufficiency of the existing data for evaluating the impact of in-place sediments. If existing data are insufficient, data gaps are identified, validated, and screened based on factors such as potential for development and time and resources needed to fill the gaps. If the needs are valid, then a data collection effort is planned. Unvalidated requirements result in either no further evaluation of the in-place sediments or a reassessment of the study objectives. Once the initial data requirements are met or, if necessary, additional data requirements identified, Phase I is completed.

Phase II - Phase II consists of collecting required additional data and conducting a data analysis of sufficient detail to evaluate the impact of in-place sediments as they relate to the objectives delineated under Phase I.

Phase III - Phase III uses the results obtained under Phase I and Phase II to conduct the detailed evaluation as required to address the study objectives. This process will occur in conjunction with alternative evaluations that consider engineering, economic, social, and environmental cost and benefits.

In addition to Phases I-III, consideration must also be given to the implementation of any alternative or proposed action and monitoring the results. Without a feedback mechanism, the validity of the analysis of both the impact of in-place sediments on water quality and the benefits from their removal or alteration will not be fully known.

## CASE STUDY

At the request of the U.S. Army Engineer District, Chicago, the impact of in-place contaminated sediments on the water quality in the Grand Calumet River/Indiana Harbor Canal (GCR/IHC) system was investigated during the 1985-1986 period in conjunction with a study on disposal alternatives for PCB-contaminated sediments from Indiana Harbor (USAE 1987). It was the intent of the Chicago District to use the results of this study to identify and quantify the potential benefits gained from dredging contaminated sediments from a Federally maintained project, thereby removing a continuing contaminant source for Lake Michigan. The U.S. Environmental Protection Agency was also



interested in the approach used in the study for assessing cleanup alternatives for the GCR/IHC system. The approach used in this study was limited to the assessment of existing data. A brief discussion from the report (Brannon et. al. 1986) of the study results is provided to illustrate the approach and its limitations and strengths.

The approach used for the evaluation consisted of obtaining and analyzing existing information obtained from Federal and non-Federal sources, including data files, in-house and published agency reports, and literature from scientific publications. The analysis focused on sediment-water interactions and their relationship to water quality, methods for estimating impacts of sediment-water interactions on water quality, and sediment and water quality data from the GCR/IHC system.

The scientific literature consistently identified the movement of suspended sediment as the major mechanism for transport of sediment associated contaminants. Other routes of contaminant mobilization from the sediment are through release of adsorbed contaminants from resuspended sediments and diffusion of contaminants from in-place sediment. Based on the literature and system data, the relative importance of mechanisms controlling contaminant movement from sediment in the GCR/IHC is in the order: transport of contaminants associated with particulates > transport of contaminants desorbed from suspended particulates > transport of soluble contaminants released from deposited sediment. Another mechanism for contaminant movement is through bioaccumulation. At present, this last mechanism is of minor importance due to the limited numbers of pollution-tolerant fish and low numbers of less pollution-tolerant fish species in the GCR/IHC.

Sediment oxygen demand (SOD) is an important oxygen consumption process and is also instrumental in turning on and off the sediment surface layer as a "valve" for oxidized and reduced materials. SOD is also a key parameter in water quality models that include dissolved oxygen utilization and balance. From the data available for waterways in the Chicago area, it appears that SOD is frequently found to be quite high; this is not unexpected in streams that are moderately to heavily polluted. The values given in published reports for the GCR/IHC are much lower than values given for similarly polluted streams in the Chicago area and thus are probably too low. Therefore, it is not possible to state with any degree of certainty the existing SOD values for the GCR/IHC system without laboratory and/or field studies.

Diffusion rates of PCB's into the water column from deposited sediments were developed by estimating equilibrium partitioning values of PCB's in sediment interstitial waters and appropriate diffusion equations. The estimated diffusion rates of PCB's in the sediments indicated that, in the absence of disturbances, movement of soluble PCB's is relatively minor. On the average, 1 sq m of bottom sediment would annually contribute 0.025 ng of PCB's to the overlying water. This value would be increased in the presence of bioturbation, but would remain a fairly minor component of contaminant input into the overlying water.

Results of equilibrium partitioning calculations made using data specific for the GCR/IHC system indicate that the U.S. Food and Drug Administration limits on PCB's concentrations in fish tissue for human consumption will be exceeded; this is provided that fish remain in the Indiana Harbor Canal for sufficient period to come to equilibrium with sediment PCB's. Unfortunately,

equilibrium partitioning cannot be conducted on compounds other than hydrophobic organic compounds for which sediment data are available. As a result, this procedure is restricted in evaluating polar organic compounds, heavy metals and those hydrophobic organic compounds known to be present in the Indiana Harbor Canal sediments, but for which sediment data are unavailable. In addition, a major weakness of the equilibrium partitioning approach is that the time necessary to reach equilibrium between sediment contaminants and the biota is unknown.

Based on a number of wastewater allocation models and water quality monitoring studies, estimates have been made on a number of pollutants from combined sewer overflows (CSOs) and urban runoff. However, pollutant loading estimates from other sources including waste fills are lacking. This information, along with data on toxic organic loadings from point and nonpoint sources, is essential to determine contaminant loading to Indiana Harbor.

In an evaluation of the benefits of dredging the Indiana Harbor Federal Channel, a knowledge of sediment sources and contaminant loading and how these contaminants move through the system is necessary. At present, this information is lacking; however, based on past studies of other harbor systems, it is anticipated that CSOs and urban runoff can be significant sources of sediments and contaminants during storm events. Further, these sources of contaminant and sediments may be the major long-term contributors to the Federal channel in the Indiana Harbor.

Under nondredging conditions, there are two major avenues for the resuspension and transport of sediment from the GCR/IHC system--normal ship traffic and storm events. Examination of data from bathymetric surveys for the years 1972, 1976, 1980, and 1984 indicates that the Indiana Harbor Canal has reached a shoaled equilibrium with the channel thalweg provided by passage of boat traffic. A sharp decrease in the channel depth was found between the years 1972 and 1976, with progressively smaller depth changes since 1976. The 1984 survey shows only a small overall change from the 1980 survey, an indication that the total amount of shoal material has not changed, but may only be redistributed.

The database for the GCR/IHC has only limited data on contaminant releases during interactions between suspended sediment and water. Velocity data and information on sediment resuspension are also very limited. To determine the mass of contaminants transported from the sediments during dredging and nondredging conditions, it will probably be necessary to use mathematical models. Further, prediction of the ultimate fate of contaminants in the GCR/IHC system, required for evaluation of overall water quality, may be aided by the use of contaminant models, but additional field and laboratory data should be obtained prior to intensive contaminant fate modeling studies.

Results of this study have shown that the available data allow only rough estimates, such as that in the CE's Indiana Harbor Environmental Impact Statement, of the sediment loadings, sediment yield, and benefits that would accrue from dredging the Indiana Harbor Canal. Historical dredging data strongly suggest, however, that dredging the Indiana Harbor Canal would allow it to act as a sediment trap, retaining contaminated sediment that would otherwise be transported into Lake Michigan. Additional data must also be collected before analytical techniques more sophisticated than those already conducted can be applied to the GCR/IHC system for either metals or toxic

organics. More detailed hydrodynamic and suspended sediment transport data are also necessary to allow use of more sophisticated analytical techniques for evaluating sediment sources, sediment resuspension, and sediment transport. Therefore, the immediate detailed application of either hydrodynamic or contaminant models is not recommended.

#### SUMMARY AND CONCLUSIONS

This paper reviews a concept that can be used by CE planners to identify and quantify environmental impacts from in-place contaminated sediments on a water body. The concept can be applied through a three-phase approach which allows quantification of cost and benefits associated with in-place sediments and proposed actions. By using a three-phase approach that incorporates the maximum use of existing data during Phase I, cost for field data collection and analyses can be kept at a minimum. Further, by using a phase approach decision points can be incorporated during each phase for assessing proposed benefits to be gained from collection and analyses of additional data which may be disproportionate to the incurred cost.

In the GCR/IHC case study, the approach was limited to Phase I with limited data collection under Phase II. Based on the analyses of existing data, it was concluded that insufficient data exist to quantify benefits. A report was prepared that delineated the findings and made recommendations on additional studies. To provide for flexibility, recommendations for future studies were given at three study levels. This approach allows the Chicago District the option of tailoring studies to meet specific objectives for maximum benefit at lowest cost.

#### ACKNOWLEDGEMENTS

This study was sponsored in part by the Office, Chief of Engineers, under the DOTS Program. The case study was sponsored by the Chicago District. The authors acknowledge the assistance of Mr. Jan Miller, Chicago District, Mr. James Martin and Mr. Daniel Averett, Waterways Experiment Station, in the conduct of the study. Permission was granted by the Chief of Engineers to publish this information.

#### REFERENCES

Brannon, J. M., Gunnison, D., Averett, A., Martin, J., Chen, R., Athow, R. Jr. 1986. "Analyses of Impacts of Bottom Sediments from Grand Calumet River and Indiana Harbor Canal on Water Quality," MP EL-86- , US Army Engineer Waterways Experiment Station, Vicksburg, Miss.

US Army Engineer Waterways Experiment Station. 1987. "Disposal Alternatives for PCB-Contaminated Sediments from Indiana Harbor, Indiana," US Army Engineer Waterways Experiment Station, Vicksburg, Miss.

EVALUATING BIOAVAILABILITY  
OF NEUTRAL ORGANIC CHEMICALS IN SEDIMENTS--  
A CONFINED DISPOSAL FACILITY CASE STUDY

Joan U. Clarke<sup>1</sup>, Victor A. McFarland<sup>2</sup>, and John Dorkin<sup>3</sup>

INTRODUCTION

Bioavailability of neutral organic chemicals such as polychlorinated biphenyls (PCB) in sediments can be evaluated using a simple two-tiered approach. This approach is based upon the fact that neutral organic chemicals are associated primarily with the organic carbon fraction of sediment and the lipid fraction of organisms. In the first tier of the bioavailability evaluation, the sediment concentration of a neutral organic contaminant is normalized on the decimal fraction organic carbon content of the sediment. Normalization in this sense means that the neutral organic contaminant concentration is expressed in terms of the organic carbon fraction of the sediment, where the contaminant is almost entirely concentrated, rather than in terms of the whole sediment. From this normalization, a lipid-fraction bioaccumulation potential (LBP) can be calculated. LBP reflects the maximum concentration of the contaminant that can occur in the lipid fraction of any organism, if that sediment is the only source of contaminant to the organism. LBP can easily be converted to a maximum whole-body bioaccumulation potential (WBP) for a particular organism, providing the organism's lipid content is known.

In the second tier of the bioavailability evaluation, actual bioaccumulation of the contaminant at steady state is determined from laboratory or field exposures of organisms to contaminated sediment. Comparison of the actual bioaccumulation at steady state to the maximum potential bioaccumulation (WBP) results in a numerical measure of bioavailability,  $p$ . If *all* of the contaminant in a sediment is available to the organism and metabolic degradation is negligible, then the value of  $p$  will be 1. Values of  $p < 1$  indicate limitations on bioavailability or that steady-state conditions have not been achieved; values  $> 1$  may indicate that the tested sediment is not the only source of contaminant to the organism.

The theoretical background and derivation of this two-tiered approach are detailed in McFarland (1984) and McFarland and Clarke (1986). McFarland and Clarke (1987) provide a nomograph for rapid estimation of WBP, and apply the approach to laboratory data from mussels exposed to PCB-contaminated sediments. This paper carries the approach beyond the laboratory to field data. PCB bioavailability is estimated for animals exposed to PCB-contaminated sediment within and outside of a confined disposal facility (CDF) in Calumet Harbor, Lake Michigan.

<sup>1</sup> Statistician (Biologist), Ecosystem Research and Simulation Division, Environmental Laboratory, U.S. Army Engineer Waterway Experiment Station

<sup>2</sup> Aquatic Biologist, Ecosystem Research and Simulation Division, Environmental Laboratory, U.S. Army Engineer Waterway Experiment Station

<sup>3</sup> Biologist, Environmental and Social Analysis Branch, U.S. Army Engineer Waterway Experiment Station

## STUDY LOCATIONS

The four study locations consist of a portion of the Chicago River (Station D) in the downtown area of Chicago, Illinois (Figures 1 and 2), and three areas (Stations A, B, and C) in Calumet Harbor on the southwest shoreline of Lake Michigan (Figures 1 and 3).

Station A is the pond inside a confined disposal facility (CDF) located in Calumet Harbor. This facility, called the Chicago Area CDF, was completed in 1984 for the disposal of contaminated dredged material from navigation projects maintained by the Chicago District, Corps of Engineers. These projects include the Chicago Harbor, the Chicago River, and the Calumet River and Harbor.

Stations B and C in Calumet Harbor are located inside the protection of breakwaters that form the harbor. Station B is directly adjacent to the outside walls of the Chicago Area CDF. Since the CDF is triangular in shape, Station B is subdivided into two sampling reaches. One reach is along the north-facing wall adjacent to the original river mouth, and the second reach is along the east-facing wall. The third leg of the triangle forming the CDF is landfill from an abandoned steel mill. The landfill was part of Lake Michigan's southwestern shoreline prior to construction of the CDF, and is now used as a commercial docking facility (Iroquois Landing) by the local port authority.

Station C is approximately one km north of the CDF against the protected side of one of the breakwaters. Station C is far enough away from the CDF or the influence of the river and harbor channel to serve as a relatively uncontaminated reference area.

The portion of the Chicago River chosen as Station D is a highly contaminated reach of the North Branch of the Chicago River in an area of downtown Chicago called Goose Island. In this reach of the navigation project channel, PCB concentrations average approximately 30 parts per million (ppm) in sediment cores up to 6 m in depth.

Stations A, B, C, and D are hereafter referred to as the Inside CDF, Outside CDF, Breakwater Area, and Chicago River study locations, respectively.

## SAMPLE COLLECTION AND ANALYSIS

Because determination of sediment and organism contaminant residues was not the sole purpose of this study, only a limited number of PCB analyses could be performed with available funding. Therefore, sediment aliquots taken from 22 grab samples (black circles in Figures 2 and 3) were composited to obtain samples for seven PCB analyses. These composites included one each from Inside CDF, Breakwater Area, and Chicago River; and four from Outside CDF, along the north and east walls (Stations B-North and B-East), and 200 m out from each wall (Stations B-N-200 and B-E-200 in Figure 3). Fish, crayfish, and a few samples of seston, worms and leeches were composited to provide samples for 50 PCB analyses; 48 of these tissue composites had detectable PCB concentrations and are included in this study. An additional eight composites of game fish and four quality control split samples are currently being analyzed by State of Illinois laboratories for a more extensive list of chemical variables.

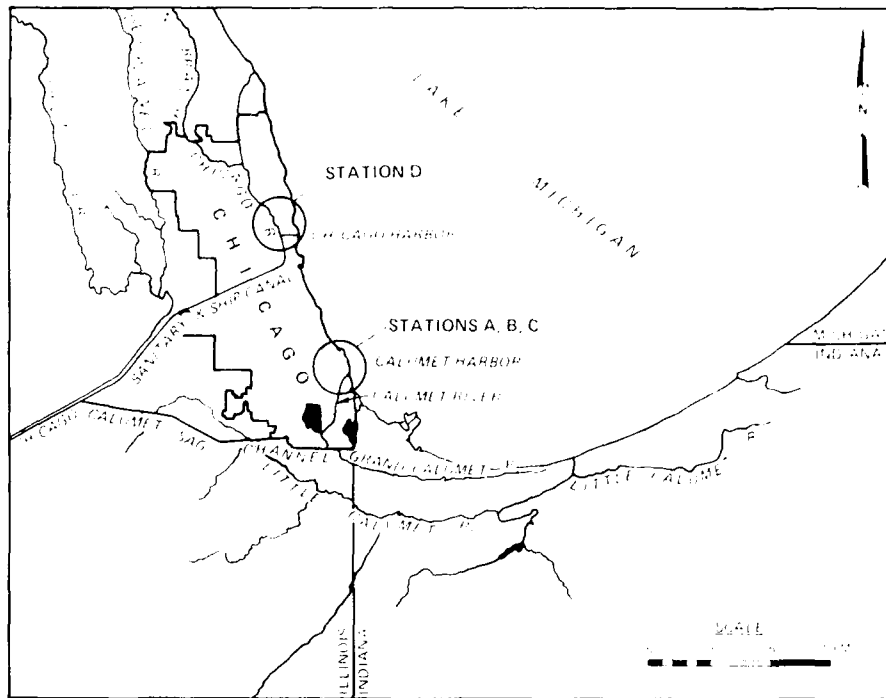

Figure 1. Study locations (Stations A, B, C, and D) in the Chicago area.

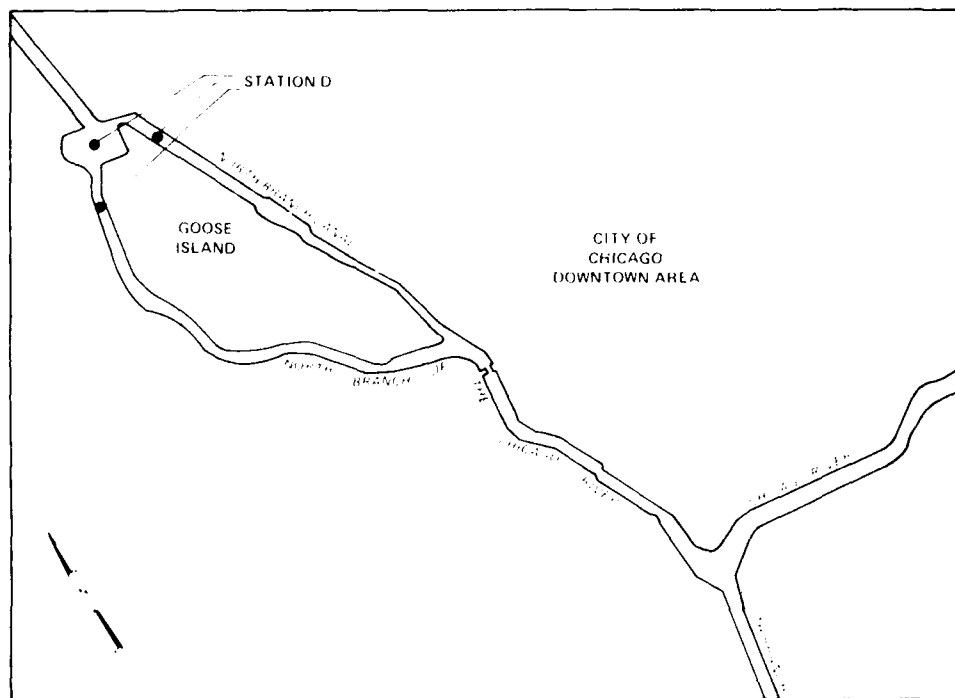

Figure 2. Sediment sample collection sites at Station D, Chicago River.

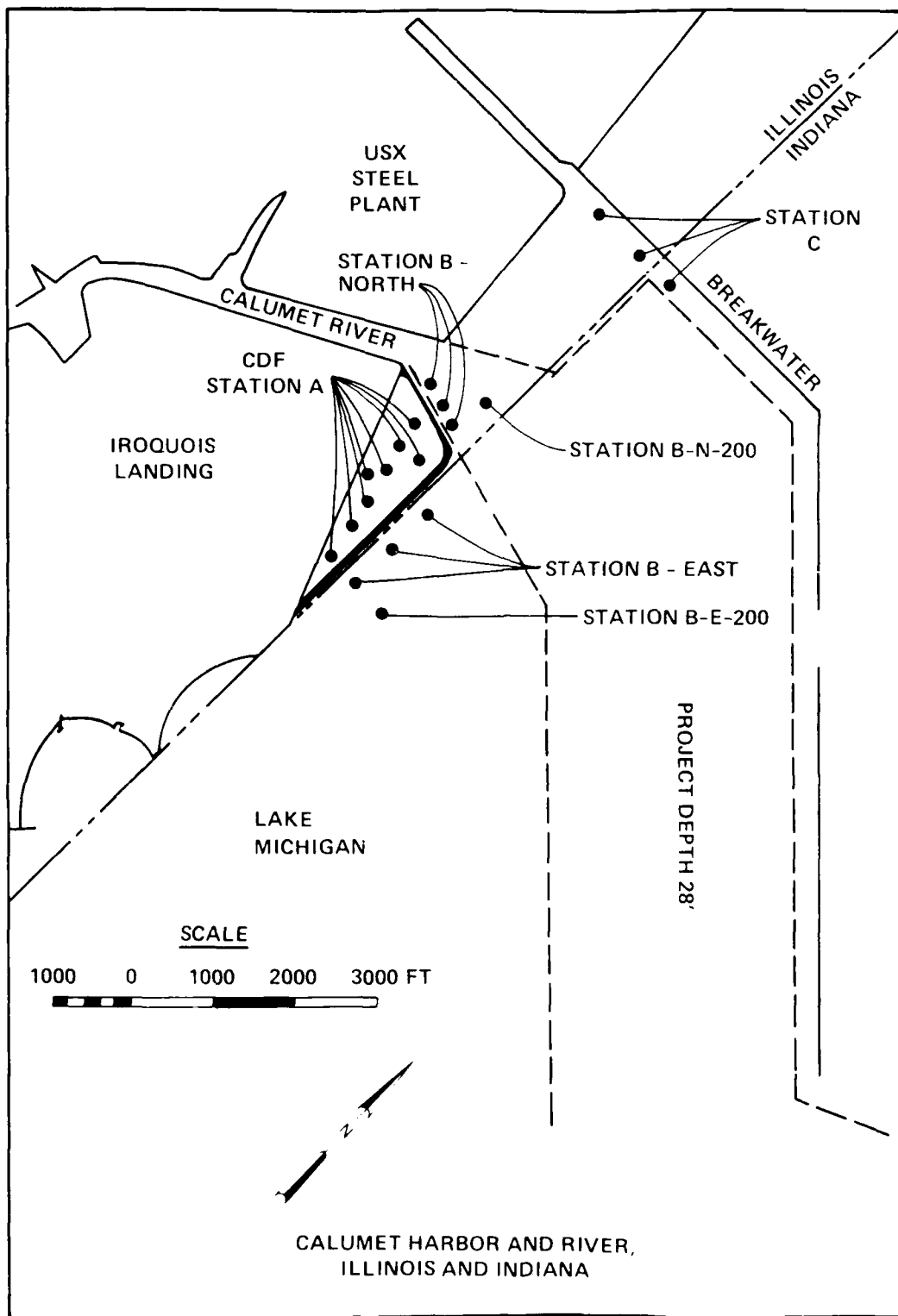

Figure 3. Sediment sample collection sites at Station A. Inside CDF; Station B, Outside CDF; and Station C, Breakwater Area.



Surficial sediments were collected with a ponar grab, and composites were formed by mixing equal volumes of homogenized material. Fish were collected using 38-m experimental gillnets and by electrofishing shoreline areas with a 230-volt AC shockerboat. Crayfish were collected using inverted cone minnow traps with openings enlarged 3 to 5 cm.

Fish and crayfish were composited in the field by species and size, wrapped in foil, and deep frozen immediately in space rented at a nearby commercial meatlocker. Composites were selected for analysis with the first priority to maximize the number of logical comparisons among the four study locations. A second priority was to concentrate effort on species and sizes of fish, such as yellow perch and alewife, that would most likely be readily collected in future studies of Lake Michigan navigation projects. The remaining samples were selected to provide information on species not routinely analyzed for contaminants by state and federal monitoring programs, such as invertebrates, sunfish and gizzard shad.

Sediment and biological tissue samples were analyzed for total PCBs and quantified using two different methods. One quantitation was performed with a standard composed of a mixture of equal portions of Aroclors 1242, 1248, 1254, and 1260. The second quantitation was performed by summing the measured concentrations of each of the computer-evaluated Aroclor peaks. Except for a couple of sediment samples, the results of these two quantitations were nearly identical. The results in this report are the average of the two quantitation methods.

Sediment samples were further analyzed for total organic carbon, and biological samples were analyzed for lipid. These analyses permit an examination of the ability of equilibrium partitioning theory to predict the fate of PCBs under field conditions.

#### BIOACCUMULATION POTENTIAL

Bioavailability of sediment PCBs (expressed as total PCB) is calculated through a modification of the two-tiered evaluation approach of McFarland and Clarke (1987). In Tier I, LBP is determined using the formula:

$$\text{LBP} = 1.72(C_s/\text{foc}) \quad (1)$$

where

- LBP = equivalent concentration of a chemical in organism lipid in the same units of concentration as  $C_s$
- 1.72 = preference factor of neutral organic chemicals for organism lipid over sediment organic carbon
- $C_s$  = concentration of chemical in the sediment (any units of concentration)
- foc = decimal fraction organic carbon content of the sediment.

Sediment data and LBP values for the four study locations are given in Table 1. The values of  $C_s$  and foc for the Outside CDF East side and North side are mean values from composites taken near the wall and 200 m from the wall. Values for East + North are the mean of values from all four Outside CDF sediment composites.

Table 1  
PCB Content, Organic Carbon Fraction, and Calculated LBP  
for Sediments from the Four Study Locations

Location	Total PCB C <sub>s</sub> , ppm	fOC	Total PCB LBP, ppm
Inside CDF	1.1	0.049	38.6
Outside CDF			
East side	0.4	0.0093	74.0
North side	1.36	0.0475	49.2
East + North	0.88	0.0269	56.3
Breakwater Area	0.04	0.017	4.05
Chicago River	1.4	0.045	53.5

LBP is a generalized bioaccumulation potential for the lipid of any organism. To convert LBP to a WBP for a specific organism of known lipid content, the following formula is used:

$$\text{WBP} = \text{LBP}(\text{fL}) \quad (2)$$

where

WBP = maximum whole-body bioaccumulation potential in the same units of concentration as LBP

fL = decimal fraction lipid content of an organism.

Lipid content and WBP values for total PCB in the tissue composites from the four study locations are shown in Table 2.

The sediment composites from the study locations are surficial sediments (top 8-15 cm) ranging in organic carbon content from <1 to almost 5%, and have relatively low total PCB concentrations of 1.4 ppm or less. Sediment from the Breakwater Area, in particular, was collected from a protected area consisting of clean, fine sand, away from areas of contaminated material deposition, and contained only 0.04 ppm total PCB. LBP values range from 4 ppm total PCB for organisms exposed to Breakwater sediment, to 74 ppm total PCB for organisms exposed to sediment collected near the outer east wall of the CDF.

Lipid content of the invertebrates from this study is generally <1%, whereas fish lipids range from about 1% in an orangespot sunfish sample to 17% in a gizzard shad sample (Table 2). The animals collected at the study locations may be arranged in seven groups based on feeding and migratory habits. Group 1, invertebrates (crayfish and worms), are most closely associated with the sediment and are the least migratory of the animals collected. Group 2, alewife and shad, are nomadic planktivores. Group 3, yellow perch, are omnivores that move diurnally from nearshore to offshore. Group 4, minnows, carp and goldfish, are mud foragers. Group 5, bullheads and catfish, are predators that feed near the bottom. Group 6, sunfish, reside close to shore

Table 2  
Lipid Fraction and Calculated WBP for Animals  
Collected from the Four Study Locations

Organisms	Lipid, Decimal Fraction	Total PCB WBP, ppm	Organisms	Lipid, Decimal Fraction	Total PCB WBP, ppm
<u>Inside CDF</u>			<u>Outside CDF*</u>		
Crayfish	0.014	0.54	Crayfish-E	0.0062	0.46
Crayfish	0.0088	0.34	Crayfish-N	0.0054	0.27
Alewife	0.14	5.41	Alewife-E+N	0.042	2.36
Yellow Perch	0.034	1.31	Alewife-N	0.032	1.58
Yellow Perch	0.033	1.27	Alewife-N	0.035	1.72
Yellow Perch	0.041	1.58	Yellow Perch-E	0.034	2.52
Bluntnose Minnow	0.013	0.50	Yellow Perch-N	0.035	1.72
Bluntnose Minnow	0.079	3.05	Yellow Perch-E	0.04	2.96
Black Bullhead	0.011	0.42	Yellow Perch-E	0.052	3.85
Channel Catfish	0.11	4.25	Yellow Perch-N	0.056	2.76
Orangespot Sunfish	0.011	0.42	Rainbow Trout-E	0.051	3.77
Green Sunfish	0.02	0.77	Brown Trout-N	0.12	5.91
Green Sunfish	0.018	0.70	Gizzard Shad-E	0.11	8.14
Pumpkinseed	0.022	0.85			
<u>Breakwater Area</u>			<u>Chicago River</u>		
Crayfish	0.0026	0.011	Worms/Leeches	0.0013	0.070
Crayfish	0.0061	0.025	Black Bullhead	0.029	1.55
Alewife	0.036	0.15	Green Sunfish	0.035	1.87
Alewife	0.017	0.069	Orangespot Sunfish	0.027	1.44
Yellow Perch	0.044	0.18	Carp	0.043	2.30
Yellow Perch	0.035	0.14	Goldfish	0.12	6.42
Yellow Perch	0.028	0.11			
Yellow Perch	0.048	0.19			
Yellow Perch	0.027	0.11			
Rainbow Trout	0.062	0.25			
Brown Trout	0.11	0.45			
Black Bullhead	0.022	0.089			
Channel Catfish	0.14	0.57			
Gizzard Shad	0.17	0.69			
Carp	0.066	0.27			

\*-E refers to average value from Station B-East and Station B-E-200 composites; -N refers to average value from Station B-North and Station B-N-200 composites; -E+N refers to average value from east and north composites

and graze on plants and large plankton. Group 1, trout, are migratory predators in the water column. The ranges of WBP values for the seven groups of animals are illustrated in Figure 4. WBP values for all animals are quite low in the Breakwater Area and correspond to the low sediment PCB concentration. Somewhat higher WBP values are calculated for animals inside the CDF, while the highest values for most animal groups occur at the Outside CDF and Chicago

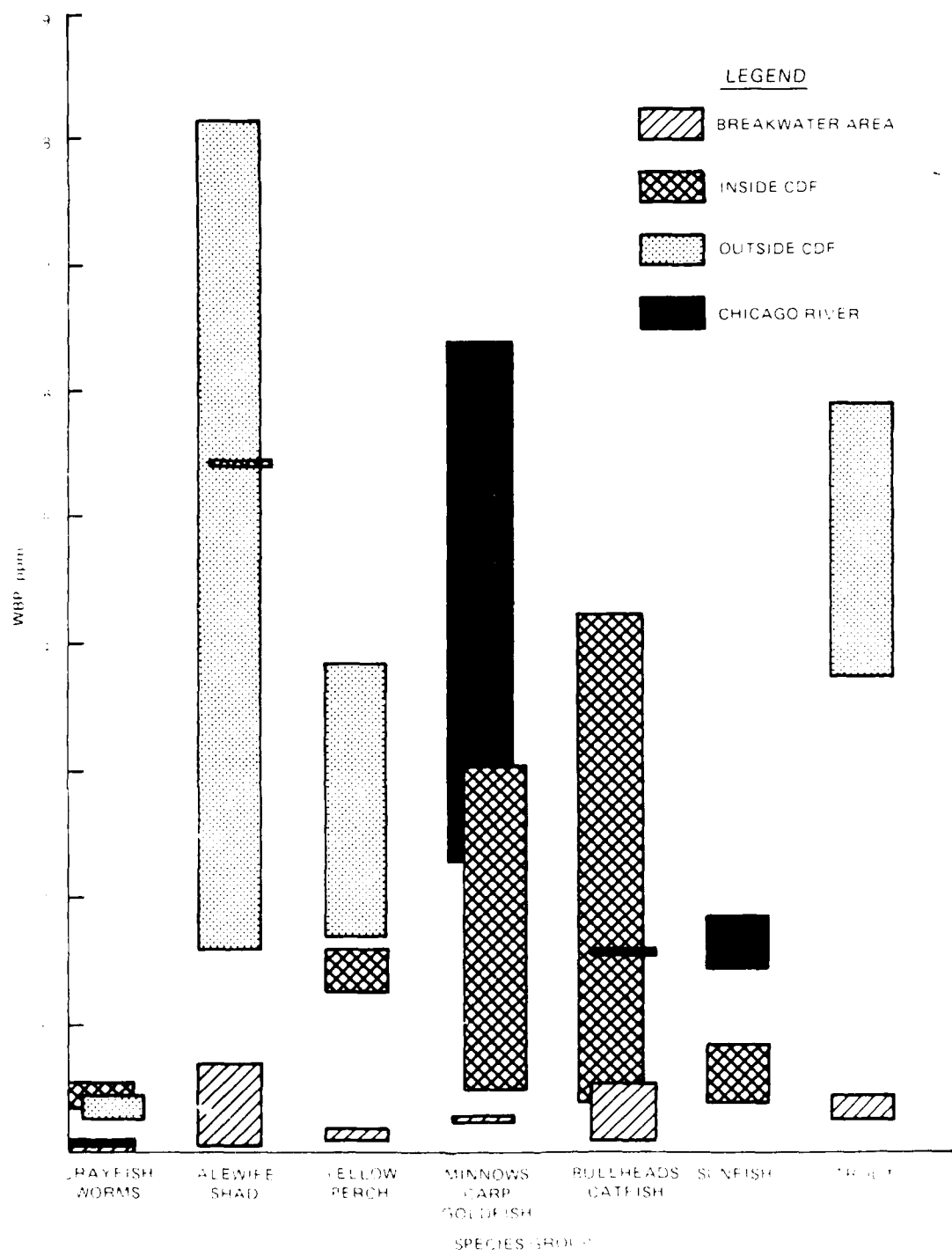

Figure 4. Total PCB Whole-body Bioaccumulation Potential (WBP) calculated from sediment composites from Breakwater Area, Inside CDF, Outside CDF, and Chicago River. Bars represent range of values for each species group.

River study locations. This trend will change considerably when bioavailability is examined in the next section.

### BIOAVAILABILITY

In Tier II evaluation for neutral organic chemicals, tissue concentrations actually achieved in an organism are compared with the maximum potential bioaccumulation (WBP) of the chemical of interest from the sediment to which that organism has been exposed. The approach as previously developed involved the determination of steady-state tissue concentrations from laboratory exposures under constant exposure conditions. Since steady state for many neutral organic chemicals would not be achieved during a short laboratory exposure, this approach generally required projecting steady-state tissue concentrations from time-sequenced sampling using a simple kinetic model, as described by McFarland and Clarke (1987).

The ratio of steady-state tissue concentration ( $C_{SS}$ ) to WBP may be considered a measure of bioavailability,  $p$ :

$$p = C_{SS}/WBP \quad (3)$$

This measure of bioavailability is the concentration of chemical that an organism would actually have at steady state compared to the maximum possible concentration that the organism *could* accumulate from the sediment under ideal conditions. A  $p$  value of 1 would indicate total bioavailability, *i.e.*, the organism has accumulated all of the chemical that it can accumulate from that sediment as the only source of exposure.

Field exposures present a somewhat different situation from the laboratory. In natural aquatic systems, exposure conditions cannot be held constant as they can in the laboratory, and in many cases fluctuate greatly. Fish move around freely and some species may travel great distances. Certain benthic invertebrates also migrate to some extent, and currents may alternately deposit and remove contaminants. Thus, a particular sediment may not be the only source of contaminant to the organisms collected in or near it. Determining bioavailability from field collections may have more utility as a means of assessing the nature of the exposure than as a measure of the extent to which maximum possible bioaccumulation has occurred. For example,  $p$  values much less than 1 could indicate that much of the contaminant in the sediment is not bioavailable, or that steady-state conditions have not been achieved. Conversely,  $p$  values much greater than 1 may be an indication that organisms have accumulated tissue residues from other, more highly contaminated sources than the sediment tested.

If time-sequenced tissue samples cannot be obtained, bioavailability may still be assessed for a given point in time from a single set of samples. In this case, no assumptions are made concerning steady state. The bioavailability formula then becomes:

$$p = C_T/WBP \quad (4)$$

where

$C_T$  = concentration of chemical in tissues of the organism at the time sampled.

For field samples, these p values may provide clues concerning exposure conditions, as described above. P values close to 1 could be indicative of a closed system near equilibrium, in which steady-state tissue concentrations have been achieved. Such could well be the case in a CDF.

Tier II results using Equation (4) are presented in Table 3 for the four study locations. Tissue PCB concentrations ( $C_T$ ) are mostly less than 4 ppm, with one alewife sample from Inside CDF having 6.4 ppm total PCB. These ranges are illustrated in Figure 5 for the seven groups of animals from the four study locations. There is more overlap in the  $C_T$  values at the four locations than in the WBP values (Figure 4), and breakwater animals do not always have the lowest tissue PCB concentrations.

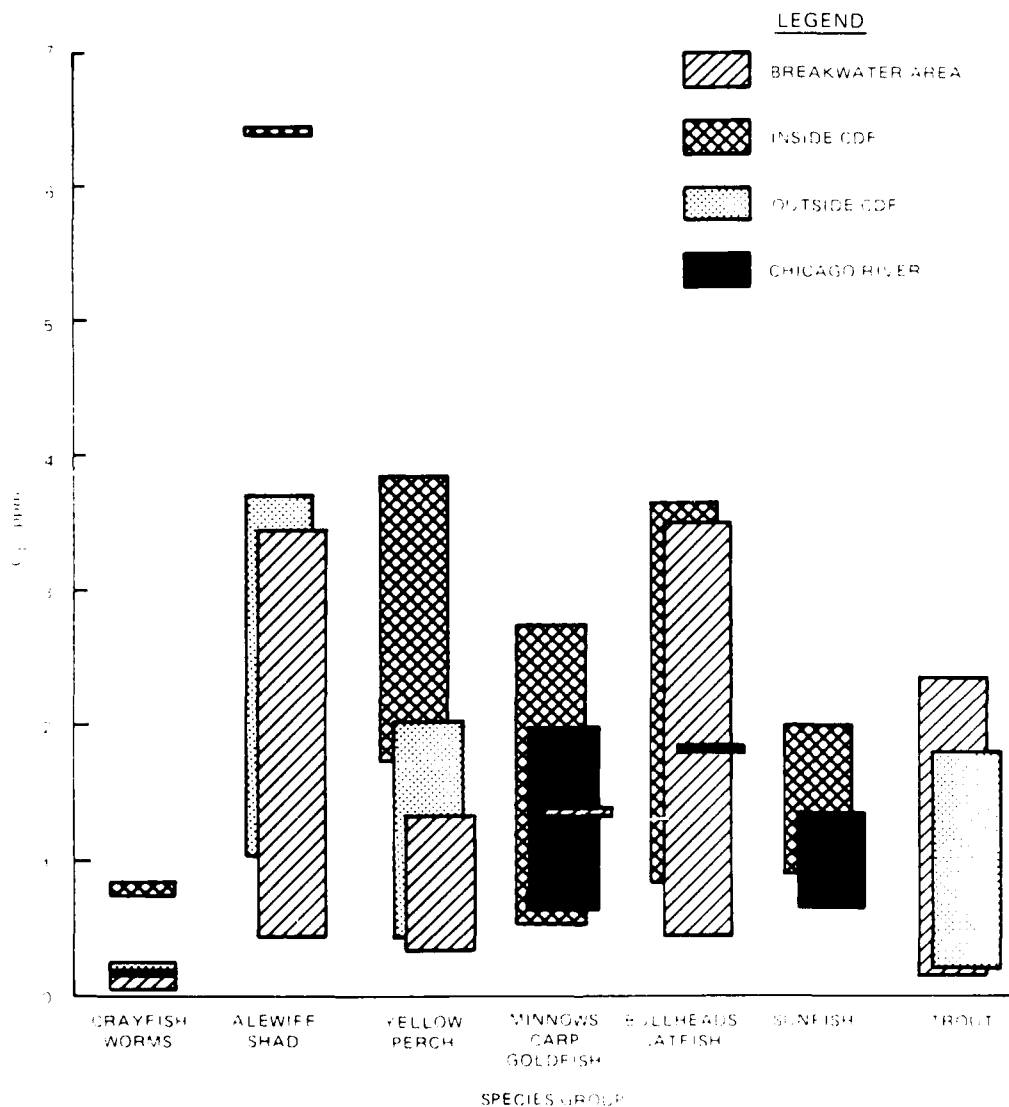

Figure 5. Total PCB tissue concentrations ( $C_T$ ) in biological composites from Breakwater Area, Inside CDF, Outside CDF, and Chicago River. Bars represent range of values for each species group.

Table 3  
PCB Tissue Concentrations and Calculated Bioavailability  
for Animals Collected from the Four Study Locations

Organisms	Total PCB C <sub>T</sub> , ppm	p	Organisms	Total PCB C <sub>T</sub> , ppm	p
<u>Inside CDF</u>			<u>Outside CDF*</u>		
Crayfish	0.76	1.41	Crayfish-E	0.18	0.39
Crayfish	0.84	2.47	Crayfish-N	0.26	0.98
Alewife	6.4	1.18	Alewife-E+N	1.05	0.44
Yellow Perch	1.75	1.33	Alewife-N	1.95	1.24
Yellow Perch	1.75	1.37	Alewife-N	1.35	0.78
Yellow Perch	3.85	2.43	Yellow Perch-E	0.56	0.22
Bluntnose Minnow	0.57	1.14	Yellow Perch-N	0.46	0.27
Bluntnose Minnow	2.75	0.90	Yellow Perch-E	1.05	0.35
Black Bullhead	0.85	2.00	Yellow Perch-E	2.05	0.53
Channel Catfish	3.65	0.86	Yellow Perch-N	1.9	0.69
Orangespot Sunfish	0.92	2.17	Rainbow Trout-E	0.19	0.05
Green Sunfish	2.0	2.59	Brown Trout-N	1.8	0.30
Green Sunfish	1.5	2.16	Gizzard Shad-E	3.7	0.45
Pumpkinseed	1.9	2.24			
<u>Breakwater Area</u>			<u>Chicago River</u>		
Crayfish	0.05	4.75	Worms/Leeches	0.18	2.59
Crayfish	0.18	7.29	Black Bullhead	1.8	1.16
Alewife	0.44	3.02	Green Sunfish	1.35	0.72
Alewife	1.55	22.53	Orangespot Sunfish	0.65	0.45
Yellow Perch	0.74	4.16	Carp	0.66	0.29
Yellow Perch	0.35	2.47	Goldfish	2.0	0.31
Yellow Perch	0.95	8.38			
Yellow Perch	1.35	6.95			
Yellow Perch	1.15	10.52			
Rainbow Trout	0.17	0.68			
Brown Trout	2.35	5.28			
Black Bullhead	0.45	5.05			
Channel Catfish	3.5	6.18			
Gizzard Shad	3.45	5.01			
Carp	1.35	5.05			

\*-E refers to average value from Station B-East and Station B-E-200 composites; -N refers to average value from Station B-North and Station B-N-200 composites; -E+N refers to average value from east and north composites

If tissue concentrations are normalized on organism lipid content, separations among the study locations become more distinct (Figure 6), and the trout samples, rather than the invertebrates, now have the lowest values. For most animal groups, the highest lipid-normalized tissue concentrations occur in samples from Inside CDF. One exceptionally high value (138 ppm) is noted for the worms and leeches collected in the Chicago River. Lipid-normalized C<sub>T</sub> values for crayfish, however, fall within the same range as the values for most of the fish.

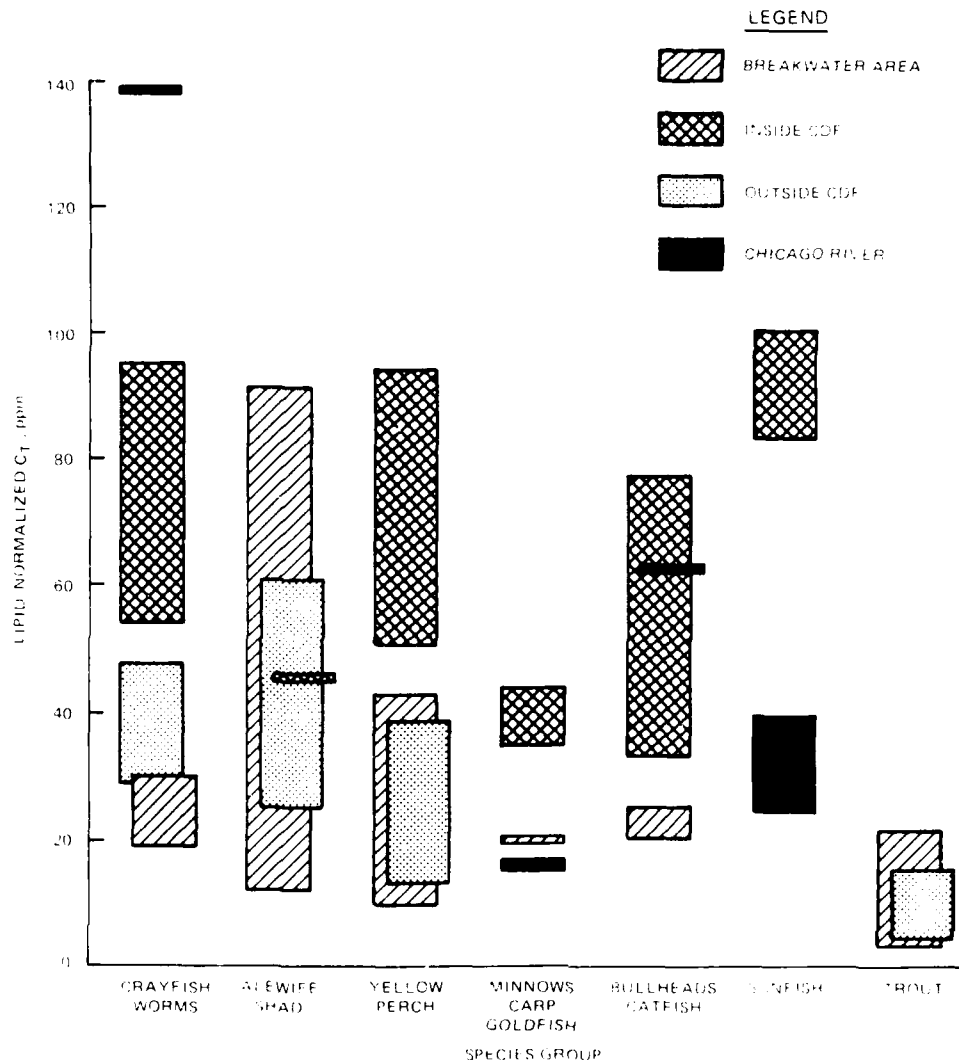

Figure 6. Lipid-normalized total PCB tissue concentrations ( $C_T$ ) in biological composites from Breakwater Area, Inside CDF, Outside CDF, and Chicago River. Bars represent range of values for each species group.

Calculated bioavailability ( $p$ ) values for most animal groups show distinct differences among the four study locations (Table 3 and Figure 7). In all groups (except sunfish, which were not collected at Breakwater Area), the highest bioavailability occurs at Breakwater Area, with  $p$  values ranging up to 22.5. The lowest  $p$  values occur Outside CDF, and are generally less along the east side than along the north side (Table 3). Bioavailability for samples Inside CDF is on the order of 1 to 2. These trends are illustrated more fully in Figure 8, in which the actual  $p$  values for each sample are plotted against the corresponding WBP values. If a reference line is drawn at  $p = 1$ , all but one of the Outside CDF samples and four of the six Chicago River samples fall on or below the line. Inside CDF samples are concentrated near and slightly above the reference line. All but one of the Breakwater Area samples lie well above the line.



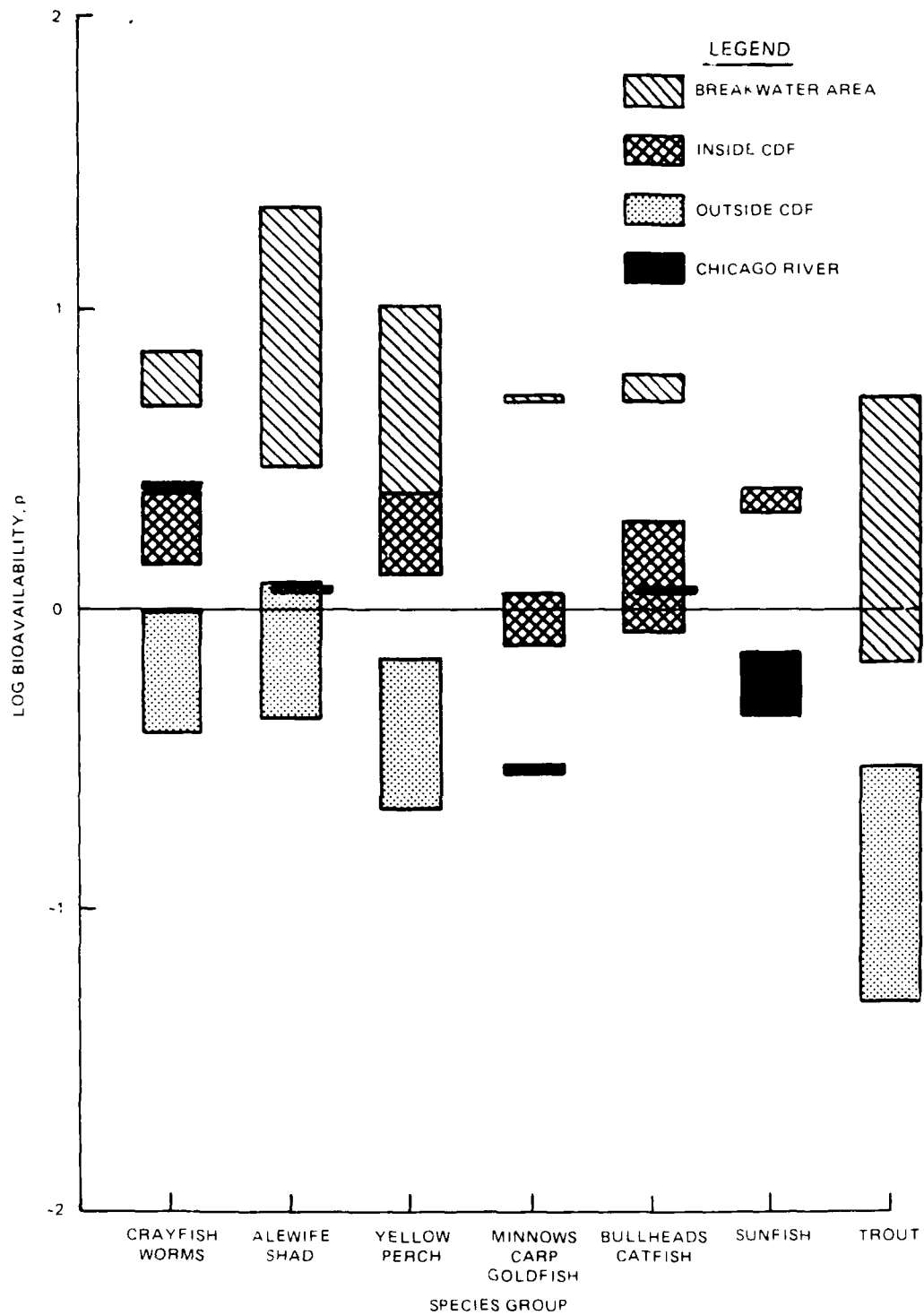

Figure 7. Total PCB bioavailability ( $\log_{10} p$ ) for biological composites from Breakwater Area, Inside CDF, Outside CDF, and Chicago River. Bars represent range of values for each species group.

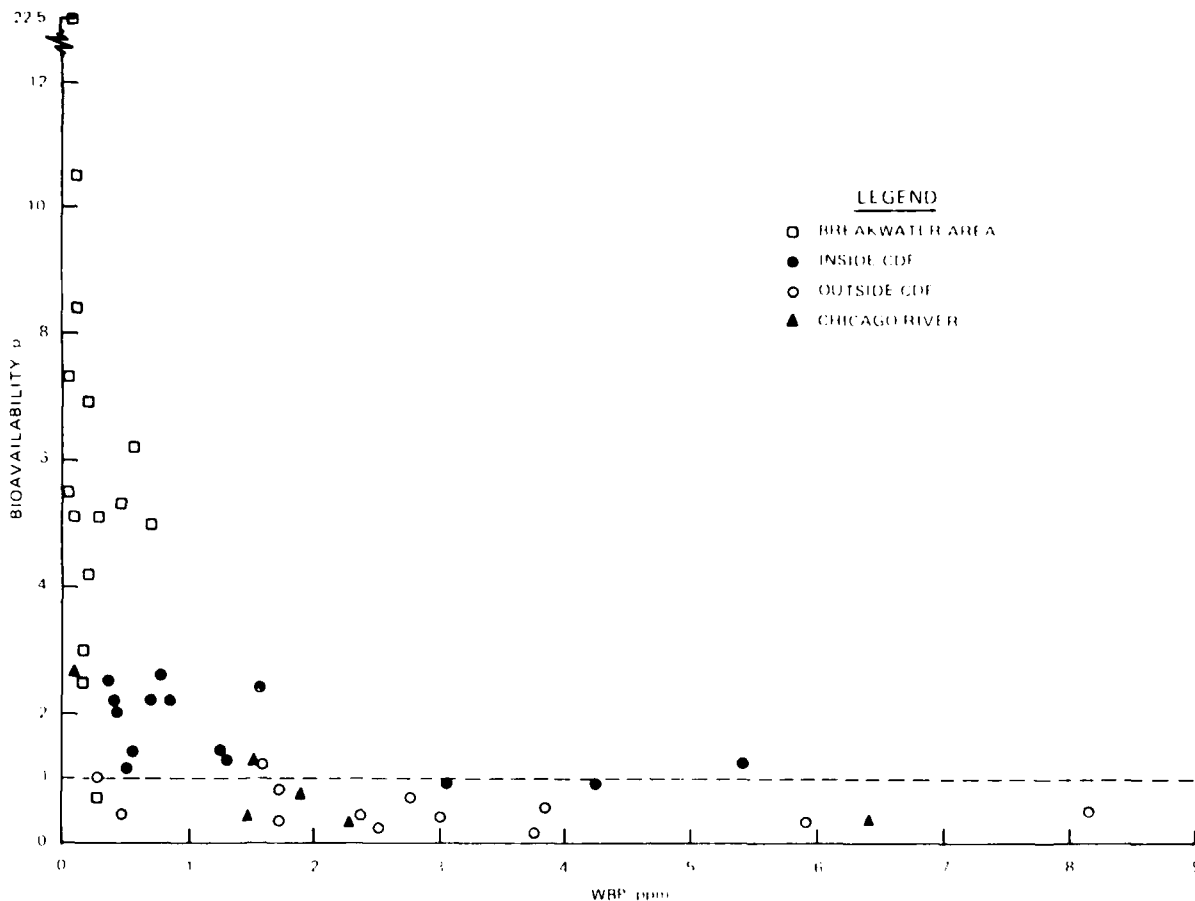

Figure 8. Plot of bioavailability (p) vs. Whole-body Bioaccumulation Potential (WBP) for biological composites from Breakwater Area, Inside CDF, Outside CDF, and Chicago River.

#### DISCUSSION

The relationships underlying the bioaccumulation potential and bioavailability calculations described above are derived from classical equilibrium partitioning theory (Prausnitz 1969). Simply put, a chemical can be expected to distribute itself in a closed system consisting of two or more mutually distinct, homogeneous phases, according to its relative solubility in each of the phases (Mackay 1979; Mackay and Paterson 1981, 1982). Distribution may occur rapidly or slowly but the end result will be the same. At equilibrium the net transfer of chemical between phases is zero, and the relative concentrations of chemical in any two phases of the system are described by a partition coefficient. The "preference factor" (pf) used to calculate bioaccumulation potential from sediment chemistry data is a partition coefficient for the two phases represented by sediment organic carbon and organism lipid. In other words, concentration in lipid equals concentration in sediment organic carbon multiplied by the preference factor (McFarland 1984).

Natural environments are complex systems consisting of a number of separate phases that are by no means internally homogeneous. In aquatic systems, chemicals are distributed primarily among the phases represented by water, sediment, biota, and suspended particulate material (Reuber et al. 1987). True equilibrium probably never exists in natural aquatic systems. However, on a local scale, where change in composition and in volume of contiguous phases is very slow, a non-equilibrium steady state is possible. A small-scale example of such a steady-state condition would be the distribution of a chemical contaminant in the tissues of a sediment-processing infaunal organism, the sediment it inhabits, and the interstitial water of the sediment. On a somewhat larger scale the pond inside a confined disposal facility, such as the Chicago Area CDF, which has a slow rate of water advection, may represent a steady-state condition in terms of the distribution of neutral, persistent chemicals. For the sediment and biota in the Chicago Area CDF, we would expect calculations of bioavailability (p) to be consistently near unity for the PCBs. At each of the other study locations, there would be much greater variability in conditions of water mixing and rate of advection, perturbation of the sediments by traffic and storm activity, and discontinuous residency of biota in the vicinity. In other words, the PCB body burden of organisms collected near where the sediment samples were taken at sites outside of the CDF may or may not reflect local sediment contamination.

That the Chicago Area CDF is, in fact, an ecosystem with near steady-state conditions in terms of PCB contamination is suggested by the results depicted in Figures 7 and 8. Calculations of bioavailability appear quite consistent for all organisms taken inside the CDF regardless of phylogenetic differences, association with sediment, or place in the food chain. Values of p tend to be higher than unity, but by less than a factor of two. The preference factor (pf) used in these calculations was derived from laboratory investigations involving equilibrium partitioning of neutral organic chemicals to either fish lipids (Könemann and van Leeuwen 1980) or to sediment organic carbon (Karickhoff 1981). In both of these investigations, partitioning of chemicals to the organic phase (lipid or organic carbon) from water was regressed on the octanol:water partition coefficients ( $K_{ow}$ ) of the chemicals involved. Calculation of the preference factor for organism lipid relative to sediment organic carbon involved taking the difference in the intercepts of the two regression estimates at the geometric mean log  $K_{ow}$  of the combined data sets (McFarland and Clarke 1986). The pf obtained was 1.72, meaning that at equilibrium the concentration of a neutral organic chemical (assuming total bioavailability and negligible degradation) in organism lipid would be about 1.72 times the concentration in organic carbon of the sediment source. This study has shown that the hypothesized value of 1.72 may be low, as is also suggested by the results of some other investigators.

At the USEPA Environmental Research Laboratory, several species of sediment-processing infaunal polychaetes and bivalve molluscs were recently exposed to PCB-contaminated natural marine sediments until steady-state conditions were achieved. Empirically derived preference factors or "accumulation factors" (AF) in moderately or highly contaminated sediment averaged  $3.82^4$ . Similarly, infaunal organisms collected from the field together with the

4. Personal communication, Norman I. Rubinstein, USEPA Environmental Research Laboratory, Narragansett, RI.

sediments they inhabited produced an average AF of 3.39<sup>5</sup>. In the present investigation, pf (or AF) calculated using sediment and organism residue data from Inside CDF averages 2.98. These results strongly suggest that in actual field situations involving contaminated sediments and associated biota at steady state, one should expect a pf of approximately 3, rather than the laboratory-derived value of 1.72.

In contrast with the consistency of bioavailability across species in the CDF, the Outside CDF and Chicago River calculations tend to show species differences. Crayfish, worms and some bottom-dwelling fish from the Outside CDF and Chicago River sites appear to have PCB residues that reflect sediment contamination. Fish with more nomadic habits, particularly the trout and yellow perch taken at these locations, produce p values that fall far below unity, indicating that residues in these fish are much less than are the sediment bioaccumulation potential levels.

The contrast between bioavailability calculations for organisms taken at Breakwater Area and all other sites is especially marked. Breakwater sediments were less contaminated by a factor of 20 to 30 than were any others, and PCB residues in all organisms collected from the Breakwater were substantially greater than predicted by the simple model based on sediment contamination alone. Figures 5 and 6 show that Breakwater Area crayfish and worms, the species having most direct sediment contact, are less contaminated than the same species taken from any other site. Yet, p values for these organisms at Breakwater Area are far greater than unity. The pattern is similar for other organisms, particularly the lipoidal shad and alewife group, and p values only for some trout are low enough to approximate unity. The researchers at Narragansett, in the work cited above, similarly found that AF's (or bioavailabilities) were much higher than expected when sediment contamination was low. An obvious implication of this result is that contamination of Breakwater Area biota is the result of exposure to other sources of PCB having higher bioaccumulation potential than exists in Breakwater Area sediments. In recent laboratory investigations at the U.S. Army Engineer Waterways Experiment Station<sup>6</sup>, fish exposed to PCB-contaminated sediments in the absence of suspended particulate matter bioaccumulated virtually the same amount of PCB from relatively uncontaminated as from contaminated sediments. Contaminated microparticulate material arising from the surface of the sediments may have been the primary route of exposure. In both cases the absolute levels of tissue residues were low. These laboratory results reflect those observed in the field and reported here.

Another possible explanation is that food chain transfer (biomagnification) or particulate ingestion dominate as routes for uptake of neutral chemicals when sediment contamination is very low. In this event waterborne pollutants sorbed with algae or organic microparticulates from remote sources could be major contributors to contamination of larger organisms and their food. Under these conditions kinetics of uptake may be favored over elimination because of the very low solubility of PCBs in water. Alternatively,

5. Personal communication, James L. Lake, USEPA Environmental Research Laboratory, Narragansett, RI.

6. V.A. McFarland, J.U. Clarke, A.H. Karara, B.P. Pierce and W.A. Boyd. Ecosystem Research and Simulation Division, Environmental Laboratory, U.S. Army Engineer Waterways Experiment Station, Vicksburg, MS. In preparation.

properties of organic carbon or organism lipid that strongly affect chemical distribution in favor of lipid under conditions of low contamination, may exist but have not yet been identified.

Bioaccumulation potential and bioavailability evaluations as described in this paper can be used as a tool for determining some of the impacts that dredging and disposal of contaminated sediment, or alternatively, leaving contaminated sediment in place, may have on aquatic ecosystems. Application of the evaluation procedure to moderately contaminated sediments and associated biota in this case study produced results that were consistent with the assumptions of the model, but indicated that adjustment of the preference factor may be necessary. Results obtained with sediments having a low order of contamination were also consistent with recent laboratory results of Rubinstein and field results of Lake, but are not explained in the model, and are not yet well understood. Additional research, both in the laboratory and in the field, is necessary to resolve apparent anomalies and to fully develop the model and evaluation procedure for regulatory use.

#### SUMMARY

A simple model for bioaccumulation potential and bioavailability of neutral chemicals from sediments was applied in a Chicago Area CDF case study. Tissue residues of total PCB in a number of fish and invertebrates within the CDF consistently reflected contamination of the sediments. Ratios of residues to sediment contamination were approximately constant regardless of species when concentration data were normalized on sediment organic carbon and on organism lipid. Steady-state conditions between sediment and organism contamination appear to exist within the CDF for all organisms analyzed, including those fish that normally are not thought to have direct contact with the sediments. Comparison of organism-residue:sediment-contamination relationships at sites outside the CDF indicated non-steady-state conditions where high sediment contamination existed. Higher tissue residues than are predicted by the model were found in biota taken from a site of low sediment contamination. This result is consistent with other recent laboratory and field results, but is not accounted for in the model.

#### ACKNOWLEDGMENTS

Funding for this work was provided in part by the Chicago District North Branch Chicago River Dredging Project, and in part by the Long-Term Effects of Dredging Operations Program (LEDO), Work Unit 31772. The LEDO Program is sponsored by the Office, Chief of Engineers, U.S. Army. Permission was granted by the Chief of Engineers to publish this information. Sample collection and analysis were performed by the Illinois Natural History Survey and Daily Analytical Laboratories. The authors wish to thank Drs. Henry Tatem and Thomas Wright, U.S. Army Engineer Waterways Experiment Station, and Messrs. Paul Whitman and Jan Miller, U.S. Army Engineer District, Chicago, for technical review of the manuscript.

## REFERENCES

- Karickhoff, S.W., "Semi-empirical Estimation of Sorption of Hydrophobic Pollutants on Natural Sediments and Soils," Chemosphere, Vol. 10, No. 8, 1981, pp. 833-846.
- Könemann, H. and K. van Leeuwen, "Toxicokinetics in Fish: Accumulation and Elimination of Six Chlorobenzenes by Guppies," Chemosphere, Vol. 9, 1980, pp. 3-19.
- Mackay, D., "Finding Fugacity Feasible," Environ. Sci. Technol., Vol. 13, No. 10, 1979, pp. 1218-1223.
- Mackay, D. and S. Paterson, "Calculating Fugacity," Environ. Sci. Technol., Vol. 15, No. 9, 1981, pp. 1006-1014.
- Mackay, D. and S. Paterson, "Fugacity Revisited", Environ. Sci. Technol., Vol. 16, No. 12, 1982, pp. 654A-660A.
- McFarland, V.A., "Activity-based Evaluation of Potential Bioaccumulation from Sediments," Dredging '84 - Proceedings, R. L. Montgomery and J. L. Leach, Eds., American Society of Civil Engineers, New York, Vol. 1, 1984, pp. 461-467.
- McFarland, V.A. and J.U. Clarke, "Testing Bioavailability of Polychlorinated Biphenyls from Sediments Using a Two-Level Approach," Proceedings, USAE Committee on Water Quality, Sixth Seminar, The Hydrologic Engineering Center, Davis, CA, 1986, pp. 220-229.
- McFarland, V.A. and J.U. Clarke, "Simplified Approach for Evaluating Bioavailability of Neutral Organic Chemicals in Sediment," Environmental Effects of Dredging Technical Note EEDP-01-8, U.S. Army Engineer Waterways Experiment Station, Vicksburg, MS, 1987, pp. 1-11.
- Prausnitz, J.M., Molecular Thermodynamics of Fluid-phase Equilibria, Prentice-Hall, Inc., Englewood Cliffs, NJ, 1969.
- Reuber, B., D. Mackay, S. Paterson and P. Stokes, "A Discussion of Chemical Equilibria and Transport at the Sediment-Water Interface," Environ. Toxicol. Chem., Vol. 6, No. 10, 1987, pp. 731-739.

USE OF DAPHNIA MAGNA AND MYSIDOPSIS ALMYRA  
TO ASSESS SEDIMENT TOXICITY

By

1

Henry E. Tatem

INTRODUCTION

Sensitive aquatic crustaceans, such as the freshwater species Daphnia magna, and two estuarine species, Mysidopsis almyra and Mysidopsis bahia, are recognized as good laboratory test organisms. They have been recommended for a variety of water quality applications, including water quality criteria investigations and studies to determine the toxicity of effluents and sediments (APHA 1985, Nebeker et al. 1984, Nimmo and Hamaker 1982).

Daphnia species have been used for laboratory bioassay testing for at least four decades (Buikema et al. 1982). The two mysids, M. almyra and M. bahia, have been used as laboratory test animals since 1978 (USEPA 1978, Rogers et al. 1986). These organisms are now being used to evaluate the toxicity of sediments that contain contaminants such as metals, pesticides, polychlorinated biphenyls (PCBs), petroleum hydrocarbons and polycyclic aromatic hydrocarbons (PAHs). Daphnid species used for laboratory toxicity testing include D. magna, D. pulex, and Ceriodaphnia affinis/dubia; mysid species used similarly include M. bahia, M. almyra, and M. bigelowi. Ceriodaphnia is a recent addition to the list of available daphnid test species (Mount and Norberg 1984) and is considered by some to be difficult to culture (DeGraeve and Cooney 1987). There are also problems associated with the long-term laboratory culture of mysids (Rogers et al. 1986).

Aquatic sediments readily trap and retain many contaminants. Sediments, especially those containing relatively high percentages of organic carbon, clay and silt, or oil and grease compounds, trap contaminants from the water column and thereby protect aquatic organisms from acute toxic effects. However, the sediments can retain contaminants to the point that they become harmful to sensitive aquatic organisms.

Both daphnids and mysids are being used, and in many cases required, for sediment and drilling mud toxicity determinations. Daphnia have been used for the testing of contaminated freshwater sediments (Prater and Anderson 1977, Nebeker et al. 1984, Cairns et al. 1984, LeBlanc and Suprenant 1985, and Malueg et al. 1984) while mysids have been used for dredged material testing, general aquatic toxicity tests and tests of drilling muds (USEPA/CE 1977, Duke et al. 1984, USEPA 1985).

1

Biologist, US Army Engineer Waterways Experiment Station, Environmental Laboratory, CEWES ES-R, PO Box 631, Vicksburg MS 39180 601 634-3695

This paper describes a series of sediment toxicity tests using Daphnia magna and Mysidopsis almyra. Four test sediments, from an estuarine area, were mixed in the laboratory, using non-spiked contaminated material, to produce a range of contaminated sediment from relatively low to relatively high contaminant concentrations. Since a major sediment contaminant was mercury, the sediments have been categorized by their mercury content. Previous studies of this area (Santoro and Koepp 1986, Albers et al. 1986, Weis et al. 1986, Kraus and Kraus 1986) have examined mercury (Hg) levels in organisms or behavioral effects on organisms but have not documented sediment contaminants, other than Hg, and have not examined overall sediment toxicity. One objective of this study was to determine whether sediment toxicity could be related to degree of sediment contamination. Another was to determine whether sediment storage at 4 degrees C affected sediment toxicity.

## MATERIALS AND METHODS

### Sediment Collection and Mixing

Contaminated sediment was obtained from a shallow estuarine area in the northeastern United States. Over 50 containers (5-gallon plastic buckets) were taken from 10 sites in the area. Subsamples from each container were taken, at the collection site, for Hg analyses. Containers were filled to the top, sealed and transported, using a refrigerated truck, to the laboratory in Vicksburg, MS. They were held at 4 degrees C. The holding period was to allow time for sediment chemical analyses and to prepare four homogenized composite sediment mixtures that would contain different Hg levels, from "low" to "high". During the holding period sediments were analyzed for 12 metals, PCBs, pesticides, PAHs and phthalates.

### Sediment Bioassay Testing

Daphnia were exposed to the sediment mixtures at 2 and 4 parts per thousand (ppt) salinity; Mysidopsis were exposed at 14 ppt salinity. Sediment mixed with 0 ppt water (the freshwater used to culture the daphnids) produced sediment suspended particulate phase (SPP) at 1 to 2 ppt salinity. The goal was to expose the test organisms to sediment and SPP at the same time, and for a period long enough to determine both acute toxicity and important sublethal effects. Daphnia surviving the sediment exposure period were weighed to determine whether relative weight could be used as a sublethal indicator of contaminated sediment effect. The test procedures were developed by combining previously established methods for sediment toxicity tests (Nebeker et al. 1984, Swartz et al. 1985, USEPA/CE 1977) and elutriate preparation (Plumb 1981). Conditions for these tests were 24 degrees C temperature with a photoperiod of 12 hr L:12 hr D.

Sediment SPP was prepared by adding sediment and water to a glass jar at a 1:4 ratio (one part sediment to four parts water). Sediment and water were stirred by hand for 2 minutes and shaken for 40 minutes, at 120 rpm. After shaking, the mixtures were allowed to settle overnight (approximately 20 hours). The liquid SPP was siphoned from the mixing jar into a second jar and aerated for one hour. During this time, sediment left at the bottom of the mixing jar was removed and placed in the test beakers. Thus, 200 ml of sediment was added to each of 5 one-liter beakers. The SPP (800 ml) was then added to the beakers and they were placed in a lighted, temperature-regulated water bath.



The animals, 10 for each of 5 test beakers, were exposed to SPP and sediment for the initial 48 hr of the test. During this time it was difficult to count the small animals due to the presence of fine sediment particles in the water column. The age of the *Daphnia* at the beginning of the test was 48 to 72 hr; age of the mysids was 7 to 9 days. *Daphnia* were removed from the beakers at 48 hr, counted, and placed in glass dishes containing SPP from the same beakers that had held the test animals. They were counted and observed for the remaining 96 hr of the test. At the end of the test, remaining animals were weighed and examined for reproductive effects. Weight data reported here are the mean of 7 or 8 separate determinations using 2 *Daphnia* for each number. The sediment mixtures were tested six times during a period starting 5 months after collection to 7 months later, or 12 months after collection. Toxicity and weight data were statistically analyzed using the SAS ANOVA procedure followed by the Waller-Duncan K-Ratio T test for means separation (SAS 1985).

## RESULTS AND DISCUSSION

### Sediment Chemical Analyses

Sediment chemical analysis data for metals, pesticides, PCBs, PAHs and phthalate esters are shown in Table 1. Sediments were also analyzed for other USEPA priority pollutants but these were below detection limits. The data reveal a range of sediment contaminants with sediment 1 (Sed 1) material generally containing lower levels of contaminants compared to the other 3 sediments. It is evident that the sediment mixture containing the most Hg (Sed 4) generally contained the greatest concentrations of all the contaminants.

Many of the metals are high in relation to background concentrations for sediments (Malueg et al. 1984, LeBlanc and Surprenant 1985). Sediment 2 could be considered heavily contaminated with Hg, As, Cr, Pb, and other metals by some criteria (LeBlanc and Surprenant 1985). Sediment 1 contained <0.5 ppm of PCBs compared to over 100 ppm in Sed 4. This was fortuitous since the sediments were mixed according to their Hg content. Sediment PCB concentrations of 3 to 10 ppm are not unusual but concentrations of over 100 ppm could be considered heavily contaminated and potentially toxic (Tatem 1986a).

Two pesticides were found in these sediments, dieldrin and endrin. The data for dieldrin are similar to those for the metals and PCBs in that Sed 1 contained the lowest concentration and Sed 4 contained the most dieldrin. A number of PAHs were found but only in Sed 3 and Sed 4. Total PAHs in Sed 4, >11.0 ppm are not extremely high (Neff 1979, Tatem 1986b). One phthalate, bis(2-ethylhexyl), also known as DEHP was found in all of the sediments. It is not considered very toxic but is ubiquitous in the environment (Wams 1987).

### Sediment Toxicity Data

*Daphnia* were exposed to the contaminated sediments, and a clean, sandy reference material, six times during a 7-month period (Tables 2 and 3). The first experiment lasted 48 hr. It revealed high *Daphnia* survival for controls (animals held in beakers without sediment) and those exposed to the reference sediment. Test sediments 1 and 3 also produced relatively good survival, i.e., 82% and 74%, respectively. This test also showed that survival of Sed 2 daphnids was less than that for Sed 3 and Sed 4 organisms. This result was surprising since the chemical

data showed that Sed 3 and Sed 4 were much more contaminated than Sed 2. Experiment 2 (Exp 2) was run immediately after the first test and indicated that, at 4 ppt salinity, the daphnids could survive 5 days exposure to Sed 1 and Sed 2 but were adversely affected by Sed 3 and Sed 4. At 72 hr, survival of animals exposed to Sed 3 and Sed 4 was significantly ( $p < 0.05$ ) less than that for controls or animals exposed to the other, less contaminated sediments. This trend continued at 116 hr; the data at 116 hr also indicate that Sed 3 was more toxic than Sed 4. Another test (Exp 3) was conducted within 5 days of Exp 2. Since there had been differences in the results for the two previous tests, and they were conducted at two salinities, Exp 3 was conducted using both the 2 ppt and the 4 ppt salinities, side by side. Daphnia were not exposed to reference sediment or Sed 1 because previous tests had shown that the animals were relatively unaffected by these sediments. The Exp 3 data confirmed the lack of toxicity associated with Sed 2 and showed the dramatic effects of Sed 3 and Sed 4, but only after the full 120-hour exposure period. One difference between Exp 2 and Exp 3 was the 72-hr results. In Exp 2 there were significant results after 72 hours. In experiment 3 there was little toxicity exhibited until 120 hours exposure to the sediments and SPM. The third test also showed that animals exposed to the heavily contaminated Sed 3 and Sed 4 at 2 ppt salinity were more affected than those exposed at 4 ppt. Again these results were not readily apparent until 120 hours of exposure.

Approximately 4 months later, Exp 4 and Exp 5 were run, using only the 2 ppt salinity (Table 3). This condition, it was felt, would be the most likely to demonstrate potential toxicity. Exp 4 again showed sediments 1 and 2 to be relatively harmless while sediments 3 and 4 were toxic. There was concern, however, that sediments 3 and 4 were becoming more toxic after 4 months storage, based on the 48- and 72-hr data, so Exp 5 was conducted within 5 days of Exp 4. The Exp 5 results were, in general, similar to Exp 2 and 3 in that the 48-hr results did not indicate the dramatic toxicity shown at 48 hr in Exp 4. The Exp 5 results (72 hr) again show Sed 3 to be more toxic than Sed 4.

Overall, for Exp 2 to Exp 5, animals exposed to sediments 1 and 2 revealed > 80% survival at 120 hours whereas animals exposed to the more contaminated sediments had significantly lower survival, especially at the 2 ppt salinity, usually < 10% survival. The last test, conducted 2 months after Exp 5, again confirmed the earlier results. Animals exposed to the reference sediment and to Sed 1 and Sed 2 had 100% survival throughout the test while animals exposed to Sed 3 and Sed 4 were adversely affected after only 72 hours exposure and showed only 10% or 12% survival at 120 hours of exposure.

Daphnia magna has been shown to be one of the most sensitive sediment test organisms (Prater and Anderson 1977, Nebeker et al. 1984) and is easy to use for simple, static sediment toxicity tests. Although they are water-column animals, their feeding habits cause them to closely interact with surface sediments. There have been few studies of the effects of storage on sediment toxicity. Malueg et al. (1986) studied copper-spiked sediments stored for 25 weeks at either 5 or -20 degrees C. Freezing seemed to reduce sediment toxicity. The toxicity of sediment stored at 5 degrees C showed a trend of increasing toxicity for 12 weeks and then declined at week 25. These data do not appear to be definitive, however, since Daphnia mortality at weeks 0, 3, 8, 12 and 17 were not substantially different from each other (Maleug et al. 1986, Table 2). These data are not directly comparable to the present work since Maleug et al. (1986) used a spiked sediment to which peat moss had been added. Their sediment without peat moss was spiked to contain as much as 1100 or 1500 ppm Cu. This is a higher Cu concentration than in Sed 4 used in the

present study. However, Sed 4 also contained substantial levels of Hg, PCBs and other contaminants. Thus, direct comparisons are difficult, yet it can be concluded that both studies demonstrate that heavily contaminated sediments, stored at 4 or 5 degrees C, do not lose their toxicity after being held in the laboratory for up to 4 months (Maleug et al. 1986) or 12 months (this study).

Data for the one mysid toxicity test are shown in Table 4. Experimental conditions for Mysidopsis were similar to the Daphnia tests except salinities were 14-16 ppt and animals were not removed from the beakers at 48 hr. Controls, reference sediment animals and those exposed to Sed 2 had >90% survival. The lowest survival, 78%, was found for animals exposed to Sed 4. The mysid tests were not continued since one objective of this work was to show that sediment toxicity, when present, did not change dramatically over time. Daphnia, it was felt, were more likely to provide the necessary data.

Mysids have not been used for sediment toxicity testing, except for dredged material SPP testing, to the degree that the freshwater daphnids have (Nimmo and Hamaker 1982, Rogers et al. 1986). Shuba et al. (1978) reported that mysids exposed to contaminated harbor dredged material were adversely affected in a series of preliminary tests. Mysids are now being used to test drilling muds (Rogers et al. 1986); however, the more commonly used marine sediment toxicity organism is the Pacific amphipod Rhepoxynius abronius (Swartz et al. 1985).

#### Sediment Sublethal Effects Data

Data on the fresh weight of Daphnia after 5 days exposure to the different treatments (Exp 2 to 5) are shown in Table 5. They show that Daphnia surviving the exposure period had, in general, significantly less growth with Sed 3 or Sed 4 than with Sed 1 or Sed 2. In experiments 2 to 4 the weights of animals exposed to the more contaminated materials were significantly less than those of control animals. Weights of the controls increased from Exp 2 to 5 due to more feeding times for all treatments for Exp 4 and 5 compared to Exp 2 and 3. The data show that animals exposed to nontoxic, but moderately contaminated sediments, such as Sed 1 and Sed 2 derived some nutritional benefit from the sediments. In 3 out of 4 cases, animals exposed to these sediments showed the greatest weight at the end of the test.

Weight data can show sediment effects that are not readily apparent from the toxicity data alone. The Exp 4 data illustrate this. Toxicity data for Exp 4-Sed 2 were similar to the other tests (Exp 2 to 5) but the weight data in Table 5 show that Daphnia exposed to Sed 2 did not grow at the same rate as the animals exposed to this sediment in Exp 2, 3 and 5. The Sed 1 animals from Exp 4 weighed less than the controls which was unusual. Toxicity data for Exp 4 show that, at 72 hr, Sed 4 was more toxic than for any of the other tests. It seems apparent that Exp 4 was different in some manner from the other tests. This fact would not have been revealed without the animal weight data. There appear to be no other studies or data available on the growth of Daphnia exposed to contaminated sediments although Daphnia growth and reproduction are discussed by Nebeker et al. (1984) as useful parameters to monitor during sediment toxicity tests.

## SUMMARY

Daphnia magna have been shown to be useful organisms for screening contaminated sediments for acute toxicity and for determination of sublethal effects on growth. This freshwater species demonstrated acceptable control survival in 4 ppt salinity water and revealed better survival when exposed to the contaminated sediments at 4 ppt compared to 2 ppt salinity. The data suggest that sediment toxicity tests should be run for at least 120 hr to insure definitive results of either acute toxicity or sublethal effects. Contaminated sediments held at 4 degrees C for 5 months were shown to be toxic and retained their toxicity for 12 months of storage. The toxicity was generally related to the overall concentration of chemical contaminants in the sediments. The Mysidopsis results were not conclusive but suggest that mysids exposed to the sediments at 14 ppt salinity were not as sensitive to Sed 3 and Sed 4 as the Daphnia. The Daphnia were easily weighed after the sediment tests and can be observed for reproductive effects. The Daphnia weight data supported the toxicity data and can be used to show the relative health of the test animals. Weight data for Exp 4 showed a harmful effect of Sed 2 that was not apparent from the toxicity data alone.

## ACKNOWLEDGMENTS

The author would like to thank Ms. Joan Clarke and Drs. Lloyd Saunders, John Simmers and Richard Lee, US Army Engineer Waterways Experiment Station (WES), for technical review of this manuscript. This study was completed with the expert technical assistance of Ms. Susan Portzer. Funding for this work was provided by an agreement between the State of New Jersey Department of Environmental Protection (NJDEP) and the WES. Permission to publish this information was granted by the NJDEP and the Chief of Engineers.

## REFERENCES

Albers, P.H., L. Sileo and B. Mulhern, "Effects of Environmental Contaminants on Snapping Turtles of a Tidal Wetland," Arch. Environ. Contam. Toxicol. Vol. 15, 1986 pp. 39-49.

American Public Health Association (APHA), Standard Methods for Examination of Water and Wastewater, 16th Edition, APHA, Washington DC, 1985.

Buikema, A.L. Jr., B. Niederlehner and J. Cairns Jr., "Biological Monitoring Part IV-Toxicity Testing," Water Res. Vol. 16, 1982 pp. 239-262.

Cairns, M.A., A. Neberker, J. Gakstatter and W. Griffis, "Toxicity of Copper-Spiked Sediments to Freshwater Invertebrates," Environmental Toxicology and Chemistry, Vol. 3, 1984 pp. 435-445.

DeGraeve, G.M. and J. Cooney, "Ceriodaphnia: An Update on Effluent Toxicity Testing and Research Needs," Environmental Toxicology and Chemistry, Vol. 6, 1987 pp. 331-333.

Duke, T.W., P. Parrish, R. Montgomery, S. Macauley, J. Macauley and G. Cripe, "Acute Toxicity of Eight Laboratory-Prepared Generic Drilling Fluids to Mysids

(Mysidopsis bahia)," USEPA-600-36-067, USEPA, Gulf Breeze FL, 1984.

Kraus, M.L. and D. Kraus, "Differences in the Effects of Mercury on Predator Avoidance in Two Populations of the Grass Shrimp Palaemonetes pugio," Marine Environmental Research, Vol. 18, 1986 pp. 277-289.

LeBlanc, G.A. and D. Surprenant, "A Method of Assessing the Toxicity of Contaminated Freshwater Sediments," Aquatic Toxicology and Hazard Assessment: Seventh Symposium, ASTM STP 854, R. Cardwell, R. Purdy and R. Bahner, Eds., American Society for Testing and Materials, Philadelphia, 1985 pp. 269-283.

Malueg, K.W., G. Schuytema, and D. Krawczyk, "Effects of Sample Storage on a Copper-Spiked Freshwater Sediment," Environmental Toxicology and Chemistry, Vol. 5, 1986 pp. 245-253.

Mount, D.I. and T. Norberg, "A Seven-Day Life-Cycle Cladoceran Toxicity Test," Environmental Toxicology and Chemistry, Vol. 3, 1984 pp. 425-434.

Nebeker, A.V., M. Cairns, J. Gakstatter, K. Maleug, G. Schuytema and D. Krawczyk, "Biological Methods for Determining Toxicity of Contaminated Freshwater Sediments to Invertebrates," Environmental Toxicology and Chemistry, Vol. 3, 1984 pp. 617-630.

Neff, J.M., Polycyclic Aromatic Hydrocarbons in the Aquatic Environment, Applied Science Publishers LTD, London, 1979.

Nimmo, D.R. and T. Hamaker, "Mysids in Toxicity Testing-A Review," Hydrobiologia, Vol. 93, 1982 pp. 171-178.

Plumb, R.H., Procedures for Handling and Chemical Analysis of Sediment and Water Samples, USAEWES Environmental Laboratory, Vicksburg MS, 1981.

Prater, B.L. and M. Anderson, "A 96-Hour Bioassay of Otter Creek, Ohio," Journal WPCF, Vol. 49, 1977 pp. 2099-2106.

Rogers, J.H., P. Dorn, T. Duke and R. Parrish, "Mysidopsis sp.: Life History and Culture, A Report from a Workshop Held in Gulf Breeze, FL October 15-16, 1986," Institute of Applied Sciences-NTSU, Denton TX, 1986.

Santoro, E.D. and S. Koeppe, "Mercury Levels in Organisms in Proximity to an Old Chemical Site (Berrys Creek, Hackensack Meadowlands, NJ, USA)," Marine Pollution Bulletin, Vol. 17 (5), 1986 pp. 219-224.

SAS Users Guide: Statistics, Version 5 Edition, Cary, NC: SAS Institute Inc., 1985.

Shuba, P.J., H. Tatem and J. Carroll, "Biological Assessment Methods to Predict the Impact of Open-Water Disposal of Dredged Material," Technical Report D-78-50, USAEWES Environmental Laboratory, Vicksburg MS, 1978.

Swartz, R.C., W. DeBen, J. Jones, J. Lamberson and F. Cole, "Phoxocephalid Amphipod Bioassay for Marine Sediment Toxicity," Aquatic Toxicology and

Hazard Assessment: Seventh Symposium, ASTM STP 854, R. Cardwell, R. Purdy and R. Bahner, Eds., American Society for Testing and Materials, Philadelphia, 1985 pp. 284-307.

Tatem, H.E., "Bioaccumulation of Polychlorinated Biphenyls and Metals from Contaminated Sediment by Freshwater Prawns, Macrobrachium rosenbergii and Clams, Corbicula Fluminea," Arch. Environ. Contam. Toxicol., Vol. 15, 1986a pp. 171-183.

Tatem, H.E., "Exposure of the Clams Rangia cuneata and Yoldia limatula to Sediment Containing PAHs, PCBs and Metals," Abstract and Presentation at the ASTM 10th Symposium on Aquatic Toxicology and Hazard Assessment, May 4-6, New Orleans LA 1986b.

USEPA/CE Technical Committee on Criteria for Dredged and Fill Material, "Ecological Evaluation of Proposed Discharge of Dredged Material into Ocean Waters," USAEWES Environmental Laboratory, Vicksburg MS, 1977.

USEPA Ocean Disposal Bioassay Working Group, "Bioassay Procedures for the Ocean Disposal Permit Program," EPA 600/9-78-010, USEPA, Gulf Breeze FL, 1978.

USEPA, "Effluent Limitations Guidelines and New Source Performance Standards: Appendix 3-Drilling Fluids Toxicity Test," Federal Register 50 (165):34631-34636, USEPA, Washington DC, 1985.

Wass, T.J., "Diethylhexylphthalate as an Environmental Contaminant-A Review," The Science of the Total Environment, Vol. 66, 1987 pp. 1-16.

Weis, P., J. Weis and J. Bogden, "Effects of Environmental Factors on Release of Mercury from Berrys Creek (New Jersey) Sediments and Its Uptake by Killifish Fundulus heteroclitus," Environ. Pollut. Ser. A, Vol. 40, 1986 pp. 303-315.

TABLE 1. Chemical Analyses of Four Sediment Mixtures

PARAMETER	SED 1	SED 2	SED 3	SED 4
Percent Sand, Silt, Clay *	-	-	-	-
Percent TOC, TVS	-	-	-	-
O and G	-	-	-	-
COD	-	-	-	-
TKN, NH3-N	-	-	-	-
TP	-	-	-	-
METALS-ppm * *				
Hg	1.6	29.2	301.0	1490.0
Ag	0.9	8.4	12.7	17.0
As	8.2	10.3	22.2	91.1
Cd	0.8	15.8	33.1	120.0
Cr	123.0	414.0	917.0	2560.0
Cu	82.7	268.0	571.0	858.0
Ni	52.7	72.0	74.8	144.0
Pb	118.0	279.0	392.0	294.0
Zn	248.0	774.0	3960.0	16000.0
Se	0.8	0.7	0.8	0.6
Be	0.8	0.8	1.0	1.2
Tl	<0.1	<0.1	1.0	12.6
POLYCHLORINATED BIPHENYLS-ppm				
PCB-1242	<0.01	<0.05	<0.1	<0.5
PCB-1248	0.14	1.73	6.51	55.80
PCB-1254	0.16	1.42	2.87	40.30
PCB-1260	0.10	0.45	0.93	6.92
-----	-----	-----	-----	-----
TOTAL PCBs	0.42	3.70	10.51	104.02
PESTICIDES-ppm				
BHC-G(Lindane)	<0.001	<0.005	<0.01	<0.05
Heptachlor	<0.001	<0.005	<0.01	<0.05
Aldrin	<0.001	<0.005	<0.01	<0.05
Endosulfan 1	<0.001	<0.01	<0.05	<0.05
Dieldrin	0.001	0.03	0.12	0.16
DDE-DDD-DDT	<0.001	<0.005	<0.01	<0.05
Endrin	<0.001	0.08	0.20	<0.05
Chlordane	<0.01	<0.05	<0.10	<0.50
Toxaphene	<0.01	<0.05	<0.10	<0.50

Table 1. continued

-----  
 POLYCYCLIC AROMATIC HYDROCARBONS--ppm

Naphthalene	<0.84	<1.20	1.48	1.73
Acenaphthylene	<0.84	<1.20	<0.90	<0.98
Acenaphthene	<0.84	<1.20	<0.90	<0.98
Flourene	<0.84	<1.20	<0.90	<0.98
Phenanthrene	<0.84	<1.20	1.36	1.08
Anthracene	<0.84	<1.20	<0.90	<0.98
Fluoranthene	<0.84	<1.20	2.30	3.20
Pyrene	<0.84	<1.20	1.80	2.50
Chrysene	<0.84	<1.20	<0.90	<0.98
Benzo(b)fluoranthene	<0.84	<1.20	1.47	1.35
Benzo(k)fluoranthene	<0.84	<1.20	1.47	1.35
Benzo(a)pyrene	<0.84	<1.20	<0.90	<0.98
Indeno(123cd)pyrene	<0.84	<1.20	<0.90	<0.98
Benzo(ghi)perylene	<0.84	<1.20	<0.90	<0.98
-----	-----	-----	-----	-----
TOTAL PAHs (14)	<0.84	<1.20	9.88	11.21

PHTHALATE ESTERS--ppm

Phthalate, bis(2-ethylhexyl)	3.3	4.7	7.3	7.9
------------------------------	-----	-----	-----	-----

-----

\* Particle size and organic carbon (TOC), volatile solids (TVS), oil and grease (O and G), chemical oxygen demand (COD), kjeldahl and ammonia nitrogen (TKN and NH<sub>3</sub>-N), and phosphorus (TP) data are useful for sediment toxicity screening but are not available for these sediments

\* \* Metals data are reported on a dry weight basis; all other data are reported on a wet weight basis



TABLE 2. Toxicity Response of Daphnia magna to Reference and Contaminated Sediment-Initial Results

Treatment	Mean Number of Survivors						
	Exp1	Exp2			Exp3		
	48h	48h	72h	116h	48h	72h	120h
Control(0ppt)	9.6A *	10.0A	10.0A	10.0A	10.0A	10.0A	9.6A
Control(4ppt)	-	10.0A	10.0A	10.0A	9.8A	9.2A	8.6A
Ref Sediment (2ppt)	9.8A	-	-	-	-	-	-
(4ppt)	-	10.0A	9.8A	9.0B	-	-	-
Sed-1 (2ppt)	8.2B	-	-	-	-	-	-
(4ppt)	-	9.4A	9.2A	9.2B	-	-	-
Sed-2 (2ppt)	1.4C * *	-	-	-	10.0A	10.0A	10.0A
(4ppt)	-	9.6A	9.6A	9.0B	10.0A	10.0A	10.0A
Sed-3 (2ppt)	7.4B	-	-	-	9.6A	9.0A	0.2C
(4ppt)	-	9.2A	5.0B	0.4D	9.8A	8.8A	1.6C
Sed-4 (2ppt)	2.0C	-	-	-	10.0A	9.0A	0.4C
(4ppt)	-	9.2A	4.4B	4.2C	9.4A	7.8A	3.2B

\* Numbers with the same letter are not significantly different, between treatments, at the 0.05 level; the means comparison procedure used was the Waller-Duncan K-Ratio T Test

\* \* Low survival most likely related to initial low DO levels

TABLE 3. Toxicity Response of Daphnia magna to Contaminated Sediment-Results After Storage at 4 degrees C

Treatment	Mean Number of Survivors								
	Exp 4			Exp 5			Exp 6		
	48h	72h	120h	48h	72h	120h	48h	72h	120h
Control	10.0A	10.0A	10.0A *	9.75A	9.75A	9.75A	10.0A	10.0A	10.0A
Ref sed (2ppt)	9.4A	9.4A	9.0B	-	-	-	10.0A	10.0A	10.0A
Sed-1 (2ppt)	10.0A	10.0A	10.0A	-	-	-	10.0A	10.0A	10.0A
Sed-2 (2ppt)	10.0A	9.6A	8.4B	9.75A	9.75A	9.75A	10.0A	10.0A	10.0A
Sed-3 (2ppt)	4.8B	1.6B	0.0C	8.25B	2.5B	0.0B	9.0B	5.4C	1.2B
Sed-4 (2ppt)	4.6B	0.8B	0.0C	10.0A	8.0A	0.0B	9.6B	7.0B	1.0B

\* Numbers with the same letter are not significantly different, between treatments, at the 0.05 level; the means comparison procedure used was the Waller-Duncan K-Ratio T Test

TABLE 4. Toxicity Response of Mysidopsis almyra to Contaminated Sediment

Treatment	Mean Number of Survivors
	120h *
Control (14ppt)	9.8
Ref Sediment	9.6
Sed-1	8.2
Sed-2	9.4
Sed-3	8.8
Sed-4	7.8

\* Data were not obtained at 48 or 72h due to the difficulty of counting the animals in the SPP

TABLE 5. Growth Response of Daphnia magna Exposed to Four Sediment Mixtures

Treatment	Mean Fresh Weight (mg) of 2 Daphnia			
	Exp 2	Exp 3	Exp 4	Exp 5
Control	1.14B *	2.14B	3.29A	3.97B
SW Control (4ppt)	0.94B	2.27B	- * *	-
Sed-1 (2ppt)	-	-	2.63B	-
(4ppt)	1.42A	-	-	-
Sed-2 (2ppt)	-	3.82A	0.95C	4.48A
(4ppt)	1.45A	4.63A	-	-
Sed-3 (2ppt)	-	0.00D	0.00D	0.00C
(4ppt)	0.00C	1.35C	-	-
Sed-4 (2ppt)	-	0.00D	0.00D	0.00C
(4ppt)	0.38C	1.00C	-	-

\* Numbers with the same letter are not significantly different, between treatments, at the 0.05 level; the means comparison procedure used was the Waller-Duncan K-Ratio T Test

\* \* A dash indicates that animals were not exposed at that salinity

## DREDGED-MATERIAL DISPOSAL PLANNING PROGRAMS

by David T. Ford<sup>1</sup>

### INTRODUCTION

Efficient long-term dredged-material management requires long-term planning. Three computer programs are available to assist with this planning. The programs are (1) an operation optimization program, (2) a geographic information system (GIS), and (3) a capacity-expansion program. The operation optimization program determines the least-costly annual allocation of material to available disposal sites. The GIS identifies potential new disposal sites. The capacity-expansion program finds the least-costly site acquisition sequence. The programs were used in the Delaware River dredging disposal study.

### OPERATION OPTIMIZATION PROGRAM

**Program Objective.** - The operation optimization program determines the minimum-cost operation policy for any existing or proposed disposal system (Ford, 1984).

**Procedure.** - The optimization program models a disposal system as a network, as illustrated by Fig. 1. Dredging sites and disposal sites are represented by network nodes. The nodes are connected with arcs that represent transportation links through which material may be moved. The material volume moved is constrained by the capacity of the physical link. For example, an arc that represents a pipeline has a limitation on flow in the arc equal to the capacity of the pipeline. Also associated with each arc is a unit cost for moving material. To analyze long-term operation, single-period networks are linked by arcs that represent storage of material in the disposal sites.

A network-flow programming optimization algorithm is used to determine the minimum-cost assignment of material to the network arcs. The operation represented by this assignment is the optimal policy.

**Program Input and Output.** - Input required includes (1) estimated quantities of material dredged at each site each period, (2) description of disposal-site physical and economic characteristics, (3) description of material-transportation facility characteristics, and (4) specification of any mandatory material movement. The specific form of the data is described in the program user's manual (USACE, 1984b). Program output shows the least-cost operation policy. The optimal allocation of material to each disposal site is shown, along with the corresponding storage, elevation, and surface area.

<sup>1</sup>Hyd. Engr., Planning Div., Hydrologic Engineering Center

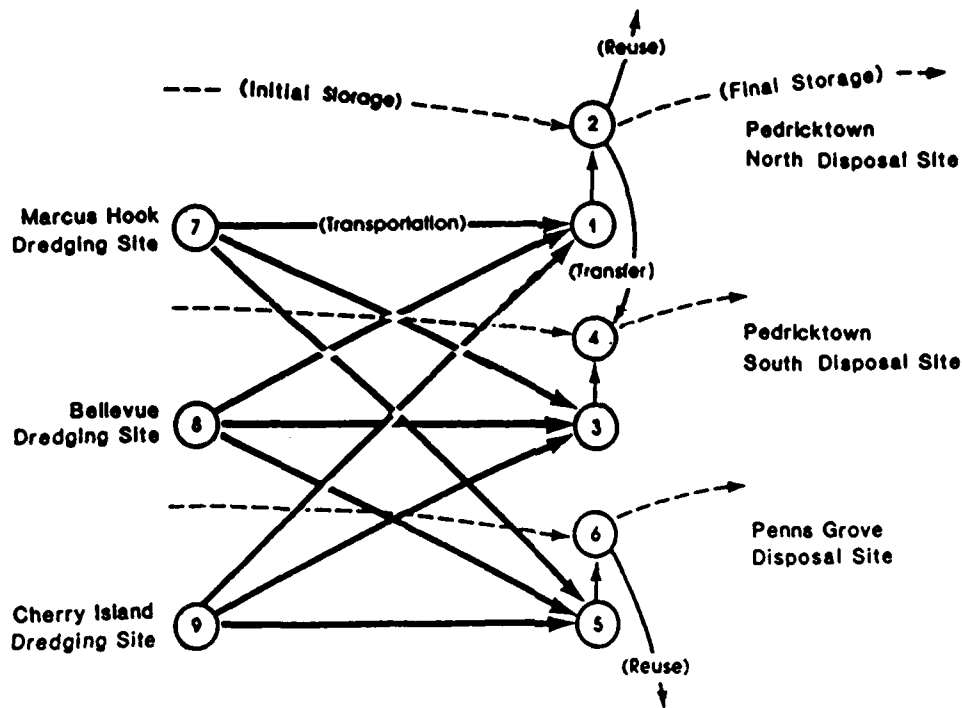

FIG. 1. - Network Representation of Disposal System

#### GEOGRAPHIC INFORMATION SYSTEM

**Program Objective.** - The GIS provides quantitative information for identification of new disposal sites. It accepts user-defined definition of and weighting of critical physical, economic, environmental, social, and political criteria, and yields site-attractiveness maps.

**Procedure.** - Data necessary for objective disposal-site identification typically are spatially-oriented. For example, the following may influence site location:

- |                                |                             |
|--------------------------------|-----------------------------|
| Land use/land cover            | Navigational features       |
| Fish and wildlife habitat      | Archaeological sensitivity  |
| Historical significance        | Groundwater protection zone |
| Existing development           | Recreational features       |
| Distance to navigation channel | Elevation                   |

These and other spatially-oriented data can be stored and analyzed conveniently with a GIS. Fig. 2 illustrates a typical grid-cell GIS (USACE, 1978). With such a system, a regular, rectangular grid is

superimposed on the study area. Values or indices of the critical attributes are found for each grid cell. These values are stored in a computerized data bank. They may then be retrieved and manipulated for any analysis.

Potential new disposal sites are identified by overlaying the data. The analytical procedure, referred to as site-attractiveness mapping, develops an index value for each grid cell. This index represents the relative attractiveness of that cell for the desired activity, based on a weighted combination of pertinent attributes. Weights are assigned by the analysts, with public input as appropriate.

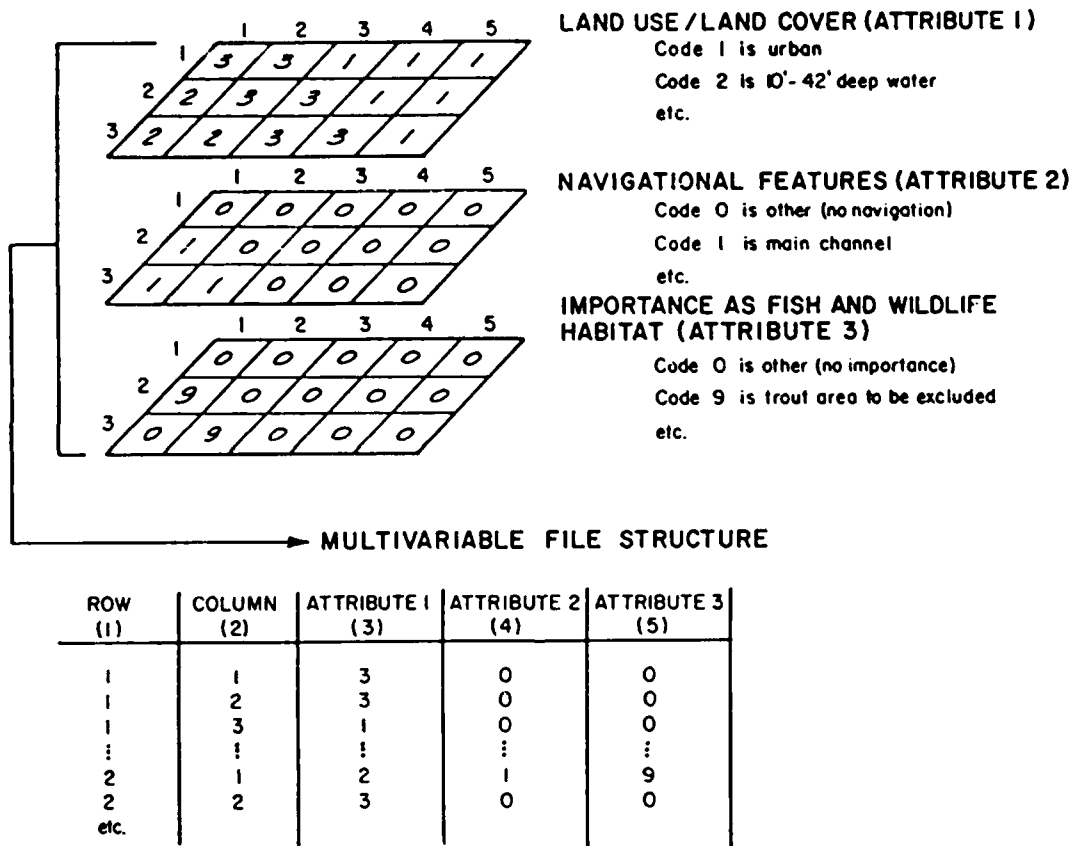
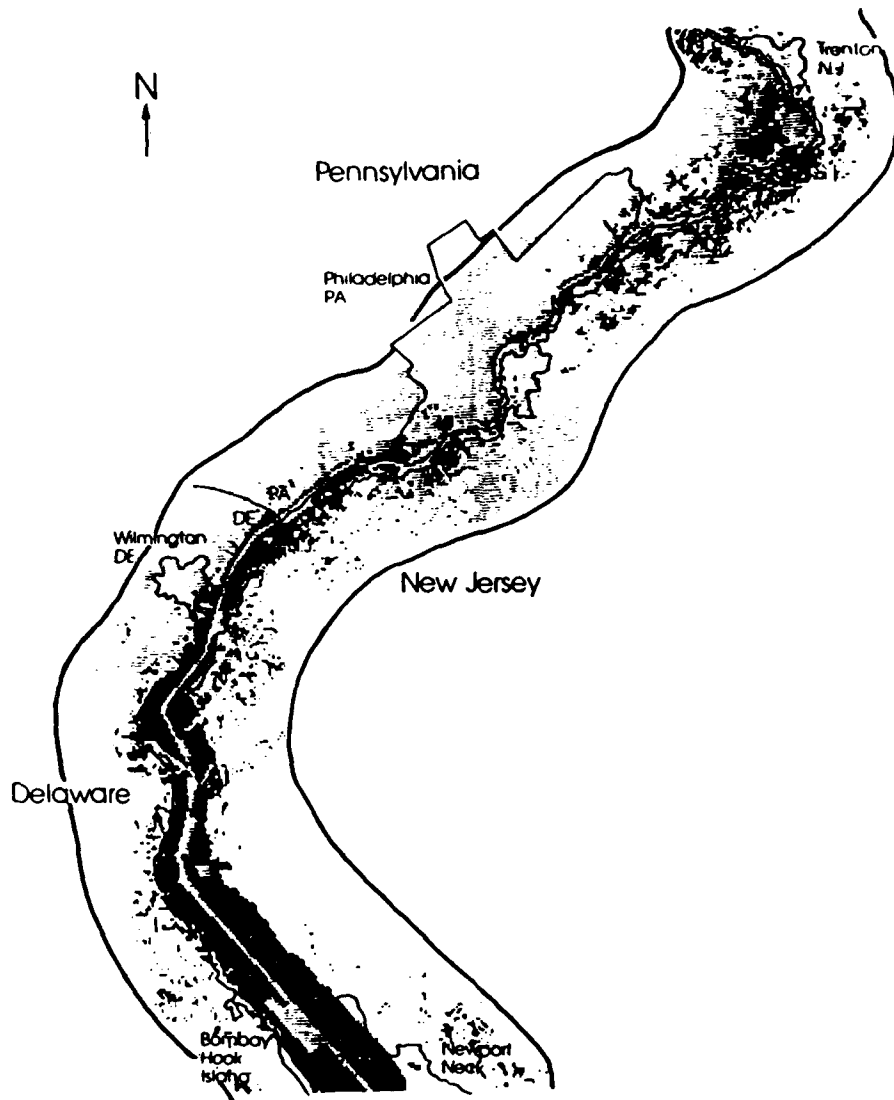

FIG. 2. - Grid-cell GIS

**Program Input and Output.** - To use the GIS, a grid-cell representation of the study area must be defined. Values of all selected attributes must be defined for all grid cells. Weights must be defined for site-attractiveness mapping. Output is tabular or graphical. For graphical display, the index value for each cell is represented by a combination of overprinted characters, and an attractiveness map is produced. Fig. 3 is an example of such a map. In that map, the most attractive cells are printed darkest, and less attractive cells are blank.



**FIG. 3. - Attractiveness Map**

## CAPACITY-EXPANSION PROGRAM

**Program Objective.** - The capacity-expansion program identifies the optimal disposal-system expansion plan (Ford, 1986). The optimal expansion plan is defined as the plan that satisfies all present and forecasted material-disposal requirements with minimum total cost.

**Procedure.** - The program identifies the least-costly expansion plan with an enumeration scheme that

- (1) Separates the expansion plans yet to be evaluated into mutually-exclusive subsets;
- (2) Branches to one of the subsets and bounds (estimates an upper limit on) the minimum cost possible for the plans in the subset;
- (3) Compares the bound with the cost of the best plan identified and eliminates the subset if it clearly contains no plans yielding lesser-cost solutions;
- (4) Repeats steps 1, 2, and 3 until all proposed plans are evaluated explicitly or eliminated implicitly.

The lower bound is estimated by formulating a network model in which the acquisition, operation, maintenance, replacement, and operating costs are approximated as unit costs. Solution of the resulting network-flow-programming problem yields a cost for each period that is a fraction of the true acquisition and OMR costs. The lower bound thus estimated for plans in a subset always equals or exceeds the true cost of the individual plans in the subset.

**Program Input and Output.** - Input required for the capacity-expansion program includes all input required for the operation optimization program. In addition, physical and economic characteristics of all potential disposal sites must be defined. Program output shows the least-cost capacity-expansion schedule plus the optimal operation policy for the expanded system.

## DELAWARE RIVER SYSTEM APPLICATION

The planning programs were used to analyze operation of the Delaware River system. The Delaware River navigation system extends approximately 130 miles from the Delaware Bay to Trenton, New Jersey. The system consists of 15 developed port areas and 2 open-bay ports. Waterborne commercial traffic through these ports is 132,000,000 tons annually. To maintain the channel depth required for this navigation, approximately 11,500,000 cu yd are dredged annually. The material is disposed in 21 upland sites.



In 1978, Philadelphia District staff concluded that existing sites would fill by 1990 (USACE, 1979). Consequently, additional disposal capacity was required. A district study suggested this capacity could be provided by (1) improvement of operation to extend the useful lives of individual sites, (2) more efficient allocation system-wide of the available capacity, and (3) development of new disposal sites. The computer programs described were used to investigate these alternatives (Heverin and Rohn, 1984).

Analysis of improved site operation techniques was accomplished with the operation optimization program. In a typical execution of the program, 50 years of operation were analyzed. The resulting network consisted of 900 nodes and 3,700 arcs. Time required for identification of the optimal policy was 59 CP sec on a commercial Cyber 175 computer.

To identify additional disposal sites, a GIS representing the river and a five-mile band on either side was developed (USACE, 1984a). An 800 ft by 1,000 ft grid-cell size was selected. The entire data bank includes approximately 43,500 cells. An advisory committee representing the port community and Federal, state, and local agencies was formed to identify critical attributes. The value of each attribute was determined and stored for each grid cell. Public expression of system operation priorities and constraints on site location was solicited, and a series of site-attractiveness maps was produced. From these maps, potential new sites were defined.

The least-costly sequence for acquiring the identified disposal sites was defined with the capacity-expansion program. For this analysis, the Delaware system was subdivided. Program runs then analyzed subsystems with 4 or 5 existing disposal sites and 2 or 3 expansion sites. The results were used as a guide for real estate acquisition and lease renegotiation.

## CONCLUSIONS

Efficient long-term dredged-material management requires planning for efficient disposal-system operation and expansion. Three computer programs are available to assist with this planning. The programs are (1) an operation optimization program, (2) a geographic information system (GIS), and (3) a capacity-expansion program. The programs were used in the Delaware River dredging disposal study.

## REFERENCES

Ford, D.T., "Dredged-material Disposal Management Model," *Journal of the Water Resources Planning and Management Division*, ASCE, Vol.110, No. 1, Jan., 1984, pp. 57-74.

Ford, D.T., "Dredged-material Disposal System Capacity Expansion," *Journal of the Water Resources Planning and Management Division*, ASCE, Vol.112, No. 2, Apr., 1986, pp. 277-291.

Heverin, T.B., and Rohn, G.R., "Computer Models for Dredged-material Disposal Planning," presented at the Nov. 14-16, 1984, ASCE Dredging '84 Conference, held at Clearwater Beach, FL.

USACE, "Delaware River Dredging Disposal Study, Stage 1 Reconnaissance Report," U.S. Army Engineer District, Philadelphia, PA, Jun., 1979.

USACE, "Delaware River Dredging Disposal Study Report," U.S. Army Engineer District, Philadelphia, PA, Jun., 1984a.

USACE, "Dredged-material Disposal Management Model (D2M2) User's Manual," The Hydrologic Engineering Center, Davis, CA, Jul., 1984b.

USACE, "RIA (Resource Information and Analysis) Program User's Manual," The Hydrologic Engineering Center, Davis, CA, Sep., 1978.

RELATIONSHIP BETWEEN SUBSURFACE GEOHYDROLOGIC  
INVESTIGATIONS AND SITING OF UPLAND DISPOSAL  
SITES/DEWATERING SITES FOR USE OF DREDGED  
MATERIAL AS SANITARY LANDFILL COVER

by

1 2  
Carol A. Coch and John F. Tavolaro

INTRODUCTION

Preliminary site screening, including geohydrologic investigations, is one of the key factors in determining the feasibility of regional upland disposal/dewatering areas for use of dredged material as sanitary landfill cover. This is especially true in a highly urbanized area such as the New York/New Jersey Harbor area where waterfront land is at a premium, and there is a potential for ground water contamination due to prior uses of sites or adjacent areas. In this paper we will show the application of geologic and hydrologic studies, dredged material characteristics, consolidation rates and possible control measures to determine the environmental, engineering and economic suitability of regional upland disposal/dewatering sites for contaminated dredged material. These types of investigations can be applied elsewhere to identify sites best suited for regional upland disposal or landfill cover alternatives for dredged material disposal.

BACKGROUND

Subsurface geohydrologic investigations were performed by Malcolm Pirnie, Inc., under contract to New York District, U.S. Army Corps of Engineers, as part of feasibility studies for siting of regional upland disposal/dewatering sites for use of dredged material as sanitary landfill cover. These options would be used to dispose contaminated dredged material as part of the Dredged Material Disposal Management Plan for the Port of New York and New Jersey. The upland disposal facilities would consist of diked areas into which dredged material is disposed. The same areas could be used as dewatering sites. Dredged material would be emplaced in two-foot thicknesses (thin lift) and allowed to dry for one year so that it could be harvested for use at nearby landfills in place of conventional cover materials. The dewatered dredged material would be used for daily, intermediate or final cover depending upon its characteristics.

1  
Oceanographer, Water Quality Compliance Branch, NY District

2  
Chief, Water Quality Compliance Branch, NY District

Initial studies showed that use of dredged material as sanitary landfill cover was technically feasible (Malcolm Pirnie, Inc., 1982). Fifty percent of the annual demand at 19 area landfills for daily cover could be met with dewatered contaminated dredged material (2.4 million cu yd). This would potentially enable New York District to dispose of all contaminated dredged material that is currently capped each year if ocean disposed and material that does not meet the testing criteria for ocean dumping.

Criteria was developed for both site uses by an interagency Steering Committee composed of federal and state regulatory agencies. Further review by the States of New York and New Jersey, which have jurisdiction over upland disposal, resulted in narrowing the number of potential sites from 292 barren areas (Conner et al., 1979, Leslie, 1980) to 13 potential sites (New York District, (1983). Criteria related to the site geology and hydrology were used to eliminate sites if they were: located on or adjacent to a major sole source aquifer or within 1 mile of a municipal water supply, located in drainage areas of high quality waters (such as trout streams), located on easily soluble bedrock (limestone, porous sand or gravel), adjacent to coastal erosion hazard areas, or considered to contain wetlands or agricultural areas. Public forums led to designation of four sites for further study (New York District, 1984). Siting of upland disposal areas was combined with siting of dewatering areas for use of dredged material for sanitary landfill cover because limited barren area is available in the New York/New Jersey Harbor area. The siting criteria and feasibility studies are discussed in further detail in Coch et al., (1985), Coch and Mansky (1984) and Tavolaro and Zammit (1986).

The remaining sites are: L-13, Hutchinson River, Bronx, NY; Raritan Center (Summit Associates), NJ; N-61, Belford, NJ, and N-37, Elizabeth, NJ. These four sites were evaluated for regional disposal/dewatering of dredged material together with a fifth site (N-30, Fresh Kills, NY), which was studied for use as a potential dewatering site for dredged material from marine transfer stations used by the New York City Department of Sanitation (NYCDOS). A location map of the sites appears as Figure 1.

#### SITE SPECIFIC STUDIES

The site specific studies included: soils investigations, basement geology, site characteristics, availability of dike construction materials on site, and sampling and analysis of ambient ground water quality measurements from on-site monitoring wells. Soil characteristics, ground water flow and water quality were collected on three of the sites (L-13, Raritan Center and N-61) using a combination of borings, test pits and monitoring

**FIGURE 1: LOCATION OF CANDIDATE REGIONAL UPLAND DISPOSAL AND DEWATERING SITES FOR USE OF DREDGED MATERIAL AS SANITARY LANDFILL COVER**

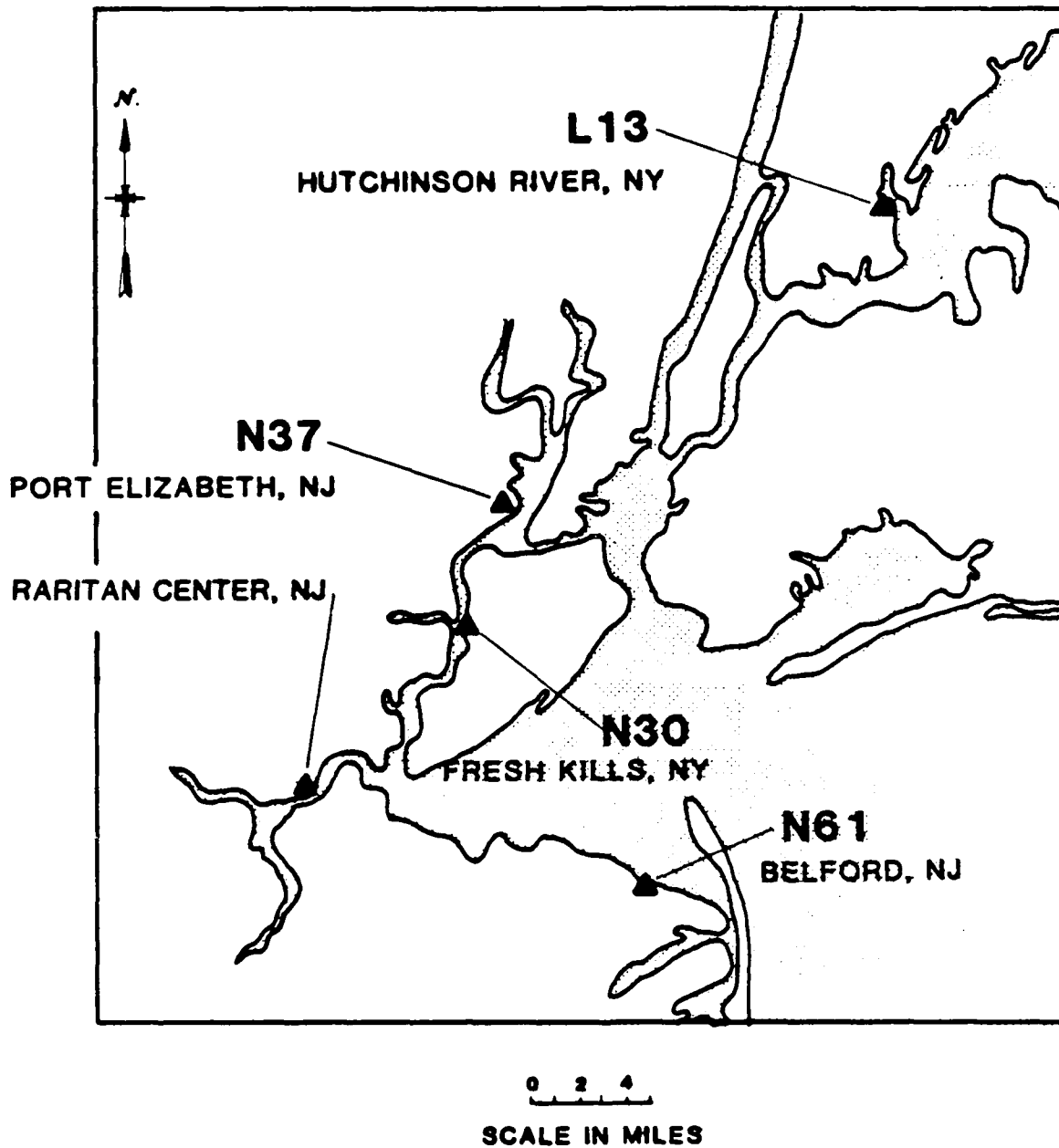

NOTE: SITE N-30 is the location of the NYC DEPARTMENT OF SANITATION PILOT PROJECT

wells (Malcolm Pirnie, Inc., 1987c). Basement geology and site characteristics were used to determine the placement and feasibility of constructing a dewatering/disposal facility. Soil data was used to indicate soil suitability and the types of on-site construction materials available for preliminary structural design of dikes. The boring and test pit data were used to appropriately locate the monitoring wells. Slug type aquifer samples were taken in the monitoring wells to determine the characteristics of the aquifers. Water quality was monitored to determine ambient conditions and changes through time. Subsequently, disposal/dewatering areas were designed to limit potential impacts to aquifers and receiving waters.

Numerous water quality parameters were tested for in the ground water at N-61, L-13 and the Raritan Center site (Table 1). Selected water quality parameters are presented in this paper. Those that were not found at their respective detection limits or were not appreciably higher than federal drinking water standards are not discussed. (See Malcolm Pirnie, Inc., 1987a,b,c for a detailed discussion.)

The geology, hydrology, preliminary engineering design and costs are described in this paper for each of the sites studied (Malcolm Pirnie, Inc., 1987a,b,c). The general plan for the upland/dewatering structures was a diked upland containment area divided into three or more cells by internal dikes to promote settling of dredged material. The dredged material would be emplaced by hydraulic pumping from an offshore location. In addition, a weir system and settling basin would be used to trap suspended solids and ensure that the return flow water would meet water quality standards. Fine grained dredged material pumped into the site would form a low permeability layer at the bottom. This layer would form a barrier between the area of subsurface drainage and subsequent dredged material deposition.

Dewatering would be accomplished by surface trenching and crustal management to enhance evaporative drying. The dewatered material would be used to raise the dikes to the desired levels, thereby maximizing internal storage space. Considerations of consolidation and elutriate testing of characteristic harbor-wide dredged material together with thin lift and thick lift (4-12 feet) emplacement were used in this effort. Only the thin lift emplacement method is described here with respect to site costs and capacities because it was found to be the most cost effective method. The cover material would be removed mechanically and either trucked or barged to area landfills.

As described below, although costs for use of the sites as upland disposal areas are only slightly higher than those for ocean disposal, it was decided that the sites would be used for production of cover material. This would make

TABLE I

**WATER QUALITY PARAMETERS TESTED  
(AT L-13, N-61 AND RARITAN CENTER)**

<u>PARAMETER</u>	<u>FEDERAL SDWA LIMITS</u>
Chlorides (mg/l)	250
Nitrate -N (mg/l)	10
Total Dissolved Solids (mg/l)	500
Sulfates (mg/l)	250
Calcium (mg/l)	---
Cadmium (mg/l)	0.01
Chromium (mg/l)	0.05
Iron (mg/l)	0.3
Lead (mg/l)	0.05
Magnesium (mg/l)	---
Manganese (mg/l)	0.05
Mercury (mg/l)	2.00
Petroleum Hydrocarbons (mg/l)	---

VOLATILE ORGANIC COMPOUNDS

<u>COMPOUND</u>	<u>DETECTION LIMIT (ppb)</u>
Aldrin	0.02
Benzene	10
Chlorobenzene Methyl Chloride	10
1,4-Dichlorobenzene	10
1,2-Xylene	10
1,3-Xylene	10
1,4-Xylene	10
1,1' Oxybisethane	10
Ethylmethylbenzene	10
1,2,3-Trimethylbenzene	10
Trimethylbenzenes	10
Ethylmethyl-benzene	10
Diethylbenzene	10
2-Propanone Acetone	10

PCB's

<u>COMPOUND</u>	<u>DETECTION LIMIT (ug/l)</u>
PCB - 1016	0.3
PCB - 1221	0.3
PCB - 1232	0.3
PCB - 1242	0.3
PCB - 1248	0.3
PCB - 1254	0.3
PCB - 1260	0.3

TABLE I - CONTINUED

PESTICIDES

<u>COMPOUND</u>	<u>DETECTION LIMIT, ug/l</u>
alpha-BHC	0.01
beta-BHC	0.01
gamma-BHC	0.01
delta-BHC	0.01
Heptachlor	0.01
Aldrin	0.02
4,4' DDE	0.02
Dieldrin	0.02
4,4 DDD	0.03
Endrin Aldehyde	0.04
4,4' DDT	0.06
Chlordane	0.20
Endosulfan I	0.03
Endosulfan II	0.03
Endosulfan Sulfate	0.04
Endrin	0.03
Heptachlor Epoxide	0.03
Toxaphene	2.0

OTHER PARAMETERS

Temperature (°C)  
Conductivity (umhos/cm)  
Salinity (parts per thousand)  
pH

NOTE: Federal SDWA = Federal  
Safe Drinking Water Act



SITE L-13: HUTCHINSON RIVER, NY  
On-Site Investigation:

The Hutchinson River site, Bronx, New York (Figure 2, Figure 3) is a 48-acre site of which 20 acres are unusable due to the presence of wetlands. It is located in the Piedmont Physiographic Province and is underlain by Fordham Gneiss (most common formation), Manhattan Schist and Inwood Marble bedrock formations. Surficial deposits consist of unconsolidated silts and clays and some peat (several feet thick) with bedrock outcrops. The surficial deposits consist of sediments laid down when the site was part of a coastal wetland, glacial fill (10-150 ft. thick) and outwash, and shallow marine deposits. It is located 1,000 ft. from the Hutchinson River and has previously been filled with 10 to 25 feet of construction debris.

Ground water flow occurs in fractures in the Fordham Gneiss aquifer, which has a low permeability but a high transmissivity with low yields in the silt and clay deposits. As a result, ground water use in the Bronx is limited to industrial use due to its limited availability, local contamination and availability of an abundant public water supply. Two distinct aquifer systems, which are separated by a discontinuous semi-confining layer of peat, silt and clay, occur on site: an upper unconfined system and a deeper semi-confined system. In the semi-confined system, ground water flow is towards the Bay and the Hutchinson River at less than 1 foot per day. Average hydraulic conductivity is estimated at 1.7-3.6 m/day. The low velocity can be accounted for by the flat hydraulic gradient and the relatively low soil permeability. Ground water velocities in the semi-confined aquifer range from 0.06 to 0.01 ft/day.

The shallow and deep aquifers have significantly different water quality. The deep water aquifer has high chloride levels: 10,700 (MW-3) and 5,170 (MW-4) mg/l, which is probably due to chloride intrusion from the Hutchinson River and the bay. This is coupled with high dissolved solids (22,000 and 10,400 mg/l, respectively). By comparison the chloride levels in the shallow wells were 30 (MW-1), 492 (MW-2) and 148 (MW-5) mg/l. The dissolved solids were 2,750, 3,840 and 1,420 mg/l. Ground water velocities in the deeper semi-confined unit are greater than in the shallow aquifer due to a steeper hydraulic gradient in the confined aquifer. Transmissivities are in the range of  $2 \times 10^{-6}$  square feet per day with a specific yield of up to 35%. Nevertheless, the ground water is limited to industrial uses in this area.

The pesticide aldrin was present at .001-.008 ppb at MW 2 (shallow well), and benzene was present at 5.3 mg/l in MW-

FIGURE 2: MONITORING WELL LOCATIONS

SITE L-13 BRONX, NY

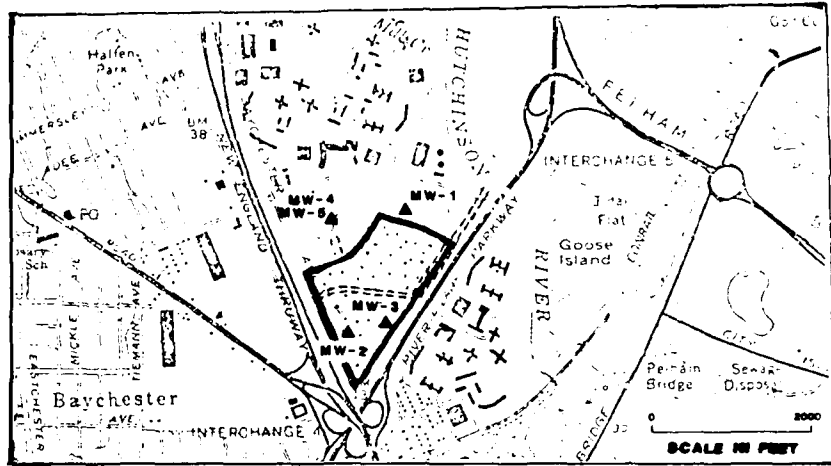

RARITAN CENTER SITE ,NJ

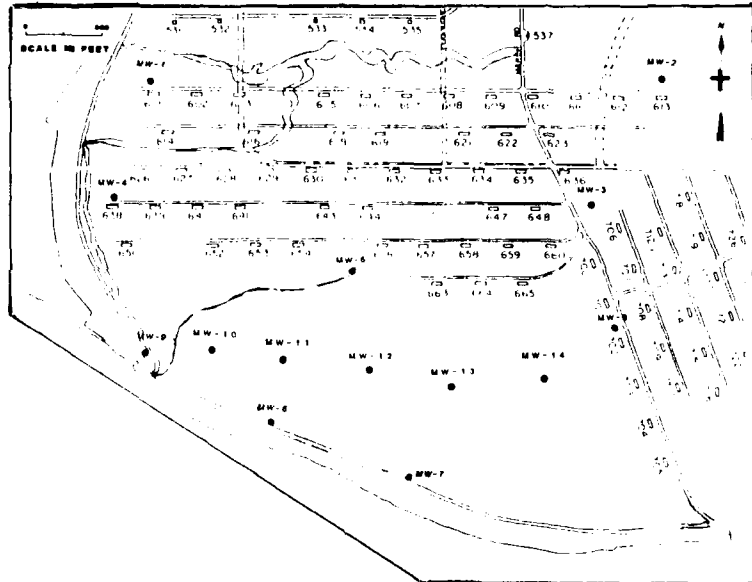

SITE N-61 BELFORD, NJ

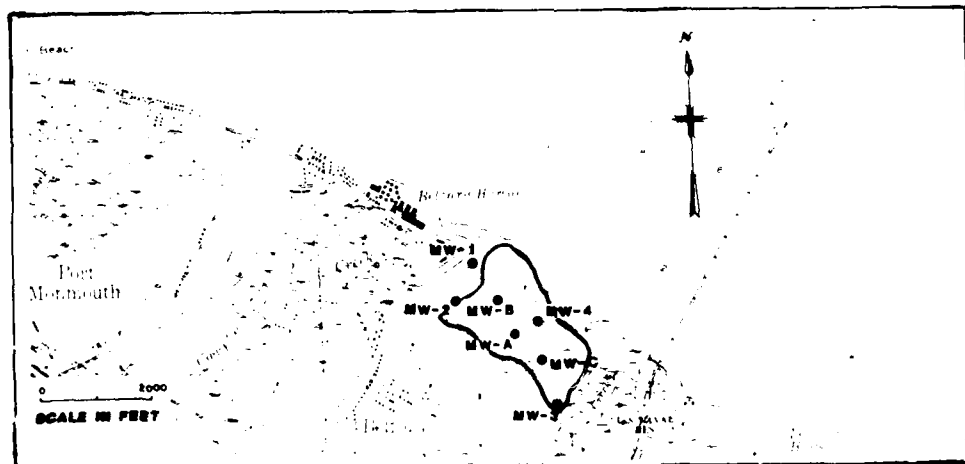

**FIGURE 3:**

**SCHEMATIC DIAGRAMS OF UPLAND DISPOSAL/DEWATERING SITES**

**L-13 BRONX, NY**

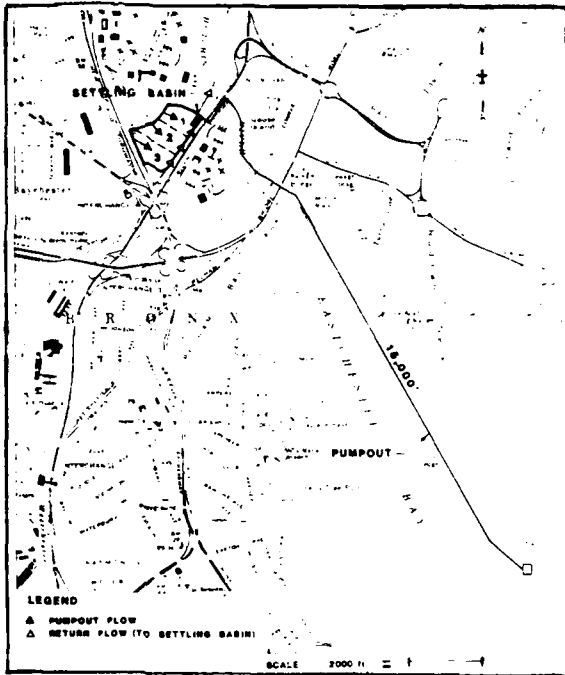

**RARITAN CENTER SITE, NJ**

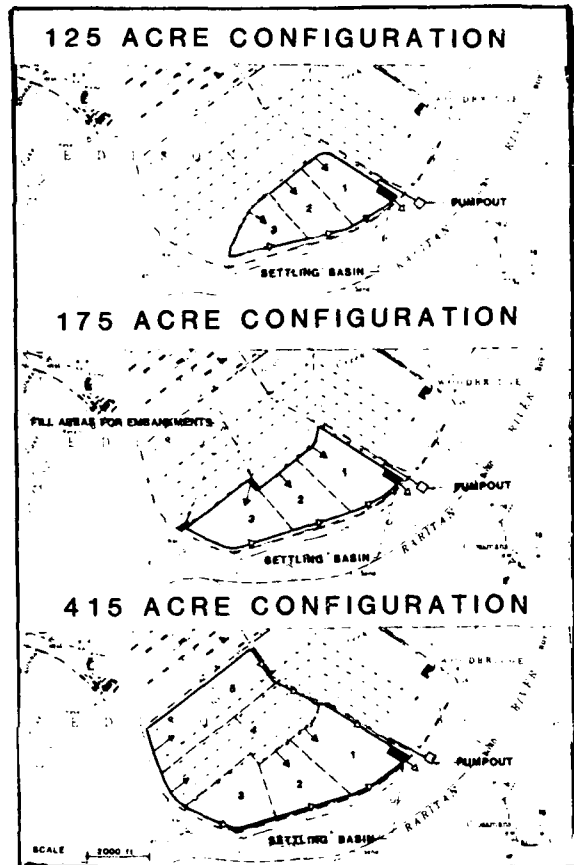

**SITE N-61 BELFORD, NJ**

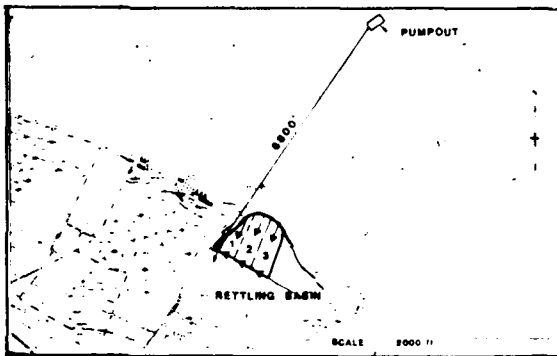

**SITE N-37 ELIZABETH, NJ**

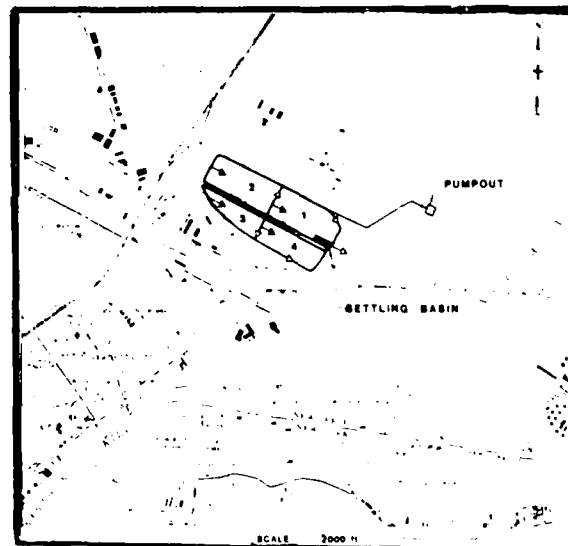

**SITE N-30 FRESH KILLS, NY**

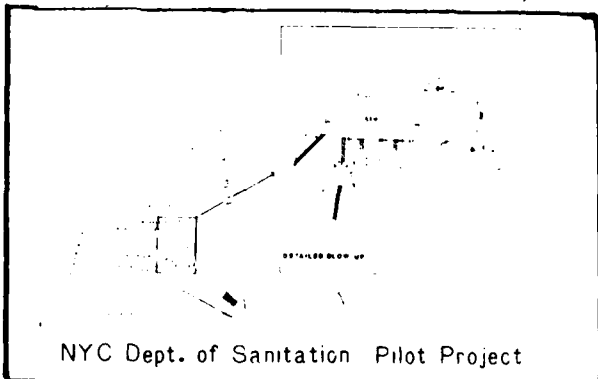

NYC Dept. of Sanitation Pilot Project

1. The pH varied from 6.2 to 6.6 in the shallow wells and was 6.9 in the deep wells. Temperature varied from 13°C to 15°C in the shallow wells and from 12°C to 13°C in the deep wells.

Iron was present in both the shallow and deep monitoring wells, and in the shallow wells it varied between 0.18 ppm and 22.4 ppm. The highest value was found in MW-1, which is located in an area of wetlands/tidal flats. Sulfates varied from 73 ppm (MW-5) to 1,630 ppm (MW-2). Salinity in the shallow wells was 1.0 ppt to 2.5 ppt, contrasting strongly with salinities of 11.5-17 ppt in the deep wells. Specific conductance was 1,800-3,200 um hos/cm in the shallow wells and ranged from 14,200 to 21,000 um hos/cm as would be expected from the corresponding chloride and salinity values.

Results of the water quality monitoring indicated that the ground water was strongly affected by salt water intrusion. The characteristics of the aquifers present indicate that emplacement of dewatering/upland disposal facilities would not adversely affect the ground water, which is already somewhat contaminated because it is located in a highly urbanized area.

Analysis of the soils indicated that the permeability would be  $1 \times 10^{-5}$  feet per day. Recommendations for dike construction were that they be made of on site rubble, silt and sand and that cut and fill techniques be used.

The Hutchinson River site was dropped from further consideration because new owners purchased the property and planned to develop the site. The development plans were not compatible with its use as an upland disposal/dewatering site, and it is reported here as an example of a relatively small site with large basin development costs and a long pump out distance.

#### Upland/Dewatering Cost Analysis:

Underground streams and a municipal sewer easement traverse the site. Tidal fluctuations have direct impact on the ground water since no confining surficial deposits occur above the fractured gneissic bedrock. Construction on the fill would need to be carefully monitored as settling would likely be substantial.

Dredged material emplacement would be compatible with existing surface water quality at L-13 due to the saline and sulfate rich nature of both the existing site water and expected leachate levels from the dredged material.

Upland disposal would have a 28-year lifetime with a total site capacity of 2,276,700 cu yd at a cost of approximately \$20 per cu yd (assuming land costs of \$5.2

million). The long pumpout distance (15,000 ft.) is due to the shallow nature of Eastchester Bay.

The site is adjacent to "Co-Op City," a major high density residential area. Eastchester Bay is used for recreation and swimming. Hence it is anticipated that return flow requirements would be more stringent than at the other sites. The annual dredged material capacity is 90,333 cu yd with an annual cover yield of 39,747 cu yd. Costs range from \$38.93 per cu yd to Hastings-on-Hudson landfill (15-mile transport) to \$80.87 per cu yd to Monmouth Co. Reclamation Center landfill (71-mile transport).

The costs for both upland disposal (\$20 per cu yd) and cover material (up to \$81 cu yd) far exceed the cost for ocean disposal (\$4 cu yd) so it is unlikely that this site would have been used for these purposes (Table 2). Meanwhile, development is underway on the site, which would preclude the implementation of this disposal option.

RARITAN CENTER SITE, EDISON, NJ  
On-Site Investigation:

The Raritan Center site, which is approximately 500 acres (Figure 2, Figure 3), was not considered as one of the original 292 barren sites. Owners of a portion of Raritan Center (Summit Associates) requested that their site be included in the study. At that time a complete wetlands evaluation of the site had not been completed, and the site was included in the feasibility evaluation for upland disposal/dewatering by consensus of the Steering Committee.

The Raritan Center site is located on the Raritan River and was formerly the location of the U.S. Army Raritan Arsenal. In the past, the site was purposely flooded, using a series of tide gates to keep water in the rows of trenches between several series of ammunition bunkers. Several episodes of dredged material emplacement from Raritan River dredging have created pockets of upland among areas of wetlands. A drainage ditch bisects the site, which is primarily Phragmites wetlands.

This site has been held in abeyance from further consideration due to wetlands and other environmental concerns. If these matters are resolved, the site may again be considered for regional dredged material disposal. Raritan Center is discussed here as an example of a large site with no land acquisition costs.

The Raritan Center site is located in the New Jersey Coastal Plain Province and is underlain by the Triassic Brunswick formation (approximately 50 feet deep) of the Newark Group as bedrock (shales, sandstones and basalts). The Pennsauken/Cape May formation unconformably overlies the

**TABLE 2: COST SUMMARY FOR REGIONAL UPLAND DISPOSAL AND USE OF DREDGED MATERIAL AS SANITARY LANDFILL COVER**

**UPLAND DISPOSAL**

COMPARISON OF DISPOSAL COSTS PER CY AT 4 UPLAND SITES

Site	Location	Acreage	Gross Wet Disposal Cost per cy		Land Costs	Total Cost/cy	
			5 m.*	10 m.*		5 m.	10 m.
			N-37	Fort Elizabeth		105	4.14
N-11	Bullard	31	4.98	5.62	-0-	4.46	5.01
L-13	Hutchinson River	28	8.69	9.32	11.52	20.21	21.91
-	Raritan Center	125	3.96	4.60	-0-	3.96	4.60
-	Raritan Center	175	3.86	4.49	-0-	3.86	4.49
-	Raritan Center	415	3.72	4.35	-0-	3.72	4.35

\*5 or 10 mile barge haul from dredging site to dewatering site unloading area.

**SANITARY LANDFILL COVER**

COMPARISON OF COSTS TO PROVIDE DEWATERED DREDGED MATERIAL AS COVER

Regional Dewatering*	Site	Acreage	Dewatering Cost (\$/cy)	Cost to Stockpile (\$/cy)	Land Acquisition (\$/cy)	Transport (\$/cy)	Total (\$/cy)
Regional Dewatering*	N-37	58	9.06	1.90	0	5.26	16.22
	N-37	105	8.23	1.90	5.08	12.00	27.41
	N-61	31	10.80	1.90	0	12.00	24.70
	L-13	28	17.95	1.90	11.52	7.56	38.93
	Raritan Center	125	6.15	1.90	0	4.52	14.57
Local Dewatering	Raritan Center	175	7.92	1.90	0	4.52	14.34
	Raritan Center	415	7.59	1.90	0	4.52	14.01
	Wilmington	10	7.11	0	0	0	7.11

\*Assumes 5 or 10 mile barge haul and transport to the "closest" landfill; optimum thin lifts.

Farrington member of the Cretaceous Magothy/Raritan formation. These formations in turn underlie surficial quaternary deposits of reworked Pleistocene fine grained silts and clays. Surficial deposits of recent origin consist of typical coastal wetland-type fine, organic rich sands and silty clays that are found throughout the site. This unit contains extensive peat mats that are not sufficiently consolidated to form an aquiclude and may be 20 feet thick. Tidal influence changes the ground water flow and configuration diurnally.

The Pennsauken/Cape May Formations, Pleistocene deposits and Farrington member form one aquifer that outcrops in the Raritan Center area. Quaternary sands and organic silt/peats (5-10 feet below ground surface) form an aquitard overlying this aquifer system. The thickness of the peat varies from less than 5 feet (MW-2) to more than 20 feet (Boring 5). Permeability is low in the clay and peat deposits ( $1 \times 10^{-6}$  to  $1 \times 10^{-7}$  feet per day), while the alluvial deposits have higher permeabilities ( $1 \times 10^{-1}$  to  $1 \times 10^{-2}$  feet per day).

Ground water depths range from 2-6 feet depending on the depth of overburden. Ground water elevations are highest in the center of the site, flowing radially towards the Raritan River and the creeks surrounding the site. Surficial deposits and the Pennsauken/Cape May formation are minimally used for public water supply due to salt water intrusion and low flow. The site is not located near any wells or recharge areas or reservoir drainage areas.

Chloride remains high throughout the site as compared with federal drinking water standards. It varies between 612 mg/l and 7,190 mg/l. Generally, values of approximately 1,200 to 2,900 mg/l occur in the center of the site with values of 3,200 to 6,000 at the periphery. Likewise, total dissolved solids are high throughout the site with values of 2,040 mg/l to 13,440.

Sulfates are also high and can be attributed to a combination of wetland conditions and the underlying peat. Although found at levels as low as 3-105 mg/l (MW-7, MW-9) on the Raritan River, on most of the site the levels range from 534 (MW 5) mg/l to 2,586 (MW-13) mg/l. Iron ranged from 0.14 (MW-13) to 114 mg/l (MW-11). Petroleum hydrocarbons ranged from <0.1 to 5.6 (MW-5) mg/l. The higher concentrations were generally in the center of the site. Gamma BHC (a volatile organic compound) was found in one well (MW-1) at 0.013 ppb. An isolated occurrence of benzene was found at 0.003 mg/l (MW-14). Magnesium occurred at 28.9 to 502 mg/l (at MW-14).

The ground water characteristics of Raritan Center reflect its varied uses in the past and the tidal influence of the Raritan River. Aquifer measurements show that the water quality does not meet United States Environmental

Protection Agency (USEPA) drinking water standards for several constituents. The type of soil conditions on site, namely, extensive peat mats that form a surficial aquiclude, do not allow percolation of potentially contaminated leachate from an upland disposal/dewatering area into the ground water system. Dredged material dewatering and disposal would be compatible with the subsurface hydrologic conditions; however, the presence of extensive wetlands on Raritan Center and environmental concerns have resulted in the site being held in abeyance.

#### Upland/Dewatering Cost Analysis:

Three scenarios were evaluated: a 125-acre parcel, a 175-acre parcel and a 415 acre parcel for upland disposal and use of dredged material as sanitary landfill cover (Malcolm Pirnie, Inc., 1987a,b,c). Construction of dikes would be achieved using on site peat and organic clays provided that the toes of the dikes abut existing roads and the center of the basin is raised using fill (possibly dredged material) to bring it above the ground water table. Fill to 2 ft. above ground water elevation is included in site preparation costs. Dewatering would be expected to be slow due to the location of the water table and the underlying peat layer.

For upland disposal (Table 2), the 125-acre parcel would have a capacity of 10.2 million cu yd over a 28-year period (178,000 cu yd/yr) at a cost of \$3.96 to \$4.60 per cu yd (5-mi & 10-mi hauls, respectively). The costs are approximately the same for the 175-acre parcel, and slightly lower for the 415-acre parcel at \$3.72 to \$4.35/cu yd with a total site capacity of 33,744,480 cu yd (28-year life) and a yearly capacity of 1,205,160 cu yd. No land costs are included in the cost of disposal.

Dewatering at the 125-acre site would be 403,333 cu yd per year with a cover yield of 177,467 cu yd. Cost would range from \$14.57 per cu yd (Edison Landfill/7 mi) to \$25.54 per cu yd (Haverstraw landfill/59 mi). For the 175-acre site, 564,700 cu yd would be disposed annually with a cover yield of 248,468 cu yd. Costs range from \$14.33 to \$24.70 per cu yd. For the 415-acre site, annual disposal would be 1,339,000 cu yd with a cover yield of 589,160 cu yd. Costs range from \$14.01 per cu yd to \$22.92 per cu yd.

Return flow would be discharged into the Raritan River. The river is naturally brackish so the addition of salt water return flow would not cause significant adverse impacts. The costs associated with upland disposal (\$3.96 to \$4.60) per cubic yard are close to that of ocean disposal. The costs for cover material are higher than that of ocean disposal or conventional cover. Therefore, institutional and financial arrangements would be needed for this option to go forward. The Raritan Center studies did show that as the dewatering



site size increased, production costs per cubic yard decreased for thin lift dewatering.

SITE N-61: BELFORD, NEW JERSEY  
On-Site Investigation:

The Belford site is a 32-acre site that is located on Sandy Hook Bay adjacent to a former municipal landfill. The site has been disturbed by past dumping of solid waste and dredged material. Existing dikes on the site were deposited using dredged material from the adjacent Shoal Harbor and Compton Creek Federal Channels.

Belford is located in the New Jersey Coastal Plain Physiographic Province and is underlain by unconsolidated sediments including the Englishtown, Woodbury/Merchantville (clay/silt) and Magothy/Raritan formations. This sequence is covered by a peat zone and a top layer of quaternary alluvial sands and coastal marsh deposits that vary in thickness across the site. The Englishtown formation is a regionally significant aquifer that is not capped with a continuous confining unit on the site. Ground water flow is usually from east to west but is influenced by tidal cycles and precipitation.

Site ground water was characterized by high salinity (chloride up to 9,547 mg/l) and conductivity (17,000  $\mu$ hos/cm) as well as high sulfate content (up to 5,724 mg/l) that may be attributed to adjacent wetlands. Water hardness (total calcium and magnesium) reached 1,000 mg/l, which exceeds the USEPA drinking water standard of 250 mg/l. Comparison of water samples taken on the Belford site show that organic compounds such as 1,3 xylene (50 ppb) and trimethylbenzene (253 ppb) appear to be migrating onto the site from the adjacent landfill. Sands, clays and solid waste material were found in test pits at N-61.

Permeability of the fill material (which attains thicknesses of 28-feet) ranges from  $1 \times 10^{-6}$  to  $1 \times 10^{-5}$  feet<sup>2</sup> per day. Transmissivity is approximately  $3 \times 10^{-6}$  ft<sup>2</sup>/day. The fill is highly variable in composition and would be expected to settle over time. Dewatering slurries would tend to percolate rapidly down to the silt and clay layer where their flow would be impeded throughout most of the site. In areas where the silt and clay is discontinuous, this material would slowly percolate through the Englishtown sands. No adverse effects on drinking water use is anticipated because the Englishtown aquifer primarily discharges into Sandy Hook Bay.

## Upland/Dewatering Cost Analysis:

Preliminary engineering designs for dewatering/upland disposal were developed using a 6,800-foot offshore pumpout for hydraulically emplaced dredged material. The site was divided into three cells for dewatering. It would provide a 2.6 million cubic yard disposal capacity for upland disposal over a 28 year lifetime. Initially, on-site materials and existing dike structures would be used to construct perimeter containment dikes. Dewatered materials would be used to raise perimeter containment dikes. Investigation of on-site topographic features led to recommending the use of the earth fill embankment adjacent to an old treatment basin, the northern perimeter of the old landfill and the sand dunes to be used as containment structures in lieu of constructing new dikes. Filling of the disposal area will probably cause some settling of the underlying organic deposits.

Dredged material leachate tests indicate that the level of chloride in the leachate (1,020 to 7,419 mg/l) is similar to chloride levels in the ground water on site with slightly higher hardness values. Low concentrations of PCB's, pesticides and organics may be present, depending upon the source of the dredged material. Since the possibility exists that ground water from the Belford site may be drawn into nearby wells, an impermeable liner or other barrier should be installed as a precautionary measure.

Costs for upland disposal (Table 2) would range from \$4.98 to \$5.62 per cubic yard (5- and 10-mile hauls) assuming no land acquisition costs.

Costs for cover material range from \$24.91 per cubic yard (including 20-mile trucking to Monmouth Co. landfill) to \$44.69 per cubic yard (barge transport to Haverstraw landfill), not including land acquisition costs. Annual disposal would be 103,333 cu yd (annual cover yield would be 45,467 cu yd).

Based on the borings, ground water analyses and site evaluation, the geology of N-61 was determined to be suitable for upland disposal/dewatering. However, several development ideas have been put forth that may affect use of the property in whole or in part, including a fishport (Port Authority of NY/NJ) and a fuel tank farm (Earle Navy Base, NJ). The Monmouth County Planning Board had indicated that they might be interested in using dewatered dredged material as final cover for the adjacent landfill, if we established the dewatering site. This option is clearly more expensive (\$24.91/cu yd minimum) than either current ocean disposal or cover costs. Institutional and financial arrangements would be required in order to implement this option.

SITE N-37: PORT ELIZABETH, NEW JERSEY  
On-Site Investigation:

The Port Elizabeth site is a 105-acre site located in Union County, New Jersey (Figure 3, Figure 4). It is traversed by the Great Ditch (a tidal stream) and is underlain by the Brunswick formation, which is covered by unconsolidated sediments (glacial till, stratified and unstratified drift up to 50 feet thick). The Brunswick shale is the major aquifer in the area with ground water occurring in joints and fractures of the unit. Transmissivity of the Brunswick shale ranges from 5,900 to 25,400 gallons per day per foot.

Possible presence of contaminated soils and ground water on site would need to be investigated further before the Port Elizabeth site could be used for upland disposal. The site owners, in compliance with New Jersey State laws, have performed this testing, but the results are not available to date.

Upland/Dewatering Cost Analysis:

Based on the subsurface geology and hydrologic site conditions, a four-cell dewatering/disposal layout with two cells on either side of the Great Ditch was recommended.

Leachate concentrations of contaminants could probably be ameliorated by addition of polymers to the settling basin if needed. The presence of contamination in the area is likely, and the existing water quality in Newark Bay is relatively poor due to its industrial and urbanized nature. Limited additional impacts to water quality in Newark Bay would be expected from the return flow from the hydraulically pumped dredged material and leachate entering the bay due to long term dewatering. Sedimentation in the settling basin would minimize any potential surface water impacts from the return flow.

Upland disposal (Table 2) would have an annual disposal volume of 304,920 cu yd with a total of 8,537,800 cu yds over its 28-year life. The cost would be \$9.22 to \$9.85 per cu yd (5 and 10 mile haul, respectively).

For dewatering, the annual site capacity is 338,800 cy of dredged material. Costs range from \$27.90 for disposal at Fresh Kills landfill to \$38.56 per cubic yard at Haverstraw landfill. However, costs for upland disposal and cover material production are substantially higher than those of ocean disposal or conventional cover. Therefore, institutional and financial arrangements would need to be in place before this option would be feasible.

SITE N-30: FRESH KILLS, NY

As a direct result of the upland disposal/use of dredged material as sanitary landfill cover studies (Figure 1,2,3; Table 2), the New York City Department of Sanitation has implemented a pilot project for dewatering of dredged material for use as daily and intermediate landfill cover (Waffenschmidt, 1988, in press). The pilot project (Figure 3) has been constructed at Fresh Kills adjacent to the New York City landfill. Material was dewatered in six cells using various proportions of dredged material and cover. Aeration to aid drying was performed using auger type bulldozers.

Drying was mostly accomplished during the summer months (June-August) during which approximately 4,125 cu yd of material was produced and placed upland as cover, with the approval of NY State. Collection of leachate has been performed; the results of leachate analysis and economic considerations will be key factors in deciding whether to expand the pilot project to full scale. The cost for the experimental drying of dredged material was approximately \$40 per cubic yard. Economies of scale and more efficient use of equipment (i.e., crustal management only during the summer months) are expected to bring the costs down to an acceptable operational level (Waffenschmidt, J. 1987).

It had been difficult in the past for the NYC Department of Sanitation to obtain ocean dumping permits for dredged material from their marine transfer stations. Often, dredged material was mixed with solid waste and did not meet the criteria without substantial reworking to screen out the garbage. This method resulted in a dredged material disposal cost of approximately \$25 per cubic yard. If successful, the concept used at Fresh Kills will contribute not only towards beneficial use and placement of dredged material, but to improved water quality in the NY/NJ Harbor area.

## CONCLUSIONS:

Hydrologic and geologic surveys that were conducted as part of the feasibility studies for upland disposal/use of dredged material as sanitary landfill cover proved valuable in identifying sites for further consideration. Site N30 is currently being used for a pilot program for use of dredged material as landfill cover by the New York City Department of Sanitation. Two other potential sites remain: N-37 (Elizabeth, NJ) and N-61 (Belford, NJ), which could be considered for either regional upland disposal or regional dewatering sites.

The result of the investigations was to design the potential upland/dewatering sites so they would have minimal impact on ground water and to maintain acceptable surface water standards. Concern had been expressed by the States of New York and New Jersey, which have jurisdiction over upland disposal, in allowing dewatering of contaminated dredged material that may have the potential for increasing salinity or contaminant levels in areas with underlying aquifers that are sources of drinking water. Our studies show that each of the potential sites does not pose a contamination threat to underlying aquifers. The sites exhibit one or more of the following features: naturally occurring aquitards preventing downward percolation of leachate, existing high levels of salinity and total dissolved solids (as compared with federal drinking water standards) in surface waters and underlying aquifers, and lack of drinking water supply from aquifers in the vicinity of the sites. Only on site N-61, where a semi-confining or discontinuous aquitard was found overlying an aquifer, was a recommendation made to line the upland/dewatering basins with an impervious liner to assure that possible impacts to ground water are minimized.

Sixty percent of the dredged material tested had permeabilities of  $10^{-7}$  to  $10^{-8}$  cm/sec. Such fine grained material would tend to form an impervious lining at the base of the dewatering/disposal areas soon after decant. In addition, many of the organic contaminants that were found in the dredged material tested (such as petroleum hydrocarbons and phthalates) would tend to remain associated with the fine-grained material rather than become leached out in the return flow. The fine-grained character of much of the dredged material also makes it highly suitable for cover material in preventing percolation of leachate in landfills. Because of the very fine grained size of typical dredged material, settling basins were recommended at the sites to reduce potential impacts to surface waters. Depending upon the characteristics of the specific dredged material to be disposed, control measures such as polymer addition to decrease suspended sediments in the return flow could be implemented.

The geologic investigations and soils analyses on the sites were considered in the design of the partitioned diked containment areas, which maximizes the amount of dredged material that could be disposed/dewatered on the available acreage and within existing environmental constraints (such as avoidance of wetlands). Engineering design of the facilities also considered optimum consolidation and dewatering rates of dredged material. Thin lift dewatering and upland disposal were found to be more cost effective than thick lift emplacement. Wherever possible, on site materials were used for initial dike construction, with the knowledge that they would be supplemented and replaced by dewatered dredged material through time. Economies of scale (125-to 400-acre sites) for the Raritan Center site would have allowed fill material (probably dredged material) to be used to bring the bottom of the dewatering basins consistently 2 feet above the ground water table. However, consideration of this site was held in abeyance due to extensive wetlands and other environmental concerns on the site. Heterogeneous fill in L-13, N-61 and Raritan Center was found, which may cause differential settling of the dewatering basins and dikes and would need to be taken into account in final design.

As a direct result of New York District's studies, the New York City Department of Sanitation has undertaken a pilot project for dewatering dredged material from its marine transfer stations for use as landfill cover at Fresh Kills landfill. Initial results indicate that there is potential for expanding the project providing that overall costs can be reduced. So far the experimental dewatering project at N-30, Fresh Kills, has yielded cover material at \$40/cu yd. Although there is a clear need for cover in the NY/NJ Harbor area, the cost of producing it at N-61 and N-37 at \$24.92 and \$27.91, respectively, is considerably higher than that of conventional cover (\$8/cu yd) and is several times that of ocean disposal (\$4/cu yd).

Upland disposal ranged in cost from \$3.96/cu yd to \$20.85/cu yd on sites ranging from 28 acres to 415 acres with a 28-year lifespan. Major factors in these costs were the cost of land acquisition and hydraulic unloading distances. At the remaining sites, N-61 and N-37, upland disposal (\$4.98 and \$9.22/cu yd, respectively) is still more expensive than the current cost of ocean disposal.

#### RECOMMENDATIONS/APPLICATIONS:

Preliminary site screening is a key factor in selection of sites that are hydrologically, geologically and environmentally suited to regional upland disposal/use of dredged material as sanitary landfill cover. Subsurface geologic investigations show the extent and location of confining or semi-confining layers that separate surface aquifers from underlying drinking water aquifers. The number

of sites available for these disposal options are likely to be small in an urban environment due to competing land uses. Control measures such as settling basins to reduce suspended solids in the outflow water and the use of cells within the diked dewatering/upland areas are recommended in all cases. Addition of polymers to aid settling may be warranted in certain cases to meet turbidity criteria.

Although one of the criteria was to avoid sites containing hazardous wastes, care should be taken in site selection due to the possibility of existing contamination of the surface and ground water. Frequently it is not possible to assess whether an urban site requires remediation without on-site studies. Therefore, geohydrologic monitoring is an essential element of final site selection. This data would also be used to determine the compatibility of the existing ground water with any potential leachate from dredged material, in order to determine the true source of environmental impacts at future dates.

Feasibility of these options is also dependent upon their comparability to the cost of current disposal methods and conventional cover. Costs may be reduced by cooperative arrangements such as use of the land at no cost (which eliminates land purchase or leasing costs), by maximizing site size, minimizing pumpout distances, and by locating dewatering sites in close proximity to landfills. Actual feasibility of construction of regional upland disposal/dewatering facilities will be dependent upon these factors as well as local sponsors and institutional and financial arrangements.

## REFERENCES

Coch, C., Tavolaro, J., Krauser, R., and Tischbein, P., "Alternatives to Open Water Disposal of Contaminated Dredged Material," in Management of Bottom Sediments Containing Toxic Substances, Proceedings of the Ninth Meeting of United States-Japan Experts on Management of Bottom Sediments Containing Toxic Substances, Jacksonville, FL, Oct. 17-18, 1983, Thomas R. Patin, Ed., 1985, p. 176-197.

Coch, C. and Mansky, J., "Feasibility Study of Use of Dredged Material as Sanitary Landfill Cover in the New York/New Jersey Harbor Area," Dredging and Dredged Material Disposal, Proceeding of the American Society of Civil Engineers Dredging 84 Conference, Clearwater, FL, Nov., 1984, Vol.2 p. 830-838.

Conner, G., Aurand, D., Leslie, M., Slaughter, J., Amr, A., and Ravenscroft, F., Disposal of Dredged Material Within The New York District: Present Practices and Candidate Alternatives, Volume I, MITRE Technical Report MTR 7808, V. I., 1979, 188 p. Contracted by the U.S. Army Corps of Engineers, New York District.

Leslie, M., Aurand, D., Schultz, D., And Holman, R., Disposal of Dredged Material in the New York District: Volume II, Preliminary Evaluation of Upland Disposal, MITRE Tech. Rpt. MTR-7808, V. II, Rpt. to the New York District, 1980, 114 p. + Appendices.

Malcolm Pirnie, Inc., Feasibility Study for Use of Dredged Material from NY/NJ Harbor as Sanitary Landfill Cover, Phase I: Development and Application of Criteria to Sediment Sampling Results, Rpt. to the New York District, 1982, 58 p. + Appendices.

Malcolm Pirnie, Inc., Feasibility Study for Use of Dredged Material from NY/NJ Harbor as Sanitary Landfill Cover, Phase II: Evaluation of Dewatering Sites, Upland Disposal Sites and Sanitary Landfills, Final Rpt. to the New York District, 1987a, Vol. I (283 p.), Vol. II + Appendices.

Malcolm Pirnie, Inc., Handbook for Determining Suitability of Dredged Material for Sanitary Landfill Cover, Final Report to the New York District, 1987b, 20 p. + Appendices.

Malcolm Pirnie, Inc., Subsurface Investigation for Upland Disposal Sites, Final Rpt. to the New York District, 1987c, 47 p. + Appendices.



Tavolaro, J. and Zammit, J., "Dredged Material Disposal Management Studies for the Port of New York and New Jersey: Progress Report," Management of Bottom Sediments Containing Toxic Substances: Proceedings of the 12th U.S./Japan Experts Meeting, November 1986, in press.

U.S. Army Corps of Engineers, New York District, "Locating Upland Disposal Sites for Dredged Material," 1983, 28 p.

U.S. Army Corps of Engineers, New York District, "Locating Upland Disposal Sites for Dredged Material: Progress Report, January 1984," 28 p.

Waffenschmidt, J., Environmental Scientist, New York City Department of Sanitation, personal communication, 1987.

Waffenschmidt, J. G., "Innovative Uses of Dredged Material: Upland Dewatering of Dredged Material for the Creation of Landfill Cover Material," Proceedings of the Regional Workshop on the Beneficial Uses of Dredged Material, Baltimore, MD, 1988 (in press).

RECENT DEVELOPMENTS IN ESTIMATING POLYCHLORINATED  
BIPHENYL (PCB) LOSSES FROM CONFINED DISPOSAL FACILITIES

Tommy E. Myers<sup>1</sup>, Jan A. Miller<sup>2</sup>, and Frank L. Snitz<sup>3</sup>

INTRODUCTION

Polychlorinated biphenyls (PCBs) belong to a group of organic chemicals produced by chlorination of a biphenyl. This group of chlorinated organic compounds is composed of 209 possible forms referred to as congeners. Isomers or homologues are groups of PCB congeners with the same number of chlorine substitutions, irrespective of position on the biphenyl. Aroclors are commercial mixtures of PCB isomers. PCB concentrations are often reported as Aroclors, although the only material that is actually an Aroclor is the original product of commerce.

PCBs have characteristics of carcinogenicity, toxicity, and environmental persistence. The Toxic Substances Control Act (TSCA) of 1976 (PL94-469) specifically banned the manufacture of PCBs within the United States, restricted the use of materials already in service, and regulated disposal of PCB-contaminated materials. When present in sediment, PCBs present special technical and regulatory problems for dredging and disposal that must be carefully evaluated.

The US Army Corps of Engineers (USACE) in fulfilling its mission to maintain, improve, and extend navigable waterways in the United States, dredges, relocates, and disposes approximately 340 MCY (million cubic yards) of sediment annually (Klesch 1986). Another 100 MCY are dredged and disposed each year under the Corps of Engineers regulatory program (Klesch 1986). Over 90 per cent of the sediment dredged each year is suitable for a wide variety of beneficial uses and open water disposal (Francingues et al. 1985). The presence of heavy metals, PCBs, and other toxic substances in the balance of materials dredged may require special handling and site-specific restrictions on placement and disposal operations. Contaminated dredged material disposal and management is typically placed under thorough review by the resource agencies involved.

The USACE management strategy for dredged material (Francingues et al. 1985; Palermo et al. 1986a) identifies four disposal alternatives: open-water, open-water with restrictions, confined, and confined with restrictions. A decision making framework has been developed to provide a logical

1. Environmental Engineer, US Army Engineer Waterways Experiment Station
2. Environmental Engineer, US Army Engineer District, Chicago
3. Physical Scientist, US Army Engineer District, Detroit

methodology for application of the management strategy (Peddicord et al. 1986). The management strategy/decision making framework (MS/DMF) evaluates alternatives on the basis of comparison of laboratory test results with standards or criteria provided by local or regional authorities to determine if contaminant control measures are required.

One frequently used disposal alternative for material that is unsuitable for open-water disposal is disposal in a diked containment area or confined disposal facility (CDF). CDFs are built by raising dikes around a prescribed area and can be located upland, near-shore, or in-water. Hydraulic disposal operations involve pumping dredged material into the CDF as a slurry. Mechanical disposal typically involves dredging and transfer of material to a CDF using a clamshell bucket. During hydraulic disposal, solids settle and consolidate, and water is discharged through an outlet structure or permeable dikes or both to make room for additional dredged material. The volume of water introduced into a CDF that must later be discharged is significantly less when mechanical dredging and disposal methods are used as compared to using hydraulic dredging and disposal.

To fully evaluate the confined disposal alternative for PCB-contaminated sediments, a comprehensive analysis of the fate and transport of PCBs along various contaminant migration pathways is required. Potential migration pathways include effluent released through outlet structures, runoff, seepage through dikes and foundation materials, volatilization, and bio-uptake by transient wildlife. Release rates along these pathways vary depending on the chemical and engineering properties of the dredged material and other factors affecting the containment effectiveness of CDFs including the method of dredging and disposal, site location, stage of filling, and CDF design, operation, and management.

This paper reviews recent developments in estimating PCB release from proposed and existing CDFs, and is intended to give a broad perspective of the technical issues. Site-specific details are selectively introduced to illustrate important developments. Two completed studies and two on-going studies are discussed in terms of technical approaches, testing requirements, results, and problem areas. Since two of the studies have not been completed, discussion of results is limited.

#### INDIANA HARBOR, INDIANA

Indiana Harbor and Canal (IHC) is located in East Chicago, Indiana, on the southern shore of Lake Michigan. The area is heavily industrialized with steel mills and oil refineries. Up until 1972, the Chicago District maintained the navigation channel by periodic dredging. IHC has not been dredged since 1972 because of concerns about the environmental impacts of dredging and disposal. IHC sediments are polluted with heavy metals and organic chemicals including PCBs. The levels of PCB contamination in two reaches of the Federal project exceed 50 mg/kg, the limit for exemption from regulation under TSCA. The in-place volume of polluted sediments in IHC is

approximately 900,000 CY, of which about 200,000 CY are contaminated with PCBs exceeding the TSCA limit.

There are three TSCA disposal alternatives for this material -- incineration, disposal in a chemical waste landfill, and disposal alternatives approved by the US Environmental Protection Agency (USEPA) Regional Administrator (Environmental Laboratory 1987). An alternative method of disposal approved by the USEPA Regional Administrator appears to be the only feasible option available to the Chicago District under navigational maintenance authority.

#### Technical Approach

The disposal of dredged materials from IHC was approached along two parallel lines. The Chicago District prepared a Draft Environmental Impact Statement (DEIS) for a proposed in-water CDF to contain the dredgings from IHC with less than 50 mg/kg PCBs (USACE 1986) and requested the US Army Engineer Waterways Station (WES) to evaluate selected disposal alternatives for the dredgings from IHC which contained 50 mg/kg and greater PCBs.

The Chicago District DEIS included a desk top analysis of probable dissolved PCB (and other contaminants) release from the CDF for non-TSCA sediments. This effort was initiated in response to a request from Region V, USEPA for estimates of dissolved contaminant releases from the proposed CDF. The estimates were made using a simple mass-balance model of the CDF which accounted for contaminant release during active (dredged material disposal) and non-active (non-dredging) periods over several filling cycles. To the authors' knowledge, this was the first attempt to develop a pre-project estimate of dissolved PCB release from a CDF.

The WES studies of TSCA sediment from IHC considered environmental effects and contaminant releases for three disposal alternatives: upland and in-water CDFs and confined aquatic disposal (CAD) (Environmental Laboratory 1987). Upland and in-water CDF alternatives were evaluated using appropriate testing protocols as identified by the MS/DMF for contaminated dredged material.

#### Testing Requirements

As part of the studies on disposal alternatives for the TSCA sediment, forty 55-gallon barrels of contaminated sediment from IHC and five barrels of uncontaminated Lake Michigan sediment considered appropriate for use as a capping material were collected and transported by refrigerated truck to the WES. At WES the contaminated sediment barrels were emptied into a concrete mixer and mixed for 30 minutes. The homogenized sediment was placed back into washed drums and stored at 4 degrees C until needed for testing. The uncontaminated sediment was not homogenized. A variety of chemical, biological, and engineering tests were performed by WES as follows:

- 1) Physical/engineering properties
- 2) Settling and consolidation tests
- 3) Solidification/stabilization tests

- 4) Bulk chemical analysis
- 5) Modified elutriate tests
- 6) Column capping tests - chemical/biological
- 7) Plant uptake
- 8) Animal uptake
- 9) Leach tests
- 10) Runoff tests

## Results

A proposed in-lake CDF was used as the basis for projections of PCB release by the Chicago District and the WES. The proposed CDF design uses a filter dike with a prepared limestone core and a sand blanket on the inside face for treatment of water released during disposal.

The Chicago District estimated PCB releases based on mechanical dredging and disposal of the non-TCSA sediments using available sediment PCB data and equilibrium partitioning coefficients from the literature as input to a mass balance model. The maximum quantity of PCBs expected to be released through the dike during individual disposal operations of 200,000 CY was between 4 and 18 grams.

WES analysis of probable effluent quality for water filtering through the dike was estimated from the results of settling and modified elutriate tests and other information. For hydraulic dredging and disposal and mechanical dredging with hydraulic transfer from scows, the CDF effluent was predicted to exceed State of Indiana standards for Lake Michigan for PCBs and other contaminants. For mechanical dredging and disposal, the CDF effluent was predicted to meet Indiana's Lake Michigan standards for all parameters with the possible exception of PCBs which should approach ambient lake concentrations. The maximum quantity of PCBs expected to be released from an in-lake CDF during the disposal operation was 6.3 kg for the hydraulic transfer from scows alternative, 4.2 kg for the matchbox dredge alternative, and 0.0027 kg for the mechanical disposal alternative.

Plant uptake studies showed no PCB translocation by rooted plants. Animal uptake studies, however, showed toxic effects and indicated the need for a clean cover. Leach tests indicated that PCB migration by seepage should not be a problem due to the small quantity of leachate leaving the site (very small hydraulic gradient and very low permeability) and the low PCB concentrations (less than 1 ug/L) found in the leach tests.

An upland CDF for hydraulic disposal of PCB-contaminated sediments was evaluated, though no specific site was identified. Without site specific information, PCB loss in terms comparable to the in-water site could not be estimated. However, it was determined to meet applicable water quality criteria, control measures would be required to reduce the release of contaminants in effluent, surface runoff, and seepage. Effluent quality after treatment by filtration and carbon adsorption was predicted to exceed water quality standards for some parameters.

## Problem Areas

The major limitations of the Indiana Harbor study related to the availability of testing protocols for estimating PCB migration along certain pathways. These limitations and others are discussed below.

Laboratory tests were not available for directly evaluating effluent quality for clamshell disposal into the proposed CDF or for disposal using a matchbox dredge with a submerged diffuser. To estimate effluent quality for these disposal methods, it was necessary to use modified elutriate and leach tests results and some assumptions based on engineering judgment. While this approach was necessary because verified procedures for making the needed estimates have not been developed, such estimation techniques may be overly conservative and not very realistic.

In addition, potential water quality impacts were evaluated without the benefit of a mixing zone model capable of simulating the direction, spread, and dilution of contaminants by local advective and dispersive processes outside the CDF. The contaminant concentration field around an in-water CDF depends on local currents, wind speed and direction, bathymetry, nearby structures, and wave action. Mixing zone models that account for these factors and treat the CDF as a diffuse source must be developed and verified before the near-field water quality impacts can be fully evaluated.

PCB volatilization, a potentially important contaminant migration pathway for the upland CDF alternative, could not be evaluated quantitatively because laboratory methods for determining volatile emission rates from dredged material have not been developed. Measurements of bulk PCB concentrations in Indiana Harbor sediment before and after six months of open air curing showed that PCBs disappeared, probably by volatilization. The information obtained, however, was not adequate for calculating the volatile emission rates needed for comparing overall containment effectiveness for in-water and upland CDF alternatives.

For highly contaminated sediments, a disposal alternative that meets all criteria cannot always be identified. In such cases, a rational basis for evaluation of engineering, environmental, and economic trade-offs is needed that includes the no-action alternative. Part of the problem is due to the emphasis placed on contaminant concentrations in applicable criteria by the MS/DMF. For example, in the Indiana Harbor study, predicted effluent concentrations were compared to concentrations listed in applicable water quality criteria for Lake Michigan. However, it is not concentration alone that impacts water quality; it is the combination of flow and concentration -- mass loading or mass flux -- that ultimately impacts water quality. Evaluations based on mass loadings or mass fluxes could provide a better basis for evaluating selected impacts and analyzing trade-offs among alternatives. However, it should be realized that total mass loss calculations are incomplete without evaluation of specific environmental effects. Evaluation of specific environmental effects is best accomplished using the MS/DMF.

## EVERETT HARBOR, WASHINGTON

The US Navy has proposed to homeport a carrier battle group at Everett, Washington. Development of the homeport will involve dredging and disposal of approximately 928,000 CY of contaminated sediments from the East Waterway, Everett Harbor. PCB concentrations are on the order of less than one mg/kg. The US Navy requested the Seattle District to provide technical assistance in developing a dredging and disposal plan for these sediments. The Seattle District has requested the WES to provide support for testing and evaluations required for its technical assistance role for the Everett project. A report describing the results of the testing and evaluations was prepared by WES (Palermo 1986b).

### Technical Approach

The technical approach was similar to that used in the Indiana Harbor studies with one significant difference. In addition to the MS/DMF, a total mass loss calculation was used for comparison of near-shore CDF alternatives to other disposal alternatives. Contaminant concentrations for a reference water and water quality criteria needed for application of the MS/DMF were specified by the Seattle District. In addition, a performance goal of 5 per cent or less release of total contaminant mass in the in-place sediment during dredging and disposal was specified by the Seattle District. The reference, criteria, and performance goal were judged by the District to be a conservative means to indicate the need for contaminant controls.

### Testing Requirements

Twenty-nine 55 gallon barrels of contaminated sediment were collected and mixed on site in a concrete mixer for 45 minutes. The homogenized contaminated sediment was placed back into washed drums and prepared for shipment to WES. Six barrels of clean native sediment considered appropriate for use as a capping material were collected, but not homogenized. The sediments were shipped to WES by refrigerated truck for the suite of tests (except plant and animal uptake) previously identified for the Indiana Harbor studies. The standard elutriate test was also run.

### Results

Modified elutriate test results showed that the dissolved contaminant concentrations in the effluent from a CDF during hydraulic filling should be below reference water concentrations or criteria for most parameters. PCBs were in the parameter list that exceeded the reference water concentrations or water quality criteria.

Surface runoff tests showed that the dissolved contaminant concentrations in runoff from a representative storm event were below reference water concentrations or criteria for most parameters. PCBs were below detection limits in the surface runoff tests (0.0002 mg/L).

Drinking water standards were exceeded in the leachate tests for some parameters. PCBs were measurable in the leachate, but since there are no drinking water standards for PCBs, a comparison to criteria could not be made.

Estimates of total contaminant mass released during dredging and disposal for the various alternatives showed that the CAD alternative using clamshell dredging and surface release using bottom-dump barges provided better overall contaminant control than hydraulic dredging-CDF disposal alternatives that did not include chemical clarification of CDF effluent. (Hydraulic cutterhead dredging was considered the best dredging technique for the CDF alternatives.) Total mass release calculations for the CDF alternatives showed that surface runoff and leachate seepage were negligible compared to the mass lost in the CDF effluent. Contaminant loss by leaching was calculated using the Hydrologic Evaluation of Landfill Performance (HELP) computer model (Schroeder et al. 1984) in conjunction with data from leach tests. With the addition of mass release due to cutterhead dredging, the estimated total mass releases for two near-shore CDFs were 4.3 and 5.5 per cent of the in-place sediment contaminant mass. For comparison, the mass release for the CAD alternative involving clamshell dredging with surface release using bottom dump barges was 4.1 per cent of the in-place sediment contaminant mass.

Since the performance standard may be exceeded by one of the near-shore CDF alternatives, controls would be required at this site to meet the performance standard. Cost effective controls would include reductions in sediment resuspension during cutterhead dredging and chemical clarification to reduce suspended solids and associated contaminants in the effluent during filling operations.

#### NEW BEDFORD HARBOR, MASSACHUSETTS

New Bedford Harbor, a tidal estuary at the head of Buzzards Bay, Massachusetts, is a designated Superfund site. PCB concentrations in New Bedford Harbor sediments are in the range of tens to thousands of mg/kg. The site has been divided into two areas, upper and lower estuaries. The upper estuary is the most contaminated. Since most of the remedial action alternatives involve dredging and dredged material disposal, the USEPA asked the USACE to evaluate the engineering feasibility of various alternatives for dredging and disposal of contaminated sediments in the upper estuary (USEPA 1987). The New England Division, Omaha District, USACE Dredging Division, and WES are responsible for various elements in the USACE's involvement in the New Bedford Harbor project. Because the engineering feasibility study (EFS) for the upper estuary is not complete and specific results are not available, discussion of this project will be limited to the technical approach and testing requirements.

The technical approach uses the previously discussed MS/DMF, literature reviews, desk-top analyses, computer simulations, and a proposed pilot-scale dredging and disposal project to develop conceptual designs and assess engineering feasibility. To implement the testing required by the MS/DMF, twenty-five 55-gallon barrels of sediment were shipped to WES for the suite of



tests (except plant and animal uptake studies) previously listed for the Indiana Harbor study.

A pilot-scale dredging and disposal project has been proposed by the USEPA and the USACE after the laboratory studies and before final selection and design of a remedial action (USEPA 1987). This is a sound engineering approach for evaluation of alternatives and verification of design parameters. Pilot-scale testing is particularly important where dredging and disposal of highly contaminated sediment must be considered an innovative application of conventional technology, where certain evaluations must be made without benefit of field-verified laboratory testing protocols, and where the data base for the impact of site specific factors on design is currently not available.

The proposed pilot study will be a small (15,000 CY) field test carried out in the upper estuary using three hydraulic type dredges and two disposal alternatives. The disposal alternatives include a near-shore CDF and a CAD site in the upper estuary. For evaluation of the containment effectiveness of CDFs, the pilot-scale study provides opportunities for refining and/or verifying runoff, leachate, modified elutriate, settling, consolidation, and solidification/stabilization tests. In addition, there is an opportunity for obtaining information on air emissions.

Computer modeling has been and is expected to be an important tool for evaluating remedial alternatives at the New Bedford Harbor Superfund site. A two-dimensional sediment and contaminant transport model developed at WES for the upper estuary is being used to evaluate alternative CAD sites for the proposed pilot project. The HELP computer model is being used in conjunction with data from leach tests to develop preproject estimates of PCB loss by leaching for the proposed pilot CDF. A USEPA Superfund contractor for New Bedford Harbor is developing a three-dimensional sediment and contaminant transport model for the entire estuary that will be coupled with a food-chain model. It is anticipated that the contractor's models will be used to simulate ecosystem response for various remedial action alternatives.

#### SAGINAW CONFINED DISPOSAL FACILITY, MICHIGAN

The Saginaw CDF, Bay City, Michigan is the disposal site for navigational maintenance dredgings from the Saginaw Bay and Saginaw River. The CDF is an in-water, porous dike structure with a design capacity of 10 MCY. The CDF is located in Saginaw Bay, approximately one mile from the mouth of the Saginaw River. Portions of the Federal project contain sediments with PCB levels in the range of 10 to 20 mg/kg. Dredging and disposal of these sediments is a concern because of the potential for PCB transport through the porous dikes.

#### Technical Approach

The WES is assisting the Detroit District with a monitoring program designed to evaluate the containment effectiveness of the Saginaw CDF for PCBs. The assistance includes sampling and analysis of sediment, influent,

and ponded water for total and dissolved PCBs. The objectives of this field study are as follows:

a. Determine site specific distribution coefficients for PCBs in dredged material from the Saginaw River and compare the measured values to the values predicted by empirical relationships from the literature.

b. Compare measured ponded water dissolved PCB concentrations during disposal operations to values predicted using equilibrium partitioning and modified elutriate tests.

c. Compare observed response characteristics of ponded water dissolved PCB during and after disposal operation to predicted response.

d. Based on the measured dissolved PCB concentrations in the ponded water, estimate dissolved PCB entering the inside face of the dike and possibly being released from the CDF.

#### Testing Requirements

Field sample collection was conducted at the Saginaw CDF in September 1987. Ponded water was collected before, during, and after disposal operations for total and dissolved PCB and suspended solids analyses. Information from a concurrent dye study was used to locate sampling stations along the porous dike for collection of ponded water entering the dike. Samples for dissolved PCB were field prepared for analysis by centrifugation and filtration to minimize desorption from suspended solids during shipment to WES for chemical analysis. Samples of dredged material influent were also collected and processed on site by centrifugation and filtration for dissolved PCB analysis. The separated dredged material solids were shipped to WES for bulk PCB analysis and batch equilibrium testing. Sediment samples for elutriate and modified elutriate tests were also collected.

#### Results

Chemical analyses of the samples generated by the field sampling and laboratory tests have not been completed. When complete, these data will be used to estimate the amount of dissolved PCB entering the dike and potentially escaping the CDF. These data will also be compared to the values predicted by equilibrium partitioning and modified elutriate tests. Preliminary calculations using equilibrium partitioning suggest that the dissolved PCB concentrations in the ponded water may exceed ambient lake concentrations by one or more orders of magnitude depending on the concentration of suspended dredged material solids in the ponded water.

#### Problem Areas

Data from the testing described above will provide part of the information needed for comprehensive evaluation of the CDF's containment effectiveness for PCBs. If PCB concentrations on the outside face of the dike are to be estimated, information on sorption and mixing processes in the dike will be needed. Depending on the sorption properties of the dike material and

the dike volume, significant retention of PCB in the dike is possible. Physical and mathematical models of PCB transport through the dike are potentially applicable tools for estimating PCB loss through the dikes and are, therefore, being considered for future work.

#### SUMMARY

Recent developments in estimating polychlorinated biphenyl losses from confined disposal facilities for dredged material indicate a trend for increased complexity in laboratory testing and computer modeling. Technical approaches to evaluation of CDF containment effectiveness are evolving toward increased sophistication as new issues about potential migration pathways are raised. The new issues relate to the adequacy of available predictive techniques for seepage losses, volatilization, transport through permeable dikes, ponded water quality during disposal, surface water quality impacts of near-shore and in-water confined disposal facilities with permeable dikes, and the technical basis for trade-off analysis.

Estimates of PCB losses are being made in spite of the fact that some of the laboratory tests and computer models have not been fully verified. Thus, the need for comprehensive analysis of the transport and fate of contaminants introduced into a confined disposal facility is pushing the available tools to their limits. New work in many areas is being initiated to address specific needs on a project-by-project basis. As various studies are completed, the results should be integrated and an internally consistent set of computational procedures for performing comprehensive analysis of migration pathways and evaluating trade-offs should be developed. Otherwise, there is a potential for developing large, inconclusive and/or contradictory data sets that will support vigorous adversarial debate for years to come.

#### ACKNOWLEDGEMENT

The preparation of this paper was sponsored by the US Army Engineer Dredging Operations Technical Support (DOTS) Program, the US Army Engineer District, Chicago, and the US Army Engineer District, Detroit. The Seattle District sponsored the Everett Harbor studies, and Region I, US Environmental Protection Agency sponsored the New Bedford Harbor studies. Permission was granted by the Chief of Engineers, US Army Corps of Engineers to publish this information.

## REFERENCES

Environmental Laboratory 1987. "Disposal Alternatives for PCB-Contaminated Sediments from Indiana Harbor, Indiana, Volumes I and II," Miscellaneous Paper EL-87-9, US Army Engineer Waterways Experiment Station, Vicksburg, MS.

Francingues, N. R., Jr., M. R. Palermo, C. R. Lee, and R. K. Peddicord. 1985. "Management Strategy for Disposal of Dredged Material: Contaminant Testing and Controls," Miscellaneous Paper D-85-1, US Army Engineer Waterways Experiment Station, Vicksburg, MS.

Klesch, W. L. 1986. "Long-Term Management Strategy for the Disposal of Dredged Material: Application of the Environmental Effects of Dredging Program," In Proceeding of a Seminar on Water Quality R & D: Successful Dredging Between Theory and Applications, 25-27 February 1986, New Orleans, LA, Committee on Water Quality, US Army Corps of Engineers, Washington, DC.

Palermo, M. R., Francingues, N. R., Lee, C. R., and Peddicord, R. K. 1986a. "Evaluation of Dredged Material Disposal Alternatives: Test Protocols and Contaminant Control Measures," Proceedings of the WODCON XI, the Eleventh World Dredging Congress, Brighton, United Kingdom.

Palermo, M. R. et al. 1986b. "Evaluation of Dredged Material Disposal Alternatives for U.S. Navy Homeport at Everett, Washington," Technical Report prepared for US Army Engineer District, Seattle, by U.S. Army Engineer Waterways Experiment Station, Vicksburg, MS.

Peddicord, R. K., Lee, C. R., Kay, S., Palermo, M. R. and Francingues, N. R., Jr. 1986. "General Decisionmaking Framework for Management of Dredged Material: Example Application to Commencement Bay, Washington," Miscellaneous Paper D-86-xx, (Final Draft Report), prepared for State of Washington Department of Ecology, US Army Engineer Waterways Experiment Station, Vicksburg, MS.

Schroeder, P. R., Morgan, J. M., Walski, T. M., and Gibson, A. C. 1984. "The Hydrologic Evaluation of Landfill Performance (HELP) Model," EPA/630-SW-84-009, Municipal Environmental Research Laboratory, US Environmental Protection Agency, Cincinnati, OH.

USACE 1986. "Draft Environmental Impact Statement: Indiana Harbor Confined Disposal Facility and Maintenance Dredgings, Lake County, Indiana," US Army Engineer District, Chicago, Chicago, IL.

USEPA 1987. "Superfund Update: New Bedford, Massachusetts," Region I, US Environmental Protection Agency, Boston, MA.

EROSION AND RESUSPENSION EFFECTS OF HURRICANE GLORIA  
AT LONG ISLAND SOUND DREDGED MATERIAL DISPOSAL SITES

Thomas J. Fredette<sup>1</sup>, W. Frank Bohlen<sup>2</sup>, Donald C. Rhoads<sup>3</sup>,

and

Robert W. Morton<sup>3</sup>

ABSTRACT

Dredged material disposal mounds at water depths of 20-30 m in Long Island Sound experienced relatively little erosion during the passage of Hurricane Gloria on 27 September 1985. Hurricane Gloria passed directly over the Central Long Island Sound disposal site with sustained winds of 130-140 km/h (80-90 mph). Bottom currents measured at a station at the New London disposal site, approximately 65 km east of the storm track, increased approximately 10 cm/sec over the ambient maximum of 35 cm/sec, and bottom wave pressures were significantly perturbed during the height of the storm. Near-bottom suspended sediment loads at the New London station were 2 mg/l before the storm and increased to 16 mg/l in response to the effects of wind-induced waves during the storm. Bathymetry and REMOTS surveys of the disposal mounds at Western and Central Long Island Sound disposal sites were conducted in late October 1985, and the results were compared to surveys from earlier in the year. In addition, the New London disposal site was surveyed in July 1986. At the Central Long Island Sound disposal site, only the mound designated CS-1 (with a silt cap) had a detectable volume change. The volume change observed at this mound may have occurred because of both erosion and consolidation. At the Western Long Island Sound and New London disposal sites, no differences in volume or minimum depth were observed at the sites' mounds. Results of this study provide increased confidence in the stability of dredged material disposal mounds at similar and greater depths and the caps used to isolate more contaminated material.

---

<sup>1</sup>U.S. Army Corps of Engineers, New England Division, 424 Trapelo Rd., Waltham, MA 02254

<sup>2</sup>University of Connecticut, Avery Point Marine Sciences Department, Groton, CT 05340

<sup>3</sup>Science Applications International Corporation, Admiral's Gate, 221 3rd St., Newport, RI 02840

## INTRODUCTION

A primary environmental concern with disposal of dredged sediment in open water is the risk of erosion and transport of this material during severe storms. Concerns are even greater when contaminated materials have been disposed and capped. Capping has been a commonly applied management practice in the New England region, especially at the Central Long Island Sound disposal site, where several of the disposal mounds containing contaminated sediments have been capped with clean sediment. Predictions of material behavior during severe conditions can be made, but field verification of these predictions greatly improves the confidence placed in such disposal management practices.

In September 1985, we took advantage of the passage of Hurricane Gloria to observe the effects of storm conditions on the suspended sediment field and disposal mound topography at dredged material disposal sites in Long Island Sound. Based on the storm's forecasted track, an oceanographic instrumentation array (DAISY) was deployed on the bottom of eastern Long Island Sound to record wave, current, salinity, and suspended material concentrations, before, during, and following the storm. In addition, bathymetric and sediment profile camera surveys of the disposal mounds were conducted in the months following the storm's passage.

## METHODS

The New London (NLON), Central Long Island Sound (CLIS), and Western Long Island Sound (WLIS) disposal sites (Fig. 1) are all located in water depths between 17.5 and 34 meters, although individual disposal mound crests may be as shallow as 14 meters. Using point disposal methods, distinct disposal mounds have been created at all three sites (Fig. 2). Pre-storm surveys at these sites were obtained from monitoring data collected during investigations conducted under NED's Disposal Area Monitoring System (DAMOS).

Bathymetric and REMOTS sediment profiling camera surveys were conducted at Central and Western Long Island Sound disposal sites in October 1985 and at New London disposal site in July 1986. The objectives of these surveys were to determine large scale and small scale effects of sediment erosion following storm passage at all of the existing disposal mounds in these sites including the capped mounds, CS-1, CS-2, STNH-N, STNH-S, and MQR located at CLIS (Fig. 2).

The precise navigation required for all field operations was provided by the Science Applications International Corporation's (SAIC) Integrated Navigation and Data Acquisition System (INDAS). This system uses a Hewlett-Packard 9920 Series computer to provide real-time navigation and collect depth and time data. The computer system calculates positions to an accuracy of  $\pm 3$  meters from ranges provided by a Del Norte Trisponder system. Shore stations were established over known benchmarks used in previous surveys to allow accurate comparisons of successive surveys.

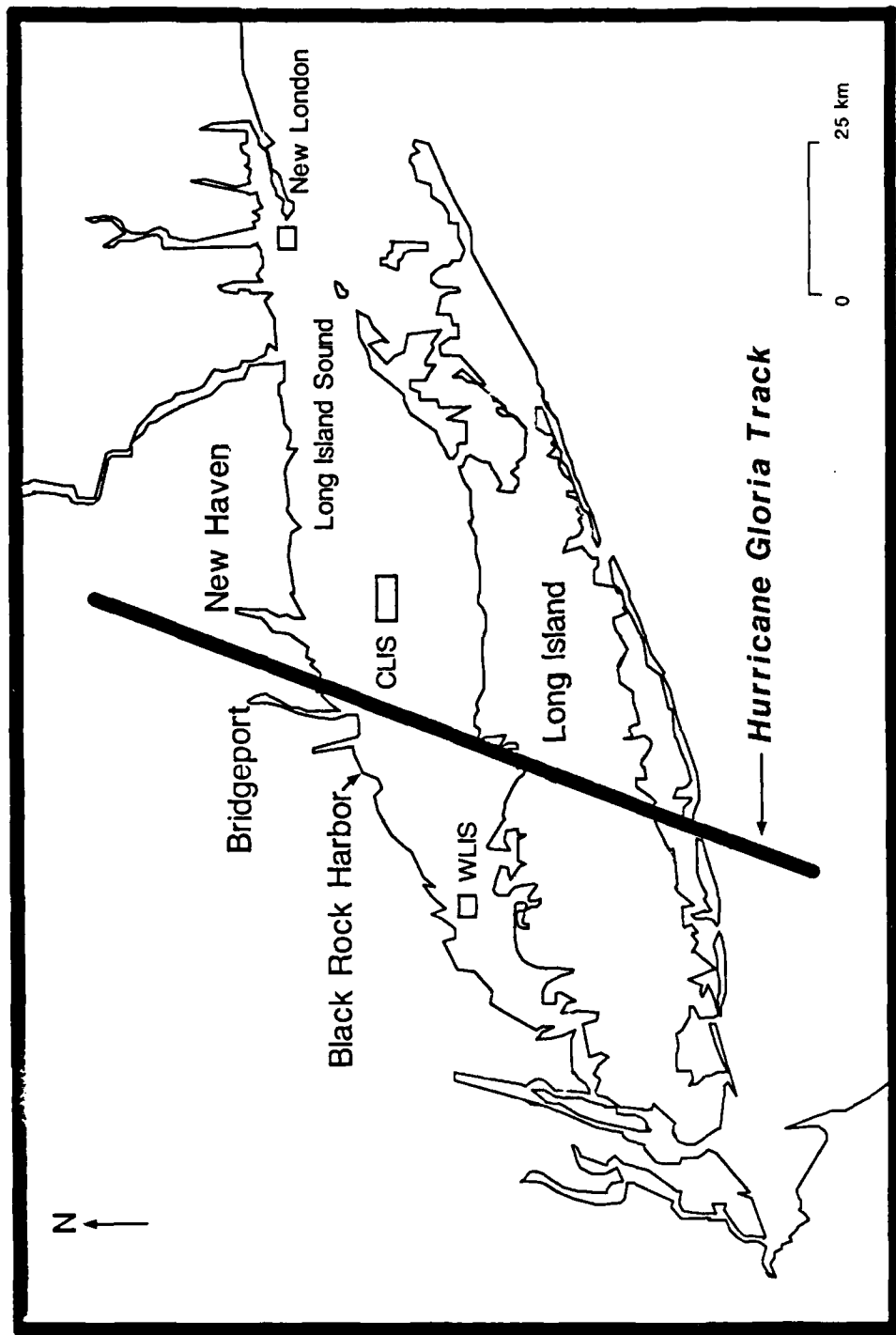

Figure 1. Location of the three disposal sites, Western Long Island Sound (W LIS), Central Long Island Sound (CLIS), and New London, in Long Island Sound and the track of Hurricane Gloria on 27 September 1985. The instrument array was located at the New London site.

# Bathymetric contour chart (m) of CLIS, July 1985.

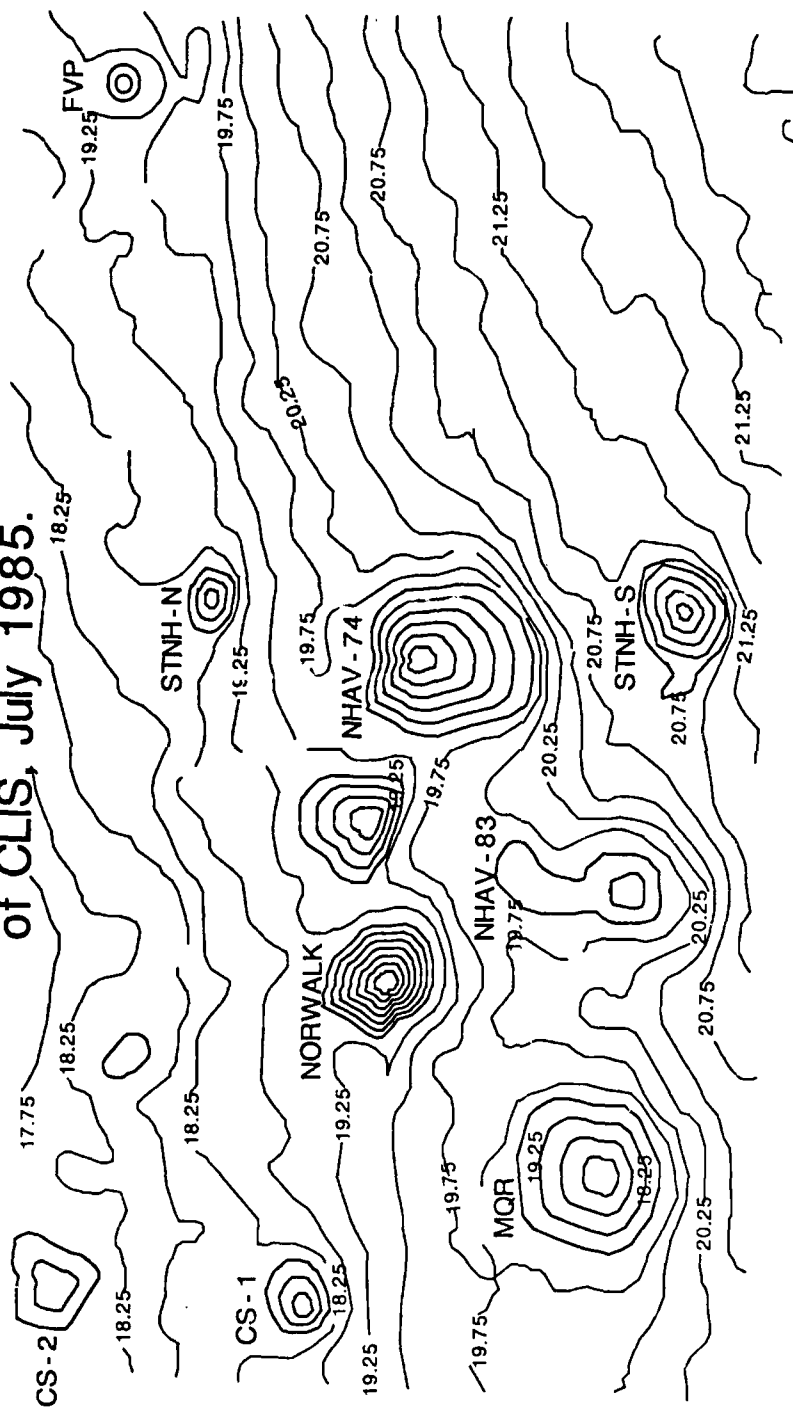

Figure 2. Bathymetric contour chart of Central Long Island Sound disposal site showing typical configuration of disposal mounds created at these sites. Pre- and post-storm surveys were based on more detailed grids than this chart and were focused on the individual mounds.



The depth was determined to a resolution of  $\pm 0.3$  meters using a Raytheon DE-719 Precision Survey Fathometer with a 208 kHz transducer. The fathometer was calibrated with a bar check at fixed depths below the transducer before the surveys began. A Raytheon SSD-100 Digitizer was used to transmit the depth values to the SAIC computer system. Survey lanes, spaced 25 m apart, were run east and west over the individual disposal mounds.

REMOTS photos were taken with a Benthos Model 3731 sediment profile camera. The REMOTS camera is designed to obtain in-situ profile photos of the top 15-20 cm of sediment. REMOTS photos were analyzed for evidence of erosion, such as benthic community type, mud clasts, shell lag deposits, worm tubes extending above the sediment surface, and the depth of the oxygenated sediment layer (OSL) which appears as a high reflectance surface layer. These data can be used to estimate the amount of sediment eroded. For example, post-storm presence of a thick OSL would suggest that only the top few centimeters or millimeters of the sediment could have been affected as pre-storm OSL depths were typically on the order of 2-5 cm. REMOTS surveys occupied stations in a cross-shaped pattern centered on the disposal mound and extending out from 500 to 600 m. In addition, at Central a transect from the disposal site toward shore was sampled to determine the water depth at which sediment erosion became evident.

A bottom-mounted instrumentation array (DAISY) was deployed at the New London disposal site on 26 September 1985 in 25 m of water just prior to the storm's arrival to observe current, wave, and suspended sediment responses to the storm. The DAISY contained a variety of instruments including a two-axis electromagnetic current meter, two optical transmissometers, temperature-conductivity probes, and a tide and wave gage. Logic control and data recording were provided by a digital data logger. All data were recorded on magnetic tape cassettes, which on recovery were converted into standard IBM compatible format for analysis.

All array instruments were attached to an aluminum framework configured to sample conditions at points approximately 1 m above the sediment-water interface. With the exception of the wave gage, all primary array components sampled four times each hour for a period of approximately 3 minutes and 10 seconds. The wave gage sampled twice each hour over periods of approximately 17 minutes each for eight days. Each sampling period provided 4,096 wave measurements and 4 measurements of concurrent tidal amplitude.

#### Storm Characteristics

Hurricane Gloria developed first as a tropical storm in the North Atlantic adjacent to the Cape Verde Islands and then tracked to the northwest towards the continental United States and intensified. On 27 September 1985 the storm passed over Fire Island, NY, 40 miles to the east of Manhattan, approximately at noon (Fig. 1). After crossing Long Island, the speed of advance increased, with the storm moving quickly over the Sound near the Central Long Island Sound disposal site, over New Haven, Connecticut, and on northward to Massachusetts.

Reviews of the available data from the National Weather Service station at Bridgeport and the meteorological station maintained at the University of Connecticut's Marine Sciences Institute at Avery Point in Groton, Connecticut,

indicate that the storm was relatively short-lived and essentially confined to a two-hour period between 1300 and 1500 EDST. The winds during this period were from the south to southeast with an observed maximum speed at Avery Point of approximately 140 km/h (87 mph). Observations during the height of the storm at all local stations were lost due to widespread power outages.

## RESULTS

### Current Speed and Direction

The passage of Hurricane Gloria along the continental shelf and over Long Island Sound significantly perturbed the near-bottom current field in the vicinity of the New London disposal site. Pre-storm currents displayed a regular tidal variability with peak speeds of approximately 35 cm/sec at 100 cm (Fig. 3) above the bottom. As Gloria approached, both current speed and direction began to display irregular behavior. Over 26 September and into the early part of 27 September, current speeds during both the flood and ebb remained similar in peak values while displaying some slight increase in short-term variability. This pattern was disturbed during the early morning hours of 27 September and the flood, which commenced at 0529 Eastern Daylight Savings Time (EDST), displayed a significantly reduced peak value. The subsequent ebb, commencing at 1119 EDST, spanned the period during which Gloria passed over the Sound and displayed peak values of about 45 cm/sec.

Following storm passage, there were additional perturbations to the typical tidal cycle. Specifically, the ebb tide beginning at 1119 EDST on 28 September displayed peak values equal to those observed during Gloria (45 cm/sec) and generally well in excess of those found during the pre-storm period. In contrast to the majority of the tidal cycles, these high current speeds persisted over much of the ebb phase, resulting in generally high kinetic energy levels favoring sediment resuspension. This event appeared to be primarily associated with the relaxation of the tidal system and outward flow of waters from nearshore areas following departure of Gloria. Subsequent tidal cycles displayed characteristics essentially similar to pre-storm conditions.

### Surface Wave Characteristics

The bottom-mounted wave and tide gage indicated that the passage of Hurricane Gloria resulted in the generation of a surface wave field with sufficient potential to resuspend the bottom sediments at 25 m. Beginning at 1215 EDST on 27 September, the amplitude of wave-associated bottom pressures progressively increased to a peak of 0.35 PSI near 1415 EDST, approximately coincident with the observed minimum in barometric pressure. Winds during this period were primarily from the south to southeast direction, providing sufficient fetch to allow generation of substantial surface wave energy. After 1415, the amplitude of the surface wave-associated pressure perturbation progressively decreased coincident with decreasing wind speeds and a general shift in direction from the south to the southwest and eventually northwest. These data indicate that significant surface wave generation and associated pressure and velocity perturbations produced by the passage of Hurricane Gloria were essentially confined to the immediate storm period. Beyond this

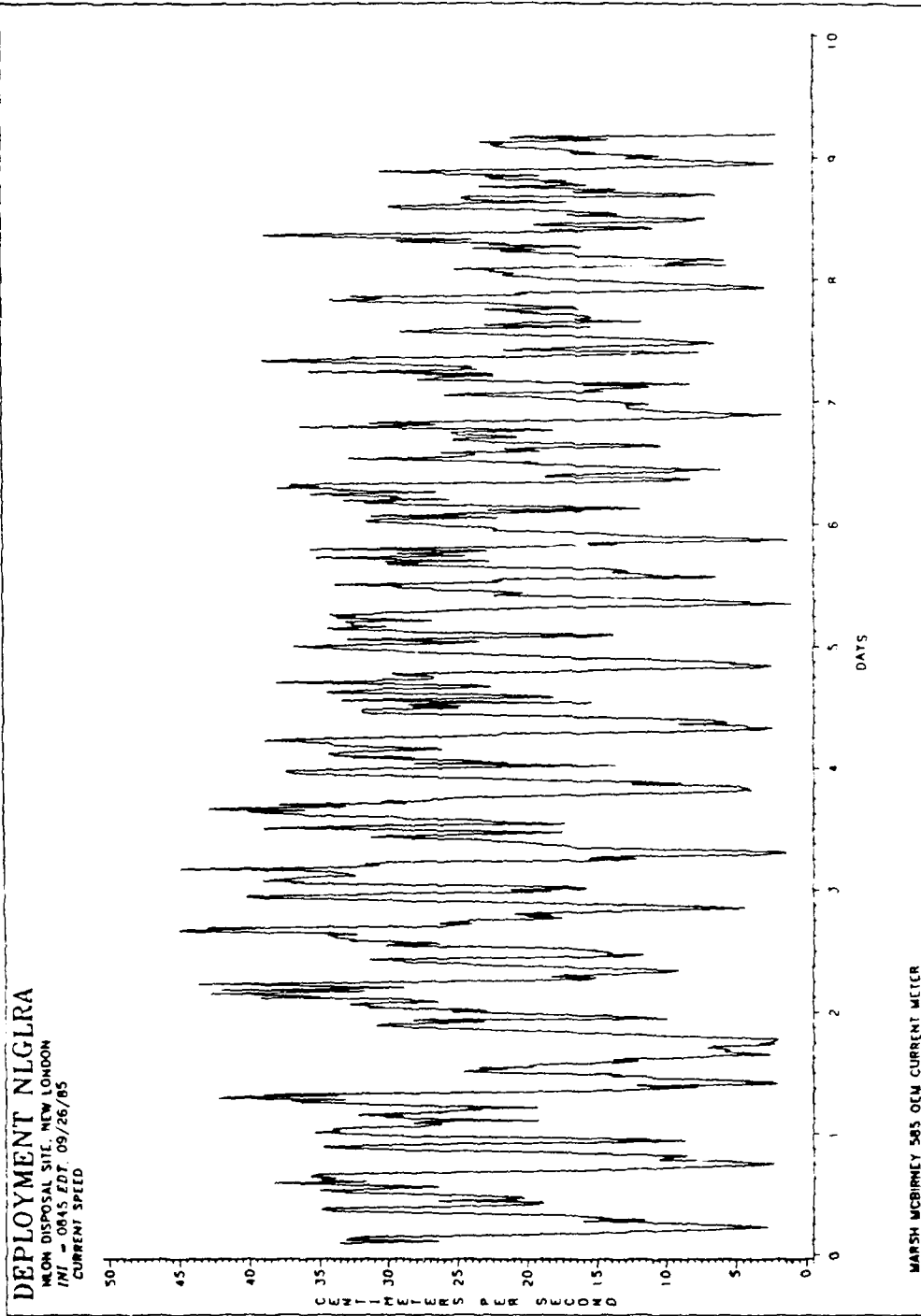

Figure 3. Near bottom current speed as recorded by the bottom instrument array (DAISY) at the New London disposal site. Hurricane Gloria passed during Day 1 which begins at 0945 EDT on 27 September 1985.

time, the sediment-water interface was effectively sheltered from surface wave effects by the overlying water column.

#### Suspended Material Characteristics

Prior to the passage of Hurricane Gloria, near-bottom suspended material concentrations in the vicinity of the DAISY deployment site displayed an average value of approximately 2 mg/l (Fig. 4). The onset of Gloria produced a significant perturbation in near-bottom concentrations with peak values increased to approximately 16 mg/l. This perturbation was relatively short-lived, however, and essentially confined to the immediate storm period. This response and the coincidence with the period of maximum surface wave generation suggests that the increase in near-bottom suspended materials resulted primarily from resuspension of materials from the sediment-water interface under the combined effects of wind wave-induced velocities and the increased tidal stream. As noted above, both of these factors decreased sharply following storm passage - the waves decaying due to a decrease in the surface wind field and tidal velocity decreasing due to storm-associated perturbations in the local tidal system. In the absence of these forcing functions, the high settling velocities characterizing the reworked materials residing along the sediment-water interface (sands and sandy, silty clays) favored a rapid decay in suspended material concentrations and a return to pre-storm conditions.

Following the post-storm decay, concentrations remained low for a period of approximately 3 hrs and then began a progressive and persistent increase to a maximum approaching 30 mg/l, almost twice the values during the storm (Fig. 4). This increase was approximately coincident with the rebound of the tidal velocity system and appeared to be the result of offshore advection of inshore materials suspended during storm passage, but retained within the nearshore shallow water areas during storm passage due to the absence of a significant onshore to offshore circulation. This post-storm surge is apparently a common phenomenon (Hayes, 1978).

#### Bathymetry and REMOTS Photography

At the Central and Western Long Island Sound disposal areas, the results of the post-storm REMOTS surveys indicated that hurricane-induced erosion of bottom sediments occurred both on and off the disposal mounds, but was limited to only the top few centimeters of the sediment surface. Evidence of disturbance of the sediment-water interface, such as mud clasts, shell lag deposits, exposed worm tubes and truncated OSL's, was apparent in many REMOTS images. However, this sediment redistribution was limited in extent to the top few centimeters of the sea floor (Table 1). Bottom disturbance was especially evident on the central (apical) portions of the disposal mounds.

DEPLOYMENT NLGLRA  
M/LON DISPOSAL SITE, NEW LONDON  
/M/ - 0845 EDT, 09/26/85  
SUSPENDED SOLIDS

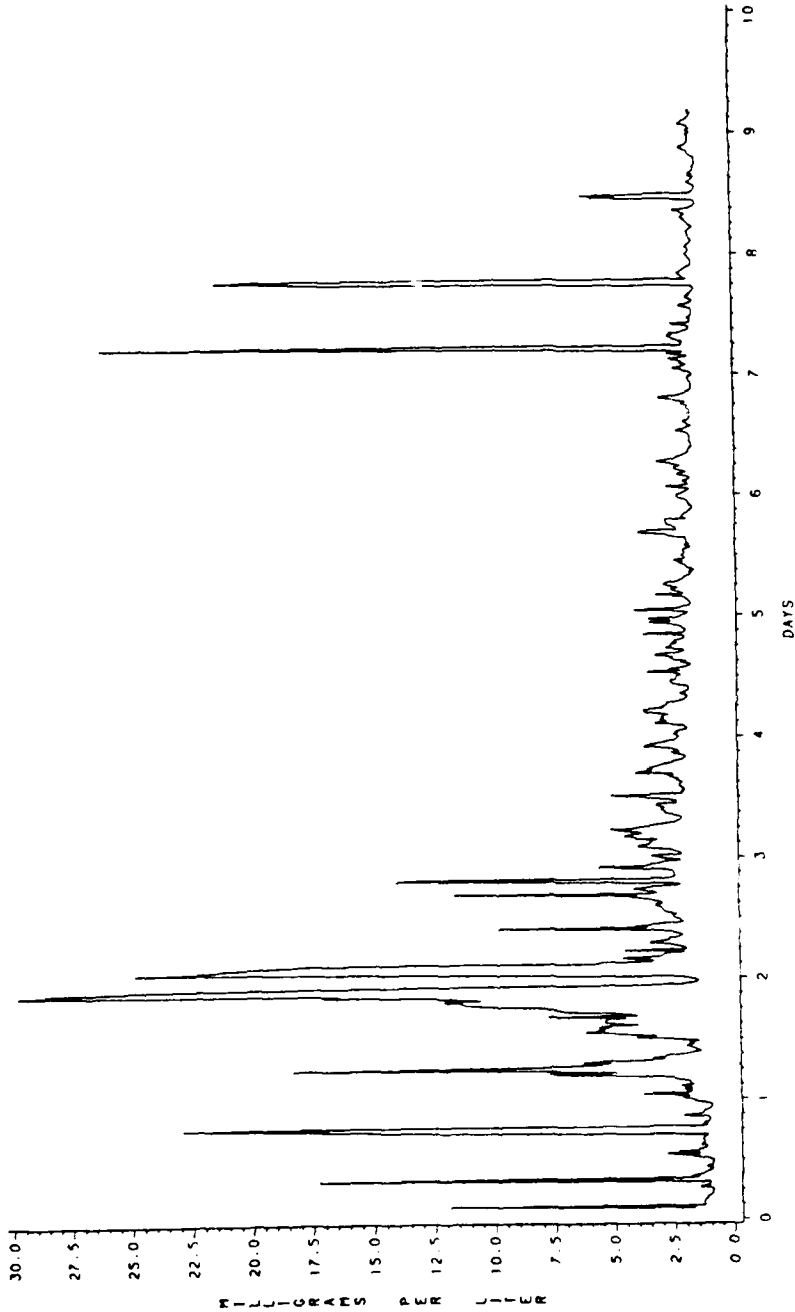

NEPHELOMETER NEPH-2

Figure 4. Near bottom suspended material concentrations as recorded by the bottom instrument array (DAISY) at the New London disposal site. Hurricane Gloria passed during Day 1 which begins at 0945 EDT on 27 September 1985. The absence of a return to background conditions and the peaks observed after Day 6 were attributed to sensor fouling.

Table 1. Estimates of the extent of erosion at the Central Long Island Sound disposal site based on the oxygenated sediment layer (OSL) thickness.

MOUND	Mean Thickness of OSL		
	AUGUST	OCTOBER	Change in Thickness (cm)
STNH-N	3.97	1.97	2.0
STNH-S	4.08	2.07	2.0
CS-1	4.02	2.97	1.0
CS-2	3.98	2.56	1.4
MQR	4.58	2.58	2.0

The results of the shoreward REMOTS transect at Central indicated that bottom areas shallower than the 15 m isobath experienced more extensive sediment erosion and redeposition than observed at the disposal site. Shell lag deposits and rippled sand layers overlying silt-clay sediments were evident throughout this region. Conversely, the deepest station located on the transect in 25 m of water showed little evidence of bottom disturbance and was apparently located below the hurricane wave base.

Analysis of the pre- and post-storm precision bathymetric data detected significant change in volume of only the CS-1 mound (limit of resolution  $\pm 10$  cm) while all other mounds were unchanged (Fig. 5). This disposal point (CS-1) was the most recently used disposal point at Central. The newly disposed, unconsolidated dredged material at this mound was potentially more susceptible to storm-induced erosional forces.

#### DISCUSSION

The erosion and sediment transport impacts of Hurricane Gloria on disposal sites in Long Island Sound were, for the most part, minor and resulted in resuspension of only the top few centimeters of sediment. Bottom currents at the New London disposal site, 65 km to the east of the storm track, were sufficient to resuspend some bottom sediments both during the storm and following storm passage when the normal tidal cycle was perturbed. However, substantial erosion was not detected with REMOTS and bathymetry.

With the exception of the CS-1 mound, pre- and post-storm volume differences of the disposal mounds at the Central, Western, and New London disposal sites were undetectable, suggesting that any disturbance that did occur was small-scale (less than could be detected with high resolution acoustics). REMOTS sediment profile photos supported this conclusion: shortly after storm passage, well developed OSL's were still present at most stations. This indicated that the resuspended sediment layer was less than 5 cm, the maximum average level of OSL development before the storm.

Even though a volume loss at the CS-1 mound was observed, it does not appear that cap effectiveness was significantly decreased. Distributing the volume loss evenly over the entire surface of this 280 meter diameter mound translates to an elevation loss that ranged from 13 to 37 cm (Fig. 5). Part of this elevation loss is probably a result of sediment consolidation and not erosion since this mound was being used for disposal up until a month before the storm. Previous experience (Morton 1980) has indicated that prior to stabilization of mounds following disposal significant depth changes can occur as a result of consolidation. However, some erosion of the mound would be expected during storm conditions, especially of that material which still had high water content.

REMOTS sediment profile photos on CS-1 suggest very little erosion as the mean OSL depth was 4 cm in August and 3 cm in October (Table 1). Even assuming some post-storm redevelopment of the OSL thickness, these observations suggest that the actual loss of sediment was at most only 1-2 cm, and consolidation may have been the major contributor to elevational change. In addition, more recent surveys (1986) have shown low contaminant levels on CS-1 and a normal benthic community. This information, along with the estimated minimum cap thickness of 40 cm, provides reasonable assurance that a sufficient cap is in place to effectively isolate the underlying contaminated sediments.

This study, along with prior studies following Hurricane David (Morton 1980) and Hurricane Belle (McCall 1978), provide evidence that disposal management practices at these disposal sites have effectively contained both contaminated and uncontaminated sediments within the sites, even during severe oceanographic conditions. Wave hindcasting of hurricane conditions suggests that bottom shear stress is negligible below a depth of 20 meters in the central and western portion of the Sound (McCall 1978). This supports the observations made here for disposal sites located at or below this depth.

#### REFERENCES CITED

- Hayes, M. O. 1978. Impact of hurricanes on sedimentation in estuaries, bays, and lagoons. In, Estuarine Interactions (M. L. Wiley, ed.). Academic Press, N.Y. Pp. 323-346.
- McCall, P. L. 1978. Spatial-temporal distribution of Long Island Sound infauna: the role of bottom disturbance in a nearshore marine habitat. In, Estuarine Interactions (M. L. Wiley, ed.). Academic Press, N.Y. Pp. 191-219.
- Morton, R. W. 1980. The management and monitoring of dredge spoil disposal and capping procedures in central Long Island Sound. DAMOS Contribution No. 8. U.S. Army Corps of Engineers, New England Division, Waltham, Mass., 57 pp.

# VOLUME CHANGE OF DISPOSAL MOUNDS

FOLLOWING HURRICANE GLORIA

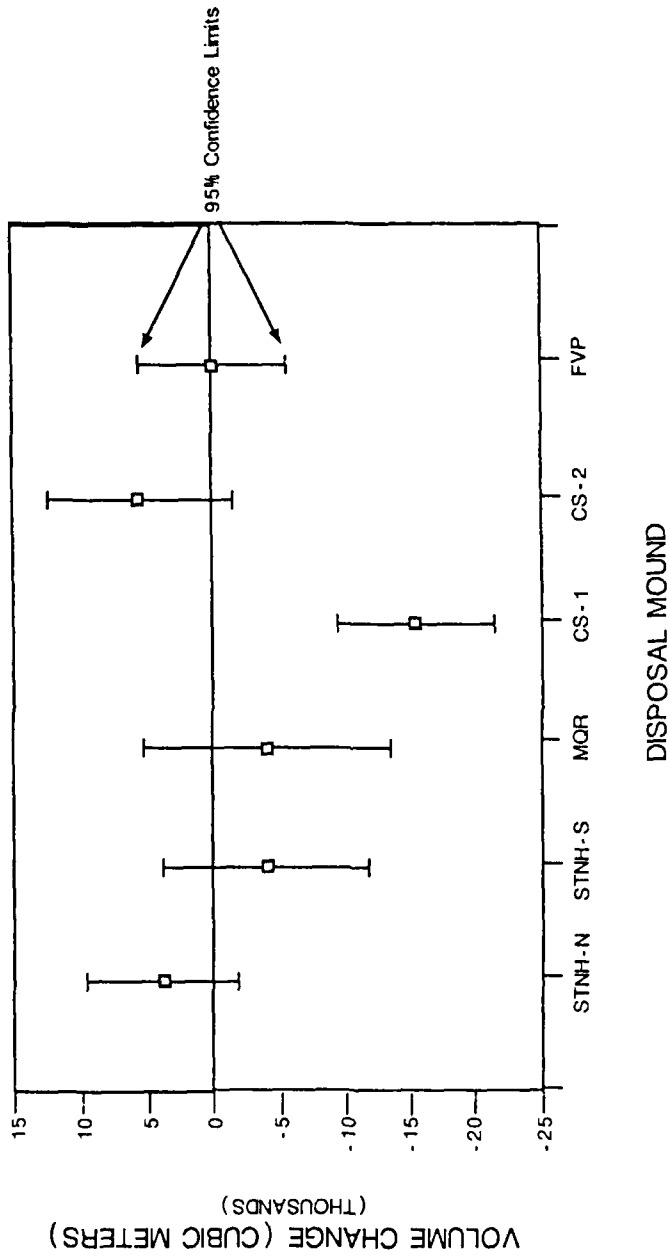

Figure 5. Mean and 95% confidence limits of disposal mound volume changes as based on precision bathymetric mapping. Means are derived from individual sectors that comprise each survey grid. Only CS-1 showed a change detectable from zero.



USE OF SPOT HRV DATA IN THE  
CORPS OF ENGINEERS DREDGING PROGRAM

By

Carolyn J. Merry<sup>1</sup>, Harlan L. McKim<sup>1</sup> and Nancy LaPotin<sup>1</sup>

John R. Adams<sup>2</sup>.

INTRODUCTION

The Corps of Engineers has a wide variety of water-related mission responsibilities, but one of the most important is navigation. There are 25,000 miles of navigable inland waterways in the United States. The barge traffic on these waterways transports millions of dollars worth of commercial goods annually. The Corps is responsible for keeping these waterways open. In addition, the Corps must keep navigation channels open in nearshore and estuarine environments by dredging these channels and maintaining them, in many cases at a minimum channel depth of 35 to 40 ft.

As a result of these dredging operations, there are millions of tons of material that must be disposed of on the land, in nearshore environments, or in the ocean. The dredged material from many locations can be used beneficially for beach nourishment projects and for developing waterfowl and fishery habitats. When the dredged material contains pollutants that could be harmful to human and aquatic life, other techniques, such as containment facilities, must be used when disposing of it.

In areas where the impact of unconfined disposal of dredged material must be monitored, the cost of site selection and subsequent water quality monitoring can become very high. It is important in these instances to select representative water quality sampling locations, but it is equally important to minimize the number of water quality samples required.

With this in mind, a study was done to: 1) review the application of existing remote sensing techniques for providing data in the Corps' dredging program, 2) define promising new remote sensing techniques for monitoring and managing dredged disposal sites, and 3) recommend which remote sensing techniques should be used now and which techniques should be developed for the future (McKim, et al., 1985). It was found that additional research is required to study the use of multispectral scanners for bathymetric mapping of large coastal areas, for mapping

---

1. U.S. Army Cold Regions Research and Engineering Laboratory,  
72 Lyme Road, Hanover, New Hampshire 03755-1290

2. U.S. Army Engineer District, Buffalo,  
1776 Niagara Street, Buffalo, New York 14207-3199

sediment transport in shallow waters, for mapping concentrations of suspended matter of organic or inorganic origin, and for detecting vegetative stress and soil properties (McKim, et al., 1985). Along with acquiring multispectral data, ground truth needs to be taken to verify the interpretation of the data.

The spatial resolution and time frequency of data acquisition are important when evaluating remote sensing techniques for use in the dredging program. The French Systeme Probatoire d'Observation de la Terre (SPOT) satellite system is the first operational system that will allow data acquisition and distribution in a short time frame (less than 48 hrs). Initially, the SPOT high resolution and pointable system was evaluated as a means of collecting water quality data that would augment and potentially reduce the conventional data collection activities of the Corps and the state of Maryland at the Hart-Miller Island disposal area (Band, et al., 1984). The research begun at Hart-Miller Island has been continued for the dredging operation in the Toledo Harbor, Ohio, area. This paper reports on the study completed for Toledo Harbor.

### DESCRIPTION OF THE SPOT SATELLITE SYSTEM

The French SPOT satellite, launched on 21 February 1986, is in a sun-synchronous, near-polar orbit. For any given region, the satellite images the Earth at the same local time on consecutive passes. In its nominal orbit at 832 km altitude, the SPOT satellite crosses the Equator during its descending node at about 1030 am. The satellite's motion is also synchronized with the daily rotation of the Earth so that the pattern of successive ground tracks is repeated at 26-day intervals.

The sensor package consists of two High Resolution Visible (HRV) sensors. The HRV is a "push-broom" scanner, which means it images a complete line of the ground scene in the cross-track direction in one "look" without any mechanical scanning. The instrument is also pointable and can image an area on the ground  $\pm 27^\circ$  from nadir. Each imaging adjacent 60-km ground areas. There is a 3-km overlap in the center, for a total image width of 117 km (Fig. 1).

The satellite can point off to either side of nadir at 0.6 increments and can thus image any area within a 950-km swath centered over the orbital path (Fig. 1). This allows for stereo acquisition of imagery and for more revisit opportunities over an area of interest than is possible with the Landsat series. At the latitude of 42N for Hanover, New Hampshire, the sensor could image an area 11 times during a 26-day orbital cycle. A maximum of six stereo-pairs can also be obtained during the 26-day cycle. The data are of high radiometric quality with 8-bit resolution for 256 radiometric levels. There are two modes of instrument operation: multispectral and panchromatic. The 20-m multispectral mode covers three spectral regions -- two in the visible (0.50 - 0.59 m, 0.61 - 0.68 m) and one in the near infrared (0.79 - 0.89 m). The 10-m panchromatic mode

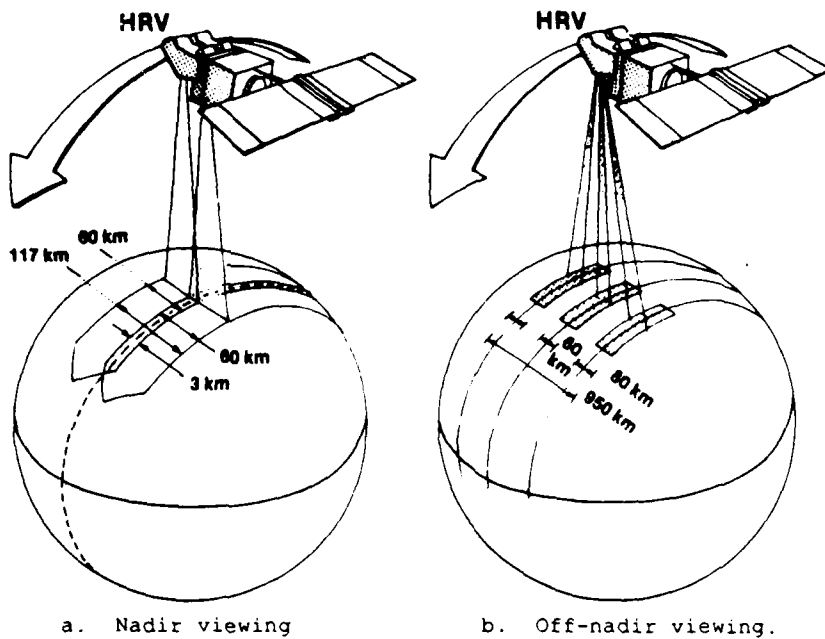

Figure 1. Nadir and off-nadir viewing capability of the SPOT satellite.

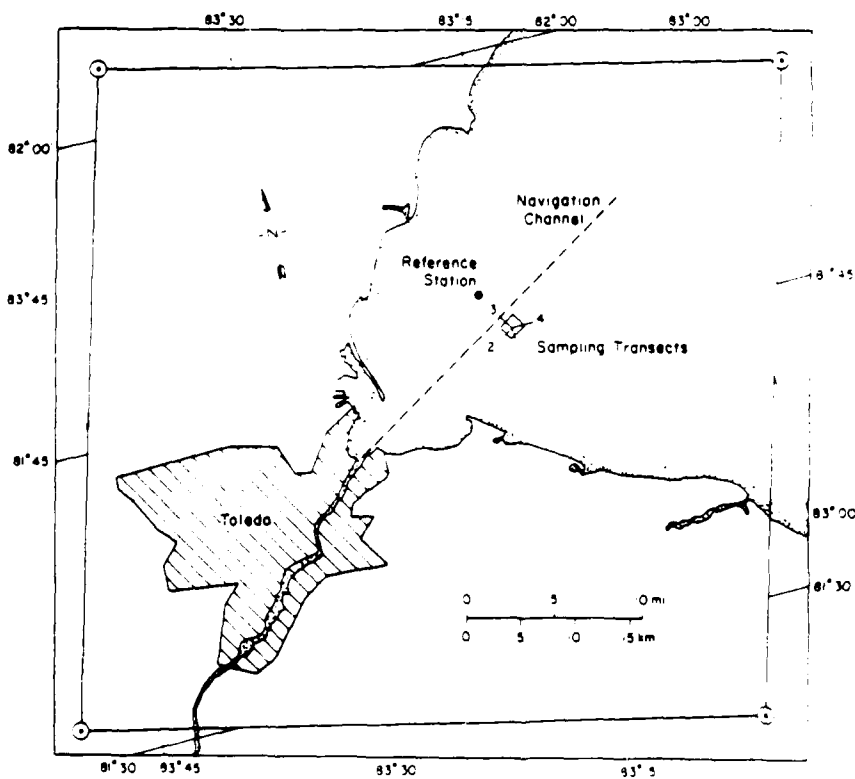

Figure 2. Site location map of the study area.

covers a wide band ranging from 0.51 to 0.73  $\mu$ m. Additional details on the SPOT satellite system can be found in Begni (1982), Begni, et al. (1984), Chevrel, et al. (1981) and CNES (1982).

In this paper we address the possibility of using the off-nadir viewing capability with 20-m multispectral data for mapping relative ranges of suspended sediment concentration associated with a Corps dredged material disposal operation.

### GROUND TRUTH DATA ACQUISITION

The Buffalo District, Corps of Engineers, conducted a monitoring program during the summer of 1986 to study the effects of open-lake disposal operations on the water quality of Lake Erie. The dredged material disposal area is located northeast of Toledo, Ohio, and is within the rectangle located southeast of the navigation channel (Fig. 2).

The dredged material disposal operation occurred over a period of 14 weeks, starting on 7 April and ending on 8 June 1986. In situ measurements of water quality were performed twice before the dredging operation began on 7 April. Water quality measurements were then made every week until 18 June 1986, including two measurement sets after dredging ceased on 8 June 1986.

A programming request was made of SPOT IMAGE Corporation to obtain SPOT HRV data over the Toledo area during the Corps dredging operation. The District's water quality sampling program was readjusted to coordinate with a dredged disposal operation and a SPOT overpass on 4 June 1986. As a result, a completely cloud free SPOT image was acquired successfully on 4 June at 1242 hrs (DST).

The water quality data taken on June 4 are shown in Table 1, with the location of the water quality sampling stations shown in Figure 3. Seventy percent of the dredged material disposed during the 4 June operation was clay.

### ANALYSIS OF THE SPOT HRV DATA

#### Matching the image to the map

The SPOT HRV data set was analyzed on a Dipix ARIES-II image processing system. The HRV image was registered to a NOAA map sheet (scale 1:40,000) using an Altek digitizing table and Gentian controller interfaced to the image processing system. The navigation channel and the location of the water quality sampling stations were located, digitized and stored as overlay theme files on the SPOT image.

Interpretive analysis of the spectral reflectance data for the entire SPOT scene indicated that there were from five to

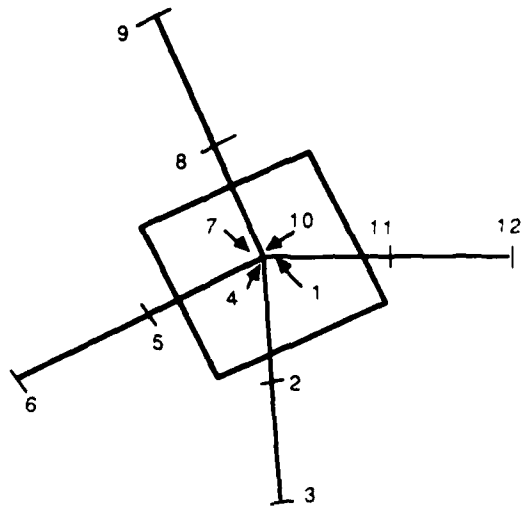

Figure 3. Location map of the water quality sampling stations.

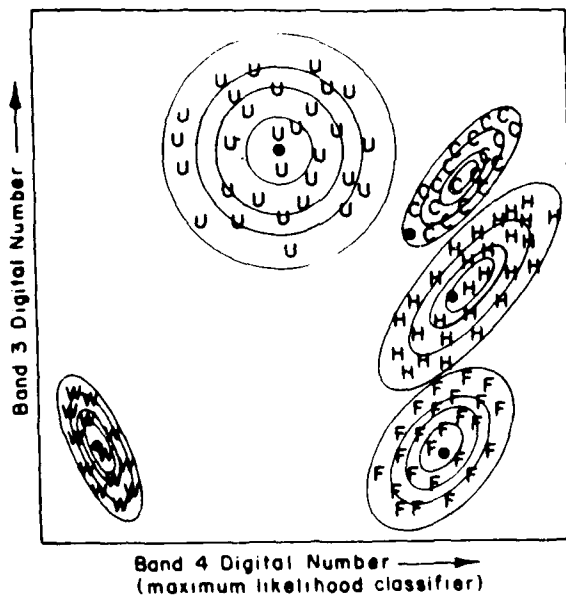

Figure 4. Schematic of maximum likelihood classifier. For example, the letters (W, U, C, H, F) are clusters of pixels, each representing a unique spectral response.

seven different water types in the area of interest. Using this information as a guideline, a 723 by 670-pixel subarea (approximately 8.5 miles on a side) that contained the dredged material disposal area was selected from the HRV image for analysis.

#### Unsupervised classification of data

An unsupervised maximum likelihood classification was performed on the subarea. The classifier delineates "equiprobability contours," shown as ellipsoids for two spectral bands (Fig. 4). A normal probability density function is calculated for each of these ellipsoids, which are also characterized by a mean vector and a covariance matrix. The shape of these equiprobability contours shows the sensitivity of the maximum likelihood classifier. The probability density function is used to classify an unknown pixel by computing the probability of a pixel belonging to each of the categories. After the probabilities are evaluated, the pixel is assigned to the most likely class.

The unsupervised classification procedure of the ARIES-II software generates n-dimensional histograms, with the n dimensions in this case representing the three SPOT spectral bands, and searches for maximum values within each histogram. There were 17 maximum histogram peaks generated for the three-band data. The range of values used in the histogram generation process was limited to the range of the histogram values within each band. An equal number of pixels per histogram bin was allocated so that an equal number of bins represented each band. The 17 maxima were then merged into five multiple parallelepiped classes to create Gaussian multispectral signatures. A maximum likelihood classification was performed on the data set using these five spectral signatures. The mean values of the five multispectral signatures show that the reflectance increases from class 1 to class 5 for each spectral band (Fig. 5).

There were many unclassified pixels in the initial water classification. Therefore, post-classification filtering was performed on the classification map. The filtering algorithm is based on the minimum area of a homogeneous theme, 7 pixels in this case (Dipix Systems Limited, 1986). Results from the smoothing algorithm showed that the water classification was not affected significantly. The differences between the "before" and "after" maps of the areal distribution of each class were less than 2%, as shown in Table 2.

#### Matching the image data to the water quality data

To correlate the water quality data at the 13 stations with the spectral class information, the overlay of the water quality sampling locations was superimposed on the water classification map (Fig. 6). Spectral class 1 (pink) was the least reflective water, and spectral class 5 (green) contained the most

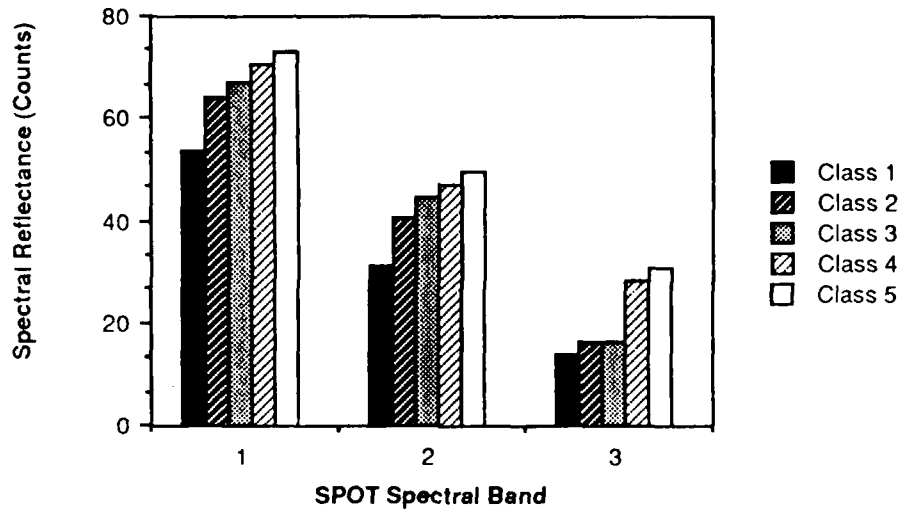

Figure 5. Mean values of the five multispectral signatures.

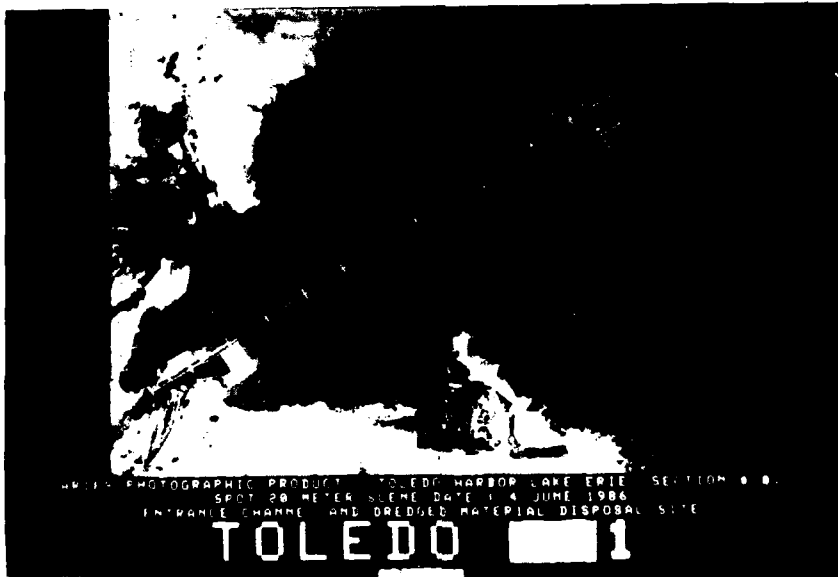

Figure 6. Water sampling transects and navigation channel overlaid on the water classification map.

reflective water. The basis for this interpretation is that in pure water the attenuation of light is dominated by the absorption of water below wavelengths of 0.3 m and above 0.7 m (Morel, 1974). The presence of particulate and dissolved material in the water will affect the penetration of light in water and the intensity and color of the light scattered back in the direction of the remote sensor (Philpot and Klemas, 1979). Since spectral class 1 had the lowest values for all three bands and spectral class 5 the highest values (see Fig. 5), then spectral class 5 contained the greatest suspended sediment load.

The water quality data from the 13 locations were analyzed next. Sampling point 13 represents the District's reference sampling location and is considered an outlier<sup>3</sup>. The strongest correlation between the water quality data shown in Table 1 and the spectral classes was found with the turbidity (measured in NTUs), which is a measure of light scattering. However, a quantitative measure of suspended load is normally expressed in mass per unit volume or concentration (mg/L). To obtain the relationship between the concentration and the spectral class, two models were developed. The first model related the turbidity level (in NTU) to the suspended sediment concentration (in mg/L), and the second model related the turbidity (measured in NTU) to the spectral classification index (from class 1 to 5).

Figure 7 shows an exponential model correlating the suspended sediment with the turbidity. The equation for model 1 is shown below:

$$y = (0.511) (10^{0.042x}) \quad (1)$$

<0.01005>
(4.15908)
(0.002)

where: y = suspended sediment concentration (mg/L)

x = turbidity (NTU)

< > = standard error of estimate

( ) = t statistic

---

3. The suspended sediment concentration for point 13 is high in comparison to the other data (6.0 mg/L), the turbidity value is low (7.5 NTU), but the secchi disk depth is high (measuring 3.5 ft), which is inconsistent with the other 12 data values (see Fig. 7 and Table 1). Also, the spectral values for point 13 were examined in each band to check for inconsistencies and were found to be representative for spectral class 2. This implies a probable measurement error with point 13, perhaps resulting from the relatively low concentrations of suspended sediment (ranging from <1.0 to 8.0 mg/L).



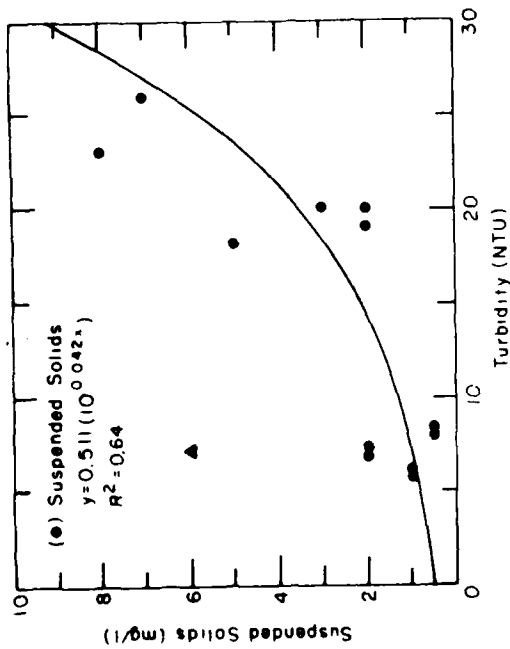

Figure 7. Exponential model relating suspended sediment concentration (mg/L) with turbidity (NTU).

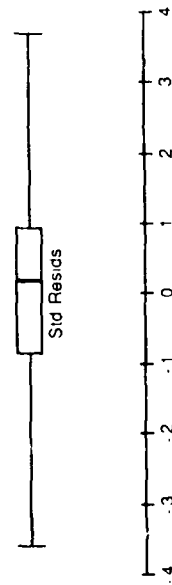

Figure 8. Schematic plot of the residuals for the exponential model shown in equation (1).

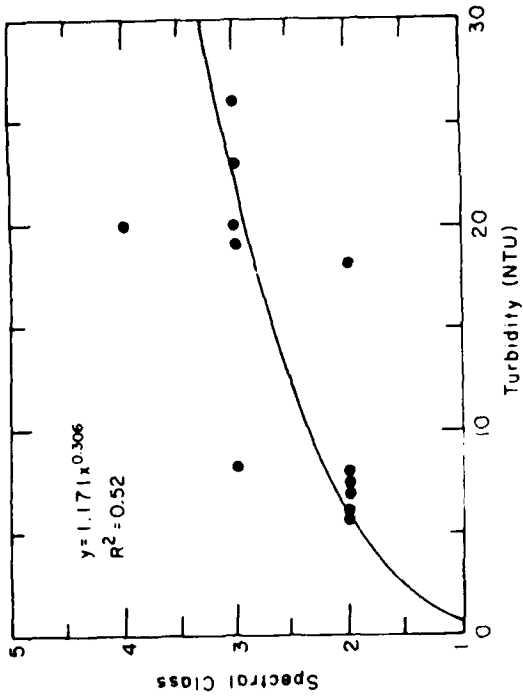

Figure 9. Logarithmic model relating spectral classification to turbidity level.

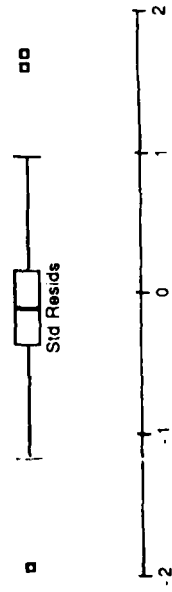

Figure 10. Schematic plot of the residuals for the logarithmic model shown in equation (2).

( ) = p-value for t statistic

Table 3 shows the ANOVA table for equation (1). The residuals are symmetric around zero with no outliers (Fig. 8). About 64% of the variance in suspended sediment concentration is explained by using the turbidity value, as an indicator. The standard error of the model is 0.01 mg/L<sup>4</sup>.

Figure 9 shows the model developed relating the spectral class to the turbidity level. The relationship was logarithmic of the form:

$$(2) \quad y = (1.171) (x^{0.306})$$

$<0.09284> \quad (3.29805)$   
 $(0.008)$

where: y = spectral class (from 1 to 5)

x = turbidity (NTU)

< > = standard error of estimate

{ } = t statistic

( ) = p-value for t statistic

Table 4 shows the ANOVA table for equation (2). The residuals are symmetric around zero with three outliers (Fig. 10). The coefficient of determination for the model is 0.52, suggesting that 52% of the variation in spectral class definition is explained by using the turbidity value as an indicator. The model illustrates the non-linear association between turbidity and spectral class; however, it should be used solely as an illustrative model due to the small sample size (12).

#### SUMMARY AND CONCLUSIONS

The results from the study indicate that the 20-m multispectral data from the SPOT satellite is useful for differentiating between relative suspended sediment levels at dredged disposal areas. Around the immediate dredged disposal area, very little variation was seen in the water quality sampling data. The sparsely sampled ground truth data and the 2-mg/L measurement accuracy did not warrant a complete

4. The measurement accuracy of the suspended load concentration for the sampling procedure used  $\pm 2$  mg/L.

statistical analysis of the digital image data. The first model showed a nonlinear association between suspended sediment concentration and turbidity. The highest nonparametric correlation (0.807) for spectral class separation was with the turbidity value (in NTU) for low levels of suspended sediment.

Future efforts should include measurements at both surface and non-surface points. In addition, algorithms need to be developed to relate surface measurements to sub-surface concentration profiles and spatially distribute this information across the test area. Provided that an adequate sample size is obtained, equations of the form (1) and (2) might be helpful for correlating SPOT image data to water quality sampling and other ground truth measures.

Because of the small amount of field data available from the study, another test will be done in the future. Near-real-time remotely sensed information, such as the NOAA Advanced Very High Resolution Radiometer (AVHRR) imagery, will be used to select areas of Lake Erie for positioning the water quality sampling transects. Additional point data will be collected over a wider range of turbidity or suspended sediment concentration data. These measurements will be made over the entire water column as determined by the secchi depth measurement. This will allow comparison with the data collected in June 1986.

#### ACKNOWLEDGMENTS

The work was sponsored under the Corps of Engineers Civil Works Remote Sensing Research Program, CWIS 31746, Evaluation of SPOT and Landsat-4 Satellite Data Products, and reimbursable orders from the Buffalo District, Corps of Engineers, and the Water Resources Support Center, Dredging Division (WRCC-D). Appreciation is extended to Eleanore Meredith (SPOT IMAGE Corporation) for her help in coordinating with SPOT IMAGE to acquire the satellite image during our water quality sampling program, to Charles Hummer (WRSC-D) for his support of our research with SPOT HRV data for application to the Corps Dredging Program, to Perry J. LaPotin for helpful technical discussions, and to Richard Birnie (Dartmouth College), Stephen Yaksich (Buffalo District, Corps of Engineers) and Andrew J. Bruzewicz (Rock Island District, Corps of Engineers) for technical review of this report.

## LITERATURE CITED

Band, L.E., H.L. McKim and C.J. Merry (1984) The potential use of SPOT HRV imagery for analysis of coastal sediment plumes, SPOT Simulation Applications Handbook, Proceedings of the 1984 SPOT Symposium, 20-23 May, Scottsdale, Arizona, pp. 199-204.

Begni, G. (1982) Selection of the optimum spectral bands for the SPOT satellite, Photogrammetric Engineering and Remote Sensing, vol. 48, no. 10, pp. 1613-1620.

Begni, G., D. Leger and M. Dinguirard (1984) An in-flight refocusing method for the SPOT HRV cameras, Photogrammetric Engineering and Remote Sensing, vol. 50, no. 12, pp. 1697-1705.

Chevrel, M., M. Courtois and G. Weill (1981) The SPOT satellite remote sensing mission, Photogrammetric Engineering and Remote Sensing, vol. 47, no. 8, pp. 1163-1171.

CNES (1982) SPOT satellite-based remote sensing system, CNES: Paris, France.

Dipix Systems Limited (1986) ARIES System User's Manual.

Lillesand, T.M. and R.W. Kiefer (1979) Remote Sensing and Image Interpretation, John Wiley & Sons, Inc.: New York, New York.

McKim, H.L., V. Klemas, L.W. Gatto and C.J. Merry (1985) Potential of remote sensing in the Corps of Engineers Dredging Program, CRREL Special Report 85-20, 47 p.

Morel, A. (1974) Optical properties of pure water and pure sea water, in Optical Aspects of Oceanography, Jerlov and Nielsen (eds.), Academic Press: New York.

Philpot, W. and V. Klemas (1979) The use of satellites in environmental monitoring of coastal waters, Final Report, CRS-1-80, NASA Langley Research Center: Hampton, Virginia.

Table 1. Measurements from the water quality stations located near the dredged disposal site at the time of the SPOT overpass.

<u>Location no.</u>	<u>Suspended Sediment (mg/L)</u>	<u>Turbidity (NTU)</u>	<u>Secchi Depth (ft)</u>
1	2.0	19.0	2.0
2	2.0	7.3	2.5
3	2.0	6.8	2.5
4	7.0	26.0	2.0
5	5.0	18.0	2.5
6	<1.0	7.9	2.5
7	<1.0	8.3	3.0
8	8.0	23.0	2.0
9	3.0	20.0	2.5
10	2.0	20.0	2.5
11	1.0	6.1	3.0
12	1.0	5.7	3.0
13	6.0	7.5	3.5

Table 2. Classification summary statistics for the non-filtered and filtered water classifications.

Difference	<u>Non-filtered</u>		<u>Filtered</u>		
	Pixels	Total	Pixels	Total	
<u>Class no.</u>	<u>(no.)</u>	<u>(%)</u>	<u>(no.)</u>	<u>(%)</u>	<u>(%)</u>
1 (pink)	27268	5.6	24259	5.0	-0.6
2 (yellow)	245565	50.6	254125	52.3	1.7
3 (red)	151480	31.2	149359	30.7	-0.5
4 (blue)	43370	8.9	41009	8.4	-0.5
5 (green)	16586	3.4	17043	3.5	0.1
Unclassified	1535	0.3	9	0.1	-0.2
Total	485804	100.0	485804	100.0	0.0

Table 3. ANOVA table for equation (1).

<u>Source</u>	<u>Sum of Squares</u>	<u>Deg. of Freedom</u>	<u>Mean Squares</u>	<u>F-Ratio</u>	<u>Prob &gt;F</u>
Model	1.111	1	1.111	17.298	0.002
Error	0.642	10	0.064		
Total	1.753	11			

Coefficient of determination: 0.635

Standard error of estimate: 0.253

Spearman's corr. (suspended solids, turbidity): 0.597; p = 0.031

Table 4. ANOVA table for equation (2).

<u>Source</u>	<u>Sum of Squares</u>	<u>Deg. of Freedom</u>	<u>Mean Squares</u>	<u>F-Ratio</u>	<u>Prob &gt;F</u>
Model	0.357	1	0.357	10.877	0.008
Error	0.328	10	0.032		
Total	0.685	11			

Coefficient of determination: 0.521

Standard error of estimate: 0.181

Spearman's corr. (spectral class, turbidity): 0.807; p = 0.001

Kruskal-Wallis one-way nonparametric ANOVA: 8.188; p = 0.017

A TIERED APPROACH FOR EVALUATING SEDIMENT QUALITY  
AT MULTIPLE COASTAL AND RIVERINE DREDGING PROJECTS

By

1

A. Rudder Turner, Jr.

INTRODUCTION

Most dredging and disposal actions, involving either maintenance or new work materials, require sediment/water quality evaluations or determinations of toxicity potential to comply with Clean Water Act or Marine Protection, Research and Sanctuaries Act (MPRSA) provisions. Sediment quality issues must be adequately addressed in order for the Corps to receive water quality certifications from State environmental quality agencies and disposal site approvals from the U.S. Environmental Protection Agency (EPA). Evaluations are conducted for a wide range of sediment types and dredging quantities with potential impacts ranging from minimal to severe. An evaluation can range from an available information review to physical characterizations, chemical analyses, or comprehensive bioassay/bioaccumulation tests.

A total of 15 - 20 million cubic yards of sediments are dredged annually from 32 authorized projects in the Portland District navigation program (Figure 1). Most materials are clean sands with little toxicity potential. However, several projects contain some slightly to moderately contaminated silt/clay sediments. Also, high levels of public environmental awareness in the Pacific Northwest have resulted in concern with contamination levels that would be considered low to moderate by national perspectives. In response to these concerns, we have developed a tiered sediment quality evaluation framework that allows for more consistent design of project-specific testing programs. Its main objective is to provide a method for more efficiently maintaining statutory compliance while conducting Portland District's dredging program. The framework minimizes tendencies for excessive testing of low-risk projects while justifying more attention to higher-risk actions. This has resulted in more efficiently completing required evaluations, has reduced costs, and is making data available to Corps managers and resource agencies in a more timely manner.

EVALUATION FRAMEWORK

A tiered sediment quality evaluation framework has been utilized by Portland District since 1986 (Turner 1987). The version presented in this paper is slightly modified from that one and represents our current rationale on sediment quality evaluation design. It is a 3-tiered scheme

-----  
1

Environmental Specialist. Advance Planning Branch, USACE Portland District  
(CENPP-PL-A). 503/221-6401.



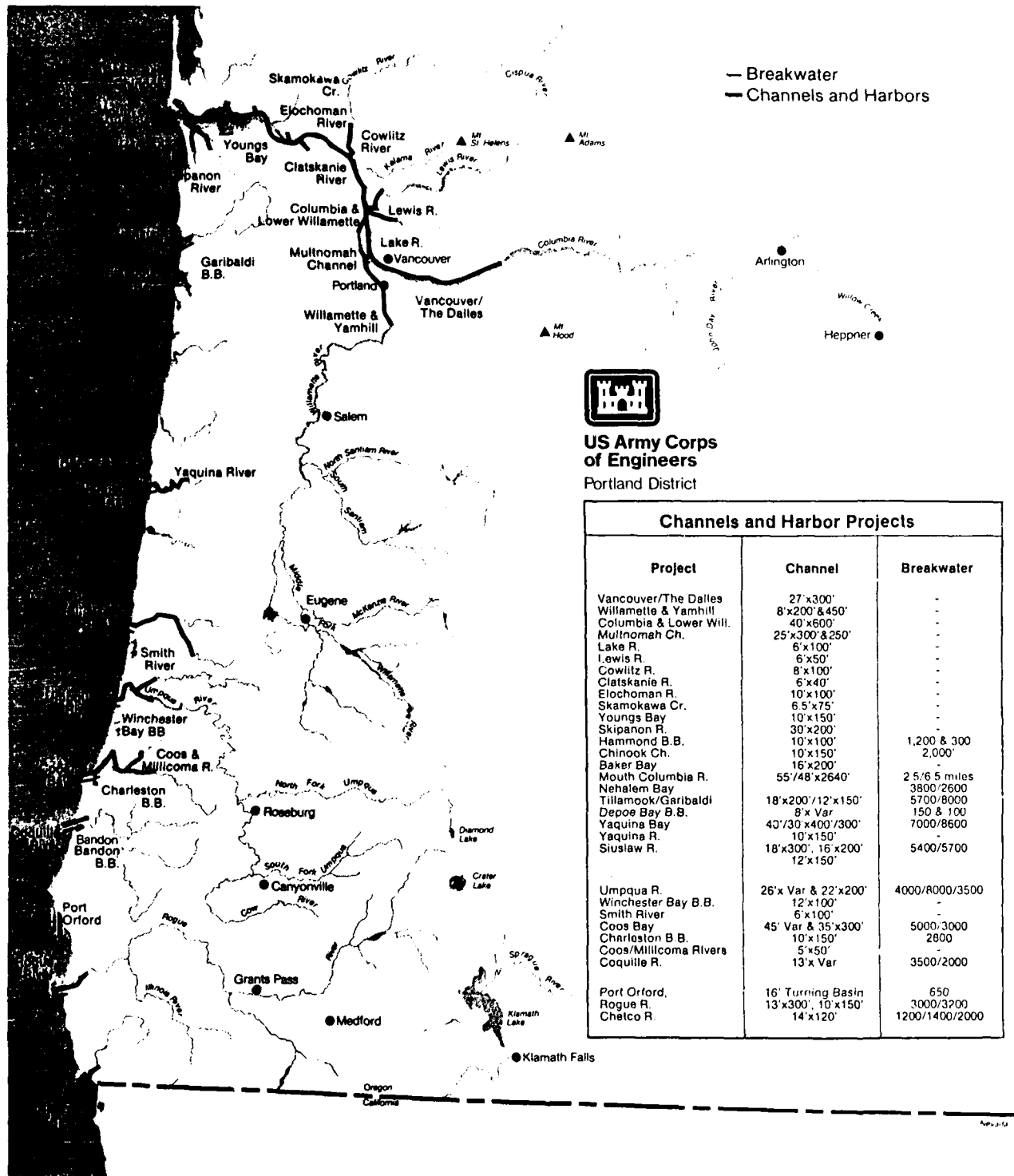

Figure 1. Federal Navigation Channel and Harbor Projects Maintained by the U.S. Army Corps of Engineers, Portland District.

and begins with a review of available information (Figure 2). Concerns are identified and testing levels appropriate to these concerns are selected. After completion of tests, higher tiers are entered or, if results are acceptable, the dredging action proceeds with few or no restrictions.

#### AVAILABLE INFORMATION REVIEW

The initial task in the evaluation is the compilation of pertinent environmental information on project sediments as well as pollutant sources and transport routes within the watershed, to identify potential extent of contamination. Information types and sources described by Francingues et al. (1985) and Peddicord et al. (1986) are appropriately utilized here. These data include:

- (1) existing data on project sediment quality/toxicity,
- (2) point/nonpoint contaminant sources,
- (3) present/historic industrial aquatic discharges,
- (4) agricultural and forestry areas, and pesticides applied,
- (5) natural mineral deposits and dominant rock characteristics, and
- (6) spills of toxic or hazardous substances.

Existing data and those to be collected should be adequate to characterize and compare sediments from both dredging and disposal sites. After the information is gathered, its adequacy to address sediment quality concerns is determined. If inadequate, Tier I testing is initiated. If adequate, questions are asked about physical, contaminant, and toxicity concerns. If any exist that cannot be resolved by available information, the appropriate tier is entered and testing initiated. If there are no unresolvable concerns, tests are not performed and dredging can proceed.

#### TIER I: PHYSICAL CHARACTERISTICS

The first testing tier involves determination of basic physical sediment properties. These are good indicators of potential contamination for Oregon sediments (Felstul 1987a and 1987b), and criteria have been developed to determine whether they can be excluded from further testing. These routine analyses and criteria are:

- (1) Grain size distribution (less than 20% silt/clay).
- (2) Organic content (volatile solids less than 5% of dry weight).
- (3) Oil & grease (less than 1,000 ppm by gravimetric method).
- (4) Available information adequate and no cause for concern.

If one or more of these criteria are exceeded, it is necessary to initiate Tier II testing.

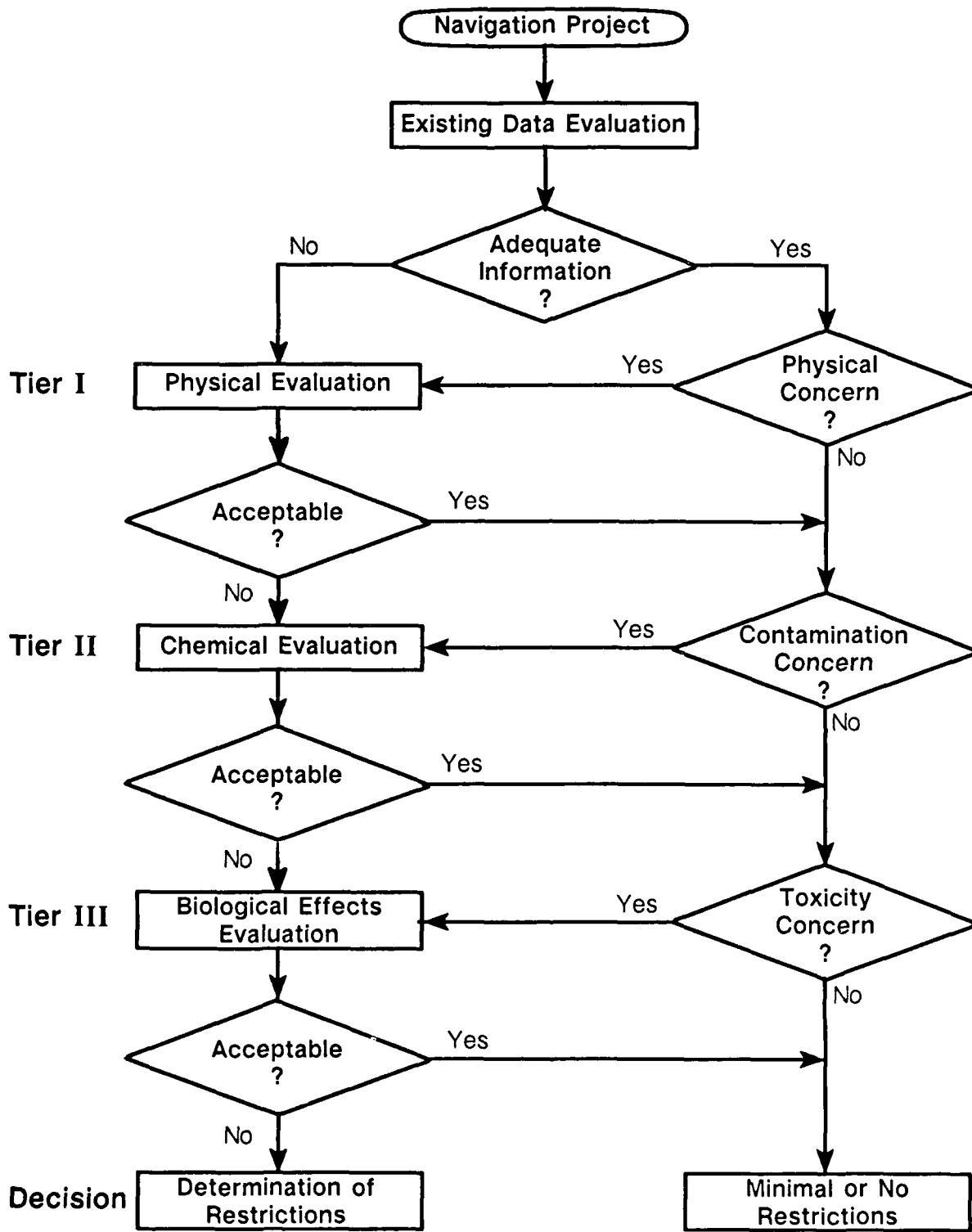

Figure 2. Tiered Sediment Quality Evaluation Framework for Dredging Projects.

## TIER II: CHEMICAL ANALYSIS

This testing tier determines chemical contaminant levels and establishes degree of concern about acute and chronic sediment toxicity. It includes analyses for the following constituents:

- (1) Total organic carbon (TOC).
- (2) Heavy metals: Routinely: arsenic (As), cadmium (Cd), copper (Cu), lead (Pb), mercury (Hg), zinc (Zn).  
Periodically: chromium (Cr), iron (Fe), manganese (Mn), nickel (Ni).
- (3) Pesticides: aldrin, chlordane, DDD, DDE, DDT, methoxychlor, perthane, 2,4-D, heptachlor, lindane.
- (4) Polychlorinated biphenyls (PCBs).
- (5) Polynuclear aromatic hydrocarbons (PAHs): base/neutral extractibles.
- (6) Additional compounds as indicated by available information, up to full priority pollutants scan for one or more samples per project.

At this testing level, both standard elutriate and bulk (total extractible) analyses are run. While there is little relationship between total sediment contaminant level and bioavailability (Brannon 1978, Lee and Jones 1984, Dillon and Gibson 1986), the analysis nevertheless is employed as a conservative screening tool to help establish whether a potential for longer-term biological effects may exist. Also, while we have developed informal in-house criteria to evaluate bulk chemistry results (Felstul 1987b), there are no regulatory standards available for evaluating Oregon bulk sediment data. The standard elutriate test is useful in that the dissolved fraction which is measured can be compared with State regulatory water quality standards. Mixing zones also can be computed from test results when standards are exceeded for specific compounds. Compounds released under aerobic mixing conditions are considered representative of levels released during hopper dredging and open-water disposal operations (Lee and Jones 1984), the most common dredging practice in Portland District.

## TIER III: BIOLOGICAL EFFECTS TESTING

This tier is entered if results of lower tier tests or available information indicates that detrimental effects on benthic or water column biota reasonably could be expected to occur. Biological effects tests in the following categories will be considered if appropriate to the action being evaluated:

- (1) Acute toxicity bioassay (EPA/CoE 1977).
- (2) Bioaccumulation testing.
- (3) Chronic (sublethal) effects testing.

Biological effects tests have not been performed by Portland District since implementing the tiered testing scheme, so detailed strategies have not been developed. Also, testing at this level needs to be project-specific, to address toxicity questions that are dependent on the action proposed and system that can be impacted. The strategy developed by Francingues et al. (1985) and Peddicord et al. (1986) categorizes dredged material by type of disposal proposed and environmental compartments likely to be impacted, then specifies tests for each situation. This strategy would be applicable to Portland District sediments if the need should arise.

A key feature of the tiered evaluation scheme is that, for several reasons, chemical test results do not function as final exclusion criteria. In other words, an action is not prohibited exclusively by levels of contaminants in the sediments. First, it is not practical to test for all constituents that could cause sediment toxicity. The most common are considered reliable indicators but this is only a small fraction of the total number possibly present. Second, contaminants interact unpredictably in sediments to either enhance or reduce toxicity. These interactions cannot be inferred reliably from chemistry results alone.

Third, neither the bulk nor elutriate analyses are reliable indicators of total bioavailability. Elutriates are designed to measure short-term water column releases from mixing and aeration; thus, they approximate contaminant availability to cause immediate acute toxicity effects. Additional contaminant levels that could have longer term availability to chronically effect benthic infauna (deposit or filter feeders) may be underestimated. Conversely, rigorous acid extraction techniques employed in the bulk analysis are much harsher than any natural phenomena that might act on dredged material; therefore, tightly bound contaminants are measured that are not bioavailable. Presently, no single extraction technique is widely accepted as measuring total bioavailable contaminants in sediments. In summary, the most defensible approach for evaluating sediments of dubious quality is to rely on biological effects tests, not chemical analyses, to make final decisions about dredged material disposal.

#### APPLICATIONS

(1) Lower Willamette River. Maintenance dredging and semi-confined inwater disposal occurred in 1987 at the request of the McCall Oil Company to restore authorized depths to the Federal channel in front of their dock facilities at Willamette River Mile (WRM) 8 in Portland, Oregon. Available information review prior to sediment sampling revealed that high Pb and DDT contamination had been previously documented from WRM 6 - 7.5. This part of the river also includes numerous Port of Portland facilities, including drydocks, grain terminals, petroleum hydrocarbon unloading/storage areas, and other activities. Initial sediment sampling occurred at 6 stations in August 1986 to determine physical sediment characteristics (Figure 3). Results showed homogeneous fine sediments with moderately high organic content that exceeded our Tier I criteria.

Tier II testing was conducted in December 1986, utilizing the same station locations. All elutriate test results were at or below State water quality standards while bulk results showed moderate but not excessive PAH levels. Contaminant levels were substantially lower than those in sediments that had passed bioassays conducted by the Port of Portland in 1985 on

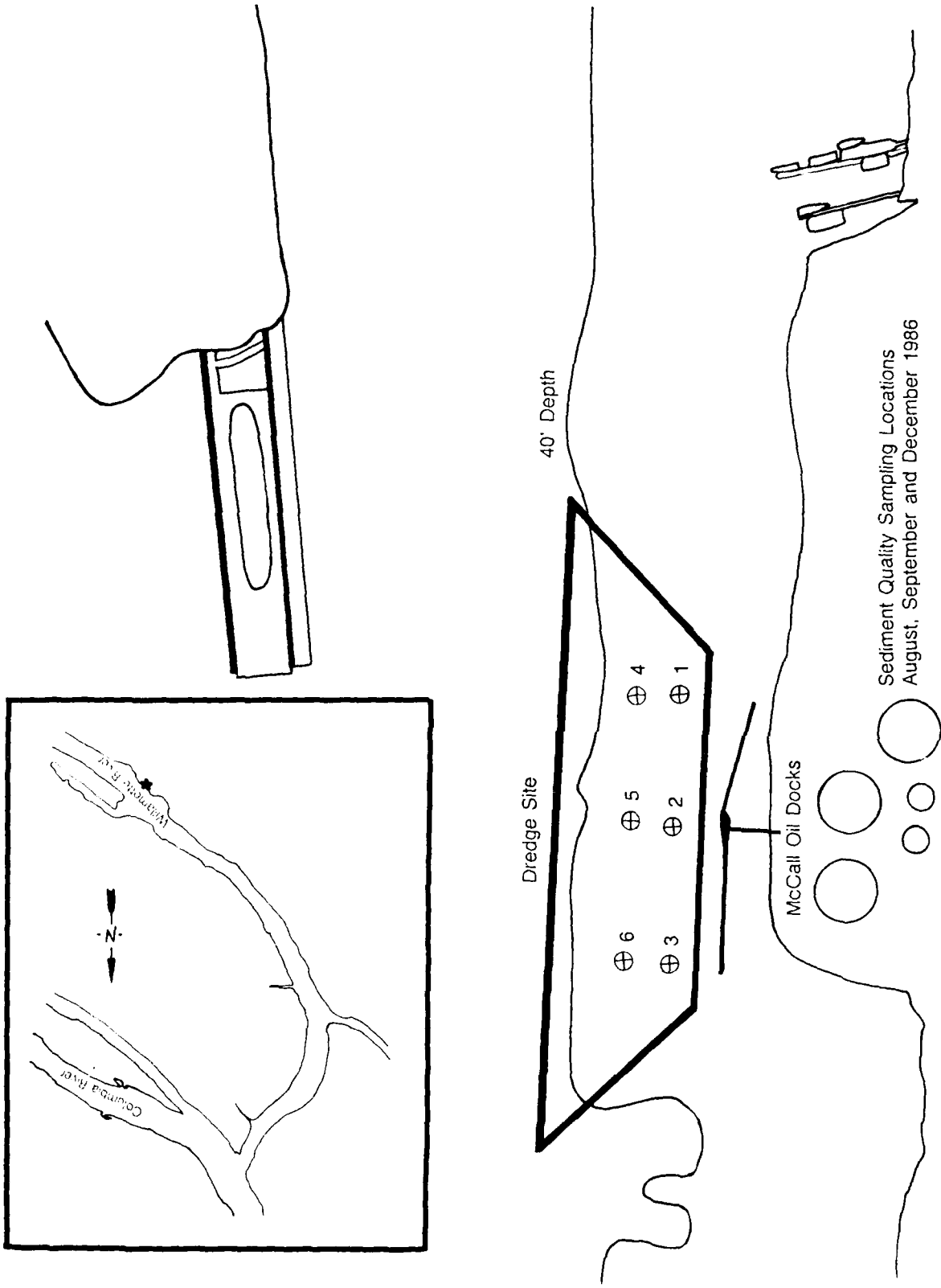

Figure 3. McCall Oil Docks (Lower Willamette River) Sediment Evaluation Sampling Location, 1986.

terminal slip sediments nearby. Lack of toxicity potential was further confirmed in a data review by Waterways Experiment Station (WES) experts in May 1987, following continued toxicity concerns expressed by EPA Region X. The project was dredged in September 1987 with 98,000 cubic yards of sediments excavated and disposed in the Ross Island lagoon 5 miles upstream.

(2) Chinook Channel. The Chinook channel project in the Columbia River estuary requires annual dredging of approximately 180,000 cubic yards of sandy and fine sediments to maintain authorized depths. The fine sediments, about half of the total dredged, traditionally have been pumped to an upland disposal site on East Sand Island. This site is filling and very tight environmental timing windows for the project preclude hydraulic dredging except during times of year when birds are nesting on the disposal site. Therefore, we considered placing more material at the inwater site used for the lower channel sands, called Area D. Sediment quality and sediment transport were identified as the two key issues to resolve before such an action would be acceptable. Sediment sampling and Tier II testing occurred in December 1986 and July 1987 at 11 stations along the channel, more intensive than previous sediment quality work (Figure 4). Results showed that sediments from the lower channel contained 10 - 60% fines, more than previously suspected. Also, neither lower or upper channel sediments were heavily contaminated with priority pollutant heavy metals or organics.

In a resource agency coordination meeting held in July 1987, we presented these data and proposed inwater disposal of all materials at area D. Agency representatives indicated that this might be feasible. As a result of the Tier II testing and close agency coordination, we have since received water quality certifications from the Washington and Oregon environmental quality agencies, as well as concurrence from EPA Region X, to put all sediments at Area D in 1988. Biological effects testing has not been required to obtain these approvals. We will monitor sediment transport from the site to determine the fate of fine sediments placed there. Inwater placement of fine sediments will be considered for several other Portland District projects if this year's work at Chinook is accomplished without creating adverse environmental impacts.

(3) Coos Bay, Ocean Disposal Site H. Fine grain sediments from upper Coos Bay and Isthmus Slough, on the southern Oregon coast, have been deposited in ocean dredged material disposal Site H since 1985. The site has been designated under MPRSA specifically as a fine sediment repository. About 500,000 cubic yards of sediments are placed there every 2 - 3 years. Extensive studies were completed under Corps contract by Oregon State University (OSU) during 1980 - 1984 to document conditions in the disposal site area and changes that resulted from a 60,000 cubic yard test dumping action in 1981 (Sollitt et al. 1984). We have monitored the site since its designation to determine transport off the site and environmental impacts (USACE Portland District in prep.), collecting data from a total of 25 stations established within and near the site (Figure 5). A tiered approach has been applied to the monitoring program and has helped reduce costs while providing information on which to build further monitoring activities.

The first two Site H monitoring surveys were conducted in 1985 and 1986. These included Tier I sediment analyses for grain size and organic content only, since the OSU studies had indicated that organic content was a very good predictor of contaminant load. Hydrographic surveys were also conducted at the site. Results indicated that material was not mounding and

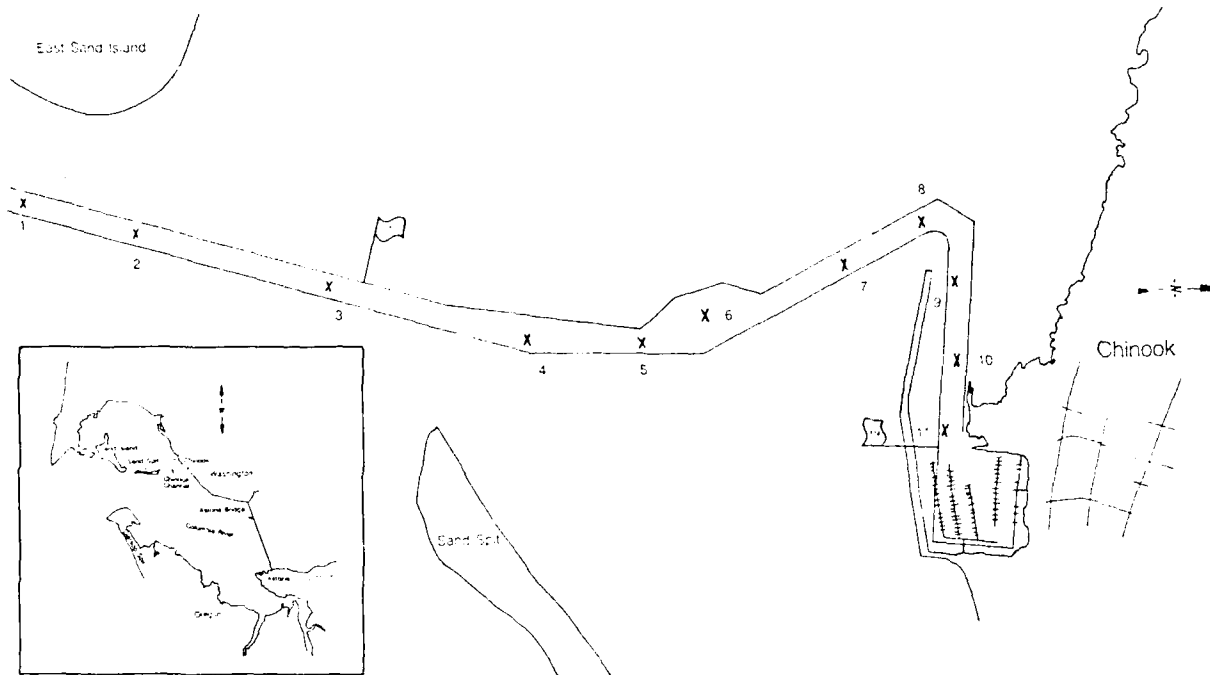

Figure 4. Chinook Channel (Columbia River Estuary) Sediment Evaluation Sampling Locations, 1986 and 1987.

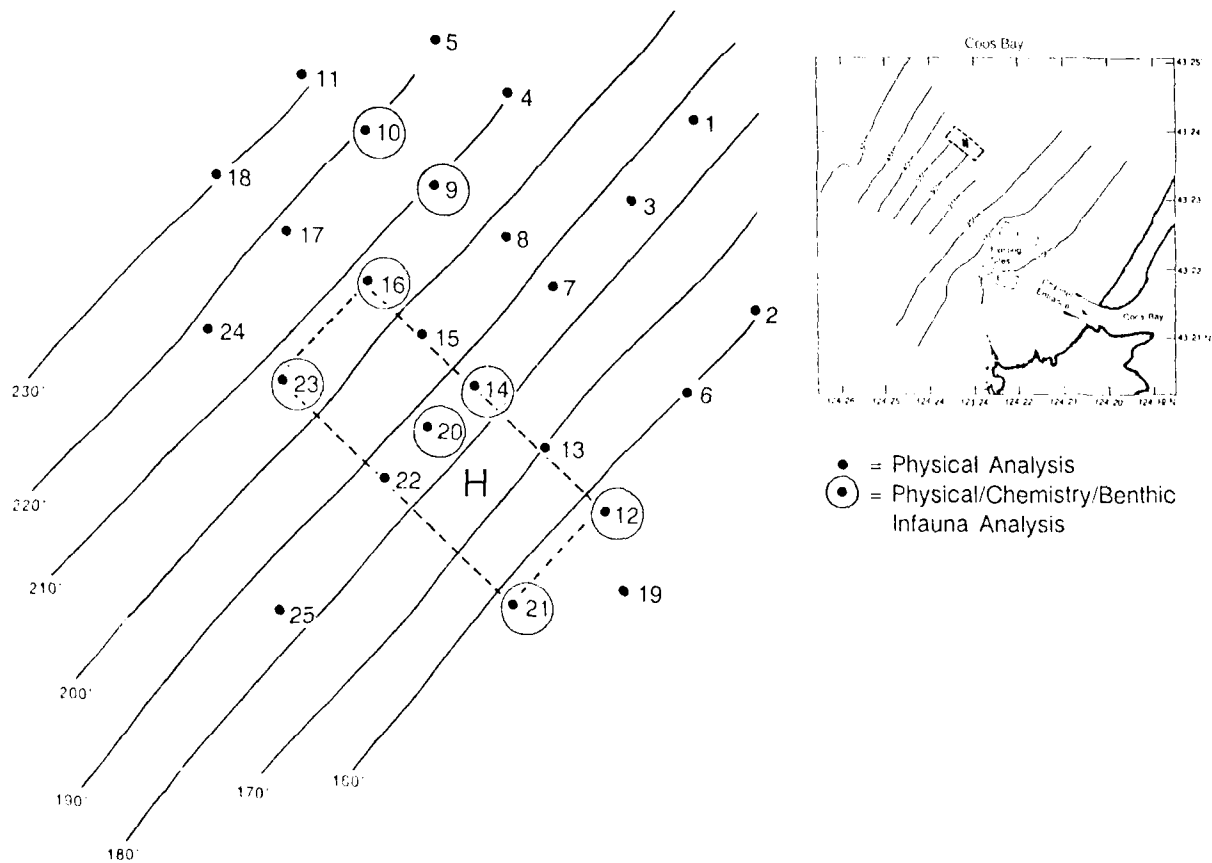
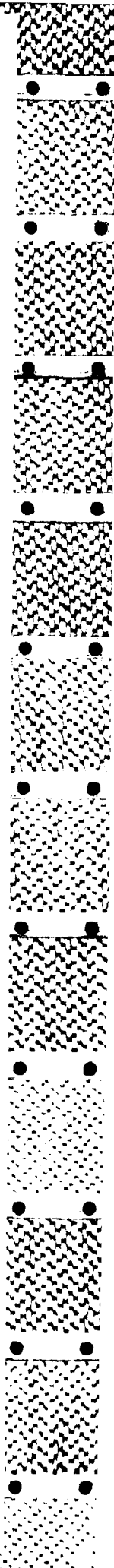

Figure 5. Coos Bay Ocean Disposal Site H Monitoring Stations, 1986-1988.





was being incorporated into the sediments, causing an approximate doubling of percent fines and organic content within the site. Some sediment changes were also occurring north and offshore from the site. These changes were the same as had been predicted in the ocean disposal EIS, based on the OSU work, thus verifying the dispersive nature of the site and dominant transport directions. Chemical and benthic infauna sampling at 8 stations was added to the program in 1987, based on the fact that substrate had been altered substantially near the site. Benthic infauna are showing shifts to increased polychaetes and decreased molluscs, and some recruitment of polychaete species from outside the area, apparently caused by increased fines and organics in the sediments. The sediment changes are persistent, indicating that this will be a long-term impact of continued use of the site. So far it is being regarded as a nonsignificant impact.

## CONCLUSIONS

Several tiered or hierarchical schemes for evaluating sediment quality and toxicity potential have been developed recently (Francingues et al. 1985, Peddicord et al. 1986, Dillon and Gibson 1986, Turner 1987, USAED San Francisco 1987, PSDDA 1988). While they differ in specifics such as content and number of tiers, it is apparent that the tiered approach is being increasingly viewed as a logical means of designing sediment quality programs to address a wide range of toxicity concerns. Such schemes can offer credible, defensible rationales for designing project-specific sediment quality studies appropriate to the level of reasonable concern about sediment toxicity. The Oregon Department of Environmental Quality (DEQ) is initiating a program in 1988 to develop regulatory sediment quality standards for the State (Hal Sawyer, DEQ, pers. comm.). They feel that the Portland District tiered evaluation framework is a reasonable approach to evaluate sediment quality and desire to incorporate our framework into their guidelines, an action we fully support.

As shown by the Coos Bay ocean disposal Site H studies, a tiered evaluation scheme is applicable to monitoring as well as project evaluations. A study design to monitor bottom dispersal from a disposal site, for example, may be limited initially to Tier I physical analyses at stations within and adjacent to the site. Chemical or biological monitoring would be initiated if Tier I results showed substantial changes in sediments that would cause concern about long-term habitat changes or contaminant bioaccumulation. A benefit to this strategy in a monitoring program is that station number or sampling frequency can be increased to improve coverage of potentially impacted areas while controlling study costs.

The establishment of our tiered sediment evaluation scheme has been an important step toward providing for efficient testing programs that are appropriate to project-specific concerns about sediment quality and toxicity. The scheme allows for the fact that most dredged material is uncontaminated and makes it possible for low risk projects to forego testing if existing data are adequate. It also provides justification for detailed studies where significant toxicity concerns exist. The implementation of this project has resulted in cost savings and has allowed available resources to be directed more effectively to the most significant toxicity concerns in regards to Portland District's dredging program.

## BIBLIOGRAPHY

- Brannon, J.M. 1978. Evaluation of dredged material pollution potential. Technical Report DS-78-6, Dredged Material Research Program. U.S. Army Engineer Waterways Experiment Station, Vicksburg, Mississippi. 39 pp.
- Dillon, T.M. and A.B. Gibson. 1986. Bioassessment methodologies for the regulatory testing of freshwater dredged material; proceedings of a workshop. Miscellaneous Paper EL-86-6. U.S. Army Engineer Waterways Experiment Station, Vicksburg, Mississippi. 37 pp. + appendices.
- Environmental Protection Agency/Corps of Engineers. 1977. Ecological evaluation of proposed discharge of dredged material into ocean waters. Environmental Laboratory, U.S. Army Engineer Waterways Experiment Station, Vicksburg, Mississippi. 24 pp. + appendices.
- Felstul, D.R. 1987a. Sediment characteristics as indicators of toxic cadmium and copper concentrations in Oregon estuaries. Masters Thesis, Oregon State University, Corvallis, Oregon. 43 pp.
- Felstul, D.R. 1987b. Tiered testing plan for metals in Oregon sediments. Unpublished report, U.S. Army Corps of Engineers, Portland District, Portland, Oregon. 23 pp.
- Francingues, N.R., Jr., M.R. Palermo, C.R. Lee, and R.K. Peddicord. 1985. Management strategy for disposal of dredged material: Contaminant testing and controls. Miscellaneous Paper D-85-1. U.S. Army Engineer Waterways Experiment Station, Vicksburg, Mississippi. 40 pp.
- Lee, G.F. and R.A. Jones. 1984. Evaluating the water quality significance of dredged sediments. IN: Montgomery, R.L. and J.W. Leach, eds. Dredging and dredged material disposal. Proceedings of the Dredging '84 conference, 14-16 November 1984, Clearwater Beach, Florida. Vol. 2: 1050-1062.
- Peddicord, R.K., C.R. Lee, M.R. Palermo, and N.R. Francingues, Jr. 1986 (draft). General decision making framework for management of dredged material. U.S. Army Engineer Waterways Experiment Station, Vicksburg, Mississippi. 87 pp. + appendices.
- Puget Sound Dredged Disposal Analysis (PSDDA). 1988 (draft). Proposed management plan for unconfined, open-water disposal of dredged material, Phase I (Central Puget Sound). U.S. Army Corps of Engineers, Seattle District, Seattle, Washington. 142 pp.
- Sollitt, C.K., D.R. Hancock, and P.O. Nelson. 1984. Coos Bay offshore disposal site investigation, final report, phases IV & V. Oregon State University, Corvallis, Oregon, contract report to U.S. Army Corps of Engineers, Portland District, Portland, Oregon. 355 pp. + appendices.
- Turner, A.R., Jr. 1987. Tiered sediment quality evaluations for dredging projects. IN: Magoon, O.T., H. Converse, D. Miner, L.T. Tobin, D. Clark, and G. Domurat, eds. Coastal Zone '87, proceedings of the fifth symposium on coastal and ocean management, 26-29 May 1987, Seattle, Washington. Amer. Soc. of Civil Eng., New York, NY. Vol. 4: 4246-4256.

USACE Portland District. (in prep.) Monitoring disposal of fine sediments at Coos Bay ocean disposal site H. U.S. Army Corps of Engineers, Portland District, Portland, Oregon.

USACE San Francisco District. 1987 (proposed). Interim testing procedure for evaluating dredged material suitability for open-water disposal in San Francisco Bay. Public Notice No. 87-1. Regulatory Branch, U.S. Army Corps of Engineers, San Francisco District, San Francisco, California. 9 pp.

SURFACE AND GROUNDWATER MONITORING  
AT TIMES BEACH  
CONFINED DISPOSAL FACILITY  
BUFFALO, NEW YORK

By

Richard P. Leonard<sup>1</sup>

INTRODUCTION

The October 1984 report of the Niagara River Toxics Committee identified the Times Beach Confined Disposal Facility (CDF) as a possible source of contamination to the Niagara River. (Wagner 1984, p. 3.20) In addition, the Times Beach CDF was cited under the Comprehensive Environmental Response, Compensation and Liability Act of 1980 ("CERCLA") for the possible release of hazardous substances. The 54-acre Times Beach CDF was used from the period of 1972 to 1976 for the confined disposal of polluted sediment dredged from Federal navigation channels in the Buffalo Harbor, the Buffalo River, and the Black Rock Channel. The area has received approximately 550,000 yd<sup>3</sup> of dredge material.

Although the Times Beach area is owned by the City of Buffalo, permission to install monitoring wells was granted to the Buffalo District by the City. The primary purpose of well installations was to determine the extent to which heavy metal and organic pollutants contained in the dredge material might be influencing groundwater quality. Groundwater levels in wells were also periodically monitored to determine any relationship between lake water levels and groundwater levels.

Monitoring Well Placement

Figure 1 is a topographic map of the Times Beach CDF site. Since the area was not completely filled, about half of the 54-acre site contains a shallow water pond with an estimated average depth of 3-4 feet. Approximately 1/4 of the site contains an upland woodland consisting primarily of scrub cottonwood.

Placements of Buffalo District monitoring wells installed in December 1984 are shown in Figure 1. The locations of United States Geological Survey (USGS) wells installed in 1982 are also shown. Three clusters of wells were installed. The cluster comprised of Well Numbers 9-11 is in the wooded upland; the 6-8 cluster is located in the wetland, and wells 12-14 are in the shallow water pond. Table 1 summarizes the depth placements of the 3' long well screens. Well screen placements were based on sediment and soil stratigraphy, and depths to bedrock as revealed by drilling investigations prior to well placement.

---

<sup>1</sup>Environmental Scientist, Water Quality Section, Buffalo District

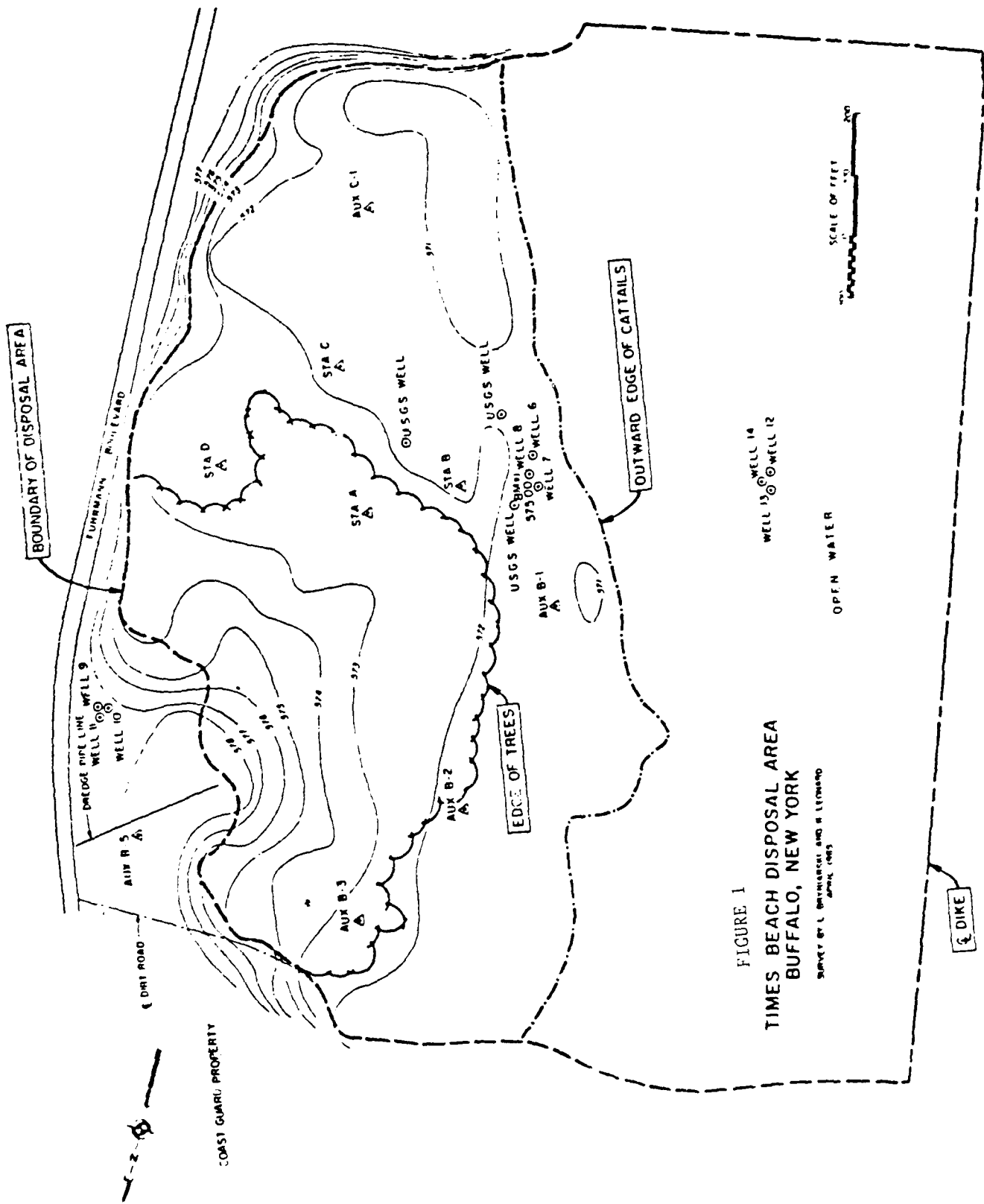

FIGURE 1  
 TIMES BEACH DISPOSAL AREA  
 BUFFALO, NEW YORK  
 SURVEY BY L. BRUNNENBERG AND H. LEONARD  
 APRIL 1963

PROFILE B - B<sup>1</sup> TIMES BEACH

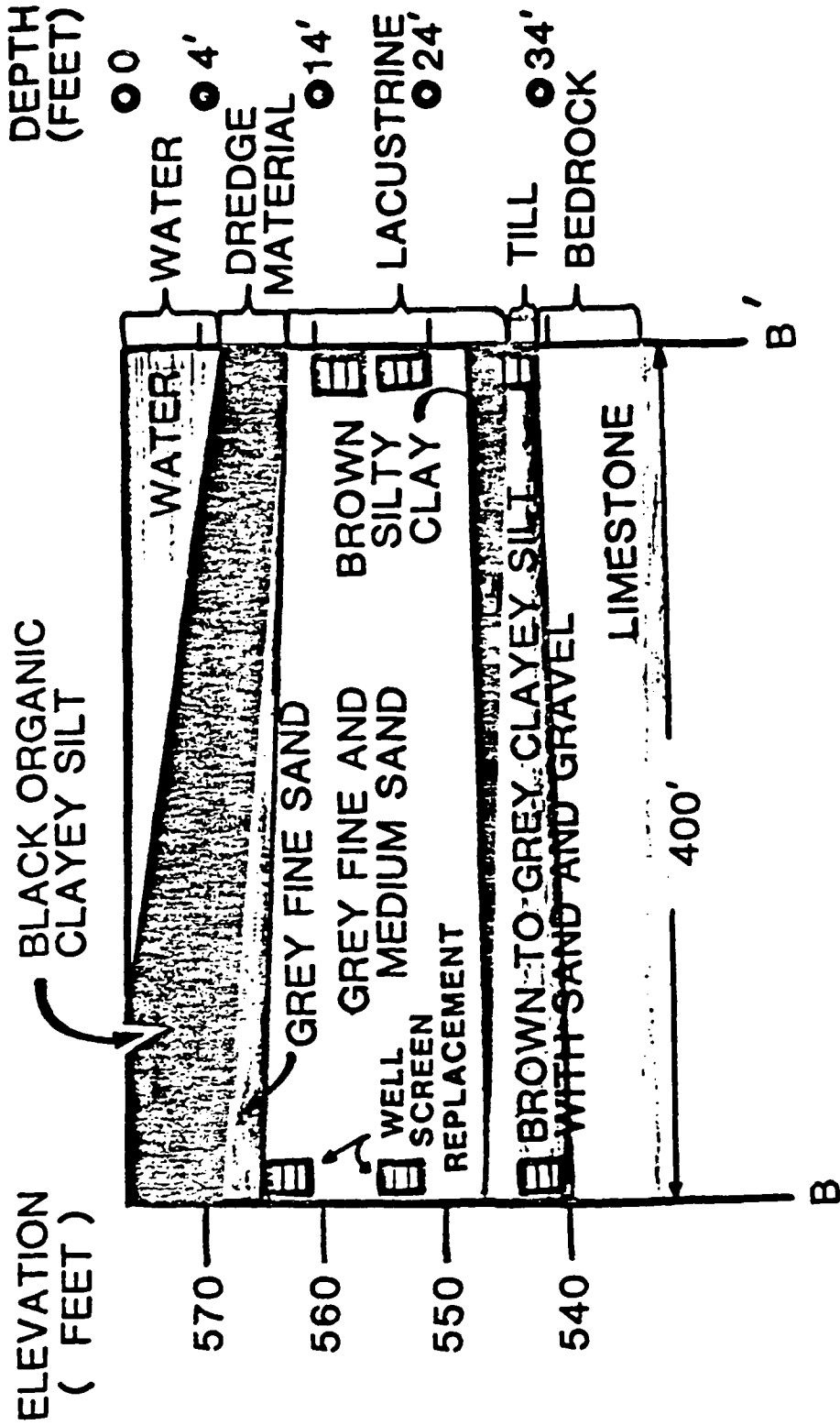

FIGURE 2

TIMES BEACH DISPOSAL AREA

BUFFALO, NEW YORK

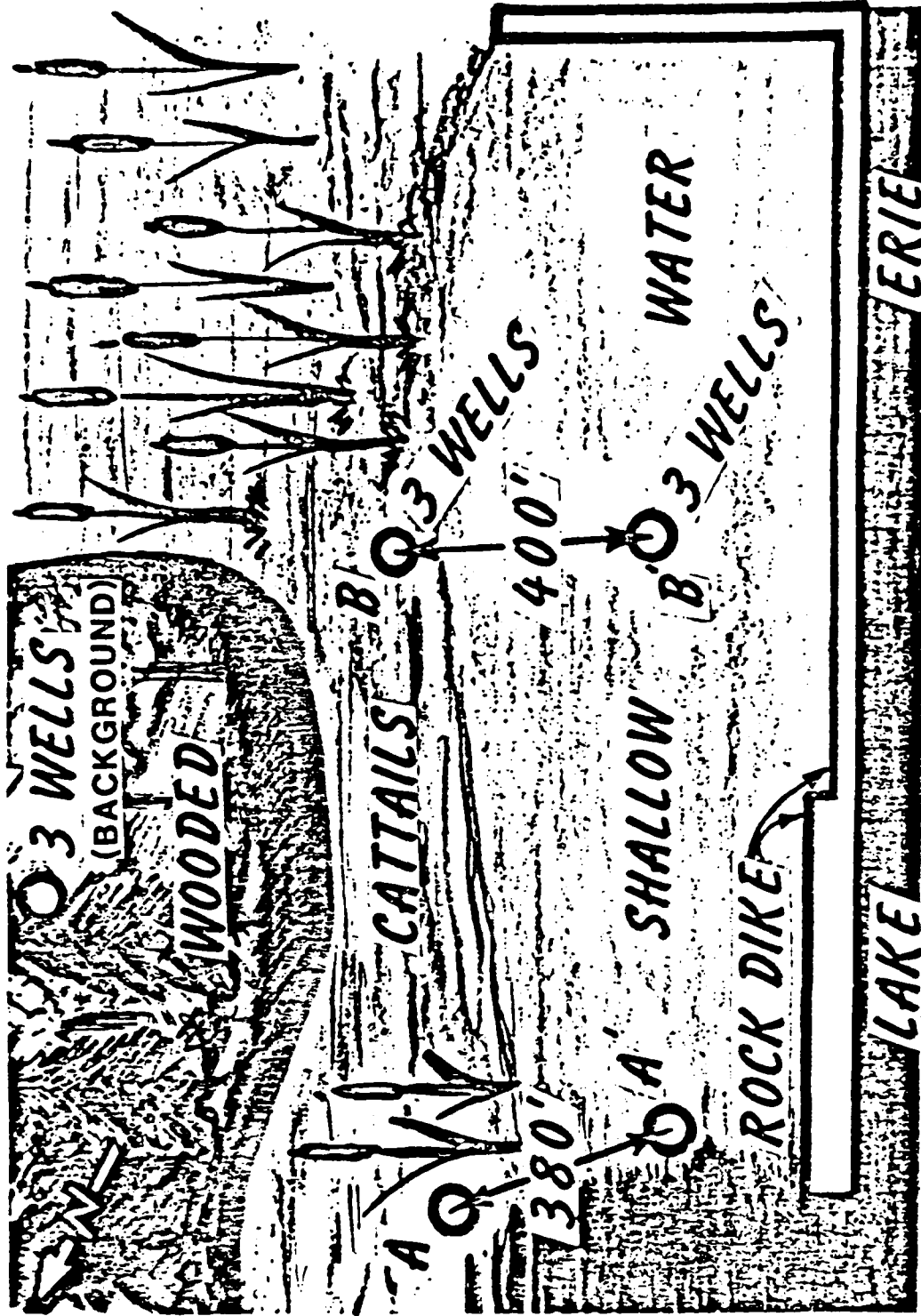

FIGURE 3

Figure 2 is a profile of sediment stratigraphy from well cluster 6-8 to well cluster 12-14 showing well screen placements. The locations of this profile and another profile (A-A1) are schematically shown in Figure 3. These profiles show the thicknesses of the dredge sediment in the marsh and open water areas vary from about 6-8'. As might be expected from the pump discharge of dredge sediments into the area, sandy material settled out first with later settling of the black fine silts and clays. A thick layer of glacio-lacustrine sands varying from 15 to 20 feet thick underlies the dredge material. Discontinuous layers of lacustrine clays and water worked glacial till overlie Onondaga limestone bedrock which occurs at 27 to 37 feet below the sediment surface. The water saturated glacio-lacustrine sands is an aquifer which readily stores and transmits water.

Borings at well clusters 9-11 show a similar thick deposit of glacio-lacustrine sands except the fill overburden is not dredge material. The dredge material thickness in the wooded portion of the disposal area is probably a few feet thicker than in the cattail area and open water due to the close proximity to the discharge pipe (See Figure 1). A greater proportion of sand and gravel is also present in this dredge material.

#### Monitoring Well Design

Figures 4 and 5 show the configuration of wells placed in the upland and marsh (land-based wells) and wells placed in the ponded area (water based wells). Except for the 6" diameter black steel protective casings and locking caps, all wells contain stainless steel construction. Risers consist of 4" diameter stainless steel pipe. Three-foot long 3" diameter well screens were used as well points and placed at depth intervals previously given in Table 1. Screen slot spacing was 0.01". Each well point was packed with 4' of clean quartz sand (Size 40) to promote water movement into well points.

The land based wells had 5' of bentonite pellets inserted over the sand filter and were backfilled to the ground surface with cement/bentonite slurry. Bentonite pellets could not be used in open water wells because they tended to be buoyant; therefore, sand filterpacks were completely backfilled with cement/bentonite slurry. The purpose of backfilling with bentonite was to insure that the water entering the well is from the nearby vicinity of the well point and represents water quality at the depth of the well point.

#### Pond Water and Well Sampling

Open water samples and monitoring well water samples were obtained and analyzed by Aqua Tech Environmental Consultants, Melmore and Marion, Ohio, under contract to the Buffalo District, Corps of Engineers. Samples were collected on one occasion in 1984, twice in 1985, three times in 1986, and once in 1987.

Each well was evacuated a minimum of three well volumes with an Isco well sampling pump and allowed to recharge before sample collection. Sampling in December 1984 was done with the Isco Model 2600 well sampler using compressed air. The design of the sampler prevents air from entering



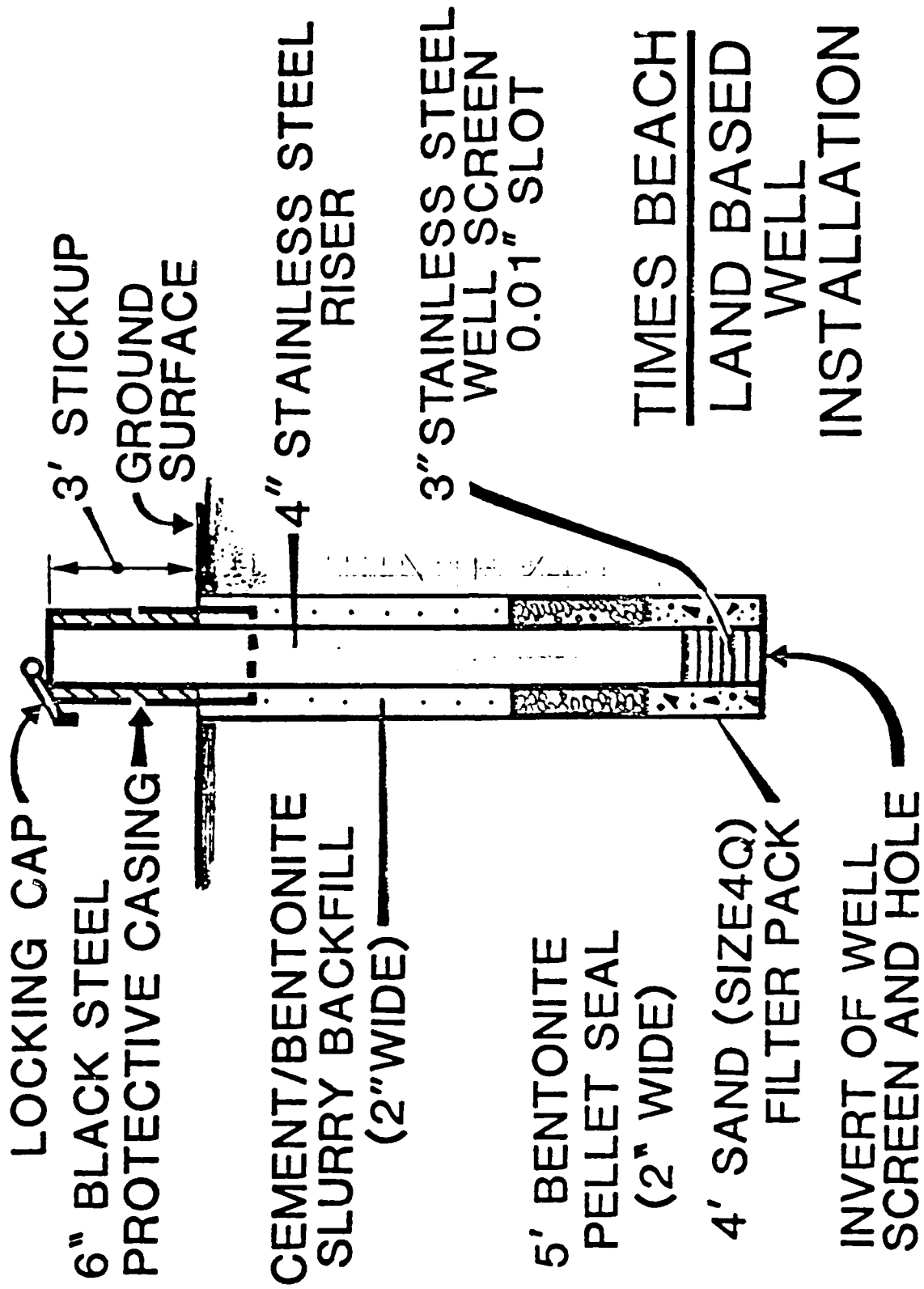

FIGURE 4

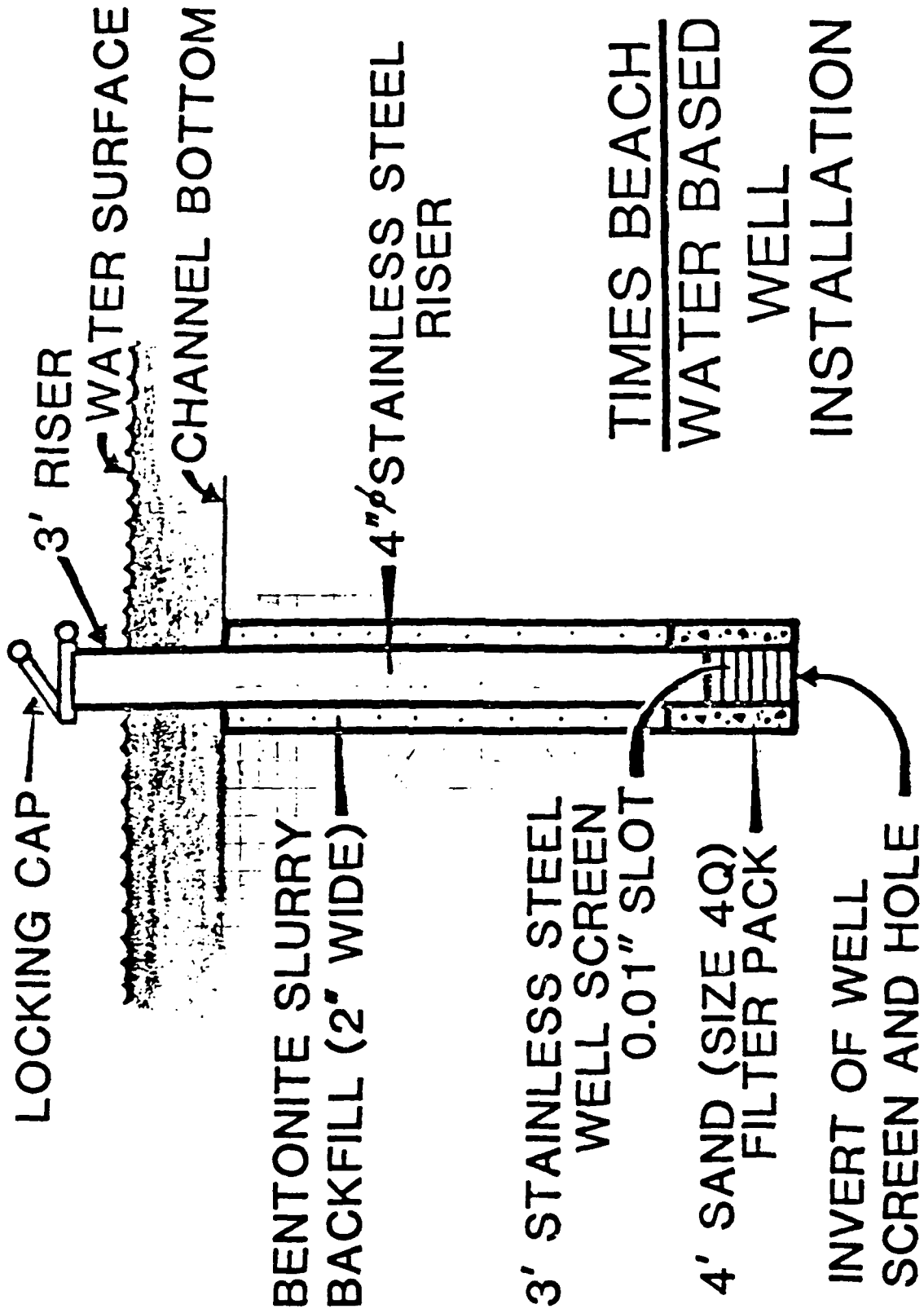

FIGURE 5

the sample. Subsequent sampling was done with a stainless steel bailer. Some samples were filtered in the field through a 0.45 micron nucleopore pressure filter (Model No. 425900) in order to provide filtered and unfiltered samples for analyses. Temperature, pH and conductivity were recorded before samples were drawn from the wells.

Filtered and unfiltered samples were split into appropriate containers and preserved as follows:

- One plastic quart with nitric acid for metals
- One glass quart for non-volatile organics
- One 250 ml. VOA bottle for volatile organics

All samples were maintained under refrigerated conditions until analyzed at Aqua Tech laboratories. In 1985, pond water samples were obtained in the vicinity of the open water well cluster (Well Nos. 12-14) using a hand-held peristaltic pump. A surface water sample and deeper water (3 foot depth) sample were obtained on each of the sampling events. In 1986, 8 pond water samples were taken at mid-pond depth with an alpha bottle.

#### Chemical Analyses of Water Samples

The analyses of groundwater and surface water samples were performed in accordance with United States Environmental Protection Agency established methods. Table 2 summarizes the methods used. The results of chemical analyses are reported in the following Aqua Tech Environmental Consultants, Inc. reports:

- Technical Report No. G 0130-11, February 28, 1985
- Technical Report No. G 0130-12, April 30, 1985
- Technical Report No. G 0130-13, October 1985
- Technical Report No. G 0176-05, June 1986
- Technical Report No. G 0176-05B, September 1986
- Technical Report No. G 0176-05C, January 1987
- Technical Report No. G 0176-07A, November 1987

These reports also contain quality control data including check standards, spiked samples and replicate analyses.

Tables 3 through 11 contain the measured concentrations of heavy metals in water samples from Well Nos. 6 through 14, for filtered and unfiltered samples. Tables 12 and 13 give metal concentrations for surface and deeper pond water, respectively. Table 14 contains mid-depth pond water quality in 1986. Generally, but not always, filtered sample metal concentrations were less than unfiltered concentrations. On some occasions, measured chromium, zinc, nickel, barium and zinc levels were higher in unfiltered samples. The practice of field filtering samples before analyses would appear to give more accurate information on the mobility and transmission of metal pollutants in groundwater. Filtering reduces the entrainment of fine particulates in the samples - these particulates are not apt to be carried in groundwater flow.

Tables 15 and 16 summarize mean metal concentrations in filtered and unfiltered monitoring well samples for the sampling events. The national maximum allowable concentrations for drinking water are as follows:

Arsenic - 50 ug/l  
Barium - 1000 ug/l  
Cadmium - 10 ug/l  
Chromium - 50 ug/l  
Copper - 1000 ug/l  
Lead - 50 ug/l  
Mercury - 2 ug/l  
Zinc - 5000 ug/l

## DISCUSSION

### Metals

Table 17 summarizes the number of occurrences in which national primary drinking water standards for metals were exceeded for unfiltered and filtered well samples. As expected, levels in unfiltered samples more often exceeded standards, even though more filtered samples were analyzed. Lead and chromium levels appear to exceed standards in some filtered as well as some unfiltered samples. Only unfiltered samples had elevated cadmium levels, while five out of seven elevated Arsenic levels were in unfiltered samples. Although there were appreciable levels of barium, copper and zinc in filtered and unfiltered samples, national standards were not exceeded.

Well water samples from the marsh area were lowest in metals with one filtered sample from the deep well (No. 8) exceeding the lead standard. The shallow well from the ponded area (No. 12) showed the heaviest metals contamination for filtered and unfiltered samples. This well also exhibited the highest organic contamination for filtered and unfiltered samples. The intermediate depth and deep wells were much cleaner. Well No. 14, located on top of limestone bedrock, had the only occurrence of mercury above the national standard. It should be noted that the background monitoring wells also showed levels of arsenic, cadmium and lead above national standards.

### Organics

Purgeable organics, nitrosamines, PAH's naphthalene, aniline, and chloroaniline were analyzed in well water samples and in pond water samples collected in 1984 and 1985. Chlorobenzene was detected on one occasion each from Well Nos. 8, 12, and 13. Concentrations in filtered and unfiltered samples ranged from 1.2 ug/l to 4.2 ug/l. Toluene was measured at 60 ug/l for an unfiltered sample from open water Well No. 13 in September 1985. The filtered sample was less than 1.0 ug/l.

In May and August 1986, four unfiltered pond water samples and unfiltered samples from the nine monitoring wells were collected for analysis of selected organics. Except for Well No. 12, no organics were detected above the detection limit of 1 ug/l. The following levels were measured in unfiltered samples from Well No. 12 in August. Well No. 12 was not sampled in May 1986.

Benzene - 47 ug/l  
Toluene - 2 ug/l  
Ethyl Benzene - 7 ug/l  
Chlorobenzene - 225 ug/l  
m - Dichlorobenzene - 6 ug/l  
e - Dichlorobenzene - 28 ug/l  
o - Dichlorobenzene - <1 ug/l

In September 1987, the monitoring wells were again sampled and analyzed for purgeable halocarbons and PAH's in unfiltered samples. No PAH's were detected in any of the well samples. As in 1986, purgeable halocarbons were detected only in Well No. 12:

Chlorobenzene - 372 ug/l  
1, 3 Dichlorobenzene - 2 ug/l  
1, 4 Dichlorobenzene - 9 ug/l

The data clearly shows that groundwater from the shallow Well No. 12 was much more contaminated than groundwater from the other wells with respect to both metals and organics. It was intended that the screened interval be placed just below the dredge material in natural lake sand deposits. The high turbidity and oil smell of some samples from this well indicate that the well point may have actually been placed in the dredge material. The elevated levels appear to be associated with the high content of fine dredge material particulates in samples from Well No. 12. Comparison of filtered and unfiltered metals data from Well No. 12 (Table 9) strongly supports this assertion.

Monitoring wells placed in the dredge material by the United States Geological Survey and sampled under this program, also showed high contamination levels associated with filterable and colloidal solids.

## CONCLUSIONS

The data suggests that significant heavy metal and organic contamination are associated with filterable and colloidal solids in groundwater or suspended sediment in the ponded areas of Times Beach. Filtered samples generally, but not always, showed lower levels of contaminants. Even filtered samples will have considerable colloidal particulates associated with them when it is considered that the filter size is  $0.45 \mu$  and colloidal particles range in size from approximately  $1 \mu$  to  $0.0001 \mu$ .

The data indicates that groundwater below the dredge material is not being contaminated by leaching from the overlying dredge material even though it is a permeable sandy aquifer.

Contaminants attached to the sediment do not solubilize significantly (i.e., above detection limits) into the overlying pond water at the site. Suspended sediments in unfiltered samples may contain contaminants exceeding national standards. To the extent that sediments and suspended sediment are retained in the confined disposal facility, contaminants are greatly excluded from adjoining Lake Erie water.

## REFERENCE

Wagner, E. T., et al. Report of the Niagara River Toxics Committee, Environment Canada, Ontario Ministry of the Environment, U.S. Environmental Protection Agency, New York State Department of Environmental Conservation, October 1984.

Table 1  
Times Beach  
Well Screen Placements

	Well No.	Depth of Screened Interval	Soil Material at Screened Interval
Wetland	6	9-12'	Grey fine and medium lacustrine sands
	7	19-22'	Grey fine and medium lacustrine sands
	8	31-34' (Top of Rock)	Brown to grey clayey silt with sand and gravel (Glacial till)
Upland	9	9-12'	Grey fine and medium Lacustrine sands
	10	19-22'	Lacustrine silts and fine sands with trace of clay @ 29.2' to 29.6'
	11	29-32' (Top of Rock)	Lacustrine fine sands with some silt; silty clay seam
Pond	12	14-17'	Grey fine and medium lacustrine sands
	13	20-23'	Grey fine and medium lacustrine sands
	14	29-32'	Brown to grey clayey silt with sand & gravel (Glacial till)

Table 2  
Methods of Analysis

Parameter	U.S. EPA Method
Arsenic	206.2
Barium	208.1
Cadmium	213.1 and 213.2
Chromium	218.1
Copper	220.1
Lead	239.1 and 239.2
Mercury	245.1
Nickel	249.1
Thallium	279.1 and 279.2
Zinc	289.1
Nitrosamines	625
Purgeable Aromatics	624
Polynuclear Aromatic Hydrocarbons	610
Aniline	625
4-Chloraniline	625
Napthalene	610

U.S. EPA 1979. "Methods for Chemical Analysis of Water and Wastes",  
EPA-600/4-79-020. 460 p.

U.S. EPA 1981. "Methods for Organic Chemical Analysis of Water and Wastes by  
GC, HPLC, an GC/MS".



Table 3  
Times Beach  
Metals Concentrations  
Well No. 6 (ug/l)

Parameter	Filtered						Unfiltered				
	Dec 84	April 85	Sept 85	May 86	Aug 86	Dec 86	Sept 87	Dec 84	April 85	Sept 85	Sept 87
Arsenic	:30	<4	17	14	29	<4	13	35	<4	87	22
Barium	:<100	160	180	80	100	40	80	<100	<100	180	80
Cadmium	:<2	3	<1	<1	<1	<1	4	<4	<1.0	<2	<4
Chromium	:20	<20	<4	<10	<10	<10	<10	<20	<20	50	<10
Copper	:<10	30	<3	4	<4	60	12	40	30	<3	4
Lead	:<10	<5	<3	<3	4	<3	36	<10	6	12	<10
Mercury	:<0.3	<0.3	<0.3	<0.3	<0.3	0.5	<0.1	<0.3	<0.3	<0.3	<0.1
Nickel	:30	120	50	<10	14	100	<10	60	150	<20	40
Thallium	:<5	<5	<4	-	-	-	-	<5	<5	<4	-
Zinc	:80	40	30	28	8	28	12	140	20	50	8

Table 4  
Times Beach  
Metals Concentrations  
Well No. 7 (ug/l)

Parameter	Filtered					Unfiltered				
	Dec 84	April 85	Sept 85	Aug 86	Sept 87	Dec 86	Dec 84	April 85	Sept 85	Sept 87
Arsenic	: 6	<4	<4	4	17	17	11	<4	16	27
Barium	: <100	<100	130	92	120	120	200	<100	<100	160
Cadmium	: <2	<1	<1	<1	<4	<1	<4	<1.0	<2	<4
Chromium	: 30	<20	<4	<10	<10	<10	20	<20	9	<10
Copper	: 20	10	3	4	8	60	40	20	60	24
Lead	: <10	<5	<3	<3	<10	<3	<10	9	14	<10
Mercury	: <0.3	<0.3	<0.3	<0.3	0.2	0.4	0.3	<0.3	<0.3	<0.1
Nickel	: 60	30	40	<10	12	100	60	30	30	16
Thallium	: <5	<5	<4	-	-	-	<5	<5	<4	-
Zinc	: 110	20	40	72	8	30	130	20	50	36

Table 5  
Times Beach  
Metals Concentrations  
Well No. 8 (ug/l)

Parameter	Filtered					Unfiltered					
	Dec 84	April 85	Sept 85	May 86	Aug 86	Dec 86	Sept 87	Dec 84	April 85	Sept 85	Sept 87
Arsenic	<4	<4	<4	<4	<4	<4	<4	<4	<4	7	<4
Barium	:110	160	250	170	200	240	240	190	130	390	280
Cadmium	<2	<1.0	<1	<1	<1	<1	<4	<2	1.6	<2	<4
Chromium	<20	<20	<4	<10	<10	<10	<10	<20	<20	10	16
Copper	:30	10	3	<4	8	100	8	30	60	50	24
Lead	<10	<15	<3	<3	<3	5	60	<10	5	16	16
Mercury	<0.3	<0.3	<0.3	<0.3	<0.3	0.7	0.1	<0.3	<0.3	<0.3	<0.1
Nickel	:90	20	20	12	<10	240	36	100	20	<20	36
Thallium	<5	<5	<4	-	-	-	-	<5	6	<4	-
Zinc	:70	10	10	16	8	36	16	150	30	40	68

Table 6  
Times Beach  
Metals Concentrations  
Well No. 9 (ug/l)

Parameter	Filtered						Unfiltered				
	Dec 84	April 85	Sept 85	May 86	Aug 86	Dec 86	Sept 87	Dec 84	April 85	Sept 85	Sept 87
Arsenic	:49	12	61	26	38	37	69	59	32	70	105
Barium	:<100	<100	210	<20	40	40	40	90	<100	120	160
Cadmium	:<2	<1.0	<1	1.4	1.4	<1	<4	<4	3.7	<2	4
Chromium	:<20	<20	<4	<10	<10	<10	<10	30	<20	9	44
Copper	:20	60	50	4	4	60	8	50	80	50	56
Lead	:<5	<5	14	<3	<3	<3	24	20	16	26	80
Mercury	:<0.3	<0.3	<0.3	<0.3	<0.3	0.5	<0.1	<0.3	0.7	<0.3	<0.1
Nickel	:70	20	60	<10	16	76	20	110	30	50	88
Thallium	:<5	<5	<4	-	-	-	-	<5	<5	<4	-
Zinc	:70	10	110	36	8	36	20	190	50	90	180

Table 7  
Times Beach  
Metals Concentrations  
Well No. 10 (ug/l)

Parameter	Filtered						Unfiltered				
	Dec 84	April 85	Sept 85	May 86	Aug 86	Dec 86	Sept 87	Dec 84	April 85	Sept 85	
Arsenic	:5	<4	5	<4	<4	<4	<4	7	<4	6	<4
Barium	:80	<100	260	24	40	40	80	100	<100	100	40
Cadmium	:<2	<1.0	<2	<1	<1	<1	4	<2	<1.0	<2	<4
Chromium	:30	20	<4	<10	12	<10	<10	20	20	5	<10
Copper	:20	50	6	4	8	60	12	30	130	9	12
Lead	:<5	<5	<3	<3	<3	<3	52	<5	<5	4	24
Mercury	:<0.3	<0.3	<0.3	<0.3	<0.3	0.5	<0.1	<0.3	<0.3	<0.3	<0.1
Nickel	:20	20	<20	<10	<10	84	24	60	30	<20	12
Thallium	:<5	<5	<8	-	-	-	-	<5	<5	<10	-
Zinc	:80	30	80	16	12	32	40	110	60	40	16

Table 8  
Times Beach  
Metals Concentrations  
Well No. 11 (ug/l)

Parameter	Filtered						Unfiltered				
	Dec 84	April 85	Sept 85	May 86	Aug 86	Sept 87	Dec 86	Dec 84	April 85	Sept 85	Sept 87
Arsenic	<4	<4	<4	<4	<4	<4	<4	<4	14	<4	<4
Barium	:500	110	470	390	360	200	280	530	290	570	480
Cadmium	:<2	<1.0	<2	1.5	<1	4	3	<4	26	<2	24
Chromium	:<20	<20	<4	12	16	<10	12	20	<20	4	12
Copper	:<20	<20	9	4	4	8	68	30	90	15	<4
Lead	:<5	<5	<3	<3	<3	20	<3	8	5	7	16
Mercury	:<0.3	<0.3	<0.3	<0.3	<0.3	<0.1	1.0	<0.3	<0.3	<0.3	<0.1
Nickel	:20	20	<20	<10	<10	16	96	60	40	<20	12
Thallium	:<5	<5	<10	-	-	-	-	<5	8	<10	-
Zinc	:80	20	50	660	640	96	540	120	20	50	280

Table 9  
 Times Beach  
 Metals Concentrations  
 Well No. 12 (ug/l)

Parameter	Filtered				Unfiltered		
	April 85	Sept 85	Aug 86	Sept 87	April 85	Sept 85	Sept 87
Arsenic	<4	14	34	24	<4	220	220
Barium	140	190	160	120	120	540	320
Cadmium	<1.0	<1	<1	<4	<1.0	<1.0	16
Copper	100	190	4	4	370	190	480
Lead	<5	156	<3	16	9	156	1000
Mercury	<0.3	<0.3	<0.3	0.2	<0.3	<0.3	2
Nickel	20	260	<10	24	30	260	68
Thallium	<5	<4	-	-	<5	<4	-
Zinc	10	680	180	20	10	680	2100
Chromium	90	110	12	<10	60	110	430

Table 10  
Times Beach  
Metals Concentrations  
Well No. 13 (ug/l)

Parameter	Filtered					Unfiltered		
	April 85	Sept 85	May 86	Aug 86	Sept 87	April 85	Sept 85	Sept 87
Arsenic	<4	12	5	6	18	23	31	<4
Barium	<100	100	120	<25	80	<100	120	80
Cadmium	<1.0	<1.0	<1	<1	<4	<1.0	1.5	4
Copper	50	70	8	4	8	40	25	12
Lead	<5	<3	<3	<3	56	12	3	12
Mercury	<0.3	<0.3	<0.3	<0.3	0.1	<0.3	<0.3	<0.1
Nickel	30	80	20	<10	28	40	40	28
Thallium	<5	<2	-	-	-	<5	<4	-
Zinc	40	50	40	4	12	20	40	20
Chromium	<20	<4	<10	<10	<10	20	8	<10



Table 11  
 Times Beach  
 Metals Concentrations  
 Well No. 14 (ug/l)

Parameter	Filtered			Unfiltered				
	April 85	Sept 85	May 86	Aug 86	Sept 87	April 85	Sept 85	Sept 87
Arsenic	<4	6	<4	<4	<4	28	<4	<4
Barium	<100	140	110	480	320	<100	230	480
Cadmium	<1.0	4	2.4	<1	4	1.3	1.4	4
Copper	40	140	80	<4	16	90	800	170
Lead	<5	<3	<3	<3	36	14	12	48
Mercury	4.9	0.3	<0.3	<0.6	0.1	10.8	<0.3	<0.1
Nickel	<20	50	<10	<10	48	20	90	52
Thallium	<5	<4	-	-	-	<5	<4	-
Zinc	10	30	20	4	20	30	60	150
Chromium	<20	<4	<10	<10	<10	50	50	44

Table 12  
 Times Beach  
 Surface Pond Water Metal  
 Concentrations, 1985  
 ug/l

Parameter	Filtered		Unfiltered	
	April 85	Sept 85	April 85	Sept 85
Arsenic	<4	<4	<4	<4
Barium	<100	150	<100	<100
Cadmium	<1	<1	<1	<1
Chromium	:40	<4	20	<4
Copper	:30	4	30	4
Lead	:<5	<3	13	<3
Mercury	:<0.3	<0.3	<0.3	<0.3
Nickel	:<20	<20	<20	<40
Thallium	:<5	<4	<5	<4
Zinc	:20	30	20	40

Table 13  
 Times Beach  
 Pond Water Metal  
 Concentrations,  
 One Foot Above Bottom, 1985  
 ug/l

Parameter	Filtered		Unfiltered	
	April 85	Sept 85	April 85	Sept 85
Arsenic	<4	<4	<4	4
Barium	<100	<100	<100	<100
Cadmium	<1	<1	<1	<1
Chromium	:40	<4	40	<4
Copper	:30	<3	40	4
Lead	: 6	<3	7	3
Mercury	:<0.3	<0.3	<0.3	<0.3
Nickel	:<20	<20	<20	<20
Thallium	:<5	<4	<5	<4
Zinc	:10	30	10	10

Table 14  
 Times Beach Mid-Depth  
 Pond Water Samples  
 Metals Analyses 1986  
 (ug/l)

Metal	Sample Number											
	1		2		3		4					
	Filtered	Unfiltered	Filtered	Unfiltered	Filtered	Unfiltered	Filtered	Unfiltered	Filtered	Unfiltered	Filtered	Unfiltered
Barium	:May :<20	:Aug :40	:May :<20	:Aug :40	:May :<20	:Aug :80	:May :24	:Aug :80	:May :44	:Aug :40	:May :32	:Aug :92
Cadmium	:<1	:<1	:1.0	:<1	:<1	:2	:<1	:<1	:1.1	:<1	:<1	:1.1
Chromium	:<10	:<10	:64	:<10	:10	:<10	:72	:<10	:<10	:<10	:<10	:40
Copper	:4	:4	:52	:8	:4	:8	:56	:<4	:8	:4	:16	:44
Lead	:<3	:3	:170	:9	:<3	:6	:140	:8	:5	:<3	:13	:92
Mercury	:<0.3	:<0.3	:1.1	:<0.3	:<0.3	:1	:0.5	:<0.3	:<0.3	:<0.3	:<0.3	:0.7
Nickel	:<10	:<10	:<10	:16	:<10	:16	:<10	:<10	:<10	:<10	:12	:12
Zinc	:8	:24	:200	:12	:8	:12	:200	:16	:16	:4	:24	:150
Arsenic	:<4	:<4	:11	:<4	:<3	:<4	:9	:<4	:<4	:<3	:4	:8

Table 15  
 Mean Metals Concentrations  
 Times Beach Monitoring Wells  
 Filtered Samples (ug/l)

Parameter:	Upland Control			Marsh			Water		
	#9(9-12')	#10(19-22')	#11(29'-32')	#6(9-12')	#7(19-22')	#8(31-34')	#12(14-17')	#13(20-23')	#14 (29-32')
Arsenic	33	<4	<4	<16	<8	<4	<19	<9	<4
Barium	<79	<89	280	<106	<106	196	153	<85	<230
Cadmium	<2	<2	<2	<2	<2	<2	<2	<2	<2.5
Chromium	<12	<14	<13	<12	<13	<12	<56	<11	<11
Copper	29	<23	<19	<18	<16	<24	75	26	<56
Lead	<8	<11	<6	<9	<5	<13	<45	<14	<10
Mercury	<0.3	<0.3	<0.2	<0.3	<0.3	<0.3	<0.3	<0.3	<1.2
Nickel	<39	<27	<27	<48	<38	<61	<79	<34	<28
Zinc	41	41	298	32	42	24	223	29	17

Table 16  
 Mean Metals Concentrations  
 Times Beach Monitoring Wells  
 Unfiltered Samples (ug/l)

Parameter:	Upland Control			Marsh			Water		
	#9(9-12')	#10(19-22')	#11(29'-32')	#6(9-12')	#7(19-22')	#8(31-34')	#12(14-17')	#13(20-23')	#14 (29-32')
Arsenic	67	<6	<7	<37	<15	<5	<148	<19	<12
Barium	<118	<85	468	<115	<140	248	327	<100	<270
Cadmium	<3.4	<2	<14	<3	<3	<2	<6	<2	<2.2
Chromium	<26	<14	<14	<20	<15	<17	200	<13	48
Copper	59	45	<35	<19	36	41	347	26	<1.8
Lead	36	<10	9	<10	<11	<12	388	9	25
Mercury	<0.4	<0.3	<0.3	<0.3	<0.3	<0.3	<0.9	<0.2	<4
Nickel	70	<33	<33	<68	<34	<44	119	36	52
Zinc	128	57	118	30	59	72	930	27	150

Table 17 Frequency of Exceeding  
National Drinking Water Standards

Well No.	As		Ba	Cd		Cr	Cu		Pb	Hg	Zn	Total
	F	U	F	U:F	U:F	U:F	U:F	U:F	U:F	U:F	U:F	U
6(S)	:	:	:	:	:	:	:	:	:	:	:	0
Marsh 7(I)	:	:	:	:	:	:	:	:	:	:	:	0
8(D)	:	:	:	:	:	:	:	1	:	:	:	0
Upland 9(S)	2	3	:	:	:	:	:	:	1	:	:	4
Back 10(I)	:	:	:	:	:	:	:	1	:	:	:	0
Ground 11(D)	:	:	:	2	:	:	:	:	:	:	:	2
12(S)	2	:	:	1:2	3:	:	1	2:	:	:	:	8
Pond 13(I)	:	:	:	:	:	:	1	:	:	:	:	0
14(D)	:	:	:	:	:	:	:	1	1:	:	:	1
Total	2	5	0	0:0	3:2	3:0	0:4	3:1	1:0	0:9	:	15

S-Shallow Well  
I-Intermediate Well  
D-Deep Well (on top of rock)

F-Filtered  
U-Unfiltered

THIN-LAYER DISPOSAL  
A MODIFICATION OF CONVENTIONAL OVERBOARD DISPOSAL  
OF DREDGED MATERIAL

BY

R. DOUGLAS NESTER<sup>1</sup>

INTRODUCTION

Open water disposal of dredged material typically results in severe impact to bottom resources within a designated disposal area primarily through suffocation due to direct coverage with dredged material. Recovery of these bottom resources has been shown to require approximately 12-18 months. In an effort to reduce impacts associated with the open water disposal of dredged material, a test was initiated to determine the feasibility and impact of thin-layer open-water disposal. The concept of thin-layer open-water disposal suggests that the active spreading of dredged material in a 6-12 inch lift would reduce the short-term impact on bottom resources such that recovery of these affected resources would be faster. The test case for the thin-layer disposal was an existing Federally authorized navigation project known as the Fowl River navigation project. The project provides an 8- by 100-foot channel for commercial fishing and recreational boating interests and is a small coastal stream which meanders through extensive wetland areas along the western shore of Mobile Bay in Mobile County, Alabama. This project had not been maintained on a regular basis due to environmental controversy surrounding open water disposal.

MONITORING OBJECTIVES

The dredging of the Fowl River channel commenced in July 1986 and the dredged material was spread over a 350-acre area of Mobile Bay in an approximately 6-inch layer. Monitoring began two weeks prior to disposal with an investigation of the bathymetry, benthic and fishery resources, and water quality of the area. Monitoring of the dredging activity and water quality also occurred during dredging. Post disposal monitoring efforts began two weeks after the dredging operation ceased and continued at irregular intervals (6, 20 and 52 weeks) for one year. The objectives of the monitoring effort were: a) to assess the changes in sediment characteristics resulting from thin-layer disposal; b) to evaluate the effectiveness of the particular dredge plant used in attaining a uniform 'thin-layer' overburden; c) to determine the areal extent of the overburden and changes in distribution of disposed material through time; d) to

<sup>1</sup> Biologist, Coastal Environment Section, Mobile District



determine the persistence of the overburden through time; e) to assess the impacts of this disposal on benthic resources; f) to establish the rate and method of recovery of the benthos to pre-project levels; g) to determine whether or not utilization by fishery resources change in the disposal area as compared to surrounding reference area.

#### DREDGING/DISPOSAL EQUIPMENT

A portable 20-inch dredge was used to maintain Fowl River in July-August 1986. Dredge pipeline used during the project was a combination of 20-inch plastic pipe and steel pipe. The plastic pipe was connected to two vertical swivels mounted on pontoon barges. The first swivel was located approximately 600 feet from the dredge and the second swivel was located 4,400 feet from the dredge. The discharge pipe was mounted on a floating barge approximately 200 feet from the second swivel via a ball joint. The end of the discharge pipe was fitted with a spreading device which consisted of a moveable steel plate located just in front of the discharge pipe. The steel plate was connected with cable to winches mounted on either side of the discharge barge which are operated by means of a small diesel engine equipped with a hydraulic pump.

#### DREDGING/DISPOSAL METHODOLOGY

The Fowl River Navigation Project was divided, for purposes of dredging, into a bay portion and a river portion. The bay portion of the project is the focus of this paper and is 7,149 feet long with a bottom width of 100 feet and a side slope of five feet horizontal to one foot vertical. The dredging requirement was for the removal of about 306,000 cubic yards of material, estimated to be 40 percent sand, 50 percent silt and possibly 10 percent sandy clay. Disposal of this material was in a previously used open water disposal area in Mobile Bay located just south of the channel. The previously used disposal area is approximately 240 acres in size but the actual disposal area (total area impacted by the discharge of material) was approximately 350 acres. The northern limit of the disposal area is located 1,050 feet south of the channel and parallels the channel for approximately 4,000 feet. The southern limit of the disposal area is not defined.

The dredge discharge pipe was moved by means of the previously described steel plate structure which was attached to winches on the discharge barge, and, when needed, with the assistance of a shallow draft tug. The discharge pipe was allowed to move around the swivel joint in a 200-foot radius, 300 degree arc. From the initial location, the discharge barge was moved regularly throughout the disposal area to maximize the dispersal of the material. The discharge barge was moved a total of 41 times during the job.

## MONITORING METHODOLOGY

The Mobile District contracted the monitoring of the disposal operation with TAI Environmental Sciences, Inc. of Mobile, Alabama (TAI Environmental Sciences, Inc. 1987). The information presented in the remainder of this paper is summarized from the draft final contract report.

Bathymetry. Bathymetric surveys were conducted both before and after the dredging operation to quantify the change in sediment depth and the areal extent of coverage. A total of three bathymetric surveys were conducted: one pre-disposal survey 2 weeks prior to initiation of dredging and two post-disposal surveys at 6 and 20 weeks after termination of the disposal operation. The information was used to evaluate the efficiency of the thin-layer disposal methodology by directly measuring the extent of the overburden and observing the changes in the overburden materials over time.

Water Quality. Two water quality investigations were conducted to assess the impact of disposal operations relative to dissolved oxygen, salinity, temperature and total suspended solids. Current speed and direction were measured in order to provide useful information for the assessment of impacts on the above water quality constituents. The first survey was conducted 2 weeks prior to disposal and was designed to determine ambient water quality conditions. A total of 108 samples were taken during this pre-disposal survey, half of which were taken at ebb tide and half at flood tide.

A second water quality survey was performed during the dredging operation and provided information on the impact of the open-water disposal operation on the water column by measuring the suspended sediment fields throughout the disposal area and at a reference station. A total of 144 samples were taken at specified points around the discharge pipe, half of which were taken during ebb tide and half during flood tide.

Benthic Macroinfauna. Changes in resident benthic macroinfauna community were documented and used to assess the impacts associated with environmental perturbations. Specifically, sampling programs for this project were designed to determine what portion of benthic community recovery was due to upward migration of the existing organisms and what portion was due to recruitment of juvenile organisms by post-larval settling from the plankton and recolonization from adjacent undisturbed areas. Benthic macroinfauna samples were taken from 60 fixed stations located within the study area. One sample was taken with a boxcore sampler with a square meter coverage at each station. One sample was taken at each of the

60 fixed stations. Also, an additional 6 stations were randomly selected within each of three design strata (reference, fringe and disposal areas). The random station results represent samples consisting of 8 replicate core samples. The purpose of these replicates was to show within station variability. A total of 1,020 benthic samples were collected and analyzed throughout the study.

Vertical Sediment Profiling. Vertical sediment profiling, the technique of taking cross-sectional in situ photographs of sediment layers can provide the best quantitative data on the success of the thin-layer disposal operation at meeting the design criteria of a nominal 6-inch dredged material thickness. The sediment profiling camera is capable of profiling a maximum of approximately 8 inches of sediment and can detect layering of sediments on the order of millimeters, thereby providing a highly detailed record of the dredged material overburden. Application of this technique to the disposal operation at Fowl River provided detailed information on the extent and coverage of the operation. Sediment profile imagery was obtained at each of the 60 fixed benthic stations and an additional 12 floating stations each sampling period, for a total of 360 images (72 stations X 5 sampling activities). Since the main objective of the profiling was to document the thickness and impact of the disposal operation both color slide and black and white film were used. The color film provided the best contrast for identifying the dredged material layers and general environmental conditions.

Fish Utilization. Fisheries studies were conducted to assess the changes in the utilization of the disposal area by fisheries resources. These fish data also provide a useful comparison to benthic macrofauna since fishes are a highly motile and comparatively transient part of the faunal community utilizing the study area. This assessment encompassed both vertebrate and invertebrate demersal organisms, as collected in trawl samples, and was used to determine the impact of the operation on this resource. Samples were collected within three designated areas including the disposal area, north of the disposal area, and south of the disposal area. Three replicate samples were collected for each trawl corridor. These samples were divided between daytime and nighttime collections to produce a diel sampling regime, thus yielding 18 samples in a given 24-hour cycle. Each field effort, therefore, resulted in the collection of 72 trawl samples or a total of 360 trawl samples throughout the study.

## DISPOSAL RESULTS/DISCUSSION

Bathymetry. Results of the three bathymetric surveys conducted at the Fowl River Channel open water disposal area identified specific regions of sediment accumulation within both the disposal and fringe areas. The region with the greatest depth of sediment accumulation was located primarily in the disposal area. Results of the 6 week post-disposal survey showed a sediment rise of 0.5-foot or greater covering a total of 203 acres. Results of the 20 week post-disposal survey showed that sediment migration had occurred and suggests that

migration was likely due to the prevailing current direction during and after disposal operations and the direction of the discharge. It is also likely that shallow water depths in the study site and wave action were factors controlling sediment migration.

Sediment accumulation in the study area was found to range in depth from 0.5 to approximately 2.0 feet. Of the total 203 acres with a sediment accumulation of 0.5-foot or greater, 24 percent had a sediment rise exceeding 1.0-foot. Only 1 percent had a sediment rise exceeding 2.0 feet. Overall, 76 percent of the total area with a detectable sediment rise had an increase in sediment depth of 0.5 to 1.0 feet. Results of the 6 week post-disposal survey showed the thin-layer disposal technique was successful in obtaining a sediment rise of less than 1.0-foot in depth in the majority of the disposal area. Results of the 20 week post-disposal survey also showed a net decrease in the total area with a detectable sediment accumulation of 0.5-foot or greater, and a net decrease in the total volume of accumulated sediment. The total area of sediment accumulation with a rise of 0.5-foot or greater decreased by 26 percent between the 6 week and 20 week post-disposal surveys. The total volume of accumulated sediment in the overall study area was found to decrease by 10 percent during the same time period. These decreases were due to a continuation of natural sediment migration and dispersion as a result of tidal currents and wave action.

Water Quality. Water quality data collected during disposal operations showed highest concentrations of total suspended solids to be found down current of the discharge point, in the same direction as sediment discharge. Both the direction of sediment migration and the areal coverage of the total suspended solids plume appears to have been controlled to a large part by the prevailing currents.

Mean dissolved oxygen concentrations at the study site were similar during both the pre-disposal water quality survey and during the disposal operation. A diurnal fluctuation in dissolved oxygen concentrations, with levels reaching a minimum during early morning hours followed by increasing concentrations toward late afternoon, was observed during both water quality surveys.

Results from both water quality surveys show dissolved oxygen, temperature, and salinity in the water column were not significantly impacted by the thin-layer disposal operation.

Benthic Macroinfauna. Mean abundance of benthic macroinfauna was relatively constant throughout the study ranging from 800 to 1,200 organisms/m<sup>2</sup>. Seasonal fluctuations were noted throughout the study with a peak abundance in the 2 week post-disposal. During the 2 week post and 6 week post disposal collections, mean macroinfauna abundance was lower in the disposal area when compared to the reference and fringe areas. Lowest abundances were noted during the 6 week post-disposal sampling. A total of 123 taxa representing 70

families of macroinvertebrates were identified from the samples. Polychaetes, molluscs and crustaceans dominate the community both numerically and in terms of the number of taxa. Turbellarians were abundant at most stations throughout the sampling effort.

Species diversity ranged from 2.0 - 3.0, indicating moderately low diversity for the area and is typical of a middle salinity estuary. Dominant taxa in the sampling area include Mediomastus ambiseta, Parandalia americana, Macoma sp., Paramphinome pulchella and Rhynchocoela all of which are taxa found to be characteristic of Mobile Bay. These taxa are more characteristic of a middle bay salinity, stage I or pioneering sere. The characteristics of such a community are that they sometimes have an eruptive population growth, exhibit a high biomass turnover rate and are generally tolerant to a variety of physical and chemical perturbations of the environment. Thus, they are indicative of a naturally "stressed" community exposed to large amounts of disruptive energies.

Variability in individual species, spatial variability and variation in community structure were not found to be related to the disposal activity. Spatial variability appeared to be more a function of bottom type and depth rather than being related to the disposal operation. Seasonal trends were most likely driven by changes in the physical and chemical environment rather than changes brought about by the disposal activity.

Vertical Sediment Profiling. The 360 photos of the project area suggest that the general site character of the study area appears to be dominated by physical disturbances. Inshore sandy areas were dominated by sand ripples on the order of 1 to 2 cm in height. Muddy areas were characterized by a uniform surface and layering of subsurface sediments. Approximately 3 to 5 layers of different grey color tone sediments were seen at most stations. Evidence for trawl induced resuspension-deposition in the muddy areas was strong during the pre-disposal photographs. Numerous small boats were trawling in the study area during the entire pre-disposal vertical profiling task.

The entire surface of the study area is considered pioneering or Stage I community development. The presence of burrowing polychaetes, the only subsurface fauna seen in the photos, indicated that the total community successional stage could be late Stage I. A broad scale recolonization event occurred after the disposal operation and was seen during the 2 week post-disposal sampling period. The entire surface of the control, fringe and disposal areas was colonized by the capitellid polychaete Mediomastus. Areas that received dredged material were similar with respect to recruitment to control and fringe areas that appeared to be unaffected by dredged

material. The 6 week post-disposal photographs indicate that the Mediomastus tube mats only sparsely covered the disposal area. No difference could be seen in the distribution of tubes that related to dredged material. The entire study area appeared to remain at the same level of community development.

Sediment profile photos indicated that most of the disposal area was filled to over 8 inches with dredged material. Only the inshore fourth of the disposal area had no dredged material layers. Dredged material readily spread south of the disposal area, but northward movement was extremely limited. In general, the thickness and distribution of the dredged material did not significantly change up to the 20 week sampling effort. Thick layers of dredged material were easily recognized by lighter grey tone and more uniform texture relative to background sediments. Thin layers were more difficult to identify due extensive physical and biological reworking. The reworking of the sediments was evident in photos from the 2 week through the 20 week sampling efforts.

Fisheries. In general, temporal influence far exceeded that of the spatial or spatial-temporal interaction. The temporal influence on species abundance showed a high degree of significance for most of the numerically dominant species including the bay anchovy, hardhead catfish, fringed flounder, Atlantic croaker, bighead searobin and least puffer. Two common species, spot and hogchoker, showed no significant temporal trend in abundance. It does appear that the deposition of dredged material may have had a temporary effect on the spatial distribution of the spot, but this did not extend for more than 6 weeks. The fringed flounder and Atlantic croaker showed a highly significant temporal distribution that may mask a close relationship to the disposal of dredged material. Approximately 99% of all fringed flounder collected were from the 2 week and 6 week post-disposal sampling efforts and a large percentage of the Atlantic croakers were collected during the 6 week sampling effort. These data may indicate that these species were attracted to the study area by the presence of the newly worked dredged material. Alternately, filter feeders such as the bay anchovy appeared to be displaced from the disposal area since very few specimens were found in trawl samples.

The invertebrate species collected during the study also indicate some possible effects of the dredged material. Squid and white shrimp demonstrated high abundance during the 2 and 6 week sampling efforts. Approximately 99% of the total number of white shrimp were collected during the 2 and 6 week sampling efforts. The dominance of the temporal over the spatial influence on the utilization of the study area by the fisheries resource probably reflects the shallow depth and relatively small size of the study area. However, these data show no significant impact of thin-layer dredged material disposal on the fisheries resource, and no significant changes in the utilization of the disposal area.

## CONCLUSIONS

Based on the results of the bathymetric surveys and vertical sediment profiling, dredged material was disposed in the deeper portion of the disposal area and south fringe area. The depth of the material was observed to be 2.0 feet or greater in only 1 percent of the disposal area. The materials were detectable throughout all post-disposal sampling efforts including the 52-week sampling effort. There was evidence that the materials were slowly drifting in a southeasterly direction and were being reworked mainly by physical forces.

Transient impact to water quality was observed during dredged material disposal in terms of elevated total suspended solids. The impacts were localized to a small area around the dredge discharge during the disposal operation.

A slight reduction in total macroinfauna abundance was observed following the dredged material disposal within the disposal area. However, this reduction was not verified statistically. Community changes attributable to dredged material disposal were not observed with either the community analyses on the biological data or with community observations with the vertical sediment profiling. Variation both temporally and spatially were attributable to the physical and chemical changes which were naturally observed in the estuarine environment.

The impact of the dredging operation on the utilization of the area by fishes was not statistically verified. Some fish species were extremely abundant in the disposal area during the 2 and 6 week post-disposal sampling efforts and some species present in the disposal area prior to disposal were not found at all. In general, however, changes in fish communities appeared to follow the usual temporal and seasonal trends observed in estuaries. No net decrease in the utilization of the study area by the fisheries resources was seen.

For more detailed information on this monitoring program, please contact the author at telephone (205) 694-3854. Limited copies of a final report entitled "Monitoring of Environmental Impacts Associated with Open-Water Thin-Layer Disposal of Dredged Material at Fowl River, Alabama" will be available in the near future.

## REFERENCES

TAI Environmental Sciences, Inc., "Monitoring Environmental Impacts Associated with Open-Water Thin-Layer Disposal of Dredged Material at Fowl River, Alabama," Draft Final Report, prepared for the U.S. Army Engineer District, Mobile, 1987, 164 p. plus appendices.

MOBILE HARBOR, ALABAMA, DUMP SCOW OVERFLOW TEST

PRELIMINARY REPORT OF FINDINGS

by

F. Dewayne Imsand<sup>1</sup>

INTRODUCTION

The Dredged Material Dump Scow Overflow Test in Mobile Bay was conceived and conducted in an effort to investigate a possible way to lower dredging costs where hydraulic dredging in combination with dump scows might be used. The test was designed to determine if, through the use of a hydraulic dredge, dredging fine-grained estuarine sediments with discharge into dump scows, it would be possible to increase the sediment content of the scows by continued dredging and discharge past the point of scow overflow. Additionally, the test design also provided for an analysis of the environmental impacts associated with such overflow.

The continued use or establishment of new open water sites in estuarine waters for the disposal of dredged material is undergoing increased opposition. In many cases there are no suitable alternative sites available within feasible hydraulic pipeline distances. In those cases where open water disposal is excluded from use and there are no suitable upland sites available, the transport of dredged material via scows to more remote sites is a likely alternative. This type of dredged material transport is expensive and the costs increase substantially with the distance from the dredging site to the disposal area. The increasing number of approved ocean disposal sites in recent years reflects the scarcity of suitable upland areas and the trend to abandon the traditional open water disposal.

Maintenance of estuarine channels in the Mobile District costs approximately \$17 million per year, and the costs are rising. In addition, several new construction projects are presently being planned that will involve transportation of dredged material. Accomplishing adequate channel maintenance and channel construction, while at the same time protecting the environment from unacceptable deleterious effects is, many times, a challenging undertaking. While channel construction and maintenance operations are constantly reviewed for cost effectiveness, this overflow test represents a special initiative involving significant investment of funds, and manpower, time and effort in the quest for improved ways of doing business. The Environmental Protection Agency (EPA), Region IV, also sensitive to increased dredging costs, as well as their environmental responsibilities, fully sanctioned and cooperated in the test. Likewise, the test was endorsed by other Federal and state environmental agencies.

<sup>1</sup>Environmental Engineer, Coastal Environment Section, U.S. Army Corps of Engineers, Mobile District.



This paper presents the findings from preliminary analysis of selected aspects of the test. A full report of all test findings, including an environmental impact analysis of sediment slurry waters entering the bay, is scheduled for the spring of 1988. Following the completion of all planned analyses, the adoptability of various findings to new work and maintenance dredging projects within the District will be assessed. The information gained as a result of the test will also be incorporated into the new Dredging Research Program being conducted by the Waterways Experiment Station (WES) at Vicksburg, Mississippi. This program is directed toward producing cost savings in the national dredging program.

#### DESCRIPTION OF MOBILE BAY

Mobile Bay is located in southwest Alabama and has a water surface area of about 335 square miles. The bay, shown on Figure 1, is about 31 miles long with an average width of nearly 11 miles and averages about 9.5 feet deep. The bay is the receiving body for the water originating from the fourth largest river system in the United States (Hardin, et al., 1976). The Mobile River System drains about 43,700 square miles and discharges at an average annual rate of 62,300 cfs. The river system also discharges an average of nearly five million tons of suspended sediment each year (Ryan, 1969). The magnitude of this relatively large sediment load, composed principally of silt and clay, was determined from suspended sediment sampling taken daily by the Corps of Engineers (COE) for over a decade. It has been estimated that approximately 60 percent of the annual sediment inflow is deposited in the bay and results in a bay-wide average filling of 0.02 inches per year (Ryan, 1969).

The easily suspended, fine-grained sediment transported into the bay causes seasonally high suspended sediment/turbidity values in unison with the rainfall patterns in the river basin. Although the suspended sediment/turbidity content of the bay waters fluctuate seasonally, winds can cause significant increases at any time by the erosion and resuspension of bottom sediments. For example, measurements taken during a 25 knot wind event indicated a sediment concentration of 160 mg/l (about five times the daily average amount). This represents the equivalent of 569,000 tons of suspended sediment in the bay waters (May 1976).

Commercial navigation through Mobile Bay via manmade channels dates back to the 1800's. Historically, most of excavated material has been disposed of alongside the channel. While there has been a measurable buildup of sediment in the upper reach of the bay, where the highest percentage of sand is present, the bottom configurations in the remaining disposal areas have changed very little or not at all over the years. The very fluid, fine-grained silt and clay (i.e., typical maintenance material) is simply dispersed by the action of the currents and wind effects. Notwithstanding the natural suspended sediment levels and dynamic sedimentological character of the bay as well as the results of many site specific investigations which have shown minimal impacts resulting from past open-water disposal, as previously stated, there is increasing opposition to this type of disposal. The Water Resources Development Act of 1986, which authorized the deepening of the Mobile Ship Channel from its present

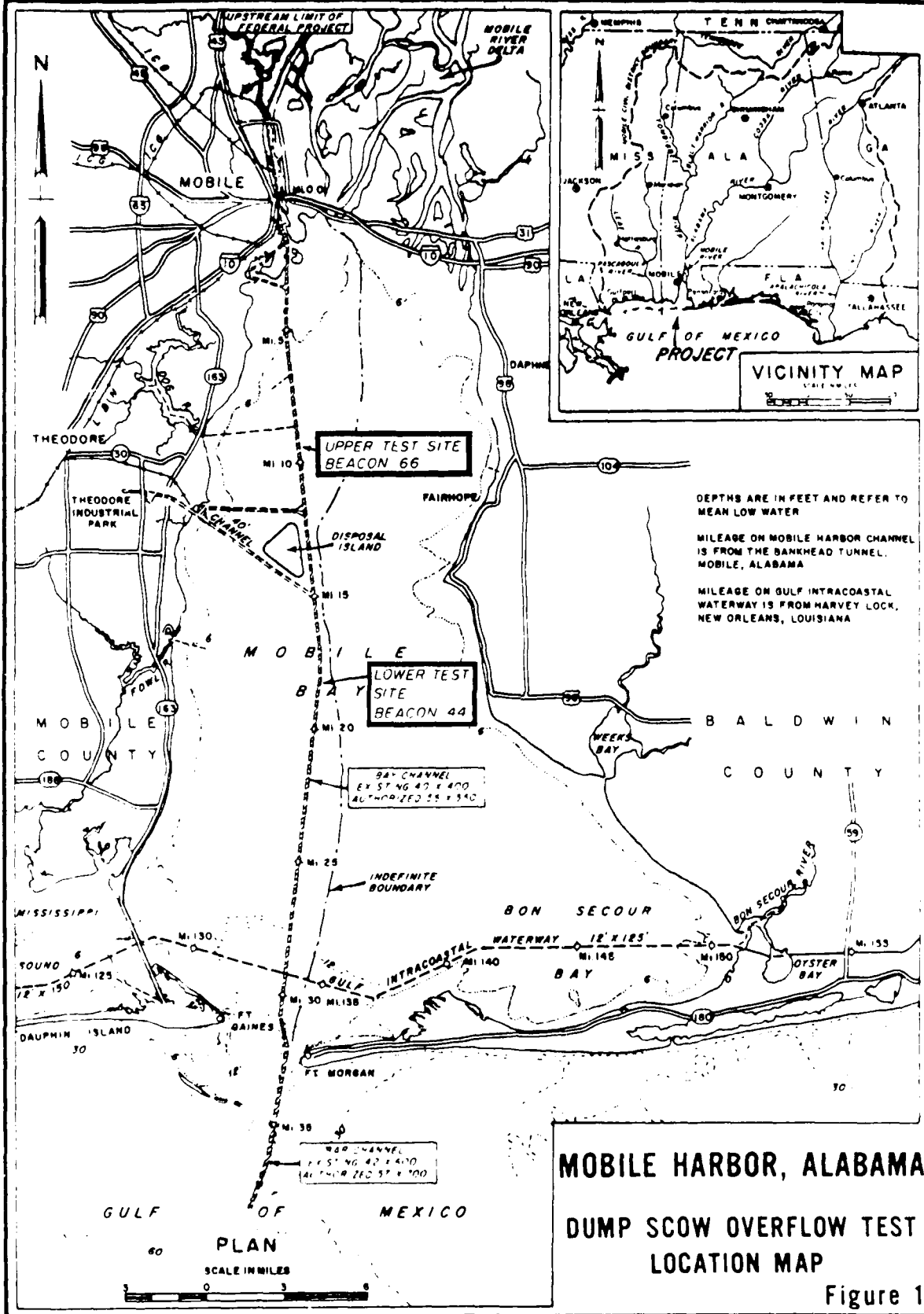

40 foot depth to 55 feet, specifically precludes the open-water disposal of both "new" and future maintenance material and specifies that all material must be transported to the Gulf of Mexico. It is with this backdrop that the current investigation was undertaken.

#### TEST PLAN OF STUDY

Following a COE/EPA agreement in late 1986, that the test should be conducted, an initial plan of study was prepared with the assistance of WES. The concept was presented to Federal and state environmental agencies in January 1987. The plan of study was expanded and refined with a subsequent interagency meeting held in June 1987. It was then planned to conduct the test the following August; however, the unavailability of the necessary dump scows delayed the test until December 1987.

The Final Plan of Study specified the following major items:

- a. All tests will be conducted within daylight hours to facilitate monitoring activities.
- b. Tests will be conducted of both maintenance and virgin material at one lower bay site (channel beacon 44, east of the mouth of Fowl River) and one upper bay site (channel beacon 66, east of the mouth of Dog River) to evaluate the efforts of differing channel bottom material.
- c. All filled scows will be towed to the Gulf of Mexico with disposal to occur at the approved Mobile Disposal Area.
- d. Prior to actual testing, optimal hydraulic dredging techniques to maximize slurry sediment content will be investigated and verified.
- e. The dredge scows will be equipped with recording instrumentation to monitor slurry velocity and specific gravity and scow loading rate.
- f. Manual sampling of slurry entering scows and scow overflow will be conducted for each test to provide for analysis of the sedimentological characteristics.
- g. Manual and automatic sampling of sediment plumes generated by the overflow will be conducted during each test event in order to determine the sediment distribution and rate of change within each plume for mathematical model calibration and verification.
- h. Hydrographic surveying at each test site will be performed.
- i. Scaled aerial photography will be taken at intervals during each test to monitor the surface area and change of each plume.
- j. A weather station and tide gages at both the lower and upper test site will be established to monitor onsite conditions.

k. A sampling network at each test site will be established for the acquisition of vertical profile photographic imagery of the bottom sediments before and after testing to measure the thickness of sediment deposition and for biological impact analysis.

l. A mathematical model of the bay will be developed, calibrated and verified to provide ebb and flood current and salinity patterns based upon average monthly boundary conditions.

m. A dispersive plume model will be developed, calibrated and verified to evaluate plume evolution and decay.

n. An environmental analysis of impacts to both the water column and bay bottom will be performed.

#### SITE AND DREDGING DEPTH SELECTION

Considerable deliberation was devoted to determining how many sites along the channel should be tested. It was known that the surficial channel bottom sediment (maintenance material) is generally a very fluid, black, silt-clay mixture with a small amount of sand exhibited in the upper bay channel. Information concerning the subbottom strata was gained through an examination of numerous channel borings that were made in connection with the present channel deepening project. The borings showed the sediment underlying the existing channel bottom (virgin material) is dominately sandy in the uppermost reach of the bay and a very soft to soft, plastic marine clay-silt mixture elsewhere. A major difference in the characteristics of the silt-clay mixtures in the lower and upper bay channel is apparent in the water content of the respective materials. Since this type material was the most predominate along the length of the channel and had the most questionable nature, it was decided that two representative silt-clay areas, one in the lower bay and one in the upper bay, should be tested.

In the lower bay channel, the in-place water content of the virgin material at the test site varied from 98 percent at the top to 60 percent 15 feet deeper. The virgin material at the upper site was about 2-3 times more dense with the water content varying between 29 to 41 percent. Examination of historic cross sections taken at the two locations showed that the bottom sediments had been disturbed to irregular depths below the existing channel bottom. Therefore, in order to test strictly maintenance material and virgin material, and to provide an optimum dredge cutting face (about five feet), elevations of 47 feet below mean lower low water at the lower site and 48 feet at the upper site were selected to represent the maintenance material-virgin material dividing line.

#### DISCUSSION OF TEST EQUIPMENT

Early in the test formulation stage it was recognized that some type of slurry discharge manifold system would be necessary in order to reduce the slurry velocity entering the dump scows. This would minimize turbulence and more evenly distribute the sediment retained in the scows. It was also considered necessary to develop, prior to the test, tentative

dredge operational procedures optimized for the equipment to be used and the type of sediment to be encountered. To perform these tasks and to provide guidance throughout the test, a team of three dredging consultants was selected. They were: Mr. Tom M. Turner, Sarasota, Florida; Mr. Carl B. Hakenjos, New Orleans, Louisiana; and Mr. Charles E. Woodbury, Tampa, Florida. The tasks were accomplished in a very successful manner through the excellent interest and cooperation of the consultants and T. L. James and Co., Inc., of New Orleans, Louisiana, the dredge contractor for the test.

The dredge used for the test was the George D. Williams. This 24-inch hydraulic cutterhead dredge was equipped with a 600 hp, constant speed, ladder pump. Evaluation of the test conditions indicated that the ladder pump alone could only marginally produce the necessary minimum slurry velocity and since its speed could not be varied, it was decided to also use the adjustable main pump. Utilizing both pumps together with 1,442 feet of floating pipeline, the slurry velocity could easily be adjusted throughout the desired range. The cutterhead used was a five-blade, smooth side basket cutter with a diameter of five feet.

The scows used were of split hull, bottom dump design with a capacity of 4,000 cubic yards and a draft of about 20 feet when fully loaded. The scows were designed to squat several inches in the stern when evenly loaded for towing stability. This feature was an aid in overflow sampling by tending to confine the overflow from the coaming to a relatively narrow region. The scows were also equipped with two 8-inch diameter stilling wells mounted on diagonal outside corners in which pressure sensitive tide gages were installed. These recording gages provided information on the loading of the scows. In addition to permanently recording the measured scow draft, the readings were also automatically radioed to the office on the dredge every two minutes during tests and plotted to provide immediate feedback on the loading characteristics.

The slurry discharge manifold system, termed spider barge, was designed to evenly distribute the slurry throughout the scows which were positioned alongside. Even sediment distribution was accomplished by the reduction of the diameter of the main 24-inch discharge line, in two stages along the length of the spider barge, from 24 inches to 20 inches to ultimately, 15 inches. From each of the three different diameter sections of the main line, a 15-inch diameter feeder pipe was attached. The feeder pipes sloped upwards and over the side of the spider barge and each terminated in two, 12-inch flexible downcomers. The feeder pipes extended to about mid-width of the scows and the downcomers were equally spaced over the scow length. The downcomers were 22 feet long to aid sedimentation in the scows and were flexible to allow the scows to be placed into position without the need to raise and lower the discharge manifold. At two points in the main discharge line, where the feeder pipes exit, baffle plates were installed to aid in the equalization of the slurry into the feeder pipes. Also, a valve-controlled sampling port was installed in the 24-inch discharge line to allow for the monitoring of the sediment content and slurry characteristics.

## TEST PROCEDURES AND RESULTS

With all preparations having been made, the test began at the lower site on December 2, 1987. The first day was devoted to "tuning-up." All equipment was operated, instrumentation checked and dredging procedures were conducted in a trial test to assure everything operated satisfactorily for actual testing the following day. The testing cycle at both locations, following "tune-up," was to first test the maintenance material while dredging to the prescribed depth. With the maintenance material removed, the dredge was relocated to the starting point in the channel and virgin material testing begun. At the lower site, one maintenance material test and two virgin material tests were conducted. Two maintenance and three virgin material tests were conducted at the upper site.

Due to the naturally fluid characteristics of the fine-grained maintenance material, there was little expectation that consolidation would occur in the scows past the point of overflow. However, since the material had to be removed to expose the virgin material, it was decided to also include maintenance material tests and use the information collected as a frame of reference. As expected, none of the three maintenance material tests showed much gain in scow load when dredging past the point of overflow. The increase in scow draft due to overflowing for an average of 31 minutes averaged only 0.29 foot or about 2.4 percent of the average draft of the filled scows.

Realizing that the water content of the virgin material in the lower bay was high (60 to 98 percent) and the experience of the maintenance material test at that location, optimism that a large scow-load increase when dredging the virgin material began to wane. As a matter of fact, the two virgin material tests confirmed that in spite of the utilization of the best known operational techniques to maximize the slurry specific gravity, this material, too, did not settle in the scow in large amounts. During these two tests, the scows were overflowed for an average of eleven minutes and resulted in a scow draft increase of 0.35 foot for both tests. This gain represents 2.8 percent of the average total scow draft.

Consideration then turned to the upper site and a reassessment of planned dredging techniques was made, particularly for the virgin material tests. The virgin material at the upper site was considerably more dense than the lower site and contained more sand. Also, it was recalled that during the construction of the western end of the Theodore Channel in the bay about six years ago, a significant amount of cobble-sized "clay balls" were hydraulically discharged, and the dredging depths for these tests were to be deeper. All things considered, it was believed the upper site had a higher potential for better results. After three tests, all showing fairly similar characteristics, the field tests were concluded. The average time of scow overflow for the three virgin material tests at the upper site was 37 minutes. The average additional scow draft was 0.45 foot which equates to 3.2 percent of the average draft of the filled scows. Table 1 presents a summary of operating times, flow rates and volumes. A preliminary summary of dredged sediment specific gravity and volumetric results is shown on Table 2. The total amount of sediment discharged into the scows

TABLE 1

MOBILE HARBOR DUMP SCOW OVERFLOW TEST

SUMMARY OF OPERATING TIMES, FLOW RATES AND VOLUMES

Date	Test No/ Type/ Location	Dredging Start Time	Overflow Start Time	Time Dredging Stopped	Time Pumping Stopped	Time Overflow Stopped	Average Flow Rate (GPM)	Average Velocity (Ft/Sec)	Total Slurry (Gal)	Total Overflow Volume (Gal)
12/3/87	1ml <sup>1</sup>	1035	1119	1133	1135	1137	18,364	13.0	1,101,840	293,824
12/4/87	2v1	0827	0857	0905	0907	0913	26,933	19.1	1,077,320	269,330
12/4/87	3v1	1218	1247	1258	1300	1305	27,862	19.8	1,170,204	362,206
12/6/87	4mu	0907	0943	1013	1015	1021	22,444	15.9	1,526,192	718,208
12/6/87	5mu	1310	1346	1414	1416	1422	22,444	15.9	1,481,304	673,320
12/7/87	6vu	0846	0915	0937	0940	0942	27,862	19.8	1,504,548	696,550
12/8/87	7vu	0930	0957	1022	1025	1028	29,926	21.2	1,645,930	837,928
12/9/87	8vu	1428	1459	1550	1552	1556	26,065	18.5	2,189,460	1,381,445

<sup>1</sup>ml = first test; maintenance material; lower site.

6vu = sixth test; virgin material; upper site.

TABLE 2

MOBILE HARBOR DUMP SCOW OVERFLOW TEST

PRELIMINARY SUMMARY OF DREDGED SEDIMENT SPECIFIC GRAVITY AND VOLUMETRIC RESULTS

Test Number/Type/Location <sup>1</sup>	1ml	2v1	3v1	4m1	5m1	6vu	7vu	8vu
Total Slurry (Cuyds)	5,454	5,332	5,793	7,555	7,332	7,448	8,147	10,838
Average Specific Gravity of Slurry	1.03	1.10	1.09	1.07	1.09	1.13	1.14	1.18
Percent Sediment in Slurry	2.9	9.1	8.3	6.5	8.3	11.5	12.3	15.3
Volume of Sediment in Slurry (Cuyds)	158	485	481	491	609	857	1,002	1,658
Overflow Volume (Cuyds)	1,454	1,333	1,793	3,555	3,333	3,448	4,148	6,838
Volume of Sediment in Scow (Cuyds) <sup>2</sup>	116	364	332	260	332	460	492	612
Volume of Sediment in Overflow (Cuyds) <sup>2</sup>	42	121	149	231	277	397	510	1,046

<sup>1</sup>1ml = First test; maintenance material; lower site.

6vu = Sixth test; virgin material; upper site.

<sup>2</sup>Assuming no significant gain in scow load.



for each test is known from the specific gravity record of the slurry. However, the amount of sediment retained in the scows and the amount present in the overflow, as shown on Table 2, are computed based on no significant scow load gain. These quantities will require adjustment to reflect the actual load gains when the ongoing sediment sample analyses have been completed. Representative scow load curves are shown on Figure 2.

Using the percentage change of the total scow draft, from the beginning to the end of overflow, as a tool to evaluate the effectiveness of the scow overflow technique in the bay shows that, as expected, the maintenance material performed the poorest of any material tested. The virgin material in the lower bay had a better scow retention rate than the maintenance material but less than the upper bay virgin material. The average percentage changes of the total scow draft for the maintenance material and the lower and upper virgin material tests are 2.4, 2.8 and 3.2, respectively. Although the scow load curves for the virgin material tests were similar in nature, there was some variability between them. For example, test 8, shown on Figure 2, shows the greatest rate of change of any test. The reason or reasons for this are being evaluated. This and other questions, including the significance of the load gains, will be addressed when all laboratory analyses of the sediment samples have been completed.

#### ONGOING WORK

Together with sediment sample analysis, other ongoing work includes the mathematical modeling of sediment plume behavior in the bay. The detailed knowledge gained of the migration and decay of sediment plumes associated with the discharge of a sediment slurry adjacent to the main channel will be important information for this and other projects within the bay. Analyses are also continuing utilizing the bottom sediment profile imagery data. This tool for physical and biological impact assessments will also be used to investigate natural, bottom-sediment perturbations documented during the course of the test. The information obtained will also have relevance to other bay projects. The plan of study for the test was broadly developed to not only provide information necessary for purposes of the test, but also to collect information in a manner which would have the broadest possible application. So even though the test did not indicate the degree of scow load increases originally hoped for, increased knowledge and important results are anticipated when all data analyses are completed. The final report is scheduled for completion in the spring of 1988.

#### REFERENCES

- Hardin, J. D., et al., "Shoreline and Bathymetric Changes in the Coastal Area of Alabama," Geological Survey of Alabama, University, Alabama, 1976.
- May, Edwin B., "Holocene Sediments of Mobile Bay, Alabama," Alabama Marine Resources Bulletin, No. 11, June 1976.

Ryan, John J., "A Sedimentological Study of Mobile Bay, Alabama," The Sedimentological Research Laboratory, Florida State University, Tallahassee, Florida, June 1969.

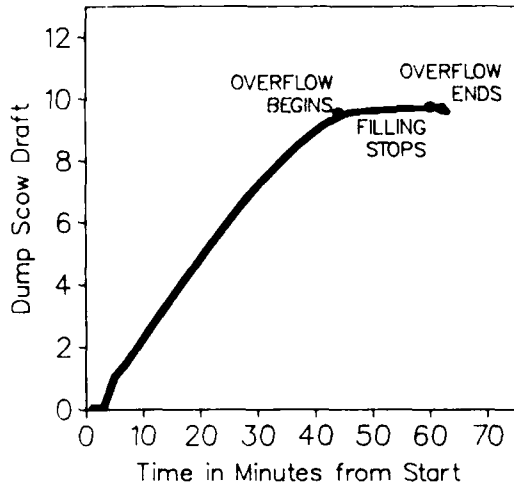

Test 1, 12/3/87, Maintenance Material

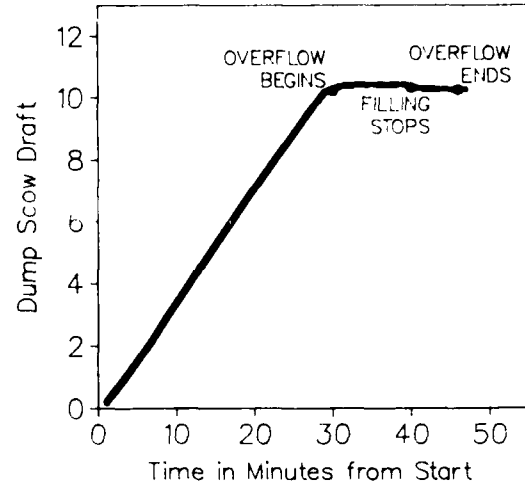

Test 2, 12/4/87, Virgin Material

**MOBILE HARBOR DUMP SCOW OVERFLOW TEST  
DUMP SCOW DRAFT VERSUS DREDGING TIME  
LOWER TEST SITE**

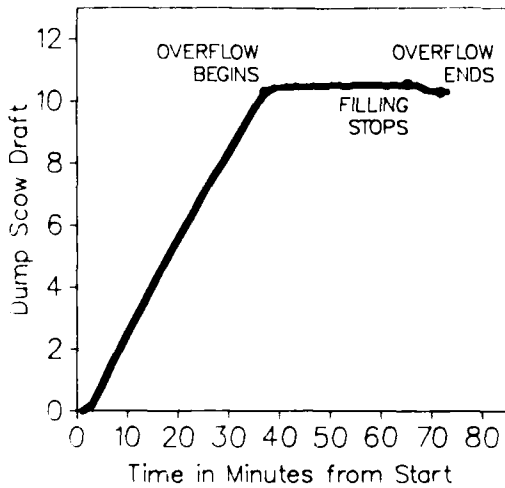

Test 5, 12/6/87, Maintenance Material

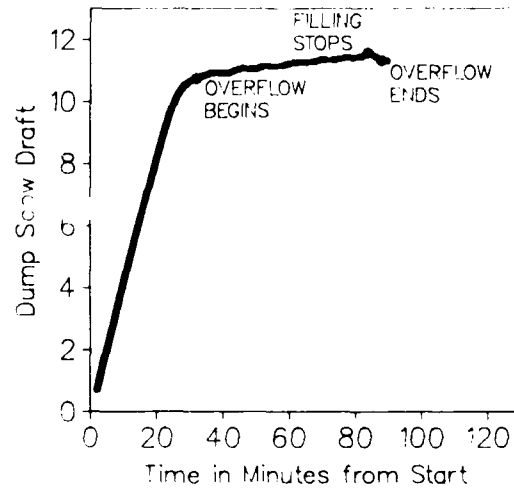

Test 8, 12/9/87, Virgin Material

**MOBILE HARBOR DUMP SCOW OVERFLOW TEST  
DUMP SCOW DRAFT VERSUS DREDGING TIME  
UPPER TEST SITE**

Figure 2

## MANAGEMENT OF DREDGED MATERIAL DISPOSAL AREAS

by

I. Braxton Kyzer<sup>1/</sup>

The Charleston District's method of disposing of dredged material from its harbors and waterways through the years is probably typical of most coastal navigation projects. Prior to the 1950's, the predominant method of dredged material disposal for all projects was to discharge into open water disposal areas, or onto unconfined marsh areas. A significant problem with this method was first noticed in Charleston Harbor. Due to the volume of material being pumped into unconfined areas, a significant amount of the material found its way back into the navigation channels. In the early 1950's, a diking program was started in Charleston Harbor primarily for the purpose of containing the material. In essence, diking was justified as a method of reducing the dredging cost. In the late 1960's and early 1970's, the District experienced a similar problem along the Atlantic Intracoastal Waterway (AIWW). The easement areas along the AIWW are a thousand (1,000) feet deep and continuous on one side of the waterway or the other. Originally, the AIWW easement areas were either open water areas or marsh areas. The primary reason the District commenced diking these areas was that the dredged material could not be contained within the easement areas, which resulted in filling creeks and marsh outside the easement area. Many of the creeks were good oyster grounds that were leased to commercial fishermen. By diking, the impact on both the adjacent creeks and marsh was reduced.

By the mid 1970's, most of the diked disposal areas that are in use today had been constructed. The diking program did not go smoothly, nor did it solve all the problems. The dikes were constructed over a soft marsh foundation and were of material that had a very high water content. Initially, dikes could only be constructed five (5) or six (6) feet high with top widths of about four (4) feet. Lack of material, its wet condition and poor foundation conditions prevented a larger cross section from being constructed. After construction, the dike dried out and settled, often leaving only 2.5 to 3.0 feet of freeboard when the dredging effort commenced. Spillways were also a problem as they were difficult to anchor and either floated or tilted. The discharge pipe was pushed into the mud by the weight of the dike, affecting its usefulness.

The dredging program was plagued with problems: breached dikes; dike failures before and during dredging; spillway failures; spillway boards mysteriously pulled in the middle of the night during a dredging operation;

<sup>1/</sup> Chief, Dredging Management Branch, Charleston District, COE

and a continuous problem of deltas forming in the marsh where spillways discharged. While the above problems can be related to water quality, yet another environment problem was created, i.e., a salt-marsh mosquito problem. Conditions found in an unmanaged disposal area were ideal for mosquito production. The District was the scapegoat every time there was a heavy infestation of mosquitoes and at times, rightly so.

In 1975, as the Dredged Material Research Program (DMRP), conducted by the U.S. Army Waterways Experimental Station (WES), was nearing completion, the District began working with WES personnel and applying some of the techniques (1, 2) developed during the DMRP for managing dredged material disposal areas. In addition to DMRP personnel, the District developed strong ties with Dr. William B. Ezell of The Citadel. Dr. Ezell conducted a study on mosquito control for WES during the DMRP (3) and several for the District (4, 5) concerning the effectiveness of structural modifications on mosquito control. By working closely together, Kyzer (COE) and Ezell concluded that mosquito control and dewatering dredged material were compatible activities. After experimenting with several disposal areas and noting positive results, the District initiated a disposal area management program and established the following goals:

- (a) Design and develop dredged material disposal areas that will contain all the shoal material safely and efficiently and that can be operated in such a manner that the effluent can be released without harming the environment and meet applicable standards.
- (b) Densify the dredged material and consolidate subsurface sediments such that the maximum amount of volume may be regained from the areas.
- (c) Develop techniques which can be used to accelerate drying and dewatering of the dredged material.
- (d) Development and apply techniques which will reduce the mosquito breeding potential of the disposal areas.
- (e) Create wildlife habitat within disposal areas during periods of inactivity.
- (f) Find off-site uses for the dewatered dredged material.

Due to the size of the diking program, i.e., 70 diked areas, 94 miles of dikes, and 10.5 sq. miles of area, the management program was commenced on the most important area in the District, Daniel Island Disposal Area in Charleston Harbor. It was gradually expanded to include the eight (8) major areas in Charleston and Georgetown Harbors and to the Atlantic Intracoastal Waterway.

Basically the goals of the Disposal Area Management Program have not changed over the years. The success of a Disposal Area Management Program can be measured by the success of "crust management." Crust management is an effort to dewater each new lift of dredged material in its entirety, prior to placement of an additional lift of dredged material. By dewatering the crust, conventional equipment such as low-ground pressure bulldozers, self-loading

scrapers, backhoes, and farm tractors with dirt buggies can be utilized. Once interior access was accomplished, a number of the goals listed above were much easier to achieve due to the following:

- (a) An unlimited source of material for dike construction became available.
- (b) It was possible to construct semi-compacted dikes of larger cross section.
- (c) Underdrains could be installed in the dewatered crust.
- (d) Stable, functional spillways were easier to construct.
- (e) Ditches and low spots could be filled before the next dredging effort, thus eliminating potential future mosquito breeding areas.

The Charleston District's Disposal Area Management Program has evolved over a number of years. Many approaches have been tried to enhance drying of the dredged material, and many have been discarded as being ineffective or not practical for large scale application. The methods that have been found to be most effective either in dewatering dredged material or promoting rapid mobilization of conventional equipment after the dredging effort are covered in detail in other publications (6, 7, 8). These methods are briefly described below:

- 1. Preparation of disposal area prior to dredging.
  - a. Install additional spillways to aid dewatering.
  - b. Fill ditches, holes, etc., i.e., level interior of area.
  - c. Raise dike berm above interior of area.
  - d. Subdivide area as appropriate.
  - e. Install underdrains as appropriate.
  - f. Improve site access with ramps outside and inside area and perimeter roads.
- 2. Action after dredging process.
  - a. Keep spillway boards lowered.
  - b. Dig sump in front of spillway.
  - c. Ditch perimeter.
  - d. Ditch interior.
  - e. Construct dike.

The above items are an over-simplification of a complex problem. Dredging and Disposal Area Management are ongoing and dynamic programs. They deserve constant attention; otherwise the program will be set back. For instance, if a disposal area is ignored for one year and the crust not dewatered throughout, it is almost impossible to dewater the material at a future date when it is covered with subsequent lifts.

### Conclusion

Surveys indicate that millions of cubic yards of volume have been regained from the disposal areas in the Charleston District, thus extending their useful life. Had a management program not been initiated, many of the areas now used would have been abandoned for one reason or another. In general the dikes have been improved in terms of stability and detention time of the improved basins. Spillway structures, while still a problem, have been improved in terms of structural integrity and stability. However, no matter how successful a management program is, eventually the areas will be filled to a height that will render them unuseable. Unless some use is found for the material, remote upland sites or ocean disposal will be required in the future.

### References

1. Bartos, Michael J., Jr., Containment Area Management to Promote Natural Dewatering of Fine-Grained Dredged Material, Technical Report D-77-19. U.S. Army Engineer Waterways Experiment Station, Vicksburg, MS.
2. "Best Ways to Dewater Dredged Material," Civil Engineering ASCE, August 1979, p. 57.
3. Ezell, William Bruce, Jr., An Investigation of Physical, Chemical and/or Biological Control of Mosquitoes in Dredged Material Disposal Areas, Technical Report D-78-48. U.S. Army Engineer Waterways Experiment Station, Vicksburg, MS.
4. Ezell, William Bruce, Jr., and Vorgetts, Joseph, Jr., A Study of Structural Modifications of Dredged Material Disposal Sites for Mosquito Control, Contract Report for USAED Charleston.
5. Vorgetts, Joseph, Jr., and Ezell, William Bruce, Jr., Investigation of Comparative Mosquito Breeding in Dredged Material Disposal Sites Used in the Maintenance Dredging of the Atlantic Intracoastal Waterway in South Carolina, Contract Report for USAED Charleston.
6. Kyzer, I. Braxton, Techniques For Installing Underdrains in Fine-Grain Dredged Material, 1978, unpublished paper.
7. Kyzer, I. Braxton and Moebs, Norman, A Cycle of Dewatering and Dike Raising at Waccamaw Point Disposal Area, 1982, unpublished paper.
8. Kyzer, I. Braxton, Management of Dredged Material Disposal Area, Proceedings of the Conference on Dredging, 1984, Vol. 2, p. 802.

BLUE PAPER

FACE ONLY

APPENDIX  
POSTER ABSTRACTS



## Sedimentation in the Baltimore District

by

Robert A. Bank \*

Sedimentation has been a serious problem at several Baltimore District reservoirs. Accumulation rates have far exceeded those projected in the design phase. At Almond Lake, a 38-year-old reservoir project with a 124-acre surface area (conservation pool), water-based recreation has been terminated because the lake has essentially been eliminated by sedimentation. If sedimentation continues at its present rate in Bloomington Lake, a 6-year-old reservoir with a 950-acre surface area (conservation pool), the 100-year storage allocation set aside for sediment will be exceeded in just a few more years. Storage allocation will soon have to be reallocated to account for storage loss. In Cowanesque Lake, observed sediment is accumulating at an apparently excessive rate and has required dredging access channels to boat launch facilities after only 6 years of operation. This paper will examine some sources, problems and possible solutions to the sedimentation in the Baltimore District.

\* Civil Engineer, Water Control Management Section,  
Baltimore District, Corps of Engineers

**A HISTORY OF  
THE NORTH PACIFIC DIVISION'S DISSOLVED GAS  
MONITORING PROGRAM  
IN THE COLUMBIA/SNAKE RIVER BASINS**

by

**Ken Avery\***

Dissolved gas monitoring at selected dams along the Columbia and Lower Snake Rivers began in the mid-to-late 1960's and covers three periods: pre-1970; 1977-1978; and 1979 to present. Different monitoring techniques were used during each period to gather the needed data throughout the fish migration season and to provide the collected information to the interested agencies.

Initial techniques employed to collect the data varied from WEISS Saturometers for direct, very shallow field readings to depth bottle grab samples that were then analyzed in a laboratory for total dissolved, dissolved oxygen and nitrogen plus argon concentrations. Float planes had also been used by National Marine Fishery Services personnel from 1971 to 1976 to acquire the data at selected river sampling stations.

During the 1977 season, the Columbia and Snake Rivers were at record low flows and no dissolved gas monitoring was done for lack of spill. In 1978, the river flows were near normal, but no dissolved gas monitoring was accomplished by the Division.

In early 1979, the Water Management Branch's Water Quality Section was assigned the task of re-establishing the dissolved gas monitoring program. A new type of instrument (Tensionometer) was acquired that could directly measure dissolved gas and water temperatures at various depths from a boat or at a fixed station or from a float aircraft taxiing along the river surface. Original instruments manufactured by COMMON SENSING, INC. of Bainbridge Island, Washington, as well as upgraded models, are now still in use at the monitoring stations.

In October 1984, Tensionometers were first interfaced with SUTRON Data Collection Platforms at selected dams to offer fully automated monitoring facilities utilizing the GOES Satellite data transmission capability. Improved computer programs were also developed to retrieve the data for real-time operational use. Full automation at 11 Corps and two USBR stations (which make up the majority of the present 17 station network) was achieved in 1986.

The Division's dissolved gas monitoring network provides data that are used on a daily basis by the Reservoir Control Center, Fish Passage Center plus other interested parties during the fish migration season. The present system is a very efficient and reliable method of gathering and disseminating dissolved gas and related data that are critical for the operation of a large reservoir system such as the Columbia and Lower Snake Rivers.

\* Hydrologist, Water Management Branch, COE - North Pacific Division

A Conceptual Model for Evaluating Water Quality Impacts  
of Streambank Protection Program

by Russell L. Davidson,<sup>1/</sup>M.S., P.E.

A study was initiated in 1986 to assess the effectiveness of a bank protection program used by the Portland District for the Willamette River Basin, Oregon. This study evaluated future erosion and other impacts on streams and the environment, alternative bank protection methods to lower costs and reduce environmental impacts, and ways of increasing benefits of bank protection. The lower 20 river miles of South Santiam River were chosen as a pilot study area because of the density of revetments, the anadromous fishery, and the active interest of the local project sponsors and their years of river knowledge.

A geographical information system (GIS) was used to compare river features and ground cover, so that rates of change in these parameters could be measured. Maps from 1852 and aerial photography from 1936 provided the most of the data for the study, with field investigations supplementing. Channel locations and 15 classes of land cover were mapped at a scale of 1:12,000. Geomorphic data obtained were the active channel meander belt (locations during the past 130 years); erosion rates; morphologic changes; soil erodibility; and sediment transport rates. Land cover changes, development trends, and rates of vegetative succession were also identified. A historical account of river response to revetments was developed, so that the GIS parameters could be correlated with actual erosion behavior. The cumulative impacts (physical, economic, and environmental) of bank protection were investigated by comparing this information on revetted and unrevetted reaches.

This conceptual model provides a historical account of river response to revetments, a map of erosion risk zones and information on the economic and environmental values of land within the individual risk zones. A better understanding of the physical and environmental effects of bank protection was achieved. This model can be applied to a wide variety of basins. In addition to its application to erosion problems, this methodology may be used to assess effects of streamflow regulation, land development along streams, and changes in fish and wildlife habitat on a basin wide scale.

<sup>1/</sup> Mr. Davidson is a Civil Engineer/ Water Resource Planner in the Planning Division of the Portland District, Corps of Engineers.

BIOACCUMULATION OF CONTAMINANTS FROM BLACK ROCK HARBOR  
SEDIMENT BY NEREIS VIRENS

by

A. Susan Portzer\*

The purpose of this study was to examine the accumulation of contaminants in Nereis virens exposed to Black Rock Harbor (BRH) sediment. Nereis virens, a polychaetous annelid, was exposed to deposited BRH sediment for 36 days in 15 ppt flowing artificial seawater. There were two experimental treatments, a sediment control and a 50 percent concentration of BRH sediment. The 50 percent concentration was chosen because preliminary information indicated that 100 percent BRH sediment was potentially toxic. The 50 percent BRH sediment was prepared by mixing BRH sediment with appropriate amounts of the control sediment. The treatments were duplicated. In each treatment, 60 Nereis were placed in a 110L aquarium containing 20L of deposited sediment and 20L of 15 ppt artificial seawater. A photoperiod of 14 hr L:10 hr D and a temperature of 20 degrees C were maintained throughout the experiment. Tissue samples were taken after 0, 2, 5, 10, 19, and 36 days of exposure. At each sampling interval, 10 Nereis were removed and placed in artificial seawater for 24 hr to allow them to deplete.

During the experiment, Nereis virens accumulated polychlorinated biphenyl (PCB) as Aroclor 1254. Tissue concentration of Aroclor 1254 at 36 days was 9.08 ppm dry wt. Chemical analysis of the BRH sediment showed the presence of PCB that could be quantitated as Aroclor 1242 (1.85 ppm dry wt) and 1254 (8.20ppm dry wt). Steady state was not achieved by day 36.

Chemical analysis of the BRH sediment showed 18 polycyclic aromatic hydrocarbons (PAHs) present, including naphthalene, fluorene, phenanthrene, anthracene, and pyrene. Total PAHs in the sediment was 98 ppm dry wt. The chemical analysis of tissue for PAHs showed that Nereis virens accumulated pyrene, phenanthrene, and anthracene. Accumulation of PAHs increased to a peak at day 19 and decreased rapidly by day 36. Tissue concentration of total PAHs at 36 days was 0.96 ppm dry wt in the 50 percent BRH treatment compared to 0.03 ppm dry wt for the controls.

Trace metals analysis of BRH sediment showed the presence of Fe, Cu, Cr, Zn, Pb, Ni, Cd, As, Ag, and Hg. The trace metals, Cr, Cu, Ni, Ag, Cd, Pb, and Zn were accumulated in the exposed Nereis during the 36 day period, while Hg and As were not.

---

\* Biologist, Environmental Laboratory, U.S. Army Engineer Waterways Experiment Station.

# OPERATIONAL MONITORING OF CONFINED DISPOSAL FACILITIES

## IN HARBORS ALONG THE UPPER GREAT LAKES

by

M. Pam Bedore<sup>1</sup>

Confined Disposal Facilities (CDF's) have been constructed, under Public Law 91-611, to contain contaminated dredged material at 15 harbors within the Detroit District. Water quality monitoring is performed to provide an indication of the environmental effects of our activities and subsequently provide a check on dredging disposal operations to ensure environmental acceptability. The parameters to be monitored are based on sediment data of the channel material. The types of facilities monitored include: (1) CDF's with a weir outflow with impermeable dikes (i.e., with a clay core) and permeable dikes (i.e., rock and sand mixtures or prepared limestone) and (2) CDF's without a weir outflow which have a filtered release. These are generally constructed with a prepared limestone core. Effluent release is through the dike wall itself or through filter cells.

The frequency of monitoring is based mainly on the remaining capacity of the facility and pumping rate of the dredge since these factors are most directly related to retention time and quality of effluent. The duration of disposal and known problem contaminants which must be given specific attention are also used to determine the frequency of testing.

The water quality monitoring stations for a typical permeable dike or impermeable dike with a weir overflow into a lake include: (1) dredge discharge pipe, (2) disposal facility weir overflow, (3) mixing zone and (4) three ambient stations located in a semi-circle 250 feet from the weir discharge. For CDF's located in a river, the ambient stations include an upstream and downstream station located 250 feet from the weir discharge. The example provided was for the Pte. Mouillee CDF, an in-water CDF located off the Pte. Mouillee State Game Area in Western Lake Erie. Dredged material from the Detroit and Rouge Rivers are placed into the Pte. Mouillee CDF.

The water quality monitoring stations for a typical permeable dike without a weir overflow include: (1) dredge discharge, (2) pond water inside CDF near filter cells, (3) monitoring wells located in dike wall, (4) mixing zone and (5) one ambient station located 500 feet lakeward from the filter cells. The example provided was of Kewaunee CDF, an in-water CDF adjacent to shore located in Lake Michigan, Kewaunee, Wisconsin. Dredged material from the Kewaunee Harbor are placed into the Kewaunee CDF.

1. Physical Scientist, U.S. Army Engineer District, Detroit

FIELD TESTING OF LOCALIZED MIXING SYSTEM  
J. PERCY PRIEST LAKE, TENNESSEE

By

1

Robert B. Sneed

The Nashville District experiences a seasonal pattern of poor quality hydropower releases from J. Percy Priest Lake. J. Percy Priest Dam is located within the metropolitan area of Nashville, Tennessee at Stones River Mile 6.8. Hydropower releases made from June through November, when the lake is stratified, are characterized by a low dissolved oxygen concentration, elevated concentrations of iron and manganese, and during the fall a hydrogen sulfide odor. Downstream water users, including the city of Nashville and those as far downstream as Clarksville on the Cumberland River, have experienced taste and odor problems as well as increased treatment costs associated with these releases.

In the spring of 1987, the District's Water Quality Section, with assistance from the Waterways Experiment Station, evaluated various methods of improving the water quality of these hydropower releases. Enhancement techniques were judged on their ability to effectively meet water quality objectives while not impacting other project purposes. Localized mixing was selected for application at J. Percy Priest. Localized mixing is a very simple concept. Good quality surface water is forced down the water column where it mixes with poor quality hypolimnetic water. This results in a dilution of the release and effects a corresponding improvement in downstream water quality. Localized mixing has two characteristics which distinguish it from other approaches. First, it does not disturb the stratification pattern of the lake, possibly creating additional water quality problems. Second, it responds quickly; therefore, such a system would only operate when the turbine is operated and then only during the time of the year when the lake is stratified.

Localized mixing is a developing technology, and as such, there is a shortage of applicable design criteria. In the summer and fall of 1987 the Nashville District field tested a localized mixing system at J. Percy Priest. Three 40 hp downdraft mixers, an off the shelf item commonly used in wastewater treatment plants, were used in the field study. The major objectives of the field investigation were to determine the number of mixers required and where they should be positioned. To accomplish this and satisfy additional concerns approximately 40 different mixer configurations were evaluated during each of three intensive week long testing periods.

1 Hydraulic Engineer, Water Quality Section, U.S. Army Engineer  
District, Nashville

# Studies on the Chemical Reduction of the Selenate Ion in Water

by

Andrew P. Murphy<sup>1</sup>

A previous unknown chemical reaction in which selenate ion is reduced to elemental selenium is the basis of a chemical process to remove selenate from water systems and to control selenate agriculturally. The reaction occurs with ferrous hydroxide under alkaline conditions to produce magnetic iron oxides and hydroxide ion. The reaction stoichiometry is presented. The reaction rate reaches a maximum between pH 8 to 10 and then drops sharply at higher pH. At pH 9, with increasing selenate to ferrous hydroxide ratio, more maghemite rather than magnetite seems to form. At pH 9, with selenite ion and ferrous hydroxide, magnetite and elemental selenium are produced. The reduction of selenite is considerably faster than selenate. The reduction of selenate may proceed on a stepwise fashion to selenite and then to selenium. The reaction appears to be first order with respect to selenate (ca. 0.03 min<sup>-1</sup>). The Gibbs free energy of the selenate reduction reaction is calculated to be -83.2 kcal/mole. The Se<sup>0</sup> remains trapped in the iron oxide.

<sup>1</sup> Chemist

U.S. Bureau of Reclamation  
Denver Federal Center

The Influence of Nitrogen Supersaturation  
on the Ecology of the Bighorn River, Montana

by

Dr. James F. LaBounty<sup>1</sup>

The Bureau of Reclamation is sponsoring investigations of the causes and effects of supersaturation of dissolved gases on the fishery of the Bighorn River downstream of the Yellowtail Afterbay Dam in Montana. Investigations began in 1985 utilizing the talents of the Montana Cooperative Fishery Research Unit. The project is scheduled to be completed in 1989.

The Yellowtail Afterbay Dam serves as a reregulating facility below Yellowtail Dam and Powerplant to provide uniform daily discharges into the Bighorn River. The presence of gas bubble disease in trout below the Afterbay Dam was first documented in 1973. The Bureau and Montana Department of Fish, Wildlife and Parks subsequently concluded that gas entrainment occurs when water passes through gates in the Afterbay Dam, particularly the sluiceway gates. However, they surmised that no practical modifications in the Afterbay operation would preclude gas levels from exceeding 110 percent saturation, the present Environmental Protection Agency criterion for total dissolved gases to protect freshwater aquatic life.

As an example, from February through August 1981, 33 percent and 11 percent of the brown and rainbow trout, respectively, exhibited external symptoms of gas bubble disease. Disease incidence in brown trout during 1981 peaked in June when 72 percent of those captured were affected. Most of the traumatized fish were found in the first 8 kilometers below Afterbay Dam. In fall 1982, the Bureau attempted to solve the problem by installing deflector plates (flip lips) on the face of the dam. However, turbulence resulting from these structures caused rocks to be pulled into the afterbay stilling basin and threatened to erode the base of the dam; because of this, they were removed in July 1983.

Investigations into the many questions of the causes and effects of gas bubble disease are being carried out in the Bighorn River. Results of these investigations should be transferable to other locations where gas bubble disease exists.

<sup>1</sup> U.S. Bureau of Reclamation, Denver Federal Center



Oxidation of Waste Aqueous Formaldehyde Solutions  
to Carbon Dioxide

by

A.P. Murphy, W.J. Boegli, and M.K. Price<sup>1</sup>

Hydrogen peroxide and an iron (ferric chloride) catalyst is used to cause deep oxidation of formaldehyde at ambient temperatures. The oxidation was tested in a bench-scale adiabatic reactor to develop operating curves for several concentrations of formaldehyde and to show the total oxidation time as a function of selected variables. These variables included initial solution temperature, reactant concentration, stirring rate, and the type of purge gas used above the reaction.

The reaction, which proceeds by formic acid production, was shown to be effective in completely oxidizing formaldehyde solutions to carbon dioxide and water (with formaldehyde vapor detected in the product gas stream at less than  $.4 \text{ mg/m}^3$ ) at concentrations at, or greater than, 250 mg/L to carbon dioxide and water. The oxidation was found to be rate rather than mass diffusion controlled and, based on chemical similitude considerations, can be scaled up directly.

<sup>1</sup> Chemist, Civil Engineer, and Chemical Engineer, respectively, U.S. Bureau of Reclamation, Denver Federal Center

The Use of a New Tagging Agent to Identify  
Seeping Problems on Bureau Dams

by

Andrew P. Murphy<sup>1</sup>

Identifying the source of water leaks on Bureau structures can be a difficult task. The use of microtaggents<sup>2</sup> have proved to be a significant improvement over organic dyes, radioactive tags, non-radioactive isotopes, and rare earth metals for either environmental or economic reasons.

These microtaggents are an inert melamine plastic that range in size from 30 to 300 mesh. Originally used to identify explosives, they are purchased in lots of 5 pounds (a 1-gram sample can contain 2.5 million particles), and each lot can be made with its own unique code. This is achieved by having up to 10 layers of different colors on each particle. Since there can be 10 layers with 10 different colors, the number of possible combinations is over a billion since:

$$\text{Number of different lots} = (10 * 9^9)/2$$

The color code is read with the use of a microscope. The particles are nontoxic with a density that can vary from 1.4 to 1.7 g/cm<sup>3</sup>. Since pigments rather than dyes are used to color the layers, long-term stability is anticipated for the particles. The particles used in this study were made magnetic by embedding iron into one of the layers, and a florescent pigment was used for easy identification by UV light. Particle size was 100 and 200 mesh.

These particles were recovered from soils, grouts, cement and water. In addition, a simulated, scale model of a dam was used to recover these particles prior to field tests.

<sup>1</sup> Chemist, U.S. Bureau of Reclamation, Denver Federal Center

<sup>2</sup> The Bureau of Reclamation in no way endorses this product.

UNCLASSIFIED

SECURITY CLASSIFICATION OF THIS PAGE

Form Approved  
OMB No 0704-0188

REPORT DOCUMENTATION PAGE

1a REPORT SECURITY CLASSIFICATION UNCLASSIFIED		1b RESTRICTIVE MARKINGS	
2a SECURITY CLASSIFICATION AUTHORITY		3 DISTRIBUTION AVAILABILITY OF REPORT	
2b DECLASSIFICATION/DOWNGRADING SCHEDULE			
4 PERFORMING ORGANIZATION REPORT NUMBER(S) SEMINAR PROCEEDINGS 18		5 MONITORING ORGANIZATION REPORT NUMBER(S)	
6a NAME OF PERFORMING ORGANIZATION THE HYDROLOGIC ENGINEERING CTR	6b OFFICE SYMBOL (if applicable) CEWRC-HEC	7a NAME OF MONITORING ORGANIZATION	
6c ADDRESS (City, State, and ZIP Code) CORPS OF ENGINEERS 609 SECOND STREET DAVIS, CA 95616		7b ADDRESS (City, State, and ZIP Code)	
8a NAME OF FUNDING, SPONSORING ORGANIZATION HOUSACE	8b OFFICE SYMBOL (if applicable) CEEC-EH-W	9 PROCUREMENT INSTRUMENT IDENTIFICATION NUMBER	
8c ADDRESS (City, State, and ZIP Code) 20 MASSACHUSETTS AVENUE, NW WASHINGTON, D.C. 20314-1000		10 SOURCE OF FUNDING NUMBERS	
		PROGRAM ELEMENT NO	PROJECT NO
		TASK NO	WORK UNIT ACCESSION NO
11 TITLE (Include Security Classification) WATER QUALITY '88 SEMINAR PROCEEDINGS			
12 PERSONAL AUTHOR(S) R. G. WILLEY, Editor			
13a TYPE OF REPORT TECH TRANSFER	13b TIME COVERED FROM 23 FEB TO 25 FEB	14 DATE OF REPORT (Year, Month, Day) MAY 1988	15 PAGE COUNT 424
16 SUPPLEMENTARY NOTATION COLLECTION OF PAPERS PRESENTED AT THE U.S. ARMY CORPS OF ENGINEERS, COMMITTEE ON WATER QUALITY SEMINAR HELD IN CHARLESTON, SOUTH CAROLINA, 23-25 FEBRUARY 1988.			
17 COSATI CODES		18 SUBJECT TERMS (Continue on reverse if necessary and identify by block number)	
FIELD	GROUP	WATER QUALITY, WATER CONTROL, RESERVOIR, RIVERINE, COASTAL, ESTUARINE	
19 ABSTRACT (Continue on reverse if necessary and identify by block number) A COLLECTION OF 37 PAPERS INCLUDING TOPICS ON RESERVOIR AND RIVERINE CASE STUDIES, AND COASTAL AND ESTUARINE CASE STUDIES. ALSO INCLUDED ARE 10 ABSTRACTS REGARDING POSTER SESSION DISPLAYS.			
20 DISTRIBUTION AVAILABILITY OF ABSTRACT <input checked="" type="checkbox"/> UNCLASSIFIED/UNLIMITED <input type="checkbox"/> SAME AS RPT <input type="checkbox"/> DTIC USERS		21 ABSTRACT SECURITY CLASSIFICATION UNCLASSIFIED	
22a NAME OF RESPONSIBLE INDIVIDUAL R. G. WILLEY		22b TELEPHONE (Include Area Code) (916) 551-1748 x46	22c OFFICE SYMBOL CEWRC-HEC

DD Form 1473, JUN 86

Previous editions are obsolete

SECURITY CLASSIFICATION OF THIS PAGE

UNCLASSIFIED

GPO 585-063/89640

END

DATE

FILMED

DTIC

10-88