

ACORN USER

BBC micro, Electron and Atom magazine

May 1983 £1

GRAPHICS: mixing colours
SCHOOLS: language work
PRINTERS: the easy way
BBC: new OS details
ATOM: sound board
BBC: new Basic



MUSIC:
folk, jazz
blues on a
BBC micro



DIY interface box for the Beeb
SCOOP! Electron
£150 hobby micro
revealed

YES IS OUR STOCK ANSWER -



FOR ALL YOUR BBC NEEDS

LVL
LEASLINK VIEWDATA
LIMITED

- * BBC & ACORNSOFT SOFTWARE * BBC BUGGY * DISC DRIVES
- * PRINTERS * JOYSTICKS * MONITORS * BOOKS AND MANUALS
- * GAMES AND PUZZLES * SERVICE * ADVICE

BEST FOR USERS

Acorn and BBC users will find everything they want – and we mean everything – at our Nottingham retail store. For instance we have just been appointed distributors of the BBC Buggy, the clever little mobile featured in the television series “Making the Most of Your Micro” and BBC software. Don’t worry if you can’t get to Nottingham. Just send us a SAE and we will send you a list of dealers, and details of our mail order stock.

NEW! 200K DISK DRIVES

Upgrade your BBC Micro with our new 200K dual disk drive. Designed to fill the gap between the Acorn 100K and 800K disc drives, our 200K unit has already won rave reviews and it’s ready now. It costs £389.00 plus £110.25 for the operating system. To order fill in the coupon below.

BEST FOR DEALERS

As Acorn’s only official distributors we can supply anything you want, as soon as you want it. Ordering Acorn and BBC products through us means quick and efficient service. We are prompt, reliable and offer excellent service back-up.

You will like our credit terms as well.

We can get you any Acorn or BBC product without fuss and by using the official distribution channel you can be sure of a completely safe delivery service.

If you are thinking about becoming an Acorn/BBC dealer talk to us now.

We have just been appointed UK distributor for BBC Software and the BBC Buggy.

COMING SOON – ‘E’ DAY!

Yes it’s almost here, the Acorn Electron, the microcomputer the whole industry’s talking about.

If you are an Acorn/BBC dealer then you will want to be the first when the Electron is launched.

Through us you will guarantee enough Electrons to keep your customers fully satisfied from day one – and keep you one step ahead of your competitors.

Leasalink Viewdata Software are the sole distributors for the Logical program shown on BBC TV as well as Spreadsheet.

LVL
LEASLINK VIEWDATA
LIMITED

Scientific House, Bridge Street, Sandiacre, Nottingham NG10 5BA Tel: 0602 394000

To: Leasalink Viewdata Ltd Scientific House, Bridge Street, Sandiacre, Nottingham NG10 5BA

Please send me

_____ 200K Dual Disc Drive(s) @ £389.00 (inc VAT)

_____ Operating System(s) @ £110.25 (inc VAT) Current Price List Only* FREE

I enclose a Cheque For: £ _____ Please Debit My Access/Barclaycard/Amex

No. _____

Name: _____

Address: _____

Post Code: _____ Day time Tel No: _____

*Please enclose s.a.e. Allow 28 days for delivery.

Cumana drives BBC Micro best!

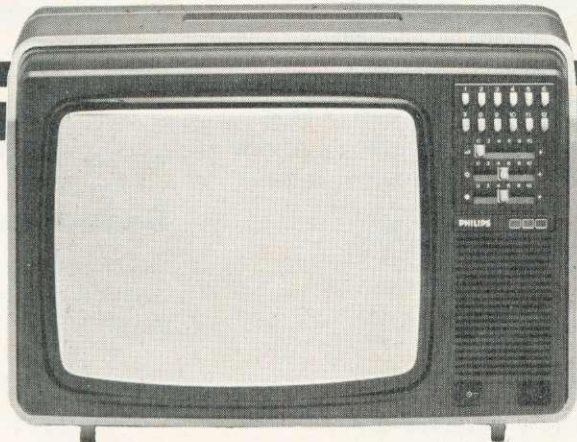

**CUMANA DRIVES +
OWN POWER SUPPLY
= BIG PLUS FOR
BBC MICRO USERS
... JUST FOR
STARTERS**

**... PLUS NO HASSLE
12 MONTH WARRANTY**

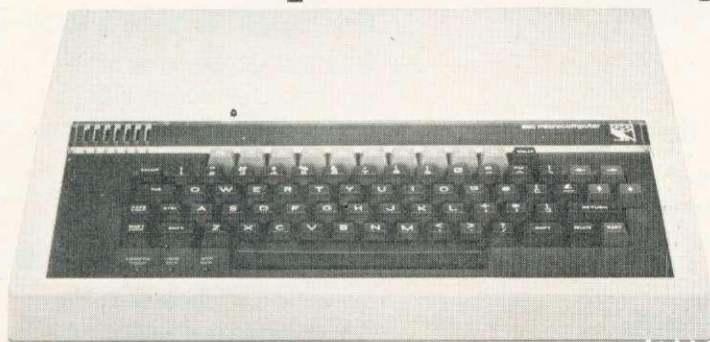

The 'ice on the cake' is that, because the Cumana Drive has its own power supply, it can be used with many other Micros when connected via the appropriate cable. Cumana supply a Drive connecting cable which has a standard 34 way edge connector plus 34 way BBC connector in the same cable length. This allows the Cumana Drive to be connected to numerous makes of micro without the need to change connecting cable. And the Japanese manufactured disk drives are quiet and utterly dependable.

CS50A	Single sided 40 track TEAC drive in a cabinet with own power supply 100K	£199
CD50A	2 single sided 40 track TEAC drives in a cabinet with own power supply 200K	£369
CS50E	Single sided 80 Track TEAC Drive with cabinet and own power supply 200K	£265
CD50E	2 single sided 80 Track TEAC Drives in cabinet with own power supply 400K	£495
CS50F	Double sided 80 Track TEAC Drive with cabinet and own power supply 400K	£345
CD50F	2 double sided 80 Track TEAC Drives with cabinet and own power supply 800K	£619
	2 drive Cable for BBC Micro	£15
	2 drive Cable for BBC Micro plus TRS80, Video, Genie etc.	£18

UPGRADE KITS

A → B £90

CUMANA LTD

Unit 1, The Pines Trading Estate, Broad Street,
GUILDFORD, Surrey. GU3 3BH. Tel: (0483) 503121.
Telex: 859380 CUMANA.

Please add VAT to all prices

**DEALER & EDUCATIONAL ENQUIRIES WELCOME -
GENEROUS DISCOUNTS AVAILABLE**

Special offer to readers on binders

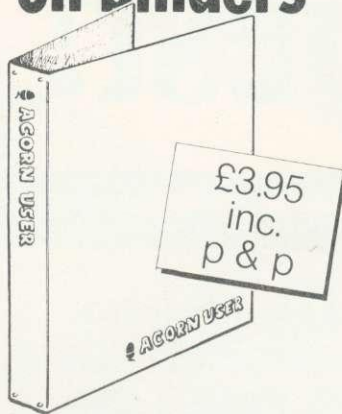

THESE quality binders have been specially commissioned for readers from a major British manufacturer. They are available exclusively through *Acorn User* at an introductory price of £3.95 which includes postage and packing.

So, to keep a year's worth of your favourite magazine in prime condition, send for one of these maroon, simulated leather finish binders. *Acorn User* is printed in gold on the front and spine of each.

Make your cheque payable to Addison-Wesley Publishers Ltd, and send it to BKT (Subscriptions), Douglas Rd, Tonbridge, Kent TN9 2TS.

Include your name and address or use the form in page 92. Allow four weeks for delivery. This offer applies to the UK only.

Also turn to page 92 for details of other reader services—subscriptions, back issues, photocopies and reprints.

MAY 1983
NUMBER TEN

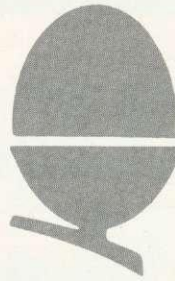

5

EXCLUSIVE: Electron revealed

Others claim to have shown one, now see the real thing.

News that effects YOU

BBC anger at logo misuse, Acorn attack business market, fast tape system, competition results, live BBC TV micro show

11

Basic II

Some deny its existence. We give you the low down.

12

Graphics listings

Tim Fish shows how to generate Lissajou's figures.

14

New *FX calls

Details of commands in new OS1.2 chip.

16

Lightpen revisited

Joe Telford adds to his March article.

19

More colours

Peter Voke explains mixing on a model A and B.

27

Hints and tips

A selection from Joe Telford covering procedures, discs and functions – and more.

35

Musical synthesis

Jim McGregor and Alan Watt analyse jazz, blues, nursery rhymes and folk.

42

Beeb Forum

Retrieving the lost program, beating a dreaded error message in Ian Birnbaum's expert corner.

45

Schools: 8 page pull-out

Heather Govier examines some exciting developments in language work on micros.

53

DIY Beeb interface box

Down to practice with Paul Beverley with a major project.

57

Atom sound board

Rival the Beeb's noises with David Tilston.

67

Reviews

Olivetti's ink-jet printer
Starship command game
Horserace forecast program
Basic with Holmes book

How to submit articles: You are welcome to send articles to the Editor of *Acorn User* for publication. *Acorn User* cannot undertake to return them unless a stamped addressed envelope is enclosed. Articles should be typed or computer written with double line spacing. Black and white photographs or transparencies are also appreciated. If submitting programs a cassette or disc is vital. Payment is £50 per page or pro rata. Please indicate if you have submitted your article elsewhere. Send articles, reviews and information to: The Editor, *Acorn User*, 53 Bedford Square, London WC1B 3DZ.

Subscription Information: Send your cheque or postal order made payable to Addison-Wesley Publishers Ltd to: *Acorn User*, BKT (Subscription Services) Ltd, Douglas Road, Tonbridge, Kent TN9 2TS, England. Tel: (0732) 351216 Telex: 95573

75

Competition

Simon Dally offers software, and speaks out on piracy.

83

A to Z of printing

George Hill takes a step-by-step look at how to get going.

89

Readers' letters

Teletext, sound, EPROMs, TV problems – we provide the answers.

92

Reader services

Subscriptions, back issues, binders, photocopies, reprints: all the facts are here.

95

User groups

Plenty of news this month for clubs

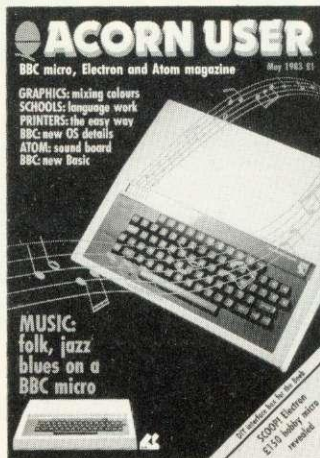

Cover design
by Phil Kanssen
Photo by Malcolm Aird

Editor
Tony Quinn
Editorial Assistant
Kitty Milne
Managing Editor
Jane Fransella
Production
Peter Ansell
Tina Teare
Marketing Manager
Paul Thompson
Promotion Manager
Pat Bitton
Publisher
Stanley Malcolm
Designers and Typesetters
GMGraphics, Harrow Hill
Graphic Designer
Phil Kanssen

Printed in Great Britain
by E.T.Heron & Co. Ltd

Advertising Agents
Computer Marketplace Ltd
20 Orange Street
London WC2H 7ED
01-930 1612

Distributed to the News Trade
by Magnum Distribution Ltd.
72-8 Fleet Street,
London EC4Y 1HY.
Tel: 01-583 0961
Telex: 893340 Magnum G.

Published by
Addison-Wesley Publishers Ltd.
53 Bedford Square,
London WC1B 3DZ
Telephone: 01-631 1636
Telex: 8811948
ISSN: 201-17002 7

©Addison-Wesley
Publishers Ltd 1983

Coming soon in *Acorn User*:

New series: Introduction to programming techniques

Schools: Information technology and syllabus

Atom: Programming forum

BBC: Interrupt handling

Printers: Learn to write your own graphics dump

Interfacing: Using this month's DIY project

Electron: We're going to get one!

Annual subscription rates

UK	£15
Europe	£18
Middle East	£20
The Americas and Africa	£22
Rest of the World	£24

These prices are inclusive of post and packing (air mail overseas) for 12 issues

All rights reserved. No part of this publication may be reproduced without prior written permission of the publisher. The publisher cannot accept any responsibility for claims or errors in articles, programs or advertisements published. The opinions expressed on the pages of this magazine are those of the authors and do not necessarily represent those of the publisher, Acorn Computers Ltd. or Acornsoft Ltd. Acorn, Acornsoft, and the Acorn symbol are the registered trademarks of Acorn Computers Ltd and Acornsoft Ltd.

ACORN USER EXHIBITION

BBC MICRO · ATOM · ELECTRON

Cunard Hotel London W6
25 - 28 August

As you'll have read in last month's *Acorn User*, this year sees the first Acorn User Exhibition to be held at the Cunard International Hotel, Hammersmith, London W6, August 25-28.

You'll find everything you need to make the most of your micro at the Acorn User Exhibition:

- Hardware
- Software
- Add-ons
- Books

And, of course, Acorn User magazine.

Admission will be £2 for adults and £1 for children. If you're a subscriber to the magazine, look out for half-price entry vouchers nearer the time of the show.

Reduced price admission will also be available for school parties. For further details, write to:

John Jones or Susan Phipps
Acorn User Exhibition
20 Orange Street
London WC2H 7ED
Tel: 01-930 1612

Official BBC Dealer

BBC Model B £399

(price includes VAT, Carr. extra £8)

Complete Upgrade Kit **£50**
Installation **£15**
Individual Components also available.
All mating connectors with cables in stock.

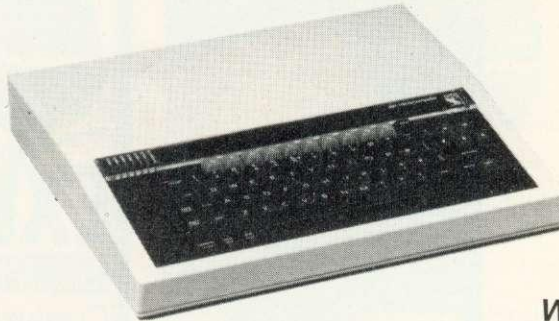

'VIEW' BBC Word Processor ROM	£52
Teletext Adaptor	£196
2nd Processor (6502) + 64K RAM	£170
2nd Processor (Z80) + 64K RAM	£POA

Please Phone to Check Delivery Details on New Add-ons

SEND or PHONE FOR OUR BBC LEAFLET

BBC COMPATIBLE 5¼" DISC DRIVES

These are TEAC mechanism fully compatible with BBC. They are supplied with independent power supply and housed in BBC matching cabinet.

SINGLE DRIVES: 100K **£190** 200K **£255** 400K **£345**
DUAL DRIVE: 200K **£360** 400K **£480** 800K **£610**

Carr. £6/Single drive £8/Dual drive. Disc Cable: Single £8 Dual £12

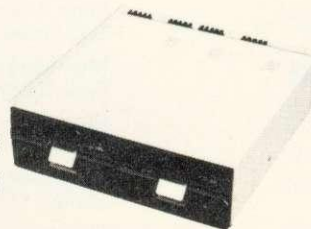

PRINTERS

NEC PC8023 BEC

- 80 Cols. 100 CPS • Proportional Spacing • Hi-Res & Block Graphics
- Bi-directional Logic Seeking • Forward & Reverse Line Feed • International & Greek Alphabet • Auto underline
- Super & Sub Scripts • 2K Built-in buffer

£345 + £8 Carr.



EPSON RX80 & FX80

RX80 100 CPS 80 COL Tractor Feed
FX80 160 CPS 80 COL F& T Feed

- Hi-Res Graphics • Bi Directional Logic Seeking • International Characters
- 32 Print FONTS • Auto underline
- Super & Sub Scripts

MX80 F/T3 **£325 + £8 Carr.**
MX100 F/T **£425 + £10 Carr.**
RX80 F/T3 **£298 + £8 Carr.**
FX80 F/T3 **£420 + £8 Carr.**

Please send SAE for our detailed price list of electronic and computer components

SEIKOSHA GP100A

- 80 Cols. 30 CPS • Self Testing • Hi-Res Graphics • Standard & Double width characters only

£185 + £6 Carr.



MONITORS

Microvitec 1431 14" Colour Monitor **£249 + £8 Carr.**
Microvitec 2031 20" Colour Monitor **£319 + £8 Carr.**

Kaga 12" Colour Monitor RGB **£250 + £8 Carr.**
Kaga 12" Antiglare Green Monitor **£107 + £6 Carr.**
Hi-Res 12" Green Screen Antiglare Monitor **£99 + £6 Carr.**

Sanyo Cassette Recorder **£26.50 + £1.50 Carr.**
Cassette Leads
7 pin DIN 3 jacks **£3.50**
7 pin DIN pin DIN + jack **£4.00**

We carry a wide range of connectors and assemblies, Microprocessors, RAMs, EPROMs, Crystals, etc. Price Lists, Leaflets available on request. Large stocks enable same day despatch on most orders. Special pricing for dealers purchasing in quantity.

BBC DISC SYSTEM
Disc Interface inc. 1.2 operating System **£95** Installation **£20**
BBC Single Drive (100K) **£230 + £6 Carr.**
BBC Dual Drive (800K) **£699 + £6 Carr.**

WIDE RANGE OF SOFTWARE HELD IN STOCK

BOOKS

Basic Programming on BBC **£5.95**
30 HR Basic (NEC) **£5.95**
Let your BBC teach you to Program **£6.95**
BBC Micro Revealed **£7.95**
Assy. Lang. Program on BBC **£8.95**
Program the 6502 **£10.75** 6502 Games **£10.75**
6502 Software Design **£10.50**
(No VAT on Books — £1 p&p/book)

TECHNOMATIC LTD
MAIL ORDERS TO: 17 BURNLEY ROAD, LONDON NW10 1ED
SHOPS AT: 17 BURNLEY ROAD, LONDON NW10
(Tel: 01-452 1500, 01-450 6597. Telex: 922800)
305 EDGWARE ROAD, LONDON W2

PLEASE ADD 40p p&p & 15% VAT
(Export: no VAT, p&p at Cost)

Orders from Government Depts. & Colleges etc. welcome.



Detailed Price List on request.
Stock items are normally by return of post.



Summer launch for Electron

JUNE is the date set for full-scale production of Acorn's new £150 home computer – the Electron.

A major feature of the machine is that its language is BBC Basic, which means it will run most software written for the BBC micro.

Memory provided is the same as the model B – 32k ROM and 32k RAM. The Basic interpreter also includes the BBC machine's powerful 6502 assembler.

As revealed in last October's *Acorn User*, all the Electron's keys will be programmable. Ten are set aside as function keys, while 29 provide single key entry for Basic commands such as CHAIN, LIST, etc. The caps lock key doubles as a function shift to control the programmable keys.

The Electron is really a 'chopped down' BBC micro – and this is reflected in the fact that its processing speed is slower, it does not support the mode 7 screen, has only one sound channel and few interfaces. The changes to BBC Basic are to allow for these hardware differences.

However, a range of add-on modules are planned to provide disc and printer interfaces (Centronics and RS232), the Econet networking system, the Tube for running second processors, the 1 MHz bus interface, teletext, Prestel, and speech synthesis.

Cassette input is at 1200



Acorn's Electron – the first picture to be printed

EXCLUSIVE

baud, and outputs are provided for colour television through the standard aerial socket, composite video, and PAL or RGB monitors.

Power to the Electron comes through a separate transformer which is provided with the machine.

The Electron's casing measures 330x160x50mm, which is about the same width and height as the BBC micro, but less deep. It is, however, a lot stronger than the Beeb's and the same colour. The grid strip on the casing is brown, with cream lettering and green acorn – very Habitat!

The 6502 microprocessor runs at 2MHz (same as the BBC micro) and a real-time

clock is included. The major speed difference will be seen in the high resolution graphics modes (0 to 3). In other display modes the Electron will run at about two-thirds the speed of a BBC micro.

An American TV standard version will undoubtedly be produced. However, Acorn is waiting to see how the BBC micro goes down across the Atlantic first. The Beeb has been modified and is already being tested in the US to meet their safety standards. So far it has been well received in their computer press (see for example *Computing and Electronics*, March issue).

The Electron will be built in Singapore, unlike the BBC micro which is mainly from Britain with overseas sales provided from the Far East.

BBC to get tough over logo misuse

THE BBC has hit out at companies which misuse its logo and is prepared to take legal action to stop the worst offenders.

In letters to computing magazines and advertisers the Corporation warns that use of its logo (the letters BBC inside their distinctive rhomboids) is infringement of copyright and that 'the BBC is not prepared to allow such use'.

BBC solicitor Tom Rivers told *Acorn User* companies had so far been co-operative although he had received no reply from one major culprit. But Mr Rivers was adamant about the BBC's intent to stamp out abuse. 'I am going to stop it', he declared.

This action has been prompted by concern within the BBC that use of its logo implies products have been licensed by the Corporation. However, in most cases this is not so, the letters point out. The BBC feels 'the quality of the products is not acceptable' and is 'keen to impose some form of quality control on the market'.

Application for permission to use the logo should be made to BBC Enterprises.

Entry discount to subscribers

SUBSCRIBERS to *Acorn User* will receive a special £1 discount on entrance to the Acorn User Exhibition in August.

Vouchers to be inserted in a future copy of the magazine will give £1 off the entry fee (adults £2, children £1).

Only one voucher will be issued per subscription, and these will be collected at the door.

The Exhibition is set to provide the first major appearance of the new Acorn Electron, Second Processors and Teletext adaptors.

Bulk discounts on tickets are available to schools for the Exhibition which runs from Thursday August 25 to Sunday August 28.

Details from Acorn User Exhibition, 20 Orange St, London WC2H 7ED.

**ACORN
USER
EXHIBITION**
BBC MICRO · ATOM · ELECTRON
Cunard Hotel London W6
25 - 28 August



Help with Quest

GOOD news for anyone who keeps getting trampled on by elephants in Philosopher's Quest - Acornsoft has released a book of jumbled hints and answers.

The eight page leaflet covers the most popular questions and replaces the old postcard for clues. It is sent to anyone who needs help.

Acornsoft are due to release seven new packs this month - three on chemistry, a programming package called *Microtext*, *Draughts* and *Reversi*, *Starship Command* (see reviews) and another adventure - *Countdown to Doom*.

Acorn means business with '£2000 system'

ACORN is planning to go into business in a big way this year.

Hermann Hauser, joint managing director, told *Acorn User* the company will 'launch a business machine this year for under £2000.'

'The Acorn Business Machine will be based on a BBC micro with Z80 Second Processor' said Hauser. 'It will include two disc drives, integral TV screen and communication facilities - Econet as well as links to the telephone system.'

The expertise and technology to build the ABM has long been available within Acorn, says Hauser. 'It is merely a matter of packaging.'

Meanwhile, Acorn is finalising the CP/M software package for release with the £295 Z80 Second Processor - as revealed in last month's

Hauser says, ABM is only months away as Z80-program pack is finalised

issue.

'The software is aimed at the small business and gives great value for money,' said a spokesman.

'It is pitched at the right level for an introduction to business computing, but expands to give entry to more sophisticated techniques.'

The package covers accounting, productivity and programming. Acorn claims to have 'scoured the world for good software', and to be dealing with market leaders in each sector.

Buying British was one of the original aims, but, says Acorn, software houses were unable to provide the



sort of integrated systems needed.

Reliability checks are being stepped up on the BBC micro now Acorn has two years' experience on the machine. A redesign is also being made to reduce the number of components which will in turn reduce the possibility of things going wrong.

Recent checks were made on the machine's packaging and involved throwing it down the stairs at the company's HQ!

The customer service department has been expanded and Acorn now plan to virtually double their office space to meet expansion in this and other departments.

Small Employers

BEAT THE THURSDAY NIGHT BLUES

with PAYECALC

Payroll, Tax and N.I. package-BBC32K

ONLY
£9.95

Incl p&p.

Pentland Software Ltd
39 Scollon Avenue
Bonnyrigg
Midlothian EH19 3QB



Cassette microdrive for Beeb

IF YOU CAN'T afford a disc drive and interface, but cassettes drive you insane, the *Hobbit* could be the answer.

The *Hobbit* is an automatic digital cassette recorder (rather than acoustic) which plugs into the user port of the BBC micro and is ready to go for £135 plus VAT. It is claimed to be almost as good as a disc system - at half the price. It is up to seven times faster than a normal cassette.

Hobbit uses tiny cassettes,

similar to those used by dictating machines, each with a capacity of 60k per side (disc capacity is 100k for single-sided, single-density). Like discs, cassettes are formatted for easy information retrieval.

An EPROM operating system is supplied which is plugged into a sideways ROM socket alongside the BBC operating system and Basic - the manual gives full instructions. If the thought of fitting the EPROM is too much, the makers, Ikon Computer Products, will fit it.

Existing files or programs can be copied from normal cassettes onto the *Hobbit* either for back-up or to load your favourite games that much faster.

Ikon claim the *Hobbit* is compatible with all versions of the Beeb operating system and it comes with its own leads and cables.

Further details are available from Ikon Computer Products, Kiln Lake, Laugharne, Carmarthen, Dyfed. Tel: (099 421) 515.

Hi-res telly

ELECTRONEQUIP have announced a new 14" TV/monitor which, they say, has better resolution than most other receiver/monitors. It is not a modified TV but a purpose-built unit which can accept RGB or normal TV input. There is also a separate sound input. It costs £210 + VAT. Details from Electronequip, 36-38 West Street, Fareham, Hants. Tel: 0329 230670.



MYSTERIOUS ADVENTURES



FOR BBC MICROCOMPUTER MODELS A & B*

Join the growing band of Adventurers who are enjoying these absorbing and stimulating programs. Step into another world of Fantasy, Magic, Mystery and Sorcery. Only your wits and cunning can ensure success in these scenarios!



● WRITTEN IN ULTRA-FAST MACHINE CODE.

● SAVE GAME FEATURE.

● SPLIT SCREEN DISPLAY.

1. THE GOLDEN BATON — Venture into a strange province of Sorcery and Evil Magic to recover the Golden Baton, a priceless artifact whose powers are said to bring great Health and Prosperity to the Land.
2. THE TIME MACHINE — As a Newspaper reporter you are sent to investigate the eccentric professor who lives in the old house on the Moors. What is his secret and why is his house now deserted?
3. ARROW OF DEATH (Pt. 1) — A blight has fallen on your homelands, the Baton has become tarnished and now radiates a malevolent aura of Evil. Your mission is clear — trace the source of this Evil and destroy... or be destroyed. This is the first part of an Epic Adventure although each part can be played as a stand alone scenario.
4. ARROW OF DEATH (Pt. 2) — You now have the means to destroy your enemy... but you are far from home and this land is strange to you. Can you cope with the deadly perils which approach you and have you the strength to see your mission through to the final conflict?
5. ESCAPE FROM PULSAR 7 — Alone on a gigantic Space-Freighter... The rest of your crew have died horribly at the hands of a mutated Zoo-Specimen. Your only chance of escape is to reach the Frail Shuttlecraft. But the lurking Monster is hungry and you are the only food it has left...
6. CIRCUS — Your Car has run out of Petrol on a lonely road miles from habitation. As you trudge reluctantly down the road in search of help you are suddenly confronted by an amazing sight... in a nearby field is a Huge Circus tent! But this is no ordinary Circus as you will soon discover...
7. FEASIBILITY EXPERIMENT — Far across the gulfs of time and space, a dying race of super-intelligent beings search the Universe for a Hero to save their existence... At length their thoughts turn to planet Earth. You are chosen to be their saviour in a bizarre scenario where death is a mere thought away...
8. THE WIZARD OF AKYRZ — You are in the Royal Palace. The King beseeches you to rescue his daughter from the evil wizard. If you succeed your reward will be priceless... failure will bring certain death.
9. PERSEUS AND ANDROMEDA — Travel into the realms of ancient mythology. Battle with grotesque monsters and supernatural powers as you search for the hidden secrets of myth and legend.
10. TEN LITTLE INDIANS — This mystery begins with a train journey into a strange country. What secrets are held by the strange country mansion? What meaning is attached to the strange idols? Maybe you will find out if you live long enough...

*Adventures 5-10 require 32K RAM

Each adventure comes attractively packaged for just £10.29 inc.

Dealer enquiries welcome

Available soon for ZX SPECTRUM, ZX81 (16K), APPLE II



SEND CHEQUE OR P.O. TO:

DIGITAL FANTASIA DEPT ACU,
24 NORBRECK ROAD, NORBRECK, BLACKPOOL, LANCASHIRE.
Tel: (0253) 56279



BBC programme goes live

Following the success of their latest series 'Making the Most of the Micro' the BBC are planning to put on a live computer programme. The BBC are inviting comments and queries in the series from viewers with and without machines.

The live show will go out on BBC1 on Sunday October 2nd from 11am to 12.55pm with a studio audience. The show will be headed by Ian McNaught-Davis with a panel of experts, including Acorn's John Coll, to answer queries.

If you would like to join the studio audience or put your comments, ideas or questions, write to Micro Special, P.O. Box 7, London W3 6XJ giving your name and daytime phone number.

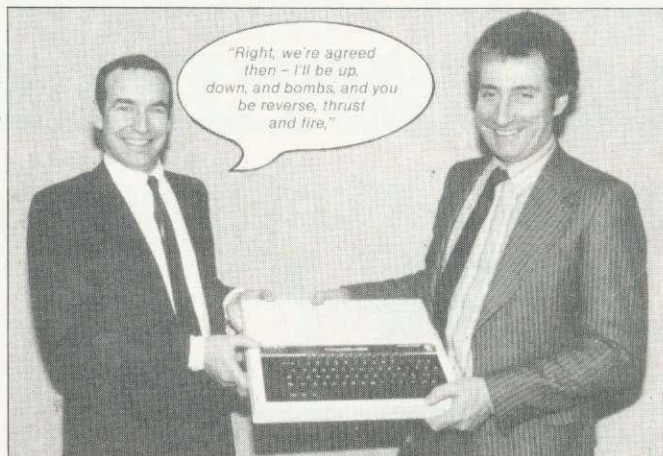

March competition winners

Our winning caption came from Mr P.L. Callan of Oldham, Lancs. Runners up were Mr T. Tugwell of Northampton, Thomas Perry of Barking, J. Olive of Basingstoke and Matthew Healy of Walsall.

We had over 400 entries to our other March competition to find the hidden message. The first correct entry received was from Mr R.B. Hargreaves of Stockport who receives a free subscription. A runners-up prize goes to Ian D. Fildes of Vancouver who sent in his reply by telegram as well as post card! For those still guessing, the message was in morse code on pages 12 and 13 and read 'Checkmate checkmate ha ha'.

Concern in Commons over Computer Education

Education Secretary Sir Keith Joseph's proposals unveiled in a government White Paper, 'Teaching Quality' have one gaping hole . . . there is no mention of computers. The failure to include any reference to computer studies or the proper use of computers in teaching came despite growing Commons criticism that teachers are too often handicapped by inadequate training or lack of suitable software.

The White Paper looks at ways teacher training could be improved and the need for practical experience. But nowhere, throughout the 35-page document, is attention focused on equipping teachers to use micros, either for computer studies or as a teaching aids.

Liberal education spokesman Alan Beith MP describes the White Paper's omission as "very surprising." It was a view echoed by Labour's information technology spokesman John Garrett MP.

Down at the Department of Education and Science it was being pointed out how part of the package to put a micro into every school involves sending two teachers from each secondary school on a special course.

special course. How far this will take the total novice though might be debatable - for the course lasts just four days. Meanwhile many primary schoolteachers are finding themselves with a "Do-It-Yourself" course and a step-by-step manual.

Dol recommends Acorn Econet

The Department of Industry and the Manpower Services Commission have recommended the Acorn Econet for their two hundred Information Technology Centres.

Acorn say that nearly a quarter of the 12,000 BBC micros they sell each month are equipped with Econet interfaces. Most of these go to the education market but other customers include British Telecom, the DHSS, National Physical Laboratories and Gas Boards. As typical networks have around 10 machines, this means that around 250 networking systems are being set up each month.

Software Sales Overseas

British software, as well as British micros, is growing in popularity overseas. One education software house, Chalksoft of Somerset has just announced distributorship for its home and school software for the BBC micro in Australia and Africa. Deals are also pending for several countries in Europe. This is just one more in the increasing number of software companies joining the export drive.

HEXADECIMAL PRESS

Spring Software Sale

Cassettes:

WORDPLAY (BBC Models A & B).....£5.75

Text formatter with: Justification, pagination, 'soft' tabs, centering, word counting, string search, margin control, etc, etc.

PLUS: Subprogram embedding within text, video screen dump, FREE Turtle graphics on demo tape.

WORDPLAY (Acorn Atom, min. 12K RAM).....£5.50

As above, without Turtle graphic routines. Requires Micro-Power 'Toolbox'.

BBC 6502 (UTILITIES).....£4.95

Disassembly, Memory Dump, Trace, etc. The Rolls-Royce of disassemblers. For models A or B.

SPECTRUM Z80 DISASSEMBLER.....£4.95

Disassembly, tracing, debugging facilities, mnemonics for ROM locations, etc.

'SOCCER SIX'.....£4.95

Fast-paced interactive video football game. For BEC model B.

ASTRO-NAVIGATOR.....£4.95

Solar navigation calculations for BBC Models A & B.

These special introductory prices (which include postage, etc.) can only be held till 1st July '83.

Cheque or PO with orders to:

HEXADECIMAL PRESS
23 Torrington Gardens, Bounds Green
London N11 2AB

N.B. Logarithmic discount scale for multiple orders. Write for details.

Salamander Software PRESENTS

EDG GRAPHICS PACKAGE

Salamander Software has recently obtained sole U.K. marketing rights to a sophisticated graphics package for use with the BBC Model B microcomputer. The package was developed by a firm of consultants and design engineers to the oil and utility industries for in-house use, and has now been assembled in commercial form for applications in the home, business and schools.

The package consists of an advanced picture drawing system controlled entirely by normal keyboard input and using cassette tapes for software and picture storage, so that no additional hardware is required.

THE MAIN SYSTEM FEATURES ARE:

- * Picture drawing in mode 0, 1 or 2
- * Actual and Logical colour changes at any time
- * Drawing functions include lines, boxes, circles, arcs, text and shape repetition
- * Drawing aids include grid, elastic band, save and home cursor (5 positions)
- * Colour fill
- * Text window showing X, Y cursor position, length, angle, colour menu and current colour
- * Saving and loading of pictures using cassette tapes
- * Multi file picture
- * Flashing crosshairs cursor
- * User instructions/prompts
- * Spiral bound manual

PRICE £24.95 inc VAT

Available from:

Salamander Software
27 Ditchling Rise
Brighton
East Sussex
BN1 4QL

or ask at your local Acorn dealer
Trade enquiries: Tel: B'ton (0273) 771942

Send stamped s.a.e. for full catalogue



Eltec HOME & BUSINESS TECHNOLOGY computers

Probably the widest selection of software available by mail order.

All the top manufacturers including Acorn Soft, IJK (Sinclair), Superior Software, Bug Byte, Program Power, Hessel, Procyon.

HERE IS A SELECTION

Peeko Computer	9.95
Junior Maths Pack	6.84
Philosopher's Quest	9.95
Planetoid	9.95
Meteors	9.95
Arcadians	9.95
Swoop	7.99
Chess Model B	7.99
Space Invaders Model B The best	6.95
Atlantis — Superb fast Action 32K	6.95
Hyperdrive 32K	5.95
Stratobomber	6.95

Send SAE for full list.

HARDWARE EXPANSION

Sound pick-off module (simple to fit)	6.95
Amplifier and loudspeaker suitable for above	37.50
Light pen	34.50
X-Y digitiser	80.00

SUPER ACCESSORIES

Cover Polyester Cotton	3.97
Cover Soft PVC	4.45
Carrying Case for Computer, Cables, Cassette/ Disc Drive	55.20
Carrying Case a soft supported nylon version of above	23.00

**BBC models A & B in stock:
A - £299 B - £399**

DISK DRIVES FOR BBC

BBC 100K Single drive (Requires discs (a))	265.00
TORCH Z80 800K Disc pack includes Z80 proc'r + 64K (b)	897.00
BBC/LVL 200K Twin Drive (a)	397.00
TEAC 200K Single Drive (a)	304.75
TEAC 400K Twin Drive (a)	569.25
TEAC 400K Single Drive (b)	396.75
TEAC 800K Twin Drive (b)	711.85
Connecting cable for TEAC drives	17.25
(a) SCOTCH Single sided discs Box of 10	28.75
(b) SCOTCH Double sided discs Box of 10	39.80

BBC UPGRADES

Full upgrade kit (fitting £31.00)	69.00
Disc interface (fitting £15.00)	109.25

The above prices are VAT inclusive. Add £1.00 p&p for orders below £100.00 and £10.00 (Securicor delivery) for orders above £100.00. Access and Barclaycard accepted on all items except BBC computers.

ELTEC COMPUTERS AU
217 Manningham Lane, Bradford, BD8 7HH.
Tel (0274) 722512.

MICROAGE ELECTRONICS FOR THE BEST DEAL ON BBC MICRO DISK DRIVES

Microage of Edware - Acorn's largest dealer - now bring you the most powerful range of disk drives for your BBC Microsystem B*

- A BBC Compatible Single drive (100K) - £235
- B BBC Single drive (100K) - £269
- C BBC compatible Dual drives (200K) - £389
- D BBC compatible slimline Single drive (400K) - £399
- E BBC compatible slimline Dual drive (800K) - £799
- F BBC Disk Interface (inc 1.2 ROM & fitting 24 hrs) - £95

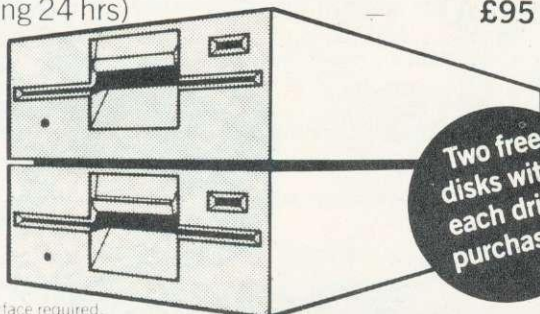

Disk Interface required.

Two free disks with each drive purchased.

Dealer and Institutional Orders Welcomed.

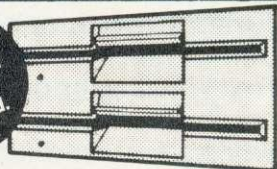

Free courier delivery to your door.

All drives are fully compatible with the BBC Micro and are complete with full manual, utility disk and connecting cables. Remember these are top quality products manufactured by TEAC and Mitsubishi. All prices include VAT.

Open Mon-Sat 9.15-6.00 Thurs 9.15-1.00 Send this coupon in to obtain a 5% discount on all products (excluding B & F).

To: Microage Electronics, 135 Hale Lane, Edware Middlesex HA8 9QP AU5

Please send me qty. A B C D E F
at total cost of £ _____ I enclose cheque no: _____

Or debit my Access/Barclaycard No. _____

Signature _____
Name _____
Address _____
Postcode _____ Telephone _____

MICROAGE ELECTRONICS

135 HALE LANE EDWARE MIDDLESEX HA8 9QP TEL: 01-959 7119 TELEX 881 3241

LOW-DOWN ON NEW BASIC

IN, the new version of Basic, Acorn's programmers have put right a number of rather obscure errors they discovered in Basic I, and have also added some features. Most of the errors are fairly obscure, and will not even have been noticed.

Apart from the errors which have been corrected, the LN and LOG functions have been recoded to make them more accurate.

The new functions include OSCLI, which stands for operating system command line interpreter. The idea is that from Basic it is impossible to use a command line that contains a Basic variable. For example, you cannot say *FX5,X% where X% has some particular value. This is because as soon as Basic meets the * it passes the whole of the rest of the line to the command line interpreter, and the command line interpreter does not understand X% since it is a Basic variable. You cannot even say:

```
*FX5,2 : REM Serial printer
```

as the colon is specific to Basic.

What OSCLI does then is to say pass the string which follows (in brackets) to the command line interpreter. The examples below shows how to use OSCLI with a variable by turning the variable into a string, concatenating it with the rest of the command, and then passing them to the command line interpreter.

The second useful new feature is the keyword OPENUP, for updating disc files. Previously, the file had to be opened using OPENIN to read data from it, and then

Despite doubts aired about its existence in some magazines, Acorn has released a second BBC Basic.

The differences are, however, minor. Here, Paul Beverley covers the major changes.

closed, before it could again be opened using OPENOUT to write to it. To read more data, the file had to be closed and re-opened again using OPENIN. This made random access filing tedious and slow.

OPENUP allows users to read and write to the same file without having to close it and re-open it every time. Program 1 creates a file using OPENOUT and allows you to look at individual items of data and change them.

However, OPENUP cannot extend a file. The way to do that is to OPENIN the file, OPENOUT another filename, and copy it all across the old file to new and add the extra data.

The third feature is handy for putting machine code programs in EPROM in the sideways ROM sockets. The idea is that when assembling a machine code program you continue to use P% as the program counter but use O% to

specify where the code should be stored. For example, suppose you want to assemble code for use in a sideways ROM at &8000 and you want to put the code temporarily at memory location &3000 upwards from where it can be transferred into the EPROM. You will need to set O% = &3000, but P% should be set as &8000 - the actual execution address of the code.

To make this compatible with the original arrangement (where P% was used for both the program counter and the origin at which the code was to be stored), OPT is used. The first two bits of the OPT command (ie OPT 0-3) determine whether a listing is produced and/or errors are reported. The third bit is now used to determine whether O% and P% are separate (if the bit is set to 1) or linked (if the bit is cleared to 0). Thus OPTs 0-3 work as before with P% acting as program counter and origin, while OPTs 4-7 should be used when the code is to be stored at a place other than where it is to be executed.

Program 2 illustrates this. Using OPTs '4 TO 7 STEP 3' gives the two pass assembly with listing and errors reported only on the second pass. As the program is assembled, the addresses used are in the &8000 range, but if you examine memory locations &3000 onwards, you will find the assembled codes.

● The new Basic ROM is already going out in machines and will be available from dealers. To discover which you have, type REPORT. A copyright line will result. BBC Basic II is dated 1982.

```
10 X = OPENOUT("DATA")
20 FOR NZ = 1 TO 100
30 PRINT# X, NZ
40 NEXT
50 CLOSE# X
60
70 X = OPENUP("DATA")
80 REPEAT
90 INPUT "Number of data item to be changed", NZ
100 IF NZ = 0 GOTO170
110 PTR# X = (NZ - 1) * 5 :
    REM Set pointer to data item
120 INPUT# X, R% :
    REM Pointer moves on by five bytes
    PTR# X = PTR# X + 5 :
    REM So move pointer back by five bytes
140 PRINT"The current value is "; R%
150 INPUT "New value", D%
160 PRINT# X, D%
170 UNTIL NZ = 0
180 CLOSE# X
190 END
```

Program 1. Creates file using OPENOUT

```
INPUT "Serial or Parallel Printer", A#
IF ASC(A#) = 80 THEN X% = 1 ELSE X% = 2
OSCLI("FX 5," + STR$(X%))
```

```
10 DIM CODE 100
20 FOR NZ = 4 TO 7 STEP 3
30 O% = CODE
40 P% = &8000
50 [ OPT NZ
60 .start
70 LDA# 33
80 JSR &FFEE
90 JMP start
100 \ etc
110 ]
120 NEXT NZ
>RUN
8000 .start
8000 LDA# 33
8002 20 EE FF JSR &FFEE
8005 4C 00 80 JMP start
8008 \ etc
>P. ~ ? &3000
A9
>P. ~ ? &3000
21
>P. ~ ? &3000
20
```

Program 2. Uses temporary memory location



LOOPY GRAPHICS

THIS short program by Tim Fish for the BBC micro produces the well-known Lissajou figures in mode 2. Type in the listing, type RUN and press return. The program then asks you to input a phase number. Numbers which are simple divisors of 360, eg 45, 90, 180, 270, will produce simple patterns. Values slightly higher than these, eg 271,

180.2 are most attractive.

As listed it will run on a BBC model B. For model A change mode 2 to mode 5 at the start of line 130 and change line 250 to:

```
c=c+1:IF c=4 THEN c=1
```

Pressing any key will stop the display, except R which will restart the pattern.

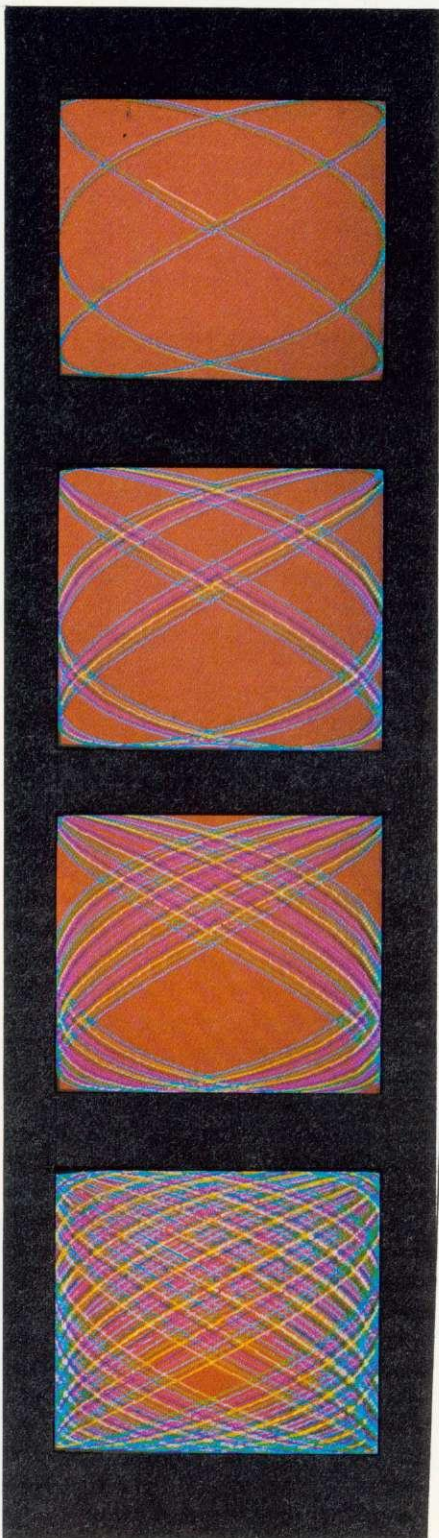

Photos: Pam Fish

```

10 REM ** Lissajou **
20 REM ** (c) Tim Fish **
30 MODE6:IFC%=-1THEN40ELSEPROCCPYRT:CY=-1
40 c=1:CLS:C=0:COLOUR128
50 PRINT"Enter Phase (0-360)";
60 INPUTDY:IFDY<0ORDY>360THENPRINT"0-360"
:GOTO60
70 B=RND(6)
80 DY=DY/360
90 C=C+1:IFDY*C-INT(DY*C)>.1THEN90
100 CX=0:CY=0:DX=1:c=RND(6):IFc=B THEN100
110 REM **Change to Mode 5 next line**
120 REM **if you have a model A**
130 MODE2:MOVE640,512:VDU19,0,B,0,0,0
140 GCOLOR,c
150 VDU23,1,0;0;0;0;
160 VDU29,640;512;
170 FORRPT=1TOC
180   FORCX=0TO360STEP6:CY=CY+DY*B
190     X=SIN(RAD(CX))*639:Y=SIN(RAD(CY))
200     DRAW X,Y
210     IFINKEY(0)X<-1THENIFGET$="R"
THENRUN
220     NEXT:NEXT
230 REM **Change next line for model A**
240 REM **to read "c=c+1:IFc=4THENC=1"**
250 c=c+1:IFc=7THENC=1
260 IFc=B THEN250
270 GCOLOR,c
280 GOTO170
290 IFGET<>-1THEN40
300 DEFPROCCPYRT
310 PRINTTAB(0,24)"Press any key":X=GET
320 ENDPROC

```

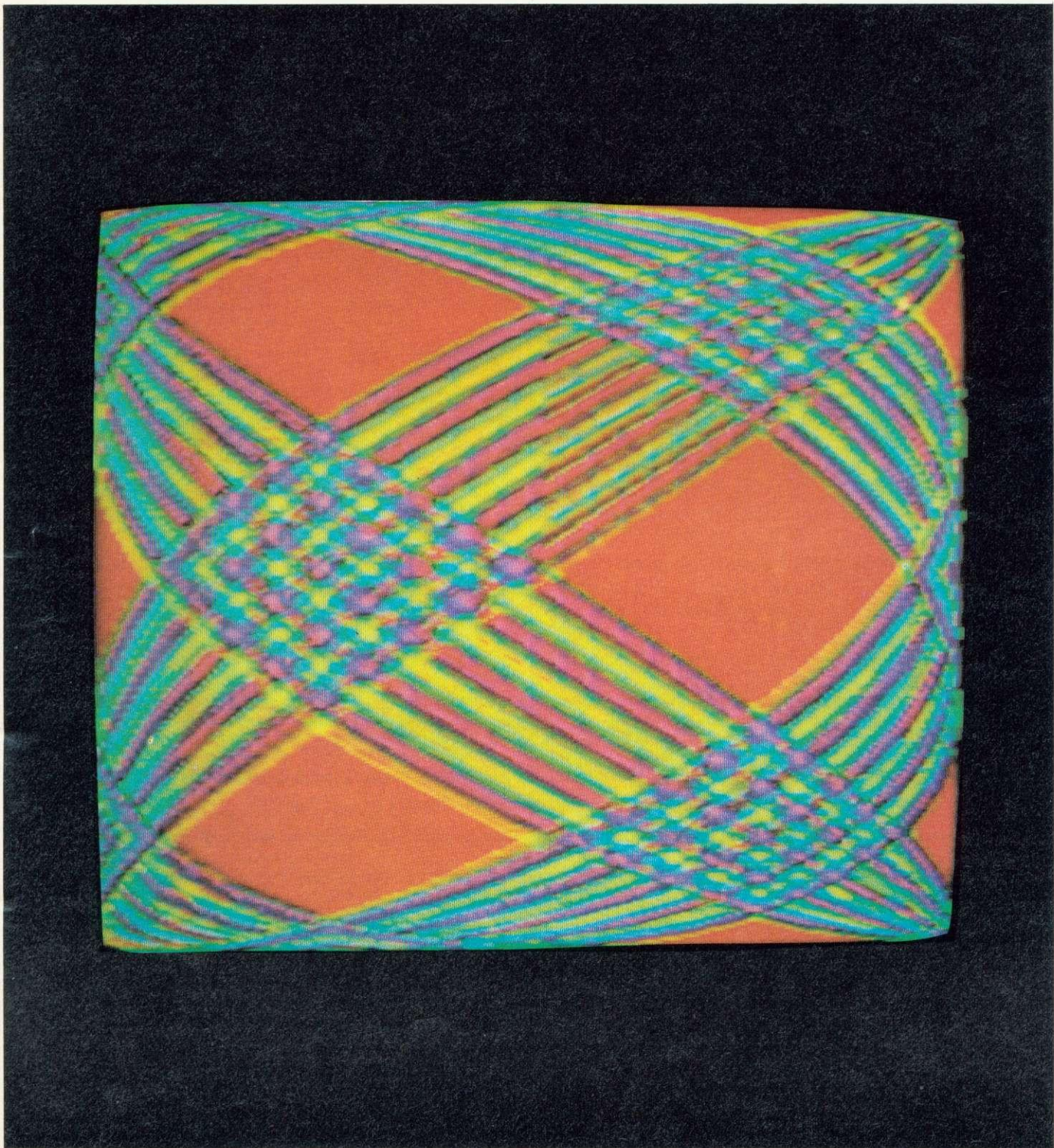
THIS list of *FX/OSBYTE calls reached Acorn User from Acorn. Most are undocumented in the BBC micro User Guide (page 501) and are all implemented in the Series One operating system.

Decimal Hex(&) Function

- *FX 13 0D Two parameters may be supplied in X to disable events (*User Guide* p465):
X = 7 disable RS423 receive error event
X = 8 disable service/network error event
- *FX 14 0E As above, but parameters enable events
- *FX 117 75 Returns the VDU status byte (which contains various status flags in the X register.
Bit 0 - set if VDU2 sent, cleared by VDU3
Bit 2 - set if paged mode on, cleared if off
Bit 3 - set if software scrolling, cleared if hardware scrolling

Software scrolling is used when text windows have been defined whereas hardware scrolls are used when the whole screen scrolls
Bit 5 - set when cursors joined by VDU5
Bit 7 - set if VDU disabled
- *FX 118 76 Returns with the carry bit set if the CTRL key is pressed, and with the negative bit set if the SHIFT key is pressed. Machine code routines may branch on these conditions.
- *FX 123 7B This call is used by the user print routine to indicate to the MOS it has finished its task (cf *FX 5,3 command).
- *FX 138 8A This call has been expanded to allow a character to be inserted into any buffer. X must contain the buffer number, and Y the character to be inserted. A list of buffer numbers appears with *FX 21 (*User Guide* p428).
- *FX 141 8D Exactly equivalent to *ROM
- *FX 152 98 This call examines a buffer. The buffer number must be in X, and the call returns as follows:
Carry bit set if buffer empty
Carry bit clear indicates character(s) present in buffer.
Y contains the next character which will be returned if the buffer is read. Character in Y has not actually been removed from the buffer).
- *FX 153 99 Inserts a character into an input buffer handling the interrupt character, generating an escape condition if necessary. Valid only for X = 0 or 1. Y must contain character to be inserted.
- *FX 156 9C Change 6850 control register. The 6850 is altered to: (Old value AND Y) EOR X (*User Guide* p438). Refer to 6850 data sheet.
- *FX 158 9E Respectively read and write to the speech processor chip.
- *FX 159 9F
- *FX 233 E9 As for &E7 (*User Guide* p441) but affects the system 6522. The system 6522 is used extensively in the normal operation of the micro. *This call should be used with extreme care.*
- *FX 235 EB Return presence of speech processor:
X = &FF if present, &00 if not.
- *FX 241 F1 Read/Write *FX 1 value (*User Guide* p438)
- *FX 245 F5 Read/Write *FX 5 value (*User Guide* p438)
- *FX 246 F6 Read/Write *FX 6 value (*User Guide* p438)
- *FX 252 FC Reads identity of current language (a number from 0 to 15). This indicates which socket the presently selected language ROM is in. The sockets are numbered from right to left starting at 15. On board sockets are 15, 14, 13 and 12: the remainder can be installed offboard.
- *FX 253 FD Returns a number indicating what sort of reset last occurred: 0 = soft break; 1 = power-on break; 2 = CTRL break
- *FX 254 FE Read/Write RAM: 128 = 32k, 64 = 16k
- *FX 255 FF Read/Write start-up option byte. This allows the keyboard link value to be read. It may be written to, but the value will be reset to the actual wired value on any reset other than a soft-reset. The links are configured as follows:
1 2 3 4 5 6 7 8
X D₂ D₁ B M₃ M₂ M₁
D₂, D₁: disc configuration bits (see Disc Manual)
B: auto-boot select (auto-boot when fitted)
M₃, M₂, M₁: screen mode on hard reset (0-7)
X: unused

C.J.E. Microcomputers

BBC Specialists

VAT Included where applicable

Quality Disk Drives

Single drive 40 track single sided 1 x 100k	£210.00
Dual drive 40 track single sided 2 x 100k	£350.00
Dual drive 40 track double sided 2 x 200k	£546.25
Dual drive 80 track double sided 2 x 400k	£799.25

All drives are cased with own PSU for reliability, and include connecting cables and utilities disk. Delivery £4.00

Software for the BBC Micro

MISSILE CONTROL the first implementation on the BBC Micro of the popular arcade game. (32K)	£9.00
MAZE MAN an authentic version of the popular arcade game. (32K)	£6.00
BALLOONS a highly original game that soon becomes compulsive playing. (32K)	£6.00
DISSASSEMBLER the memory dump routine includes a scrolling back in memory facility. (16K)	£5.00

MISSILE CONTROL, MAZE MAN and BALLOONS use the Keyboard or Joysticks for control

30+ Programs for the BBC Microcomputer

This Book contains program listings, with explanations and tips on using the BBC Micro

GAMES UTILITIES GRAPHICS and MUSIC
Most programs will run on Model's A and B
Edited by C. J. Evans, various Authors.

A pair of cassettes with all the programs is available.

BOOK	£5.00
BOOK and CASSETTE SET	£9.00

LEADS

The BBC Micro comes without a cassette lead

7Pin Din to 2 x 3.5mm and 1 x 2.5mm minijacks	£4.00
7Pin Din to 5Pin Din and 2.5mm minijack	£4.00
7Pin Din to 7Pin Din	£4.00
7Pin Din PLUGS	Two for £0.65
6Pin Din PLUGS (for RGB socket)	Two for £0.65
5Pin Din PLUGS (360' for RS232)	Two for £0.65
RS423 TO RS423 (BBC Micro to BBC Micro)	
Two metre cable £4.00 Four metre cable £5.00	
TELEVISION/MONITOR LEADS full range available	
Phono plug to Co-ax with high quality cable 3 Metres	£3.00
BNC Plug to BNC Plug	£3.10
BNC Plug to Phone plug (i.e. BBC Micro to Rediffusion TVRM)	£2.20
RGB 6PIN DIN to 6PIN DIN	1 metre £4.00 2 metre £5.00

PRINTER CABLES

BBC to 36 way Centronics Type connector	£17.50
BBC to 25 way D Type (For use with RS232)	£ 9.50
BBC to 40 way edge connector (Centronics 739)	£20.00
TORCH to 36 way Centronics Type connector	£20.00

Blank C30 Computer Cassettes

Ten for £4.50
15 Way D Type Plug with Cover £2.75
Computer graphics design pads 100 sheets £4.00

BBC Upgrade Kits

RAM UPGRADE (100ns)	£23.00
KIT A Printer and I/O Port	£ 9.50
KIT B Analogue Port	£ 8.00
KIT C Serial I/O and RGB	£10.00
KIT D Expansion Bus/Tube	£ 8.00
Full Upgrade kit	£60.00

All components full specification

STAR DP8480 PRINTER From £250.00 Inc VAT

80 CPS : 80/96/132 COLS BIDIRECTIONAL LOGIC SEEKING TRACTOR WITH FRICTION FEED	
CENTRONICS £17.39 + £32.61 VAT = £250.00	
RS232 £235.00 + £35.25 VAT = £270.25	
High Res Graphics option to allow BBC Screen dumps £15.00/£20.00 (24HR SECURICOR DELIVERY FOR PRINTERS £8.00)	

VAT Included where applicable

Send SAE for full Price List of our large range of accessories.

C.J.E. POSTAGE Add 50p per order or as stated
Dept (AU), 25 HENRY AVE, RUSTINGTON,
W.SUSSEX. BN16 2PA (09062) 6647

Microcomputers

Available now

Full instructions supplied

MICROVOC — the Sound System for the BBC Micro

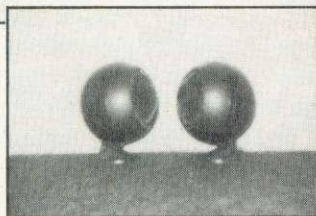

Yes it's here. A complete sound system for the BBC Micro, realistically priced at £21 (inc VAT) plus £1.50 post and packaging.

Microvoc is a complete sound system designed specifically for the BBC Micro, capable of use with either speech synthesis or computer produced music.

Using the BBC Micro's own power, Micro-

voc can literally fill the average sized room with a quality of sound you may not have believed possible.

Supplied with robust, ultra modern, spherical speakers which can be free standing, to complement the BBC machine, or fixed to the wall, or indeed out of sight on the underside of your desk, Microvoc brings out the true quality of the BBC Micro's sound facilities.

The external speakers can be disconnected at will leaving Microvoc's volume control to operate the internal speaker of the BBC Micro.

OUR GUARANTEE

None of the original components of the BBC Micro, including the cabinet need to be modified in any way to install Microvoc

Our prime concern whilst designing Microvoc was to ensure that your BBC Micro warranty would remain unaffected.

Microvoc can easily be fitted in five minutes and requires no drilling, soldering, or any technical expertise whatsoever. It can just as easily be removed, leaving your BBC Micro in its original condition.

Microvoc simply plugs into the existing fittings on the BBC Micro and makes use of the

'Reset' and 'Econet' apertures at the rear of the machine.

If your BBC Micro suffers from the infuriating 'Buzz' then you will also need 'Buzzgo'. Buzzgo simply plugs into the 1Mhz Bus to eliminate the infernal buzz. If purchased with Microvoc, Buzzgo costs an additional £2 (inc VAT). For separate purchases Buzzgo costs £3.50 (inclusive).

MICRO-ADVENT (A subsidiary of Advent)

Ashlyn House, 113 Writtle Road, Chelmsford, Essex

Opening hours: 9.30 a.m.-3.30 p.m. Monday-Friday. Telephone 0245 59708



Joe Telford corrects his design in March's *Acorn User*, and explains how to use the pin photodiode and Schmitt receiver

LIGHTPEN CHANGES

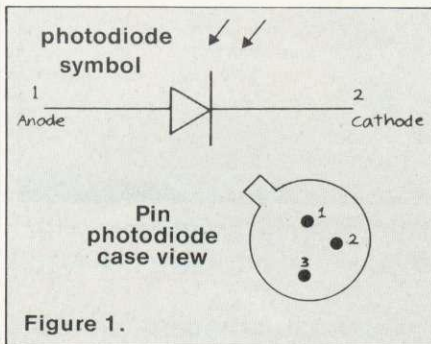

Figure 1.

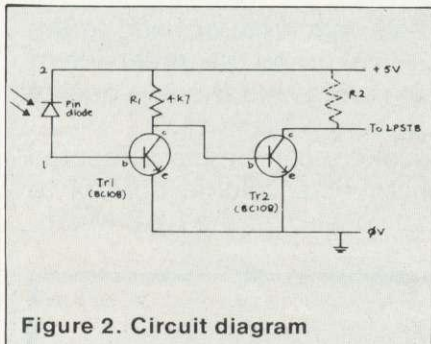

Figure 2. Circuit diagram

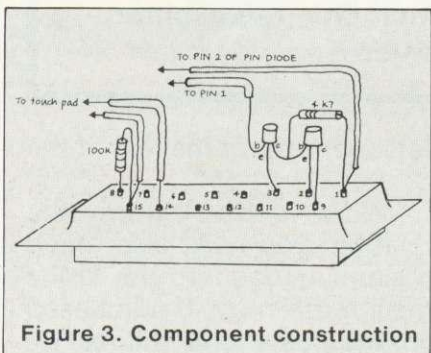

Figure 3. Component construction

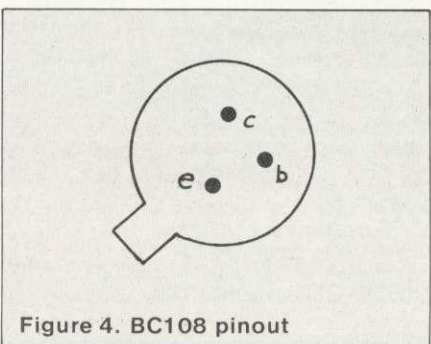

Figure 4. BC108 pinout

THE lightpen article in the March issue of *Acorn User* caused a good deal of comment. The final circuit shown incorporated a pin photodiode which does not operate in the circuit given – although a few minor alterations allow it to do so.

Adventures with the lightpen began back in September, and the initial circuit relied on the photodiode. However, to improve on development time, and cut down the component count, the later circuit used a different device – the Schmitt receiver, RS part number 303 270. Unfortunately, the final text was written five months later, and unwittingly referred to the incorrect device.

For readers who have not invested in the lightpen yet and wish to do so, the simplest approach is to use the Schmitt receiver, in the March circuit as the pin numbers are exactly compatible. For readers having difficulty ordering from RS, most High Street TV repair/hi-fi shops can order it.

If you have bought a pin photodiode, there is no need to worry, because for an extra 50p or so, it will work.

Figure 1 shows the pin photodiode as an electronic symbol and from the viewpoint of the casing connections. If we connect pin 2 to +5V, the diode will conduct when illuminated. It has an extremely fast response time, but the TV screen is not bright enough to give a pulse the CRTC can detect. We need to amplify the pulse from the pin photodiode. Probably the easiest approach is to use a couple of transistors to provide the necessary signal. Figure 2 is such a circuit suggested by Mr M. Lee of Cheshire.

Tr2 is normally conducting because its base is held at +5V by resistor 1. This means the full 5V is

developed across R2, a resistance normally tying LPSTB on the CRTC to +5V. This effectively means that the LPSTB input is pulled to 0 when the diode isn't illuminated. Once the diode is illuminated by a TV screen, it will begin conducting, and hence Tr1 will turn on. This places zero potential on the collector of Tr1, which effectively switches off Tr2. The LPSTB input is then pulled back to 5V.

This change of state can be detected by the CRTC and the software provided in the March issue will calculate the position of the pen on the screen, although the offset values may vary because of the components used, and readers may find a little experimentation necessary, though Mr Lee has found that three such pens have worked perfectly. The normal approach to adding extra components would be to include them in an interfacing box, but they are small enough to be mounted directly onto the D connector.

Readers wishing to do this may find figures 3 and 4 useful, but should remember that too much heat will destroy the transistors. In addition, the leads may need to be protected against shorting, especially if the connector cover is metallic. Figure 4 is the pinout of the BC108 transistor Mr Lee has used.

The final connection to the pin photodiode is shown in figure 3 and readers must remember to connect pin 2 of the diode to +5V and pin 1 to the base of Tr1.

Assuming the photodiode is already available the extra components needed are: R1, 4k7 resistor 1/8th watt 10%, about 5p; Tr1, Tr2 BC108 transistors, 20p each.

The circuit will react to the brightness of the TV screen which may need adjusting. Mr. Lee has found the accuracy of his circuit to be approximately plus or minus one pixel, and so amending program 3 in the March issue by changing line 40 to:

40 x=20:y=15

will help set the accuracy of the pen, which is partly dependant on brightness.

Our thanks to dealers and RS Components for handling enquiries about the March article.

Come to

MICROAGE ELECTRONICS

NEWSFLASH
we are now

ORIC!

hardware and software dealers

*** BBC + Disk Interface, 800k Disk Drive, Word Processing ROM, Epson Printer, Dust covers for all units, Basic Programming Book, Cassette lead, Paper & Cable.**
Normal Price £1748.80
Our Price £1599.00
Saving **£149.80** **FREE COURIER**

ACORNSOFT FOR BBC

*Snapper, *Planetoid, *Monsters, *Rocket Raid, *Meteor, *Super Invaders, Philosophers Quest, Sphinx Adventure, Arcadians, Lisp Cassette, Peeko Computer, Creative Graphics Tape, Graphs and Charts Tape, Desk Diary, Arcade Action, View (on ROM) and Printer Drive Cassette.

Available on Disk.

All Acornsoft at £9.95 each, except Arcade Action (£11.90), Lisp (£16.85), View and Printer Drive (£69.90), Wordwise word Processing ROM (£46.00) + £2.00 p+p.

Only a selection of Acornsoft available.

Drawn to scale.

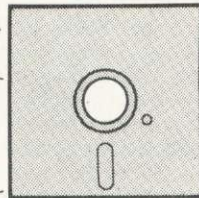
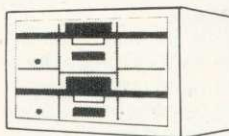

BBC compact, slimline Disk Drive.

BBC MACHINES

Model A, 32K RAM & 6522 Chip	£329.00
Model B	£399.00
Model B + Disk Interface	£494.00
BBC Dust Covers	£3.95
BBC Compatible Single Disk Drive* (100K)	£235.00
BBC Compatible Dual Disk Drive* (200K)	£389.00
BBC Dual Slimline Disk Drive* (Double Sided & Density 800K)	£799.00
Verbatim Single Sided Diskettes 10 for	£22.50
Verbatim Double Sided Diskettes 10 for	£39.95
Let us fit a disk interface in 24hrs	£95.00
RH Electronics colour light pen	£37.00

BBC MONITORS

14" RGB Microvitec Colour Monitor (as used in the BBC Computer Prog.) Including lead	£284.00
Microvitec High Res. Colour Monitor	£575.00
12" Zenith High Res. Green screen Monitor	£95.00
BNC Cable for above	£4.95
BBC Compatible Cassette Player price on application	
Blank Data Cassettes 10 for	£3.50
DIN to Jack Lead	£2.00
Official Joysticks per pair	£13.00

*All Drives include manual and utility Disk.

All items subject to availability.

All the products are the official versions, beware of imitations, they will invalidate your guarantee.

We accept official orders from educational establishments.

Credit card holders can phone in for express despatch.

Send large S.A.E. for lists and info pack.

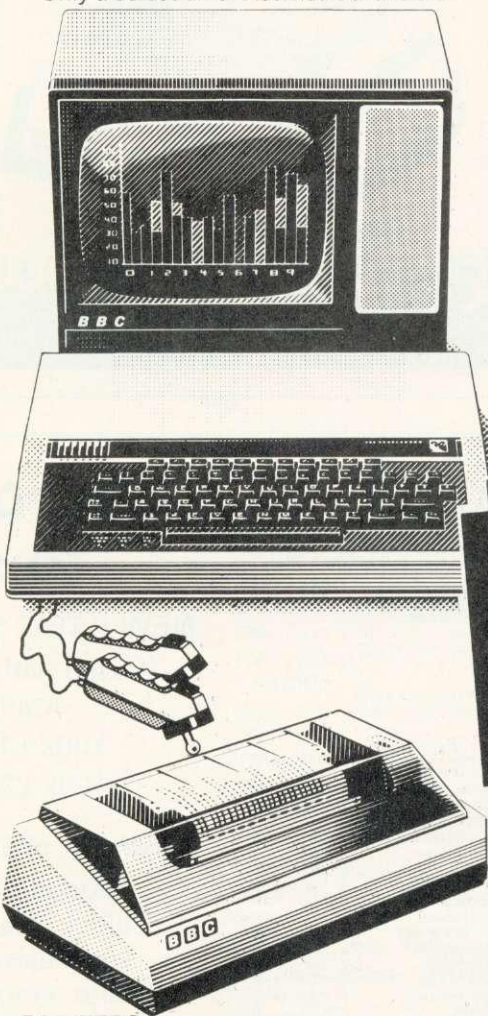

PRINTERS

Acorn AP-80A now down to	£189.00
Acorn AP-100A now down to	£215.00
AP-80A Ribbons	£4.95
AP-100A Ribbons	£5.95
Brand new Epson FX 80	

Contact us for details

All printers include cable & paper

Epson Dust Cover	£3.95
Parallel printer cable	£15.00

BOOKS

Practical Programs for BBC & Atom	£5.95
BASIC Programming on the BBC Micro	£5.95
Assembly language programming for BBC	£8.95
BBC Micro Revealed	£7.95
Creative Graphics, Graphs & Charts, LISP	all at £7.50 each
30hr. BASIC	£5.95
Let your BBC Micro teach you to program	£6.45

*** BBC Model 'B' wordprocessing pack at a low price of only £699. Save £44. Normal price £743.**
The Pack consists of: BBC Model 'B' GP100 Printer Cables, Cassette Player Word Processing ROM 1,000 sheets of paper. Then add the GP100A Printer at only £215.
The lowest price ever.

FREE COURIER

POSTAGE RATES*



Small items such as Ribbon, books & software:— 1 item **£1.00**, 2 items or more All Dust Covers **£1.00** p+p **50p** per unit

BY COURIER TO YOUR DOOR

Large items such as Computers, Disk Drives & Monitors:— 1 item **£7** 2 items **£10** 3 or more **£13**

ATTENTION!!

All Lynx, Oric, BBC, Commodore 64 owners, we pay top royalties for quality software programs. Please write or phone for details.

Barclaycard and Access  
welcomed All prices include VAT

ALL PRICES INCLUDE VAT. FOR FURTHER DETAILS AND MAIL ORDER LIST SEND LARGE S.A.E.
Open Mon - Sat 9.15 am - 6.00pm. Thurs 9.15 am - 1.00pm.

MICROAGE ELECTRONICS
135 HALE LANE EDWARE MIDDLESEX HA8 9QP
TEL: 01-959 7119 TELEX 881 3241

MICROAGE

ELECTRONICS

BIG value in small printers

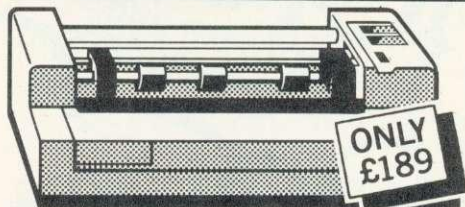

The Incredible Seikoshia AP80

The AP80 is probably the world's LOWEST COST, compact 80-column graphic dot-matrix printer available.

It can produce single and double width characters and has the ability to produce any pattern through its dot-matrix capability.

The AP80's robust construction and its unique "unihammer" make it an extremely cost effective and efficient printer.

Its features include

80 Cols 30 cps ● Dot Matrix Unihammer action ● 96 ASCII standard characters ● Up to 8" paper width ● Upper and lower case ● Double width printing ● Standard interface: Centronics

The Amazing Seikoshia AP100

Big brother to the AP80 the AP100 is a wider more sophisticated version of the AP80 with a full graphics capability and the ability to take standard width computer stationery, the AP100 is an ideal choice for anyone with a microcomputer.

Its features include:

80 cols 30 cps ● Dot Matrix Unihammer action ● 116 ASCII standard characters ● Full graphics capability ● Up to 10" paper width ● Upper and lower case ● Double width printing ● Centronics interface: Only £215.

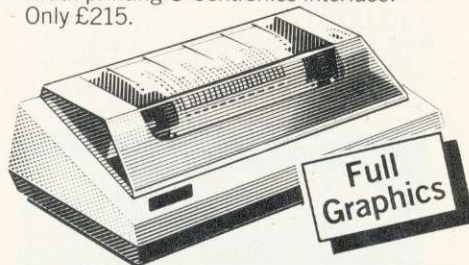

Official Orders Accepted

At Microage you can now get the very best value in microcomputer printers. We've selected only the best printers available so you can choose confidently, knowing you're getting the best value for money.

Free Cable + paper with printers

Accessories

Seikoshia GP-80 Ink Ribbon £4.75 (75p p+p)
Seikoshia GP-100 Ink Ribbon £5.75 (75p p+p)
Dust and sound Cover £3.95 (75p p+p)

Please Rush me details of all Printers.

Name _____

Address _____

The computer I shall be using it with is: _____

AU 5

MICROAGE ELECTRONICS

135 HALE LANE EDWARE MIDDLESEX HA8 9QP TEL: 01-959 7119 TELEX 881 3241
Open Mon - Sat 9.15 am - 6.00pm. Thurs 9.15 am - 1.00pm.

DEALER ENQUIRIES WELCOME

CALL 01-959 7119
FOR TRADE PRICES

Micro-Aid

SOFTWARE - Programs that are guaranteed to run! Save hours of work and worry with these utilities and practical programs on cassette or disc.

102	CASHBOOK	Double entry 4 columns with accounts	£ 5.95	B
103	LEDGER	Complements CASHBOOK with ageing & analysis	£ 5.95	B
104	MAILING	Holds 218 addresses. System with 6 options, 2 Sorts, Labels, 2 Searches & Update.	£ 5.95	B
105	PAYROLL	In two parts to handle weekly or monthly PAYE & NI for 100 employees. Supported.	£13.90	B
105a	Manual	Extra (No VAT)	£ 2.50	
106	MEMO-CALC	Database/Calcsheet with up to 255 columns, string or numeric data, sorts, searches, calculations, with full print facility.	£ 9.95	B
106a	Manual	Extra (No VAT)	£ 2.00	
201	CARDS	Beat Bruce Forsyth at his own game.	£ 2.95	A/B
202	BATTLE	Fast moving game simulation of a minefield.	£ 2.95	B
203	HANGMAN	Word game. French, German, Italian, Spanish.	£ 7.95	B
301	BANNER	Paper printout of large text & graphics.	£ 2.95	A/B
302	DISTANCES	Graphic maps of U.K., EUROPE & WORLD. Calculate distance between any two places.	£ 3.95	B
303	FLAGS	Full colour flags of the world & questions.	£ 3.95	B
304	STATPAK	Statistics offering over 30 results.	£ 8.95	B
501	SEARCHBAS	PROC to search a BASIC program & alter it.	£ 1.95	A/B
502	PROCVAR	PROC to list variables used in a program.	£ 1.95	A/B
503	PROCFLUSH	PROC to clear Resident Integer Variables.	£ 1.00	A/B
504	PROCAID	A combination of programs 501, 502 & 503.	£ 3.45	A/B
505	DEFCHR	Design, display & store graphic characters.	£ 2.95	A/B
506	SORTM/C	Machine code sort for up to 255 integers.	£ 1.00	A/B
507	SORTBAS	A very fast BASIC sort. 1000 items in 42s.	£ 1.00	A/B
508	UTILITY-A	A Combination of 501 to 507. Superb value.	£ 5.95	A/B
600	FORTH	Second language ROM for either OS.	£34.74	B
601	WORDWISE	ROM Superb fast & easy Wordprocessor OS 1.0	£34.74	B
701	BOOKS	Various titles for the BBC Micro from (No VAT)	£ 6.95	
801	CASSETTES	C12 Computer quality boxed in 10's.	£ 4.50	
810	DISCS	MEMOREX Soft Sector 40 track 5.25"	£19.95	
901	NEW EPSON	FX-80 F/T. 160CPS. 3 FOUNTS. Graphics	£379.00	
905	SEIKOSHA	GP-100a Printer 50cps, 80 columns, tractor	£195.00	
910	NEW TEAC	Slimline Disc drives suitable for BBC Micro with Power supply, Format disc & Manual.		
920	100K VDU STAND	Single Sided, 40 Track. OTHERS AVAILABLE. Stainless steel support protects your micro	£199.00 £19.95	

ADD VAT TO ALL PRICES. FOR COPY ON DISC ADD £1.00. NO PACKING CHARGE.

If you want further information before parting with your hard earned cash send for our new brochure to:-

Micro-Aid (AU)

25 Fore Street, Praze, Camborne, Cornwall TR14 0JX.
Tel: 0209-831274

Micro-Aid expand to serve you

NEW TEAC SLIMLINE DISC DRIVES NEW

(Cased with their own Power Supply, Manual & Format Disc)

100k £199.00 - 200k £265.00
400k £345.00 - 800k £619.00

NEW EPSON FX-80 PRINTER NEW

160cps, 40, 80 or 137 columns. Elite, pica, italic, proportional and emphasised text in three sizes and nine languages. Tractor, roll or sheet paper feeds.

RRP £379.00

SEIKOSHA GP100A Printer

50 cps, 80 columns. Tractor paper feed.
£195.00

MEMOREX 5.25" discs - £19.95 for 10
C12 cassettes - £4.50 for 10

Add VAT to all prices. Packaging included

If you think the model A BBC micro can only display eight different colours, with a maximum of four at one time, read on. Forty distinct shades would be nearer the mark, with more than a dozen displayed simultaneously. Mode 2 on a model B can put all these hues on the screen at once.

But how is it done? The usual technique is to put bytes directly into that part of memory storing the picture. However, it is not the best way, for these reasons:

- putting bytes one by one into memory ('poking') is slow and inefficient,
- screen memory locations vary between modes and are different in models A and B,
- the numbers put into memory are related to the colours in a complex way (more about these below),
- people using television sets may find annoying stripes running diagonally across colours, similar to radio interference,
- programs using direct memory addressing will run into big trouble with expanded systems.

A different method to poking is demonstrated by the photo program on the *Welcome* cassette, although it does not hint at how many colours could be present. For large areas, the principle is simple: generate a new shade by mixing existing colours (black, red, green, yellow, blue, magenta, cyan, white) on alternate horizontal lines. For instance, alternating lines of red and yellow will give a convincing orange, while red and magenta give bright pink. Type in and run program 1 to see the range. Model B owners can use program 2 which puts all the shades on the screen simultaneously. This is by far the best method of getting mixed colours on a TV display.

There are a number of points about these programs. *TV 0,1 in line 100 resets the vertical position of the display and turns off the interlace. This makes the new colours steadier (at least on my TV), and gives a wider range of mixtures. To reset the position and interlace, use *TV X,0 (with X= 0 or 1 or 255 (*User Guide* pages 23, 435).

STEP 8 in lines 170 and 220 is crucial. The vertical resolution

Peter Voke explains how to get more colours out of your BBC micro...

A SHADE MORE COLOURFUL

(number of distinct horizontal lines on the screen) is 256 'pixels' in all graphics modes (0, 1, 2, 4 and 5) even though the Y coordinates run from 0 to 1023. This means that plotting a point at coordinates 100,100 (PLOT69,100,100) followed by another at 100,101 is a waste of time, since both points lie inside the same pixel, which has a vertical spread of Y coordinates from 100 to 103. So PLOT69,100,Y commands with Y = 100, 101, 102, or 103, all affect the same pixel, the 25th from the bottom, since 100/4=25.

Don't attempt to fill the screen with orange by plotting alternate

red and yellow lines at Y= 0,1,2,3, and so on; use Y = 0,4,8,12,16 hitting a new set of pixels each time. One colour goes at Y = 0,8,16 ... and the other at 4,12,20...

To construct a particular colour generated in program 1 or 2, you need to know which underlying colours it is made from. In both programs the underlying pure colours occur on the diagonal running from bottom left to top right of the rectangle. Each mixture is obtained by alternating the underlying colour in the same row with the one in the same column as the mixture. For example, check

page 22▶

```

>L.
10*****
20
30REM "COLOURS 4"
40REM DEMONSTRATES COLOUR MIXTURES
50REM IN 4-COLOUR MODES.
60REM PETER VOKE 1982
70
80*****
90
100*TV0,1
110*FX11,0
120MODE 7
130IFHIMEM>%6000THENMODE1 ELSEMODE5
140VP%=100:HP%=0:VDU23:8202:0:0:0:
150
160FOR CX=0 TO 3:GCOL 0,CX
170FOR VX=VP% TO VP%+188 STEP 8
180MOVE 0,VX:PLOT1,1280,0:NEXT
190VP%=VP%+192:NEXT
200
210FOR CX=0 TO 3:GCOL0,CX
220FORVX=104 TO 868 STEP 8
230MOVE HP%,VX:PLOT1,319,0:NEXT
240HP%=HP%+320:NEXT
250
260PRINT TAB(0,1)"PRESS RETURN"
270PRINT "FOR NEW COLOURS"
280FOR IX=0 TO4:FOR JX=IX+1 TO 5
290FOR KX=JX+1 TO 6:FOR LX=KX+1 TO 7
300A=GET:VDU19,0,IX:0:19,1,JX:0:
310VDU19,2,KX:0:19,3,LX:0:
320NEXT: NEXT: NEXT: NEXT: A=GET
330
340CLS:PRINT TAB(6,4) "FINISHED"
350A=GET:CLS:VDU20:*FX12,0
360END
    
```

Program 1. Colours for model A

WATFORD ELECTRONICS

DEPT ACORN, CARDIFF ROAD, WATFORD, Herts, England
Tel Watford (0923) 40588. Telex: 8956095

MAIL ORDER AND RETAIL SHOP. TRADE AND EXPORT INQUIRIES WELCOME. GOVERNMENT AND EDUCATIONAL ESTABLISHMENTS OFFICIAL ORDERS ACCEPTED. Carriage: unless stated otherwise, please add min. 50p to all cash orders. **VAT** APPLICABLE TO UK CUSTOMERS ONLY. ALL PRICES EXCLUSIVE OF VAT. PLEASE ADD 15% VAT TO THE TOTAL COST INCLUDING POSTAGE. SHOP HOURS: 9.00am TO 5.00pm MONDAY TO SATURDAY. AMPLE FREE CAR PARKING. ACCESS ORDERS: Simply telephone through your order on Watford 50234/40589.

BBC MICROCOMPUTER

Model A **£299** Model B **£399**
incl. VAT (carr £7)

UPGRADE KITS. Upgrade your Model A to Mod. B with our Upgrade Kits and save yourself £ s s s

- BBC1 16K Memory (8 x 4816AP-3 100nS) **£16.00**
- BBC2 Printer User I/O Port **£6.98**
- BBC3 Disk Interface Kit **£75.00**
- BBC4 Analogue I/O Kit **£6.40**
- BBC5 Serial I/O Kit **£6.70**
- BBC6 Expansion Bus Kit **£6.10**
- Printer Cable Ready made 36" **£11.95**
- Complete Upgrade Kit Mod. A to Mod. B **£43.00**

DISC DRIVES 'TEAC' BBC Compatible

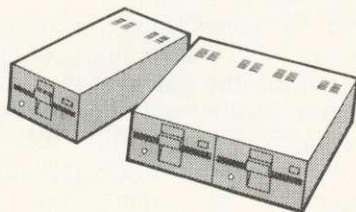

- US50A - Uncased, Single sided, 40 track, 5 1/4", 100K **£125**
- CS50A - Cased with own Power Supply, S/S 40 track, 5 1/4", 100K **£180**
- CD50A - Twin Cased with own PSU, Single sided, 40 track, 5 1/4", 200K **£350**
- CS50E - Single case with own PSU, Single Sided, 80 track, 5 1/4", 200K **£250**
- CD50E - Twin cased with own PSU, Double sided, 80 track, 5 1/4", 400K **£475**
- CD50F - Twin cased with own PSU, Double sided, 80 track, 5 1/4", 800K **£599**
- Mitsubishi Slim Line - Uncased, Double density, Double track, 5 1/4", One Megabytes, track density 96TPI, track to track access time 3mSec only **£249**
- Single Mitsubishi Slimline cased with own PSU. 1 Megabytes **£299**
- Twin Mitsubishi Slimline cased with PSU. 2 Megabytes **£575**
- Single Drive Cable for BBC Micro **£8**
- Twin Drive Cable for BBC Micro **£12**
- 10 Verbatim Diskettes, 5 1/4", S/sided **£18**
- 10 Verbatim Diskettes, 5 1/4", D/Sided **£30**

BBC PRINTER GP100A



10" Tractor Feed, 80 Columns, 30 CPS normal & double width Characters. Dot res graphics. Parallel Interface Standard. Our price includes **FREE** 500 SHEETS of PAPER.

Only **£175** (£7 carr)

- **SEIKOSHA GP250X** 10" Tractor Feed, 80 col. 50 CPS, normal & double width & height characters, RS232 & Centronics Interfaces standard. **£235** (£7 carr)

NEC PC8023BE-C Printer

100 CPS, Bi-directional, logic seeking, 80 columns, Tractor/Friction, 2K Buffer, proportional spacing, attractively finished **£320** (£7 carr)

EPSON NEW FX80

10" Tractor/ Friction feed, 160 CPS, 11 x 9 matrix, 137 columns max., Bidirectional, Logic seeking, proportional spacing, Hi-res bit image, Italics & Elite Char, Subscript & Superscript. **£399** (£7 carr)

MX100FT/3

15" Carriage, 136 columns, plus all the facilities of MX80FT/3 Only **£425** (£7 carr)

LISTING PAPER

- 8 1/2" or 9 1/2" Fanfold paper plain or ruled (1000 sheets) **£7** (150p carr)
- 15" fanfold paper (1000 sheets) **£9** (150p carr)
- Teleprinter Roll (econo paper) **£3** (150p carr)

MONITORS

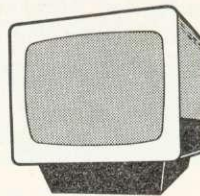

MICROVITEC 1431. 14" Colour Monitor, RGB Input. (as used in BBC programmes.) FREE Interface Lead **£249.95** (carr £7)

SANYO 3125 14" Colour. RGB & V.H. Sync. Attractive screened metal Cabinet. Value for money. **£199** (carr £7)

Interface lead for Sanyo **£8**

ZENITH 12" Green Monitor. Hi-resolution **£75** (carr £7)

BBC FORTH on Cassette

Follows FORTH-79 standard and has FORTH facilities—Provides 260 FORTH words—infinitely extensible—Full screen editor—Allows full use of MOS—Permits use of all graphic modes, even 0-2 (just)—Easy recursion—Runs faster than BBC BASIC

Only **£13**

FREE 70 page manual & a Summary card.

BBC FORTH TOOLKIT

Adds following facilities to FORTH. 6502 Assembler, providing machine-code within FORTH—Turtle graphics enables easy to use colour graphics—Decompiler routines enables versatile examination of your compiled FORTH programs—Full double number set—An example FORTH program & graphics demonstration—other useful routines—64 page Manual. Only **£10**

CASSETTE RECORDER & ACC.

Top quality Slim-line, portable Cassette Recorder. Ideal for Computer use. Mains/Battery operated with counter. **£28**

C12 Computer Grade Cassettes in library cases **40p**

RIBBON CABLE LEADS 36" long

- (Female Plug at one end, other end free)
- SK9 Printer Cable (26 way Female) **£2.75**
- SK10 I/O cable (20 way Female) **£2.00**
- SK11 1MHz Bus Cable (34 way Female) **£3.20**
- SK 12 Tube Cable (40 way Female) **£3.70**

PRINTER LEAD 36" Ready made **£11**

MISCELLANEOUS CONNECTORS

	Plugs	Sockets
RGB (6 pin DIN)	30p	45p
RS423 (5 pin Domino)	30p	40p
Cassette (7 pin DIN)	25p	65p
ECONET (5 pin DIN)	15p	25p
Paddles (15 pin 'D')	£1.10	£2.15

READY-MADE LEADS for BBC

- CASSETTE LEADS: 7 pin DIN Plug**
- to 5 pin DIN Plug + 1 Jack Plug **£2.00**
- to 3 pin DIN Plug + 1 Jack Plug **£2.00**
- to 7 pin DIN Plug **£2.50**
- to 3 Jack Plugs **£2.00**
- 6 pin DIN to 6 pin DIN Plug (RGB) **£2.50**

Official JOYSTICKS **£11.50/pr**

LIGHT PEN

All parts available for the Acorn User's "SHINE A LIGHT" Light Pen article for £8.50

BUSINESS SOFTWARE for BBC. Written by professional Chartered Accountants and coded by competent Programmers. Ideal for small & medium size companies.

- **CASH BOOK ACCOUNTS PACKAGE** **£82**
- **SPREAD SHEET ANALYSIS. BEEBCALC** **£17.35**
- **INVOICES & STATEMENTS**
Has customer file to produce Invoices & monthly statements. Calculations include automatic VAT. Saves hours of tedious work. **17.35**
- **COMMERCIAL ACCOUNTS**
The features include: Daily Journal, Credit Sales, Cash Sales, Credit Purchases, others, Sales Ledger, Purchase Ledger, Bank Account. Year to date summary. A fully interactive program suitable for all businesses. Files can be saved and loaded. Useful for Cashflow control with an immediate accessibility to Debtors & Creditors totals. Bank totally supported incl. running balance. **17.35**
- **MAILING LIST**
A dedicated database to allow manipulation of Names, Addresses & other information. The unique 'searchkey' system gives further 10 user definable parameters for own selections. Facility to find name or detail when only part of the detail is known. Prints labels in variety of user specified formats. **£17.35**
- **DATABASE**
The program that everybody needs. Facility includes: Sort Search, List print if req., Ideal for Card Index application. You can write your own Database to suit your req. with limitless number of entries on separate cassettes. **£17.35**
- **STOCK CONTROL**
Takes tedium out of stock control & saves time and money. Routines include stock setup, user reference numbers, minimum stock level, financial summary, line print records, quick stock summary, add/delete stock, etc. **£17.35**
- **HOME ACCOUNTS**
Runs a complete home finance package for you with every facility necessary for keeping track of all expenses like, H.P., Bank, Mortgage, etc. **£17.35**

★ SPECIAL OFFER ★

2764 EROM 1 + 425p **25 + 395p**

EPROM COPYING SERVICE

Now available while-u-wait
£2 per chip

SPACE GAMES

ALIEN DESTROYERS (32K) £7.95

Sensational, high speed 'INVADERS' program with an abundance of features. This program has many unique extras e.g.; 'Battle Analysis' showing the number of each alien type shot down.

ASTRO NAVIGATOR (32K) £6.95

Navigate your way through a variety of treacherous caverns, inhabited by killer rockmites. There are 5 skill levels and the top 5 scores are ranked at the end. Excellent colour graphics and sound.

ASTEROID BELT (16K/32K) £7.80

A great new space game practically identical to the arcade original. An inspired piece of machine code programming producing one of the most exciting games around.

CROAKER (32K) £6.95

People—HUH! Pity us poor Frogs! Trying to hop the logs over the rivers was difficult but now the motorways. Then come the Crocodiles and diving turtles. Survival becomes just impossible. Arcade type, machine code, excellent sound and graphics.

GALACTIC COMMANDER (32K) £7.95

Nine phase aptitude test for aspiring space vehicle commanders. The program presents a real challenge and the use of machine code and hi-res graphics makes for beautifully smooth action. Great sound effects.

HITCH-HICKER (32K) £5.95

A great adventure game. Tests your skill and wits whilst trying to collect 5 objects scattered round the universe. Directions can be found in the clues.

LASER COMMAND (32K) £7.50

Classic Defence of 6 Cities against attack from Alien planets plus random bombing raids from alien spacecraft. Super fast machine code arcade game with superb sound and graphics.

MARTIANS £6.95

Very popular. Defend your planet against the descending Martians with your Force-Field but beware of the Destroyers who can annihilate you.

SPACEMAZE (32K) £6.95

You have crash landed in the legendary labyrinth of Titan, inhabited by monsters known as 'FROOGS'. Find your way through to the 'TRANSMAT' before being cornered and eaten. The game has 8 levels of skill and 3D colour graphics.

SWOOP (32K) £6.95

The new GALAXIANS IT'S HERE AT LAST! Galaxian style machine code arcade game. 30 screaming, homing, bomb-dropping, explosive egg-laying BIRDMEN, swooping down in ones and twos to destroy your laser bases. The explosive eggs feature makes a normally difficult game into a challenge 'par excellence'.

TIMETREK (32K) £7.50

The ultimate 'real-time' Startrek, where indecision in the battle zone is your major enemy. 20 skill levels. Special features: PANIC BUTTON for once only space leap, New Klingon fleet after 30 Stardates and Torpedo sight control.

OTHER GAMES

ADVENTURE (16K/32K) £7.50

All the excitement, intrigue and frustration of a mainframe adventure. Explore the tortuous forests, dark caverns and castle dungeons. Great skill and imagination are required to play this game.

ZOMBIES' ISLAND (32K) £7.95

Fight for survival on an island inhabited by hungry, dangerous cannibals. An excellent BASIC and MACHINE CODE program.

CHARACTERS (16K/32K) £5.80

Makes redefining of Invaders, Foreign Characters, Technical symbols, etc.'s character shapes simpler. Clumsy binary and hexadecimal notations are not req. anymore.

CHESS (32K) £9.95

An excellent machine code program with superb Mode 1, colour graphics. 6 levels, play black or white, illegal moves rejected, 'en passant', castling, take-back of moves and display of player's cumulative move-time.

COWBOY SHOOTOUT (32K) £6.50

Full feature, 2 Player, cowboy shooting game. Hide behind the cactus plants and moving chuck wagons until they are shot away. Shoot your opponent and avoid getting hit yourself.

ELDORADO GOLD (32K) £6.50

Legend has it that old Bill McCusky, who met a sudden death, had built up a vast treasure somewhere in the nearby territory. Can you end up rich where many have failed?

FOOTER (32K) £6.95

Another high resolution graphics game from the author of our Galactic Commander. A 2 player game in which each player has to use his football skills to try to out-run, out-dribble and finally score against his opponent. A serious contender to 'MATCH OF THE DAY'.

LOGO II £9.95

This language is now very popular in American schools as it is an ideal educational program. It can graphically demonstrate the ideas of defined procedures, sub-routines, loops and even recursive programming. Gives excellent intro to LOGO language for young and old alike.

MUNCHYMAN (16K/32K) £6.95

Colourful and highly entertaining version of the popular arcade game. Munch your way to high score before the 'MUNCHERS' devour you.

REVERSI (16K/32K) £7.80

A sophisticated multi-option game. Play against the computer or another player or even watch the computer play itself. 5 skill levels allows any player to enjoy the game without continually winning (or losing).

ROULETTE (16K/32K) £5.95

All the fun of the Casino in your own home. This is a beautifully presented game for up to 6 players. The odds are calculated according to the official rules.

SNAKE (32K) £7.80

An arcade type game. Gives hours of fun. One of the best games available for this machine. Try it for yourself.

NEW . . . NEW . . . NEW

3 New Adventure games. May be the best yet written. We strongly recommend them. All have over 200 individual locations and packed with puzzles. A game can take easily months to finish. Only sophisticated compression techniques can squeeze so much in.

ADVENTURE QUEST (32K) £8.60

COLOSSAL ADVENTURE (32K) £8.60

DUNGEON ADVENTURE (32K) £8.60

APPLICATIONS

CONSTELLATION (32K) £6.50

The great Bear! The Southern Cross! The Horned Goat! See the night sky gloriously depicted in hi-res graphics. Constellation has been adapted and enhanced from our successful ATOM program.

DISASSEMBLER (16K/32K) £6.95

Relocatable disassembler program. Lists object code and Assembler mnemonics from and to any specified addresses. The listing can be stopped and restarted. Page mode option and output to a printer are available. ASCII symbols may be output if required. The Assembler code may be stored and modified and the program re-assembled.

FILER £8.95

A powerful file handling program for BBC. FILER allows the user to build up, manipulate, store and retrieve data on the BBC. A very powerful package indeed.

WORDWISE

Special offer only £35.00

Without doubt the most sophisticated piece of Software yet written for BBC Micro. Wordwise contains all the usual word processing features. The more complex facilities such as search and replace or file handling commands are menu driven so that even a beginner can understand how to operate them.

Wordwise will work with whatever filing system is currently implemented. Supplied with full instructions and manual.

EDUCATION

JUNIOR MATHS PACK (32K) £6.95

Makes learning fun for 5-11 year olds. This package consists of 3 programs (menu driven) that increase in difficulty as your child becomes competent. A very good supplement to standard educational methods.

WHERE? £6.95

Do you know 'WHERE?' you are? This well written program, using high resolution graphics offers timed tests on the geography of Great Britain.

WORLD GEOGRAPHY (32K) £7.00

Beautifully drawn Hi-Res colour map of the world illustrates and aids this graded series of tests on capital cities and populations of the world.

PROGRAMMING MADE EASY Only £8.00

A new concept for schools—A set of workcards to introduce programming to primary school pupils. An invaluable asset to Teachers and Parents alike. The language has been carefully chosen to provide a balance between 'Computer Technology' and standard language. Bulky and often despised text books have been replaced by the set of Workcards. Each card can be handled easily at the Computer Keyboard. Also included are a SUPPORT PROGRAM specially produced to reinforce the work covered by the cards and a CHECK LIST for children and teachers to monitor progress. A must for primary schools undertaking computer learning.



Acorn ATOM UTILITY ROM

WEROM is Watford Electronic's own most sophisticated but easy to use 4K ROM based on BASIC extension for Acorn ATOM. Plugs straight into the utility socket in an ATOM with floating point. The special features are:

High Speed Tape Interface—Memory Dump, Modify Machine code breakpoints—BASIC Error Trapping—READ, DATA and RESTORE—Full BASIC Keyboard Scanner (BBC like)—FULL Disassembler—AUTO Line Numbering—PLUS: CHAIN, Cursor Movement, Loop Aborting—Easily Extendible further. Supplied complete with instructions. **£9.95**

BOOKS

30 Programs—BBC Micro £ 4.95
30 Hour BASIC (BBC Micro) £ 6.00
6502 Application Book £10.25
6502 Assembly Lang. Programming £12.50
6502 Assembly Lang. Subroutines £11.80
6502 Software Design £10.50
ACORN ATOM Magic Book £ 5.50
Advanced 6502 Interfacing £10.95
ALP for the BBC Micro £ 8.95
BASIC Programming on BBC Micro £ 6.90
BBC Micro Revealed £ 7.95
BBC Micro Instant Machine Code including Software Cassette £34.00
Creative Graphics on BBC Micro £ 7.50
Discover FORTH—Osborne £11.25
Easy Prog. for BBC Micro £ 6.50
Further Prog. for BBC Micro £ 6.90
FORTH Programming (Sams) £12.50
Getting Acquainted/Acorn ATOM £ 7.95
Graphs and Charts on BBC Micro £ 7.50
Intro to Micro Beginners Book (3 Ed) £ 9.90

Let your BBC teach you to program £ 6.45
Micros in the Classroom £ 4.90
Practical Prog. for BBC & ATOM £ 5.95
Programming the 6502 £11.20
Mastering VISICAL (Sybex) £11.95
Structured Prog. with BBC BASIC £ 9.50
The BBC Micro An expert Guide £ 7.90

► page 19

that orange is made up of red and yellow. With a mixture of yellow and black, or blue and white, the strips of the two colours running horizontally can be clearly seen. To get a particular range of shades, first select the appropriate palette of pure underlying colours using VDU19 commands (*Acorn User*, July/August, page 7, *User Guide* page 382); then use those colours, in pairs on alternate lines, to produce the mixtures. Model B owners using mode 2 will not need VDU 19 since all eight pure colours are available anyway.

This brings out an important point. On some TV displays there is a distinct difference between shades produced by programs 1 or 2 that are opposite each other (top left to bottom right) and hence are made up of the same underlying

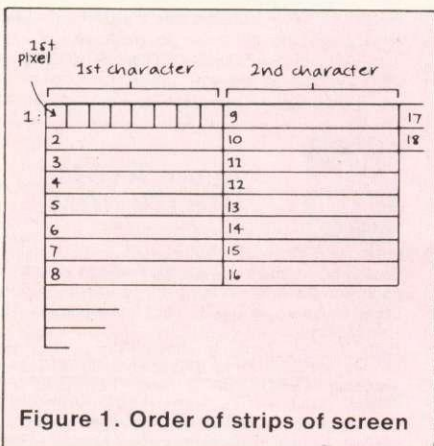

Figure 1. Order of strips of screen

colours. (This does not work on a monitor or with interlace off.) For instance when red and green are the underlying colours, the two mixtures can look utterly different, one being bluish, the other khaki, with interlace off. The reason is that the appearance of an underlying colour depends on precisely where the lines are plotted on the screen, which in turn depends on when the program starts relative to the TV's vertical synchronisation. If program 1 or 2 is run several times, the two different mixtures of red and green (say) change places in a random way from one run to the next.

In one sense this is a bonus since it gives still more subtle hues, but it is important to remember that the precise appearance of these colours cannot be predicted. In many situations this may be an advantage. Program 3 is another

```

10*****
20
30REM "COLOURS 16"
40REM DEMONSTRATES COLOUR MIXTURES
50REM IN 16 COLOUR MODE (MODE 2).
60REM PETER VOKE 1982
70
80*****
90
100*TV0,1
110*FX11,0
120MODE 2:VPX=200:HPX=160
130VDU23:8202:0:0:0:;REM CURSOR OFF.
140
150FOR CX=1 TO 7:GCOL0,CX
160FOR VX=VPX TO VPX+88 STEP 8
170MOVE 0,VX:PLOT1,1280,0:NEXT
180VPX=VPX+96:NEXT
190
200FOR CX=1 TO 7:GCOL0,CX
210FORVX=100 TO 888 STEP 8
220MOVE HPX,VX:PLOT1,159,0:NEXT
230HPX=HPX+160:NEXT
240
250PRINT TAB(0,1) "PRESS RETURN"
260PRINT "FOR FLASHING COLOURS"
270VDU23:8202:0:0:0:;REM CURSOR ONFF.
280FOR IX=1 TO 7:*FX15,1
290A=GET:VDU19,IX,IX+8:0:;NEXT
300
310COLOUR 4:A=GET:*FX10,0
320PRINT TAB(6,1) "FINISHED":A=GET
330CLS:VDU20:*FX10,50
340*FX12,0
350END
    
```

Program 2. Colours for model B

```

10*****
20
30REM "NEW YORK"
40REM MULTICOLOURED PATTERNS
50REM PETER VOKE 1982
60
70*****
80
90MODE 5:DIM JK(3)
100VDU23:8202:0:0:0:;*TV0,1
110
120FOR IX= 0 TO 3
130JK(IX)=RND(8)-1:KX=IX
140KX=KX-1:IF KX<0 GOTO 160
150IFJK(IX)=JK(KX) GOTO130 ELSE GOTO140
160VDU19,IX,JK(IX):0:;NEXT
170
180CLS:T=10+RND(70):REPEAT:T=T-1
190HI%=512+RND(511):LO%=RND(511)
200RT%=640+RND(639):LT%=RND(639)
210GCOL3,RND(3)
220FOR YX=LO% TO HI% STEP 8
230MOVE LTX,YX:DRAW RTX,YX:NEXT
240UNTIL T<0 OR INKEY(-69)
250
260IF INKEY(-69) GOTO 120
270*FX15,1
280PRINT TAB(1,30)"NEW COLOURS? (Y/N)"
290Y#=GET#:IF Y#="Y" OR Y#="y" GOTO120
300IF Y#<>"N" AND Y#<>"n" GOTO 270
310
320VDU20:MODE 7
330CLS:END
    
```

Program 3. Random pattern generator

```

10*****
20
30REM "GCOL"
40REM DEMONSTRATES THE EFFECT OF
50REM VALUES OF GCOL 1ST PARAMETER
60REM PETER VOKE 1982
70
80*****
90
100MODE 7:B%=0:IF HIMEM>=6000 B%=-1
110IF B% THEN MODE 2:ELSE MODE 5
120PRINT TAB(0,31):VDU5
130B%=(B%+1) MOD 2
140
150MOVE 0,900
160INPUT "INPUT A NUMBER LESS THAN 255: --"GX
170IF GX>255 THEN GX=GX-256:GOTO 170
180HX=0
190PRINT "*****Press SHIFT for
more****for DELETE to stop."
200IF B% GOTO 230
210VDU19,3,3:0:19,0,4:0:19,2,2:0:
220
230REPEAT
240
250FOR CX=1 TO 9
260MOVE579,96:MOVE579,32
270FOR XX=1 TO 7:GCOL0,XX
280PLOT85,579+100*XX,96
290PLOT85,579+100*XX,32
300NEXT
310IF CX=9 THEN 400
320GCOL0,7:MOVE 0,80:PRINTGX,HX
330GCOLGX,HX
340MOVE 479,96:MOVE 479,32
350PLOT85,1279,96:PLOT85,1279,32
360VDU4,10,10,5
370HX=HX+1
380IFHX>7 THEN HX=0:GX=GX+1
390IF GX>255 GX=GX-256
400NEXT
410
420IF NOT(INKEY(-1) OR INKEY(-90)) GOTO 420
430UNTIL INKEY(-90)
440
450VDU4,20:MODE 7
460END

```

Program 4. More reliable than program 3

```

10*****
20
30REM "STRIPES"
40REM DEMONSTRATES COLOUR MIXING
50REM BY USER CHARACTERS.
60REM PETER VOKE 1982
70
80*****
90
100MODE 2:MOVE 0,1023:VDU5
110VDU23,224,255,0,255,0,255,0,255,0
120VDU23,225,0,255,0,255,0,255,0,255
130A#=STRING$(18,CHR$(224))
140B#=STRING$(18,CHR$(225))
150
160FOR C1%=1 TO 7:FOR C2%=0 TO 7
170FOR T%=1 TO 4
180GCOL0,C1%:PRINT A#
190VDU11:GCOL0,C2%:PRINT TAB(2) B#
200VDU11:NEXT
210NEXT:T=A:GET:NEXT
220VDU4:END

```

Program 5. Displays all possible colour mixes (A and B)

random generator for model A, but uses colour mixtures.

A simple way of obtaining these shades reliably and predictably is to use program 4. The user definable characters 224 and 225 have been set up to fill in alternate lines, 224 filling in one set, 225 the other. Lines 110 and 120 set up the characters.

In this program model A owners should use MODE 5 in line 100. The VDU5 in line 100 is important as it allows the second character to be printed on top of the first without destroying it, and prevents scrolling. If VDU5 is left out, everything becomes faster, but only one character of the two can be printed in any position, mixing its colour with the background. Without the VDU5, use COLOUR 0 instead of GCOL 0,C. When speed is everything, user defined characters and no VDU5 is the way to do it.

Let us now look at byte-poking and related methods. If you have never seen it, try this in mode 5:

```
FOR X% = HIMEM + 1 TO HIMEM
+10240: ?X%= 15: NEXT
```

The screen fills with red. Changing the 15 to 240, produces yellow. Now change 240 to 90. Orange results, made up of red and yellow stripes, but the stripes are vertical instead of horizontal.

To understand this, we have to know how the computer codes the colours in its memory. In modes 0, 3, 4 and 6 it is simple with only two logical colours, 0 and 1. The first byte of the so-called screen memory (beyond HIMEM) contains the information for the first eight pixels across the top of the screen in all cases, though the pixels are twice as wide in modes 4 and 6 as in mode 0 or 3. The next byte codes for the eight pixels *underneath* the first eight, and so on to the eighth byte, making an eight by eight matrix of pixels – the first character on the screen. The ninth byte codes for the eight pixels at the top of the next character along (figure 1). This continues all the way along the line, and onto the next, to the bottom of the screen.

But what has this to do with colour modes? Simply that the same sequence of bytes in memory is assigned to the same sequence of small strips on the screen (as in figure 1) in all modes. In modes 4

to 6 the strips are twice as wide as in modes 0 to 3, while modes 3 and 6 just put some space between lines. However, in a colour mode individual pixels within a strip are bigger.

For instance, in mode 5 the pixels are twice as wide as in mode 4, so there are only four in the strip instead of eight. There are still eight bits in the byte memory, so each pixel has two bits – just enough to code for four colours. The two bits for a pixel represent the colours in just the way you would expect: 00 for logical colour 0, 01 for logical colour 1, 10 for 2, and 11 for 3 (if you know your binary). The tricky part is the way these four pairs of bits are arranged in the byte. The bits for pixel 1 are in positions 1 and 5, those for pixel 2 are in positions 2 and 6, 3 in 3 and 7, 4 in 4 and 8. Figure 2 may make it clearer. Pixel 1 is at the right end of the strip, pixel 4 at the left.

The orange effect was produced by alternating red and yellow, colours 1 and 2, within the strip. Merging 1, 2, 1, 2 as in figure 1 gives 90. Another way would be to alternate 2, 1, 2, 1, which gives 165. A less stripey, more checkerboard effect can be obtained by putting 90 in the first byte, 165 in the second, 90 in the third, and so on.

Model B owners will find the above method works in mode 1, although the resolution is finer as the strips are half the width. In mode 2 things are a little different since each pixel has the possibility of being any one of 16 colours, and needs four bits to code it. There are only two pixels per strip, and the merging of binary numbers is shown in figure 3.

By now you may have noticed the diagonal stripes mentioned earlier moving across the mixed colours, rather like radio interference on a TV picture. This is due to drifting of the horizontal sync, causing the colours to wash across each other.

A faster method of producing these mixtures is provided by the Basic commands GCOL and PLOT. GCOL is followed by two numbers, G and H, the first of which specifies the 'action' and the second the logical number of the colour to be plotted. Making H bigger than the number of logical colours has no

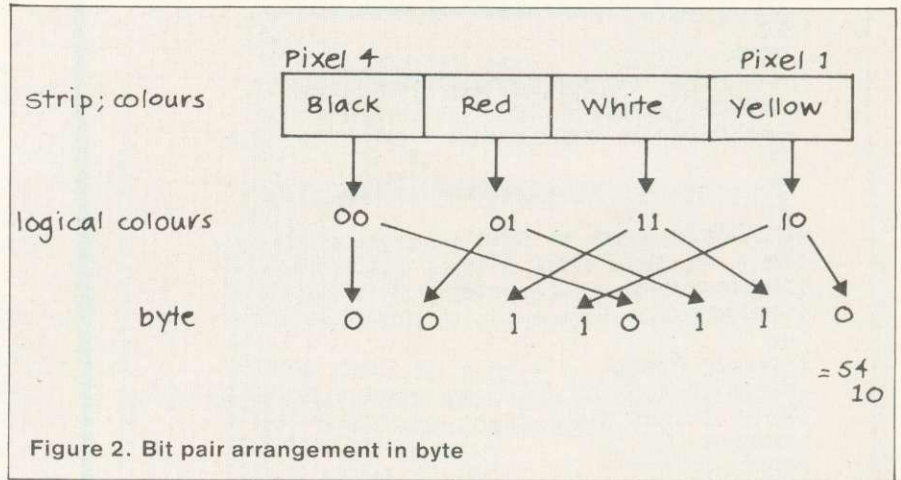

Figure 2. Bit pair arrangement in byte

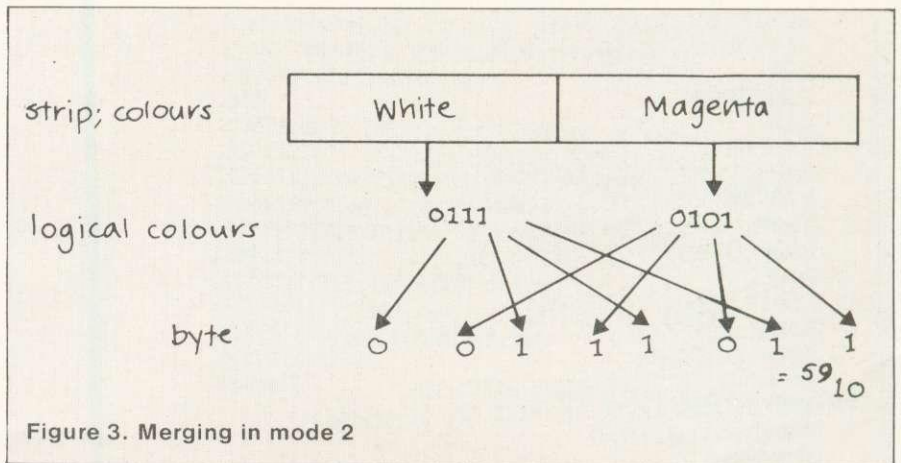

Figure 3. Merging in mode 2

special effect; but making G bigger than 4, its normal maximum, produces mixed colours which are the same as the ones created by poking the screen memory directly – but does it much more quickly. In mode 2 the mixtures are usually flashing.

The parameter G can be given any value up to 255 before it starts to repeat its actions. Values 0 to 4 are the usual ones (*User Guide* page 262), while 5 to 255 produce mixtures. The effect not only depends on the values of G and H, but on the colour plotted on top, and the specific assignments of actual to logical colours made by VDU19 commands. The best way of making use of this method is to have a program on hand that shows all possible mixtures, and gives the numbers G and H needed to produce them, hence program 5.

The program works in mode 2 for model B, or mode 5 for model A. First the colours available in the mode are plotted in columns across the screen. Then the values of G and H are written on the left,

GCOL G,H is called (line 330) and PLOT85 is used to plot a strip of mixture across the other colours. The 'underneath' colours show at the bottom of the screen. Since so many of the mixtures are flashing, this is turned off using *FX9,0 in line 130.

To get a particular mixture, note the pure colour at the bottom of the same column, and the figures G and H printed on the left. In the program where you want the mixture, first ensure the same pure colour is plotted in the area concerned, using GCOL0,N and PLOT. Then do GCOL G,H using the values of G and H given by program 5, and replot over the same area with PLOT85 or 81.

Model A owners should work in mode 5, and line 210 selects the palette. Change this line for a different set of colours, but always use the same palette in any program.

Ten minutes spent playing with program 5 will convince anyone the BBC micro has a cauldron of colour effects hidden inside.

Midwich

COMPUTER COMPANY LIMITED

1st choice for BBC microcomputers

BBC COMPUTERS

Model B	£346.95
Model B + Disc Interface	£441.95

BBC MICRO DISC DRIVES

BBC 31	Single 100K Drive Expandable to 2 x 100K	£199.00
BBC 32	Dual 100K Drives	£330.00
BBC 33	100K Upgrade for BBC 31	£122.00
BBC 34	Dual 400K Drives	£649.00

BBC 35 Acorn Utilities Disc/Manual £30.00
(supplied only with BBC 31, 32, 34)
All Drives except BBC 33 supplied cased
with Connecting Leads.

BBC UPGRADE KITS

BBCA2B	Complete A to B Upgrade	£44.75
BBC 1	16K Memory	£18.00
BBC 2	Printer/User I/O Kit	£ 7.50
BBC 3	Disc Interface Kit	£95.00
BBC 4	Analogue Input Kit	£ 6.70
BBC 5	Serial I/O RGB Kit	£ 7.30
BBC 6	Bus. Expansion Kit	£ 6.45

All kits are supplied with full fitting
instructions.

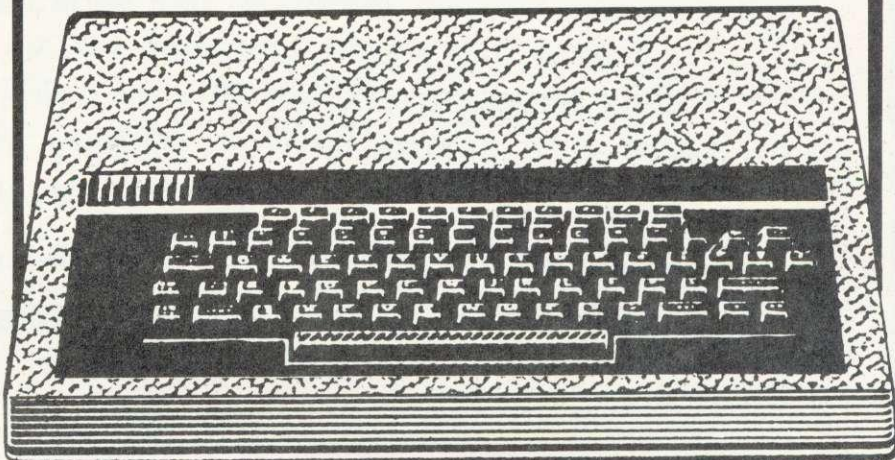

**Fast ex-stock
delivery by Securicor...**

Midwich
COMPUTER COMPANY LIMITED

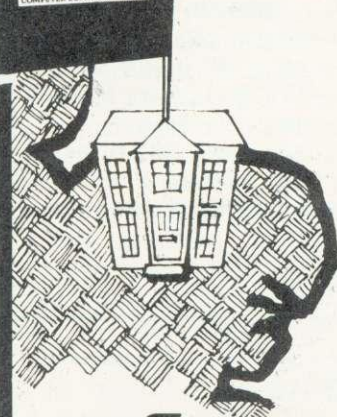

Fitting Service
available

12 month "no quibble"
warranty on all products

BBC CONNECTORS

BBC 21	Printer Cable and Amphenol Plug (not assembled)	£13.00
BBC 22	User Port Connector and Cable 36"	£ 2.46
BBC 23	Cassette Lead	£ 3.50
BBC 24	7 Pin Din Plug	£ 0.60
BBC 25	6 Pin Din Plug	£ 0.60
BBC 26	5 Pin Din Plug	£ 0.60
BBC 35	Disc 1.0 Cable 34WIDCto 2 x 34 way Card Edge	£12.00
BBC 36	Disc Power Cable	£ 6.00
BBC 44	Analogue Input Plug & Lever	£ 2.25
BBC 66	1M Bus Connector + 36" Cable	£ 3.50

BBC ACCESSORIES

BBC 45	Joysticks (per pair)	£11.30
BBC 67	Eprom Programmer (assembled)	£57.95

ACORN SOFTWARE FOR THE BBC

SBE03	Business Games	£ 8.65
SBE04	Tree of Knowledge	£ 8.65
SBE02	Peeko Computer Inc Manual	£ 8.65
SBE01	Algebraic Manipulation PK	£ 8.65
SBX01	Creative Graphics Cassette	£ 8.65
SBX02	Graphs & Charts Cassette	£ 8.65
SBB01	Desk Diary Inc Manual	£ 8.65
SBL02	Lisp Cassette	£14.65
SBL01	Forth Cassette	£14.65
SBG01	Philosophers Quest	£ 8.65
SBG07	Sphinx Adventure	£ 8.65
SBG03	Monsters	£ 8.65
SBG04	Snapper	£ 8.65
SBG15	Planetoid	£ 8.65
SBG06	Arcade Action	£10.35
SBG05	Rocket Raid	£ 8.65
SBG13	Meteors	£ 8.65
SBG14	Arcadians	£ 8.65
SBG10	Chess	£ 8.65

ACORN SOFTWARE FOR THE BBC MICRO

SBD01	Creative Graphics	£ 7.50
SBD02	Graphs - Charts	£ 7.50
SBD04	Lisp	£ 7.50
SBD03	Forth	£ 7.50

* Please ring for current delivery on
Acornsoft products before ordering.

BBC MICRO COMPONENTS

4516	100NS	£ 2.25
6522		£ 3.19
74LS244		£ 0.59
74LS245		£ 0.69
74LS163		£ 0.34
DS3691N		£ 4.50
DS88LS120N		£ 4.50
UPD7002		£ 4.50
8271		£36.00
20 Way Header		£ 1.46
26 Way Header		£ 1.76
34 Way Header		£ 2.06
40 Way Header		£ 2.32
15 Way D Skt		£ 2.15
6 Way Din Skt		£ 0.90
5 Way Din Skt		£ 0.90

BBC SOFTWARE IN ROM.

Wordprocessor "View"	£52.00
1.2 MOS	£10.00

Delivery Charges
Computers/Disc Drives £5.00
Components/Software £0.50
Books/Joysticks £1.00

...from East Anglias
leading supplier



MIDWICH COMPUTER COMPANY LIMITED

RICKINGHALL HOUSE, RICKINGHALL, SUFFOLK IP22 1HH
TELEPHONE (0379) DISS 898751

FINANCIAL GAMES

BBC Model B

THE WORLD TRAVEL GAME



1 or 2 Players,
Choice of Game,
'Exciting, Tense, Competitive and
even Educational'



★ ★ ★ ★ ★

Travel the World; Journey by air, rail and road.
Exchange currencies; Buy souvenirs; Book tickets.
Cope with hijacks, strikes, robbery and other problems
inherent with travel.

Visit countries as diverse as Russia & the Falklands.

Your aim is to collect 6 souvenirs and return to
LONDON intact!

— £6.95 —

GREAT BRITAIN LTD.



You are P.M.
and Chancellor of
'Great Britain'

You must select the Party you wish to represent and your aim is to stay in office for as long as possible. You must control inflation and unemployment, maintain the exchange rate, introduce social reforms and stay popular. The game is split into sectors: country profile, shopping basket, budget day, reform opportunities, manifesto, and most important election nights (a telling time).

A COMPLEX GAME THAT YOU WILL NOT TIRE OF IN A HURRY

— £5.95 —



INHERITANCE

Gt. Uncle Arburthnot
is dead.
You stand to inherit!!

A 2 part game. Prove your financial accumen in Part 1 by investing wisely at the stock and metal markets; if desperate try the casino or the horse races. If you are successful you will enter the world of big business in Part 2. Find the secret formula for paradise cola; manufacture and market the drink; cope with strikes, fires, frauds, cash shortages, etc. Your ultimate aim is to become a millionaire! **A MAMMOTH GAME PACKED FULL OF FEATURES**

— £5.95 —

See Reviews in:

Acorn User Dec '82 — Personal Computer Jan '83

Trade Enquiries Welcome. Special Deals for Schools.

Simon W. Hessel (Dept A)

15 Lytham Court, Cardwell Crescent, Sunninghill, Berks.

Telephone: Ascot 25179

24HR DESPATCH — ONE YEAR GUARANTEE — MONEY-BACK IF NOT SATISFIED



A POT POURRI OF ROUTINES

Reader response has galvanised Beeb Guru Joe Telford into producing this month's wealth of ideas. Procedures, discs, functions and recursion are all dealt with in simple terms giving some elegant results

This month we look at a number of hints which cover some library routines and FX calls. First, though, a word of thanks to readers who have written in appreciation of my column. *Acorn User* readers are always willing to share their knowledge and expertise, so this month I include a number of their useful ideas. They are all expanded upon, so complaints to me please, *not* to our helpful readers.

Sergeant T M Murphy of Blandford Camp, Dorset, suggests that disc system users who wish to enter the cassette filing system on break need simply press delete-break. In fact holding down any key while tapping break will let you enter the CFS from DFS. However, that character is displayed after the break message, and because of auto repeat the character is soon multiplied. This happens with

delete too, but because it is an invisible character and it cannot delete past the beginning of the line the screen display is left uncluttered. Pressing delete-shift-break produces the message:

```
BBC Computer
Searching
File not found
BASIC
>
```

I first assumed that the DFS was hunting for a program on disk, but on noticing no drive lights, I realised that this couldn't be the case. The speed of access between 'Searching' and 'File not found' indicates that the micro is searching memory. As OS 1.0 onward have the *ROM command, I presume that the delete-shift-break combination is trying to autoboot a program in ROM. I have View and Wordwise in my machine and neither of these were run, so the *ROM filing system seems to deal with Basic applications programs. Who will produce the first applications chip?

Concluding, I notice that in all these cases page is not altered ie it remains at &1900 for disc based systems. Further information on the OS will be given in a future Hints and Tips.

page 30 ►

RELOCATING PROGRAMS WITH DISCS

Regular readers will be aware of different techniques used by myself and that master of machine code, Ian (Buzz-bomb) Birnbaum, over the problem of relocating large programs. If you have a machine with a DFS chip then the memory from &E00 to &1900 is used by the DFS. Some programs will load into the space left, but not execute. The solution is to relocate them beginning at &E00 (&E00 is page for V 0.1 OS).

How we do this is the problem. In January, I suggested an approach in Basic using a user defined key. I felt this was simple and being in Basic (is there a better language?) easy to understand. Ian followed up with a high-powered machine code routine to go one better, and that was that. However, driven by a couple of letters from readers, I felt that the honour of Basic was at stake,

and so I offer program 1.

This routine can be spooled then added to any existing program. Running the complete program on machines with page set at &E00 will result in no relocation. Page set to any other value, ie for DFS or Econet, will result in a jump to line 32000 where the CFS is selected and the Basic code moved down to &E00. Line 32015 resets top and the program is then re-run. This time, however, page is &E00

and so the program proper is executed. This routine takes about three or four seconds to relocate a program of 10k, which seems reasonable. It was produced by the Micro-electronics Education Programme when it was discovered that some of the programs commissioned for the Primer Pack were too large to fit into a BBC micro with a resident DFS chip. I am grateful to Bob Coates for permission to reproduce the coding.

```
1 IF PAGE(>&E00 GOTO32000
2 CLEAR:7&E04=244
```

```
32000 *TAPE
32005 FORI%=0 TO TOP-PAGE STEP4
32010 I%!*E00=I%!PAGE: NEXT
32015 7&13=7&13-(PAGE-&E00)DIV 256
32020 PAGE=&E00:RUN
```

Program 1. Relocation

IT'S NEW ACCESS SOFTWARE for your business at petty cash prices.



INVOICES AND STATEMENTS . . . £19.95

Compatible with most micros. See table. Ideal for the small business. A complete suite of programs together with generated customer file for producing crisp and efficient business invoices and monthly statements on your line printer. All calculations include VAT automatically, and the program allows your own messages on the form produced. This program gives you superb presentation and saves time on one of the most tedious tasks in the office.



COMMERCIAL ACCOUNTS . . . £19.95

Compatible with most micros. See table. A gem of a program, all for cassette, with the following features:— Daily Journal. Credit Sales. Cash Sales. Credit Purchases. Purchases — other. Sales Ledger. Purchase Ledger. Bank Account. Year to date summary. A fully interactive program suitable for all businesses. Files can be saved and loaded and totals from one file carried forward to another on cassette. Particularly useful from a cash flow point of view, with an immediate accessibility to totals for debtors and creditors. Bank totally supported with entries for cheque numbers, credits and, of course, running balance.



MAILING LIST . . . £19.95

Compatible with most micros. See table. A superb dedicated database to allow for manipulations of names and addresses and other data. Gemini's unique 'searchkey' system gives you a further ten 'user-defined parameters' to make your own selections. Features include the facility to find a name or detail when only part of the detail is known, it will print labels in a variety of user specified formats.



DATABASE . . . £19.95

Compatible with most micros. See table. The program that everyone needs, the most valuable and versatile in your collection. Facilities include sort search, list print if required. Can be used in place of any card index application; once purchased you can write your own dedicated database to suit your particular needs with a limitless number of entries on separate cassettes.



STOCK CONTROL . . . £19.95

Compatible with most micros. See table. Dedicated software with all that's necessary to keep control of stock. This program will take the tedium out of stock control and save time and money. Routines include stock set up, user reference number, minimum stock level, financial summary, line print records, quick stock summary, add stock, delete/change record and more.



HOME ACCOUNTS . . . £19.95

Compatible with most micros. See table. Runs a complete home finance package for you with every facility necessary for keeping a track of regular and other expenses, bank account mortgage, H.P. etc. This program also allows you to plot graphically by Listograms your monthly outgoings.



WORD PROCESSOR . . . £19.95

Compatible with most micros. See table. This program features routines found in much larger and more expensive packages with a typical word length of 5-6 letters it allows for around 1000 words in memory at one time. Ideal for the user who requires a simple program to write letters on his computer. Features include, block delete, block insert, search and replace, edit text, display text and more.

Dealer/Trade enquiries invited — generous trade discounts for quantity
Special ACCESS card instant sales hotline Tel: 03952-5165
 for **GUARANTEED** despatch within 24 hours . . .
 24 hr Ansaphone Service.

All enquiries other than credit card sales to 03952-5832

Gemini. Functional Software Specialists. 9, Salterton Road, Exmouth, Devon.

Tick the box for Program you require. Prices include V.A.T. and Package and Postage.
 Please supply the following cassette software.

Database	£19.95	<input type="checkbox"/>	ZX81 16K Database	£9.95	<input type="checkbox"/>
Stock Control	£19.95	<input type="checkbox"/>	BBC Cash Book disk or tape	£95.00	<input type="checkbox"/>
Mailing List	£19.95	<input type="checkbox"/>	BBC Disks — other titles	£23.95	<input type="checkbox"/>
Invoices and Statements	£19.95	<input type="checkbox"/>	Osborne Disk Database	£23.95	<input type="checkbox"/>
Commercial Accounts	£19.95	<input type="checkbox"/>	Word processor	£19.95	<input type="checkbox"/>
Home Accounts	£19.95	<input type="checkbox"/>	Beebcalc	£19.95	<input type="checkbox"/>
			Dragoncalc	£19.95	<input type="checkbox"/>

Name _____
 Address _____
 Machine Type _____ Memory Size _____
 I enclose _____
 Make cheques and postal orders payable to Gemini Marketing Ltd.
 Diners Card Number _____ Access Number _____
 Signature _____



Gemini. Functional Software Specialists, 9 Salterton Road, Exmouth, Devon EX8 2QG



AU4



RECURSION, OR HOW TO GET A PROCEDURE TO CALL ITSELF

```

10 X=0
20 PROC_recur
30 END
40 DEFPROC_recur
50 X=X+1
60 PRINTX
70 PROC_recur
80 ENDPROC
    
```

Program 2. Procedure recursion

```

10 X=0
20 PRINTFN_recur
30 END
40 DEFFN_recur
50 X=X+1
60 PRINTX
70 PRINTFN_recur
80 =X
    
```

Program 3. Function recursion

BACK to procedures and functions. Can a procedure or function call itself? The answer is 'yes' and the process is called recursion. It is useful to know how many times a function or procedure can call itself in a recursive loop.

Running program 2 shows how many times a procedure can call itself. The maximum number of times this can happen depends on how many procedures are in memory, each one reduces the number of times any particular procedure can call itself. Now add line 65:

```
65 IF X=1930 THEN ENDPROC
```

This stops the recursion when X is 1930 (almost the maximum number

of times the procedure can call itself). There is a short delay when the condition of line 65 is true, because the program has to 'ENDPROC' down 1930 levels of recursion to conclude the procedure.

We can try the same technique with a defined function. Look at program 3 and run it to check on the number of times a function can call itself. As with procedures the maximum number of recursive calls depends on how many other functions coexist in the program. Adding line 65:

```
65 IF X=930 THEN =X
```

demonstrates visually the 'domino' effect of returning from the 930th recursive call.

Why use recursion? Well, let's consider the problem of finding the factorial of a number. Figure 1 shows the calculations required for factorials. How can this be coded in Basic for the BBC micro? The problem is that the sequence cannot easily be expressed as a formula and, therefore, the solution to the problem may be more easily found by a repetitive algorithm. Program 4 is one possible solution. This is probably acceptable to most users, though it requires variables and would need fitting into a procedure for regular use. Some would consider program 5 an improvement. It is about the same length as program 4 but includes the function, already defined. It should be easy to follow, as the only complicated line is line 50 which simply says:

'While the number you are at (n) is more than 0, multiply F by it, calling the answer F, and reduce the number by 1 then repeat this line with the new number you have reached.'

Perhaps not so simple? Anyway, the best way to become used to recursion is to do it again and again and ...

Now that the number of disk users are increasing, we need to produce some library routines, which will run as self-contained units in any program. I now offer some possibilities to start libraries

```

10 F=1:n=5
20 FOR i= n TO 1 STEP-1
30 F=F*i
40 NEXT i
50 PRINT F
    
```

Program 4. Factorials from loops

```

10 F=1
20 PRINTFN_factorial(5)
30 END
40 DEFFN_factorial(n)
50 IF n>0 F=F*n:=FN_factorial(n-1)
60 =F
    
```

Program 5. Factorials from recursion

Factorial	Calculation	Answer
1	1	1
2	2 * 1	2
3	3 * 2 * 1	6
4	4 * 3 * 2 * 1	24
5	5 * 4 * 3 * 2 * 1	120
..
..
..
n	n * n-1 * n-2 * n-3 1	???

Figure 1. Factorial calculations

```

8300 DEFPROC_backing(x$)
8310 LOCAL j%
8320 CLS
8330 FOR j%= 0 TO 24
8340 PRINTTAB(0,j%);x$;CHR$157;
8350 NEXT
8360 VDU30
8370 ENDPROC

```

Program 6. Mode 7 background

```

8000 DEFPROC_db1ht(x$,x,y)
8010 PRINTTAB(x-1,y);CHR$(141);x$
8020 PRINTTAB(x-1,y+1);CHR$(141);x$
8030 ENDPROC

```

Program 7. Double-height characters

```

8100 DEFPROC_delay(time)
8110 LOCAL z
8120 z=TIME+(time*100)
8130 REPEAT UNTIL TIME>=z
8140 ENDPROC

```

Program 8. Delay procedure

```

8200 DEFPROC_space
8210 PRINTTAB(7,24);
8220 PRINT"Press SPACE to continue";
8230 *FX15.1
8240 REPEAT UNTIL GET=32
8250 ENDPROC

```

Program 9. Space bar move procedure

off. They need *SPOOLing to disc so that they can be EXECed at a later date.

If a routine is to provide a value needed in the main body of a program then that routine should be defined as a function. If the routine is doing something which doesn't need a value returned, then the routine may be defined as a procedure. Generally speaking, a function can do anything which a procedure can, though the reverse is not necessarily the case.

Look at program 6, which is a procedure intended to clear a mode 7 screen to a required background colour. The effect appears almost instantaneously, and is very effective.

The procedure is called by a line such as

```
PROC_backing(CHR$130)
```

The CHR\$130 can be reduced to the key sequence (quotes SHIFT-f2 quotes> on machines with OS 1.00 or later. The shifted function keys and related colours are given in the *User Guide* on page 439. The basic idea of the routine is to print the colour character transmitted as a parameter (x\$) down the left-hand side of the screen. This is followed by the teletext control character 157, which turns the background for that line to the colour preset by x\$. Remember that if you print on any line after calling this procedure that the first two positions in each row must not be overwritten or the background for that line will vanish. Note also that any text will need to be preceded by a colour character. For example, following the procedure call with

```
P."Hello Cheeky"
```

will destroy the background effect, while

```
P.TAB(2,0);"Hello Cheeky"
```

would be invisible. Success is

```
P.TAB(0,2);CHR$129"Hello Cheeky"
```

which shows up as red lettering, unless you have selected a red background. Note that this clumsy CHR\$129 can be avoided by shifted function keys. For example, in

```
P.TAB(0,2);"rHello Cheeky"
```

where the first 'r' indicates a character formed by pressing SHIFT-f1.

Program 7 is a very simple procedure which prints double-height characters at any point on the mode 7 screen. The information is passed in three parameters:

- x\$ - the string to print (which might be prefixed by a colour code);
- x - the column position of the start of the string;
- y - the row position of the string.

A possible calling line might be:

```
PROC_db1ht("Hello Cheeky",14,12)
```

which would print a double-height message centrally on the screen.

Looking at the routine, the x-1's of lines 8010 and 8020 are there so that the x value transmitted is actually the start of the string. This is because the double-height on character, CHR\$141, is issued just before the string. It is also possible to print double-height numbers by converting them to strings:

```
Number = 12 * 8
```

```
PROC_db1ht(STR$(Number),10,2)
```

will print 96 in double-height numbers at TAB(10,2). One value of such simple procedures as that there is a saving on space within the program. If users need double-height lines more than three times in a program then the double-height routine can save memory. In a long program, such a simple routine could save hundreds of bytes.

Program 8 is another short routine which does nothing for a specified time. Calling the procedure:

```
PROC_delay(.5)
```

will cause the program to hesitate during its execution by a half second. Any time from 0.01 seconds to millions of seconds could be passed as a parameter, though at 0.01 seconds the procedure is inaccurate, because of the time taken in calling the routine. As the delay required increases, so the accuracy improves, and is acceptable for normal delays, say 0.25 seconds upwards.

Delays in a program are useful, but it is often better to let a program progress at the rate of its user, (this is particularly true with children using programs, as they need to think and re-read text).

Look at Program 9 which is called by the line:

```
PROC_space
```

and prints the message "Press SPACE to continue" in the centre of the bottom line of the mode 7 screen. The current buffer is flushed by line 8230 but

experiment with *FX15,0 or *FX21,0. Altering the program to run in any mode is simply a matter of changing the numbers 7 and 24 in line 8120 to centre text on the last line of the screen.

Remembering the comments about functions being used to return a value to the program, one useful library routine which could be coded as a function is the general purpose input routine (GPIR) of program 10. The MEP project maintains that a GPIR is a concept rather than a particular routine, and so the version presented is only one realisation. Users should provide their own versions.

Rather than explore this function line by line, I will describe how to use it, and what features are available.

Value	result
0	No effect
1	Convert to Upper Case
2	Convert to Lower Case
3	Capitalizes 1st letter of names

Figure 2. Results of 'effect' parameter

A possible calling line would be:

```
month=FN_gpi(2,2,"0123456789")
```

which says get a two-digit number from the digits available in quotes and place it into the variable 'month'.

The benefits of the routine are:

- It operates at any point on the screen (you *must* tab to the required position first).
- Only the number of characters set by the first parameter (len)

are accepted, though it is possible to delete back through the string.

- Problems associated with the input command are automatically overcome.
- End of text entry field is signalled by sound, as are unacceptable characters.
- The range of valid characters can be set on entry to the routine.
- Special effects are featured to control input, using the effect parameter.

Let's examine each parameter in turn. First 'len'. This value tells the function how many characters are allowed in the text entry field. Each possible character is marked by a dot, over which characters may be typed. The dots re-appear on deleting. Any attempt to enter more than the number of characters set by len is ignored, though there is a short beep. Exit from the GPIR is only after pressing return.

The next parameter is 'effect'. This may be a value from 0 to 3 inclusive. It alters each character as it is typed at the keyboard using figure 2.

The last parameter is 'valid\$', a [page 72](#)

```

10 ON ERROR GOTO 90
20 MODE4
30 REM MAIN PROGRAM
40 REPEAT
50 CLS
60 INPUT LINE"Procedure name: "Q$
70 UNTIL NOT EVAL ("FN_" + Q$)
80:
90 IF ERR (<) 29 THEN MODE 7:
REPORT:PRINT " at ";ERL:END
100:
110 PRINT"Sorry, Procedure
";Q$;" doesn't exist"
120:
130 IF FN_ready THEN 30
140 END
150:
160 REM define Procs from here.
180 DEFFN_SQUARE
190 MOVE 200,200
200 DRAW 400,200
210 DRAW 400,400
220 DRAW 200,400
230 DRAW 200,200
240 =FN_ready
260 DEFFN_TRIANGLE
270 MOVE 200,200
280 DRAW 400,200
290 DRAW 300,300
300 DRAW 200,200
310 =FN_ready
330 DEFFN_OBLONG
340 MOVE 200,200
350 DRAW 800,200
360 DRAW 800,500
370 DRAW 200,500
380 DRAW 200,200
400 DEFFN_ready
410 PRINT"SPACE continues
- any other exits"
420 =GET=32
    
```

Program 11. Elegant PROC calls

```

9000 DEFFN_gpi(len,effect,valid$)
9010 LOCALa$,b
9020 a$=""
9030 PRINTSTRING$(len,".");STRING$(len
+1,CHR$(8));" ".*FX15,1
9040 b=GET:IF b=13 THEN =a$
9050 IF b=127 AND a$="" THEN 9040
9060 IF b=127 a$=LEFT$(a$,LEN(a$)-1):
PRINTCHR$b;". ";CHR$(8);:GOTO9040
9070 IF effect=0 THEN9100
9080 IF effect=1 b=b AND 223 ELSE
b=bOR32
9090 IF effect=3 AND(RIGHT$(a$,1)=" "
OR a$="") b=b AND 223
9100 IF LEN(a$)=len OR
INSTR(valid$,CHR$b)=0 VDU7:GOTO9040
9110 PRINTCHR$b;:a$=a$+CHR$b:GOTO9040
    
```

Program 10. Possible GPIR

LEOsoft

B B C B B C B B C B B C B B C B B C B B C B B C B B C B B C B B C B B C B B C B B C B B C B B C

EASYFILE

A general purpose card index filing system on tape, stores up to 500 files within the program (no messy data tapes to load). Menu prompt driven with user definable field width, file length etc. (A or B) £6.95

BANK

Keep track of your bank accounts with this easy to use bank statement generator. Automatic insertion of standing orders. Standard Bank format Hardcopy (with any printer). Over 500 transactions can be stored with this single loading program on tape. (A or B) £6.95

CASH BOOK

A complete cash book ledger system with daily takings register (in three categories), displays and prints weekly balance sheet with bankings, drawings, wages, VAT etc. Petty cash register with search and print accounting summaries. Hardcopy options include VAT period ending summary, petty cash summary, balance sheet etc. Too many features to list here. This single loading program stores complete VAT period cash transactions on tape. A must for the small businessman. £19.95 (B only)

EDUCATIONAL FUNCTION PLOTTER

Plots sin, cos, tan, log, quadratic, cubic, in fact an almost unlimited range of maths functions can be plotted. Multi colour overlay allows comparison of functions. ZOOM facility allows closer inspection of important features. This program is a must for the study of maths functions to "O" level and beyond. (B only) £9.95

All the above programs are available "NOW" with full documentation.

LEOsoft (Devon), 65 New Road, Brixham, Devon. Telephone Brixham 3159

B B C B B C B B C B B C B B C B B C B B C B B C B B C B B C B B C B B C B B C B B C



Newnes Book of Personal Computing

Edited by Philip Chapman

- * Written by a team of well known specialists
- * A non-technical introduction for the layman
- * Well illustrated

Whether you are interested in personal computing for education, business or hobby— or whether you simply want to know what all the fuss is about!—**Newnes Book of Personal Computing** will lead you gently through the micro minefield. The book has been specially written for those with no previous technical knowledge and aims to introduce you to the fascinating world of personal computing in a readable and friendly way.

Personal computer hardware, programming, applications and future possibilities are all covered by our experienced team of writers, each of whom deals with one aspect of personal computing.

0 408 01320 6 128 pages £6.95

N Newnes Technical Books—an imprint of
Butterworth & Co (Publishers) Ltd
Borough Green, Sevenoaks, Kent TN15 8PH

Contents:

The World of Personal Computing . Henry Budgett
Personal Computers in the Home . Ian Graham
Personal Computers for Learning . Eric Deeson
Personal Computers in Business . David Tebbutt
BASIC for Personal Computers . A P Stephenson
Personal Computer Programming Languages . Garry Marshall
A Look Inside . Ian Sinclair
Where next for Personal Computers? . Mike James
Glossary of Terms
User Groups and Clubs
Directory of Manufacturers and Suppliers
Index

What do you do if your BBC Micro goes wrong?

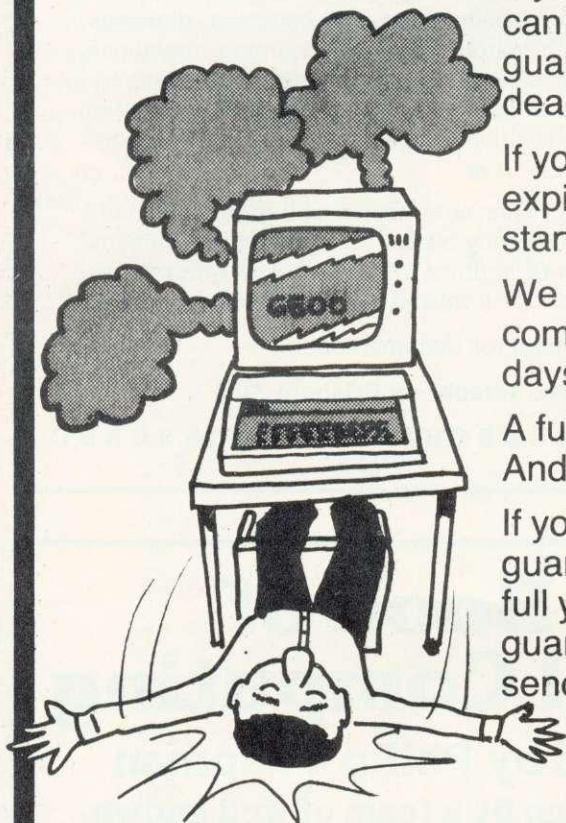

If you value your BBC Micro and your money you can now purchase extra one and two year full guarantees direct from us or via most Acorn dealers.

If your Micro is still under warranty, just fill in the expiry date on the coupon* and the guarantee will start from that date.

We carry a full stock of parts and should your computer malfunction we will repair it within five days of receipt.

A full one year guarantee costs just **£18.40**
And a full two year guarantee costs just **£27.60**

If your Micro is already faulty, and out of guarantee, we will repair it on receipt and issue a full years guarantee for **£29.90** or a full two years guarantee for **£39.10**. Please state fault when sending micro.

For you and your BBC Micro's peace of mind send the coupon today

Please tick service required.

I enclose **£18.40** for a full 1 years guarantee

I enclose **£27.60** for a full 2 years guarantee

I enclose **£29.90** for an immediate repair and a full 1 years guarantee

I enclose **£39.10** for an immediate repair and a full 2 years guarantee

Surname

Initials

Address

.....
or telephone your access card number to Madingley 210212

Access Card No

Make/Model A/B

Serial No.

Send remittance to:

**Cambridge Processor Services,
25 Parsonage Street, Dept. A
Cambridge CB5 8DN.**

Warranty Expiry*
Date / /83
If applicable

This offer applies to mainland UK only

This guarantee does not apply to major damage caused by abuse.

THE BEEB COMPOSES

Jim McGregor and Alan Watt explain how to compose any style of music using a BBC micro. Their programs analyse style and generate rhythm structures and pitch values from the results

Music has been called a compromise between chaos and monotony. Program 1 provides an example of chaos and program 2 three examples of well-organised monotony. For a computer to compose interesting music, there must be some degree of each involved, and it must satisfy certain rules that make it recognisable.

Random music is not necessarily unpleasant, particularly if the texture of the music is controlled. Program 3 illustrates this point and plays music selecting two random numbers to direct the pitch and duration in a sound statement. Superimposed on this basic method are three effects:

- an echo (two sound statements referencing separate envelopes);
- a glissando or slide (*de rigueur* in arcade games) at pseudo-random instants;
- pitch distortion at pseudo-random instants.

The net effect is not uninteresting. The pitch distortion is inserted by changing the parameters in a

single envelope statement. In this case, we could have used two envelope statements with different parameters and selected, but the setting and resetting of envelope parameters (PROCpitchset and PROCpitchreset) is the structure required for dynamically changing envelope parameters and back again in a playing loop.

Rhythm is a very important component of all music. Indeed in some primitive cultures, music consists of rhythm and very little else. We examine ways of making a

computer generate a rhythmic structure that is similar to that of a simple folk tune.

In music, rhythm is concerned with the grouping of notes into beats, of beats into bars, bars into phrases and so on. In the *Oxford Companion to Music*, the entry under 'phrase' states that any simple four line hymn or folk tune falls clearly into two halves or 'sentences'. Each sentence falls into two phrases and each phrase normally consists of four bars (although this is sometimes varied). We shall use this simple model for our first attempts at automatic composition.

To a computer scientist or linguist, the above description suggests the use of a 'generative grammar' to describe the structure of a piece of music. Such grammars are used extensively by computer scientists to describe the structure of programming languages. In this case we might start with the rule:

TUNE ::= SENTENCE SENTENCE

which we read as 'a tune consists

```

10 ENVELOPE 1,1, 0,0,0,0,0,0,
    126,-4,0,-63,126,100
20 ENVELOPE 2,1, 0,0,0,0,0,0,
    63,10,0,-63,63,110
30 ENVELOPE 3,1, 0,0,0,0,0,0,
    126,-8,0,-10,126,50
40 FOR note=1 TO RND(100)
50   channel = RND(3)
60   envelope = RND(3)
70   pitch = RND(256)-1
80   duration=RND(32)
90   SOUND channel,envelope,pitch,duration
100 NEXT note

```

Program 1. Chaos

```

10 ENVELOPE 1,1, 0,0,0,0,0,0,
    126,-4,0,-63,126,100
20 ENVELOPE 2,1, 0,0,0,0,0,0,
    63,10,0,-63,63,110
30 ENVELOPE 3,1, 0,0,0,0,0,0,
    126,-8,0,-10,126,50
40 FOR note = 1 TO 20
50   SOUND 1,1,53,8
60 NEXT note
70 key=GET
80 FOR pitch=53 TO 101 STEP 4
90   SOUND 1,1,pitch,8
100 NEXT pitch
110 key=GET
120 FOR phrase = 1 TO 10
130   SOUND 1,1,53,8
140   SOUND 1,1,69,8
150   SOUND 1,1,81,8
160   SOUND 1,1,101,8
170 NEXT phrase

```

Program 2. Monotony

```

10 ENVELOPE 1,1, 0,0,0,0,0,0,
    126,-4,0,0,126,100
20 ENVELOPE 2,1, 0,0,0,0,0,0,
    63,-4,0,0,63,50
30 prevnote = 0
40 FOR I = 1 TO 100
50   note = RND(255)
60   IF note MOD 11 = 0 THEN PROCslide(prevnote,note)
70   IF note MOD 7 = 0 THEN PROCpitchset
80   SOUND 1,1,note,RND(8)
90   SOUND 1,2,note,RND(8)
100  prevnote = note
110  PROCpitchreset
120 NEXT
130 END

```

```

140 DEFPROCslide(Old,new)
150 IF old>new THEN step = -1 ELSE step = 1
160 SOUND &1001,0,0,0
170 FOR i = old TO new STEP step
180   SOUND &1001,0,0,0
190   SOUND &11,1, i, 2
200   PROCpitchreset
210 NEXT
220 ENDPROC

```

```

230 DEFPROCpitchset
240 pi1 = 16:pi2 = -16: pi3 = 16
250 pn1 = 2: pn2 = 4: pn3 = 2
260 ENVELOPE 1,1, pi1,pi2,pi3,pn1,pn2,pn3,
    126,-4,0,0,126,100
270 ENDPROC

```

```

280 DEF PROCpitchreset
290 ENVELOPE 1,1, 0,0,0,0,0,0,
    126,-4,0,0,126,100
300 ENDPROC

```

Program 3. Random stroll



```

10 ENVELOPE 1,1, 0,0,0,0,0,0,
    126,-8,0,-63,126,50
20 ENVELOPE 2,1, 0,0,0,0,0,0,
    100,-8,0,-80,100,50
100 INPUT "Beats per bar",timesig
110 INPUT "Minimum note",minnote
120 PROCtune
130 END

200 DEF PROCtune
210 PROCsentence
220 PROCsentence
230 ENDPROC

240 DEF PROCsentence
250 PROCphrase
260 PROCphrase
270 ENDPROC

280 DEF PROCphrase
290 LOCAL bar
300 FOR bar=1 TO 3
310 PROCbar(minnote)
320 NEXT bar
330 PROCbar(16)
340 ENDPROC

350 DEF PROCbar(minfinish)
360 envelope = 1
370 beatsleft=timesig
380 REPEAT
390 PROCselectgroup

400 IF beatsleft=0 THEN PROCsubdividegroup(minfinish)
    ELSE PROCsubdividegroup(minnote)
410 FOR note=1 TO nextgroup DIV duration
420 PROCplaynote
430 NEXT note
440 UNTIL beatsleft=0
450 ENDPROC

460 DEF PROCselectgroup
470 LOCAL g,timeleft
480 timeleft=beatsleft*8
490 IF beatsleft=1 OR timeleft=minfinish THEN
    nextgroup=timeleft:beatsleft=0:ENDPROC
500 REPEAT:g=RND(beatsleft)
510 UNTIL beatsleft-g=0 OR timeleft-g*8>=minfinish
520 nextgroup=g*8
530 beatsleft=beatsleft-g
540 ENDPROC

550 DEF PROCsubdividegroup(mindur)
560 IF nextgroup=mindur OR nextgroup MOD mindur<>0 THEN
    duration=nextgroup:ENDPROC
570 REPEAT
580 duration=2RND(5)
590 UNTIL nextgroup MOD duration=0 AND duration>=mindur
600 ENDPROC

610 DEF PROCplaynote
620 pitch=53
630 SOUND 1,envelope,pitch,duration
640 envelope=2
650 ENDPROC

```

Program 4. Syntax generated hythm

of a sentence followed by another sentence'. We could then go on to define

```

SENTENCE ::= PHRASE PHRASE
PHRASE ::= BAR BAR BAR BAR

```

or we might decide that the last bar of a phrase should have a different structure from the other bars. Thus

```

PHRASE ::= BAR1 BAR1 BAR1 BAR2

```

where a BAR2 will have a different definition from a BAR1. Rules like these are usually referred to as 'rewrite rules'.

A more complicated example of a musical grammar might start off with

```

PIECE ::= SONATA | RONDO |
        FUGUE

```

The sign '|' is read as 'or'. The rewrite rule states that a piece is either a sonata or a rondo or a fugue. The definition might continue with

```

SONATA ::= EXPOSITION
          DEVELOPMENT
          RECAPITULATION

```

Simple rewrite rules provide a concise notation for describing the structure of language or music, but they have many limitations and the system has to be 'augmented' for more advanced applications.

Returning to our simple folk-tune example, the structure of the rules constituting the grammar can be directly reflected in the structure of a Basic program that generates a

piece of music from the grammar. In program 4, the rule defining a tune has been transcribed directly into a procedure that generates a tune.

```

DEF PROCtune
  PROCsentence
  PROCsentence
ENDPROC

```

Corresponds to rule

```
TUNE ::= SENTENCE SENTENCE
```

PROCsentence is defined similarly. These two procedures could have been combined into one, a tune being defined as four phrases, but it is always advisable to maintain a procedure structure that reflects the structure of the process being modelled. We may decide later that the first sentence in a tune should have a slightly different structure than the second. Defining a tune in terms of sentences and a sentence in terms of phrases will make it easier to incorporate changes like this.

PROCphrase is defined in a similar way. It makes three identical calls of PROCbar and then a fourth call of PROCbar to generate the last bar of the phrase. The type of bar to be generated has been indicated by a parameter.

```

DEF PROCphrase
  LOCAL bar
  FOR bar=1 TO 3
    PROCbar(minnote)
  NEXT bar

```

```

PROCbar(16)
ENDPROC
Corresponds to rule
PHRASE ::= BAR1 BAR1 BAR1
          BAR2

```

The parameter indicates the minimum duration permitted for the final note of the bar and we have created the last bar of a phrase (a BAR2) by supplying a different parameter, 16. This indicates that the bar generated by this call should have a final note of duration at least 16 time units, ie a minim. (A semibreve has duration 32, a minim 16, a crotchet 8 and so on - see April's *Acorn User*). Forcing a phrase to end with a longish note gives an impression of rounding off the phrase. The first three bars of a phrase are allowed to terminate with the shortest permitted note available for the tune being composed. This value is called 'minnote' and is input to program 4 as a parameter. The value input determines the overall 'tempo' of the piece.

The 'grammar' of a bar will depend on the number of beats in a bar (another input parameter). For example, in 2/4 time, we could have

```

BAR1 ::= CROTCHETGROUP
         CROTCHETGROUP |
         MINIMGROUP

```

A bar can be a group of notes equivalent to a crotchet followed by another crotchet group, or a bar can consist of a group of notes

equivalent to a minim, we shall not allow note groupings to cut across the 'beat' structure of the bar. We could define

CROTCHETGROUP ::= 

assuming a semiquaver as the minimum permitted note (duration = 2). For convenience, we insist that notes in a group all have the same duration. We do not permit

CROTCHETGROUP ::= 

A minim group is defined as

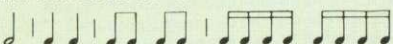
MINIMGROUP ::= 

Recall that we require a phrase to terminate with at least a minim. With two beats to the bar, this means

BAR2 ::= 

The complete grammar for 2/4 time is listed in figure 1. The whole process of generating a sequence of symbols (in this case notes of a certain duration) using rewrite rules can be viewed as a tree structure. Using choice where choice is available we could generate the tree shown in figure 1. This particular tree is just one of a large number that could be generated from the rewrite rules. BAR1 and BAR2 would be defined slightly differently if we had three or four (or more) beats to the bar. The definitions of BAR1 and BAR2 are implemented in a fairly *ad hoc* fashion in PROCbar in program 4.

The procedure repeatedly chooses a group consisting of a random number of whole notes less than or equal to the number of beats left to be played, subject to the constraint imposed by the 'minimum last note' parameter. Each group chosen is then split into an equal number of notes whose duration divides into the group chosen and whose duration is less than or equal to the minimum permitted duration. The notes of the group are then played (all on middle C).

One further enhancement that assists the listeners' perception of rhythm is to use a slightly louder envelope for the first note of a bar than that used for the remaining notes of the bar.

Listen to some of the output from program 4 and you will find that the 'sentence', phrase, bar and beat

```
TUNE ::= SENTENCE SENTENCE
SENTENCE ::= PHRASE PHRASE
PHRASE ::= BAR1 BAR1 BAR1 BAR2
BAR1 ::= CROTCHETGROUP CROTCHETGROUP | MINIMGROUP
CROTCHETGROUP ::= 
MINIMGROUP ::= 
BAR2 ::= 
```

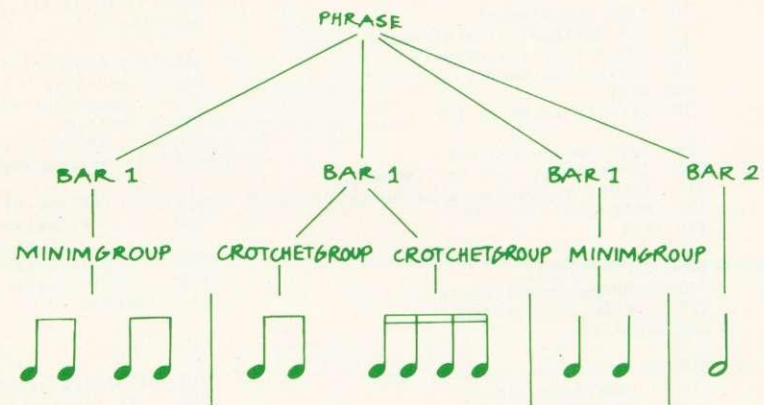

Figure 1. Grammar for 2/4 rhythm and part of sample once generated

major	53, 61, 69, 73, 81, 89, 97, 101
diminished	53, 57, 65, 69, 77, 81, 89, 93, 101
blues	53, 65, 73, 77, 81, 93, 101
Hindu	53, 61, 69, 73, 81, 85, 93, 101
whole tone	53, 61, 69, 77, 85, 93, 101
dorian minor	53, 61, 65, 73, 81, 89, 93, 101
aeolian minor	53, 61, 65, 73, 81, 85, 93, 101
harmonic minor	53, 61, 65, 73, 81, 85, 97, 101
pentatonic	53, 61, 69, 81, 89, 101
major arpeggio	53, 69, 81, 101

Table 1. Scales with sample pitch codes

structure is usually fairly evident.

We now turn our attention to the pitch of the notes played in the tune.

A particular piece of music (or at least a section of a piece of music) is usually confined to notes taken from a set of notes that are closely related to each other in some way. The set of notes, or 'scale', used contributes in a large way to the character of the music. Table 1 gives some scales and arpeggios together with sample sequences of pitch codes based on middle C. We can easily alter our rhythm on middle C program so that it selects random notes from a particular scale. Program 5 indicates the modifications needed to do this. The data statement at line 80 defines the number of notes and the pitch values for the scale used,

in this case a major arpeggio.

One further addition has been made to this program. A new parameter is passed to each of PROCsentence, PROCphrase and PROCbar to indicate whether it is the final example of that construction in the tune. This enables the program to recognise the last note and constrain it to fall on the keynote of the scale.

Try running the program with notes taken from the major arpeggio and you will obtain a moderately pleasing if rather monotonous effect. Then try some of the other scales listed above.

We shall now use notes taken from the scale of C major extended downwards by three notes to lower G and up one note to upper D.

Once the set of notes (the key) on which a tune will be played has

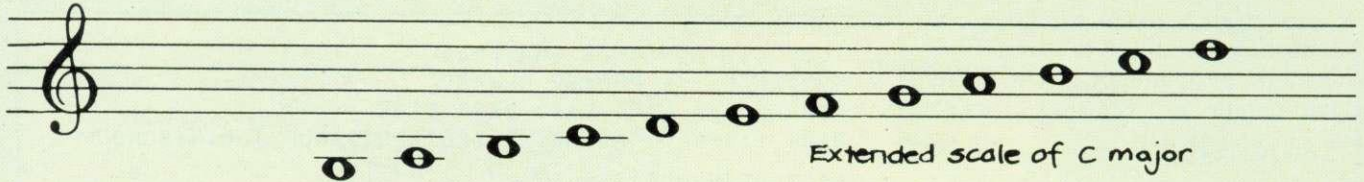

Extended scale of C major

```

10 ENVELOPE 1,1, 0,0,0,0,0,0,
126,-4,0,-63,126,100
20 ENVELOPE 2,1, 0,0,0,0,0,0,
100,-4,0,-80,100,80

30 READ scalelength
40 DIM scalenote(scalelength)
50 FOR n=1 TO scalelength
60 READ scalenote(n)
70 NEXT
80 DATA 4, 52,69,81,101

90 keynote=scalenote(1)
100 INPUT "Beats per bar",timesig
110 INPUT "Minimum note",minnote
120 PROCtune
130 END

200 DEF PROCtune
210 PROCsentence(FALSE)
220 PROCsentence(TRUE)
230 ENDPROC

240 DEF PROCsentence(finalsent)
250 PROCphrase(FALSE)
260 PROCphrase(finalsent)
270 ENDPROC

280 DEF PROCphrase(finalph)
290 LOCAL bar
300 FOR bar=1 TO 3
310 PROCbar(minnote,FALSE)
320 NEXT bar
330 PROCbar(16,finalph)
340 ENDPROC

350 DEF PROCbar(minfinish,finalbar)
360 envelope = 1
370 beatsleft=timesig
380 REPEAT
390 PROCselectgroup
400 IF beatsleft=0 THEN PROCsubdividegroup(minfinish)
ELSE PROCsubdividegroup(minnote)
410 FOR note=1 TO nextgroup DIV duration
420 PROCplaynote(note=nextgroup DIV duration AND
beatsleft=0 AND finalbar)
430 NEXT note
440 UNTIL beatsleft=0
450 ENDPROC
:
:
610 DEF PROCplaynote(finalnote)
620 IF finalnote THEN pitch=keynote
ELSE pitch=scalenote(RND(scalelength))
630 SOUND 1,envelope,pitch,duration
640 envelope=2
650 ENDPROC
    
```

Program 5. Rhythm with random notes from a scale

been determined, there are a number of further constraints that can be applied to make a tune mimic a particular style as certain notes and combinations of notes will be more common than others.

One way of making our program select pitch values more systematically is to make it use probability distributions when selecting the pitch of a note to be played. The simplest (and least satisfactory) type of distribution that can be used is the first order probability distribution.

Table 2 shows the result of a 'first order analysis' of nine simple

well-known tunes taken from a child's recorder tutor (*Baa Black Sheep, Bobby Shaftoe*, etc). If we imagine all these tunes being played in C major, on the 12 notes from lower G to upper D, then the figures in table 2 give, as percentages, the relative frequency of occurrence of each note over the nine tunes analysed. (These were produced by program 9.)

We now generate a note so that the probability of getting a particular note matches its entry in table 2. The tunes generated by doing this will not be much better than those obtained by choosing a

random note from the scale, but the basic technique used is easily extended.

First set up an array containing the percentages in table 2. In order to select a note, we generate a random number in the range 0 to 100 and add up values from the array until the total exceeds the random number generated (see figure 2). The number of percentages added determines the note from the scale that is selected. This approach is implemented in program 6.

Note sequences are much more important in composing melodies, and if we want to constrain the note sequences that are chosen by our program, then consider higher order probabilities.

The use of second order probability distributions makes the choice of a note dependent on the preceding note.

Table 3 shows second order distributions resulting from analysis of our nine simple tunes. One row in this table corresponds to one of our notes and the entries in a row give the percentage of occasions on which each of the other notes followed the note to which the row corresponds. For example, row one indicates that lower G is followed

	g	a	b	c	d	E	F	G	A	B	C	D
	3.4	0.7	3.4	15.0	12.6	13.8	8.5	14.3	8.0	11.1	6.3	2.9

Table 2. First order note probabilities

	g	a	b	c	d	E	F	G	A	B	C	D
g	42.9	0.0	0.0	28.6	14.3	7.1	0.0	7.1	0.0	0.0	0.0	0.0
a	0.0	0.0	66.7	0.0	33.3	0.0	0.0	0.0	0.0	0.0	0.0	0.0
b	21.4	0.0	7.1	50.0	21.4	0.0	0.0	0.0	0.0	0.0	0.0	0.0
c	0.0	0.0	12.7	40.0	14.5	18.2	10.9	3.6	0.0	0.0	0.0	0.0
d	7.7	0.0	7.7	26.9	28.8	13.5	9.6	5.8	0.0	0.0	0.0	0.0
E	0.0	3.5	0.0	17.5	26.3	21.1	14.0	17.5	0.0	0.0	0.0	0.0
F	0.0	2.9	0.0	0.0	20.0	45.7	8.6	22.9	0.0	0.0	0.0	0.0
G	0.0	0.0	0.0	3.5	1.8	15.8	21.1	22.8	31.6	0.0	1.8	1.8
A	0.0	0.0	0.0	0.0	0.0	0.0	3.0	24.2	18.2	48.5	0.0	6.1
B	0.0	0.0	0.0	0.0	0.0	0.0	0.0	13.0	13.0	43.5	23.9	6.5
C	0.0	0.0	0.0	0.0	0.0	3.8	0.0	3.8	3.8	30.8	42.3	15.4
D	0.0	0.0	0.0	0.0	0.0	0.0	0.0	33.3	16.7	8.3	25.0	16.7

Table 3. Second order probabilities

```

10 ENVELOPE 1,1, 0,0,0,0,0,0,
    126,-4,0,-63,126,100
20 ENVELOPE 2,1, 0,0,0,0,0,0,
    100,-4,0,-80,100,80

30 READ scalelength
40 DIM scalenote(scalelength)
50 FOR n=1 TO scalelength
60   READ scalenote(n)
70 NEXT
80 DATA 12, 33,41,49,53,61,69,73,81,89,97,101,109
90 keynote=scalenote(4)

100 PROCsetupfreqtable1
110 INPUT "Beats per bar",timesig
120 INPUT "Minimum note",minnote
130 notesplayed=0
140 PROCtune
150 END
.
.
.
610 DEF PROCplaynote(finalnote)
620   IF finalnote THEN pitch=keynote
    ELSE PROCselectpitch1
10010 DATA 3.4,0.7,3.4,15.0,12.6,13.8,8.5,14.3,8.0,11.1,6.3,2.9

```

Program 6. First order tunes

by another lower G on 42.9 per cent of occasions by middle C on 28.6 per cent of occasions by D next to middle C on 14.3 per cent of occasions, by E on 7.1 per cent of occasions and by upper G on 7.1 per cent of occasions.

The modifications to the previous program needed to generate notes according to the second order probability distributions are presented in program 7. The first note of the tune is generated using the previous one, and from then on, a note is generated according to the probabilities in the row of table 3 that corresponds to the previous note played. Using this method eliminates the occasional violent leaps in pitch that occurred with the previous version of the program. The entries in table 3 associated with such violent leaps are mostly 0.

The use of second order probability thus encourages the program to use commonly acceptable pitch intervals between consecutive notes.

If we want the program to use commonly-used sequences of notes, we can move on to third order distributions where the probability of choosing a note will depend on the two previous notes played. This makes a marked improvement to the sequences generated. We leave you to think about the details.

In case you want to analyse your own favourite type of music, we present program 8 which was used to generate the distributions of tables 2 and 3 together with the data for one tune (*Baa Baa Black*

	(1)	(2)	(3)	(4)	(5)	(6)	(7)	(8)	(9)	(10)	(11)	(12)
freq 1	3.4	0.7	3.4	15.0	12.6	13.8	8.5	14.3	8.0	11.1	6.3	2.9

rand=RND(1)*100 Say, for example, rand=43.5. Then the first six values in freq1 added before we obtain a total that exceeds 43.5. This means that we play the sixth note in the scale.

pitch=scalenote(6)

Figure 2. Selecting a note by probability distribution

Sheep). The string at the start of the data for a tune establishes the range of notes for the tune starting three notes below the keynote. There then follow the names of the notes in the tune in the order in which they appear. The program prints the tables in the form of data statements numbered from 10000 upwards that can be absorbed into another program. To do this, type

```

*SPOOL "freqtables"
RUN
*SPOOL

```

and the data statements for the tables will be stored on cassette. These can be added to any program by typing *EXEC "freqtables".

If you want to analyse music that includes accidentals, then you will have to invent your own nomenclature for the notes involved and extend the program accordingly. You can make music more like the original by using higher probability orders, but as it becomes more like the target style it becomes less original.

Finally we return to letting the computer do its own thing and get it to play some 12 bar blues. Program 9 plays or improvises on 12 bar blues. It does not use probability tables but selects notes

from two jazz blues scales (Bb and Eb, data statement 670). It uses a rhythmic chordal accompaniment and the three voices are synchronised using the technique in April's *Acorn User*, where we described how PROCinitialise, PROCharmonise and PROCsound work. Voices two and three are loaded up into rows two and three of the three row pitch and duration arrays, and a simple blues chord progression is taken from data statements 560 to 590. PROCjazz initialises row one of this array by randomly selecting starting notes for a phrase from the appropriate scale. The rhythm for a phrase is randomly selected from data statements (1091 onwards).

The creative part of the program could be significantly improved:

- The intervals used in the phrases are all major or minor seconds and could be varied.
- Rests or gaps of silence should be introduced as space is very important in music.
- Fast note phrases used consecutively should be followed by a long note.
- Repetition of a phrase should be occasionally introduced.



```

100 PROCsetupfreqtable1
101 PROCsetupfreqtable2
.
.
.
610 DEF PROCplaynote(finalnote)
620 IF finalnote THEN pitch=keynote
ELSE IF notesplayed=0 THEN PROCselectpitch1
ELSE PROCselectpitch2
.
.
.
840 DEF PROCsetupfreqtable2
850 LOCAL l,n
860 DIM freq2(12,12)
870 FOR l=1 TO 12
880 FOR n=1 TO 12
890 READ freq2(l,n)
900 NEXT NEXT

910 ENDPROC

920 DEF PROCselectpitch2
930 LOCAL rand, n, sum
940 rand=RND(1)*100
950 n=0 : sum=0
960 REPEAT
970 n=n+1 : sum=sum+freq2(lastnoteplayed,n)
980 UNTIL sum>=rand
990 pitch=scalenote(n)
1000 Lastbut1=lastnoteplayed : lastnoteplayed=n
1010 ENDPROC

10010 DATA 3.4,0.7,3.4,15.0,12.6,13.8,8.5,14.3,8.0,11.1,6.3,2.9
20010 DATA 42.9,0.0,0.0,28.6,14.3,7.1,0.0,7.1,0.0,0.0,0.0,0.0
20020 DATA 0.0,0.0,66.7,0.0,33.3,0.0,0.0,0.0,0.0,0.0,0.0,0.0
... (Table 2)
    
```

Program 7. First order tunes

```

10 DIM freq1(12), freq2(12,12), freq3(12,12,12)
20 INPUT "Number of tunes",nooftunes
30 FOR tune=1 TO nooftunes
40 PROCanalysetune
50 NEXT tune

60 PROCstandardisetable1
70 PROCstandardisetable2

90 PROCoutputtable1
100 PROCoutputtable2

120 END

130 DEF PROCanalysetune
140 LOCAL scale$,lastbut1$,last$,next$,lastbut1,last,next
150 READ scale$
160 READ lastbut1$,last$,next$
170 lastbut1=INSTR(scale$,lastbut1$)
180 last=INSTR(scale$,last$)
190 freq1(lastbut1)=freq1(lastbut1)+1
200 freq1(last)=freq1(last)+1
210 freq2(lastbut1,last)=freq2(lastbut1,last)+1
220 REPEAT
230 next=INSTR(scale$,next$)
240 IF next=0 THEN PRINT "Error in DATA ";tune;" ";scale$;" ";next$
250 freq1(next)=freq1(next)+1
260 freq2(last,next)=freq2(last,next)+1
270 freq3(lastbut1,last,next)=freq3(lastbut1,last,next)+1
280 lastbut1=last: last=next
290 READ next$
300 UNTIL next$="Z"
310 ENDPROC

330 DEF PROCstandardisetable1
340 LOCAL n,total
350 total=0
360 FOR n=1 TO 12
370 total=total+freq1(n)
380 NEXT n
390 FOR n=1 TO 12
400 freq1(n)=freq1(n)*100/total
410 NEXT n
420 ENDPROC

440 DEF PROCstandardisetable2
450 LOCAL l,n
460 FOR l=1 TO 12
470 total=0
480 FOR n=1 TO 12
490 total=total+freq2(l,n)
500 NEXT n
510 IF total>0 THEN
FOR n=1 TO 12:freq2(l,n)=freq2(l,n)*100/total:
NEXT n
520 NEXT l
530 ENDPROC

660 DEF PROCoutputtable1
670 LOCAL n
680 PRINT "10000 DATA ";
690 @%=820105
700 FOR n=1 TO 12
710 PRINT ;freq1(n); :IF n<12 THEN PRINT ",";
720 NEXT n
730 PRINT
740 ENDPROC

750 DEF PROCoutputtable2
760 LOCAL l,n,lineno
770 lineno=20010
780 FOR l=1 TO 12
790 @%=5
800 PRINT lineno;" DATA ";
810 @%=820105
820 FOR n=1 TO 12
830 PRINT ;freq2(l,n); :IF n<12 THEN PRINT ",";
840 NEXT n
850 PRINT
860 lineno=lineno+10
870 NEXT l
880 ENDPROC

1120 DATA gabcdEFGABC, c,c,G,G,A,B,C,A,G,F,F,E,E,d,d,c,G,G,G,
F,F,F,E,E,d,G,G,G,F,G,A,F,E,d,d,c,c,Z
... etc. for other tunes.
    
```

Program 8. Generates first and third order frequency tables

```

10 ENVELOPE 1,1,0,0,0,0,0,0,63,10,0,-63,63,126
20 ENVELOPE 2,1,0,0,0,0,0,0,126,-4,0,-100,126,100
30 ENVELOPE 2,1,0,0,0,0,0,0,126,-4,0,-100,126,100
40 DIM pitch(3,200),duration(3,200),noofnotes(3),nextnote(3),clock(3)
50 tempo = 1
60 PROCinitialise(2)
70 PROCinitialise(3)
80 PROCjazz
90 PROCcharmonise(3)
100 END

110 DEF PROCinitialise(voice)
*** Defined last month ***
300 ENDPROC

310 DEF PROCcharmonise(noofvoices)
*** Defined last month ***
460 ENDPROC

470 DEF PROCsound(voice,sync)
*** Defined last month ***
550 ENDPROC

560 DATA 24, AH,h,AH,dq,AH,e,R,w,AH,e,AH,e,R,q,AH,dq,AH,e,R,w
570 DATA C#H,h,C#H,dq,C#H,e,R,w,AH,h,AH,dq,AH,e,R,w,D#H,w,C#H,w,
AH,h,AH,dq,AH,e,AH,w
580 DATA 24, D',h,D',dq,D',e,R,w,D',e,D',e,R,q,D',dq,D',e,R,w
590 DATA G,h,G,dq,G,e,R,w,D',h,D',dq,D',e,R,w,R,w,R,w,D',h,D',dq,
D',e,D',w

600 DEF PROCjazz
620 DIM Bb(13), Eb(13)
630 ii = 0
640 FOR note=1 TO 13
650 READ Bb(note)
660 NEXT note
670 DATA 45,57,65,69,73,85,93,105,113,117,121,133,141
680 FOR note = 1 TO 13
690 Eb(note) = Bb(note) + 20
700 NEXT note
710 PROCplaytheblues
715 noofnotes(1)=ii
720 ENDPROC

730 DEF PROCplaytheblues
740 PROCplaybars(4,"Bb")
745 PROCplaybars(2,"Eb")
750 PROCplaybars(6,"Bb")
760 ENDPROC

770 DEF PROCplaybars(n, key$)
780 FOR bar = 1 TO n
790 FOR phrase = 1 TO 2
800 PROCselectstartnote
810 PROCselectupdown
820 PROCselectphrase
830 PROCplayphrase(key$)
840 NEXT phrase
850 NEXT bar
860 ENDPROC

870 DEF PROCselectstartnote
880 startnote = RND(13)
890 ENDPROC

900 DEF PROCselectphrase
910 sphrase=RND(6)
920 restoreto = 1090 +sphrase
930 RESTORE restoreto
940 ENDPROC

950 DEF PROCplayphrase(key$)
960 READ noofnotes
970 note = startnote
980 FOR i = 1 TO noofnotes
990 READ length
1000 ii = ii + 1: duration(1,ii) = length
1010 IF key$ = "Eb" THEN pitch(1,ii) = Eb(note)
ELSE pitch(1,ii) = Bb(note)

1020 note=note+updown
1030 Ifnote > 13 OR note < 1 THEN note=7
1040 NEXT i
1050 ENDPROC

1060 DEF PROCselectupdown
1070 IF RND(2) = 2 THEN updown= -1
ELSE updown= 1

1080 ENDPROC

1091 DATA 8,2,2,2,2,2,2,2
1092 DATA 4,4,4,4,4
1093 DATA 2,8,8
1094 DATA 1,16
1095 DATA 4,2,6,2,6
1096 DATA 11,1,2,1,2,1,2,1,2,1
    
```

Program 9. Micro Blues



**Windsor Computer
Centre**

BULKREED LTD.

BERKSHIRE'S LEADING

B B C

DEALER

PHONE WINDSOR 58077

FOR ALL YOUR

B B C

REQUIREMENTS

1 THAMES AVENUE, WINDSOR, BERKS



IAN BIRNBAUM sets out to improve your programming techniques on the BBC micro.

He will answer reader's questions in this column and develop their ideas - as well as giving some of his own. But the real aim is for readers to provide the questions and the answers.

At least £5 will be paid for any tip published, with £10 for those which merit a one-star award and £20 for real humdingers!

The idea must be original and be described clearly and fully. It should not have been published before.

Your contribution should be typed or printed, with any substantial listings on cassette, but only included to make a point.

Send your hints or questions to BBC Forum, Acorn User, 53 Bedford Square, London WC1B 3DZ. Please include a self-addressed envelope if your contribution is to be returned. We cannot answer letters individually, but a cross-section of common and interesting points will be covered.

BUG STUMPS CASSETTE

Paul Knight writes from Devon: In the time I have owned a BBC model B, writing programs and recording them on cassette has produced no difficulties. However, having developed one particular program over 100 hours, I fear it is lost.

Having loaded the program from cassette, and made some amendments I tried to save the new program over the top of the old - a mistake I shall not repeat. The new program, longer than the previous, appeared to save correctly and as a check the tape was rewound. *CAT indicated all was well, and the numbers following the file-name were 29 2973.

When it next came to load the program, everything seemed to go well, but although the block numbers 29 2973 appeared, the tape was not turned off. The noise from the earpiece during loading sounds normal, but LIST produces nothing after Escape. Other frantic attempts yield at best 'bad program'.

There is clearly data on tape but I cannot extract it. This must be a common beginner's problem. Can you help?

From the description, I suspect the program is not loading at all! Let me explain.

When you load a program from tape, the operating system will search for block zero of the file with the appropriate name. Thus, if the program is called PROG, you should get on the screen:

Searching
Loading
PROG 00 etc

and the program will load.

However, if block zero is missing, you will get:

Searching
PROG 01 etc

and the program will not load! The clue is the omission of the word 'loading' (as well as there being no block 00).

This is a common problem

```
*OPT2,0
>*OPT1,1
>CLOSE#0:X=OPENIN(""):REP.:U.BGET#1=13: ?PAGE=13: I%=0:REP.: I%=I%+1: I%?PAGE=BGET#1
:U.EOF#(1):CLOSE#1:*OPT2,1
```

Listing 1.

```
10FORI%=0 TO 3 STEP3
20P%=&C00
30IOPTI%
40LDA &1D
50STA &71
60LDA #0 \START ADDRESS IS PAGE
70STA &70
80TAY
90
100LDA #&0D
110STA (&70),Y \CARRIAGE RETURN AT THE BEGINNING
120
130.LOOP1
140JSR INCRE
150LDY #0
160LDA (&70),Y
170CMP #&FF \END IF = &FF
180BNE N
190RTS
200
210.N
220LDA &70
230STA &72 \START ADDRESS OF LINE
240LDA &71 \IS SAVED
250STA &73
260JSR INCRE
270JSR INCRE
280LDA #3 \INITIALISE COUNTER
290STA &74
300
310.LOOP2
320JSR INCRE
330INC &74 \INCREMENT COUNTER
340LDA (&70),Y
350CMP #&0D
360BEQ N2
370CMP #&20
380BCS LOOP2
390LDA #&40 \PUT @ IN PLACE OF CONTROL CHARACTERS
400STA (&70),Y
410JMP LOOP2
420
430.N2
440LDA &74
450LDY #2
460CMP (&72),Y \IS THE LINE SUM CORRECT?
470BEQ LOOP1 \YES....
480STA (&72),Y \NO,SO REPLACE BY CORRECT SUM
490BNE LOOP1
500
510.INCRE \ROUTINE TO INCREMENT ADDRESS
520CLC
530LDA &70
540ADC #1
550STA &70
560LDA &71
570ADC #0
580STA &71
590RTS
600JNEXT
```

Listing 2.

LOADING

with OS 0.1, where occasionally block zero is not correctly recorded (April and September's *Acorn User* contain a fix to prevent this bug). *CAT will not pick this up, and is not the best way to verify. *LOAD ""8000 is better - and it gives an almost complete check whilst leaving your program intact.

This is all very well, but what about Mr Knight's program? Fortunately, there is a way to recover most of it. The key is to treat the program as a file, and read it byte by byte.

Type in listing 1 below, wind your tape to the program start and press PLAY. Most of it will load in. Ignore any 'Block?' errors (*OPT2,0 ensures the computer will ignore them).

Once loaded, the program should list, with just the last few lines missing. If by chance you get 'Bad program' use Mr Denis's machine code routine on it, and you should recover most of what you want.

Way round the dreaded bad program

£10

LISTING 2 gives a machine code routine from Mr E Denis of Brussels to retrieve any program when the dreaded 'Bad program' occurs. Save the assembly code as backup, and also save the machine code by running the listing and using *SAVE "BADPMC" 0C00 0CFF. Now *RUN "BADPMC" will retrieve your masterpiece lost in memory.

It will retrieve as much as possible, replacing any errant control codes by @. It is fairly straightforward to go through and locate the whereabouts of one of these. Alternatively, a short program could be written to do the search for you.

M. Cozens of Kent earns £5 for this tip on loading machine code and saving memory

£5

THE January *Acorn User* (page 25) indicated ways of reducing program length and loading machine code routines. The following is an alternative which has been used successfully. The machine code program to be located in say &C00 to &CFF is first loaded and run in OPT3, the contents of &C00 being noted, eg if the first code instruction is LDY #0 then &C00 would contain 160. The Basic program is then loaded and line numbering adjusted to allow a new first line of:

```
IF ?C00<>160THEN*LOAD "MC"
The Basic program is then resaved once on a clean tape,
```

followed by the machine code saved as:

```
*SAVE "MC" C00 CFF
```

To use the program in future CHAIN"" the Basic program. This will automatically test the memory and if the machine code is not present LOAD it and then carry on. If the code is present, for example after an escape during program use, then the *LOAD command is ignored. In addition the original machine code program can contain key and character definitions, to be used later in the Basic program. These would be stored in &B00 onwards, of course.

TWO WARNINGS ON VDU DRIVERS

A number of letters have pointed out that VDU22 will change mode inside a procedure, but it is not quite as simple as that.

For example, listing 3 will work only when the value of HIMEM for mode B% is at least as high as for mode A%. That is, the following applies:

```
if A%=7, B% must be 7
if A%=6, B% must be 6 or 7
if A%=4 or 5, B% must be at least 4
if A%=3, B% must be at least 3
if A%=0, 1 or 2, B% can be anything
```

This said, it seems that in most instances you can just as easily change mode outside the procedure, and you should do so unless there is a good reason to execute the change inside.

□Here's a warning about VDU14.

Compare

```
FOR I%=1 TO 100:VDU14:PRINT I%:NEXT
```

with

```
VDU14:FOR I%=1 TO 100:PRINT I%:NEXT
```

Running them will produce different results. This is because each VDU14 resets the count for paging and so repeated use has no effect.

CLEAR RESETS LOMEM

One more point about CLEAR which does not seem to be widely known (see last month's column)

Like RUN, it resets LOMEM to the value of TOP. This is actually quite logical, and is used to good effect in my self-erase routine (January's *Acorn User*).

```
10MODE A%:A%="Out of Procedure"
20PROCTEST("Inside Procedure"):PRINTA$:END
30DEF PROCTEST(A%):VDU22,B%:PRINTA$:ENDPROC
```

Listing 3.

A two-minute operation turns your BBC Micro into the heart of a word processor.

VIEW is a software program from Acornsoft (the software division of Acorn Computers Ltd., who designed and built the BBC Micro) that enables you to use your BBC Micro, together with a printer, as a fully operational word processor.

View is supplied as a Rom chip that can easily be fitted to your BBC Micro by your local dealer, in a painless two-minute operation.

Then, once installed, you only have to switch on and View is operating immediately. (You can easily switch back to normal computing with a single command.)

Also included in the View package are two special books: 'Into View,' that takes you by easy stages through all the word processing commands and explains the



many ways in which View can help you, and the 'View Guide,' which provides a quick reference to all View facilities.

You'll find that View is, by any standards, a thoroughly professional system, yet still surprisingly simple for the beginner to master.

The 'Spark-Jet Printer' shown in the photograph is the ideal choice of printer for your word processing application. Extremely quiet, it offers high resolution graphics from monitor or TV screen and is available now from dealers.

If you'd like more information, write to Acornsoft, 4a Market Hill, Cambridge CB2 3NJ.

Or, for details of your local Acornsoft dealer, phone 01-200 0200.

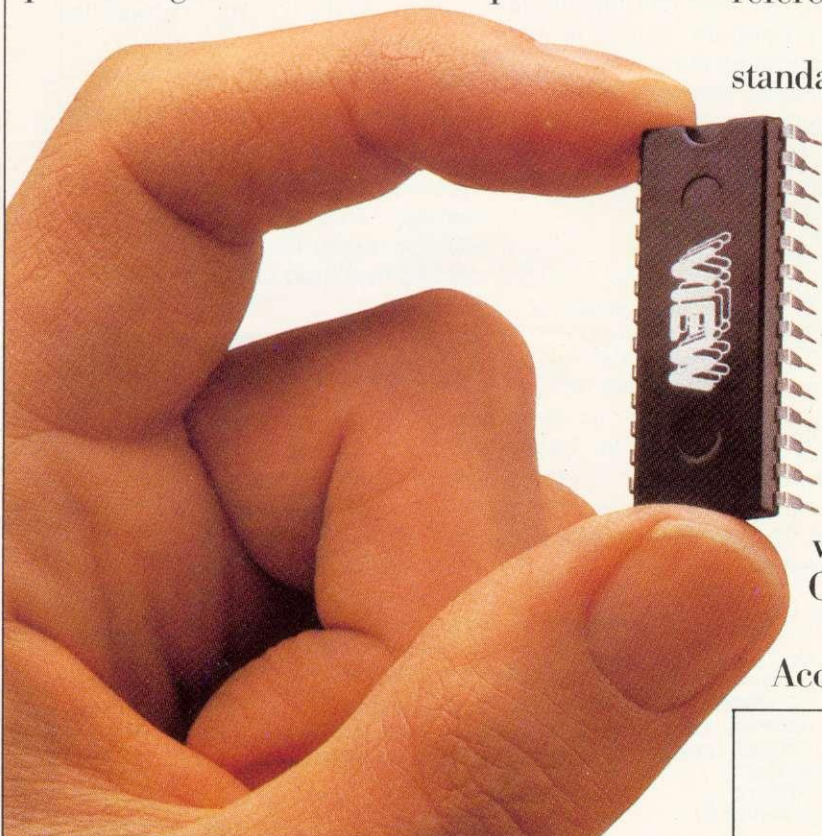

ACORN^{SOFT}

PRIMARY LANGUAGE DEVELOPMENT

Heather Govier outlines some exciting work on language programs for primary schoolchildren in the fifth part of our education series

Much software strengthens the view that microcomputers have no contribution to make to language development. However, programs are now appearing which offer far more than just 'barking at video'.

Since many computer aided learning programs are written by people with a mathematical or programming background, it is not surprising that those developed for language work concentrate more on denotation rather than connotation.

While the first part of this article concentrates on such programs and the second part looks at more open-ended approaches, the major program discussed, *Tray*, is an outstanding example of how the microcomputer can develop pupils' feeling for the structure and meaning of language.

Programs exist which test spelling either by displaying a word for a fixed period of time and then asking the pupil to type it on the screen, or by drawing pictures and asking for the appropriate word. The first technique merely tests short-term memory, while the second presupposes that a picture demands a noun rather than an adjective, phrase or sentence. One early version of picture naming gave two screens full of detailed instructions to pupils who were then asked to spell such words as 'cat' or 'dog'. It would probably be cheaper and easier to buy a device such as 'Speak and Spell' now that the spelling has been anglicised, rather than using a £400 computer.

Children develop language by

talking, listening, reading and recording. Adventure games (such as that reviewed by Charles Bake in April's *Acorn User*) are a good source of stimulation for creative or descriptive writing, or for creating situations beyond pupils' experience. Ideally, the teacher or pupil should be able to alter the hazards and rewards to make them relevant to particular pupils, or to develop particular aspects of language.

Hangman is a popular computer game which can help with spelling and word recognition. Good versions allow for some progression from easy to hard words and give the user some way of altering words, allowing the teacher to match topics pupils are studying or to help reinforce words from the reading scheme. The best versions allow for input of words and clues, and this is particularly valuable when it is the pupil who enters the data rather than the teacher.

If a game has a series of rewards and punishments, the effect is lost if the punishment, eg, being eaten by the technicolour monster which growls and belches, is far more attractive than the reward of 'Well done, Sally'.

Games can have the advantage of encouraging group discussion. *Hangman* is much more valuable if a group works together and must reach unanimous decisions before letters are entered.

The focusing of attention on the monitor screen can oil the social wheels. Because eye contact can be safely avoided even the most introvert child is able to put a point of view. This aspect is especially

LYNDA

TEST YOUR KNOWLEDGE

1. WHAT DO YOU CALL A WOMAN WHO ISN'T MARRIED.
SPINSTER
WIDOW
SINISTER
WINNOWER
2. WHAT DO YOU CALL WATER WHEN IT IS LUKEWARM.
TEPID
HUMID
TORPID
HUMUS
3. ANOTHER NAME FOR A GHOST.
SPECTRE
SPECTRUM
SCEPTRE
SCEPTIC
4. WHICH OF THESE CAN YOU DRINK FROM.
GOBLET
GOBLIN
GLOBULE
GLOBULIN
5. WHICH IS A PART OF THE BODY
ARTERY
ARCHERY
ARTILLEY
ARTISTRY

Figure 1. Quiz produced by pupil using Microprimer program

Heather Govier of a microelectronics advisor to the London Borough of Croydon. Series consultant is Paul McGee.



important with poor readers with a record of failure and a low self-image.

Communicating with a computer may seem a surprising route to improving communication between people, but the computer's demand for precision can be used to good effect. Pupils who use information retrieval systems find that they learn to be less precise if their enquiries produce too few possible responses, and more specific if too many responses are found. Similarly, they have to consider synonyms if the particular information they want does not seem to be present in the database.

One pupil using a quiz program, very similar to the one provided in the Microprimer package, produced the quiz which is illustrated in figure 1. The Croydon version of *Quiz* also allows pupils to enter a range of comments which appear when users obtain particular scores. They realise that an expression may seem humorous when used once but can become irritating when used frequently, and this is made clear to them by their fellow pupils rather than the teacher.

Teachers are sometimes reluctant to correct all the grammatical errors, spelling mistakes and poor choice of words for fear of disheartening their pupils. Similarly, pupils dislike rewriting work and so rarely see a well-finished piece of work. Word processing systems can provide the environment in which pupils are willing to continually improve a particular piece of text until it is satisfactory.

This assumes that schools have discs and printers. A further use for these peripherals is in cloze testing, where the disc is used to record all of the pupil's responses and this uses the teacher's time more effectively.

Problem solving is generally considered to be a mathematical activity, but a fluent reader is a problem solver par excellence. In tackling a complex piece of text, the reader is constantly formulating hypotheses, testing them against the text and revising, accepting or rejecting as appropriate.

Such a reading strategy is difficult to teach because of the complexity of the task and the speed at which such thinking is

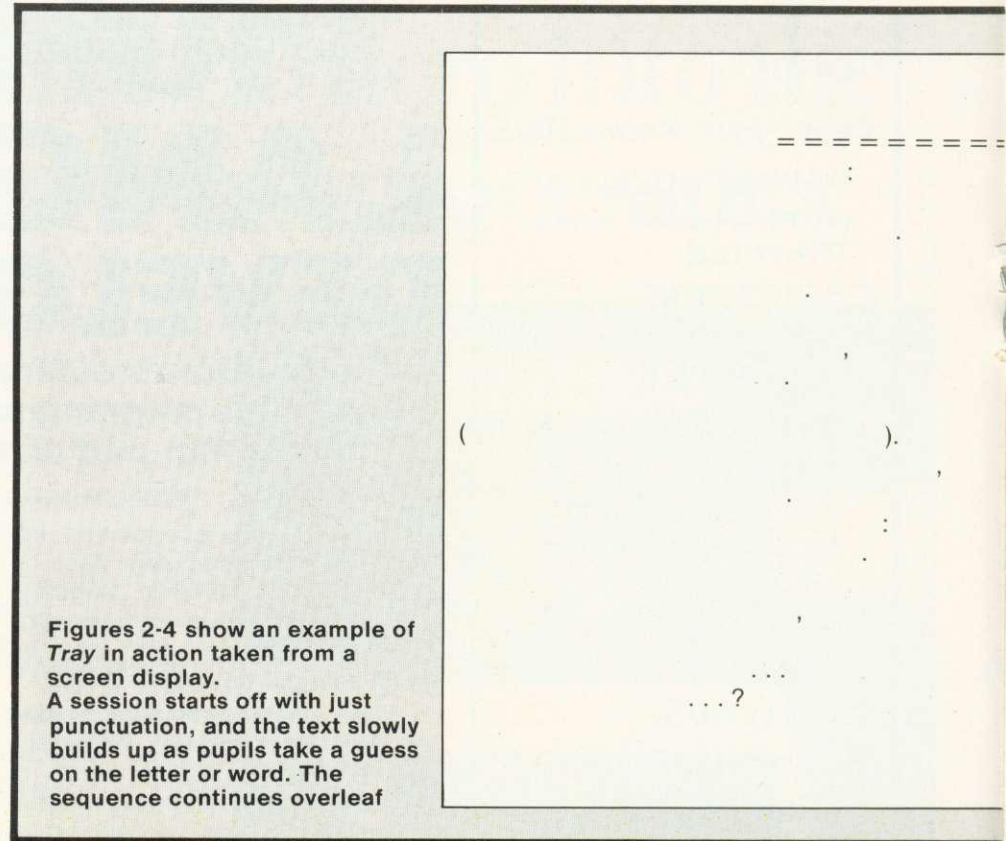

Figures 2-4 show an example of *Tray* in action taken from a screen display. A session starts off with just punctuation, and the text slowly builds up as pupils take a guess on the letter or word. The sequence continues overleaf

usually performed. It is difficult to provide a situation in which reading can be slowed down to such a degree that pupils are able to take the process in steps or stages.

It is not surprising that schools have frequently abandoned the effort and once the basic skills have been mastered have left pupils to develop their reading. The traditional comprehension exercise and cloze procedure test rather than teach, although with discussion they may help to extend vocabulary.

The appearance of computers in schools provides a medium for language work which proceeds step by step in the right atmosphere. Pupils need a sense that it is alright to play and safe to experiment. They need a social climate sufficiently relaxed to be capable of exorcising the spectre of the 'right answer', an environment capable of giving house-room to all sorts of shy little insights most of which will turn out to be wrong but many of which will have a useful, indirect part to play. Pupils also must have some equally 'green' colleagues to compare notes with. Others may see alternative possibilities and in discussion all participants are called upon to defend and explain their preferred interpretations.

The program *Tray* combines all these factors to create a new dynamic approach to the teaching of reading. *Tray* is a sort of Hangman activity, but to describe it thus, fails to do justice to its use and potential. A piece of text is stored in the computer but remains hidden from the readers as though it were an undeveloped photographic print. The pupils are able to bring up the text a little at a time in the developing tray. As it is slowly revealed the readers are called upon to hypothesise about the meaning, initially with inadequate information. Thus their comprehension grows slowly through a series of false starts and blind alleys until a final consensus is reached.

While the ideal size of group is about half a dozen the program has been used satisfactorily with a full class, and once children have become familiar with the activity there is no need for the teacher's constant presence. The program was developed for remedial readers in secondary schools but can also be used with primary pupils, although the abilities of pupils in the group should not be too disparate for maximum collaboration.

The program has a scoring system which uses a jackpot. Initially the jackpot is 26 and falls



```

T   T   E   =====,
  E   T E   :
T E E   E   E E
  E   E   ET
T   T E T   E T T
      E E T E   T .
T E   E E T
      E   T E ,
      T   T E   E .
T E   E   E
(T E T   T T E   E E ).
      E T E   E   E E ,
      T E E
T E T E T E   :
T   E T E E   T .

T H O S E   T   E ,
      E T E   E
E T E T E   T ...
T E   ...?

```

```

T R I T   E R   =====,
  R E I T H E I R   I :
T H E   E   E R   H E R E
  R E   E   E T
T H R   H T H E I R T R   R E T   R T
      E E T H E I R   T .
T H E I R   E E T R
      E   R I   T E ,
      R   I T H   H I T E   I E .
T H E   H   E   R E E
(T H E T   T T H E   R E R E ).
      E T I E   E I   E   E ,
H I   I T H E E   H I .
T H E   T H E   T H E R   :
I T ' S   E R T H E   R E   E T H I .

T T H   E   T   H   E ,
H   I   I   E T H E I R   H R   I E
R E T H E   T H E I R   T ...
R T H E I R   R I   ...?

```

by one each time a letter is bought. When the pupils reach the stage of being able to predict letters, they win a number of points calculated against the current jackpot level. Thus early predictions are rewarded more highly than late ones.

For predicting a single letter the group can win only one point. For predicting a word or phrase they can win as many points as there are letters in the word, plus a quarter of the jackpot for each letter. Thus they are encouraged to be bold and predict larger chunks of text. Penalties for failure are arranged so as to promote the same strategy.

When the jackpot falls to 16, and again after every two jackpot points have been lost, the pupils are invited to write a brief telegram on what they think the message is about. This requirement forges a link between reading and writing. The process of phrasing a telegram forces the pupils to question their current understanding. The program is able to store all telegrams and present them at the end of the session to allow the pupils to review the emergence of their understanding.

The pupils were a group of six third year junior children who were working with a teacher away from

class distractions in the school library. The pupils were introduced to the text as a blank screen except for punctuation marks (see figure 2). The workings of the cursor, which can be used as a pointer, were explained to them and the task introduced as a game of Hangman. At the outset the team were given a budget of 50 points and told that they might buy a letter for 10 points. In considering which would be the best letter to buy there was much discussion about vowels and about which was the most usual vowel, resulting in a communal decision to buy the letter 'e'.

In discussion over which letter should be bought next 'a', 'r' and 's' were suggested. When one child said, 'Who votes for "a"?' the teacher introduced the group to the consensus politics of the game. If a vote were taken some pupils would be disappointed and thus it was agreed that a letter would be chosen only if all pupils agreed.

Pupils were encouraged to think now in terms of words rather than just letters and to ask themselves which words are common. 'The' was felt to be the most common word and after discussing the relative merits of buying 'h' or 't' the letter 't' was finally chosen. The

jackpot was now 24, the team had 30 points and the text looked like figure 3.

Now some pupils began to spot words. Was that 'feet' in the seventh line down? Where could they predict 'h'? After several possible the's had been pointed out the best bet was felt to be the one which began a phrase at the beginning of line three.

'The' was predicted correctly and the computer instructed to reveal all further instances of the same triplet of letters (this can be done at no further cost). Fifteen instances of 'the' were counted although they could be parts of words such as 'there', 'they' or 'either'. Someone spotted the apostrophe in line fifteen and 'it's' was predicted followed by 'here' in the third line of text. All the 'r's and 'i's were now taken giving a text which looked like figure 4. Focus was immediately turned to 'their' with much discussion as to its meaning. 'Their feet' seemed a likely combination and was successfully predicted and after taking 's' a combination 'Th__se' was spotted. What could it be: 'These' or 'Those'? 'Yes, but we've had all the "e"s' said one girl, 'so it must be "those"!'

This type of good thinking and



checking is seen throughout a session with *Tray* and is just as apparent with groups of pupils as it is with adult groups such as teachers. Teachers, as with all aspects of computer use, exercise more caution and are more inclined to be reticent when asked to theorise. The scoring system encourages the more adventurous approach.

Successful prediction of 'a tourist' in the first line added a new dynamism. Now it was possible to speculate about the general meaning of the passage. 'Perhaps it is about visitors to America or Hollywood?'

There was much discussion about the word hidden by the stars. It was explained that this word had been deleted from the passage and would not appear even at the end of the exercise. Perhaps this hidden word indicated where the tourist had come from. It clearly had a lot of letters and so the children tried to think of long place names. Could it be Switzerland or Australia?

Suddenly it became possible to spot words and phrases. 'Are these their boots' was suggested for the penultimate line but after careful counting 'boots' was seen to be too long. Was that 'around here' in line three? Perhaps line five read 'you can see their huts'?

This led to much discussion about whose 'huts' they were until a bit of good checking was exhibited when some one said 'No we've had all the aitches it can't be "huts"! Perhaps it was 'nuts'! All agreed on 'you can see' and a successful prediction was made. The score now stood at 123 but not many of the pupils were still interested in it. The task had become so engrossing that the score had now become almost irrelevant.

After taking 'n' the screen looked like figure 5. Ideas began to pour in thick and fast. 'In', 'around' and 'transparent' were spotted and the opening was read as 'A tourist came from'. The last two words seemed to be 'their reins'. Perhaps the passages was about 'asses'. But how should reins be spelt? No, the spelling was wrong. Reins must be something else, anyway wasn't there a letter missing? It could not be 'trains' because 't's have gone, could it be 'brains'?

This level of thinking and

```

A TOURIST A E RO =====,
AR E I THE AIR A SAI :
THE EO E AROU HERE
ARE A EO ETA A ASS.
THROU H THEIR TRA S ARE T ARTS
OU A SEE THEIR UTS.
THEIR FEET RO
O O EASURI TA ES,
AR ITH HITE I ES.
THE HA E OUR E ES
(THE T O AT THE A ARE RE ).
SO ETI ES A S E IA O E ASSES,
HIS I THE E ASHI .
THE THE OTHERS S O O :
IT'S EAR THE RES E THI .

UT THOSE SO T SHA ES,
SHA O I SI E THEIR HAR O IES
ARE THE THEIR UTS...
OR THEIR RAI S...?
    
```

Figure 5. From this pupils were encouraged to explain the story in a telegram.

Figure 7. ET-inspired theory of a visitor from space?

```

A TOURIST CAME FROM =====,
PARKED IN THE AIR AND SAID:
THE PEOPLE AROUND HERE
ARE ADE OF ETAL AND LASS.
THROUGH THEIR TRANSPARENT PARTS
YOU CAN SEE THEIR UTS.
THEIR FEET ROLL
ON LON MEASURING TAPES,
DAR WITH WHITE LINES.
THEY HA E FOUR EYES
(THE T O AT THE A ARE RED).
SO ETI ES A SPE IAL ONE PASSES,
HIS FIFTH EYE FLASHIN .
THEN THE OTHERS SLO DO N:
IT'S LEAR THEY RESPE THI .

UT THOSE SOFT SHAPES,
SHADO Y INSIDE THEIR HARD ODIES
ARE THEY THEIR UTS...
OR THEIR BRAINS...?
    
```

```

A TOURIST CAN
PAR E IN TH
THE PEOPLE A
ARE A EO
THROUGH THE
YOU CAN SEE
THEIR FEET RO
ON ON MEA
AR WITH WH
THEY HA E O
(THE T O AT T
SO ETI ES A
HIS I THE E
THEN THE OTH
IT'S EAR THE

UT THOSE SO
SHA O INS
ARE THEY THE
OR THEIR RA
    
```

Figure 6. Telegram title: Is the tourist from America? Are the people museum?

Figure 8. The correct answer: One child felt connected.

```

A TOURIST CAME FROM =====,
PARKED IN THE AIR AND SAID:
THE PEOPLE AROUND HERE
ARE MADE OF ETAL AND LASS.
THROUGH THEIR TRANSPARENT PARTS
YOU CAN SEE THEIR UTS.
THEIR FEET ROLL
ON LONG MEASURING TAPES,
DARK WITH WHITE LINES.
THEY HAVE FOUR EYES
(THE TWO AT THE A ARE RED).
SOMETIMES A SPECIAL ONE PASSES,
HIS FIFTH EYE FLASHES.
THEN THE OTHERS SLOWLY DO NOT:
IT'S CLEAR THAT THEY RESPECT THIS.

BUT THOSE SOFT SHAPES,
SHADOWY INSIDE THEIR HARD BODIES
ARE THEY THEIR UTS...
OR THEIR BRAINS...?
    
```



CAME FROM =====,
 IN THE AIR AND SAID:
 PEOPLE AROUND HERE
 MADE OF METAL AND GLASS.
 THEIR TRANSPARENT PARTS
 SHOW THEIR GUTS.
 BUT ROLL
 MEASURING TAPES,
 WITH WHITE LINES.
 FOUR EYES
 (AT THE BACK ARE RED).
 SHE HAS A SPECIAL ONE PASSES,
 WITH EYE FLASHING.
 OTHERS SLOW DOWN:
 DO THEY RESPECT HIM.

SOFT SHAPES,
 INSIDE THEIR HARD BODIES
 SHOW THEIR GUTS...
 BRAINS...?

am time again.
 m Australia?
 museum models?

orrect text.
 onned, but exhilarated.

T CAME FROM =====,
 N THE AIR AND SAID:
 PLE AROUND HERE
 E OF METAL AND GLASS.
 H THEIR TRANSPARENT PARTS
 SEE THEIR GUTS.
 ET ROLL
 MEASURING TAPES,
 H WHITE LINES.
 E FOUR EYES
 AT THE BACK ARE RED).
 ES A SPECIAL ONE PASSES,
 EYE FLASHING.
 E OTHERS SLOW DOWN:
 R THEY RESPECT HIM.

SE SOFT SHAPES,
 Y INSIDE THEIR HARD BODIES
 THEIR GUTS...
 BRAINS...?

reasoning permeated the whole session which lasted uninterrupted from 1.30 to 3.45 pm. All the pupils chose to work through break time and some wanted to stay after school.

In this session it was getting close to telegram time. What could the group now read of the text? What did it all mean? They were encouraged to try to read as much as they could substituting a nnnnnn for the words which they could not guess. With nothing more than figure 5 to support them the group read:

'A tourist came from nnnnnn in the air and said the people around here are nnnnn nnnnn and ass through their transparent parts you can see their cuts, their feet nnnnn on treasuring tables (no! measuring tapes) number with white lines.'

They constructed a telegram:

'We think it is about a tourist who measures with tapes'.

What sort of people, they wondered, had transparent parts. Were they models in a museum? Perhaps you could see their 'guts' not their 'cuts'. It must be 'guts' because 'cuts' would be on the skin and if you can see through them...

The phrase 'parked in the air' was spotted in line two leading to much speculation on how someone could park in the air. The tourist must be in an aeroplane, a helicopter, a balloon, a hovercraft or a jump jet.

By the time the second telegram was required the screen looked like figure 6. The final section had been laid open and the telegram read:

'We think it is about a tourist who came by plane from Australia, who measured hard bodies with dark tapes with white lines, and she or he didn't know if it was their guts or their brains.'

There was thus still much confusion but the group hung tenaciously to the theory that the tourist came from Australia (despite the fact that the letter count was wrong) and that these strange people were museum models.

By the time the screen looked like figure 7 it had become possible to read almost everything. The 'special one' was like a

commander who ruled the others. But who were these strange people? Where had they ever seen 'people' whose 'feet' roll on long measuring tapes, dark with white lines? 'Perhaps they have wheels - these people are they cars?' 'Yes!!'

Suddenly it all made sense. The space tourist comes to earth and mistakes the cars for the inhabitants. The measuring tapes are the roads and the 'special one' with the 'fifth eye flashing' is a police car.

'Oh what a con!' shouted one pupil but the pleasure and satisfaction was there on the faces of all of them. All were amused and intrigued by the final question:

But these soft shapes
 Shadowy inside their hard
 bodies
 Are they their guts
 Or their brains?

There was no doubt that the session had been exhausting for pupils and teacher alike but everyone involved left with a feeling of exhilaration. (The correct text is shown in figure 8.) By taking things slowly, and working collaboratively in a relaxed non-censorious atmosphere this team of nine-year olds had been involved in a process of deep text analysis rarely seen in the primary school.

The process had required the simultaneous application of analytic, convergent thinking as well as creative thought. Pupils had to combine both styles and everyone's talents were used to the full.

Pupils quickly learn to doubt their first hypothesis

One of the most clear-cut effects of repeated use of *Tray* with a group of pupils is that they quickly learn to doubt and question their first hypothesis, becoming more open to alternatives. With this, their first experience of using *Tray*, it was a long time before someone suggested that these were beings from a different world, that the tourist came from outer space and

BUY THE BEST BRITISH COMPUTER

As supplied to schools,
local authorities and
government departments
by the leading BBC Acorn
dealer & service centre

**In stock
NOW!**

BBC Model A £299 incl VAT
BBC Model B £399 incl VAT

- + Wordwise Word Processor (needs 1.0 System)
- + Software - Acorn, Bugbyte, Computer Concepts (Logo 2)
- + Joysticks for the BBC + 100K Single Disk Drives
- + Torch 800K Twin Disk Drives with CPN
(Equivalent to CPM*)

*Reg. trademark of Digital Research

WE DELIVER
NATIONWIDE!

**SPECIAL
OFFERS**
Whilst stocks last!

For the BBC:
Screen Layout Pad,
Flow Chart Pad &
Symbol Design Pad
Kit with ring binder
Rec. retail price £15.50
OUR PRICE ONLY
£12.50 incl VAT

VIC-20 Clearance:
Arfon Expand Unit £85
VIC Games Cartridges:
Mission Impossible £20
Rat Race £16
Road Race £16
Mole Attack £16
All prices include VAT!

PLUS computers, peripherals, printers, software, games, books and much, much more from leading makers at low prices - always available from your local stockist:

**TWICKENHAM
COMPUTER CENTRE LTD**



72 Heath Rd Twickenham Middx TW1 4BW (01-892 7896/01-891 1612)

BITS & BYTES

44 Fore St. Ilfracombe, Nth Devon. Tel: (0271) 62801

ACORN DEALERS, BBC, DRAGON, VIDEO GENIE SALES & SERVICE EPSON HX20 COMPUTER

Atom Micros	BBC Upgrade Kits
Colour Monitors	BBC printer interfaces
Seiksha GP100A Printers	5¼" Floppy Discs
Epson Printers	C-12 Cassette Tapes
Monitors - 12" B/W	Cassette Recorders
Monitors - 12" Green	Continuous Stationery Software
5¼" Disc Drives (C/W P.S.U. & CASE)	Software written to order

REPAIRS & SERVICE

To all Micros

OFF RECORDS...

The London ACORN-BBC Centre
Suppliers to Schools and Colleges
Maintenance Contractors

Atom:

Full hardware and software support.

BBC:

Model A £299
Model B £399
Memory up-grades £21.99
Repair service and component supply.

Printers:

Seiksha 100 £215
Epson MX80FT/3 £385
SCM Daisywheel £485

Cassettes:

Matched Cassette Recorders £26

Monitors:

12" Green Screen (Hitachi/Phoenix) £110
12" Colour (Kaga) £255
14" Colour (BMC/Cable) £255

Discs:

TEAC 40-track £199
Shugart twin 40-track £299
TORCH dual disc drive with Z80 processor, 64K RAM, CP/M and FREE software £780

Eprom programmer:

Specially designed for BBC. Programs 12 different Eproms including 27128. Includes screen software £95 (dealer enquiries invited)
Add 15% VAT to all prices. Carriage extra.

Tapes:

Top Tape: see adverts in Radio Times.
OFF Records beats all published prices.

Stationery:

Moore Paragon main agents. Large selection of continuous stationery, forms and labels.

Books:

Browse through the Computer Book Department for educational, scientific and business applications.

COMPUTER HOUSE

58 Battersea Rise
Clapham Junction
London SW11 1HH
Telephone 01-223 7730

New Showroom:

OFF Records would expect you to buy best value. Spend some time in the relaxed atmosphere of our new showroom to find out exactly what you are getting for your money.

OFFware:

CHARAID for the design of a block of 4 characters in any graphics mode including mode-7. Outputs VDU23 commands, teletext commands and printer commands to screen or printer together with actual design. Substantial software with more than 20 well-documented commands. Indispensable for graphics work.

£7.50 p.p. & VAT incl.

ATILITY contains seven essential routines for the disc based Atom:

*COPY, *COPYT, *COPYD, *RENAME, *PURGE, *BACKUP, *AUTORUN.
£25 p.p. & VAT incl.

Vacancy:

OFF Records are looking for a bright spark with good knowledge of both software and hardware. Initially a Saturday job with a view to full-time employment.





that the spaceship had been parked in the air because there was no gravity.

Tray does something more than all other current software designed for language work. It allows children to read in a new way, a way both magical and powerful. It is based upon the assumption that

Tray allows children to learn in a new way

good reading and writing often grow best rooted in a rich subsoil of good talk, and links reading with talking, listening and writing.

Tray thus brings to language work much of what Logo brings to maths. Readers are set in a 'microworld' where:

- even mistakes become profitable learning experiences;
- a trial and error approach is possible allowing exploration with a structure imposed from inside rather than outside the group;
- discussion and hypotheses testing are possible at all levels from the simple spotting of words to the complex analysis of deep meaning;
- final understanding results from combined analysis and synthesis using elemental building blocks.

Further, it encourages co-operation in an atmosphere in which it is recognised that everyone has a valuable contribution to make. This is an important aspect of *Tray*. By requiring consensus the teacher encourages the members of the team to argue their point of view, explain and persuade. Through such a process, weakly thought out ideas are tested and more strongly supported ones tend to be adopted. This may lead to problems when a well reasoned and strongly supported hypothesis is opposed by a new more powerful one. In text analysis, as in science or maths, individuals find it very hard to abandon their theories,

clinging tenaciously to them even against mounting evidence. Perhaps it is this last point which most of all makes *Tray* a significant new teaching tool.

Tray consists of a program to play the game and keep the score as well as a program to allow the user to set up text files. These files are separate from the program and can be stored on cassette or disc for later use. The teacher can thus create a piece of text which fits in well with current classroom activities so that the emphasis can be on the meaning rather than the spelling of individual words.

The initial version of the program was developed on a computer which used capital letters only. This is unacceptable as pupils should see text presented on the screen in a way that is as close to normal text as possible. Thus letters should have true descenders and upper and lower case letters made available. *Tray* is now being developed as part of an MEP project, Developing Thinking Skills in Primary School, which is based at the Davidson Centre in Croydon. Teachers who are interested in taking part in the serious evaluation of this program should contact Heather Govier.

Even when schools operate on integrated days, pupils rarely get the opportunity to pursue a task uninterrupted over a long period of time. Use of this program shows that when the task is sufficiently

Pupils can rarely pursue a task uninterrupted over a long period

absorbing pupils are perfectly capable of persevering with full concentration for three hours or more.

On Inset courses the same happens with teachers who happily abandon their coffee break and have to be reminded to stop for lunch. It is also interesting to note that the same text can be used for teachers and pupils alike.

TEN POINTS

TO NOTE

- Language development is concerned with improving pupils' abilities to talk, listen, read and record. Clearly identify which of these is helped by a particular program.
- Do not accept any program which does not use upper and lower case when the pupils could.
- Poor readers should not suffer additional difficulties so check that the screen and the printer use true descenders.
- Ensure that programs have instructions written at an appropriate level of difficulty.
- Some games, particularly adventure games, can stimulate pupils to increase their range of vocabulary and creative writing.
- The easy availability of word processing could revolutionise the relative importance of mechanical and creative writing skills in the same way that calculators dramatically change the balance of skills in mathematics.
- Information retrieval systems can help to develop pupils' linguistic ability because of the need to refine the criteria for searches.
- The computer's role as a neutral referee and score-keeper can provide the reassuring framework for pupils to undertake complex reading and interpretive tasks.
- Reject programs which purport to teach spelling but essentially test only short term memory.
- Avoid games which 'reward' mistakes by giving a more exciting display than that for correct responses.

Next month: Information technology in the curriculum

THE PROGRAM THAT'S LEAPS AHEAD OF ALL THE REST...

THE FROG



©1983

STOP PRESS. NOW IN STOCK! "SHAPE GENERATOR" FOR BBC MICRO.
Allows you to design and redesign full colour graphics and shapes in enlarged form then reduced to normal size in programs! Ideal for development of software! Useful utility program for BBC Micro owners! £11.50

FROM

SOFTWARE FOR ALL

"Programs for the people"

THE MOST FANTASTIC ACTION GAME FOR THE BBC MICRO!

FAST ARCADE PLAY!
MODE 2 COLOUR GRAPHICS AT ITS BEST!
FIVE TUNES!
INCREDIBLY ADDICTIVE!

AVAILABLE NOW AT YOUR SOFTWARE FOR ALL DEALER

ONLY £8.95

SEE IT NOW AT YOUR NEAREST SOFTWARE FOR ALL DEALER!

AB & C COMPUTERS 11 Brockstone Road St Austell Cornwall PL25 3DW	COMPUTER PLUS 47 Queens Road Watford, Herts WD1 2LH	GAMES WORKSHOP Unit 37 Birmingham Shopping Centre Birmingham B2	RAM ELECTRONICS (FLEET) 106 Fleet Road, Fleet Hants GU13 8PA
ANGLIA COMPUTER CENTRE 88 St Benedicts Street Norwich, Norfolk NR2 4AB	COMPUTERS FOR ALL 72 North Street Romford, Essex RM1 1DA	GRAVESEND HOME COMPUTERS 39 The Terrace Gravesend, Kent	RDS ELECTRICAL LTD 157-161 Kingston Road Portsmouth, Hants PO2 7EF
A & D COMPUTERS 143A Fore Street Exeter, Devon	COMPUTERIST 642 London Road Westcliff-on-Sea, Essex	KANDYS 40 High Street Huntingdon Cambridgeshire PE18 6AO	RITCHIE ELECTRONIC 31 North Parade Bradford, West Yorkshire
BLADEN COMPUTER SYSTEMS 22 Glynne Street, Farnworth Lancashire BL4 7DY	COMP-LEASE 121 Queensway, Alsager Cheshire ST7 2SP	MANSFIELD COMPUTERS 79 Ratcliffe Gate Mansfield Notts NG18 2JB	STORKROSE LTD 44 Shroton Street London NW1
BRAINWAVE LTD 24 Crown Street Ipswich, Suffolk	DIGITAL FANTASIA 24 Norbreck Road Norbreck, Blackpool FY5 1RP	MICROSTYLE 29 Belvedere Lansdowne Road, Bath	SUPERIOR SYSTEMS LTD 178 West Street, Sheffield South Yorkshire S1 4ET
BRIDLINGTON COMP CENTRE 46 Market Place, Old Town Bridlington YO16 4QL	EMPRISE LTD 58 East Street Colchester Essex CO1 2TQ	MICROWARE 5 St Peters Lane Leicester	SOUND ON SOUND 64 Lawton Street Congleton, Cheshire CW12 1RS
J W BAGNALL LTD 18 Salter Street Stafford ST16 2JU	ESSEX COMPUTER CENTRE LTD 150 Moulsham Street Chelmsford, Essex	MODEL PLUS 55A West Street, Boston Lincolnshire PE12 8QN	STATACOM LTD 234 High Street Sutton, Surrey
BINDERMAN LTD 12C Manor Road London N16 5SA	FALSOFT COMPUTERS 8 St Georges Arcade Falmouth, Cornwall	NORTHERN COMPUTERS Churchfield Road Frodsham, Cheshire	TECHNOMATIC LTD 17 Burnley Road London NW10
CARLTON COMPUTERS LTD 4 Swanstons Road Great Yarmouth Norfolk NR30 3NQ	FAREHAM COMPUTER CENTRE 56 High Street, Fareham Hants PO16 7BG	OFF RECORDS Computer House 58 Battersea Rise Clapham Junction, London	TOMORROWS WORLD Esplanade, Lerwick Shetland Isles
CASTLEHURST LTD 1291 High Road London N20	GALAXY VIDEO LTD 60 High Street Maidstone, Kent	RMK ELECTRONICS LTD Hinton House, Station Road New Milton, Hants BH23 6HZ	THE VIDEO PALACE 62 Kensington High St. London W8
	GAMER 24 Gloucester Road Brighton BN1 4AQ		WATFORD ELECTRONICS 33/35 Cardiff Road Watford, Herts WD1 8ED
			YORKSHIRE MICROCOMPUTERS 28 Ramshill Road, Scarborough North Yorkshire YO11 2QF

Having covered 1 MHz bus theory, Paul Beverley gets down to practice

INTERFACE BOX FOR THE BEEB

Having looked at the theory of hardware connections for the 1MHz bus, here is a practical application – an interface box for the BBC micro. This brings out both user and printer ports as well as adding two fast eight-bit analogue to digital converters (ADCs) and two eight-bit digital to analogue converters (DACs) so you can output voltages. You may wonder about adding two more when there are already four in the machine with higher resolution – 12 bits as against eight. The point is that the on-board converters are extremely slow – each one takes 10 milliseconds (ms) to work out the digital equivalent of the voltage applied to it. This means it is virtually useless if you want, for example, to look at a voltage waveform and display it on the screen – like a digital storage scope. The ADCs used in this interface box can do a conversion in about 10 microseconds (μ s). They are only guaranteed to work at a clock rate of 600 kHz, giving them a conversion time of 15μ s, but if run at 1 MHz they do a complete conversion in 9μ s. Despite the quoted maximum clock rate of 600 kHz, the ZN427s I have tried work at 1 MHz. Using 1 MHz is convenient because the bus we are using has, as its name suggests, a

supply of 1 MHz clock pulses readily available.

Figure 1 shows the address decoding used. It places the two DACs at &FCF0 and &FCF1, and the two ADCs at &FCF2 and &FCF3. Those who read last month's article may well have noticed one or two deliberate mistakes. For example, I suggested that when connecting up the address lines to enable various devices, you could connect directly from a 74LS138 address decoder to the chip select lines of the converters. This works with the ZN428 because its chip select line is negative active, but the ZN427 has an 'output enable' input (pin 2) which is in fact *positive* active, and not negative active as suggested. Therefore, since the lines from the 74LS138 are normally high, and only go low when the particular address appears on the address lines, we have to invert them before applying them to the output enable lines of the ADCs.

Since we have to put an extra inverter into each line anyway, we might just as well add a third gate as suggested last month to gate these output enable pulses with the read/not-write (R/NW) line on the bus. This ensures the outputs of the ZN427 are only enabled when you

are trying to read them. Thus if you accidentally try to write to the ADC you won't get the problem of the data bus drivers and the ZN427 trying to write different things onto the same data bus!

Another mistake in the last article concerns the read/not-write line. Following Acorn's Application Note on the 1 MHz bus, I said this was just an extension of the read/not-write line of the main 6502 processor with extra buffering. In fact it only ever goes low (= write) when you are trying to write to a device on the bus. This doesn't make a great difference practically, but we might as well know the truth. This will avoid any confusion which might have arisen if, when fault-finding the interface box, you had looked at the 1 MHz bus read/not-write line. You would have expected to see a continuous train of pulses as on the processor's read/not-write line, but would have found it was sitting at logic 1 unless the bus was being accessed.

The decode logic also provides four spare lines – &FCF4 to &FCF7. Two of these can be used to provide 'start convert' pulses for the ADC's since if you read or write to, say, &FCF4 then the 'NFCF4' line (figure 1) will go low for just a

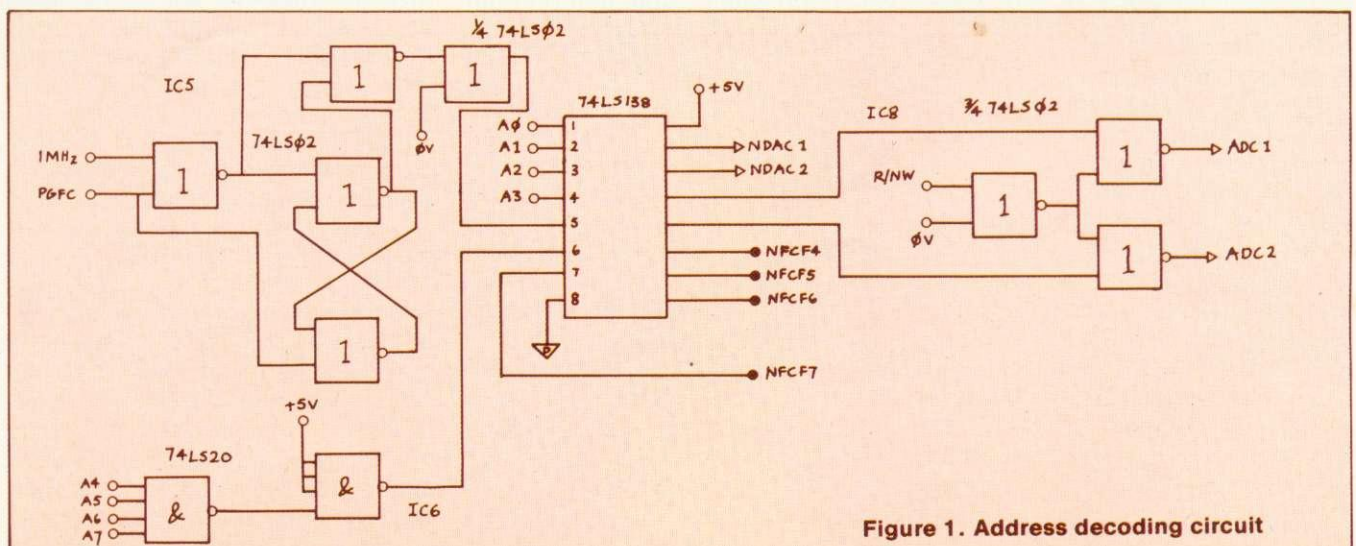

Figure 1. Address decoding circuit



go low for just a fraction of a microsecond – but long enough to initiate the conversion. If the system clock is being used for the conversion, there is no real need to use the 'end of conversion' (EOC) output of the analogue to digital converter since, because we are using the 1 MHz clock signals, we know conversion takes $9\mu\text{s}$. If you really want to use the EOC signals, either attach them to the input lines of the user port, or to the two spare digital input lines on the analogue ports (15 way D-type connector) which go to the internal versatile interface adaptor at &FE40.

Another point which hasn't been made strongly concerns the problem of what the Application Note calls 'possible address decoding spikes which may occur during the 1 MHz high'. The inference drawn from this was that it was not a problem unless you were trying to attach a lot of devices onto the bus, for example if you were interfacing to an extra memory board. Indeed I had successfully attached two DAC's and an extra 6522 VIA onto the bus without becoming aware of the seriousness of the problem. The reason for such blissful ignorance was the use of the DAC 0800 chips which cannot be directly interfaced to the bus and I was therefore using two 74LS374 octal latches to read them. This created no problem because these chips are clocked on the positive-going edge of the clock pulse. (So here's another deliberate mistake – I said that the 74LS374 was clocked on the negative-going edge of the clock

34-way connector 1 MHz Bus		26-way connector Printer Port	20-way connector User Port
1 - GND	27 - A0	1 - CA2	1 - +5 volts
2 - R/NW	28 - A1	2 - GND	2 - CB1
3 - GND	29 - A2	3 - PA0	3 - +5volts
4 - 1MHz	30 - A3	4 - GND	4 - CB2
5 - GND	31 - A4	5 - PA1	5 - GND
6 - NNMI	32 - A5	6 - GND	6 - PB0
7 - GND	33 - A6	7 - PA2	7 - GND
8 - NIRQ	34 - A7	8 - GND	8 - PB1
9 - GND		9 - PA3	9 - GND
10 - NPGFC		10 - GND	10 - PB2
11 - GND		11 - PA4	11 - GND
12 - NPGFD		12 - GND	12 - PB3
13 - GND		13 - PA5	13 - GND
14 - NRST		14 - GND	14 - PB4
15 - GND		15 - PA6	15 - GND
16 - ANALOG IN		16 - GND	16 - PB5
17 - GND		17 - PA7	17 - GND
18 - D0		18 - GND	18 - PB6
19 - D1		19 - CA1	19 - GND
20 - D2		20 - GND	20 - PB7
21 - D3		21 - NC	
22 - D4		22 - GND	
23 - D5		23 - NC	
24 - D6		24 - GND	
25 - D7		25 - NC	
26 - GND		26 - NC	

(NC = no connection)

Figure 3 - Pin Connections on the various connecting cables

pulse!) What you have to do then is to use one of the circuits given last month to 'clean up' the select line for page &FC (NPGFC) before applying it to the 74LS138 decoder (figure 1).

The *User Guide* does not make it desperately clear which pins on the various connectors are which. All it gives is a circuit diagram from which you have to count the pin numbers. Figure 3 shows clearly which are which. Note that on both

the user port and the printer port there is an earth line inbetween each signal line for screening. However, on the printer port they are the even numbered pins; on the user port the odd numbers.

The operational amplifiers on the inputs of the ADCs are just unity gain amplifiers to provide a higher input impedance and to prevent the ZN427 chips being blown by excessive voltages. If you apply too large a voltage to the analogue inputs you just blow up the 741s instead which are somewhat

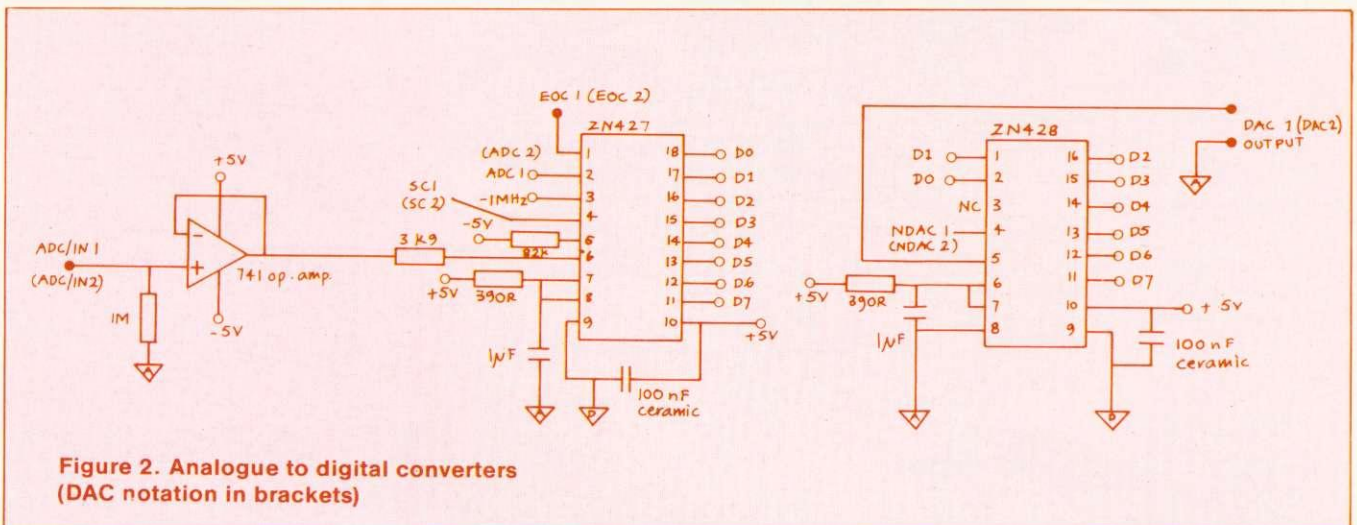

Figure 2. Analogue to digital converters (DAC notation in brackets)

cheaper (14p instead of £7). The outputs of the DACs could be protected in the same way by adding the same operational amplifier circuits, but I have not bothered since I feel it is less likely to do something silly with an output.

A parts list (figure 4) is given for the main circuits, including printer and user port connectors, but excluding any protection on the DACs. Most parts can be bought easily from RS Components, but more cheaply elsewhere if you shop around. You can make the circuit up on Veroboard, but the company mentioned in the parts list will give you details of a printed circuit board, kit of parts or a built and tested board.

The other thing missing from the parts list is the box in which the unit is to be housed, and the sockets to connect up equipment, because these will differ according to your application. In my college for example 4mm sockets are the standard.

With this interface box you are mixing analogue and digital signals, so care is needed with supply lines and earth lines. In particular it is important that parts of the circuit which require an analogue earth - marked on figures as an earth symbol with an 'A' in it ∇ - should not be connected to the line which is supplying the zero volts to the various chips on the board. I have referred to this as the digital earth ∇ . It is also important to decouple the supply effectively. Each chip should have a 10nF ceramic capacitor connected across its supply lines as close to the chip as possible. In the case of the ADCs I have used 100nF. Operational amplifiers should have 10nF capacitors on the positive and negative supplies.

This brings me to power supplies. Where are you going to obtain the +5 volts and -5 volts to power these circuits? There is a +5V supply on the user port, so with a separate external supply for the -5V there is no problem other than choosing a suitable connector. As an alternative, there is an outlet on

Semiconductors			Cost
2	ZN427	A to D converters	(309-464) 13.16
2	ZN428	D to A converters	(303-523) 9.56
1	74LS138	3 to 8 line decoder	0.27
1	74LS20	2 x 4-input NAND	0.13
2	74LS02	4 x 2-input NOR	0.22
2	741	Operational amplifier	20p ea 0.40
Capacitors			
4	1uf	polyester	42p ea 1.68
4	100 nF	ceramic	7p ea 0.28
8	10 nF	ceramic	4p ea 0.32
Resistors			
2	1M		
2	82k		2p ea 0.20
2	3k9		
4	390R		
Hardware			
1	20-way jumper lead with DIP socket		1.85
1	26-way jumper lead with DIP socket		2.10
1	34-way jumper lead with DIP socket		2.70
1	20-way transition connector	(468-147)	1.44
1	26-way transition connector	(468-153)	1.80
1	34-way transition connector	(468-169)	2.30
2	18-way DIL sockets	16p	0.32
3	16-way DIL sockets	11p	0.33
3	14-way DIL sockets	10p	0.30
2	8-way DIL sockets	9p	0.18
Veroboard or PCB			
PCBs, kits of parts and fully built and tested boards are available from: Electro Technical Services 55 Raymond Road, Halesdon, Norwich, NR6 6PN (see page 64)			

Figure 4 - Parts List

the BBC micro's own power supply unit which has both supplies as well as +12 volts. These are intended for disc drives, but the power we need is fairly small. The only problem is getting hold of the appropriate connector. They are not the same as the six pin QM multipole connectors in the RS Components catalogue even though they look similar. In fact they are made by A-MP and are distributed by Ampliversal of Terminal House, Stanmore, Middlesex.

There is another slight problem for those using a disc drive that does not have its own power supply. You will need to get yourself a suitable socket as well as a plug to take power from the PCB to the disc drive. If you buy the board from Electro Technical

Services, there should be no problem as there is space on it for a board mounting plug.

In designing the front panel you will have to decide exactly which facilities to provide. I have included the BBC's four ADC inputs, the spare digital inputs used by the paddles and the lightpen strobe input, all of which can be brought up on a multi-way screened cable from the 15 way D-type connector that plugs into the back of the computer. Various other lines from the 1 MHz bus have also been brought out to sockets. For example, the analogue input is a useful tool for 'listening' to what the computer is doing. If you put one finger on, say the interrupt line (NIRQ) and another on the

page 64 ▶

THE BEST INDEPENDENTLY PRODUCED BBC MICRO SOFTWARE

BBC TOP QUALITY MACHINE CODE PROGRAMS BBC

SPECIAL OFFER!
Deduct £1 per cassette or disc when ordering 2 or more.

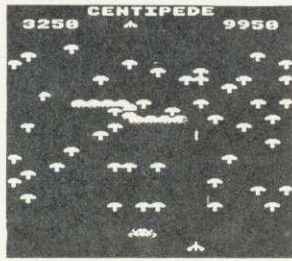

CENTIPEDE (32K) £6.50
Incredible arcade type game featuring mushrooms, snails, flies, spiders and the centipedes of course. Excellent graphics and sound, 6 skill levels, hi-score, rankings, bonuses, and increasing difficulty as the spiders become more active and the number of mushrooms increases. "Visually this game compares well with the arcade version, being colourful and clear." ... YOUR COMPUTER

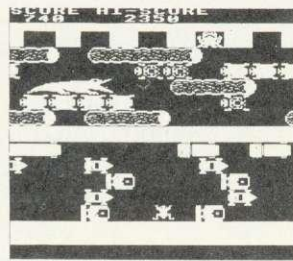

FROGGER (32K) £6.50
Not just another version of Frogger ... this is the proper high-quality version that you've been waiting for. Graphically brilliant, with gaping-mouthed crocodiles, diving turtles, and frogs that flex their legs as they jump along. Increasing difficulty, hi-score, responsive controls, sound effects, etc.
●●● NEW RELEASE ●●●

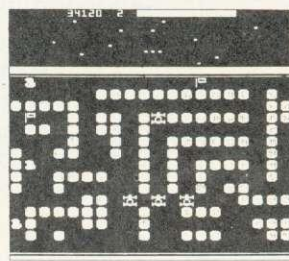

ROAD RUNNER (32K) £6.50
The only full feature machine-code version of the arcade game available for the B.B.C. micro. Features include: scrolling screen, radar display, checkpoint flags, fuel gauge, smoke screens, 6 skill levels, rankings, increasing difficulty, and sound effects.
Suitable for use with keyboard or joysticks.
●●● NEW RELEASE ●●●

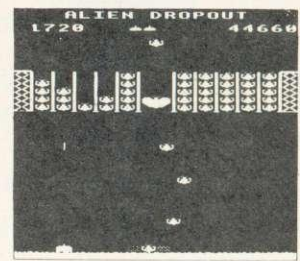

ALIEN DROPOUT (32K) £6.50
Based upon the arcade game of ZYGON, but our version improves upon the original arcade game itself. You have to shoot the aliens out of their "boxes" before the "boxes" fill up. Once full, the aliens fly down relentlessly, exploding as they hit the ground. Suitable for use with keyboard or joysticks.
"Do not be fooled by their placid purple appearance - these molts are out to get more than the clothes in your wardrobe." ... YOUR COMPUTER

SPACE FIGHTER (32K) £6.50
Arcade-style game based upon features from DEFENDER and SCRAMBLE. 5 types of menacing alien fire at you and may attempt to ram you. Separate attack phases, fuel dumps, repeating laser cannon, asteroids, smart bombs, hi-score, rankings, 6 skill levels, sound effects.

GALAXIANS (32K) £6.50
Fast action version of the popular arcade game. 4 types of Galaxian (in 3 initial screen formations) swoop down individually or in groups of two or three. 6 skill levels, high score, rankings, bonus laser bases and increasing difficulty. Superb sound effects and graphics.

INVADERS (32K) £6.50
Superb version of the old classic arcade game, including a few extras. 48 marching invaders drop bombs that erode your defences, and two types of spaceship fly over releasing large bombs that penetrate through your defences. Increasing difficulty, high score, superb graphics and sound.

FRUIT MACHINE (32K) £6.50
Probably the best fruit machine implementation on the market. This program has it all ... HOLD, NUDGE, GAMBLE, spinning reels, realistic fruits and sound effects, multiple winning lines. This is THE fruit machine program to buy.
"The graphics are very good and with a little imagination you might be able to convince yourself you are in Las Vegas." ... YOUR COMPUTER

"Both ... are well-produced, with colourful graphics, responsive controls and the usual bunch of extra-terrestrials." ... YOUR COMPUTER

SUPERIOR SOFTWARE
Dept. AU2,
69 Leeds Road, Bramhope, Leeds.
Tel. 0532-842714

DISC SOFTWARE AVAILABLE NOW
All our programs are ready for despatch on 5 1/4" discs at £9.90 each.

WE GUARANTEE THAT:
(1) All our software runs correctly on all current operating systems.
(2) All our software is available before we advertise.
(3) All our software is despatched within 48 hours by first class post.
(4) In the unlikely event that any of our software fails to load, return your cassette or disc to us and we will immediately send a replacement.

PLEASE ADD 50p per order for p. & p.
- V.A.T. at 15%.

We pay 25% royalties for high quality programs.

Dealer enquiries welcome.

3D COMPUTERS

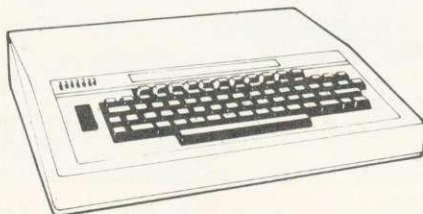

PERIPHERALS
PRINTER
COLOUR MONITOR
DISK DRIVE
TORCH Z80 DISK
CASSETTE RECORDER

SOFTWARE
ACORNSOFT
BBC SOFT
PROGRAM POWER
BUG-BYTE
HESSEL

THE ACORN SPECIALISTS

BBC Micros Ex-stock

ADD-ONS
JOYSTICK
LIGHT PEN
GRAPHICS TABLET
TELETEXT
Z80 PROCESSOR
6502 PROCESSOR
MEMORY UPGRADE
DISK INTERFACE

BOOKS
30 HOUR BASIC
BBC BASIC
BBC MICRO REVEALED
LET YOUR BBC TEACH
LEARNING TO USE BBC
ASSEMBLY LANGUAGE
30 PROGS FOR BBC

COMPUTER SHOPS OPEN 9.30-6.00 TUESDAY-SATURDAY EASY PARKING

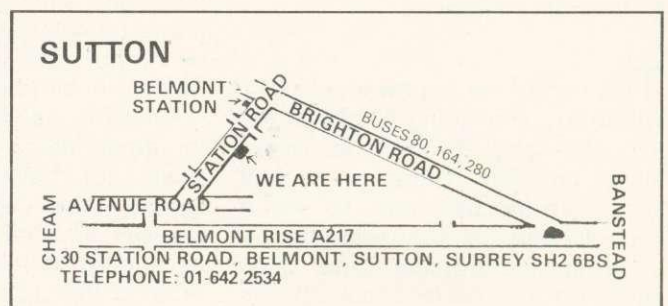
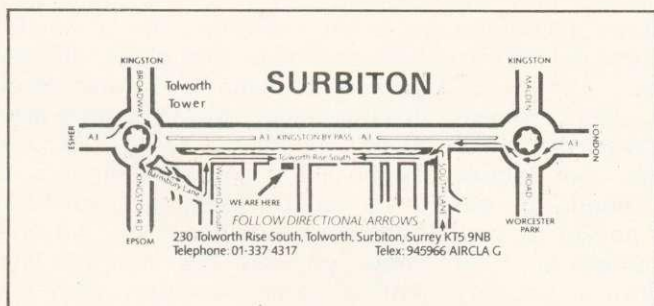

The AY38910 sound generator is a readily available chip which at around £6 offers all that is needed for the generation of fairly complex sound effects, such as gunshots, space sirens, helicopters and explosions.

The PSG (programmable sound generator) contains three separately programmable output channels: a white noise source, two eight-bit I/O ports and full ADSR (attack, decay, sustain, release) control of the output. It can continue to produce sound after the initial commands have been given, thus releasing the host processor for other tasks.

The circuit diagrams and software illustrated in this article will allow Acorn Atom owners to use this chip to add special effects to their favourite programs. The circuit can be constructed with a minimum amount of effort using only a handful of readily available components, for about £19.

The circuit makes use of the Atom's two I/O ports and requires the 6522 chip to be fitted inside the Atom; it uses the eight lines of port-B and lines PA0, PA1 of port-B. The only other components needed to interface this IC are an audio amplifier circuit, which can be created easily by the use of an LM386 audio amp IC.

SOUND OUT OF AN ATOM

For £20, you can build David Tilston's sound board and produce effects, including envelopes, to rival the BBC micro

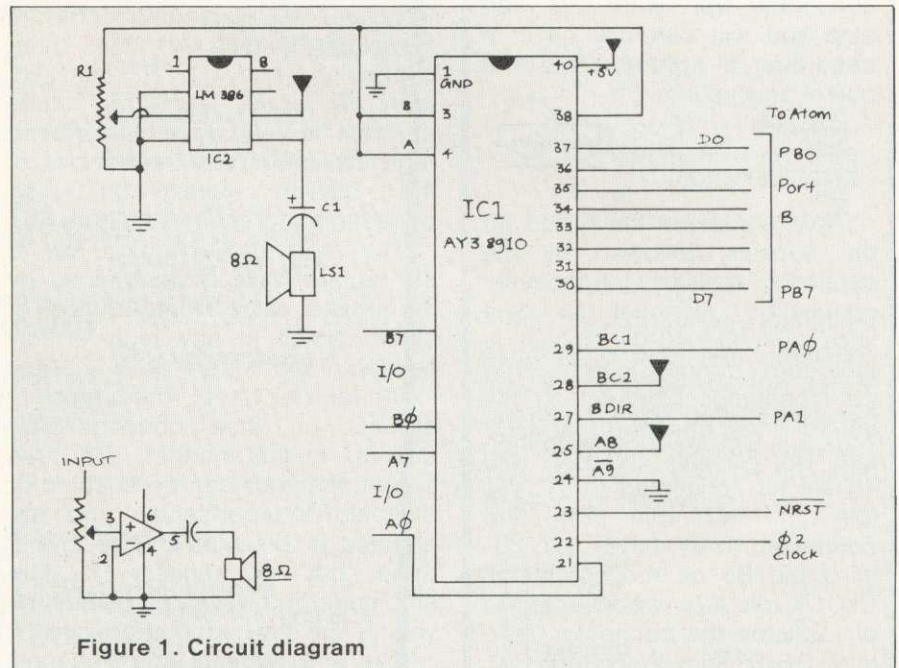

Figure 1. Circuit diagram

- 64-way A&B Eurocard connector with right angled pins (or wire-wrap pins) to fit PL6 on the back of the Atom.
- 64-way A&B Eurocard breadboard with correct patterning for euroconnector type DIN 41612 or DIN 41617.
- AY38910 PSG with data sheets. It is important to obtain the data sheets as they contain all the necessary information on the structure of the PSG, and how to program it.
- 40-pin socket, 8-pin socket, single strand wire.
- LM386 audio amp available from Tandy etc.
- 220 to 500 microfarad electrolytic capacitor, and any small type.
- 10k linear variable resistor, any small type, eg rotary.
- 8-ohm loudspeaker, low power type.

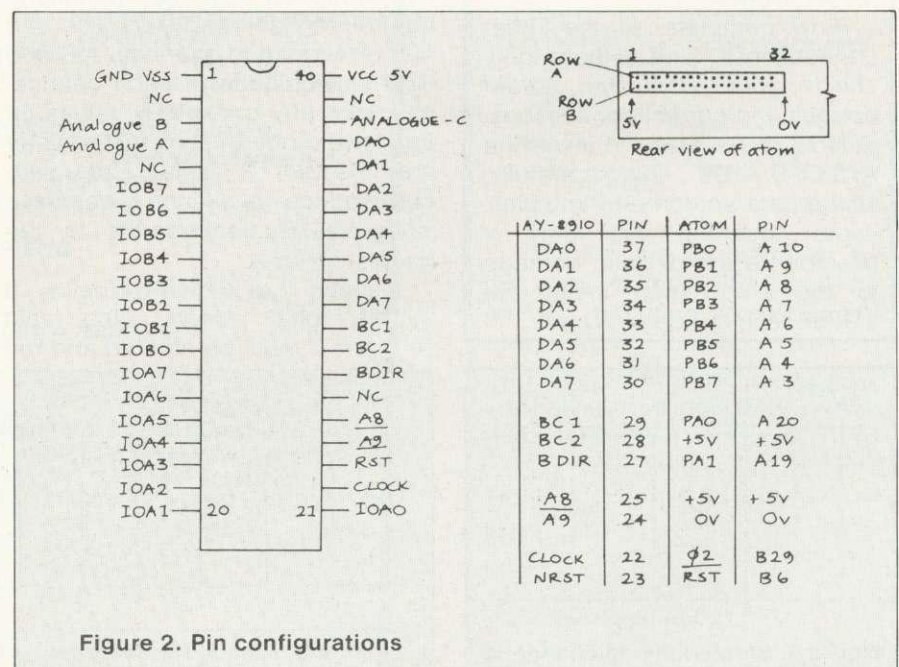

Figure 2. Pin configurations



BUILDING THE

BREADBOARD VERSION

The circuit can be built on a Eurocard breadboard using the following tools; soldering iron (low wattage with small tip), solder, wire strippers, wire snippers and sharp knife (figures 1 and 2).

First, solder the Eurocard connector onto the Eurocard ensuring correct orientation so the component side faces up and the board will stick out of PL6 (see below). If you have the connector type with wire-wrap pins you will carefully have to bend them at right angles with a pair of small pliers.

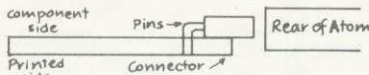

Next, solder on the 8 and 40 pin sockets, followed by the capacitor, resistor, loudspeaker connection. Connect all data lines from the 40-pin socket to their corresponding port lines on the connector. Connect all the control lines, ensuring that; BC2 (pin 18), A8 (pin 25), VCC (pin 40), are all connected to 5V. Vss (pin 1), A9 (pin 24), are connected to 0V. NRST (pin 23), joins pin B6 on the connector. CLOCK (pin 22), is connected to pin B29 on the connector. BC1 and BDIR join PA0 and PA1 respectively.

Now complete all the other connections and thoroughly check your work for solder bridges and correct connections.

Now you're ready to insert the AY38910. Do this carefully, taking care not to bend any pins. Avoid touching the pins if possible to avoid static damage to the chip. Then insert the LM386 taking the same care.

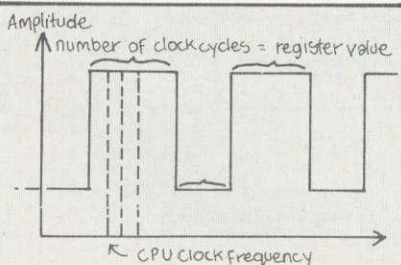

Figure 4. Single tone on channel A

PROGRAMMING THE SOUND CHIP

THE programmable generator creates sound by producing square waves on any or all of its three output channels. The faster the rate of the output the faster the rate of vibration and the higher the sound pitch (figure 3).

Frequencies of the square waves on the three output channels are controlled by the three 12-bit tone control registers:

- Channel A registers R0 and R1
- Channel B registers R2 and R3
- Channel C registers R4 and R5

Registers R0, R2 and R4 form the lower eight bits of the three channels, while R1, R3 and R5 form the upper four. The values programmed into any of these three registers control the frequencies of the output waves on their corresponding channels (figure 4).

The width of each high low of the square wave is determined by the register value, ie the number of clock cycles in any high or low section of the square wave is equal to the register value. Three registers all act on their corresponding channel in this manner. The three output channels can be enabled or disabled independently, and are enabled or disabled by the lowest three bits of register 7. The amplitude of a wave determines the volume of the sound produced.

The amplitude of each channel is controlled by its amplitude control register (registers 8,9 and 10 correspond to channels A,B and C). The amplitude of each channel can take any one of 16 values (ie the lower four bits of the register are used.) A value of zero corresponds to silence whereas a value of 15 corresponds to the loudest volume.

Listings 1 to 4 give examples of simple tonal effects. Note that program 1 must be entered and run

first. If the values in listing 1 for Y are changed in lines 500 and 510, the tone will change in frequency. If the value in line 530 is made smaller the sound will become quieter.

The frequency sweep routine (listing 2) runs through all the possible tones from a single channel, starting from the highest. Changing the step rates in lines 520 and 540 will produce some unusual variations, also changing the wait period in line 560.

On this soundboard, all three channels are connected to the same amplifier. Hence if more than one channel is enabled at a time the resultant wave will be a combination of the channels. It will sound like a chord, rather than a pure note.

Register 7 is used to enable or disable the output channels and the I/O ports (table 1). For example, a value of 240 (11110000 binary) will set port B to output, set port A to output, enable tones on channels A,B and C, enable noise on channel A.

Registers 14 and 15 correspond to two eight-bit input/output ports; A and B respectively. These are simple ports and using the I/O registers has no effect on sound generation.

As well as simple tones, a white noise source can be mixed with the three output channels. Noise creates a hiss similar to that on a radio which is not tuned. The PSG creates noise by adding small 'glitches' to the output wave. The degree of noise is controlled by register 6, a five-bit register, and so hiss values can be in the range 0 to 31. The mixing of the hiss with the output channels is controlled by bits 3,4 and 5 of register 7 in exactly the same way that the tones are enabled. Noise may be enabled onto a channel independently of

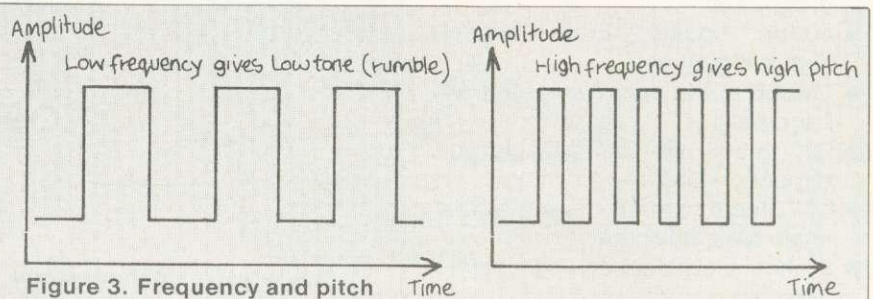

Figure 3. Frequency and pitch

Program 1.

```

10 DIM LL4
20 P.$21
30 P=#2800
40 [
50:LL0
60 LDA @ 03
70 STA #B801
80 STX #B800
90 LDA @ 02
   :latch data
100 STA # B801
110 STY # B800
120 LDA @ 00
   :latch tristate signal
130 STA # B801
140 RTS
145:LL1
150 LDA @ 03
   :latch address
160 STA # B801
170 STX # B800
180 LDA @ 01
   :initiate read
190 STA # B801
200 LDA @ 00
220 STA # B802
230 LDA # B800
240 STA # 80
250 LDA @ 00
   :set bus tristate
260 STA # B801
270 LDA @ # FF
280 STA # B802
290 RTS
300 ]
310 P.$6
320 ?#B803=255;?#B802=255
330 W LL0 ; R LL1
340 END
    
```

Routine LL0 writes data to one of the AY-3-8910 registers.
 x - register no (0 to 15)
 y - data (0 to 255)

Routine LL1 reads from the PSG registers.
 x - register no (0 to 15)
 # 80 data read from register.

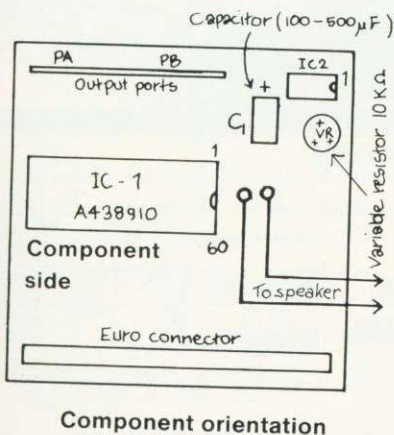

Listing 1. Single continuous tone

```

500 X = 0; Y = 120; LINK W
   : tone value low byte:
   Channel A
510 X = 1; Y = 0; LINK W
   : tone value high byte.
   Channel A
520 X = 7; Y = 254; LINK W
   : enable tone channel A
530 X = 8; Y = 15; LINK W
   : set volume level
   (maximum)
540 END
    
```

Listing 2. Frequency sweep

```

500 X=7; Y=254; LINK W
   : enable channel A single
   tone
510 X=8; Y=15; LINK W
   : set volume level
520 FOR A=0 TO 15 STEP 1
   : step through course
   values
530 X = 1; Y = A; LINK W
540 FOR B=0 TO 255 STEP 1
   : step through fine
   values
550 X=0; Y=B; LINK W
560 WAIT
   : slow sweep down
570 NEXT B
580 NEXT A
590 END
    
```

Listing 3. Varying tone

```

500 X=0; Y = 88; LINK W
   : set tone on channel A
510 X=7; Y=254; LINK W
   : enable channel A
520 X=8; Y=16; LINK W
   : set 'envelope' mode on
   channel A
530 X = 11; Y = 144; LINK W
   : set envelope period
   low byte
540 X=12; Y=200; LINK W
   : set envelope period
   high byte
560 X=13; Y=10; LINK W
   : set envelope pattern 10
570 END
    
```

Listing 4. Gunshot

```

500 X=7 ; Y=247 ; LINK W
510 X=8 ; Y=16 ; LINK W
520 X=11 ; Y=0 ; LINK W
530 X=12 ; Y=12 ; LINK W
540 X=13 ; Y=1 ; LINK W
550 X=6 ; Y=6 ; LINK W
560 LINK #FFE3
570 GOTO 500
580 END
    
```

CONSTRUCTION DETAILS
 FOR PCB VERSION

MOUNT components on the component side of the printed circuit board, ensuring correct orientation. Pin 1 is marked for both ICs.

Ensure the electrolytic capacitor (100 - 500uF) is oriented correctly. Mount the variable resistor (100KΩ, linear variable type).

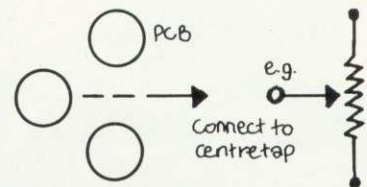

Fit the Eurocard connector ensuring correct pin orientation (row a and b, pins 1 and 32 are marked on the board.) See pin configuration diagrams if unsure. The connector may be mounted in either of two ways:

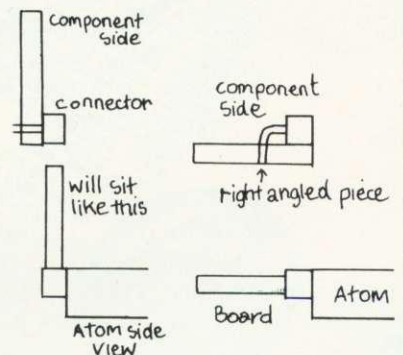

Connect the loudspeaker by two wires to the PCB. Insert the two ICs, ensuring correct orientation. Avoid touching pins to avoid static damage.

Finally, enter program 1 and run it. Then enter listing 2, insert board and adjust the volume control.

WORLD'S LARGEST LIST OF



**ECONET?
ASK US**

HARDWARE

(All prices include VAT)

- MMB01 BBC MODEL B
- MMB02 BBC MODEL B + ECONET
- MMB03 BBC MODEL B + ECONET/DISK INT
- MMB04 BBC MODEL B + DISK INTERFACE
- MMB05 BBC MODEL A
- MMB06 BBC MODEL A + ECONET
- MMB07 BBC MODEL A 100K
- MMB08 BBC DISK DRIVE BOOK
- MMB09 BBC DISK INTERFACE
- MMB10 BBC 6502 2nd PROCESSOR
- MMB11 BBC 280 2nd PROCESSOR
- MMB12 TELETEXT RECEIVER
- MMB14 JOYSTICKS (PAIR)
- MMB15 RGB COLOUR MONITOR S/RES
- MMB16 RGB COLOUR MONITOR H/RES
- MMB17 RGB CABLE
- MMB18 12" GREEN MONITOR
- MMB19 12" AMBER MONITOR
- MMB20 PLINTH FOR RGB MONITOR
- MMB21 A TO B UPGRADE (KIT)
- MMB22 A TO B UPGRADE (KIT)
- MMB23 MEMORY UPGRADE (KIT)
- MMB24 PRINTER I/O (KIT)
- MMB25 ANALOGUE (KIT)
- MMB26 SERIAL I/O & RGB (KIT)
- MMB27 EXPANSION BUS (KIT)
- MMB28 PARALLEL CABLE ASSEMBLED
- MMB29 USER PORT CONNECTOR/CABLE
- MMB30 ANALOGUE PLUG & CABLE
- MMB31 5 PIN DIN
- MMB32 6 PIN DIN
- MMB33 7 PIN DIN
- MMB34 BUS CONNECTOR
- MMB35 SEIKOSHA GP250
- MMB79 EPSON RX80
- MMB80 EPSON FX 80 160 CPS
- MMB81 EPSON MX100
- MMB82 SEIKOSHA GP100
- MMB83 SMITH CORONA D/WHEEL
- MMB84 SPARK JET PRINTER
- MMB85 TEC STARWRITER
- MMB86 5 1/4" DISKS (10)
- MMB87 COMPUTER CASSETTE TAPES £1.00
- MMB88 COMPUTER DUST COVER (MICRO MAN) £ 5.74

- MMB44 DISK DRIVE DUST COVER
- MMB45 CASSETTE RECORDER
- MMB46 FLOWCHART STENCIL
- MMB47 DISK LIBRARY BINDER
- MMB48 PAPER 9 1/2" 11" (2000)
- MMB49 GRAPHICS TABLET (DISK)
- MMB50 LIGHT PEN
- MMB51 A/D CONVERTOR
- MMB52 128 K RAM PACK
- MMB53 COOLING FAN
- MMB54 DISK DRIVE S.S.40 TRACK
- MMB55 DISK DRIVE D.S.80 TRACK
- MMB56 DISK DRIVE 2"D.S.80 TRACK
- MMB57 2 DRIVE CABLE FOR ABOVE
- MMB58 API FOR BBC COMP (BOOK)
- MMB59 30 PROGS FOR BBC (BOOK)
- MMB60 PROG THE 6502 (BOOK)
- MMB61 6502 APPLICATIONS (BOOK)
- MMB62 LET BBC BASIC (BOOK)
- MMB63 BBC MICRO TEACH (BOOK)
- MMB64 30 HOUR BASIC (BOOK)
- MMB65 280 DISK PACK
- MMB66 480 SOFTWARE DESIGN
- MMB67 INTRODUCTION TO FORTH
- MMB68 DISCOVER FORTH
- MMB69 PRACTICAL PROGS FOR BBC
- MMB70 PRACT PROGS FOR BBC & ATOM
- MMB71 (D.JOHNSTON-DAVIS)
- MMB72 (BBC)
- MMB73 THE COMPUTER BOOK
- MMB74 EASY PROG FOR BBC
- MMB75 GAMES FOR BBC COMPS PLAY
- MMB76 BASIC PROGRAMMING FOR BBC
- MMB77 FORTH PROGRAMMING FOR BBC
- MMB78 1.2 OPERATING ROM

SOFTWARE

(All prices include VAT)

- MMS001 OPTIONS TIMETABLE (C)
- MMS002 RECORD CHANGER
- MMS003 WORD PROCESSOR
- MMS004 EDUCATIONAL - 1
- MMS005 COLOSSAL ADVENTURE
- MMS006 ADVENTURE QUEST
- MMS007 DUNGEON ADVENTURE
- MMS008 STARSPELL
- MMS009 TABLE STAR
- MMS010 EARLY WARNING
- MMS011 ROADRUNNER
- MMS012 PLANES
- MMS013 PHARAOS TOMB
- MMS014 FROGGER
- MMS015 LUNAR LANDER
- MMS016 TOWER OF ALTOS
- MMS017 MAZE INVADERS
- MMS018 FOOTER
- MMS019 GOMOKO
- MMS020 MUNCYMAN
- MMS021 MASTERMIND
- MMS022 SPACE MAZE
- MMS023 COWBOY SHOOTOUT
- MMS024 ALIEN MARTIANS
- MMS025 MARS
- MMS026 SEEK
- MMS027 SWEEP
- MMS028 GALACTIC COMMANDER
- MMS029 CAT & MOUSE
- MMS030 ZOMBIES
- MMS031 STARTREK
- MMS032 REVERSI 1
- MMS033 CHESS
- (A & F SOFTWARE) £7.99
- (A & F SOFTWARE) £7.99
- (A & F SOFTWARE) £6.90
- (PROGRAM POWER) £ 7.99
- (PROGRAM POWER) £ 4.54
- (PROGRAM POWER) £ 6.84
- (PROGRAM POWER) £ 4.54
- (PROGRAM POWER) £ 6.84
- (PROGRAM POWER) £ 7.99
- (PROGRAM POWER) £ 6.84
- (PROGRAM POWER) £ 7.99
- (PROGRAM POWER) £ 6.84
- (PROGRAM POWER) £ 7.99
- (PROGRAM POWER) £ 7.99
- (PROGRAM POWER) £ 5.69
- (PROGRAM POWER) £ 4.54
- (PROGRAM POWER) £ 5.69
- (PROGRAM POWER) £ 5.69
- (PROGRAM POWER) £ 7.99
- (R.ZAKS)
- (R.JUSTON)
- (T.HARTNELL)
- (C.PRIGMORE)
- (TORCH)
- (L.J.SCANLON)
- (K.NECHT)
- (T.HOGAN)
- (W.J.WELLER)
- (N.B.PRYER)
- (S.A.M.S)
- (ACORN)
- £ 5.95
- £ 6.75
- £ 5.95
- £ 5.95
- £ 5.95
- £ 780.00
- £ 10.25
- £ 8.25
- £ 10.25
- £ 14.95
- £ 18.40
- £ 23.00
- £ 18.40
- £ 9.25
- £ 11.38
- £ 11.38
- £ 11.38
- £ 11.50
- £ 11.50
- £ 6.90
- £ 6.90
- £ 7.99

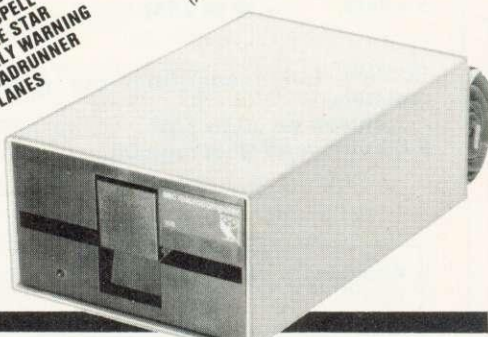

MICRO MANAGEMENT ORDER FORM

CODE	ITEM	QTY	AT		COST	
			£	p	£	p
CREDIT CARD No			SUB TOTAL			
NAME		BARCLAY/ACCESS	POST & PACKING			
ADDRESS			TOTAL			



BBC MICROS ACCESSORIES

Market your own software through us Write with details

- MMS060 ALGEBRAIC MANIPULATION (ACORN/SOFT) £ 9.95
- MMS061 MONSTERS (ACORN/SOFT) £ 9.95
- MMS062 PLANETOID (ACORN/SOFT) £ 11.90
- MMS063 ARCADE ACTION (ACORN/SOFT) £ 9.95
- MMS064 DESK DIARY (ACORN/SOFT) £ 9.95
- MMS065 PHILOSOPHERS QUEST (ACORN/SOFT) £ 16.85
- MMS066 LISP (ACORN/SOFT) £ 9.95
- MMS067 GRAPHS & CHARTS (ACORN/SOFT) £ 7.50
- MMS068 CREATIVE GRAPHICS (BOOK) (ACORN/SOFT) £ 11.50



- MMS034 WORLD GEOGRAPHY (PROGRAM POWER) £ 6.84
- MMS035 JUNIOR MATHS (PROGRAM POWER) £ 6.84
- MMS036 DISASSEMBLER (PROGRAM POWER) £ 7.99
- MMS037 TIMETREK (PROGRAM POWER) £ 7.99
- MMS038 ADVENTURE (PROGRAM POWER) £ 6.84
- MMS039 EL DORADO GOLD (PROGRAM POWER) £ 7.99
- MMS040 LASER COMMAND (PROGRAM POWER) £ 5.89
- MMS041 ASTRO NAVIGATOR (PROGRAM POWER) £ 7.99
- MMS042 MICRO BUDGET (PROGRAM POWER) £ 10.29
- MMS043 FILER (PROGRAM POWER) £ 6.84
- MMS044 CONSTELLATION (PROGRAM POWER) £ 4.60
- MMS045 BEEBTREK (PROGRAM POWER) £ 5.00
- MMS046 MICRODRIBBY (CSL MICRODATA) £ 8.00
- MMS047 SPACE PIRATES (BUG-BYTE) £ 9.95
- MMS048 CHESS (BUG-BYTE) £ 9.95
- MMS053 ARCADIAN (ACORN/SOFT) £ 9.95
- MMS054 SNAPPER (ACORN/SOFT) £ 9.95
- MMS055 METEORS (ACORN/SOFT) £ 9.95
- MMS056 CREATIVE GRAPHICS (ACORN/SOFT) £ 9.95
- MMS057 TREE OF KNOWLEDGE (ACORN/SOFT) £ 9.95
- MMS058 BUSINESS GAMES (ACORN/SOFT) £ 9.95
- MMS059 PEEKO-COMPUTER (ACORN/SOFT) £ 9.95

- MMS069 LOGO II (COMPUTER CONCEPTS) £ 7.50
- MMS070 FRUIT MACHINE (BUG-BYTE) £ 11.50
- MMS071 FORTH (LEVEL 9) (COMPUTER CONCEPTS) £ 5.50
- MMS073 HITCH-HIKER (COMPUTER CONCEPTS) £ 6.87
- MMS074 SPACEHAWKS (COMPUTER CONCEPTS) £ 8.97
- MMS075 ASTEROID BELT (COMPUTER CONCEPTS) £ 8.97
- MMS076 CHESS (COMPUTER CONCEPTS) £ 11.50
- MMS077 ANGLEZUP (GEM SOFTWARE) £ 6.88
- MMS078 L TRAP (GEM SOFTWARE) £ 6.88
- MMS079 TAKE OFF (GEM SOFTWARE) £ 5.73
- MMS080 GRAPH CAPERS (GEM SOFTWARE) £ 6.88
- MMS081 MONTE CARLO (BUG-BYTE) £ 6.88
- MMS082 SPACE WARP (BUG-BYTE) £ 9.00
- MMS083 GOLF (BUG-BYTE) £ 5.50
- MMS084 DRAGON QUEST (BUG-BYTE) £ 11.50
- MMS085 AIRLIFT (BUG-BYTE) £ 5.50
- MMS086 POLARIS (BUG-BYTE) £ 5.50
- MMS089 CUBE MASTER (ACORN/SOFT) £ 9.95
- MMS090 GRAPHS & CHARTS (BBC) (ACORN/SOFT) £ 7.50
- MMS091 HOME FINANCE (BBC) £ 10.00
- MMS092 EARLY LEARNING (BBC) £ 10.00
- MMS093 MUSIC (BBC) £ 10.00
- MMS094 THE COMPUTER PROG VOL 1 (BBC) £ 10.00
- MMS095 THE COMPUTER PROG VOL 2 (BBC) £ 10.00
- MMS096 PAINTING (BBC) £ 10.00
- MMS097 DRAWING (BBC) £ 10.00
- MMS098 GAMES OF STRATEGY (MICRO MAN) £ 10.00
- MMS099 FUN GAMES (MICRO MAN) £ 10.00
- MMS100 THE COMPUTER BOOK (MICRO MAN) £ 10.00
- MMS101 SALES LEDGER DISK (ACORN/SOFT) £ 10.00
- MMS102 PURCHASE LEDGER DISK (ACORN/SOFT) £ 10.00
- MMS103 FILE IT DISK (ACORN/SOFT) £ 10.00
- MMS104 MAILING LIST DISK (ACORN/SOFT) £ 10.00
- MMS105 MISSING SIGNS (ACORN/SOFT) £ 10.00
- MMD106 ROCKET RAID (J.J.K.) £ 10.00
- MMD107 SENTENCE SEQUENCING (J.J.K.) £ 10.00
- MMD108 MONSTERS (J.J.K.) £ 10.00
- MMD109 SNAPPER (J.J.K.) £ 10.00
- MMD110 METEORS (J.J.K.) £ 10.00
- MMD111 PLANETOID (J.J.K.) £ 10.00
- MMS112 MUTANT BREAKOUT (J.J.K.) £ 10.00
- MMS113 INVADERS (J.J.K.) £ 10.00
- MMS114 3-D MAZE (J.J.K.) £ 10.00
- MMS115 BEE BEEP (J.J.K.) £ 10.00
- MMS116 HYPERDRIVE (J.J.K.) £ 10.00
- MMS117 SUPER HANGMAN (J.J.K.) £ 10.00
- MMS118 FLAGS (J.J.K.) £ 10.00
- MMS119 STRATOBOMBER (J.J.K.) £ 10.00
- MMS120 FAMILY GAMES (J.J.K.) £ 10.00
- MMS121 ATLANTIS (J.J.K.) £ 10.00
- MMS122 BEEBUNCH (J.J.K.) £ 10.00
- MMS124 STARTDROK (J.J.K.) £ 10.00
- MMS125 WORDPRO (J.J.K.) £ 10.00
- MMS126 POLAR BEAR (J.J.K.) £ 10.00
- MMS127 DATABASE FOR 16/32K (SOFTWARE FOR ALL) £ 10.00
- MMS128 J.R. (SOFTWARE FOR ALL) £ 10.00
- MMS129 SPACE KINGDOM (SOFTWARE FOR ALL) £ 7.95
- MMS130 CAR WARS/ALIEN PLANET (SOFTWARE FOR ALL) £ 6.95
- MMS131 TIME TRAVELLER (SOFTWARE FOR ALL) £ 7.45
- MMS132 UTILITY PACK 1 (SOFTWARE FOR ALL) £ 7.94
- MMS134 ROW OF FOUR (SOFTWARE FOR ALL) £ 6.54
- MMS135 ZOMBIE ISLAND (SOFTWARE FOR ALL) £ 7.95
- MMS136 BEEBTREK INTRUDER (SOFTWARE FOR ALL) £ 6.95
- MMS137 INHERITANCE (SOFTWARE FOR ALL) £ 5.95
- MMS138 GREAT BRITAIN LTD. (SOFTWARE FOR ALL) £ 5.95
- MMS139 WORLD TRAVEL GAME (SOFTWARE FOR ALL) £ 5.95
- MMS140 PASCAL (SOFTWARE FOR ALL) £ 5.95
- MMS141 ANGLE (SOFTWARE FOR ALL) £ 5.95
- MMS142 INKOSI (SOFTWARE FOR ALL) £ 5.95
- MMS143 INVISIBLE MAN (SOFTWARE FOR ALL) £ 5.95
- MMS144 LETTERS (SOFTWARE FOR ALL) £ 5.95
- MMS145 METRICS (SOFTWARE FOR ALL) £ 5.95
- MMS146 SEQUENCES (SOFTWARE FOR ALL) £ 5.95
- MMS148 BBC CASTLE OF RIDDLES (SOFTWARE FOR ALL) £ 5.95
- MMS149 FORTH (SOFTWARE FOR ALL) £ 5.95
- MMS150 ROCKET RAIDER (SOFTWARE FOR ALL) £ 5.95
- MMS151 SPHINX ADVENTURER (SOFTWARE FOR ALL) £ 5.95
- MMS152 SLIDING BLOCK PUZZLER (SOFTWARE FOR ALL) £ 5.95
- MMS154 MORSE TUTOR (SOFTWARE FOR ALL) £ 5.95
- MMS155 30+ PROGS FOR THE BBC (C.J.E.) (SOFTWARE FOR ALL) £ 4.60
- MMS156 WAR & PEACE NUMBERS (FISHER MARRIOTT) £ 11.50
- MMS157 WAR & PEACE TABLES (FISHER MARRIOTT) £ 11.50
- MMS158 WORDWISE (COMPUTER CONCEPTS) £ 44.85
- MMS159 EDUCATIONAL 2 (GOLEM) £ 8.25
- MMS160 SUPERLIFE (GOLEM) £ 10.58
- MMS161 KATAKOMBS (GOLEM) £ 10.58
- MMS162 UTILITIES (GOLEM) £ 8.25

Local Authorities and Government Departments. Orders welcomed. Educational Seminars given.

Overseas dealers and distributors welcomed. Enquiries a speciality. Exports a speciality.



Mail or telephone order Barclaycard or Access Credit Card accepted



Only defective or faulty goods may be returned.

MICRO MANAGEMENT

POST and PACKING

IS STILL ONLY £1 PER ITEM

Micro Management 32 Princes Street, Ipswich, Suffolk. Telephone: (0473) 59181

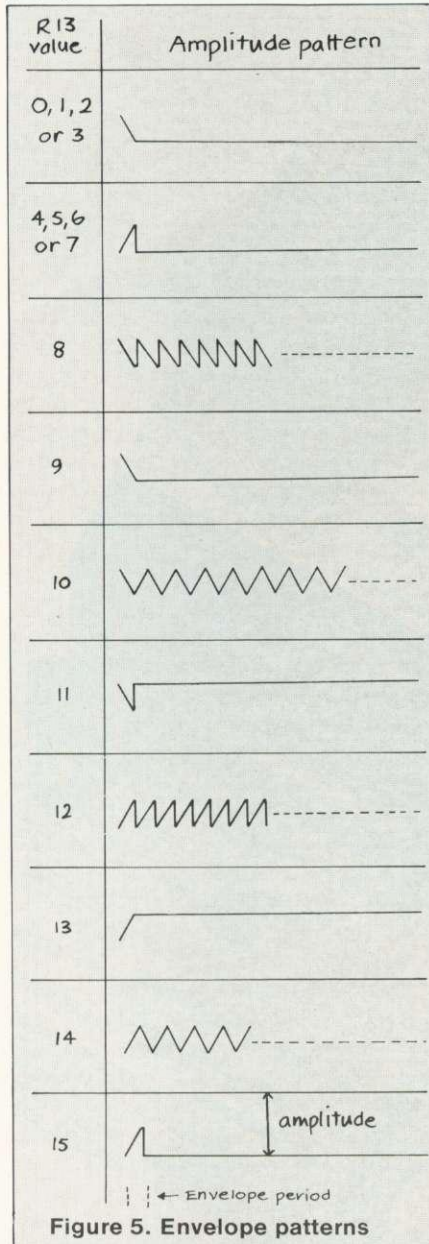

bit 7	port B control	1 - output	0 - input
bit 6	port A control	1 - output	0 - input
bit 5	channel C noise enable	0 - enabled	1 - disabled
bit 4	channel B noise enable	0 - enabled	1 - disabled
bit 3	channel A noise enable	" "	" "
bit 2	channel C tone	" "	" "
bit 1	channel B tone	" "	" "
bit 0	channel A tone	" "	" "

Table 1. Register 7 functions

the tones. A value of 0 produces a high pitched hiss, whereas 31 produces a low rumbling hiss. The listing below demonstrates this:

```
500 X=6; Y=15; LINK W
      : set noise level
510 X=7; Y=247; LINK W
      : enable noise on to channel A
520 X=8; Y=15; LINK W
      : set volume to maximum
530 END
```

Now we come to the most useful register of all, envelope control. We have seen that simple or multiple tones can be created with set volume levels. However, in the production of more complicated sounds the AY38910 offers full ADSR control of the output channels (attack, decay, sustain and release). This allows volume levels of channels to be varied in accordance to specific output patterns, eg sounds can be made to drop in volume from maximum to zero over a specific period of time. Envelope mode is enabled onto any channel by placing a volume value of 16 in the corresponding amplitude control register (set bit 4 in registers 8,9 and 10).

When an envelope is chosen for a channel (ie 16 has been placed

in the corresponding amplitude control register setting 'envelope' mode), the output volume will vary according to the wave pattern (envelope pattern) selected. For examples, see figure 5.

The envelope period control register controls the time periods for the envelope pattern. This is a 16-bit register formed by combining the two eight-bit registers, 11 and 12. Register 11 forms the lower eight bits (fine tune) and register 12 forms the upper eight bits (coarse tune). This period varies from a few microseconds up to several seconds; ie, a low value (eg 20) will produce a time period of a few microseconds, whereas a maximum value of 65536 will produce a period of several seconds.

Before entering any data, it is advisable to write zero to every location in the AY38910. This cancels any sounds and can be done by:

```
FOR X=0 TO 15; Y=0; LINK W;
NEXT X
```

When a sound has been programmed into the registers, it will continue until altered or reset,

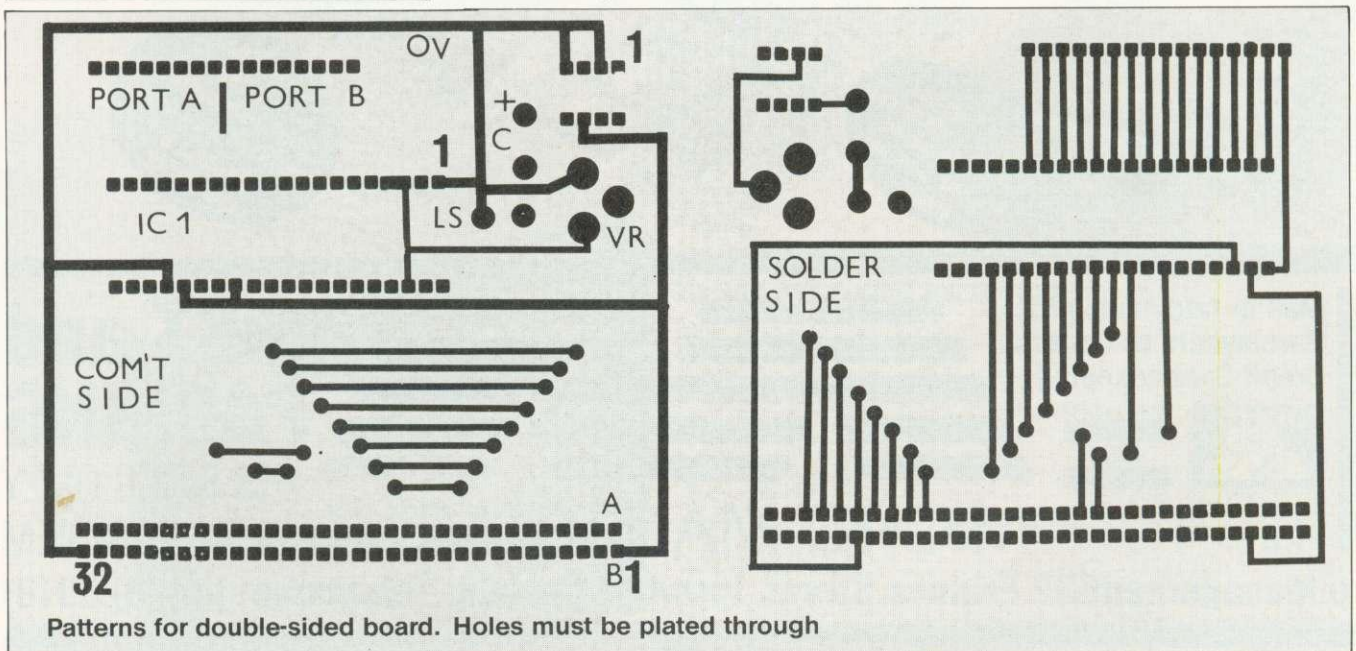



SOFTWARE INVASION

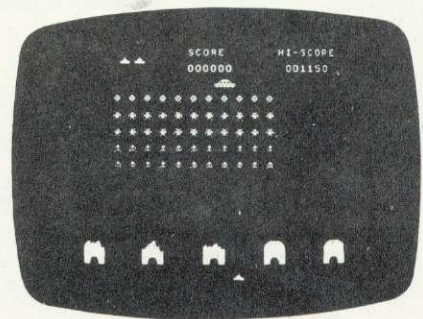

001 INVADERS

Arcade quality full feature Space Invader game, written in machine code using Mode 1 colour graphics. Hi-Score, Mystery Ship, Bonus Base, Advancing, Walking Aliens.
Runs on a model B for £6.95 inc.

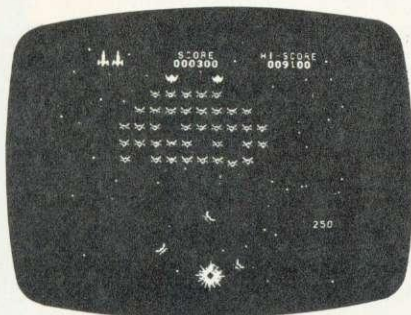

002 GALAXIAN

Arcade quality game using machine code, vivid Mode 1 colour, Moving Stars, Hi-Score, Bonus Ship, Flagships, Swooping Aliens and Exciting Sound Effects.
Runs on a model B for £6.95 inc.

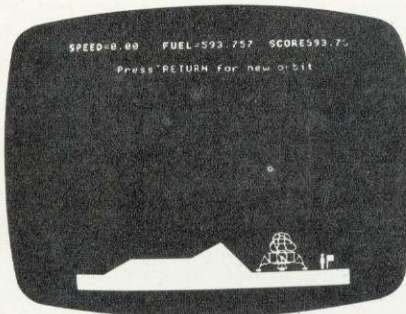

003 APOLLO

Lunar Lander with a difference! 4 stage game comprising Orbit, Long Range, Mid Range, Detailed Landings, Limited Fuel, Hall of Fame, Sound, Moon Walk etc.
Runs on a model B for £6.95 inc.

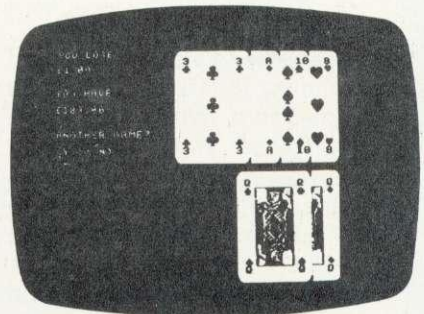

004 BLACKJACK, TEXTPRO, DISASSEMBLER

1 tape containing 3 programs representing incredible value for money. **BLACKJACK** is like the arcade game, but uses much better graphics - so real you could pick them off the screen!
TEXTPRO is a simple word processor, offering text scrolling, cassette routines, line editing, justification, insertion and deletion, variable line width and page length, data verification, line centralizing and printer commands including page scrolling, large print and variable spacing. Full instructions and function key labels supplied.
DISASSEMBLER lists object code and Assembler mnemonics. Includes a pause function, printer option, page mode and only occupies 4.5K of RAM. Full instructions and function key labels supplied.
Runs on a model B for £6.95 inc.

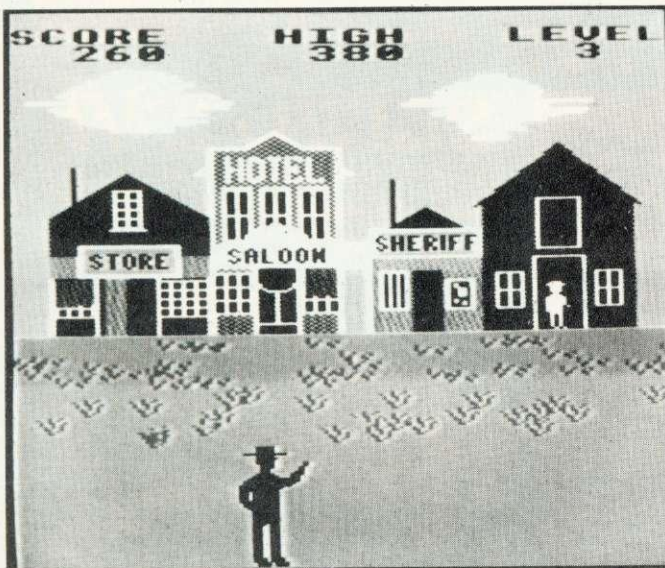

005 GUNSMOKE is the latest release from SOFTWARE INVASION. It's completely different from any game you've played before. Superb realistic sound effects - high speed animation - nail biting action - fantastic highly detailed graphics, mixing colours to produce brown, grey and olive in addition to the normal shades. You play the part of a Wild West Gunslinger, dodging bullets and trying to shoot bandits as they appear in doors, windows, alleys and on the roof. There's sixteen different bandits who need no provocation to fill you full of lead. If you manage to kill them all, it's not over, day turns to night and the nightmare begins again.

If you're quick on the draw, this game's for you!

GUNSMOKE runs on a BBC Micro model B and costs just £7.95 inclusive.

**AND
NOW**

GUNSMOKE

50 Elborough St., Southfields,

London SW18 5DN.



and thus releases the Atom to continue with its program. A sound can be modified by changing the required registers. On entering a new value into any of the registers, the generator will take immediate action and create a sound relating to the new values. Before entering any of the example programs, the main program must be entered and run. Once the program has been run it can be deleted, since the machine code it creates is placed out of the way. (NB the machine code can be relocated to any desirable address since it occupies only 60 bytes).

The best way to see what sort of sounds the AY38910 is capable of is to experiment. When using the write routine, set W to the start of the write routine, X should be set to the required register number (0 to 15), and Y should contain the data to be written. Use with LINK W. With the read routine R should be set to the start, X should be set to the required register number. #80 will contain the data read.

Because the PSG is latch driven the following sequence must be

performed to write to any register:

Write

1. send latch address signal.
2. send address (0 to 15).
3. send latch data signal.
4. send data bus tristate signal.

Read

1. send latch address signal.
2. send address.
3. send read data signal.
4. read data.
5. send set bus tristate signal.

Once a register has been latched it will remain latched until a new register address is sent. This allows multiple read and writes to a register. Reading any register will give its present value.

To conclude, the AY38910 offers good quality sound effects at a modest price and is easily adapted to interface most small eight-bit micros. Programming simple tones and notes is child's play, but complex sounds require a little more work with up to 13 data registers. The chip can produce sounds that vary in volume as well as pitch can be made to die or increase in volume or even repeat. If any Atom enthusiasts are thinking of expanding the capabilities of their machines then the Ay38910 offers an inexpensive addition, of particular interest to games fanatics. Atom owners using Forth also have the possibility of stimulating the envious sound and envelope commands of the BBC micro.

Acorn User has arranged for a high-quality circuit board to be made up for use in the circuit outlined in this article. The cost of a double-sided silkscreen printed circuit, with plated through holes and component overlay is £5.38. This includes VAT and UK postage (write in for overseas prices).

Kits of parts, as well as fully built and tested boards are being prepared, prices on application.

Write to Acorn User Board Offer, Electro Technical Services, 55 Raymond Road, Hellesdon, Norwich NR6 6PN. Discounts are available on large orders. Please allow 28 days for delivery.

INTERFACE BOX FOR THE BEEB

▶ page 55

analogue input, you can hear the noise of the continuous stream of interrupts which the machine is producing. This can be useful in an educational context.

If using a printer with a parallel interface, you may decide not to use the printer port for interfacing. There is no harm in simply leaving it off the circuit since none of its lines is essential to the working of the circuit as a whole. On the other hand, since the printer port can only be configured as an output and since it has a buffer chip to give it extra driving capability, there is no harm in using the port for both purposes. However, to avoid connecting and disconnecting the sockets underneath the micro, it would be worthwhile mounting an IDC plug on the box and wiring it in parallel with the sockets, so the printer could then be plugged into

the interface box. This has the added advantage that if you have a set of eight LEDs you can monitor data on the lines going to the printer - this again has obvious educational value.

Whilst on the subject of the printer port it is worth saying again that it is configured for output only

Acorn User has arranged for a high-quality circuit board to be made up for use in the circuit outlined in this article. The cost of a double-sided printed circuit, with plated through holes and component overlay is £11.95. This includes VAT and UK postage (write in for overseas prices).

Kits of parts, as well as fully built and tested boards are being prepared, prices on application (should be about £80 for completed board).

Write to Acorn User Board Offer, Electro Technical Services, 55 Raymond Road, Hellesdon, Norwich NR6 6PN. Discounts are available on large orders. Please allow 28 days for delivery.

since it has a 74LS244 buffer on it which is uni-directional and permanently enabled. Thus if you do try to input to the printer port you may blow up the chip. The advantage of having the buffer chip is that the drive capability of the port is thereby increased markedly over the PA port on the 6522 versatile interface adaptor from which it comes. If a given line is at logic 1 it is capable of supplying 1mA with hardly any voltage drop and can manage up to about 5mA. When it is at logic 0 it can 'sink', ie draw into the chip, something like 10mA, and I have tested it up to 25mA with no obvious ill effects. But in practice I would work on being able to supply 2mA at logic 1 and sink 10mA at logic 0.

Next month: Applications for the interface box and some test routines if you decide to make the circuit yourself rather than buy it ready-built and tested.

Software for the BBC Micro

...ROMS...

Available Soon!
SEND FOR DETAILS

Beeb-calc

A ROM based spread sheet program, like Wordwise this firmware is very fast and simple to use — yet is a powerful spread sheet analysis program, considerably better than the original 'calc' program — full floating point maths. Works in 80 or 40 column screen modes, variable column widths. Works with either cassette or disk.

This ROM coupled with Wordwise can turn your micro into an ideal small business machine.

£34.00 + VAT

Debugging Program

2 machine code programs — one in ROM, one on tape. Essential for the machine code programmer. An ideal compliment to the assembler built into the BBC machine. Contains a full machine code monitor allowing examination and alteration of memory, registers, setting of break points and even single stepping through machine code programs.

ROM based £19.00 + VAT

cassette £10.00 + VAT

Disk Doctor

A ROM containing useful disk utility programs. Enables the recovery of any data off the disk including deleted files etc. The full disk editor allows the alteration of any bytes directly on the disk (or in memory), or the loading and saving of any track or sector on the disk. Automatic transfer of programs from tape to disk and visa versa.

Includes a whole host of other useful utilities — string search, function key editing, the ability to format 35, 40 & 80 track disks.

£19.00 + VAT

Printer toolkit ROM

This includes routines for high resolution screen dumps for both the EPSON and NEC printers. Will work in any graphics mode with automatic grey shading of all screen colours. The most useful feature of this program is its 'spooling' capability, this enables data such as a program listings or high res screen dumps to be automatically spooled from your disk to the printer while using your BBC machine for running other programs.

£19.00 + VAT

Quantity discounts, starting at five off.

Wordwise

THE WORD PROCESSOR FOR THE BBC MICRO



SUPERB REVIEWS!

Wordwise

The word processor for the BBC machine.

This ROM based word processor has received superb reviews.

A powerful and flexible system — it's greatest strength being that it is fast, simple and very easy to use. No other existing word processor (even ROM based, costing twice as much) can compare with the flexibility of this system.

Supplied with full spiral bound manual and cassette containing an example document and free typing tutor program.

£39.00 + £1.50 p&p + VAT

Now available from stock. Quantity discounts, starting at five off.

all ROM based software requires new series 1 Operating Systems. We are now in the position to supply 1.2 ROM's for £5.00 + VAT when you buy any of the above software.

Computer Concepts

CASH OR ROYALTIES waiting for any interesting software (not just games) for the BBC Micro. The better the program the more we will pay

Dept AC8

16, Wayside, Chipperfield,

Herts, WD4 9JJ. tel(09277) 69727



**EXTENDED COLOUR-FILL GRAPHICS
E.C.F.G. GIVES YOU A CHOICE OF
!! 4 BILLION + !!
SHADES FOR TRIANGLE FILLING
IN BBC MODES 0,1,2,4 & 5**

- * PLOT 81 and 85 commands for triangle-filling have been adapted to use the ECFG fill-shade currently selected by new ECFG user-friendly commands. GCOL is still used for line colour.
- * Easy choice of 17, 289 & 6561 subset colours between those normally available in 2, 4 & 16 colour MODEs. Further options include colours, angles, spacings & widths of cross-hatch etc.
- * ECFG commands can be used in BASIC, typed from the keyboard, accessed in Assembler, or in future BBC Micro languages. ECFG is MOS-adaptive, and proven with versions 0.1 to 1.2
- * Bootstrap from cassette rapidly builds an ECFG module at a RAM address pre-defined by PAGE, which is then automatically increased 512 bytes to allow immediate LOADING of programs etc.

Price : £10 inc : Mail Order only

GAELSETT (ECFG)

44 EXETER CLOSE, STEVENAGE, HERTS. SG1 4PW.
(Tel. Stevenage 51224)

BBC MICRO

● scientific & educational applications ●

COMPLETE HARDWARE & SOFTWARE PACKAGES
FOR MODEL B BBC MICROCOMPUTER SYSTEM

Professional Joystick 35.50

Environmental Monitoring Packages
- Temperature, Illumination, Humidity etc. FROM 18.00

100 year Clock-Calendar Unit 35.50

ALL SOFTWARE PROVIDED ON CASSETTE

manuals only available at 75p each
refundable against package purchase

ALL PRICES INCLUDE P+P and VAT

for details of these and other products
please send s.a.s. to :-

Chris Hall Software Engineering

Department B
47 Bush Lane
Freckleton
PRESTON PR4 1SB

BBC MICRO

Cost-effective instrumentation for Home or School

WEST OF SCOTLAND

BBC & ATOM DEALER AND SERVICE CENTRE

HARDWARE

Model A	£299.00 inc.
Model B	£399.00 inc.
Postage & Packing	£6.00 inc.

SOFTWARE

Acornsoft Bug Byte Program Power also
30 Golf Fruit Machine Dodgems
Send SAE for full list

MONITORS PRINTERS

A selection on display A

Upgrades carried out
Disk and Econet interfaces fitted
Also a wide selection of books and magazines

WEST COAST PERSONAL COMPUTERS

47 Kyle Street
AYR
Tel 0292 (285082)

Bourne Educational Software

BES makes learning fun **B B C**

WORLD-WISE (Code P19) £7.95

Constructive geography programs allowing children to build databases covering both the UK and the World.

- Choice of 10 categories in each program eg. rivers, antiquities, towns, mountains etc.
- Powerful review and edit facilities to correct entries if necessary.
- Save or load the database at any time.
- Sound adds interest—and level is adjustable!
- Motivates children as computer tries to guess what they're thinking of.
- Encourages use of atlas and reference books as children create the database.
- Maintains extensive information on individual children's entries.
- Suitable for ages 7-15 and for Model B.

WORDHANG (Code P20) £7.95

Educational version of 'hangman' word game, with limited allowance of wrongly guessed letters.

- Learning to spell no longer a chore as children try to keep him alive.
- Full colour graphics and simple screens appeal.
- Includes lists totalling 260 words. Your own word lists easily created and saved too.
- Adjustable time limit for each guess.
- Monitors details of individual childrens performance, list used etc.
- Suitable for ages 5-13 and Model B.

ANIMAL/VEGETABLE/MINERAL (Code P21) £4.95

Think of an object and see if the computer can guess it correctly. The computer asks a series of questions as it tries to guess the answer. The program either guesses correctly or asks for a question to distinguish the object from the incorrect guess.

- Stimulates fascinating and education discussions as to eg. the difference between an alligator and crocodile.
- Encourages use of reference books.
- Monitors details of childrens entries.
- Suitable for ages 7-13 and Models A & B.

For 24 hour despatch send cheque/PO to:

**BES, Dept AU3, Bedford Lane, Headbourne Worthy,
Winchester, Hants SO23 7SQ. Tel: (0962) 882474**

Typeface and manual spoil excellent graphics from fast Olivetti printer, says George Hill

THE Olivetti printer is of a type not seen before in the home-computer market as it operates on the 'ink-jet' principle. The ink is not liquid, but is a compressed solid, in a small, easily replaceable glass tube. Ink is 'fired' at the paper by a spectacular electrical discharge, and the resulting black dots are directed by electrical fields. In effect it is a dot-matrix printer, and must be judged by the standard of others in its price-range (£360).

The Olivetti is very compact, but its big advantage is that the dots are very small which means superb graphics printing – I doubt whether any other printer can rival the resolution. It prints 110 dots per inch in the horizontal direction, and an amazing 220 vertically. The picture of the film star's face (Marilyn Monroe or Jean Harlow?) beloved of printer adverts can be reproduced in amazing detail on a rectangle less than two and a half by two inches.

On sending a single escape code ESC CHR\$(45), the image can be reversed, and another sequence ESC CHR\$(47) doubles the picture size. The resolution is in fact greater than that available in any Atom or BBC graphics mode.

Graphics dumps are easy to write for the Olivetti. A minor quibble is that there are 880 dots in the horizontal direction, while most computers use multiples of 320 on this axis.

The image is defined in terms of bytes both horizontally and vertically, which means the whole picture is defined in a single escape sequence at the start of the program. The manual is as usual confusing on this point. I would explain it as follows. The sequence is: ESC G I ; m ; n ; o ESC Z

I is the number of dots skipped in the left margin.

m is the number of dots on the X axis divided by 8.

n is the number of dots on the Y axis divided by 8.

o is the spacing between rows of dots.

As usual these parameters are critical, and miscalculations cause chaos!

The printer has a good variety of printing styles (figure 1), including three selectable horizontal spacings giving 80, 97 and 147 characters

ITALIAN PRINTER, GOOD FOR GRAPHICS

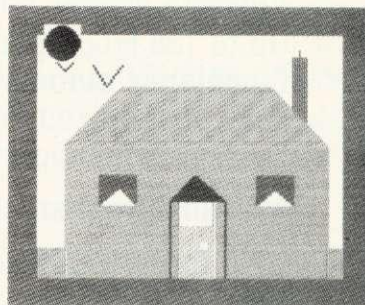

per line; and double width, double height, and double width-and-height in each of these spacings. Unfortunately it does not seem possible to mix single and double height characters on a line, and the linefeed is automatically doubled when printing double height. Thus it is possible to produce superscripts, but subscripts are less successful.

Printing is fast, giving 50 full lines per minute at whatever spacing. Maximum speed is 120 characters per second, and an average during program listing of about 60.

The Olivetti has enormous potential, but (and it is a big *but*) the ship seems to have been spoiled for a ha'p'orth of tar. The character font (in ROM) produces characters on a seven by seven dot matrix. This means capital letters are printed on a notional line one dot below that on which lower case letters appear (figure 2). Thus although g, y etc, have 'true descenders', so do all capitals and numbers.

The print is thus not letter quality,

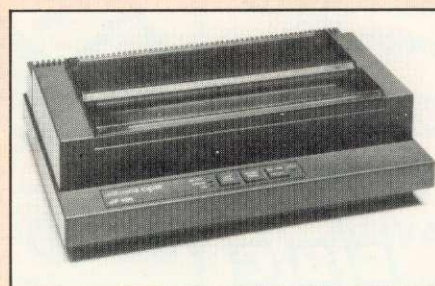

The Olivetti JP 101 Dry Ink-Jet Printer

and has a curious 'squashed' appearance. Changing to a nine by seven matrix would have produced such a huge improvement that the minor decrease in speed would have been well worth the sacrifice. The character set is 'international', as befits an Italian printer, with the ability to produce German, Norwegian and French characters. The 96 character font does not include 'chunky graphics' characters or italics, and characters from 128 to 255 feebly repeat those from 0 to 127.

Also the linefeed arrangements leave something to be desired. You can select linefeeds from one line upwards, so the paper always advances at least one line whenever the printhead returns to the start of the line. This is not selectable, and you are thus barred from overprinting.

The printer is clean in normal use, producing an unsmudged output. However, if you leave the paper stationary after a dense graphics dump (eg a 'reversed' picture), the printer leaves a faint black line on the paper where ink has been deposited from the paper guide.

Finally, to my *bête noire*, the manual. Do manufacturers deliberately set out to confuse their customers? Have they no idea their product may be bought by people with no experience? The Olivetti's 'Little Red Book' is one of the worst.

Four pages are devoted to the trivial task of using the roll holder, and feeding paper into it, while 12

BBC OWNERS

Why not consider the HOBBIT FLOPPY TAPE SYSTEM for your computer?

The HOBBIT gives you all the facilities you would expect from a floppy disc at a fraction of the price.

Brief Specifications

- ☆ Read/Write speed of 750 BYTES per second
- ☆ Capacity: 101K BYTES per CASSETTE
- ☆ Average access time 22 seconds
- ☆ Up to 138 FILES per CASSETTE
- ☆ Completely automatic – no buttons to press
- ☆ Fully built, boxed and tested. Just plug in and go
- ☆ System can support TWO DRIVES

Available from stock **PRICE £135.00 plus VAT**

Also available for NASCOM computers **PRICE £120.00 plus VAT**

Access and Barclaycard accepted

For more details contact:

Ikon Computer Products

KILN LAKE, LAUGHARNE, CARMARTHEN, DYFED, SA33 4QE. Tel: Laugharne (099 421) 515

The BBC Microcomputer Specialists

GUILDFORD COMPUTER CENTRE offers a complete range of Computers for Home, Business and Educational applications.

Large stock of additional equipment available includes:- Printers, Hard/Floppy Disc drives, Monitors etc., for most makes.

An extensive range of Business software (Accounts, Stock, Payroll, Word Processing etc.).

Drop in for a frank discussion and expert advice on your requirements or arrange a demonstration. We give a full and expert backup to ALL our sales.

Stockists of:- BBC/Acorn, Torch, Oric, Olivetti, Hitachi, TRS-80, Commodore, Dragon, Sharp, Sirius, Osborne, IBM, Newbrain, Epson, Seikosha, Cumana, etc.

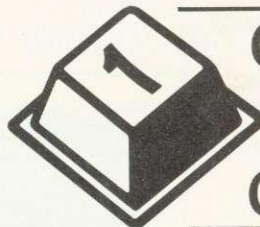

**GUILDFORD
COMPUTER
C·E·N·T·R·E**

 **commodore**

olivetti

**ACORN
COMPUTER**

 **HITACHI**

BBC **TRS-80®**

1 The Quadrant, Bridge Street,
Guildford, Surrey GU1 4SG
Telephone (0483) 578848

pages are wasted on technical details of the interfaces. The only important piece of information in the latter section, the settings of the DIP switches, contained a serious misprint in the numbering.

The section devoted to operating commands occupies a mere nine pages (omitting pictures). A curious convention is used throughout, with hexadecimal numbers represented by fractions! These are nowhere translated into decimal, and in some cases are omitted altogether. The only program examples concern graphics, and use LPRINT, rendering them difficult for Atom or BBC users to translate. Finally, in common with most printer manuals, there is no alphabetical index.

So, if you want to produce legible program listings and superb pictures, the Olivetti is as good as anything in its price range. However, if letters and circulars are your aim, better print quality is available from a conventional dot matrix printer for the same price.

Next month: A Basic graphics dump for the Olivetti.

This is printed at 10 characters per inch (the default value) and this is at 12 CHARACTERS per inch and NOW the little characters at 18 characters per inch

Normal
line spacing
Reduced
line spacing
This is

double spaced

using the variable option

NORMAL size
DOUBLE width
DOUBLE height

DOUBLE width and HEIGHT

Back to normal
Not underlined
Normal underlining
Double underlining
dotted underlining

acters per inch
is at 12 CHARACTERS
18 characters per inch

Figure 2. Close up of the offending type design

Figure 1. Sample output (also see listings in Joe Telford's article, p27)

BBC Spectrum nascom

GIANT ADVENTURE GAMES

- 1) COLOSSAL ADVENTURE:** The classic mainframe game "Adventure" with all the original treasures & creatures + 70 extra rooms.
- 2) ADVENTURE QUEST:** Through forest, desert, mountains, caves, water, fire, moorland and swamp on an epic quest vs Tyranny.
- 3) DUNGEON ADVENTURE:** The vast dungeons of the Demon Lord have survived His fall. Can you get to their treasures first?

Every Level 9 adventure has over 200 individually described locations and is packed with puzzles - a game can easily take months to complete. Only sophisticated compression techniques can squeeze so much in! Each game needs 32K and costs £9.90

BBC FORTH, FORTH TOOLKIT

"r q FORTH" runs on 16K or 32K BBC micros and costs £15. It:

- * follows the FORTH-79 STANDARD and has fig-FORTH facilities;
- * provides 260 FORTH words;
- * is infinitely extensible;
- * has a full-screen editor;
- * allows full use of the M.O.S.;
- * permits use of all graphic modes, even 0-2 (just!);
- * provides recursion easily;
- * runs faster than BBC BASIC;
- * needs no added hardware;
- * includes a 70 page technical manual and a summary card;
- * has hundreds of users.

Level 9 Computing are pleased to announce a new toolkit for "r q FORTH" on 32K BBC micros. It costs only £10 and adds the following facilities to FORTH:

- * a 6502 assembler, providing machine-code within FORTH;
- * turtle graphics, giving you easy-to-use colour graphics;
- * decompiler routines, allowing the versatile examination of your compiled FORTH Programs;
- * the f double-number set;
- * an example FORTH program; and demonstrations of graphics;
- * other useful routines.

nascom

- Extension Basic** £15/£30 ROM
Adds 30 new keywords to BASIC
- Compression Assembler 2** £12
Small Source + high speed

- Asteroids** m/c,g £7.90
- Galaxy Invaders** m/c,g £5.90
- Missile Defence** m/c,g £7.90
- Super Gulp** eb,g £4.90
- 5-games cassette** misc £5.90
(FULL RANGE IN CATALOGUE)

ALL PRICES INCLUDE P & P AND VAT. All programs are in stock and will be sent within 2 days of receipt. Please send order or SAE for catalogue, describing your micro, to:

LEVEL 9 COMPUTING

Dept A, 229 Hughenden Road, High Wycombe, Bucks. HP13 5PG

**CLEAR AND CRISP
CHARACTERS AND GRAPHICS**

Get the best from your BBC/Acorn by using the RGB output

Get crisp, clear graphics in full bold colours with one of our TV/Monitors fitted with a 6 pin DIN input socket.

Each is a TELEVISION!

Each is a COMPUTER MONITOR!

Why buy just a monitor when you can have a standard TV as well?

- A2102/5, 14½" - £295.54 A6100, 20" - £365.68
- A3104/5, 16" - £327.08 A7100, 22" - £399.11
- A8400, 26" - £499.35. Remote control (ideal for schools)

All prices include VAT, carriage, 12 month warranty and a 2m 6 pin DIN lead.

The TVs are from GRUNDIG's range. Remote control and stereo sound also available.

contact:

NEWARK VIDEO CENTRE

108 London Road, Balderton, Newark, Notts

Tel: 0636 71475. Open 6 days a week.



BEEBUG FOR THE BBC MICRO

REGISTERED REFERRAL CENTRE FOR THE BBC PROJECT

BRITAIN'S LARGEST SINGLE - MICRO USER GROUP

BRITAIN'S LARGEST COMPUTER USER GROUP DEVOTED EXCLUSIVELY TO THE BBC MICRO

MEMBERSHIP NOW EXCEEDS 16,000

16,000 members can't be wrong - BEEBUG provides the best support for the BBC Micro. BEEBUG Magazine - NOW 68 PAGES devoted exclusively to the BBC Micro.

Programs - Hints & Tips - Major Articles - News - Reviews - Commentary.
PLUS members discount scheme with National Retailers. PLUS members Software Library.
10 Magazines a year. First issue April 1982. Reprints of all issues available to members.

SCREEN SHOTS FROM PROGRAMS

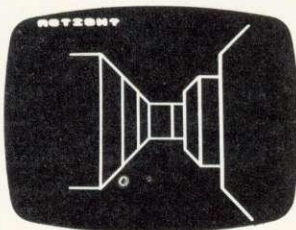

BEEBMAZE FEB 1983

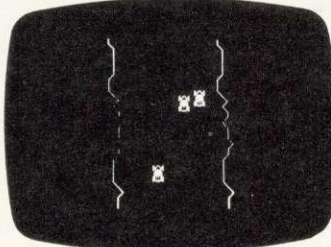

WINDY FIELDS FEB 1983

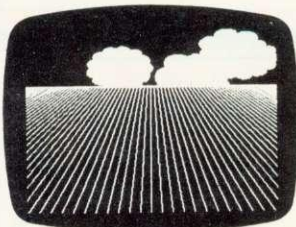

RACER nov 1982

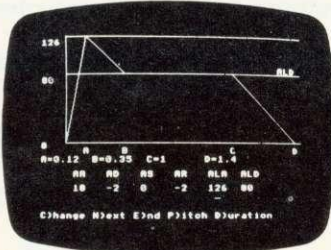

ENVELOPE EDITOR NOV 1982

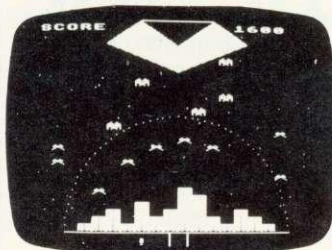

SPACE CITY DEC 1982



3D ROTATION, MARCH 1983

July Issue BEEB INVADERS and other programs - plus articles on using the Teletext mode, BBC cassette bugs fix, Software Review, using user defined keys. More on structuring in Basic. Using the User Port, and many hints and tips.

September Issue: High/Low Card Game, and Hangman Programs. Articles on Logic on the Beeb, Debugging, Moving multicoloured characters, creating new colours, Operating system 1.1. Plus Postbag, Hints and Tips, and Procedure Library.

October Issue: Program Features: Alien Attack; Calendar Generator; Union Jack; Memory Display utility. Plus articles on Beebugging; Improving Key Detection; Acorn Press Release on O.S.H.2; and Issue II Basic; The Tube and Second Processor Options; or New Series for less experienced users; and Software Reviews.

November Issue: Program Features: Racer (excellent 16K racing car game), Mini Text Editor (Mk2), Transparent Loader, Music with Memory, Harmonograph Emulator, New Character set for Modes 2 & 5; and cassette block-zero - bug retrieve. Plus articles on sound and envelope design - includes indispensable envelope editor program; Debugging Part 3, BBC Basics - Memory Maps and addressing explained; Serial Printer Port (RS423) and RGB upgrade. Plus a large number of Hints & Tips, and a guide to our past issues and their contents.

Dec/Jan Issue: Program Features: Space City (invader-type game), Breakout, Artist (Joystick painting program); Rescue (miraculously retrieves programs after bad loading or 'Bad Program' message); and Pack - a program to compact Basic programs. PLUS Disc System Review, Software reviews - including Wordwise, Book reviews, Adding Joystick interface to model A; How to access the video controller chip; and ideas for the newcomer; plus a new crop of Hints and Tips.

February Issue: Program Features: BEEBMAZE - Find your way through the random maze, guided by 3D views from inside the maze - an excellent game. FIVE-DICE - A Beeb implementation of YAHTZEE (R), a novel dice game. Also a listing of WINDY FIELD - a creation from Acornsoft, SPIRO PLOT screen doodler, and a complete memory display program in a user key. Plus Machine Code Screen Dumps for the Epson and Seikosha Printers; articles on USING FILES, IDEAS ON ANIMATION (Including a Rotating Cube program), an Introduction to the Use of Procedures, a Survey of Books on the BBC Micro, and a Roundup of Disc System Hints. PLUS a variety of HINTS, TIPS AND INFO, including a single VDU command to perform a SIDEWAYS SCROLL. WIN A COLOUR MONITOR, WORDWISE WORD PROCESSORS AND ACORN SOFTWARE BOOKS IN OUR THIRD SOFTWARE COMPETITION.

March Issue: Program Features: Life (32K), Artillery Duel (16K/32K), Square Dance. 3D Rotation (will rotate any object). Printers for the BBC micro - Review of Epson, Seikosha, Tandy and Olivetti. What to do with the new Operating System Chip, Disc Formatter Program, and full Disc instruction set, Newcomers, article on Text and Graphics Windows. PLUS How to get a new Operating System ROM and a special deal on Wordwise (members only).

SPECIAL ANNIVERSARY ISSUE THIS APRIL - INCLUDES FREE BBC MICRO REFERENCE CARD, AND COMPLETE INDEX TO VOLUME 1.

BEEBUGSOFT: BEEBUG SOFTWARE LIBRARY offers members a growing range of software from £3.50 per cassette.

1. Starfire (32K).
 2. Moonlander (16K).
 3. 3D Noughts and Crosses (32K).
 4. Shape Match (16K).
 5. Mindbender (16K).
 6. Magic Eel (32K).
 7. Cylon Attack (32K).
 8. Astro-Tracker (32K).
- Utilities: 1. Disassembler (16K). Redefine (16K). Mini Text Ed (32K).
Applications: 1. Superplot (32K). 2. Masterfile (32K).

13% DISCOUNT TO MEMBERS ON THE EXCELLENT WORDWISE WORD PROCESSING PACKAGE - THIS REPRESENTS A SAVING OF OVER £5.00.

BEEBUG NEW OPERATING SYSTEM OFFER
BEEBUG members can now obtain the new 1.2 OPERATING SYSTEM ROM at around HALF PRICE
See BEEBUG Magazine February, March or April for details.
As a result of BEEBUG negotiations with Acorn the ROM now may also be offered by other user groups to their members.

Send £1.00 & SAE for Sample
Membership: UK 5.40 for six months, 9.90 for one year.
Overseas one year only: Europe £16.00, Middle East £19.00, Americas & Africa £21.00, Other Countries £23.00
Make cheque to BEEBUG and send to: BEEBUG Dept 13, 374 Wandsworth Rd, London SW8 4TE
Send editorial material to: The Editor, BEEBUG, PO BOX 50, St. Albans, Herts AL1 2AR

ACORNSOFT REACH DIZZY HEIGHTS

FIVE minutes on *Starship Command* and I was hooked – but dizzy. It's a *Star Trek* and *Asteroids* combined with keys controlling rotation, thrust, brake and fire (for starters!).

There are two strategies. You can sit tight and let the enemy ships come to you (saving energy and dizziness) or chase them, dog fight style. The dizzy spells come in because everything rotates around your ship, which stays in the centre of the screen.

Once your ship's energy has gone, it self-destructs – but there is an escape capsule and you can get another chance.

It's all in black and white, hi-res graphics on a model B. Acornsoft produce the game for £9.95. Another neat feature is a 'freeze' option, so you can stop, answer the phone, and re-start. – TQ

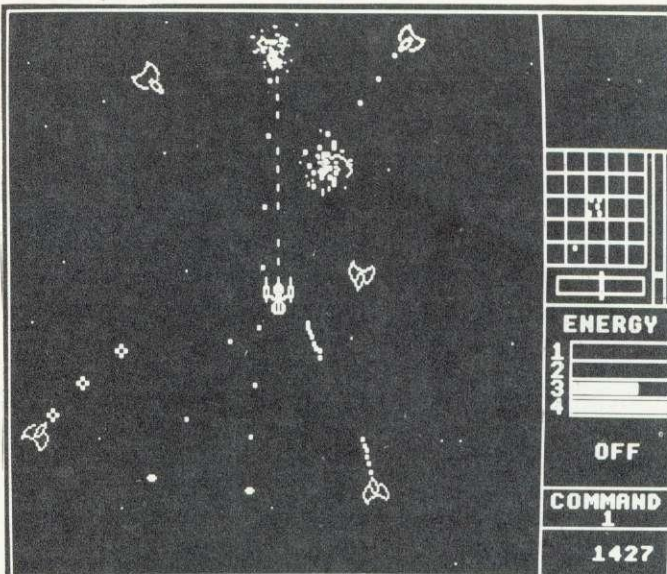

BASIC, MY DEAR WATSON

Elementary Basic by Henry Ledgard and Andrew Singer (272pp, Coronet, £4.95)

THIS unusual book is aimed at people who are keen on learning to write serious programs. It purports to be an unpublished Sherlock Holmes manuscript which reveals how Holmes got his hands on Babbage's Analytical Engine.

Through the eyes of Dr Watson (being his usual doltish self) the great detective uses the engine, programmed in Basic, to solve a number of criminal cases. On the way, Watson (and the reader) are shown a great deal about program structures, functions, subroutines, data files, algorithms, etc.

Holmes's main emphasis throughout is on the necessity of adopting the 'top-down' approach in designing and writing a program. In essence this method requires the programmer to design the program in a hierarchical system of different levels. At the topmost level the more general aspects of the problem are defined (probably in English rather than a computer language), and the more specific questions (such as the internal representation of data) are worked out in increasingly fine detail in Basic on the lower levels.

It is certainly the most rigorous approach, requiring the author to have thought through every aspect of the program before writing a single line of code.

Unfortunately, the programs are

'Holmes' book for Pascal uses same programs and ideas as Basic version

Covers are identical except for name of language

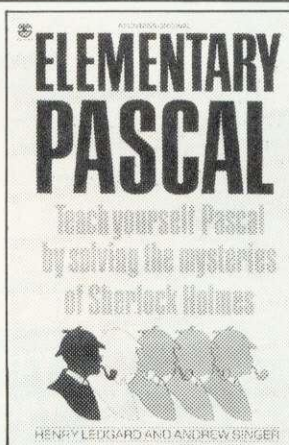

unlikely to be of much use outside the context of this book. This is not surprising when you consider that their main function is to illustrate different aspects of programming and problem-solving. The last chapter entitled 'The Final Programme', consists of a piece of software some 20 pages long, but I doubt if many readers will be prepared to type it out when the end result is only a word processor.

Against this it should be said that all the programs in the book are laid out with tremendous clarity and documentation. The Basic used conforms to ANSI (American National Standards Institute) Basic, which means only the file handling statements will need amending for the BBC micro and Atom.

The Sherlock Holmes gimmick is well-sustained both by the spoof Conan-Doyle prose style and by reproductions of Sidney Paget drawings from the *Strand* magazine. Certainly a book with a difference.

Simon Dally

TURF PROGRAM WON'T

BEAT THE BOOKIES

Horse Race Forecast Program, by Professor Frank George, *Sporting Forecasts*, £19.95

THIS program enables you to enter data about all the horses in a race and then evaluates the good bets. A word of caution to the get-rich-quick merchants, however: It doesn't claim to be infallible!

The author, according to the booklet which accompanies the program, is professor of cybernetics at Brunel University and 'an expert in all aspects of forecasting'. What his program does is to accept information about a race (so you'll have to equip yourself with a serious racing paper like *The Sporting Life* or *The Sporting Chronicle*) containing up to 40 horses. Using the paper, you feed in information on something like ten factors.

However, the program takes no account of factors which some fanciers of horse flesh may hold to be important: such as jockey, handicap, racetrack, and the going.

The chief drawback of the program (apart from its limited range of important variables) is the amount of time it takes to feed in data: a 10-horse race took me 30 minutes to evaluate, including the time taken to rummage through *Sporting Life*.

Still, aficionados of the turf tired of always backing a donkey may find this a useful companion while risking their shirts. Do not, however, think this package is a gateway to your fortune!

► page 32

string to contain the characters from which the user may choose. Some GPIR's include a range of such strings built into them. This version doesn't simply to save space. One suggestion is that in a setup section early in the program, define strings such as:

```
cap$="ABCDEFGHIJKLMNPOQ
RSTUVWXYZ"
low$="abcdefghijklmnopqrstuv
wxyz"
pun$="!#$%&'()-,.<>+*"
+CHR$34
nos$="0123456789"
```

plus any other special valid strings such as "YesNo". Then call up the GPIR by a line like

```
name$=FN_gpi(21,3,cap$+low$)
```

which would allow any name of up to 21 characters to be entered, using only letters. Initial letters would be capitalised.

In February, I explained a method of dynamically accessing procedures. I mentioned that this was rather naughty, but worked quite well. There were several

problems based around this technique, but the main problem was that we had to self-modify code in one program line, and then use that line to call a procedure.

I have recently received a few letters from readers pointing out a much more elegant approach. It is always gratifying to see that readers will not only digest the written word, but will spend time improving on it.

Look at program 11. This is the coding which Acorn suggested could demonstrate an improved method of calling procedures.

The theory behind the coding is that while dynamic procedure calls are not covered under version 1 of Basic, functions are. The reason for this is that the reserved word EVAL is intended to enable the user to type, during the execution of a program, an expression which the computer can decode. The *User Guide* warns that EVAL can only evaluate mathematical expressions, for example:

```
A$="M*X+C"
P.EVAL(A$)
```

However, Acorn quite rightly point out that their implementation of functions is procedure-like, in that a function can have many lines, and once in a function any number of Basic commands can be executed. Finally, because a function is regarded as a mathematical expression, it can be called during execution of the EVAL statement.

The result is we write all the necessary procedures as functions, as in lines 180 to 400, then we can call them by a line like line 70, which is set up by the input line of line 60. If EVAL cannot find a function to match Q\$ then the error trapping set up by line 10 ensures that we don't fall out of the program.

Of course this approach is extremely useful, but if you re-examine the self-modification technique in February's article, you will find that it can be easily modified to handle *SAVE <variable> and *LOAD <variable> commands, for Basic version 1. I hope to detail these in the near future, unless you know a better way?

BBC SOFTWARE

QUALITY SOFTWARE PRODUCED BY PROFESSIONALS

And used in hundreds of schools throughout Great Britain

Present their latest tape:

- | | | |
|---|--------|-------|
| FUN WITH WORDS | A/B | £8.05 |
| Start your fun with alphabet puzzles in GUESS A LETTER. Continue your play as you learn about VOWELS, know the difference between THERE & THEIR and have games with SUFFIXES. After working so hard reward yourself with games of HANGMAN. Learning should be fun. The tape includes GUESS A LETTER, VOWELS, THERE/THEIR, SUFFIXES and HANGMAN. | | |
| EDUCATIONAL-1 | A or B | £8.05 |
| Hours of fun and learning for children aged 5 to 9 years. Animated graphics will encourage children to enjoy maths, spelling and telling the time. The tape includes MATH1, MATH2, CUBECOUNT, SHAPES, MEMORY (Model B only), SPELL and CLOCK. | | |
| EDUCATIONAL-2 | A or B | £8.05 |
| Although similar to Educational-1 this tape is more advanced and aimed at 7 to 12 year olds. The tape includes MATH1, MATH2, AREA, MEMORY (Model B only), CUBECOUNT and SPELL. | | |
| GAMES OF LOGIC & CUNNING | A/B | £9.20 |
| For children and adults alike. The tape includes AUCTION, FLIP, REVERSE, TELEPATHY and HEXA 15 (Model B only). | | |
| SUPERLIFE | B | £9.20 |
| Fast (machine code) version of a popular 'Game of Life' in a large universe. | | |
| KATAKOMBS | B | £9.20 |
| Are you cunning enough to discover and seize the treasure in the Katakombs AND return alive? What and where are your enemies? Can you outwit them? Yes? Then your adventure will take you through unending forests, besides tumbling streams, over lonely plains to desolate ruins and finally underground to the tortuous Katakombs. Be prepared for anything! | | |
| UTILITIES | A/B | £8.05 |
| Behind the mundane title lies an assortment of useful procedures and functions which can save you hours/days of programming effort: date conversion, input and validation routines, graphic routines (cube, rectangle, etc), sorts, search and many more. | | |
| ***SPECIAL OFFER*** Any 3 cassettes for £20.70. | | |
| Add 50p p/p per order. Please state your model. | | |
| Cheque/PO to GOLEM Ltd, Dept A,
77 Qualitas, Bracknell, Berkshire RG12 4QG.
Telephone (0344) 50720 | | |

Also available from reputable dealers and on Micronet 800

TIMESHARE YOUR COLOUR MONITOR WITH THE FAMILY

£299 inc.VAT

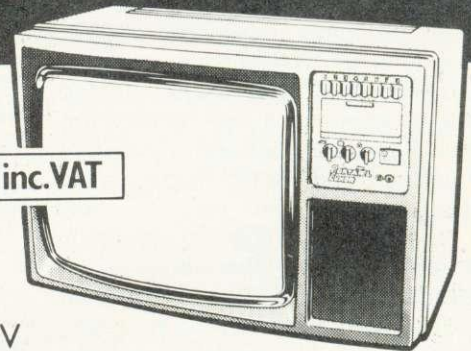

COLOUR TV

PLUS RGB MONITOR PLUS PAL VIDEO AND AUDIO

PortoTel-LUXOR RGB 3711

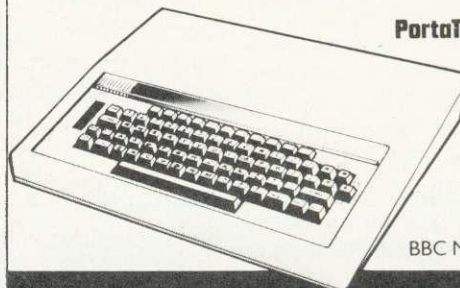

EXCELLENT RESOLUTION AND GEOMETRY

BBC MICRO LEAD INCLUDED



PORTATEL CONVERSIONS LIMITED,
25 SUNBURY CROSS CENTRE,
SUNBURY-ON-THAMES,
MIDDLESEX TW16 7BB
Telephone: Sunbury-on-Thames 88972

SIR Computers Ltd

CARDIFF

Agents for Acorn, BBC and TORCH Computers

BBC Microcomputers

BBC Model B with 1.2 operating system.....	£399
Model B with disc interface.....	£509.00
Single 100K disc drive.....	£249.00
Dual 2x100K disc drive.....	£389.00
The disc manual and utilities disc are both included.	
Disc interface for the BBC Micro (kit).....	£ 95.00
(fitted).....	£110.00
Upgrade of BBC Model A to B.....	£ 90.00

Please telephone for up to date information on Prestel, Teletext, speech synthesis, second processors, econet, etc.

TORCH Computers

Z-80 Disc Pack for the BBC Microcomputer..... £895.00

This unit connects to the BBC Micro in the same way as a normal disc drive, but as well as offering a dual 2x400K disc drive for use under BBC BASIC or other languages it provides the option of using the wide range of CP/M software available for business and data processing applications. The firmware supplied with the machine allows switching between BASIC and CPN, a powerful operating system developed from CP/M 2.2.

In addition to the disc pack a second processor is supplied. This is a Z-80A with its own 64K RAM card, communicating with the 6502A in the BBC computer through the 'Tube'. Typically the speed of execution of programs under the twin-processor system is increased by up to 50% compared with a conventional single-processor computer.

A third processor, the 16 bit 68000, will shortly be available.

TORCH CF240..... £2795.00
(Ex. VAT)

This is an extension of the BBC microcomputer/Torch disc pack system, available in a single unit. The computer contains a BBC-based peripheral processor connected to the main Z-80 computer, a dual 2x400K disc drive as described above, a high resolution (80 character) colour monitor and a complete British Telecom approved 1200 baud modem. It is the only microcomputer which has been granted permission for direct connection to the Public Switched Telephone Network both in the UK and the United States.

The TORCH can communicate either directly with another TORCH or with virtually any other type of computer via Prestel. Using the Gateway facility of Prestel it is possible for the TORCH to access vast amounts of information stored by private organisations on public database systems. The Mailbox facility of Prestel also allows the use of electronic mail.

TORCH CH240/10 As above but with a 10 MB hard disc drive.
TORCH CH240/21 As above but with a 21 MB hard disc drive.

Peripherals

Seikosha GP 100A printer.....	£229.00
NEC PC 8023 printer.....	£389.00
Microvitec 14" RGB Monitor.....	£299.00
Kaga 12" RGB Monitor.....	£280.00
Sanyo 14" RGB Monitor.....	£260.00
High resolution 12" black/green monitor.....	£ 85.00
Epson FX 80.....	£475

Software

We currently hold in stock programs from the following suppliers:

Acornsoft	Level 9 Software
A & F Software	Molemerx
Bug Byte	MP Software
Computer Concepts	Program Power
Digital Fantasia	Salamander Software
Golem	Software for All
IJK Software	Superior Software

Wordwise word processing ROMs now in stock.

Unfortunately we are unable to supply software by mail except as part of a larger order.

Delivery by Interlink of any of the above items..... £ 10.00
Unless otherwise stated all prices include VAT.

SIR Computers Ltd
91 Whitchurch Road
Cardiff

Telephone (0222) 21341

Official BBC Programmers Kit

for all BBC Microcomputer users!

De-luxe BBC Programmers Kit consisting of:

* 100 sheet flowchart pad with de-luxe BBC grip binder

* 100 sheet screen layout pad with de-luxe BBC grip binder

* 100 sheet symbol design pad with de-luxe BBC grip binder

PLUS super quality BBC ringbinder to store your programmes and notes

All items finished
in Official BBC Livery
and specially boxed.

Price
only

£15

R.R.P.
(inc.VAT.)

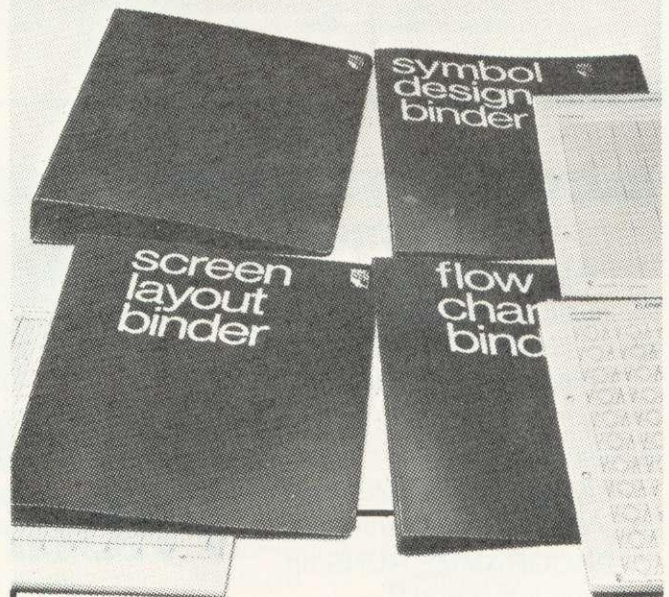

Available from
your BBC Microcomputer dealer,
or in cases of difficulty add £1 post and packing
and order direct from:

Intastor Micro Aids,
FREEPOST,
Stroud,
Gloucestershire, GL6 1BR.



Trade Enquiries welcome.

Draw with the BBC micro and show the true potential of your machine

Fill shapes in one of 23 colours (Mode I)
 Draw points, lines, rectangles, ellipses and circles
 Smooth curves
 Wire frame diagrams
 Hidden line removal
 Draw in perspective
 Measure scaled distances
 Ekta sketch lines, Half tone facility
 Mirror images
 Repeat images, SS, enlarged, reduced, stretched
 Actual colour displayed
 Store up to 10 ellipses or circles in memory
 Redraw any one of these at cursor position
 Change any actual colour for one of 8 others
 Clear screen, load screen, save screen
 Print characters or numbers at any pixel point
 Error messages for incorrect input
 Fully comprehensive manual

356 496 • □ •••
 +

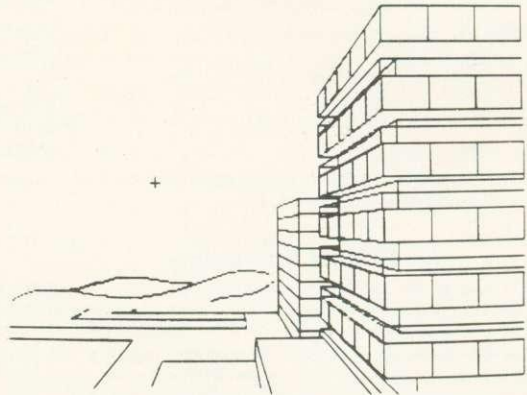

This programme has been purpose designed by professional Graphic Designers for simplicity and ease of use, and is undoubtedly the most versatile drawing programme on the market at this time. There is no need to input any numerical data, as all judgements are made visually. The BBC Micro is the finest drawing machine in its price range. Find out what it can do.

The A.B. Designs drawing programme costs only £35 for over 70 functions (Model B). When ordering send Cheque/PO and include 50p for P&P. Please include phone no. with all correspondence. For further information send SAE and phone no. to A.B. Designs, 81 Sutton Common Road, Sutton, Surrey. 01-644 6643 (closed all day Thursday).

BBC COMPUTER-EPROM PROGRAMMER WITH AUTO-RUN FACILITY

FEATURES

COMPREHENSIVE eprom programmer for 24/28 pin packages 2516/2716/2532/2732/2564/2764/27128/27256.

AUTOMATICALLY RUNS a user programme on power-up or pressing BREAK.

EASY CONNECTION with BBC via 1MHz bus interface.

PROGRAMME RUNS on BBC models A and B.

FULLY AUTOMATIC configuration for all eproms.

EASY USE with full operator prompting.

**BLOW
YOUR**

**FAVOURITE
PROGRAMME**

**ONTO
EPROM**

BBC AND **AUTO-RUN**
 MICROCOMPUTER

COMPLETE with C10 cassette containing programme, cables, software listings and full explanatory manual.

Model A's may require a 34 way connector fitting onto the 1MHz bus.

**ON
RESET**

COMPLETE BOXED UNIT

for only **£120** + VAT INCL. P & P

DISCOUNTS AVAILABLE for Schools, Colleges & Clubs. Trade enquiries welcome

Send cheque for order to:



**Advanced
Technology
Products
Limited**

Station Road, Clowne, Chesterfield
 S43 4AB

For further details send a stamped self addressed envelope to the address above.

Please allow 28 days for delivery.

VERSION ALSO AVAILABLE FOR USE ON ACORN ATOM, SYSTEM 3, SYSTEM 4.



Simon Dally offers £60-worth of software and examines a difficult issue

SOFTWARE PIRATES SET FOR THE BIG TIME

How many microcomputer owners can put their hands on their hearts and claim that they have bought all the commercially produced software in their library? The answer is precious few. And yet the vast majority of micro-enthusiasts are wholly law-abiding citizens who would be appalled to hear themselves described as thieves. The grossest culprits might concede *sotto voce* that they occasionally indulge in a little 'piracy' – an agreeable, romantic and swashbuckling-sounding word – but to suggest that by breaching someone else's copyright they are indulging in theft – well!

Evidence shows that illicit copying is virtually universal. A recent analysis of the owners of the popular Acornsoft game *Snapper* concluded that less than one in fifty had purchased their copy of the program. User groups are particularly guilty here. Whenever micro-owners congregate programs are swapped to and fro like cigarette cards. All this may seem fairly innocent and friendly. After all, the pooling of knowledge and the passing on of hints and tips is the fuel which powers the engine that keeps our hobby moving. But from the point of view of the software authors and distributors these trivial little transactions, multiplied by the thousand, add up to a massive loss of revenue. One software writer friend of mine has lost count of the number of times he has been offered an expensive accounting package at user group meetings. The would-be traders have no idea that he himself wrote the program!

This at least is the conventional view of software piracy, that tens of thousands of pounds are being taken from the mouths of the starving legitimate dealers because of widespread theft. But is this view necessarily correct?

One of the more disturbing features of the software market worldwide is the extent to which rubbish has become the norm rather than the exception. This is hardly surprising when to set

January's problem proved a mite difficult for many of you (no doubt you were too busy trying to locate the Beale treasure). There were 26 correct entries. The first message (a substitution code) read: *to all substations new signals section chief is a right XXXX he says we are lazy with security and make too many miftaks eeee mistakes new cipher replaces existing procedure and starts twelve hundred hours tomorrow based on a famous poem every day I hate poetry.*

The second message was a book cipher based on Gray's *Elegy* ('The curfew tolls the knell of parting day . . .'). It read: *to all substations I hope this took you as long to decipher as it took me to encode the problem is how much wood could a woodchuck chuck if a woodchuck could chuck wood.*

The winner, to whom £50 worth of Acornsoft packages have been sent, was M. Booth of Morecambe, Lancs.

yourself up as a software supplier your investment is limited to buying a micro and some advertising space in magazines. It is amazing how trusting people are in sending off comparatively large sums of money to advertisers they've never heard of for products they haven't seen and which all too frequently do not live up to their description. Most of us learn this lesson fairly quickly: one of the first programs I bought for my first micro was an 'expert' chess program which not only proved to be wholly ignorant of the *en passant* rule but was also inordinately fond of illegally castling through check!

Moreover, the attitude of many hardware suppliers has not helped. Some dealers chuck in a load of (pirated) software in order to clinch a sale; others try feebly to cash in on an area they don't know much about. Despite the fact that, with a

few notable exceptions, Tandy software is notably inferior to other TRS 80 software (especially its disk operating systems), Tandy resolutely refuses to acknowledge the existence of anything other than its own programs. Even more deplorable was the behaviour of Commodore, who market the Vic and the Pet. They ran an advertising campaign claiming that Commodore-approved software was in some way 'good' for your machine. It later transpired that all that was necessary to obtain the 'officially approved' label was to pay Commodore some money to advertise your products.

Against this dismal background, with the bad swamping the good and with many consumers feeling 'ripped off', you have only to place the normal human desire to get something for nothing and you have all the ingredients for a flourishing pirate trade. And the problem is that when pirates flourish good software gets ripped off even more frequently than the bad, sloppy stuff flung out to make its slapdash creator a few bob.

Considerable ingenuity and expertise have gone into the business of software protection in recent years: the most commonly-used methods are tapes which run automatically upon loading and cannot be listed, and diskettes formatted in non-standard ways. There is a growing trend to produce expensive software on EPROMs (erasable programmable ROMs) or to insist on 'dongles' being resident in the system (a dongle is a small piece of hardware marketed with the software which has to be plugged into something like the cassette interface before the program will work). There is little evidence that any of these methods adds significantly to the protection. No cassette program in the world is immune from straightforward reel-to-reel copying – on decent equipment the quality of the backup will be only marginally inferior to the original. People openly market tapes and discs

For the best hardware, the best software.

The BBC Microcomputer system is generally regarded to be the best micro in its price range you can lay your hands on. So, if you're thinking of buying one or already own one, you'll want to know about the software that's been specially designed for it.

Not surprisingly, it's made by Acornsoft, the software division of Acorn Computers Ltd., who designed and built the BBC Microcomputer. So naturally you can expect the highest quality software with the built-in ingenuity to fully exploit the BBC Micro's potential.

Further education for everyone.

Number Balance (price £11.90) contains two programs on cassette for practising simple mathematical operations from numbers 1 to 20. The object of the exercise is to make a balance level by inputting the correct missing number into one side of a simple equation. Incorrect answers will tilt the balance in the appropriate direction; after three incorrect attempts the program responds with the correct answer.

Chemical Analysis (price £13.80) contains three Chemistry programs on cassette and a booklet. 'Elements' presents a series of mystery elements which the student is asked to identify. 'Inorganic' presents a series of inorganic substances to be

identified by performing tests selected from a menu of standard tests. 'Organic' is a program dealing with organic compounds.

Learn more languages.

LISP (price £24.35) is the fundamental language of artificial intelligence research.

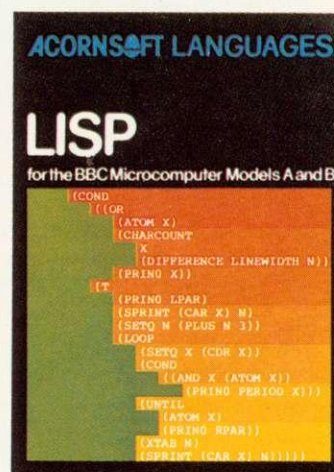
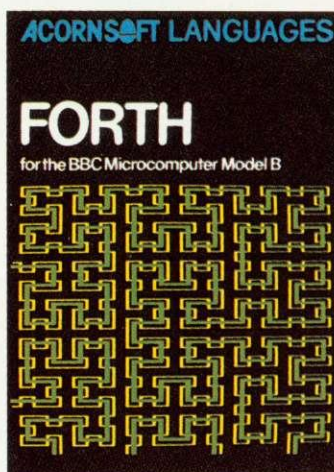

It is easy to learn, and is widely used for writing substantial and sophisticated programs, with practical applications including design of education systems and medical research.

It comes complete with a book that introduces you to programming in LISP, as well as some fascinating applications.

FORTH (price £24.35) is a complete implementation of the FORTH language to the 1979 standard specification for the BBC Microcomputer Model B. This much acclaimed programming language is also accompanied by a specially written book explaining all you need to know.

Mind-boggling games.

Sphinx Adventure (price £9.95) is a full-sized classic adventure game in which you move through caves, fight with trolls, collect treasure and finally make your way to the sphinx

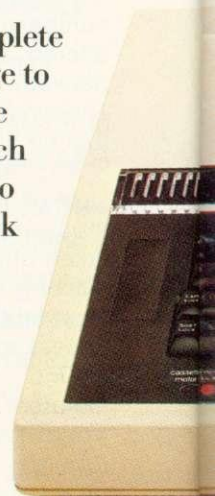
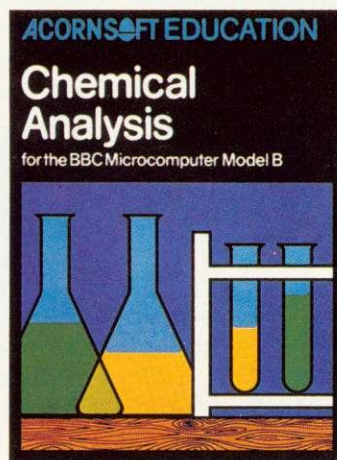
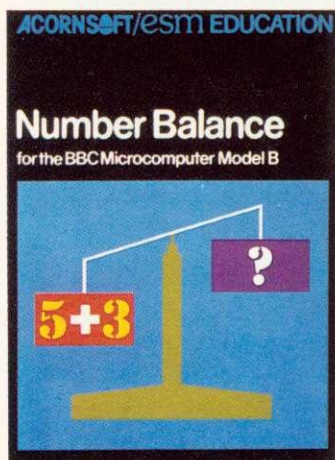

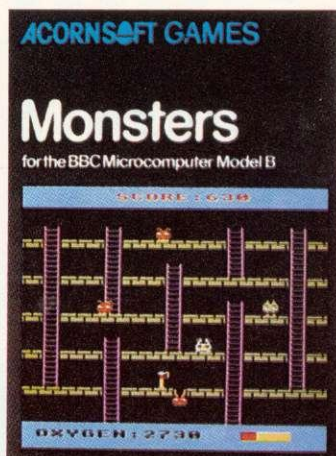
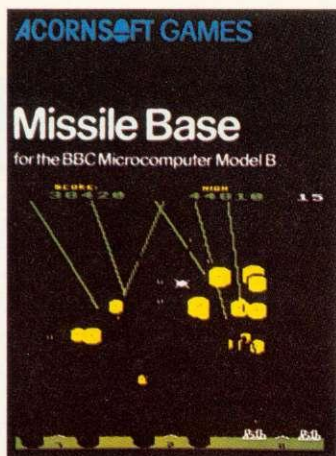
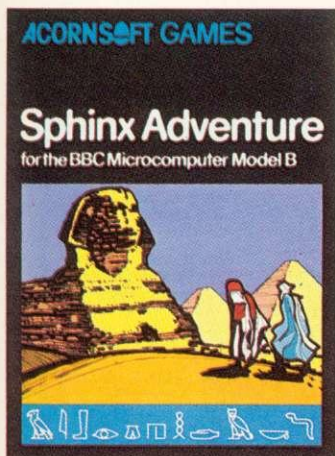

How to get Acornsoft programs.

If you're a credit card holder and would like to buy cassettes of the programs shown in this advertisement, or if you would like to know the address of your nearest stockist, just phone 01-200 0200.

to collect your reward.

Missile Base (price £9.95) sees you as Moon Base Commander, and you must ward off the salvos of deadly neutron missiles falling from space onto your base. As the game progresses, intelligent missiles arrive on the scene. They must be destroyed with cunning. Comes complete with satellites and planes and includes a table of high scores.

Monsters (price £9.95) is a game where your man is pursued by monsters who chase him up and down ladders and along walls. The only hope of survival is to dig holes in the walls and trap the monsters by filling them in. Complete with sound effects and high score.

Increase your business acumen.

VIEW (price £59.80) is a program that enables your machine, together with a printer, to operate as a fully operational word processor. For convenience the program is in ROM so that it can become a permanent feature of your machine. (It can easily be fitted by your local dealer.) You'll find out more by going to your dealer or by sending for the free catalogue.

Alternatively, you can buy the cassettes directly by sending off the order form below to: Acornsoft, c/o Vector Marketing, Denington Estate, Wellingborough, Northants NN8 2RL.

Also use this form if you would like to receive the current free Acornsoft catalogue.

Please allow 28 days for delivery.

 Credit Card Holders. Ring 01-200 0200.

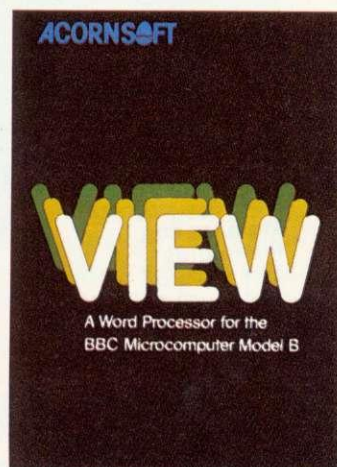

To Acornsoft, c/o Vector Marketing, Denington Estate, Wellingborough, Northants NN8 2RL.

Please send me the following:-

PROGRAM	PRICE	QUANTITY	TOTAL	(Code Acornsoft use only)
Number Balance	£11.90			SBE08
Chemical Analysis	£13.80			SBE12
Lisp	£24.35			SBL02/SBD04
Forth	£24.35			SBL01/SBD03
Sphinx Adventure	£9.95			SBC07
Missile Base	£9.95			SBC18
Monsters	£9.95			SBG03
			TOTAL	

I enclose PO/cheque payable to Acornsoft Ltd. Or charge my credit card.

Card Number _____
(Amex/Diners/Visa/Access (Delete))

Please send me the Acornsoft brochure

Please send me the VIEW catalogue

Name _____

Address _____

Postcode _____

Signature _____ AU5

Registered No. 1524763

VAT No. 215 8123 85

ACORNSOFT



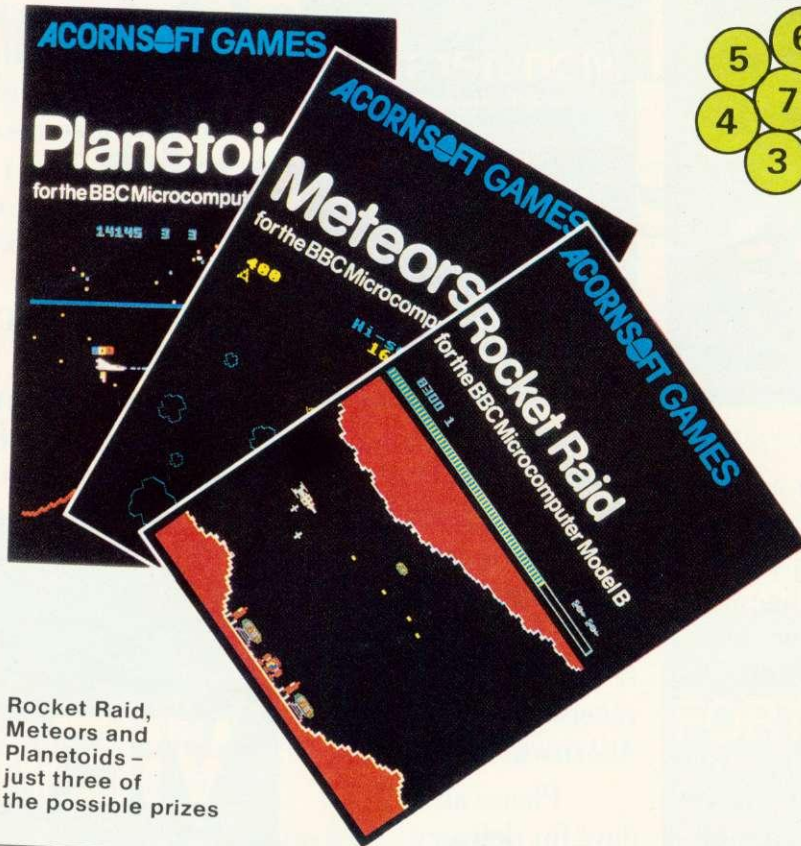

Rocket Raid, Meteors and Planetoids - just three of the possible prizes

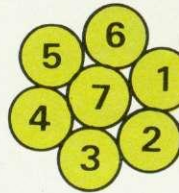

£60 worth of software to be won

A) This is for under-13-year-olds only. Please give your school and class with your answer. A prime number is a whole number exactly divisible only by itself and 1. 1, 2, 3, 5, 7, 11 are all primes. For many years it was thought that both the numbers 1,757,051 and 222,221 were prime numbers. Why aren't they?

B) Use the accompanying diagram to form seven-digit numbers by starting at any number and moving to any adjacent number but using each digit once only. How many numbers can be formed which are exactly divisible by 11?

Answers on a postcard please to May Competition, Acorn User, 53 Bedford Square, LONDON WC1B 3DZ before 1 June 1983. The first three winners picked will win £20 of Acornsoft packages. Please state which machine you have.

which are claimed to copy any other tape or disk (the advertising usually claims that it is to enable you to back up your valuable personal software but who are they trying to kid?) Dongles can be circumvented by amending the part of the program which checks to see if they're in residence. And for around £10 a reasonably competent pirate can build himself an EPROM copying machine. Ironically, an advanced and user-friendly machine like the Beeb makes a pirate's life even easier. It's fairly simple to dump virtually any block of memory on to disc and thence into an EPROM. The one area on the Beeb which looks as if it may increase protection is the use of plug-in cartridges.

All this means that the job of copyright - and hence revenue - protection for software authors is extremely difficult. However, there is one line which can be tried in addition to electronic protection and that is to market, along with the program, other items which are essential to the running of the program. The most obvious example is a bulky manual. OK, photocopying machines aren't difficult to find but they do make the pirate's job more expensive and time consuming. Some American

companies sell their manuals independently of the program at, say, half price, presumably reasoning that if you've pirated their program half a loaf is better than no bread from their point of view. Others refuse to sell manuals without proof of purchase of the program.

Best of all would be a plastic membrane which can be attached to the VDU, without which the program would make little sense - but this clearly poses practical difficulties with machines like the

'Wholesale piracy for profit may become professional and ruthless'

Beeb which are not sold with a standard size VDU included.

Until recently the problem of piracy has been more or less confined to individual users trading 'swops'. There are signs however that a far more serious problem is looming. As the microcomputer boom moves from the cottage industry stakes into big business (one industry forecast believes that by the middle of next year about 10

per cent of UK households will have a home computer), it appears likely that wholesale piracy for profit will become professional and ruthless. A recent case occurred of a dealer in the home counties selling a word-processing program for the Beeb which he bought from a man who had walked into his shop with a packet of EPROMS and demonstrated it. It later emerged that this person had merely copied it from another commercially available package and the dealer had to pay out £2000 compensation to the aggrieved copyright owner. How frequently this sort of thing is occurring is anyone's guess, but it is certain to increase in the future.

The video-cassette and music industries have been brought virtually to their knees by pirates in recent years and it is beginning to look depressingly as if computer software will follow the same course. The problems - the ease of electronic copying, the pitiful legal penalties which the criminals face, and the indifference of the consumers who merely want a cheap or free deal - are easy to identify. The solutions, alas, are going to be much more difficult to find.



A J SOFTWARE for BBC

'The Record Changer' 32K £19.95 Cass. £24.95 Disc.
for indexing, membership lists, directories, inventories, budgeting, etc., etc.

**don't buy a database in the dark —
check the spec!**

- * **Visible File** — Scroll around the file UP/DOWN/SIDEWAYS by function keys
- * **FULL SCREEN UPDATE** — Use cursor to overtype; character INSERT/DELETE within field; ERASE rest of field; TAB from field to field, etc.
- * **Sort** — on character and numeric fields
- * **Search** — for a match on field content
- * **Select** — select records satisfying conditions on one or more fields; or manually
- * **Total** — total numeric fields of SELECTED records
- * **Arithmetic** — combine one or more fields of your SELECTED records with any arithmetic expression; put the result in any numeric field
- * **Print** — print your SELECTED records with pagination
- * **Up to a 1000** records, (typically 330 at length 40)
- * **Up to 20** fields, number of decimal places can be specified for numeric fields
- * **Utility** — to ADD/CHANGE/DELETE fields

**'The Wordsmith' 32K for Centronics 737/739
£19.95 Cass. £24.95 Disc.**

For Reports, Essays, Theses, etc., etc.

**Forget control codes — let 'Wordsmith'
realise your printer's potential**

- * Full Screen text editor with wordspill
- * Unlimited document size
- * Page numbering, headings, footings, margins, indentation
- * Full Support for **proportional**, mono, condensed, elongated and underlined printing
- * Right justification maintained even when mixing proportional, condensed, elongated on same line

**Simple Word Processor 32K
£9.95 Cass. £14.95 Disc.**

Simple to use; allows you to set margins, justify text, insert and delete lines of text, set page length or force a page, variable TAB, Multiple copies. Save text on cassette or disc. View text formatted before printing. Works with any printer.

**Options Timetable 32K
£14.95 Cass. £19.95 Disc.**

A must for every secondary school. This programme helps with the timetabling of pupils 3rd year option choices. Try the effect of any changes to your Options Timetable and let the micro do all the donkey work. Has been in use for the last three years in a 6 form entry comprehensive using a CBM 3032 — now runs even faster on the BBC Model B.

Not only the cheapest, but the best
Switchable 14" RGB Monitor/Colour TV
£250 inc. VAT and cable, £8.00 carr.

Royalties for quality software
All prices VAT inclusive

**AJ Vision Service Ltd
61 Jeddo Road
London W12 9ED**

BBC MICRO INSTANT MACHINE CODE!

Yes, it's true. Instant machine code from a good subset of BBC BASIC. Type your BASIC program into your model B BBC Micro, trigger the compiler, and your program is changed almost instantaneously into superfast machine code. For £34.95 you get: Cassette version of the complete compiler (along with a version of the compiler for use with discs, ready for when you upgrade, the disc version being dubbed on the cassette after the cassette version); complete compiler listing; extensive documentation and instructions. The compiler was written by Jeremy Ruston.

THE BBC MICRO REVEALED

By Jeremy Ruston

'...destined to become the bible of all BBC microcomputer users. . . ' (Personal Computing Today). If you've mastered the manual, then this book is for you. Just £7.95

LET YOUR BBC MICRO TEACH YOU TO PROGRAM

By Tim Hartnell

'...takes you further into the cloudy areas of the BBC machine than anything else I've yet seen. . . ' (Computer and Video Games). If you're just starting out in the world of programming, then this book is the one for you. Forty complete programs, including Othello/Reversi, Piano and a host of dramatic graphic demos. Just £6.45

Interface, Dept. AA

44-46 Earls Court Road, London W8 6EJ

Please send me:

() INSTANT BBC MACHINE CODE—tape and book—£34.95

() THE BBC MICRO REVEALED—Ruston—£7.95

() LET YOUR BBC MICRO TEACH YOU TO PROGRAM—
Hartnell—£6.45

I enclose £

Name

Address

Electronequip

Authorised BBC Dealer, and service centre

NEW PRODUCTS

Utility Disc for BBC
Contains VER FORM35
FORM40 and FORM80
Cost 9.95

BBC Sparkjet Printer
New quiet printer
for BBC. Friction &
tractor feed 80cps.
Cost 379.50

Torch Z80 Disc pack
800K dual disc drive
plus Z80 processor
with CMP compatible
operating system.
Cost 897.00

TORCH Computer
800K to 21.4M disc
drives. High res.
colour monitor. Plus
autodial modem.
From 2795.00+vat

NEW Epson FX80
FX80 160cps printer
in stock. Friction
and tractor feed +
proportional spacing
Cost 458.85

BBC 2	BBC Model B Micro Computer	399.00
BBC 3	BBC Model A Micro with 32K	333.50
BBC 4	BBC Model A Micro with 32K and VIA	339.50
BBC 5	BBC Model B with Disc Interface	469.00
BBC 6	BBC Model A with Econet Interface	356.00
BBC 7	BBC Model B with Econet Interface	456.00
BBC 8	BBC Model B with Disc & Econet Interface	526.00
BBC 21	BBC Model A to B Upgrade	99.82
BBC 28	Econet Upgrade for BBC	92.00
BBC 23	BBC Acorn Memory Upgrade for Model A	34.50
BBC 27	Disc Upgrade for BBC B (inc fitting)	92.00
BBC 30	BBC 14" Colour Monitor	287.50
BBC 33	Sanyo SML2N Green Monitor 15MHz	90.85
BBC 34	BMC 12E Green Monitor 18MHz	113.85
BBC 35	Karga K12A 12" Orange Monitor	129.95
BBC 41	BBC Single 100K 5.25" Disc Drive (AND01)	265.00
BBC 43	BBC Dual 800K 5.25" Disc Drive (AND02)	803.85
BBC 44	Single Disc Drive (100K) for BBC (Teac)	205.85
BBC 45	Single Disc Drive (200K) for BBC (Teac)	263.35
BBC 46	Single Disc Drive (400K) for BBC (Teac)	343.85
BBC 47	Dual Disc Drive (200K) for BBC (Teac)	411.70
BBC 48	Dual Disc Drive (400K) for BBC (Teac)	526.70
BBC 49	Dual Disc Drive (800K) for BBC (Teac)	687.70
BBC 50	Epson FX80T 160cps Printer	458.85
ATM 2	Acorn Atom assembled 12K ram	184.00
ATM 26	Atom New Power Supply 1.8A	9.66
ATM 21	Floating Point ROM for Atom	21.85

Large stocks of software for BBC and Atom, Business, Games and Educational. Send for comprehensive lists.



14" Colour portable Monitor/TV

This Monitor/TV is not a modified television as many TV/Monitors are, but a 14" Monitor/TV which has been designed to perform both functions. It has RGB and Composite video and sound. An RGB cable for a BBC is supplied as standard

Cost 259.90 Trade enquires welcome

Large stocks. Prices inclusive of VAT
All prices inclusive of postage except micros 3.00

All Upgrades etc. are fitted free of charge and the computer
fully re-tested. Access and Barclaycard Welcome.



Electronequip

BBC



36-38 West Street, Fareham, Hants

(0329) 230670

EDUCATIONAL SOFTWARE

YOUR BBC COMPUTER IS MORE THAN A GAMES MACHINE!
PROGRAMMES AVAILABLE FOR THE MODEL A(32K) OR B

ZS1 MATHS

- ★ Simple equations $Ax + B = C$
- ★ Equations $Ax + B = Cx + D$
- ★ Simultaneous Equations
- ★ Linear Equations & Graphs $y = Mx + C$

ZS2 MATHS

- ★ Binary Arithmetic (Base 2)
- ★ Hexadecimal Arithmetic (Base 16)
- ★ Trigonometry—Pythagoras
- ★ Trigonometry—Sin, Cos, Tan

ZS3 ELECTRICAL THEORY

- ★ Direct Current
- ★ Ohms Law
- ★ Resistance in Series
- ★ Resistance in Parallel
- ★ Alternating Current RMS Peak
- ★ Power

- ★ EXAMPLES ★ NUMEROUS QUESTIONS
- ★ ANSWERS CHECKED BY COMPUTER
- ★ SOLUTIONS TO QUESTIONS AT YOUR REQUEST

CASSETTES £8.90ea. or 3 for £24.00

DISC (40 track) £10.90ea. or 3 for £26.00

(Prices include VAT and postage)

**ZENCOM
SYSTEMS**

64 CLOSE LANE
ALSAGER
CHESHIRE ST7 2JT

MUSE

- SOFTWARE
- INSURANCE
- PUBLICATIONS
- INFORMATION

MUSE is an organisation for parents and teachers.

MUSE offers its members: insurance, courses, booklets, journals, an annual conference, a friendly and unbiased information service

MUSE has an extensive library of educational software covering Apple, BBC, PET, RML380Z, Spectrum and ZX81

MUSE has just published a booklet "A Beginner's Guide to the BBC Micro" by Richard D'Silva—a step by step guide to simple BBC programming
Price £1.00 including post and packing

Guides and membership details from:

MUSE (Dept AU)
FREEPOST
Bromsgrove
Worcs.
B61 7BR





electronic monitor manufacturer

BUY BRITISH



- * Quality
- * Reliability
- * Manufactured in Britain 100%
- * A moulded case with carrying handle
- * Meets British standard safety regulations (BS415)
- * Automatic black level compensation for tube ageing
- * Mullard AX37-590x Tube
- * Power consumption 60w

CABEL offers you a new high quality 14" inch colour monitor

The case has been designed with safety upmost in our minds.

This advanced model cuts the component count and incorporates the most sophisticated parts on the market today.

Using the MULLARD AX tube, which gives perfect colour registration with reliable and stable operation. Automatic drift (Black level) compensation adjusts automatically with the ageing of the tube.

All this and many other features, including years of experience in the data display industry and backed up by our 2 year guarantee.

We GUARANTEE long service and reliability.

Price £199.50 + VAT Includes R.G.B. Lead

DEALER ENQUIRIES AND EDUCATION ENQUIRIES WELCOME

CHEQUE/POSTAL ORDER, OR FOR FAST DELIVERY, RING US WITH YOUR CREDIT CARD NUMBER

Factory

Unit 15
Whitegate Industrial Estate
Whitegate Road
Wrexham LL11 1AY

Tel 0978 350345

Office

Lloyds Bank Chambers,
The High Street,
Tewkesbury,
Gloucestershire
Tel 0684 298840
Telex 339671 ALD FAB



THE CE370A
NEW R.G.B.
COLOUR MONITOR
£199.50

NEW: The CE370B R.G.B.
Composite Video and
Audio Colour Monitor
£250.00 + VAT



Registered No. 1370335

BIG IN LITTLE COMPUTERS

SOFTWARE NOW IN STOCK
AT THE VIDEO PALACE

COME AND SEE
OUR FULL SELECTION



THE FROG (Software for All) Superb Frogger game. Extremely good piece of programming	£ 8.95
COWBOY SHOOTOUT (Micropower) Model B Two player gunfighter game. Really good graphics.	£ 6.85
ARCADIANS (Acorn) Model B This is the best Galaxian type game on the market.	£ 9.95
THE CENTIPEDE (Superior) Model B Excellent Centipede game.	cassette £ 6.50 disk £ 9.90
MODEL B INVADERS (IJK) Superb invaders game with many options.	£ 5.50
GALACTIC COMMANDER (Micropower) Model B High resolution lunar lander game.	£ 7.99
PLANETOID (Acorn) Model B A must for all BBC owners.	cassette £ 9.95 disk £11.50
SWOOP (Micropower) Model B Galaxian with a difference!	£ 7.99
3D MAZE (IJK) Model B Mindboggling maze game.	£ 4.50
CASTLE OF RIDDLES (Acorn) Model B Highly recommended word adventure game.	£ 9.95
ROCKET RAID (Acorn) Model B Superb Scramble game. Our best seller.	£ 9.95
CHESS (Bugbyte) Model B Graphical chess game.	£11.50
STRATTO BOMBER (IJK) Model B Blast the alien mother ship and save your planet.	£ 7.50
ELDORADO GOLD (Micropower) Model B This game will get you started with adventure games.	£ 6.85
SNAPPER (Acorn) Model B Great Pacman game. Joystick option.	£ 9.95
PEEKO COMPUTER (Acorn) Model A or B Confused with machine code? Buy this and solve your problems	£ 9.95
WORDSWORTH (Ian Copestake) Model B Excellent word processor. Very good value for money.	£13.00
JOYSTICKS (Acorn) Model B Play games such as Rocket Raid, Snapper, etc. just like in the arcades.	per pair £12.99
CASSETTE CABLE Seven pin DIN to 3 x jack-plug.	£ 1.95
PARALLEL PRINTER CABLE (Acorn) To connect the Model B to a centronics type printer.	£18.40

ALL THE ABOVE PROGRAMMES CAN BE ORDERED BY POST

Add 50p p&p for the first and 15p for each subsequent item. Allow up to 28 days for delivery. Payment by cheque or postal order.



ORDER BY TELEPHONE

Access and Barclaycard holders may order by phone: 01-937 6258

THE VIDEO PALACE

62 KENSINGTON HIGH ST. LONDON W8.



GAMES PROGRAMMERS

Palace Software, part of a leading film and video company, is looking for games for Atari 400/800, BBC Model B, TI99/4A, Spectrum, VIC 20 and CBM 64 for distribution in the UK, Europe and USA. High royalties will be paid for top quality and highly original material. Send samples to: Pete Stone, Palace Software, 62-64 Kensington High Street, London W8 (Tel: 01-937 6258)

BBC EXPANDABLE CONSOLE

Not just a TV/VDU stand but an expansion console which gives your micro the professional look. Protects and encloses your micro with room for disc drives and 2nd processor or teletext adapter etc. All untidy connecting wires out of sight and reach within the console. Made of light yet strong aluminium with a textured finish in matching BBC colour. Coming soon, a bolt-on extra module for the console, for further expansion options, ie dual drives, 2nd processor, teletext adapter joysticks, cassette etc, all in one console. YES, this console will grow with your needs. If that was not all a matching printer stand is available. Rest the printer on the stand and stack your paper underneath. The console will also house the torch disc pack.



PRINTER/VDU STAND

BBC owners who only need a VDU stand will find the stand slips comfortably over the BBC with adequate ventilation allowed for. After use the micro can be slid UNDER the stand acting as a dust cover when micro not in use



PRICES BASIC CONSOLE as shown

only £39.99 + £4.00 p/p

PRINTER/VDU STAND

only £14.99 + £2.00 p/p

For further information enclose sae or send cheque to,

Mail Order Only

Silent 01-801 3014

27 Wycombe Rd
London N17

Viewing by arrangement

COMPUTERS

24 hour ansaphone

Please allow 28 days for delivery

BBC computer software BBC

SECTA INVADERS

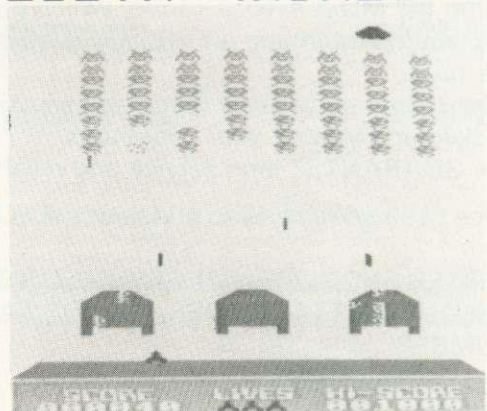

ACTUAL SCREEN PHOTO

FEATURES

- 14K MACHINE CODE FOR MODEL B OR 32K MODEL A
- JOYSTICKS OR KEYBOARD. FULL COLOUR
- FAST/SLOW BOMBS. NEW HIGH SCORE TUNE
- SOUND ON/OFF. TOP TEN SCORES WITH NAMES
- SAVE YOUR TOP TEN SCORES ON CASSETTE
- LOAD YOUR OLD TOP TEN SCORES FROM CASSETTE
- FIVE SKILL LEVELS WITH COLOUR CHANGES
- UNIQUE EXPLOSION GRAPHICS. ETC.

ONLY £5.95 inc.

SECTA SOFTWARE

14 BRACADALE CLOSE
WEST COOMBE PARK
COVENTRY CV3 2PS TEL: (0203) 662078

Baffled by the manual? George Hill explains how to get your printer going

PRINTING FROM A TO Z.....

This article is aimed at those with a BBC model B and a printer. I shall expand on the somewhat sketchy (and in some respects misleading) information in the *User Guide*, to enable you to start using the facilities of your printer to the full.

After unpacking your printer and connecting up, establish that it works by carrying out the 'self-test' procedure (available on almost all printers). Instructions for setting it in motion will be in the printer manual. Normally, it involves switching the printer on while holding down one or more of the control buttons. The printer will print all of its characters and maybe some other information.

You have now established that the printer works and provided that the computer does as well, you can connect the two and try them out.

First you must make a crucial check. Is your printer connected in serial or parallel? If it plugs into the printer socket under the computer, then you have a parallel printer, if it plugs into the RS423 socket at the back of the computer, you have a serial system.

The parallel printer socket is selected by default (if you do nothing about it, then all output designated for the printer will be sent to the printer socket under the computer). To be certain you can type *FX5,1 which directs output to this socket. This procedure is often referred to as calling the printer.

For a serial printer there is a two-stage calling process. Type *FX5,2 to select the RS423 socket. Then type *FX8,n to select the baud rate. This must be matched between computer and printer to stop the printer from misunderstanding signals from the computer. The printer baud rate will be selected in the depths of the printer by dip switches or jumpers. Your manual will tell you how to set them. If possible select 9600 bits per second and use *FX8,7. Otherwise, select the highest rate possible at the printer, and choose n to match the computer's rate to the printer's.

In the following I have used the

```
10 REM send A to Z to screen via PRINT CHR$
20 FOR I = 65 TO 90
30 PRINT CHR$I
40 NEXT I
```

Program 1. Letters on separate line

```
10 REM send A to Z to screen via VDU
20 FOR I = 65 TO 90
30 VDU I
40 NEXT I
```

Program 2. Letters on same line

symbol <RETURN> to mean 'press the return key', and CTRL B means 'hold down the control key (marked CTRL), strike the capital B once and then release the CTRL key'.

To test your printer initially, try the following procedure. Type

```
CTRL B <RETURN>
PRINT"THIS IS TO TEST THE
PRINTER"<RETURN>
```

Both screen and printer should respond

```
>PRINT"THIS IS TO TEST THE
PRINTER"
THIS IS TO TEST THE PRINTER
```

The screen will also show > at the beginning of the next line, but the printer is often one step behind, and it may not print the > until it receives the next instruction to print. Next type <RETURN> CTRL C and the printer will print the missing >.

If your printer overprinted everything on one line, then type *FX6,0 and try again. This instruction will be explained later. Now type

```
PRINT"PRINTER OFF ?"
<RETURN>
```

The printer should remain silent, but the screen shows

```
PRINTER OFF ?
>
```

Your computer transfers all its information about letters and other characters around its circuits as numbers. These numbers must be between 0 and 255, as they are a

single byte (see April's article). The code system used is the ASCII code (American Standard Code for Information Interchange). In this system the letters A to Z are represented by the numbers 65 to 90 and the other letters and symbols by other numbers between 32 and 127. These codes can be sent to the screen in two different ways. Programs 1 and 2 illustrate the methods. One involves the use of PRINT CHR\$n where n is the ASCII code, but the other quicker and more convenient method uses VDU drivers. I advise all BBC users to familiarise themselves with the VDU codes as they are extremely useful and powerful.

You will notice a difference in the outputs from the two programs. Program 1 prints the letters on separate lines, program 2 prints them all on the same line. Each PRINT statement implies a <RETURN> at its end, unless it is followed by a semi-colon. To make the output of the programs identical you change line 30 in program 1 to PRINT CHR\$; and PRINT CHR\$n; is identical to VDU n.

If you now run either program (program 1 in the modified form) with the printer enabled by CTRL B, output will also appear on the printer. But some printers have a buffer (a memory of their own) and the buffer stores items to print until it receives an instruction to empty, or it is full. So to get output at the printer type

```
RUN CTRL B <RETURN>
<RETURN> CTRL C
```



and the printer should print A to Z, and a > (the BBC's prompt), all on the same line.

The CTRL key simply subtracts 64 from the ASCII code of any key pressed simultaneously. CTRL B is actually sending (66 - 64) which is 2, to the central processor, which interprets this as a signal to enable the printer. Similarly CTRL C sends 67-64, ie 3, which disables the printer. We can send these codes within a program, using VDU2 and VDU3. Programs 3 and 4 will enable the printer, send A to Z to it and the screen, and disable the printer. Note the use of an extra PRINT or VDU13 (<RETURN>) to ensure that the printer empties its buffer.

Characters which are genuine in the sense of printing a character on the screen, start at an ASCII value of 32 - the space character. Codes 0 to 31 have specific effects which are detailed in pages 378 to 388 in the *User Guide*. All are important and useful, but some are of crucial importance to the printer user.

VDU2 enables the printer, and VDU3 disables it. I have used the same terms as in the *User Guide*, as these describe the action better than any combination of on and off, which might cause confusion with on/off line, and power on/off.

Three other codes which affect the printer in simple ways are VDU10, VDU12, and VDU13. These are linefeed, formfeed and carriage return respectively. Most printers respond to all three of these codes, but some (for instance the Amber) only accept 13 and ignore the others. The formfeed character clears the screen if sent there (it is the equivalent of CLS) and the printer accepts it as an instruction to advance the paper to the next top of form (top of a page). It is set when the printer is switched on, and can be reset by switching the printer mains switch off, moving the paper by hand to the top of a page (normally the perforation on fanfold paper) and switching back on again. Some printers have a set top of form button which you can use to avoid having to switch on and off.

If you type CTRL B CTRL L (ie enable printer, send [76-64]) the printer should now move the paper up to the next perforation, and the screen should blank. If the paper

```

10 REM send A to Z to printer and screen
20 REM enable printer
30 PRINT CHR$2;                               OR 30 VDU2
40 FOR I=65 TO 90
50 PRINT CHR$I;                               OR 50 VDU I
60 NEXT I
70 REM empty print buffer if necessary
80 PRINT                                       OR 80 VDU 13
90 REM disable printer
100 PRINT CHR$3                               OR 100 VDU 3
    
```

Program 3.
Sends 'A to Z' to printer

Program 4.
Change lines in program 3

moves up to a position other than the one you wanted, you need to reset the dip switches which control formlength on the printer, to match the length of your paper. Details of how to do this will be found in the printer manual.

Now to the linefeed problem. The BBC micro is set to suppress linefeeds in its printer output. This means that when the computer reaches the end of a line it sends code 13 and code 10 to the screen, causing the cursor to go back to the beginning of the line and go down one line. Only code 13 is sent to the printer. This may be compensated for in two different ways. Either the printer may generate its own linefeed on the receipt of each return, or it may be made to send both codes to the printer. The reason for this flexibility is that printers respond in different ways to codes 10 and 13. There are four main possibilities.

- Literal - 13 returns the printhead to the beginning of the line, and 10 advances the paper by one line, and returns the printhead.
- Auto-linefeed, with code 10 ignored - on receipt of code 13 the printer returns the printhead to the beginning of the line and advances the paper by one line, but ignores code 10.
- Auto-linefeed with all linefeeds acted on - on receipt of code 10 or code 13 the printhead returns and the paper is advanced one line.
- Intelligent auto-linefeed - in this method the action is as for auto-linefeed in that both codes 10 and 13 are accepted as instructions to empty the print buffer and perform the appropriate action. When codes 13 and 10 are received together (as

at the end of a line) it only acts on one of them.

You may be able to select some of these options by dip switches at the printer. In many ways the first is the best option, as it allows you to overprint lines. If you had the problem of overprinting at the start of this test procedure and had to type *FX6,0 then you probably have this option.

The *FX6 command is used to suppress any one character in the output to the printer. On switching on the BBC micro it defaults to *FX6,10. That means that the linefeed character is suppressed. By typing *FX6,0 you have suppressed character 0 (which does nothing anyway) and reactivated character 10. Note that only one character can be suppressed at a time. Try typing

```

*FX6,65 <RETURN>
PRINT"AARDVARK" CTRL B
<RETURN>
<RETURN> CTRL C
    
```

The printer should respond RDVRK while the screen shows AARDVARK. You have suppressed A (code 65) in the printer output.

To test which of the four options your printer has in operation, try the following test procedure. Type

```

*FX6,10 <RETURN>
CTRL B <RETURN>
<RETURN> <RETURN>
<RETURN>
CTRL J CTRL J CTRL J
*FX6,0 <RETURN>
CTRL J CTRL J CTRL J
<RETURN> <RETURN>
<RETURN>
CTRL C <RETURN>
    
```

If at step 3 your printer printed three > signs at the start of the

same line, without the paper moving, you have the first option. Step 4 should produce no effect (linefeeds are disabled and CTRL J is code 10).

If at step 6 the paper did not advance then you have the second option.

If after step 7 your printer printed the > signs with a blank line between them then you have the third option otherwise you have the last option.

If this test shows that you have the second or third then you should leave the default setting of *FX6,10 in operation. If you have the first then you must type *FX6,0 before using the printer. If you have the last then it does not matter whether you use *FX6,0 or *FX6,10. If you want to use CTRL J or VDU10 to advance the paper then use *FX6,0.

Note that any second option printers (like the Amber) will not respond to any code 10 calls in the next program, and these will have to be replaced by code 13.

There are two ways of sending control characters (those with codes between 0 and 31) to printer and screen. From the keyboard (CTRL and a letter) and in a program (VDU followed by a number). Program 5 illustrates the latter process.

It is often important to be able to send characters to the printer only and not to the screen. The code which allows this is code 1. This code has a slightly different action in OS 0.1 from that in OS 1.0 causing me considerable problems! It is intended to work by enabling the printer, sending code 1 and the code for the character. This last will be ignored by the screen but sent to the printer. Program 6 illustrates this and sends A to Z to the printer only.

Owners of machines with OS 0.1 may have found that they can use code 1 followed by a character, without enabling the printer first, eg typing VDU1,12 <RETURN> sends a formfeed to the printer, but does not affect the screen. To have the same effect in OS 1.0 you must type VDU2,1,12,3 <RETURN> (enable the printer), send formfeed to printer only, and disable printer. The same sequence in CTRL characters is obtained by holding down the CTRL key and typing BALC, then releasing the CTRL key.

```
10 REM send 3 linefeeds to the printer, print message,
20 REM and advance to top of form.
30 *FX6,0
40 VDU2,10,10,10
50 PRINT"TEST PROGRAM"
60 VDU12,3
```

Program 5. Sending control characters

```
10 REM send A to Z to the printer only
20 REM enable printer and send A to Z
30 VDU2
40 FOR I=65 TO 90
50 VDU1,I
60 NEXT I
70 REM send linefeed and disable printer
80 VDU1,10,3
```

Program 6. Sends 'A to Z' to printer only

Acorn refer to this change as correcting a bug in OS 0.1, but it is a pity that this particular bug has been altered.

Furthermore, the *User Guide*, in its printer section refers to *FX3,n as the preferred method of directing output to the printer only. *FX3 does not exist in OS 0.1, so most people will merely get 'Bad Command' messages from any attempt to use it. There is, anyway, a serious fault in this mechanism, which is not apparently being corrected even in OS 1.2. The command which should send output to the parallel printer only (*FX3,2) simply does not work. The BBC micro therefore remains without an LPRINT equivalent, except for the use of VDU1 (which is not mentioned in the *User Guide* printer section!). For those with OS 1.0, *FX3,10 can be used to disable the screen, and *FX3,0 to re-enable it, giving a limited LPRINT facility, but codes 1, 2 and 3 still have to be sent via VDU1,n as they are intercepted by the CPU and interpreted as commands to redirect output.

Several people have written in to ask how to translate the programs given in printer manuals into BBC Basic. Most Basic's have the LPRINT command which directs output to the printer only. Lacking a satisfactory equivalent, we have to use VDU 1 to get over this problem. In normal use it probably does not matter if output destined for the printer also goes to the screen, and so the sequence

```
VDU2
PRINT"Anything"
VDU3
```

produces the desired effect.

We can avoid the total disappearance of wanted material by judicious use of the commands governing graphics and text windows, and scrolling only the text area. This involves the use of VDU 4,5,24 and 28 which you should explore but lie outside the scope of this article.

A more pressing problem is how to send escape sequences and control characters to the printer to get it to alter its style or go into graphics mode. I offer, as examples of this process, translations of two sequences detailed in the EPSON MX80 type 3 manual, but the principles are the same for all printers if the examples are given in terms of LPRINT.

To control line-spacing you use a sequence given as ESC A + n (note that the + sign is misleading and irrelevant), which is translated at the foot of the page as LPRINT CHR\$(27);CHR\$(65);CHR\$(n) where n is the amount of line-spacing required in multiples of 1/72 of an inch. Normal line-spacing is 1/6 inch (12/72 inch). To double-space, therefore, we must increase the line-spacing to 24/72 inch. The sequence for this is ESC A 24. The codes to be sent then are 27 (ESC) 65 (A) 24.

We must not send the 27 or 24 anywhere but the printer, as 27 causes the computer to carry out its escape routine, and 24 makes it attempt to define a graphics window. It is also important to realise that the escape key is not used in escape sequences.

The command needed is VDU2,1,27,1,65,1,24,3 <RETURN>, ie enable printer, send ESC A 24 to



printer only, disable printer. The above sequence can be typed in direct from the keyboard, or used in a program. The <RETURN> is of course redundant in a program, and it is only necessary to use VDU2 and 3 once each at the start and end of the program. Program 7 illustrates this, and also the use of the ' character to generate returns.

Note that on the type.1 printer additional commands are necessary to implement these changes. Some converted type 2's may also need the additions. At lines 50 and 80 append 1,27,1,50 (ie ESC"2") to the

end of the escape sequences, if program 7 fails to work.

The next program translates one of EPSON's bit image printing test programs, to test the dual density mode of the printer. The program is shown in program 8 as it appears in the manual, then translated into BBC Basic, using hexadecimal numbers, and finally using decimal numbers.

Finally, several enquiries have arisen about the use of the printer tab function. Printers do not respond to the PRINT TAB(x,y) format. It is necessary to set up a tabulation program for the printer,

using the sequences described in the printer user manual. Program 9 illustrates how to do this for the Olivetti ink-jet printer, but the principles can be followed for any printer which has this facility. Set up the tab stops (ie the points along each line at which you want columns of printing to start), and thereafter the printer will advance to the next tab stop on receipt of each code 9.

In the next article in this series, I hope to introduce the principles of printing pictures, to enable readers to write their own graphics dumps.

```

10 REM Linefeed alteration for EPSON MX 80/FT type 2 printer
20 VDU2
30 PRINT"These three""Lines should be""singly spaced"
40 REM alter linefeed
50 VDU1,27,1,65,1,24
60 PRINT"but these three""should be""double spaced"
70 REM restore linefeed
80 VDU1,27,1,65,1,12
90 VDU3
    
```

Program 7. Illustrates line spacing

LINE NUMBER	EPSON PROGRAM	BBC(hex)	BBC(decimal)
150	REM bit image printing (dual density)	REM ditto	REM ditto
155		VDU2	VDU2
160	LPRINT CHR\$(&H1B);"L"; CHR\$(&H50);CHR\$(&H0)	VDU1,&1B,1,&4C,1,&50,1,&0	VDU1,27,1,76,1,80,1,0
170	FOR N=1 TO 50	FOR N=1 TO 50	FOR N = 1 TO 50
180	LPRINT CHR\$(&HFF);	VDU1,&FF	VDU1,255
190	NEXT	NEXT	NEXT
200	LPRINT CHR\$(&HA)	VDU1,&A	VDU1,10
210	GOTO 160	GOTO 160	GOTO 160

Program 8. Epson test translated

```

10 REM LETTER
20 REM TAB is set by the sequence ESC P 80;15;60 ESC Z
30 REM Where line length is 80, and the TAB stops are at 15 and 60
40 REM enable printer
50 VDU2
60 REM send TAB program via VDU 1
70 VDU 1,27,1,80,1,56,1,48,1,59,1,49,1,53,1,59,1,54,1,48,1,27,1,90
80 REM new page
    
```

Program 9. Olivetti TAB function

```

90 VDU12
100 REM space at top of page
110 VDU13,13,13,13
120 PRINT CHR$9;CHR$9;"10 Small Street"
130 PRINT CHR$9;CHR$9;" Small Town"
140 PRINT CHR$9;CHR$9;" Mirkshire"
150 VDU13,13,13,13
160 PRINT"Dear customer,"
170 PRINT CHR$9;"Thank you for your valued advice."
180 VDU 13
190 PRINT CHR$9;"The manager regrets the sad loss of
    
```

Program 9 continued

```

your budgerigar, and the consequent damage to the vacuum cleaner."
200 VDU13
210 PRINT CHR$9;"He hopes that the enclosed will enable you to assuage your grief in some appropriate way."
220 VDU 13,13
230 PRINT CHR$9;"Yours faithfully,"
240 VDU 13,13,13,13
250 PRINT CHR$9;"A.SMARM"
260 REM disable printer
270 VDU3
    
```

HAVE YOU GOT A BBC MICRO? THEN YOU NEED:



THE NEWSLETTER OF THE INDEPENDENT NATIONAL BBC MICROCOMPUTER USERS GROUP

IN RECENT MAGAZINES:

Articles: Teletext Graphics, User Definable Characters, User Definable Keys, Sounds, *FX, Telesoftware, Line Structure and Merging, Epson Screen Dump, Pixel Power, Moving Things, Manual Review, What Printer?, Seikosha Dump, Machine Code, How To Get More Colours Out Of Your BBC Micro, Circles Galore, Conversions for RGB Inputs, How To Use Joysticks, Instant Graphics, Software Protection, String, String, String, What Monitor? Speeding Up Your Programs, Computer Conversions, Questionnaire Results, Formatting, Assembler Programming On The BBC Micro, Errors? Focus On Adventure, Diskspot, Computer Programme Review, ADC Corner, Make The Most Out Of Sound, and lots, lots more

Programs: Labyrinth (Game), Pontoon (Game), Artillery (Game), Life (Misc.), Calendar (Misc.), Prism (Educ.), Spiral Patterns (Graphics), Bazooka (Game), 4-In-A-Row (Game), Mortgage (Misc.), Oxygen (Game), Teletext Terminal (Utility), Wordprocessor (Business), Mixer (Graphics), How Many Colours? (Graphics), Disassembler (Utility), Maths Race (Educ.), Puzzle Program (Game), TV Test Signal Generator (Utility), Alphabet Tester (Educ.), Repeat (Game), Memory Analyser (Utility), Wallball (Game), Dating (Misc.), What's The Time? (Educ.), Grand Prix (Game), Nine Dice (Game), Memory Dump (Util.) and lots, lots more

Regular Features: Bookreview, Letters, Hardspot, Softreview (we review *at least* 8 programs per magazine from all sources), Oddspot (a different graphical program every month), Meeting Place (where we list local user groups), Contacts (spans over 1 page of names and addresses of people who want to get in touch with other users in their area), Competitions, Printereview (we have looked at the Seikosha and Amber 2400 and give full details on how to use them with screen dump programs), Seasons (a seasonal program every month), Queryspot, Special Offers (special offers and exclusive club discounts), Assembler Programming On The BBC Micro, Software Protection and lots, lots more

**WE WON'T TRY TO PUSH LASERBUG ON YOU LIKE THE OTHERS – SEND OFF FOR
A SAMPLE COPY AND YOU'LL FIND THAT LASERBUG SELLS ITSELF**

ALSO AVAILABLE FROM LASERBUG:

Do you want a dust cover for your BBC Micro but can't find one anywhere??? If so then look no further, LASERBUG has the answer. LASERBUG Dust Covers are specially made for us in a high quality polyester/cotton looking much better than the PVC covers you can get from some places. And the real good news? They are only £3.25 each inclusive.

If you need a cassette lead for your BBC Micro the chances are that you are about to pay between £4 and £8 for the right lead! Why bother when you can get a suitable lead from LASERBUG for just £3.00. Send for either a DIN and Remote Jack or a 3 Jack lead today.

Please supply me with: A sample copy of LASERBUG @ £1.00
A 12 Month subscription to LASERBUG @ £12.00 for 12 issues of the magazine
A 6 Month subscription to LASERBUG @ £6.00 for 6 issues of the magazine
An overseas subscription to LASERBUG @ £14.00 (Surface Mail – write for details of air mail)
..... LASERBUG Dust Cover(s) @ £3.25 each
..... LASERBUG Cassette Lead(s) (Please state type(s)) @ £3.00 each

I enclose a cheque/PO for £..... made payable to LASERBUG

NAME ADDRESS

.....

.....

Please send the completed form to: LASERBUG Dept. A, 10 Dawley Ride, Colnbrook, Slough, Berks., SL3 0QH.

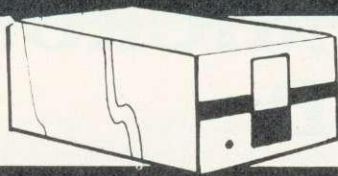

FLOPPY DISC DRIVES

SINGLE AND DUAL DISC DRIVES
40 OR 80 TRACK FOR BBC MICRO

includes utility disc and Dos Manual Phone for prices:—

BBC MICRO

BBC COMPUTER MODEL 'A' £262.00 + VAT
BBC COMPUTER MODEL 'B' £349.00 + VAT
BBC COMPUTER WITH DISC £410.00 + VAT

MONITORS

High resolution 18 MHZ 12"
Green Phosphor Monitor

£99.00 + VAT

Includes Cable



OTHER ITEMS AVAILABLE FOR THE BBC MICRO

Books, Cables, Joy Sticks, Cassette Decks, Dust Covers, Teletext Adaptor, Speech Upgrade.
SEND FOR PRICE LIST

SEIKOSHA GP-100A

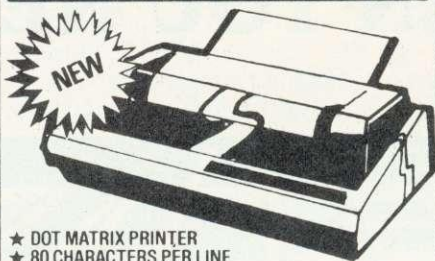

- ★ DOT MATRIX PRINTER
- ★ 80 CHARACTERS PER LINE
- ★ 30 CHARS/SEC
- ★ FREE HI-RESOLUTION 'DUMP OUT' LISTING

£179 + VAT. Carr £6

BBC Printer Cable £16 + VAT

BBC MICRO

WORD PROCESSOR
ROM £46.00



CHESS £11.50
 ASTEROIDS £ 8.95
 GLAXIAN £ 8.95
 BILLIARDS £ 8.50
 FROGGER £10.00
 GOLF £ 8.00

BBC MICRO MICRO UPGRADES

RAM KITS: Upgrades the Model 'A' to 32K RAM
Supplied with full fitting instructions. £29.90 + VAT

ANALOGUE KITS: Suitable for adding joysticks,
controllers etc. £15.00 + VAT

PRINTER INTERFACE & I/O PORT: Enables a
Centronic Interface printer to be attached ... £16.00 + VAT

MODEL 'A' TO MODEL 'B' UPGRADE
£89.00 + VAT (fitted)

DISC EXPANSION £80.00 + VAT

DISC DRIVES from £179.00 + VAT

COLOUR MONITORS from £229.00 + VAT

Send for details on other items, cables, cassettes, plugs,
software etc.

**WHY NOT SEND YOUR MACHINE TO US FOR
UPGRADING?**

PRINTERS

EPSON FX80 - The printer recommended for the
BBC Microcomputer

- ★ Dot Matrix Printer
- ★ 80 Cps

- ★ Hi-Resolution Graphics
- ★ Bi-directional Printing



SPECIAL PRICE
£399 plus VAT
Printer Cable
£16 + VAT

Q-TEK Systems

Telephone STD (0438) 65385
2 Daltry Close, Old Town, Stevenage.

BBC
Service &
Information Centre.

BBC

OUR PROGRAMS ARE NOT
JUST FUN—they're an
education!!

PUNCMAN
£7.95
(two programs)

Features two animated 'Computer bugs'. Punzman writes the stories, and Noshier eats punctuation symbols. You put them back. Interactive fun—a great way to learn.

STORY A
£6.95
(2 programs)

'Spanish Gold'—an illustrated story-book on the screen. Multiple endings selected by the child as the story progresses. First in a series and a fine stimulus to creative writing

CAPITALS
£9.95
(5 programs)

Follow-up to our successful LETTERS program. Capital letters and numerals as designed by Christopher Jarman (Basic Modern Hand).

REVERSALS
£7.95
(2 programs)

Similar to PUNCMAN, but this time Noshier reverses letters (like 'b' for 'd'). You turn them round again. Encourages children to look more closely at their own writing.

PIRATE
£6.95

Follow-up to INKOSI. This is our second 'Adventure/Simulation' game for children. Would you make a good pirate? A world-wide game based on real events from the past.

ANGLE†
£8.95
(4 programs)

Graded programs with superb graphics demonstrate Angle as 'turning', degrees, names of various angles, how to use a protractor, with questions to check understanding. Measure angles direct from the screen. Ages 8-14.

INVISIBLE MAN
£5.95*†

Draws and labels a grid, and displays a cartoon man who disappears! Feed in co-ordinates to find him in the time allowed. Complete with on-screen compass point clues. Ages 7-14.

COMING SOON
TOP OF THE POPS
TRIANGLES
MUSIC INVADERS

Programs marked * are now
available for the VIC 20 with at
least 3k rampack. SPECTRUM
programs are marked †.

Send SAE for details to:

chalksoft

Lowmoor Cottage (AU4)
Tonedale
WELLINGTON
Somerset TA2 10AL
082 347 7117

TRADE AND EXPORT ENQUIRIES WELCOME

WORDSCAN.

FOR ALL BBC MICRO OWNERS - A WORD PROCESSOR ON CASSETTE.
Even for those owners with 0.1 Operating System.
Even for those owners who do NOT own a printer.

So far, you have used your machine to play games. Now
you can really benefit, using it for WORD PROCESSING.

An extremely fast and easy to use program,
professionally written caters for over 400 by 40
character lines of text on the BBC Micro Model B.

There are versions to cater for the special facilities
of the EPSON MX80 FT3, Seiksha GP100A and Centronics
printers, but the program will operate on any 'machine
compatible' printer.

Bureau Service available for PRINTING if required.
'Edit' your text on your TV monitor.
'Save' it on cassette when you have checked it out.
'Send' it to me for a fast confidential PRINT service.
Epson MX80 FT3 used for Print Service with all features.

For Demonstration cassette just send £2 deposit + £1 to
cover p&p. Please state printer to be used.

Otherwise, full details of the Package, priced at £15
and the Bureau Service, minimum charge £2 for 2000
words can be obtained from "Dial Software", 72 Downend
Road, Downend, Bristol BS16 5UE.

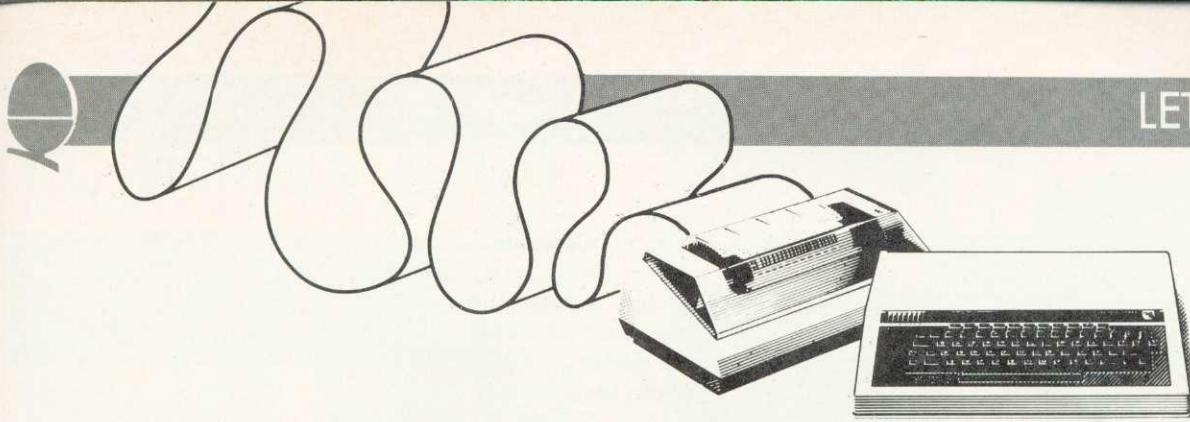

PROSE WHERE PROSE IS DUE

Sir, As a piece of journalistic literature one can hardly fault *Acorn User*. However, don't you think that users of the BBC micro want more than prose to read? After all, how many of us can correctly construct a program from a given set of criteria?

Take your competition page. Would it not be more useful and constructive if you were to use this page to show a complete analysis of your solution to the problem, with detailed comments as to how and why you did it that way?

So, please, become the first computer journal to help the programmers/analysts of the future.

Ian Crawford
Banbury

We have taken your constructive suggestion to heart – so watch the competition pages for further developments. In the meantime you might be interested to know that we will shortly be starting a series on programming techniques.

It should be said that what you described as 'prose' has proved popular with many readers.

DIA VIA CIRENCESTER

Sir, In the March issue of *Acorn User* the information regarding the distribution of the DAI personal computer is incorrect.

Data Applications of Cirencester (tel: 0268 61828) have taken over distribution of the DAI personal computer in the UK.

Lisa Reuben
for Data Applications



TELETEL PRETEXT?

Sir, What is the difference between a Teletext receiver and a Prestel receiver?

S. Smith
Birmingham

Teletext is a set of information pages transmitted with TV signals, and decoded by a special circuitry in your television or by a special BBC micro adaptor. The BBC TV service is called Ceefax, and ITV's is Oracle. The information is free and Ceefax is also transmitting software which can be loaded into the BBC micro and run, using the Teletext adaptor. There is also a computer newsletter called REM on Ceefax page 700.

Prestel is a much bigger system which uses the telephone network and is two-way (ie you can send information as well as receiving it). For Prestel you need to be connected to a British Telecom line, either directly or via an acoustic coupler (sometimes called a modem). Some pages are free, but most have to be paid for. A new addition to Prestel is Micronet, for

computer users (see April's *Acorn User*). Prestel and Micronet are paid for by subscription, and are protected by a set of access codes.

The two receivers you mention are specific to one system or the other, as they use fundamentally different principles. Teletext adapters are already in production, while Prestel receivers will not be available for several months.

RE-CALL STATEMENT

Sir, There is one error in Shaw and Ferguson's review of my book (*Assembly Language Programming on the BBC Micro*, Macmillan) (*Acorn User*, March) which I hope you will allow me to correct.

The review states that 'one omission is a full treatment of the Beeb's powerful CALL statement'. This is not so. Chapter 10, pages 180–186, contains a full discussion with applications to integer and string sorting.

Ian Birnbaum
Cambs

CANARY TWEETERS

Sir,

Would you publish a note in *Acorn User* stating that some members of our club are interested to get in contact with British radio amateurs already using the BBC Micro for coding/decoding both CW & RTTY. Many thanks in advance.

I. Beng
BBC Micro Club – Tenerife
PO Box 1297
Santa Cruz de Tenerife
Canary Islands, Spain

COPESTAKE'S
MISTAKE

Sir, Thank you for your letter and £20 cheque for my 'auto-destruct' tip in April's Beeb Forum.

However, since submitting the tip I have discovered certain situations where it doesn't work. I would be grateful if you would therefore publish an amendment.

Line 20 should read:

```
20 DIMP%6:?514=P%:?515
=P%DIV256:COPT0:LDA#124:
JSR&FFF4:RTS:]*K.10 1:1M
```

Line 30 should read:

```
30 REPEAT PROCx
```

There are also three places where I is printed as I.

Ian Copestake
Surrey

And our thanks to you for pointing this out so promptly.

EPROMS
SAVE RAM

Sir, I have recently noticed adverts for EPROM programmers. Could you please explain what I can program onto these: can the programs be in Basic or assembler? If I can put my own programs on them, can they be slotted into the PCB? I would be grateful if you could explain my questions.

Colin Rice
Merseyside

EPROMs - erasable/programmable ROMS - are chips which can be used to store programs, rather than using up RAM. They can be re-used, and function as temporary ROM - for example with the BBC micro's 0.1 operating system.

Both machine code and Basic programs may be burned into EPROM and plugged into the empty sideways ROM sockets on the front right of the main circuit board. For either sort of program, special

information must also be placed into the EPROM to inform the micro of the presence of the chip. Details of this format information are available from Acorn at Fulbourn Road, Cherry Hinton, Cambridge CB1 4JN. Tel: 0223 245200

SOUNDS
SIMPLE

Sir, I have been following, with interest, the correspondence in *Acorn User* on the subject of audio connections to the BBC micro. Your reply to the lost chords letter in the February edition has finally incensed me to put printer to paper.

If, like me, your writer owns a model B which has no PL16 then the replies given by you only serve to increase the frustration.

My model B has the marking PL16 on the left hand edge of the PCB but there is no plug or socket connected to the board. Is the external connection supposed to go here? Could Acorn give us connection details for the two pads on the PCB so that we can make our own PL16?

A. Turnbull
Netherlands

PL16 doesn't need a plug or a socket. Simply solder a wire to each pad (one is ground and the other is the audio output) and connect to the tape input of your hi-fi.

SIGHT
& SOUND

Sir, Several readers have commented about the need for better quality sound reproduction and higher volume, but the solutions offered, whilst bringing some improvement (eg larger/better quality speaker or use of the cassette recorder's amplifier) do not really provide a satisfactory long-term answer.

I feel sure that it should be possible to channel sound through the television itself, where there is ample volume and quality, and from where, naturally, one expects the sound to come. Such an improvement would enhance the already spectacular performance of the BBC micro, as I'm sure most readers would agree.

B. Sharrock
Bolton

There is a technical problem in sending a sound signal to the TV, because it has no separate audio input socket. This means the sound signal would have to be combined with the vision signal by replacing the existing modulator in the BBC micro (that tin box in the far right corner of the circuit board). However, the new modulator would have to be exactly the right type, and much bigger than the existing one - consequently, it would be difficult to fit.

A far simpler and better solution is to connect the Beeb's audio output to an hi-fi amplifier and through a set of speakers, as explained elsewhere in this section.

AMBER
BOOB

The Amber printer graphics dump of February's issue should be amended to read:

```
1019 REM send carriage return
to clear paper
1020 VDU1,13,1,13,1,13
1039 VDU1,13,1,13,1,13
```

P.L. DIGITISER SYSTEM™

Designed for use with the BBC Model B Microcomputer

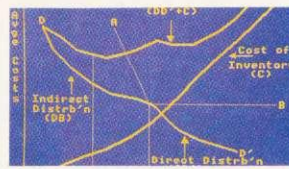
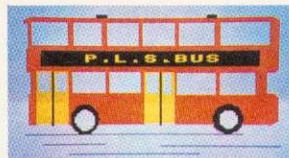
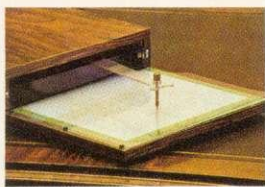

photos of screen image

The P.L. Digitiser System enables you to reproduce complex pictures and diagrams, or produce original designs, quickly, easily, and accurately.

The package consists of the 'Graphics Digitiser' incorporating a tracing pad (mapped out by rectangular grid) 256mm x 205mm and the 'Control Program' (cassette tape or disk) which handles the information passed from the digitiser to the microcomputer.

WIDE RANGE OF INSTRUCTION BLOCKS. Instruction blocks enable: boxes and circles of any size to be constructed by specifying two probe positions; filling area with chosen colour; drawing of irregular shapes using chosen resolution; outlining defined area in different colour and varying line thickness; creating lines in Horizontal, Vertical or Angled modes, with parallel lines in repeat or multiple repeat styles again in selected thickness; write and position text.

COMPLETE EDITING FACILITY. Mistakes can immediately be erased and rectified.

RELOCATION AND SCALE. Images may be relocated simply by inputting two probe positions and

scale may be increased or reduced by making just two inputs.

STORAGE. Pictures may be saved on cassette or disk file or reproduced by a line printer.

FULL COLOUR. The range of colour facilities offered by the BBC micro is easily handled by the Digitiser, in modes 4 and 5.

ACCURACY. The probe position is continuously displayed on the screen and fidelity of image to original drawing is very accurate.

NO KNOWLEDGE OF BASIC REQUIRED. Users can very easily and quickly familiarise themselves with the P.L. DIGITISER SYSTEM.

TM—B. S. Dollamore Ltd, Castle Gresley, Burton-on-Trent, Staffs DE11 9HA. Telephone: Burton-on-Trent (0283) 217905

TO: B. S. Dollamore Ltd, Castle Gresley, Burton-on-Trent, Staffs DE11 9HA

Please supply the following:

Qty	Description	Cost	Value
	P.L. DIGITISER	£149.95	
Price includes post, packing & VAT @ 15%			

Each Digitiser is supplied with cassette/disk* Control Program, key card and comprehensive operating instruction manual.

I enclose cheque/P.O. for £..... or please charge on Access/Visa Card

No.

Signature

Name

Address

.....

.....

*Please delete.

Also available through authorised dealers. Contact Leasalink Viewdata Limited, Scientific House, Bridge Street, Sandiacre, Nottingham. Telephone 0602 394000 for details of nearest stockist.

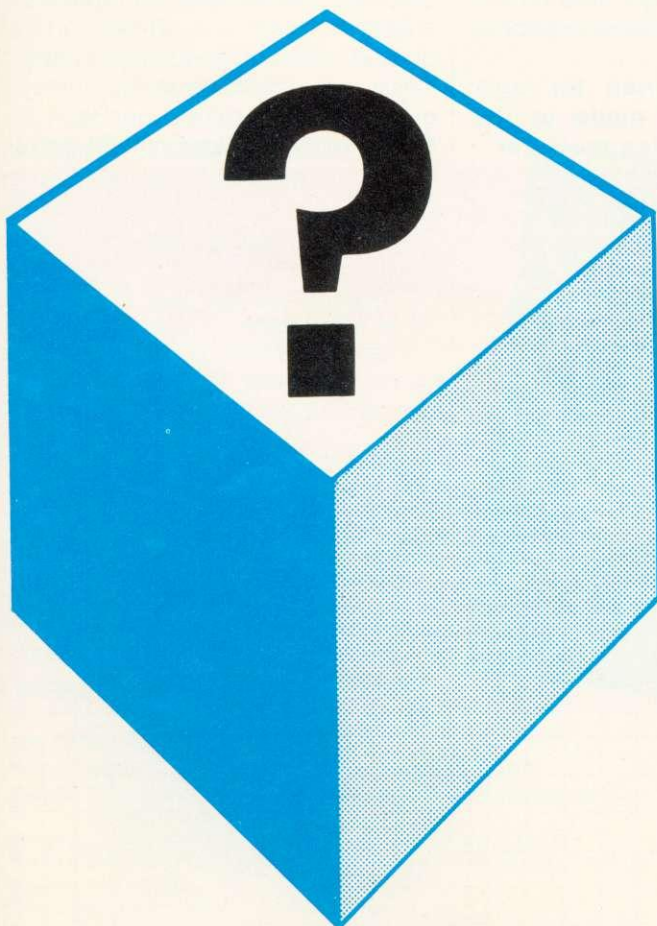

Electronics & Computing

MONTHLY

Electronics & Computing Monthly is Britain's FIRST electronics and computer applications magazine.

Electronics & Computing Monthly is designed for the technically aware computer enthusiast.

Electronics & Computing Monthly has a unique blend of theory, projects, software and product reviews, plus science and general features on a wide variety of topics.

Electronics & Computing Monthly keeps you fully informed on changes in computer technology.

Electronics & Computing Monthly is at your newsagent now.



Two top quality programs from Kansas – for four years the Brand Leader in microcomputer software ...

Don't struggle with your keyboard,
make it easy with

MICROTYPE

The ultimate typing tutor
– now upgraded for the BBC

Recognised as the standard in typing tutors since it was introduced to microcomputers some three years ago, the Kansas Microtype has been still further improved and converted to the BBC Micro.

So you have a Beeb! Which means you, and most likely those around you are going to spend a fair bit of time in the future at the keyboard. Not just in the near future, but for many years to come, as computers are here to stay.

So why not master the keyboard now? Stop chugging away with just a few fingers and your eyes for ever on the keys – learn to touch type, giving you speed and accuracy.

Microtype will allow you to teach yourself, and will progress as you improve. Just a few short sessions and you will see results. Keep at it for say half a hour a day and you will be touch typing within a week, with no need to look at

the keys ever again! Keep at it and speed will follow.

Apart from simple working instructions and a finger position chart, everything is actually shown on the screen. You don't have to wade through a printed course. You will be prompted the characters to type on the screen and will be shown which are being keyed in correctly and which are not.

At the start you will be given the 'home' keys to practice, but unlike normal typing tutors, the computer can tell on which keys you are inaccurate or slow and so can give more practice on these keys whilst at the same time replacing those on which you are proficient.

There is also the choice of practice mode or paragraph mode. So once the program has given, and you have learned, most of the keys, paragraphs can be attempted.

There are ten short exercises in each lesson, with a complete analysis of your performance at the end. This includes your average typing speed, accuracy and any keys you mis-keyed. If a response time is set, the program will also show the keys on which this time was exceeded. Being designed for micro keying, a great many of the words selected by the program are those which are actually used in programming the BBC. But of course, it is also ideal as a normal typing tutor, as both typewriter and computer keyboards are the same.

VAT and post paid – £12.50

A real traditional Adventure for the BBC...

DRACULA ISLAND

Ever played a good adventure game on a Micro? If not, you are in for endless hours of enjoyment, with no little hair tearing in the bargain in the attempt to solve it. A traditional adventure always has a purpose and is absolutely logical in that the locations are always in the same place, objects are either in their place or where you leave them, and the conditions depend exactly on the action you take.

Using directions or two word sentences, you set off on your adventure, in this case to kill Count Dracula! But beware, there are many pitfalls awaiting you on your journey and many objects will have to be found, always bearing in mind what happens to Dracula when the sun goes down. But it all adds up to days and days of fun – and frustration!

Being written for the BBC, use is made of the micro's colours during operation, not just because they are there, but to actually help in playing the game.

The programmer says it will take on average three weeks to solve. But there is a bonus, for unlike the adventures already available for the BBC, your progress with Dracula Island can actually be saved to tape. This means that after making progress, you can save the data, and then load it back at a later time to carry on playing from the actual place at which you last finished, and as many times as you want. Unlike others, this one IS logical and IS solveable...

If you have played adventures on other micros, you will find this one exceptional, and if you have never played an adventure before, it will get you hooked – try it ...

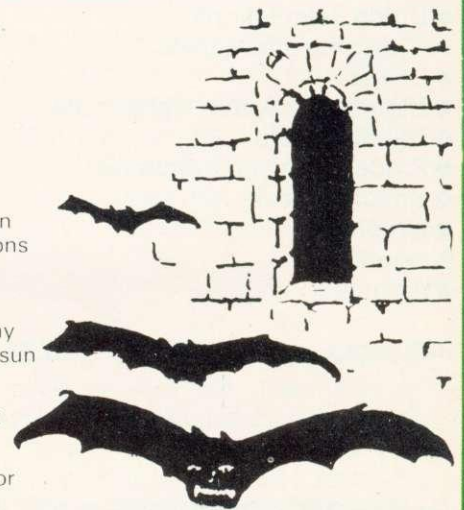

HELP! If you get absolutely stuck with Dracula Island, give our adventure expert, Jan Green, a ring – she'll help!

VAT and post paid – £9.50

If you have never purchased a program from Kansas before, you are in for a pleasant surprise!

We have been in the software business ever since it first started, and so have the experience and expertise to produce the very best programs, unlike the many new firms which have to reply on new programmers offering them their wares. Little wonder the software buyers for the BBC have become so disillusioned at the amateur programs currently being offered. But not only the programs, the complete lack of packaging and presentation leaves a great deal to be desired.

And the length of time you have to wait! How different at Kansas, for we boast the fastest software service in the country. Every single order is completed and despatched the very same day it is received – whether payment is by cheque or credit card. We have even gone to the expense of a private Post Office collection at 4.30 every working day to speed the delivery. In fact, if you order by credit card over the phone by 4pm you will get the software tomorrow!

Now is the time to bring some professionalism to the BBC scene, and who better than Kansas, recognised for the past four years as Brand Leader in microcomputer software...

SEE US AT THE SHOWS

Midland Computer
Fair Birmingham
28-30 April

Computer Fair
Earls Court
16-19 June



SORRY – NO DEALERS
In view of our guarantee and return post service
Kansas programs can only be purchased direct.

Kansas

Publishers of the famed Kansas 'Arcade' series – now available for the BBC Micro

Kansas City Systems, Unit 3, Sutton Springs Wood, Chesterfield, S44 5XF. Tel. 0246 850357

HUMBER MICROS

The **Hull and District TRS80/Beeb Users Group** meets twice monthly at the psychology department of Hull University at 8pm. Second Tuesday of the month is a talk or demonstration and the Thursday 16 days later is for members to do their own thing. For further information contact R. Souter (0482 654117) or J. Lawrence (0482 493856).

ESSEX NAMEBUG

Attention Beeb users in Essex. The **North and Mid Essex Micro User Group (Namebug)**

has been formed to provide talks and demonstrations by local dealers and workshop evenings for help with mods, upgrades and interfacing. They meet at 7.30 on the second Thursday of each month in Witham. For details phone (after 7pm) Nigel Ballard (0206 72889), Dave Watts (0245 358127) or Andy Purkiss (0376 515609).

BEEB DOWN UNDER

We are very pleased to hear from the **Australian Beeb and Atom User Group** which is run from Canberra by Steve McLeod (address below). Good on you, Steve, we wish you lots

of fun and hope others will follow your lead.

UNIVERSAL CORBY

Peter Wilson is the man to contact if you are a micro user (Beeb, Vic, Pet or Spectrum) in and around Corby. The **Universal Micro Club** meets fortnightly at the Spread Eagle in Oakley Hay. Details from the address below.

HELP WANTED

Would anyone wishing to help set up an Acorn User Group in the Wimbledon area please contact Mr A. Quinn, 19 Victory Road, London SW19.

CLUB CONTACTS

● Rupert Steele
Amateur Computer Club
St John's College
Oxford OX1 3JP

● **West Midlands Computer Group**
12 Apsley Road
Oldbury
West Midlands B68 0QZ

● Mr J. Price
Bedford House
27-28 St George's Road
Brighton
Sussex

● Mr P. Beverley
Norwich Area Acorn User Group
Room 12a, Norwich City
College
Ipswich Road
Norwich NR2 2LJ

● Keith Mitchell
Edinburgh ZX Computer Club
19 Meadowplace Road
Edinburgh
Tel: 031-334 8483

● Steve White
Atom/BBC User Group
c/o Superior Systems Ltd
178 West Street
Sheffield
Tel: (0742) 755005

● Robin Bradbeer
Association of London Computer Clubs
Polytechnic of North London,
Holloway
London N7 8DB

● Nik Kelly
Liverpool BBC & Atom Group
56 Queens Drive
Liverpool L4 6SH
Tel: 051-525 2934

● Nigel Ballard
Namebug
27 Crowhurst Road
Colchester
Essex CO3 3JW
Tel: 0245 358127/
0376 515609

● Dr Leo McLaughlin
North London BBC Micro Users Group
Dept. of Chemistry
Westfield College
University of London
Kidderpore Avenue
London NW3 7ST
Tel: 01-435 0109

● Mr C. Rutter
Medway Atom Users Club
St John Fisher School
Ordnance Street
Chatham
Kent

● **Beebug**
374 Wandsworth Road
London SW8 4TE

● Mr J. Ashurst
Acorn Computer Users Group
Abraham Moss Centre
Crescent Road
Manchester 8

● Mr D.L. Evans
23 Hitchin Road
Henlow Camp
Bedfordshire

● N.P. (Bazyle) Butcher
Harrow Computer Group
16 St Peter's Close
Bushey Heath
Watford WD2 3LG

● R. Welch
Harpenden Microcomputer Group
7 Tylers
Harpenden
Herts AL5 5RT

● Mr P. Frost
Atom Users Group
18 Frankwell Drive
Potters Green
Coventry CV2 2FB

● Oivind Grenness
BBC Norway
O-Inform
PO Box 716
N3191 Horten
Norway

● R.V. Souter
TRS/80 Beeb Users Group
25 Carr Lane
Willerby
Hull HU10 6JP
Tel: 0482 654117

● E.R. Piper
Bognor Computer Group (BUG)
2 Ely Gardens
Aldwick Park
Bognor Regis
Sussex PO21 3RY

● **Liverpool BBC Microgroup**
c/o Fred Shaw
14 Albany Avenue
Eccleston Park
Prescot
Merseyside L34 2QW

● John Harris
Bottisham Acorn User Group
1 Rowan Close
Bottisham
Cambridge CB5 9BN
Tel: (0223) 811487

● Peter Smith
Fareham and Portchester Amateur Computer Club
23 Sandy Close
Petersfield
Hants

● Paul Barbour
Laserbug
10 Dawley Ride
Colnbrook
Slough
Berks. SL3 0QH
Tel: 02812 3064

● Brian Pain
Colour Micro Users Group
40a High Street
Stony Stratford
Milton Keynes
Tel: (0908) 564271

● Mr. D. Coulter
Preston BBC User Group
8 Briar Grove
Ingol
Preston PR2 3UR

● **Acorn Users Group of Sweden**
c/o Janne Soderberg
Frihetsvagen 32
S-175 33 Jarfalla
Sweden

● Dilwyn Jones
Bangor & District Micro Users Group (BADMUG)
Fodol Farm
Hafod Lane
Bangor
Gwynedd LL57 4BU

● Peter Wilson
Universal Micro Club
26 North Cape Walk
Corby
Northants NN18 9DQ
Tel: Great Oakley 742622

● Mr J. Craig
National BBC User Group
40 Mount Pleasant Avenue
Wells
Somerset BA5 2JQ

● Mr R. Luff
Kingbee
54 Arlington Close
Kingswinford
West Midlands

● **Computer Club**
Caterham Leisure Centre
Godstone Road
Caterham
Surrey CR3 6RE
Tel: Caterham 48304/43316

● Ted Ryan
Eastwood Town Microcomputer Club
15 Queens Square
Eastwood
Nottingham NG16 3BJ

● Mr T.A. Kayani
SOBAT Computer Club
B25 Beridge House
Hillfield Road
West Hampstead
London NW6

● Mr M.G. Forster
Potbug BBC Users Group
8 St George's Avenue
High Lane
Tunstall
Stoke-on-Trent
Tel: 818499

● **Muse** (for teachers)
Freeport
Bromsgrove
Worcs B62 7BR

● Mr B. Carroll
The Cottage,
42 Manor Road,
Aldershot GU11 3DG

● Steve McLeod
BBC Users Group of Canberra
5 Hatfield Street
Evatt A.C.T. 2617
Australia
Tel: (062) 58 7719

INDEX OF ADVERTISERS

A B Designs.....	74	Interface.....	79
Acornsoft.....	44/76/77	Kansas.....	94
Addison-Wesley.....	93	Laserbug.....	87
A J Vision.....	79	Leasalink Viewdata.....	IFC
ATPL.....	74	Leosoft.....	33
Beebug.....	70	Level 9.....	69
Bits & Bytes.....	50	Micro Advent.....	15
Bourne Educational.....	66	MicroAge.....	10/17/18
Butterworths.....	33	MicroAid.....	18
Cabel.....	81	Micro Management.....	60/61
Cambridge Processor.....	34	Micro Power.....	OBC
Chalksoft.....	88	Midwich.....	25
CJE.....	14	Muse.....	80
Coker, Paul.....	96	Newark Video Centre.....	69
Computer Concepts.....	65	Off Records.....	50
Contex Computing.....	96	P L Digitiser.....	91
Control Universal.....	91	Pentland.....	6
Cumana.....	1	Portatel Conversions.....	72
Dial Software.....	88	Q Tec.....	88
Digital Fantasia.....	7	Salamander.....	9
Dr Soft.....	96	Secta Software.....	82
Electronequip.....	80	Silent Computers.....	82
Electronics Computing.....	91	Sir Computers.....	73
Eltec Computers.....	10	Software For All.....	52
Gaelsett.....	66	Software Invasion.....	63
Gemini.....	28/29	Superior Software.....	56
Golem.....	72	3D Computers.....	56
Guildford Computers.....	68	Technomatic.....	4
Hall, Chris.....	66	Twickenham Computers..	50
Hessel, Simon W.....	26	Video Palace.....	82
Hexadecimal.....	8	Watford Electronics...	20/21
IJK Software.....	IBC	West Coast Computers....	66
Ikon.....	68	Windsor Computers.....	41
Intastor.....	73	Zencom.....	80

THE P.M.C.

WORDWORKER

PROFESSIONAL BBC WORDPROCESSOR*
EASY TO USE AND VERY POWERFUL

Includes full editing ability. Correct and change single words. Delete and insert any amount of text any time.

**AUTOMATIC REALIGNING
TEXT ALWAYS ON VIEW**

Set margins and page length to any size. Hold many pages at one time to print out together. Paper feed between pages allowed for. Print hard copy any time on any printer. Multiple copies.

IDEAL FOR OFFICE OR HOME

i.e. manuscripts/essays/documents and reports.

ENORMOUS TIME SAVING

Eliminate wasted work by typing errors etc.

SAVE WORK AT ANY TIME

Retrieve a hard copy (on printer) from pre-recorded work in seconds.

Sets out standard letters and inserts variable data.

i.e. Change . . . Name/Account No./Quotations in a widely used letter.

AMAZINGLY LOW PRICE . . . £9.50

Make cheque or P/O payable to . . . Paul Coker (Software)
Send to 25 Farquhar Road, Crystal Palace, London SE19 1SS.
Phone 01-761 2087.

Tape program reproduction guaranteed.

Discounts on bulk orders.

Completely confidential printing service available.

£2.00 per 100 lines.

Will adapt and supply hardware for disabled. i.e. Dyslexics.

Other software available.

Maze Game. £4.50 (Model B or upgraded (RAM) A)

8-11 educational. Maths and English help. £5.50 (Model A/B)

All prices all inclusive.

*WORDWORKER (Model B or upgraded (RAM) A)

CONTEX

**Adult Educational Software
for the BBC computer**

TYPING TUTOR 32K

Specifically designed for the BBC micro the 90 smoothly graded lessons teach, train and encourage you to become quickly proficient at touch typing. Keyboard display highlights each lesson. Word scan error checking, times (wpm) and recommends next lesson. Audio key feedback, metronomic pacing beat, many user configurable options. Instruction booklet supplied **£10 inc.**

SPREADSHEET 32K

A complete and versatile 'calc' program and tutorial. Models containing over 1000 cells can be built using up to 26 columns and 99 rows. Equations, constants or text in any cell. Emphasis on ease of use includes copy, row/col insert, delete, totals, headers, variables, row colours, save and restore. Tutorial, application examples and documentation of the all Basic program for those who wish also to explore the design. **£8 inc.**

Cassette based. Professional software and service always. Special Offer! Deduct £1.50 if both programs ordered together.

**Cheque/PO payable to 'Contex Computing'
(A5) 15 Woodlands Close, Cople, Bedford MK44 3UE**



Doctor Soft Presents

*Also currently
on prestel via
Micronet 800

£7-95 32K

WOLFPACK III

A new concept, a new classic. . .

True in "space" cumulative motion—unlimited freedom and movement—amazing colour graphics and sound.

"Sometimes your first warning is a lancing disrupter beam striking from beyond visual range, sometimes they materialise close at hand. You are either quick or dead!"

Prowl lush starfields commanding a mighty fleet of deadly star cruisers. Carefully plan your strategy. Switch control from ship to ship, each has its own mission, each its own destiny.

Seek out lethal enemy battle stations, planets, cruisers, and phantoms using base station radar and target data.

Fight to the death! Detonate the enemy for a harvest of energy to transport to base. Lose, and risk a rescue under heavy fire!

Features include real and enhanced time; docking, refuelling, rotating base station, meteor strikes, rank and promotion, damage reports, crew comments, hyperspace walk between galaxies and separate briefing programme. A total experience.

Other Doctor Software for the BBC Micro includes:

747 *32K £6.95—Full-blown flight simulator by the same B.A. Captain who wrote the famous Atom programme.

Cremlin *32K £6.95—3D multi-level maze escape with Gremlin Kombar! Maps, skill levels, standard or random structure.

Harmony *16K £5.95—Delightful, infinite, saleable patterns of light and sound.

Royalties—The Doctor pays top royalties for top programmes. All types of popular machines and all types of software.

NO EXTRAS, prices fully inclusive.

Cheques and P.O.'s to:-

Doctor Soft,
258 Coneygree Road,
Peterborough PE2 8LR.

**BBC
MICRO**

DOCTOR SOFT

IJK

the one to watch

MODEL A/B

Cassette 1: Star Trek/Candy Floss

(very popular) **£6.50**

Cassette 2: Family Games (hours of fun) **£4.50**

Cassette 3: Mutant Invaders/ Breakout **£6.50**

Cassette 8: Model A Invaders (M/C) **£5.50**

MODEL B (or A+32K)

Cassette 4: Beep-Beep (Super Simon Game) **£4.50**

Cassette 5: Beebmunch (full colour Munchman) **£6.50**

Cassette 6: Super Hangman (animated, educational) **£4.50**

Cassette 7: 3D Maze (fast and intricate) **£4.50**

CASSETTE 9

MODEL B Invaders (or A+32K) (M/C) **£7.50**

CASSETTE 10

WORDPRO. (Cassette W.P. system). **£10.50**

CASSETTE 12

FLAGS. (Countries and Capitals). **£4.50**

CASSETTE 13

HYPERDRIVE (M/C arcade). Destroy the Drone aliens in the caverns with your laser tank. **£6.50**

CASSETTE 14

STRATOBOMBER (M/C arcade). Keep the enemy fleet at bay in order to destroy the rogue star ships nuclear reactor. **£7.50**

CASSETTE 15 - LEAP FROG

The fabulous 'frogger' arcade game reaches the BBC micro. Superbly written full colour machine code version for the Model B (or A+32K). Help the frog cross the road avoiding the vehicles travelling at different speeds, and cross the multi current river to reach the safety of the lilly pads. The game gets progressively harder - perfect for arcade addicts **Only £7.50 for MODEL B (or A+32K)**

CASSETTE 11

ATLANTIS. The superb fast action arcade game written in machine code to illustrate to the full the machines fantastic colour graphics and capabilities. This game includes all the usual ATLANTIS/SORAMBLE features. Guide your submarine Nautilus along the undersea landscape and through the caverns avoiding mines, depth charges, rockets, jelly fish, serpents etc. **Only £7.50 for MODEL B (or A+32K)**

BBC MICRO GAMES

- All Programs will run on all operating systems
- All software in stock before we advertise
- Send SAE for Brochure



ATLANTIS



LEAP FROG

ALL PRICES FULLY INCLUSIVE OF VAT AND P&P - NO MORE TO PAY

IJK
Software Limited

9 King Street, Blackpool, Lancashire.
(0253) 21555

24 HOUR ANSAFONE
 48 hour despatch



GREAT B.B.C. PROGRAMS FROM BRITAIN'S LEADING SOFTWARE HOUSE

Croaker

CROAKER (B) £6.95

People—HUH!! Pity us poor Frogs!! It was tough before, just trying to hop logs over the river. Now you've built multi-lane motorways, packed with fast-moving traffic. And if we get the family safely over that little lot, you drive faster and faster and breed ever increasing numbers of crocodiles and diving turtles to make things impossible. How long will we survive the ravages of Human Expansionism?

Full feature, arcade-standard, machine code program, with excellent sound and graphics. The faster you complete each level, the more you score. One for the Connoisseur!!

SWOOP (B) £6.95 — the NEW GALAXIANS Galaxian-style, machine-code arcade game. THIRTY screaming, honking, bomb-dropping, explosive egg-laying BIRDMEN, swooping down to destroy your laser bases. Bonus bases, score & high-score, hall of fame etc.

CHESS (B) £6.95
Our excellent machine code program—now with superb MODE 1, colour graphics. Six skill levels, play black or white, illegal moves rejected, 'en passant', castling, take-back of moves, and display of player's cumulative move-time. Options include Blitz Chess where you must move in 10 seconds, set-up of positions for analysis, replay of a game just played and saving of part completed games on tape. On loading, a 1972 Spassky/Fischer game can be replayed.

LASER COMMAND (B) £6.95
Classic 'Defence of 6 Cities'. Detonate single mines or patterns to counter laser fire from alien planets. Store and recall mine patterns. Super fast, machine-code arcade game with superb graphics, sound effects, many skill levels, bonus points. etc.

LASER COMMAND

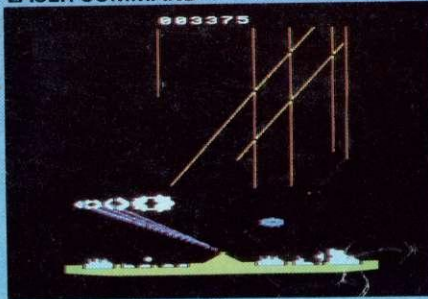

CROAKER

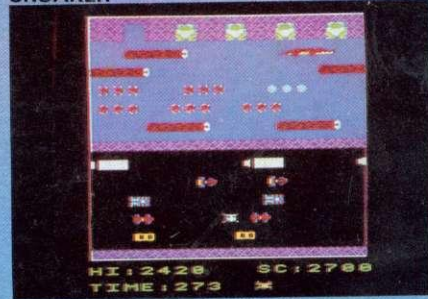

SWOOP



CHESS

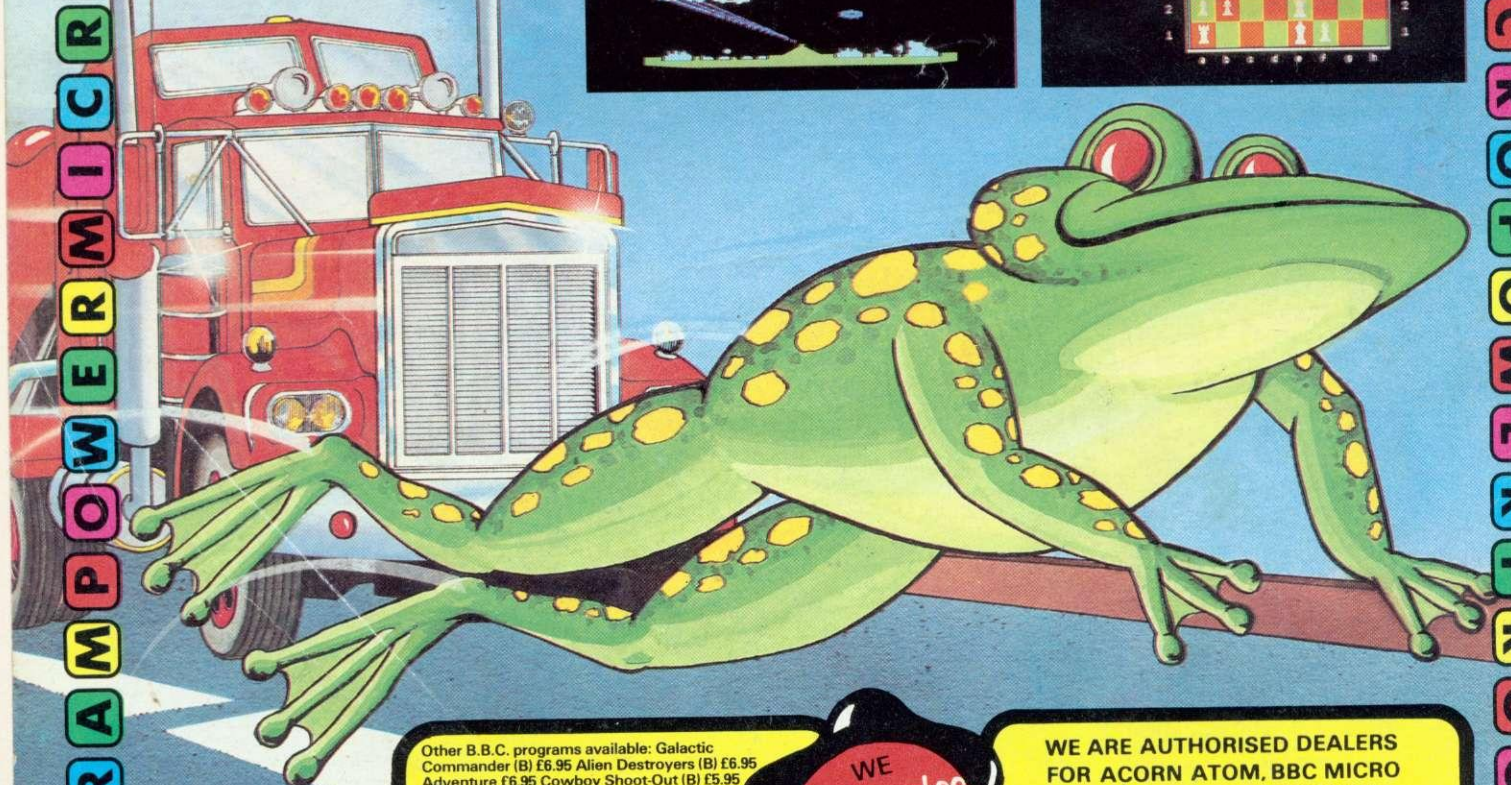
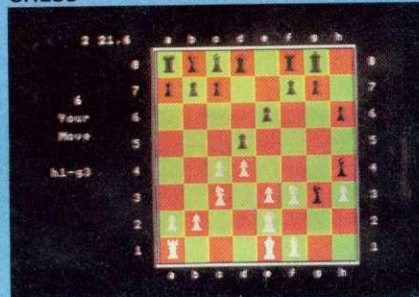

Other B.B.C. programs available: Galactic Commander (B) £6.95 Alien Destroyers (B) £6.95 Adventure £6.95 Cowboy Shoot-Out (B) £5.95 Filer £8.95/Micro Budget £6.95 World Geography (B) £5.95 Timetrek (B) £6.95/Spacemaze (B) £5.95/Martians (B) £5.95/Astro Navigator (B) £4.95/Star Trek £4.95/Munchyman £5.95/Seek £5.95/Eldorado Gold (B) £5.95/Cat & Mouse £4.95/Mastermind £3.95/Reversi 1 £4.95/Reversi 2 (B) £4.95/Roulette (B) £4.95/Gomoku £3.95/Zombies £3.95/Dissassembler £5.95/Constellation (B) £5.95/Junior Maths Pack (B) £5.95.Where? (B) £5.95

WRITTEN ANY PROGRAMS!
WE PAY 20% ROYALTIES
FOR DRAGON, SPECTRUM,
B.B.C. PROGRAMS

WE
Guarantee
THAT ALL OUR ADVERTISED
PROGRAMS HAVE BEEN
COMPLETED AND ARE
READILY AVAILABLE

WE ARE AUTHORISED DEALERS
FOR ACORN ATOM, BBC MICRO
& DRAGON 32

SPECIAL OFFER

Deduct £1 per cassette
when ordering
two or more.

MICRO POWER LTD.
Dept. AU3
8/8a REGENT STREET,
CHAPEL ALLERTON,
LEEDS LS7 4PE
Tel: (0532) 683186 or 696343

Please Note:

All programs are now available at all good
dealers or direct from MICRO POWER LTD.

Please add 55p order P & P + VAT at 15%

