

48783

**WHO REALLY INVENTED  
THE TELEPHONE**

\$1.75 JAN. 1984  
U.K. 85p  
DGS

# Radio- Electronics

COMPUTERS - VIDEO - STEREO - TECHNOLOGY - SERVICE

**Build this C-QUAM  
STEREO AM DECODER**  
for your radio

**Do-it-yourself  
VCR REPAIRS**  
and adjustments

**All about  
LOGIC ANALYZERS**  
and how to use them

**Build a  
SELECTRIC ADAPTER**  
for letter-quality printouts

**How to design  
SWITCHING CIRCUITS**  
using transistors

**PLUS:**

- ★ Hobby Corner
- ★ Equipment Reports
- ★ Drawing Board
- ★ Service Clinic
- ★ New Idea
- ★ State-Of-Solid-State



A  
**GERNSBACK**  
PUBLICATION



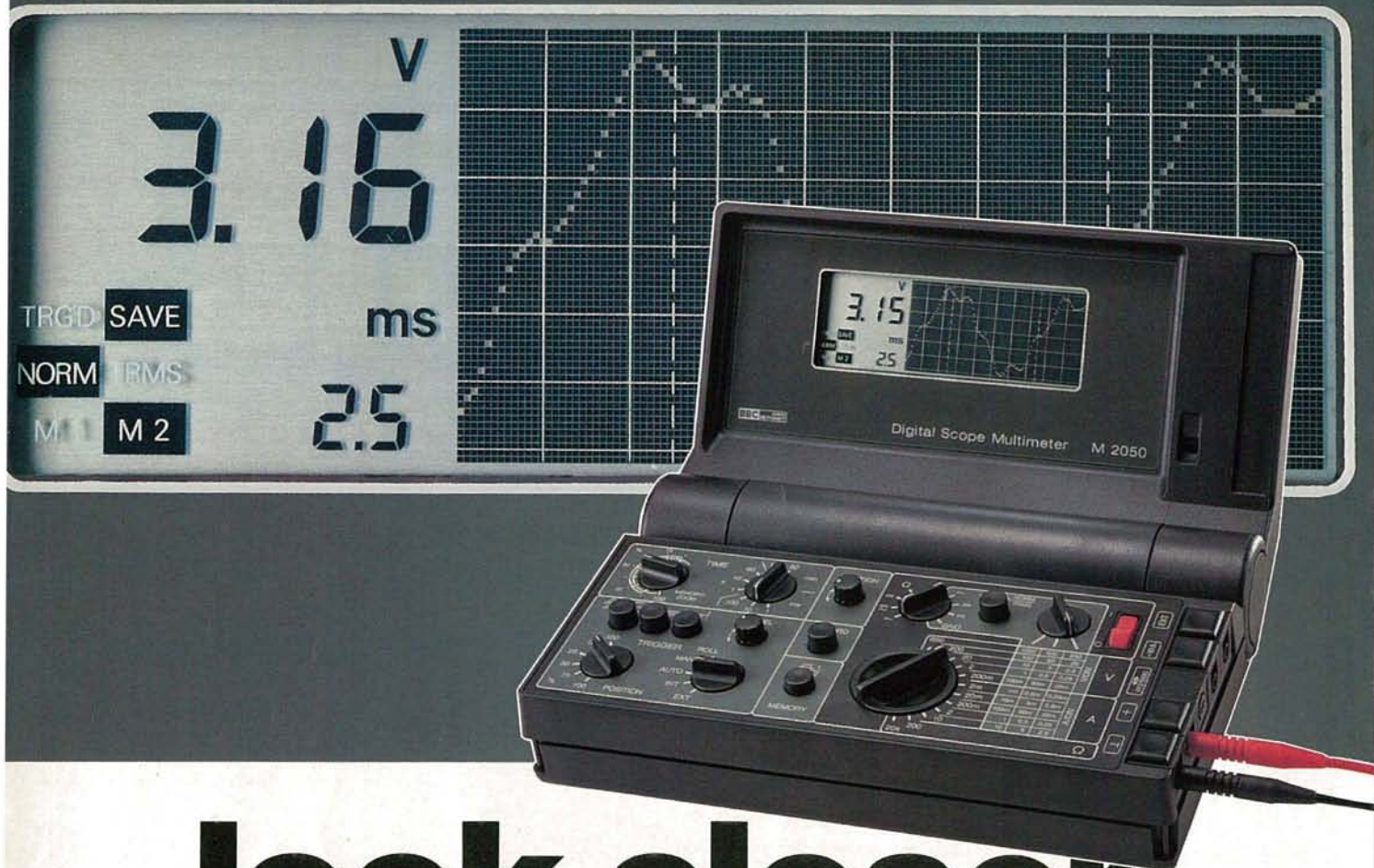

# look closer at a DSM!

**Here's a flat-panel scope, a transient recorder, and a 32-range DMM in a compact 4 lb. box.**

Now you can use one instrument to capture 2  $\mu$ s transients, evaluate their waveform characteristics on a flat-panel LCD, and simultaneously measure their true RMS values.

It's all made possible with the first in a new class of instruments from BBC, the Digital Scope Multimeter, Model M 2050 DSM. By applying precision European engineering to the measurement needs of design and service engineers, BBC is revolutionizing test and measurement.

#### Large Flat-Paneled Scope Display

The LCD provides excellent resolution, 128 dots by 64 dots, for waveform displays. It measures 4-5/8 in. (118 mm) x 1-5/8 in. (42 mm). Simultaneous display capabilities let you use the scope portion of the LCD to evaluate signal characteristics while the DMM portion displays the true RMS signal value. Your measurement evaluations will be more accurate and consistent.

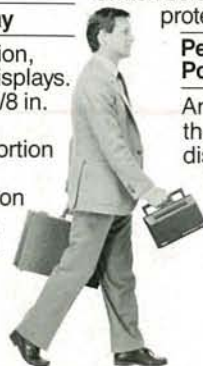

#### Transient Recording

Two independent memories of 512 words (horizontal dots) with 8-bit vertical resolution let users capture information about events ranging from 2  $\mu$ s to 1-hr in duration. Five selectable trigger points (0, 25%, 30%, 75%, and 100%) give users options as to how much data is stored before and after the triggering event.

#### True RMS Multimeter Measurements

You get 15 voltage ranges (to 650V), 15 current ranges (to 10A), and two resistance ranges (200 $\Omega$  and 20k $\Omega$ ). True RMS and Averaging RMS modes are switch selectable. All ranges are overload-protected (Spikes to 6,000 V or 60A).

#### Performance Packed and Portable

An impact resistant case protects the M 2050 DSM. When open, the display angle is easily adjustable. When closed, the display and the controls are protected, the meter shuts itself off, and the tilt bail becomes a carrying handle.

#### Affordable and Available

The price of the M 2050 DSM is only \$1,795.00 (for the optional analog output, add \$200.00). Rechargeable batteries for 8 hours of portable operation are available for \$35.00

BBC's M 2050 DSM and other innovative instruments are available via select distributors throughout the U.S. If your instrumentation supplier doesn't carry BBC yet, we'll gladly tell you who does. Call toll free:

**1-800-821-6327**  
(In CO, 303-469-5231)

BBC-Metrawatt/Goerz  
6901 W. 117th Avenue  
Broomfield, CO 80020, Telex 45-4540

*Engineering Excellence in Test and Measurement*





# Regency Scanners

Bring you the Excitement of Police, Fire, Emergency Radio, and more.

Our radios deliver the local news. From bank hold-ups to three alarm fires. It's on-the-scene action. While it's happening from where it's happening . . . in your neighborhood.

You can even listen to weather, business and marine radio calls. Plus radio telephone conversations that offer more real life intrigue than most soap operas. And with our new model MX5000, there's even more.

## UNIQUE CAPABILITIES

Introducing the all new Regency MX5000, a 20 channel, no-crystal scanner that receives

continuously from 25 MHz to 550 MHz. That's right! Continuous coverage that includes CB, VHF and UHF television audio, FM Broadcast, and civil and military aircraft bands. Plus a host of other features like keyboard entry, a multifunction liquid crystal display that's sidelit for night use, selectable search frequency increments, and a digital clock.

## PRACTICAL PERFORMANCE

Another new addition to the Regency line is the 30 channel MX3000. It's digitally synthesized so no crystals are necessary, and the pressure sensitive keyboard makes programming simple. What's more, it has a full function digital readout, priority, search and scan delay, dual scan speed,

and a brightness switch for day or night operation.

## AT HOME OR ON THE ROAD

With the compact design, slanted front panel, and mounting bracket the MX3000 and MX5000 are ideal for mobile\* use. But we also supply each radio with a plug-in transformer and a telescoping antenna so you can stay in touch at home.

See your Regency Scanner Authorized Dealer for a free demonstration on these and other new Regency Scanners. Or, write Regency Electronics, 7707 Records Street, Indianapolis, IN 46226.



MX5000

MX3000

 **Regency ELECTRONICS, INC.**

7707 Records Street, Indianapolis, Indiana 46226

\*Mobile use subject to restriction in certain localities.

CIRCLE 19 ON FREE INFORMATION CARD



# NEW!

# Regency®

# Scanners

Communications Electronics,™ the world's largest distributor of radio scanners, introduces new models with special savings on all radio scanners. Chances are the police, fire and weather emergencies you'll read about in tomorrow's paper are coming through on a scanner today.

We give you excellent service because CE distributes more scanners worldwide than anyone else. Our warehouse facilities are equipped to process thousands of scanner orders every week. We also export scanners to over 300 countries and military installations. Almost all items are in stock for quick shipment, so if you're a person who prefers fact to fantasy and who needs to know what's really happening around you, order your radio today from CE.

## NEW! Regency® MX3000

List price \$299.95/CE price \$199.00  
**6-Band, 30 Channel • No-crystal scanner**  
**Search • Lockout • Priority • AC/DC**  
 Bands: 30-50, 144-174, 440-512 MHz.

The Regency Touch MX3000 provides the ease of computer controlled, touch-entry programming in a compact-sized scanner for use at home or on the road. Enter your favorite public service frequencies by simply touching the numbered pressure pads. You'll even hear a "beep" tone that lets you know you've made contact.

In addition to scanning the programmed channels, the MX3000 has the ability to search through as much as an entire band for an active frequency. The MX3000 includes channel 1 priority, dual scan speeds, scan or search delay and a brightness switch for day or night operation.

## NEW! Regency® HX650

List price \$119.95/CE price \$84.00  
**5-Band, 6 Channel • Handheld crystal scanner**  
 Bands: 30-50, 146-174, 450-512 MHz.

Now you can tune in any emergency around town, from wherever you are, the second it happens. Advanced circuitry gives you the world's smallest scanner. Our low CE price includes battery charger/A.C. adapter.

## NEW! Regency® MX7000

Allow 120-240 days for delivery after receipt of order due to the high demand for this product.  
 List price \$599.95/CE price \$449.00

**10-Band, 20 Channel • Crystalless • AC/DC**  
 Frequency range: 26-27, 30-108, 108-136 AM, 144-174, 440-512, 806-881 MHz., 1.0 GHz., 1.1 GHz.

In addition to normal scanner listening, the MX7000 offers CB, VHF, and UHF TV audio, FM Broadcast, all aircraft bands (civil and military), 800 MHz communications, cellular telephone, and when connected to a printer or CRT, satellite weather pictures.

## NEW! JIL SX-200

CE price \$269.00/NEW LOW PRICE  
**8-Band, 16 Channel • No-crystal scanner**  
**Quartz Clock • AM/FM • AC/DC**

Bands: 26-88, 108-180, 380-514 MHz  
 Tune Military, F.B.I., Space Satellites, Police & Fire, D.E.A., Defense Department, Aeronautical AM band, Aero Navigation Band, Fish & Game, Immigration, Paramedics, Amateur Radio, Justice Department, State Department, plus thousands of other restricted radio frequencies no other scanner is programmed to pick up.

## NEW! JIL SX-100

CE price \$134.00/NEW LOW PRICE  
**6-Band, 16 Channel • Crystalless • AC/DC**  
 Frequency range: 30-54, 140-174, 410-514 MHz.

The JIL SX-100 scanner is a mobile keyboard programmable scanner that puts you in the seat of the action at home or in your car. Compact and good looking, the SX-100 even gives you the time and date. It's small size will easily fit in most domestic or foreign cars and it's AC/DC adaptable for home use.

## Regency® HX1000

Allow 90-180 days for delivery after receipt of order due to the high demand for this product.  
 List price \$329.95/CE price \$209.00

**6-Band, 20 Channel • No Crystal scanner**  
**Search • Lockout • Priority • Scan delay**  
**Sidelit liquid crystal display**

Frequency range: 30-50, 144-174, 440-512 MHz.  
 The new handheld Regency HX1000 scanner is fully keyboard programmable for the ultimate in versatility. You can scan up to 20 channels at the same time. When you activate the priority control, you automatically override all other calls to listen to your favorite frequency. The LCD display is even sidelit for night use. A die-cast aluminum chassis makes this the most rugged and durable hand-held scanner available. There is even a backup lithium battery to maintain memory for two years. Includes wall charger, carrying case, belt clip, flexible antenna and nicad battery. Reserve your Regency HX1000 now.

## Regency® R106

List price \$149.95/CE price \$99.00  
**5-Band, 10 Channel • Crystal scanner • AC/DC**  
 Frequency range: 30-50, 146-174, 450-512 MHz.

A versatile scanner, the Regency R-106 is built to provide maximum reception at home or on the road. Rugged cabinet protects the advanced design circuitry allowing you years of dependable listening.

## NEW! Regency® D810

List price \$399.95/CE price \$259.00  
**8-Band, 50 Channel • Crystalless • AC only**  
 Bands: 30-50, 88-108, 118-136, 144-174, 440-512 MHz.

This scanner offers Public service bands, plus Aircraft and FM broadcast stations. You can listen to Bach or a Boeing 747, the Rolling Stones or the riot squad, or any of 50 channels. Plus special direct access keys let you listen to police, fire, emergency, or any of your favorite channels just by pushing a button.

## Regency® R1040

List price \$199.95/CE price \$129.00  
**6-Band, 10 Channel • Crystalless • AC only**  
 Frequency range: 30-50, 144-174, 440-512 MHz.

Now you can enjoy computerized scanner versatility at a price that's less than some crystal units. The Regency R1040 lets you in on all the action of police, fire, weather, and emergency calls. You'll even hear mobile telephones.

Programming the R1040 is easy. Merely touch the keyboard and enter any of over 15,000 frequencies on your choice of 10 channels.

### TEST ANY SCANNER

Test any scanner purchased from Communications Electronics™ for 31 days before you decide to keep it. If for any reason you are not completely satisfied, return it in original condition with all parts in 31 days, for a prompt refund (less shipping/handling charges and rebate credits).

### OTHER RADIOS & ACCESSORIES

Regency® C403 Scanner.....	\$59.00
NEW! Panasonic RF-B50 Shortwave receiver.....	\$129.00
Panasonic RF-9 Shortwave receiver.....	\$84.00
Panasonic RF-799 Shortwave receiver.....	\$219.00
Panasonic RF-2600 Shortwave receiver.....	\$199.00
Panasonic RF-2900 Shortwave receiver.....	\$249.00
Panasonic RF-3100 Shortwave receiver.....	\$269.00
Panasonic RF-6300 Shortwave receiver.....	\$539.00
NEW! Bearcat® 151 Scanner.....	\$169.00
NEW! Bearcat® Five-Six Scanner.....	\$129.00
Bearcat® 300 Scanner.....	\$349.00
Bearcat® 250 Scanner.....	\$279.00
Bearcat® 200 Scanner.....	\$189.00
Bearcat® 210XL Scanner.....	\$229.00
Bearcat® 20/20 Scanner.....	\$289.00
Bearcat® 100 Scanner.....	\$289.00
Bearcat® Weather Alert.....	\$49.00
Freedom Phone® 4000 Cordless telephone.....	\$239.00
Fanon FCT-200 Cordless telephone.....	\$139.00
Fanon 6-HLU Scanner.....	\$99.00
CHB-6 Fanon AC Adapter/Battery Charger.....	\$15.00
CAT-6 Fanon carrying case with belt clip.....	\$15.00
SP55 Carrying case for Bearcat Five-Six.....	\$15.00
MA-506 Carrying case for Regency HX650.....	\$15.00
SCMA-6 Fanon Mobile Charger/Audio Amplifier.....	\$49.00
AUC-3 Fanon auto lighter adapter/Battery Charger.....	\$15.00
FB-E Frequency Directory for Eastern U.S.A.....	\$12.00
FB-W Frequency Directory for Western U.S.A.....	\$12.00
TSG "Top Secret" Registry of U.S. Government Freq.....	\$15.00
RRF Railroad Frequency Directory.....	\$10.00
ESD Energy Services Directory.....	\$10.00
ASD Frequency Directory for Aircraft Band.....	\$10.00
SRF Survival Radio Frequency Directory.....	\$10.00
TIC Techniques for Intercepting Comm. Manual.....	\$12.00
CIE Covert Intelligence, Elect. Eavesdropping Man.....	\$12.00
B-4 1.2 V AAA Ni-Cad batteries (set of four).....	\$9.00
B-6 1.2 V AA Ni-Cad batteries (set of four).....	\$12.00
A-135c Crystal certificate.....	\$3.00
Add \$3.00 shipping for all accessories ordered at the same time.	
Add \$12.00 per shortwave receiver for U.P.S. shipping.	

### INCREASED PERFORMANCE ANTENNAS

If you want the utmost in performance from your scanner, it is essential that you use an external antenna. We have a base and a mobile antenna specifically designed for receiving all bands. Order #A60 is a magnet mount mobile antenna and order #A70 is an all band base station antenna. Price is \$35.00 each plus \$3.00 for UPS shipping in the continental United States.

### BUY WITH CONFIDENCE

To get the fastest delivery from CE of any scanner, send or phone your order directly to our Scanner Distribution Center.™ Be sure to calculate your price using the CE prices in this ad. Michigan residents please add 4% sales tax or supply your tax I.D. number. Written purchase orders are accepted from approved government agencies and most well rated firms at a 30% surcharge for net 30 billing. All sales are subject to availability, acceptance and verification. All sales on accessories are final. Prices, terms and specifications are subject to change without notice. All prices are in U.S. dollars. Out of stock items will be placed on back-order automatically unless CE is instructed differently. Minimum prepaid order \$35.00. Minimum purchase order \$200.00. Most products that we sell have a manufacturer's warranty. Free copies of warranties on these products are available prior to purchase by writing to CE. International orders are invited with a \$20.00 surcharge for special handling in addition to shipping charges. All shipments are F.O.B. Ann Arbor, Michigan. No COD's please. Non-certified and foreign checks require bank clearance.

**Mail orders to:** Communications Electronics,™ Box 1002, Ann Arbor, Michigan 48106 U.S.A. Add \$7.00 per scanner for U.P.S. ground shipping and handling in the continental U.S.A. If you have a Visa or Master Card, you may call and place a credit card order. Order toll-free in the U.S. Dial 800-521-4414. In Canada, order toll-free by calling 800-265-4828. Telex anytime 810-223-2422. If you are outside the U.S. or in Michigan dial 313-973-8888. Order today.

Scanner Distribution Center™ and CE logos are trademarks of Communications Electronics.™

† Bearcat is a federally registered trademark of Electra Company, a Division of Masco Corporation of Indiana.

‡ Regency is a federally registered trademark of Regency Electronics Inc.

AD #092683

Copyright ©1983 Communications Electronics

Order Toll Free ... call  
**1-800-521-4414**

**COMMUNICATIONS ELECTRONICS™**

**Consumer Products Division**

818 Phoenix □ Box 1002 □ Ann Arbor, Michigan 48106 U.S.A.  
 Call toll-free 800-521-4414 or outside U.S.A. 313-973-8888

RADIO-ELECTRONICS



CIRCLE 35 ON FREE INFORMATION CARD



**SPECIAL FEATURE**

- 47 **WHO REALLY INVENTED THE TELEPHONE?**  
The answer to that question, and a bit of history about that device we now take for granted. **George Delucenay Leon**

**BUILD THIS**

- 41 **C-QUAM AM STEREO CONVETER**  
Convert your AM radio to receive AM stereo broadcasts with this C-QUAM decoder. **Marty Bergan**
- 61 **TYPEWRITER-TO-COMPUTER INTERFACE**  
Part 2. Convert your IBM typewriter into a letter-quality printer with a 30K buffer. **Bill Green**
- 69 **SOUND GENERATOR DESIGN CONSOLE**  
This console lets you get just the right sound from your sound-generator IC by simply dialing in the external component values you want. **D.L. Holmes**

**TEST EQUIPMENT**

- 51 **ALL ABOUT LOGIC ANALYZERS**  
A comprehensive look at what a logic analyzer is and how you can use one. **Kenneth Piggot**

**TECHNOLOGY**

- 4 **VIDEO ELECTRONICS**  
Tomorrow's news and technology in this quickly changing industry. **David Lachenbruch**
- 8 **SATELLITE/TELETEXT NEWS**  
The latest happenings in communications technology. **Gary H. Arlen**

**CIRCUITS AND COMPONENTS**

- 38 **NEW IDEAS**  
An award-winning project from one of our readers.
- 77 **HOW TO DESIGN TRANSISTOR SWITCHING CIRCUITS**  
This month we take a look at the transistor as a switching device. **Mannie Horowitz**
- 88 **HOBBY CORNER**  
A look at multiplexed displays. **Earl "Doc" Savage, K4SDS**
- 95 **DRAWING BOARD**  
Our contest and (of course) more about counters. **Robert Grossblatt**
- 97 **STATE OF SOLID STATE**  
A melody microprocessor. **Robert F. Scott**

**RADIO**

- 96 **COMMUNICATIONS CORNER**  
Can we recreate the sounds of yesteryear? **Herb Friedman**

**VIDEO**

- 65 **VCR REPAIRS AND ADJUSTMENTS THAT YOU CAN DO**  
Part 2. If you're careful and know your limitations, there are some repairs that you can do for yourself. **John D. Lenk**
- 104 **SERVICE CLINIC**  
Some things never change. **Jack Darr**
- 104 **SERVICE QUESTIONS**  
R-E's Service Editor solves technicians' problems.

**COMPUTERS**

- 83 **BUSINESS SOFTWARE**  
A look at the features of some popular programs. **Herb Friedman**
- 103 **COMPUTER CORNER**  
Your computer's environment. **Les Spindle**

**EQUIPMENT REPORTS**

- 14 **Phillips Model PM 6668 High-Resolution Frequency Counter**
- 22 **Heath EE-101 Operational-Amplifier Course**
- 26 **Triplett Model 3550 DMM**

**DEPARTMENTS**

- |                                 |                    |
|---------------------------------|--------------------|
| 6 Advertising and Sales Offices | 107 New Books      |
| 142 Advertising Index           | 112 New Literature |
| 143 Free Information Card       | 28 New Products    |
| 10 Letters                      | 6 What's News      |
| 116 Market Center               |                    |

**ON THE COVER**

As you are probably aware, stereo broadcasts are now legal on the AM band. Because of the FCC's "let-the-market-decide" approach, there are now four systems in competition. One that is very promising is Motorola's C-QUAM (Compatible Quadrature Amplitude Modulation) system. We'll take a look at Motorola's MC13020 decoder IC and build a stereo converter for your radio. The story begins on page 41.



The telephone shown above is the one that the now-famous words "Mr. Watson, come here, I want you" were spoken in 1876. Our look back at the telephone begins on page 47.

**COMING NEXT MONTH**  
On Sale January 19

- Cable-TV descrambling
- Digital voltmeter modules
- And lots more!

**Radio-Electronics**, (ISSN 0033-7862) Published monthly by Gernsback Publications, Inc., 200 Park Avenue South, New York, NY 10003. Second-Class Postage Paid at New York, N.Y. and additional mailing offices. One-year subscription rate: U.S.A. and U.S. possessions, \$14.97, Canada, \$17.97. Other countries, \$22.47 (cash orders only, payable in U.S.A. currency). Single copies \$1.75. © 1983 by Gernsback Publications, Inc. All rights reserved. Printed in U.S.A.

**Subscription Service:** Mail all subscription orders, changes, correspondence and Postmaster Notices of undelivered copies (Form 3579) to Radio-Electronics Subscription Service, Box 2520, Boulder, CO 80322.

A stamped self-addressed envelope must accompany all submitted manuscripts and/or artwork or photographs if their return is desired should they be rejected. We disclaim any responsibility for the loss or damage of manuscripts and/or artwork or photographs while in our possession or otherwise.



# VIDEO ELECTRONICS

DAVID LACHENBRUCH  
CONTRIBUTING EDITOR

## 8-mm VIDEO

While Japanese manufacturers seemingly have sent the concept of 8-mm Video back to the drawing board (**Radio-Electronics**, December 1983), Europe's biggest consumer electronics manufacturer, Philips, has demonstrated a prototype and says its version will be on the market in Europe in the fall, in a combination camera-recorder unit that will sell for \$1,500-\$1,600, including all taxes. The camcorder, a PAL-SECAM unit, uses metal-evaporated tape in a cassette just about the size of an audio cassette. The camera-head is detachable from the recorder, with each unit weighing about 2.4 lb., and the battery, which can operate one hour per charge, weighs about 3/4 lb., giving the system a total weight of 5.5 lb. That system weight is actually almost a pound heavier than the upcoming Video Movie camcorder, which uses a VHS-C 20-minute cassette.

Philips' cassette initially will be available in 30- and 60-minute versions, but the company says that future cassettes should have the capability to store at least three hours of video. The 8-mm camcorder has an electronic viewfinder, 6:1 power zoom, on-screen date insert, LCD tape counter, and fade and pause/still controls. The soundtrack is hi-fi FM, helically scanned mono, but future models are expected to have PCM digital stereo. The pickup is a 3/4-inch Newvicon, eventually to be replaced with a CCD image sensor. In separate packages are a combination AC power supply with RF modulator and battery charger, and a tuner-timer.

Japanese manufacturers have lost much of their original enthusiasm for the 8-mm Video standard—probably because sales of the current half-inch VCR's are so much better than they anticipated. As a result, they're looking with considerable favor upon a French proposal to re-engineer the standard using a baseband recording technique that would make possible recordings that could be played back in PAL, SECAM, or NTSC.

## TV SETS FOR '84

The emphasis in 1984-model color-TV sets is on the "modified component" approach—tacit admission by many manufacturers that they guessed wrong last year by taking tuners (and sometimes loudspeakers) out of the sets and charging premium prices. There has been virtually no increase in the number of "true component" models offered; the trend now is definitely toward the monitor-receiver, which can be used as a stand-alone TV set or as the basic component in a home-video system. In other words, the approach is the one chosen by RCA as opposed to that selected by Zenith last year. Even such an esoteric brand as Proton is adding self-contained systems to its component lines.

The number of monitor-receivers — probably best defined as color sets with multi-inputs and at least one set of outputs — is growing by leaps and bounds; set sizes range from 4.6 to 25 inches. The trend for 1984 is to increase the number of input jacks, and to locate at least one pair at the front of the set, so devices may be connected temporarily without pulling the receiver out of a wall rack or cabinet. RGB jacks are finally becoming popular and are being added to models that didn't sport them last year — including those by Mitsubishi, NEC, Panasonic, Proton, Sanyo, Sony, and Zenith. Along with RGB inputs, more brands are offering higher-resolution pictures for computer monitoring.

## VIDEO DISC GAMES

The new sensation of the video arcade could spread to the home—at least videodisc-player manufacturers hope so. The first coin-operated videodisc arcade game to be widely distributed—*Dragon's Lair* by Cinematronics—has been an overnight success. The next is likely to be *Astron Belt* by Sega Entertainment.

*Dragon's Lair* uses animated footage and *Astron Belt* "live" material to add new realism and action to coin games. They both use microprocessor-equipped industrial optical videodisc players made by Pioneer, which at press time was having difficulty keeping up with orders. Cinematronics thinks there's a market for 20,000 to 30,000 *Dragon's Lair* games, but must be content to ship 200 to 400 daily (about half the number ordered) because of the shortage of disc players.

All of that is being watched closely by videogame, home computer, and videodisc manufacturers. Based on past experience in the videogame business that arcades spark demand for home products, the industry is working away furiously on game systems for the home that use videodiscs. And videodisc-player manufacturers, whose products have been selling none too briskly, are joining in the effort—with fingers crossed.

R-E



# Now 60 MHz or 100 MHz Tek quality is just a free phone call away!



**New lower price!  
100 MHz 2235  
now just \$1650.**

**Tek has expanded its best-selling 2200 scope line up to 100 MHz. And brought it all as close as your phone.** Tek's revolutionary, reduced-component architecture brings unprecedented quality, reliability and affordability to the 60 MHz 2213 and 2215, and now, the 100 MHz 2235.

All three of these lightweight (13.5 lb.) scopes feature 2 mV/div vertical sensitivity and 5 ns/div sweep speeds, plus a complete trigger system for stable triggering on digital, analog or video waveforms.

**Scopes with a comprehensive 3-year warranty\*... probes... and expert advice. One free call gets it all!** You can order, or obtain literature, through the Tek National

	2213	2215	2235
Bandwidth	60 MHz	60 MHz	100 MHz
No. of Channels	2	2	2 + Trigger View
Alternate Sweep	—	Yes	Yes
Vert/Trig B/W Limit	—	—	Yes—20 MHz
Single Sweep	—	—	Yes
Accuracy: Vert/Horz	3%	3%	2%
Delay Jitter	1:5,000	1:10,000	1:20,000
Trigger'g Sensitivity	0.4 div at 2 MHz	0.4 div at 2 MHz	0.3 div at 10 MHz
Input R-C	1MΩ -30pf	1MΩ -30pf	1MΩ -20pf
Variable Holdoff	4:1	4:1	10:1
Price	\$1200†	\$1450†	<del>\$1950†</del> Now \$1650†

Marketing Center. Technical personnel, expert in scope applications, will answer your questions and expedite delivery. Direct orders include operating and service manuals, two 10X probes, 15-day return policy, and worldwide service back-up.

**Order toll free:  
1-800-426-2200,  
Extension 108.**

In Oregon call collect:  
(503) 627-9000, Ext. 108.

†Price F.O.B. Beaverton, OR.  
\*3-year warranty includes CRT and applies to 2000 family oscilloscopes purchased after 1/1/83.  
Scopes are UL Listed, CSA and VDE approved.

**Tektronix**  
COMMITTED TO EXCELLENCE



# WHAT'S NEWS

## Flicker-free 3-D movies with new stereo system

Various "3-D" optical systems used in videogames, movies, etc., have shown weaknesses. Those using red-green eyeglasses limit the color spectrum and often cause eyestrain. Polarizing systems render color better but produce ghosting if the viewer's head is not kept rigidly vertical.

In a new system, originated by Stereographics Corp. of San Rafael, CA, glasses are used in which the left and right lenses are triggered alternately on and off in sync with the program source (videogames, computer software, videotape, stereoscopic microscope, or video camera).

The stereoscopic program source is connected to a "black box", which decodes the image for each eye and keeps it in sync with the electro-optical shuttering glasses.

In earlier versions of the system, the glasses are connected to the black box by wire. In later systems, infrared rays or ultrasonic waves have been used experimentally.

## New Tektronix shutter makes color from black and white

Tektronix announces that it plans to sell its new Liquid Crystal Color Shutter (LCCS) first demonstrated in May, 1983, on a contract basis to customers outside the company. The decision is based on a feeling that the cost-effective application of that color technology extends beyond the company's product lines.

With the new shutter, a monochrome display tube is used, preferably one whose output peaks in the red and green portions of the spectrum. It is activated in field-sequential manner, which is reminiscent of the old CBS color-television proposal.

The color shutter consists basically of a sandwich of special polarizers and Tektronix's proprietary liquid-crystal pi-cell, which acts as a switchable, red-green birefringent filter that switches between two states, the first allowing red to pass and then green. The alternate fields, viewed through the different colored polarizing filters, are integrated by the viewer's eye

to produce color images. The full range of colors between red and green can be achieved through the varying intensity of the two primary colors—or in lower-cost instruments a simple three-color display (red, green, yellow) can be used.

Earlier attempts to produce a field-sequential system have not been entirely satisfactory, largely due to the long switching time of the cells available. The new Textronix cell has a switching time between 2 and 5 milliseconds, as compared to tens of milliseconds in older types.

## Cellular mobile radio approved in Pittsburgh

The first cellular mobile franchise was granted through a comparative hearing process to MCI Communications Corp. A construction permit for a system in Pittsburgh was awarded the company by an FCC judge, and MCI stated that it would begin operation as soon as it received authorization from the Pittsburgh Public Utilities Commission. "We should be operational by early 1984," said an MCI spokesman.

Cellular radio (**Radio-Electronics**, p. 41, Feb. 1982 and p. 6, July 1983) is a technology that permits "virtually unlimited" mobile and portable telephone service in an area. The FCC will allow two competitors in each market designated for cellular service.

MCI estimated that its construction costs will run over \$7 million, and expects first year revenues to be nearly \$1 million.

## New electronic mail is faster and cheaper

MCI has introduced an electronic mail system that it claims is faster and can be as much as 90 percent cheaper than comparable time-sensitive mail services. The new service provides a variety of speeds and delivery systems, from "Instant," delivered electronically in seconds, to next-day delivery by local regular mail.

MCI Mail can be used with almost any personal computer, word processor, electronic typewriter, data terminal, Telex, or other digital communications device. The messages can be printed on laser-printed replicas of the customer's letterhead and signed with pre-reg-

istered, laser-printed signatures.

If the recipient has no terminal, the mail is routed via MCI's network to the MCI postal center nearest the recipient for laser printing and mail delivery.

There are four delivery and rate options:

Instant—from terminal to terminal via MCI's electronic mailbox, at a cost of about \$1.00.

Four-hour—hard-copy delivery by courier anywhere within the metropolitan areas of 15 major cities. Cost for that service is about \$25.00.

Overnight—(by noon). Delivery by courier in 20,000 continental U.S. cities. Cost, about \$6.00.

MCI letter—Transmitted electronically to the nearest MCI postal center, then delivered via local mail service. Cost, about \$2.00.

## 512-kilobit memory IC developed by IBM

An experimental version of a new computer-memory IC with a capacity of 512 Kilobits was announced by IBM this past October. The new IC is said to be the biggest single product in the history of microelectronics.

The new IC, if found to be adaptable to mass production, will be most useful in large-scale systems like IBM's 308X line, which are capable of executing up to 23 million instructions a second.

## A new "square look" for RCA picture tubes

RCA announces that it is developing several new sizes of color-picture tubes that will provide squarer screens and a "new look" for future TV receivers. The new tubes will come out in 26-inch, 20-inch, 16-inch, and 14-inch, (diagonal) picture sizes.

Existing picture tubes—in 13, 15, 19, and 25-inch sizes—are so designed as to curve inward at the sides and round off the corners of the viewing screen. That reduces the sharpness in the corners of the picture. The new "full square" tube provides a more pleasing rectangular picture, with greater picture area to enhance television viewing.

The new tubes will be available for sale to TV receiver manufacturers beginning in 1984. R-E

# Radio-Electronics

Hugo Gernsback (1884-1967) founder

M. Harvey Gernsback, editor-in-chief

Larry Steckler, CET, publisher

Arthur Kleiman, editor

Carl Laron, WB2SLR, associate editor

Brian C. Fenton, assistant technical editor

Robert A. Young, assistant editor

Jack Darr, CET, service editor

Robert F. Scott, semiconductor editor

Herb Friedman, communications editor

Gary H. Arlen, contributing editor

David Lachenbruch, contributing editor

Earl "Doc" Savage, K4SDS, hobby editor

Danny Goodman, contributing editor

Ruby M. Yee, production manager

Robert A. W. Lowndes, production associate

Dianne Osias, production assistant

Joan Roman, circulation director

Arline R. Fishman, advertising coordinator

Cover photo by Robert Lewis

Radio-Electronics is indexed in *Applied Science & Technology Index* and *Readers Guide to Periodical Literature*.

Gernsback Publications, Inc.

200 Park Ave. South

New York, NY 10003

President: M. Harvey Gernsback

Vice President: Larry Steckler

ADVERTISING SALES 212-777-6400

Larry Steckler

Publisher

EAST/SOUTHEAST

Stanley Levitan

Radio-Electronics

200 Park Ave. South

New York, NY 10003

212-777-6400

MIDWEST/Texas/Arkansas/Okla.

Ralph Bergen

Radio-Electronics

540 Frontage Road—Suite 325

Northfield, Illinois 60093

312-446-1444

PACIFIC COAST

Mountain States

Marvin Green

Radio-Electronics

15335 Morrison St., Suite 227,

Sherman Oaks, CA 91403

818-986-2001





# The Digital vs. Analog battle is over.

**\$85\*** buys you the new champion. **The new Fluke 70 Series.**

They combine digital and analog displays for an unbeatable two-punch combination.

Now, digital users get the extra resolution of a 3200-count LCD display.

While analog users get an analog bar graph for quick visual checks of continuity, peaking, nulling and trends.

Plus unparalleled operating ease, instant autoranging, 2,000+ hour battery life and a 3-year warranty.

All in one meter.

Choose from three new models. The Fluke 73, the ultimate in simplicity. The feature-packed Fluke 75. Or the deluxe Fluke 77, with its own multipurpose protective holster and unique "Touch Hold" function (patent pending) that captures and holds readings, then beeps to alert you.

Each is Fluke-tough to take a beating. American-made, to boot. And priced to be, quite simply, a knockout.

For your nearest distributor or a free brochure, call toll-free anytime **1-800-227-3800**,

**Ext. 229.** From outside U.S., call 1-402-496-1350, Ext. 229.

FROM THE WORLD LEADER  
IN DIGITAL MULTIMETERS.



### Fluke 73

**\$85\***  
Analog/digital display  
Volts, ohms, 10A, diode test  
Autorange  
0.7% basic dc accuracy  
2000+ hour battery life  
3-year warranty



### Fluke 75

**\$99\***  
Analog/digital display  
Volts, ohms, 10A, mA, diode test  
Audible continuity  
Autorange/range hold  
0.5% basic dc accuracy  
2000+ hour battery life  
3-year warranty



### Fluke 77

**\$129\***  
Analog/digital display  
Volts, ohms, 10A, mA, diode test  
Audible continuity  
"Touch Hold" function  
Autorange/range hold  
0.3% basic dc accuracy  
2000+ hour battery life  
3-year warranty  
Multipurpose holster

\* Suggested U.S. list price, effective October 1, 1983.





# SATELLITE/TELETEXT NEWS

GARY ARLEN  
CONTRIBUTING EDITOR

## TRANSTEXT TO OFFER SERVICES

"Transtext"—a hybrid telephone-cable TV package offering home banking, shopping, information retrieval, energy management, security and other two-way services through a "gray box"—will be tested early next year. More than a dozen major companies, including Southern Bell Telephone, Georgia Power, a data-management company, cable-TV operators, and a home-computer retailer, are taking part in the experiment, which is being set up in a suburban Atlanta community.

The Transtext system includes delivery of video still-frames on demand when a customer pushes buttons on his telephone keypad; images are delivered via the cable-TV hook-up into a standard TV set. Conventional teletext information plus other sophisticated interactive services will be part of the package being tested, with an eye toward future national service possibly by next year (1985). Energy companies are interested in Transtext because the system can handle meter reading plus peak-load management.

Transtext is said to include a "breakthrough" facility that allows users to capture and manipulate video material that is fed through a one-way cable channel for downstream delivery; a telephone-line hookup is used for upstream transmission. At the technological heart of the system is a "superswitch gateway," which is an upgraded version of the Local Area Data Transport (LADT) packet-switched network being used for the south Florida Viewtron service. The companies setting up Transtext characterize it as an enhancement of current videotex/teletext projects offered in a lower-priced package.

## TELETEXT-CAPABLE SETS

Matsushita, unveiling its first line of digital TV sets, which will be sold in the U.S. under the Panasonic label by late 1984, has put an unusual emphasis on the equipment's capacity to display videotex/teletext signals. One of the new Panasonic units is a collapsible, portable unit being promoted as a display terminal for videotex and other video-information services. Pricing and distribution plans have not been completed.

The 6.6-pound portable unit has a 6.3-inch projection-TV display screen. The digital technology will presumably deliver a sharper image when the unit is hooked into a videotex or teletext circuit.

Sony has also published a product-availability list for its line of videotex and teletext equipment to be sold in the U.S. during the coming year. The basic Prestel videotex terminal costs \$912, with optional additions of a \$280 full keyboard (as opposed to the small keypad that comes with the basic terminal) and a \$560 black-and-white printer. Sony's NAPLPS videotex decoder will cost \$975; the NABTS teletext decoder costs \$950. There are no prices yet for the optional items that Sony plans to add to its NAPLPS format videotex items, such as a remote commander, optional keypad, and full keyboard. Prices are expected to drop dramatically after the first round of equipment is introduced.

## SUPERSTATION SATELLITE

The European Broadcasting Union plans to launch a multinational satellite superstation during 1984 that will become a commercial TV programming service with up to five hours a night of programming. The European superstation will be beamed from Holland's transponder on the European Communications Satellite. The Pan-European Broadcast Satellite will include programming from England, West Germany, Sweden, Italy, Holland, Ireland, and Switzerland. EBU expects that the satellite broadcasting project may help European viewers bypass the cable TV systems that are now being built or planned in many European countries—an issue that is sure to raise political problems. Plans also call for commercials on the satellite service, a fairly unusual situation in Europe, where commercials are rare on the government owned broadcast TV channels.

## AROUND THE SATELLITE CIRCUIT

AT&T has launched the first of its three Telstar 3 domestic satellites, with two others due to go up on the space shuttle in 1984 and 1985. Each bird will have 30 transponders.

RCA Astro-Electronics will build three high-powered Ku-band DBS satellites for sister company RCA Americom, at a total cost of more than \$120 million. The first of this new generation is due to be launched in 1985, with all three slated for orbit by 1987. R-E



# The 100MHz scope that won the largest scope contract ever awarded...

## Now just \$1,950.

For sales and technical information: call toll free 800-421-5334 (in Calif., Alaska, Hawaii 213-515-6432)

Kikusui International Corp.  
17819 Figueroa Street, Gardena, Calif. 90248  
TWX 910-346-7648  
In Canada call: Interfax Systems, Inc. 514-336-0392  
Subsidiary of Kikusui Electronics Corp., 3-1175  
Shinmaruko-Higashi, Nakaharu-Ku, Kawasaki City,  
Japan (044)-411-0111 © Kikusui International 1983

# KIKUSUI

Ch1 & Ch2 (1 mV w/5X mag)

Alternate trigger

Multi-mode. Any combination of modes may be selected. 5 channels

Multi-trace. 500KHz chop frequency. 20 KV acceleration potential

Alternate time base

Lock (P-P auto trigger)

Sweep time: 0.5S to 20nS. Ch3 external sweep input

Ch4 input

3rd channel [0.1 & 1V/div]

20 MHz bandwidth limit

Beam finder

Calibrated sweep delay

A & B trace separation for alternate sweep

Ch5 input

10X sweep mag

CIRCLE 48 ON FREE INFORMATION CARD



# LETTERS

Address your comments to: Letters, **Radio-Electronics**,  
200 Park Avenue South, New York, NY 10003

## VOLTAGE-REGULATOR CIRCUIT

I would like to comment on the high-current voltage-regulator circuit that Robert Grossblatt presented in the "Drawing Board" department, for July 1983. Although Mr. Grossblatt's circuit certainly works, it suffers from two drawbacks: First, it uses two expensive PNP power transistors, and, second, it is more complex than it needs to be.

National Semiconductor's *Voltage Regulator Handbook* suggests the following circuit (Fig. 1).

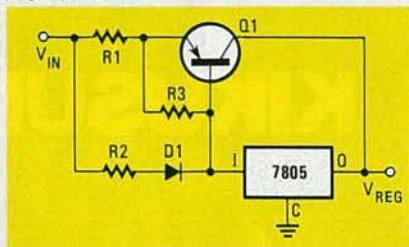

FIG. 1

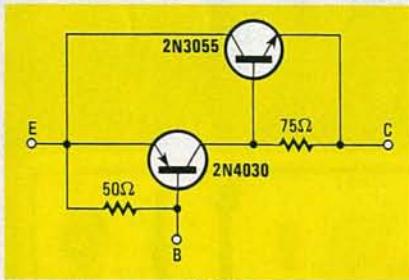

FIG. 2

This circuit uses the regulator's internal short-circuit protection to protect the transistor as well. The current through Q1 is  $R_2/R_1$  times the regulator current, so the short-circuit current through Q1 is  $R_2/R_1$  times the regulator's short-circuit current. Assuming appropriate heat-sinking, the regulator's thermal protection will also be extended to Q1.

For typical applications, National recommends the following components; Q1—2N4398, D1—1N4719,  $R_2/R_1 \geq 3$ ,  $R_3$ —5 to 10 ohms.

Instead of using the expensive PNP power transistor, a small PNP transistor and an NPN power transistor can be combined as shown in Fig. 2.

LAWRENCE J. JONES  
Cincinnati, OH

*The short-circuit protection in the 7805 was designed to handle the current capabilities of the 7805. Aside from dunking it in liquid nitrogen, you must have external protection if you use a pass transistor to increase the current. The circuit you sent will dump all the short-circuit current through the chip's internal pro-*

*tection and, believe me, you'll fry the chip ... absolutely. You must provide another path for the excess current, as I did with Q2. The capacitors I indicate are needed for obvious reasons, and I can only assume that you left them out to make the drawing simpler. The same goes for the diode, D1, I used to protect against an input short.*

*As far as expense goes, the transistors needed only have to handle the current generated by the circuit that I developed, and you can get them for under \$1.00—about the same cost as the transistor you showed in your drawing. In any event, expense is a minor factor if the circuit cashes in the first time you have a short circuit. Remember—always design for worst case operation, because Murphy's Law shows clearly that pessimism can save you a lot of time and money.*

ROBERT GROSSBLATT

## THE KAYPRO II

I was very interested in reading your review of the *Kaypro II* portable computer in the April 1983 *Radio-Electronics*. Having just sold my Osborne so that I might get the *Kaypro II*, I expected the review to confirm my good judgment. Instead, I was amazed at the very superficial coverage of a most excellent product.

The price stated for the *Kaypro* double density, \$1795, is correct; but the price for the double-density Osborne is \$1995. In addition, you must add \$250 for the 80-line conversion, plus about \$150 for a monitor big enough to see, plus \$40 for a connector—bringing the total to \$2185, or about \$400 more for a somewhat similar product.

Software includes, as stated, *Perfect Writer*, *Speller*, *Calc*, and *Filer*; *Profit Plan*, an extremely flexible calculating spreadsheet and table maker; S-BASIC, a translator of a BASIC programs into machine language, so that they can run many times faster, and CP/M. Not advertised, but also included with the CP/M, are DDT, a well-known program debugger, and XAMN, a program to examine a faulty disk and salvage it and the program. Also included are Microsoft's BASIC-80 and *The Word Plus*. Wayne Holder's *THE WORD Plus* is fantastic; it has a 45,000-word dictionary, and a small-file specialty dictionary. It also has a word count, hyphen helper, a "in-context" one line viewer, plus FIND (h?t?o?s = hotdogs) and Anagrams. One of the advantages of the four Perfect programs is that they have a common keyboard language. You don't have to relearn for each program, and they can also co-mingle in the same edited product. Also included are about a dozen choice games that my kids enjoy and, I must confess, have been known to entrap me, too.

Your reviewer's comment that the *Kaypro II*

"falls down on screen usability" would be good for a laugh if he were not serious. After using that "scrolling postage stamp" on the Osborne, he has to be kidding! As for the "green on green", has he never heard of a blanking-level adjustment? Every CRT has one; some use it for a brightness control (cheap design). *Kaypro* has a true video-level adjustment, and the blanking level is an internal pot. Maybe that is why he sometimes sees noise. It will take his service man about three minutes to adjust. His "soft-touch" keyboard complaint just is not valid. He just plain hasn't gotten used to things other than his 1936 Underwood. The *Keytronics* keyboard is used on some of the most expensive units around. And what's that "outer glass defeats the matte finish on the inner surface" that he talks about? All CRT's have bonded safety glass; there is no "inner-outer glass". RF noise? A high-resolution system means fast risetimes, infinitely rich in odd harmonics. And that CRT screen is a big window for them to get out of. I've designed high-rise monitors for the military ... shielding is a very tough problem. Who wants mesh screens over the face of the CRT?

Getting down to the nitty-gritty of what a computer is all about, why couldn't the reviewer point out the split-screen capability? The screens can scroll independently, and in the spreadsheet mode they can also scroll horizontally, either locked or separate. Why not tell about the seven-buffer capacity that keeps different files at your fingertips, doing its own auto-swapping to the disk to keep up with your usage? It makes any multiple-file work easy, and I can't name another computer that has it. Why not tell how easy it is to move the cursor, by letter, word, line, sentence, paragraph, screen, or file? Why not describe how easy it is to delete? I'm at a loss to think of anything that it can't do.

The computer is easy to use. The keyboard will sit in your lap. It has a telephone-type coiled cord ... not a cable off some power tool. How about not having your desk cluttered with wires of all types? The connectors are at the back, out of the way, where they belong.

Mr. Osborne really started something. But now the competition will be hard to catch. The *Kaypro II* is a great machine, with great software, at a great price. Let's hear it like it *really* is!

HARVEY DEGERING  
Pasadena, CA

## HORIZONTAL/VERTICAL OSCILLATORS

I have read most of your June 1983 issue with interest. However, I believe that Jack Darr has a problem on page 98 ("Service Clinic") wherein he says: "Since the horizontal-sync



# Micro-Professor

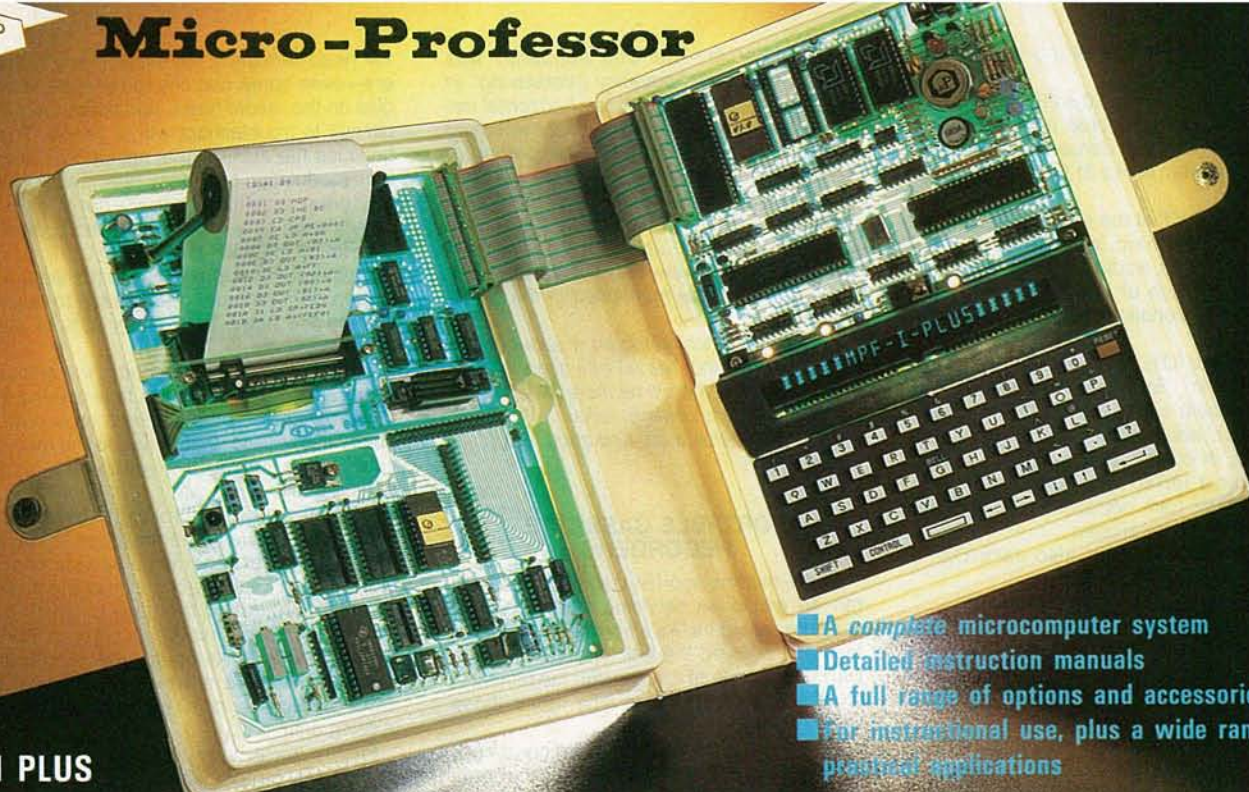

**MPF-I PLUS**

- A complete microcomputer system
- Detailed instruction manuals
- A full range of options and accessories
- For instructional use, plus a wide range of practical applications

## Learn Computing with the Micro-Professor-IP for \$199

The Micro-Professor (MPF-IP) is a complete hardware and software system that will expose you to the amazing world of microprocessors. A comprehensive teaching manual gives you detailed schematics and extensive examples of program code. All of this makes for a superb learning tool for students, hobbyists and microprocessor enthusiasts alike. Also serves as an excellent teaching aid for instructors of electrical engineering and computer science.

With the Micro-Professor-IP you get:

- Z-80 processor chip
- High quality 49-key keyboard
- On board 4 K-byte RAM
- On board 8 K-byte ROM including:
  - Interactive Monitor
  - Line Assembler
  - Two Pass Assembler
  - Tekt Editor
  - Disassembler
  - Language options of BASIC and FORTH.

You'll also get a lot more including:

- Built-in speaker
- 20 digit alphanumerical green tube display.
- 48 Input/Output lines
- Battery back-up circuits for RAM
- Bus expandable Z-80\* architecture
- Three user's manuals
- Program storage/reading cassette interface

**Options**

- Student Workbook (\$15)
- Printer (\$99)
- Speech Synthesizer Board (\$129)
- Sound Generation Board (\$99)
- EPROM Programming Board (\$169)
- Input/Output and Memory Board (\$99)



**MPF-I Micro-Professor**

Z-80\* CPU, 2K RAM expandable to 4K, 2K RAM, sophisticated monitor expandable 8K, 6-digit LED display plus a built-in speaker, cassette interface, and sockets to accept optional



CTC/PIO, BUS is extendable. As well as being an exciting learning tool, the MPF-I is a great lowcost board for OEM's.



**MULTITECH ELECTRONICS INC.**  
 195 WEST EL CAMINO REAL SUNNYVALE, CA  
 94087 U.S.A. TEL: 408-7738400  
 TLX: 176004 MAC SUVL FAX: 408-7498032

\*Z-80 is a trademark of Zilog Inc.

**Distributor list U.S.A**

**Learning Labs, INC.**  
 P.O. Box 122  
 Calhoun, GA 30701  
 TEL: 404-629-1521

**SIVAD INC**  
 P.O. Box 16664,  
 Jackson, MS39206  
 TEL: 601-355-3110

**Etronics**  
 3928 148th N.E.  
 Redmond WA 98052  
 206-881-0857

**Technical Laboratory Systems, INC.**  
 P.O. Box 218609  
 Houston, TX77218  
 TEL: 713-465-9793

**L.A.B. Corporation**  
 4416 River Road  
 Afton, MN 55001  
 TEL: 612-436-1169

**DIGIAC CORP.**  
 175 Engineers Road,  
 Smithtown, N.Y. 11787  
 TEL: (516) 273-8600

**Canada Future Electronics INC.**

**Montreal**  
 237 Hymus Boulevard  
 Pointe Claire, Quebec  
 H9R 5C7  
 TEL: (514) 894-7710

**OTTAWA**  
 Boxter Centre  
 1050 Boxter Road,  
 Ottawa, Ontario K2C  
 3P2

**TORONTO**  
 4800 Dufferin Street  
 Downsview, Ontario  
 M3H 5S8

**CALGARY**  
 5809 Macleod Trail  
 South Unit 109 Calgary,  
 Alberta T2H 0J9

**Vancouver**  
 3070 Kingsway  
 Vancouver, B.C. V5R 5J7

Outside of North America mail to:  
**Multitech Industrial Corporation**  
 977 Min Shen E. Road,  
 105 Taipei, Taiwan, R.O.C.  
 Tel: 02-769-1225 Tlx: 19162 MULTIC  
 23756 MULTIC



frequency is a multiple of the vertical-sync frequency ...".

The ratio of 15,750 to 60 is 262.5, of course, and cannot be considered compatible with counting. When I first derived a raster in the late 40's, I started with a 31,500-cycle oscillator.

Next he says that the system uses no oscillators. Without them, in the absence of signals, the sweeps would collapse and there would be no high or boost voltages. That would not be conducive to well-being, methinks.

Perhaps the IC is doing something that it is not telling him. For example, phase-locked loops are built using the oscillator, phase comparator, and counters for multiple outputs. And, of course, they will lock a 31,500 oscillator to a 15,750 sync pulse ...

Incidentally, I am not acquainted with the circuits to which he alluded.

I like your magazine, also Jack Darr's items. L.D. SMITHEY, Pacific Palisades, CA

Dear Mr. Smithley:

Thank you for your letter. I'll give you one: I did say "No horizontal/vertical oscillators." There aren't any discrete oscillators as we used to have, but there would have to be some kind of "keep alive" circuit in there to make a raster with no signal. I should have made that plainer.

The horizontal frequency is a multiple of the vertical-sync frequency. In fact, in a color set, everything is a multiple of the horizontal frequency! Even the "3.58" MHz color oscillator, which isn't 3.58, but is rounded off from

3.574595 MHz. That odd frequency was chosen to allow "frequency interleaving" in the composite TV signal; the horizontal frequency isn't 15,750 any more but something like 15,749 or so (I can never remember it!) Vertical frequency is now 59.94 Hz—not even a nice 60. Hz. Same reason. So, the countdown IC's can divide or multiply those oddballs and come up with the proper frequencies for the sweep. I know that it does work, and the tests mentioned in the article are valid.

Thanks for catching the error about no oscillators. One other reader has already mentioned that, and there'll be more. Keep those cards and letters coming, folks.

Hope that helps a bit, and good luck. JACK DARR

### PORTABLE CASSETTE RECORDERS

Some months ago (September 1982), you ran an article on servicing small, portable cassette recorders. As a service technician, I read and enjoyed the article, but there were two important parts missing. For the benefit of other service technicians who repair those little horrors, here they are:

First, you have a recorder which plays back perfectly, but will not record at all, or records weakly and distortedly. If everything else checks out OK, change the head; that usually cures the complaint. Use a scope to check the signal on the head terminals.

Some of the cheaper recorders use DC for recording bias, as well as for erasing. Those are easy to troubleshoot—the scope clearly shows the presence or absence of signal at

the head terminals. However, many recorders—even some real cheapies—use AC HF bias on the record head, and those are more difficult to troubleshoot with a scope. That's because the audio signal appears as amplitude modulation on the HF bias, and not with any great amplitude either—but it can be clearly seen as a ripple on top and bottom of the steady-state HF bias.

That is sufficient to modulate the tape, and if seen on a recorder that refuses to record, change the head. That cures 95% of such complaints.

Another fault not mentioned in the article is when a recorder winds the tape around the drive spindle or simply spews tape out. In nearly every case, that is due to the take-up spool either turning the wrong way or not turning at all.

When the spool is turning the wrong way, that is always due to the drive belt, replaced by the customer (and some service shops, too), passing on the wrong side of the pulley, which, in turn, drives the take-up spool. Before putting a tape into the recorder, check to be sure that the take-up spindle turns counter-clockwise. It is a very easy mistake to make if a recorder comes in with a broken or missing drive belt.

Finally, here is another hint: The long changeover switch, which operates on "record", is a source of trouble as well. If you have a recorder that is unstable (and even expensive machines are prone to that trouble), just try a good dose of contact cleaner to the switch. In probably 75% of cases, that will solve the problem.

D.J. BRUYNS  
Rep. of South Africa

R-E

## QUALITY COMPONENTS - NOT MAIL ORDER "SECONDS"

Send SASE for FREE Flyer or send \$1.00 postage and handling for FREE COMPLETE CATALOG which includes coupon for \$1.00 OFF purchase.

### ARIES ZERO INSERTION FORCE SOCKETS

cam actuated, true zero insertion - tin plated solder tail pins - capable of being plugged into dip sockets, including wire wrap.

Stock No.	No. Pins	1-9	10-49	50
11055	24	4.98	\$4.35	\$3.90
11056	28	5.15	4.50	4.05
11057	40	6.81	5.95	5.35
11058	84	12.02	10.50	9.45

UNTRACKS from IC-TRACKS! Dissipate over 2 watts of heat from IC's producing longer life and better performance. Just push IC into socket. Heat is collected from top and bottom of IC and dissipated. Won't shake loose.

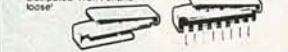

Stock No.	No. Pins in IC	Price
22225	14	\$ .29
22226	16	.29
22228	18-20	.29

### MIC 6000Z



Stock No. 82500  
\$7500  
For 1 year warranty

DIGITAL MULTIMETER Single rotary switch operation. Large easy to read 5 1/2 digit display. 800 hours operating life with single 9v battery. Seven functions—DC Volt, DC Amps, Ohms, AC Volts, AC Amps, Diode and Resistor Junction. Audible Continuity Check!

Stock No. 82504  
Call it up with bill loop \$10.00

### TI WIRE WRAP SOCKETS

Tin plated phosphor bronze contact - 3 wrap  
Stock No. No. Pins 1-99 -499 500  
11301 8 \$.40 \$.36 \$.30  
11302 14 .59 .54 .45  
11303 16 .64 .58 .48  
11304 18 .73 .66 .55  
11305 20 .99 .90 .75  
11306 22 1.12 1.02 .85  
11307 24 1.25 1.14 .95  
11308 28 1.52 1.38 1.15  
11309 40 2.05 1.86 1.55

### TI LOW PROFILE SOCKETS

Tin plated copper alloy 688 contact pins with gas tight seal.  
Stock No. No. Pins 1-24 25-99 999  
11201 8 \$.10 \$.09 \$.08  
11202 14 .14 .13 .12  
11203 16 .16 .15 .14  
11204 18 .18 .17 .15  
11205 20 .20 .18 .16  
11206 22 .22 .20 .18  
11207 24 .24 .22 .20  
11208 28 .28 .26 .25  
11209 40 .40 .37 .33

WILD ROVER Touch switch capsule. Operating motion is .005" without the use of a levered arm. Extremely fast on and off with low noise. Normally open - rated 115 VAC, 1.6 amp-30 milliohm resistance - 515 radius by .160 thick.  
Stock No. 1-9 10 & Up  
12098 \$1.42 \$1.28

60/40 ROSIN CORE SOLDER  
Stock No. Dia. Length Weight Price  
50075 .062 9 1.5 \$1.16  
50076 .062 25 4 2.39  
50077 .062 50 8 4.25  
50078 .032 33 1.5 \$1.31  
50079 .032 85 4 2.47  
50080 .032 175 8 4.57

EKI KITS come with all parts necessary to assemble!  
Stock No. 88844 TV Jammer Kit "wipes out" your TV screen... \$ 7.71  
Stock No. 88850 Whooper Alarm Kit makes a great alarm or siren... \$11.33  
MANY, MANY MORE KITS AVAILABLE IN FULL LINE CATALOG

ELPAC POWER SUPPLIES - DC/DC CONVERTERS  
SINTEC Stock No. 300 MW Type  
13825 CB3801 3.0-7.0 12±0.6 0-25 48x.51x3.05 \$ 7.95  
13826 CB3811 3.0-7.0 12±0.6 0-25 48x.51x3.05 7.95  
13827 CB3802 3.0-7.0 15±0.7 0-20 48x.51x3.05 7.95  
13828 CB3812 3.0-7.0 15±0.7 0-20 48x.51x3.05 7.95  
13829 CB3804 3.0-7.0 28±0.7 0-10 48x.51x3.05 7.95  
13830 CB3814 3.0-7.0 28±0.7 0-10 48x.51x3.05 7.95  
1.5 W TYPE:  
13831 CL3801 4.0-7.0 12±0.6 125 .651x1.2x1.77 \$24.95  
13832 CL3811 4.0-7.0 12±0.6 125 .651x1.2x1.77 24.95  
13833 CL3802 4.0-7.0 15±0.7 100 .651x1.2x1.77 24.95  
13834 CL3812 4.0-7.0 15±0.7 100 .651x1.2x1.77 24.95  
13835 CL3804 4.0-7.0 28±1.4 50 .651x1.2x1.77 24.95  
13836 CL3814 4.0-7.0 28±1.4 50 .651x1.2x1.77 24.95  
13825-1 DATA SHEET FOR DC/DC CONVERTERS..... 25

Special of the Month!  
INDUCTION AMMETER No direct electrical connections—the current-carrying conductors are simply slipped into channels on the back of the meter. The magnetic field set up by the current actuates the moving magnet mechanism. The dual scale is for zero center ranges 75-0-75 and 400-0-400, and is suitable for monitoring both the alternator/generator and starter of a motor vehicle. Metal case and bright chrome plate bezel.  
Stock No. 13734  
Price \$7.50

OPCOA Single Digit Displays - Common Cathode  
Stock No. Color 1 100  
12082 Red \$1.12 \$ .99  
12085 Green 1.84 1.63  
12087 Yellow 1.92 1.70  
12089 Orange 2.08 1.84  
Right Angle Socket for Above Displays  
Stock No. 1 100  
11010 \$1.24 \$ .99

The Battery Just Wrap™ Tool New battery powered tool wraps insulated wire around .025" square posts without need for pre-cutting and piecing. Complete with bit and 100 ft. 30 AWG wire.  
Stock No. 13340  
Description Price  
13340 Battery just-wrap tool with bit and 100 ft. 30 AWG wire \$49.95  
13341 Replacement bit .95  
13342 100 ft. blue replacement wire 6.95  
13343 100 ft. white replacement wire 6.95  
13344 100 ft. yellow replacement wire 6.95  
13345 100 ft. red replacement wire 6.95

MINI-DRILL This portable hand drill is appropriate for circuit board drilling. Runs at 2500 RPM on 4 "AA" batteries (not included). Supplied with one .030 dia. drill bit. Drill stand is designed like a drill press for precise hole drilling.  
Stock No. Description Price  
13346 Hand drill with .030 dia. bit and batteries \$24.95  
13347 Replacement bits 2 each of .040 and .060 dia. 5.95  
13348 Drill stand 13.95

PIN FORMING TOOL puts IC's on their true row to row spacing. One side is for 300 centers. Flip tool over for devices on .600 centers. Put device in tool and squeeze.  
NEW! ANTI-STATIC MODEL  
ONE TOOL DOES 8 THRU 40 PINS!  
Stock No. 10200 \$14.95  
Stock No. 11059 \$12.95

OPTEL LCD's with pins  
+18:8.8 Stock No. 47005  
8.8:8.8 Stock No. 47006  
8.8:8.8 Stock No. 47007

OK MACHINE AND TOOL  
IC INSERTION/EXTRACTION KIT  
Stock No. 13309 \$37.74

SOCKET WRAP ID  
\$1.82 per pack

IC EXTRACTOR One-piece, spring steel construction. Will extract all LSI, MSI and SSL devices with 8 to 24 pins.  
Stock No. 13313  
Price \$2.10

SINTEC co. 28 8th St., Box 410 Frenchtown, NJ 08825  
TOLL 800-526-5960 FREE in NJ (201) 996-4093  
We accept VISA, MC, C.O.D., CHECK or M.O. \*INCLUDE SHIPPING CHARGES - 0 to \$100 - \$3.00 \$100 to \$250 - \$4.00 over \$250 - \$5.00



HITACHI

NLS Non-Linear Systems

HICKOK

WESTON

DATA PRECISION

KETTLER

AWS  
A. S. SPERRY  
INSTRUMENTS INC.

FLUKE

PHILIPS

BK PRECISION

VIZ R&B

TRIPLETT

Simpson

LEADER

# HITACHI HI-PERFORMANCE PORTABLE OSCILLOSCOPES

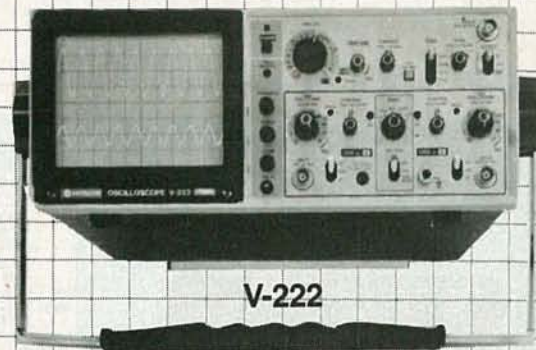

V-222

ALL HITACHI OSCILLOSCOPES FEATURE  
2-YEAR PARTS & LABOR WARRANTY

ALL FEATURE 6" RECTANGULAR CRT

V-422

DC to 40 MHz, 1mV/div,  
dual-trace, DC offset function

**\$599<sup>95</sup>**

V-222

DC to 20 MHz, 1mV/div, dual-trace,  
DC off. func., Alt. magnify function

**\$499<sup>95</sup>**

V-212

DC to 20 MHz, 1mV/div,  
dual-trace

**\$439<sup>95</sup>**

PRICE DOES NOT INCLUDE PROBES. \$50. A PAIR WHEN  
PURCHASED WITH SCOPE. \$10 SHIPPING WITHIN CONTINENTAL U.S.

FLUKE  
SERIES  
MULTIMETERS

# 70

- Analog Display
- Rotary Knob
- Volts AC & DC
- Resistance to



- 32 M $\Omega$  • 10 Amps • Diode Test
- 3200 Counts • Fast Autoranging
- Function Annunciators in Display
- Power-Up Self Test • 2000+ Hour Battery Life w/ Power Down "Sleep Mode" • New Test Leads • VDE & UL Approval

MODEL 73 **\$85<sup>00</sup>**

MODEL 75 **\$99<sup>00</sup>**

MODEL 77 **\$129<sup>00</sup>**

## BECKMAN'S CIRCUITMATE<sup>®</sup> ALL UNDER \$100.

DM77

Autoranging plus  
10 AMPS ac/dc  
measurement capabilities

**\$76<sup>95</sup>**



DM73  
smallest DMM—complete  
autoranging, audible  
continuity checking **\$63<sup>95</sup>**

DM20 3½ digit,  
pocket-size; 0.8%  
Vdc accuracy

**\$64<sup>95</sup>**

DM25 3½ digit,  
0.5% Vdc accuracy,  
diode test,  
capacitance

**\$79<sup>95</sup>**

DM40 3½ digit,  
Vdc 0.8% accuracy,  
diode test,  
hFE test

**\$69<sup>95</sup>**

DM45 3½ digit,  
0.5 Vdc accuracy,  
continuity beeper

**\$89<sup>95</sup>**



TOLL FREE HOT LINE  
**800-223-0474**

THE TEST EQUIPMENT SPECIALISTS

26 WEST 46th STREET, NEW YORK, N.Y. 10036 212-730-7030

# ADVANCE ELECTRONICS



# EQUIPMENT REPORTS

## Philips Model PM 6668 High-Resolution Frequency Counter



CIRCLE 101 ON FREE INFORMATION CARD

Philips		PM 6668											
OVERALL PRICE													
EASE OF USE													
INSTRUCTION MANUAL													
PRICE/VALUE													
		1	2	3	4	5	6	7	8	9	10		
		Poor			Fair			Good			Excellent		

JUST BY LOOKING AT THE PM 6668, YOU might not think that there was anything special about it. It's packed in a gray plastic cabinet and its uncluttered front panel has only three controls and two input jacks. However, that frequency counter

from Philips Test and Measuring Instruments, Inc. (85 McKee Drive, Mahwah, NJ 07430) proves that looks can indeed be deceiving.

Its 8048 microprocessor is what sets it apart from the run-of-the-mill counter.

But before we talk about how the PM 6668 uses the microprocessor, let's take a look at the front panel in more detail to get an idea of the counter's functions.

### Controls

As we mentioned previously, there are only three front-panel controls, one of which is a pushbutton POWER switch. Next to that is another pushbutton switch labeled MEASUREMENT RATE. You have a choice of two rates. The first, NORMAL, sets the measurement rate to about one measurement-per-second. The FAST mode sets the rate to about five measurements-per second (one measurement every 200 ms). The fast mode can be used when measuring quickly changing frequencies.

The third control, SENSITIVITY, lets you vary the input sensitivity in 6 steps, from  
*continued on page 20*

**DESOLDER-IT,  
CLEAN-IT, COAT-IT,  
FREEZ-IT...SEND FOR IT!**  
Our new electronic problem solving catalog  
and Free Chem-Wik™ samplers!



**Chemtronics**  
681 Old Willets Path  
Hauppauge, NY 11788  
800-645-5244  
In NY 516-582-3322  
Telex 968567

CIRCLE 37 ON FREE INFORMATION CARD

## THE NEW SA-6 DESOLDER IRON



\$19.75\*

Revolutionary new electric desoldering iron combines the ease and portability of a hand-held, manual, desolder pump, with performance of an industrial desolder station. This unique AC powered compact tool features portable, one-hand desoldering eliminating the need for separate soldering iron and desolder pump. No shop air required. Essential for all tool kits, field service technicians, and repairmen, as well as production applications. Vacuum chamber is easily removed for cleaning or replacement. Replacement tips available. Tool is supplied with SAT-6-059 tip; diameter 0.059 inch (1.5 mm).

### FEATURES:

- Self contained suction power and heating element.
- Economical.
- Lightweight 4oz. (113gms).
- Compact size 10¼ inches (26 cm).
- Replacement nozzles available.

\*Does not include shipping charges and local taxes.

**DT DAVLE TECH INC**  
ELECTRONIC TOOLS & ACCESSORIES  
CIRCLE 54 ON FREE INFORMATION CARD

2-05 BANTA PLACE  
FAIR LAWN, NJ, 07410  
TEL: 201-796-1720  
TELE: 968771





# FREQUENCY COUNTERS to 1.3 GHz

By **OPTOelectronics inc.** Ft. Lauderdale, Florida

EST. 1974

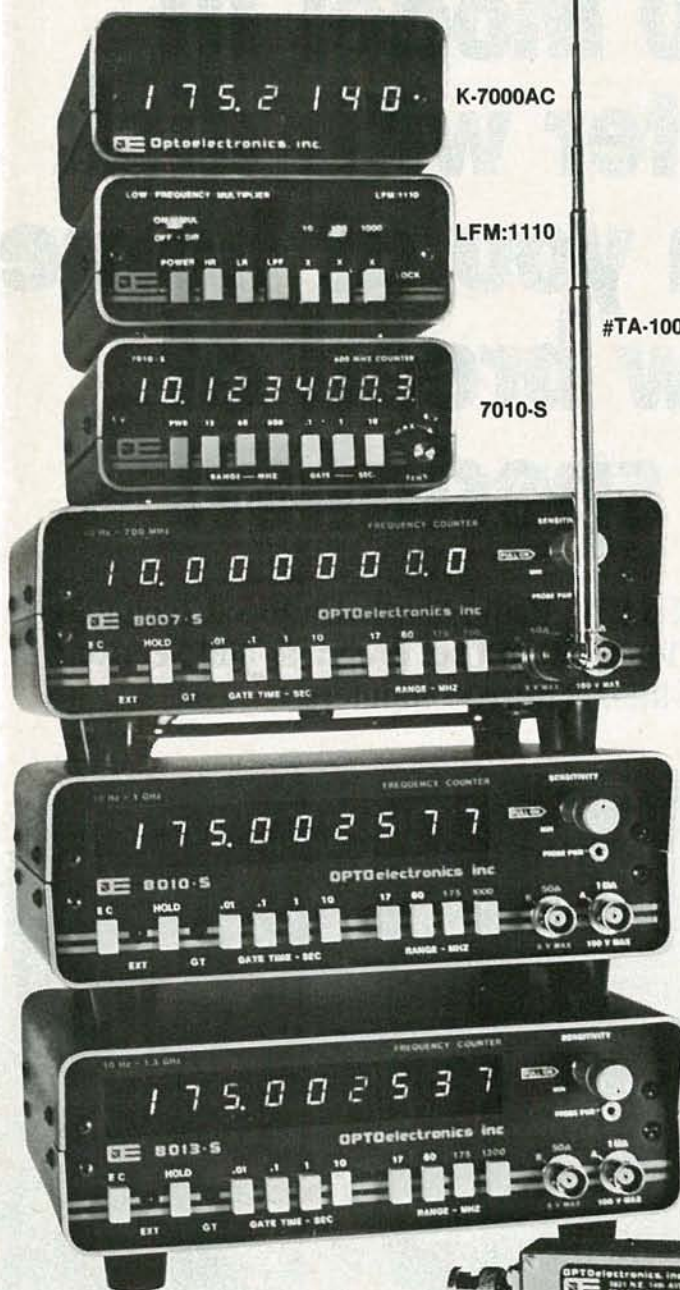

#TA-100 Ant.

**MODEL K-7000-AC** 10 Hz to 550 MHz counter. 50 Ohm & 1 Megohm inputs via BNC type connectors on rear panel. This model is available in optional kit form.

- #K-7000-AC counter assembled 115VAC/12VDC ..... \$150.
- #K-7000-ACK counter kit form ..... 120.
- #Ni-Cad-70S internal Ni-Cad battery pack ..... 25.

**MODEL LFM:1110** Low frequency multiplier. A frequency counter accessory enabling tone frequencies to be counted faster and more accurately. Has low pass filter for off-the-air. Tone-squelch measurements. BNC input/output.

- #LFM:1110 115VAC/12VDC ..... \$150.

**MODEL 7010-S** 10 Hz to 600 MHz counter. 50 Ohm & 1 megohm inputs via BNC type connectors on rear panel.  $\pm 1$  PPM TCXO standard  $\pm 0.1$  PPM TCXO time base optional for greater accuracy. 10 mV average sensitivity. Very compact 6 1/2 digit counter: Size 2" H x 4" W x 5" D, 1 lb.

- #7010-S 600 MHz counter 115 V AC/12 V DC ..... \$235.
- #TCXO-80  $\pm 0.1$  PPM TCXO time base ..... 75.
- #Ni-Cad-76 Internal Ni-Cad Battery Pack ..... 25.

**MODELS 8007-S, 8010-S, 8013-S** Deluxe series with frequency ranges of 10 Hz to 700 MHz, 1 GHz and 1.3 GHz. Standard features include: external clock input/output, excellent sensitivity, sealed  $\pm 1$  PPM 10 MHz TCXO time base, 4 gate times, 9 digit resolution to 175 MHz, front panel power jack for optional Broadband Preamp accessory, 115 V AC or 12 V DC operation, high quality compact construction housed in rugged aluminum cabinet. Optional features: internal Ni-Cad rechargeable battery operation, precision  $\pm 0.1$  PPM TCXO or  $\pm 0.05$  PPM proportional oven (OCXO) time base. All time base oscillators, including the standard TCXO, have 10 turn calibration adjustment accessible from rear panel. Size 3" H x 7 1/2" W x 6 1/2" D. 2 3/4 lbs.

- #8007-S 700 MHz counter ..... \$350.
- #8010-S 1 GHz counter ..... 425.
- #8013-S 1.3 GHz counter ..... 495.

**OPTIONS:**

- #TCXO-80  $\pm 0.1$  PPM TCXO time base ..... 75.
- #OCXO-80  $\pm 0.05$  PPM (prop. oven) OCXO time base ..... 125.
- #Ni-Cad-86 Internal Ni-Cad battery pack ..... 60.

**MODEL AP-8015-A** Broadband Preamp with 25 dB nominal gain from 1 MHz to 1 GHz, 10 dB gain at 1.3 GHz. Noise Figure less than 5.5 dB. supplied with AC adaptor or may be powered from power jack on 80XX-S series counters.

- #AP-8015-A ..... \$195.

#TA-100 Antenna, RF pick-up telescope style with right angle elbow and BNC connector ..... \$12.

- FULL YEAR GUARANTEE — ALL PRODUCTS.
- CERTIFIED NBS TRACEABLE CALIBRATION.
- ALL ALUMINUM CABINETS.

MOST ITEMS SHIPPED FROM STOCK

Prices/Specifications subject to change without notice or obligation.

MADE IN USA

AP-8015-A



MODEL	RANGE (FROM 10 Hz)	TIME BASE		AVERAGE SENSITIVITY		GATE TIMES	MAX RESOLUTION				SENSITIVITY CONTROL	EXT CLOCK INPUT/OUTPUT	METAL CASE	PROBE POWER JACK
		FREQ	STAB-DESIGN	BELOW 500 MHz	ABOVE 500 MHz		12 MHz	17 MHz	60 MHz	175 MHz				
K-7000-AC	550 MHz	5.24288	$\pm 1$ PPM-RTXO	15 mV -24 DBM	N/A	(2) .1, .1 SEC	10 Hz		100 Hz	No	No	Yes	No	
7010-S	600 MHz	10.0 MHz	$\pm 1$ PPM-TCXO $\pm 0.1$ PPM-TCXO	10 mV -27 DBM	20 mV -21 DBM	(3) .1, .1, 10 SEC	.1 Hz	1 Hz	10 Hz	Yes	No	Yes	No	
8007-S	700 MHz	10.0 MHz	$\pm 1$ PPM-TCXO $\pm 0.1$ PPM-TCXO $\pm 0.05$ PPM-OCXO	10 mV -27 DBM	20 mV -21 DBM	(4) .01, .1, 1, 10 SEC	.1 Hz	1 Hz	10 Hz	Yes	Yes	Yes	Yes	
8010-S	1 GHz													
8013-S	1.3 GHz													

**OPTOelectronics inc.**  
5821 NE 14 AVE. FT. LAUDERDALE FL 33334

VISA  
MC  
COD

**TOLL FREE 800-327-5912**  
FLA 305-771-2050

To US and Canada Add 5% to max of \$10. per order for shipping/handling  
Foreign orders add 15%

CIRCLE 62 ON FREE INFORMATION CARD



# Now NRI takes you inside the TRS-80 Model III microcomputer with disk drive to train you at home as the new breed of computer specialist!

**NRI Teams Up With Radio Shack Advanced Technology To Teach You How To Use, Program, and Service State-of-the-Art Microcomputers.**

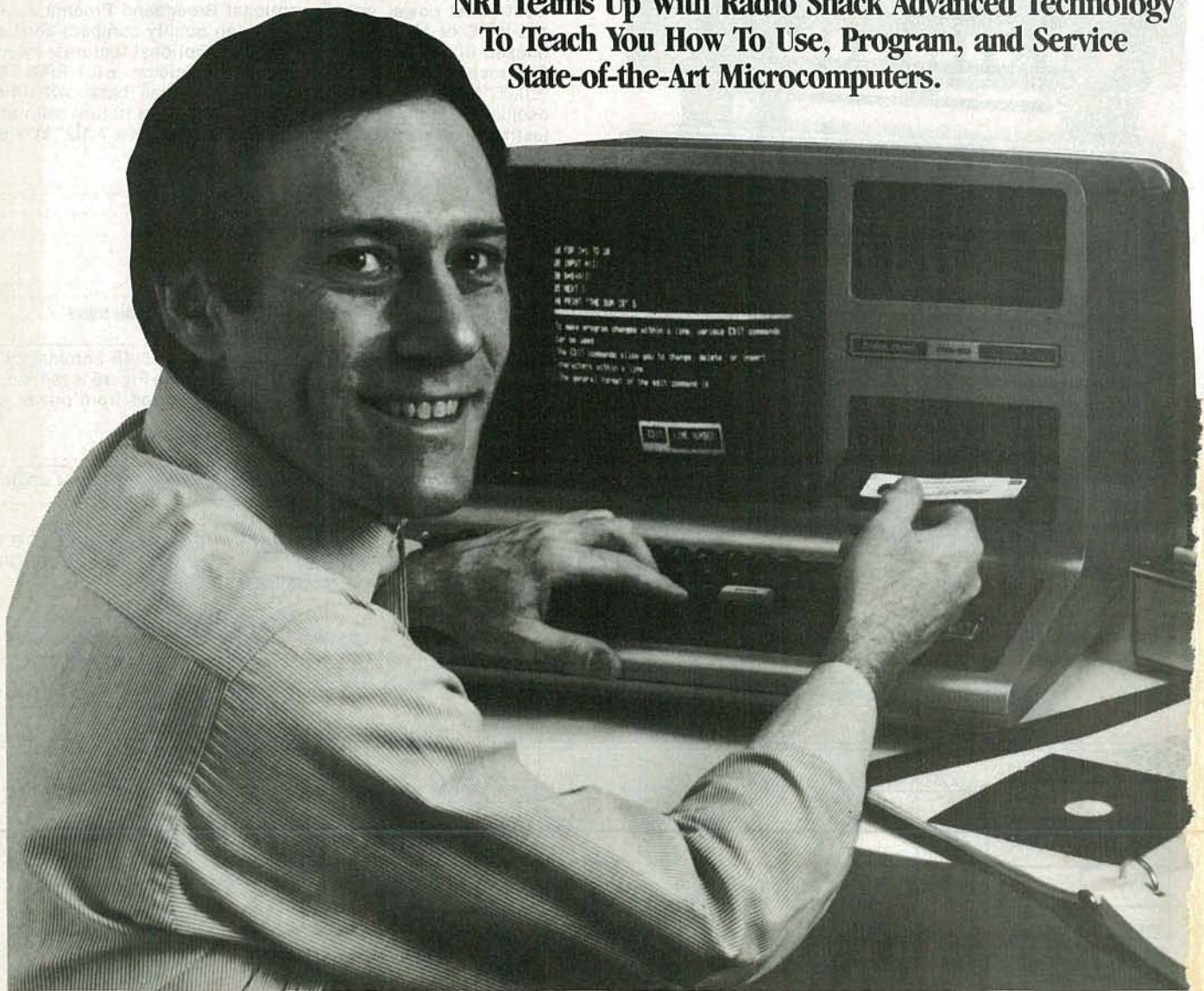



It's no longer enough to be just a programmer or a technician. With microcomputers moving into the fabric of our lives (over 250,000 of the TRS-80™ alone have been sold), interdisciplinary skills are demanded. And NRI can prepare you with the first course of its kind, covering the complete world of the microcomputer.

### Learn At Home In Your Spare Time

With NRI training, the programmer gains practical knowledge of hardware, to design simpler, more effective programs. And, with advanced programming skills, the technician can test and debug systems quickly and easily.

Only NRI gives you both kinds of training with the convenience of learning at home. No classroom pressures, no night school, no gasoline wasted. You learn at your convenience, at your own pace. Yet you're always backed by the NRI staff and your instructor, answering questions, giving you guidance, and available for special help if you need it.

### You Explore the TRS-80 Model III Inside and Out

NRI training is hands-on training, with practical experiments and demonstrations as the very foundation of your knowledge. You not only learn to program your computer, you learn all about it . . . how circuits interact . . . interface with other systems . . . gain a real insight into its nature. Under NRI's carefully planned training, you even install a DISK DRIVE verifying its operation at each step.

You also work with a professional

4-function multimeter, featuring full portability and a 3½-digit liquid crystal display. Using it along with the exclusive NRI Discovery Lab® and your TRS-80, you perform over 60 separate experiments. You learn how to troubleshoot and gain greater un-



**Now training includes either the TRS-80 Model III Microcomputer with Disk Drive or TRS-80 Color Computer with Computer Access Card; professional LCD multimeter; the NRI Discovery Lab; and hundreds of demonstrations and experiments.**

derstanding of any microcomputer from the information your testing procedures give you.

### TRS-80 Model III With Disk Drive Is Yours To Keep

As part of your training, NRI sends you the TRS-80 Model III microcomputer plus DISK DRIVE. This functional unit is complete with 65-key keyboard and 12" display in one desk-top unit. Its 32 RAM is internally expandable to 48K and its BASIC language is compatible with most Model I software. It features built-in interface for parallel printer and disk drive which allows for high speed storage and rapid access and manipulation of data. This ensures a powerful and versatile computer at your command.

Along with your multimeter and the NRI Discovery Lab, this latest concept in advanced microcomputers is yours to learn

with, yours to keep and use for your own personal programs, business use, and other applications. Additional lessons give you a thorough understanding of all the important peripherals.

### Same Training Available With Color Computer

NRI offers you the opportunity to train with the TRS-80 Color Computer as an alternative to the Model III. The same technique for getting inside is enhanced by using the new NRI-developed Computer Access Card. Only NRI offers you a choice to fit your specific training needs.

### Send For Free Catalog

Get all the details on this exciting course in NRI's free, 104 page catalog. It shows all equipment, lesson outlines, and facts on other electronics courses such as Electronic Design, Industrial Electronics, TV/Audio/Video Servicing . . . 12 different career opportunities in all.

Send today. Prepare to take advantage of the incredible job and earnings possibilities of the microcomputer revolution as you learn on the world's most popular computer. If postcard has been used, write to NRI Schools, 3939 Wisconsin Avenue, Washington, DC 20016.



**NRI Schools**  
McGraw-Hill Continuing  
Education Center  
3939 Wisconsin Ave.  
Washington, D.C. 20016

**We'll give you tomorrow.**



(TRS-80 is a trademark of the Radio Shack division of Tandy Corp.)



## EQUIPMENT REPORTS

continued from page 14

15 millivolts RMS to 5 volts RMS. By setting the sensitivity only as high as necessary, you can reduce the effect of some interference.

At the bottom right of the panel is a high-impedance (1 megohm) AC-coupled input for signals with frequencies from 10 Hz to 120 MHz. To its left is a 50-ohm AC-coupled RF input for signals from 50 MHz to 1 GHz.

The accuracy of the counter is determined by several factors. The relative frequency-error (or innaccuracy) can be

thought of as the sum of three terms: the resolution error, the trigger error, and the timebase error.

The resolution error is equal to  $LSD / \text{input frequency}$ , where LSD is the Least Significant Digit. The LSD varies depending on whether the NORMAL or FAST mode is in use. (The NORMAL mode yields 7-digit resolution, which results in an error between 1 part in  $10^6$  and 1 part in  $10^7$ . The FAST mode yields 6- or 7-digit resolution, which results in an error between about 1 part in  $5 \times 10^6$  and 1 part in  $5 \times 10^7$ .)

The second term is the trigger error, which can be written (measurement rate/signal slope)  $\times$  noise voltage (P-P). We

can see that the error decreases as the input signal's frequency and signal-to-noise ratio increase.

The final term in the error expression is the timebase error. Regardless of its initial accuracy, an oscillator's frequency will change with time and temperature. (That's why an internal adjustment is provided.) The standard counter model has a temperature stability (referenced to 25°C) of 1 part in  $3 \times 10^6$  between 20° and 30°C. An optional TCXO (or temperature-compensated crystal oscillator), which the unit we received was equipped with, improves that figure to 1 part in  $3 \times 10^7$ .

The oscillator's aging rate is the long-term stability when all factors (temperature, voltage, etc.) are held constant. It is dependent on the processing of the crystal. The standard model claims an aging rate of 1 part in  $5 \times 10^7/\text{month}$ , while with the TCXO that changes to 1 part in  $10^7/\text{month}$ .

If you don't want to use the PM 6668's internal oscillator, there is a BNC jack on the back of the unit that lets you connect your own 10-MHz oscillator. (A jumper inside the case must also be changed if you want to do that.)

Now that you have a general idea of the capabilities of this counter, let's take a look at how the 8048 microprocessor makes the PM 6668 different from conventional counters.

### Computing reciprocal counter.

In a conventional counter, the cycles of the input wave are counted during a set period of time—the gate time. As the frequency of the input signal increases, the number of cycles that are counted during the gate time increases and thus the relative resolution is increased. The PM 6668 (called a computing reciprocal counter by Philips) however, uses two counting registers that permit high-resolution measurements on low-frequency signals. The event register counts the cycles of the input wave, while the time register counts the cycles from a 10-MHz reference oscillator. Both counts are sent to the microprocessor, which computes event counts/(time counts  $\times 10^{-7}$ ) and sends that value to the display. The result is a resolution of  $\pm 1$  Hz in 10 MHz in the NORMAL mode (1-second gate time).

The measured frequency is always displayed with maximum resolution without overflow—the decimal point and unit (Hz, kHz, MHz) are automatically displayed properly. That automatic range selection is another feature that the microprocessor makes possible.

An available option—one our unit was not equipped with—is a rechargeable battery pack that fits inside the PM 6668 case and permits portable operation. When batteries are installed, a low-battery indicator on the display will become visible when there is less than 15 minutes of operating time left. The external-oscillator

# Introducing the analog/digital handheld multimeter.



### Fluke 73

\$85

Analog/digital display  
Volts, ohms, 10A, mA, diode test

Autorange

0.7% basic dc accuracy  
2000+ hour battery life  
3-year warranty



### Fluke 75

\$99

Analog/digital display  
Volts, ohms, 10A, mA, diode test

Audible continuity

Autorange/range hold  
0.5% basic dc accuracy  
2000+ hour battery life  
3-year warranty



### Fluke 77

\$129

Analog/digital display  
Volts, ohms, 10A, mA, diode test

Audible continuity

"Touch Hold" function  
Autorange/range hold  
0.3% basic dc accuracy  
2000+ hour battery life  
3-year warranty  
Multipurpose holster

FROM THE WORLD LEADER  
IN DIGITAL MULTIMETERS



The Professional Test Equipment Source

**The Instrument Mart**

295 Community Drive, Great Neck, New York 11021  
(516) 487-7430 Outside N.Y. (800) 645-6535

Sales, Service, Rental/Leasing Programs  
... and Pre-Owned Test Equipment also Available

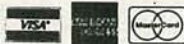

CIRCLE 28 ON FREE INFORMATION CARD



FLUKE

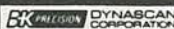

DYNASCAN CORPORATION



BECKMAN



POWER DESIGNS

HAMEG

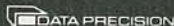

WESTON





jack that we just discussed can be replaced by a jack for connecting to an external 12-volt supply. Complete instructions are supplied in the manual.

### Self diagnosis

Another feature of the PM 6668 is the self-diagnosis routine that the microprocessor runs through whenever the unit is powered up. If a fault is found, then an error code (Error1 through Error6) will be displayed on the readout. By consulting the flowcharts in the service manual, you can isolate the fault. Let's give a quick example.

If "Error3" is displayed, you would, as the flowchart instructs, interchange two IC's that we'll call "A" and "B." If "Error2" is then displayed, you know to replace IC "A." However if that error message does not appear, then you have to check for a reset pulse at IC "A." If that pulse is missing, then you have to trace it to find the problem. But if the reset pulse is there, then the microprocessor must be replaced.

Of course, not all faults are handled by error displays. What the microprocessor does do is to test program memory and data memory; it also tests that the external logic can be set to zero. So, for example, a power-supply malfunction will not produce an error code. But even though there are many potential problems that the microprocessor will not indicate, you should have little problem if something goes wrong. As we have come to expect from Philips, the service manual is very helpful. It contains troubleshooting instructions and circuit descriptions, as well as maintenance instructions and performance checks.

In operation, the PM 6668 worked well. It is an easy-to-use instrument. But you must be careful to use high-quality, shielded test leads to avoid misleading readings. That's especially true in noisy environments—around computers, for example. If you need a lab-quality, high-resolution frequency counter that can measure up to 1 GHz, we wouldn't hesitate to recommend this Philips unit. Its base price is \$640. With the TCXO option, that increases to \$820. The optional battery pack adds \$200 to either unit. **R-E**  
*continued on page 22*

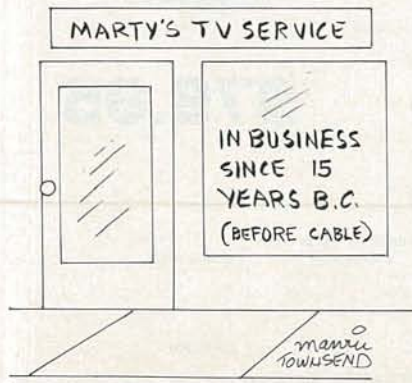

# SLASH THE HIGH COST OF SATELLITE TV INSTALLATION

*by Doing-It-Yourself with this All-In-One-Guide...*



## Build a Personal Earth Station For Worldwide Satellite TV Reception

Here's the opportunity you've been waiting for . . . a one-stop, money-saving source that tells you HOW to pick out the best location for an earth station, WHERE to buy the best equipment possible (at a reasonable cost), and WHAT you need to know to hook it up, tune it in, and receive unlimited entertainment from every corner of the world.

You won't have to settle for the same old Cable TV menu anymore, because this guide shows you how easy it is to tune into first-run movies, world-class sporting events, 24 hour news, and entertainment specials from around the globe. No more costly cable rent bills—you own the equipment, *you* will be your own program director!

To order, call toll free: 800-233-1128. (In Pennsylvania, Hawaii, and Alaska, call direct: 717-794-2191.)

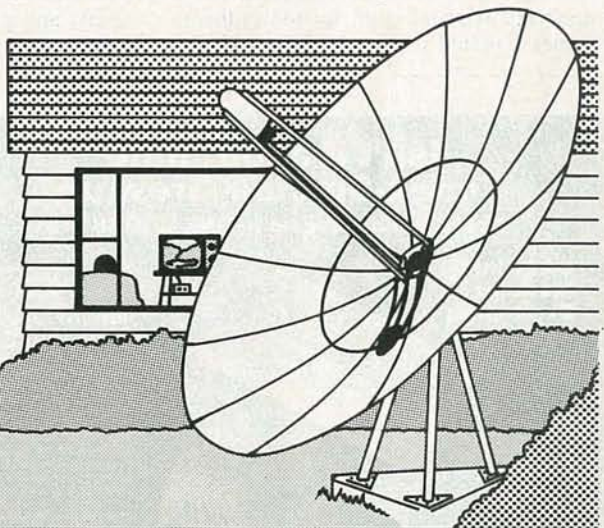

### TAB 10-Day FREE Trial Offer

Please send me \_\_\_\_\_ copies of Build A Personal Earth Station For Worldwide Satellite TV Reception (Order No. 1409H) at \$15.95.

Bill me \$ \_\_\_\_\_ (plus postage and handling)

Check enclosed for \$ \_\_\_\_\_ (TAB pays postage and handling)

Charge my  VISA  Master Card (TAB pays postage and handling)

Account No. \_\_\_\_\_ Expires \_\_\_\_\_

Signature \_\_\_\_\_

Name \_\_\_\_\_

Address \_\_\_\_\_

City/State/Zip \_\_\_\_\_

**TAB TAB BOOKS Inc.**  
P.O. Box 40  
Blue Ridge Summit, Pa. 17214

PA add 6% sales tax. Foreign customers must pay in advance in U.S. currency.

RET-14A

CIRCLE 59 ON FREE INFORMATION CARD



## Heath EE-101 Operational-Amplifier Course



CIRCLE 102 ON FREE INFORMATION CARD

HEALTH		EE-101											
OVERALL PRICE													
EASE OF USE													
INSTRUCTION MANUAL													
PRICE/VALUE													
		1	2	3	4	5	6	7	8	9	10		
		Poor			Fair			Good			Excellent		

AT ONE TIME OR ANOTHER DURING EVERYONE'S involvement with electronics, there comes a period when a refresher course

might be needed. It doesn't matter whether you've worked with electronics for 25 years or 5 years, recent developments in the field have almost made it mandatory, especially if you want to remain current with up-to-date technology.

Even in such a take-it-for-granted area as operational amplifiers, there may come a need for fresh information. The problem that arises, though, is where do you get it? You can read manufacturers' specifications sheets or the latest technical manuals and papers, but those only give you the facts and figures. A better alternative is the op-amp course offered by Heath (Benton Harbor, MI 49022). It's part of their electronics technology education series and at \$44.95 for the text and study materials, it's a bargain.

The Heath Operational Amplifier Course (EE-101) combines written theory materials and hands-on experiments into a package that provides a comprehensive overview of operational amplifiers. It's more than enough to provide even the most jaded veteran of the electronics wars with some new insights.

As usual, when the course first arrived in the office, we were quick to inspect the contents and we found that everything needed to complete it was there. It was packaged in a heavy cardboard box, which contained a binder, the course material, and parts needed for the course experiments. As we were opening the ma-

terial, we also glanced through it and found it was well presented and very readable.

### What's covered

The course material presents everything you wanted to know about op-amps, but might have been afraid to ask. For instance, the first chapter of the course takes you through op-amp basics and the characteristics of those devices. The second chapter takes you through some basic amplifier circuits and discusses the inverting and non-inverting amplifier, while the third chapter (Heath calls them units) moves to the differentiator and integrator.

The fourth chapter moves on to voltage and current regulator circuits, while chapter five takes you through non-linear signal-processing circuits and discusses such items as comparators and Schmitt Triggers. Chapter six covers various generators, including sinewave, squarewave, and triangular-wave generators.

Other chapters move on through active filters and discuss bandpass filters, state-variable filters and notch filters. Single-supply operation, including single-supply biasing, the inverting amplifier, the summing amplifier, and the difference amplifier are also covered.

The final chapter, chapter 10, includes a discussion of the instrumentation amplifier or "committed gain" amplifier.

As you can see, the Operational-Am-

## Isn't it about time Timex-Sinclair Grew up? Would you believe up to ONE MEGABYTE!

### BASICare Modular Expansion Systems

TS1000 ZX81



Modules are available to provide:

- Input/output devices for control of relays and other 'real world' devices including robotics
- 128 new high definition characters for hi-resolution graphics
- Permanent non-volatile RAM memory storage
- Sophisticated music and sound synthesizers programmable from BASIC
- Centronics printer interface

It can grow up. To a real computing system with up to ONE MEGABYTE of memory. Memory that is INSTANTLY AVAILABLE. Memory that can be added AS REQUIRED in 'blocks' of 16K or 64K. And memory expansion is only the start of what can be done with the BASICare Modular Expansion System.

This is a unique flexible 'Building Block' expansion system that enables you to expand your system in any configuration you choose.

BASICare modules are what is required to turn any Timex Sinclair into a serious computer for business, education, industrial, and hobby applications.

Call our toll-free number NOW at 800-833-8400

N.Y. (716) 874-5510 or a free catalog

BASICare is available from **GLADSTONE ELECTRONICS INC.** and selected dealers

1585 Kenmore Ave., Buffalo, New York 14217

Please CALL, WRITE or circle reader service number Dealer and educational enquiries welcome.

CIRCLE 71 ON FREE INFORMATION CARD

## WHY SPEND A FORTUNE ON A DIGITAL CAPACITANCE METER?

As a matter of fact you don't have to pay \$180 to \$500 and up anymore for a Digital Capacitance Meter that is both dependable and rugged with good accuracy. The MC100A comes completely assembled and calibrated and at \$79.95 is an outstanding value. The extensive range of 30 pF to 9,999 uF (no external meters required) and true hand held portable size (only 4 3/4" x 2 1/2" x 1 1/2") make the MC100A an extremely practical and easy to use instrument for the hobbyist technician or engineer.

### CHECK THESE OTHER FEATURES

- \* Basic accuracy 2% ( $\pm$  one count) on pF, nF ranges, 5% ( $\pm$  one count) on uF range.
- \* Uses single 9V battery (not included).
- \* Decimal points light up when battery is low or when capacitor is overrange.
- \* Full 4 digit high efficiency LED display uses special circuitry to save on batteries.
- \* Maximum conversion time for 9,999 uF is less than 6 seconds.
- \* Constructed with a tough impact resistant plastic case.
- \* 90 day parts and labour warranty.



**DAETRON**  
1748 MAIN ST., SUITE 105  
BUFFALO, N.Y. 14211  
(416) 441-1733  
DEALER ENQUIRIES INVITED



**\$79.95**

### PLEASE SEND ME

(Quantity) MC100A(s) @ \$79.95 U.S.

Shipping & handling \$2.25

I ENCLOSE CHECK  MONEY ORDER  BILL MY VISA

VISA CARD NO. \_\_\_\_\_ EXPIRY DATE \_\_\_\_\_ SIGNATURE \_\_\_\_\_ TOTAL \$ \_\_\_\_\_

Immediate shipping on orders with money orders or VISA.

Personal checks please allow 2 to 3 weeks for clearance.

NAME \_\_\_\_\_

ADDRESS \_\_\_\_\_

CITY \_\_\_\_\_

STATE \_\_\_\_\_

ZIP CODE \_\_\_\_\_

MAIL TO DAETRON 1748 MAIN STREET, SUITE 105  
BUFFALO, N.Y. 14211



# Here's How You Can Learn 16-Bit Technology. And Graduate To One Of Today's Most Powerful And Advanced Microcomputers.

Now you can master 16-bit technology with an all-new Advanced Microprocessor course. And build hands-on experience with the only 16-bit microcomputer specifically designed for the hobbyist, working engineer and student.

## Advanced Microprocessor Course

This all-new self-study course (EE-8088) provides in-depth coverage of 16-bit, state-of-the-art technology.

You will gain a thorough understanding of microprocessors from this 1200 page course. In 10 easy-to-understand units, starting with microcomputer basics, you'll cover all phases of 16-bit microprocessing. Assembly language. Program writing. Addressing modes. Dynamic and static RAM. And hardware interfacing.



And by using your 16-bit Trainer/Learning Computer for hands-on experiments (over 60 included), you'll gain actual circuit interface and software programming experience with an 8088 microprocessor system.

## Trainer/Learning Computer

A unique combination of design features makes this versatile microprocessor system much more than a "teaching machine." Use it as a trainer with the Advanced Microprocessor course. Use it as an experimental design computer. And use it to run a wide variety of 16-bit software—including Z-Dos, Multiplan, Z-Basic, Condor File Manager, and much more.



In its most basic form, the Trainer/Learning Computer is a 16-bit,

cassette-based microcomputer.

Its unique design features access ports and solderless breadboards to allow you to build interfaces, design and modify circuits, or simply experiment with the inner workings of the microprocessor system.

The basic system has an 8088 processor, 32K ROM (including assembler, editor and debugger) and 16K RAM.

The unit also features a serial I/O printer port, cassette interface and a detached 95-key keyboard (including 16 function keys and a numeric keypad) which generates a full ASCII character set. It's available either in kit form or factory assembled.

And you can take advantage of the system's H/Z-100 computer design heritage by easily upgrading it to a disk-based, 16-bit microcomputer that will run H/Z-100

series software and many other forthcoming programs.

## Fully Upgradeable

The powerful upgrade package and variety of accessories allow you to make the basic 16-bit system more powerful and versatile. You can add 128K or 192K bytes



of RAM. Floppy disk controller. 48TPI double-sided, double-density, single or dual floppy disk drive. Bit-mapped video graphics or full-color graphics. Two RS-232 ports. Programmable timer. And a Centronics-compatible printer port.

## Learn on it. Design with it. Use it as a 16-bit computer.

It's the only 16-bit microprocessor system specifically designed to integrate theory with a hands-on understanding of how 16-bit computers work. And it's from Heathkit/Zenith Educational Systems, the world-leader in problem-solving courses, trainers and accessories to help you learn state-of-the-art technology.



Get more information in the  
**FREE  
HEATHKIT CATALOG**

Mail to: Heath Company, Dept. 020-134  
Benton Harbor, MI 49022

Name \_\_\_\_\_

Address \_\_\_\_\_

City \_\_\_\_\_

State \_\_\_\_\_ Zip \_\_\_\_\_

ED-200

**Heathkit**<sup>®</sup>  
Heath  
Company

A subsidiary of Zenith Radio Corporation

CIRCLE 15 ON FREE INFORMATION CARD



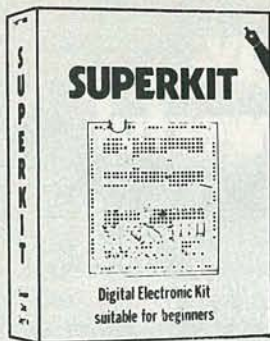

# DESIGNING DIGITAL SYSTEMS

Meet the challenges of today's incredibly rapid changes in electronics quickly and easily. This innovative kit is as exciting as the circuits you build and explore.

Learn the wonders of digital electronics and see how quickly you are designing your own circuits with the SUPERKIT which contains:

Seven TTL integrated circuits, breadboard, LED's, and all the DIL switches, resistors, capacitors and other components to build interesting digital circuits; plus a very clear and thoroughly tested instruction manual. This course teaches Boolean logic, gating, R-S and J-K flipflops, shift registers ripple counters and half adders. You will learn about fault finding, improvisation and sub-system checking and the manual asks plenty of questions, but never leaves you stuck for an answer. You don't even need a soldering iron! Using the same breadboard you may construct literally millions of different circuits. . . . . \$39.95  
Order one of our written Courses to complement your SUPERKIT.

**Digital Computer Logic & Electronics** - An introduction to digital electronics designed specifically for the raw beginner. If you're just starting with Digital Electronics this is the Course for you. . . . . \$13.95

**DIGITAL COMPUTER DESIGN** - A totally revised and updated Course using the programmed learning system. This book is not intended for beginners but is ideally suited to engineers, technicians and hobbyists who want to know more about digital electronics. . . . \$17.95

### TO ORDER BY MAIL

Just send your check or money order to the address below. Make sure you enclose your address and specify which Courses you are ordering. Payment must be in US Dollars drawn on major US Bank. Mass. Residents add 5% sales tax. Company Purchase Orders also accepted.

### PHONE ORDERS - FREE

To order by phone call (617) 664-3657 with your credit card information. It won't cost you a dime, because we'll deduct the cost of the call from the cost of the Courses you order.

### NO RISK GUARANTEE

There's absolutely no risk to you. If you're not completely satisfied, simply return your order within 30 days. We'll send you a full refund.

### AIR MAIL

The prices shown include surface mail postage. For Airmail shipment please write for additional cost, specifying Courses to be ordered.

## CAMBRIDGE LEARNING Inc.

P.O. BOX 307, North Reading, MA 01864

CIRCLE 8 ON FREE INFORMATION CARD

## The professional breadboard. (For professional, hobbyist or student.)

Global Specialties' PB-203A Proto-Board®

The solderless breadboard that set the industry standard for speed, versatility and convenience. With a capacity up to twenty-four 14-pin DIPs and three regulated power supplies (one fixed, two variable), PB-203A features a large array of sockets and bus strips that emulates standard PC layouts. Permitting instant insertion and removal of virtually any component from the largest DIP to the smallest discretres. Helping you design, assemble, test and modify circuits almost as fast as you can think! And built with professional durability, for all types of applications.

Our PB-203A. Only \$174\* (kit \$149.95\*) or PB-203 with single 5V supply, \$133.\* One more reason so many people say "Proto-Board" for solderless breadboarding.



## GLOBAL SPECIALTIES CORPORATION

70 Fulton Terr., New Haven, CT 06509 (203) 624-3103, TWX 710-465-1227  
OTHER OFFICES: San Francisco (415) 648-0611, TWX 910-372-7992, Europe: Phone Saffron-Walden 0799-21682, TLX 817477  
Canada: Len Finkler Ltd., Downsview, Ontario

Call toll-free for details **1-800-243-6077** During business hours

\*Suggested U.S. resale. Prices, specifications subject to change without notice. © Copyright 1981 Global Specialties Corporation.

CIRCLE 96 ON FREE INFORMATION CARD

plier Course easily provides you with a good refresher on op-amps. In fact, it covers them from A to Z.

Not only does it supply the basics, but it also reinforces those basics with a constant series of review quizzes and tests. Those quizzes and tests culminate in a final exam for the course, which you may return to Heath for grading. That constant reinforcement is a good educational technique and assures that you will retain much of what you have learned.

Reinforcement is also supplied through a series of hands-on course experiments that help you understand the material you are learning. Those experiments are done using components which Heath supplies. Included in the course are resistors (both 1% and 5% film types); a special light-dependent resistor; a 20K linear control; various capacitors, including electrolytics, mylars, and ceramics; diodes; indicators, and, of course, the op-amps.

The experiments are very beneficial to the learning process and point to one improvement in the material that is noteworthy. In other Heath courses, the general guidelines for circuit breadboarding are presented and you are then left to sketch out any further experiment layout on a separate piece of paper. In this course, Heath has taken the time to provide you with a printed template to help you with the wiring.

A nice added benefit to the course is that it can also serve as a reference source when you've completed it. Two appendices contain some of the latest specification sheets on many of the operational amplifiers in common use.

### What's needed

At this point, it is fair to note that while the initial price for the course seems low, it can actually work out to be quite expensive for the newcomer to the electronics business or hobby. That's because the course experiments use certain basic test instruments, such as an oscilloscope, frequency counter, frequency generator, and digital multimeter. And, while all service technicians and many hobbyists may already have access to that equipment, a beginner may find himself spending upwards of \$800 to obtain all the items needed to get the full benefit of the course. In addition, the same breadboard/trainer (ET-3300B) used in the other Heath courses is used here. That trainer costs \$99.95 in kit form; \$179.95 assembled. It is also available in a package consisting of the trainer kit and the course for \$129.95.

As you can see, it can be an expensive proposition to the person without access to the proper equipment. Keep in mind, though, that the list of need equipment includes only items that any reasonably equipped workshop should have.

One last note on the value of the course is the fact that it can earn you continuing education credits from Heath and those



# State-of-the-Art VIDEO EQUIPMENT

Quality • Low Prices • Immediate Delivery

**SPECIAL!**



MODEL V-1880

**BP STABILIZER/IMAGE ENHANCER/  
RF CONVERTER/VIDEO FADER/2-WAY  
DISTRIBUTION AMPLIFIER**

**OUR PRICE \$119<sup>95</sup>**

Contains five units in one; stabilizer (video guard remover); image enhancer; video to RF converter; video fader; and dual output distribution amplifier.

**Stabilizer** Will correct entire range of copy guard distortion such as jitter, vertical roll or black bar travelling through picture.

**Enhancer** Attain best picture for your preference.

**RF Converter** Allows your TV set to receive video and audio signals from your image enhancer, guard stabilizer, video camera, computer, VCR, etc. The direct video signal from any video component can be fed into the V-1880 and converted to a usable RF signal that can go to your TV antenna terminals.

**Video Fader** Used to produce fade ins and outs.

**NEW!**



MODEL V-2250

**BP TV TO STEREO  
AUDIO ADAPTOR/  
ENHANCER \$19<sup>95</sup>**

**OUR PRICE**

Easily connects to any TV and Stereo Amplifier or simulated stereo sound. Makes taping TV Audio simple - TV can be located any distance from stereo. Delivers two channels of simulated stereo. With noise eliminator and special output level controls. Frequency response: 50 Hz - 15,000 KHz.

**NEW! BP VIDEO COLOR PROCESSOR/RF CONVERTER/  
STABILIZER/3-WAY DISTRIBUTION AMPLIFIER**

**OUR PRICE**

**\$189<sup>95</sup>**

Corrects video signal directly into tape not just on playback. Luminance meter monitors brightness levels for quality recordings. Can also be used between video cameras and VCR, VCR and VCR and from VCR to TV during playback mode. Corrects off-color tapes. Center detent, luminance, chroma, phase and audio controls. Stabilizer for removing copyguard.



MODEL V-1890

**BP VIDEO GUARD STABILIZER  
MODEL V-1875**



**OUR PRICE \$39<sup>95</sup>**

Has self contained A&B and bypass switch. Many movies, concerts and special programs for sale or rental are copy guarded. This removes copy guard and allows you to make copies. Many TV sets will not play prerecorded tapes because copy guard causes picture to roll and jitter, turn to snow or disappear. Video Guard Stabilizer removes copy guard from signal.

**BP RF CONVERTER/MODULATOR  
MODEL V-1885**

**OUR PRICE \$39<sup>95</sup>**

Allows your TV to receive video and audio signals from image enhancer, guard stabilizer, video camera, computer, VCR, etc. The outputs of many video components cannot be directly hooked up to the VHF antenna terminals on your TV set. This problem is solved by using the Model V-1885 RF Converter. Converts video signal from any video component to adjustable RF signal at antenna terminals. Allows your VCR output to feed two TV sets at the same time, with virtually no signal loss.



**BP VIDEO SELECTOR CENTER  
MODEL V-4803**

**OUR PRICE \$49<sup>95</sup>**

A switcher that can accept 6 inputs and direct them to 3 outputs. Utilizes switch similar to one used on home VCR's. You avoid signal loss incurred by using splitters.



**JERROLD 58 CHANNEL  
CORDLESS TV CONVERTER  
MODEL LCC-58 (DRX 3-105)**

**OUR PRICE \$99<sup>95</sup>**

Receive up to 58 TV channels. Remote TV Control. Attaches to any age or model TV in minutes. No tools required. On/Off button, Channel selection, Channel Stepping, Fine Tuning.



**BP UHF CABLE CONVERTER  
WITH FINE TUNING/46 CHANNEL  
MODEL V-5746**

**OUR PRICE \$24<sup>95</sup>**

Fully shielded oscillator eliminates herring bone distortion. For Beta/VHS recording. Record & use TV's remote control. Complete programming of VTR.



**BP VIDEO GUARD STABILIZER/  
RF CONVERTER  
MODEL V-1877**



**OUR PRICE \$69<sup>95</sup>**

Same as V-1875 but with a built-in RF Converter that gives the model V-1877 an RF output which can be fed directly to the antenna terminals of a TV set. This enables you to remove the copy guard from a pre-recorded tape and view it on a TV using only a VCR.

**Use as an RF Converter only.** Used in conjunction with your TV, you can feed direct audio and video signals from any video device such as video camera, computer, portable VCR, etc.

**BP IMAGE ENHANCER  
MODEL V-1860**

Dramatically improves performance of video cameras and VCR's (off-the-air or second generation recordings), by compensating for deterioration of detail and sharpness. Includes video distribution amplifier with two video outputs.



**OUR PRICE \$49<sup>95</sup>**

**FORDHAM**

260 Motor Parkway, Hauppauge, N.Y. 11788

Master Charge  
VISA  
Money Order  
Check

N.Y. State  
residents add  
appropriate  
sales tax.

COD's extra (required 25% deposit)

ADD FOR SHIPPING AND INSURANCE  
\$250.00 ..... \$4.50  
\$251.00 to 500.00 ..... 6.50  
501.00 to 750.00 ..... 8.50  
751.00 to 1000.00 ..... 12.50  
over 1000.00 ..... 15.00

**TOLL  
FREE**

**(800) 645-9518**

in N.Y. State call 800-832-1446



**FREE**

# McIntosh STEREO CATALOG and FM DIRECTORY



Get all the newest and latest information on the new McIntosh stereo equipment in the McIntosh catalog. In addition you will receive an FM station directory that covers all of North America.



**SEND  
TODAY!**

McIntosh Laboratory Inc. RE  
East Side Station P.O. Box 96  
Binghamton, N.Y. 13904-0096

NAME \_\_\_\_\_  
ADDRESS \_\_\_\_\_  
CITY \_\_\_\_\_ STATE \_\_\_\_\_ ZIP \_\_\_\_\_

If you are in a hurry for your catalog please send the coupon to McIntosh. For non rush service send the Reader Service Card to the magazine.

CIRCLE 93 ON FREE INFORMATION CARD

## Radio-Electronics REPRINT BOOKSTORE

- |  |   |
|--|---|
| <input type="checkbox"/> Build Your Own Satellite TV Receiver . . . . \$7.00 | <input type="checkbox"/> Special Projects (Spring 1981) . . . . . \$4.50  |
| <input type="checkbox"/> 8-Ball Satellite TV Antenna . . . . . \$5.00        | <input type="checkbox"/> Special Projects #4 (Summer 1982) . . . . \$4.50 |
| <input type="checkbox"/> Build Your Own Robot . . . . . \$12.00              | <input type="checkbox"/> Special Projects #5 (Winter 1983) . . . . \$4.00 |
| <input type="checkbox"/> TV Descrambler (January, February 1981) \$3.00      | <input type="checkbox"/> Special Projects #6 (Spring 1983) . . . . \$3.50 |
| <input type="checkbox"/> Radio-Electronics back issues (1983) . . . . \$3.00 | <input type="checkbox"/> Special Projects #7 (Summer 83) NOT AVAILABLE    |
| (January, February 1983 not available)                                       | <input type="checkbox"/> Special Projects #8 (Winter 83) . . . . . \$3.00 |
| Write in issues desired.   | <input type="checkbox"/> Radio-Electronics Annual 1983 . . . . . \$3.50   |
| <input type="checkbox"/> Radio-Electronics back issues (1982) . . . . \$3.50 | <input type="checkbox"/> Radio-Electronics Annual 1984 . . . . . \$2.50   |
| (January 1982 not available)   | <input type="checkbox"/> Radio-Electronics Annual . . . . . \$2.50        |
| Write in issues desired.   | <input type="checkbox"/> How to Make PC Boards . . . . . \$2.00           |
| <input type="checkbox"/> Radio-Electronics back issues (1981) . . . . \$4.00 | <input type="checkbox"/> All About Kits . . . . . \$2.00                  |
| (February, March, December 1981 not available)                               | <input type="checkbox"/> Modern Electronics (Vol. 1. #1 . . . . . \$2.25  |
| Write in issues desired.   | April 1908)   |
| <input type="checkbox"/> Etch your own PC boards . . . . . \$3.00            | <input type="checkbox"/> Electro Importing Co. Catalog . . . . . \$4.95   |
|  | (1918) (176 pp)   |

To order any of the items indicated above, check off the ones you want. Complete the order form below, include your payment, check or money order (DO NOT SEND CASH), and mail to Radio-Electronics, Reprint Department, 200 Park Ave. South, New York, NY 10003. Please allow 4-6 weeks for delivery.

If you need a copy of an article that is in an issue we indicate is unavailable you can order it directly from us. We charge 50¢ per page. Indicate the issue (month & year), pages and article desired. Include payment in full, plus shipping and handling charge.

ARTICLE \_\_\_\_\_  
MONTH \_\_\_\_\_ YEAR \_\_\_\_\_  
PAGES \_\_\_\_\_  
TOTAL PAGES \_\_\_\_\_ @ 50¢ each TOTAL PRICE \_\_\_\_\_

MAIL TO: **Radio-Electronics** 1-84  
Reprint Department, 200 Park Ave. South, New York, NY 10003 **All payments must be in U.S. funds**

Total price of order . . . . . \$ \_\_\_\_\_  
Sales Tax (New York State Residents only) . . . . . \$ \_\_\_\_\_  
Shipping & Handling (U.S. & Canada only) (Includes FIRST CLASS POSTAGE) \$1.00 per item . . . . . \$ \_\_\_\_\_  
All other countries (\$2.00 per item, sea mail) . . . . . \$ \_\_\_\_\_  
(\$4.00 per item, air mail) . . . . . \$ \_\_\_\_\_

Total Enclosed . . . . . \$ \_\_\_\_\_  
Name \_\_\_\_\_  
Address \_\_\_\_\_  
City \_\_\_\_\_ State \_\_\_\_\_ Zip \_\_\_\_\_

credits are accepted by some colleges for work toward a degree.

Overall, the Heath EE-101 Operational Amplifier Course is a worthwhile instructional program and one of the best ways we know of to learn about operational amplifiers. R-E

### Triplet Model 3550 DMM

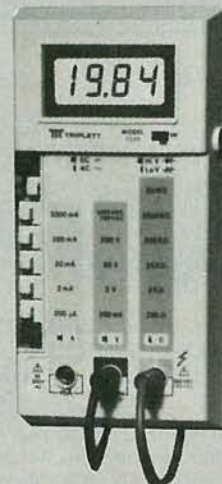

CIRCLE 103 ON FREE INFORMATION CARD

Triplet	3550									
OVERALL PRICE										
EASE OF USE										
INSTRUCTION MANUAL										
PRICE/VALUE										
	1	2	3	4	5	6	7	8	9	10
	Poor			Fair			Good			Excellent

THE WORLD OF ELECTRONIC TECHNOLOGY is changing so rapidly that it is hard to imagine what tomorrow will bring. And as electronic equipment becomes more and more sophisticated, so must the instruments used to service it. That, of course, holds true for DMM's. Over the years, that basic instrument has been constantly upgraded and redesigned to make test and repair procedures more simple, less time consuming, and more accurate. The Triplet Corporation (One Triplet Drive, Bluffton, OH 45817) in keeping with that trend, has introduced the model 3550, the latest in its line of DMM's. We thought you might like to know a little about it.

That meter is designed for ease of use. For instance, the eight range and function controls are located so that they can be operated by the hand holding the meter, leaving the other one free for placing probes, etc. Those probes connect to the device through three jacks that are located at the bottom of the case. The jacks are of the recessed type, meaning that there is no metal exposed when the probe is plugged

*continued on page 32*



# The complete library of replacement semi's.

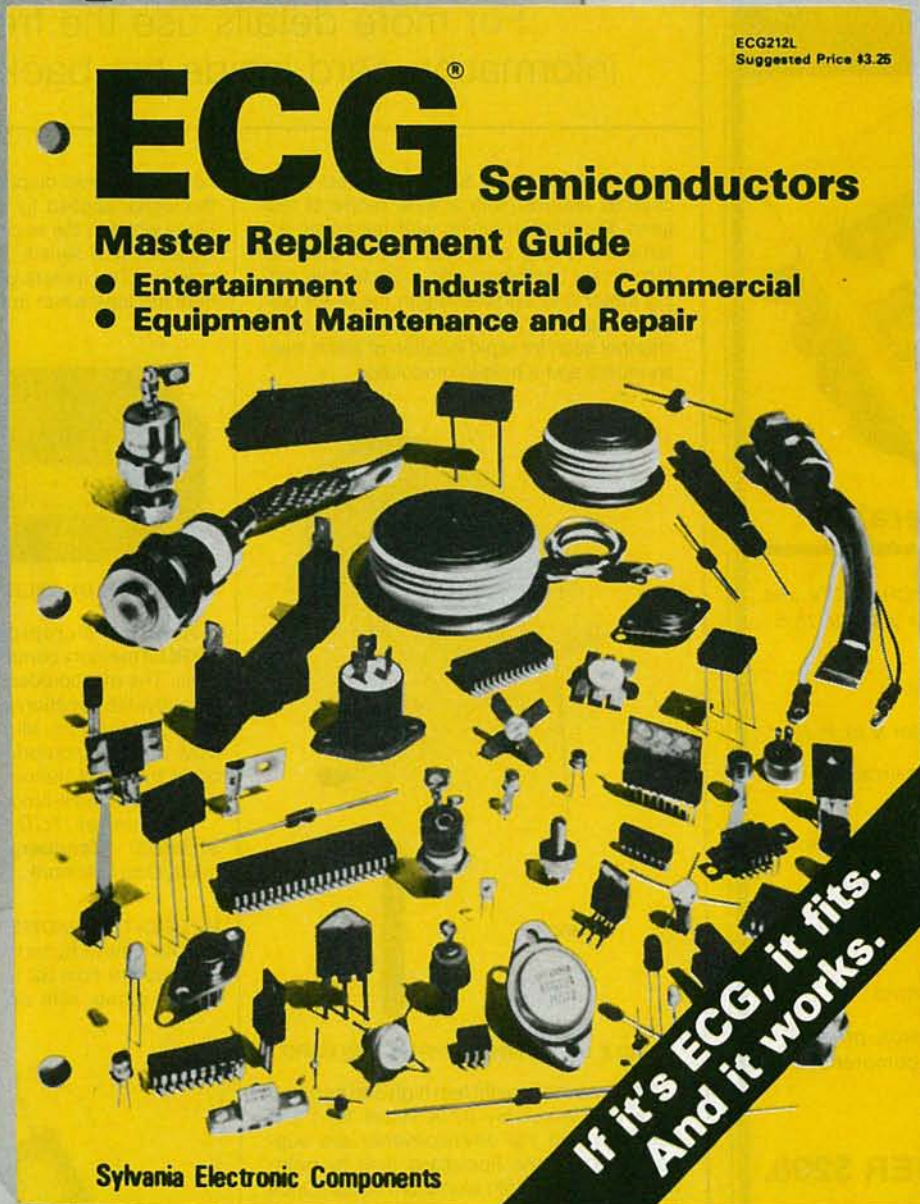

ECG212L  
Suggested Price \$3.25

## • ECG<sup>®</sup> Semiconductors

### Master Replacement Guide

- Entertainment • Industrial • Commercial
- Equipment Maintenance and Repair

Sylvania Electronic Components

**If it's ECG, it fits.  
And it works.**

Here's the one guide that has it all—the new ECG<sup>®</sup> Master Guide. It's 545 pages, packed with over 3000 ECG semiconductors that replace over 200,000 industry numbers. And our replacements meet or exceed the specs of the original parts. So if it's ECG, you can count on it to fit and work.

Reduce equipment downtime and save yourself endless hours of parts hunting. For everything from analog amplifiers to zener diodes, go with replacement semiconductors from ECG. Get your new ECG Master Guide and our "Counterpoints" product updates from your nearest distributor. For his name and number, call 1-800-225-8326 toll-free (in Massachusetts, dial 1-617-890-6107). Or just send \$3.25 for your ECG Master Guide to Philips ECG, Inc., Dept. RE, 70 Empire Drive, West Seneca, NY 14224.

**If it's ECG, it fits.  
And it works.**

**Philips ECG**

A North American Philips Company

CIRCLE 38 ON FREE INFORMATION CARD



# BIG PERFORMANCE

# small PACKAGE

## Model 240



### Video Generator

- Video output for all VCR, CCTV and Monitor Applications  $\pm 1$  volt into 75  $\Omega$  load
- RF output: CH 2, 3, 4
- Scope trigger output for V or H sync
- 10 step gray-scale staircase signal for video circuit analysis
- 10 bar and 3 bar gated rainbow pattern
- 8 other dot, bar and line patterns
- Operates from 2 std. 9V batteries or 115VAC
- Single slide switch control
- Complete with test leads, protective cover, AC adapter, comprehensive instruction manual

**PRICED UNDER \$200.**  
**THE 240 DOES SO MUCH**  
**FOR SO LITTLE!!**



THE HICKOK ELECTRICAL INSTRUMENT CO.  
 10514 Dupont Avenue • Cleveland, Ohio 44108  
 (216) 541-8060 • TWX: 810-421-8286

CIRCLE 85 ON FREE INFORMATION CARD

# NEW PRODUCTS

For more details use the free information card inside the back cover

**SATELLITE EARTH STATION**, offers a 24-channel receiver with a wide range of features. Pushbutton tuning with automatic polarity switching and LED digital channel display are combined with a center/fine tuning meter and signal-strength meter for precise reception. Additional features include channel scan for rapid location of active transponders and a built-in modulator.



CIRCLE 104 ON FREE INFORMATION CARD

The antenna is eight feet high and its prime focus-feed assembly (LNA scaler feed and polarizer) and the downconverter are supported above the fiberglass dish by lightweight, high-strength aluminum struts. Once installed and aligned, the polar mount provides full domestic satellite coverage through a single manual (or optional remote-control) motorized adjustment. It is designed to withstand hurricane-force winds in excess of 100 miles per hour.

The *Satellite Earth Station* is priced at \$2495.00.—**Channel Master**, Division of Avnet, Inc., Ellenville, NY 12428.

**TAPE DECK**, the model *TCD 3014* cassette recorder has separate record and playback heads to enable the user directly to compare the input signal with its recorded result. User adjustments for bias, sensitivity, and record-head azimuth are facilitated by two built-in test generators. Equalized peak-reading meters with rapid attack and slow release show the precise signal level being fed to the tape, and eliminate the uncertain readings of

segmented-level displays. The meters show the signal applied to the record head at all times when in the RECORD mode, even if the TAPE/SOURCE switch is moved to the TAPE position. The meters only indicate the signal from the tape when in the PLAY mode.

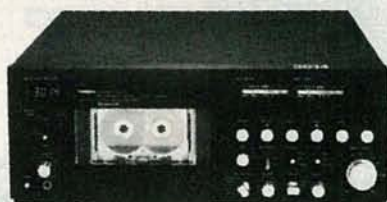

CIRCLE 105 ON FREE INFORMATION CARD

An 8-bit microprocessor with a 32K EPROM memory controls all transport operations. The microprocessor allows almost any conceivable function of scan, search, and memory functions, all accessed by pressing STOP and an appropriate combination of the other transport buttons. All transport touch sensors are multi-functional.

The model *TCD 3014* is priced at \$1,395.00.—**Tandberg of America, Inc.**, Labriola Court, Armonk, NY 10504.

**HYGRO-THERMOMETER**, model *DH200*, checks relative humidity from 10 to 95% and temperature from 32 to 175 degrees F via a remote probe, with an accuracy of  $\pm 2.0\%$



CIRCLE 106 ON FREE INFORMATION CARD

(RH) and  $\pm 0.5$  degrees F (temperature). Response time is two to three minutes from 10 to



# Amazing new solid-state oscilloscope... fits in the palm of your hand

**CRT oscilloscopes just became obsolete!** The revolutionary new solid-state digital LED Pocket-O-Scope does it all, in a 4-ounce package you can put in your pocket.

**Easy to use.** Ideal for the hobbyist or the technician. The Pocket-O-Scope is 100% solid-state, focus and brightness on the 210 point, high-intensity illuminated screen are *electronically* self-controlled. The trace is *always* in sharp focus. Zero and sweep positions are maintained automatically. Zero-reference, or cross-over line is always centered for full trace minimum on the screen. Automatic internal circuitry always assures a properly positioned wave form. **4 solid-state controls do it all.** The only knobs on the Pocket-O-Scope are for positive and negative sensitivity and for coarse and fine synchronization of the frequency of the incoming signal. The easiest to use, full capability scope available!

**Years in development.** The Pocket-O-Scope is the culmination of years of development in high technology, micro-electronic components and digital design.

**Features:** All solid-state, digital design • Hand-held or bench operation • High resolution 210 point, 1.5" square display • Battery or A/C operation with adapter • Factory calibrated – *never requires recalibration* • Full function, single trace capability plus 1/2 channel dual trace and signal inverter • Full overload protection to prevent damage to scope



Patent Pending

Automatic zero voltage centering • Automatic free run or locked image • Automatic full horizontal sweep circuit • External input/output for add-on capability

**Specifications:**  
 5 Megahertz bandwidth • Sensitivity – vertical, 10MV • Accuracy  $\pm 3\%$  on wave forms – sweep linearity  $\pm 5\%$  • Time base – .1 microseconds to .5 seconds

• Vertical gain – 0 to 120 volts • Continuous free run to locked image response • Power supply 9VDC – dual polarity  
**Controls:** Single or dual trace • On-off, battery-A/C • Sensitivity; separate pos. & neg. controls • Sync C & Sync F controls

**Limited, 90-day warranty**

**No risk introductory offer.** The revolutionary Pocket-O-Scope is a development of Calvert Instruments, Inc., for 25 years a manufacturer of electrical equipment. As an introductory offer for a limited time only, you can buy the Pocket-O-Scope including a carrying case, A/C adapter, 3 standard "grabber" probes and 2 high voltage probes for only \$249.95, a \$321 value. If you act now, you will also receive FREE Calvert's 200-page Comprehensive Oscilloscope Training Manual, a \$15.95 value!

Put your Pocket-O-Scope to the test for two weeks. And if you decide, for *any* reason, that the Pocket-O-Scope is not for you, return it within the 14-day trial period for a prompt refund. The training manual will still be yours to keep.



**Mail this coupon today, or call toll-free\* while the introductory offer is still in effect.**

**Calvert Instruments, Inc.**

19851 Ingersoll Dr., Cleveland OH 44116 • 216-356-2155

Please send me:

Pocket-O-Scope(s), including carrying case, A/C adapter, standard and high voltage probes, and FREE training manual. (Batteries not included) all for \$249.95 plus \$5 for postage and insurance. Ohio residents add 6.5% sales tax.  
 Pocket-O-Scope only with standard probes: \$179.95 plus \$5 postage. Ohio Residents add 6.5% sales tax.

My check is enclosed.  
 Please charge the credit card account checked below. (Fill in all account number digits of the *one* credit card you wish to use.) **RE-184**

MasterCard  Visa

Expiration Date \_\_\_\_\_ Interbank No. \_\_\_\_\_  
 (MasterCard only)

Full signature \_\_\_\_\_

Name \_\_\_\_\_ (please print)

Address \_\_\_\_\_ Apt. \_\_\_\_\_

City \_\_\_\_\_

State \_\_\_\_\_ Zip \_\_\_\_\_

\*CALL TOLL-FREE 800-835-2246 EXT. 118 to order by phone, request further information or to inquire about becoming a distributor. In Kansas, call 800-362-2421 Ext. 118. Allow 6-8 weeks for delivery.

CIRCLE 7 ON FREE INFORMATION CARD



**WP-709.  
Double-slot  
Supplyst™  
power supply.**

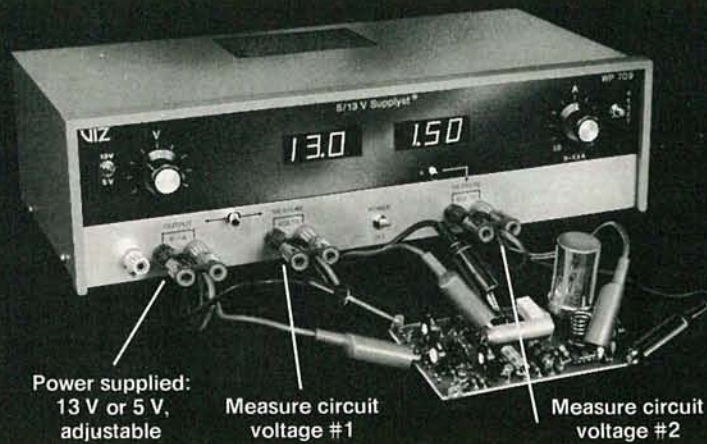

Power supplied:  
13 V or 5 V,  
adjustable

Measure circuit  
voltage #1

Measure circuit  
voltage #2

Outputs: 5V or 13V DC,  
adjustable  $\pm 1\frac{1}{2}$ V  
Zero to 7.5 amp, each voltage.

Two LED displays,  
monitor V or A—  
or two DC voltmeters

Adjustable current limiting

Only  
**\$339.00**

# DC power to test logic or mobile equipment. Another VIZ Value

**HERE'S REAL PRECISION**  
Select the precise voltage you want: 5V or 13V, adjustable  $\pm 1\frac{1}{2}$ V at each range. Output is laboratory quality. Ripple less than 10mV, peak to peak. Regulation better than 0.1%.

**HERE'S REAL POWER**  
Up to 7.5 amp. at each voltage—

plenty for computer circuits, PA systems, mobile transmitters, autos, boats, planes.

**HERE'S REAL CONVENIENCE**  
Front panel controls for instant voltage adjustment and precise fine adjustment to within 0.1V. Two 3-digit LED displays permit continuous

monitoring of both voltage and current during use. Current limiting control with instant pushbutton reset.

The WP-709 is like two precision power supplies for a price less than you might pay for one— PLUS two digital DC voltmeters.

## VIZ Supplyst™

power supplies with digital displays of voltage and current

Fully regulated, adjustable current limiting power supplies, PLUS two built-in digital DC voltmeters in a single quality unit. Digitally monitor output voltage or current, or two external voltages.



**WP-705 \$325.00**

Single output  
0-50VDC, 0-2A.

**WP-706 \$341.00**

Single output  
0-25VDC, 0-4A.



**WP-707 \$423.00**

Dual output  
Two 0-25VDC, 0-2A.

**WP-708 \$489.00**

Triple output Two 0-20VDC, 0-2A.  
One 5VDC, 0-4A.



## VIZ DC power supplies

Fully regulated, continuously adjustable voltage outputs with short circuit protection. Analog meters and overload indicators.



Dual WP-702A Two 0-20VDC, 0-200mA **\$167.00**



Single WP-703A  
0-20VDC, 0-500mA **\$119.00**

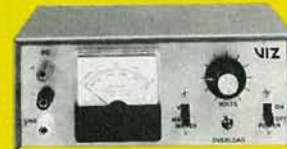

Single WP-704A  
0-40VDC, 0-250mA **\$125.95**

### VIZ RELIABILITY

VIZ is a 50 year-old company. Our instruments are fully warranted, parts and labor, for a year. All items tested to NBS standards. We offer service and parts availability for a minimum of ten years. Over 15 repair depots in U.S.A.

Want full technical details and a demonstration? Call toll-free, 1-800-523-3696, for the VIZ distributor nearest you



**Look to VIZ for value, quality, availability.  
Over 70 instruments in the line— PLUS full accessories.**

VIZ Mfg. Co., 335 E. Price St., Philadelphia, PA 19144



50% RH and three to five minutes from 50 to 90% RH. It is supplied complete with remote probe, carrying case, and battery. The model *DH200* is priced at \$249.00.—**Pacer Industries, Inc.**, 1450 First Avenue, Chippewa Falls, WI 54729.

**COMPUTER SYSTEM**, the *Jupiter Ace 4000*, uses the FORTH programming language and can serve as an intelligent programmable controller when combined with interfaces suitable for control of DC or AC power.

The basic machine includes the *Z80A* microprocessor operating at 3.25 MHz, an implementation of the FORTH 79 standard in ROM, and an internal timer. User RAM is expandable to 51K. It supports a text mode of 32 columns by 24 lines and a low-resolution graphics mode of 64 by 46 pixels. A 256- by 192-pixel mode is also available. The machine can be directly connected to video monitors.

The *Jupiter ACE 4000* has 40 moving keys with auto repeat, caps lock, and alternate functions. Sound is available through an internal speaker. A high-speed cassette interface provides program and data storage.



CIRCLE 107 ON FREE INFORMATION CARD

Expansion capability has been provided through direct connection to the *Z80A* bus from a rear-panel connector. ROM, RAM, or peripherals can be connected to the expansion port. The FORTH words IN and OUT can directly address peripherals at assigned port numbers.

The *Jupiter ACE 4000* is priced at \$175.00. The book, *Jupiter Ace—FORTH Programming*, is available for \$14.95 separately.—**Computer Distribution Associates**, 17 South Main Street, Pittsford, NY 14534.

**RECEIVERS**, model *KR-950* (shown) and model *KR-930* are computerized AM/FM stereo receivers, featuring digital quartz-PLL synthesizer tuning systems, digital two-deck tape dubbing/monitoring, dual speaker-system capability (A, B, A + B), and headphone jacks. The tuner sections provide presets for six FM and six AM stations, and automatic scan tuning.

The model *KR-950* delivers 80 watts per channel, minimum RMS, both channels driven at 8 ohms from 20 to 20,000 Hz with no



CIRCLE 108 ON FREE INFORMATION CARD

more than 0.01% harmonic distortion. FM sensitivity is 1.9  $\mu$ V; signal-to-noise ratio is 80 dB in mono, 76 dB in stereo. It is priced at \$530.00.

The model *KR-930* has a minimum output of 50 watts per channel RMS, both channels driven at 8 ohms, with no more than 0.05% THD. FM sensitivity is 1.9  $\mu$ V and signal-to-noise ratio is 80 dB (mono) and 76 dB (stereo). It is priced at \$380.00.—**Kenwood**, 1315 East Watsoncenter Road, Carson, CA 90745.

**LIGHTING INSTRUMENT**, model *MX114*, is a combination fluorescent lamp with a 5-inch, 3 $\times$  distortion-free magnifying lens. It is constructed of heavy-duty metal, fully adjustable to any angle, with a maximum reach of 45 inches. Included with the lamp is a 22-watt circline fluorescent light and a heavy-duty



CIRCLE 109 ON FREE INFORMATION CARD

clamp-type mounting bracket. The model *MX114* is priced at \$79.95.—**Ora Electronics**, 18215 Parthenia St., Northridge, CA 91325.

**PLOTTERS**, model *HP 7475A* (shown at right in photo) and model *HP 7470A* (shown at left in photo) are compatible with personal computers from Apple, IBM, Hewlett-Packard, and many others.

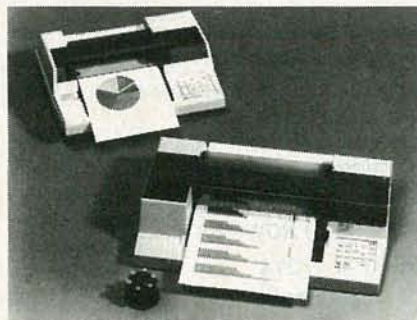

CIRCLE 110 ON FREE INFORMATION CARD

The model *HP 7475A* accepts 11  $\times$  17-inch paper, 8 $\frac{1}{2}$   $\times$  11-inch paper, and overhead-transparency film. With its six-pen carousel, the plotter can produce a variety of multicolor pie, bar, line, and text charts. Resolution is as fine as 0.001 inches.

Pens are selected from the carousel by either front-panel controls or program commands. When returned to the carousel, pens are capped automatically to prevent dry-out. A variety of pen colors and widths is available.

*continued on page 114*

## New from B&K-PRECISION



## Auto/manual ranging DMMs from \$75

### Model 2806

- Autoranging on volts and ohms
- Manual ranging on amps
- 0.7% DC accuracy
- 500 hour battery life
- Continuity test beeper
- Diode check
- Transient and overload protected
- High energy fuse

### Model 2807 \$115

Manual or autoranging on volts and ohms with 0.5% DC accuracy.

### Model 2816 \$150

Same features as 2807 with 0.25% DC accuracy.

For more information contact your  
B&K-PRECISION  
distributor or write for specifications.

**BK PRECISION**  
**DYNASCAN**  
**CORPORATION**

6460 West Cortland Street  
Chicago, Illinois 60635 • 312/889-9087

International Sales, 6460 W. Cortland St., Chicago, IL 60635  
Canadian Sales: Atlas Electronics, Ontario

South and Central American Sales,  
Empire Exporters, Plainview, NY 11803

CIRCLE 77 ON FREE INFORMATION CARD



## The Most Valuable Tool on Your Workbench

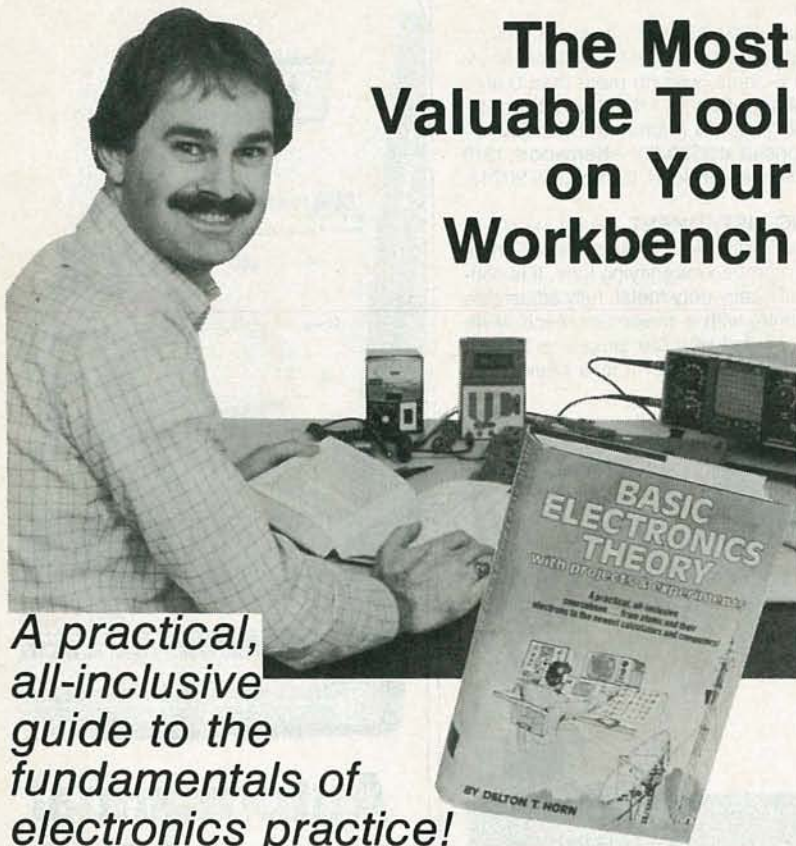

**A practical, all-inclusive guide to the fundamentals of electronics practice!**

"All of the information needed for a basic understanding of almost any electronic device or circuit," says **Radio Electronics**.

A complete self-study course in electronics, this incredibly thorough sourcebook covers everything from atoms and electrons to the newest computer and digital electronics technology!

An ideal reference for every hobbyist and experimenter, it's arranged in logical chapter groupings by topic so you can quickly and easily locate exactly the information you need when you need it!

Packed with hands-on experiments that demonstrate how electronics theories work in real life applications... 530 information-filled pages and more than 700 clear, concise drawings, illustrations, and schematic diagrams!

Save 20% by ordering your copy of **Basic Electronics Theory** now, during this special Limited-time offer!

Order by mail, or Call Toll Free 800-233-1128 (Alaska, Hawaii, and Pennsylvania Call Direct: 717-794-2191)

### 10-Day FREE Trial Offer

Examine FREE for 10 Days. If not completely satisfied, return the book. You'll pay nothing, owe nothing.



TAB BOOKS Inc.

P.O. Box 40, Blue Ridge Summit, Pa. 17214

ORDER NOW—SAVE 20%!

Please send me **Basic Electronics Theory With Projects & Experiments** (Order No. 1338H), a regular \$19.95 value for \$15.95. (**Limited Time Offer**)

Bill me \$ \_\_\_\_\_ (plus postage and handling)

Check enclosed for \$ \_\_\_\_\_ (TAB pays postage and handling)

Charge my  VISA  MasterCard (TAB pays postage and handling)

Account No. \_\_\_\_\_ Expires \_\_\_\_\_

Signature \_\_\_\_\_

Name \_\_\_\_\_

Address \_\_\_\_\_

City/State/Zip \_\_\_\_\_

Pa add 6% sales tax. Foreign customers must pay in advance in U.S. dollars.

RET-14B

in. In addition, when plugged in, the probes seat firmly, making it difficult to accidentally unplug them. The probes that come with the meter have a protective collar for working safely with high voltages, and sharp tips to make good contact on PC boards, etc.

All measurements are shown on a large, 3½-digit LCD readout. Decimal-point placement is automatic. Display annunciators include polarity and low battery. Battery life is claimed to be 200 hours with a standard nine-volt transistor-radio-type battery, or longer if alkaline units are used.

Looking more closely at the controls, two of them (located at the top and bottom of the row of pushbutton switches) are used to select the functions. The bottom switch is used to select whether current/voltage or resistance is to be measured; whether current or voltage is to be measured is determined by which of the input (mA or VΩ) jacks the positive lead is connected to.

The top switch is used to set the meter to measure either AC or DC voltage or current. Also, when measuring resistance, the top switch is used to set the meter to either the HI V or LO V mode. In the HI V mode, the meter has an output of 3 volts; that's enough to turn on any diode or transistor junction without damaging the device. That mode is useful for testing diodes, transistors, etc. In the LO V mode, the meter has an output of 0.26 volt; that is useful for testing circuits that contain semiconductors such as diodes and transistors because that low voltage level will not turn on a junction.

The remaining six switches are used for range selection. The meter measures AC and DC current in 5 ranges, from 200μA to 2000 mA, full scale. Resistance is measured over 6 ranges, from 200 ohms to 20 megohms, full scale. Turning to voltage, it is measured over 5 ranges, from 200mV to 1000 DC (750 AC), full scale.

Every range, including the resistance ranges, is overload protected to 250-volts RMS according to the manufacturer. The meter's accuracy is claimed to 0.25%. The response time is good for a meter of this type, varying between one and eight seconds, depending on the function and range.

The attractive tan case is made of high-impact plastic. There is a flip-out bail in the rear for bench use.

The instruction manual is simple, yet contains all the information most users are likely to need including a schematic and parts list. The meter is covered by a one-year limited warranty.

All-in-all, the model 3550 is a very useful little instrument for the hobbyist or technician. It carries a suggested list price of \$85.

R-E



# ELECTRONIC GIFT IDEAS!

**NEW! NO INSTALLATION  
REQUIRED**

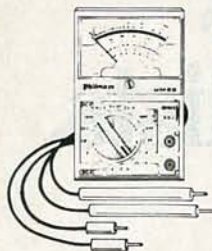

## AC/DC 2000 OHM/VOLTMETER MULTIMETER

This pocket size, battery-operated multimeter has 15 ranges, selector switch, and comes with its own test leads. Perfect for hobbyists and technicians who like a bargain.

**\$17<sup>98</sup>**  
only  
Model UM 20

## 3½ DIGIT LOW-COST VOLT/OHM MILLIAMMETER

This low-cost digital meter has: 10 Megohm input impedance AC&DC, with accuracy at DCV  $\pm 0.8\% \pm 1$  digit, ACV  $\pm 1.2\% \pm 2$  digits. It has auto polarity, auto zero and 24 ranges. Fuse overload protection, test leads, battery and carrying case included at this low price.

**\$71<sup>88</sup>**  
only  
Model MD 100

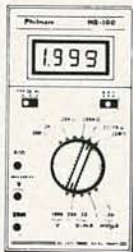

## PRECISION DMM WITH ±.25% DCV ACCURACY AT THIS LOW, LOW PRICE

More features for this price than you would imagine: 10 amp range, AC and DC, extended 2,000 hour battery life, 250 mV for in-circuit resistance measurement, 2.8 Volts for diode testing on "Ohms." Heavy-duty test leads and carrying case included.

**\$91<sup>88</sup>**  
Model MD210

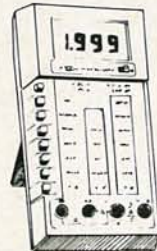

Here's the new low-cost Simpson 470 meter you've heard so much about! With 0.15% DCV accuracy and full measurement capability—100 mV to 1000 VDC, 100 mV to 750 VAC, 0.1  $\Omega$  to 19.99 M $\Omega$ , AC/DC current up to 10A, plus a full line of available accessories. Battery, test leads and manual included. Made in U.S.A.

**\$138<sup>88</sup>**  
Model 470



## NEW CIRCUITMATE DMM's from BECKMAN

Features: 3% DC Volts accuracy, 5 AC/DC ranges, 6 resistance ranges, diode test function, plus the kind of quality you'd expect from Beckman.

**\$69<sup>88</sup>**  
only  
Model DM40



Features: .5% DC Volts accuracy, 15 AC/DC Volts ranges, 6 current ranges, 6 resistance ranges, diode test, continuity beeper, and Beckman quality at this very low price.

**\$89<sup>88</sup>**  
Model DM45

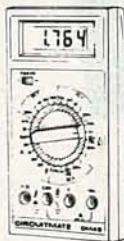

## MODEL PS101 POWER SUPPLY

**\$119<sup>88</sup>** A LOW-COST, QUALITY  
TRIPLE-REGULATED  
POWER SUPPLY!!!

Designed for hard-to-please, but budget-minded lab technicians, students and hobbyists, the DC triple regulated variable power supply has all the features you could ask for, plus a full 1 year manufacturer's warranty:

3 outputs:  
Fixed 5 VDC  $\pm 0.2V$   
2 variable  $\leq 1\frac{1}{2} V$  to  $\geq 15 VDC$   
Polarity: floating; can be used as pos. or neg.

Ripple less than 10mV at full load  
Regulation  $\leq 1\%$  no load to full load  
Line regulation  $< 0.2\%$  108 VAC to 135 VAC.

Current:  
Fixed supply 1.0 amp max.  
Variable supplies 0.5 amp max.

Protection built in, current limiting, with thermal shutdown.

Power: 108-135 VAC.

Dimensions: 8¼" x 3¼" x 7¼" (WxHxD)

Wood grain finished metal case.

Weight: 4 lbs., 9 ozs.

Lighted on/off power switch, easy-to-read Voltmeter and large binding posts.

Warranty: one year full replacement warranty from date of purchase.



## MURA MM-100 COMPUTER TELEPHONE MODEM

### Features:

- 0-300 Baud compatible with most time-shared computer systems
- Full duplex operation
- RS232C connector interface
- Carrier Detect indication
- Top quality at this low, low price
- Answer/Originate/Off select switch

LIST PRICE  
\$99.95  
Model MM-100  
**\$79<sup>88</sup>**

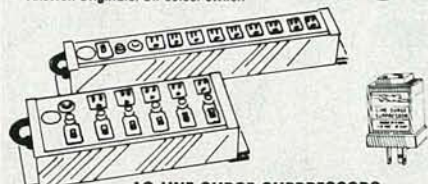

## AC LINE SURGE SUPPRESSORS

Protect your delicate computer and expensive equipment from destructive and dangerous transient AC line surges.

Spikes suppressed 6,000 Amps. max. energy absorbed 50 JOULES; spike clamping starts 184V, max. spike voltage allowed 340V.

Model 009 **\$79<sup>88</sup>**  
9 outlets

Model 010 **\$85<sup>88</sup>**  
5 outlets

Model 012 **\$37<sup>88</sup>**  
1 outlet

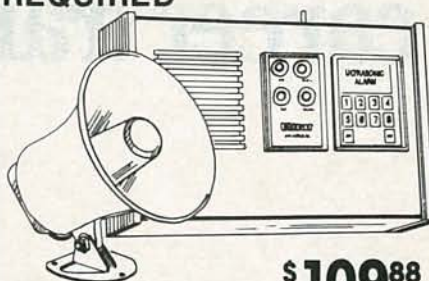

## BURGLAR ALARM

Ideal for home or office, this ultrasonic burglar alarm requires no installation. Just plug it in, enter your secret code through the push-buttons for operation. Full battery back-up. Covers up to 600 square foot area. Has own internal alarm, or add the external horn (shown) as an accessory. Entry and exit delays—5-minute automatic shut-off and alarm memory.

**\$109<sup>88</sup>**

Model ULTRAR  
SP-1212 External  
Horn Option \$24.88

## SPECO HI-FI/STEREO/ BIG SOUND CROSSOVER NETWORKS

HN3-60 **\$10<sup>88</sup>**  
60 Watt 3-Way  
Crossover Network  
EACH

HN3-100 **\$16<sup>88</sup>**  
100 Watt 3-Way  
Crossover Network  
EACH

HN3-200 (shown) **\$29<sup>88</sup>**  
200 Watt 3-Way  
Crossover Network  
EACH

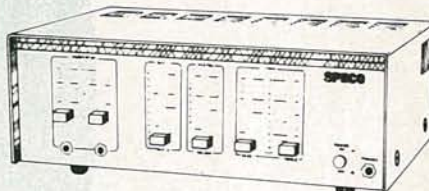
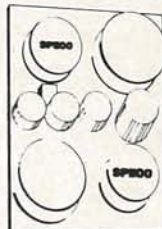

## SPECO PROFESSIONAL QUALITY PA AMPLIFIERS

Model PAT-30  
30 Watts Music Power  
50-18,000 Hz Freq. Response  
4 Controls (MIC-1, MIC-2, AUX & TONE) **\$117<sup>88</sup>**

Model PAT-60  
60 Watts Music Power  
100-20,000 Hz Freq. Response  
4 Controls (MIC-1, MIC-2, AUX (Fader) & TONE) **\$147<sup>88</sup>**

Model PAT-120 (shown)  
120 Watts Music Power  
50-20,000 Hz Freq. Response  
6 Controls (MIC-1, MIC-2, VOLUME (Master), BASS, TREBLE & AUX (Fader) ) **\$277<sup>88</sup>**



ALL ITEMS CARRY FULL  
MANUFACTURER'S  
WARRANTY PLUS OUR  
COMPLETE 45 DAY  
MONEY BACK  
GUARANTEE!

# ELECTRONICS WAREHOUSE

Halls Rd. - P.O. Box 624 - Old Lyme, CT 06371

TERMS: U.S. funds, Visa, Amex, MC, Money Order, Check (allow 2 weeks to clear). CT residents add 7½% sales tax. Sale prices for prepaid orders only. Prices and availability of product subject to change without notice. Write for free catalog. C.O.D. orders cash or certified check add \$1.60. Shipping and handling charges add \$3.60 for orders under \$100, add \$7 for orders over \$100 (air freight extra).

TELEPHONE ORDERS  
FILLED FAST! ORDER  
DESK OPEN FROM 9  
A.M. TO 5 P.M. EST. CALL  
(203) 434-8308.



CIRCLE 33 ON FREE INFORMATION CARD



# At CIE, you get electronics career training from specialists.



**If you're interested in learning how to fix air conditioning, service cars or install heating systems— talk to some other school. But if you're serious about electronics... even earning an Associate Degree... come to CIE —The Electronics Specialists.**



**Why trust your education and career future to anything less than a specialist?**

You shouldn't. And you certainly don't have to. If you talked to some of our graduates, chances are you'd find a lot of them shopped around for their training. They pretty much knew what was available. And they picked CIE as number one.

Be sure to shop around. Because, frankly, CIE isn't for everyone.

There are other options for the hobbyist. If you're the ambitious type—with serious career goals in electronics—take a close look at what we've planned for you at CIE. **What you should look for first.**

Part of what makes electronics so interesting is it's based on scientific discoveries—on ideas! So the first thing to look for is a program that starts with ideas and builds on them!

That's what happens with CIE's Auto-Programmed® Lessons. Each lesson takes one or two principles and helps you master them—before you start using them!

**How practical is the training?**

This is the next big important question. After all, your career will be built on what you can do—and on how well you do it.

Here are ways some of CIE's career courses help you get your "hands-on" training...

**With CIE's Personal Training Laboratory...**

you learn and review the basics—perform dozens of experiments. Plus, you use a 3-in-1 precision Multimeter to learn testing, checking, analyzing!

**When you get your own 5MHz, solid-state**

**oscilloscope,** you take some real professional steps. You use it as a doctor uses an X-ray machine—to "read" waveform patterns...lock them in...study, understand and interpret them!

**When you get your Digital Learning Laboratory,** you'll

be into digital theory—essential training today for anyone who wants to keep pace with the state of the art of electronics. With CIE's Digital Lab, you'll be applying in dozens of fascinating ways the theory you've learned. For example, you'll compare analog and digital devices. You'll learn to make binary to decimal conversions and to work with semiconductor devices and circuits. You'll see how digital equipment is vital to today's exciting, growing fields such as security... where digital theory provides the brains for space-age alarm and protective devices.

**You'll build your Microprocessor Training Laboratory,** a working microcomputer—from "scratch." You'll also learn how to program and interface it with displays, memories, switches, and more.

**Earn An Associate Degree from CIE.**

One of the best credentials you can have in electronics—or any other career field—is a college degree. That's why CIE gives you the opportunity to earn an Associate in Applied Science

in Electronics Engineering Technology. Any CIE career course can offer you credit toward the degree...more than half of the number needed in some cases.

You can also prepare for the government-administered FCC (Federal Communications Commission) Radiotelephone License, General Class. It can be a real mark in your favor... government-certified proof of your specific knowledge and skills.

**Shop around...but send for CIE's free school catalog first!**

Mail the card. If it's gone, cut out and mail the coupon. If you prefer to write, mention the name and date of this magazine. We'll send you a copy of CIE's FREE school catalog—plus a complete package of independent home study information! For your convenience, we'll try to have a representative contact you to

answer your questions. Mail the card or coupon—

or write: CIE, 1776 East 17th St., Cleveland, OH 44114.

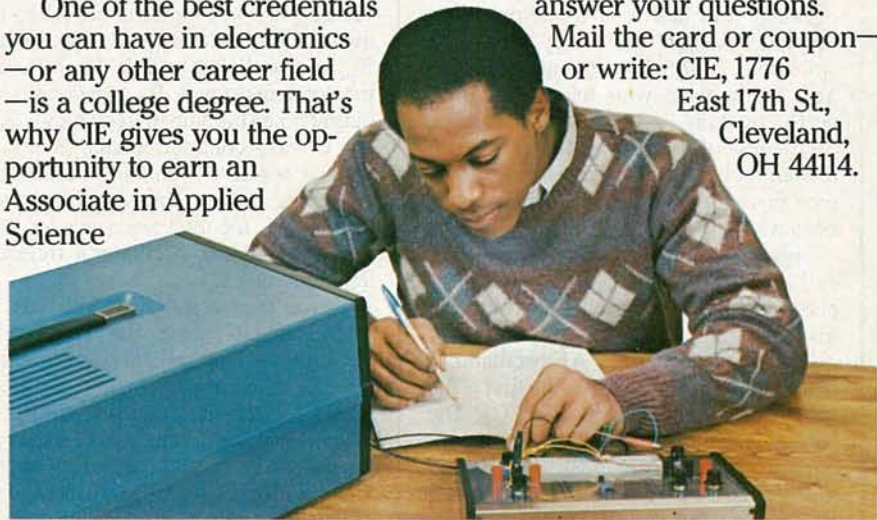

**CIE** **Cleveland Institute of Electronics, Inc.**  
1776 East 17th Street, Cleveland, Ohio 44114  
Accredited Member National Home Study Council

YES... I'm shopping around for the right kind of career training in electronics—and CIE sounds well worth looking into. Please send me my FREE CIE school catalog—including details about the Associate Degree program—plus my FREE package of home study information!

Print Name \_\_\_\_\_  
Address \_\_\_\_\_ Apt. \_\_\_\_\_  
City \_\_\_\_\_ State \_\_\_\_\_ Zip \_\_\_\_\_  
Age \_\_\_\_\_ Area Code/Phone No. \_\_\_\_\_ / \_\_\_\_\_  
Check box for G.I. Bill information:  Veteran  Active Duty

**MAIL TODAY!**

RE-76

JANUARY 1984



# NEW IDEAS

## Sliding-tone doorbell

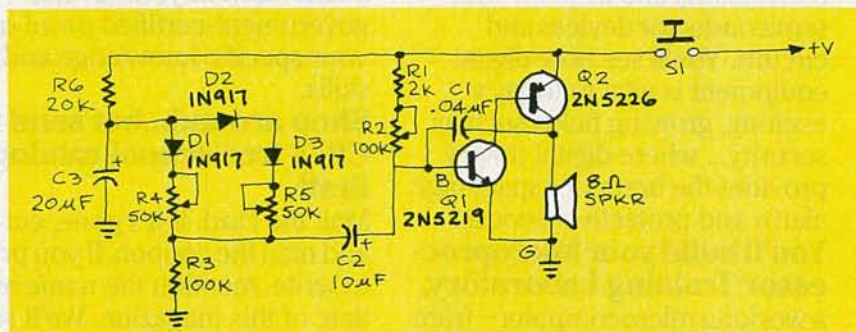

FIG. 1

HAVE YOU EVER BEEN STARTLED BY YOUR own doorbell? I have heard some doorbells that are so harsh and startling that they are sure to wreck anyone's nerves. But my doorbell is not of that type—at least not any more.

But if your bell *is* of that type, don't despair. I'll show you a way to prevent your quiet home from being disturbed. You can replace your harsh-sounding, nerve-wracking bell with what I'll call a "mild dose of sound stimulation." When the doorbell is pushed, you'll hear a low tone that will "slide up" to a higher frequency.

Figure 1 shows the sliding-tone doorbell circuit. It's made up of two main parts: an AF (Audio Frequency) oscillator and a variable resistance.

The frequency of the AF oscillator is determined by two factors. The first is the value of the coupling capacitor, C1. The second is the value of the resistance connected between the base of Q1 and ground. That resistance, which we'll call  $R_{BG}$ , is equal to  $(R1 + R2) \parallel R3$ .

When either of those two factors increases, the frequency of oscillation will

decrease. Thus, whenever  $R_{BG}$  or C1 decreases, the frequency will increase.

First, assume that S1 is closed and R2 has been adjusted to produce a pleasant, low-frequency tone. Capacitor C3 will charge through R6 until it reaches such a voltage that will cause diode D1 to conduct. When that happens, the value of  $R_{BG}$  is paralleled by R4. Thus, because the total resistance  $R_{BG}$  decreases, the output tone slides up in frequency. Capacitor C3 will continue to charge until the voltage across D2 and D3 causes those diodes to conduct. Then  $R_{BG}$  is paralleled also by R5, the total resistance again decreases, and the oscillator's frequency again increases.

If you're not satisfied with how the "bell" sounds, there are several things you can do. First, if you want to change the tone variation, feel free to try different values for R2, R4, and R5. And if you want to vary the sliding speed of the tone, then you can try different values of R6.

As with the rest of this easy-to-build circuit, the transistor types are not critical. Feel free to experiment!—Tseng C. Liao

### NEW IDEAS

This column is devoted to new ideas, circuits, device applications, construction techniques, helpful hints, etc.

All published entries, upon publication, will earn \$25. In addition, Panavise will donate their model 333—The Rapid Assembly Circuit Board Holder, having a retail price of \$39.95. It features an eight-position rotating adjustment, indexing at 45-degree increments, and six positive lock positions in the vertical plane, giving you a full ten-inch height adjustment for comfortable working.



I agree to the above terms, and grant **Radio-Electronics Magazine** the right to publish my idea and to subsequently republish my idea in collections or compilations of reprints of similar articles. I declare that the attached idea is my own original material and that its publication does not violate any other copyright. I also declare that this material has not been previously published.

Title of Idea

Signature

Print Name

Date

Street

City

State

Zip

Mail your idea along with this coupon to: **New Ideas Radio-Electronics**, 200 Park Ave. South, New York, NY 10003

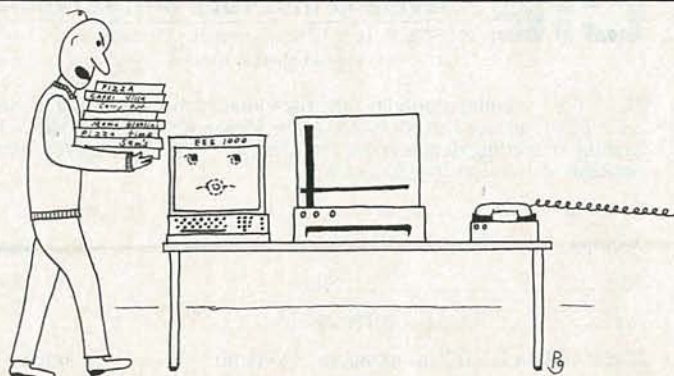

"One more stunt like this and I'll cut your modem cord!"



# UNGAR DESOLDERING & SOLDERING

## Special Pricing... Special Free Offer

### Hot VAC Desoldering System



Model 4000

Built-in vacuum pump eliminates the need for shop air. Compact design and portability make it ideal for use at any location where there is an AC electrical plug-in outlet.  
**Self-Contained, Super-Quiet Air Pump:** The vacuum pump is not only virtually maintenance free, it is remarkably quiet. The pump operates only when the handle switch is actuated.

**Temperature Control:** Variable solid-state control that adjusts the tip temperature from 500° - 1000° F. An electric circuit assures that transient spikes are fully suppressed thereby making the system safe for desoldering voltage-sensitive components.

Reg \$599.95  
**OUR SPECIAL PRICE**  
**\$379<sup>95</sup>**

### Electronic Temperature Controlled Soldering System with Built-in Controller



Model 9100

Includes: base unit with built-in controller, micro-size handle with THERMO-DURIC heater, 1/16" #9012 screwdriver tip, sponge and tip tray, sponge, and Iron Holder. A low cost alternative in an operator-adjustable, temperature controlled soldering system.

• Electronic, closed-loop temperature control for maximum precision • Temperature is operator-adjustable from 400° F to 800° F • Continuous, variable control so you can select the exact temperature you need • Neon "on-off" light • Iron Holder can be right- or left-hand mounted to accommodate all operators.

**OUR SPECIAL PRICE**  
**\$89<sup>95</sup>**

**FREE UNGAR 9100**  
 with purchase of  
 Ungar 4000

TOLL FREE (800) 645-9518

**FORDHAM**



260 Motor Parkway, Hauppauge, N.Y. 11788

in N.Y. State 800-832-1446

- VISA ■ COD ■ Master Charge
- Money Order N.Y. State residents add appropriate sales tax.
- Check
- COD's extra (required 25% deposit)

ADD FOR SHIPPING AND INSURANCE

\$250.00	to	500.00	.....	\$4.50
501.00	to	750.00	.....	6.50
751.00	to	1000.00	.....	8.50
over 1000.00	.....			12.50
				15.00

# FORDHAM DISCOUNTS DISCOUNT PRICES ON HITACHI SCOPES

**SPECIAL OFFER!**  
*For a limited time only*

### 35 MHz DUAL TRACE SIGNAL DELAY LINE

Vertical sensitivity 5m V/div to 5V/div and 1m V/div to 1 V/div with 5X amplifier • Trigger modes Automatic, Normal, TV (+), TV(-).

REG \$895  
**OUR PRICE**  
**\$599<sup>95</sup>**  
 WITH PROBES



Model V-352F

### 60 MHz DUAL TRACE DELAYED SWEEP

High sensitivity • 1 mV/div (10 MHz) • 5 ns/div sweep rate • 3rd channel display (trigger view) • Variable trigger hold-off • Full TV triggering • Single sweep • Automatic focus correction.

**OUR PRICE**  
**\$995**  
 WITH PROBES



Model 650F

### 100 MHz QUAD TRACE DELAYED SWEEP

Large, bright 8x10 cm screen • Quad trace operation/Ch1, Ch2, A trigger and B trigger • High sensitivity 500 μ V/div (5 MHz) • Full TV triggering.

**OUR PRICE**  
**\$1299<sup>95</sup>**  
 WITH PROBES

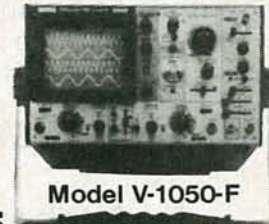

Model V-1050-F

TOLL FREE (800) 645-9518

**FORDHAM**



260 Motor Parkway, Hauppauge, N.Y. 11788

in N.Y. State 800-832-1446

- VISA ■ COD ■ Master Charge
- Money Order N.Y. State residents add appropriate sales tax.
- Check
- COD's extra (required 25% deposit)

ADD FOR SHIPPING AND INSURANCE

\$250.00	to	500.00	.....	\$4.50
501.00	to	750.00	.....	6.50
751.00	to	1000.00	.....	8.50
over 1000.00	.....			12.50
				15.00



# Where's Your **ELECTRONICS** Career Headed?

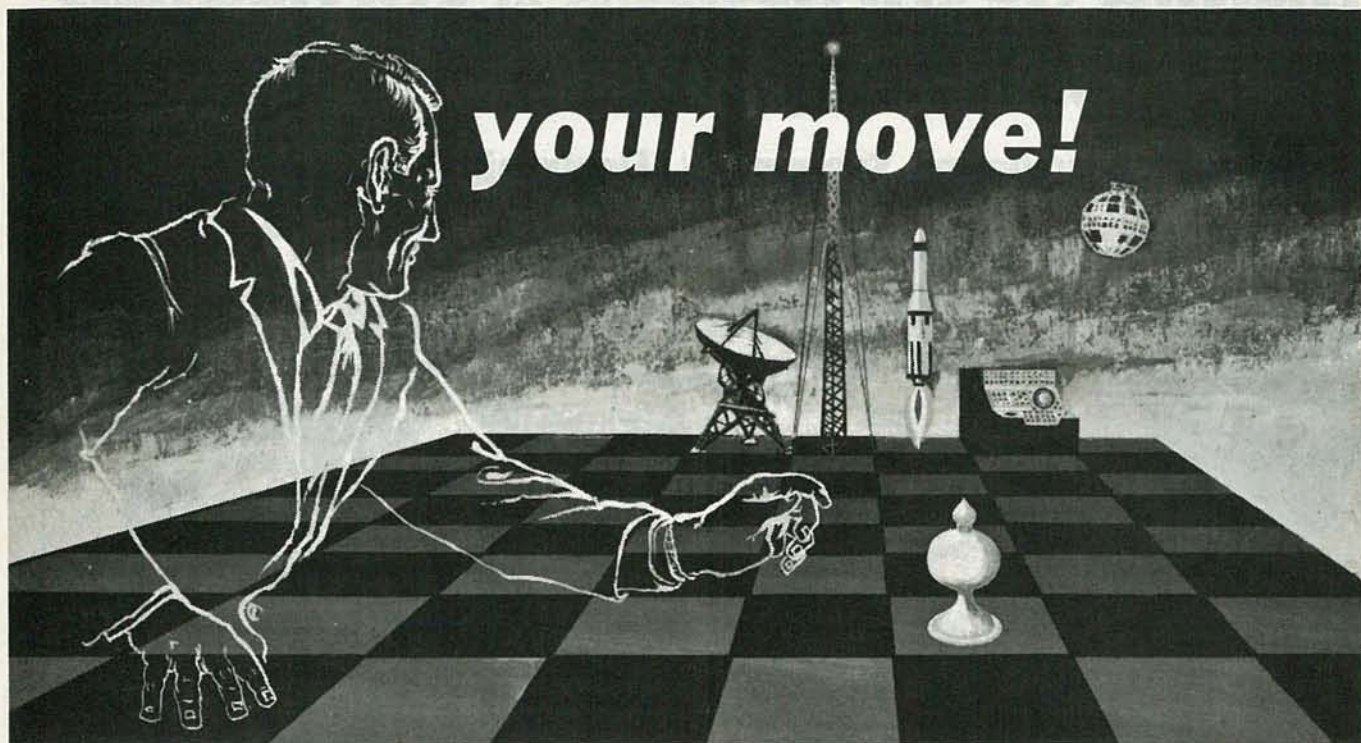

## The Move You Make Today Can Shape Your Future

Yes it's your move. Whether on a chess board or in your career, you should plan each move carefully. In **electronics**, you can *move ahead* faster and further with a

## B. S. DEGREE

Put professional knowledge and a COLLEGE DEGREE in your electronics career. Earn your degree through independent study at home, with Grantham College of Engineering. No commuting to class. Study at your own pace, while continuing your present job.

The accredited Grantham non-traditional degree program is intended for mature, fully employed workers who want to upgrade their careers . . . and who can successfully study electronics and supporting subjects through

### INDEPENDENT STUDY, AT HOME

Free Details Available from:

**Grantham College of Engineering**  
2500 South La Cienega Blvd.  
P. O. Box 35499  
Los Angeles, CA 90035

### Independent Home Study Can Prepare You

Study materials, carefully written by the Grantham staff for independent study at home, are supplied by the College, and your technical questions related to those materials and the lesson tests are promptly answered by the Grantham teaching staff.

### Recognition and Quality Assurance

Grantham College of Engineering is accredited by the Accrediting Commission of the National Home Study Council.

We are located at 2500 S. LaCienega Blvd., Los Angeles, California, but for faster response please use our mailing address: P. O. Box 35499, Los Angeles, CA 90035.

**Grantham College of Engineering** 1-84  
P. O. Box 35499, Los Angeles, CA 90035

Please mail me your free catalog which explains your B.S. Degree independent-study program.

Name \_\_\_\_\_ Age \_\_\_\_\_

Address \_\_\_\_\_

City \_\_\_\_\_ State \_\_\_\_\_ Zip \_\_\_\_\_



# C-QUAM AM STEREO CONVERTER

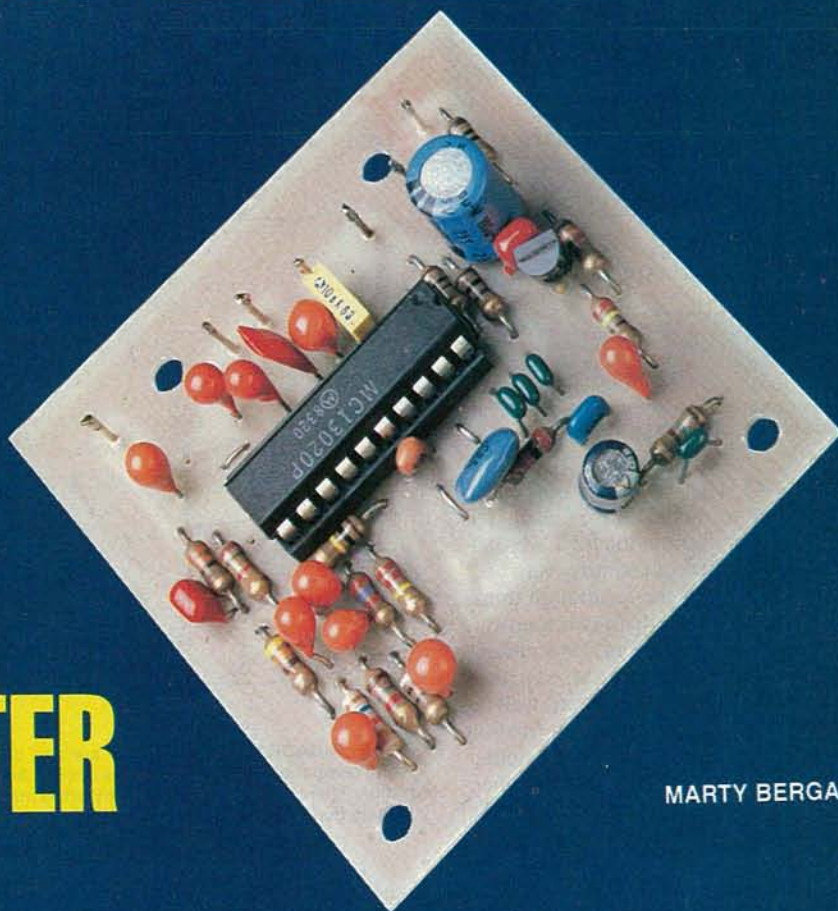

MARTY BERGAN\*

*AM stereo broadcasting is now well under way and more stations are beginning stereo broadcasts every week. Hear for yourself what all the fuss is about by converting your AM radio to receive C-QUAM stereo broadcasts.*

STEREO BROADCASTING BY AM RADIO stations was authorized in March, 1982 by the Federal Communications Commission (FCC). AM broadcasters hoped that the introduction of stereo would help to bring back many of the listeners they lost to FM radio. If you want to find out what AM stereo sounds like, it's easier than you think. You don't have to go out and buy some special receiver—you can convert your present AM radio to receive stereo C-QUAM broadcasts.

The C-QUAM system, designed by Motorola, is one of four systems that the FCC authorized for AM stereo broadcasting. (The Commission declined to determine which of several competing technologies would become the industry standard and instead took a "wait-and-see" attitude. In that way, the marketplace could decide which system would become the standard.) In this article, we will take a look at what the C-QUAM system is and then we'll look at how an AM radio

can be converted to decode stereo.

Let's say right from the start, though, that many radios are simply not capable of handling stereo. We'll explain the reasons for that and we'll explain ways around some of the problems. Because AM radios now on the market were not designed to accommodate stereo requirements, you might convert a radio but then be disappointed by the results. We'll give you some pointers on how to choose a good candidate for conversion.

Each of the hundreds of radio designs will probably behave and sound a little different. But each radio's problems can be resolved with the right know-how and test equipment. For those of you who are not equipped to handle such problems, the stereo conversion may be a disappointment, and you might be better off to wait a few months until the AM stereo receivers become available in the marketplace. But if you want to learn about this new system, and you have a good receiver to start with, then the conversion described here should be accomplished easily and successfully.

## What is C-QUAM?

C-QUAM is an acronym for Compatible *QU*adrature Amplitude Modulation. That's certainly a mouthfull—let's see what it means. The most important word there is *compatible*. That means that any ordinary (monaural) AM radio can receive a C-QUAM broadcast and produce the same results as it would if it received a monaural signal. In other words, the C-QUAM system does not make standard radios obsolete—as is necessary to gain FCC approval. C-QUAM is a *quadrature* system. That means that it somehow uses the relationship between two periodic functions that differ in phase by 90°. We'll take a closer look at that shortly. But let's first say that the final term in the acronym indicates that the transmitted signal is amplitude-modulated by each of the two periodic functions that we just mentioned.

A quadrature system combines and transmits two signals that are 90° out-of-phase with each other. Of course, those two signals must be separated again at the receiver, and that's the purpose of this

\*Linear Applications, Motorola Inc., Semiconductor Products Sector



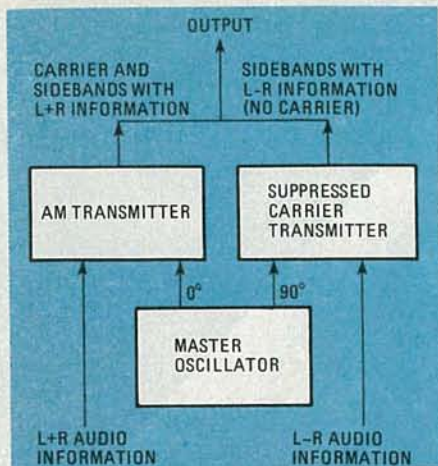

FIG. 1—YOU CAN THINK of a quadrature transmitter as one actually made up of two transmitters that are out of phase by 90°.

decoder. AM stereo is not the only place that quadrature modulation is used. For example, color information for TV broadcasts is transmitted in a similar way.

You can think of the quadrature transmitting system as one with two transmitters, as shown in Fig. 1. One transmitter is a standard AM transmitter at, say, zero phase. It transmits a carrier as well as sidebands that contain audio information (the I sidebands). The second transmitter operates 90° out-of-phase with the other. Because a carrier already exists to provide a phase reference for the receiver, we do not want another to be generated. So the second transmitter cancels out the carrier and produces only sidebands (the Q sidebands). Now, since those Q sidebands are generated from a carrier that is 90° out-of-phase from the original carrier, they are 90° out-of-phase with the I sidebands. In other words, the I and Q sidebands are in quadrature.

What information do the I and Q sidebands contain? The I sidebands contain the sum of the left- and right-channel audio information, or  $L + R$  signals. The Q sidebands contain the difference of the information of the two audio channels, or  $L - R$  signals.

There is a problem with quadrature-modulated signals, though. They produce distortion in the envelope detectors of normal AM radios. So a quadrature stereo system is not compatible with existing radios. That's because the envelope detectors in normal AM radios don't see the I and Q sidebands separately—they see the sum of the two, as shown in Fig. 2-a. One vector represents the  $L + R$  information that is modulated on the carrier (at what we'll call 0°). The other vector is the  $L - R$  information that's modulated on the suppressed carrier (at what we'll call 90°). The magnitude of the sum of those two vectors—which the receiver's envelope detector sees—is:

$$\sqrt{(1+R)^2 + (L-R)^2}$$

However, the envelope detector in a standard AM radio expects to see simply the

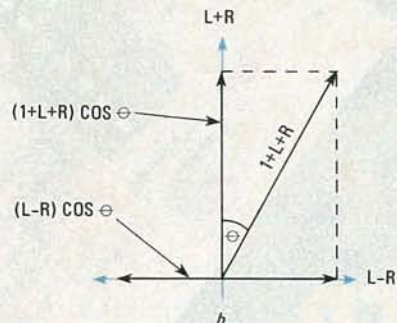
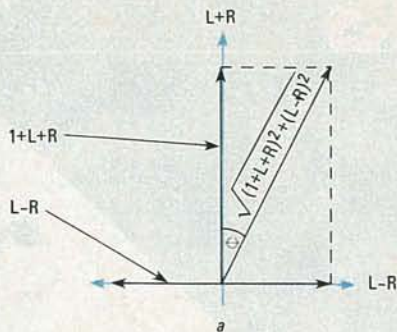

FIG. 2—QUADRATURE SIGNALS are not directly compatible with the detectors used in AM radios. Therefore, they must be converted into signals that will not produce distortion.

the carrier and the left- and right-channel audio, or  $1 + L + R$ . That difference or error is the cause of the distortion or incompatibility problem.

Motorola found, however, that they

could eliminate that error by multiplying each carrier axis by the cosine of the angle that resulted from the addition of the  $L + R$  and  $L - R$  signals. Figure 2-b shows that when that is done, the result is the  $1 + L + R$  that we want—the standard AM radio sees this signal as the same signal received from a monaural AM broadcast. Thus we have complete compatibility.

The C-QUAM system adds a 25-Hz pilot tone to the  $L - R$  information at 4% modulation that serves several purposes. It signifies that a stereo transmission is present; it permits decoding of the  $L - R$  signal, and it aids in control of mono-stereo switching.

### The MC13020P

The MC13020P decoder IC is housed in a 20-pin, standard dual in-line package, or DIP. A block diagram of the IC is shown in Fig. 3. The associated circuitry needed to build a complete decoder is made up of inexpensive components, and, in most cases, no coils or adjustments are necessary. A schematic of the decoder circuit is shown in Fig. 4. The schematic does not show the exact connection of the C-QUAM decoder circuit to the radio to be converted, or an exact external-oscillator circuit. But we'll give details later.

Taking an overall look at the block diagram of the decoder IC (Fig. 3), we see that the decoder takes the output of the AM IF amplifier, decodes the C-QUAM signal, and provides left- and right-channel audio outputs. In the absence of a good stereo signal, it will produce an un-degraded monaural output from both channels.

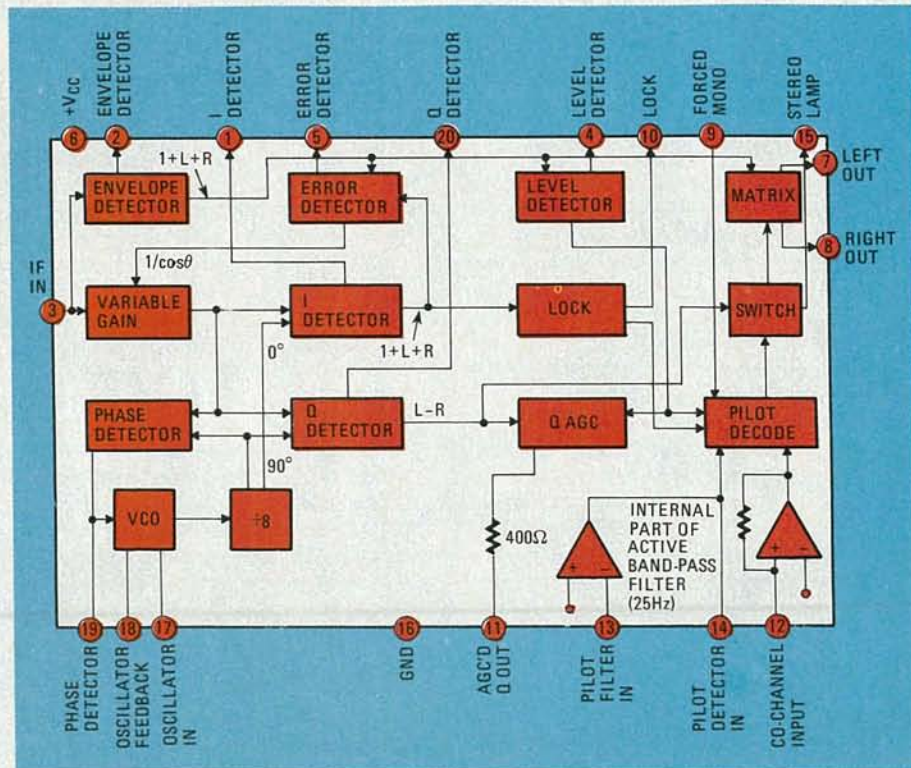

FIG. 3—A BLOCK DIAGRAM of the MC13020 AM-stereo decoder IC.



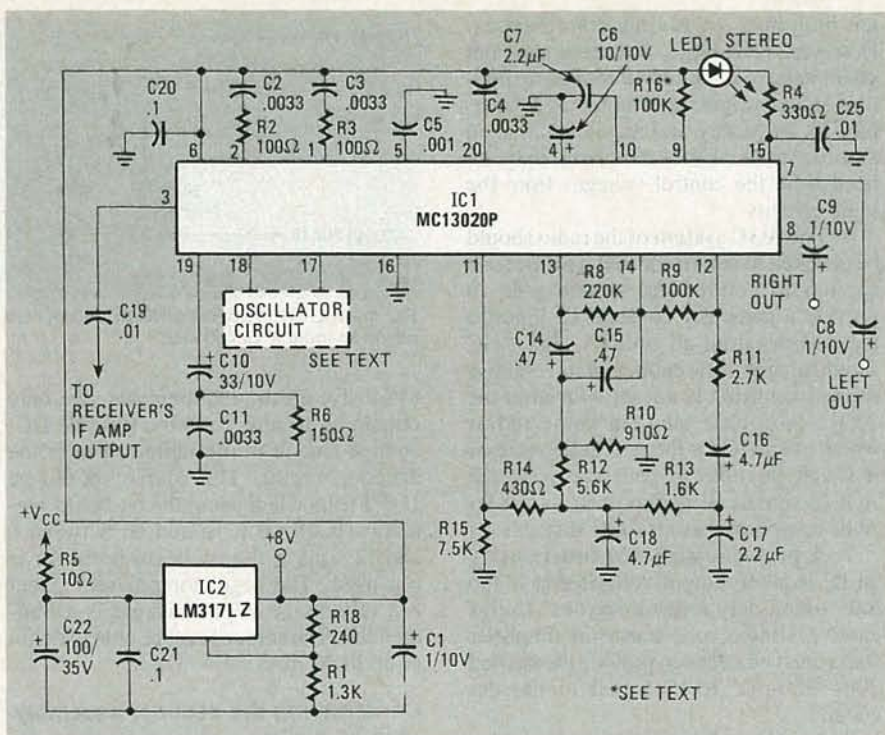

FIG. 4—THE SCHEMATIC OF THE decoder shown here does not show the VCO circuit.

The first step in decoding the stereo information is to convert C-QUAM to QUAM. That conversion is accomplished by comparing the outputs of the envelope detector and the I (L+R) detector in the error detector. Let's say, for example, that the incoming signal is monaural. Then it consists only of L+R information, and the envelope detector and I detector see the same signal. Therefore the error detector does not produce an error signal. However, when the incoming signal is stereo, there will be an error signal produced. That's because the envelope detector sees the same signal as it did before—the sum of the L+R and L-R signals—because it is not sensitive to the phase modulation. But the I detector—because it is sensitive to phase modulation—sees only the L+R information. When both signals are sent to the error detector, a  $1/\cos\theta$  correction factor is produced.

In the variable-gain block, the incoming C-QUAM signal is multiplied by that  $1/\cos\theta$  factor. The resulting product is a conventional quadrature or QUAM signal—not the C-QUAM that is compatible with standard AM-radio envelope detectors. It can be detected (synchronously) by conventional means.

The process to detect or demodulate the conventional quadrature signal involves first deriving a reference phase from the transmitted signal. That's the purpose of the phase-locked-loop (PLL) that we'll now describe. The phase detector is a product detector—its output is equal to the product of the two input signal voltages (in this case, a reference carrier from the VCO and the QUAM signal from the variable-gain block). If the two signals are

of the same frequency and  $90^\circ$  out of phase, the DC output of the detector will be zero. That DC output of the phase detector is fed back to the VCO as an error signal. Thus, the frequency of the VCO "zeros in" and locks on the input carrier frequency and we have our phase reference to the I and Q demodulators.

The internal VCO operates at eight times the IF input frequency. That ensures that the VCO's frequency is outside the AM band, even if the receiver's IF is 262 kHz. (Typically, a 450-kHz IF is used with synthesized front ends. But the IF of many auto radios—even if synthesized—is 262.5 kHz.) A 450-kHz IF places the VCO at 3.6 MHz, so you can use an economic ceramic resonator instead of a crystal. (See the Parts List.) But, as we mentioned before, the oscillator configuration will be discussed later in the text.

In the PLL filter at pin 19, C10 is the primary factor setting a loop corner frequency of 8–10 Hz. An internally controlled fast pull-in is provided. (Pull-in time is the time required for achieving synchronization in a phase-locked loop.) Resistor R6 slightly overdamps the control loop, and C11 prevents high-frequency instability. The value of C10 can be increased to 68  $\mu$ F to lower the filter corner frequency—that may be necessary to accommodate synthesized receivers. It may also be necessary if the filter affects the 25-Hz pilot signal (which must be 0.5 to 0.7 volts P-P at pin 14.). Resistor R6 may also affect the pilot amplitude, and can be decreased slightly if it's necessary to increase the pilot voltage to the required level.

The level detector senses carrier level and operates on the Q AGC block to

provide a constant amplitude of the 25-Hz pilot signal at pin 11. It also sends information on signal strength to the pilot decoder.

The Q AGC output drives a low-pass filter, made up of a 400-ohm internal resistor, C18, and R15. From that point, an active filter (made up of both internal and external components) is coupled to the pilot decoder, pin 14, and another low-pass filter is connected to the co-channel input, pin 12.

### Stereo/mono switching

A 50% reduction in the level of the 25-Hz pilot signal sent to the pilot-decode circuit will cause the system to go to monaural. A signal at a selected level to the co-channel input will also cause the system to go into its monaural mode.

That co-channel input signal contains any low-frequency beat notes caused by interference from a source very close in frequency to the desired signal. The level of the input that will cause the pilot-decode circuit to go into monaural can be adjusted by changing R11. The values that are shown in the schematic set the "trip" level at about 7% modulation.

The pilot decoder has two modes of operation. On a strong signal, the decoder will switch to stereo after it sees seven consecutive cycles of the 25-Hz pilot waveform. When conditions are bad, pilot decoder detects the interference and waits until it sees thirty-seven consecutive cycles of the 25-Hz pilot (that takes about 1.5 seconds) before it goes into the stereo mode. (In a frequency-synthesized radio, the logic that mutes the audio during tuning can be connected to pin 9 of the decoder to hold that pin low until the synthesizer and decoder have locked onto a new signal.) When pin 9 is held low, the decoder is held in its monaural mode and switches to the short count.

If no pilot is detected for seven consecutive counts, it is assumed the incoming signal is a monaural station and the decoder is switched to the long count (37 consecutive cycles of pilot). That reduces the possibility that noise or signal-level fluctuations will cause stereo triggering. The decoder will also switch to the long count if the PLL is out of lock, or if interference is detected by the co-channel detector before seven cycles are counted. (Each disturbance will reset the counter to zero.) The level detector will keep the decoder from going into stereo if the IF input level drops 10 dB, but will not affect the pilot counter.

Once the decoder has entered the stereo mode, it will switch instantly back to monaural if either the lock detector at pin 10 goes low, or if the carrier level drops below the preset threshold. Seven consecutive counts of no pilot also will cause the switch to monaural.

In stereo mode, the co-channel input is disabled. Then, co-channel or other noise is detected by negative excursions of the I



detector. When those excursions reach a level caused by about 20% negative modulation of the L-R signals, the lock detector switches the system to monaural, even though the PLL may still be locked. Here, the higher tolerance to co-channel and other interference prevents chattering in and out of stereo because of a marginal signal or high noise-levels (such as during a thunderstorm). If you wish to decrease the effectiveness of the interference sensing (to keep the decoder in its stereo mode in the presence of some narrow spike type of interference) the 2.2  $\mu$ F capacitor, C17, may be increased to as much as 47  $\mu$ F.

When all inputs to the pilot-decode block are correct, and the appropriate (long or short) count is complete, the switch block is enabled. That block turns on the stereo-indicating LED and passes the L-R information to the matrix block, which outputs stereo audio signals.

### Selecting a radio

Not every AM radio can be converted to receive broadcasts in stereo. But if you are careful when you examine the radio's capabilities, the conversion should go smoothly. Since there are literally hundreds of different radio designs on the market, we can't discuss the details of converting a particular radio. But we can give you some general pointers:

1. **Old vacuum-tube radios** are unacceptable. You'll undoubtedly have problems because of the high voltages and temperatures involved.

2. **Cheap pocket radios**, clock radios, small table radios, and the like should not be used in most cases. They typically have narrow bandwidths, poor sensitivity, and self-generated phase and frequency modulations that can seriously degrade channel separation and increase distortion and noise. (The C-QUAM system uses phase-related information, so the decoder is sensitive to phase variations or modulation.)

3. **Manually tuned radios**, whether variable-capacitor or variable-inductor types, may cause audible microphonics when in stereo mode. (Microphonics are electrical noise signals caused by mechanical disturbances of circuit elements.) Radios with self-contained speakers may be subject to microphonic problems because of the speaker vibrations. Those vibrations may generate phase modulation and the associated problems of poor separation, distortion, and noise.

4. **The local oscillator** must be stable and produce a reasonably clean sinewave. An unstable oscillator or a severely distorted waveform may cause a fluttering or warbling in the audio in the stereo mode. Disturbances of the front end and local oscillator introduce phase noise or ringing.

5. **Radios with synthesizer front ends** or logic-controlled varactor tuning are best adapted to AM stereo because of the more precise, automatic tuning, and bet-

ter immunity to tuning disturbances. However, those types of receivers are not guaranteed to be trouble free. Phase modulation can originate from the PLL comparison frequency and may appear as an audible tone. Extra filtering may be needed on the control voltages from the logic circuits.

6. **The AGC system** of the radio should be checked to determine that it is effective enough to control the system gain to provide a generally constant IF input to the decoder from all stations. The AGC should also be slow enough in its response so that distortion is not introduced in the 25-Hz pilot-tone area. In some radios which use an IC for the AM tuner section, it is not possible to gain access to the AGC'd signals. It is important to test for AGC response after all AGC'd stages.

7. **A problem with AM tuners** using an IC is an IF output voltage that is too low—often only a few millivolts. In this case, a simple, one-transistor amplifier stage must be added to provide the needed 200–350-mV RMS signal to the decoder.

8. **A major advantage** is a radio with a tuned RF amplifier at the front end. The increased sensitivity and selectivity aid in stereo reception and stability.

9. **The IF bandwidth** should be at least 5 kHz and reasonably flat. The bandwidth



FIG. 5—HERE IS A FULL-SIZE foil diagram of the single-sided decoder board.

of AM radios can vary from 2 kHz to more than 10 kHz. The wider the bandwidth, the better the performance and audio quality. (The fact that so many radios have narrow bandwidth has prompted radio stations to pre-emphasize the upper audio frequencies—anywhere from 2 kHz on up—to improve sound quality. Such pre-emphasis will be reduced in the future as AM stereo encourages better receiver designs.

You can see that determining whether a particular radio is suitable for conversion to AM stereo is really the more difficult part of the conversion process. Once the radio has satisfied (or has been modified

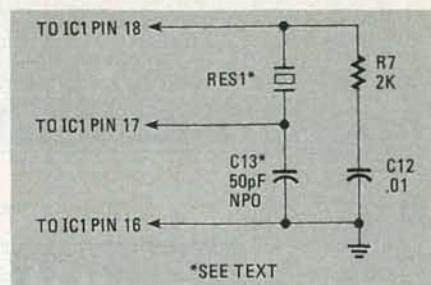

FIG. 6—THE OSCILLATOR CIRCUIT shown here needs an input IF of 450 kHz.

to satisfy) all the requirements, the only remaining need is to find a suitable DC-voltage source in the radio to power the decoder circuit. The source should be 11–30 volts when using the on-board regulator (IC2). Or it should be between 6 and 12 volts if the on-board regulator is not used. The regulator provides about 8.2 volts to the IC, and its use is recommended. The source must be able to deliver up to 40 mA continuously.

### Constructing the decoder assembly

Figure 4 shows the complete schematic of the AM stereo decoder circuit and Fig.

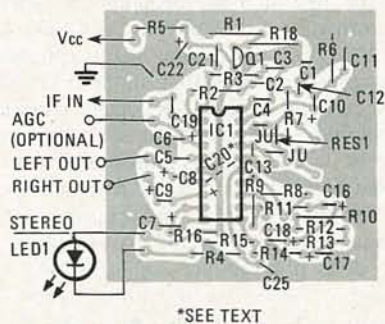

FIG. 7—THE PARTS-PLACEMENT diagram shown here corresponds to the VCO circuit of Fig. 6. Note that C20 is mounted on the foil side of the board.

5 shows a full-size foil pattern for a single-sided printed-circuit board. Before we talk about parts-placement, though, we have to select an oscillator circuit. We will discuss three.

The requirements of the VCO circuit design are not terribly critical—it must provide a one-volt P-P clean sinewave at 8 times the IF frequency to pin 14 of the MC13020P. One circuit that we can use is shown in Fig. 6. The corresponding parts-placement diagram for the decoder is shown in Fig. 7.

Of the three designs we'll discuss, the ceramic oscillator with its matched NPO (temperature-compensated) capacitor is preferred for its stability and simplicity. Both the ceramic resonator (RES1) and its matched (nominally 50 pF) capacitor are available from the source indicated in the parts list.

A quartz crystal can be used instead of RES1, but that will result in an extremely narrow pull-in range—only suitable for stable, accurate digital front ends. The



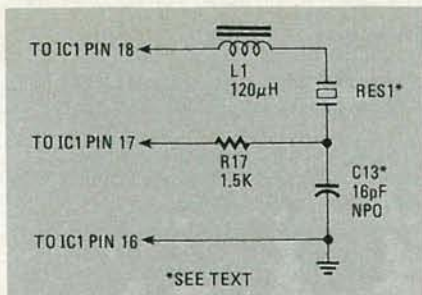

FIG. 8—THIS VCO CIRCUIT can be used if you need to broaden the tuning area to pull the resonator into lock at the required frequency. (Manually tuned radios may require that.)

ceramic resonator permits a much broader pull-in range, but it does have two drawbacks. The available resonator oscillates at 3.6 MHz—that requires a 450-kHz IF input to the decoder. Radios with a 455-kHz IF will have to be re-aligned. The second drawback concerns manually tuned radios. Tuning to the station's center frequency is quite critical. (That's not likely to be a problem with synthesized tuners.) To broaden the tuning area, R7 is added to lower the Q of the VCO. Capacitor C12 provides a DC block.

If greater broadening is needed, L1 and R17 may be added, and C13 changed, as shown in Fig. 8. (The corresponding parts-placement diagram is shown in Fig. 9.) That aids the circuit in pulling the resonator into lock at the required frequency. If L1 and R17 are not used, each must be replaced with a jumper wire as shown.

If your radio does not readily tolerate re-alignment, or if it has an IF of 260 or 262.5-kHz, or if you prefer not to attempt re-alignment, an alternative VCO, using a tunable L-C oscillator circuit, is shown in Fig. 10. It replaces the ceramic-resonator circuit and is very stable. The coil must be tuned so that the oscillator frequency is 8 times the radio's IF frequency. The circuit shown accommodates the 260-262.5-kHz IF range. Coil L2 is an adjustable RF coil made up of 60 turns of No. 36 enamelled wire tightly wound on a 1/8-inch-diameter form with a No. 2 ferrite core, a pot core (ferrite shield) and a shield can.

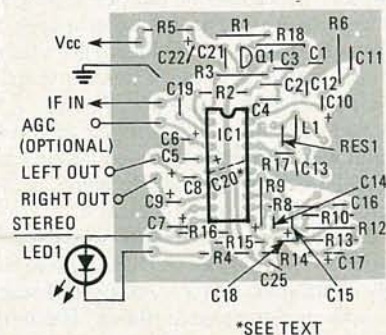

FIG. 9—THIS PARTS-PLACEMENT diagram corresponds to the VCO circuit shown in Fig. 8. Capacitor C20 is the only component mounted on the board's foil side.

## PARTS LIST

### All resistors 1/4 W, 5%, carbon film

- R1—1300 ohms
- R2, R3—100 ohms
- R4—330 ohms
- R5—10 ohms
- R6—150 ohms
- R7—2000 ohms
- R8—220,000 ohms
- R9, R16—100,000 ohms
- R10—910 ohms
- R11—2700 ohms
- R12—5600 ohms
- R13—1600 ohms
- R14—430 ohms
- R15—7500 ohms
- R17—1500 ohms
- R18—240 ohms

### Capacitors

- C1, C8, C9—1 µF, 10 Volts, electrolytic
- C2, C3, C4, C11—0.0033 µF, ceramic disc, 25–50 volts
- C5—0.001 µF ceramic disc, 25–50 volts
- C6—10 µF, 10 volts, electrolytic
- C7, C17—2.2 µF, 10 volts, tantalum
- C10—33 µF, 10 volts, electrolytic
- C12, C19, C25—0.01 µF ceramic disc, 25–50 volts
- C13—NPO. See Text and Figs. 6, 8, and 10
- C14, C15—0.47 µF, 10 volts, tantalum
- C16, C18—4.7 µF, 10 volts, tantalum
- C20, C21, C24—0.1 µF ceramic disc or monolithic
- C22—100 µF, 35 volts, electrolytic
- C23—see text and Fig. 10

### Semiconductors and other components

- IC1—MC13020P C-QUAM decoder (Motorola)
- IC2—LM317LZ adjustable regulator
- LED1—standard red LED, 20 mA
- L1—120 µH choke
- L2—55 µH coil: 60 turns of #36 enamelled wire tightly wound on 1/8-inch diameter form with No. 2 ferrite core and shield can.
- RES1—Ceramic resonator, Murata CSA2.60MT7 with matching capacitor (C13), Murata CSC500K7

The following are available from Circuit Specialists, Box 3047, Scottsdale, AZ 85257: Complete kit, including PC board and all parts (including parts for the VCO circuit as in Fig. 6 only), \$24.95; Circuit board only, \$4.95; Ceramic resonator RES1 with matching NPO capacitor (as in Fig. 6) only, \$3; MC13020P decoder IC, \$3.50. All prices include postage inside the US.

You can use the circuit in Fig. 10 (it's parts-placement is shown in Fig. 11) with an IF of 450 or 455 kHz by making C13 39 pF NPO and C23 10 pF NPO, and adjusting L2 so that the oscillator frequency is eight times the input IF.

Except, perhaps, for some of the oscillator parts, the components required for the decoder circuit are common parts. We recommend that you use tantalum capacitors for the polarized capacitors in the filter circuits at IC pins 10–14. They have

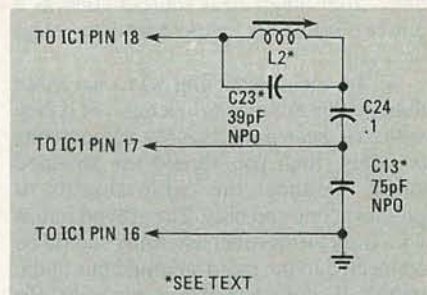

FIG. 10—THIS VCO CIRCUIT can be used to replace the ceramic-resonator circuit if your radio has an IF of 260 or 262.5 kHz. You can also use it with an IF of 450 or 455 kHz if you change the value of C13.

better tolerance and small size. But regular electrolytics, if accurate, can be used with no sacrifice of performance. Non-polarized capacitors may be ceramic-disc types unless otherwise specified in the parts list. The 0.1-µF capacitor, C20—shown in Fig. 4 connected from IC1 pin 6 to ground—should be soldered on the circuit side of the PC board under the IC from pin 6 (V<sub>CC</sub>) to pin 16 (ground); use short leads when installing that unit. Note that there is intentionally no provision for this capacitor in the board layout.

## Converting the radio

The input signal to the decoder must be at least 160 mV RMS for stereo. But for quiet, clean reception, it should be 200–350 mV. That is a typical range for most AM radios. In the radio, the stereo decoder goes where the detector would normally go—after the last IF stage before the detector diode. The radio's detector circuit may be disconnected by removing the diode or disconnecting one lead. In some radios, AGC voltages are obtained from the detector circuit and, in that case, the detector should be left connected. In most instances it won't interfere with the operation of the decoder. In any case, the audio output from the radio's detector must be disconnected, to avoid conflict with the two audio channels coming from the MC13020P.

The decoder assembly may be mounted in any convenient place, but try to keep it

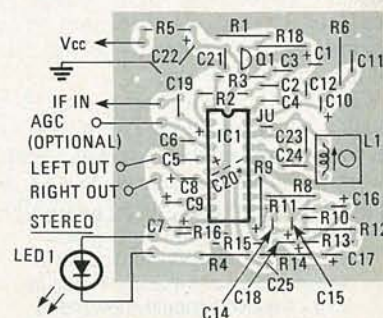

FIG. 11—THE PARTS-PLACEMENT diagram shown here corresponds to the VCO circuit of Fig. 10.



away from major heat sources such as a power transformer, output transistors, and heat sinks.

If the interconnecting wires are more than a couple of inches in length, or if they will pass near power-supply components or wires, then you should use shielded cable. Connect the cable shields to ground at one end only. The ground return wire from the decoder assembly should be connected to the radio's ground bus at the radio's IF output or detector circuit. To avoid ground loops, *this should be the only common ground connection.*

If the receiver has a high IF output (over 350 mV RMS) a series resistor can be added to drop the voltage to the desired level of 200-350 mV RMS at pin 3, the decoder input. The input impedance of the decoder is about 27 kilohms.

Pin 9 of the IC is the FORCED MONO control pin. Grounding that pin locks the decoder in its monaural mode. For automatic mono/stereo switching, pin 9 can be pulled up with a 100-kilohm resistor to the 8-volt supply (as shown in the schematic), or it can be connected to pin 10. (That permits the most rapid re-acquisition of stereo after retuning.) If you look closely at the parts-placement diagrams, you'll notice that, although the jumper is not shown, pads are provided on the board so that you can easily tie pin 9 to pin 10. You could also bring pin 9 out to a switch and manually force the decoder to its monaural mode by switching pin 9 to ground. If that is the case, the 100K resistor must be added. But be sure to remember: Do not add the resistor if you jumper pins 9 and 10.

The left and right audio outputs are "tuner-level" signals (100-200 mV RMS) and can be connected directly to the tuner or auxiliary inputs of a stereo amplifier. If the conversion is in an AM/FM receiver, one that has its own stereo amplifier, the decoder outputs should be connected through the band switch. Capacitors C8 and C9 will provide the necessary AC coupling to the audio circuits.

### Troubleshooting

If the decoder will not go into the stereo mode even with a strong signal, then you should troubleshoot the circuit as we'll describe. Of course, before you start troubleshooting, you have to know that the local radio station is transmitting Motorola C-QUAM stereo—feel free to call the station to be sure.

When you're certain that a C-QUAM signal is being received, (we'll assume that you've checked that the power supply is working correctly and that 8 volts DC is supplied to pin 6) then, using an oscilloscope, look at the following signals:

1. Pin 3—The input signal. The signal envelope (and that at the IF output of the receiver) should show modulation at the top and bottom edges symmetrically. The average amplitude must be 1 volt peak-to-peak,  $\pm 0.4$  volt.

### WHERE TO LISTEN

As we went to press, these stations (listed alphabetically by city) were broadcasting C-QUAM stereo, with almost 50 orders on backlog. (Those stations wished to remain confidential.)

KRZY	1450	Albuquerque, NM	CKNW	980	New Westminster, BC
WSAN	1470	Allentown, PA	KXXY	1340	Oklahoma City, OK
WCHL	1360	Chapel Hill, NC	CJSB	540	Ottawa, ONT
WAIT	820	Chicago, IL	KGW	620	Portland, OR
WFAA	570	Dallas, TX	CJCI	620	Prince George, BC
WJR	760	Detroit, MI	WHWH	1350	Princeton, NJ
KQWB	1550	Fargo, ND	KIPN	1350	Pueblo, CO
WKQT	1010	Garyville, LA	KKLS	920	Rapid City, SD
WGSW	1350	Greenwood, SC	KKYX	680	San Antonio, TX
CKOC	1150	Hamilton, ONT	KFMB	760	San Diego, CA
WIRE	1430	Indianapolis, IN	KYA	1260	San Francisco, CA
WNDE	1260	Indianapolis, IN	KRDZ	1230	Steam Boat Springs, CO
CKOV	630	Kelowna, BC	KJOY	1280	Stockton, CA
WITL	1010	Lansing, MI	CFRB	1010	Toronto, ONT
CFPL	980	London, ONT	KRMG	740	Tulsa, OK
KFI	640	Los Angeles, CA	CJVB	1470	Vancouver, BC
KZLA	1540	Los Angeles, CA	CKWX	1130	Vancouver, BC
WISM	1480	Madison, WI	CKLW	800	Windsor, ONT
WSM	650	Nashville, TN			

2. Pin 17—The VCO input. The oscillator input should be a sinewave of about 1-volt P-P at 8 times the input IF.
3. Pins 7 and 8—The left and right audio outputs. These signals should typically be about 200 mV P-P, centered on a DC level of about 1 volt.
4. Pin 14—Pilot tone. You should see a 25-Hz sinewave that is steady and 0.5-0.8 volts P-P. The amplitude can be increased, if necessary, by decreasing the value of R12 (but to no less than 1.8K). The pilot signal will be present, of course, only if the radio is properly tuned to a station transmitting C-QUAM stereo.
5. Pin 1—L + R signal. This signal looks like the audio signals on pin 7 and 8 but it is centered on a DC level of about 6 volts.
6. Pin 20—L - R signal. This should appear about the same as L + R signal. (If you observe closely, you should also see the 25-Hz pilot tone as a low-amplitude component of the complex waveform.)
7. Pin 10—DC lock voltage. The voltage should be 4 volts in lock, 0 volt out of lock. If it's out of lock, the VCO is not at 8 times the input IF. Adjust the VCO or re-align the radio's IF.
8. Pin 9—FORCED MONO. If wired to pin 10, it must have the same voltage condition as pin 10. If not wired to pin 10, pin 9 must have +4 VDC or higher via a 100k pull-up resistor (R16) to the 8 V supply. If the voltage at pin 9 is at or near 0 V DC, the decoder is held in monaural mode.

If all the above conditions are satisfied, the decoder will switch into the stereo mode. Failure at this point indicates a workmanship problem, defective component, a fault in the receiver system, or an incoming signal that is not correct for C-QUAM stereo detection.

### Proven conversions

In preparation of this article, three radios were converted in our lab. The first was an AM (only) portable radio, a Realistic (Radio Shack) model 12-656A. (It is not listed in Radio Shack's latest catalog.) That radio was chosen because it has an FET-tuned RF amplifier in front, no ceramic filters, (they usually narrow the bandwidth), three tuned IF stages, and a substantial AGC system. Our testing showed that its 3-dB bandwidth was 12 kHz with a very flat response. One AGC voltage is developed from the detector circuit, so the detector was left connected as is. The IF was re-aligned to 450 kHz. The speaker and battery holder were removed to make room for the decoder circuit and a complete 4-watt-per-channel stereo amplifier with volume, balance, bass, and treble controls. The radio's original audio section was disconnected. The radio lent itself readily to the conversion with only one problem. As previously discussed, manually tuned radios often prove to be microphonic. The 12-656A was no exception. The main culprit was the oscillator coil. Filling the coil assembly with beeswax to stop vibration greatly improved it. The tuning capacitor also was sensitive, but no attempt was made to suppress it because of the possibility of damage. Even so, at this point it took a substantial rap on the cabinet to get a little "ping" sound. The radio was connected to a pair of Radio Shack's *Minimus-3.5* speakers that presented a full, clean stereo sound with both laboratory equipment as the C-QUAM signal source and a commercial radio station in Chicago.

The second radio converted was a Sears model 564.50800, a car radio with digitally controlled varactor tuning, FM stereo, and an 8-track tape player. The unit presented a different challenge because of its compact assembly and complexity. The selected frequency is digitally dis-

*continued on page 102*



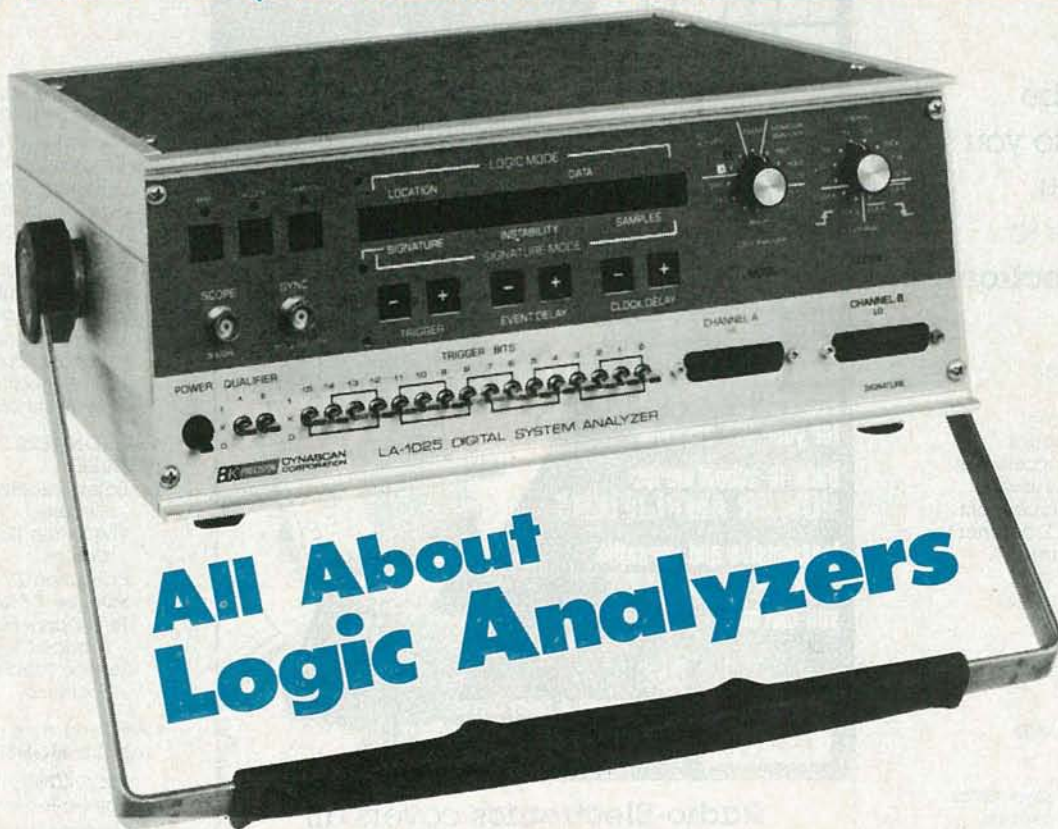

## All About Logic Analyzers

THE LOGIC ANALYZER CAN BEST BE thought of as the digital equivalent to the (analog) oscilloscope. However, unlike the oscilloscope—which displays events as they happen—the logic analyzer samples digital signals and stores them as logic-level 1's and 0's so they can be reviewed later. Because of that fundamental difference, the operation of a logic analyzer may, at first glance, appear intimidating.

In order to dispel that feeling, we'll discuss the basic operation of logic analyzers and take a close look at a relatively low-cost (\$2075/\$2475) unit: the model LA-1020/25 (manufactured by B&K Precision 6460 W. Cortland, Chicago, IL 60635). We'll also build a simple, single-IC logic analyzer. Although limited in its capabilities, it can be used to demonstrate some of the logic-analyzer techniques we'll describe.

### Applications of logic analyzers

Although logic analyzers can be used to monitor any logic circuit, they are mainly used on microprocessor-oriented circuits, usually to monitor the logic states of the address bus. That way, you can follow the execution of the program steps in a program.

That's helpful because a program is rarely executed in a straight-line manner. Instead, it will frequently branch off or jump from one address to another at different parts of the program. That action is analogous to a hobbyist on his way home from work. He will not always travel in a

*The logic analyzer is a not-too-well-understood test instrument. We'll try to make you more familiar with it by taking an in-depth look at one.*

### KENNETH PIGGOT

straight-line manner. Instead he may stop at the computer store, parts shop, etc.

In the real world we can observe the path taken by the hobbyist simply by looking at him. However, in the world of the microprocessor, our senses fail us and we must rely on instruments—like the logic analyzer that uses techniques such as address-state analysis—to see what is happening.

When the address bus is monitored by a B&K Precision logic analyzer during each instruction-fetch cycle, 250 steps of the processor's program sequence will be stored in its memory. By using various trigger modes (we'll discuss those later), you can begin the storage of program steps at any selected point of the program's execution.

The B&K Precision models LA1020 and LA1025 logic analyzers feature many of the capabilities of larger, more expensive machines. (The two models are identical except for the inclusion of signature-analysis capability in the LA1025.) The

LA1020 allows you to monitor and store 250 16-bit TTL-level data samples. In a typical microprocessor system, you would monitor the address, data, and control buses.

To hook the analyzer up to the system under test, two *data pods*, like the one shown in Fig. 1, are used. Each data pod or probe samples eight TTL-level data lines, one QUALIFIER line, and one CLOCK line. The QUALIFIER and CLOCK lines will be explained in the "Triggering" section. Each data pod also contains the circuitry to terminate the sampling leads and to drive the connecting ribbon cable between the data pod and the main unit. The logic analyzer's MODE switch can be turned to the POD ACTIVITY position. When in that position, each data pod acts as an 8-bit logic probe with the display

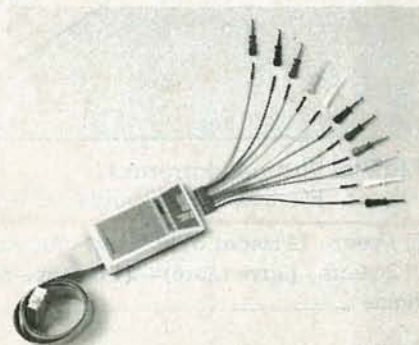

FIG. 1—THE LP1 DATA POD or probe that is used with the LA1020/25. Each pod monitors eight bits of data, a qualifier line, and a clock line.



This will be coming to you when you subscribe to **Radio-Electronics:**

- **HELPFUL CONSTRUCTION ARTICLES . . .**  
 Test Equipment  
 Hi-Fi Accessories  
 Telephone Accessories  
 Music Synthesizers  
 Computer Equipment  
 Automotive Equipment  
 Intruder Alarms  
 Home & Car  
 Video Accessories

- **NEWS ON NEW TECHNOLOGY . . .**  
 Computers  
 Microprocessors  
 Satellite TV  
 Teletext  
 Automotive Electronics  
 Speech Synthesizers  
 IC Applications

- **FASCINATING "HOW TO DO IT" ARTICLES . . .**  
 Build Your Own Projects  
 Make Your Own PC Boards  
 Wiring Techniques  
 Soldering and Desoldering  
 Design and Prototyping

# Radio-Electronics

HOW TO REJUVENATE ANTIQUE RADIOS

\$1.50 MAR. 1983

COMPUTERS - VIDEO - STEREO - TECHNOLOGY - SERVICE

Portable **SHORTWAVE RECEIVER**  
 Buyers guide

Inside the new **767 COCKPIT**

Build an **ACTIVE ANTENNA**  
 for your VLF receiver

Back-to-school series **POWER AMPLIFIERS**

Inexpensive and versatile **2 DVM CIRCUITS**  
 you can build

**PLUS:**

- ★ Videogames ★ Hobby Corner
- ★ Computer Corner ★ Drawing Board
- ★ State-Of-Solid-State ★ Equipment Reports



**Radio-Electronics** covers all aspects of the fast moving electronics field . . . featuring **COMPUTERS • VIDEO • STEREO TECHNOLOGY • SERVICE COMMUNICATIONS • PROJECTS**

# Get it all!

• **HOW YOU AND THE COMPUTER CAN BE FRIENDS . . .**

- Getting Started
- Programs, Circuit Design, Games
- A/D-D/A Interfacing
- Peripheral Equipment

• **NEW AUDIO DIMENSIONS FOR YOUR PLEASURE . . .**

- Noise-Reduction Devices
- How to Connect that Extra Add-On
- Hi-Fi Accessories
- New Technology

• **TV WONDERS FOR YOUR FUTURE . . .**

- Latest Receivers and Circuits
- The Home Entertainment Center
- Projection TV Today
- Satellite TV Receivers
- Jack Darr's Monthly Service Clinic
- Service Problems and Solutions

• **AND you also get these regular MONTHLY FEATURES:**

- **LOOKING AHEAD** by Dave Lachenbruch
- **HOBBY CORNER** by "Doc" Savage
- **STATE-OF-SOLID-STATE** by Bob Scott
- **WHAT'S NEWS**, new products, stereo news
- **VIDEOGAMES**, new products, game reviews
- and **NEW IDEAS, STEREO PRODUCTS, NEW COMPUTER PRODUCTS FOR HOME/JOB** and MUCH MORE!

Subscribe today to **Radio-Electronics**. Don't miss a single issue and . . . you save as much as \$7.03 off the newsstand price.

When you select one of the subscription offers listed on the handy coupon—you'll be assured of having your copy reserved, even if it sells out on the newsstand. Make sure you get all the excitement in every issue of **Radio-Electronics**, every month, by filling in and mailing the coupon, today.

Mail to: **Radio-Electronics**  
 P.O. Box 2520, Boulder, CO 80322

**Every Month!**  
**Get the Best—Mail Today!**

THA47

- 1 year—**12 issues only \$14.97** (You save \$3.03 off newsstand price.)
- 2 years—**(Save More)—24 issues—\$28.97** (Save \$7.03 off the newsstand price.)

- Payment Enclosed
- Bill Me

Name \_\_\_\_\_ (please print)

Address \_\_\_\_\_

City \_\_\_\_\_ State \_\_\_\_\_ Zip Code \_\_\_\_\_

Offer Valid in U.S. Funds Only.  
 Allow 6-8 weeks for delivery of first issue

**Canada**—Add \$3.00 per year  
**All other countries**—Add \$7.50 per year



# "I built this 16-bit computer and saved money. Learned a lot, too."

Save now by building the Heathkit H-100 yourself. Save later because your computer investment won't become obsolete for many years to come.

Save by building it yourself. You can save hundreds of dollars over assembled prices when you choose the new H-100 16-Bit/8-Bit Computer Kit – money you can use to buy the peripherals and software of your choice.

## H-100 SERIES COMPUTER SPECIFICATIONS:

### USER MEMORY:

128K-768K bytes \*

### MICROPROCESSORS:

16-bit: 8088

8-bit: 8085

### DISK STORAGE:

Built-in standard

5.25" disk drive,

320K bytes/disk

### KEYBOARD:

Typewriter-style,

95 keys, 13

function keys,

18-key numeric pad

### GRAPHICS:

Always in graphics mode.

640h/225v resolution;

up to eight colors

are available \*\*

### COMMUNICATIONS:

Two RS-232C Serial

Interface Ports and

one parallel port

### DIAGNOSTICS:

Memory self-test

on power-up

### AVAILABLE SOFTWARE:

Z-DOS (MS-DOS)

CP/M-85 +

Z-BASIC Language

Microsoft BASIC

Multiplan

SuperCalc

WordStar

MailMerge

Data Base

Manager

Most

standard

8-bit CP/M

Software

\*128K bytes standard.

\*\* Optional.

The H-100 is easy to build – the step-by-step Heathkit manual shows you how. And every step of the way, you have our pledge – "We won't let you fail." Help is as close as your phone, or the nearest Heathkit Electronic Center.†

And what better way to learn state-of-the-art computing techniques than to build the world's only 16-bit/8-bit computer kit? To run today's higher-speed, higher-performance 16-bit software, you need an H-100. It makes a big difference by processing more data faster.

Dual microprocessors for power and compatibility. The H-100 handles both high-performance 16-bit software and most current Heath/Zenith 8-bit software.

Want room to grow? The H-100's standard 128K byte Random Access Memory complement can be expanded to 768K bytes – compared to a 64K standard for many desktop computers.

And the industry-standard S-100 card slots support memory expansion and additional peripheral devices, increasing future upgradability of the H-100.

High-capacity disk storage, too. The H-100's 5.25" floppy disk drive can store 320K bytes on a single disk. The computer also supports an optional second 5.25" and external 8" floppy disk drives. And an optional internal Winchester disk drive will be available soon.

For more information, circle the reader service number below. Better yet, visit your Heathkit Electronic Center for a demonstration!

*The H-100 gives me the most for my computer dollar!*

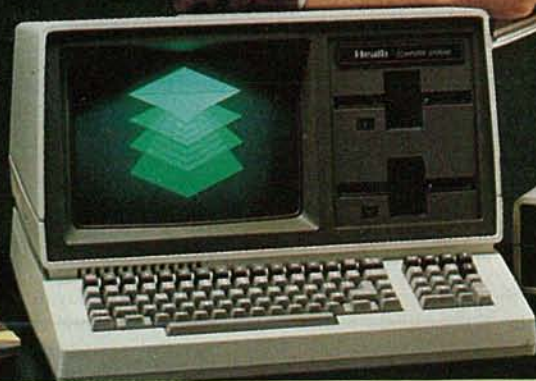

**Heathkit**  
Heath  
Company

Heathkit Electronic Centers are units of Veritechnology Electronics Corporation. Heath Company and Veritechnology Electronics Corporation are subsidiaries of Zenith Radio Corporation. CP/M is a registered trademark of Digital Research Corporation.

CIRCLE 20 ON FREE INFORMATION CARD



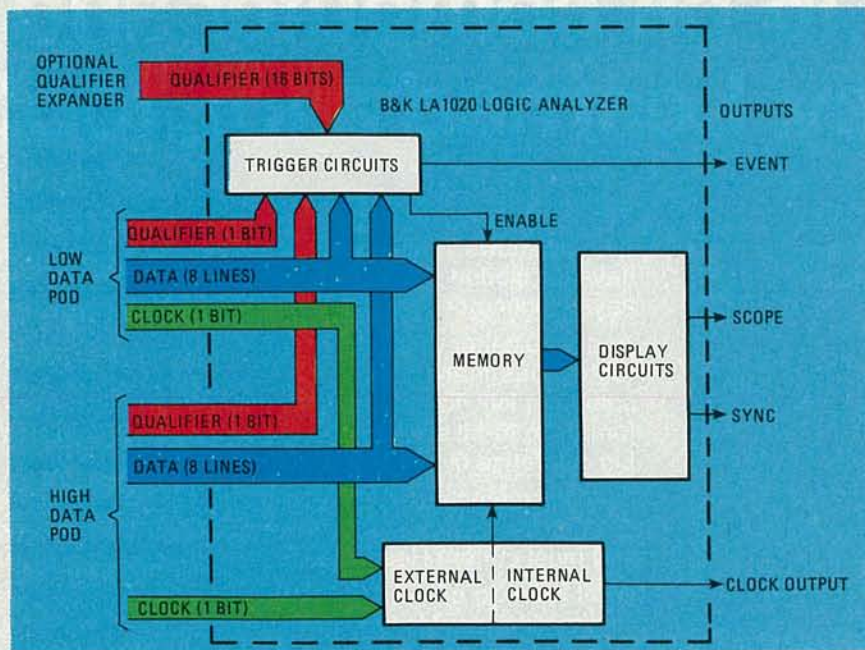

FIG. 2—SIMPLIFIED BLOCK DIAGRAM of the LA1020 showing the external inputs and outputs.

indicating 0's, 1's, or P's (pulses), depending on the logic activity on each data line.

As can be seen in the block diagram in Fig. 2, the two 8-bit sets of data samples from the data pods are routed to the logic analyzer's memory and trigger circuits. As previously mentioned, the LA1020 can store up to 250 16-bit samples in its internal memory. Data sampling can occur at sample rates of up to 20 MHz. (That equates to a minimum time between samples of 50 nanoseconds.)

### Triggering

The trigger circuit of the logic analyzer lets you select the starting point for storing data samples. It continuously compares the incoming data bits to a user-selected trigger word. That trigger word is selected by throwing each of the 16 three-position TRIGGER BITS switches on the front panel to either 1, 0, or X, where the X stands for "don't care." In the "don't care" position, the incoming data line will satisfy the trigger requirements whether it is a logic 1 or a logic 0.

The LA1020 also monitors a QUALIFIER line from each of the data pods. That bit is not stored in memory and is only used by the trigger circuit. Each of the qualifier bits has a corresponding switch that operates identically to the TRIGGER BITS switches. The easiest way to describe the purpose of the qualifier lines is to give an example of how they could be used. If you hooked one of the qualifier lines to a control signal such as a microprocessor's READ line, data storage would be triggered only when the READ pin was high (or low, depending on how the qualifier switch was set). If the two qualifier lines are not used, their trigger switches can be set to the "don't care" position and they

will be ignored.

An optional LP-3 qualifier pod (seen in Fig. 3) adds 16 more trigger bits to the trigger word. With it, you could monitor a system's data lines while triggering from the address lines that are connected to the qualifier pod. Sixteen three-position switches on the qualifier pod can also be set to a logic 0, 1, or a "don't care" position. That optional expander pod is plugged into a connector on the rear panel of the logic analyzer.

The easiest way to picture the operation of the trigger circuit is as a multi-input AND gate for which the active levels can be user-defined by setting the TRIGGER BITS switches. When the logic levels on the 16 DATA lines and the QUALIFIER lines being sampled match those set on the TRIGGER BIT switches, the memory-storage process will be enabled.

Before the various trigger modes are described, it would be appropriate to examine how the 250 samples are loaded into memory.

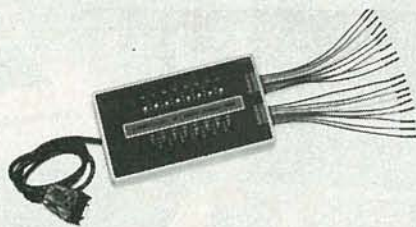

FIG. 3—THE LP3 TRIGGER EXPANDER PROBE or qualifier pod adds 16 more trigger bits to the trigger word.

### Clocking

Once the trigger circuit enables the storing of data samples, it no longer has any effect on sample loading—the storing

of the data samples occurs in conjunction with the clock circuit.

The clock circuit tells the memory when the incoming data samples are valid. You can select between two external clock lines (one located on each data pod) or an internal clock. If you decide to use the external clock signals, either clock line—and whether the rising or falling edge of the signal on that line is used—can be selected. It is important to note that the clock as it is referred to here is not necessarily the microprocessor system's clock. It can be any control signal that's used to indicate when the sampled data is valid.

The appropriate control-bus signal for clocking the logic analyzer will vary with the type of data being observed and the particular microprocessor in the system. For example, if you wanted to look at the address lines of a Z80 microprocessor during the instruction-fetch cycle, the clock line would be hooked to the READ line and the clock edge would be set to FALLING EDGE. Or, even better, a qualifier line would be connected to the M1 line with the corresponding trigger switch set to logic 0.

When the internal clock is used, data will be stored at one of eight user-selected sampling rates ranging from 10 MHz (a sample every 100 ns) to 1 Hz. That means it can take a minimum of 24.9 microseconds or a maximum of 249 seconds to fill the logic analyzer's memory.

The internal clock allows you to observe a circuit that has no clock signal available. You could set the logic analyzer to begin storing samples when a particular set of inputs occurs and then store periodic samples over the user-selected period of time. (See Fig. 4.)

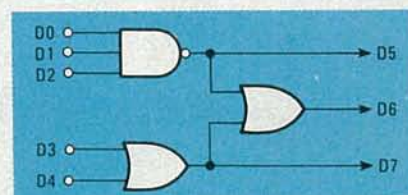

FIG. 4—A TTL CIRCUIT THAT can be monitored by a logic analyzer. The TRIGGER-BIT switches would be set for the desired logic levels for D0–D4, and for X for D5–D15. The internal-clock selector is used to set the sampling rate.

### Data storage

Once the trigger word and the clock source have been selected, the machine is simple to use. You simply push the ARM button to activate the trigger circuit. When the data on the incoming lines match the trigger word, the analyzer will begin storing samples in conjunction with the selected clock. During the data-storing process, the TRIGGER LED will light. When all 250 samples have been stored, the TRIGGER LED will go out and the COMPLETED LED will light.



Let's consider, however, the real-life situation where the incoming data never matches with the trigger word. That typically occurs when a program locks up in a loop. You can manually initiate storage of the data samples by pushing the TRIGGER button. In that instance, if you are sampling the address lines, the data stored will be the locations of the program instructions then being executed. Also, if you were to encounter an instance where a program halted before 250 samples were stored, you could manually complete the sampling process by pushing the COMPLETE button. Once the sampling process is complete, you can view the analyzer's stored data.

### Data display

The display circuit shown on the block diagram in Fig. 2 lets you observe the stored samples. The LA1020 will display its stored information one word at a time on its LED display when in the DISPLAY mode. By pushing the + and - TRIGGER switches you can examine, individually, each of the 250 data samples stored in the LA1020's memory. You can select your choice of displaying the memory in a decimal, octal, binary, or hex format by turning the MODE switch to the appropriate position. In addition to the data being displayed, the location of the data word in the logic analyzer's memory is also displayed. The display circuit also supplies the synchronizing and vertical-input signals to allow an oscilloscope to be used as a 16-word by 16-sample display. The data displayed on the oscilloscope will scroll as you scroll through the logic analyzer's memory.

There are two additional outputs on the logic-analyzer unit. One is a CLOCK output. When you select an internal clock rate, an output at the same rate is available from a BNC connector on the rear panel. The other output is the EVENT output.

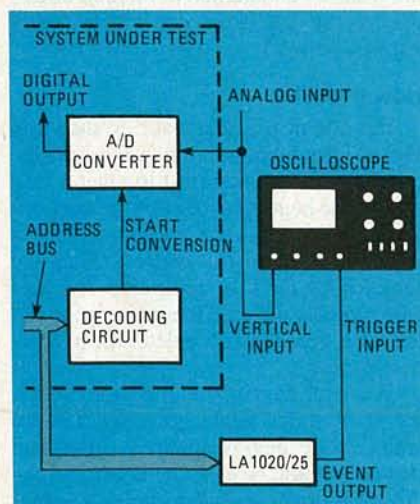

FIG. 5—THE LOGIC ANALYZER can be used as a digital trigger for an oscilloscope. If the selected trigger word is the starting address of the A/D conversion routine, the scope will be triggered every time the conversion is started.

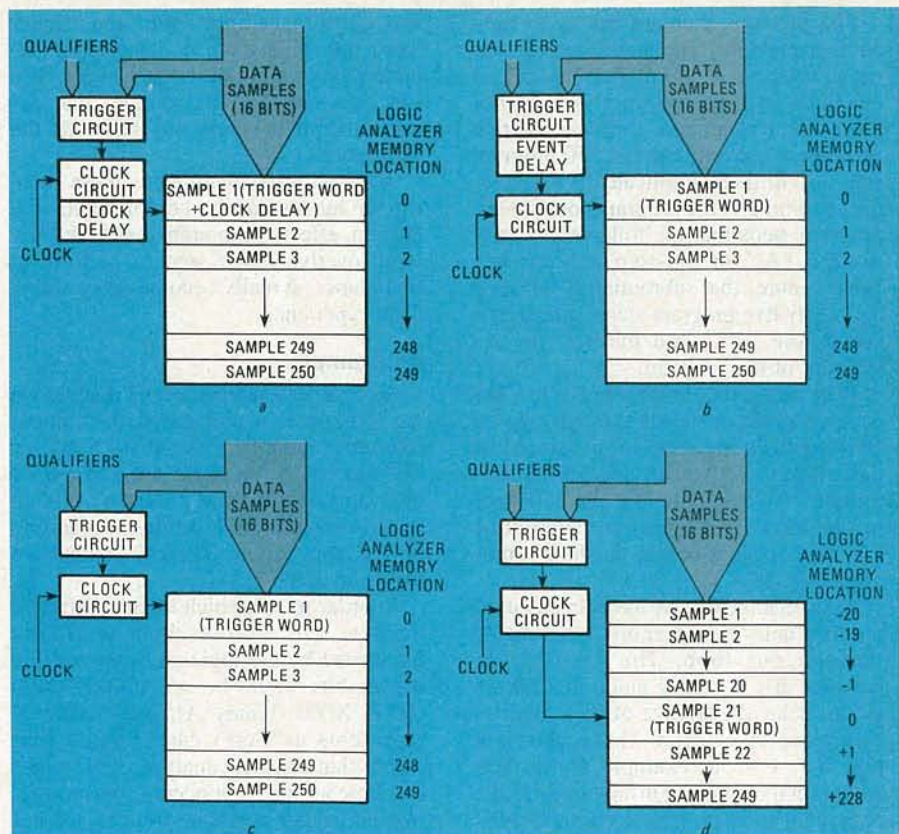

FIG. 6—TRIGGER MODES OF THE LA1025. The basic mode is shown in a; the event-delay mode in b; the clock-delay mode in c, and the trigger-position mode in d.

When the logic analyzer's MODE switch is changed to the EVENT position, the logic analyzer acts as a digital trigger for an oscilloscope. Whenever the incoming data sample matches the trigger word as selected on the TRIGGER BIT switches, a pulse that can be used to trigger an oscilloscope will be generated on the EVENT output line.

A typical application would be to troubleshoot the analog input of an erratic A/D converter. By hooking the data-sampling lines to the address lines and setting the trigger bits to the starting address of the A/D conversion routine, as shown in Fig. 5, the oscilloscope can monitor the stability of the input voltage to the A/D converter.

### Trigger modes

The real versatility of the logic analyzer lies in its triggering modes. We have already discussed the basic trigger mode—the configuration when the logic analyzer is powered up. As shown in Fig. 6-a, the logic analyzer's trigger circuit monitors the incoming 16 data sampling lines and qualifier bits. When the incoming data samples match the user-selected 16-bit trigger word, a condition we'll call the *trigger event* occurs and the storage of data samples on subsequent clock signals begins. In this mode, the first word stored in the logic analyzer's memory will be the trigger word. (If some of the trigger bit switches are set to the x or "don't care"

position, the actual data stored in the corresponding bit position may be either a logic 1 or 0).

The basic trigger scheme can be altered when the MODE switch is turned to the STAT (status) position. In that position, you can select any combination of event-delay, clock-delay, or trigger-position modification.

Figure 6-b shows the effect of the event delay, which can probably best be thought of as a loop delay and can be used in the following way: Let's assume that you want to look at a program with a 300-step loop that is going astray in its tenth pass through the loop. In the basic triggering mode shown in Fig. 6-a, the logic analyzer would trigger and fill its 250-word memory on the first pass through the loop. Using the event delay you can trigger the logic analyzer on the tenth pass through the loop. To accomplish that, the MODE switch is set to the STAT position and, for the example above, the event delay is set to 9 by using the + and - EVENT DELAY switches. By setting 9 as the event delay, you are instructing the logic analyzer to ignore the first 9 trigger-word matches (events) and to enable the logic analyzer's memory when the tenth trigger event occurs. The event delay can be user selected to any number from 0 (no event delay) to 999. As with the basic triggering mode (Fig. 5-a), the first data sample stored in memory will be the sampled data that matches the triggering requirements.



The previous problem brings to light another problem. The loop length in our example above is 300 program steps and our logic analyzer can only store 250 of those. Let's assume for this example that we want to see only the last 250 program steps. To further complicate the problem, the beginning of the program contains ten program steps that are followed by subroutine "A" (a ten-step subroutine). What's more, that subroutine is followed by twenty-five program steps, a repeat of subroutine "A," and then by the remainder of the program.

Note that since subroutine "A" executes both from step 11 through step 20 and step 46 through step 55, we cannot set the trigger word to an address in subroutine "A" to capture the last 250 steps in our loop. That's because subroutine "A" also occurs before the loop's program-step 50.

Keep in mind that we have already used our loop delay to trigger on the tenth pass through our loop. The LA1020/25, however, has a trigger mode that allows you to delay the storage of data samples by a preset clock delay. That is shown in Fig. 6-c. For our example above, you would set the TRIGGER BIT switches to the beginning address of our loop and set the clock delay to 50 by using the + and - CLOCK DELAY switches. The result is that after the event delay (Fig. 6-b) is satisfied (it has priority over the clock delay), the unit will not store any samples until the 51st clock pulse occurs. The remaining samples will then be loaded on subsequent clock pulses. In that manner, the clock-delay feature gives you another tool for "zeroing in" on the portion of the program that you want to observe. The clock delay can be set for values from 0 (no clock delay) to a maximum of 999.

The last triggering modification to be discussed is the trigger position (Fig. 6-d). With the + and - TRIGGER POSITION switch, you can locate the trigger event anywhere within its 250 word memory. If, for example, 20 was set into the TRIGGER POSITION register and the trigger event occurs, 20 samples prior to the trigger event will be stored in the first 20 words of the logic analyzer's memory. The trigger word will be stored in the 21st position in the logic analyzer's memory and then 229 samples will be stored after the trigger word.

This example, of course, assumes that the clock delay was not set. The trigger-position feature is perhaps the most useful on the logic analyzer. Let us look at an example where you have a program that contains a subroutine where the program is locking up. The trigger word can be set for the starting address of the subroutine (found by manually triggering the unit) and the trigger position set to 125. (The trigger-position register can be set to any number from 0 to 249.) Now, when the sampling process is completed, you will not only be able to view the trigger word

and the 124 samples after the trigger word, but also the 125 samples immediately preceding the trigger event. You can then see the data samples that occurred before the entry was made into the subroutine.

As previously mentioned, these three trigger modes can be combined for the desired effect. Although that task may seem overly complicated to perform at first glance, it really becomes easy after a little experience.

### An example

As another example, let us assume we are looking at a problem with multiple interrupt routines for the 8080, 8085, or Z80 (mode 0). As there are 8 levels of interrupts possible, the program could go to any one of eight locations, depending on the application. These locations are shown in Table 1.

In order to see which interrupt routine occurs, the address bus would be monitored by the logic analyzer and the trigger bits would be set to 0000 0000 00XX X000 (binary A15-A0) where X represents a "don't care" state. That means that the logic analyzer will trigger any time an interrupt occurs. By modifying the trigger position, you can see not only what interrupt occurs but the address of the program steps occurring before the

TABLE 1

Interrupt level	Subroutine starting address (hex)
0	0000
1	0008
2	0010
3	0018
4	0020
5	0028
6	0030
7	0038

interrupt. If the interrupt routine were a long one, the clock-delay function could position the start of the sampling process anywhere within the interrupt routine.

### Extended bus monitoring

In the case of monitoring a system with extended addressing (more than 16 bits), the LP3 qualifier probe (Fig. 3) is useful. Even though the logic analyzer will only store 16 bits at one time, the extended address bits can be used to trigger the unit with the LP-3 qualifier pod. Then, by knowing the address location of the trigger word, the 16 stored bits would generally be enough to follow the program sequence.

A similar situation occurs when monitoring the data buses. Eight- and sixteen-bit data buses can be monitored without problems. A trade-off must be made, however, when you want to monitor both the address and data bus; let's see what's involved.

With an eight-bit data bus, eight address lines (usually the lower eight bits) can be stored in addition to the eight data lines. The high-order address lines could then be used as part of the trigger word by using the LP3 qualifier pod. Similarly, when monitoring a 16-bit data bus, the address lines could only be used for triggering. It is important to note that we are confronted with the basic design limitations of a 16-bit machine—only 16 bits of data can be stored at one time. Two alternatives are possible. One is to run two LA1020/25 units in tandem. The other would be to buy a unit with more than 16 bits of data storage. Generally, though, a unit with 16 bits of data storage is sufficient for most requirements.

### A single-IC analyzer

So far we have explored a commercially available logic analyzer. Unfortunately, not everyone can afford more than \$2000 for such a logic analyzer. Recently, I found myself in the same situation. The B&K unit that had been loaned to me wasn't available any longer and I didn't have the money to spend for one. Yet, the project I was working on—a stand-alone printer interface card with an on-board Z80 microprocessor—was giving me a rough time. The program just wasn't executing as it should. Fortunately, a circuit that I had recently run across, was adaptable to my needs. Based on that circuit, I was able to design a one-IC "logic analyzer" to perform the function of address-state analysis.

Obviously, a one-IC logic analyzer will have many limitations. The first limitation with ours is that it will only work on Z80 microprocessors. The second limitation is that the output from the circuit under test has to be fed into 2 parallel ports on a host computer.

Figure 7 shows the typical hookup between the circuit under test and the host computer for address-state analysis. Figure 8 shows an alternative method of displaying the data if you don't have 2 extra parallel ports.

### How it works

The circuit (its schematic is shown in Fig. 9) is really quite simple. It causes the microprocessor under test to enter a wait state at the beginning of every instruction-fetch cycle. While the microprocessor is in its wait state, the address lines are sampled by the host computer. The host computer then clears the wait signal and the microprocessor completes the instruction cycle.

When the next instruction fetch occurs, the WAIT signal again goes low and the whole cycle begins again. A limitation that you should be aware of is that, unlike the B&K logic analyzer, which samples the circuit in real time (without slowing down the program's execution), this circuit halts the program's execution after each program step. Therefore, it is possi-



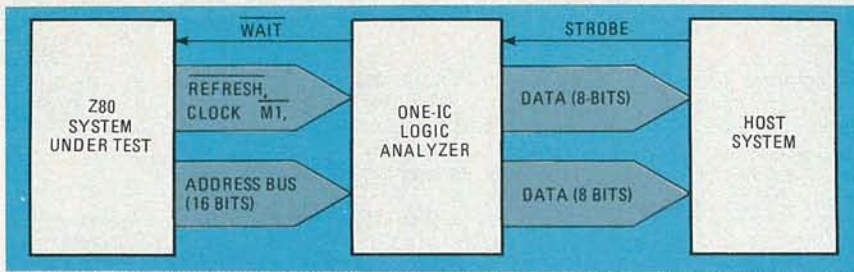

FIG. 7—INTERCONNECTION BETWEEN the logic analyzer host system and the test system.

ble that this circuit could cause some strange occurrences in programs that have critical timing loops.

The heart of the circuit is a simple dual D-type flip-flop. When the Z80's instruction-fetch cycle begins and the  $\bar{M}$  line goes low, the next clock pulse toggles the flip-flop, and the  $\bar{WAIT}$  line is pulled low via Q1. That transistor functionally acts as an open-collector output. Pin 24, the  $\bar{WAIT}$  line on the Z80, should be connected to a pull-up resistor. To protect any other non-open-collector gates hooked up to the  $\bar{WAIT}$  line, they should be disconnected. Since a wait state occurs each instruction cycle when using this logic analyzer, that shouldn't cause too many difficulties. When a positive-going strobe is sent from the host system, the second flip-flop is toggled and the wait state ends. The  $\bar{REFRESH}$  line prevents the wait cycle from repeating until it goes high during the next

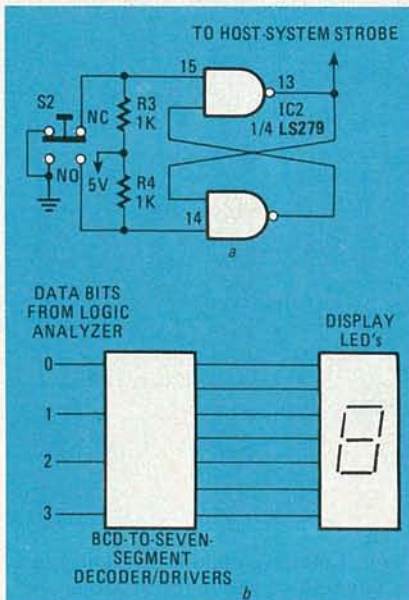

FIG. 8—AN ALTERNATE METHOD to display data from the one-IC logic analyzer. The circuit in a will cause an additional data sample to be taken each time S2 is pressed. Three additional BCD-to-decimal decoder/drivers and LED's are needed to display the value of the 16 data bits.

instruction cycle. At the end of this article we'll explore some options to expand the capabilities of this circuit.

The circuit was built on a small piece of

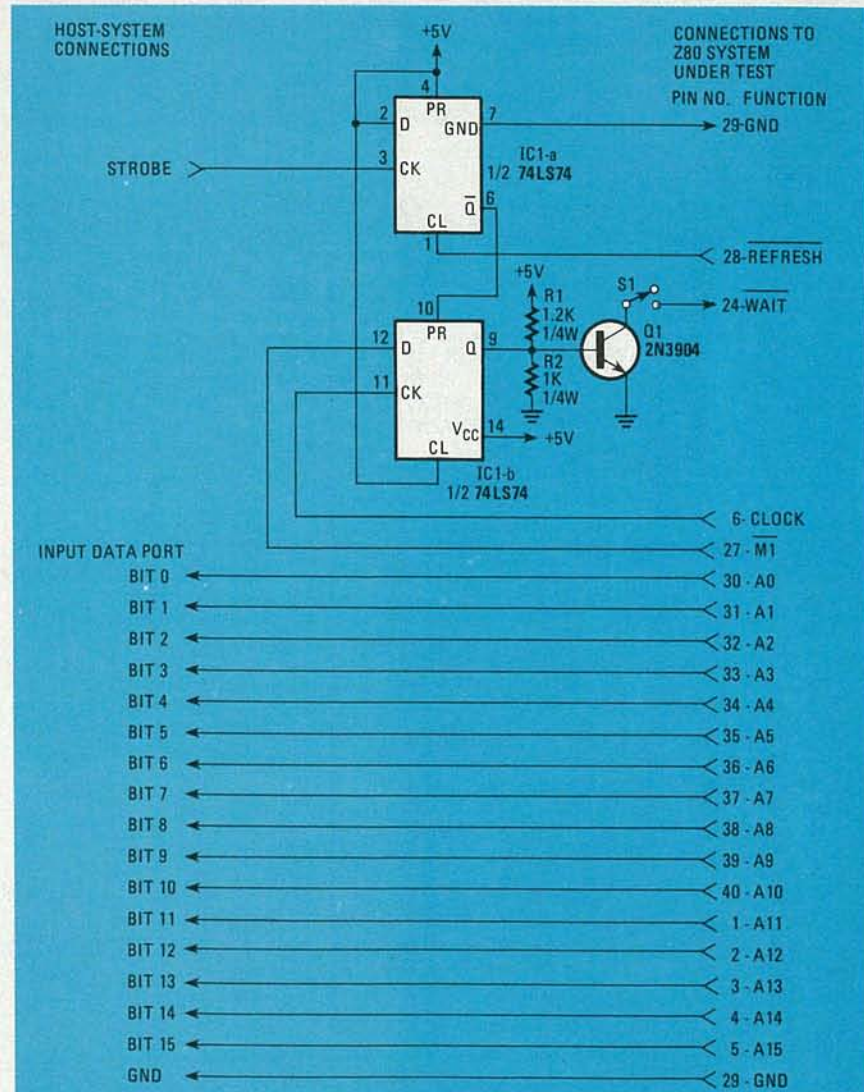

FIG. 9—SCHEMATIC OF THE LOGIC ANALYZER. No on-board buffering is provided because enough time for the data to settle is provided in software. When S1 is closed, the analyzer controls the test system. When open, it has no effect on the test system.

perf board using wire wrap techniques and is shown in Fig. 10. The connection to the host system was made by a 25-conductor ribbon cable with DB-25 connectors at each end. Connection to the system under test was accomplished by using a 40-pin clip with standard DIP spacing that attached to the Z80. No buffering was used on the address lines between the system under test and the host system. The software (Table 2) that I used leaves a long enough delay time—from

the start of the wait state until the host takes its sample—for the address lines to settle for a stable sample. Nonetheless, it is strongly recommended that the length of the connections between the tested system and the host system be kept as short as possible.

When the program in Table 2 is entered, a "\*" is printed as a prompt. You can then press any number between 1 and 9 on the keyboard. That number of program-step addresses will be displayed on

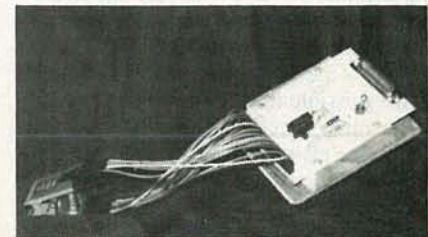

FIG. 10—THE ONE-IC LOGIC ANALYZER doesn't look elegant, but it does work! It was built using wire-wrap techniques. Connection to the Z80 test system is by a 40-pin clip.



TABLE 2—LISTING

This is a simple program to display the addresses of instructions as they are executed. When run, the program displays an "\*". The user then selects a number between 1-9 on the keyboard. That number of program steps will then be displayed on the console. If the RETURN key is hit, the system reboots. This program is written in 8080 code for the ASM assembler.

```

BDOS EQU 5          ;BDOS ENTRY POINT
CONOUT EQU 2        ;CONSOLE OUT
                        ;FUNCTION CODE
CONIN EQU 1         ;CONSOLE IN
                        ;FUNCTION CODE
1XI SP,200H        ;LOAD NEW STACK
                        ; POINTER
PMT: MVI E,0DH      ;PRINT LINE FEED &
                        ;CARRAGE RETURN
MVI C,CONOUT
CALL BDOS
MVI E,0AH
MVI C,CONOUT
CALL BDOS
MVI E,2AH         ;PRINT PROMPT
MVI C,CONOUT
CALL BDOS

MY SYSTEM I/O PORTS ARE:
STROBE OUT PORT = 03H
STROBE OUT BIT = 02H
LOW ADDRESS INPUT PORT = 06H
HIGH ADDRESS INPUT PORT = 05H
PORTS AND BITS SHOULD BE CHANGED
TO REFLECT YOUR SYSTEM

MVI C,CONIN        ;GET THE NUMBER OF
                        ; STEPS
CALL BDOS
CPI 0DH            ;COMPARE TO
                        ;CARRAGE RETURN
JZ 0               ;YES- THEN JUMP TO
                        ; CPM
CPI 20H           ;CHECK FOR SPACE
                        ; BAR
JNZ INC           ;YES-THEN ENTER 1
MVI A,31H        ;ENTER 1
ORA A             ;CLEAR CARRY FLAG
SBI 30H          ;MAKE ZERO RELATIVE
MOV D,A          ;PUT RESULT IN D
                        ; REGISTER
PUSH D           ;SAVE IT
MVI E,20H        ;OUTPUT A SPACE ON
                        ; THE CONSOLE

MVI C,CONOUT
CALL BDOS
POP D            ;GET COUNT BACK
PUSH D          ;SAVE LOOP COUNT
MVI A,2         ;OUTPUT STROBE
OUT 03H
CALL DELAY      ;ALLOW SIGNALS TO
                        ; SETTLE
                        ;GET UPPER 8 DATA
                        ; BITS
CALL PRTHX     ;PRINT HEX NUMBER
IN 06H         ;GET LOWER 8 DATA
                        ; BITS
CALL PRTHX     ;PRINT HEX NUMBER
MVI E,20H     ;OUTPUT A SPACE ON
                        ; THE CONSOLE
MVI C,CONOUT
CALL BDOS
POP D         ;GET LOOP COUNT
                        ; BACK
DCR D        ;DECREMENT LOOP
                        ; COUNT
JNZ LOOP    ;LOOP UNTIL OUTPUT
                        ; IS DONE
JMP PMT     ;DONE - PROMPT
                        ; USER

; SETTLING DELAY - ALLOW DATA LINES TO SETTLE
DELAY: MVI C,10 ;LOAD DELAY
TLOOP: DCR C    ;DECREMENT COUNT
JNZ TLOOP      ;LOOP UNTIL DELAY IS
                        ; OVER
RET            ;DONE - RETURN

; PRINT TWO HEX NUMBERS ON CONSOLE
PRTHX: PUSH PSW ;SAVE REGISTER
CALL ASCII ;OUTPUT ONE
                        ; CHARACTER
POP PSW ;GET CHARACTER
                        ; BACK
JMP BYPASS ;SKIP ROTATION
ASCII: RLC ;POSITION DIGIT
RLC
RLC
RLC
BYPASS: ANI 0FH ;MASK HIGH FOUR
                        ; BITS TO ZERO
CPI 0AH ;CHECK FOR HEX A-F
JC PASS ;NOT THEN SKIP
                        ; NEXT
ADI 7 ;INDEX TO 'A'
ADI 30H ;INDEX TO ASCII
MOV E,A ;POSITION OUTPUT
MVI C,CONOUT ;OUTPUT IT
CALL BDOS
RET
END

```

the terminal's CRT. In that way, the execution of the program can be followed. When you want to exit the program, simply press the carriage return.

It's possible that you would like to see all memory accesses by the Z80 in addition to the instruction fetches. The memory-request signal (Z80 pin 19—MREQ) and the READ and WRITE signals (pins 21 & 22) are candidates for triggering signals that could be used in place of the M signal to trigger the unit.

If you use a microprocessor other than

the Z80, the requirement for the refresh signal can be eliminated by adding an inverting gate from a 74LS00 or 74LS04. The input of that gate would be connected from pin 12 of the 74LS74 and the output of the gate would be connected to pin 1 of the 74LS74, eliminating the requirement for the resetting of the logic analyzer via the Z80 refresh signal. Although I haven't actually tried it, the address latch enable (ALE) of the 8085 or the valid memory address (VMA) of the 6800 should take the place of the M signal in triggering this

circuit. Caution should be used to insure that any restrictions on the maximum duration of the wait signal should not be exceeded. (The Z80 has no restriction on the maximum duration of the wait signal).

Despite its limitations, this simple logic analyzer enabled me to successfully complete my project and saved me the cost of an expensive logic analyzer. With a little work with the software, many of the features of the commercial logic analyzer we previously discussed could be implemented. **R-E**



# BUILD THIS

## Typewriter -to-



## Computer Interface

BILL GREEN

Build this interface/buffer and use your IBM typewriter as a low-cost letter-quality computer printer. The 30K buffer can be used with the typewriter or any parallel printer.

**Part 2** WE HAVE ALREADY looked at the theory behind the interface and looked at its features. Now we'll go through the assembly and begin the interface installation.

As we now go through the assembly instructions, be sure that you install parts in their proper locations and double check your work! Make sure all parts are properly oriented or polarized. Solder all leads and clip the leads close to the board. Don't forget that MOS devices are static sensitive—use sockets and follow proper handling procedures to avoid damage.

Follow the parts-placement diagrams shown in Figs. 9 and 10 to help with the assembly. To start, install sockets for (preferably all) the IC's. Note that IC1 and IC2 are MOS devices and should definitely be socketed. The same holds true for IC12 through IC27, which are used in the buffer. Two high-current drivers, IC10 and IC11, are used only with the *Selectric*. You might want to install sockets there, anyway—it will make the interface easier to modify in the future.

Next, install the fuse clip and a 20-position right-angle header at SO1. Install the voltage regulator and its heatsink. Then, connect switches S1, S2, and S3. Install D1, all the resistors except R3, and all the capacitors except C5.

There are still some components and jumpers to be installed. Which components you now install—and where you install them—depends on what printing device you're going to use. We'll discuss each case in the following paragraphs.

If you will be using a *Selectric*, install R3 near pin 1 of IC1. (Note that the parts-placement diagram shows two possible locations for R3.) Install jumper JU1 and diodes D2–D4. Next, connect switch

S4, following the parts-placement diagram for the proper pads. (Again, note that there are two possible ways to connect S4.)

For the *Electronic* typewriter, install R3

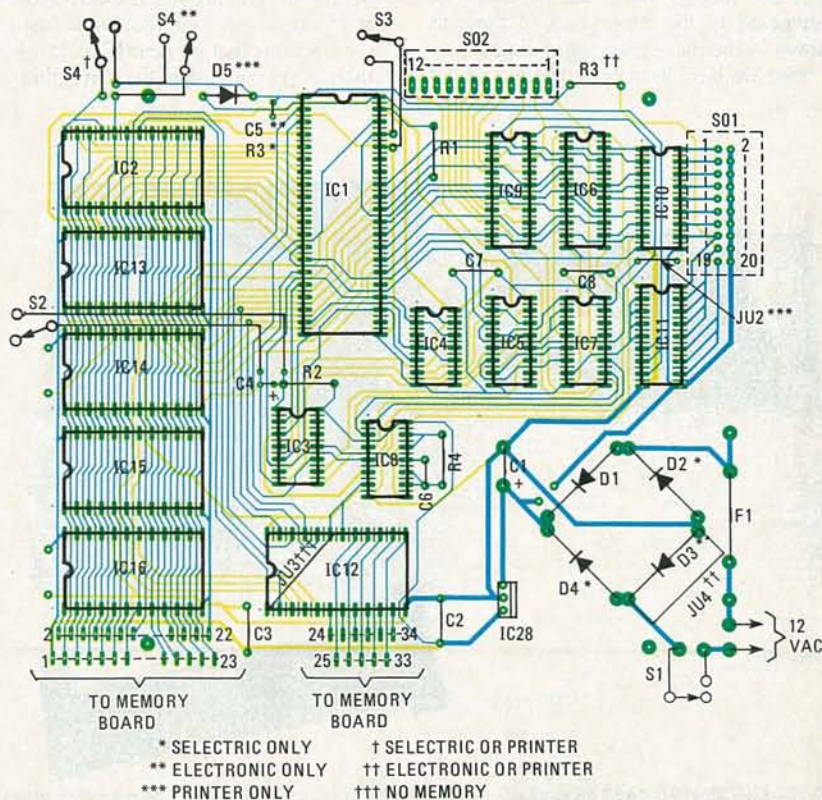

FIG. 9—PARTS-PLACEMENT DIAGRAM for the main board. Note that some components depend on what printing device you're going to use.



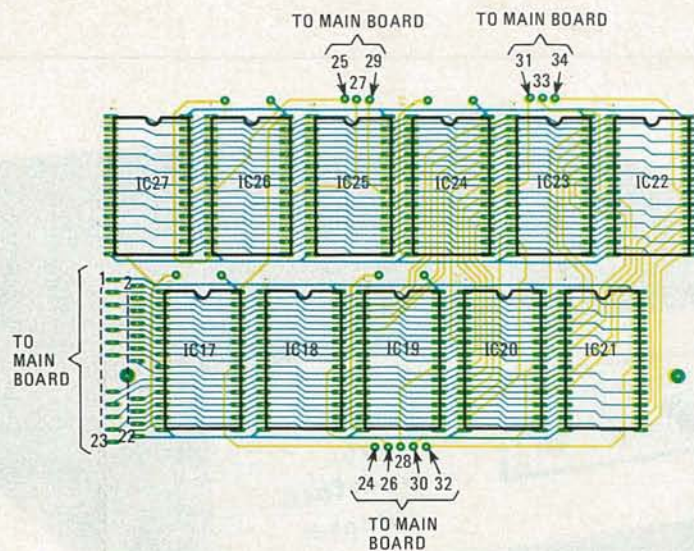

FIG. 10—PARTS-PLACEMENT DIAGRAM for the memory board, and connections to the main board are shown here.

above IC6 and then install C5. Install JU4, JU5—JU11, and JU13 (See Figs. 2 and 9). As we mentioned earlier, you may want to install a socket at IC10 and insert a properly jumpered DIP header in the socket. Next connect S4 to the proper pads as indicated for the *Electronic* in the parts-placement diagram.

If you will use this interface only with a printer, install R3 above IC6. Then install diode D5 and install JU2, JU4, and JU5—JU13 (See Figs. 3 and 9). Here, too, you may want to use a DIP socket and header for those jumper connections. Wire S4, making sure that the wires are connected to the proper set of pads as shown in the parts-placement diagram.

Next we have to decide whether or not

buffer memory will be installed. If you don't want any buffer memory, then install jumper JU3. If you do want the buffer, but need only 8K or less, then install sockets on the main board for IC12 through IC16, and then install the IC's.

If more than 8K of buffer memory is to be used, then you need the separate memory board. Install and solder sockets for the IC's on that board. Of course, the main board and the memory board have to be wired together. As you can see from the photo in Fig. 11, ribbon cable helps to keep things neat. The connections from the memory board to the main board near IC15 are about 3 inches long. The other connections that go near IC12 are about 6 inches. As you follow the parts-placement

diagrams, you'll note that the interconnections near IC16 are tricky. If you arrange the boards as shown in Fig. 11, then you'll note that all the wires cross.

Now, again referring carefully to Figs. 9, 10, and 11, connect the 34 three-inch and six-inch wires from the main board to the memory board.

The next step is attaching the interface to your computer. You'll need a 3-foot length of flat ribbon cable and a suitable connector to connect to the parallel port of your computer. The other end will just be stripped, tinned and soldered to the main board at SO2. Referring to the manual for your computer and the pinout of SO2 (as shown in the schematic), attach the cable between the two. If you have a Radio Shack computer (*Models III or 4*) or an IBM PC, then you don't even have to look at your manual—the proper pin connections are shown in Fig. 12.

Connect a 6-foot length of No. 22 zip cord to the main board near the fuse clips and install a 5-amp fuse. Now we're ready to install the board(s) in a suitable case. Use No. 4 × ¼-inch self-tapping screws to mount the boards. Punch or drill holes for the switches in the front panel of the case, install the switches, and label them. Orient S1 and S3 so that the unused terminal of those toggle switches is up. Punch or cut the rear panel to clear the connection to the header at SO1. Leave plenty of extra room to allow for ventilation.

Connect the free end of the zip-cord wires to a 12-volt, 2-amp, wall-mounted transformer. Turn on the POWER switch and measure for 5 volts at the output of IC28. If that voltage is not correct, or if the fuse blows, double check *everything*. Check carefully for solder bridges and check the polarity of the voltage regulator, diode(s), and electrolytic capacitors.

## Installation

Now that assembly is complete and the interface is hooked to your computer, it's time to connect it to your printing device. In the following sections, we'll go through installation for each of the three cases: printer, *Selectric*, and *Electronic*. We'll start assuming that the adapter will be used only as a printer buffer along with a standard parallel printer.

## Printer installation

This is by far the easiest configuration, which is why we're starting with it. The only thing you have to do here is to make up a custom cable. You need to get a connector that will plug into the parallel input of your printer, a connector to mate with the 20-pin jumper header at SO1, and some cable to run between the two.

Refer to the manual for your printer and to the schematic in Fig. 3 for the pinouts of your printer's port and SO1. Wire the cable to go between the appropriate pins of the interface and your printer. Then after double checking that your cable is wired correctly, attach the cable to each

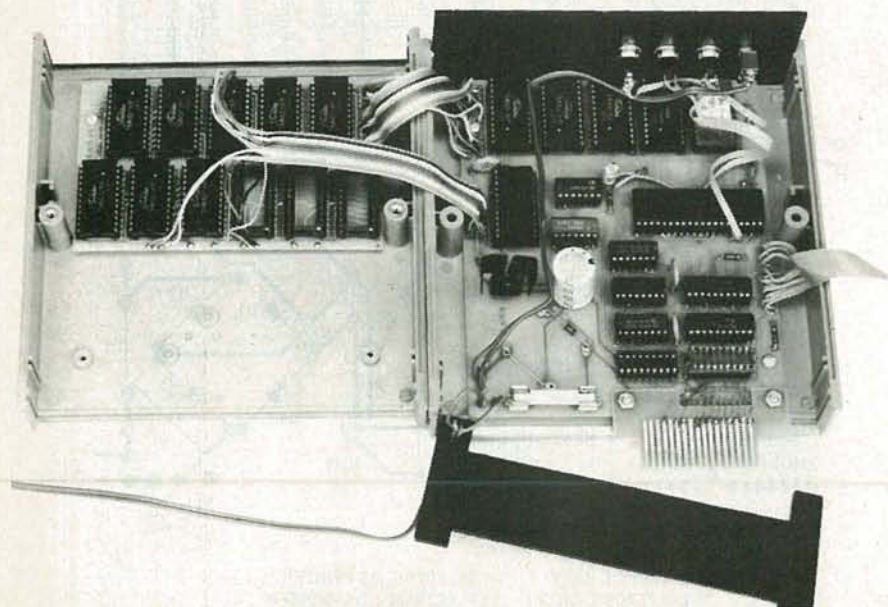

FIG. 11—SUGGESTED CASE MOUNTING. When the case is closed, the memory board will be on top of the main board, and the components on each board will face the other. Note that a right-angle header was not used at SO1—we used what we had on hand.



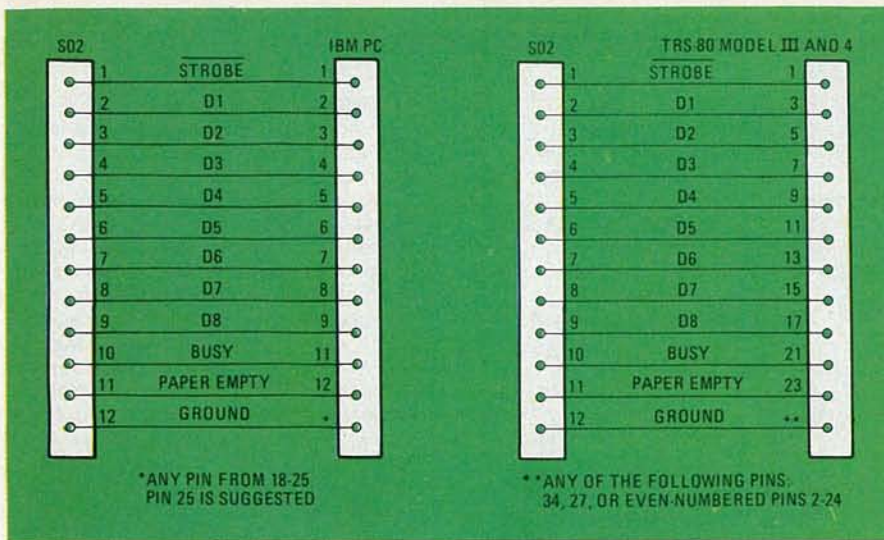

FIG. 12—HOOKING UP THE INTERFACE to your computer is straightforward but requires making a custom cable. Shown here are the connections to a TRS-80 and IBM PC.

device. Check everything again to make sure that the connectors are properly polarized (not inserted backwards). Then turn the interface on and power your printer and computer in the usual order, and press RESET. Dump some text from the computer to the interface. If you have buffer memory installed, press PRINT. (If no buffer memory is installed, printing should begin immediately.) That's all there is to it! If the interface has been assembled correctly and the cables are correctly connected, the text should be printed correctly on the printer.

### Electronic installation

Now we're going to look at how to adapt your *Electronic* model 50, 60, or 75 typewriter for use as a printer. You're probably worried about what the connection will do to your warranty. IBM Corporation's policy on this (as pertains to warranty and service policies) is to inspect and accept for service each installation on an individual basis. Their interest is primarily to assure that their service personnel will not be subjected to hazardous conditions or voltages. The adapters that this interface requires present no hazards. Contact your IBM field service office for inspection.

Before we get to the "nuts and bolts" of the installation, we should point out that if you do not use care (and some common sense) in the following procedures it is possible that you'll damage your typewriter—so be careful. With that in mind, position the typewriter carriage near the center and *unplug the power cord* until we tell you otherwise.

The first step is to remove the top of the machine; following Fig. 13 will help you. Raise the cover and pivot the paper table up and back. Remove the platen by pressing the release levers on either end of it. Raise the carriage pointer. Using a screwdriver with a long blade, slide the left and right cover-latches forward. These latches are directly below where the platen was.



FIG. 13—REMOVING THE COVER of the IBM *Electronic* is an easy process.

Remove the cover by lifting it straight up. Then reinstall the platen. Lift the typewriter by the metal frame at the front and pull

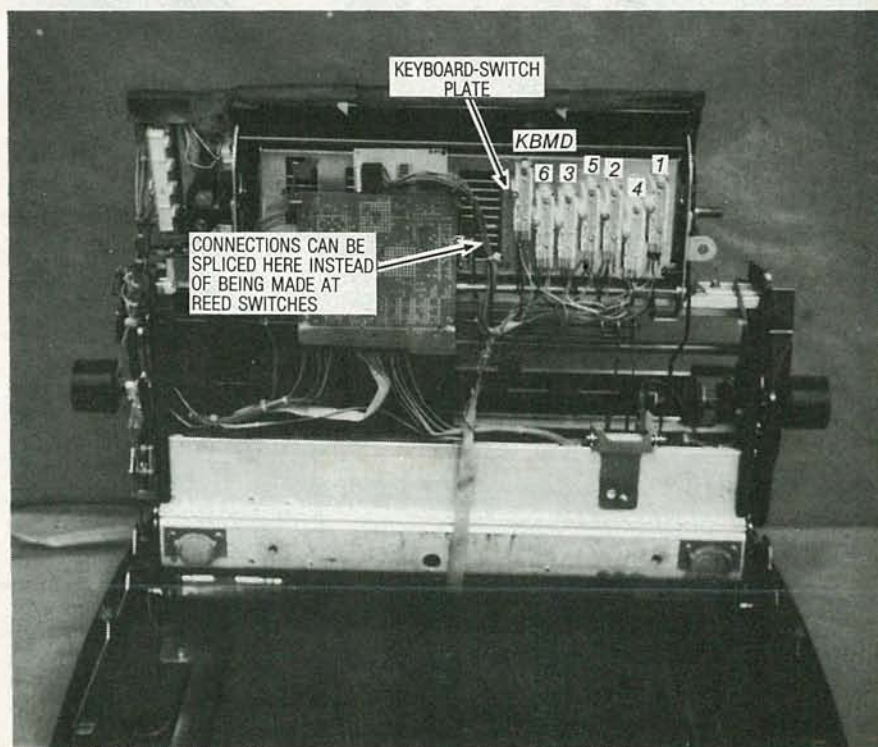

FIG. 14—BOTTOM VIEW of typewriter assembly showing reed-switch locations.

forward a few inches. Then tilt it back until it rests on the rear support brackets, as shown in Fig. 14. At the top right side of the assembly is the keyboard-switch plate. There are seven reed switches mounted on this plate. Their designations are shown in Fig. 14.

You will be connecting wires from SO1 on the main board to the reed switches (or, as we'll describe, to the wires leading to the switches).

Cut the wire ties on the wire harness running to the reed switches. Referring to the schematic in Fig. 2, note the pinout of SO1 for the *Electronic*. The odd-numbered pins are the output to the reed switches. (Only one even-number pin, we chose pin 14, is used here.) Spread the wiring harness from the reed switches open to determine what switch each wire goes to. The black wire which loops between one terminal of each reed is ground. At a point an inch or so to the left of *KBMD*, splice the wire from pin 14 of SO1 into that black wire. (The *KBMD* or *KeyBoard-MoDe* reed is what tells the *Electronic* to print shifted characters.) Following Fig. 3, splice the other wires from SO1 to the other wires from the reeds—pin 1 to reed 1, pin 3 to reed 2, etc.—until all seven reeds are connected. Solder and tape the splices.

About halfway up and on the left side of the machine is the *PFB* (Print FeedBack) reed. (See Fig. 15.) Splice the wire from pin 17 of the header at SO1 to the light-colored wire from this reed. Solder and tape this splice. Rebundle the wire harness from the switch plate using wire ties. Position the flat cable as shown and secure with wire ties. Be sure that the ties do not interfere with the moving parts of the ma-



## PARTS LIST—PRINTER AND ELECTRONIC INTERFACE

All resistors 1/4-watt, 5%, unless otherwise specified

R1, R3—1000 ohms

R2—10,000 ohms

R4—220 ohms

Capacitors

C1—2200  $\mu$ F, 25 volts, electrolytic

C2, C3, C7, C8—0.1  $\mu$ F, 6 volts, ceramic disc

C4—4.7  $\mu$ F, 10 volts, electrolytic

C5—1  $\mu$ F, 6 volts, electrolytic (used only with *Electronic*)

C6—1500 pF, 6 volts, ceramic disc

Semiconductors

IC1—2650 microprocessor, (Signetics)

IC2—13941 PROM, (Alpha)

IC3—74LS14 hex inverter

IC4—74LS20 dual 4-input NAND gate

IC5—74LS139 dual 2-to-4 line decoder/multiplexer

IC6, IC9—74LS373 octal D-type latch

IC7—74LS279 quad S-R latch

IC8—7400 quad 2-input NAND gate

IC12—74LS154 4-to-16 line decoder/demultiplexer (for buffer)

IC13-IC27—TMM2016P 2K  $\times$  8 static RAM (Toshiba) (for buffer)

IC28—LM340T five-volt regulator

D1—1N5400

D5—1N4148 (used only with printer)

F1—5-amp fuse

S1, S3—Switch, SPDT toggle

S2, S4—Switch, SPST, momentary push button

T1—12-volt 2-amp wall-mounted transformer

**Miscellaneous:** PC boards, fuse clip, IC sockets, 20-pin header for SO1, 5-watt heat sink for IC28, suitable case, wire, connectors and cables for your computer and printer

The following are available from Alpha Electronics, PO Box 1005, Merritt Is., FL. 32952 (305-453-3534). A complete kit of parts—including main PC board, memory PC board, cable, case—for printer conversion (does not include memory IC's): \$129 plus \$6 postage; complete kit for *Electronic* conversion (does not include memory PC board or memory IC's): \$119 plus \$6 postage; 2K  $\times$  8 static RAM IC's, \$6.50 each postpaid; 13941 PROM, \$25; memory PC board (PC1832) \$13 postpaid; main PC board, (PC1831), \$18 postpaid; ABS plastic case, \$12. Florida residents please add 5% tax. Canadian orders please add \$2 per order in addition to U.S. postage. Other countries please add \$6 per order in addition to U.S. postage.

### OOOOOOOPS!

Last month, some errors crept into the article: In Fig. 1, the LM340T voltage regulator should have been labeled IC28 and R3 should have been labeled 1K. In Fig. 4 and the Parts List, IC's 13-27 are TMM2016's. We're sorry for any inconvenience this may have caused you.—ED

chine. Lower the assembly backs to its proper position. Run the flat cable along with the power cord out through the notch in the bottom cover. Remove the platen and lower the top cover into place. Relock the two case latches, reinstall the platen, and pivot the paper tray forward. Lower the carriage pointer and the cover.

Now that that's done, we can try it out. Plug the flat cable into the interface and plug the cable from SO2 into your computer. Turn on the interface (making sure

## PARTS LIST—SELECTRIC ADAPTER

All parts mentioned in the Parts List for the *Electronic* and Printer versions, plus: IC10, IC11—ULN2813A or ULN2803A high-voltage/current darlington transistor array, (Sprague)

D2—D4—1N5400

SOL1—SOL10—Solenoid, 12-volts DC

**Miscellaneous:** PC boards, No. 6 hardware: (two 1  $\times$  1/4 inch male/female threaded round spacers, two 3/8-inch flathead screws, two 1/8-inch pan-head screws, hex nut), music wire (12 inches, .031-inch diameter), plastic-covered stainless steel cable (27 inches, .020-inch diameter) 18 crimp sleeves (.040-inch diameter), wire ties, ribbon cable, etc.

A complete kit of all parts for *Selectric* conversion, including main PC board, case, cable for typewriter, solenoids, etc. (not including memory board or memory IC's) is available from ALPHA Electronics, PO Box 1005, Merritt Is., FL. 32952 (305-453-3534) for \$169 plus \$6 postage. The mechanical adapter alone (solenoid boards and solenoids) is available for \$90 plus \$5 postage. The ULN2813A or ULN2803A IC's can be purchased for \$3 each postpaid. Florida residents please add 5% sales tax. Canadian orders please add \$2 additional to US postage; other foreign orders please add \$6 additional to US postage.

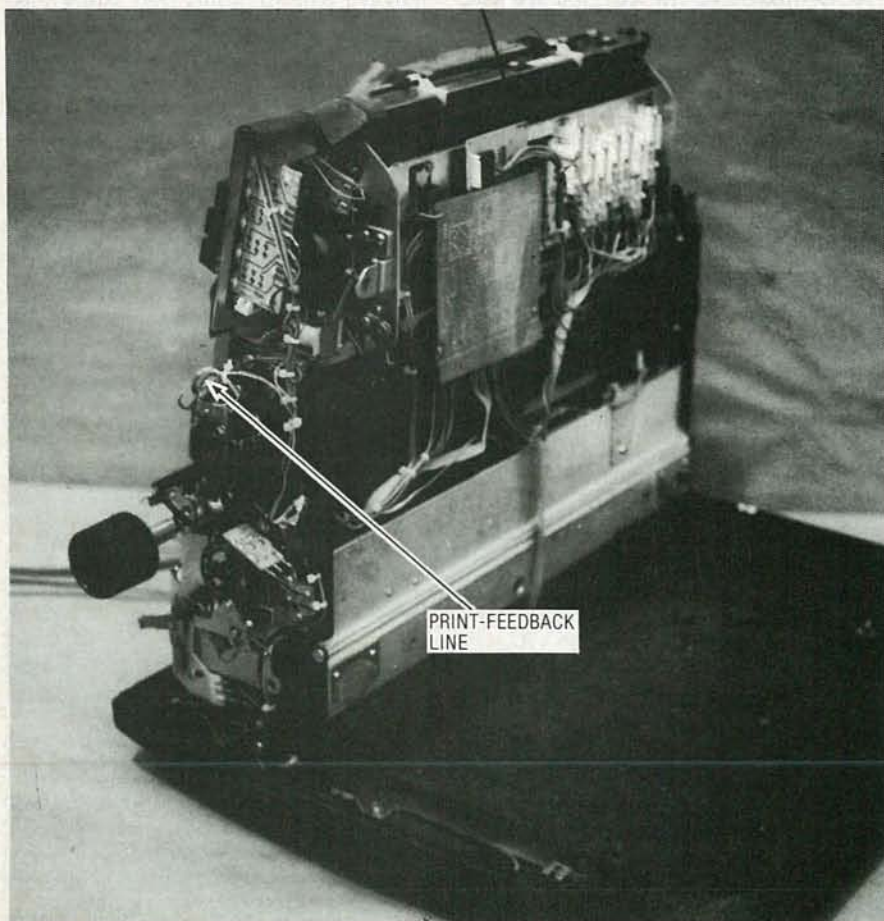

FIG. 15—THE PRINT-FEEDBACK LINE is used by the interface for timing purposes.

that PAUSE is off), the typewriter, and then the computer. Then press RESET. Enter some text into the computer and dump it to the interface. If you have buffer memory installed, press PRINT. (If you don't have any buffer memory, printing should begin immediately.) Check the characters printed. If they're not correct, double check the wiring to the reeds and to the computer, and be sure that all components are installed correctly in the interface.

Unfortunately, that's all we have room for here. Next time we'll look at how to install the interface in a Selectric. R-E

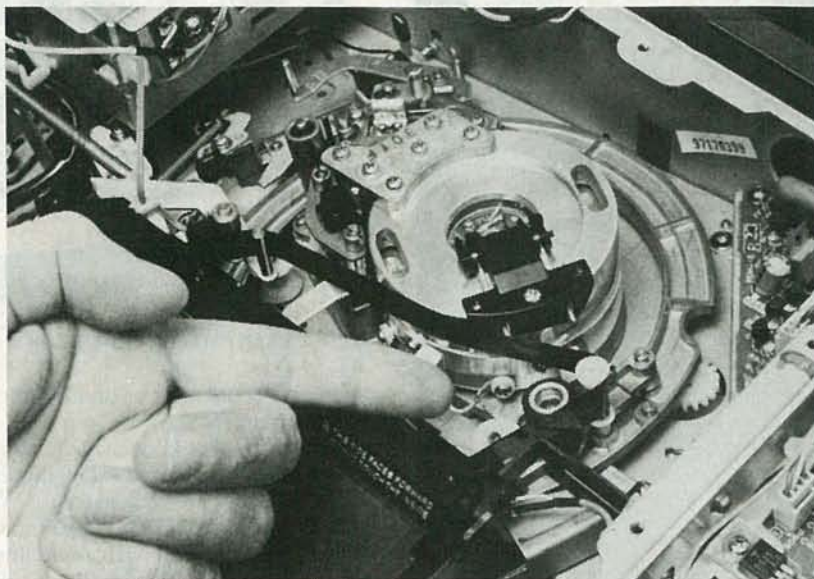

## VCR

REPAIRS AND  
ADJUSTMENTS

## THAT YOU CAN DO

JOHN D. LENK

*Repairing and aligning VCR's isn't easy, but it is possible to do some of the work yourself if you know how! In this article we'll tell you what repairs and adjustments you can make using standard test equipment.*

**Part 2** LAST MONTH, IN THE first part of this article, we skimmed through the basics of VCR's. We looked at VCR circuits and at how a video signal is recorded. Now let us drop the subject of circuits, and get on to more practical matters.

Keep in mind that about 95% of the circuits we've described are contained in a few special-purpose IC's. (That applies equally to video, audio and servo circuits.) You can not get at the detailed circuits for test or analysis. Likewise, if there is a failure of even one circuit in an IC, the entire IC must be replaced (as is the case with most TV circuits). About the only electronic components in a VCR that can be replaced on an individual basis are adjustment controls. We will talk about those components and the related adjustments later on. But before that, let us discuss the test equipment and tools you need for VCR service.

**Test equipment and tools for VCR's**

The test equipment used in VCR service is basically the same as that used in TV and audio service. Most service procedures are performed using meters, sig-

nal generators, color generators, oscilloscopes, frequency counters, power supplies, probes, and so on. However, there are some problems to be considered when selecting test equipment for VCR service.

The subject of tools, test jigs, and fixtures for VCR service is an entirely different matter. Generally, each VCR requires a special set of tools, available from the VCR manufacturers in the form of kits. Although there are some tools found in all kits, such as tension gauges, there are many special-purpose tools for most VCR's. Keep in mind that it is impossible to perform a full set of manufacturer-recommended test and adjustment procedures without having all of those special tools.

Let us consider the minimum requirements for test equipment and tools that you'll need to work with VCR's.

**Meters**

Any meter suitable for TV and audio work is probably suitable for VCR service. (However, most VCR service literature lists audio signals in terms of dB's rather than volts, so a meter with a dB

scale would be useful and time-saving.)

**Signal generators**

As a minimum you should have a sweep/marker generator as well as an analyst and/or pattern generator for basic VCR service.

**Color generators**

You can perform some of the adjustments required for VCR service with a keyed rainbow generator, but you must have an NTSC color generator to perform all of the adjustments. As a minimum, the NTSC generator should produce the standard NTSC bar pattern (for display on the TV screen) and a five-step linear staircase pattern (for display on an oscilloscope being used to monitor various points in VCR circuits).

**Oscilloscopes.**

As in the case of meters, any oscilloscope suitable for TV and audio work will be fine for VCR service. That means a bandwidth of at least 10 MHz is best, although you probably could get by using a scope with a bandwidth of as low as 5-6 MHz.



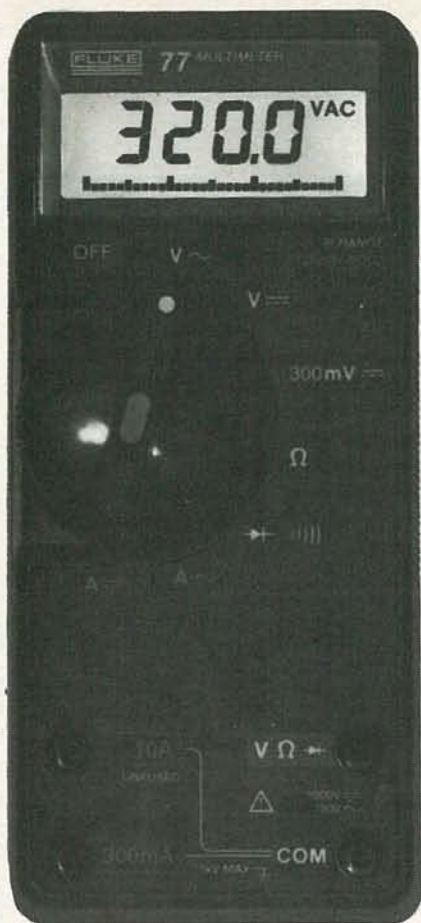

A HANDHELD MULTIMETER like this one should be fine for VCR servicing.

### Frequency counters

If you want to go through a full set of VCR adjustments, you will need a frequency counter to check or adjust the various 3.58-MHz oscillators in the color record and playback circuits, and to measure servo-system timing. Most frequency counters have a sufficient frequency range to measure the 3.58-MHz signals; but many of the servo-system signals are in the 30-Hz range, and low-cost counters often do not go down that far, or are not that accurate. Typically, low-cost counters have an accuracy of about 100 Hz. (Accuracy is not to be confused with counter resolution, which is set by the number of digits in the readout.)

One way to overcome the accuracy problem is to use the period function of the counter. (Again, many inexpensive counters do not have a period function.) When period is measured on a counter, the unknown input signal controls the counter timing gate, and the timebase frequency is counted and read out. For example, if the timebase frequency is 1 MHz, the indicated count is in microseconds (a count of 333 indicates that the gate has been held open for 333 microseconds. In effect, the timebase accuracy is divided by the time period. For 30-Hz signals, where the time period is approximately 1/30-second, an accuracy of 100 Hz is increased to 3.3 Hz (100/30). Of course,

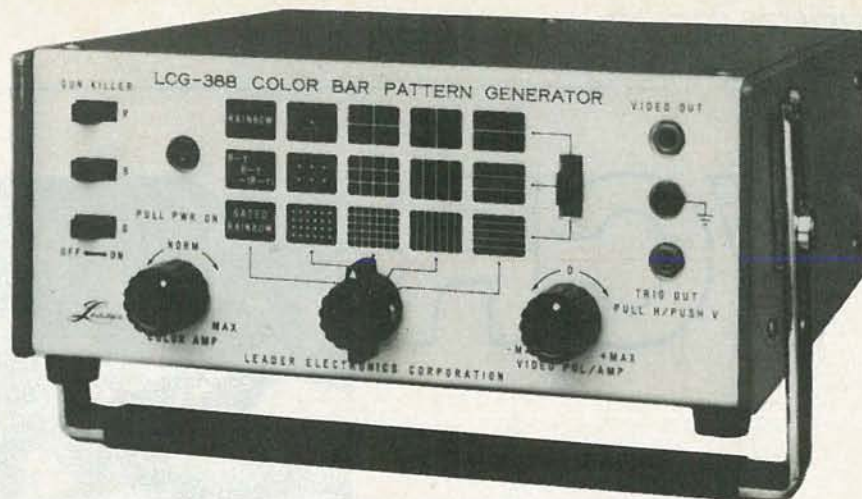

A COLOR BAR PATTERN GENERATOR is useful, but an NTSC generator is preferred.

the period count must be divided into 1 to find the frequency.

No matter what frequency counter you select, check its accuracy at regular intervals. If it is not convenient to use WWV signals for such checks, a simpler method is to monitor the 3.58-MHz oscillator in a color TV receiver. That oscillator is locked in frequency to a color broadcast at a frequency of 3.579545 MHz. The TV receiver oscillator remains locked to that frequency, even though the phase and color hue may shift. Keep in mind that the TV receiver should be operating properly (with good color rendition), and that a 7-digit counter is needed to get the full frequency resolution.

### Probes

Both the meters and oscilloscopes used for VCR service should have a full set of probes, including RF, demodulator, and low-capacitance probes. High-voltage probes are not usually needed for any VCR circuit.

### Video monitor

If you are planning to go into VCR

service on a full-scale basis, you should consider a receiver/monitor such as used in studio or industrial video work. Those receiver/monitors are essentially TV receivers, but with video and audio inputs and outputs brought out to some accessible point (usually the front panel).

The output connections make it possible to monitor broadcast video and audio signals as they appear at the output of a TV-receiver IF section (the so-called baseband signals, in the range 0 to 4.5 MHz, at 1 volt P-P for video, and 0 dB, or 0.775 volt, for audio). Those output signals from the receiver/monitor can be injected into the VCR at some point in the signal flow after the tuner IF section.

The input connections make it possible to inject video and audio signals from the VCR (before they are applied to the RF output unit), and monitor the display. In that way, you can check the baseband output of the VCR independently from the RF unit.

If you do not want to go to the expense of a monitor, you can use a standard TV receiver to monitor the VCR. Of course, with a TV receiver the VCR video signals

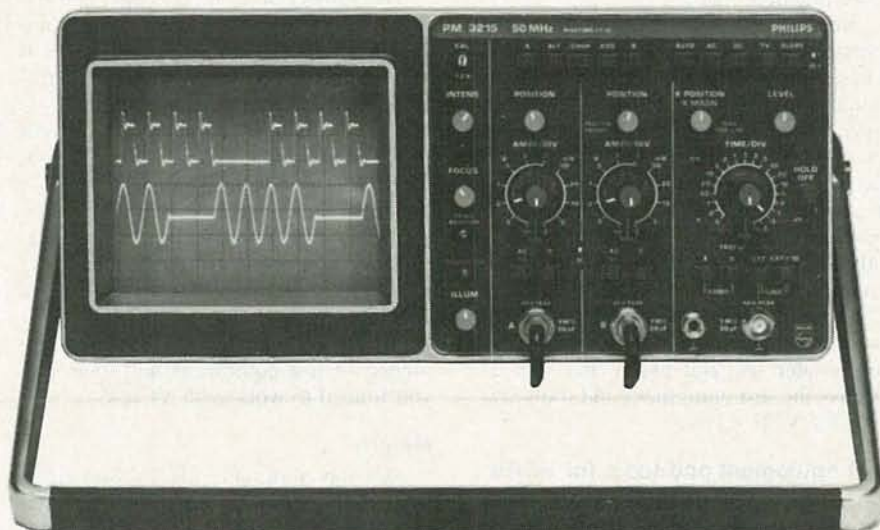

THOUGH THE PHILIPS SCOPE shown here has a bandwidth of 50 MHz, you should do nicely with a scope with a 10-MHz bandwidth.



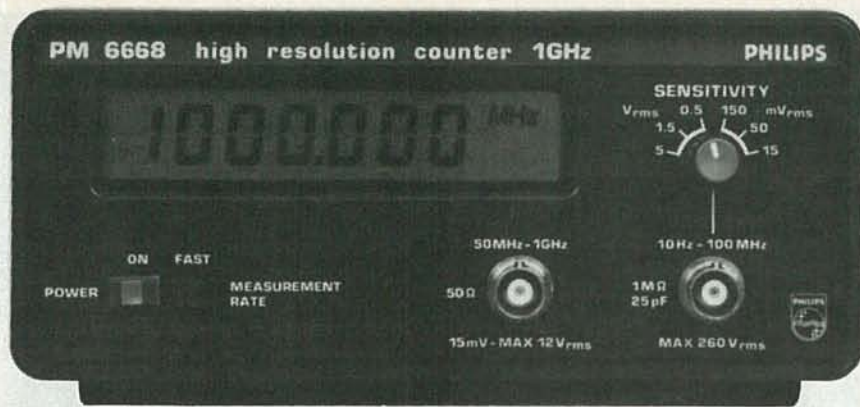

**THIS FREQUENCY COUNTER** measures frequencies up to 1 GHz. But more important for VCR work, it measures signals down to 10 Hz.

are used to modulate the VCR RF unit. The output of the RF unit is then fed to the receiver's antenna input. Under those conditions, it is difficult to tell if faults are present in the VCR video or in the VCR RF unit. Similarly, if you use an NTSC generator for a video source, the generator output is at an RF or IF frequency, not at the baseband video frequencies.

If you use a TV receiver as a monitor, adjust the vertical height control to under-scan the picture so you can see the video switching point in relation to the start of vertical blanking.

#### Special tools and fixtures

VCR service literature usually describes a number of adjustment procedures in extensive detail. Those procedures are useful in that they illustrate the use of special tools and fixtures available from the manufacturer, often in kit form. There are also other tools and fixtures used by the manufacturer for both assembly and service of VCR's. Those factory tools are not available for field service (not even to factory service centers in some cases). That is the manufacturer's subtle way of telling service technicians that they should not attempt any adjustments (electrical or mechanical) not recommended in the service literature.

The author strongly recommends that you take that subtle hint! He has heard many horror stories from factory service people concerning virtually ruined VCR's brought in from the field. Most of those problems are the result of tinkering with mechanical adjustments (although there are some technicians who can destroy a VCR with a simple electrical adjustment). One effective way to avoid any chance of destroying a VCR is to use only recommended factory tools and perform only recommended adjustment procedures (i.e. when all else fails, follow instructions!).

#### Hand tools

Except for those cases where special tools and fixtures are required, most VCR's can be disassembled, adjusted, and reassembled with common hand tools such as wrenches and screwdrivers. Keep

in mind that most VCR's are manufactured to Japanese metric standards, and your tools must match. For example, you will need metric-sized Allen wrenches and Phillips' screwdrivers with Japanese metric points. You will also need tools and applicators to apply solvents and lubricants (cleaner sticks for the video heads, etc.).

#### Alignment tapes

Most VCR manufacturers provide an alignment tape as part of their recommended tools. An alignment tape is housed within a standard cassette and has several very useful signals recorded at the factory using precise test equipment and signal sources. Although there is no standardization, a typical alignment tape contains audio signals (at low and high frequencies, such as 333 Hz and 7 kHz), an RF-sweep signal, a black-and-white signal or pattern, and NTSC color-bar sig-

nals. If you intend servicing one type of VCR extensively an investment in the recommended alignment tape would be well worth it.

A typical use for the audio signals recorded on the alignment tape is to check overall operation of the servo-speed and phase control systems. For example, if the frequency of an audio playback is exactly the same as recorded (or within a given tolerance), and remains so for the entire audio portion of the tape (as checked on a frequency counter), the servo control systems (both speed and phase) must be functioning normally. If there are any mechanical variations, or variations in servo control, that produce wow, flutter, jitter, and so on, the audio playback varies from the recorded frequency.

If you do not want to invest in a factory alignment-tape, or if you do not want to wear out an expensive factory tape for routine adjustments (alignment tapes do deteriorate with continued use), you can make up your own alignment tape or "work" tape using a blank cassette. The TV stations in most areas broadcast color bars before or after regular programming. (Use the VCR timer for convenience.) Those color bars can be recorded using a VCR known to be in good operating condition. Any stationary color pattern with vertical lines (such as the white color bar that extends down to the bottom of the screen) is especially useful.

#### Lapping cassette

A lapping cassette contains a non-magnetic tape coated with an abrasive. The idea is to load the lapping cassette and run the abrasive tape through the normal tape

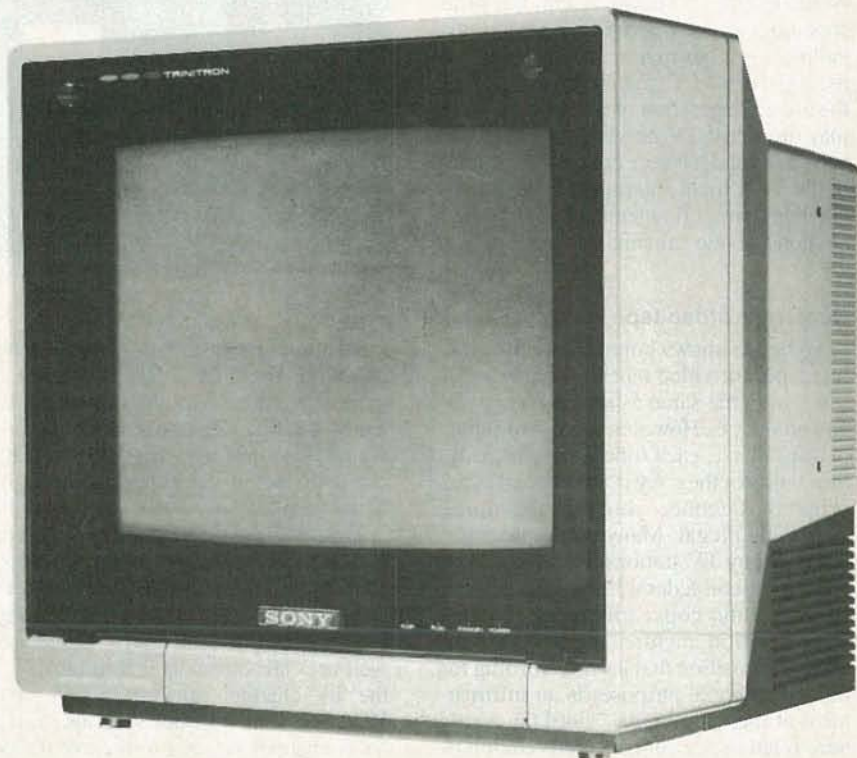

**A VIDEO MONITOR**, such as this one from Sony, is extremely useful to have in almost any VCR-service application.



path (across the video heads, around tape guides, etc.) for a few seconds. That cleans the entire tape path (especially the video heads) quite thoroughly. However, prolonged use of a lapping tape can result in damage (especially to the video heads). Follow the manufacturer's recommendations. Never use any lapping cassette for more than a few seconds; there are other ways to clean the heads and tape path.

### Installing a VCR

On the off-chance that you may not know how to install and connect a VCR, let us review some basics. Fig. 12 shows the connections for a typical VCR and applies to the great majority of VCR installations. As shown, if the antenna cable is 75-ohms, connect it directly to the VHF-IN terminal; use an F-type connector. If the cable is a 300-ohm ribbon type, connect the cable to a 300Ω-to-75Ω adapter, then connect the adapter to the VHF-IN terminal.

Connect the VHF-OUT connector on the VCR to the VHF antenna terminal on the TV receiver with a 75-ohm coax cable. If the TV is equipped with 300-ohm antenna terminals, use an adapter. Connect the UHF-OUT terminals on the VCR to the TV's UHF-IN terminals with the 300-ohm cable.

Where a combination VHF/UHF antenna is used, separate the VHF and UHF signals using a signal separator, and connect the VHF and UHF lead-ins to VHF-IN and UHF-IN, respectively.

One note of caution: Connections between the VHF-OUT connector of a VCR and the antenna terminals of a TV should be made only as shown in Fig. 12, or as specified in the operating instructions. Failure to do so may result in operation that violates FCC regulations regarding the use and operation of RF devices. (You may broadcast TV programs to the entire neighborhood!) Never connect the output of the VCR to an antenna or make simultaneous (parallel) antenna and VCR connections at the antenna terminal of the TV!

### Copying a video tape

Figure 13 shows connections for making copies of video tapes. The process is essentially the same as making a copy of an audio tape. However, keep two points in mind. First, each time a copy is made, the quality of the copy is not as good as the original. Second, you may be doing something illegal. Many of the programs broadcast by TV stations are protected by copyright, and federal law imposes strict penalties for copyright infringement. Some motion picture companies have taken the position that home recording for non-commercial purposes is an infringement of their copyrights. Until the courts have ruled on the proper interpretation of the law as applied to home video recording, a VCR used to record copyrighted

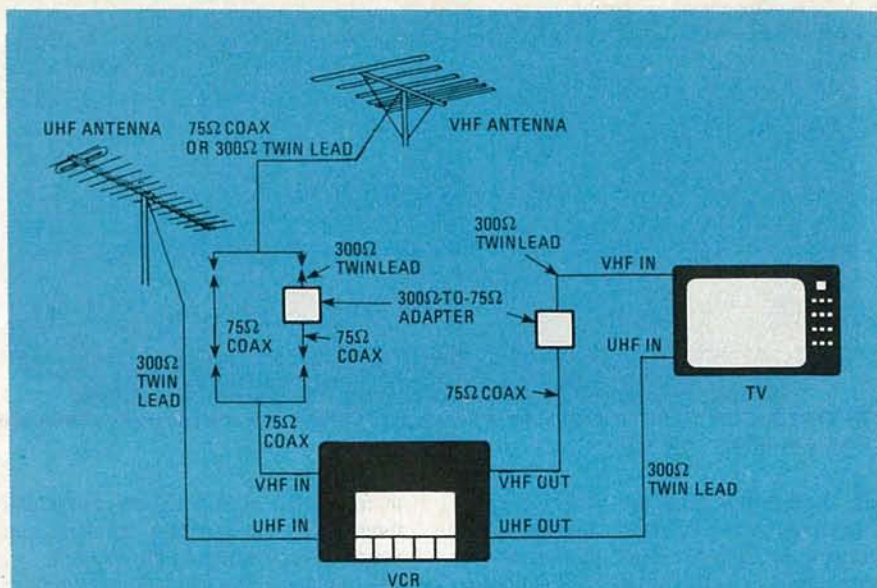

FIG. 12—FOLLOWING THIS VCR connection scheme will help insure that your video system will work properly.

material should be operated at the user's own risk.

### Connecting a VCR to a CATV system

It is recommended that you consult with the cable TV company before installing any VCR. Always follow their recom-

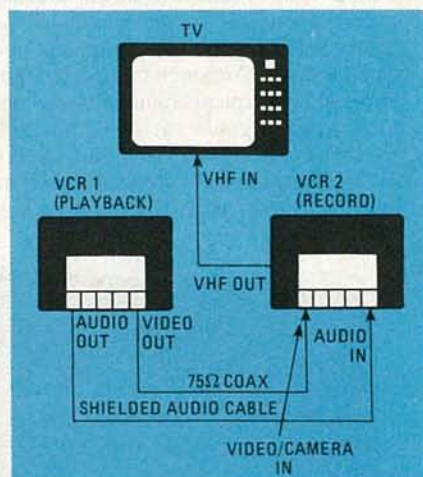

FIG. 13—BASIC SET UP for making a copy of a videotape.

mendations for installation. Also, before operating the VCR with any cable TV system, set the RF-modulator channel selector on the VCR to channel 3 or 4, whichever is not active in the area. If both channels are in use, check which gives better results.

Fig. 14 shows the most often recommended configuration for connecting a VCR to a CATV system. With the set up shown in that figure, it is possible to record programs from all CATV channels, as well as VHF channels 2 through 13. Set the TV channel selector to that of the VCR RF unit channel selector. Set the VCR channel selector to receive the output channel of the converter. Set the VCR program select switch to the VCR posi-

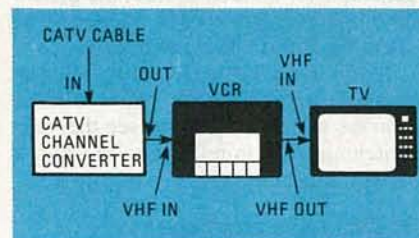

FIG. 14—HOOKING UP YOUR VCR to a cable system.

tion. With that connection, the channel to be viewed or to be recorded is selected on the converter.

Figure 15 shows another possible configuration for connecting a VCR to CATV. With that set up it is possible to view one program from the converter, while recording another program on VHF

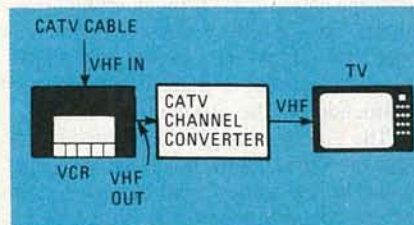

FIG. 15—WITH THIS ARRANGEMENT it is possible to record a cable channel while viewing a VHF channel.

channels 2 through 13. Set the TV channel selector to the output channel of the converter and set the VCR program select switch to the TV position. For playback of the program recorded on the VCR, set the channel selector on the converter to that of the VCR RF-modulator channel selector. When the CATV channel converter is not needed, connect the CATV input to the VCR, then connect the VCR and TV receiver in the normal manner.

When we continue, we'll look at some troubleshooting procedures for VCR servicing. **R-E**



# BUILD THIS

# SOUND GENERATOR DESIGN CONSOLE

D.L. HOLMES

*Discover the the wonders of a sound-generator IC, without the bother of breadboarding, using this easy-to-build design console.*



TEXAS INSTRUMENTS FEATURES A NUMBER of interesting sound-generator IC's in their semiconductor line; one of the most versatile is their SN76488N. That IC, an improved version of their SN76477N, is a monolithic device that combines both analog and digital circuitry. Like the other devices in the line, it boasts a noise generator, a VCO (Voltage-Controlled Oscillator), an SLF (Super-Low-Frequency) oscillator, a noise filter, a mixer, attack/delay circuitry, control circuitry, and even one-shot circuitry for generating momentary sounds. In addition to those features, the 76488 offers an internal 125-milliwatt audio amplifier capable of driving an 8-ohm speaker, and external outputs for the VCO, the SLF oscillator, the noise clock, and the one-shot circuitry.

The device can produce noises, tones, or low-frequency sounds either individually or in any combination. All sounds are programmed using control inputs and user-selected external components. The uses for that versatile IC are limited only by the user's imagination; and if you run out of ideas, a little experimentation is sure to turn up many more.

While most hobbyists like to breadboard with discrete components when either designing or experimenting, that technique has several drawbacks when designing with this IC. Since this IC can produce a wide variety of sounds, with each sound being determined by the value of the external components connected to it, it is far easier to listen to the sounds

produced by this IC while varying the value of the external components. The design console described here does just that; it enables you to control the value of those external components while listening to the sound produced.

Before we look at the console, and how it is built, it will be helpful to get to know the 76488 a little better. A block diagram of the device is shown in Fig. 1. Let's examine the operation of each functional circuit block.

## SLF oscillator

The SLF feeds a 50%-duty-cycle squarewave to the mixer. It also feeds a triangular wave to the external VCO or SLF-select logic circuitry; that circuit selects either external-voltage or SLF modulation of the VCO. If the VCO-SELECT pin, pin 20, is high, the SLF is fed through to modulate the frequency of the VCO; if it is low, an external voltage is used (more on that shortly). The SLF's normal operating range is 0.1 to 30 Hz, but it will

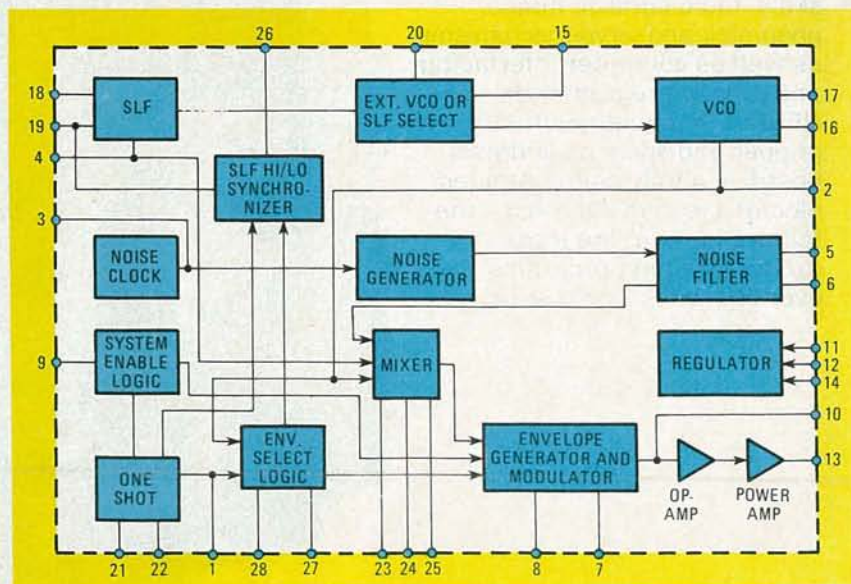

FIG. 1—BLOCK DIAGRAM of SN76488N sound generator. Refer to this figure as we describe the operation of the device.



# NTS Electronics

**Learn Robotics, Microcomputers, Microprocessors, Digital Video, Test Equipment and more with NTS INTRONIC™ home training. Courses include state-of-the-art equipment, lessons and texts to make your hands-on programs exciting and down-to-earth practical.**

**HERO 1** is included in two courses, one basic and one advanced. You'll cover principles of industrial electronics, microprocessor troubleshooting, fundamentals of mechanics, and robotic applications in industry. You'll learn analog and digital skills, radio control, fluidic, pneumatic and servo-mechanisms, as well as computer interfacing and robotic programming. **HERO 1**, complete with arm, gripper and speech synthesis board, is a fully self-contained electro-mechanical robot—the featured unit in the most exciting training programs ever offered in home study.

**NTS Intronic Training** is a carefully developed and tested learning system providing a thorough intergration of advanced electronic hardware with modern lesson texts. The relationship between theory and practical applications is made clear through the hands-on experience of building and assembling kits of state-of-the-art equipment. Courses include a wide variety of test instruments, both digital and analog, as well as other units not shown here. And, depending on the NTS program you select, you can earn up to 30 CEU credits for successful completion. Our full-color catalog has complete details. NTS has taught industrial skills for over 78 years—a record that has no equal.









produce frequencies of up to 20 kHz. The SLF frequency is determined by two external components, the SLF-control resistor connected to pin 18 and the SLF-control capacitor connected to pin 19. The output of the SLF is available externally from pin 4 and can drive one TTL load.

### Voltage controlled oscillator (VCO)

The VCO produces a tone whose frequency depends upon the voltage at its input. That controlling voltage can be either the SLF output described above, or an externally generated signal applied to the EXTERNAL VCO CONTROL pin, pin 15. The higher the voltage applied to the VCO, the lower the VCO frequency. The minimum VCO frequency is determined by two external components: the VCO-control resistor connected to pin 17 and the VCO-control capacitor connected to pin 16. The maximum frequency of the VCO is ten times the minimum frequency. The method of controlling the VCO is selected by the logic-level present on pin 20. If that logic level is low, the VCO frequency is controlled by the external signal applied to pin 15. The input at pin 15 may be a DC voltage, which produces a constant tone, or any digital or analog signal. If the logic level at pin 20 is high, the VCO frequency is controlled by the output from the SLF oscillator.

The output of the VCO is a squarewave and is supplied to the mixer and, if selected by the envelope-select logic, to the envelope generator and modulator. The VCO output is available at pin 2 and can drive a single TTL load.

### Noise clock

The noise clock internally generates a clock signal and supplies it to the noise generator; the minimum frequency of that clock signal is 10 kHz. The clock signal is also available externally at pin 3; it is capable of driving one TTL load.

### Noise generator/filter

The noise generator produces pseudo-random white noise that passes through the variable-bandwidth low-pass noise filter before being fed to the mixer. That filter has its cutoff point defined by the noise-filter control resistor connected to pin 5 and the noise-filter control capacitor connected to pin 6.

### Mixer

The mixer combines one or more signals from the SLF, VCO, and noise generator by performing a logical AND function and feeds the resulting output signal to the envelope generator and modulator. The signals that are to be input to the mixer are chosen by setting the logic levels present on the MIXER-SELECT pins, pins 23, 24, and 25, in accordance with those shown in Table 1. Figure 2 shows how the mixer combines an SLF and noise signal to produce an SLF/noise output. If more than

A (PIN 24)	B (PIN 25)	C (PIN 23)	Mixer output
L	L	L	VCO
H	L	L	SLF
L	H	L	noise
H	H	L	VCO/noise
L	L	H	SLF/noise
H	L	H	SLF/VCO/noise
L	H	H	SLF/VCO
H	H	H	inhibit

H = high level  
L = low level or open

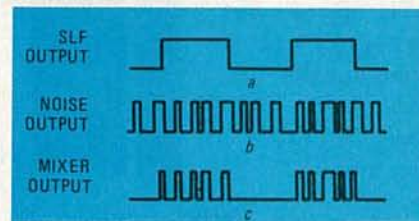

FIG. 2—THE MIXER combines the SLF output, shown in a, and a noise signal, shown in b, to produce the output shown in c.

one sound at a time is desired, (for example, a car engine and siren, or a steam engine and whistle), multiplexing is required. That can be done by switching the mixer-select lines at such a rate that the two sounds seem to occur simultaneously. A multiplexing-drive signal with a 50% duty cycle is required to provide equal amplitudes for both sounds. The frequency of that signal should be above the range of human hearing (i.e., above 20 kHz).

### One shot

The one-shot circuit controls momentary sounds, and is triggered by a high-to-low logic-level transition at the SYSTEM-ENABLE pin, pin 9. The duration of the one-shot's output is determined by the one-shot control resistor connected to pin 22 and the one-shot control capacitor connected to pin 21. The maximum duration of the signal is approximately 10 seconds. The signal can be cut off earlier by taking the SYSTEM-ENABLE pin high. If that is done, however, the one-shot timing must be allowed to end before another one-shot timing sequence can be triggered; that is

necessary to allow an internal latch to reset. The output of the one-shot is fed through the envelope-select logic to the envelope generator and modulator. Rather than being a sound source, the one-shot signal merely provides an envelope for the sound that is output from the mixer. The one-shot circuit is operational only when the one-shot envelope is selected as explained in the next section. Its output is available at pin 1 and can drive one TTL load. While in the one-shot mode, the SLF ramp can be forced to start at either a high or low level by placing a high or low logic-level respectively on the SLF-SELECT pin, pin 26.

### Envelope select

The envelope-select logic determines which envelope is combined with the mixer output in the envelope generator and modulator. That envelope is selected using the ENVELOPE-SELECT pins, pins 27 and 28. The operation of the envelope-select circuit is summarized in Table 2. Figure 3 shows the four possible envelopes that could be generated. The noise and VCO inputs to the mixer are shown in Fig. 3-a. If the mixer-only function is selected as shown in Fig. 3-c, the mixer output is supplied continuously to the audio amplifier. If the VCO function is selected as shown in Fig. 3-b, the squarewave output of the VCO is the envelope for the mixer output, meaning that the mixer output is passed on to the audio

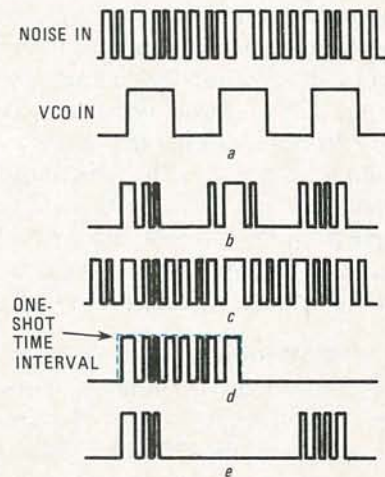

FIG. 3—WITH THE MIXER AND VCO outputs as shown in a, the four possible envelopes that could be generated are shown in b-e.

Envelope select 1 (Pin 28)	Envelope select 2 (Pin 27)	Function selected	Waveform (see figure 3)
L	L	VCO	b
L	H	Mixer only	c
H	L	One-shot	d
H	H	VCO with alternating cycles	e

H = high level  
L = low level or open



amplifier while the VCO output is high but not when it is low. The VCO with-alternating-polarity function, shown in Fig. 3-e, is similar to the VCO function described above except that the output from the mixer is enabled only during every other VCO pulse. When the one-shot function is selected, the output from the mixer is enabled only for the duration of the one-shot pulse as shown in Fig. 3-d.

### Decay control

The decay circuitry, which is part of the envelope-generator-and-modulator block, alters the fall time of the envelope selected by the envelope-select logic. The decay time is determined by the decay-timing capacitor that is connected to pin 8, and the decay-timing resistor that is connected to pin 7. The decay has no effect on the mixer-only function, but for the one-shot, VCO, and VCO-with-alternating-cycle functions, the decay ramp is triggered by each high-to-low transition of the envelope; it serves to prolong the sound at a decreasing volume that is proportional to the selected decay-rate. Figure 4 shows examples of how a waveform may be modified by decay when the mixer output is noise and the one-shot envelope is selected. Figure 5 shows a similar example, this time using a VCO rather than a one-shot envelope.

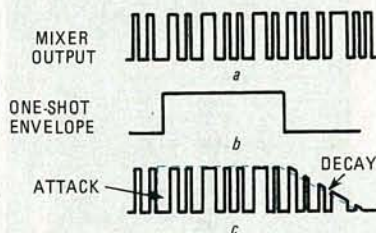

FIG. 4—HOW A WAVEFORM IS MODIFIED by decay when the mixer output is noise and a one-shot envelope is selected.

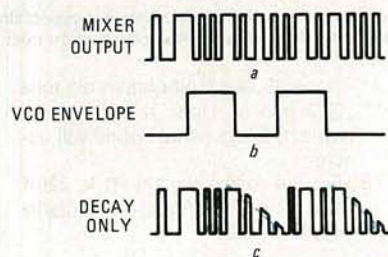

FIG. 5—IN THIS EXAMPLE of how a waveform is modified by decay, the VCO envelope is selected.

### System enable

The system-enable logic provides enable/select control for the sound output of the system. A high logic-level at the SYSTEM ENABLE pin (pin 9) inhibits the sound output, a low logic-level (or open pin connection) enables it. That pin is also used to trigger the one-shot circuit for momen-

tary sounds such as gunshots, bells, explosions, etc. The one-shot logic is triggered on the negative-going edge of a system-enable input signal. The input applied to pin 9 must be held low for the entire duration of the one-shot sound, including attack and decay periods, if the sound is to be completed. Taking pin 9's input high early, terminates the sound.

### Output amplifier

The output amplifier (see Fig. 6) is contained entirely on the IC and has a push-pull output capable of delivering 125 mW into an 8-ohm load connected to pin 13. External signals may be input to the amplifier via pin 10.

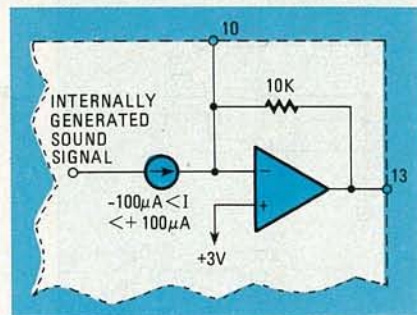

FIG. 6—THIS AMPLIFIER is entirely contained on the IC and is capable of supplying 125 mA into a capacitively-coupled 8-ohm load.

### Regulator

The 76488 will operate from a single-voltage power supply connected between pin 12 (positive) and pin 14 (ground); an internal 5 volt regulator allows use of an unregulated supply of between 7.5 and 10.5 volts. In addition to supplying power for the IC, the regulator is capable of providing a regulated 5-volts, at up to 5 mA, from pin 11 for use by any external circuitry. That is used to supply the high-level logic voltage used by the design console.

That concludes our look at the SN76488; its pinout is shown in Fig. 7. We'll now turn to construction of the design console itself.

### Console construction

Construction of the design console is relatively simple and straightforward. The schematic for the circuit is shown in Fig. 8. Little about the design is critical, and substituting freely from your junk-box can help hold down the device's cost. In the author's version, for instance, mica capacitors were used in place of ceramic discs in some instances simply because they were on hand. You can't, of course, substitute for the sound-generator IC. If your local supplier does not stock that device, it is available from Active Electronics, PO Box 1035, Framingham, MA 01701.

A 8<sup>1</sup>/<sub>16</sub> × 7<sup>1</sup>/<sub>16</sub>-inch instrument case and cover were used to house the prototype

## PARTS LIST

All resistors 5% unless otherwise noted

R1-R6—1 megohm, potentiometer, linear taper

R7—100,000 ohms

R8—50 ohms, potentiometer, audio taper

### Capacitors

C1, C18—390 pF, ceramic disc

C2 9—680 pF, ceramic disc

C3—1000 pF, ceramic disc

C4, C13—.22 µF, ceramic disc

C5, C12—.47 µF, ceramic disc

C6, C11—4.7 µF, 25 volts, electrolytic

C7, C9, C10, C15—10 µF, 25 volts, electrolytic

C8—220 µF, 10 volts, electrolytic

C14—22 µF, 10 volts, electrolytic

C16—1 µF, 10 volts, electrolytic

C17, C22—0.1 µF, ceramic disc

C20—.005 µF, ceramic disc

C21—.01 µF, ceramic disc

### Semiconductors

IC1—SN76488N sound generator (TI)

B1—9-volt battery

S1-S5—1 pole, 6 position rotary switch

S6-S19—SPST miniature slide switch

S20, S21—SPDT miniature slide switch

S22—SPST momentary pushbutton switch, normally open

TP1-TP18—test point jack

J1-J3—phono jack

Miscellaneous: IC socket, perforated construction board, case, etc.

Adhesive backed overlays for the front panels are available from Design Specialty, 15802 Springdale St, No. 80, Huntington Beach, CA 92649. The cost is \$3.00 each, postpaid. California residents add state and local taxes.

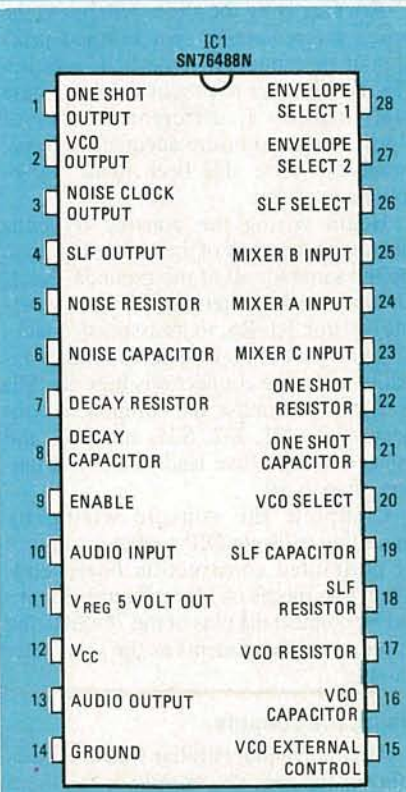

FIG. 7—PINOUT of the SN76488N sound generator IC from Texas Instruments.







# How to Design Transistor Switching Circuits

MANNY HOROWITZ

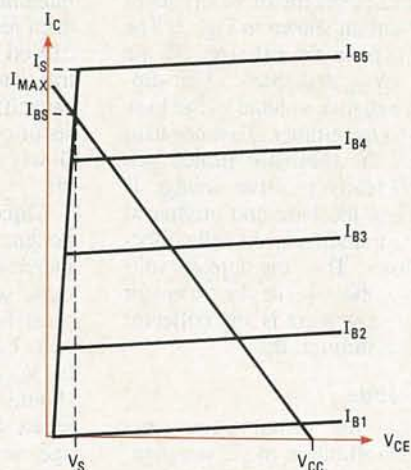

FIG 1.—CHARACTERISTIC CURVE of a typical bipolar transistor.

*This month we'll learn how to design switching circuits using transistors, as well as other devices.*

WE'VE ALREADY LEARNED ABOUT HOW transistors and other solid-state devices are used in circuits such as amplifiers, oscillators, etc. There are, of course, many other applications for those devices. One of the most common, and useful, of those applications is in electronic switching circuits. Unlike analog circuits where the output signal is some function of the input, in switching circuits the output is in one of only two states—on or off. This month, we are going to begin our look at electronic switching circuits, beginning with the most basic of them, the transistor switch.

## Transistor switches

To use a transistor as a switch it must be biased so that the device is in either one of two states. In one of those states, the transistor is "off" and no collector current flows. In the other, the transistor is "on" and the collector current is limited only by the resistances in the emitter and collector circuits.

There are three common ways to bias a transistor so that it operates as we just

described. Those methods of biasing are referred to as modes of operation. In what is referred to as the *saturated mode* of operation, the transistor is turned on by biasing it so that it is in, as you might have guessed, saturation. When that happens, the voltage across the transistor, called the saturation voltage, is at a minimum and depends on the collector current and load resistance. The device is turned off by biasing it so that it is in cutoff.

When a transistor is turned on in the second mode of operation, the *current mode*, it is biased so that the transistor operates near, but not quite in saturation. The collector-emitter voltage is somewhat above the saturation voltage of the device. Once again, the transistor is turned off by biasing it so that it is in cutoff.

Switching speed is faster in the current mode of operation than it is in the saturated mode. It is still faster, however, when the transistor is used in the *avalanche mode*. In that mode, the on and off states of a transistor are maintained in the breakdown portion of its curve. The switching speed of a transistor in the ava-

lanche mode is exceeded only when tunnel, snap-off, hot-carrier, or pin diodes are used as the switching devices.

## Switching modes

A transistor's characteristic curves can be approximated as shown in Fig. 1. Each curve (which here is shown as a relatively horizontal line) represents the relationship between the collector current,  $I_C$ , and the collector-emitter voltage,  $V_{CE}$ . You'll note that several of those curves are plotted in the figure. That's because the relationship between  $I_C$  and  $V_{CE}$  depends on the base current,  $I_B$ ; each curve shows the relationship for a specific value of  $I_B$ .

The more-or-less vertical solid line near the vertical axis represents the saturation resistance of the transistor. That resistance is equal to  $V_S/I_S$ . At the maximum permissible transistor collector current,  $I_S$ , the minimum voltage that can be across the transistor is  $V_S$ , the saturation voltage. That voltage is reduced at lower collector currents.

A load line is also shown in the figure. It extends from  $V_{CC}$  on the  $V_{CE}$  axis to



$I_{MAX}$  on the  $I_C$  axis. You'll note that even when the transistor is fully turned on by the application of a large current to the base, the collector current cannot reach  $I_{MAX}$  if the device's load line is as drawn in Fig. 1. The maximum current that flows is determined from the point where the load line crosses the saturation resistance curve. Collector current at the intersection of the two lines is at its maximum. It cannot be made any larger no matter how much the base current is increased.

Saturation and current modes of operation function only if a steady input voltage is applied to the base circuit of the transistor to keep it in either the on or off state. Examine the circuit shown in Fig. 2. The transistor is kept in the off state by the presence of  $-V_{BB}$  at the base. That supply applies a negative voltage to the base with respect to the emitter. That negative voltage keeps the transistor turned off. When a sufficiently positive voltage is applied between the base and emitter at input  $V_{IN}$ , the transistor is on and collector current flows. Thus the applied voltages determine the state of the transistor and whether or not there is any collector current flowing through  $R_L$ .

### Saturation mode

Switching is not instantaneous, especially in the saturation mode of operation. It takes time for the transistor to go from an off state to an on state as well as from an on state to an off state. Let's start our examination of the saturation mode by assuming the transistor is turned off. We'll be referring to Fig. 2 once again as we proceed through the following discussion.

When a positive pulse of voltage is applied to  $V_{IN}$ , it is also applied to the base of the transistor. That positive pulse causes base current to flow instantly, but there is a lapse of time before the base-emitter voltage reaches even a 0-volt level. Collector current, on the other hand, does not start to flow until the base-emitter voltage is just above zero. The time between the application of the positive voltage to the base and the instant that the collector current reaches 90% of its maximum, is referred to as the turn-on time. The phrase

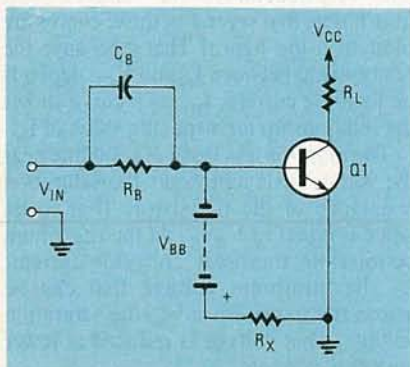

FIG. 2—CURRENT FLOWS through  $R_L$  when a positive pulse is applied to  $V_{IN}$ . The flow is stopped when that pulse is removed.

"delay time" is also used to describe that turn-on period.

After the positive input voltage has been removed, the negative ( $-V_{BB}$ ) supply takes over to restore the transistor to an off state. But that does not occur instantly. First, the base current becomes negative for a while, but eventually the base-emitter junction ceases to conduct current in either direction. As for the base-emitter voltage and collector current, they remain positive for a short interval after the positive switching voltage has been removed. The time it takes for the collector current to drop to 90% of its maximum after the positive voltage has been removed is called storage time. It is caused by the capacitances formed in the transistor when it is in saturation. Those capacitances are charged when the transistor conducts and discharged relatively slowly after the transistor has been turned off.

Capacitor  $C_B$  is not an essential component in the circuit. It is included only to increase the switching speed. To determine what its capacitance must be you must first determine the saturation current,  $I_{C(SAT)}$ , of the transistor; it is equal to  $V_{CC}/R_L$ . Next, calculate what  $R_X$  should be by setting it equal to  $V_{BB}/I_{CBO}$  where  $I_{CBO}$  is the collector-to-base leakage current when the transistor is operating at its maximum temperature. Continue the design by plotting the load line for the collector circuit as shown in Fig. 1. From that plot, estimate the approximate base current,  $I_{BS}$ , at the point where the load line crosses the transistor's saturation resistance curve. In Fig. 1, it is about midway between  $I_{B4}$  and  $I_{B5}$ . If the maximum voltage applied to the input of the circuit is  $V_{IN(max)}$ ,

$$R_B = V_{IN(max)}/I_{BS} - I_{CBO}$$

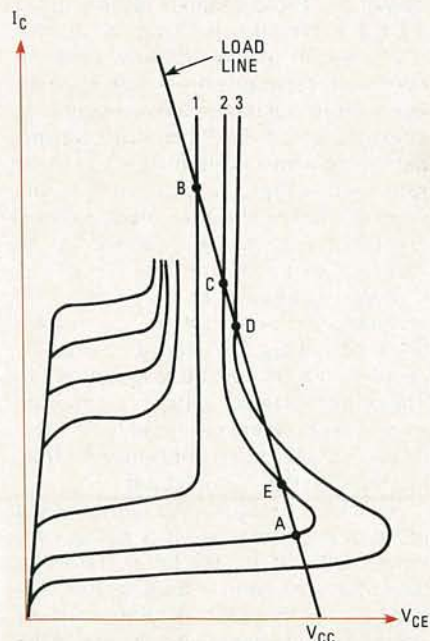

FIG. 3—IN THE AVALANCHE switching-mode transistors operate in the breakdown region of their characteristic curves.

Capacitor  $C_B$  is used to increase the positive drive on the transistor at the instant that  $V_{IN}$  is applied. Its capacitance can be calculated mathematically, but it is best that the circuit be built and different capacitors placed across  $R_B$  until it is determined which capacitor will provide you with reasonable performance in a particular switching application.

Another factor that you may run into when designing a switching circuit is latch-up. In that situation, the reverse voltage applied to the base circuit is insufficient to bring conduction down to its lowest level. Instead, collector current drops only to some level above the desired minimum. That low current is determined by the point where the load line crosses the breakdown section of the collector curve. (The breakdown portion of the curve is illustrated in Fig. 3. It is the vertical sections of curves 1, 2 and 3.) Should latch-up occur, increase the negative or reverse-bias voltage that is applied to the base circuit.

### Current mode

To improve the switching speed of a transistor it should be kept out of saturation when turned on. When that is done, the transistor is said to be operating in the current mode. In that mode of operation, the off states are identical to those in the saturated mode, while the on states differ in that in the current mode the transistor is kept just slightly out of saturation. (The excess charge in the base is kept to a minimum.)

In the current mode of operation, the transistor can be kept off by a resistor-battery combination connected between the base and ground. That is shown in the current-mode switching circuit shown in Fig. 4. Note that there is also a resistor-battery-diode combination in the emitter circuit of the transistor; let's take a closer look at it.

Diode D1 is kept turned on at all times because of the polarity of the  $V_{EE}$  supply. If a silicon junction diode is used, about 0.7 volt is across the device. If there is no voltage between ground and the base,

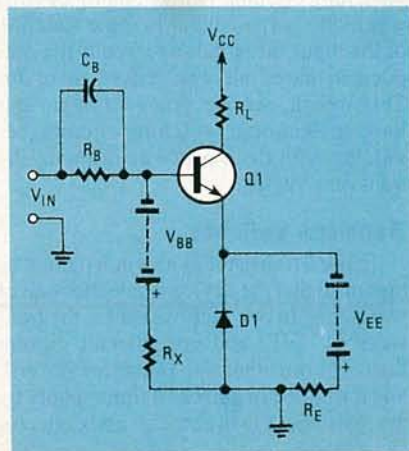

FIG. 4—A BATTERY AND RESISTOR are connected between the base and ground in a current-mode switching circuit.



only that diode voltage would be between the base and emitter of the transistor, keeping it turned on. But the transistor does get turned off due to the presence of the  $-V_{BB}$  supply. To keep the transistor turned off,  $V_{BB}$  must be large enough to counter the voltage across the diode.

The real significance of the emitter circuit is seen when the transistor is turned on by a positive pulse at  $V_{IN}$ . If there's only a resistor in the emitter circuit, or a short as in Fig. 2, the collector current will be equal to the beta of the transistor multiplied by the base current  $I_{IN}$ . If  $I_{IN}$  is sufficiently large, the collector current can be driven into saturation. But the presence of  $D1$ ,  $R_E$  and  $V_{EE}$  in the emitter circuit prevents that from happening so that the maximum transistor current level is less than its saturation current. That maximum is set by the components in the emitter circuit.

Because of the orientation of the diode in the circuit, no current from the emitter can flow through it. But it does limit the current through  $R_E$  because of the 0.7 volt developed across the diode. The current flowing through  $R_E$  is the maximum current that can flow through the emitter or collector circuit of the transistor. With that as the current limit when the transistor is turned on, the transistor will stay out of saturation if  $V_{CC}/R_L$  is greater than is the current in  $R_E$ . For practical purposes, the current through  $R_L$  should be limited to a maximum of  $V_{EE}/R_E$ .

### Avalanche mode

In current- and saturation-mode switching, a voltage with a specific polarity must be maintained at the base of the transistor to keep it either in an on or an off state. The relative polarity of the applied voltage depends on whether you want to keep the transistor turned on or off. In the avalanche switching-mode, however, an instantaneous pulse is all that is required to keep the transistor in either an on or off state. An additional advantage for that arrangement is that the circuit switches at almost the instant that the switching pulse is applied.

The circuit used in that mode of operation is basically the same as is used for the saturation mode (see Fig. 2). Now, however,  $C_B$  is not needed to improve the switching speed, for it is quite rapid even without the capacitor in the base circuit. In addition, the  $V_{CC}$  voltage in the avalanche mode of operation is quite high, so that operation of the transistor is in the voltage breakdown region of the collector characteristic. The characteristic curves in that breakdown region, along with the load line for  $R_L$ , are shown in Fig. 3.

Curve 1 shows the collector characteristics when the base current is 0 mA; curve 2 is the collector voltage-current relationship when the base current is somewhat negative. Curve 3 is for the case where the base current is very negative but within the region where the transistor will not be

destroyed. (Reverse base current obviously depends to a large degree upon the reverse base voltage applied for test purpose to the base circuit.) Besides the load line, the other curves shown illustrate the usual transistor characteristics when the base current is positive. The latter group of characteristics is the one usually shown on data sheets.

When the transistor is idling, assume that the negative base voltage,  $-V_{BB}$ , is of such magnitude that the transistor idles at point A on curve 2. A positive voltage at  $V_{IN}$  will push the idling point to a second curve. That second curve is determined by the magnitude of the positive voltage applied to the base. If we assume that that curve is for  $I_B = 0$ , then the new idling point is at B on curve 1. It remains on that curve as long as a base voltage is applied. At the instant the positive voltage is removed, the on-point drops to point C on curve 2 because only  $-V_{BB}$  remains to bias the base-emitter junction. The transistor keeps idling at that point despite the absence of any voltage or additional pulse. It is stable because the slope of the load line,  $1/R_L$ , is less than the slope of the transistor curve. Ordinarily, a point on that portion of the curve would not be stable because of the transistor's negative resistance. But in this case, operation does not shift from point C because of the relative slopes of the load line and transistor curve.

A negative pulse must be applied to the circuit in order to turn the transistor off or to lower the collector-current level. If the negative pulse is of sufficient magnitude, the collector current will drop to point D on curve 3. When idling there, the transistor remains turned on. But at the instant the negative pulse is removed, operation reverts to a point on curve 2. That point is point E. Because the slope of the transistor curve around point E is less than the slope of the load line, the transistor cannot remain in an idling condition at that point. If the transistor is idling in the off state, it reverts rapidly to point A, the starting point. Here, current is at a minimum and the transistor is effectively turned off.

### Switching FET's

Even though their switching speed is slower than that of bipolar devices, FET's have the advantage of superior on-to-off current ratios. The slower switching speed is due to the FET's large internal capacitances.

The characteristic curves of an n-channel FET, and the load line for the drain circuit, are shown in Fig. 5. Although the curves shown are not of any particular device, they can be used to describe the switching action of the FET in general. A schematic of an FET switching circuit is shown in Fig. 6.

With no positive voltage applied at  $V_{IN}$ , a negative voltage exists between the source and gate due to the  $-V_{GG}$  supply.

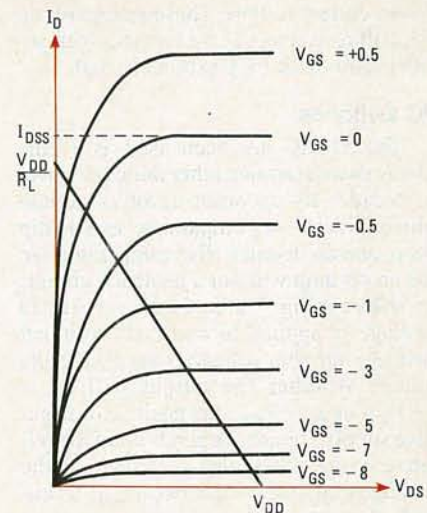

FIG. 5—THE CHARACTERISTIC CURVES of a typical FET, as well as a load line for the device, is shown here.

If that voltage is more negative than  $-8$  volts (that is the pinch-off voltage for the device we are examining) very little current flows through the drain circuit. This can be found from the curves; note that  $I_D$  is very low when  $V_{GS} = -8$ . Thus, drain current is negligible because the transistor is operating in the pinch-off region.

A positive voltage at  $V_{IN}$ , or 0-volt at the gate, puts the operation of the transistor at the upper end of the  $I_D$  range where conduction is at a maximum. No matter what the collector load is, current flows through it.

FET switches can be considered in another way. When the transistor current is at a minimum, operation is in the pinch-off region (the right hand section of the curves). Because the curves there are almost parallel to the x-axis, the drain resistance is extremely high. That high resistance limits the drain current to minute levels.

Once it has been turned on, the FET operates in the ohmic region (the left-hand portion of the curves). In the ohmic region the characteristic is almost vertical and the drain resistance is extremely low, permitting relatively large amounts of

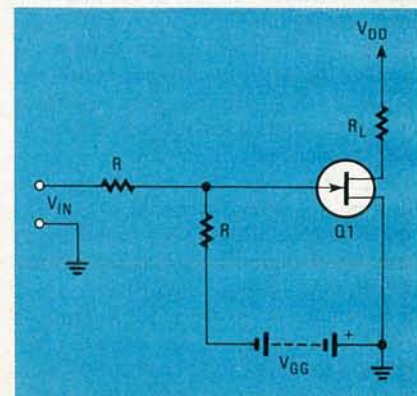

FIG. 6—AN FET SWITCHING CIRCUIT. In such a circuit, the ratio of the on and off resistances is very high.



drain current to flow. Those respective on and off resistances make the on-to-off current ratio of an FET extremely high.

### IC switches

The 555 IC has been used as a time delay switch (among other things) for over a decade. Its operation revolves around three circuits—a comparator, an S-R flip flop, and an inverter. The comparator can be an op-amp without a feedback circuit, as shown in Fig. 7-a. In the circuit, a fixed voltage is applied to one input terminal while a variable voltage is applied to the other. Whether the output will be at  $+V_{CC}$  or at  $-V_{CC}$ , the positive or negative supply voltage, depends upon the relative magnitudes and polarities of the voltages applied to the two input terminals. Note that in some circuits,  $-V_{CC}$  is set equal to 0 volts, so that the output from the op-amp will vary from 0 to  $+V_{CC}$ .

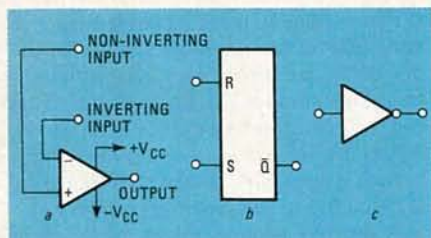

FIG. 7—THE THREE MAJOR circuits in a 555 timer IC. They are a comparator (a), an S-R flip-flop (b), and a not gate (c).

Suppose a fixed +5 volts is applied to the non-inverting input of the comparator and less than +5 volts (or even a negative voltage) is applied to the inverting input; then the output will be  $+V_{CC}$  volts. Should the voltage at the inverting input be greater than +5, regardless of how little, the output becomes  $-V_{CC}$ . In a similar fashion, if the inverting input is set at a fixed +5 volts, the output is minus  $V_{CC}$  when the voltage at the non-inverting input is less than +5 volts, and is  $+V_{CC}$  when the voltage at the non-inverting input is higher than +5 volts.

To sum up, the comparator compares the respective voltages at its input terminals. If the voltage at the non-inverting input is greater than that at the inverting input, the output is  $+V_{CC}$ , and if the voltage at the non-inverting terminal is less than that at the inverting terminal, the output is  $-V_{CC}$ . The change in polarity at the output occurs when the two input voltages are identical.

The second circuit in the IC is an S-R flip-flop; it is shown symbolically in Fig. 7-b. By itself, a flip-flop is a switch that's made up of digital logic circuits. In the type of flip-flop considered here, when the S terminal is low while the R terminal is high (the actual voltage levels for the high and low depend upon the flip-flop), the Q output is high. Should the conditions at the R and S inputs be reversed, the Q output is low.

Next, let's look at what happens when an input that's high is taken low again. Say, for instance, that the R input is high and the S input is low. When the R input is taken low again, the Q output does not go low again as you might expect; instead it is latched high and will remain so until the S input is taken high. If the conditions were reversed (i.e. the S input high and the R input low) the Q output would remain low until the R input is taken high. When both inputs are low the output remains in its previous state. Thus, this flip-flop can act as a switch. To change the state at the output all you need to do is reverse the states of the voltages at the inputs. In this type of flip-flop, care should be taken to prevent both inputs from being taken high at the same time.

The third circuit in the 555 is an inverter, often called a NOT gate; the symbol for that circuit is shown in Fig. 7-c. It gets its name from the fact that its output is the inverse of its input. Specifically, when the input to the gate is high the output is low, and vice versa.

A functional block diagram of a 555 is

capacitor connected to pin 6. The time it takes to charge the capacitor is instrumental in determining the time it takes for the output to switch from a high to a low state. The charging process can take place only after a negative pulse has been applied to pin 2. Pin 7 is connected to pin 6 so that the capacitor will discharge after the internal transistor, Q1, connected to pin 7 has been turned on. All of the external components and connections we've discussed are shown in Fig. 9.

Before power is applied to pin 5, it is at ground potential because the capacitor connected there is fully discharged by the two identical internal resistors that run from it to ground. A slight potential may exist at pin 6 because the "hot" terminal of the capacitor in the timing circuit,  $C_T$ , is brought only close to ground potential through the internal discharging transistor (Q1 via pin 7), but is never precisely at ground. The slight voltage on the capacitor is due to the existence of a saturation voltage in the discharging transistor, just as it exists in any other transistor. That voltage, however small, is always across

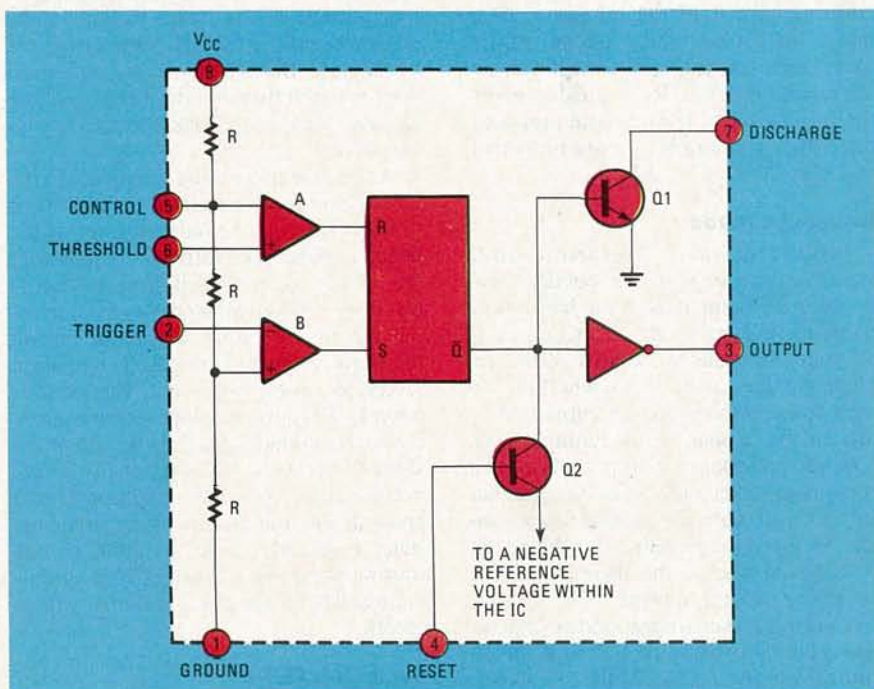

FIG. 8—FUNCTIONAL BLOCK DIAGRAM of a 555 timer IC.

shown in Fig. 8. In it you can see how the three circuits we've just discussed are used in that device. The IC is idling when a voltage higher than  $2V_{CC}/3$  is applied to pin 2. A 0.01- $\mu$ F capacitor is usually connected between pins 5 and 1; that stabilizes the DC voltage at the input to comparator A. The switched voltage from the IC is developed across a load resistor,  $R_L$ , or some other device. That load is connected between pins 3 and 8.

In addition to the above, an R-C timing network is connected between pins 8 and 1, with the junction of the resistor and

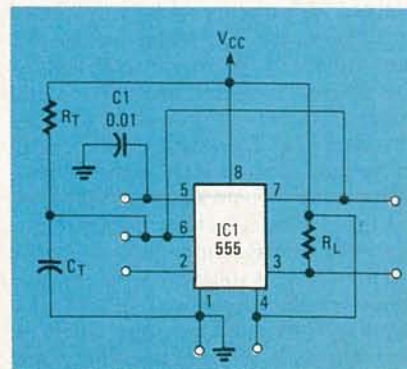

FIG. 9—SWITCHING CIRCUIT using a 555.



the transistor, and is consequently across the capacitor. As a result, voltage at the output of op-amp A is high at the instant that power is applied to the circuit.

Voltage at the output of op-amp B is at zero because when power is initially applied to the device, the non-inverting input of that op-amp is again grounded through an internal resistor in the IC. At the same time, the inverting input, which is tied to pin 2, is held at some value above  $2V_{CC}/3$  as discussed above. That condition is one that must be satisfied if the 555 is not to be triggered.

The outputs from op-amps A and B are applied to the R and S inputs of the flip-flop respectively. Thus, when the output from op-amp B is low and the output from op-amp A is high, the Q output of the flip-flop is high. But the signal available at pin 3 of the 555 is low; that's because the output from the flip-flop is passed through the NOT gate before it is fed to pin 3. The discharge transistor, Q1, is turned on by the high voltage at Q. The transistor shorts the timing capacitor, to maintain the status quo of the circuit and keep the output low.

The initial low output level from the IC is maintained from the time that power is applied to the circuit until a negative pulse is applied to the trigger input, pin 2. That status quo is maintained because almost immediately following the application of power, the supply voltage is applied, via a resistor, to the inverting input of op-amp A. Because of that, a low is applied to the R input of the flip-flop. As for op-amp B, its output is maintained low because the idling voltage from the trigger input, pin 2, which is high, is applied to the non-inverting input of that op-amp. As low voltages are at the R and S inputs of the flip-flop, the output from the IC cannot change states; it remains low. The discharge transistor remains turned on until the S input goes high.

When a short negative pulse with a voltage of less than  $1/3V_{CC}$  is applied to pin 2, op-amp B's output goes high and that signal is applied to the S input of the flip-flop. That brings Q low. The low signal is subsequently inverted by the NOT gate and is available as a high at pin 3 of the 555. In the meantime, the low at the Q output of the flip-flop, which is connected directly to Q1, turns that discharging transistor off. That, in turn, removes the short from across the timing capacitor,  $C_T$ , allowing it to charge. When voltage across  $C_T$  exceeds the voltage at pin 6, or is more than  $2/3V_{CC}$ , the state of op-amp A changes and a high appears at its output. (The output from op-amp B went low immediately after the trigger pulse was completed.) That brings Q high, the output at pin 3 low, and the discharging transistor is once again turned on to discharge the timing capacitor.

The time it takes for the capacitor to charge and trip the circuits is  $1.1R_T C_T$  seconds. During that time, voltage at the

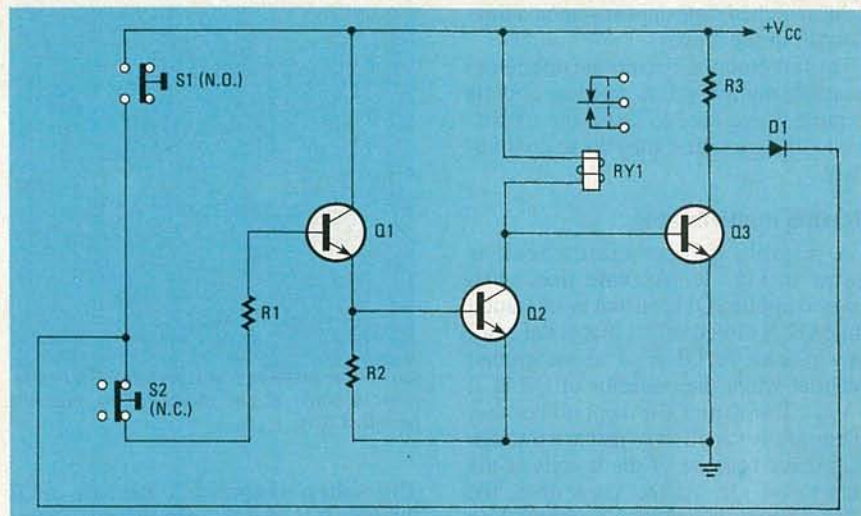

FIG. 10—THE STATE OF RY1 is controlled by S1 and S2—pressing S1 closes the relay while pushing S2 opens it.

output is high. It stays there until the charging period has been completed. The capacitor is then discharged, the output becomes low, and the circuit awaits the next negative pulse to start the next timing cycle.

The charging cycle of the capacitor can be disturbed only by placing a low voltage pulse at the reset input of the IC, pin 4. That pulse turns on transistor Q2, which, in turn, turns on the discharging transistor. If the reset terminal is not to be used, it should be connected to a fixed high voltage such as the  $+V_{CC}$  supply.

### Latching relay

Circuitry can be built around a mechanical relay so that its operation is controlled by a pair of momentary switches. Closing one switch closes the relay and closing the second switch opens it. A transistor circuit that can be used to accomplish that goal is shown in Fig. 10. When S1 is pressed, current flows through the relay's coil and the contacts close. When S2 is pressed, the current ceases to flow and the contacts open. Of course, a normally closed relay could be used in place of RY1; in that case the action of the relay is reversed.

Let's start our look at the circuit by assuming that S2 has been pressed for an instant, thereby opening the circuit to the base of Q1. No current flows through it or through Q2, so that the supply voltage,  $+V_{CC}$ , is at the collector of Q2. This voltage is there because, in the absence of current, there is no voltage drop across the coil of the relay. The high voltage at the collector of Q2, and hence at the base of Q3, turns on the latter transistor. Collector current through Q3 is limited only by R3. Because of the voltage drop across R3, there is close to 0 volt at the collector of Q3. That is fed back and causes 0 volt to also be applied to the base of Q1, keeping both Q1 and Q2 turned off so that current does not flow through the relay coil.

Current will flow through the relay coil after S1 has been pressed momentarily. When that is done,  $+V_{CC}$  is applied for an instant to the base of Q1. That turns on Q1 as well as Q2. Because Q2 then conducts, current flows through the relay coil. A voltage, very close to zero, is at the collector of Q2 due to the voltage drop across the transistor. That is also applied to the base of Q3 but is insufficient to turn that device on. The collector voltage of Q3 is high because there is no voltage drop across R3. That relatively high voltage is applied through D1, S2, and R1, to the base of Q1, keeping it and Q2 turned on.

### Multivibrators

Two switching transistors are used to form a multivibrator. In their stable states, one transistor is turned on and one is turned off. The purpose of a multivibrator is to switch (and possibly even keep switching) the stable states of the two devices. To accomplish that, positive feedback is placed around the two transistors so that the circuit becomes unstable. That instability must be present if the states of the transistors are to be interchanged.

There are three basic types of multivibrator circuits. In one of those, the bistable multivibrator, both transistors are in stable states—one transistor is on and the second one is off. When a pulse is applied to the circuits, the states of the device reverses. The transistors remain in their new states until another pulse is applied; that once again reverses the states of the devices.

The second group of multivibrators are monostable. Here, the two transistors assume specific states, depending upon the circuitry. States are interchanged after a pulse has been applied but they do not remain indefinitely in those new states. After a period of time, the transistors in the monostable multivibrator revert to their original states. The time they remain



in the switched state depends upon a time constant in the circuit.

The last group of circuits are referred to as astable multivibrators. In those circuits no pulse is required to cause the transistors to change states; they do so continuously.

### Bistable multivibrator

A bistable multivibrator circuit is shown in Fig. 11. Assume that when power is applied Q1 is on and in saturation while Q2 is turned off. If that is the case, the collector of Q1 is at about ground potential while the collector of Q2 is at  $+V_{CC}$ . Transistor Q2 is kept off because no current is supplied to its base through  $R_{F2}$ ; that's because of the 0 volts at the collector of Q1. At the same time, the  $-V_{BB}$  supply is applying a reverse bias voltage to the base of Q2 through  $R_{B2}$ . Transistor Q1 is kept turned on despite the fact that the  $-V_{BB}$  supply is applied to its base. That is because there is a current flowing through  $R_{F1}$ ; that current is due to the voltage at the collector of Q2. The states of Q1 and Q2 are interchanged if a negative pulse is applied to the base of Q1 to turn it off while Q2 gets turned on. After that, the transistors remain in their newly acquired states. A similar change of states can be accomplished by applying a positive pulse to the base of Q2 to turn it on.

For the circuit to behave as described, several design criteria must be satisfied.

1. The values of  $R_{C1}$  and  $R_{C2}$  (as they are identical we'll simply refer to their value as  $R_C$  from now on) must be less than  $V_{CC}/I_{C(sat)}$ .  $I_{C(sat)}$  is the minimum saturation current of the transistor.
2. Assume that  $R_{B1} = R_{B2} = R_B$ . To keep the off transistor in that state,  $V_{BB}/R_B$  must be greater than the leakage current,  $I_{CBO}$ , of the off transistor at the maximum temperature at which it is to be used.
3. Assume that  $R_{F1} = R_{F2} = R_F$ . For the transistor to be in saturation, beta multiplied by  $R_C$  must be greater than  $R_F$ . The Beta of both transistors should be about the same.
4. To keep the on transistor in saturation, the base current must be

$$\beta \left( \frac{V_{CC}}{R_C + R_F} - \frac{V_{BB}}{R_B} \right) > I_{C(sat)}$$

### Monostable multivibrator

A monostable multivibrator is shown in Fig. 12. In that circuit, Q1 is kept turned on because the  $+V_{CC}$  supply provides base current to that transistor through  $R_{B1}$ . Transistor Q2 remains off because of the negative voltage applied to its base from the  $-V_{BB}$  supply. Those states are interchanged after a negative pulse has been applied to the base of Q1. When such a pulse is applied, Q1 is turned off and the voltage at the collector jumps to  $+V_{CC}$ .

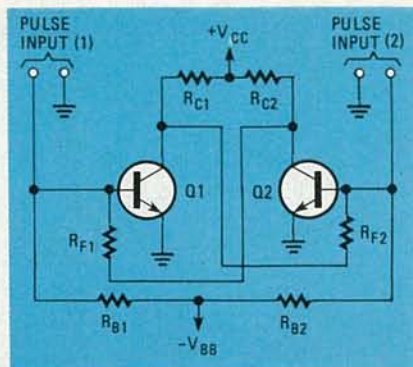

FIG. 11—A BISTABLE MULTIVIBRATOR can remain in either of two states for an indefinite period of time.

That voltage is applied to the base of Q2 through  $R_{C1}$  and  $R_{F1}$ , turning that device on. Transistor Q2 remains on until after capacitor C1 has had time to discharge through Q2 and  $R_{B1}$ . The time that Q2 remains on, is equal to about  $0.69R_{B1}C1$ . After that time, the transistors return to their original states.

For this circuit to perform properly, the following circuit details must be satisfied.

1. Q1 is on when  $V_{CC}/R_{C1}$  is greater than  $\beta(V_{CC}/R_{B1})$ .
2. From the transistor's specifications, determine the saturation voltage,  $V_{CE(sat)}$ , of Q2. If that information is not available, assume it to be 0.5 volt for a small signal transistor and 2 volts for a large power device. Use intermediate values for intermediate size devices. The base-emitter voltage,  $V_{BE1}$ , due to  $V_{CE(sat)}$  is  $V_{CE(sat)} \times R_{B2}/(R_F + R_{B2})$ . The base-emitter voltage,  $V_{BE2}$ , due to the  $-V_{BB}$  supply, is  $-V_{BB} \times R_F/(R_F - R_B)$ . Q2 is off when  $V_{BE1} + V_{BE2}$  is negative.

### Astable Multivibrator

The multivibrator behaves as an oscillator when used in an astable circuit. In that arrangement, both transistors are usually in identical circuits with the collector of one transistor coupled through a capacitor to the base of the second. The states of both devices keep changing from on to off, and back again, at a fixed rate. A basic arrangement of an astable multivibrator is in Fig. 13.

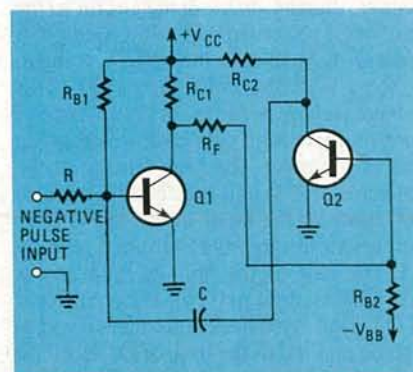

FIG. 12—A MONOSTABLE MULTIVIBRATOR has only one stable state.

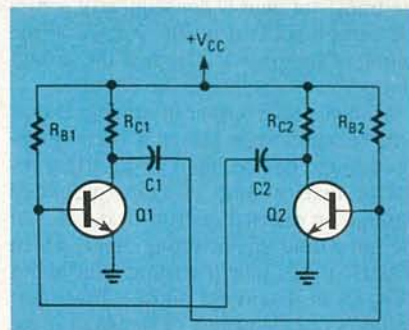

FIG. 13—AN ASTABLE MULTIVIBRATOR Changes states continuously.

Start by assuming that Q1 is turned fully on and is in saturation while Q2 is off. Because the collector of Q2 is at  $+V_{CC}$ , C2 charges to just under  $+V_{CC}$ , with the polarity as shown in the diagram. (The curved side of the capacitor represents the side at the lower potential.)

Capacitor C1 was charged, with the polarity as shown, during the previous half-cycle. When C1 is discharged, a base current flows in Q2 due to the current flowing through  $R_{B2}$ ; the current in the resistor is caused by  $+V_{CC}$ . The presence of a base current turns Q2 on, putting its collector as well as the positive side of C2, at ground potential.

Because the voltage across C2 has the polarity shown, the base of Q1 is placed at a negative voltage with respect to ground. That turns Q1 off. While Q1 is off, C1 charges, with the polarity shown, to just under  $+V_{CC}$ , just as C2 did when the transistors were in their previous states. In the meantime, C2 is being discharged through  $R_{B1}$  so there is no voltage left across C2 and thus none applied to the base of Q1. Transistor Q1 is turned on because the only major factors that now affect its base current are  $+V_{CC}$  and  $R_{B1}$ . Transistor Q2 is turned off because of the negative voltage at its base. It is negative because the positive end of C1 is at ground potential after Q1 has been turned on.

The process continues without a stop. The time for switching from one state to the other is  $0.69R_{B1}C2$  or  $0.69R_{B2}C1$ . If  $R_{B1}$  is not equal to  $R_{B2}$  and C1 is not equal to C2, then the time in which the transistors are in alternate states differ. Should  $R_{B1} = R_{B2} = R_B$  and  $C1 = C2 = C$ , both switching times are identical. Fully symmetrical squarewave cycles will then be seen at the collector of either Q1 or Q2. The period of the full cycle is  $1.38R_B C$  and the frequency will be  $1/1.38R_B C$ .

### More switching devices

In this article, switching circuits using bipolar transistors, FET's, and IC's were described. But there are other semiconductor devices designed to perform as switching devices. Those include UJT's, SCR's, PUT's, and so on. Those and similar devices will be discussed in our next article.

R-E



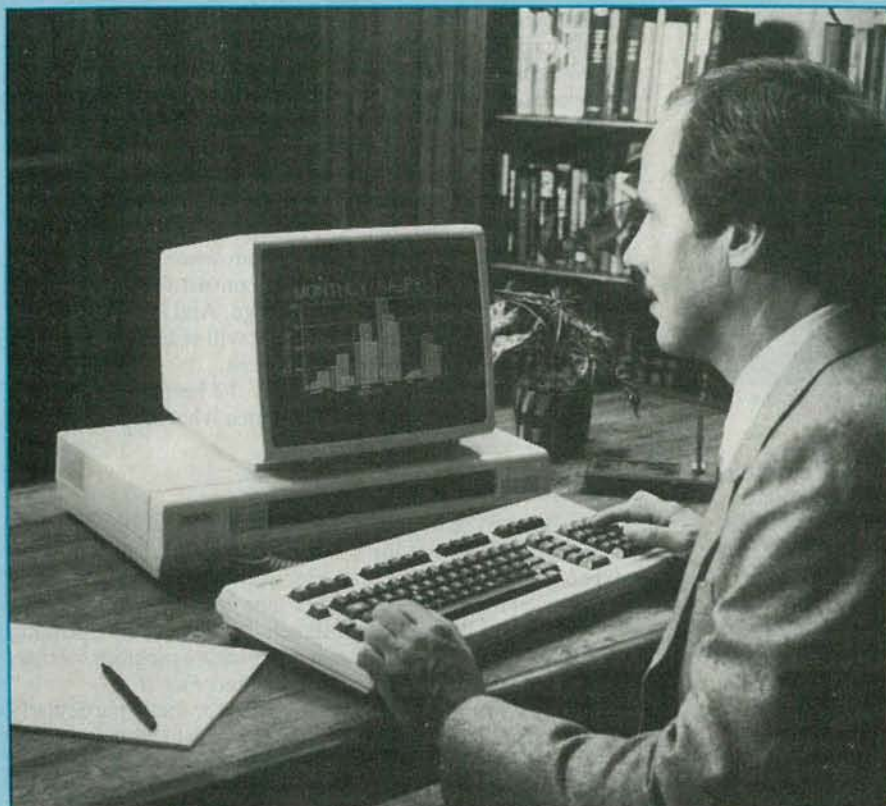

*You've finally decided to computerize your small business. Now you have a computer, but no software to run. Let's take a look at the features of some programs to help you decide what you need.*

## Small Budget Business Software

HERB FRIEDMAN

IN RECENT MONTHS, THE TREND OF BUSINESS-RELATED SOFTWARE has been to the all-inclusive computer program. The way most of the computer shops tell it now, the best software is a big, accounting program that costs upwards of \$1500, or integrated (multi-function) software that serves as a database, word processor, electronic spreadsheet, communications package, and heaven knows what else. And if an integrated package still won't meet your needs, they are ready to sell you a super-duper program that will let you write virtually any kind of imaginable database system.

While multi-function software and database generators are very nice to have, they are not only expensive, most are so complex it can take weeks or even months to learn how to use them. In fact, the heavily advertised, consumer-recognized, and expensive *dBase II* is virtually a high-level programming language that needs an almost equally expensive software package as an intermediary so that the average user—the non-programmer—can write a database using it.

Having all the records in one gigantic database isn't always the easiest way to do things, particularly for the individual entrepreneur who has enough trouble finding time to take care of business, let alone spend hours keying data into a computer. As a general rule, many small electronics-related businesses can get along with much lower-cost and less complex software by using the computer solely for the most difficult jobs. In many instances, individual specific-function programs are less expensive and more convenient to use.

To illustrate the kind of feature that's available in relatively inexpensive software packages for the small businessman, we'll look at some of the best software we've recently had a chance to

try. We make no recommendation that they are the best available; they simply have so many decent and often unusual features, they may give you—the typical **Radio-Electronics** reader—a good insight to the particular type of software that will work best for you.

Don't skip over some of the software we'll cover because "...you know it's the wrong format for your computer." Keep in mind that most software is now available in many formats: much software that used to run only on Radio Shack computers is now available in CP/M, PC-DOS and MS-DOS, and vice versa. And if it's not available in your computer's disk format there might be conversion software that will permit your computer to run alien software. For example, *File-Tran* by Business Micro Products (311½ 8th, Suite 400, Glenwood Springs, CO 81601), will convert just about any CP/M or TRS-80 5¼-inch format to that of the Osborne I computer (data files and BASIC programs), while *UniForm*, by Micro Solutions, Inc. (Suite 19113, 1608 El Paso Rd., Las Cruces, NM 88001), will not only do the same for the *Kaypro II*; it will also record CP/M Kaypro files in the format of other computers. And by the time you read this, there will probably be "conversion" software for PC-DOS software, MS-DOS, etc. So it's a good chance that the type of software we cover will be available for your computer. And if you don't have conversion software, many software houses will "PIP" the software to your computer's format.

### Small packages, large power

For the electronics service shop dealing primarily with consumer appliances such as TV, Hi-Fi, air-conditioners, etc., there's usually no need to computerize the accounts receivable



```

1. IDENTIFICATION CODE 000-1234-000
2. DESCRIPTION RESISTOR 270
3. VENDOR'S ITEM No. MS-1245
4. VENDOR ID NSQWE
5. DEPARTMENT ENG
6. LOCATION A2
7. UNITS ERC
8. WEIGHT
9. LAST P.O. No. 12217
10. LAST P.O. DATE 01/03/83
11. DELIVERY DATE 02/05/83
12. ITEMS IN STOCK 0
13. No. ON ORDER 300
14. No. ON RESERVE 75
15. REORDER LEVEL 150
16. REORDER QUANTITY 300
17. ITEMS SOLD P-to-D 170
18. ITEMS SOLD Y-to-D 500
19. LATEST COST $0.03
20. AVERAGE COST $0.03
21. SELLING PRICE $0.23
22. ALTERNATE PRICE $0.00
23. SALES P-to-D $39.10
24. SALES Y-to-D $115.00

```

CHANGE WHICH FIELD (TYPE (0) WHEN CORRECT) \_

THE INVENTORY SCREEN of *Versa-Inventory* when you enter the information for a single item is shown here.

because most work is paid for cash-on-delivery; there are probably only a handful of jobs on open account or credit. Similarly, there's probably no need to computerize accounts payable because the shop deals with maybe a handful of distributors. Most likely, the primary need is for computerized inventory control: simply knowing how many widgets are in stock, what's the re-order limit, and maybe how many widgets were used last month, or last quarter, or last year; and where in heck you store the stuff you have. (Micro-widgets are hard to find if you don't remember where you put them.)

That kind of inventory system doesn't require an expensive database generator nor weeks of programming and debugging. Some notably good inventory systems are available in the range of \$50 to \$150. For example, a system such as *Versa-Inventory*, from Computronics, Inc. (50 N. Pascack Rd., Spring Valley, NY 10977), is probably better than the average computerist could write with a database program. It will print reports showing the part description, the vendor's item number and ID, the department or equipment it's used in, where the part is stored, two levels of selling price (wholesale or retail), actual stock, items on hold, items on order, and the reorder level. And it will print period-to-date and year-to-date reports on sales, cost, or whatever.

The number of inventoried items is determined by the size of the disk drive; for example, the 500K disk of a TRS-80 Model II computer will accommodate about 4000 individual items.

The amount of information that the program can print in reports is awesome when you consider it comes from a relatively inexpensive program. It might take days, weeks, or months of work to create that kind of report structure using an expensive database generator.

*Versa-Inventory* runs under MBASIC (Microsoft BASIC), which must be supplied by the user. MBASIC is indigenous to Radio Shack computers, and is available for most popular CP/M computers.

Another program that doesn't have to be integrated with a giant database is the mailing list. *MicroMailer*, from MicroVentures, Inc., is an example of the kind of thing that delivers the maximum bang-for-a-buck for a service shop's mail campaign. How? By outstanding utilization of *identifiers*.

An identifier is a code embedded in a mailing-list record that helps identify the person. As a general rule, mailing lists will accept several one, two, or three character alpha or numeric codes that stand for something. Perhaps the letter "A" would mean "Purchased a TV," or "ANT" might mean "Installed an antenna," etc.

*MicroMailer*, however, permits up to seven multi-word identifiers for each person, such as "VCR SERVICE CONTRACT," or "TUNER REPAIR 1983." It keeps track of the identifiers and automatically plugs in the correct date each time the identifier is used. It will even attempt an identifier match when printing labels. For example, if one identifier is VCR, meaning the person purchased a VCR from your store, it will flag this person and ask if you want their label if you are running a mailing list of people with a "VCR SERVICE CONTRACT."

If you send periodic mailings to your customers, the identifiers will strip out precisely the information you want; it can tell you whose service contracts are expiring, who purchased what appliance, who had warranty repairs, etc. You can prepare the mailing record at the time of each sale or at the end of the day. At the time of record entry you can not only key in all relevant identifiers, but even the salutation for a form letter, such as "Dear Ms. Austin;," or "Dear VCR Owner," or "Dear Jim."

You can sort on just about any field or identifier, have a wide assortment of label styles to choose from when printing—even design your own—and you can even convert the data into the correct format for a *WordStar* mail-merge. And in case you can't keep track of who your customers are, it will search for duplicate mailing list entries by address and name.

While *MicroMailer* isn't necessarily the best mailing list for small businesses, it gives you a good idea what to look for your own use.

## Create your own forms

Let's assume you have a need for a program that allows you to create a precise format for a filing system and that there's no inexpensive program that does precisely what you want. Let's say you want to catalog a record or tape collection in your own way: you would like to design screen displays and the printing formats yourself. OK—there's an inexpensive program for that, too. It's by Swan Software and it's called *File It*.

*File It* is a sort of mini-database generator that's particularly well suited for catalog-type files. It allows you to write your own screens and printout formats without days or perhaps weeks of training. The program is relatively inexpensive, but works quite nicely if you are aware of some of its limitations. For example, its high speed sort is only on the "key" field, the "key" being the first field—which should be a "catalog number." While it can search rapidly on the key field, search and sorts on other fields can be relatively very slow. The user must work it out the way that works best for him.

*File It* searches can be by date, math operators such as < (less than) and > (greater than), equal, not equal, limits, specific numbers, match and not match, forced match, etc. While *File It* is really a miniature database system, it's easy to learn and use; the busy technician can learn it in a couple of hours and do some heavy customized design before the evening is out.

## Automatic check printing

If your business or interest requires writing a stack of checks at the end of the week or the beginning of the month, or you're trying to keep the personal expenses separate from the tax-deductibles, then some form of electronic checkbook program will make the paperwork a little easier. There's a junior, intermediate, and sophisticated version of checkbook programs for every computer, from the least to most expensive. The

```

O IDENTIFIER LIST page 1
1. VCR SERVICE CONTRACT
2. IN HOME CONTRACT
3. ANTENNAS 1980
4. ANTENNAS 1981
5. COMPUTER
6. ANTENNA 1982
7. ANTENNA 1983
8. WALK IN CONTRACT
9. BETA VCR
10. VHS VCR
11. COMPONENT TV
12. COMPONENT VCR
13. PROJECTION TV
14. HI-FI SERVICE
15. HI-FI SALES
16. AUTO HI-FI
17. RESPONDS TO MAILING
18. CONTRACT RENEW 1983
19. CONTRACT RENEW 1984
20. CONTRACT RENEW 1985
21. FIRE VOLUNTEERS
22. LIONS CLUB
23. ROTARY
24. COMPUTER SERVICE 1983
25. AIR CONDITIONING SERVICE
26. BOY/GIRL SCOUTS

```

Type in RD below to add a new identifier  
Change which identifier (by number, 'S' to show) : \_

MICROMAILER builds its identifier list in English phrases until it eventually runs out of disk space.



trouble is that most are oriented for home use and don't have the muscle for commercial records. An exception to this rule is *Bookkeeper* by Chuck Atkinson Programs.

*Bookkeeper* is an electronic checkbook system that seems almost tailor-made for the small business person who periodically writes an unusually large number of checks for either personal or business expenses. It not only keeps a balance account of the checks, it actually writes them, catalogs them, and distributes them into individual tax-deductible and non-deductible expense categories. There are 50 deductible category codes: Codes 1 through 32 are pre-named; 33 through 50 can be named by the user. Codes 51 through 98 are pre- and user-named non-deductible expenses. The last code, No. 99, is used to split a check up to four ways; the amounts are added to the proper expense categories.

*Bookkeeper* even remembers the last person to whom a check was issued, and will automatically print the recipient directly on the check if desired. For example, assume the printer is loaded with "tractor-feed" blank checks and the user writes a check to the local telephone company. The program has remembered the name of the telephone company, and when the amount is keyed in, the check is automatically printed with the amount and company name. Just as a checkbook, *Bookkeeper* will accept data entry on deposits and withdrawals, keeping a running account of the balance. There is even provision for manually correcting the information to accommodate bank fees and out-of-pocket cash expenditures. In addition to printing the check itself (using standard tractor-feed checks), it will prepare pay checks; provide a check register; list outstanding checks; provide a listing of check registers by alphabet, expense code, or deposits; and provide lists-of-cash summaries by date, by reference, code, credits, cash analysis, and expenditures.

#### Hide and seek

Do you need to store and selectively retrieve information of any kind, such as what magazine had what article? What page it was on? Where did you put the schematic of the signal generator you purchased from the Army 10 years ago? Who will volunteer their services for your favorite charity? There are almost as many "datafile" programs as there are checkbook systems and word processors. Most do more or less the same thing in similar ways: you put the information in and the software lets you find it by looking for key words. The problem is, most electronic filing systems require precise information; if you misspell a word, enter an extra character—even a space—the computer will reject your search.

However, an electronic filing system such as *Cardfile* from Digital Marketing (2363 Boulevard Circle, Walnut Creek, CA 94595) will ignore your mistakes as long as you don't try to deliberately fool the computer. It will dig out your information if all you can remember is a few letters of a single word. Basically,

```
CATALOG NUMBER : _      NUMBER OF COPIES :
TITLE :
COMPOSER :
ARTIST :
PURCHASED ON (DATE) :      FROM :
PRICE:      BACKUP MADE? (Y/N):
OKAY TO LOAN? :      WHO? :
DATE TO BE RETURNED :

.....
Enter      TEST [ 0.00%]      Page 1
```

FILE IT is a database that allows you to create your own screen formats. This sample was for a tape library.

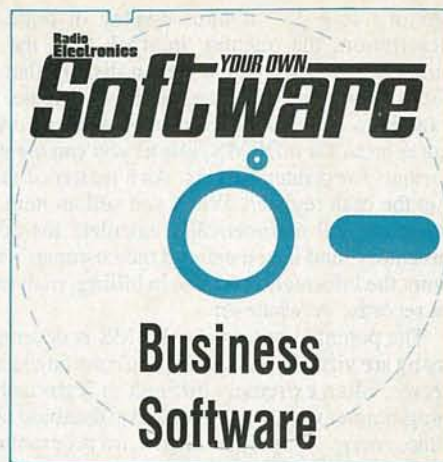

its search is similar to the electronic file index of computerized libraries.

*Cardfile* works this way. There are four fields. They can be used for any type of filing system because the program permits the user to create individual prompts for the fields. For a book file, the fields might be: "Subject," "Title," "Author," "Text." To keep a file on your music library, you might have prompts for the composer, title, artist, and for comments. Each set of prompts can be named so it is maintained as an individual file, and there can be several files on a disc. The information is literally poured in when creating the file. To search for any information you simply key in as much as you know for one or any of the four fields. The program searches the specific file reserved for the prompts and comes up with the data.

Now suppose you're not too certain of what the data is. Assume that a long time ago you stored information on a Kurtzweil reading machine, an optical scanner/computer that reads books to the blind. You don't recall how to spell Kurtzweil. The best you can do is Kurt. That's all you need for *Cardfile*. The search will take a little longer but *Cardfile* will find the entry. As long as you don't enter an erroneous string (fooling the computer) the program will locate your data record. The more words and descriptions, or partial words, the faster the search. If you wanted to locate a magazine article on transistor oscillators and you could not recall how to spell either word, simply keying in as much as you know, say, "trans" and "osc," will find it faster than just the single string "trans" or "osc."

The amount of information you can store in the low-cost electronic file programs varies from as low as six lines of 32 characters to almost 100 lines of 80 characters. As a general rule, the quantity is not as important as how easy it is to retrieve the data.

#### The do-anything database

Eventually, everyone wants a DBMS, a *DataBase Management System*. That's a system of storing information in selected fields that can be interrelated in any order by the user. A DBMS can hold all the information on your business or other interests: the names and addresses of your customers, your suppliers, your inventory, accounts receivable and payable, the general ledger—anything you want. You then create screens (video monitor displays) that allow you to enter or retrieve only the specific data for a given purpose. For example, suppose you have created your own inventory system with perhaps twenty fields, everything from the part number to the name and address of the supplier to a complete set of purchase order records. If desired, the DBMS will use the purchase-order data to calculate the average costs for any time period. The DBMS will do this for you because you set up the fields and their relationships any way you want.

To make life easier for you when a customer comes in, you



would like a TV monitor display of only the part item and description, the quantity in stock, and the selling price. It's simple: you just create a screen display that selects only those fields from the database, and you create the screen layout exactly as you want it. Normally, you can create several different screens for a DBMS, just as you can create several different formats for printed reports. As a matter of fact, the DBMS can run the cash register. When you sell an item, keying it into the database will automatically calculate the cost and update the inventory; and if you entered the customer's name and address, enter the information for use in billing, mail campaigns, warranty records, or whatever.

The potential power of a DBMS is enormous, which is why many are virtually complete programming languages unto themselves, often extremely difficult to learn and use. For the non-programmer who needs a powerful database but doesn't have the time, energy, or inclination to learn programming, there are two outstanding DBMS systems that can be learned in a couple of evenings, and even mastered within a week. The first is almost a legend because someone with the barest of knowledge about computers can create quite sophisticated database systems without too much trouble. It's Radio Shack's *Profile III+* for their *Model III* and 4 computers and its sister program *Profile Plus* for their *Model II* computer. While not the most powerful DBMS by any means, its level of sophistication is extremely high—yet it is created by on-screen menus rather than programming statements or free-form creating on the screen. *Profile's* capabilities are much too extensive to describe here; basically, if you can think of it *Profile* will probably do it. Third-party enhancements add even greater power to *Profile*. For example, the program will sort or search on up to four fields. However, the people that wrote the program for Radio Shack, The Small Computer Company, Inc. (230 West 41 St., Suite 1200, New York, NY 10036), have a set of enhancements for both versions of *Profile* that make them almost standards of excellence, or at the least, reference standards to which others are compared. One enhancement allows selection by up to sixteen criteria, and then sorts on up to five of those. Another allows the preparation of forms such as shipping invoices—with graphics no less. Still another allows you to rearrange a screen without having to re-do the database. There are data-transfer enhancements, cross references, and a whole series of other easy-to-use but complex functions. If you go for either version of *Profile*, find out what enhancements are available from the people who wrote the programs.

One final note on *Profile III+*. The documentation is good, but not great; there are some sections which are a bit confusing. A third-party outfit called Crest Software (2132 Crestview Drive, Durango, CO 81301) publishes a set of notes, called *Plus Explained*, that clears up virtually all the rough spots in Radio Shack's manual. If you use *Profile III+* it's the best \$14 investment you can make.

The second user-friendly DBMS is *Super*, from the Institute for Scientific Analysis (Dept. M-3, Box 7186, Wilmington, DE 19803). It is available for TRS-80 Models I and III using NEWDOS, LDOS and DOSPLUS operating systems, for *Model II*, *III*, and *16* under the TRS-DOS operating system. Versions are also available for CP/M and IBM-PC.

A menu-driven DBMS, it is offered as competition for *dBase II*, not *Profile*. The reason appears to be that *Super's* structure is intended specifically for business. It's oriented towards ease in setting up customer files, depreciation, cost accounting, accounting systems, and manufacturing control. Most important, it will integrate with word processors such as *WordStar*, *Scipsit*, and *Newscrip*. It, too, is jam-packed with features; you really must send for a descriptive brochure to see if it meets your needs because it sets up a rather sophisticated database and report generator.

Unlike *Profile*, which can be handled by a beginner, *Super* requires some knowledge of what goes into a DBMS because the documentation often leaves a lot to be desired. At times it is pedantic (deadly dull reading); other times it assumes you know too much. There aren't enough illustrations, and what there are

are not where they should be—accompanying the associated text. Also, screen formatting for reports is not menu-driven and is relatively difficult and frustrating; our CP/M version in no way conformed to the documentation. Perhaps that was a result of the conversion process from the TRS-DOS format to CP/M. Whatever the reason, it needs much superior documentation.

Essentially, *Super* would be an excellent DBMS for the beginner and non-programmer if the manual were somewhat improved. Most likely, if the program becomes popular, someone will come out with a special "how to use *Super*" manual, much like the insert notes for *Profile*. With or without the extra documentation, *Super* is still a good DBMS for the small businessman.

### Itty-bitty programs

We have gotten into some pretty heavy stuff with our database-management systems, so I'd like to close with an absolute dynamite program, actually 100 programs in all; one of the best software packages for a small business even if you don't use the computer for any other purpose.

This software package is called *Business Pac 100*, from Computronics, Inc., and it's available for just about every popular computer. *Pac-100* consists of 100 ready-to-run BASIC programs, all of which are the kind you often need, and would write yourself if you had the time or programming expertise. They run under Radio Shack's version of BASIC or MBASIC. (The programs were originally written for the Radio Shack computers.)

The 100 programs encompass virtually every financial calculation needed by a business, from calculating the apportionment of interest, to calculating the future or present value of an investment or compound interest, to calculating the value of a bond or an annuity. It will calculate how much your children's educational fund will be worth when they go off to college, determine the NPV (Net Present Value) of a project, and the effects of inflation. There is even an electronic version of the *Dome* business bookkeeping system.

And away from straight calculations, there are programs to print multiple labels of any kind, keep an in-memory mailing list (great for small lists of a few hundred names), and prepare shipping labels. There's a letter-writing system that interlocks with its own mailing list, a computerized telephone directory, a UPS-zone-from-ZIP-code directory...it just goes on and on. There are 100 of the greatest mini-programs, and it comes with excellent documentation. Every program is described on its own page(s), and is listed in alphabetic order. As we said, it's exactly what you would do for yourself.

The one problem is the conversion from the original Radio Shack BASIC to MBASIC. Radio Shack's Microsoft BASIC can handle a statement such as "GOTO150." Note there is no space between "GOTO" and "150." MBASIC, however, requires the space; the statement must read "GOTO 150." In a few programs we found that the conversion from Radio Shack to MBASIC missed a few GOTO statements and there were no spaces; the program crashed. MBASIC will crash on the line with the problem so you can go directly into the EDIT mode and insert the space. Or you can LIST the program and check all statements for the proper GOTO. *PAC-100* programs are not protected; you can modify them, make copies, do whatever you want.

We've covered a lot of ground in our trip through software for small businesses. As we stated earlier, the purpose was not to recommend any specific software, but rather to illustrate the many features (and some of the problems) in some of the best or most convenient software we used.

Keep in mind that software doesn't come cheap; it starts to add up a hundred dollars here, a few hundred there. Before you know it the software has cost more than the computer. Perhaps some of our illustrations will assist you in keeping software costs at rock-bottom. When in doubt, remember the adage: "If it works well on a 3 x 5 file card, a computer probably won't do it any better."

R-E



6 audio test accessories to build  
Tuning in worldwide SW  
Step-by-step TV IF align.

**AVAILABLE — COMPLETE  
for the FIRST TIME!**



## BUILD YOUR OWN ROBOT!

Send today for your 52-page (8½ × 11") booklet containing complete reprints of all eleven articles in the Build Your Own Robot series by Jim Gupton.

This all-inclusive reprint gives you all the data you need to build your own Robot.

■ TELLS EVERYTHING YOU NEED TO KNOW to build the Unicorn-1 Robot without the need for an engineering degree or special equipment.

The robot is fully mobile with manipulator arms to grasp, lift and carry.

■ MANIPULATOR ARMS and end-effectors (hands) are what enable the robot to perform useful tasks. Details of construction techniques and considerations are fully explored.

■ MOBILITY BASE is not a lunar space station. It is the drive system that permits the robot to move from here to there. Full construction details along with a discussion of power sources is included.

■ THE BODY—FRAME AND ROTATION MECHANISM. This is the part that makes Unicorn-1 look like a robot. Wood and Formica are the materials for the body. Motors and gears are what make it function.

■ COMMUNICATIONS. How you can tell your robot what to do. Preprogramming techniques....radio control ....computer control are all detailed.

■ SENSORS. How to add sensors so your robot doesn't bump into things.

**Radio-Electronics**

Robot Reprints  
200 Park Ave. South  
New York, N.Y. 10003

RE184

Please print

I want to order \_\_\_\_\_ reprints @\$12.00 plus \$1.00 postage and handling for U.S., Canada and Mexico. Add 96¢ sales tax for New York State residents only. U.S. Funds only.

I want to order \_\_\_\_\_ reprints @\$12.00 plus \$3.00 Air Postage and handling for all other countries. U.S. Funds only.

Allow 6-8 weeks for delivery.

\_\_\_\_\_  
(Name)

\_\_\_\_\_  
(Street address)

\_\_\_\_\_  
(City) (State) (Zip)

We do not bill, check must be enclosed.



# HOBBY CORNER

## Multiplexed readouts

EARL "DOC" SAVAGE, K4SDS, HOBBY EDITOR

IF YOU EVER INTEND TO BECOME INVOLVED in repairing, modifying, or building a device that has a readout with several digits, you should have a clear understanding of the principals of multiplexed displays. Consider, for instance, a letter we recently received. One of our readers, Gerry Vrbensky (Nova Scotia, Canada) wants to use larger readouts as an external display for his calculator but is having some problems with his modification. Our guess is that it's the multiplexed circuit that is causing the confusion.

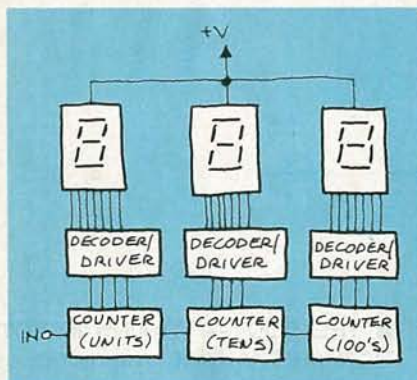

FIG. 1

Figure 1 shows a typical non-multiplexed display. Here, each LED readout has its own decoder/driver. There is no

### AN INVITATION

To better meet your needs, "Hobby Corner" has undergone a change in direction. It has been changed to a question-and-answer form. You are invited to send us questions about general electronics and its applications. We'll do what we can to come up with an answer or, at least, suggest where you might find one.

If you need a basic circuit for some purpose, or want to know how or why one works, let us know. We'll print those of greatest interest here in "Hobby Corner." Please keep in mind that we cannot become a circuit-design service for esoteric applications; circuits must be as general and as simple as possible. Please address your correspondence to:

Hobby Corner  
Radio-Electronics  
200 Park Ave. South  
New York, NY 10003

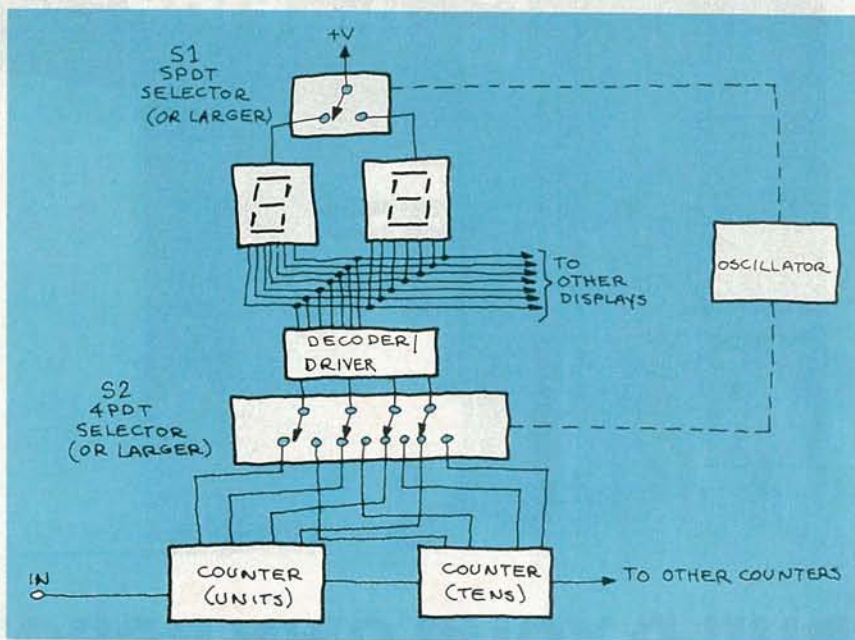

FIG. 2

sharing of circuits or components except, of course, the carry-over signal to the next counter IC. That is the type of schematic you will find in most construction articles that involve displays. It is straight-forward and easy to understand.

Figure 2 shows the block diagram of a typical multiplexed display such as the one you might find in a calculator. For clarity, only two readouts are shown. Note that there is only one decoder/driver regardless of the number of readouts used. That's possible because of the multiplexer, shown here as two separate switches and an oscillator.

Let's see how that circuit works. The oscillator serves as both a timing and triggering device. (That is, it synchronizes the switches as well as causing them to open or close.) Switches S1 and S2 simultaneously select one readout and its associated counter. The signal from the selected counter is applied to the decoder/driver, where it is converted and passed on to the appropriate segments of *all* the displays. But only *one* display lights—because only one display is connected to the supply voltage at a time (through S1). Now a second counter and its readout are selected by the switches, the signals are processed in the same manner, and so on. The process continues and all readouts are

lighted sequentially. The same sequence is repeated again and again. But you don't see the digits flicker—instead, the readouts appear to be lighted constantly because of the very rapid switching action of the multiplexer circuit.

Thus, you can replace all but one decoder/driver in a non-multiplexed display circuit with one oscillator and two switching arrays. Say, for example, you are building a display that is to have 12 digits in the readout. Using the non-multiplexed method, 12 decoder/drivers would be needed. But if that same circuitry is multiplexed, the number of decoder/drivers can be reduced to four. That's a substantial savings when you're trying to cut costs in order to be competitive and/or make a smaller device.

Also, don't be confused if you find far fewer IC's in your calculator (or clock) than you expect. Very often, the oscillator, selectors, and decoder/driver are built right into one IC package. So, if you understand Fig. 2 and are able to trace out the wiring to the digits, you can easily determine what is going on in the circuit. That information should enable you to attach that larger readout to your calculator, or at least get you on the right track. Good luck, Gerry.

*continued on page 93*



## HOBBY CORNER

continued from page 88

### Tilt switch

Donald Wendel (TX) is looking for a device to detect a tilt from the vertical. Unfortunately he didn't mention the intended application, so we don't know if a simple switching arrangement will suffice—or if the device is to be used to determine the degree of tilt. So we'll take a look at both.

Let's consider the switching device first since it's the simpler of the two. The easiest approach would be to use a mercury switch such as the "position-determining" type available from Radio Shack. If you can't get those, several standard mercury switches can be arranged so that the contacts close whenever they are moved from the horizontal.

A second possible switching arrangement is one that you can build. It consists of a hanging metal wire (braided for flexibility) with a weight on the free end. The wire hangs through a metal ring, as shown in Fig. 3, and completes a circuit when it touches the ring. The size of the ring and its distance from the supported end of the wire can be adjusted to increase or decrease the sensitivity of the device.

If the device is to show the degree of

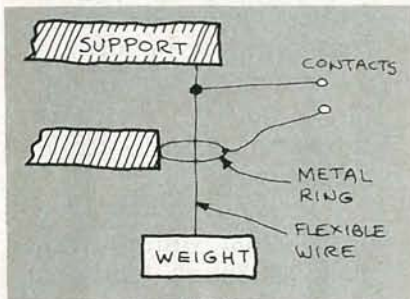

FIG. 3

tilt, that complicates matters considerably. One method that comes to mind uses a joystick (the kind that use potentiometers, not the ones that contain switches). The joystick is supported upside down and a suitable weight is attached to the handle. When the joystick (or the device it's attached to) is tilted in any direction, the resistance of its potentiometer (which you can read on an ohmmeter) will change. That reading will be in direct proportion to the degree of tilt. One supplier of the type of joystick mentioned above is Jameco Electronics (1355 Shoreway Road Belmont, CA 94002). Check the ads in the back of this magazine for other sources.

Perhaps another reader will come up with a better idea. If not, those suggestions should get you going in the right direction.

### DC to AC converter

It must have been the summer storms—

we have received several inquiries lately about building converters. The letters came from all over, including Puerto Rico and the Philippines.

The gist of those requests is for a converter circuit that will produce 115 volts AC from a square-wave generator. The writers want to power everything from refrigerators to computers. Among the various square-wave generators suggested are the 555 oscillator and the 5369 crystal oscillator.

Sorry fellows, but there's no way those oscillators can output enough wattage to operate those devices. That is, you cannot get both more voltage and current out than you put in. Electronics is no exception to the rule of life that says "You never get something for nothing."

Many people mistakenly believe that some electronic circuits manufacture power. That's probably because they see circuits where you put a couple of volts in and get 5000 volts out. Or, perhaps, a circuit that outputs ten amps when the input is only 500 milliamps. But that doesn't indicate a change in power. Power is equal to the product of voltage and current.

So those devices that you might think are creating power are not. (Don't take our word for it, though. Take any device and compare the product of the input voltage and current and the product of the output voltage and current. We guarantee that at best you'll wind up with equal numbers. You'll actually get less power out than you put in. That's because the circuit itself will use up some portion of the input power.)

Low power oscillators (such as those mentioned) cannot handle the kind of power necessary to produce 500 watts at 115 volts (even though that's only 4.4 amps). Remember—what we are dealing with are milliwatt devices.

There are two types of devices that are commercially available and can provide emergency power. One device attaches to the alternator of your car and reportedly produces 110 volts AC for operating radios, drills, and so on. As to whether or not they would be satisfactory for powering TV's or a moderate size refrigerator, we have no idea. And it's likely that the output will be too noisy for a computer. Because we have not had first-hand any experience with those units, we can't recommend them.

The other device that can produce the needed power is 12-volt DC to 110-volt AC converter or inverter. That device can produce an output of a couple hundred watts. But if more power is needed, you can simply use more than one unit. If you decide to go that route, expense will be a major factor. A device of that type—in kit form with an output of 175 watts—is available from the Heath Company (Benton Harbor, MI 49022) for about \$55. Several years ago we mounted a Heath unit in my car and used it successfully for

## Build Your Own IBM-PC Compatible!

Here are the boards, assembly instructions and parts you need... plus full back-up service from Netronics!

Complete instructions show you how to build an IBM-PC compatible that can run ANY—not just "popular"—IBM-PC programs!

Motherboard functionally duplicates IBM-PC... features IBM-PC compatible BIOS ROM plus five empty sockets for ROMs of your choice. Sockets will accept IBM-PC PROMs or other PROMs.

Instructions include step-by-step procedure for transferring ROMs from a pc onto a floppy disk, which can then be mailed away for ROM duplication.

Board kits include printed circuit board, some hard-to-get parts, and detailed assembly instructions.

Complete kits include printed circuit boards, all parts, and detailed assembly instructions.

Manuals only, \$5.00 per kit.

IBM-PC Compatible 16-bit Motherboard with IBM-compatible BIOS ROM—□ Board kit, \$89.95/□ Complete kit, add \$140.00

IBM-PC Compatible Keyboard in cabinet (wired & tested), \$229.95

64k/256k Memory with serial port with DB-25 connector □ Board kit (64k), \$39.95/□ Complete kit (64k), add \$134.00/□ Each additional 64k block (to 256k), add \$75.00

Four Drive Disk Controller with hard disk SASI interface, parallel printer port, clock/calendar—□ Board kit, \$69.95/□ Parts for Four Drive Disk Controller, add \$130.00/□ Parts for Parallel Printer Port, add \$30.00/□ Clock/Calendar, add \$45.00/□ SASI Interface, add \$50.00/□ All 4 functions wired and tested, \$329.95.

IBM-PC Compatible Color Board (or B&W)—□ Board kit with ROM, \$89.95/□ Wired and tested, \$299.95.

Printer/Spooler Board with 64k buffer, clock/calendar, parallel printer ports—□ Board kit with ROM, \$49.95

Modem Board, 300 BPS, direct connect/originate/auto-dial/auto answer plus 2 serial ports—□ Board kit with telephone company connectors, \$49.95

Power Supply □ Complete kit, \$179.95/□ Extra power for hard disk option, add \$20.00

□ Cabinet for PC, steel with brushed aluminum front panel and simulated oak cover, \$199.95

□ 5 1/4" Disk Drive, DSDD (wired & tested), \$269.95

□ 10 Megabyte Hard Disk with controller & software (wired & tested), \$1295.50

Netronics offers complete service department to customers.

### TERMINALS

(Terminals require ASCII keyboard and power supply.)

□ Power Transformer for either terminal, \$9.95

SmartVid Deluxe Terminal, 80 characters by 24 lines, microprocessor controlled with editing, reverse video and more—□ Board kit (includes board, character generator, video controller, 2k system ROM), \$99.95/□ Complete kit, add \$100.00

FastVid Deluxe Terminal, 64 or 32 characters x 16 lines, baud rate to 19 kilobaud—□ Board kit (includes controller, character generator, and PROM), \$49.95/□ Complete kit, add \$50.00

### SPEECH

Electric Mouth Apple/S-100 Speech Board, with National NSC Digitaler speech chip—□ Apple/□ S-100 (Please check your choice.)/□ Board kit (with Digitaler and 150 word vocabulary set), \$69.95/□ Complete kit, add \$30.00/□ 2nd Word Set (150 words), add \$39.95

SpeakEasy Universal Talking Board, operates with computers and terminals or in the stand-alone mode. Uses same power supply as terminals (see above). □ Board kit (includes VORTAX speech chip and system ROM), \$89.95/□ Complete kit, add \$60.00/□ Cabinet, add \$15.00

### S-100 DYNAMIC RAM BOARD

16k/64k RAM Board uses popular 4116 chips—□ Board kit (includes 8202 controller), \$69.95/□ Complete kit (16k), add \$79.95/□ Each additional 16k, add \$50.00

### ELF II BEGINNER'S PAK

ELF II is a complete 256 byte, fully expandable learning computer with excellent documentation that explains hardware and software fundamentals. Learn to program in machine language! Learn the essence of how all computers operate and "think"! If you can afford to think about an IBM-PC or IBM-PC compatible, you can't afford not to have an ELF II beginner's pak! □ Complete kit, \$139.95

USE YOUR CREDIT CARD! CALL TOLL FREE 1-800-243-7428 (In Connecticut call 203-354-9375)

To order by mail, check boxes above for products you desire. Mail entire ad with remittance to:

Netronics R & D, Ltd.

333 Litchfield Road, New Milford, CT 06776

Total enclosed \$ \_\_\_\_\_ (Conn. res. add tax) □ Visa

□ MasterCard Acct. # \_\_\_\_\_

Exp Date \_\_\_\_\_ Signature \_\_\_\_\_

Print Name \_\_\_\_\_

Address \_\_\_\_\_

City \_\_\_\_\_

State \_\_\_\_\_ Zip \_\_\_\_\_



## TOROIDAL Power Transformers



TYPE	SERIES No.	SECONDARY VOLTS	RMS Current	TYPE	SERIES No.	SECONDARY VOLTS	RMS Current
<b>50VA</b> 80 x 35 mm (3.1 x 1.4 in) 0.9 Kg (2.0 lbs) Regulation 13% <b>\$21.95</b>	2K010	6 + 6	4.16	<b>225VA</b> 110 x 45 mm (4.3 x 1.8 in) 2.2 Kg (4.9 lbs) Regulation 7% <b>\$34.95</b>	6X017	12 + 12	9.38
	2K011	9 + 9	2.77		6X018	15 + 15	7.50
	2K012	12 + 12	2.08		6X014	18 + 18	6.25
	2K013	15 + 15	1.66		6X015	22 + 22	5.11
	2K014	18 + 18	1.38		6X016	25 + 25	4.50
	2K015	22 + 22	1.13		6X017	30 + 30	3.75
	2K016	25 + 25	1.00		6X018	35 + 35	3.21
	2K017	30 + 30	0.83		6X026	40 + 40	2.81
	2K028	110	0.45		6X025	45 + 45	2.50
	2K029	220	0.22		6X028	110	2.04
<b>80VA</b> 90 x 30 mm (3.5 x 1.2 in) 1 Kg (2.2 lbs) Regulation 12% <b>\$23.95</b>	3K010	6 + 6	6.64	6X029	220	1.07	
	3K011	9 + 9	4.44	6X030	240	0.91	
	3K012	12 + 12	3.33	<b>300VA</b> 110 x 50 mm (4.3 x 2 in) 2.8 Kg (6.2 lbs) Regulation 6% <b>\$38.95</b>	7X013	15 + 15	10.00
	3K013	15 + 15	2.66		7X014	18 + 18	8.33
	3K014	18 + 18	2.22		7X015	22 + 22	6.87
	3K015	22 + 22	1.81		7X016	25 + 25	6.00
	3K016	25 + 25	1.60		7X017	30 + 30	5.00
	3K017	30 + 30	1.33		7X018	35 + 35	4.28
	3K028	110	0.72		7X026	40 + 40	3.75
	3K029	220	0.36		7X025	45 + 45	3.33
3K030	240	0.33	7X033		90 + 90	3.00	
<b>120VA</b> 90 x 40 mm (3.5 x 1.6 in) 1.2 Kg (2.6 lbs) Regulation 11% <b>\$26.95</b>	4X010	6 + 6	10.00		7X078	110	2.72
	4X011	9 + 9	6.66	7X029	220	1.36	
	4X012	12 + 12	5.00	7X030	240	1.25	
	4X013	15 + 15	4.00	<b>500VA</b> 140 x 60 mm (5.5 x 2.4 in) 4 Kg (8.8 lbs) Regulation 4% <b>\$49.95</b>	8X016	25 + 25	10.00
	4X014	18 + 18	3.33		8X017	30 + 30	8.33
	4X015	22 + 22	2.72		8X018	35 + 35	7.14
	4X016	25 + 25	2.40		8X026	40 + 40	6.25
	4X017	30 + 30	2.00		8X025	45 + 45	5.55
	4X018	35 + 35	1.71		8X033	50 + 50	5.00
	4X028	110	1.09		8X042	55 + 55	4.54
4X029	220	0.54	8X028		110	4.54	
4X030	240	0.50	8X029		220	2.27	
<b>160VA</b> 110 x 40 mm (4.3 x 1.6 in) 1.8 Kg (4.0 lbs) Regulation 8% <b>\$29.95</b>	5X011	9 + 9	8.89		8X030	240	2.08
	5X012	12 + 12	6.66	<b>625VA</b> 140 x 75 mm (4.3 x 3 in) 5 Kg (11.0 lbs) Regulation 4% <b>\$60.95</b>	9X017	30 + 30	10.41
	5X013	15 + 15	5.33		9X018	35 + 35	8.92
	5X014	18 + 18	4.44		9X026	40 + 40	7.81
	5X015	22 + 22	3.63		9X025	45 + 45	6.94
	5X016	25 + 25	3.20		9X033	50 + 50	6.25
	5X017	30 + 30	2.66		9X042	55 + 55	5.68
	5X018	35 + 35	2.28		9X028	110	5.68
	5X028	110	1.45		9X029	220	2.84
	5X029	220	0.72		9X030	240	2.60
5X030	240	0.66					

ILP toroidal transformers are half the weight and height of standard laminated transformers. Supplied with mounting kit. 5 year limited warranty. Trade and OEM enquiries welcome. Note: Regulation - all voltages quoted are full load. Add regulation figure to secondary voltage to obtain off load voltage.

**CALL TOLL-FREE TO ORDER 800-833-8400**  
In New York call (716) 874-5510.  
Mail orders accepted. VISA, Mastercard or checks.  
**GLADSTONE ELECTRONICS, INC.**  
1585 Kenmore Avenue Buffalo, New York 14217  
In Canada: Gladstone Electronics, Toronto 800-268-3640

CIRCLE 74 ON FREE INFORMATION CARD

## AUDIO KITS POWER AMPLIFIERS

### MOSFET



**120 WATT RMS (Mono) \$219.95**

ILP MOSFET power amplifiers are the logical choice for superb performance, compact size, excellent design, ease of assembly, and bargain prices! All models use famous ILP audio power amplifier modules, factory pre-assembled with bonded heat-sink and tested. Assembly is quick, easy, and assured. Each model features an ILP toroidal power transformer: half the weight and size of conventional transformers, toroids are also much quieter. ILP MOSFET power amps give no-compromise state-of-the-art performance: frequency response 15Hz - 100kHz (-3db), harmonic distortion 0.005% (1kHz), signal-to-noise ratio 100db, slew rate 20v ps. Each kit mounts into a precision die-cast aluminum chassis. Like all ILP products, MOSFET power amp kits carry a five year limited warranty. Also available: MODEL UP60 60 watts RMS MOSFET amplifier \$159.95. Available direct and from selected dealers. Write for details.

**CALL TOLL-FREE TO ORDER 800-833-8400**  
In New York call (716) 874-5510.  
Mail orders accepted. VISA, Mastercard or checks.  
**GLADSTONE ELECTRONICS, INC.**  
1585 Kenmore Avenue Buffalo, New York 14217  
In Canada: Gladstone Electronics, Toronto 800-268-3640  
CIRCLE 73 ON FREE INFORMATION CARD

a variety of purposes, including a ham transceiver (but not a computer).

### Transformer direction

Steve Pearson (WA) attempted to build the high-voltage generator shown in "Hobby Corner" last February. His project was unsuccessful, apparently because of the transformer used. Let's see if we can lend a hand and help clear up some of the confusion.

Any transformer can be used as a step-up or step-down transformer (provided that the primary and secondary have an unequal number of turns of wire in them). If the transformer has a small number of turns at its input (primary) and a large number of turns at its the output (secondary), it is a step-up transformer. On the other hand, if you apply the input to the high-turns side, you have a step-down transformer. (The relationship between the number of turns of wire in a transformer's primary and secondary is referred to as the *turns ratio*.)

For example, take the case of a 110-volt to 12-volt transformer. If you apply 110 volts to one side and get 12 volts out the other, you are stepping-down the voltage. However, you can just as easily reverse the transformer so that the input side is now the output. A transformer can step up or step down the voltage that is applied to it depending on which side is used as the primary.

As far as the high-voltage generator is concerned, what you need is a transformer with very high turns ratio. A filament transformer, such as the one you used, doesn't step-up the voltage enough because it doesn't have a sufficiently high turns-ratio.

In these days of low-impedance transistor circuits, it has become increasingly more difficult to purchase transformers with a high turns-ratio. As pointed out last February, your best bet is an audio-output transformer designed for a tube receiver. Perhaps you can take on from an old radio or even a tube-type TV. If you do find such a transformer, apply the input to the side that was connected to the speaker and you should get a sufficiently high voltage from the other side.

### Control-voltage source

Very often the solution to a problem is just a matter of using a circuit in a slightly different way. That's our advice to H.B. Armstrong (OH), who is looking for a way to control a relay with a signal from a tape recorder.

If you look back at the July "Hobby Corner" you'll see a circuit that used the audio signal from a radio to turn a device on and off. That circuit can be used to turn on a light, activate a relay, or do almost anything when an audio signal is fed to it. Now, if we understood your problem correctly, all you have to do is to connect the same device across the audio output of your recorder.

R-E



**This is for all those who ever wonder who runs the United Way.**

This is Wally Behnke, Frank Cole, Linda Thoren and Ken Smith. They're United Way volunteers. Just four of the many volunteers who help run the United Way in different communities across the country.

Volunteers who help raise funds. And, in turn, make the tough decisions of how the money can be put to the best use in their own community.

Volunteers like these are just part of the reason the United Way is so effective at meeting local human needs.

So that's who really runs the United Way. Your friends. Your neighbors. People just like you. And that's the way it should be.



**United Way**

Thanks to you, it works. FOR ALL OF US.

**Ad Council** A Public Service of This Publication



# THE DRAWING BOARD

## More about counters

ROBERT GROSSBLATT

BEFORE STARTING OUR USUAL HEAVY-DUTY discussion this month, we have a few announcements to get out of the way. So put your brains back in neutral and relax a bit, while we take care of them.

Last August's contest is officially closed. A lot of you out there sent in answers regarding the use of trimmers in the power supply we designed. The reasons you gave had to do with everything from electron flow to the price of resistors. Well, the correct answer is somewhere in between. Take a look at Fig. 1 to refresh your memory.  $R_A$  and  $R_B$  had to be 2-watt resistors—so the only kind of trimmers we could use were the wire-wound ones.

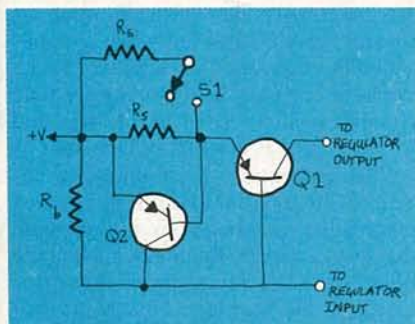

FIG. 1

The real question, then, is why couldn't wire-wound resistors have been used. Well, those two resistors have to pass a lot of current. Not only that, but if the circuit being powered by the supply suddenly draws more or less current, the voltage across the resistors is going to vary wildly from one moment to the next. Since wire-wound resistors are just long coils of resistive wire, inductive effects are definitely going to rear their ugly heads. More specifically, current spikes through the resistors are going to generate back EMF and that will momentarily change the apparent value of the resistors. As a result, all the protective circuitry for the supply, which we've spent so much time designing, would become ineffective at the exact time it's needed most. If the values of the resistors changed, the cutoff points we planned on would change. Take it from us: All the work we did would mean nothing and there'd be a good chance that the power supply would go up in smoke. An unsatisfactory state of affairs, to say the least!

And now we'll open the envelope and announce the winner of the contest.—It's Steve Geist of Des Plaines, IL. Congratulations, Steve. No prize money (we haven't been able to collect from the loser); just congratulations.

Our second announcement is that a lot of people out there have been sending in answers to another problem we outlined last August: namely, how to generate a negative supply from a two terminal transformer. Bill McFadden of Corvallis, OR not only sent us a solution, but also did a really good job of analyzing the circuit and explaining how it works. What he didn't send me was his return address. Maybe that's because we blew the prize money budget on the other contest. Seriously though—if you're taking the time to drop us a note, make sure to put your return address on the note, as well as the envelope, so we can answer you.

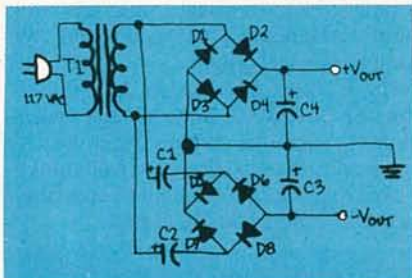

FIG. 2

Bill's final circuit is shown in Fig. 2. It could really come in handy when you're designing circuitry that needs a bit of juice from a negative supply. Its operation has all the hallmarks of a slick design—simplicity, elegance, and common sense.

Diodes  $D_1$  through  $D_4$  form a full-wave bridge rectifier and produce a positive DC voltage with respect to system ground—nothing really unusual there. But, as you all should know, that positive DC voltage is generated on every positive half-wave of the incoming AC signal from the secondary of the transformer. What Bill did was to take advantage of the negative half-cycle of that signal. Capacitors  $C_1$  and  $C_2$  charge up on the positive half-cycle of the input—as you would expect—and then dump their charges across diodes  $D_5$  to  $D_8$  on the negative half-cycle. Since  $C_1$  and  $C_2$  are always looking at signals that are  $180^\circ$  out-of-phase with each other,

none of the input is wasted (both sides are used). Capacitor  $C_3$  is the filter capacitor for the negative supply and Bill has indicated that the best performance is obtained from that circuit when  $C_1$ ,  $C_2$ , and  $C_3$  are of equal value. Anyone who needs a negative supply should take advantage of his work and give the circuit a try. If you do use it, let us know how things worked out and we'll pass the information along.

Although it wasn't mentioned when we stated the problem, there's one circuit possibility that no one has even taken into account. Suppose you need a negative supply and you're powering your circuit from batteries. There's no negative AC half-cycle to use, so everything we've discussed so far is, unfortunately, irrelevant. Therefore, our new contest is to generate a bipolar supply, with a real negative side, using only a single nine-volt transistor battery.

Now let's get on with other business.

In November's and December's "Drawing Board" we looked at counters (in particular the 4017 decade counter) and saw how they can be used as frequency dividers. We've also found that most of the obstacles associated with devices of that type can be overcome in one way or another.

But we're still left with the problem of the output duty-cycle. In a word, the duty-cycle changes every time we change the number we're dividing by. Although even-numbered divisions can be squared up by some sort of gating arrangement, (at the output) odd-numbered divisions present more of a problem.

You could work out some electronic equivalent of a "Rube-Goldberg" scheme to solve the problem—but it's much easier to try a different IC. That's exactly what we're going to do. More specifically, we'll look at the 4018—another ring counter. Not only can it divide an input frequency, but also provides a squared-up output waveform—without any unnecessary brain damage. Although that IC is superficially like the 4017, its operation is different and requires a bit of special handling to make it work properly.

Figure 3 shows the pinout of the 4018. If you compare it to the 4017 you'll see that it requires a bit more than connecting one pin to the other in order to divide by a particular number. The 4018 must be pro-

*continued on page 106*



# COMMUNICATIONS CORNER

## Recreating sound

HERB FRIEDMAN, COMMUNICATIONS EDITOR

SEVERAL YEARS AGO WE PROPOSED IN AN article on the future of high fidelity that, through the computer and frequency synthesis, it would be possible to reconstruct the sounds of yesteryear. That is, one would be able to play an old cylinder recording, process the sound through a computerized device that had stored in its memory the waveform characteristics of every musical instrument including the human voice, and eventually end up with a perfect recreation of the original signal source. Imagine hearing the full-fidelity voice of Enrico Caruso, or the legendary sound of the Original Dixieland Jazz Band.

Though we haven't quite reached that stage yet—if memory serves, we predicted it would take place sometime around 1985—we have recreated the actual voices of modern day sports announcers, and in a few emergency situations we have recreated the sound of "live" music.

Recreate voices and music? Let's explain what we mean. In the early days of broadcasting a "remote broadcast"—be it sports, drama, or whatever—meant a special radio line installed by the telephone company. Depending on the type of program material, the line might be equalized out to 15 kHz, 8 kHz, 5 kHz, or it might be unequalized (for voice transmission), and all that was missing were the upper-midrange and high frequencies. Putting the cost of that special line aside for a moment, if the head of the station called the phone company at 9 AM for a line at 1 PM it was in, equalized, and working by 1 PM—particularly if the input and output were in the same city. Today, it can take a week just to process the paperwork, possibly another week to a month to install the line, and then one hopes the line doesn't crash in the middle of the remote.

To get around the problems of cost and slow installation, many sports broadcasters went to the dial-up phone system. Using a special portable amplifier that clipped directly to a telephone line (usually across the handset's transmitter terminals), the field crew dialed the radio station's telephone, and when the phone was answered they clipped onto the handset. At the station, technicians connected the phone line's signal to the studio console, and eventually broadcast the signal they received through the dial-up tele-

phone system.

As time progressed, the remote equipment got a little fancier and the connection was neater, but one problem remained. Because the dial-up system has a restricted frequency response range of approximately 250–3000 Hz (actually more like 300–3000 Hz), not only was the announcer unhappy with his basso voice coming out sounding like a thin squeak but, what was even worse was that the shrill sound of 300–3000 Hz eventually wears down the listener.

It took a number of years, but both problems—that of the thin voice and shrill reception—were resolved by reconstructing the "missing" low frequencies with a device users call a Comrex, which is actually the name of the company that manufactures the device. Now the full-fidelity low frequencies of the announcer's voice could be broadcast over the dial-up system, and it was even possible in case an equalized radio line failed, to broadcast a "musical" program with some semblance of "balanced sound" by using the phone system.

The Comrex borrows its technology from the "freqwee," a device that makes humans sound like chipmunks in the TV and movie cartoons; the same technology is used to reduce the amount of spectrum used by a radiotelephone signal.

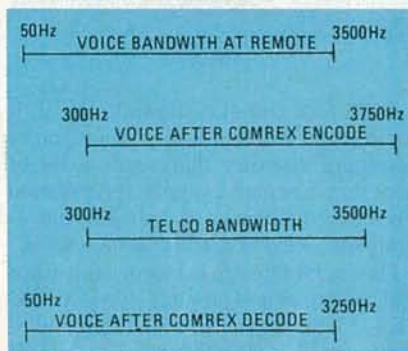

FIG. 1

Figure 1 shows how it's done. At the sending or input side of the circuit, the microphone signal is passed into a Comrex encoder that slides the entire frequency range up 300 Hz by beating the audio against a fixed crystal-controlled carrier. The lower voice frequency of 50 Hz becomes 300 Hz, while the voice frequency of 3000 Hz becomes 3250 Hz. That signal is fed into the dial-up telephone system. Because of the bandwidth restrictions of

the dial-up system and the Comrex equipment, the frequency range of 300 Hz to 3000 Hz is passed to the receiving end, while the frequencies below 300 Hz and above 3000 Hz are attenuated.

At the receiving end of the circuit a Comrex decoder "beats" the 300–3000 Hz signal back down to the range of 50 to 2750 Hz. Now, the announcer's original "bass" tones are reproduced at the radio studio. True, the upper frequencies are attenuated above 2750 Hz, but with the low frequencies back in the voice the "timbre" is restored, and the sound quality at the receiver is "more natural"—not hi-fi, but more closely approximating the "real" voice, and certainly more comfortable to listen to.

Another advantage of the Comrex is that the 300-Hz filter of the Comrex attenuates the telephone line's hum components of 60, 120, and 180 Hz caused by the telephone company using a common pole with the electric utility. The decoded Comrex signal is essentially hum-free.

What happened to the frequencies between 2750 and 3000 Hz? They are lost because the Comrex does not recreate what does not exist. Remember, when the signal from the microphone was processed by the sending Comrex the frequencies between 2750 and 3000 Hz became 3000 to 3250, and were sharply attenuated by the phone system; for all practical purpose they weren't received. The highest received frequency was 3000, which was Comrex'd down to 2750.

Keep in mind that the upper frequency limit is determined by the upper cut-off frequency of the telephone system. If by chance one were using the Comrex on a Schedule A phone line, which has a frequency range of 100–5000 Hz, the Comrex'd upper frequency limit would be a definitely acceptable 4750 Hz.

The success of the Comrex—and it is an unqualified success—raises the question of how superior the recreation might be if the receiving end had a computer that "remembered" the announcer's "actual voice." Certainly, having the low frequencies in addition to the midband should make a "high fidelity" recreation possible. And if we can do it with voice, why not with music.

Just imagine 1985—if we take a long length of string, two paper cups, and a Comrex, we might just be able to eliminate the phone company! **R-E**







If S3 is held down (closed) the tune selected by S1 and S2 repeats or the sixteen melodies will play in sequence if the chimes are set for automatic sequencing. A momentary closure of S4—the back-door button—connects pin 6 to the positive supply voltage through diode D4 and the chimes will play the single tune “Oranges and Lemons.” Holding S4 down causes the melody to repeat.

TABLE 1

Switch Auto-mode

Code	Number	Melody
A1		Pomp & Circumstance (Land of Hope & Glory)
A2		Happy Birthday
A3		Wedding March (Mendelssohn)
A4		Jingle Bells
A5		Auld Lang Syne
A6		Soldier's Chorus (Faust)
B1	13	Sailor's Hornpipe
B2	14	Charge!
B3	15	Close Encounters Theme
B4	16	Shave and a Haircut
B5		Rule Britannia
B6		O Canada!
C1	9	Colonel Bogey March
C2	10	Westminster Chimes
C3	11	Mexican Hat Dance
C4	12	Twinkle, Twinkle Little Star
C5		Deutschlied
C6		God Save The Queen (My Country 'Tis of Thee)
D1	5	William Tell Overture
D2	6	Greensleeves
D3	7	Lorelei
D4	8	Eyes of Texas (I've Been Working on the Railroad)
D5		Star Spangled Banner
D6		*Oranges & Lemons
E1	1	Mozart Sonata
E2	2	Blue Danube Waltz (Strauss)
E3	3	Beethoven's 5th Symphony
E4	4	Bach Toccata in D Minor
E5		La Marseillaise
E6		Wilhelmus *Back door tune:

Switches S1 and S2 select the thirty different melodies according to the letter/number combinations listed in Table 1. The table also lists the sequence of the 16 melodies that are played when S1 is in the AUTO position.

The MP1173A-NI melody generator IC is available from SRJ for \$6.95 (\$13.00 for two) plus \$1.50 for postage and han-

# Radio-Electronics mini-ADS

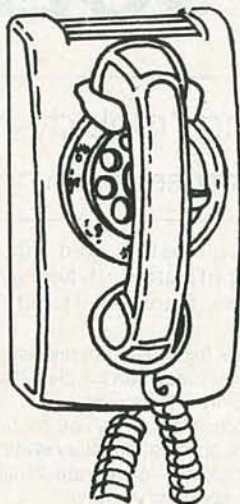

## CALL NOW AND RESERVE YOUR SPACE

- 6 × rate \$605 per each insertion.
- Reaches 235,323 readers.
- Fast reader service cycle.
- Short lead time for the placement of ads.
- We typeset and layout the ad at no additional charge.

Call 212-777-6400 to reserve space. Ask for Arline Fishman. Limited number of pages available. Mail materials to: mini-ADS. RADIO-ELECTRONICS, 200 Park Ave. South, New York, NY 10003.



TELTONE'S TRK-957 KIT makes it easier and less expensive to breadboard a low-power, central office quality DTMF detection system. The included M-957 DTMF Receiver decodes 12 or 16 digits and operates from 5 to 12V dc. The sensitivity, wide dynamic range, noise immunity, and low-power consumption make it ideal for telephone switching, computer and remote control applications. The TRK-957 DTMF Kit is only \$24.75. To order call: 1-800-227-3800, ext. 1130.

**TELTONE**

CIRCLE 5 ON FREE INFORMATION CARD

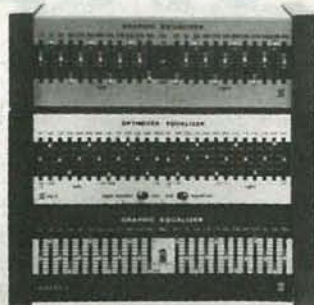

Equalizers ... Equalizers ... Equalizers • EQ-2 (top) 12 bands/channel general purpose equalizer—see R-E 5-6/78 \$89 • Optimized EQ: 10 midrange ½ octave, 3 other bands. See C&E 12/81, 1/83 \$100 • EQ-3, 24 bands mono \$110 stereo \$200. Free shipping w/check. Visa, M/C. Catalog. Symmetric Sound Systems 856L Lynn Rose Ct., Santa Rosa, CA 95404, (707) 546-3895.



**BACKUP YOUR ATARI® CARTRIDGES.** Video game cartridges are easily destroyed. You can protect your investment by making archival backup copies of your 2600 series game cartridges. Most cartridges are easily copied onto 2732 EPROM's. Build our EPROM duplicator for **under \$45**, make cartridge copies for **under \$10**. Complete detailed plans **only \$10.95. RANDOM ACCESS, Box 41770R, Phoenix, AZ 85080.**

CIRCLE 57 ON FREE INFORMATION CARD



**WIRELESS & ELECTRICAL CYCLOPEDIA.** Originally printed in 1918, this 176-page reprint of the complete catalog gives you an accurate look at the state of electronics in 1918. Contains everything from a Zinc Spark Gap to a 1000-Mile Receiving Outfit. You can get your own copy of this modern antique, profusely illustrated, for only \$4.95 plus \$1.00 P&H. Order yours from **R-E BOOKSTORE, Radio-Electronics, 200 Park Avenue, South, New York, NY 10003.**



## CALL NOW AND RESERVE YOUR SPACE

- 6 × rate \$605 per each insertion.
- Reaches 235,323 readers.
- Fast reader service cycle.
- Short lead time for the placement of ads.
- We typeset and layout the ad at no additional charge.

Call 212-777-6400 to reserve space. Ask for Arline Fishman. Limited number of pages available. Mail materials to: mini-ADS, RADIO-ELECTRONICS, 200 Park Ave. South, New York, NY 10003.

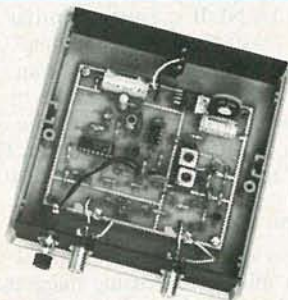

### CABLE TV DESCRAMBLER KIT \$39.95

Computerized addressable gated sync type. We also have complete line of Jerrold and Oak cable TV converters and descramblers. Such as, Jerrold gated sync (SB-3), Oak sinewave (N12), and Jerrold 61 channel remote control converter descrambler (DRX-DIC-105). 90 day warranty. **SEND \$2.00** for "INFORMATIVE CATALOG" for prices and availability to: **J & W ELECTRONICS, INC., P.O. Box 61-X, Cumberland, RI 02864.**

CIRCLE 63 ON FREE INFORMATION CARD



### 45-PIECE COMPACT ELECTRONIC TOOL KIT

A complete assortment of high quality tools. Includes: 13 screwdrivers; 10 pc. hex key set; adjustable wrench; groove-joint plier; cutter; chain & long nose pliers; wire stripper; knife and replacement blades; soldering iron; solder, desoldering wick; soldering aid; heavy-duty padded zipper case. Model **K-Z3 \$99.00** postpaid. We accept Mastercard, Visa and American Express or check. *100% satisfaction guaranteed or full refund.* **To order, call 1-800-225-5370. (In MA call (617) 272-5051.) Contact East, Inc. P.O. Box 160 Burlington, MA 01803.**

CIRCLE 56 ON FREE INFORMATION CARD

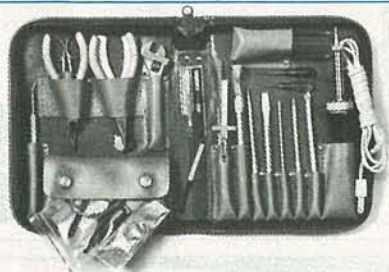

**THE MEAN LITTLE KIT** New compact kit of electronic tools. Includes 7 screwdrivers, adjustable wrench, 2 pair pliers, wire stripper, knife, alignment tool, stainless rule, hex-key set, scissors, 2-flexible files, burnisher, soldering iron, solder aid, solder and desoldering braid. Highest quality padded zipper case. Send check or charge BankAmericard, Mastercard, or American Express. The *JTK-6* sells for **\$95.00**—**JENSEN TOOLS INC., 7815 S. 46th Street, Phoenix, Arizona 85040, (602) 968-6231.**

CIRCLE 70 ON FREE INFORMATION CARD



**APPLIANCE REPAIR HANDBOOKS**—13 volumes by service experts; easy-to-understand diagrams, illustrations. For major appliances (air conditioners, refrigerators, washers, dryers, microwaves, etc.), elec. housewares, personal-care appliances. Basics of solid state, setting up shop, test instruments. **\$2.65 to \$5.90 each.** Free brochure. **APPLIANCE SERVICE, PO Box 789, Lombard, IL 60148. 1-(312) 932-9550.**

CIRCLE 21 ON FREE INFORMATION CARD

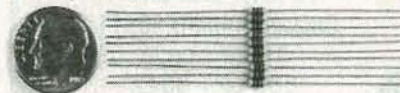

**MINIATURE 1/4W 5% CARBON FILM RESISTORS** offer superior overall performance characteristics compared to carbon composition resistors - at significant cost savings! EIA color coding. 1 ohm thru 10 megohm. **\$3.75** per hundred per value. Mastercard, Visa, American Express, accepted. Please add **\$2.00** for shipping. California residents add 6% Sales Tax. No C.O.D. **ACORN INDUSTRIAL ELECTRONICS P.O. Box 10846, SANTA ANA Ca. 92711. 1300-D E. Edinger Ave., Santa Ana, Ca. 92705. (714) 547-8424.**

CIRCLE 46 ON FREE INFORMATION CARD



**MODERN ELECTRICS.** Miniature souvenir of the first publication ever produced by Gernsback Publications. This issue appeared in April 1908—just 75 years ago. You can own your own reprint of this unique first edition for just **\$2.50** plus 75c P&H. It's available from **R-E BOOKSTORE, Radio-Electronics, 200 Park Avenue South, New York, NY 10003**

CIRCLE 17 ON FREE INFORMATION CARD



**SUBSCRIPTION TV MANUAL.** This information packed book details the methods used by subscription TV companies to scramble and descramble video signals. Covers the sinewave, gated pulse, SSAVI system, and the methods used by most cable companies. Includes circuit schematics, theory, waveforms and trouble shooting hints. **Only \$12.95** plus **\$1.50** first class shipping and handling. **RANDOM ACCESS, Box 41770R, Phoenix, AZ 85080.**

CIRCLE 17 ON FREE INFORMATION CARD

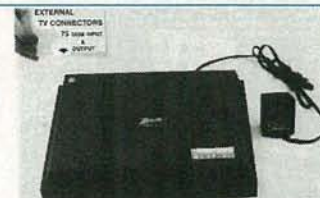

**SURPLUS ZENITH SSAVI TV DESCRAMBLER** - This is the real McCoy manufactured by Zenith and used by VHF Station operators in: Ann Arbor Ch 31, Baltimore Ch 54, Chicago Ch 66, Dallas Ch 27, Minneapolis St. Paul Ch 23, San Jose Ch 48, St. Louis Ch 30, Tulsa Ch 41, Washington Ch 50, Boston Ch 27. *This unit delivers picture & sound out of TV, no internal connections.* Complete with power adaptor (24 & 12 volt dual). Fast shipping, insured direct to you from Detroit. *To order:* send check or money order **SALE \$125.00, Reg. \$189.00.** **VIDEO ELECTRONICS, 3083 Forest Glade Dr., Windsor, Ontario N8R-1W6. Quality Orders (519) 944-6443.**

CIRCLE 89 ON FREE INFORMATION CARD



# SAVE!

MONEY • TIME • FREIGHT

QUALITY STEREO EQUIPMENT  
AT LOWEST PRICES.

YOUR REQUEST FOR QUOTA-  
TION RETURNED SAME DAY.

FACTORY SEALED CARTONS—  
GUARANTEED AND INSURED.

SAVE ON NAME BRANDS LIKE:

PIONEER	JVC
KENWOOD	TEAC
MARANTZ	SANSUI
TECHNICS	SONY

AND MORE THAN 50 OTHERS  
BUY THE MODERN WAY  
BY MAIL—FROM

## illinois audio

BANK CARDS ACCEPTED

12 East Delaware

Chicago, Illinois 60611

312-664-0020

800-621-8042

CIRCLE 94 ON FREE INFORMATION CARD

## The world of electronics gee-wizardry



### -YOURS FREE.

32-pages of test instruments—from the latest digital multimeters to the famous EICO scopes. Security systems. Automotive and hobbyist products. Kits and assembled. EICO quality. EICO value. For FREE catalog, check reader service card or send 50¢ for first class mail.

**EICO**® 108 New South Road  
Hicksville, N.Y. 11801

CIRCLE 22 ON FREE INFORMATION CARD

ding. SRJ also sells the *Phone-Tunes*, which is an FCC approved telephone-bell replacement that connects easily to the telephone system. It, of course, uses the MP1173A-NI IC. Thirty familiar tunes can be selected and different tunes can be used to identify different phones. The *Phone-Tunes* (\$39.95) can be operated from two 9-volt batteries or from an AC adapter (\$6.95). **Honeywell Inc.**, Honeywell Plaza, Minneapolis, MN 55408.

### Mike on a chip

Honeywell has just developed a new type of microphone using integrated-circuit technology that consists of a thin film of zinc oxide on a silicon substrate that is direct-coupled to the gate of a PMOS FET amplifier. The sensing element of the new mike is passive; the FET amplifier dissipates less than 40 mW so it can operate for many months before the batteries need to be replaced.

Zinc oxide, like piezoelectric crystals and ceramics, produces electric charges when subjected to stress. The new mikes have response down to 0.1 Hz while the response of most ceramic mikes is well down at 20 Hz.

The integrated-circuit sensors are lighter and smaller than their ceramic counterparts. They are one-quarter inch square while ceramic mike elements are often one-quarter inch thick and one-half inch in diameter. Their reliability is greater because they are solid state—no parts to cement or solder as with ceramics.

The new mike is expected to have many applications. For example, it is expected to reduce hearing-aid size.

### Logic optocouplers

Motorola has announced a series of infrared optocouplers with Schmitt-trigger outputs for coupling digital logic circuits in situations that require a high degree of electrical isolation between the control circuits and the controlled equipment. The digital output of the couplers eliminates the need for comparators or other wave-shaping circuitry between computer terminals and peripheral equipment. The infrared optocouplers also have many applications in digital control of power supplies, motors and servos.

The MOC5007, H11L1, MOC5008, MOC5009 and H11L2 optocoupler/isolators feature a  $V_{ISO}$  (isolation voltage) of 7500-volts AC minimum, and guaranteed switching times ( $t_{on}$ ,  $t_{off}$ ) less than 4  $\mu$ s. The LED trigger current is specified as 1.6 mA for the first two devices, 4 mA for the MOC5008, and 10 mA for the MOC5009 and H11L2. The rise and fall times for the output of the Schmitt-trigger waveform is specified as 0.1  $\mu$ s.

The H11L1, and H11L2 are equivalents of devices introduced earlier by General Electric. Prices range from \$3.30 to \$1.55 in lots of 100 and up. **Motorola Semiconductor Products**, PO Box 20912, Phoenix, AZ 85038. R-E

## CABLE TV

### CONVERTERS DESCRAMBLERS

Largest Selection  
of Equipment Available  
\$ Buy Warehouse Direct & Save \$



36 channel  
converter  
**\$45<sup>95</sup>**

36 channel  
wired remote  
converter  
only  
**\$88<sup>95</sup>**



Send \$2 for complete catalog  
of converters and unscramblers

Quantity Discounts • Visa • Master Charge  
Add 5% shipping—Mich. residents add 4% sales tax

**C&D Electronics, Inc.**  
P.O. Box 21, Jenison, MI 49428  
(616) 669-2440

### INVENTORY REDUCTION SALE!

Huge savings on  
used and demonstrator  
Video and CCTV  
equipment.

OFFER GOOD WHILE QUANTITIES LAST  
**CCTV Cameras \$69<sup>50</sup>**  
And Monitors

**Video  
Recorders \$139<sup>50</sup>**

**Lenses And  
Wall Mounts \$9<sup>97</sup>**

- Similar Savings On Other Items!
- All In Good Working Condition!
- No Limits! First Come, First Served!

Ask for Mr. Lewis

TOLL-FREE **800-221-2240**

N.Y. STATE **212-989-4433**

**GBC** CLOSED  
CIRCUIT **TV CORP.**

315 Hudson Street, New York, N.Y. 10013



# It's like no other magazine in the world!

Between the covers of this special annual publication are carefully selected articles on scientific developments, recent technical advances, consumer products trends, development of services, exotic communications advances, design information, hobbying tips, and "what's new" material compiled for your reading pleasure and information. Each article was specifically chosen and prepared for publication by the editorial staff of *Radio-Electronics* magazine, updated to the moment it went on press and printed. Here's what you will read about in the 1984 edition:

**VIDEO ENTERTAINMENT**—It couldn't be said all in one article so we compiled a 16-page special section covering the changing and growing field of entertainment in the home: new video components with screens from the gigantic to the tiny postage-stamp size, accessories that didn't exist last year, and tips on getting the most from what you own or plan to buy.

**SATELLITE TV**—The countryside is strewn with parabolic tracking dishes installed by home owners to pull-in the countless television channels transmitted back to earth by satellites poised in space in geosynchronous orbits. You, too, can enjoy the programming selection—and much of it is commercial-free, too!

**MOBILE TELEPHONES**—What was once a status symbol for the idle rich is quickly becoming a working

tool for the common man. Cellular technology promises more channels with a little help from applied computer technology.

**DIGITAL AUDIO DISCS**—Laser rays are bringing new noise-free, pulse-encoded audio programming to your stereo system embedded in a plastic disc immune to strawberry jam, sandpaper, and desert heat.

**MAIL ORDER BUYING**—You've heard the bad points, including the myths. Now, here are the facts and economics of buying mail order that will be an asset to your business or hobby.

**PLUS**—There's so much more, we have space only to mention an electronic guitar tuning project, theory on digital filters, how to make inexpensive computer cables, build a programmable home thermostat, tips on buying pocket-size shortwave receivers, stereo audio for TV, all about VLF active antennas, news on pagers, how to restore antique radios, and....



## Radio-Electronics ANNUAL 1984

### How to Order—

We can't drop your copy of *Radio-Electronics Annual 1984* into the mail sack until we receive an order from you! So, do it today! Fill out the coupon below, giving us all the information requested, write a check or money order (no stamps) for the correct amount, and mail at once to:

**RADIO-ELECTRONICS ANNUAL**  
Circulation Department  
200 Park Avenue South  
New York, NY 10003.

Okay, drop my copy of *Radio-Electronics Annual 1984* into the mail bag. I am enclosing \$2.50 for the issue plus \$1.00 for postage and handling for US, Canada and Mexico. All other countries add \$2.00. US funds only.

I can use \_\_\_\_\_ copies of *Radio-Electronics Annual 1984*. I am enclosing \$2.50 for each copy plus \$1.00 for postage and handling for US, Canada, and Mexico. All other countries add \$2.00. US funds only.

SEND CHECKS OR MONEY ORDERS ONLY

RE184

Allow 6-8 weeks for delivery.

I know you have a limited supply of the 1983 Edition of the *Radio-Electronics Annual*. Please send me \_\_\_\_\_ copies. I am enclosing \$2.50 for each copy plus \$1.00 for postage and handling for US, Canada, and Mexico. All other countries add \$2.00. US funds only.

Please Print

Name \_\_\_\_\_

Street Address \_\_\_\_\_

City \_\_\_\_\_

State \_\_\_\_\_

ZIP \_\_\_\_\_



# FREE MAIL ORDER CATALOG

**Tuners, amplifiers, effects, keyboards, studio equipment, drum computers, easy to assemble kits, books & more ....**



name \_\_\_\_\_  
address \_\_\_\_\_  
city \_\_\_\_\_ state \_\_\_\_\_ zip \_\_\_\_\_

**PA Electronics, Inc.**

Dept. 1-R, 1020 W. Wilshire Blvd.  
Oklahoma City, OK 73116  
800-654-8657 9AM-5PM CST M-F

CIRCLE 52 ON FREE INFORMATION CARD

## CABLE TV Buy Direct & Save

### SUPER SPECIALS



40 CHANNEL CONVERTER  
**\$29<sup>95</sup>**

Advanced Solid State design and circuitry allows you to receive mid & super band channels. Restores programming to Video Recorders.



36 CHANNEL REMOTE CONTROL CABLE CONVERTER  
**\$69<sup>95</sup>**

JERROLD 400 THE ULTIMATE CABLE TV CONVERTER



60 CHANNEL INFRARED REMOTE CONTROL  
**\$129<sup>95</sup>**

Send \$5 for Complete Catalog

### DIRECT VIDEO SALES

P.O. BOX 1329  
JEFFERSONVILLE, INDIANA 47130  
CALL  
1-812-282-4766

CIRCLE 53 ON FREE INFORMATION CARD

## AM STEREO

continued from page 46

played along with the band, mono-stereo mode and tape track. The IF is 262.5 kHz, and the bandswitching is all-electronic. The section of the tuner that is not in use has its DC supply turned off. Therefore a single-transistor switch was added to appropriately operate the AM-stereo decoder-circuit. The entire AM-receiver section is a single IC but, fortunately, its IF output voltage is high enough. In fact, we had to decrease it by using a 4.7K resistor in series with the decoder input. The decoder VCO circuit shown in Fig. 10 was used to match the 262.5-kHz IF. The audio outputs were connected in parallel with the outputs of the FM multiplex decoder. Since power is switched for band selection, the connected audio outputs did not interfere with each other. Series resistors had to be inserted in the decoder's audio outputs because their level was higher than that of the FM section of the radio. Doing that kept the sound level about the same when switching between bands. Also, we made up a special PC board for the decoder so that we could fit it inside the tightly packed radio.

The stereo system worked well, but the digital control-system caused phase-generated tones at about 600 Hz and also at about 10 Hz (fluttering). The tuner PLL loop compensation frequency was sneaking through the DC control lines to the varactor in the tuner section, causing phase modulation and some frequency modulation that appeared loud and clear in the audio. Rolling off the audio response below 50 Hz with smaller coupling capacitors at the AM decoder outputs took care of that low-frequency problem. An RC filter on the DC line to the varactors eliminated the 600 Hz tone.

That Sears radio worked out very well. Although it is not microphonic, it is sensitive to phase changes. Faint modulation from other stations can sometimes be heard when the selected station is quiet or has very low modulation. That would probably not be a problem in an automobile. Its bandwidth is much narrower than the Realistic portable which is noticeable in the audio-frequency response. But it's still acceptable, especially for automotive use.

The third conversion was installed in a home stereo receiver, a Technics model SA-222. This receiver has a fully synthesized control and tuning system that's operated by a microprocessor. The synthesizer presented noise problems in the very-low-frequency area and required a minor modification to a filter in the preset tuning circuit.

A small resistor was added to the loop-antenna circuit to lower the Q of the loop. That helped maintain a satisfactory band-

continued on page 114

## EARN BIG MONEY REPAIR GAMES & COMPUTERS

### ATARI 2600, 2600A ATARI 400, 800 COMPUTERS COLECOVISION • INTELLIVISION

**EXCLUSIVE!** All popular game and computer parts now available from a single source!

EWC is the exclusive national distributor of the Electronic Institute's repair courses and Kurz-Kasch Signature Analyzers and Test Fixtures, and the largest distributor of test instruments and supplies for digital servicing.

Over 28 years of proven quality, affordable prices, fast service, and guaranteed satisfaction at EWC, your one-stop electronic parts supplier.

**COMPARE OUR LOW PRICES AND TRY US FOR YOUR EVERY-DAY REQUIREMENTS.**

**GENERAL ELECTRIC TUBES**  
10 pc. minimum may be assorted  
**75% OFF LIST**

**THORDARSON #VMT-08 TRIPLERS**  
Replaces GE-528, ECG-523, SK-3306. First line, boxed premium quality.  
only **\$9<sup>95</sup>** each

Call toll-free on our 24 hour order hotline and ask for your copy of our new 92 page catalog.



**ELECTRONICS WAREHOUSE CORP.**  
1910 Coney Island Avenue  
Brooklyn, N.Y. 11230 • (212) 375-2700  
CALL TOLL FREE: (800) 221-0424

CIRCLE 78 ON FREE INFORMATION CARD

## SUPER LONG PLAY TAPE RECORDERS

10 Hour Model — \$95.00\*  
14 Hour Model — \$159.00\*

Modified Panasonic Slimline, high quality, AC-DC Recorders provide 5 or 7 continuous hours of quality recording & playback on each side of cassette for a total of 10 or 14 hours depending on model. Built-in features include • Voice level control, • Digital counter, etc. TDK DC 180 Cassette Furnished.



### PHONE RECORDING ADAPTER

Records calls automatically. All Solid state connects to your telephone jack and tape recorder. Starts recording when phone is lifted. Stops when you hang up.  
**\$24.50\***  
FCC APPROVED



### VOX VOICE ACTIVATED CONTROL SWITCH

Solid state. Self contained. Adjustable sensitivity. Voices or other sounds automatically activate and control recorder. Uses either recorder or remote mike.  
**\$24.95\***



\*Add for ship & hdg. Phone Adapter & Vox \$1.50 ea. Recorders \$4.00 ea. Cal. Res. add tax. Mail order, VISA, M/C, COD's OK. Money Back Guarantee. Qty. disc. avail. Dealer Inquiries Invited. Free data.  
**AMC SALES INC.** Dept. 9335 Lubec St., Box 928, Downey, CA (213) 90421 Phone 869-8519

CIRCLE 67 ON FREE INFORMATION CARD



# COMPUTER CORNER

## Computer environments

LES SPINDLE\*

PREVIOUS COLUMNS IN THIS SERIES HAVE discussed the various hardware and software components that make up a computer system. The terminal, CPU, mass storage devices, and printer, with the software, make up the tangible materials that you will need to get started. But once you have those important components assembled, what electrical and environmental factors will you have to take into account to ensure smooth, error-free operation? This month, let's take a look at the necessary steps in achieving a safe, efficiently-operating computer system.

Before we look at such things as power requirements, let's look at two often overlooked factors—ambient temperature and air quality. Like all other electrical appliances, computers generate heat. Most units are equipped with some form of ventilation or internal cooling system. But the temperature of the computer room itself is not to be overlooked. In many instances, suitable air conditioning will help dissipate the hot air emanating from the computer and will help ensure longer-lasting performance. The sensitive electric components will not wear out as quickly if you avoid running them for long periods of time in a hot, stuffy office. If your processing workflow can be scheduled so that the computer runs minimally on especially sweltering July or August afternoons, so much the better. You will be giving the system an extra lease on life by sparing it from such a demanding workout.

Clean air is another matter of concern. Needless to say it is wise to take whatever steps are possible to keep the system dust-free. If the air filters in, say, a hard-disk drive become too clogged with floating debris, excessive heat will be trapped within the unit, taking its toll on the longevity of the system. Worse yet, a worn-out filter will not prevent dust from settling on the components. Since a hard-disk drive stores so much information in a small space, the damage that can be caused by that is obvious. Although the disk head does not actually touch the disk surface, it travels only a minute distance above it. A scratch on either surface may well cause permanent damage to both the disk and the drive—causing an expensive repair bill and the likely loss of valuable data.

When you buy the components, make sure the sales person shows you where all filters are located. Check them regularly and replace them at prescribed intervals. The importance of that cannot be over-emphasized.

### Power requirements

Next, consider the power requirements of your system and prepare ahead for those inevitable power disturbances—voltage dips and surges, excessive line noise, and brownouts and blackouts caused by storms and other unpredictable factors.

Generally speaking, common AC line levels are sufficient for the majority of home and business computer installations. Also, most computer equipment is delivered complete with a power supply that converts that AC to the appropriate DC voltage and current levels needed for the system.

In some cases, however, either the power supply is not included with the equipment, or more current than the supply can deliver is needed to handle add-on peripherals or the like. In those cases, you can purchase an external power supply (see Fig. 1).



FIG. 1

There are too many variables involved to suggest the purchase of a specific power supply, but be sure that whichever one you choose supplies the voltage and current levels that you require. As to the current levels, be sure that the supply can satisfy the demands of your equipment comfortably. Cutting things too close can cause overheating, so as large a margin of safety as possible is recommended.

Now, what about power outages or disturbances and the loss of data that they can cause? While every computer has a degree of built-in protection against such occur-

rences, the amount of that protection varies from system to system. The kind of protection a computer offers should be one of the things that you look into when buying your system. If, however, any loss of data is unacceptable, you will want to invest in additional power-protection devices for added security. Let's look at what's available.

Line regulators (which typically range in price from \$350-\$700) automatically alter the voltage when it gets too low (referred to as a sag) or too high (spike or surge). Sags are sometimes caused by large appliances in the building—air conditioners, compressors, or other computer systems—switching on or off. Spikes (fleeting, imperceptible increase in voltage) and surges (longer increases, often obvious to the user) can be caused by electrical storms, equipment failure on a communications network, or switching of power equipment.

Line isolators (\$150-\$400) weed out interfering signals from such devices as television sets, medical equipment, and CB radios. They also head off voltage spikes.

Power conditioners (\$300-\$800) combine the functions of isolators and regulators, providing spike/surge/sag protection and also eliminating spurious electronic signals.

In cases of severe disturbances or extensive power interruptions, more sophisticated protection is needed. A brownout is a deliberate reduction of power distribution by the electric company due to heavy demand or unpredicted inadequate supply. A blackout is a total loss of power for from a few minutes to several days. Both can be disastrous, in terms of computer operation, if backup support has not been planned. An uninterruptible power supply (\$1,500-\$2,500) is the only remedy for such conditions. In the event of trouble, those supplies switch instantaneously to a powerful battery back-up system, preventing any loss of data or damage to equipment. Besides that, the device will perform all of the combined duties of isolators, regulators, and conditioners. Obviously, such a power supply is too expensive for many situations, but is necessary where the loss of computer operations data will result in a crisis of one form or another, such as the total loss of a company's payroll records. **R-E**

\*Managing Editor, *Interface Age* magazine



# SERVICE CLINIC

The more things change...

JACK DARR, SERVICE EDITOR

WE HAD JUST RECEIVED A REPRODUCTION copy of the very first issue of Hugo Gernsback's first magazine—the April 1908 issue of *Modern Electrics*. (See Fig. 1). We were vastly amused, and amazed at the column "How To Remedy Troubles in Wireless Telegraph Instruments." (I said to my wife, "Look! the very first 'Service Clinic!'" Then she asked if I wrote it. Naturally, my answer was no—since I wasn't even *born* until 1910).

There's an amazing resemblance between it and the more recent columns of

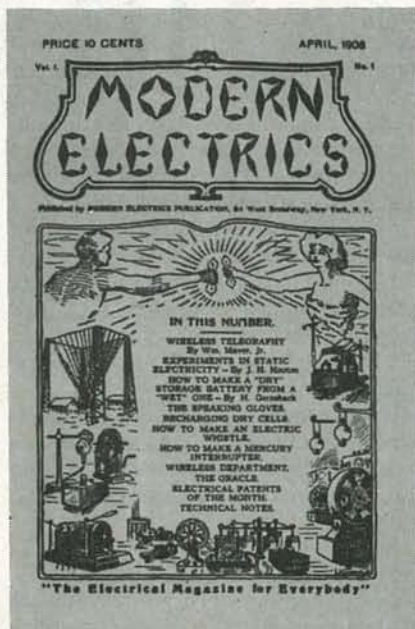

FIG. 1

"Service Clinic." In reading over that issue, we found some advice that's just as good today as it was then. That advice went something like this: "Sharpen your senses and learn to observe...In hunting for trouble, work first with your brain and then with your hands. If vice versa more trouble is sure to arise." Notice the resemblance? Some things never change. (There's a French proverb on that, which we'll spare you.) Oddly enough, we've been mulling over the idea for a clinic, along the same lines.

## Think before you jump

Over the years, we've received lots of letters from readers who were stuck on one electronics problem or another. A few years ago, we started looking into why

that happens—so, we used the most available subject that we could find—ourselves! From the study of ourselves, together with the letters you've sent in, we learned a couple of things. That information has benefited us, so we thought we'd pass it along. In fact, we've got an almost complete manuscript on the subject. We'll finish it one of these days (we keep saying).

Many of our readers, who've written to us for help, are competent electronics technicians. Therefore, they're familiar with most of the electronic circuitry found in audio and video equipment. Why then, do they still get jammed up. That's what we wanted to know, and found out. Very often we get stuck because we don't attack the problem with the right mental attitude. In other words, we simply don't work the brain first. That's because we become so familiar with the circuits and the problems associated with them, that we tend to jump in with both feet.

## Think positive!

When starting a job, it's a good idea to have a positive attitude—that is, keep an open mind and have confidence in yourself. You'll find that the problem isn't so great that you can't handle it. Often, what gets us into a hole is that we start with a fear that we can't handle the job, for one reason or another. In that case, you've got the proverbial two strikes against you before you even come to bat. (You're whipped before you start.) That belief is demonstrably false. You can find any problem and fix it, so forget all that gloom and doom.

Electronics repair, like anything else, is not sharply defined in black and white—there are gray areas. We ourselves cause faults without knowing it, thus adding to the confusion. Overconfidence is one very common cause of unnecessary repair-problem headaches. Such as, when we diagnose the fault before we've even looked at the equipment. However, if the job is approached calmly, confidently, and with an open mind you won't experience the agony of defeat.

Does this sound like you? "That's what's wrong! It's the vertical output transistor etc"—and you haven't even picked up a test prod! Because you've made a decision without hard evidence, the laws of chance are against you. Sure you stiff-

ened up sitting at a bench all day, but jumping to conclusions for the exercise isn't the answer! It's OK to suspect that a transistor or another device may be causing the problem. From there, simply test that stage and if you're right, all that's left to do is to replace the defective component or stage. Again, the best asset you can have is a completely open mind. Who cares what part is bad? All you want is to find it.

If you think some stage is bad, and after testing find you're wrong, don't worry about it. One suspected fault is already eliminated, so go on to the next. By using the process of elimination, you're bound to find the one you're looking for. It's in there somewhere. The fact that the set doesn't work, tells you there's a bad part somewhere. That may sound silly, but we've had letters that said, "There's nothing wrong in there!" That's impossible; if there were nothing wrong, the unit would work.

So, there you have our short course on successful electronic servicing. Remember, use positive thinking. You do know how the thing works, so simply make tests to find out where the abnormality is. It's in there somewhere. Keep this old saying in mind; "If you think you can do it, you can." Old sayings got to be old because they were true! Keep that good thought—and good luck!

R-E

## SERVICE QUESTIONS

### DEAD SONY

This Sony KV-1510 came to me dead. The dial lamp and auto-AFT lamps were lighted, though. I measured B+ to be 113 volts, which is OK. I measured no flyback-derived voltages at all, though. The horizontal oscillator was not running. At turn-on, B+ is applied to C517. The "kick" voltage is fed to the oscillator through R519. The problem was C517. When I took it out, one lead fell off in my hand! With that open, there was no charging kick and thus no horizontal-oscillator start. Incidentally, the correct Sams fol-



der for that chassis (SCC-25A-A) is 1322-2.

Thanks a lot to Douglas P. Hoff, Doug's Electronics of Vacaville, CA for that one. Feedback of that type is always very appreciated.

#### MODIFICATION FOR VCR USE

RCA offers a modified MAH-001A (horizontal oscillator) module to replace the original. The differences between the two units are as follows: Capacitor C14 changed to 10  $\mu$ F, 75 volts; R25 removed, and C6 shored with a jumper. That modification cleared up rolling and flag-waving at the top.

Thanks to Roy John, electronics technician at Youngstown State University, for that one.

#### TUBE SUB

I needed a 5KD8 tube the other day but couldn't find one. I looked it up in a substitution guide and came up with some subs: 6U8A, 6AX8, 6KD8, and even the old faithful 6GH8. Those seem to work very well, and the slight current difference doesn't seem to bother anything. Besides, those tubes are cheaper than the 5KD8!—D. Chinn, Chinn TV-Radio, Watertown, WI

#### TEARING IN RASTER

This Admiral 2K18-2A color chassis develops a small "tearing" at the upper left hand corner that gets increasingly worse as the set warms up. The problem eventually gets so bad that it blanks out the entire top of the screen. Please help!—B.B., Sepulveda, CA

Based on the symptoms you've described, an educated guess tells me that the problem is being caused by heater-to-cathode leakage in one of the tubes. The most likely culprit here is the 11BT11 (V302) video amplifier tube.

#### VERTICAL LINE

During a recent hot spell, the horizontal went out on my RCA CTC-76 leaving only a vertical line. When the set cooled off, everything worked fine once again. This is the second time that that has happened. Do you know anything about it?—M.G., West Hempstead, NY

Our crystal ball tells us that most times that problem can be traced to a loose connection on T-402, the pincushion transformer on the PW-400 board. Pinpointing the problem more closely may be possible, because at most times the condition of the connections can be found simply by inspection.

#### TWO PROBLEMS

A strange thing happened while working on a Sears 528.419450. The set was dead until, (when I turned the set over), the fail-safe transistor (Q553) fell out. Without that transistor, the set began to play, but not everything was normal. A special capacitor (C701) became very hot after just a

few minutes and the B+ voltages were somewhat high and could not be adjusted. After trying this a few times, for just a little while for each test, everything went out again.

I am also working on a Philco B424JBG. The problem with that one is no vertical sweep. That set, too, has me going around in circles. Can you help with either one?—I.I., Philadelphia, PA

Well, one thing seems to be sure, that fail-safe transistor must have been doing its task until it fell out. The first thing you'll have to do is find out why that set failed in the first place. Once that is cured, you'll have to find what further damage was done by operating the set without the

fail-safe. As to the first part of the job, the key may lie in the reason why the B+ was too high and could not be adjusted. This is a closed-loop type of system. If the B+ rises, so does the high voltage. If the high voltage is too high, it triggers the fail-safe transistor, which shuts down the entire system. That is apparently what happened in your case.

As for the Philco, check that set with a scope. In particular, make sure that Q302 and Q304 are oscillating. If not, use the scope to trace through the circuit until you find the point where things are not right. From there, voltage and resistance measurements should lead you to the defective component or components. R-E

The Professionals' Choice

# PTS

## All Makes/ All Models

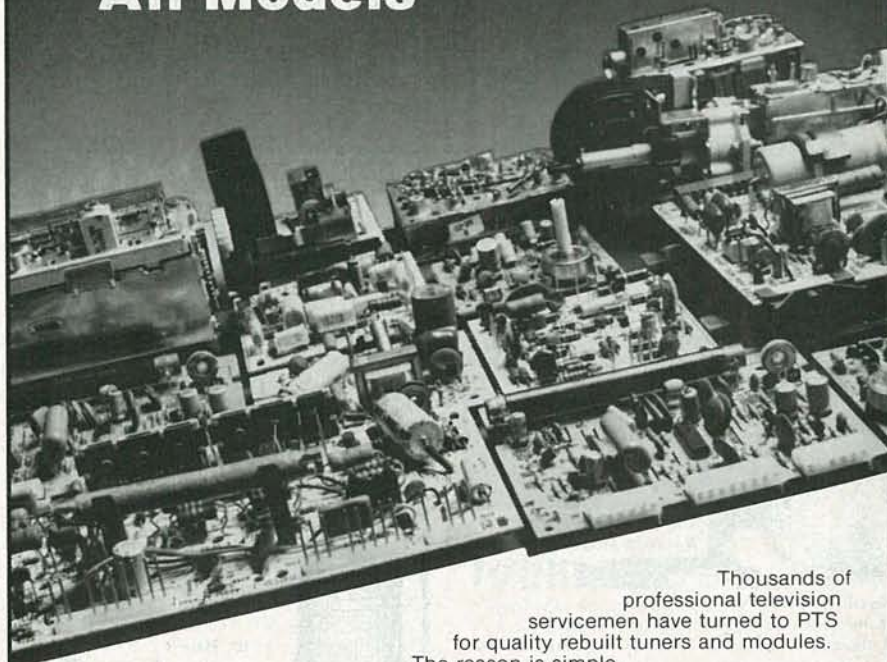

Thousands of professional television servicemen have turned to PTS for quality rebuilt tuners and modules. The reason is simple.

- One stop shopping for all makes/all models.
- Automatic updates for "better than brand new" tuners and modules.
- Over 1500 authorized stocking distributors—one near you.
- Fast 8 hour rebuilding service.
- One year limited warranty.
- Quality rebuilds that meet or exceed original manufacturer's specifications.

Send for your free Price and Technical Information Guide today!



**PTS Corporation**

*The world's largest independent electronics rebuilder.*

P.O. Box 272  
Bloomington, IN 47402  
(812) 824-9331



SEE YOUR DEALER TODAY



FROM



HERE'S A TIP THAT'S PERFECT!

AM/FM AUTO RADIO AND CB

**'Firestik' II**  
GOLDEN SERIES

BARE-HANDS TUNABLE  
"NO TOOLS NEEDED"  
HIGH PERFORMANCE ANTENNAS

ALSO ANTENNAS FOR  
CORDLESS TELEPHONES  
MONITOR SCANNERS

Dealer & Distributor Inquiries Invited  
SEND FOR FREE CATALOG

'Firestik' Antenna Company  
2614 East Adams/Phoenix, AZ 85034

Name \_\_\_\_\_  
Street \_\_\_\_\_  
City \_\_\_\_\_  
State \_\_\_\_\_ Zip \_\_\_\_\_

Serving the CB and  
Communications Market Since 1962.

**5-YEAR REPLACEMENT WARRANTY**

CIRCLE 40 ON FREE INFORMATION CARD

**DRAWING BOARD**

continued from page 95

grammed before it can function—that's accomplished through use of the JAM inputs. Its feedback circuit is a bit more complicated than the one-wire feedback used with the 4017. Pins 4, 5, 6, 11, and 13

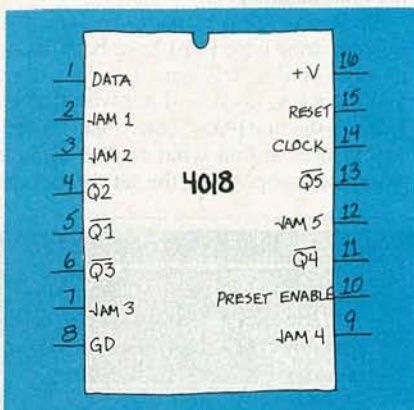

FIG. 3

are output pins. Connecting various combinations of those outputs to pin 1 allows the IC to divide by any number from 2 to 10. Pin 10 is the ENABLE pin for the JAM inputs; when pin 10 is brought high, it allows the 4018 to be programmed using the JAM inputs. Those inputs make that IC extremely interesting.

TABLE 1

Division by	Pins to connect To pin 1
2	5
3	4 and 5
4	4
5	4 and 6
6	6
7	6 and 11
8	11
9	11 and 13
10	13

Using the 4018 is a bit more difficult, but it's still a lot less complicated than trying to square-up the output of the 4017. Let's forget about the JAM inputs for the time being and look at what must be done to get the IC working. Using the IC without those inputs is really very simple. Dividing by a particular number is merely a matter of choosing the appropriate outputs and connecting them to pin 1. Different combinations of those outputs let you divide as shown in Table 1.

The problem immediately facing us is the external gating necessary to make the IC divide by an odd number. Since it's necessary to use two output pins for each odd number, it's difficult to get switch-selectable divisions. It could be done, but the wiring diagram for the switches would be a nightmare and ultimately unnecessary. Using the JAM inputs is far easier.

Try experimenting with the 4018. If you're lucky enough to have a scope, take a look at the output waveform—it should be relatively square. If you were to use all the capabilities of that IC, you'd understand why it's so versatile. If you do experiment with it remember—the reset pin and JAM inputs must be held low and enable held high for the IC to work. Next month we'll see how to take advantage of those JAM inputs and see how to cascade 4018's in order to extend the division range.

R-E

**Be an FCC LICENSED ELECTRONIC TECHNICIAN!**



Earn up to \$600 a week and more!

Learn at home in spare time. No previous experience needed.

No costly School. No commuting to class. The Original Home-Study course that prepares you for the FCC Radiotelephone license exam in your spare time! An FCC Government license is your "ticket" to thousands of exciting jobs in Communications, Radio & TV, Mobile two-way, Microwave, Computers, Radar, Aerospace and more. You don't need a college degree to qualify, but you do need an FCC License. **No need to quit your job or go to school!** You learn how to pass the FCC License exam at home at your own pace with this easy-to-understand, proven course. It's easy, fast and low cost! **GUARANTEED PASS** - You get your FCC License or money refunded. Write for free details. Soon you could be on your way to being one of the highest workers in the electronics field. **Send for FREE facts now. MAIL COUPON TODAY!**

**COMMAND PRODUCTIONS**

FCC LICENSE TRAINING, Dept. 90  
P.O. Box 2223, San Francisco, CA 94126

Rush FREE facts on how I can get my FCC License in spare time. No obligation. No salesman will call.

NAME \_\_\_\_\_  
ADDRESS \_\_\_\_\_  
CITY \_\_\_\_\_ STATE \_\_\_\_\_ ZIP \_\_\_\_\_

**FINEST QUALITY**  
Government Approved QQ-S-571e  
**SOLDER**

**SPECIAL FOR THE MONTH**

SN 60/40 Rosin Core (RA)

One lb. Reels		
16 swg. (.064)		\$7.95
18 swg. (.048)		\$8.45
19 swg. (.040)		\$8.95
20 swg. (.036)		\$9.45
21 swg. (.032)		\$9.95
1/2 lb. Reels		
22 swg. (.028)		\$5.95
24 swg. (.022)		\$7.95

SN 62 (2% Silver) Eutectic-Rosin Core  
21 swg. (.031) \$19.95

**Plus FREE Desoldering Wick** with each pound of solder

**FREE Freight On All Orders Over \$25**  
Under \$25 add \$2.50 per order. Minimum order \$10  
Check Money Order Master Charge Visa  
N.Y. State residents add appropriate sales tax.

To place your order call:  
**TOLL FREE 800-645-4808**  
In NYS (516) 334-2660 No COD's accepted

**SolderCraft**  
P.O. Box 668 Jericho, N.Y. 11753

CIRCLE 58 ON FREE INFORMATION CARD

**GLOUCESTER COMPUTER**

PO/64, all features of Promqueen less mimic mode. Software enhanced to include EPROM QC utilities, RS-232 communication, printouts. 28 pin ZIF socket. Reads, edits runs and programs all 5 volt 2500 and 2700 series EPROMS plus variety of EEPROMS all without personality modules. Commodore C-64 host computer. Inquire about the mimic mode capability in our VIC Promqueen. **\$299.00**



ROM Packs Industrial quality circuit cards are socketed, solder masked, fully bypassed, and include a ground plane for low noise operation. Includes 1 EPROM. 8K & 16K models for VIC-20 and C-64. Specify 2732 or 2764 EPROM type. Molded plastic case. **\$39.00**

**GLOUCESTER COMPUTER**  
1 Blackburn Center, Gloucester, MA 01930 617-283-7719

CIRCLE 4 ON FREE INFORMATION CARD

RADIO-ELECTRONICS



# NEW BOOKS

For more details use the free information card inside the back cover

**STUDY GUIDE FOR THE ASSOCIATE LEVEL CET TEST** edited by J.A. Sam Wilson, IS CET Test Director; International Society of Certified Electronic Technicians, 2708 West Berry, Fort Worth, TX 76109; 88 pp; 8½ × 11 inches; softcover; \$5.00.

Here is a new study guide that describes the associate test and gives some hints for those who want to take it. Each of the sections on the associate-level CET exam is discussed in detail, with descriptions of what the technician should know, and includes some sample questions with detailed explanations of the answers. The explanations in the guide were developed following an extensive survey of what types of questions were most frequently missed by those taking the test.

Subjects covered include basic components, basic mathematics, DC circuits, AC circuits, transistors and semiconductors, electronics components and circuits, tests and measurements, digital logic, and troubleshooting and network analysis.

While the price of this book is \$5.00 for a single copy, lots of 10 or more may be purchased at \$3.50 each.

CIRCLE 121 ON FREE INFORMATION CARD

**COMPUTER ART AND ANIMATION FOR THE TRS-80**, by David L. Heiserman; Prentice-Hall, Inc., Englewood Cliffs, NJ 07632; 246 pp including appendices and index; 6½ × 9½ inches; hardcover; \$17.95.

While the subject of computer graphics is often treated as a novelty, this book treats TRS-80 computer graphics and animation as a topic worthy of study and experimentation. The discussions and examples should help a programmer build up a sense of confidence in developing programs that use graphics features.

The material in the book stresses the point that the quality of the finished product requires applying time and effort, rather than just following a routine technique. The animation technique features high-speed graphics that do not require a knowledge of machine-language programming and methods. It's all in BASIC. Sample applications of the principles are given to spark the reader's imagination.

The program and procedures given here apply to the TRS-80 Model III and the original Model I. The book emphasizes a modular approach to creating some of the more complicated animation routines.

CIRCLE 122 ON FREE INFORMATION CARD

**DIGITAL PLL FREQUENCY SYNTHESIZERS Theory and Design**, by Ulrich S. Rohde; Prentice-Hall, Inc., Englewood Cliffs, NJ 07632; 494 pp including index; 7 × 9½ inches; hardcover; \$49.95.

The objective of this book is to provide as much practical circuit information as possible while presenting only the necessary mathe-

matical background and formulas. It is slanted toward college students who have to get acquainted with phase-locked loops (PLL) or have to build certain projects; as well as toward practicing engineers who are designing synthesizers for various applications, and toward senior engineers and people in management functions who want to be able to evaluate new trends and techniques. The reader is introduced to practical and reliable circuits that can be used as starting tools.

The book is divided into seven sections: Chapter 1 deals with loop fundamentals; chapter 2 outlines the noise and spurious response of loops; chapter 3 deals with special loops, most of which have been developed recently, and chapter 4 covers analyzing PLL components.

Chapter 5 goes into the details of multiloop synthesizers, starting with such earlier design principles as mix and divide, triple mix, or drift-canceling loops. The ground rules for setting up complex loops are then laid out, and the use of microprocessors in frequency synthesizers, and their use in communication equipment, is covered.

Chapter 6 consists of the analysis and schematic details of three practical synthesizers as a design guide. The final section is the appendix, which is divided into a mathematical review and a list of useful computer programs.

CIRCLE 123 ON FREE INFORMATION CARD

**AMATEUR RADIO Theory and Practice**, by Robert L. Shrader, Gregg/McGraw-Hill, 1221 Avenue of the Americas, New York, NY 10020; 340 pp. including index; 7¼ × 9¼ inches; softcover; \$14.95.

This manual presents in easy-to-read language, the latest information required by the FCC for all five amateur-grade licenses: Novice, Technician, General, Advanced, and Extra. The author covers the specifics of radio operation and the electricity and electronics theory that are required for each level.

The material is divided into easy-to-follow topics, with many diagrams, and a reinforcing quiz is presented at the end of each chapter. Each paragraph is prefaced with a bold letter indicating the particular grade license it prepares the student for, and a number that refers to the end-of-the-chapter FCC-exam-type questions on that material. Those questions are listed under the five amateur-license grades and are suffixed with references to chapter sections.

CIRCLE 124 ON FREE INFORMATION CARD

**32 ELECTRONIC POWER SUPPLY PROJECTS**, by Robert J. Traister; TAB Books, Inc., Blue Ridge Summit, PA 17214; 291 pp including appendices and index; 5 × 8¼ inches; softcover; \$10.95.

This book offers the reader a chance to get practical experience building DC power-supply circuits for a variety of applications that range from amateur radio or audio pro-

TRAIN AT HOME IN SPARE TIME!  
NO PREVIOUS EXPERIENCE NEEDED!

## BE A COMPUTER PROGRAMMER



FOR HOME or  
BUSINESS...WHAT, WHEN, HOW!

Learn how and why a computer can help you. Learn to write your own computer programs. See how easy it is to use different programs already available. See how they fit into your home or business operations...budgeting, real estate, bookkeeping, inventories, expenses, pricing, profit margins, investments, interest, taxes, shopping lists, vacation planning, addresses, phone numbers, routing...hundreds more including foreign languages, computer games and graphics. Never again be at the mercy of a so-called "computer expert." Know what really happens when you get a computer problem from a bank, store, loan company, oil company, utility or anyone else. You'll be able to talk their language...understand why and how things happen...be able to take the offensive when you're the victim of a computer error.

EXPERTS SHOW YOU WHAT TO DO,  
HOW TO DO IT...TO MAKE YOUR LIFE EASIER

Everything is explained in easy-to-understand language with plenty of examples. Step-by-step directions take you through basic computer programming. You learn everything you need to know to use the computer. You'll be able to understand computer experts and talk their language...storage, systems, terminals...you'll learn it all and much, much more.

NOW...ALL THIS IN ONE COURSE!

- Computer Training • Computer Programming
- Computer Applications • Computer Games

Find out what you need to know about computer operations



TIMEX COMPUTER  
INCLUDED WITH  
YOUR TRAINING  
Plugs into any TV!

SEND FOR  
FREE FACTS!

**ICS** COMPUTER TRAINING, Dept. DE0C3  
SINCE 1891 Scranton, Pennsylvania 18515

Please rush me free facts and color brochure that tells how I can learn computer applications, programming and operation at home in spare time. NO SALESMAN WILL CALL.

Name \_\_\_\_\_ Age \_\_\_\_\_  
Address \_\_\_\_\_  
City/State/Zip \_\_\_\_\_



# CATCH ON

**MASTER COMPUTERS IN YOUR OWN HOME!**

**LEARN PROGRAMMING AND APPLICATIONS**

Now you can learn about computers... operations... programming... applications... software. Everything you always wanted to know. Write your own programs. Or customize pre-written programs. Make a computer do exactly what you want it to do. Benefit from becoming "computer-wise" today. It's all in this one educational package!

**A COURSE IN COMPUTERS AND BASIC PROGRAMMING**

NO PREVIOUS COMPUTER EXPERIENCE NEEDED. The entire course is "user friendly", written in simple language, that's easy for a beginner to understand. You will LEARN BY DOING - programming from the very first lesson using any computer. IBM APPL; ATARI; COMMODORE; TRS; TI... even the tiny Times-Sinclair!

**A CONVENIENT WAY TO LEARN**

Progress at your own speed, in your spare time, in your own home. Take the mystery out of word processing... computerized accounting... maintaining data files and much, much more.

Get started now in the fast-growing field of computers, and CATCH ON to the technology of the future... **COMPUTERS!**

Send today for your free information package. Or call toll-free (800) 624-7760, in California call toll-free (800) 624-8646. No obligation.

**HALIX INSTITUTE**  
1743 South Vermont Ave., Los Angeles, CA 90006

... if you don't have a computer yet, don't buy one until you receive this free information.

**halix INSTITUTE** An affiliate of Hemphill Schools and IPIG. ... THE INTERNATIONAL CHOICE SINCE 1920

**HALIX INSTITUTE CENTER FOR COMPUTER EDUCATION**  
1743 SO. VERMONT AVE.  
LOS ANGELES, CA 90006

YES! Send me information on how I can learn about computers and programming at home!

Name \_\_\_\_\_ Age \_\_\_\_\_  
Address \_\_\_\_\_  
City \_\_\_\_\_ State/Zip \_\_\_\_\_

I already have a computer available.

Make \_\_\_\_\_ Model \_\_\_\_\_ 48H-A0501

CIRCLE 50 ON FREE INFORMATION CARD

jects to all types of experimental electronics devices. The reader will also learn fundamentals of power-supply theory that will be valuable later on.

The 32 DC power-supply projects range from the very simple (a half-wave supply and a Zener-diode regulator) to such advance units as a unique variable supply or a 12-volt inverter circuit.

Each project includes detailed, step-by-step building instructions, complete schematics, and parts list. Every one of the devices dealt with in this book can be built in a few hours from low-cost, readily available components.

CIRCLE 125 ON FREE INFORMATION CARD

**COMPUTERS THAT THINK?** The Search for Artificial Intelligence, by Margaret O. Hyde; Enslow Publishers, Bloy Street and Ramsey Avenue, Box 777, Hillside, NJ 07205; 126 pages, including selected reading list and index; 9 1/2 x 6 1/4 inches; hardcover, \$9.95; paperback, \$4.95.

There is wide disagreement among experts as to whether any computer can be said to "think" or exhibit real intelligence. A computer or robot is labelled "smart" or "intelligent" when it performs tasks that require smartness or intelligence for a human being to perform. However, no computer can create, or initiate a line of research, or go behind the literal meaning of the words in its memory banks and interpret what it is really being asked. Fallibility is another matter; computers are infallible so long as their power supply doesn't fail, or some component go out of order. But that isn't intelligence. Neither is the

continued on page 111

## QUALITY SPECIALS

### SOPHISTICATED I.C.'S

DATA SHEETS ARE PROVIDED FREE WITH ALL INTEGRATED CIRCUITS LISTED BELOW

PART #	DESCRIPTION	PRICE (ea.)
LS7232	TOUCH SENSITIVE LIGHT DIMMER SWITCH. MOMENTARY TOUCH TO SENSOR PLATE TURNS LIGHTS ON OR OFF. PROLONGED TOUCH GRADUALLY DIMS OR BRIGHTENS. A SLOW CLOCK INPUT ALLOWS AUTOMATIC SLOW DIMMING TO OFF-IDEAL FOR SOLVING CHILD'S FEAR OF DARK BEDROOM.	\$4.50
RDD104	CMOS DIVIDER I.C. HAS TRUTH-TABLE SELECTABLE INPUT TO YIELD DIVIDE BY 10, 100, 1000 OR 10000 OUTPUTS.	\$3.50
LS7031	D.C. TO 5MHz SIX DECADE MOS UP COUNTER WITH 8 DECADE LATCH AND MULTIPLEXED BCD OUTPUTS. DIGIT STROBES ACCESS TO LSO LATCHES ALLOWS ATTACHMENT OF PRESALERS FOR COUNTING TO 500MHz.	\$13.75
LS7200	14 PIN DIP AUTOMOTIVE MARINE ANTI-THEFT DIGITAL LOCK CIRCUIT. HAS 5040 4-DIGIT COMBINATIONS WITH 25 MICROAMP STANDBY 'SAVE' MODE FOR VALET PARKING.	\$3.50
XR2228CB	MULTIPLIER DETECTOR I.C. FOR ANALOG SIGNAL PROCESSING. CONTAINS 4 QUADRANT ANALOG MULTIPLIER-RESOLATORS AND INDEPENDENT HIGH GAIN OP-AMP DIFFERENTIAL X-Y INPUTS. APPLICATIONS FOR PHASE DETECTION UP TO 100 MHz. PLL DESIGN IN SYNCH. AM DETECTION OR GENERATION. TRIANGLE TO SQUARE CONVERSION OR FREQUENCY TRANSLATION.	\$3.20
ICL8038	PRECISION WAVEFORM GENERATOR I.C. PRODUCES SINE SQUARE, TRIANGLE, SAWTOOTH OR PULSE WAVEFORMS WITH MINIMAL EXTERNAL COMPONENTS FROM 0.01Hz TO 1 MHz. FOR PRECISION PLL TEST INSTRUMENTS.	\$3.75
XR215CN	HIGH FREQUENCY PHASE-LOCKED LOOP I/PLI I.C. FOR BOTH ANALOG AND DIGITAL COMMUNICATIONS 0.5Hz TO 25MHz. USES INCLUDE FM DEMODULATION, FREQUENCY SYNTHESIS, FSK CODING, DECODING, MODEM, DTL TTL ECL LOGIC COMPATIBLE.	\$4.20
CS258A	INTRUSION ALARM OPTICAL TRANSDUCER I.C. NEEDS IR TO PHOTO DIODE & PASSIVE PARTS TO BE COMPLETE. OPTICAL TRANSDUCER SYSTEM CAN BE AIRLY OPEN TO AMBIENT LIGHT WITHOUT FALSE ALARMS.	\$5.95
<b>HALL EFFECT DEVICES</b>		
UGN3501T	HALL EFFECT SENSOR FOR MAGNETIC FIELD CHANGES TOO SMALL TO OPERATE THE HALL SWITCHES OUTPUT IS A LINEAR FUNCTION OF MAGNETIC FIELD INTENSITY. MONOLITHIC I.C. INCLUDES HALL CELL, AMPLIFIER AND VOLTAGE REGULATOR FOR A 4.5 TO 24 VDC SOURCE. HIGH SENSITIVITY AND FLAT RESPONSE. 3 PIN T-POACK.	\$2.80
UGN3501M	SAME AS UGN 3501T BUT WITH PROVISION FOR NULLING THE OUTPUT OFFSET VOLTAGE. 8 PIN DIP.	\$2.80
UGN3504M	HALL EFFECT SENSOR WITH DIFFERENTIAL OUTPUT. A LINEAR FUNCTION OF MAGNETIC FLUX. SUPPLIED WITH INDIVIDUAL CALIBRATION CHART AT 25 DEGREES CELSIUS. 5 VOLTS. FOR CALIBRATING TESTING ALIGNING MAGNETIC SENSING DEVICES. 8 PIN DIP.	\$8.50

### FREE CATALOG OF NEW DEVICES

**GOLDSMITH SCIENTIFIC CORPORATION**

P.O. BOX 318R, COMMACK, NY 11725  
PHONE ORDERS WELCOME—(516) 979-7944  
MASTER CARD AND VISA ACCEPTED  
NEW YORK STATE RESIDENTS ADD SALES TAX  
POSTAGE—ADD 5% PLUS \$1.50 INSURANCE, C.O.D. \$2.00 EXTRA  
AVAILABILITY OF CERTAIN ITEMS MAY BE LIMITED.

CIRCLE 69 ON FREE INFORMATION CARD

## Diskette Users...

When you've heard from all the animals in the diskette zoo, but you need fast delivery and high quality diskettes...

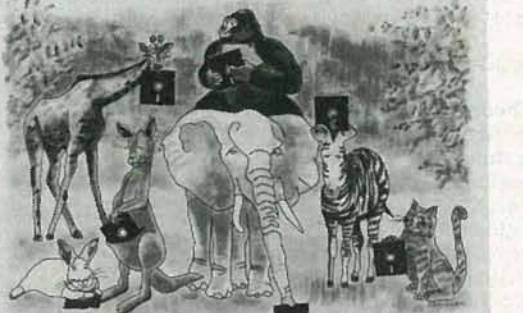

## Call Communications Electronics

Diskette order desk  
**800-521-4414**  
In Canada 800-265-4828

Choose your brand  
Choose your price



**Wabash diskettes**  
\$1.29 each



**Ultra diskettes**  
\$1.39 each



**3M diskettes**  
\$1.94 each



**Memorex diskettes**  
\$1.94 each



**Burroughs diskettes**  
\$2.09 each



**Dyan diskettes**  
\$2.99 each

Product Description	Wabash Part #	CE quant. 100 price per disk (\$)
5" 5DD IBM Compatible 128K/5, 26 Sector	F111	1.89
5" 5DD Shugart Compatible, 32 Hard Sector	F21A	1.99
5" 5DD IBM Compatible (128 K/5, 26 Sectors)	F131	2.39
5" 5DD Soft Sector (Unformatted)	F14A	2.99
5" 5DD Soft Sector (156 K/5, 26 Sectors)	F14B	2.99
5" 5DD Soft Sector (512 K/5, 15 Sectors)	F14C	2.99
5" 5DD Soft Sector (1024 K/5, 8 Sectors)	F147	2.99
5" 5DD Soft Sector w/Hub Ring	M11A	1.49
5" 5DD Same as above but bulk product	M11AB	1.29
5" 5DD 10 Hard Sector w/Hub Ring	M41A	1.49
5" 5DD 16 Hard Sector w/Hub Ring	M51A	1.49
5" 5DD Soft Sector w/Hub Ring	M13A	1.79
5" 5DD Same as above, but bulk product	M13AB	1.59
5" 5DD Soft Sector Floppy (use both sides)	M18A	2.89
5" 5DD 10 Hard Sector w/Hub Ring	M52A	1.79
5" 5DD 16 Hard Sector w/Hub Ring	M53A	1.79
5" 5DD Soft Sector w/Hub Ring	M14A	2.89
5" 5DD Same as above, but bulk product	M14AB	2.49
5" 5DD 10 Hard Sector w/Hub Ring	M44A	2.89
5" 5DD 16 Hard Sector w/Hub Ring	M45A	2.89
5" 5DD Soft Sector w/Hub Ring (88 TP)	M16A	2.59
5" 5DD Soft Sector w/Hub Ring (88 TP)	M16A	3.89
5" 5" Floppy Diskette for Apple® Lisa Computer		

Product Description	Ultra Part #	CE quant. 100 price per disk (\$)
5" 5DD IBM Compatible 128K/5, 26 Sector	B172B	1.99
5" 5DD Shugart Compatible, 32 Hard Sector	S0001	1.79
5" 5DD IBM Compatible (128 K/5, 26 Sectors)	B1701	2.49
5" 5DD Soft Sector (Unformatted)	B2701	3.19
5" 5DD Soft Sector (156 K/5, 26 Sectors)		
5" 5DD Soft Sector (512 K/5, 15 Sectors)		
5" 5DD Soft Sector (1024 K/5, 8 Sectors)		
5" 5DD Soft Sector w/Hub Ring	B2708	3.19
5" 5DD Same as above, but bulk product	S0001	1.79
5" 5DD 10 Hard Sector w/Hub Ring	O0163	1.39
5" 5DD 16 Hard Sector w/Hub Ring	S0010	1.79
5" 5DD Soft Sector w/Hub Ring	S0018	1.79
5" 5DD Same as above, but bulk product	S1401	1.89
5" 5DD Soft Sector Floppy (use both sides)	O0099	1.59
5" 5DD 10 Hard Sector w/Hub Ring	S1410	1.89
5" 5DD 16 Hard Sector w/Hub Ring	S1418	1.89
5" 5DD Soft Sector w/Hub Ring	S5401	2.79
5" 5DD Same as above, but bulk product	O0140	2.49
5" 5DD 10 Hard Sector w/Hub Ring	S2410	2.79
5" 5DD 16 Hard Sector w/Hub Ring	S2418	2.79
5" 5DD Soft Sector w/Hub Ring (88 TP)	S1801	2.59
5" 5DD Soft Sector w/Hub Ring (88 TP)	S2801	3.69

Product Description	3M Part #	CE quant. 100 price per disk (\$)
5" 5DD IBM Compatible 128K/5, 26 Sector	8888D	1.94
5" 5DD Shugart Compatible, 32 Hard Sector	8888D-25	1.94
5" 5DD IBM Compatible (128 K/5, 26 Sectors)	8888D	2.49
5" 5DD Soft Sector (Unformatted)	8888D	3.19
5" 5DD Soft Sector (156 K/5, 26 Sectors)		
5" 5DD Soft Sector (512 K/5, 15 Sectors)		
5" 5DD Soft Sector (1024 K/5, 8 Sectors)		
5" 5DD Soft Sector w/Hub Ring	8888D-1024	3.14
5" 5DD Same as above, but bulk product		
5" 5DD 10 Hard Sector w/Hub Ring		
5" 5DD 16 Hard Sector w/Hub Ring		
5" 5DD Soft Sector w/Hub Ring		
5" 5DD Same as above, but bulk product		
5" 5DD 10 Hard Sector w/Hub Ring		
5" 5DD 16 Hard Sector w/Hub Ring		
5" 5DD Soft Sector w/Hub Ring (88 TP)		
5" 5DD Soft Sector w/Hub Ring (88 TP)		

Product Description	Memorex Part #	CE quant. 100 price per disk (\$)
5" 5DD IBM Compatible 128K/5, 26 Sector	3002	1.94
5" 5DD Shugart Compatible, 32 Hard Sector	3015	1.94
5" 5DD IBM Compatible (128 K/5, 26 Sectors)	3000	2.49
5" 5DD Soft Sector (Unformatted)	3102	3.14
5" 5DD Soft Sector (156 K/5, 26 Sectors)		
5" 5DD Soft Sector (512 K/5, 15 Sectors)		
5" 5DD Soft Sector (1024 K/5, 8 Sectors)		
5" 5DD Soft Sector w/Hub Ring	3104	3.14
5" 5DD Same as above, but bulk product		
5" 5DD 10 Hard Sector w/Hub Ring		
5" 5DD 16 Hard Sector w/Hub Ring		
5" 5DD Soft Sector w/Hub Ring		
5" 5DD Same as above, but bulk product		
5" 5DD 10 Hard Sector w/Hub Ring		
5" 5DD 16 Hard Sector w/Hub Ring		
5" 5DD Soft Sector w/Hub Ring (88 TP)		
5" 5DD Soft Sector w/Hub Ring (88 TP)		

Product Description	Burroughs Part #	CE quant. 100 price per disk (\$)
5" 5DD IBM Compatible 128K/5, 26 Sector	FD-101	2.09
5" 5DD Shugart Compatible, 32 Hard Sector	FD-102	2.09
5" 5DD IBM Compatible (128 K/5, 26 Sectors)	FD-108	2.64
5" 5DD Soft Sector (Unformatted)	FD-109	3.29
5" 5DD Soft Sector (156 K/5, 26 Sectors)	FD-110	3.29
5" 5DD Soft Sector (512 K/5, 15 Sectors)	FD-111	3.29
5" 5DD Soft Sector (1024 K/5, 8 Sectors)	FD-112	3.29
5" 5DD Soft Sector w/Hub Ring		
5" 5DD Same as above, but bulk product		
5" 5DD 10 Hard Sector w/Hub Ring		
5" 5DD 16 Hard Sector w/Hub Ring		
5" 5DD Soft Sector w/Hub Ring		
5" 5DD Same as above, but bulk product		
5" 5DD 10 Hard Sector w/Hub Ring		
5" 5DD 16 Hard Sector w/Hub Ring		
5" 5DD Soft Sector w/Hub Ring (88 TP)		
5" 5DD Soft Sector w/Hub Ring (88 TP)		

Product Description	Dyan Part #	CE quant. 100 price per disk (\$)
5" 5DD IBM Compatible 128K/5, 26 Sector	800501	2.99
5" 5DD Shugart Compatible, 32 Hard Sector	800611	2.99
5" 5DD IBM Compatible (128 K/5, 26 Sectors)	800605	3.89
5" 5DD Soft Sector (Unformatted)	800803	4.59
5" 5DD Soft Sector (156 K/5, 26 Sectors)		
5" 5DD Soft Sector (512 K/5, 15 Sectors)		
5" 5DD Soft Sector (1024 K/5, 8 Sectors)		
5" 5DD Soft Sector w/Hub Ring	800839	4.59
5" 5DD Same as above, but bulk product	801184	2.99
5" 5DD 10 Hard Sector w/Hub Ring	801186	2.99
5" 5DD 16 Hard Sector w/Hub Ring	801185	2.99
5" 5DD Soft Sector w/Hub Ring	801187	3.19
5" 5DD Same as above, but bulk product		
5" 5DD 10 Hard Sector w/Hub Ring		
5" 5DD 16 Hard Sector w/Hub Ring		
5" 5DD Soft Sector w/Hub Ring (88 TP)		
5" 5DD Soft Sector w/Hub Ring (88 TP)		

For more information  
about this brand call:

8 year warranty  
For more info on Wabash call  
**800-323-9888**  
In Illinois 312-593-8363

Lifetime warranty except bulk  
For more info on Ultra call  
**408-728-7777**  
Monday-Friday 9 am-4 pm

Lifetime warranty except bulk  
For more info on 3M call  
**800-328-9438**  
In Minnesota 612-728-9524

8 year warranty  
For more info on Memorex call  
**800-538-8080**  
In California 800-672-3528

1 year warranty  
For more info on Burroughs call  
**800-448-1422**  
Monday-Friday 9am-4pm ET

1 year warranty  
For more info on Dyan call  
**800-552-2211**  
In California 408-970-8066

CIRCLE 86 ON FREE INFORMATION CARD







# NEW LITERATURE

For more details use the free information card inside the back cover

**METERS**, catalog of digital and analog instrumentation meters is 67 pages on coated paper, many of them in part or full color, and is 8½ × 11 inches. The instruments include digital panel meters, wide-vue panel meters, segmented-scale panel meters, pyro-meters, edgewise controllers, solid-state non-indicating controllers, digital multimeters, hand-portable DMM's, function generators, oscilloscopes, milliameters, micro-testers, and many others. The catalog is free on request from **Simpson Electric Company**, 853 Dundee Avenue, Elgin, IL 60120.

**CIRCLE 111 ON FREE INFORMATION CARD**

**SOLDERLESS TERMINALS**, catalog of new electrical products from Vaco is 24 pages in full color and contains all Vaco products related to electrical and electronics applications. The major section is a comprehensive listing of Vaco's solderless terminal line, which includes actual-size, actual-color illustrations, and complete specifications for

each individual terminal. Also included are special-purpose connectors, alligator clips, wire connectors, nylon ties, and wire holders. Electrical tools included are wire strippers, crimping tools, and electrical testers. The catalog is free from **Vaco Products Company**, 1510 Skokie Blvd., Northbrook, IL 60062.

**CIRCLE 112 ON FREE INFORMATION CARD**

**DMM**, data sheet is an 8½ × 11 inch flyer, in full color, that describes and specifies the performance of Fluke's handheld DMM, the model 8026B, that features true rms measurements of AC voltage and current. Free from **John Fluke Mfg. Co., Inc.**, Mail Stop 250 C, PO Box C9090, Everett, WA 98206.

**CIRCLE 113 ON FREE INFORMATION CARD**

**COMPONENTS**, catalog is 80 pages, illustrated, 8½ × 11 inches, for the hobbyist, experimenter, student, or professional. Included are semiconductors, integrated circuits, microcomputer boards, microprocessor and

support circuits, transistors, diodes, capacitors, resistors, optoelectronics, potentiometers, test meters, switches and knobs, connectors and sockets, PC boards, plastic enclosures, artwork aids, electronics tools, soldering equipment, and data and reference books—and many other categories. Free from **Active Components** (a division of Future Electronics), PO Box 8000, Westborough, MA 01581

**CIRCLE 114 ON FREE INFORMATION CARD**

**GRAPHICS PLOTTER**, brochure on the 7470A Graphics Plotter, is 6 pages, part in full color, on coated stock, 8½ × 11 inches. Provides photos, charts, and a list of specifications for the device. The specifications include the plotting area, resolution, repeatability, interfaces, and media, as well as a list of accessories supplied with the Plotter. Free from **Hewlett-Packard**, 1501 Page Mill Road, Palo Alto, CA 94304.

**R-E CIRCLE 115 ON FREE INFORMATION CARD**

## Learn About Professionalism and Profit . . .

. . . while enjoying the time of your life!

### At the 1984 Annual NESDA/ISCET National Professional Electronics Convention

and "Arch of Progress" Trade Show

1984  
The Gateway To Professionalism

- Products • Service Aids • Test Equipment
- Management & Technical Seminars • Golf & Tennis Outings • Instructors Conference
- Dealer/Mfr. Meetings • Officer Elections
- Sponsored Meals • Dealer Panels • Parties

- Special Children's Rates • Low Hotel Rates • Tax Deductible Vacation

**August 6-12 St. Louis MO**

Early Registration Discounts. Also discounts for additional persons from same family or business.

**Send for more details — Now!**

Send for more information and an application to:  
NPEC, 2708 W. Berry St., Ft. Worth, TX 76109; Ph (817) 921-9061

Name \_\_\_\_\_

Address \_\_\_\_\_

City \_\_\_\_\_ State \_\_\_\_\_ Zip \_\_\_\_\_

## LOOK



### What USO is doing today for service families

At USOs around the world, thousands of volunteers are making service families like those from your community feel they're at home. Information, classes,

tours, crisis intervention and more help families during the good times and the bad times. USO...the three most important letters in helping others.

Support USO through the United Way, OCF, or local USO campaign.



## NEW BOOKS

continued from page 111

Park, NJ 07662; 114 pages, including appendices and index; 8 1/4 x 5 1/4 inches; softcover; \$6.10.

Complaints about interference get higher each year, and most people who can get through the FCC's jammed phone lines receive a recorded message that anticipates the inquiry, instructing the caller on how to file a formal interference complaint. And those who complain formally are only a percentage of those who suffer from the problem.

This book was written both for those who suffer from interference and those who are the unintentional cause of it. It covers the problems of interference caused by transmitters, CB radios, home appliances, atmospheric noise sources, neon lights, hair dryers, and numerous other sources. Written in easy-to-understand language, the book provides all the information needed to halt interference, whatever the source may be, whether it's transmitter or non-transmitter oriented. It gives step-by-step instructions on how to detect the offending source and cure the interference. The final chapter tells the reader where to find outside resources for help with particularly difficult interference problems.

CIRCLE 130 ON FREE INFORMATION CARD

**DON LANCASTER'S MICRO COOKBOOK (Volume 1: Fundamentals);** Howard W. Sams & Co., Inc., 4300 W. 62nd Street, Indianapolis, IN 46268; 381 pages, including appendices and index; 8 1/2 x 5 1/4 inches; softcover, \$15.95.

This book contains a set of rules that will help the reader win the game of microcomputers and microprocessors. It gives many of the micro resources that you can use, and lists some of the micro trainers that are available. There is an examination and explanation of essential numbering systems and basic logic, and microcomputer/microprocessor codes and coding systems are covered. There is also a discussion of the different kinds of memory available. The author shows you how micros work, and how you can build your own micro skills. It is the first in a series on microprocessors and microcomputers.

CIRCLE 131 ON FREE INFORMATION CARD

**THE COMPLETE GUIDE TO HIGH FIDELITY,** by Martin Clifford; Howard W. Sams & Co., Inc., 4300 West 62nd Street, Indianapolis, IN 46268; 368 pages, including glossary and index; 8 1/2 x 4 1/4 inches; softcover; \$15.95.

In the preface, the author immediately dispenses of the myth that a first-class high-fidelity system "will bring the concert hall into your home." It won't do anything of the kind, he notes, and it would be unfortunate if it did. The sound of the cannon in Tchaikovsky's *1812 Overture* would probably break your windows if the music were played at concert-hall volume. What high fidelity *does* do, through a series of compromises, is to give the listener the effect of being in a good seat in a concert hall; and certainly on some stereo records you can clearly hear details that you probably would not hear—or not notice—in the concert hall.

This book leads the reader through the hi-fi maze, providing enough technical informa-

tion so that the principles can be understood. It shows 30 basic systems ranging in cost for those with limited to those with unlimited budgets. Digital recording, amplifiers, tuners, receivers, preamplifiers, drive motors, proximity effect, and impedance matching are all covered. There are many diagrams and illustrations, and a thorough glossary in the back of the book for those unfamiliar with high-fidelity's various technical terms and abbreviations or acronyms.

CIRCLE 132 ON FREE INFORMATION CARD

**DIGITAL ELECTRONICS (Second Edition),** by William H. Gothmann; Prentice-Hall, Inc., Englewood Cliffs, NJ 07632; 383pp, including index; 9 1/2 x 7 inches; hardcover; \$21.95.

Subtitled "An introduction to theory and

practice," this newly revised text is an up-to-date course in basic design techniques that will help engineers and technicians to deal with the growing use of digital electronics. The book explains both digital theory and logic hardware, bridging the gap between theory and practice and giving the designer tools with which to solve digital problems today and in the future.

Revisions of the earlier text include introducing the binary, octal, and hexadecimal systems—those used by our friendly computers; covering combinational logic and the reduction of Boolean expressions; reviewing the increasing importance of bus structures and memory systems, and presenting the principles of analog-to-digital and digital-to-analog conversion.

R-E

CIRCLE 133 ON FREE INFORMATION CARD

## Electronics Paperback Books NEW Paperbacks You'll Want To Read CHECK OFF THE ONES YOU WANT

**An Introduction to Video**... \$5.00. Covers most of the practical aspects of video recording that a newcomer to the subject might require.

**20 Programs for the ZX Spectrum & 16K ZX81**... \$5.00. Included with each program is a detailed flow chart for both games and practical applications in filing, statistics, and engineering.

**20 PROGRAMS FOR THE ZX SPECTRUM & 16K ZX81**... \$5.00. Included with each program is a detailed flow chart for both games and practical applications in filing, statistics, and engineering.

**30 Solderless Breadboard Projects—Book 2**... \$5.75. 30 more new projects based on CMOS ICs that you can try in minutes on an electronic breadboard.

**30 SOLDERLESS BREADBOARD PROJECTS—Book 2**... \$5.75. 30 more new projects based on CMOS ICs that you can try in minutes on an electronic breadboard.

**How to Get Your Electronic Projects Working**... \$5.00. When you can't get that home-built equipment to work, this book may have the answers you need.

**How to Design and Make Your Own PCBs**... \$5.75. Fascinating projects for any science fair. Includes any science fair. Includes any science fair. Includes any science fair.

**DESIGN & MAKE YOUR OWN PRINTED-CIRCUIT BOARDS**... \$5.75. Everything you ever needed to know about how to make printed circuit boards at home.

**How to Program the ZX Spectrum**... \$5.75. Make this color computer do its stuff. With this book in hand, it's easy.

**PROGRAMMING THE ZX SPECTRUM**... \$7.50. Make this color computer do its stuff. With this book in hand, it's easy.

**25 Simple Amateur Band Antennas**... \$5.00. Includes designs for dipoles, beams, triangle and even a mini-rhombic. Includes a complete set of dimension tables.

**25 SIMPLE AMATEUR BAND ANTENNAS**... \$5.00. Includes designs for dipoles, beams, triangle and even a mini-rhombic. Includes a complete set of dimension tables.

**Art of Programming the 1K ZX81**... \$6.25. What happens when you add the RAM pak. Scrolling, PEEK, POKE, Page graphics and more.

**ART OF PROGRAMMING THE 1K ZX81**... \$6.25. What happens when you add the RAM pak. Scrolling, PEEK, POKE, Page graphics and more.

**International Transistor Equipment Guide**... \$7.50. Lists possible substitutes for a popular user-oriented selection of modern transistors. The products of more than 100 manufacturers are included.

**INTERNATIONAL DIODE EQUIVALENTS GUIDE**... \$5.75. Find substitutes when you need them for diodes, transistors, OC's, photodiodes and display diodes.

**INTERNATIONAL DIODE EQUIVALENTS GUIDE**... \$5.75. Find substitutes when you need them for diodes, transistors, OC's, photodiodes and display diodes.

**Multi-circuit Board Projects**... \$5.00. 21 simple projects that can all be built on one circuit card. Use the same components in several projects.

**MULTI-CIRCUIT BOARD PROJECTS**... \$5.00. 21 simple projects that can all be built on one circuit card. Use the same components in several projects.

**International Transistor Equipment Guide**... \$7.50. Lists possible substitutes for a popular user-oriented selection of modern transistors. The products of more than 100 manufacturers are included.

**INTERNATIONAL TRANSISTOR EQUIVALENTS GUIDE**... \$7.50. Lists possible substitutes for a popular user-oriented selection of modern transistors. The products of more than 100 manufacturers are included.

**Electronic Simulated-Crystal Set Construction**... \$4.50. All of these receivers are designed around modern inexpensive components and hand-wound coils.

**ELECTRONIC SIMULATED-CRYSTAL SET CONSTRUCTION**... \$4.50. All of these receivers are designed around modern inexpensive components and hand-wound coils.

**Practical Electronic Building Blocks, Book 1**... \$5.75. Electronic circuits are all made up of individual building blocks. Make the blocks, then combine them to build the circuits you need.

**PRACTICAL ELECTRONIC BUILDING BLOCKS, Book 1**... \$5.75. Electronic circuits are all made up of individual building blocks. Make the blocks, then combine them to build the circuits you need.

**Practical Electronic Building Blocks, Book 2**... \$5.75. Follow up to Volume 1 presents more building blocks for the experimenter.

**PRACTICAL ELECTRONIC BUILDING BLOCKS, Book 2**... \$5.75. Follow up to Volume 1 presents more building blocks for the experimenter.

**The Pre-computer Book**... \$5.00. Aimed at the beginner with no knowledge of computing. An entirely non-technical discussion.

**THE PRE-COMPUTER BOOK**... \$5.00. Aimed at the beginner with no knowledge of computing. An entirely non-technical discussion.

**How to Make Your Own PCBs**... \$5.75. Fascinating projects for any science fair. Includes any science fair. Includes any science fair.

**HOW TO MAKE YOUR OWN PCBs**... \$5.75. Fascinating projects for any science fair. Includes any science fair. Includes any science fair.

ELECTRONIC TECHNOLOGY TODAY INC.  
P.O. Box 240, Massapequa Park, NY 11762

1/84

Number of books ordered

Total Price of Books \_\_\_\_\_

Sales Tax (NY State Residents only) \_\_\_\_\_

Shipping and Handling (75¢ 1 or 2 books 30¢ each add'l book) \_\_\_\_\_

TOTAL ENCLOSED \_\_\_\_\_

Name \_\_\_\_\_

Address \_\_\_\_\_

City \_\_\_\_\_ State \_\_\_\_\_ Zip \_\_\_\_\_

PRICES GOOD UNTIL MARCH 31, 1984



## NEW PRODUCTS

continued from page 31

The model HP 7475A is priced at \$1895.00.

The smaller model HP 7470A plotter has many of the performance specifications and features of the model HP 7475A, but has pen-changing capability for only two pens. It is priced at \$1095.00.—**Hewlett-Packard**, 3000 Hanover Street, Palo Alto, CA 94304.

**LOGIC ANALYZER**, the *System 2100*, features a remote-control capability that allows the operation of an analyzer located at a field site using a logic analyzer located at the home office. All analyzer functions are available, including state and timing displays.



CIRCLE 116 ON FREE INFORMATION CARD

Messages may be sent by either analyzer to signal the operator, including "Pick up the phone."

Keyboard-to-keyboard remote control is a standard feature in these analyzers when the

RS-232 I/O port is installed. Prices start at \$8995.00 for the mainframe, including the stringy floppy; and 16-channel 100-MHz modules are priced at \$1995.00, including a 1-megohm 7.5-picofarad active probe with external clock capacity.—**Intech, Incorporated**, 282 Brokaw Road, Santa Clara, CA 95050. **R-E**

## AM STEREO

continued from page 102

pass over the entire AM band. The original detector circuit was also modified to smooth AGC response and control. (The detector circuit, although not used for stereo reception, generates AGC voltages and had to be kept intact.) That modification could have been skipped, but a noticeable improvement resulted in output from stations across the band with widely varied signal strengths.

Audio outputs were connected in parallel with the outputs from the FM multiplex system. The stereo indicator already in the receiver could be driven directly from the AM decoder lamp drive through a 470-ohm resistor. The result with this receiver was excellent AM stereo, although the lack of a front end RF amplifier made reception of some stations difficult.

### Final suggestions

In radios that are AC powered, it may be necessary to suppress noise caused by rectifier circuit diodes. If a sharp buzz is heard, it may be the result of these power-switching diodes. The problem can usually be corrected by installing a .05  $\mu$ F, 250-volt (minimum) ceramic disc capacitor across each diode in the power supply circuit.

Household devices such as lamp dimmers or remote-control units that operate lights and appliances can generate tremendous noise, which is distributed by the building's electrical wiring like a huge antenna. AM radios will pick up this noise and make listening very unpleasant if not altogether impossible. The manufacturers of these devices may be able to offer methods or reducing the problem. Otherwise, they will have to be turned off or disconnected when using the AM receiver.

Installation of an outdoor, long-wire antenna for the broadcast band may alleviate most of those interference problems. Another, perhaps more important benefit is that an outdoor antenna will provide a greater source of stereo signals to choose from.

In the near future, when many major, music-program AM stations have introduced C-QUAM stereo broadcast, you'll no longer be limited to hearing good stereo from local FM station whose range is limited roughly to line-of-sight. You'll be able to hear the AM stations from hundreds of miles away (as you can now, especially at night), but in full stereo! **R-E**

## Electronics Paperback Books Projects For Project Builders

CHECK OFF THE BOOKS YOU WANT

**FIRST BOOK OF HI-FI LOUDSPEAKER ENCLOSURES**...\$4.50. Build your own speaker enclosures—corner reflex, bass reflex, lotted horn, labyrinth and more.

**ESSENTIAL THEORY FOR THE ELECTRONICS HOBBYIST**...\$5.00. Provides the background knowledge needed by the hobbyist.

**50 SIMPLE LED CIRCUITS**...\$4.25. Interesting and useful applications for LEDs. An important book for any project builder.

**50 TESTED TRANSISTOR PROJECTS**...\$4.25. A variety of projects for beginner and pro alike. Try this one. You'll like it!

**52 PROJECTS USING THE 741**...\$4.00. If you have some 741's on hand, this book will show you what you can do with them.

**HOW TO MAKE WALKIE-TALKIES**...\$5.00. Everything from licensing to frequency bands to practical circuits to antennas.

**50 PROJECTS USING IC CA3130**

**HOW TO BUILD YOUR OWN METAL & TREASURE LOCATORS**...\$5.00. The Heterodyne metal locators described here might make you rich.

**IC 555 Projects**

**IC 555 PROJECTS**...\$5.00. Basic & general circuits; motor car model railroad circuits, alarms, noise-makers, plus a section on the 556, 558, 558.

**50 PROJECTS USING THE CA3130**...\$4.50. How to use this op-amp to make audio, r.f. test equipment and household oriented projects.

**50 CIRCUITS USING GERMANIUM, SILICON & ZENER DIODES**...\$3.75. On the wonderful world of diodes. Lots of applications for inexpensive devices.

**PROJECTS IN OPTOELECTRONICS**...\$5.00. Infra-red transmitters detectors, modulated-light transmission, photographic projects are just some examples.

**50 CMOS IC PROJECTS**

**50 PROJECTS USING RELAYS, SCRS & TRIACS**...\$5.00. Motor control, dimming and heating control, light modulators, alarms, delayed timing and more.

**RADIO CIRCUITS USING IC'S**

**RADIO CIRCUITS USING IC'S**...\$4.50. Integrated circuits and how they can be used in circuit for AM, FM and stereo decoder receivers.

**50 CMOS IC PROJECTS**...\$4.50. Build multivibrators, amplifiers, oscillators, trigger devices and special devices.

**50 (FET) Field Effect Transistor Projects**

**50 (FET) FIELD-EFFECT TRANSISTOR PROJECTS**...\$4.50. RF amplifiers, rf converters, test equipment, aids, tuners, receivers, mixers, etc.

**ELECTRONIC PROJECTS FOR BEGINNERS**...\$5.00. A variety of projects, many with component and wiring layouts. Some that require no soldering.

**HOW TO BUILD ADVANCED SHORT-WAVE RECEIVERS**...\$5.00. Quality receivers and accessories you can make yourself.

**BEGINNERS GUIDE TO BUILDING ELECTRONIC PROJECTS**...\$5.00. Component identification, tools, soldering, construction techniques.

ELECTRONIC TECHNOLOGY TODAY INC. 1/84  
P.O. Box 240, Massapequa Park, NY 11762

Number of books ordered

Total Price of Books \_\_\_\_\_

Sales Tax (NY State Residents only) \_\_\_\_\_

Shipping and Handling (75¢ 1 or 2 books 30¢ each addl. book) \_\_\_\_\_

TOTAL ENCLOSED \_\_\_\_\_

Name \_\_\_\_\_

Address \_\_\_\_\_

City \_\_\_\_\_ State \_\_\_\_\_ Zip \_\_\_\_\_

PRICES GOOD UNTIL MARCH 31, 1984



# MARKET CENTER

## BUSINESS OPPORTUNITIES

**WHOLESALE MATV/CATV/VCR** equipment, antennas, audio cables, adaptors, original/replacement cartridges & styli, telephone accessories, radios, cassette recorders, speakers, etc., send letterhead for free catalog (212) 897-0509 **D&WR**, 68-12 110th St., Flushing, NY 11375.

**MECHANICALLY** inclined individuals desiring ownership of small electronics manufacturing business—without investment. Write: **BUSINESSES**, 92-R, Brighton 11th, Brooklyn, NY 11235.

**VIDEO** game repair business. Start your own. Information/parts list \$5.00. **BEST ELECTRONICS**, 4440 Sheena, Phoenix, AZ 85032.

**E-Z** learn security alarm systems. Employment-business terrific. Information \$2.00 (redeemable) **SECURITY** PO Box 1456-H, Grand Rapids, MI 49501.

**PROJECTION TV...** Make \$\$\$s assembling projectors... Easy... Results comparable to 2,500 projectors... Your cost less than \$20.00... **Plans, lens, & dealers** information \$17.50... Illustrated information free... **MACROCOM-GEX**, Washington Crossing, PA 18977. Credit card orders 24 hours. (215) 736-2880.

**TECHNICAL** writers make big money... writing short sentences! Free details: **TEK PUBS**, Box 2458-E, Oroville, CA 95965.

**LCD** watches \$2.50. Penwatch \$2.00. Catalog \$1.00. **RELIANT ENGINEERING COMPANY**, Box 33610, Sheungwan, Hong Kong.

**ACT** now and get rich! Never before mail-order business secrets revealed! Booklet, \$11.99. **DARIS DISTRIBUTORS**, Suite 519, Anaheim, CA 92804.

**ATTENTION:** In-home assemblers needed. For more information and application, send \$5.00 to: **PERSONAL DEPT.**, 1618 Ozark Ave., Gastonia, NC 28054.

## EDUCATION & INSTRUCTION

**EARN** your university degree through evaluation assessment, of existing education, experience, achievements. Call, (614) 863-1791, or write, **ASSESSMENT**, Box 13130 R, Columbus, OH 43213.

**UNIVERSITY** degrees by mail! Bachelors, Masters, Ph.D's... Free revealing details. **COUNSELING**, Box 317-RE1, Tustin, CA 92680.

**VIC-20** make backup tape of game cartridge, tape program, complete instructions \$6.00. **SHERWIN** So. 11 Foxcroft Rd, N. Hartford, NY 13413.

**ATTENTION ELECTRONIC TECHNICIANS**



Highly Effective Home Study BSEE Degree Program for Experienced Electronic Technicians Our New Advanced Placement Program grants Credit for previous Schooling & Professional Experience. Advance Rapidly! Our 36th Year!

FREE DESCRIPTIVE LITERATURE!

**Cook's Institute of Electronics Engineering**  
DESK 15, P.O. BOX 20345, JACKSON, MS 39209

**FCC LOWERS REQUIREMENTS GET YOUR RADIO TELEPHONE LICENSE**

FCC changes make obtaining High-Level Radio Telephone License much easier now. Eliminate unnecessary study, with our short cuts and easy to follow study material. Obtaining the General Radio Telephone License can be a snap! Sample exams, also section covering Radar Endorsement. A small investment for a high-paying career in electronics. \$19.95 ppd. Spi-Ro Distributors, P.O. Box 1538, Dept. R, Hendersonville, N.C. 28793.

## REEL TO REEL TAPES

**AMPEX** professional series open reel tape, 1800-or 2400-feet on 7-inch reels, used once. Case of 40, \$45.00. 10½ x 3600 feet and cassettes available. Master Card/Visa. **VALTECH ELECTRONICS**, Box 6-RE, Richboro, PA 18954 (215) 322-4866.

## CB EQUIPMENT

**CB** radio books, kits, modifications, catalog \$1.00 refundable. **APS**, PO 263RE, Newport, RI 02840.

**PALOMAR/PRIDE** electronics — exclusive repair facility. Service—update—improvements on these and similar equipment. **PALOMAR PRIDE REPAIR**, 1320 Grand, San Marcos, CA 92069 (619) 744-0720.

## WANTED

**WANTED:** old Western Electric & RCA tubes, speakers, amplifiers. McIntosh, Marantz, tube amps. (713) 728-4343. **MAURY CORB**, 11122 Atwell, Houston, TX 77096.

**INVENTIONS**, ideas, new products wanted for presentation to industry and exhibition at national technology exposition. Call **1-800-528-6050**. Arizona 1-800-352-0458. X831.

**GOLDEN** Eagle Mark IV PLL board or information on where to send unit for repair. 817-553-3631. **MIKE SHEFFIELD**, 411 Pine, Frederick, OK 73542.

## RESUMES

**PROFESSIONALLY** prepared resume to fit your job search. Kit includes sample resume and three (3) cover letters. Send \$17.00 and brief description of your objective/position level in SASE: **RESUMES FOR PROFESSIONALS**, PO Box 279, Woodland Hills, CA 91365.

## SCANNERS

**SCANNERS**— discount prices Bearcat BC-100 \$279.99; Bearcat 210XL \$214.99; Bearcat 300 \$335.99; Regency MX3000 \$186.99; JIL SX100 \$138.99; JIL SX200 \$269.99; Bearcat 20/20 \$275.99; Spectrum radar detector \$214.99; plus \$3.00 shipping. Free discount catalog. Lowest prices anywhere on scanners, radar detectors, marine radios, two-way accessories. **SCANNER WORLD**, 10-RE New Scotland, Albany, NY 12208 (518) 436-9606.

To run your own classified ad, put one word on each of the lines below and send this form along with your check for \$2.15 per word (minimum 15 words) to:

**Radio-Electronics, 200 Park Avenue South, N.Y., N.Y. 10003**

### ORDER FORM

**PLEASE INDICATE** in which category of classified advertising you wish your ad to appear. For special headings, there is a surcharge of \$20.00.

( ) Plans/Kits ( ) Business Opportunities ( ) For Sale  
( ) Education/Instruction ( ) Wanted ( ) Satellite Television

**PLEASE PRINT EACH WORD SEPARATELY, IN BLOCK LETTERS.**

1	2	3	4	5
6	7	8	9	10
11	12	13	14	15
16	17	18	19	20
21	22	23	24	25
26	27	28	29	30
31	32	33	34	35

**PLEASE INCLUDE FOR OUR FILES YOUR PERMANENT ADDRESS AND PHONE NUMBER.**

**CLASSIFIED COMMERCIAL RATE** for firms or individuals offering commercial products or services) \$2.15 per word prepaid (no charge for zip code)...**MINIMUM 15 WORDS**. 5% discount for 6 issues, 10% for 12 issues within one year, if prepaid.

**NON-COMMERCIAL RATE** (for individuals who want to buy or sell a personal item) \$1.50 per word prepaid...no minimum.

**ONLY FIRST WORD AND NAME** set in bold caps. Additional bold face (not available as all caps) at 20¢ per word. All copy subject to publisher's approval. **ADVERTISEMENTS USING P.O. BOX ADDRESS WILL NOT BE ACCEPTED UNTIL ADVERTISER SUPPLIES PUBLISHER WITH PERMANENT ADDRESS AND PHONE NUMBER.** Copy to be in our hands on the 20th of the third month preceding the date of the issue (i.e., August issue closes May 20th). When normal closing date falls on Saturday, Sunday, or a holiday, issue closes on preceding working day.



## 0-35dB GAIN VARIABLE RF AMPLIFIER

Works with All RF Signals from 40-900 MHz



### EXCELLENT FOR:

- All Antenna Systems
- Voice Communications
- Video RF Line Amplifiers
- Frequency Counters
- MATV Systems
- CCTV Systems
- Oscilloscopes
- FM Broadcasts

Now you can use one TV/FM Antenna to cover all close and distant stations without experiencing overloading problems. Ideal for outdoor and indoor use. I/O impedance is 75 ohms. Power Supply is separate coax feed system which allows amplifier to be located anywhere in cable run. Power Supply has knob to control variable gain, LED power on indicator, built-in AB switch and on/off switch.

ALL-2VG Wired and Tested ..... **\$49.95**

Take advantage of our recently purchased manufacturing and patent rights to the ALL-2VG

## MODULATOR

### Not A Game Type Modulator

The MPS-1 Kit converts Video/Audio signals to a crystal controlled RF output for TV Channels 3 and 4.

The MPS-1 Modulator's 4 adjustable inputs are designed to match all TV Cameras and VCRs and features a voltage regulated power supply, power switch and LED indicator. No Tuning Required. Operates on 117VAC. MPS-1 Modulator Kit ..... **\$29.95**



Assembly Time  
Approx 5 Minutes

## VIDEO GUARD

5030 Paradise, Suite C-100, Las Vegas, NV 89119

Telephone: 702-739-9732/9733

MAIL ORDERS: Send check or money orders. Add 5% shipping and handling, minimum \$1.50. Write for more details free.

CIRCLE 9 ON FREE INFORMATION CARD

## CB MODIFICATIONS

Increase channels, range, privacy! We specialize in frequency expanders, speech processors, FM converters, PLL & slider tricks, how-to books, plans, kits. Expert mail-in repairs & conversions. 16-page catalog \$2.

CBC INTERNATIONAL, P.O. BOX 31500RE, PHOENIX, AZ 85046 (602) 996-8700

### FOR SALE

**CABLE TV SECRETS**—the outlaw publication the cable companies tried to ban. HBO, Movie Channel, Showtime, descramblers, converters, etc. Suppliers list included. Send \$8.95 to **CABLE FACTS**, Box 711-R, Pataskala, OH 43062.

**RESISTORS** 1/4 & 1/2 W 5% C.F. 3 cents. 1% M.F. All values. No minimums. Volume discounts. Write **JR INDUSTRIES**, 5834-B Swancreek, Toledo, OH 43614.

**COLOR** computer VIC-20 programs hardware Rty code EPROM Programmer RS-232 **FRANK LYMAN**, Box 3091, Nashua, NH 03061.

**SCANNER**/monitor accessories—kits and factory assembled. Free catalog. **CAPRI ELECTRONICS**, Route 1R, Canon, GA 30520.

**TI-99/4A** software. Free price list plus newsletter. **GLEN DOBBS**, Box 801 RE, Santa Maria, CA 93456.

**ALARM!** Vic 20/64 CoCo Sinclair become \$1000 burglar fire system. Cassette, documentation (specify microprocessor) \$29.00. Retailers inquire. Catalog. **SKIDMORE'S H'N'S**, 3926 Overland, Greensboro, NC 27403. Sinclair piano, music program, cassette all hardware \$9.00.

**DESCRAMBLERS** for downconverters. High gain. Free information. **RB ELECTRONICS**, PO Box 643, Kalamazoo, MI 49005.

**PARABOLIC** dishes 20" \$6.95 ea. 28" \$15.00 ea. includes bracket. Lots of 100 pcs. **VIKING PRECISION, INC.**, 4631 South 35th Place, Phoenix, AZ 85040 (602) 276-6218.

**PICTURE flyer** lists quality electronics surplus at low prices. Since 1970. Send for the last 3 issues. **STAR-TRONICS**, Box 683, McMinnville, OR 97128.

**LATEST** bug-detection equipment for home or office. Literature, \$1.00. **CLIFTON**, Box 220-X, Miami, FL 33168.

**SATELLITE**—microwave—cable—video equipment. Systems from \$75.00. Send SASE to **H.M.S.**, 2011w. 11th St., Upland, CA 91786.

**THE Intelligence Library**—Restricted technical information & books on **electronic surveillance, surveillance-device schematics, lock-picking, investigation, weapons, identification documents, covert sciences**, etc. The best selection available. Free brochures. **MENTOR**, (Dept. Z), 135-53 No. Blvd., Flushing, NY 11354.

**MILITARY** communications receiver: R-174, tunes 1.5-18 MHz, AM-CW-SSB, amateur, shortwave frequencies: \$47.50 mint, \$27.50 good. Canadian backpack radio PRC-510, 38-54 MHz FM transceiver with headset, battery box, antenna: \$39.50 apiece, \$77.50/pair. ARC-27 guard receiver, single channel UHF aircraft receiver: \$12.50 mint. Add \$5/unit shipping. 45 day replacement guarantee. **BAY-TRONICS**, Dept. RE, Box 591, Sandusky, OH 44870.

**TUBES**, new, unused. Send self-addressed, stamped envelope for list. **FALA ELECTRONICS**, Box 04134-2, Milwaukee, WI 53204.

**CABLE TV** equipment for "beeping" or "buzzing" channels. Information \$1.00. **GOLDCOAST**, PO Box 63/6025F, Margate, FL 33063 (305) 752-9202.

**GEARMOTORS** \$35.00 12VDC 60rpm 3 amp. 1/2 in. shaft. Drives robots, antenna, boat steering, gates, etc. Also racks, pinions, chain, gears, etc. **SEPAKS**, 625 NW 41st, Seattle, WA 98107.

**COLOR** computer owners—Free hardware and software catalog. **SPECTRUM PROJECTS**, 93-15 86 Drive, Woodhaven, NY 11421 (212) 441-2807.

**FORTY-nine educational electronics** kits with self-learning project manual. Details \$2.00 refundable with order. **TRIANGLE ELECTRONICS**, 89 Arkay Drive, Hauppauge, NY 11788.

**RF parts**/Motorola transistors. MRF454 \$16.50, MRF455 \$13.50. Catalog available. **RF PARTS CO.**, 1320 Grand, San Marcos, CA 92069. (619) 744-0720.

**UP** to \$500.00 per month. Sell computer software in your home. Write to: **COMPUTER SERVICES**, PO Box 7748, Tucson, AZ. 85725.

**SAVE** on guaranteed quality surplus. Free flyer. **ELECTRONIX LTD.**, 3214 South Norton, Sioux Falls, SD 57105.

**30 channel** wired remote CATV converter kits. Complete with everything \$39.95. **CABLE SALES**, 3868 Trade Ctr. Dr., Ann Arbor, MI 48104 C.O.D. or certified funds. Other cvtrs. available.

**U-FIX-M** Oak CATV converters M-26. Buy one get one free \$19.95. **CABLE SALES**, 3868 Trade Ctr. Dr., Ann Arbor, MI 48104 C.O.D. or certified funds. Other converters available.

**WIND** power an investment in the future. The right decision is essential. Information \$2.00. **WINDESIGN**, Box 138, Boston, NY 14025.

**PRINTED-circuit** boards: quotes free. SASE to **JAHMAAL ELECTRONIC SUPPORT**, PO Box 397, Troy, NY 12181.

**MUSICAL** Christmas/Birthday cards—Microprocessor plays music when opened. \$5.00 each or \$50.00 doz. **MIPS**, 6810-N Seagull, New Orleans, LA 70126.

**CAR** alarm stickers four for \$4.00 SASE **JEFF POSNER COMPANY**, PO Box 766, Lynbrook, NY 11563.

**RADIO** Television News—Service—TV—Tech—Electronic Servicing—Radio-Electronics—Popular Electronics—622 magazines 1953-1983 all for \$500.00. **ERNEST TRENT**, 331 N. Rosina Ave., Somerset, PA 15501.

WRITE FOR  
**McGEE'S**  
SPEAKER & ELECTRONICS CATALOG  
1001 BARGAINS IN SPEAKERS  
Tel.: 1 (816) 842 5092  
1901 MCGEE STREET KANSAS CITY, MO. 64108

# SCR

## Free Buyers Guide

INTERGRATED CIRCUITS			VOLTAGE REGULATORS		
PART NO	PRICE EACH	SCR 10-PAK	PART NO	PRICE EACH	SCR 10-PAK
380	99		7805	95	7.90
386.3	99	9.10	7808	75	6.90
505	1.29	10.50	7812	95	7.90
1889	2.15	19.80	7815	75	6.90
1330	1.60	14.50	7818	95	7.90
1350	1.47	12.50	7824	75	6.90
1358	1.25	10.00			
1458	.69	5.30			
1496	1.50	13.20			
			MV 2109	39	3.49

**POWER SUPPLY**  
5 VOLT 6 AMP  
IC Regulated  
● Filtered  
● Not used  
Surplus  
\$23.95

**COAX CABLE**  
VHF UHF  
● 75 OHM  
● Black Foam  
● Low Loss  
RG-59 100 4.00  
RG-59 SCR 10-Pak 38.00

**VIDEO RECORDING TAPE** VHS T-120  
Vision High Quality as low as \$6.99 ea.  
1-9 tapes \$7.88 ea  
SCR 10-PAK \$69.99

**5 1/4 DISKETTES**  
Soft Sector Single Sided  
DOUBLE DENSITY  
\$24.95  
Box of 10

**SPECIAL SPECIAL SPECIAL**  
GENUINE "MITSUMI" A 55F Varactor Tuner  
BUY FACTORY DIRECT THROUGH  
MODIFIED SCR AND GET CONSISTANT  
VERSION QUALITY CHANNELS 14-83  
For use in our kit 18.00EA \$16.88 EA  
SCR 10-PAK 165.00 SCR 10-PAK 145.00

SCR ELECTRONICS  
5303 Lincoln Ave.  
Cypress, CA 90630  
(714) 527-2554  
TOLL FREE - OUTSIDE CA  
1-800-854-8660

TERMS: VISA, M.C., CHECK, MONEY ORDER.  
Add \$3.50 S&H  
Calif. add 6% tax.  
—PHONE ORDERS WELCOME—

CIRCLE 25 ON FREE INFORMATION CARD

RADIO-ELECTRONICS

116

## HIGH QUALITY UP TO 55dB GAIN

# MICROWAVE TV SYSTEM

Varible from 1.9 to 2.5 GHz



The latest advance in microwave technology with a **SNOW-FREE PICTURE.**

Two Models to choose from.

Both Models Include:  
● 20" Parabolic Dish

- Pre-assembled Probe with Down Converter
- Power Supply and Coax Switch
- 60' of RG-59/U Coax with Connector
- Transformer for 75 to 300 Ohms
- All Mounting Hardware for Fast and Easy Installation

**20" Fiberglass Dish**  
Up to 55dB Gain  
Special **\$98.95\***

**20" Aluminum Dish**  
Up to 40dB Gain  
Low Priced **\$74.95\***

\*Includes Shipping and Handling

Available thru Mail and Phone Orders Only  
Send Cashiers Check or Money Order to:  
(Personal Checks, allow 2-5 weeks to clear)

**PROFESSIONAL VIDEO, Inc.**  
4670 Hollywood Blvd., Hollywood, Calif. 90027  
219-0227  
For C.O.D. Orders Call (213) 352-9681

CIRCLE 30 ON FREE INFORMATION CARD



# ADVANCED COMPUTER PRODUCTS

SEND \$2.00 for 1983 CATALOG

## 16K Apple™ Ramcard

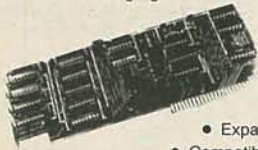

LIST 195  
ACP  
\$49<sup>95</sup>

- With 80 Columns
- Expand Apple II 48K to 64K
- Compatible with Z-80 Softcard™
- Top quality — gold fingers
- Full 1 year warranty

## 64K Apple IIe Ramcard

• Also with 80 Columns... only \$99<sup>95</sup>

## RAM UP-GRADES

64K D RAM (4164-200ns)

9 pcs for \$50<sup>00</sup>

16K D RAM (4116-200ns)

8 pcs for \$12<sup>95</sup>

## REPEAT OF SELL-OUT

58 Key Unencoded Keyboard



\$19<sup>95</sup> ea.

This is a new 58 key terminal keyboard manufactured by a major manufacturer. It is unencoded with SPST keys unattached to any PC board. Solid molded plastic base measures 11" x 4".

## Unencoded Key Pad

15 key keypad with 1-10 keys and tab, return, (.), (,) and (,). Only \$9<sup>95</sup> ea.

## UV "EPROM" ERASER



Model DE-4

\$89<sup>95</sup>

Holds 4 EPROM's at a time.

Model S-52T \$325.00

## 32K S-100 Static RAM Kit



4 MHz

Uses 2114L

ACP Price \$129<sup>00</sup>

## CORCOM FILTER

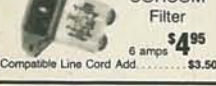

Popular CORCOM Filter

6 amps \$4<sup>95</sup>

Compatible Line Cord Add. .... \$3.50

## AMD MODEM IC

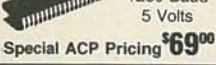

P/N AM7910

1200 Baud

5 Volts

Special ACP Pricing \$69<sup>90</sup>

## COEX 80-FT DOT MATRIX PRINTER

- 8x7 Dot Matrix, 80 CPS, Bi-Directional Printing
- 2K Buffered Memory
- 80, 96, 132 Columns, Graphics and Block Printing
- Selectable Char Pitch, Line Spacing and Feed



\$199<sup>00</sup>

PARALLEL COEX Interface Card to Apple... \$49.95  
Commodore Interface Card to VIC, 64, PET... \$79.95

## MICROPROCESSORS

Z8001	\$44.95	8008-1	\$14.95	8800P	\$7.05
Z8002	\$1.95	8008-2	6.95	8035	5.95
Z80	3.95	2801A	8.95	8039	6.95
Z80A	4.95	9900A	49.95	9073N	34.95
F-8 (8080)	16.95	8502	4.95	8502	39.95
2650	16.95	8502A	6.95	8748	39.95
1802	9.75	886100	29.95	8809	14.95
8080A	5.95	8800	10.95	8809E	19.95
8085	5.95	8800E	10.95	8800E	49.95

## RAMS

6116-2016	\$7.95	2147	\$4.95	5290	\$1.99
8254-54K	5.95	411	5.99	5298	4.99
4116-2	1.99	414	4.69	6508	4.50
4116-2	8.12	95	11.01	6518	6.79
2101	1.90	1103	9.99	6651	3.79
2102	7.90	4027	4.69	6664	3.99
21102-2	1.49	4044	3.99	6905	7.99
21102-4	4.95	4050	4.69	9130	5.99
2111	2.45	4060	4.69	9140	8.99
2112	2.75	4096	3.99	93415	6.99
2114	1.49	4115	1.49	93425	6.99
2114-L-2	2.29	4200	7.95	5101	3.75
2114-L-1	1.99	4402	1.99	26132	24.95
2125	6.99	5280	4.60		

## SUPPORT

8155	\$7.95	8282	\$9.95	6875	\$5.75
8156	9.95	8283	9.95	6880	2.10
8202	24.95	8284	9.95	68047	22.95
8205	2.69	8286	9.95	68488	19.95
8212	2.10	8287	9.95	48505	14.95
8214	4.95	8288	23.00	48974	4.95
8216	1.75	8289	49.00	6522	7.95
8224	2.20	6810	2.95	6530-X	20.50
8226	2.95	6820	4.50	6532	9.95
8228	3.95	6821	4.50	6551	11.75
8243	5.95	6828	10.50	280-PID	4.95
8250	14.95	6828	10.50	280A-PIO	4.95
8251	4.25	6845	14.95	280-CTC	4.40
8253	6.50	6847	14.95	280A-CYC	5.50
8255	4.50	6850	4.50	280-DMA	11.95
8257	7.50	6852	4.50	280A-DMA	16.95
8259	6.95	6860	10.95	280-SIO	14.95
8275	29.95	6862	10.95	280A-SIO	16.95
8279	8.50				

## MOS PROMS

2764 (8Kx8) TS	\$9.95	2708 (450nS)	\$3.95
2732 (4Kx8) TS	6.95	68764 (8x8)	39.95
2532 (4Kx8)	8.95	27128 (16Kx8)	19.95
2716-2516: 5V (2Kx8) TS	4.95	1702A	4.50
TMS2716: 5V, 12V	17.95	MM5203AQ	14.50
2758: 5V, (450nS)	3.50	MM5204Q	9.95

## HI-TECH

2513-001 (5V) Upper	\$9.50	DA208	\$9.95
2513-005 (5V) Lower	10.95	DA210	9.95
2513-ADMS (5V) Lower	14.95	8038 Function Generator	4.50
MC68010 ASCII Buffer	12.95	MC6804 VCO	2.99
MC68040 Math Symbol	13.95	MM6260 Function Generator	1.95
MC68050 Alpha Control	13.45	XR2206 VCO	5.25
1771-01 8" & MiniFloppy	24.95	TR1602S (5V, 12V)	3.95
1781 Dual Floppy	29.95	A951013 (5V, 12V)	4.95
1791-01 Dual Floppy	36.95	A951014A/1612 (5-14V)	6.95
1791-02 Dual Floppy	44.95	A951015A/1683 (5V)	7.95
1793-02 DS Floppy	44.95	IM6402	7.95
1797-02 DS Floppy	54.95	IM6403	9.95
1891 Data Separator	18.95	2350 USRT	8.95
2143 Clock Generator	18.95	16718 Astras	24.95
8703 8 bit Binary	22.00	A95300	11.95
8703 10 bit Binary	22.00	4702	14.95
8703 8 bit TS	13.50	WD1941	9.95
9400 Watt to Freq Conv.	7.25	COM5016	16.95
8750 3 1/2 Digit LCD	13.95	INS8250	15.95
1408L 6 bit	3.95	A952378	13.75
1408B 8 bit	3.95	A953000	13.75
DAC01 D to A	5.95	MM57ADAC	8.95

## SOCKETS

### LOW PROFILE SOCKETS (TIN)

1-24	24-49	50-100
8 pin LP	16	15
14 pin LP	20	19
16 pin LP	22	21
18 pin LP	29	28
20 pin LP	34	32
22 pin LP	29	27
24 pin LP	38	37
28 pin LP	44	43
40 pin LP	60	59
8 pin WW	55	54
10 pin WW (Tin)	65	63
14 pin WW	75	73
16 pin WW	80	77
18 pin WW	95	90
20 pin WW	115	108
22 pin WW	145	135
24 pin WW	135	126
28 pin WW	160	153
40 pin WW	220	209

### 3L WIREWRAP SOCKETS (GOLD)

1-24	25-49	50-100
8 pin WW	55	54
10 pin WW (Tin)	65	63
14 pin WW	75	73
16 pin WW	80	77
18 pin WW	95	90
20 pin WW	115	108
22 pin WW	145	135
24 pin WW	135	126
28 pin WW	160	153
40 pin WW	220	209

## OKI MSM5832RS

MP Compatible Clock/Calendar/Chp \$4.95 100/\$3.95  
32,768Hz Crystal... \$4.95

## LINEAR

78H05K	\$5.95	LM1414N	\$1.90
78M06	1.49	LM1458CN/N	4.9
78M G	1.49	MC1488N	9.9
LM1488H	2.95	MC1489N	9.9
LM300H	.99	LM1496M	8.9
LM301CN	.35	LM1556N	1.50
LM304H	1.98	LM1820N	.95
LM305H	1.89	LM1850N	.95
LM306H	3.25	LM1889N	3.10
LM307CN	.29	LM1111N	1.75
LM308CN	.98	LM2900N	.99
LM309K	1.49	LM2901N	2.50
LM310CN	1.25	LM2917N	2.95
LM311D/CT	.89	CA3013T	2.19
LM312N	1.75	CA3018T	1.99
LM317	1.70	CA3021T	3.49
LM318CN	1.49	CA3023T	2.99
LM319H	1.25	CA3035T	2.75
LM320K-XX*	1.35	CA3039T	1.29
LM320T-XX*	1.29	CA3046N	1.29
LM320H-XX*	1.25	LM3052N	1.95
LM323K	4.95	CA3059N	3.19
LM324N	.95	CA3060N	3.19
LM337K	5.95	CA3062N	4.95
LM338K	6.95	LM3065N	1.49
LM339K	.95	CA3080T	1.29
LM340K-XX*	1.75	CA3081N	1.69
LM340T-XX*	1.25	CA3082N	1.69
LM340H-XX*	1.25	CA3083N	1.55
LM344H	1.95	CA3089N	.80
LM345H	1.75	CA3089N	2.99
LM350K	5.60	CA3096N	3.49
LM358CN	.98	CA3097N	1.99
LM360N	1.49	CA3130T	1.30
LM372N	1.95	CA3140T	1.19
LM378N	3.75	CA3146N	2.49
LM379N	2.75	CA3180T	1.19
LM380CN/N	1.25	CA3190N	1.95
LM381N	1.79	CA3410N	.59
LM383T	1.95	MC3423N	1.49
LM389N	1.25	MC3460N	3.95
LM397N	1.40	SG3524N	3.95
LM399N	1.95	CA3600N	3.39
NE531V/T	3.75	LM3900N	.59
NE555V	.39	LM3905N	1.19
NE556N	.98	LM3909N	.98
NE561T	19.95	LM3914N	3.75
NE568H	1.25	LM3915N	3.95
NE568V/H	1.75	LM3916N	3.75
NE567V/H	1.50	RC4131N	2.95
NE592N	2.75	RC4136N	1.10
LM702H	1.99	RC4151N	3.70
LM709H/H	.29	RC4194TK	4.95
LM710N/H	.75	RC4195TK	5.40
LM711H/N	.39	ULN2001	1.25
LM715N	1.95	ULN2003	1.50
LM723N/H	.65	SN75450N	.59
LM733N/H	.98	SN75451N	.35
LM739N	1.15	SN75452N	.49
LM741CN/H	.33	SN75453N	.49
LM741CN-14	.19	SN75454N	.49
LM747N/H	.75	SN75491N	.89
LM748N/H	.39	SN75492N	.89
LM760CN	2.95	SN75492N	.89
LM1310N	1.90	SN75494N	.89
MC1330	1.95	TL494CN	4.20
MC1350	1.95	TL496CP	1.65
MC1358	1.75		

## 74S00

74S00	\$3.99	74S124	\$3.69	74S244	\$2.99
74S02	.43	74S133	.54	74S251	1.35



## PLANS & KITS

**PRINTED-circuit boards.** Quick prototypes, production, design, reflow solder send print or description for quote to **KIT CIRCUITS**, Box 235, Clawson, MI 48017.

**CABLE TV** converters and equipment. Plans and parts. Build or buy. For information send \$2.00. **C & D ELECTRONICS**, PO Box 21, Jenison, MI 49428.

**UP-TO-DATE** electronics kits. Unbelievable high quality. Amazing low price. Free catalog. **INTERNATIONAL POLYTECHNIQUES**, PO Box 862, New York, NY 10002.

**HI-FI** speaker kits, auto speaker systems, and raw drivers from the world's finest manufacturers. For beginners and experts. Free literature. **A&S SPEAKERS**, Box 7462R, Denver, CO 80207 (303) 399-8609.

**LIGHT chaser/color organ** kits, rack mount units. 20% off sale. **DESIGN SPECIALTY**, PO Box 1995, Huntington Beach, CA 92647.

**MICROWAVE television "downconverters"**. Exclusive new five stage design. Easily assembled. Catalog: \$2.00 (refundable). **NDS**, Box 12652-R, Dallas, TX 75225.

## FREE KIT Catalog

FUNCTION GENERATOR KIT \$59.95  
Auto-Ranging Cap-meter kit \$79.95

Phone 209-772-2076

Write or Phone for FREE CATALOG

**DAGE SCIENTIFIC INSTRUMENTS**  
BOX 144 VALLEY SPRINGS CA 95252

contains  
**TEST &  
EXPERI-  
METER'S  
EQUIP.**

**ULTRASONICS**— complete kit builds attractive detector and solid state switch. Control AC lights, other appliances. Turns lights on when room is entered, off when room is empty. Use alone or as part of a security system. Complete kit \$49.50. Finished unit \$74.50. Mail check for prepaid immediate shipment. **ADVANCED ENERGY TECHNOLOGIES, INC.**, 30 Brower Ave., Oaks, PA 19456. Visa & Master Card accepted.

**REPLACE NE 564** (UHF sine wave boards) deluxe I, II rev.B by IC. and parts available everywhere. Guarantee works great, modification, plans, circuit, chokes, \$25.50. Money orders only. **ADVANCE ELECTRONICS**, Box 3298, Culver City, CA 90230.

**ELECTRONIC** touch light control pad. Write for free brochure **EXOTIC ELECTRONIC IDEAS**, PO Box 446, Lake Bluff, IL 60044.

**CABLE TV** converters, descramblers, plans, parts. For catalog send \$2.00. **CROWN ELECTRONICS**, PO Box 352, Milton, FL 32570.

**PROJECTION TV...** Convert your TV to project 7-foot picture. Results comparable to \$2,500.00 projector... Total cost less than \$30.00... Plans & lens \$19.95... Illustrated information free... **MAC-ROMA-GE**, Washington Crossing, PA 18977. Credit card order 24 hours. (215) 736-3979.

**200** electronics kits, projects, plans. Send stamp for list. **MATCO ELECTRONICS**, Box 316R, Cadillac, MI 49601.

**HOBBYISTS...** simplify digital circuit design using EPROM. How to guidebook also includes nine projects you can build. \$15.00 to **TECHNILOGIK**, PO Box 45, Essex, VT 05451.

**DIGITAL oscilloscope...** Build for less than \$150.00! Complete schematics \$5.00. **MIKE MCGLINCHY**, 1878 Newell Ave., Walnut Creek, CA 94595.

**MOST advanced sine converter descrambler** available. PCB and plans \$15.00. **JIM RHODES**, 1025 Ransome Ln., Kingsport, TN 37660.

**ELECTRONIC** lock— versatile, combination entered by two buttons. CMOS— perfect for vehicular use. Plans \$3.00, plans and PCB \$25.00, complete kit \$55.00, assembled and tested \$95.00. Free flyer. **RHB ELECTRONICS**, Box 57, Northboro, MA 01532.

**TIMEX/SINCLAIR VIC-20** bible pack. Design/build any peripheral imaginable. Includes cassettes. \$39.95, info \$6.00 refundable. **JORGE SAMPSON**, Box 38663, Houston, TX 77288.

**CONVERT** your TV to an oscilloscope. A simple, fun plan. \$6.00 to **L.S.E.**, Box 8402, Madison, WI 53708.

**MAILING** list for sale. All 123,500 subscribers names and addresses to UHF Channels 60, 65, 67, and 68 W.H.T. gated syn-suppressed N.Y. and Phila. area. Never sold before, \$45.00/M. Also fully computer assembled and tested units \$49.00 ea. Write to **SEYMOUR ADVERTISING**, 9857 Tecumseh Rd. East, Windsor, Ontario, Canada N8R-1A5. (519) 735-8122.

**PLANS**— electronic VM calibration kit. Instructions, parts list, diagram. Send \$3.00 to **MORRIS ENTERPRISES**, Box 367, Converse, TX 78109.

**AUTOMATIC fine tuning (AFT)** for UHF/VHF converter board Deluxe I, II— never again readjust fine tuning, state of the art design, plans, circuit, parts list \$15.00. Deluxe I, II get clear picture as normal commercial TV channel, improve sound adjustment, stop vertical jitter \$11.00. **ADVANCE ELECTRONICS**, PO Box 3298, Culver City, CA 90230.

## World's Most Remarkable Radar Jammer!



Causes speed radar guns and devices to read out your choice of either a percentage of your true speed when in automatic mode (example: Your speed: 75 mph, auto mode set for 75%, speed displayed — 57 mph), or the speed that you dial in when in manual mode. Transmits only in the presence of speed radar, or by manual override. Operates on both X and K bands. WARNING: The device described in this literature is not legal for use against police radar, and is not FCC approved.

For complete literature and plan package, send \$14.95 to:

**Phillips Instrument Design Co. Inc.**  
8135 S.W. Nimbus, Building #11, Suite #114 S  
Beaverton, Oregon 97005

## SATELLITE TELEVISION

**SATELLITE TV** receiver breakthrough! Build your own commercial quality receiver now! In-

## CABLE TV

EQUIPMENT

Complete with Descrambler  
60 Channel Wireless  
Remote Control

Jerrold Oak, Hamlin  
Become a Cable TV Giant in  
your Town and Get in on The  
Big Profits

Send or Call for Information on  
our Dealer Catalog and Special  
Pricing, Territories.



Satellite TV  
Earth Station  
Installed

\$2,895<sup>00</sup>

Long Island Wholesale  
37 Sherwood St.,  
Greenwich, CT 06830  
For Cable Info Call  
203-869-2091

The Use of Some Cable TV Equip-  
ment is Illegal. Check With Your  
Own Local Cable Co. Before  
Ordering. We Except No Liability  
for your Misuse.

## VIDEO

EQUIPMENT



• 8 Event / 14 Day  
Programmability  
• Hi-Speed Search  
in Forward and Reverse

• 10 Function Remote Control  
• Electronic Tuning  
• 4 Video Heads  
• 2-4-6 Hour Play Back

V.C.R. - VHS \$569<sup>00</sup>

## AUTO EQUIPMENT

Page Alert 4000

A Vehicle Theft Warning  
System By Radio Signal to Your  
Personal Pocket Receiver.  
1 Mile Range.

\$69<sup>00</sup>

Car Stereo and Home Stereo  
By Audio Vox, Jensen, Pioneer  
Claron, Akai  
Send For Wholesale Dealer Catalog

Radar  
Detector



Fox  
Fuzz Buster  
Bell \$69<sup>00</sup>  
And Up

## CORDLESS PHONE

700  
Deluxe  
Range  
By Midland

Basic Model

Tele-Ranger

Wireless Telephone  
Range Extender,  
Complete

\$89<sup>00</sup>

\$79<sup>00</sup>

\$49<sup>00</sup>

Audio Whizz

Is Like Having Your Own  
Radio Station It Transmits  
Your Music Anywhere

In Your Home or Yard  
(Wireless Theater Sound)

Long Island Public Wholesale  
270 Islip Ave.,  
Islip, NY 11751  
516-581-7232  
516-277-4232



struction manuals, schematics, circuit boards!  
Send stamped envelope: XANDI, Box 25647,  
Dept. 21T, Tempe, AZ 85282.

LNA'S 120 degree \$269.00. Write for lowest satellite  
component prices. SATVISION, Box 11, Alvin, IL  
61811.

LOWEST Prices—Prodelin (Ma-Com) DH dishes,  
KLM, Satellite America, and more. Wholesale  
prices. AMERITEK SYSTEMS, 3650 James St.,  
Syracuse, NY 13206 (315) 433-6050.



## SATELLITE TV MAGAZINE

A monthly of 100-plus pages.

Product Information — Test Reports  
Antenna Installation — Legal Aspects

Satellite Television —  
the growth industry of the '80's.

Send \$1.00 for sample copy to

SATELLITE TV MAGAZINE

P.O. Box 2384 - Dept. R - Shelby, NC 28150

## SATELLITE TV VIEWERS

Get the most complete weekly listings.  
Send \$1 for sample copy.



P.O. Box 308, Fortuna, California 95540  
800-358-9997 (U.S.) • 800-556-8787 (Calif.)  
707-725-2476 (all others)

## SYNTHESIZERS

COMPLETE plans for five professional music syn-  
thesizers—bass, monophonic, duophonic, duo-  
phonic four voice, and polyphonic. Send \$15.00 to  
SYNTRON, 1075 1/2 Mill Road, Helena, MT 59601.

## ROBOTICS BOOKS

ROBOTICS books—design, theory, construction.  
Send \$1.00 for catalog. KOHN, RE1, Box 16265,  
Alexandria, VA 22302.

## NEWSLETTERS

FREE! Sample issue of **Electronic Systems  
Newsletter**, a monthly publication written especially  
for the electronics hobbyist/experimenter. Fascinat-  
ing projects, new ideas and sources. **AF PUBLISH-  
ING**, Dept. R, PO Box 524, So. Hadley, MA 01075.

## SUPERIOR UHF PREAMP KIT

MOST advanced UHF preamp kit ever to be offered!  
Unit will drastically improve picture quality of all  
UHF-TV stations and even find stations you never  
thought existed. Great for generating that extra gain  
decoders need for maximum stability. Kit includes  
all parts, power supply, enclosure and instructions  
for only \$29.95. Free postage/handling for prepaid  
orders, COD's \$1.75, catalog \$2.00. **HOWARD RE-  
SEARCH AND DESIGN**, PO Box 204, Ellicott City,  
MD 21043. (301)-456-8166.

## REVERBERATION FOR ORGANS

Solid state with controls for rever-  
beration and room size.

**EVERY ORGAN SHOULD  
OWN ONE.**

Send for free flyer—  
DEVTRONIX ORGANS, INC.  
6101 WAREHOUSE WAY  
SACRAMENTO, CALIFORNIA 95826 Dept. B

## COMPUTERS

48K computer US \$380.00, and hundreds Apple  
compatible software. Details US \$1.00. **RELIANT**,  
PO Box 33610, Sheungwan, Hongkong.

CPU'S & SUPPORT CHIPS	8251	4.50	
	8253	5.95	
	8279-5	6.95	
	8255-5	6.95	
8035	4.95	8257 (AM9617)	7.95
8039	6.95	8259	5.95
8080A	2.75	8238	25.00
8086A	7.50	8365	12.95
8086	22.50	8502	5.75
AMD 2901	8.95	2804 CPU	14.95
8202	19.95	2808 CPU	12.95
8212	1.80	2804 S10	10.95
8214	3.80	2804 P10	4.95
8216	1.75	2804 CTC	6.75
8224	2.25	TMS 9927 NL	9.95
8226	1.80	8903L	12.95
8228	3.50	8909	13.95
8155	6.00	8908	6.95
8156	8.95	8810	2.50
8237	14.00	8821	2.95
8238	3.95	8850	2.95
8755	19.95	8875	4.80
8250	10.95	8800LX	39.50

INTERFACE & DRIVERS	1488	1.50
	1489 <td>1.50</td>	1.50
	1490 <td>2.50</td>	2.50
	1491 <td>2.50</td>	2.50
	1492	2.50
	1493	2.50
	1494	2.50
	1495	2.00
	1496	2.00
	1497	2.00
	1498	2.00
	1499	2.00
	1500	2.00
	1501	2.00
	1502	2.00
	1503	2.00
	1504	2.00
	1505	2.00
	1506	2.00
	1507	2.00
	1508	2.00
	1509	2.00
	1510	2.00
	1511	2.00
	1512	2.00
	1513	2.00
	1514	2.00
	1515	2.00
	1516	2.00
	1517	2.00
	1518	2.00
	1519	2.00
	1520	2.00
	1521	2.00
	1522	2.00
	1523	2.00
	1524	2.00
	1525	2.00
	1526	2.00
	1527	2.00
	1528	2.00
	1529	2.00
	1530	2.00
	1531	2.00
	1532	2.00
	1533	2.00
	1534	2.00
	1535	2.00
	1536	2.00
	1537	2.00
	1538	2.00
	1539	2.00
	1540	2.00
	1541	2.00
	1542	2.00
	1543	2.00
	1544	2.00
	1545	2.00
	1546	2.00
	1547	2.00
	1548	2.00
	1549	2.00
	1550	2.00
	1551	2.00
	1552	2.00
	1553	2.00
	1554	2.00
	1555	2.00
	1556	2.00
	1557	2.00
	1558	2.00
	1559	2.00
	1560	2.00
	1561	2.00
	1562	2.00
	1563	2.00
	1564	2.00
	1565	2.00
	1566	2.00
	1567	2.00
	1568	2.00
	1569	2.00
	1570	2.00
	1571	2.00
	1572	2.00
	1573	2.00
	1574	2.00
	1575	2.00
	1576	2.00
	1577	2.00
	1578	2.00
	1579	2.00
	1580	2.00
	1581	2.00
	1582	2.00
	1583	2.00
	1584	2.00
	1585	2.00
	1586	2.00
	1587	2.00
	1588	2.00
	1589	2.00
	1590	2.00
	1591	2.00
	1592	2.00
	1593	2.00
	1594	2.00
	1595	2.00
	1596	2.00
	1597	2.00
	1598	2.00
	1599	2.00
	1600	2.00

DISC CONTROLLERS	1771	16.50
	1791 <td>25.00</td>	25.00
	1793 <td>35.00</td>	35.00
	1795 <td>45.00</td>	45.00
	1797 <td>45.00</td>	45.00
	D765C	16.95

SHIFT REGISTERS	2101A-4	1.50
	2110A-3 <td>1.50</td>	1.50
	2111A <td>1.95</td>	1.95
	2114-2 <td>1.40</td>	1.40
	2147-3 <td>2.50</td>	2.50
	TMS3409	1.75
	MK4027-3	1.75
	TMS4028L	2.95
	MK4096-1	1.25
	MK4902	5.95
	4108-3	1.50
	4116-15	1.50
	4118-4	5.50
	5101E	2.95
	25104A	2.50
	6118-3	6.75
	4164-15	6.95
	3242	6.00
	8118-12	6.95

RAM'S	2101A-4	1.50
	2110A-3 <td>1.50</td>	1.50
	2111A <td>1.95</td>	1.95
	2114-2 <td>1.40</td>	1.40
	2147-3 <td>2.50</td>	2.50
	TMS3409	1.75
	MK4027-3	1.75
	TMS4028L	2.95
	MK4096-1	1.25
	MK4902	5.95
	4108-3	1.50
	4116-15	1.50
	4118-4	5.50
	5101E	2.95
	25104A	2.50
	6118-3	6.75
	4164-15	6.95
	3242	6.00
	8118-12	6.95

WIRE WRAP WIRE STRAND	100'	\$1.40
	CRYSTALS	
	2,000	6.144
	3,000	8.000
	3,579	10.000
	4,000	18.000
	5,000	18.432
	6,000	20.000
	3.50 ea.	

LINEAR CIRCUITS	DAQ08EQ	3.75
	LM377 <td>1.60</td>	1.60
	LM1310 <td>1.60</td>	1.60
	LM300 <td>1.20</td>	1.20
	LM386 <td>1.60</td>	1.60
	LM388 <td>1.20</td>	1.20
	LM389 <td>1.20</td>	1.20
	LM398A <td>3.50</td>	3.50
	LM393 <td>1.50</td>	1.50
	LM393A <td>1.50</td>	1.50
	LM398 <td>1.50</td>	1.50
	LM398A <td>1.50</td>	1.50
	LM398B <td>1.50</td>	1.50
	LM398C <td>1.50</td>	1.50
	LM398D <td>1.50</td>	1.50
	LM398E <td>1.50</td>	1.50
	LM398F <td>1.50</td>	1.50
	LM398G <td>1.50</td>	1.50
	LM398H <td>1.50</td>	1.50
	LM398I <td>1.50</td>	1.50
	LM398J <td>1.50</td>	1.50
	LM398K <td>1.50</td>	1.50
	LM398L <td>1.50</td>	1.50
	LM398M <td>1.50</td>	1.50
	LM398N <td>1.50</td>	1.50
	LM398O <td>1.50</td>	1.50
	LM398P <td>1.50</td>	1.50
	LM398Q <td>1.50</td>	1.50
	LM398R <td>1.50</td>	1.50
	LM398S <td>1.50</td>	1.50
	LM398T <td>1.50</td>	1.50
	LM398U <td>1.50</td>	1.50
	LM398V <td>1.50</td>	1.50
	LM398W <td>1.50</td>	1.50
	LM398X <td>1.50</td>	1.50
	LM398Y <td>1.50</td>	1.50
	LM398Z <td>1.50</td>	1.50

TOGGLE SWITCHES	106D	SPDT	1.00
	206D <td>DPDT <td>1.40</td> </td>	DPDT <td>1.40</td>	1.40
	206P <td>DPDT <td>CENTER OFF 1.80</td> </td>	DPDT <td>CENTER OFF 1.80</td>	CENTER OFF 1.80
	IN4148 (IN914)		15/1.00
	L1411-IR DETECTOR		3/1.00
	FP 100 PHOTO TRANS.		8/1.00
	RED LED'S 2"		8/1.00
	YEL, GREEN or AMBER LARGE LED'S 2"		6/1.00
	RED-GREEN BIPOLAR LED		8/1.00
	RED-YELLOW BIPOLAR LED		8/1.00
	MLED92 IR LED		8/1.00
	MPD148 PHOTO DIARL XTOR		8/1.00
	MCT2 OPTO ISOLATORS		8/1.00
	4N26 OPTO ISOLATOR		8/1.00
	1 WATT ZENERS: 3.3, 4.7, 5.1, 5.6, 6.8, 8.2, 9.1, 10, 12, 15, 18, or 22V		6/1.00

FLAT RIBBON CABLE	28 gauge	26 conductor	.60/ft
	40 conductor <td>.90/ft</td> <td></td>	.90/ft	
	50 conductor <td>1.25</td> <td></td>	1.25	
	WIRE WRAP SOCKETS <td></td> <td></td>		
	14 PIN	45-	
	16 PIN	50-	
	18 PIN	65	
	20 PIN	90	
	24 PIN	110	
	28 PIN	125	
	40 PIN	180	

DIP SWITCHES	CTS 206-4	4 POSITION	75
	CTS 206-7 <td>7 POSITION <td>95</td> </td>	7 POSITION <td>95</td>	95
	CTS 206-8 <td>8 POSITION <td>95</td> </td>	8 POSITION <td>95</td>	95
	CTS 206-10 <td>10 POSITION <td>125</td> </td>	10 POSITION <td>125</td>	125
	DIP SOCKETS <td></td> <td></td>		
	20 PIN	25	
	8 PIN	10	22 PIN 25
	14 PIN	15	24 PIN 25
	16 PIN	18	28 PIN 35
	18 PIN	20	40 PIN 40
	20KV DIODES		
	250 ma.		\$1.95
	DB CONNECTORS		
	DB9P	42.00	DB25P 42.40
	DB9S	3.00	DB25S 3.20
	HOODS-	1.10	HOODS- 1.10

POSTAGE RATES	ADD 10%	FOR ORDERS UNDER \$25.00
	ADD 5% <td>FOR ORDERS BETWEEN \$25.00 &amp; \$50.00</td>	FOR ORDERS BETWEEN \$25.00 & \$50.00
	ADD 3% <td>FOR ORDERS ABOVE \$50.00</td>	FOR ORDERS ABOVE \$50.00

SCR's	1.5A	6A	35A	
	100	.35	.40	1.40
	200	.40	.50	1.80
	400	.60	.70	2.40



# SKYFOX

State-of-the-Art Excellence

SKYFOX DESIGN PERFORMANCE FEATURES:

- Gain 55 db • Frequency 1.9-2.5 GHz
- Range 55 miles maximum • Tuning channels 2-6
- 20 inch Parabolic dish antenna • 60 ft. cable
- Cable adapters, mounting brackets and hardware included
- Illustrated instructions

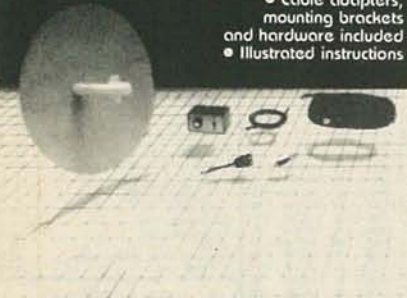

Receive movies, special presentations and educational broadcasts—ALL FREE—with the SKYFOX deep fringe microwave receiver for homeowners outside the service area of microwave TV stations. SKYFOX receives up to a distance of 55 miles. From microwave transmitters located on buildings or towers in almost all medium and large size cities. SKYFOX does not receive Cable TV or satellite transmissions.

SKYFOX I \$ 79.95 (not pictured, 25 mile line of site)  
SKYFOX II \$109.95 (as shown, 55 mile line of site)

ORDERS ONLY: Toll Free 1-800-323/1327

For Information Call: 1-312/564-0104

Visa, Mastercharge accepted. COD, cash or Money Order only. When ordering by mail, Money Orders or Cashiers Checks only. Personal checks, wait 4 weeks for check clearance.

90 day warranty • Conditional money back guarantee

**S.E.I. Inc.**

657 Academy Drive  
Northbrook, Illinois 60062

Available by  
Mail Order Only

CIRCLE 64 ON FREE INFORMATION CARD

## CABLE-TV EQUIPMENT

DESCRAMBLERS for cable TV model TX-200, amazing price, only \$79.95 compatible with Jerrold Starbase-3 or any gated pulse system. Automatic gain control. Highest quality components. One year guarantee. Other types available. Deluxe catalog \$3.00. TELTECH, 120 Wall Street, Suite 1044, Dept. RE 1, New York 1005.

## TI-99/4A SOFTWARE

TI-99/4A owners. Send for free catalog of new and exciting, low cost software. DYNA, Box 690, Hicksville, NY 11801.

## EPROM PROGRAMMING SERVICE

EPROM programming service for hobbyists and commercial users. All common EPROM types. Write for complete listing and price information. ELECTRONIC COMMUNICATIONS SERVICES, PO Box 441, Franklin Park, IL 60131.

## FREE LCD WATCH WITH KIT

LSR UHF converters with AGC: gated pulse wave BT-1 (speaker box), \$115.00. Sound out from the TV type; Deluxe IIB sine wave, \$100.00; new! I. F. sine wave, \$55.00; Digital Z/FV-5, \$175.00. Quantity discounts. Plans: large SASE (54 cents postage). Free shipping/handling for prepaid orders. Store at 3806 W. Lawrence, (1-312) 588-8828/267-3455 LSR ENGINEERING, Dept. RE, Box 6075, Chicago, IL 60680-6075.

## USA PAY-TV STATIONS

ZENITH manufactured SSAVI UHF converter manual. Explains how to turn-on boxes that were shut-off and override the addressability to receive all programming tiers. Send \$15.00. VIDEO ELECTRONICS, 3083 Forest Glade Dr., Windsor, Ontario, Canada N8R 1W6, Zenith converters (the real McCoy) available. Call (519) 944-6443.

## HOME ROBOTS

JOIN the personal robot revolution. Meet Heath's Hero-1 and RB Robot's RB5X at CAL-ROBOT, PO Box 5973, Sherman Oaks, CA 91413 (818) 905-0721.

## STOP

LOOKING FOR RESISTORS, CAPACITORS, DIODES, METERS, HARDWARE, CONTROLS, POWER RESISTORS, TRANSISTORS, IC'S, TRANSFORMERS, FUSES, KITS, LED'S, CABINETS, SEND \$1.00 (REFUNDABLE), FOR OUR CATALOG OF OVER 1200 ITEMS OR SEND A STAMP FOR OUR FLYER. 24 HOUR TURN AROUND TIME - LOW PRICES - 100% GUARANTEE

**Daytapro Electronics, Inc.**

3029 N. WILSHIRE LN., ARLINGTON HTS., ILL. 60004  
312-870-0555



## Electronic ORGAN & PIANO KITS



For Free Info Pack  
Call Toll-Free  
800-233-3865

Or write for more  
information

WERSI USA

Dept. M 38 P.O. Box 5318  
Lancaster, PA 17601

THE WORLD LEADER

## MICROWAVE TV ANTENNA SYSTEMS

Freq. 2.1 to 2.6 GHz • 34 db Gain +



### COMPLETE SYSTEMS

- (as Pictured)  
Commercial 40"  
Rod Style \$ 89.95  
Parabolic 20"  
Dish Style \$ 79.95

### COMPONENTS

- Down Converters  
(both types) \$ 34.95  
Power Supplies  
(12V to 16V) \$ 24.95  
Data Info (Plans) \$ 9.95

CALL OR WRITE FOR  
KITS, PARTS, INDIVIDUAL  
COMPONENTS

We Repair All Types Down  
Converters & Power Supplies

**Phillips-Tech  
Electronics**

P.O. Box 34772  
Phoenix, AZ 85067  
(602) 265-8255

Special Quantity Pricing  
Dealers Wanted



TWO YEAR WARRANTY  
PARTS & LABOR

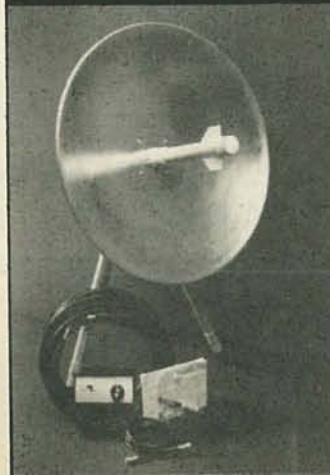

CIRCLE 29 ON FREE INFORMATION CARD

## COMPUTERIZED THERMOSTAT

FULLY PROGRAMMABLE • GUARANTEED TO  
REDUCE YOUR HEATING-COOLING BILLS 30-50%!!

- For Home or Office
- Patented Microprocessor
- Up to 6 settings a day, 7 days per week
- Simple one-button operation
- Simple 10 minute installation for do-it-yourselfer
- Qualifies for 15% Energy Tax Credit
- Warranty

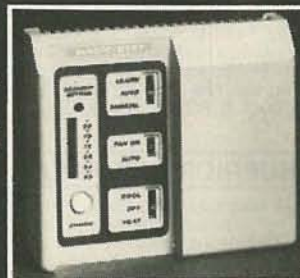

Dimensions 5 3/8 W x 4 1/2 H x 1 3/16 D  
24 V Systems • Not for 2 Stage Heat Pumps

COMPLETE UNIT \$79.95

KIT FORM \$64.95

INCL. \$2.50 FOR SHIPPING

Dealers Wanted



**KCS ELECTRONICS CORPORATION**

P.O. BOX 33205  
PHOENIX, AZ 85015

(602) 274-2885

Call or write for FREE  
Semiconductor Parts & Products Catalog

CIRCLE 83 ON FREE INFORMATION CARD



## NEW! MULTI-CHANNEL MICROWAVE

Complete Antenna Systems from \$69<sup>95</sup>

Full 800 Mhz Range  
Tune 1.9-2.7 Ghz  
Includes all  
ITFS Channels

DEALERS WANTED

COD's and Credit Card  
Orders call TOLL FREE  
1-800-247-1151

**GALAXY**  
ELECTRONICS  
6009 N. 61 Avenue  
Glendale, AZ 85301  
1-602-247-1151



## HIGHLY PROFITABLE ONE-MAN ELECTRONIC FACTORY

Investment unnecessary, knowledge not required, sales handled by professionals. Ideal home business. Write today for facts!  
Postcard will do, Barta-RE-X, Box 248, Walnut Creek, CA 94597.

## BEC Electronics

P.O. BOX 461244R  
GARLAND, TX. 75046  
(214) 487-9031

TERMS  
• COD MINIMUM \$20.00 • ADD \$2.50 FOR COD'S  
• UPS DELIVERY ADDRESS MUST ACCOMPANY ALL COD ORDERS  
• \$1.00 HANDLING ON ORDERS UNDER \$10.00  
• VISA, MASTERCARD OR CHECK  
• ADD 6% FOR SHIPPING  
• TEXAS RESIDENTS ADD 5% STATE SALES TAX  
• ALL FOREIGN ORDERS ADD 25% FOR SHIPPING (CANADA 15%) NO FOREIGN COD'S  
• CALL (214) 487-9031 TO PLACE CREDIT CARD OR COD ORDER

### OVER 45,000 SOLD SINCE 1977! SOUND EFFECTS KIT

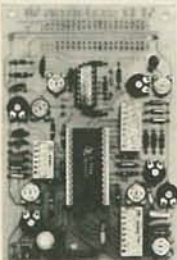

This unit uses the TI 76477 IC and after the easy assembly is completed you will be able to reproduce almost any sound you want! Quality PC board and all necessary components are provided. All you need to add is a speaker. The circuitry of the kit provides you with a Pulse Generator, MUX Oscillator & Comparator to make more complex sounds a snap. Programming examples provided to help you get used to using the unit.

18.50 ea.  
2/34.50



### THE BEST DEAL!

This hand held **Automotive Tester** checks and tests the functions listed below easily and quickly. The original manufacturer sold over a million units in 1983 at 19.95 each. Instructions and charts are printed on the back of each unit. This tester will save hours of frustration and pay for itself the first time used! Units are all new, 100% guaranteed for 90 days from date of purchase.

TESTS: Battery Condition, Pick-up Coil, Ignition Module, and HV Coil

11.88 each → order 2 BEFORE JAN. 31, PAY 18.50 FOR BOTH!

### Special SUPER MUSIC MAKER KIT 27.95



10 WATTS OUTPUT!

INCLUDES CASE & ROM CHIP ORDER KSM-03

12 VOLTS AC/DC SPEAKER NOT INCLUDED

This popular kit is great for car horns or doorbell applications. We include all components and quality PC board. You'll love our easy to follow assembly instructions. The package price includes the kit, case w/ front panel tune selection switches, and a preprogrammed 2708 memory chip (ROM) with 35 additional tunes; (60 total). Additional ROM's are available for 9.95 to 14.95 ea. (Listing sent with order). Order Now! Offer expires January 31, 1984! 12VAC transformer is available, Order TN-20 2.60 ea.

OUR PRODUCT CATALOG IS CRAMMED WITH NEAT GOODIES! SEND 50¢ REFUNDABLE ON 1ST ORDER. FREE W ORDER.

### WINDSHIELD WIPER DELAY

Complete assembled PC card with IC, relay, and control with schematic. Complete with custom molded plastic case with bracket and hardware. Special introductory price! Order: AS-01

LM1808 Audio IF & Separate 2W Audio output ICL-1805 99/TDA1002 2W Audio output Order: ICL-1002 1.25 LM301 Linear 8 pin Op Amp Order: ICL-01A .39 CD 4433 Counter & 7 seg. decoder/driver IC House # Order: ICL-4433 .69

### TELEPHONE RINGER SEMI KIT

Contains special ML8204 tone ringer IC and components to build a pleasant tone ringer for your phone. 5 pgs. of specs and circuits. Order: KTR-01S 2.50 PC Board for above Order: PCB-01 2.00

### TRANSFORMER

24 VAC @ 3A 12 VAC @ 1A 6 VAC @ 2A Completely Shielded! 115 VAC Primary 7.55 ea 10/68.50 ORDER: TN-30

## Are you supporting your child's drug habit?



An ounce of pot costs about 60 dollars.

Coke, a lot more. Quaaludes run about 4 dollars each. And if so many children are using drugs, they're spending a lot of money. Where are they getting it? Point is, your children might be spending their allowance on something other than video games.

Learn about drugs. Watch for the possible signs. Sleeping a lot. Listlessness. Poor marks in school. Lack of school attendance. Most of all, show your child that you care and you're concerned about the possibility that they may be using drugs.

And send away for our booklet, "Parents: What You Can Do About Drug Abuse." Write Get Involved, P.O. Box 1706, Rockville, Maryland 20850.

## Get involved with drugs before your children do.

Ad Council A public service of this publication and the National Institute on Drug Abuse.

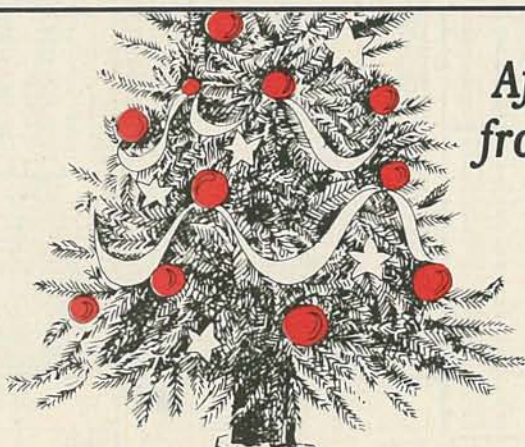

## After Xmas Sale from Components Express . . .

COEX 80 F/T Parallel Printer

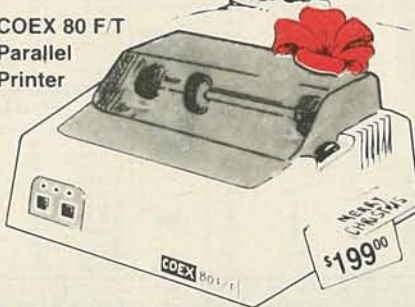

offer Expires Jan 31, 1983.



\*Bulk Boxes of 100 Diskettes Tyvec Sleeves Available.

\*\*Bulk Boxes of 100 Diskettes w/Hub Rings. Tyvec Sleeves Available.



"Kiss Your Computer For The Holidays"

## Components Express, Inc.

1380 E. Edinger • Santa Ana, Calif. 92705 • 714-558-3972

Terms of Sale: Cash, Checks, Credit Cards, M.O., C.O.D. FOB Santa Ana. Calif. residents add 6% sales tax.



CIRCLE 88 ON FREE INFORMATION CARD

JANUARY 1984







## VOICE SYNTHESIZER FOR APPLE AND COMMODORE

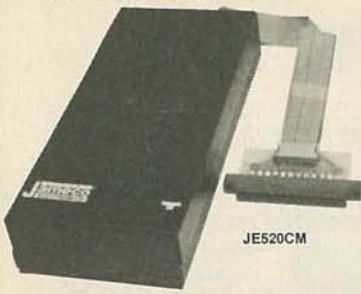

JE520CM

Over 250 word vocabulary affixes allow the formation of more than 500 words • Built-in amplifier, speaker, volume control, and audio jack • Recreates a clear, natural male voice • Plug-in user ready with documentation and sample software • Case size: 7 1/4" L x 3 1/4" W x 1-3/8" H

### APPLICATIONS:

- Security Warning
- Teaching
- Instrumentation
- Telecommunication
- Handicap Aid
- Games

The JE520 VOICE SYNTHESIZER will plug into the computer and allow you to enhance almost any application. Utilizing National Semiconductor's DIGITALALKER™ Speech Processor IC (with four custom memory chips), the JE520 compresses natural speech into digital memory, including the original inflections and emphases. The result is an extremely clear, natural vocalization.

Part No.	Description	Price
JE520CM	For Commodore 64 & VIC-20	\$114.95
JE520AP	For Apple II, II+, and IIe	\$149.95

## Micro-Logic Corp. MICRO-CHARTS

Fully decoded data • Instant access • 2-sided, totally comprehensive • Compact 8 1/2" x 11" in durable credit card plastic • Perfect for programmers & engineers • Clear & concise tables for full instruction set, disassembly, ASCII, base conversion, effect of flags, compare vs. jump, interrupt structure, pinout, cycle times, diagrams, bug notes, & much more.

PART NO.	REFERENCE	PRICE
ML-280	Z80 CPU	\$5.95
ML-8080A	8080A/8085A	\$5.95
ML-6502	6502 (65X)	\$5.95
ML-8048	8048, Relatives	\$5.95
ML-7400	5400/7400 TTL Pin-Outs	\$5.95
ML-ALGO	Basic Algorithms	\$5.95

### BOOKS

30001	National CMOS Data Book (1981) (640 pages) 74C, CD4000, and A/D Converters	\$6.95
30003	National Linear Data Book (1982) (1378 pages) LM, LF, ADC, DAC, LM Series	\$11.95
30008	National Memory Data Book (1980) (464 pages) RAMs, ROMs, PROMs, EPROMs Series	\$6.95
30009	Internal Data Book (1983) (1356 pages) Complete line.	\$9.95
30010	National Audio/Radio Handbook (1980) (240 pages) Pre-Amps, AM, FM & FM Stereo, Power Amps	\$5.95
30012	National PAL Data Book (1982) (176 pages) Application Notes, Linear Briefs, etc.	\$5.95
30013	Zilog Data Book (1983) (641 pages) Microprocessors and Support Chips	\$7.95
210830	Intel Memory Components Handbook (1983) (798 pages) Contains all Application Notes, Article Reprints, Data Sheets, and other design information on Intel's RAMs, EPROMs, EPROMs & Bubble Memories.	\$14.95
210844	Intel Microprocessors & Peripheral Handbook (1983) (1027 pages) Contains Data Sheets on all of Intel's Microprocessors and Peripherals.	\$14.95

## 4-Digit Fluorescent Alarm Clock Kit



Bright 4-digit 0.5" high display • 10 minute snooze alarm • AMPM indicator • Automatic display dimmer  
The JE750 Clock Kit is a versatile 12-hour digital clock with 24-hour alarm. The clock has a bright 0.5" high blue-green fluorescent display. The 24-hour alarm allows the user to disable the alarm and immediately re-enable the alarm to activate 24 hours later. The kit includes all documentation, components, case and wall transformer. Size: 6-5/8" L x 3 1/4" W x 1 1/2" D.

JE750 Alarm Clock Kit ..... \$29.95

## Jameco Digital Thermometer Kit



JE300 ..... \$39.95

## Universal Computer Keyboard Enclosures

DTE-8	Panel Width 7.5"	\$24.95
DTE-11	Panel Width 10.13"	\$27.95
DTE-14	Panel Width 13.5"	\$29.95
DTE-20	Panel Width 19.25"	\$34.95
DTE-22	Panel Width 21.375"	\$39.95

## CARD-EDGE CONNECTOR

Mates with double-sided 1/16" PCB board with contact fingers on 100+ centers

Part No.	No. of Contacts/Conductors	1-9	10-99	100+
C20	20	2.39	2.09	1.89
C26	26	2.69	2.39	2.09
C34	34	2.99	2.69	2.39
C40	40	3.09	2.79	2.49
C50	50	4.39	3.95	3.35

## SOLDER TRANSITION CONNECTORS

FOR PERMANENT TERMINATION TO PRINTED CIRCUIT BOARDS

Part No.	No. of Contacts	1-9	10-99	100+
ST20	20	1.15	0.99	0.89
ST26	26	1.25	1.15	0.99
ST34	34	1.49	1.33	1.15
ST40	40	1.69	1.55	1.35
ST50	50	1.89	1.69	1.49

## 36-Pin CENTRIC RIBBON CONNECTORS

Part No.	No. of Contacts/Style	1-9	10-99	100+
CEN14M	14 Male	6.39	5.49	4.49
CEN14F	14 Female	6.19	5.28	4.28
CEN24M	24 Male	7.95	6.95	5.95
CEN24F	24 Female	7.69	6.79	5.75
CEN36M	36 Male	9.59	7.59	6.49
CEN36F	36 Female	9.25	6.95	7.95

## 28AWG FLAT GREY CABLE

Part No.	No. of Contacts/Conductors	Connector & Wire Type	Price Per Foot
171-9	3	28AWG Flat Stranded	19
171-14	14	28AWG Flat Stranded	25
171-15	15	28AWG Flat Stranded	27
171-16	16	28AWG Flat Stranded	29
171-20	20	28AWG Flat Stranded	36
171-24	24	28AWG Flat Stranded	45
171-25	25	28AWG Flat Stranded	47
171-26	26	28AWG Flat Stranded	49
171-34	34	28AWG Flat Stranded	62
171-36	36	28AWG Flat Stranded	65
171-37	37	28AWG Flat Stranded	69
171-40	40	28AWG Flat Stranded	75
171-50	50	28AWG Flat Stranded	89

## SOCKET CONNECTORS

Mates with 2 rows of 025" sq. or dia. pins on 100+ centers and shielded receptacles

Part No.	No. of Contacts/Conductors	1-9	10-99	100+
S20	20	1.39	1.25	1.09
S26	26	1.69	1.48	1.35
S34	34	2.09	1.75	1.59
S40	40	2.29	2.09	1.79
S50	50	2.89	2.39	2.09
S60	60	3.29	2.95	2.59

## MALE CONNECTOR

Mates with Socket Connector 10" x 10"

Part No.	No. of Contacts/Conductors	1-9	10-99	100+
M20	20	4.09	3.65	3.19
M26	26	4.49	3.95	3.49
M34	34	4.95	4.49	3.95
M40	40	5.49	4.89	4.29
M50	50	6.49	5.75	4.85

## D-SUB CONNECTORS

Part No.	No. of Contacts/Style	1-9	10-99	100+
CD9P	9 Male	2.95	2.55	2.29
CD9F	9 Female	3.39	3.00	2.69
CD15P	15 Male	3.95	3.55	3.09
CD15F	15 Female	4.75	4.19	3.69
CD25P	25 Male	5.49	4.79	4.25
CD25F	25 Female	5.95	5.49	4.85
CD37P	37 Male	7.79	6.95	6.09
CD37F	37 Female	8.95	8.95	8.95

## CUSTOM ASSEMBLIES

Use the part numbers from the connectors and cable to order your own custom assembled cables.  
EXAMPLE: If you desire a 25-foot cable with a male "Centronics" connector on one end and a female "Centronics" connector on the other end you would order:  
CEN36M-25-CEN36F CUSTOM = \$18.44  
63 x 25 feet 26 cond. cable = \$19.25  
2.00 28-awg flat grey cable = \$2.00  
This CEN36M-25-CEN36F CUSTOM Cable would cost \$39.69  
Please specify "CUSTOM" after the part no. to ensure your order will be filled correctly. (Important: Please specify cable in FEET, not inches.)  
ALL CUSTOM ASSEMBLIES MUST BE PREPAID BEFORE ASSEMBLY. THREE DAY AND RETURNS ON CUSTOM ASSEMBLIES. \$7.00 SET UP CHARGE APPLICABLE TO ALL CUSTOM CABLES.

## ACCESSORIES FOR APPLE COMPUTERS

### Numeric/Auxiliary Keypad for APPLE IIe\*



The JE614 is a newly introduced numeric/auxiliary keypad for the APPLE IIe. It offers the flexibility of a 12-key pad and the convenience of 23 electrically accessible functions. Screen manipulating functions make word processing a snap and cursor controls make the keypad ideal for VisiCalc™ users. The JE614 Keypad is housed in a durable metal enclosure and is color coordinated with your APPLE IIe computer. Operation of the keypad can begin within minutes from unpacking. Special functions include Home, Clear, Right, End of Screen, Scroll Up, Scroll Down, Tab, Delete, Left, Right, and Done. Each key has auto-repeat!

JE614 Assembled and Tested ..... \$89.95

### Extended 80 Column/64K RAM Card for APPLE IIe\*

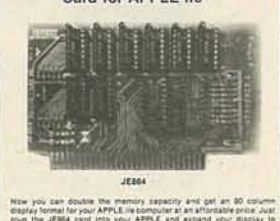

Now you can double the memory capacity and get an 80 column display format for your APPLE IIe computer at an affordable price. Just plug the JE604 card into your APPLE IIe and expand your display to 80 characters per line. Perfect for word processing, the JE604 also features 64K bytes of additional memory to allow programming not possible with standard APPLE IIe computers.  
Based: High density board design equates 64K bytes of RAM onto a 2 1/2" x 4 1/2" board. Fully tested to assure proper operation.  
Uses: Word processing - displays 1000 more characters per screen.  
Extra memory allows running of extremely large programs • Ultra High Resolution Graphics (when software available).

JE604 Assembled and Tested ..... \$149.95

### Switching Power Supply for APPLE II, II+ and IIe\*



JE614 ..... \$79.95

### Cooling Fan for APPLE II, II+ and IIe\*



JE604 ..... \$49.95

### POWER SUPPLY +5VDC @ 7.5 AMP, 12VDC @ 1.5 AMP SWITCHING

Input: 115VAC, 50-60Hz @ 3 amp/230VAC, 50Hz @ 1.5 amp. Fan vol./power supply select switches 115V/230VAC. Output: 5VDC @ 7.5 amp, 12VDC @ 1.5 amp, 9.0. 5.0. 6.0. 9.0. 11.0. 13.0. 15.0. 18.0. 21.0. 24.0. 27.0. 30.0. 33.0. 36.0. 39.0. 42.0. 45.0. 48.0. 51.0. 54.0. 57.0. 60.0. 63.0. 66.0. 69.0. 72.0. 75.0. 78.0. 81.0. 84.0. 87.0. 90.0. 93.0. 96.0. 99.0. 102.0. 105.0. 108.0. 111.0. 114.0. 117.0. 120.0. 123.0. 126.0. 129.0. 132.0. 135.0. 138.0. 141.0. 144.0. 147.0. 150.0. 153.0. 156.0. 159.0. 162.0. 165.0. 168.0. 171.0. 174.0. 177.0. 180.0. 183.0. 186.0. 189.0. 192.0. 195.0. 198.0. 201.0. 204.0. 207.0. 210.0. 213.0. 216.0. 219.0. 222.0. 225.0. 228.0. 231.0. 234.0. 237.0. 240.0. 243.0. 246.0. 249.0. 252.0. 255.0. 258.0. 261.0. 264.0. 267.0. 270.0. 273.0. 276.0. 279.0. 282.0. 285.0. 288.0. 291.0. 294.0. 297.0. 300.0. 303.0. 306.0. 309.0. 312.0. 315.0. 318.0. 321.0. 324.0. 327.0. 330.0. 333.0. 336.0. 339.0. 342.0. 345.0. 348.0. 351.0. 354.0. 357.0. 360.0. 363.0. 366.0. 369.0. 372.0. 375.0. 378.0. 381.0. 384.0. 387.0. 390.0. 393.0. 396.0. 399.0. 402.0. 405.0. 408.0. 411.0. 414.0. 417.0. 420.0. 423.0. 426.0. 429.0. 432.0. 435.0. 438.0. 441.0. 444.0. 447.0. 450.0. 453.0. 456.0. 459.0. 462.0. 465.0. 468.0. 471.0. 474.0. 477.0. 480.0. 483.0. 486.0. 489.0. 492.0. 495.0. 498.0. 501.0. 504.0. 507.0. 510.0. 513.0. 516.0. 519.0. 522.0. 525.0. 528.0. 531.0. 534.0. 537.0. 540.0. 543.0. 546.0. 549.0. 552.0. 555.0. 558.0. 561.0. 564.0. 567.0. 570.0. 573.0. 576.0. 579.0. 582.0. 585.0. 588.0. 591.0. 594.0. 597.0. 600.0. 603.0. 606.0. 609.0. 612.0. 615.0. 618.0. 621.0. 624.0. 627.0. 630.0. 633.0. 636.0. 639.0. 642.0. 645.0. 648.0. 651.0. 654.0. 657.0. 660.0. 663.0. 666.0. 669.0. 672.0. 675.0. 678.0. 681.0. 684.0. 687.0. 690.0. 693.0. 696.0. 699.0. 702.0. 705.0. 708.0. 711.0. 714.0. 717.0. 720.0. 723.0. 726.0. 729.0. 732.0. 735.0. 738.0. 741.0. 744.0. 747.0. 750.0. 753.0. 756.0. 759.0. 762.0. 765.0. 768.0. 771.0. 774.0. 777.0. 780.0. 783.0. 786.0. 789.0. 792.0. 795.0. 798.0. 801.0. 804.0. 807.0. 810.0. 813.0. 816.0. 819.0. 822.0. 825.0. 828.0. 831.0. 834.0. 837.0. 840.0. 843.0. 846.0. 849.0. 852.0. 855.0. 858.0. 861.0. 864.0. 867.0. 870.0. 873.0. 876.0. 879.0. 882.0. 885.0. 888.0. 891.0. 894.0. 897.0. 900.0. 903.0. 906.0. 909.0. 912.0. 915.0. 918.0. 921.0. 924.0. 927.0. 930.0. 933.0. 936.0. 939.0. 942.0. 945.0. 948.0. 951.0. 954.0. 957.0. 960.0. 963.0. 966.0. 969.0. 972.0. 975.0. 978.0. 981.0. 984.0. 987.0. 990.0. 993.0. 996.0. 999.0. 1000.0.

### POWER SUPPLY 4-Channel Switching - Apple Compatible

Microprocessor, mini-computer, terminal, medical equipment and process control applications. Input: 115VAC, 50-60Hz @ 3 amp/230VAC, 50Hz @ 1.5 amp. Fan vol./power supply select switches 115V/230VAC. Output: 5VDC @ 7.5 amp, 12VDC @ 1.5 amp, 9.0. 5.0. 6.0. 9.0. 11.0. 13.0. 15.0. 18.0. 21.0. 24.0. 27.0. 30.0. 33.0. 36.0. 39.0. 42.0. 45.0. 48.0. 51.0. 54.0. 57.0. 60.0. 63.0. 66.0. 69.0. 72.0. 75.0. 78.0. 81.0. 84.0. 87.0. 90.0. 93.0. 96.0. 99.0. 102.0. 105.0. 108.0. 111.0. 114.0. 117.0. 120.0. 123.0. 126.0. 129.0. 132.0. 135.0. 138.0. 141.0. 144.0. 147.0. 150.0. 153.0. 156.0. 159.0. 162.0. 165.0. 168.0. 171.0. 174.0. 177.0. 180.0. 183.0. 186.0. 189.0. 192.0. 195.0. 198.0. 201.0. 204.0. 207.0. 210.0. 213.0. 216.0. 219.0. 222.0. 225.0. 228.0. 231.0. 234.0. 237.0. 240.0. 243.0. 246.0. 249.0. 252.0. 255.0. 258.0. 261.0. 264.0. 267.0. 270.0. 273.0. 276.0. 279.0. 282.0. 285.0. 288.0. 291.0. 294.0. 297.0. 300.0. 303.0. 306.0. 309.0. 312.0. 315.0. 318.0. 321.0. 324.0. 327.0. 330.0. 333.0. 336.0. 339.0. 342.0. 345.0. 348.0. 351.0. 354.0. 357.0. 360.0. 363.0. 366.0. 369.0. 372.0. 375.0. 378.0. 381.0. 384.0. 387.0. 390.0. 393.0. 396.0. 399.0. 402.0. 405.0. 408.0. 411.0. 414.0. 417.0. 420.0. 423.0. 426.0. 429.0. 432.0. 435.0. 438.0. 441.0. 444.0. 447.0. 450.0. 453.0. 456.0. 459.0. 462.0. 465.0. 468.0. 471.0. 474.0. 477.0. 480.0. 483.0. 486.0. 489.0. 492.0. 495.0. 498.0. 501.0. 504.0. 507.0. 510.0. 513.0. 516.0. 519.0. 522.0. 525.0. 528.0. 531.0. 534.0. 537.0. 540.0. 543.0. 546.0. 549.0. 552.0. 555.0. 558.0. 561.0. 564.0. 567.0. 570.0. 573.0. 576.0. 579.0. 582.0. 585.0. 588.0. 591.0. 594.0. 597.0. 600.0. 603.0. 606.0. 609.0. 612.0. 615.0. 618.0. 621.0. 624.0. 627.0. 630.0. 633.0. 636.0. 639.0. 642.0. 645.0. 648.0. 651.0. 654.0. 657.0. 660.0. 663.0. 666.0. 669.0. 672.0. 675.0. 678.0. 681.0. 684.0. 687.0. 690.0. 693.0. 696.0. 699.0. 702.0. 705.0. 708.0. 711.0. 714.0. 717.0. 720.0. 723.0. 726.0. 729.0. 732.0. 735.0. 738.0. 741.0. 744.0. 747.0. 750.0. 753.0. 756.0. 759.0. 762.0. 765.0. 768.0. 771.0. 774.0. 777.0. 780.0. 783.0. 786.0. 789.0. 792.0. 795.0. 798.0. 801.0. 804.0. 807.0. 810.0. 813.0. 816.0. 819.0. 822.0. 825.0. 828



# Radio-Electronics Software Store

New for our readers....A mailorder source of software for Atari 400, Atari 800, IBM P C, Commodore VIC-20, Apple II, and other personal computer systems.

## IBM PC



**FLIGHT SIMULATOR** by Microsoft ... List \$49.95. Our price ... \$43.00. Highly accurate simulation of flight in a single-engine aircraft. Working instruments. Out the window graphics. Real-time flight conditions. (IBM P C, 64k, color graphics, disc)

**EASYWRITER II** by Information Unlimited ... List \$350.00. Our price ... \$300.00. Turns your computer into a word processor. You see everything on the screen. There are no imbedded commands. (IBM P C, disc)



**DEADLINE** by Infocom ... List \$49.95. Our price ... \$43.00. A locked door. A dead man. You have 12 hours to solve the mystery. One false move, and the killer strikes again. (IBM P C, 48k, disc)

**ALGEBRA, Vol. 1** by Eduware ... List \$39.95. Our price ... \$34.00. A first year algebra tutorial covering definitions, number line operations, sets, etc. (IBM P C, 48k, color graphics, disc)



**MICRO/TERMINAL** by Microcom ... List \$94.95. Our price ... \$83.00. Allows access to remote mainframes and minis, information data banks, and other personal computers. (IBM P C, disc)

**PC TUTOR** by Comprehensive Software ... List \$79.95. Our price ... \$69.00. Interactive program teaches you how to use your IBM Personal Computer, including hardware and software. (IBM P C, 64k, disc)



## APPLE



**PRISONER2** by Interactive Fantasies ... List \$32.95. Our price ... \$28.00. Escape is hardly possible. The island keeps you under surveillance. Just try and get out! (Apple II, 48k, disc)

**PRISONER2** by Interactive Fantasies ... List \$39.95. Our price ... \$34.00. (Atari disc)

**THE MASK OF THE SUN** by Ultrasoft Inc ... List \$39.95. Our price ... \$34.00. An animated adventure through a series of hi-res screens. An ultimate adventure challenge. (Apple II, 48k, disc)



**MASTERTYPE** by Lighting Software ... List \$39.95. Our price ... \$34.00. A typing instruction system in an exciting hi-res game format. Learn to type while battling waves of attacking enemy words. (Apple II, 48k/64k, disc)

**THE GRAPHICS MAGICIAN** by Penguin Software ... List \$59.95. Our price ... \$53.00. Make your own animated graphics. Handles up to 32 independent objects. Stores hundreds of color pictures. (Apple II, 48k, disc)



**RENDEZVOUS** by Eduware ... List \$39.95. Our price ... \$34.00. In four phases, simulates an actual space-shuttle flight from Earth Liftoff through Orbital Rendezvous and Approach to Alignment Docking with a space station. Hi-res graphics (Apple II, disc)

**SAT WORD ATTACK SKILLS** by Eduware ... List \$49.00. Our price ... \$43.00. A tutorial for mastering vocabulary, deciphering new or unfamiliar words, and taking tests. (Apple II, disc)



## COMMODORE VIC-20



**PIPES** by Creative Software ... List \$39.95. Our price ... \$34.00. Connect a pipeline from the water supply tank to every house. Watch out for leaks. Use as little pipe as possible. 5 skill levels. (Commodore VIC-20 cartridge)

**SHAMUS** by Human Engineered Software ... List \$39.94. Our price ... \$34.00. Only you can stop the Shadow's mad reign of terror. Two levels with 20 rooms each. A joystick challenge. (Commodore VIC-20 cartridge)



**HOUSEHOLD FINANCE** by Creative Software ... List \$17.95. Our price ... \$15.00. Home utility program records and analyzes your monthly income, expenses and budget in 16 categories. (Commodore VIC-20 tape cassette)

**HOME OFFICE** by Creative Software ... List \$29.95. Our price ... \$25.00. Combines VICPRO, a flexible and efficient word processor with VICDATA a powerful and sophisticated information storage and retrieval system. (Commodore VIC-20, cassette tape, 8k additional memory required)



## ATARI



**SUBMARINE COMMANDER** by Thorn EMI ... List \$49.95. Our price ... \$43.00. A submarine patrol simulator to hunt and destroy enemy ships. 9 skill levels. Plug-in cartridge. (Atari Cartridge 400/800)

## APPLE

**MINER 2049** by MicroLab ... List \$39.95. Our price ... \$34.00. Chase into a Uranium mine thru 10 levels of traps and capture Yukon Yohan. Scale ladders, jump from moving platforms, and win—if you can. (Apple II, 48k, disc)



## Radio-Electronics Software Store

200 Park Avenue South  
New York, NY 10003

Number of items ordered

Total Price of Software ..... \$ \_\_\_\_\_

Sales Tax (NY State Residents Must Include) ..... \$ \_\_\_\_\_

Shipping (\$2.00 per item) ..... \$ \_\_\_\_\_

TOTAL ENCLOSED (Sorry, No COD's) ..... \$ \_\_\_\_\_

Name \_\_\_\_\_

Address \_\_\_\_\_

City \_\_\_\_\_ State \_\_\_\_\_ ZIP \_\_\_\_\_

SORRY - NO CREDIT CARD OR COD ORDERS



# RAMSEY

## THE FIRST NAME IN ELECTRONIC TEST GEAR



### NEW FROM RAMSEY 20 MHz DUAL TRACE OSCILLOSCOPE

Unsurpassed quality at an unbeatable price, the Ramsey oscilloscope compares to others costing hundreds more. Features include a component testing circuit that will allow you to easily test resistors, capacitors, digital circuits and diodes • TV video sync filter • wide bandwidth & high sensitivity • internal graticule • high quality rectangular CRT • front panel trace rotator • Z axis • high sensitivity x-y mode • very low power consumption • regulated power supply • built-in calibrator • rock solid triggering • high quality hook-on probes

**\$399<sup>95</sup>** high quality hook-on probes included



#### RAMSEY D-1100 VOM-MULTITESTER

Compact and reliable, designed to service a wide variety of equipment. Features include • mirror back scale • double-jeweled precision moving coil • double overload protection • an ideal low cost unit for the beginner or as a spare back-up unit.

**\$199<sup>5</sup>**  
test leads and battery included



#### RAMSEY D-2100 DIGITAL MULTITESTER

A compact easy to use unit designed to operate like a pro. Featuring • 3 1/2 digit LCD • low BAT. indicator • all range overload protection • overrange indication • auto-polarity • Transistor Tester • dual-slope integration • vinyl carrying case

**\$54<sup>95</sup>**  
hfe test leads, battery & vinyl carrying case included

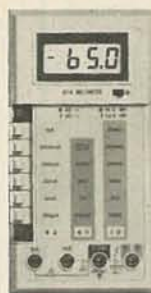

#### RAMSEY D-3100 DIGITAL MULTIMETER

Reliable, accurate digital measurements at an amazingly low cost • In-line color coded push buttons, speeds range selection • abs plastic tilt stand • recessed input jacks • overload protection on all ranges • 3 1/2 digit LCD display with auto zero, auto polarity & low BAT. indicator

**\$59<sup>95</sup>**  
test leads and battery included



#### CT-70 7 DIGIT 525 MHz COUNTER

Lab quality at a breakthrough price. Features • 3 frequency ranges each with pre amp • dual selectable gate times • gate activity indicator • 50mV @ 150 MHz typical sensitivity • wide frequency range • 1 ppm accuracy

**\$119<sup>95</sup>**  
wired includes AC adapter

CT-70 kit ..... \$99.95  
BP-4 nicad pack ..... 8.95



#### CT-90 9 DIGIT 600 MHz COUNTER

The most versatile for less than \$300. Features 3 selectable gate times • 9 digits • gate indicator • display hold • 25mV @ 150 MHz typical sensitivity • 10 MHz timebase for WWV calibration • 1 ppm accuracy

**\$149<sup>95</sup>**  
wired includes AC adapter

CT-90 kit ..... \$129.95  
OV-1 0.1 PPM oven timebase ..... 59.95  
BP-4 nicad pack ..... 8.95



#### CT-125 9 DIGIT 1.2 GHz COUNTER

A 9 digit counter that will outperform units costing hundreds more. • gate indicator • 24mV @ 150 MHz typical sensitivity • 9 digit display • 1 ppm accuracy • display hold • dual inputs with preamps

**\$169<sup>95</sup>**  
wired includes AC adapter

CT-125 kit ..... \$149.95  
BP-4 nicad pack ..... 8.95



#### CT-50 8 DIGIT 600 MHz COUNTER

A versatile lab bench counter with optional receive frequency adapter, which turns the CT-50 into a digital readout for most any receiver • 25 mV @ 150 MHz typical sensitivity • 8 digit display • 1 ppm accuracy

**\$169<sup>95</sup>**  
wired

CT-50 kit ..... \$139.95  
RA-1 receiver adapter kit ..... 14.95



#### DM-700 DIGITAL MULTIMETER

Professional quality at a hobbyist price. Features include 26 different ranges and 5 functions • 3 1/2 digit, 1/2 inch LED display • automatic decimal placement • automatic polarity

**\$119<sup>95</sup>**  
wired includes AC adapter

DM-700 kit ..... \$99.95  
MP-1 probe set ..... 4.95



#### PS-2 AUDIO MULTIPLIER

The PS-2 is handy for high resolution audio resolution measurements, multiplies UP in frequency • great for PL tone measurements • multiplies by 10 or 100 • 0.01Hz resolution & built-in signal preamp/conditioner

**\$49<sup>95</sup>**  
wired includes AC adapter

PS-2 kit ..... \$39.95



#### PR-2 COUNTER PREAMP

The PR-2 is ideal for measuring weak signals from 10 to 1,000 MHz • flat 25 db gain • BNC connectors • great for sniffing RF • ideal receiver/TV preamp

**\$44<sup>95</sup>**  
wired includes AC adapter

PR-2 kit ..... \$34.95



#### PS-1B 600 MHz PRESCALER

Extends the range of your present counter to 600 MHz • 2 stage preamp • divide by 10 circuitry • sensitivity: 25mV @ 150 MHz • BNC connectors • drives any counter

**\$59<sup>95</sup>**  
wired includes AC adapter

PS-1B kit ..... \$49.95

#### ACCESSORIES FOR RAMSEY COUNTERS

Telescopic whip antenna—BNC plug .. \$ 8.95  
High impedance probe, light loading .. 16.95  
Low pass probe, audio use ..... 16.95  
Direct probe, general purpose use ..... 13.95  
Tilt ball, for CT-70, 90, 125 ..... 3.95



PHONE ORDERS CALL  
**716-586-3950**

TELEX 466735 RAMSEY CI

TERMS: • satisfaction guaranteed • examine for 10 days; if not pleased return in original form for refund • add 6% for shipping and insurance to a maximum of \$10.00 • overseas add 15% for surface mail • COD add \$2.50 • orders under \$10.00 add \$1.50 • NY residents add 7% sales tax • all kits have a 90 day parts warranty. All wired units have 1 year parts and labor warranty.



RAMSEY ELECTRONICS, INC.  
2575 Baird Rd.  
Penfield, N.Y. 14526

JANUARY 1984

CIRCLE 79 ON FREE INFORMATION CARD



**TOLL FREE ORDERS • 1-800-826-5432**  
(IN CALIFORNIA: 1-800-258-6666)  
INFORMATION • (213) 380-8000

**SOLID STATE RELAYS**

**2 AMP**  
MOTOROLA #MP 12002  
RATED:  
CONTROL—3.6VDC  
LOAD—120VAC 2 AMPS  
T.T.L. COMPATIBLE  
SIZE: 1 1/2" x 1/2" x 1" HIGH  
**\$3.50 EACH 10 FOR \$32.00**

**10 AMP**  
TELEDYNE P/N 615-1  
CONTROL:  
3-32 VDC  
LOAD: 10 AMP  
140 VAC  
**\$9.50 EACH**

**EDGE CONNECTORS**

**22/44** 22/44 GOLD PLATED CONTACTS  
156 CONTACT SPACING.  
**\$2.00 EACH 10 FOR \$18.00**

**28/56**  
28/56 GOLD PLATED CONTACTS  
156 CONTACT SPACING.  
**\$2.50 EACH 10 FOR \$22.00**

**50/100** MICRO PLASTIC #MP-0125-50-DS-1  
STANDARD S-100 CONNECTOR  
.125" SPACING. GOLD PLATED P.C. MOUNT.  
**\$3.75 EACH 10 FOR \$35.00**

**13 VDC RELAY**  
CONTACT: S.P.N.C.  
10 AMP @ 120 VAC  
ENERGIZE COIL TO  
OPEN CONTACT...  
COIL: 13 VDC 650 OHMS  
**SPECIAL PRICE \$1.00 EACH**

**KEY ASSEMBLY 5 KEY**  
CONTAINS 5 SINGLE-POLE  
NORMALLY OPEN SWITCHES  
MEASURES 3 3/4" LONG  
**\$1.00 EACH**

**6 KEY**  
CONTAINS 6 SINGLE-POLE  
NORMALLY OPEN SWITCHES  
MEASURES 4 1/4" LONG  
**\$1.25 EACH**

**SUB-MINIATURE D TYPE CONNECTOR**

SOLDER TYPE SUB-MINIATURE  
CONNECTORS USED FOR  
COMPUTER HOOK UPS  
DB-15 PLUG **\$2.75**  
DB-15 SOCKET **\$4.00**  
DB-15 HOOD **\$1.50**  
DB-25 PLUG **\$2.75**  
DB-25 SOCKET **\$3.50**  
DB-25 HOOD **\$1.25**

**MULTI-SWITCHES**  
**5 STATION INTERLOCKING**  
3-2PDT AND 2-6PDT SWITCHES ON FULLY  
INTERLOCKING ASSEMBLY 3 1/4" BETWEEN  
MOUNTING CENTERS **\$2.50 EACH**  
**5 STATION NON-INTERLOCKING**  
SAME AS ABOVE, EXCEPT EACH SWITCH  
OPERATES INDEPENDENTLY **\$2.50 EACH**

**SEND FOR LARGER 48 PAGE CATALOG**

**COMPUTER GRADE CAPACITORS**

1700 mfd. 150 VDC **\$2.00**  
2 1/2" DIA x 4 3/4" HIGH  
3,600 mfd. 40VDC **\$1.00**  
1 3/8" DIA x 3" HIGH  
6,400 mfd. 60 VDC **\$2.50**  
1 3/8" DIA x 4 1/4" HIGH  
22,000 mfd. 15 VDC **\$2.00**  
2" DIA x 2 1/2" HIGH  
22,000 mfd. 40 VDC **\$2.00**  
2" DIA x 6" HIGH  
24,000 mfd. 30 VDC **\$3.50**  
1 3/4" DIA x 4" HIGH  
31,000 mfd. 15 VDC **\$2.50**  
1 3/4" DIA x 4" HIGH  
72,000 mfd. 15 VDC **\$3.50**  
2" DIA x 4" HIGH  
180,000 mfd. at 6V **\$1.50**  
2 1/2" DIA x 4 1/2" HIGH  
CLAMPS TO FIT CAPACITORS 50¢ ea.

**POWER SUPPLY**  
REGULATED FULLY  
ADJUSTABLE  
5 VDC AT  
3 AMPS  
**\$18.50 EACH**

**BCD DIP SWITCH**  
10 POSITION ROTARY  
SCREWDRIVER ADJUST.  
FITS 6 PIN DIP  
**\$1.85 EACH**

**WALL TRANSFORMER**  
ALL ARE 115 VAC  
PLUG IN  
4 VDC at 70 MA **\$2.50**  
9 VDC at 225 MA **\$3.00**  
16.5 VAC at 10 VA **\$3.50**  
17 VAC at 500 MA **\$4.00**

**MINIATURE TOGGLE SWITCHES**  
ALL ARE RATED 5 AMPS @ 125 VAC

**S.P.D.T. (on-on)**  
P.C. STYLE  
NON-THREADED  
BUSHING  
75¢ EACH  
10 FOR \$7.00

**S.P.D.T. (on-on)**  
SOLDER LUG  
TERMINALS  
\$1.00 EACH  
10 FOR \$9.00  
100 FOR \$80.00

**S.P.D.T. (on-off-on)**  
SOLDER LUG  
TERMINALS  
\$1.00 EACH  
10 FOR \$9.00  
100 FOR \$80.00

**S.P.D.T. (on-off-on)**  
NON-THREADED  
BUSHING  
P.C. STYLE  
75¢ EACH  
10 FOR \$7.00

**S.P.D.T. (on-on)**  
P.C. LUGS  
THREADED  
BUSHING  
\$1.00 EACH  
10 FOR \$9.00  
100 FOR \$80.00

**D.P.D.T. (on-on)**  
SOLDER LUG  
TERMINALS  
\$2.00 EACH  
10 FOR \$19.00  
100 FOR \$180.00

**ALL ELECTRONICS CORP.**  
905 S. VERMONT • P.O. BOX 20406 • LOS ANGELES, CA 90006  
QUANTITIES LIMITED • FOREIGN ORDERS  
MINIMUM ORDER \$10.00 • INCLUDE SUFFICIENT SHIPPING  
USA \$2.50 SHIPPING • CALIF RES ADD 6.12%  
NO COD!

**ACTIVE RECEIVING ANTENNA**

**Gives excellent reception, 50 KHz to 30 MHz.**

New MFJ-1024 Active Receiving Antenna mounts outdoors away from electrical noise for maximum signal. Gives excellent reception of 50 KHz to 30 MHz signals. Equivalent to wire hundreds of feet long. Use any SWL, MW, BCB, VLF or Ham receiver. High dynamic range RF amplifier. 54 in. whip. 50 foot coax. 20 dB attenuator prevents receiver overload. Switch between two receivers. Select auxiliary or active antenna. Gain control. "ON" LED. Remote unit, 3x2x4 in. Control, 6x2x5 in. 12 VDC or 110 VAC with optional adapter, MFJ-1312, \$9.95.  
**\$129.95** (+\$4.00 shipping)

Order from MFJ and try it. If not delighted, return within 30 days for refund (less shipping). One year unconditional guarantee. Order today. Call TOLL FREE 800-647-1800. Charge VISA, MC. Or mail check, money order. Write for free catalog. Over 100 products.

**CALL TOLL FREE 800-647-1800**  
Call 601-323-5869 in Miss., outside continental USA, tech/order/repair info. TELEX 53-4590.  
**MFJ ENTERPRISES, INCORPORATED**  
Box 494, Mississippi State, MS 39762

CIRCLE 66 ON FREE INFORMATION CARD

**THE WORLD FAMOUS ETCO CATALOG OF ELECTRONICS**

**FREE** **LOW PRICES**

- VIDEO
- TELEPHONE
- CABLE TV
- PARTS
- AUDIO
- ELECTRONICS
- and much, much more!

1000's OF FASCINATING FACTORY CLEAROUTS SURPLUS SPECIALS AND BARGAIN OFFERS NOT FOUND IN STORES OR CATALOGS ANYWHERE!

**ETCO ELECTRONICS DEPT. 591**  
Mailing List Control Center  
Box 840  
Champlain, N.Y. 12919  
I Enclose \_\_\_\_\_ (cash OK);  
Please rush postpaid

\$1 for 1 year subscription to the world famous ETCO catalog.  
 \$3 Canadian & Foreign 1 year subscription to the ETCO catalog.  
 304 page handbook "BUILD YOUR OWN EARTH STATION". (TA025) \$10.00  
 360 pages MASTER HANDBOOK OF TELEPHONES. (TA001) ..... \$11.00  
 FREE - sample copy of the bargain packed ETCO catalog. (USA only)

Name \_\_\_\_\_  
Address \_\_\_\_\_  
City \_\_\_\_\_  
State \_\_\_\_\_ Zip \_\_\_\_\_

CIRCLE 51 ON FREE INFORMATION CARD

**OPPORTUNITY WITHOUT RISK.**

**The biggest improvement in Savings Bonds in 40 years.**

**New Variable Interest Rate.**

Looking for an ideal investment? One with a variable interest rate? But one where rates can't drop below a certain level?

Well, there is one available to everyone, even if you have only \$25 to invest. It's U.S. Savings Bonds. Now changed from a fixed to a variable interest rate, with no limit on how much you can earn.

**A Guaranteed Minimum.**

Although interest rates will fluctuate, you're protected by a guaranteed minimum. And if you hold your Bond to maturity, you'll double your money. You may do even better.

Take another look at Savings Bonds. We did, and made them better.



**Take stock in America.**

**Ad Council** A public service of this publication and The Advertising Council.

RADIO-ELECTRONICS



# SHACK® HAS THE PARTS YOU NEED AT LOW PRICES!

Highest Quality!

Factory Fresh!

No Mail-Order Delays!

## Special-Purpose ICs

**A**  **NEW!** **B** 

**1295** Set of 2 ICs **799** MF10

**A Voice Synthesizer Set.** Get into solid-state talk! The SPO256 speech processor, a 28-pin NMOS LSI device, uses a stored program to synthesize speech or complex sounds. Works with a few simple support parts, or use the 14-pin SPR16 serial speech ROM, included, for computer interfacing. With data. **276-1783** ..... Set 1295

**B MF10 Dual Switched Filter.** Versatile CMOS building block for active filters—eliminates the need for expensive, close-tolerance parts. High performance, yet very easy to use. 20-pin DIP with data. **276-2329** ..... 7.99

## Voltage Regulator ICs

Type	Adjustable	Cat. No.	Each
LM723	0 to 40 VDC	276-1740	.89
LM317T	1.2 to 37 VDC	276-1778	2.79

Type	Fixed Output	Cat. No.	Each
7805	+5 VDC	276-1770	1.59
7812	+12 VDC	276-1771	1.59
7815	+15 VDC	276-1772	1.59
7905	-5 VDC	276-1773	1.59
7912	-12 VDC	276-1774	1.59

## 4000-Series CMOS ICs

With Pin-Out and Specs

Type	Cat. No.	Each
4001	276-2401	.79
4011	276-2411	.79
4013	276-2413	.99
4017	276-2417	1.49
4023	276-2423	.99
4049	276-2449	.99
4066	276-2466	.99

## TTL Digital ICs

With Pin-Out and Specs

Type	Cat. No.	Each
7400	276-1801	.59
7404	276-1802	.79
7408	276-1822	.79
7447	276-1805	1.19
7490	276-1808	.89

## Replacement Transistors

Type		Cat. No.	Each
2N1305	PNP	276-2007	1.19
MPS222A	NPN	276-2009	.79
PN2484	PNP	276-2010	.89
MPS3904	NPN	276-2016	.69
TIP31	NPN	276-2017	.99
TIP3055	NPN	276-2020	1.59
MPS2907	PNP	276-2023	.79
MJE34	PNP	276-2027	1.49
2N3053	NPN	276-2030	.89
MPS3638	PNP	276-2032	.79
TIP120	NPN	276-2068	1.29
2N3055	NPN	276-2041	1.99
MJ2955	PNP	276-2043	2.19
2N4124	NPN	276-2057	.59
2N4401	NPN	276-2058	.59
MPSA06	PNP	276-2059	.59
MPSA13	NPN	276-2060	.59
MPSA42	NPN	276-2061	.69
MU4891	UJT	276-2029	.99
2SD313	NPN	276-2048	1.79
2SC945	NPN	276-2051	.79
2SC1308	NPN	276-2055	7.95
2N3819	N-FET	276-2035	.99
MPF102	N-FET	276-2062	.99

## Operational Amplifiers

Type		Cat. No.	Each
741	(Single)	276-007	.79
MC1458	(Dual)	276-038	.99
LM324	(Quad)	276-1711	1.29
TL082	(Dual)	276-1715	1.89
TL084	(Quad)	276-1714	2.99
LM3900	(Quad)	276-1713	1.39
LM339	(Quad)	276-1712	1.49

## Audio Power Amplifiers

Type	Cat. No.	Each
LM383/TDA2002	276-703	3.19
LM386	276-1731	1.09
TA7205AP	276-705	2.99
LM380	276-706	1.59

## Tantalum Capacitors

- 20% Tolerance
- Standard IC Pin Spacing

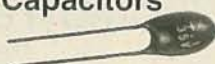

µF	WVDC	Cat. No.	Each
0.1	35	272-1432	.49
0.47	35	272-1433	.49
1.0	35	272-1434	.49
2.2	35	272-1435	.59
10	16	272-1436	.69
22	16	272-1437	.79

## Electrolytic Capacitors

Axial Leads

µF	WVDC	Cat. No.	Each
4.7	35	272-1012	.49
10	35	272-1013	.59
22	35	272-1014	.69
47	35	272-1015	.69
100	35	272-1016	.79
220	35	272-1017	.89
470	35	272-1018	.99
1000	35	272-1019	1.59
2200	35	272-1020	2.49
3300	35	272-1021	2.99
4700	35	272-1022	3.59
470	50	272-1046	1.59
1000	50	272-1047	1.99
2200	50	272-1048	3.49

PC-Mount Leads

µF	WVDC	Cat. No.	Each
220	16	272-956	.79
470	16	272-957	.89
1000	16	272-958	.99
4.7	35	272-1024	.49
10	35	272-1025	.59
22	35	272-1026	.69
47	35	272-1027	.69
100	35	272-1028	.79
220	35	272-1029	.89
470	35	272-1030	.99
1000	35	272-1032	1.59
100	50	272-1044	.89

## SPST DIP Switches

**C**  **Low As 149** **D** 

For digital or low-current switching. Mount in DIP sockets or on PC boards. Style may vary.

Fig.	Positions	Fits Socket	Cat. No.	Each
C	8	16-pin DIP	275-1301	1.99
D	4	8-pin DIP	275-1304	1.49

## Computer Connectors

Type	Positions	Cat. No.	Each
ID Card Edge	34	276-1564	4.95
ID Card Edge	50	276-1566	4.95
Card-Edge Socket	44	276-1551	2.99
ID D-Sub Male	25	276-1559	4.99
ID D-Sub Female	25	276-1565	4.99
Solder D-Sub Male	25	276-1547	2.99
Solder D-Sub Female	25	276-1548	3.99
Hood	—	276-1549	1.99

## Power Transformers

120VAC Primaries

Type	Volts	Current	Cat. No.	Each
Mini	6.3	300 mA	273-1384	2.59
Mini	12.0	300 mA	273-1385	2.79
Mini	24.0	300 mA	273-1386	2.99
Mini	12.0	CT 450 mA	273-1365	3.59
Mini	24.0	CT 450 mA	273-1366	3.99
Std.	6.3	1.2A	273-050	3.79
Std.	12.6 CT	1.2A	273-1505	3.99
Std.	25.2	1.2A	273-1480	4.39
H-D	12.6 CT	3.0A	273-1511	5.99
H-D	25.2 CT	2.0A	273-1512	6.29
H-D	18.0 CT	2.0A	273-1515	6.99

## 1/4-Watt, 5% Resistors

**39¢** Pkg. of 5

Ohms	Cat. No.	Ohms	Cat. No.
10	271-1301	10k	271-1335
100	271-1311	15k	271-1337
150	271-1312	22k	271-1339
220	271-1313	27k	271-1340
270	271-1314	33k	271-1341
330	271-1315	47k	271-1342
470	271-1317	68k	271-1345
1k	271-1321	100k	271-1347
1.8k	271-1324	220k	271-1350
2.2k	271-1325	470k	271-1354
3.3k	271-1328	1 meg	271-1356
4.7k	271-1330	10 meg	271-1365
6.8k	271-1333	—	—

## 21-Range, 30,000 Ohms/Volt Multimeter

**4995**

- 5" Color-Coded Scale
- Overload Protected

Our best VOM! Features "beep" continuity function and easy access to battery/fuse compartment. Measures AC and DC volts, DC current up to 10 amps, resistance and decibels. 6 1/16" x 5 7/16" x 2 5/8". Includes probes, leads, owner's manual. Batteries extra. **22-210** ..... **49.95**



## Home Computer Programs

Reg. 7.95

**Save \$5**  
**295**

For TRS-80® 16K Models I, III, 4



Listings for over 75 useful programs—financial, automotive, kitchen helpmates, filing, math tutoring, metric and temperature conversions, games and more. 330 pages. **62-2069** ..... **Sale 2.95**

A DIVISION OF TANDY CORPORATION

# Radio Shack®

Prices apply at participating Radio Shack stores and dealers

CIRCLE 61 ON FREE INFORMATION CARD

OVER 8800 LOCATIONS WORLDWIDE

JANUARY 1984

127



# 4164

64K DYNAMIC  
200 NS

# \$595

# TMM2016

2KX8 STATIC  
200 NS

# \$415

### STATIC RAMS

2101	256 x 4 (450ns)	1.95
5101	256 x 4 (450ns) (cmos)	3.95
2102-1	1024 x 1 (450ns)	.89
2102L-4	1024 x 1 (450ns) (LP)	.99
2102L-2	1024 x 1 (250ns) (LP)	1.49
2111	256 x 4 (450ns)	2.49
2112	256 x 4 (450ns)	2.99
2114	1024 x 4 (450ns)	8/9.95
2114-25	1024 x 4 (250ns)	8/10.95
2114L-4	1024 x 4 (450ns) (LP)	8/12.95
2114L-3	1024 x 4 (300ns) (LP)	8/13.45
2114L-2	1024 x 4 (200ns) (LP)	8/13.95
TC5514	1024 x 4 (650ns) (cmos)	2.49
TC5516	2048 x 8 (250ns) (cmos)	9.95
2147	4096 x 1 (55ns)	4.95
TMS4044-4	4096 x 1 (450ns)	3.49
TMS4044-3	4096 x 1 (300ns)	3.99
TMS4044-2	4096 x 1 (200ns)	4.49
MK4118	1024 x 8 (250ns)	9.95
TMM2016-200	2048 x 8 (200ns)	4.15
TMM2016-150	2048 x 8 (150ns)	4.95
TMM2016-100	2048 x 8 (100ns)	6.15
HM6116-4	2048 x 8 (200ns) (cmos)	4.75
HM6116-3	2048 x 8 (150ns) (cmos)	4.95
HM6116-2	2048 x 8 (120ns) (cmos)	8.95
HM6116LP-4	2048 x 8 (200ns) (cmos) (LP)	5.95
HM6116LP-3	2048 x 8 (150ns) (cmos) (LP)	6.95
HM6116LP-2	2048 x 8 (120ns) (cmos) (LP)	10.95
Z-6132	4096 x 8 (300ns) (Qstat)	34.95
HM6264	8192 x 8 (150ns) (cmos)	49.95

LP = Low Power Qstat = Quasi-Static

### EPROMS

1702	256 x 8 (1us)	4.50
2708	1024 x 8 (450ns)	3.95
2758	1024 x 8 (450ns) (5v)	5.95
2716	2048 x 8 (450ns) (5v)	3.95
2716-1	2048 x 8 (350ns) (5v)	5.95
TMS2516	2048 x 8 (450ns) (5v)	5.50
TMS2716	2048 x 8 (450ns)	7.95
TMS2532	4096 x 8 (450ns) (5v)	5.95
2732	4096 x 8 (450ns) (5v)	4.95
2732-250	4096 x 8 (250ns) (5v)	8.95
2732-200	4096 x 8 (200ns) (5v)	11.95
2732A-4	4096 x 8 (450ns) (5v) (21vPGM)	6.95
2732A	4096 x 8 (250ns) (5v) (21vPGM)	9.95
2732A-2	4096 x 8 (200ns) (5v) (21vPGM)	13.95
2764	8192 x 8 (450ns) (5v)	9.95
2764-250	8192 x 8 (250ns) (5v)	14.95
2764-200	8192 x 8 (200ns) (5v)	24.95
TMS2564	8192 x 8 (450ns) (5v)	17.95
MC68764	8192 x 8 (450ns) (5v) (24 pin)	39.95
27128	16384x8 (300ns) (5v)	29.95

5v = Single 5 Volt Supply 21vPGM = Program at 21 Volts

### CRYSTALS

32.768 khz	1.95
1.0 mhz	4.95
1.8432	4.95
2.0	3.95
2.097152	3.95
2.4576	3.95
3.2768	3.95
3.579545	3.95
4.0	3.95
5.0	3.95
5.0688	3.95
5.185	3.95
5.7143	3.95
6.0	3.95
6.144	3.95
6.5536	3.95
8.0	3.95
10.0	3.95
10.738635	3.95
14.31818	3.95
15.0	3.95
16.0	3.95
17.430	3.95
18.0	3.95
18.432	3.95
20.0	3.95
22.1184	3.95
32.0	3.95

### 74LS00

74LS00	.24	74LS173	.69
74LS01	.25	74LS174	.55
74LS02	.25	74LS175	.55
74LS03	.25	74LS181	2.15
74LS04	.24	74LS189	8.95
74LS05	.25	74LS190	.89
74LS08	.28	74LS191	.89
74LS09	.29	74LS192	.79
74LS10	.25	74LS193	.79
74LS11	.35	74LS194	.69
74LS12	.35	74LS195	.69
74LS13	.45	74LS196	.79
74LS14	.59	74LS197	.79
74LS15	.35	74LS221	.89
74LS20	.25	74LS240	.95
74LS21	.29	74LS241	.99
74LS22	.25	74LS242	.99
74LS26	.29	74LS243	.99
74LS27	.29	74LS244	1.29
74LS28	.35	74LS245	1.49
74LS30	.25	74LS247	.75
74LS32	.29	74LS248	.99
74LS33	.55	74LS249	.99
74LS37	.35	74LS251	.59
74LS38	.35	74LS253	.59
74LS40	.25	74LS257	.59
74LS42	.49	74LS258	.59
74LS47	.75	74LS259	2.75
74LS48	.75	74LS260	.59
74LS49	.75	74LS266	.55
74LS51	.25	74LS273	1.49
74LS54	.29	74LS275	3.35
74LS55	.29	74LS279	.49
74LS63	1.25	74LS280	1.98
74LS73	.39	74LS283	.69
74LS74	.35	74LS290	.89
74LS75	.39	74LS293	.89
74LS76	.39	74LS295	.99
74LS78	.49	74LS298	.89
74LS83	.60	74LS299	1.75
74LS85	.69	74LS323	3.50
74LS86	.39	74LS324	1.75
74LS90	.55	74LS352	1.29
74LS91	.89	74LS353	1.29
74LS92	.55	74LS363	1.35
74LS93	.55	74LS364	1.95
74LS95	.75	74LS365	.49
74LS96	.89	74LS366	.49
74LS107	.39	74LS367	.45
74LS109	.39	74LS368	.45
74LS112	.39	74LS373	1.39
74LS113	.39	74LS374	1.39
74LS114	.39	74LS375	.95
74LS122	.45	74LS377	1.39
74LS123	.79	74LS378	1.18
74LS124	2.90	74LS379	1.35
74LS125	.49	74LS385	3.90
74LS126	.49	74LS386	.45
74LS132	.59	74LS390	1.19
74LS133	.59	74LS393	1.19
74LS136	.39	74LS395	1.19
74LS137	.39	74LS399	1.49
74LS138	.55	74LS424	2.95
74LS139	.55	74LS447	.95
74LS145	1.20	74LS490	1.95
74LS147	2.49	74LS624	3.99
74LS148	1.35	74LS640	2.20
74LS151	.55	74LS645	2.20
74LS153	.55	74LS668	1.69
74LS154	1.90	74LS669	1.89
74LS155	.69	74LS670	1.49
74LS156	.69	74LS674	14.95
74LS157	.65	74LS682	3.20
74LS158	.59	74LS683	3.20
74LS160	.59	74LS684	3.20
74LS161	.65	74LS685	3.20
74LS162	.69	74LS688	2.40
74LS163	.65	74LS689	3.20
74LS164	.69	81LS95	1.49
74LS165	.95	81LS96	1.49
74LS166	1.95	81LS97	1.49
74LS168	1.75	81LS98	1.49
74LS169	1.75	25LS2521	2.80
74LS170	1.49	25LS2569	4.25

### EPROM ERASERS

	Timer	Capacity Chip	Intensity (uW/Cm <sup>2</sup> )	
PE-14		9	8,000	83.00
PE-14T	X	9	8,000	119.00
PE-24T	X	12	9,600	175.00
PL-265T	X	30	9,600	255.00
PR-125T	X	25	17,000	349.00
PR-320T	X	42	17,000	595.00

## ORDER TOLL FREE

## 800-538-5000

## 800-662-6279

(CALIFORNIA RESIDENTS)

### UARTS

AY3-1014	6.95
AY5-1013	3.95
AY3-1015	6.95
PT1472	9.95
TR1602	3.95
2350	9.95
2651	8.95
IM6402	7.95
IM6403	8.95
INS8250	10.95

### GENERATORS

#### BIT-RATE

MC14411	11.95
BR1941	11.95
4702	12.95
COM5016	16.95
COM8116	10.95
MM5307	10.95

### FUNCTION

MC4024	3.95
LM566	1.49
XR2206	3.75
8038	3.95

### MISC.

UPD7201	29.95
TMS99532	29.95
ULN2003	2.49
3242	7.95
3341	4.95
MC3470	4.95
MC3480	9.00
11C90	13.95
95H90	7.95
2513-001 UP	9.95
2513-002 LOW	9.95

### DISC CONTR.

1771	16.95
1791	24.95
1793	26.95
1795	49.95
1797	49.95
2791	54.95
2793	54.95
2795	59.95
2797	59.95
6843	34.95
8272	39.95
UPD765	39.95
MB8876	29.95
MB8877	34.95
1691	17.95
2143	18.95

### CLOCK CIRCUITS

MM5314	4.95
MM5369	3.95
MM5375	4.95
MM58167	12.95
MM58174	11.95
MSM5832	3.95

### KEYBOARD CHIPS

AY5-2376	11.95
AY5-3600	11.95
AY5-3600 PRO	11.95

### DYNAMIC RAMS

TMS4027	4096 x 1 (250ns)	1.99
UPD411	4096 x 1 (300ns)	3.00
MM5280	4096 x 1 (300ns)	3.00
MK4108	8192 x 1 (200ns)	1.95
MM5298	8192 x 1 (250ns)	1.85
4116-300	16384 x 1 (300ns)	8/11.75
4116-250	16384 x 1 (250ns)	8/11.95
4116-200	16384 x 1 (200ns)	8/12.95
4116-150	16384 x 1 (150ns)	8/14.95
4116-120	16384 x 1 (120ns)	8/29.95
2118	16384 x 1 (150ns) (5v)	4.95
MK4332	32768 x 1 (200ns)	9.95
4164-200	65536 x 1 (200ns) (5v)	5.95
4164-150	65536 x 1 (150ns) (5v)	6.95
MCM6685	65536 x 1 (200ns) (5v)	8.95
TMS4164-15	65536 x 1 (150ns) (5v)	8.95

5V = single 5 volt supply

### 6800

68000	59.95
6800	3.95
6802	7.95
6803	19.95
6808	13.90
6809E	19.95
6809	11.95
6810	2.95
6820	4.35
6821	3.25
6828	14.95
6840	12.95
6843	34.95
6844	25.95
6845	14.95
6847	11.95
6850	3.25
6852	5.75
6860	9.95
6875	6.95
6880	2.25
6883	22.95
68047	24.95
68488	19.95

#### 6800 = 1MHZ

68B00	10.95
68B02	22.25
68B09E	29.95
68B09	29.95
68B10	6.95
68B21	6.95
68B40	19.95
68B45	19.95
68B50	5.95

#### 68B00 = 2 MHZ

### 8200

8202	24.95
8203	39.95
8205	3.50
8212	1.80
8214	3.85
8216	1.75
8224	2.25
8226	1.80
8228	3.49
8237	19.95
8237-5	21.95
8238	4.49
8243	4.45
8250	10.95
8251	4.49
8253	6.95
8253-5	7.95
8255	4.49
8255-5	5.25
8257	7.95
8257-5	8.95
8259	6.90
8259-5	7.50
8271	79.95
8272	39.95
8275	29.95
8279	8.95
8279-5	10.00
8282	6.50
8283	6.50
8284	5.



**2732** 32K EPROM

**\$495**

**2764** 64K EPROM

**\$995**

**7400**

7400	.19	74123	.49
7401	.19	74125	.45
7402	.19	74126	.45
7403	.19	74132	.45
7404	.19	74136	.50
7405	.25	74143	2.95
7406	.29	74145	.60
7407	.29	74147	1.75
7408	.24	74148	1.20
7409	.19	74150	1.35
7410	.19	74151	.55
7411	.25	74153	.55
7413	.35	74154	1.25
7414	.49	74155	.75
7416	.25	74157	.55
7417	.25	74159	1.65
7420	.19	74160	.85
7421	.35	74161	.69
7425	.29	74163	.69
7427	.29	74164	.85
7430	.19	74165	.85
7432	.29	74166	1.00
7437	.29	74167	2.95
7438	.29	74170	1.65
7442	.49	74173	.75
7445	.69	74174	.89
7446	.69	74175	.89
7447	.69	74177	.75
7448	.69	74181	2.25
7451	.23	74184	2.00
7473	.34	74185	2.00
7474	.33	74191	1.15
7475	.45	74192	.79
7476	.35	74193	.79
7482	.95	74194	.85
7483	.50	74195	.85
7485	.59	74197	.75
7486	.35	74198	1.35
7489	2.15	74221	1.35
7490	.35	74246	1.35
7492	.50	74247	1.25
7493	.35	74259	2.25
7495	.55	74273	1.95
7497	2.75	74276	1.25
74100	1.75	74279	.75
74107	.30	74366	.65
74109	.45	74367	.65
74116	1.55	74368	.65
74121	.29	74393	1.35
74122	.45		

**LINEAR**

LM301	.34	LM340 (see 7900)	LM566	1.49	LM1558H	3.10	CA 3023	2.75	CA 3082	1.65
LM301H	.79	LM348	LM567	.89	LM1800	2.37	CA 3039	1.29	CA 3083	1.55
LM307	.45	LM350K	NE570	3.95	LM1812	8.25	CA 3046	1.25	CA 3086	.80
LM308	.69	LM350T	NE571	2.95	LM1830	3.50	CA 3059	2.90	CA 3089	2.99
LM308H	1.15	LM358	NE590	2.50	LM1871	5.49	CA 3060	2.90	CA 3096	3.49
LM309H	1.95	LM359	NE592	2.75	LM1872	5.49	CA 3065	1.75	CA 3130	1.30
LM309K	1.25	LM376	LM709	.59	LM1877	3.25	CA 3080	1.10	CA 3140	1.15
LM310	1.75	LM377	LM710	.75	LM1889	1.95	CA 3081	1.65	CA 3146	1.85
LM311	.64	LM378	LM711	.79	LM1896	1.75	CA 3160	1.19		
LM311H	.89	LM380	LM723	.49	ULN2003	2.49				
LM312H	1.75	LM380N-8	LM723H	.55	LM2877	2.05				
LM317K	3.95	LM381	LM733	.98	LM2900	.85	TL494	4.20	75365	1.95
LM317T	1.19	LM382	LM741	.35	LM2901	1.00	TL496	1.65	75450	.59
LM318	1.49	LM383	LM741N-14	.35	LM3900	.59	TL497	3.25	75451	.39
LM318H	1.59	LM384	LM741H	.40	LM3905	1.25	75107	1.49	75452	.39
LM319H	1.90	LM386	LM747	.69	LM3909	.98	75110	1.95	75453	.39
LM319	1.25	LM387	LM748	.59	LM3911	2.25	75150	1.95	75454	.39
LM320 (see 7900)	LM389	1.35	LM1014	1.19	LM3914	3.95	75154	1.95	75491	.79
LM322	1.65	LM390	LM1303	1.95	LM3915	3.95	75188	1.25	75492	.79
LM323K	4.95	LM392	LM1310	1.49	LM3916	3.95	75189	1.25	75493	.89
LM324	.59	LM393	MC1330	1.69	LM3916	3.95	75189	1.25	75493	.89
LM329	.65	LM394H	MC1349	1.89	MC4024	3.95			75494	.89
LM331	3.95	LM399H	MC1350	1.19	MC4044	4.50				
LM334	1.19	NE531	MC1358	1.69	RC4136	1.25				
LM335	1.40	NE555	MC1372	6.95	RC4151	3.95				
LM336	1.75	NE556	LM1414	1.59	LM4250	1.75	TL071	.79	TL084	2.19
LM337K	3.95	NE558	LM1458	.59	LM4500	3.25	TL072	1.19	LF347	2.19
LM337T	1.95	NE561	LM1488	.69	RC4558	.69	TL074	2.19	LF351	.60
LM338K	6.95	NE564	LM1489	.69	LM13080	1.29	TL081	.79	LF353	1.00
LM339	.99	LM565	LM1496	.85	LM13600	1.49	TL082	1.19	LF355	1.10
					LM13700	1.49	TL083	1.19	LF356	1.10

H = TO-5 CAN      T = TO-220      K = TO-3

**RCA**

CA 3023	2.75	CA 3082	1.65
CA 3039	1.29	CA 3083	1.55
CA 3046	1.25	CA 3086	.80
CA 3059	2.90	CA 3089	2.99
CA 3060	2.90	CA 3096	3.49
CA 3065	1.75	CA 3130	1.30
CA 3080	1.10	CA 3140	1.15
CA 3081	1.65	CA 3146	1.85
CA 3160	1.19		

**TI**

TL494	4.20	75365	1.95
TL496	1.65	75450	.59
TL497	3.25	75451	.39
75107	1.49	75452	.39
75110	1.95	75453	.39
75150	1.95	75454	.39
75154	1.95	75491	.79
75188	1.25	75492	.79
75189	1.25	75493	.89
75494	.89		

**BI FET**

TL071	.79	TL084	2.19
TL072	1.19	LF347	2.19
TL074	2.19	LF351	.60
TL081	.79	LF353	1.00
TL082	1.19	LF355	1.10
TL083	1.19	LF356	1.10
LF357	1.40		

**CMOS**

4000	.29	4528	1.19
4001	.25	4531	.95
4002	.25	4532	1.95
4006	.89	4538	1.95
4007	.29	4539	1.95
4008	.95	4541	2.64
4009	.39	4543	1.19
4010	.45	4553	5.79
4011	.25	4555	.95
4012	.25	4556	.95
4013	.38	4581	1.95
4014	.79	4582	1.95
4015	.39	4584	.75
4016	.39	4585	.75
4017	.69	4702	12.95
4018	.79	74C00	.35
4019	.39	74C02	.35
4020	.75	74C04	.35
4021	.79	74C08	.35
4022	.79	74C10	.35
4023	.29	74C14	.59
4024	.65	74C20	.35
4025	.29	74C30	.35
4026	1.65	74C32	.39
4027	.45	74C42	1.29
4028	.69	74C48	1.99
4029	.79	74C73	.65
4030	.39	74C74	.65
4034	1.95	74C76	.80
4035	.85	74C83	1.95
4040	.75	74C85	1.95
4041	.75	74C86	.39
4042	.69	74C89	4.50
4043	.85	74C90	1.19
4044	.79	74C93	1.75
4046	.85	74C95	.99
4047	.95	74C107	.89
4049	.35	74C150	5.75
4050	.35	74C151	2.25
4051	.79	74C154	3.25
4053	.79	74C157	1.75
4060	.89	74C160	1.19
4066	.39	74C161	1.19
4068	.39	74C162	1.19
4069	.29	74C163	1.19
4070	.35	74C164	1.39
4071	.29	74C165	2.00
4072	.29	74C173	.79
4073	.29	74C174	1.19
4075	.29	74C175	1.19
4076	.79	74C192	1.49
4078	.29	74C193	1.49
4081	.29	74C195	1.39
4082	.29	74C200	5.75
4085	.95	74C221	1.75
4086	.95	74C244	2.25
4093	.49	74C373	2.45
4098	2.49	74C374	2.45
4099	1.95	74C901	.39
14409	12.95	74C902	.85
14410	12.95	74C903	.85
14411	11.95	74C905	10.95
14412	12.95	74C906	.95
14419	7.95	74C907	1.00
4502	.95	74C908	2.00
4503	.85	74C909	2.75
4508	1.95	74C910	9.95
4510	.85	74C911	8.95
4511	.85	74C912	8.95
4512	.85	74C914	1.95
4514	1.25	74C915	1.19
4515	1.79	74C918	2.75
4516	1.55	74C920	17.95
4518	.89	74C921	15.95
4519	.39	74C922	4.49
4520	.79	74C923	4.95
4522	1.25	74C925	5.95
4526	1.25	74C926	7.95
4527	1.95	74C928	7.95
		74C929	19.95

**EXAR**

XR 2206	3.75
XR 2207	3.75
XR 2208	3.75
XR 2211	5.25
XR 2240	3.25

**INTERSIL**

ICL7106	9.95
ICL7107	12.95
ICL7660	2.95
ICL8038	3.95
ICM7207A	5.59
ICM7208	15.95

**9000 SERIES**

9316	1.00
9334	2.50
9368	3.95
9401	9.95
9601	.75
9602	1.50
96S02	1.95

**IC SOCKETS**

8 pin ST	1.99	100
14 pin ST	.13	.11
16 pin ST	.15	.12
18 pin ST	.17	.13
20 pin ST	.20	.18
22 pin ST	.29	.27
24 pin ST	.30	.27
28 pin ST	.40	.32
40 pin ST	.49	.39
64 pin ST	4.25	call
ST = SOLDER TAIL		
8 pin WW	.59	.49
14 pin WW	.69	.52
16 pin WW	.69	.58
18 pin WW	.99	.90
20 pin WW	1.09	.98
22 pin WW	1.39	1.28
24 pin WW	1.49	1.35
28 pin WW	1.69	1.49
40 pin WW	1.99	1.80
WW = WIREWRAP		
16 pin ZIF	6.75	call
24 pin ZIF	9.95	call
28 pin ZIF	10.95	call
ZIF = TEXT TOOL (Zero Insertion Force)		

**DATA ACQUISITION**

ADC0800	15.55	DAC0808	2.95
ADC0804	3.49	DAC1020	8.25
ADC0809	4.49	DAC1022	5.95
ADC0817	9.95	MC1408L6	1.95
DAC0800	4.95	MC1408L8	2.95

**SOUND CHIPS**

76477	3.95
76489	8.95
AY3-8910	12.95
AY3-8912	12.95
MC3340	1.49

**8" DRIVE SALE**

**FD100-8 \$189**  
SHUGART 801 EQUIVALENT  
SS/DD 10 FOR \$175 EA.

**FD200-8 \$239**  
SHUGART 851 EQUIVALENT  
DS/DD 10 FOR \$220 EA.

**ORDER 800-**



### CABINETS FOR 5 1/4" DISK DRIVES

**CABINET #1 \$29.95**

- \* DIMENSIONS 8 3/8 x 5 1/8 x 3 1/8"
- \* COLOR MATCHES APPLE
- \* FITS STANDARD 5 1/4" DRIVES, INCL. SHUGART
- \* INCLUDES MOUNTING HARDWARE AND FEET

**CABINET #2 \$79.00**

- \* COMPLETE WITH POWER SUPPLY, SWITCH, LINE CORD, FUSE & STANDARD POWER CONNECTOR
- \* DIMENSIONS: 11 1/2 x 5 3/4 x 3 1/8"
- \* +5V @ 1 AMP, +12V @ 1.5 AMP
- \* FITS STANDARD 5 1/4" DRIVES
- \* PLEASE SPECIFY GRAY OR TAN

NOTE: Please include sufficient amount for shipping on above items.

### CONNECTORS

RS232 MALE	2.50
RS232 FEMALE	3.25
RS232 HOOD	1.25
S-100 ST	3.95

### EDGE-CARD CONNECTORS

S-100 ST	3.95
S-100 WW	4.95
72 pin ST	6.95
72 pin WW	7.95
50 pin ST	4.95
44 pin ST	2.95
44 pin WW	4.95
44 pin SE	3.95

### MUFFIN FANS NEW UN-USED

4.68" Square	14.95
3.125" Square	14.95

### OPTO-ISOLATORS

4N26	1.00
4N27	1.10
4N28	.69
4N33	1.75
4N35	1.25
4N37	1.25
MCT-2	1.00
MCT-6	1.50
MCA-7	4.25
MCA-255	1.75
IL-1	1.25
ILA-30	1.25
ILQ-74	2.75
H11C5	1.25
TIL-111	1.00
TIL-113	1.75

### TRANSISTORS

2N918	.50	MPS3706	.15
MPS918	.25	2N3772	1.85
2N2102	.75	2N3903	.25
2N2218	.50	2N3904	.10
2N2218A	.50	2N3906	.10
2N2219	.50	2N4122	.25
2N2219A	.50	2N4123	.25
2N2222	.25	2N4249	.25
PN2222	.10	2N4304	.75
MPS2369	.25	2N4401	.25
2N2484	.25	2N4402	.25
2N2905	.50	2N4403	.25
2N2907	.25	2N4857	1.00
PN2907	.125	PN4916	.25
2N3055	.79	2N5086	.25
3055T	.69	PN5129	.25
2N3393	.30	PN5139	.25
2N3414	.25	2N5209	.25
2N3563	.40	2N6028	.35
2N3565	.40	2N6043	1.75
PN3565	.25	2N6045	1.75
MPS3638	.25	MPS-A05	.25
MPS3640	.25	MPS-A06	.25
PN3643	.25	MPS-A55	.25
PN3644	.25	TIP29	.65
MPS3704	.15	TIP31	.75
		TIP32	.79

### DISK DRIVES

<b>TANDON</b>	
TM100-1 5 1/4" (FOR IBM) SS/DD	229.00
TM100-2 5 1/4" (FOR IBM) DS/DD	259.00
<b>SHUGART</b>	
SA 400L 5 1/4" (40 TRACK) SS/DD	199.95
SA 400 5 1/4" (35 TRACK) SS/DD	189.95
<b>PERTEC</b>	
FD-200 5 1/4" SS/DD	179.95
FD-250 5 1/4" DS/DD	199.95
<b>MPI</b>	
MP-52 5 1/4" (FOR IBM) DS/DD	249.00

NOTE: Please include sufficient amount for shipping on above items.

### DIODES

1N751	5.1 volt zener	.25
1N759	12.0 volt zener	.25
1N4148	(1N914) switching	25/1.00
1N4004	400PIV rectifier	10/1.00
KBPO2	200PIV 1.5amp bridge	.45
KBPO4	400PIV 1.5amp bridge	.55
VM48	Dip-Bridge	.35

### RESISTORS

1/4 WATT 5% CARBON FILM ALL STANDARD VALUES FROM 1 OHM TO 10 MEG OHM

50 PCS. SAME VALUE	.025
100 PCS. SAME VALUE	.02
1000 PCS. SAME VALUE	.015

### BYPASS CAPS

.01 UF DISC	100/6.00
.1 UF DISC	100/8.00
.1 UF MONOLITHIC	100/15.00

CALL US FOR VOLUME QUOTES



ORDER TOLL FREE

800-538-5000

800-662-6279

(CALIFORNIA RESIDENTS)

### MICROCOMPUTER HARDWARE HANDBOOK FROM ELCOMP — \$14.95

Over 800 pages of manufacturers data sheets on most commonly used IC's.

Includes:

- \* TTL — 74/74LS and 74F
- \* CMOS
- \* Voltage Regulators
- \* Memory — RAM, ROM, EPROM
- \* CPU's — 6800, 6500, Z80, 8080, 8085, 8086/8
- \* MPU support & interface — 6800, 6500, Z80, 8200, etc.

### RIBBON CABLE

CONTACTS	SINGLE COLOR		COLOR CODED	
	1'	10'	1'	10'
10	.50	4.40	.83	7.30
16	.55	4.80	1.00	8.80
20	.65	5.70	1.25	11.00
25	.75	6.60	1.32	11.60
26	.75	6.60	1.32	11.60
34	.98	8.60	1.65	14.50
40	1.32	11.60	1.92	16.80
50	1.38	12.10	2.50	22.00

### D-SUBMINIATURE

DESCRIPTION	SOLDER CUP		RIGHT ANGLE PC SOLDER		IDC RIBBON CABLE		HOODS	
	MALE	FEMALE	MALE	FEMALE	MALE	FEMALE	BLACK	GREY
ORDER BY	DBxxP	DBxxS	DBxxPR	DBxxSR	IDBxxP	IDBxxS	HOOD-B	HOOD
CONTACTS	9	2.08	2.66	1.65	2.18	3.37	3.69	1.60
	15	2.69	3.63	2.20	3.03	4.70	5.13	1.60
	25	2.50	3.25	3.00	4.42	6.23	6.84	1.25
	37	4.80	7.11	4.83	6.19	9.22	10.08	2.95
	50	6.06	9.24	—	—	—	—	3.50

For order instructions see "IDC Connectors" below.

**MOUNTING HARDWARE 1.00**

### IDC CONNECTORS

DESCRIPTION	SOLDER HEADER	RIGHT ANGLE SOLDER HEADER	WW HEADER	RIGHT ANGLE WW HEADER	RIBBON HEADER SOCKET	RIBBON HEADER	RIBBON EDGE CARD
ORDER BY	IDHxxS	IDHxxSR	IDHxxW	IDHxxWR	IDSxx	IDMxx	IDExx
CONTACTS	10	.82	.85	1.86	2.05	1.15	2.25
	20	1.29	1.35	2.98	3.28	1.86	2.36
	26	1.68	1.76	3.84	4.22	2.43	2.65
	34	2.20	2.31	4.50	4.45	3.15	3.25
	40	2.58	2.72	5.28	4.80	3.73	3.80
	50	3.24	3.39	6.63	7.30	4.65	4.74

ORDERING INSTRUCTIONS: Insert the number of contacts in the position marked "xx" of the "order by" part number listed. Example: A 10 pin right angle solder style header would be IDH10SR.

### VISIT OUR RETAIL STORE

HOURS: M-W-F, 9-5 T-Th., 9-9 Sat. 10-3

PLEASE USE YOUR CUSTOMER NUMBER WHEN ORDERING

TERMS: Minimum order \$10. For shipping and handling include \$2.50 for UPS Ground and \$3.50 for UPS Air. Orders over 1 lb. and foreign orders may require additional shipping charges — please contact our sales department for the amount. CA residents must include 6% sales tax, Bay Area and LA residents include 6 1/2%. Prices subject to change without notice. We are not responsible for typographical errors. We reserve the right to limit quantities and to substitute manufacturer. All merchandise subject to prior sale.

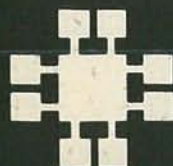

**JDR Microdevices**

1224 S. Bascom Ave. • San Jose, CA 95128

(408) 995-5430 • Telex 171-110

© Copyright 1983 JDR Microdevices

CIRCLE 49 ON FREE INFORMATION CARD



# FOR APPLE COMPUTER USERS

## JDR PRODUCTS

### JDR HALF-HEIGHT DISK DRIVE

- \* 35 Track w/Apple Controller
  - \* 40 Track Controller and DOS Available (Call for Price)
- NEW \$239<sup>95</sup>**

### JDR 16K RAM CARD FOR APPLE II+

- \* 2 YEAR WARRANTY
  - Kit with Instructions ..... \$40.95
  - Bare PC Card ..... \$14.95
- \$44<sup>95</sup>**

### JDR COOLING FAN CLEARANCE SALE!

- \* With Surge Protection
  - \* Quantities Are Limited!
- \$49<sup>95</sup>**

## MA SYSTEMS

### FD-35 DISK DRIVE ..... \$229.95

- \* Shugart Mechanism — Made in U.S.A.
- \* Direct Replacement for Apple Disk II \* 1 Year Warranty

### CONTROLLER CARD ..... \$69.95

- \* One Year Warranty

## APPLE COMPATIBLE POWER SUPPLY

- \* Use To Power Apple-Type Systems

- \* +5V @ 5A +12V @ 3A
- \* -5V @ .5A -12V @ .5A

- \* Instructions Included

**\$79<sup>95</sup>**

**800-538-5000**

**800-662-6279**  
(CALIFORNIA RESIDENTS)

## OTHER ACCESSORIES FOR APPLE II

### THUNDERCLOCK ..... \$129.95

- \* Real-Time Clock Calendar \* Software Included
- \* Mountain Software Compatible
- \* BSR Control Options Available

### KRAFT JOYSTICK ..... \$49.95

"The Choice of Professionals"



**ALL  
MERCHANDISE  
100%  
GUARANTEED**

## PERISOFT

### PRINTERLINK

- \* Low Cost Centronics Parallel Interface with Cable and Manual
- \$59<sup>00</sup>**

### MESSENGER

- \* Serial Interface Connects Virtually Any Serial Device
  - \* Includes Cable
- \$99<sup>00</sup>**

### TIMELINK

- \* Real-Time Clock Calendar with Alarm Feature
- \$84<sup>00</sup>**

**ALL WITH ONE YEAR WARRANTY**

## MICROMAX

### VIEWMAX-80 NOW ONLY \$159<sup>95</sup>

- \* 80 Column Card for Apple II+
- \* Video Soft Switch
- \* Inverse Video \* 2 Year Warranty

### VIEWMAX-80e ..... NEW \$129<sup>95</sup>

- \* 80 Column Card for Apple IIe
- \* 64K RAM Expandable to 128K
- 64K RAM Upgrade ..... \$47.60

### GRAPHMAX ..... \$129<sup>95</sup>

- \* Hi Resolution Graphics
- \* Printer Card
- \* Centronics Parallel Interface

### Graphmax with Color & Zoom Options ..... \$149.95

### Z-MAX ..... \$139<sup>95</sup>

- \* Z-80 Card for Apple II+
- \* Use to Run CPM Programs

## MONITORS

### MONOCHROME

### BMC BM 12AUW GREEN 12" NEW ..... \$89.95

### NEC JB1201M - 20 MHZ GREEN ..... \$169.00

### ZENITH ZVM-121 - 15 MHZ GREEN ..... \$99.00

### TAXAN 18 MHZ AMBER ..... \$139.00

### COLOR

### BMC BM-AU9191U COMPOSITE 13" ..... \$279.00

### AMDEK COLOR I - COMPOSITE ..... \$335.00

NO C.O.D. ORDERS PLEASE

## 5 1/4" DISKETTES

### VERBATIM DATALIFE

### SS/DD SOFT SECTOR ..... 29.95

### SS/DD 10 SECTOR HARD ..... 29.95

## NASHUA

### SS/SD SOFT SECTOR WITH HUB RING ..... \$19<sup>95</sup>

Ask about our full line of Nashua diskettes

**BEST BUY**

**ORDER TOLL FREE**

**800-538-5000**

**800-662-6279**

(CALIFORNIA RESIDENTS)

**VISIT DURING  
OUR EXPANDED  
RETAIL STORE HOURS  
SATURDAY 10 to 3**



### TUSA

A WHOLE NEW WORLD OF TV VIEWING WITH TUSA'S NEW MODEL CVU-40, 40 CHANNEL CABLE TV CONVERTER. Receive all the EXTRA CABLE TV "MIDBAND" & SUPERBAND CHANNELS on your UHF DIAL.

Eliminates the need for renting or leasing. This system takes the "midband" and "superband" channels your TV, VCR or projector can't receive and converts them to standard UHF channels that any set can tune in.

**A MUST FOR VIDEO-TAPING FROM CABLE TV!**  
The system allows you to program both pay (pay TV) decoder required and standard cable channels for taping on any VCR - while you are watching a different channel on your TV.

Simple to install and operate on any make of TV with UHF.

**Now \$28.95 ea.**  
PLUS POSTAGE

**NOW AVAILABLE**  
NEW TUNEABLE DELUXE MODEL CVU-1000 **\$34.95 ea.**

### UHF TUNERS

45 MHz Output

Click Stop Detent Tune Model. Excellent for replacement use or experimental work building UHF receivers for ham or TV.

**WHILE THEY LAST**  
**\$3.95 ea.**  
10 or more **\$2.99 ea.**

### POPULAR IC's

TOP QUALITY NO SECONDS

TYPE	DESCRIPTION	1-9	10-UP
LM 3800	2 watt Audio Power Amp	\$1.49	\$0.80
LM 3800-3	Low Voltage Audio Amp	1.59	1.19
LM 5650	Phase Locked Loop	1.49	.99
LM 733N	Video Amp	1.69	.99
MC-1330	Video Detector	2.20	1.69
MC-1349	Video If Amp	2.06	1.55
MC-1350	Video If Amp	1.75	1.19
MC-1352	Video If Amp AGC	2.69	2.09
MC-1358	Audio If Amp	1.75	1.64
MC-1374P	R.F. Modulator	3.19	2.39
MC-1458	Dual Comp. Op Amp	.88	.59
MC-1498A	Balanced Mod/Demodulator	1.79	1.34
LM 1889	Video Modulator	2.79	1.95
<b>LINEAR VOLTAGE REGULATORS</b>			
LM 7805	5 Volt Positive Volt. Reg.	1.19	.89
LM 7808	8 Volt Positive Volt. Reg.	1.19	.89
LM 7812	12 Volt Positive Volt. Reg.	1.19	.89
LM 7815	15 Volt Positive Volt. Reg.	1.19	.89
LM 7818	18 Volt Positive Volt. Reg.	1.19	.89
LM 7824	24 Volt Positive Volt. Reg.	1.19	.89
NE-564 New Plug in Replacement now in stock. \$5.75 ea or \$3.50 each with every \$50.00 purchase of other parts.			

### AC LINE CORDS

18 gauge wire  
6 ft. long cable  
Prestripped and tinned ends for easy installation.

AC-6G 12-Up **49c ea.**  
AC-6G 12-Up **39c ea.**

### WINEGARD

75 OHM UHF YAGI ANTENNAS

12 db GAIN  
Specify Channel

18db Gain  
NF - 1.8db  
**\$39.95 ea.**

12db Gain  
NF - 1.8db  
**\$7.95 ea.**

### Now Back in Stock!

SANYO UHF VARIATOR TUNERS  
75 Ohm Input - 45 MHz Output  
For Channels 14 - 83

MODEL 115-B-402A **\$18.95 EACH**

All units are brand new from Sanyo  
Call for Quantity Price

### JERROLD 400

DIGITAL CATV CONVERTER

You can receive all cable channels including the important, with the convenience of an infrared remote control. This unit receives up to 60 TV channels and outputs them to Channel 3. With the remote control you can change channels, turn your TV on or off, or even fine tune it, without leaving your chair.

Requires: 1) remote line cable  
2) 100V AC power  
3) 100V AC power  
4) 100V AC power

**\$119.95 ea.**

### COLORMAX

36 CHANNEL REMOTE CATV CONVERTER

Now you can change channels or fine-tune your TV set by remote control up to 20 ft. away. This unit receives channels 2-13 plus mid & superband cable channels then outputs them on Channel 3.

MODEL CM55-2P  
2 pc.  
REMOTE CONTROL **\$69.95 ea.**  
3 or more **\$64.95 ea.**

### NEW 1984 B&K AUTOMANUAL RANGING MULTIMETER

Model 2007

Dimensions: 7 1/2" wide x 9 1/2" high x 5 1/2" deep. Removable 1/8" thick back cover.

**\$10.95 ea.**  
SC001 **\$8.95 ea.**  
2 or more

**SPECIAL PRICE!**  
**\$94.00 ea.**

**BK PRECISION**

### POPULAR MICROWAVE PARTS

MRF-901 ..... \$2.35  
9-Up ..... 1.95  
MRF-91 ..... 3.46  
9-Up ..... 3.12  
MBD-101 ..... .58  
COP CAPS .001 mid ..... .50  
25-Up ..... .30  
2N6003 (formerly MRF-902) ..... 11.96

**Now Back in Stock!**  
MITSUMI UHF VARIATOR TUNERS  
75 Ohm Input - 45 MHz Output  
For Channels 14 - 83  
NEW LOW PRICE **\$15.95 ea.**  
All units are brand new.  
Call for Quantity Price

### PROJECT BOXES

Woodgrain

This box is 11 1/2" W. x 4 1/2" H. x 6 1/2" D with a removable aluminum U shaped chassis 11" W. x 3 1/2" H. x 6" D inside.

**\$12.50 ea.**  
4 or more **\$10.95 ea.**  
PREPUNCHED & SILVERFINISHED **\$14.95 ea.**  
For Larger Quantities Call

### 75 OHM CHASSIS MOUNT CONNECTOR

F-61 Female connector. Rear chassis mount with nut. Mates with male "F" connectors.

**Now! 4 for \$1.00**

### POPULAR MISCELLANEOUS PARTS

IN4001 Diodes 15 for ..... \$1.00  
100 for ..... \$5.00  
1/4w 10K Thumbwheel pots  
1-12 ..... .39  
13-Up ..... .29  
Toroids - T30-12 ..... .46  
20-Up ..... .25  
Toroids - T37-2 ..... .38  
20-Up ..... .25

### DELUXE A-B SWITCHES

Specify Pushbutton or lever type

For CATV - MATV - VCR  
75 ohm - 90 db Isolation  
**\$6.50 ea.**  
2 or more **\$5.95 ea.**

### SPEAKER CABINET

Popular speaker cabinets for those famous homebrew TV circuits. Speakers included.

Dimensions: 7 1/2" wide x 9 1/2" high x 5 1/2" deep. Removable 1/8" thick back cover.

**\$10.95 ea.**  
SC001 **\$8.95 ea.**  
2 or more

### QUALITY POWER TRANSFORMERS

24V CT, 500 mA

**\$3.19 ea.** 10-49 **\$2.75 ea.**  
50 or more **\$2.25 ea.**  
For Larger Quantities Call

### SONY SURPLUS UHF-VHF VARIATOR TUNERS

These tuners receive all channels 2-83, plus midband cable channels and are perfect for homebrew TV circuits etc. Output Freq. 45 MHz. Hookup data included. Name Brand.

Model #852  
**Now! \$15.95 ea.**

**ORDER NOW**  
TOLL FREE  
**800-854-4655**  
OUTSIDE CALIFORNIA  
**714-635-0090**  
INSIDE CALIFORNIA

**R.F. ELECTRONICS**  
1056 N. STATE COLLEGE BLVD., DEPT. R  
ANAHEIM, CALIFORNIA 92806

OPEN TUES - FRI 10 - 6  
SAT 10 - 5  
CLOSED SUN & MON

SEND for FREE Mail Order Catalog

PERSONAL CHECKS HELD FOR CLEARANCE - NO MINIMUM ORDER  
ALL PREPAID ORDERS 2 LBS OR LESS MUST INCLUDE \$2.50 SHIPPING & HANDLING - SHIPPED SAME DAY RECEIVED

# ELECTRONIC COMPONENTS

**MOUSER ELECTRONICS**  
NEW PUBLISHED  
160 PAGE  
**FREE CATALOG**

**MANUFACTURERS OF QUALITY ELECTRONIC COMPONENTS**

Battery Clips & Holders  
Cable Sets Connectors Capacitors  
Displays, LED Fuses Jacks & Plugs  
Knobs Lamps Potentiometers  
RF Coils Relays Resistors  
Switches Semiconductors Speakers  
Test Equipment Transformers Tools  
Wire & Cable

**WE STOCK What We Catalog!**

- Sales and Order Desk  
Open from 6:00 a.m. (PST)
- Phone and Mail Orders Welcome
- TERMS: C.O.D., Visa, MasterCard (Open Accounts Available)
- Over 10,000 Different Items in Stock

**MOUSER ELECTRONICS**  
11433 WOODSIDE AVE., SANTEE, CA 92071  
PHONE: (619) 449-2222 TWX: 910-331-1175

CIRCLE 27 ON FREE INFORMATION CARD

## POPULAR TELEVISION CIRCUITS

# WHY PAY MORE?

## SINE WAVE SUPER BOARD

### ZENITH M1 FV-5

09-151-03 Phase Video Sync. Suppression  
M1 & FV 5 used as a system

State of the art technology brings you this superior Sinewave Superboard. It has no internal connection to TV, RF modulator built on the board, AGC for stability and tunes the entire band with a varactor tuner and multi-turn pot. A high quality plated-thru circuit board with silk-screened parts layout, easy to follow, fully illustrated instructions and quality parts make this kit easy to assemble. The beautifully finished cabinet will add a touch of class to the many hours of enjoyment you will receive building and using this kit.

Sync. Suppression  
M1 & FV 5 used as a system

□ KSW 1483 Sinewave Kit **\$119.95 + \$5.95 S/H**  
□ KSO 1484 Sinewave Minus PCB **\$99.95 + \$5.95 S/H**  
□ PCS 6252 Sinewave PCB only **\$20.00 + \$3.00 S/H**

□ KZM 2083 M1 FV-5 Kit **\$199.95 + \$6.95 S/H**  
□ KZO 2084 FV-5 Kit (minus M1) **\$149.95 + \$6.95 S/H**  
□ PCZ 8000 FV-5 PCB only **\$30.00 + \$3.00 S/H**  
□ ZMO 9151 M1 Board only **\$89.95 + \$5.95 S/H**

This advanced baseband video inversion/sync suppression system which is most often used nationwide is one of our most popular kits. It features AGC for stability, RF modulator built on the board, no internal connection to TV, and full band variable tuning. High quality parts, fully illustrated instructions, prepunched cabinet and plated-thru/solder-masked P.C. board make this kit a breeze to assemble. The M1 varactor tuner board is assembled and tested and need only be interconnected to the FV-5 board. The completed circuitry is then placed in the beautifully finished cabinet. Place your order today.

### MICROWAVE PROBE BRAND NEW!

□ KMP 2030 Micro Probe Kit **\$24.95**  
+ \$3.00 S/H

□ PCM 2000 Micro PCB only **\$4.95**  
+ \$3.00 S/H

□ RFM 3040 Crystal Modulators **\$24.95**  
+ \$3.00 S/H

- Crystal Controlled
- Brilliant Picture on Ch 3 or 4
- For Video Tape Recorders, Satellite TV Receivers

□ MPD 2000 Micro 20" Dish **\$14.95**  
+ \$5.95 S/H

□ KMP 1218 Micro Power Supply Kit **\$19.95**  
+ \$3.00 S/H

**UNSURE? Order any manual for only \$9.95 post paid. Refundable with order.**

• HOBBY USE ONLY. NOT FOR UNAUTHORIZED RECEPTION OF TV SIGNALS.  
• AVAILABLE BY MAIL ONLY • SEND FOR INFORMATION ON OTHER ITEMS.  
• COMPLETE REPAIR SERVICE • CHECKS HELD 3 WEEKS FOR CLEARANCE.

4218 S. 36TH PL., PHOENIX, ARIZONA 85040  
ORDERS ONLY. **(800) 243-6700**

**WESTECH ELECTRONICS**  
**(602) 276-1600**

MasterCard NATIONAL DELIVERY VISA

CIRCLE 95 ON FREE INFORMATION CARD

## AMAZING DEVICES

**PHASOR PAIN FIELD** - Patented and recently developed in our labs is being tested by Gov't for riot control. Soon to come under weapons restrictions as an infernal machine. Easily hand-held. Hazardous IF NOT USED WITH DISCRETION.

PPF-1 PLANS (sold for animal control) **\$15.00**

**INVISIBLE PAIN FIELD GENERATOR** - Produces a directional field of moderately intense pain to back of head up to 50'. Cigarette pack size enclosure is easily hidden.

IPG-3 PLANS **\$7.00** IPG-3K KIT & PLANS **\$44.50**  
IPG-30 (assembled for animal control) **\$59.50**

**PHASOR STUN/BURNING WAND** - Produces sufficient electrical energy capable of burning flesh. Intended as a personal defense device.

PSW-3 PLANS **\$8.00** PSW-3K KIT & PLANS **\$59.50**

**RUBY LASER RAY PISTOL** - Intense visible red, burns, hazardous, with parts sources.

RUBY PLANS (includes all part sources) **\$15.00**

**CARBON DIOXIDE LASER** - Generates 20-40 watts of continuous power capable of burning, cutting, hazardous. (with all part sources) **\$15.00**

**LASER RIFLE** - Produces 200-3000 pulses of 30 watt optical energy. Portable and easily hand-held.

LRG-3 PLANS **\$10.00**  
LRG-3K KIT PLANS (minus diode) **\$129.50**

**POCKET LASER** - For the beginner, visible red optical version, non-hazardous.

LHC-2 **\$5.00** LHC-2K KIT & PLANS **\$24.50**

**HIGH POWERED PORTABLE ENERGY SOURCE FOR LASERS AND MAGNETIC WEAPONS** - Exploding wires, shockwave, etc. Miniature size.

HPS-1 PLANS **\$8.00** HPS-1K KIT & PLANS **\$49.50**

**PARTICLE BEAM WEAPON** - PLANS **\$15.00**

**INFINITY XMTR** - Uses telephone lines for selective home or office listening while away on business or vacation.

INF-1 PLANS **\$15.00**

**SEE IN DARK** - Long range, total darkness.

SD-4 PLANS **\$10.00**

**LONG RANGE WIRELESS MIKE** - Crystal clear quality - miniature.

FBT-7 PLANS **\$7.00** FBT-7K PLANS & KIT **\$34.50**

**WIRELESS TELEPHONE TRANSMITTER** - Long range, automatic.

WVPM-5 PLANS **\$10.00** WVPM-5K PLANS & KIT **\$34.50**

Send for **FREE** catalog description of above plus hundreds more plans, kits and completed items. We accept MC or Visa or when ordering, send check or money order. We pay shipping charges on orders over \$50.00, otherwise include 10% with remittance.

SEND TO: **SCIENTIFIC SYSTEMS**  
DEPT. R8, BOX 716, AMHERST, N.H. 03031



# SEI, INC.

641 Academy Drive • Northbrook, Ill. 60062 • (312) 564-0104



## THE SOLUTION COMPUTER

An Affordable 64K Assembled Computer With These Features:



- Fully compatible with Apple® II +
- Original design!
- Fully assembled and tested!
- Detachable keyboard for easy use, upper lower case.
- Uses 64K × Dynamic Ram
- 9 on board peripheral connectors for expansion.
- Uses 6502 mpu.

**\$675.00 each** (Monitor not included)

The Solution Computer is the answer for people who realize a great product when they see one. Many other peripheral card products are available for the Solution Computer. Send for a free color brochure today.

## APPLE II® COMPATIBLE SLIM DISK DRIVE

**RUNS QUIETER THAN THE ORIGINAL!**

New - guaranteed! Only 6" w x 1 1/2" h x 10" d. Complete with a 3' cable. Runs with Apple controller or our optional controller.



Now only **\$224.95**

## SOLID STATE STEREO GRAPHIC EQUALIZER PRE AMP KIT TA-2500



**Specifications:** • Total Harmonic Distortion: Less than 0.05% • Intermodulation Distortion: (70Hz: 7KHz = 4:1 SMPTTE Method) Less than 0.03% • Frequency Response: Overall 10Hz ~ 100KHz +0.5db -1dB. • RIAA Curve Deviation: (Phono) +0.2dB -0.2dB (30Hz ~ 15KHz) • Channel separation (at rated output 1 KHz) • Phono. Tuner. Aux and Tape Monitor better than 70dB. • Input sensitivity and impedance (1KHz for rated output) **Phono:** 2MV 47K ohms **Aux:** 130MV 50K ohms **Tuner:** 130MV 50K ohms **Tape:** 130MV 50K ohms. **Graphic Equalizer control:** 10 Band Slide Control. **Frequency Bands:** 31 5Hz: 63Hz: 125Hz: 250Hz: 500Hz: 1KHz: 2KHz: 4KHz: 8KHz: 16KHz also with on panel selector for Phono. Tuner. Aux 1 and Aux 2. **Power Supply:** 117 VAC

Kit comes with all electronic components, transformer, instructions and a 19" rack mount type metal cabinet.

MODEL TA-2500 **\$119.00 PER KIT**

## MONITOR (12")



- Orange amber screen
- 18 MHz bandwidth
- High resolution graphics

Composite video 1/0 75/10K ohm impedance. A phenomenal quality monitor for your computer. 110 VAC.

MON-1 ..... **\$119.95**

## APPLE II PERIPHERAL CARDS

- 80 column card ..... **\$109.95**
- 16 Ram card ..... **\$44.50**
- Z80 cpm card ..... **\$99.95**
- Disk controller card ..... **\$59.95**
- Eprom writer card ..... **\$84.95**

## INFRA-RED REMOTE CONTROL SWITCH KIT



Infra-red Remote Control switch can be used to control appliances up to 500 W. The TK-41 has effective control up to 10 meters.

No antenna needed. Features latest IC controller which excludes interferences from light or AC pulse signal.

TK-41 Kit ..... **\$24.95**

## UHF TV PREAMP



- Features:**
- 25 dB gain!
  - Kit

Your reception will dramatically improve! This unit will enable you to pull in signals you never knew were there! For both indoor and outdoor use. Input and output impedance 75 ohm. No adjustment! Easy assembly.

JH-0 Kit ..... **\$23.95**

## TA-802 160 WATT TOTAL 80W + 80W STEREO AMP KIT

This is a solid state all transistor circuitry on board stereo amplifier. Power output employs 2 pairs of matching Darlington transistors. T.H.D. less than .05% between DC to 200 KHz. Pwr supply requires 30 VCT 2 amp × FMR.

TA-802 **\$39.95**

Transformer (optional) **\$9.95 ea.**

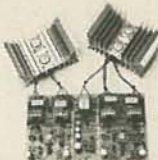

## R.F. MODULATOR

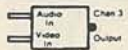

Combine both audio and video output onto channel 3 or 4 of your T.V. set. Single J.C. chip (MC 1374) makes for quick and easy assembly. Single adjustment control! A must for every video recording or computer enthusiast.

VH-0 Kit ..... **\$19.95**

## PHILIPS VARACTOR TUNER



Comes with adaptor board to directly replace Mitsumi tuner! Can use this with any board drilled for Mitsumi! High gain and phenomenal picture quality.

**SPECIFICATIONS:** • Freq. Range: 470-899 MHz • Output: Channel: 3 • Input: 75 ohm • Gain: 18 dB

MC 1045 ..... **\$23.95**

## DIGITAL MULTIMETER



- 3 1/2 digit LCD meter
- Input impedance 20 Ohm
- hFE measurement
- DC .5% accuracy
- DCA up to 10 amps
- Leads and battery included

MIC-3300A ..... **\$59.95**  
Carrying Case ..... **\$ 9.95**

## TTL/CMOS LOGIC PROBE

- 4 LED states
- Pulse memory
- Supply Voltage 3 ~ 18 VDC
- TTL CMOS checking made easy!

L101A ..... **\$34.95**

## LOGIC PULSAR PROBE

- Easily repair logic circuits
- .5Hz or 500Hz signal
- External Sync Input
- Supply Voltage 3 ~ 18 VDC

L201A ..... **\$34.95**

## FOR INFORMATION CALL (312) 564-0104

## TO ORDER OUTSIDE ILLINOIS: CALL TOLL FREE 1-800-323-1327

## LOW TIM DC STEREO PRE-AMP KIT TA 2800

Incorporates state of D.C. design that gives a frequency response from 0Hz-100KHz ±.5dB. • Features tone defeat switch, loudness, treble, midrange, bass, balance. • TA-2800 contains quad BiFet op-amp to develop T.H.D. of .005% at rated output • Input sensitivity: phone 2.5 MV tuner, aux, tape play 100MV/100K • Power supply ±15 volt DC at .2A. Kit comes with regulated power supply, all you need is a 15-20 VCT .2 amp. XFMR.

Only **\$44.50**

XFMR

**\$4.50 ea.**



## AMATEUR MICROWAVE RECEIVER KIT 1.9-2.5 GHz

- PS-1 Assembled 32 element antenna **\$19.95**
- PS-2 20 dB gain microwave receiver kit with variable power supply kit ..... **\$50.00**
- PS-3 Complete package PS-1 & 2 ... **\$65.00**

**MOUNTING HARDWARE INCLUDED**

## MICROWAVE PREAMP! NEW KIT

Use with PS-3 Kit. Adds 20-25 dB gain to boost reception distance.

- Low Noise
- High Gain
- Can be used with all existing stop sign board receivers!
- 1.9-2.5 GHz freq. range

PS-4 (Kit) ..... **\$34.95**

## SOLID STATE STEREO REVERBERATION AMPLIFIER



### Specifications:

- Total harmonic distortion less than .05%
- Frequency response 10 Hz to 50KHz ±1dB
- S/N Ratio 90dB
- Reverberation time 1 to 3 sec
- Input 150MV/50K ohm
- Max. input 2V
- Accepts input from tape, phono, or aux.

Includes an LED Reverb Level display. Kit comes with all electronic components, transformer and instructions, and 19" rack mount cabinet.

Model TA-2400 ..... **\$89.95**

## SPY EAR!

A very popular device designed to listen to sounds & voices through rooms or 3 ft. thick concrete walls. Place listening sensor against wall and earphone in ear. Adjust volume control! Hear clearly to things you might not want to!



CM-8 ..... **\$89.95**

## TY-45

20 STEP LED

## POWER LEVEL INDICATOR KIT

This new stereo level indicator kit consists of 40 3-color LED's to indicate sound level output of your amplifier from -57 dB to 0 dB. Comes with an attractive silk screen printed panel. Has selector switch to allow floating or gradual output indicating. Kit includes all parts, Front panel and power supply.

TY-45 KIT **\$34.95**



## MICRO COMPUTER POWER SUPPLY TR-626

The TR-626 is a power regulator for use with popular microcomputer circuits. Features:

- ±5V 6A
- -5V .5A
- +12V 1.5A
- -12V .5A



Each unit contains current limit protect circuit and two Darlington power transistor on a heatsink. Transformers included.

**\$39.95 each**

Minimum order \$15.00. Add 10% shipping on orders under \$35.00. Orders over \$35.00, add 5%. Catalog - \$1.00. Visa & Mastercharge acceptable.











## More BLOCKBUSTER BARGAINS!!

### Parallel, TTL Input I/O "Selectric"®

TESTED AND OPERATIONAL!



### TYPEWRITER / PRINTER

Removed from working systems, these fantastic machines have built-in driver and decoder circuitry and take TTL level, 6-bit character, plus 4-bit function input signals. Easily driven by most any micro. Use as a typewriter (with add'l repeat circuitry) or as a KSR I/O printer or both. Requires 115.60Hz for typewriter motor, 5 VDC for TTL and 24 VDC for solenoids. "Table Top" style case. Each "Selectric" I/O machine is complete and in operational condition. Includes schematics, data case, platen and ribbon.

**\$329.00** ea.

I/O Selectric .....  
Add \$20 for Packaging and Handling - Pay shipping on Delivery

SAVE!!! Untested version of the above, otherwise whole & complete. May require some service .....**\$279.00** ea.

Type Element ..... **\$21.00**ea.

### Diablo Daisy Printer HI-Type II



#### 1355-WP Word Processing Daisy Printer

- Pre-owned, TESTED & Operational!
- Uses Xerox Metal Wheels or Plastic Wheels
- Original OEM Interface (Diablo Interface)
- Requires ±15V (@ 5A & 5VDC @ 5A)
- Positional access to 1/120 "Horiz." 1/48 "Vertical"
- USED BY XEROX, WANG, & OTHERS
- Heavy Duty Printwheel Motor and 15" Frame

These fabulous daisy printers feature 35-40cps, 10 & 12 pitch as well as proportional space, and plotter capabilities. Only a power supply and interface are required for full printer capability. Fully tested and operational, ready to configure for the interface of your choice. Platen and I/O data included

- Forms tractor for the above ..... **\$ 99.00**
- Spare P.C. Board Set (6 P.C. Cards) ..... **\$279.00**
- Spare Printwheel carrier assembly ..... **\$329.00**
- Serial & Parallel Interface for Above .... **\$295.00**
- Power Supply ..... **\$ 79.00**

Just  
**\$549.00** ea.  
Add \$15.00  
for Packaging and handling

We Offer New & Used FLOPPY DRIVES, DISK DRIVES, PRINTERS, & MORE at BARGAIN PRICES!!  
Write or Call for Our Latest Flyer NOW!!!

Selectric is a registered trademark of IBM Corporation

**Computer  
Products &  
Peripherals  
Unlimited**

WAREHOUSE: 18 Granite St., Haverhill, Mass. 01830  
MAIL ORDERS: Box 204, Newton, New Hampshire 03858



**617/372-8637**

Sorry No Collect Calls  
MasterCard & VISA Accepted



CIRCLE 68 ON FREE INFORMATION CARD



## Active Electronics

**NUMBER ONE IN  
QUALITY  
SERVICE  
AVAILABILITY**

**THE WORLD'S MOST  
COMPLETE PROFESSIONAL  
AND HOME ELECTRONICS  
ENTHUSIAST INVENTORY**

- Semiconductors + Memories
- Microprocessors + Support Circuits
- Microcomputer Systems + Peripherals
- Passive Electronic Components
- Hand Tools, Wire Wrapping, Soldering Equipment + Hardware

**NOW AVAILABLE — FREE  
1983 80-page catalog**

A complete listing of products and specifications

Call, write or circle the inquiry card for your free copy today.

P.O. Box 8000, Westboro, Mass. 01581  
**CALL TOLL FREE: 1-800-343-0874**

Mass customers call (617) 366-0500

CIRCLE 3 ON FREE INFORMATION CARD

#### POPULAR CHIPS

LM 301	.49
LM 380	1.29
LM 386	.89
LM 565	1.00
MC 1330	1.25
MC 1350	1.15
MC 1358	1.25
MC 1458	.49
MC 1496	1.50
LM 1889	2.50
7805	.80
7808	.80
7812	.80
7815	.80
7818	.80
MV 2109	.69
2N2222	.30
MC1349	1.79

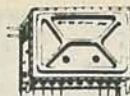

**MITSUMI**  
UES A55F  
**VARACTOR TUNER**  
CHAN. 14-83  
300 ohm INPUT **\$17.95**

#### DELUXE PARTS ASSORTMENTS

**#1 Resistors & Trimpots**  
68 1/4 watt, 5% resistors & 5 PT-15 10K trimpots. 1 each - 51, 75, 100, 470, 1.5K, 3.6K, 51K, 470K, 13-1.2K, 2-220, 3-100K, 6-330, 6-12K, 7-910, 9-3.3K, & 14-4.7K.  
**\$5.25 each**

**#2 Capacitor "A"**  
Monolithics - 1-560pf, 7-.1 mfd, & 1-22 mfd. Silver Micas - 2-10pf, & 1 each of 43pf, 110pf, 560pf, 1200pf, 3000 or 3300pf.  
**\$5.95 each**

**#3 Capacitor "B"**  
Mylars 4-.001, 2-.047, 29-.01, Radial lytics 3-10 mfd 16V, 1-1000 mfd 50V, 1-2200 mfd 35V. Disc Caps 1 each of 5, 12, 27, 36, 110, 330pf, 2-120pf, 3-39pf, 3-220pf, and 1 Vari Cap 5-35pf.  
**\$7.50 each**

**#4 Coil & Chokes**  
1 each of 15, 33, and 100 (uh) micro henries chokes. 1-variable RF coil (same as #49A537MPC)  
**\$3.25 each**

**#5 IC's, Sockets, & Semi's**  
1 each of: LM565, MC1330, MC1350, MC1496, LM1889, 7812, 7818, 2N2222A, MV2109, heat sink 2-MC1458, 4-1N4002, 4-8 pin, 2-14 pin, 1-16, & 1-18 pin socket. (564 not included)  
**\$11.95 each**

**#6 Misc. Hardware**  
LED & holder, fuse & holder, line cord, grommet, SPST switch, DPT switch, 2-F61 conn. & lugs, knob, 4-spacers, 6-screws & nuts, 2-RG-174, matching transformer w/nut.  
**\$5.95 each**

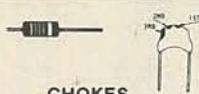

#### CHOKES

.33 uh	33 uh
.47 uh	100 uh
15 uh	10 mh
18 uh	69¢ each

#### VARI CAPS

10 - 60 pf	79¢ each
30 - 90 pf	79¢ each

**UHF AMP KIT**  
25 db gain stripline PC board using (2) BFR-90's  
**\$10.95**  
power supply for above **\$3.49**

**MINI FAN 3.125" SQ.**  
40 CMF  
115VAC-60hz  
REMOVED FROM NEW EQUIP.  
TESTED **\$6.95**



**NETWORK SALES, INC.**  
2343 W. BELMONT AVE.  
CHICAGO, IL. 60618  
312-248-3202

TERMS: Visa, M.C., Check, Money Order or COD (add \$3.00). Min. Order \$10.00. Add \$2.50 S&H for USA. Ill. add 7% Tax. **MAIL ORDER ONLY.** Prices subject to change without notice. Phone Orders Welcome. **WRITE FOR OUR MONTHLY UN-ADVERTISED SPECIALS**

©COPYRIGHT 1983 NETWORK SALES, INC.

CIRCLE 90 ON FREE INFORMATION CARD

**Look What USO is doing today worldwide**

Today's come and gone before you know it... but through the USO there are plans for the future. As a serviceman, I know how important it is to think ahead... and USO helps me do that... they have a full schedule of programs, tours and events... just for me... they help make sure that I'm involved and active... and for that I say thanks. To me... USO... is the three most important letters in helping others.

Support USO through the United Way, OCFE, or local USO campaign.





# FORMULA INTERNATIONAL INC.

12603 Crenshaw Blvd., Dept. B, Hawthorne, CA 90250

For information (213) 973-1921 • Orders Only (outside Calif.) (800) 672-8758



## POCKET LIGHT

Complete with 5' fluorescent tube, powerful bulb and handy strap. Runs on 3 pcs 1.5V 'C' size batteries (not included). It's a practical, convenient, powerful spotlight and fluorescent light. Its superior quality is ideal for indoor or outdoor use.

**LOW PRICE \$6.50**

## SANYO UHF VARACTOR TUNER

FOR UHF CHANNELS 14-83

Tuning voltage +1 to +28VDC. Input impedance 75Ω. IF band width 7-16MHz. Size 2 1/4" x 1 1/4" x 3/4". Supply voltage 15VDC.

Model 115-B-403A, Video IF 45.0MHz  
Model 115-B-405A, Video IF 62.5MHz

**\$19.95**

Tuner is the most important part of the circuit. Don't let those \$19.00 tuners fool you. All units are brand new from Sanyo. When ordering please specify model number.



## MARK IV — 15 STEP LED POWER LEVEL INDICATOR KIT

This new stereo indicator kit consists of 36 4-color LEDs (15 per channel) to indicate the sound level output of your amplifier from -36dB to +3dB. Comes with a well designed silk screen printed plastic panel and has a selector switch to allow floating or gradual output indicating. Power supply is 6-12VDC with THG on board input sensitivity controls. This unit can work with any amplifier from 1W to 200W. Kit includes 70 pcs driver transistors, 38 pcs matched 4-color LEDs, all electronic components, PC Board and front panel.

**MARK IV KIT \$31.50**



## FLOURESCENT AUDIO LEVEL MONITOR

This is the kind of VU monitor that is being used by most amplifier manufacturers. IC's are used to simplify circuit layout. Easy to assemble and can be used with all power level amplifiers. Power requirement 12VDC.



**TE-221 KIT For Just \$28.50 (Limited Stock)**

## TA-1000 KIT

**\$51.95**

Power Transformer \$24.00 ea.

## 100W CLASS A POWER AMP KIT

Dynamic Bias Class 'A' circuit design makes this unit unique in its class. Crystal clear, 100 watts power output will satisfy the most picky fans. A perfect combination with the TA-1020 low TIM stereo pre-amp.

Specifications • Output power 100W RMS into 8Ω. 125W RMS into 4Ω • Frequency response 10Hz-100kHz • THD less than 0.01% • S/N ratio better than 80dB • Input sensitivity 1V max • Power supply ±40V at 5A.

## 1 WATT AUDIO AMP

All parts are pre-assembled on a mini PC Board. Supply voltage 6-9VDC. **Special Price \$1.95**

## 6W AUDIO AMP KIT

TBA810 with Volume Control. Power Supply 6-18VDC. **Only \$7.50 ea.**

## "FISHER" 30 WATT STEREO AMP

MAIN AMP (15W x 2). Kit includes 2 pcs. Fisher PA 301 Hybrid IC, all electronic parts with PC Board. Power supply ±16VDC (not included). Voltage gain 33dB. 20Hz-20kHz.

**Super Buy Only \$18.50**



## LASER SUPER LANTERN

Brilliant fluorescent lantern with 9' 6 watt fluorescent tube. Features include: Powerful direct beam spotlight with 9V pre-focus bulb; Buzzer horn - either constant or time intervals of sonic alarm; Twin blinker - red amber flashing or red & amber flashing on time intervals; Fully adjustable nylon strap. Operates from D size batteries or plugs into vehicle cigar lighter socket.

**SPECIAL \$11.95**

## 6-WAY A/C ADAPTOR

Input: 110VAC. Output: 3V, 4.5V, 6V, 7.5V and 12VDC. Current: 300mA.

**OUR LOW PRICE \$5.50 ea.**

No FCC License Required. **OUR PRICE \$49.50** Additional Microphone (Transmitter) Available at \$28.00 ea. **MURA WMS-49**

## CRYSTAL CONTROLLED WIRELESS MICROPHONE SYSTEM

Transmitter: FET mic for flat 30Hz-18kHz response. X'tal controlled 49MHz AM Band for drift-free performance. 100mW output (range approx. 1/4 mile) for reliable long range transmission. Powered by a 9V radio battery. Receiver: X'tal controlled locks on 49MHz transmitter signal. On panel VU meter, monitors the signal strength from the microphone. Standard phone jack outlet connection to a P.A. or other phone input. 9V battery included. This professional set is ideal for on stage, in field, church, in house or outdoor use.



**A GOOD BUY at \$65.00 TA-800**



## 120W PURE DC POWER STEREO AMP KIT

Getting power hungry from your small amp? Here's a good solution! The TA-800 is a pure DC amplifier with a built-in pre-amp. All coupling capacitors are eliminated to give you a true reproduction of the music. On board tone and volume controls combined with built-in power supply make the TA-800 the most compact stereo amp available. Specifications: 60W x 2 into 8Ω. Freq Range: 0Hz-100kHz ±3dB. THD: .01% or better. S/N Ratio: 80dB. Sensitivity: 3mV into 47kΩ. Power Requirement: ±24-40 Volts.

## WHISTLE ACTIVATED SWITCH BOARD

All boards are pre-assembled and tested. You whistle to its FET condenser microphone from a distance, as far as 30 feet away (sensitivity can be easily adjusted), and it will turn the switch on. If you whistle again it will turn off. Ideal for remote control toys, electrical appliance such as lights, coffee pots, TV, Hi-Fi, radio or other projects. Unit works on 9VDC.

**Model 968 ..... \$2.50 ea.**

## LOW TIM DC STEREO PRE-AMP KIT TA-1020

Incorporates brand-new DC design that gives a frequency response from 0-100kHz ±0.5dB. Added features like tone defeat and loudness control let you tailor your own frequency supplies to eliminate power fluctuations!

Specifications: • THD/TIM less than .005% • Frequency response DC to 100kHz ±0.5dB • RIAA deviation ±0.2dB • S/N ratio better than 70dB • Sensitivity: Phone 2mV 47kΩ; Aux 100mV 100kΩ • Output level 1.3V • Max output 15V • Tone controls: Bass ±10dB @ 50Hz; Treble ±10dB @ 15Hz • Power supply ±24VDC @ 0.5A. Kit comes with regulated power supply. All you need is a 48VCT transformer @ 0.5A.

**Only \$44.50 Transformer \$4.50 ea.**



## UNIVERSAL NI-CD BATTERY CHARGER MW-398

Charges 9V, AA, C or D size Ni-CD batteries all at one time.

**Part No. 050-0190 \$11.50 ea.**

## SUPER FM WIRELESS MIC KIT

This new designed circuit uses high FREQ FET transistors with 2 stage pre-amp. Transmits FM range (88-120MHz) up to 2 blocks away and with the ultra sensitive condenser microphone that comes with the kit allows you to pick up any sound within 15 ft. away. Kit includes all electronic parts, OSC coils and PC Board. Power supply 9VDC.

**FMC-105 \$11.50 per Kit**

## PROFESSIONAL FM WIRELESS MICROPHONE

Made by one of the leading Japanese manufacturers. This factory assembled FM wireless microphone is powered by two AA size batteries. It transmits in the range of 88-108MHz. Element is built in a plastic tube type case with an omni-directional electronic condenser microphone unit. By using a standard FM radio, signal can be heard anywhere on a one acre lot. Sound quality was judged "very good." MODEL WEM-36 was \$16.50.

**ON SALE \$8.25 ea.**

## HEAVY DUTY 500mA MULTIPLE AC-DC ADAPTOR

For all battery operated electronic equipment up to 500mA with LED indicator.

Input: 117/220VAC, 50/60Hz

Output: 3, 4.5, 6, 7.5, 9 and 12VDC.

**Model SA-8112A \$25.00 ea.**



## SANYO ANTENNA SIGNAL BOOSTER

This Booster is specially designed for UHF Channels (14-83). After installing (between the antenna input cable and the UHF tuner), this unit will provide a minimum of 10dB gain, that is approximately 2 times better than you are seeing now. Ideal for those who live in apartments that can not put up an outdoor antenna. Small in size, only 2" x 1 1/2" x 1". Supply voltage is 15 VDC.

**Model 001-0076**

**\$12.50**



## PROFESSIONAL REGULATED VARIABLE DC POWER SUPPLY KIT

All solid state circuitry with high efficiency power transistor 2SD388 and IC voltage regulator MC1733. Output voltage can be adjusted from 0-30V at 1A current limited or 0-15V at 2A current limited. Internal resistance is less than 0.005Ω. Ripple and noise less than 1mV, dual on panel meters for voltage and current reading, also with on board LED and audible over load indicator. Kit comes with pre-drilled PC Board, instructions, all necessary electronic components, transformer and a professional looking metal cabinet. The best project for school and the most useful instrument for repairmen. Build one today!



**Model TR88A 0-15VDC @ 2A  
Model TR88B 0-30VDC @ 1A**

**\$59.50 per Kit**



## TA-322 30 WATTS TOTAL 15W + 15W STEREO AMP KIT

This is a solid state all transistor circuitry with on board stereo pre-amp for most microphone or phone input. Power output employs a heavy duty Power Hybrid IC. Four built on board controls for, volume, balance, treble and bass. Power supply requires 48VCT 2.5A transformer. THD of less than 0.1% between 100Hz-10kHz at full power (15 Watts ± 15 Watts loaded into 8Ω).

**\* SPECIAL \* Excellent Price! Model 001-0034 \$29.50 per Kit Transformer \$10.50 ea.**

## LOW T.I.M. TRANSISTORS 100W + 100W

Employs Hitachi low noise I.C. for pre-amp. Max. output 16 V P-P (non distortion) • With hi-low filter, and tone defeat circuit • Rear power amp with short circuit protection • Giant heat sink for maximum results • Tone controls ±14dB • All components (except pots for volume, and tone controls) are pre-assembled, the quality is guaranteed. • Power supply DC ±35V-50V



**MODEL: SA802C Part #370-0340 ..... \$85.00 POWER TRANSFORMER (68V-80V CT 6 AMP) Part #670-0220 ..... \$24.50**

## 60W + 60W O.T.L. AMP

Stereo pre-amp + tone control + power amp. All in on unit, fully assembled! Compact in size: 7"x4 1/2"x2 1/2". Can be fitted into most cabinets. Power transistors using 25C1667 X 4 to give a max output of 60W + 60W (8Ω) • Frequency response: 20Hz - 85kHz (-1dB) • Total harmonic distortion: 0.02% (1kHz) • Signal/Noise Ratio: 88 dB (open loop) • Tone control: 100 Hz ±16 dB 10 kHz ±14dB • Dynamic range: 60 dB • Power Supply: 48V - 70V 5 Amp. • Filter Capacitor: 4700µF 70V or better.



**MODEL: SA-4520 Part #370-0350 ..... \$39.95 ea. 1 Transformer Part #670-0230 ..... \$22.50 ea. 2 Filter Capacitor 4700µF 70V \$6.50 ea.**

## MAGNETIC HEAD EQUALIZER

Standard RIAA curve for all kinds of magnetic heads - 3 stages crossover circuit for best results • Output voltage guaranteed to be stable without any oscillation • Power Supply: 24 V.D.C.



**MODEL: MA-142 Part #370-370 ..... \$6.95 ea.**

## STEREO MIC. AND ECHO MIXER FOR STEREO AMPLIFIER SYSTEM

The circuitry employs all integrated circuits, BBD type echo circuit, echo time can be adjusted (max. 30 Msec.) Also with a microphone preamp on the board. Fully assembled.



**MODEL: MX205 Part #370-0360 ..... \$29.95 ea.**

## 20 STEPS BAR/DOT AUDIO LEVEL DISPLAY KIT

This new designed audio level display unit is using a new integrated circuit from National Semiconductor to drive 20 pieces of color LEDs (green, yellow and red) on each channel. It provides two types of display methods for selection "bar" or "dot". The display range is from -57dB to 0dB. Kit is good for any amplifier from 2 watt to 200 watts! Power supply requires 12V AC or DC. So it is great for cars as well! Kit comes with printer circuit board, all LEDs, electronic components, switches, and silk screen printed professional front panel.



**MODEL: TY-45 Part #370-0280 ..... \$38.50**

SEND ONE DOLLAR FOR OUR DETAIL CATALOG

Inside California  
Outside Calif. (incl. Mexico & Canada)  
Overseas

Shipping & Handling Charges	
Under \$50.00 Purchase	Over \$50.00 Purchase
10%	5%
15%	10%
25%	20%

Minimum Order \$10.00/Calif. Residents add 6.5% Sales Tax. Phone Orders Accepted on VISA or MC ONLY. NO C.O.D.'s. Prices subject to change without notice.



**STORE HOURS MON-FRI-10-7 SAT-10-6**

\*Apple and Apple II are the trademark of APPLE COMPUTERS, INC.



# Do Kay

COMPUTER  
PRODUCTS,  
Inc.

ORDER TOLL FREE

(800)

538-8800

(CALIFORNIA RESIDENTS)

(800)

848-8008



**TERMS:** For shipping include \$2.00 for UPS Ground or \$3.00 for UPS Blue Air. \$10.00 minimum order. Bay Area and Los Angeles Counties add 6½% Sales Tax, other California residents add 6% Sales Tax. We reserve the right to limit quantities and substitute manufacturer. Prices subject to change without notice.

VISIT OUR RETAIL STORE

2100 De La Cruz Blvd.  
Santa Clara, CA 95050  
(408) 988-0697

# Do Kay

## STATIC RAMS

2101	256 x 4 (450ns)	1.90
5101	256 x 4 (450ns) (cmos)	3.90
1024	1024 x 1 (450ns)	.88
2102L-4	1024 x 1 (450ns) (LP)	.98
2102L-2	1024 x 1 (250ns) (LP)	1.45
2111	256 x 4 (450ns)	2.45
2112	256 x 4 (450ns)	2.95
2114	1024 x 4 (450ns)	8/9.90
2114-25	1024 x 4 (450ns)	8/9.95
2114L-4	1024 x 4 (450ns) (LP)	8/11.95
2114L-3	1024 x 4 (300ns) (LP)	8/12.45
2114L-2	1024 x 4 (200ns) (LP)	8/12.95
2147	4096 x 1 (55ns)	4.90
TMS4044-4	4096 x 1 (450ns)	3.45
TMS4044-3	4096 x 1 (300ns)	3.95
TMS4044-2	4096 x 1 (200ns)	4.45
MK4118	1024 x 8 (250ns)	9.90
TMM2016-200	2048 x 8 (200ns)	4.10
TMM2016-150	2048 x 8 (150ns)	4.90
TMM2016-100	2048 x 8 (100ns)	6.10
HM6116-4	2048 x 8 (200ns) (cmos)	4.70
HM6116-3	2048 x 8 (150ns) (cmos)	4.90
HM6116-2	2048 x 8 (120ns) (cmos)	8.90
HM6116LP-4	2048 x 8 (200ns) (cmos)(LP)	5.90
HM6116LP-3	2048 x 8 (150ns) (cmos)(LP)	6.90
HM6116LP-2	2048 x 8 (120ns) (cmos)(LP)	9.95
Z-6132	4096 x 8 (300ns) (Datat)	33.95

LP = Low Power Qstat = Quasi-Static

## DYNAMIC RAMS

TMS4027	4096 x 1 (250ns)	1.95
UPD411	4096 x 1 (300ns)	2.95
MM5280	4096 x 1 (300ns)	2.95
MK4108	8192 x 1 (200ns)	1.90
MM5298	8192 x 1 (250ns)	1.80
4116-300	16384 x 1 (300ns)	8/10.75
4116-250	16384 x 1 (250ns)	8/10.95
4116-200	16384 x 1 (200ns)	8/11.95
4116-150	16384 x 1 (150ns)	8/13.95
4116-120	16384 x 1 (120ns)	8/28.95
2118	16384 x 1 (150ns) (5v)	4.90
4164-200	65536 x 1 (200ns) (5v)	5.90
4164-150	65536 x 1 (150ns) (5v)	6.90

5V = single 5 volt supply

## EPROMS

1702	256 x 8 (1us)	4.45
2708	1024 x 8 (450ns)	3.90
2758	1024 x 8 (450ns) (5v)	5.90
2716	2048 x 8 (450ns) (5v)	3.90
2716-1	2048 x 8 (350ns) (5v)	5.90
TMS2516	2048 x 8 (450ns) (5v)	5.45
TMS2716	2048 x 8 (450ns)	7.90
TMS2532	4096 x 8 (450ns) (5v)	5.90
2732	4096 x 8 (450ns) (5v)	4.90
2732-250	4096 x 8 (250ns) (5v)	8.90
2732-200	4096 x 8 (200ns) (5v)	10.95
2764	8192 x 8 (450ns) (5v)	9.90
2764-250	8192 x 8 (250ns) (5v)	13.95
2764-200	8192 x 8 (200ns) (5v)	23.95
TMS2564	8192 x 8 (450ns) (5v)	16.95
MC68764	8192 x 8 (450ns) (5v)(24 pin)	38.95
27128	16384 x 8Call	Call

5v = Single 5 Volt Supply

## 74LS00

74LS00	.23	74LS173	.68
74LS01	.24	74LS174	.54
74LS02	.24	74LS175	.54
74LS03	.24	74LS181	2.10
74LS04	.23	74LS189	8.90
74LS05	.24	74LS190	.88
74LS08	.27	74LS191	.88
74LS09	.28	74LS192	.78
74LS10	.24	74LS193	.78
74LS11	.34	74LS194	.68
74LS12	.34	74LS195	.68
74LS13	.44	74LS196	.78
74LS14	.58	74LS197	.78
74LS15	.34	74LS221	.88
74LS20	.24	74LS240	.94
74LS21	.28	74LS241	.98
74LS22	.24	74LS242	.98
74LS26	.28	74LS243	.98
74LS27	.28	74LS244	1.25
74LS28	.34	74LS245	1.45
74LS30	.24	74LS247	.74
74LS32	.28	74LS248	.98
74LS33	.54	74LS249	.98
74LS37	.34	74LS251	.58
74LS38	.34	74LS253	.58
74LS40	.24	74LS257	.58
74LS42	.48	74LS258	.58
74LS47	.74	74LS259	2.70
74LS48	.74	74LS260	.58
74LS49	.74	74LS266	.54
74LS51	.24	74LS273	1.45
74LS54	.28	74LS275	3.30
74LS55	.28	74LS279	.48
74LS63	1.20	74LS280	1.95
74LS73	.38	74LS283	.68
74LS74	.34	74LS290	.88
74LS75	.38	74LS293	.88
74LS76	.38	74LS295	.98
74LS78	.48	74LS298	.88
74LS83	.59	74LS299	1.70
74LS85	.68	74LS323	3.45
74LS86	.38	74LS324	1.70
74LS90	.54	74LS352	1.25
74LS91	.88	74LS353	1.25

74LS92	.54	74LS363	1.30
74LS93	.54	74LS364	1.90
74LS95	.74	74LS365	.48
74LS96	.88	74LS366	.48
74LS107	.38	74LS367	.44
74LS109	.38	74LS368	.44
74LS112	.38	74LS373	1.35
74LS113	.38	74LS374	1.35
74LS114	.38	74LS377	1.35
74LS122	.44	74LS378	1.13
74LS123	.78	74LS379	1.30
74LS124	2.85	74LS385	1.85
74LS125	.48	74LS386	.44
74LS126	.48	74LS390	1.15
74LS132	.58	74LS393	1.15
74LS133	.58	74LS395	1.15
74LS136	.38	74LS399	1.45
74LS137	.98	74LS424	2.90
74LS138	.54	74LS447	.36
74LS139	.54	74LS490	1.90
74LS145	1.15	74LS624	3.95
74LS147	2.45	74LS640	2.15
74LS148	1.30	74LS645	2.15
74LS151	.54	74LS668	1.85
74LS153	.54	74LS669	1.85
74LS154	1.85	74LS670	1.45
74LS155	.68	74LS674	9.60
74LS156	.68	74LS682	3.15
74LS157	.64	74LS683	3.15
74LS158	.58	74LS684	3.15
74LS160	.68	74LS685	3.15
74LS161	.64	74LS688	2.35
74LS162	.68	74LS689	3.15
74LS163	.64	74LS783	23.95
74LS164	.68	81LS95	1.45
74LS165	.94	81LS96	1.45
74LS166	1.90	81LS97	1.45
74LS168	1.70	81LS98	1.45
74LS169	1.70	25LS2521	2.75
74LS170	1.45	25LS2569	4.20

## 6500

1MHZ

6502	4.90
6504	6.90
6505	8.90
6507	9.90
6520	4.30
6522	7.90
6532	9.90
6545	21.50
6551	10.85

2 MHZ

6502A	6.90
6522A	9.90
6532A	10.95
6545A	26.95
6551A	10.95

3 MHZ

6502B	13.95
-------	-------

## 6800

68000	58.95
6800	3.90
6802	7.90
6808	12.90
6809E	18.95
6809	10.95
6810	2.90
6820	4.30
6821	3.20
6828	13.95
6840	11.95
6843	33.95
6844	24.95
6845	13.95
6847	10.95
6850	3.20
6852	15.70
6860	9.90
6862	10.95
6875	6.90
6880	2.20
6883	21.95
68047	23.95
68488	18.95

6800

1MHZ

68B00	9.95
68B02	21.25
68B09E	28.95
68B09	28.95
68B10	6.90
68B21	6.90
68B45	18.95
68B50	5.90

## 8000

8035	5.90
8039	6.90
INS-8060	16.95
INS-8073	23.95
8080	3.90
8085	10.95
8085A-2	28.95
8086	10.95
8087	CALL
8088	38.95
8089	88.95
8155	6.90
8155-2	7.90
8156	6.90
8185	28.95
8185-2	38.95
8741	38.95
8748	23.95
8755	23.95



## 8200

8202	23.95
8203	38.95
8205	3.45
8212	1.75
8214	3.80
8216	1.70
8224	2.20
8226	1.75
8228	3.45
8237	18.95
8237-5	20.95
8238	4.45
8243	4.40
8250	9.95
8251	4.45
8253	6.90
8253-5	7.90
8255	4.45
8255-5	5.20
8257	7.90
8257-5	8.90
8259	8.85
8259-5	7.45
8271	38.95
8272	38.95
8275	28.95
8279	8.90
8279-5	9.00
8272	6.45
8283	6.45
8284	5.45
8286	6.45
8287	6.45
8288	24.00
8289	48.95

## Z-80

### 2.5 Mhz

Z80-CPU	3.90
Z80-CTC	4.45
Z80-DART	9.95
Z80-DMA	13.95
Z80-PIO	4.45
Z80-SIO/0	15.95
Z80-SIO/1	15.95
Z80-SIO/2	15.95
Z80-SIO/9	15.95

### 4.0 Mhz

Z80A-CPU	4.90
Z80A-CTC	4.90
Z80A-DART	10.95
Z80A-DMA	15.95
Z80A-PIO	4.90
Z80A-SIO/0	15.95
Z80A-SIO/1	15.95
Z80A-SIO/2	15.95
Z80A-SIO/9	15.95

### 6.0 Mhz

Z80B-CPU	12.95
Z80B-CTC	12.95
Z80B-PIO	12.95
Z80B-DART	18.95

## ZILOG

Z6132	33.95
Z8671	38.95

## DISC CONTROLLERS

1771	15.95
1791	23.95
1793	25.95
1795	48.95
1797	48.95
2791	53.95
2793	53.95
2795	58.95
2797	58.95
6843	33.95
8272	38.95
UPD765	38.95
MB8876	28.95
MB8877	33.95
1691	16.95
2143	17.95

## UARTS

AY3-1014	6.90
AY5-1013	3.90
AY3-1015	6.90
PT-1472	9.90
TR1602	3.90
2350	9.90
2651	8.90
TMS6011	5.90
IM6402	7.90
IM6403	8.90
INS8250	9.95

## INTERFACE

8T26	1.54
8T28	1.84
8T95	.88
8T96	.88
8T97	.88
8T98	.88
DM8131	2.90
DP8304	2.24
DS8835	1.94
DS8836	.98

## VOLTAGE REGULATORS

7805T	.74	7905T	.84
78M05C	.34	7908T	.84
7808T	.74	7912T	.84
7812T	.74	7915T	.84
7815T	.74	7924T	.84
7824T	.74	7905K	1.44
7805K	1.34	7912K	1.44
7812K	1.34	7915K	1.44
7815K	1.34	7924K	1.44
7824K	1.34	79L05	.78
78L05	.68	79L12	.78
78L12	.68	79L15	.78
78L15	.68	LM323K	4.90
78H05K	9.90	UA78S40	1.90
78H12K	9.90		

C, T = TO-220      K = TO-3      L = TO-92

## DIP SWITCHES

4 POSITION	.84
5 POSITION	.89
6 POSITION	.89
7 POSITION	.94
8 POSITION	.94

## IC SOCKETS

	1-99	100
8 pin ST	.12	.10
14 pin ST	.14	.11
16 pin ST	.16	.12
18 pin ST	.19	.17
20 pin ST	.28	.26
22 pin ST	.29	.26
24 pin ST	.29	.26
28 pin ST	.39	.31
40 pin ST	.48	.38
64 pin ST	4.20	call

### ST = SOLDERTAIL

8 pin WW	.58	.48
14 pin WW	.68	.51
16 pin WW	.68	.57
18 pin WW	.98	.89
20 pin WW	1.04	.97
22 pin WW	1.34	1.23
24 pin WW	1.44	1.30
28 pin WW	1.64	1.44
40 pin WW	1.94	1.75

### WW = WIREWRAP

16 pin ZIF	6.70	call
24 pin ZIF	9.90	call
28 pin ZIF	9.95	call

ZIF = TEXTTOOL (Zero Insertion Force)

## CRYSTALS

32.768khz	1.90
1.0 mhz	4.90
1.8432	4.90
2.0	3.90
2.097152	3.90
2.4576	3.90
3.2768	3.90
3.579535	3.90
4.0	3.90
5.0	3.90
5.0688	3.90
5.185	3.90
5.7143	3.90
6.0	3.90
6.144	3.90
6.5536	3.90
8.0	3.90
10.0	3.90
10.738635	3.90
14.31818	3.90
15.0	3.90
16.0	3.90
17.430	3.90
18.0	3.90
18.432	3.90
20.0	3.90
22.1184	3.90
32.0	3.90

## RESISTORS

1/4 WATT 5% CARBON FILM ALL STANDARD VALUES FROM 1 OHM TO 10 MEG OHM

50 PCS.	1.25
100 PCS.	2.00
1000 PCS.	15.00

## APPLE ACCESSORIES

80 Column Card	129.95
16 K Card	42.50
Fan	38.95
Power Supply	84.95
RF Mod	24.95
Joy Stick (Apple II)	29.95
Paddle Apple	9.95
Z80 Card	129.95
SCRG Switch-A-Slot	19.95
Paddle Adapple	24.95
Extend-A Slot	19.95
Disk Drive	224.95
Controller Card	69.95

## 5 1/4" DISKETTES

### ATHANA OR NASHUA

SSSD	18.95
SSDD	22.95
DSDD	27.95

## PERISOFIT

ACCESSORIES FOR APPLE II & IIe  
ALL WITH 1 YEAR WARRANTY BY

### PRINTERLINK CENTRONICS PARALLEL INTERFACE

- Simple to use — No configuring required
- Use with any centronics printer — EPSON, OKIDATA, etc.
- Includes Cable & Manual

**\$58<sup>00</sup>**

### MESSINGER SERIAL INTERFACE

- Connects to any RS-232 serial device
- 8 switch selectable drivers for printers, terminals and modems
- Includes Cable & Manual

**\$98<sup>00</sup>**

### TIMELINK

#### REAL TIME CLOCK

- Applications in file management, word processing, communications, etc.
- Exclusive Alarm Clock feature
- Battery recharges automatically

**\$83<sup>00</sup>**

### NEW BUFFERLINK

#### ADD-ON PRINTER BUFFER

- No more waiting for printed output
- Connects easily to any parallel interface
- Expandable from 16K to 64K

**\$138<sup>00</sup> (16K)**

## The Flip Sort™

The new Flip Sort™ has all the fine qualities of the original Flip Sort™, with some added benefits. Along with a new design, capacity has increased 50%, to hold 75 diskettes and the price is more reasonable than ever. **\$19.95 ea.**

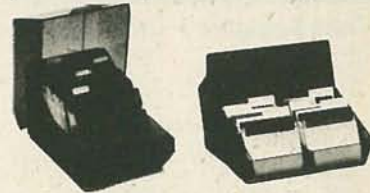

## The Flip Sort Plus™

The Flip Sort Plus™ adds new dimensions to storage. Designed with similar elegant lines as the original Flip Sort™, in a transparent smoked acrylic. The Flip Sort Plus™ has a storage capacity of over 100 diskettes and has all the outstanding features you have come to expect from the flip sort Family. **24.95 each**

# Do Kay

2100 De La Cruz Blvd.  
Santa Clara, CA 95050



# PREVENT HI-TECH HEADACHES

Our Isolators eliminate equipment interaction,



clean up interference, curb damaging power line spikes and lightning bursts.

## ISO-1 Isolator

3 isolated sockets; quality spike suppression; basic protection... \$76.95

## ISO-3 Super-Isolator

3 dual isolated sockets; suppressor; commercial protection... 115.95

## ISO-17 Magnum Isolator

4 quad isolated sockets; suppressor; laboratory grade protection... 200.95

Electronic Specialists, Inc.  
171 S. Main St., Box 389, Natick, MA 01760

Toll Free Order Desk 1-800-225-4876  
MasterCard, VISA, American Express

CIRCLE 6 ON FREE INFORMATION CARD

## ELECTRONIC KITS FROM HAL-TRONIX

2304 MHZ DOWN CONVERTERS. TUNES IN ON CHANNELS 2 TO 7 ON YOUR OWN HOME T.V. HAS FREQUENCY RANGE FROM 2000 MHZ TO 2500 MHZ. EASY TO CONSTRUCT AND COMES COMPLETE WITH ALL PARTS INCLUDING A DIE-CAST ALUM CASE AND COAX FITTINGS, REQUIRE A VARIABLE POWER SUPPLY AND ANTENNA (Antenna can be a dish type or coffee can type depending on the signal strength in your area.)

2304 MOD 1 (Basic Kit) \$19.95  
(Less case & fittings)

2304 MOD 2 (Basic-Pre-amp) \$29.95  
(Less case & fittings)

2304 MOD 3 (Hi-Gain Pre-amp) \$39.95  
(Includes case & fittings)

POWER SUPPLY FOR EITHER MODEL ABOVE IS AVAILABLE. COMES COMPLETE WITH ALL PARTS, CASE, TRANSFORMER, ANTENNA SWITCH AND CONNECTORS (Kit) \$24.95  
Assembled \$34.95  
Slotted Microwave Antenna For Above Downverters \$39.95

## PREAMPLIFIERS

HAL PA-19—1.5 mhz to 150 mhz. 19db gain operates on 8 to 18 volts at 10ma. Complete unit \$8.95.  
HAL PA-14—3 mhz to 1.4 ghz. 10 to 12 db gain operates on 8 to 18 volts at 10 ma. Complete unit \$12.95.  
(The above units are ideal for receivers, counters, etc.)

16 LINE TOUCH TONE DECODE KIT WITH P.C. BOARD AND PARTS \$69.95

12 LINE TOUCH TONE DECODER KIT WITH P.C. BOARD AND PARTS \$39.95

16 LINE ENCODER KIT, COMPLETE WITH CASE, PAD AND COMPONENTS \$39.95

12 LINE ENCODER KIT, COMPLETE WITH CASE, PAD AND COMPONENTS \$29.95

Complete Sets of P.C. Boards Available For: Unicorn Robot Project and Heart-A-Matic Project.

MANY, MANY OTHER KITS AVAILABLE

Send 30 cents stamp or S.A.S.E. for information and flyer on other HAL-TRONIX products. To order by phone: 1-313-386-1782.

HAL-TRONIX  
P.O. Box 1101  
Southgate, MI 48195

SHIPPING INFORMATION: ORDERS OVER \$25.00 WILL BE SHIPPED POSTPAID EXCEPT ON ITEMS WHERE ADDITIONAL CHARGES ARE REQUESTED. ON ORDERS LESS THAN \$25.00 PLEASE INCLUDE ADDITIONAL \$2.00 FOR HANDLING AND MAILING CHARGES.

CIRCLE 75 ON FREE INFORMATION CARD

**FREE GIANT CATALOG**  
Send for our FREE 1984 catalog of electronic components, kits, IC's, computer software, computer peripherals and unique items.

## PARTS SUPER SPECIALS!

**12VDC BRIGHT GREEN FLOURESCENT CAR CLOCK**  
Complete 12VDC car clock in case features bright green display and motion blanking. C5002 \$4.50

**CARBIDE ROUTER BIT**  
Sharpest, hardest router bit for routing pc boards, 1/8" dia. 1/2" dia and 3/8" cutting length. C4958 \$1.79

9V 30MA Solar Panel	C5006	\$12.00
2 1/4" 25 ohm Round Speaker	C5001	\$1.25
Box of Caps (at least 250 pieces)	C4610	\$5.00
TIL 122/TIP 122 Transistor	C6003	79¢ each
40 pin IC Socket	C4781	5/81.00
6" Nylon Cable Ties	C6004	10/81.00
3.579545MHZ Color Crystal	C4035	99¢ each
Miniature CDS Cell 20 MEG/500 ohm	C4818	2/51.00
Green Glow Neons	C4451	8/52.00
2x3" Zip Bags with White Block	C6005	50/\$2.50
Carbide Drill Bits #55, 56, 58		59, 61, 63 Your Choice... 1.29 ea.

**VISIT OUR NEW RETAIL STORE**  
LOCATED AT 3101 W. HAMPDEN, ENGLEWOOD, CO 80110  
Phone 781-1589

**PAC TEC ELECTRONIC ENCLOSURE**  
Professional looking case is great for instruments and projects. Black textured plastic finish with removable end panel. Size 3 1/2" x 1 1/2" x 1 1/2". C6006 \$8.95

**FASCINATION STAR KIT**  
Produces an "astounding star" visual effect using 15 LEDs and IC circuitry. Kit with all parts sold pc board. (Program from 9V) C4132 \$10.95

**3 CHANNEL COLOR ORGAN KIT**  
Handles up to 200W channel and up to 15W input. Complete with all parts and pc board. C4530 \$9.50

**NEGATIVE ION GENERATOR BOARD**  
Brand new circuit board emits negative ions that remove smoke, particles, dust, etc. from air. Only 1" square. Requires 12V to 15VDC for operation. C6002 \$14.95

**CHANEY electronics inc.**  
P.O. BOX 27038  
DENVER, COLORADO 80227  
303-781-5750

Phone Orders 303-781-5750

- Minimum AD Order \$9.00
- Please include \$2.00 for postage (UPS)
- VISA MC accepted
- Phone orders are welcome

Send for our free catalog of unique items

CIRCLE 34 ON FREE INFORMATION CARD

**2 NEW OPTO DESIGN KITS!**  
Now you can have 36 different options for easy LED design right at your finger tips!

**Opto Designer I**  
180 T-1 and T-1 1/2 Red, Green, Yellow, Orange and Red-Orange LED Lamps \$19.95

**Opto Designer II**  
180 Round, Square, Triangular, Rectangular and Cylindrical LED Lamps \$24.95

Send for FREE LED BROCHURE:  
• 3 mm (T-1) 5mm (T-1 1/2) • Round • Square • Cylindrical • Triangular • Rectangular • High Intensity • Custom • Arrays • Two-color Round, Rectangular • Level meter panel displays

**FREE 100 CB-50 T-1 1/4 mounting Clips** if you order within 7 days

**ETRONIX** 14803 NE 40th Street, Dept. RE014 Redmond, WA 98052

YES, I would like to take advantage of your offer.

Send me — Opto Designer I @ \$19.95 plus \$3.00 shipping and handling.

Send me — Opto Designer II @ \$24.95 plus \$3.00 shipping and handling.

Name \_\_\_\_\_

Address \_\_\_\_\_

Company \_\_\_\_\_

City \_\_\_\_\_ St. \_\_\_\_\_ Zip \_\_\_\_\_

Signature \_\_\_\_\_

Please charge my  Mastercard  Visa

No. \_\_\_\_\_ Exp. \_\_\_\_\_

CALL TOLL FREE 1-800-426-1044

CIRCLE 39 ON FREE INFORMATION CARD

**TECHNICIANS & SERVICEMEN COMPONENTS FOR YOUR MAINTENANCE & REPAIR WORK**

**SPECIAL: OUR LOW LOW PRICES**

REPLACEMENT FOR ECG® TYPES

TYPE NO.	YOUR COST	TYPE NO.	YOUR COST
85	FOUR for .99	125	SEVEN for .99
102A	THREE for .99	159AP	FOUR for .99
123A	FIVE for .99	177	EIGHT for .99
123AP	SIX for .99	199	FIVE for .99

**SUPER SPECIAL (MIN. 5 PC. EACH)**

TYPE NO.	YOUR COST	TYPE NO.	YOUR COST	TYPE NO.	YOUR COST
124	.85	165	2.25	375	.90
128	.45	171	.65	506	.55
129	.45	184	.45	500A	8.95
130	.80	185	.45	523	9.95
152	.40	238	2.25	526A	10.20
153	.40	276	6.95	529	13.75
154	.60	291	.95	712	1.25

**JAPANESE TYPES (MIN. 5 PC. EACH)**

TYPE NO.	YOUR COST	TYPE NO.	YOUR COST	TYPE NO.	YOUR COST
2SC867A	2.75	HA1366W	1.85	STK0029	3.80
2SC1114	3.25	HA1377A	2.90	STK0080	9.99
2SC1308K	1.95	LA4102	1.25	TA7205AP	1.50
AN214Q	1.45	M51515BL	2.95	TA7208P	1.85
AN239A	4.60	STK433	3.95	TA7222AP	1.95
BA532	1.80	STK435	3.95	UPC1181H	1.25
GH3F	.89	STK437	6.25	UPC1182H	1.25
HA1342A	2.30	STK439	6.50	UPC1185H	2.99

**COD ORDERS WELCOME (\$25 MIN. ORDER)**  
For Complete Component Catalog Call or Write  
**DIGITRON ELECTRONIC**  
110 HILLSIDE AVENUE, SPRINGFIELD, N.J. 07081  
Toll Free: 800-526-4928 In NJ: 201-379-9016

\*ECG IS A TRADE MARK OF PHILIPS ECG.  
DIGITRON ELECTRONIC IS NOT ASSOCIATED IN ANY WAY WITH PHILIPS ECG.

CIRCLE 11 ON FREE INFORMATION CARD

**DON'T FORGET**



USE YOUR READER SERVICE CARD

RADIO-ELECTRONICS



# BETA Electronics

1700 E. DESERT INN RD., SUITE 222 LAS VEGAS, NEV. 89109

TOLL FREE 800 - 782-2701

"LEADER IN THE BEST  
VIDEO CIRCUITS FOR THE  
EXPERIMENTERS."

## "The Deluxe II"

PC BOARD, PLANS, PARTS & ENCLOSURE \$152.99  
PLUS SHIPPING \$4.95 EACH

PC BOARD & PLANS ONLY \$30.00  
PLUS SHIPPING \$1.50 EACH

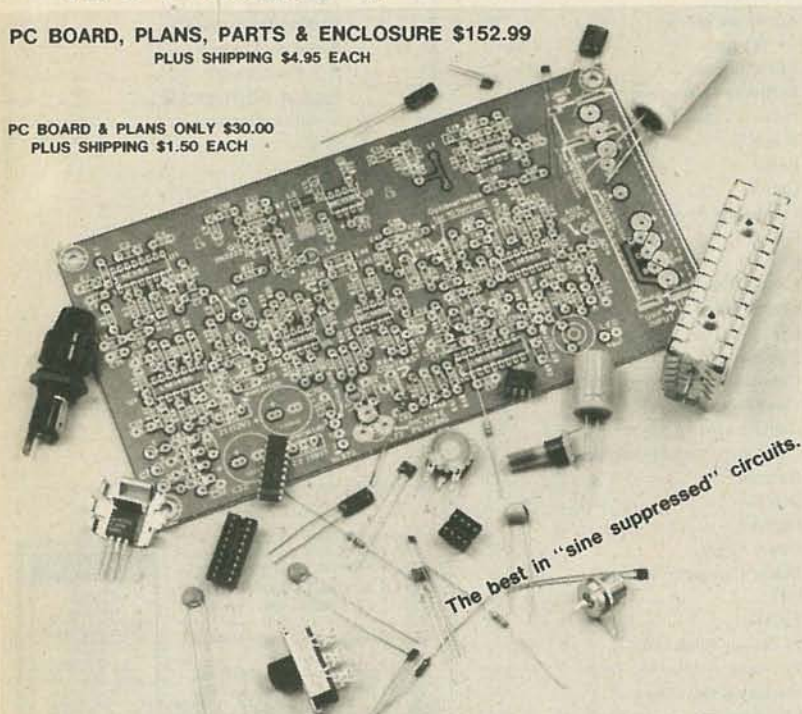

The best in "sine suppressed" circuits.

The ultimate in UHF sine wave converter technology with modulated audio.  
Easy to build with fully illustrated plans. Outstanding video clarity and stability.

## UHF AMPLIFIER KIT

PC BOARD, PLANS & PARTS \$19.99  
PLUS SHIPPING \$1.50 EACH

EASY TO BUILD & NO SPECIAL EQUIPMENT REQUIRED.  
IMPROVES RECEPTION WITH 12db GAIN.

## DUAL POWER SUPPLY

PC BOARD, PLANS & PARTS \$17.50  
PLUS SHIPPING \$2.50 EACH

# 1001

PC BOARD ONLY \$3.00  
PARTS ONLY \$14.50

REGULATED +24V & +12V

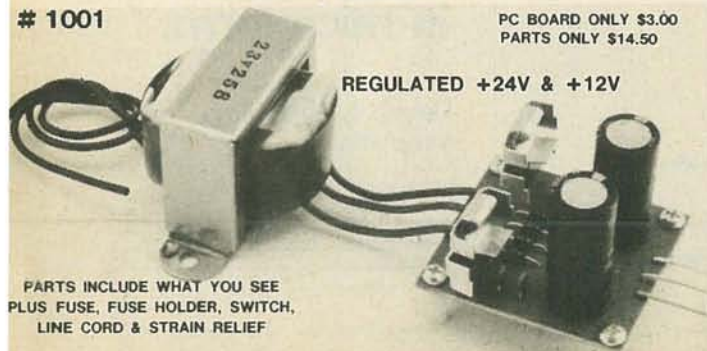

PARTS INCLUDE WHAT YOU SEE  
PLUS FUSE, FUSE HOLDER, SWITCH,  
LINE CORD & STRAIN RELIEF

WORKS GREAT WITH THE "Z BOARD," "FV4" OR "FV5"

## TWO CHANNEL SELECTOR SWITCH

PC BOARD, PLANS & PARTS \$5.95  
PLUS SHIPPING \$1.50 EACH

# 6044



FITS DIRECTLY INTO YOUR DELUXE II  
FOR CONVENIENT CHANNEL SELECTION.

SPECIAL

NE 564 SUBSTITUTE CIRCUITS AVAILABLE  
(PLUGS DIRECTLY INTO THE NE 564 POSITION)  
\$4.95 EACH PLUS \$1.50 SHIPPING.

## "THE Z BOARD"

PC BOARD, PLANS, PARTS & ENCLOSURE \$119.95  
PLUS SHIPPING \$4.95 EACH

PC BOARD & PLANS ONLY \$30.00  
PLUS SHIPPING \$1.50 EACH

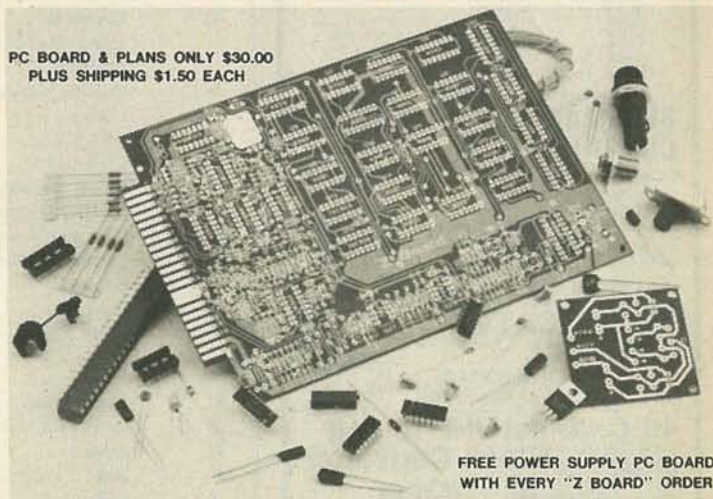

FREE POWER SUPPLY PC BOARD  
WITH EVERY "Z BOARD" ORDER

A powerful circuit with a challenge.  
The best in UHF "pulse suppressed" circuits.  
Suppressed horizontal synchronization with video inversion and  
modulated audio that mates with your Zenith M1 module.  
Fully illustrated plans for easy assembly.

QUANTITY DISCOUNTS AVAILABLE

PRICES SUBJECT TO CHANGE WITHOUT NOTICE

CALIF. ORDERS ADD 6% SALES TAX

VISA/MST MONEY ORDERS NO PERSONAL CHECKS

JANUARY 1984



# SPARTAN Electronics Inc.



CALL MAIL  
(516) 499-9500

6094 Jericho Tpke.  
Commack, N.Y. 11725

CTC9R

## Philips Remote Cable Converter



• Micro computer technology • Quartz controlled  
10's lock in picture & prevent drift • 50 channel  
selections • Programmable time on & off • 24  
hour LED digital clock • Favorite channel mem-  
ory & recall plus scan • Wireless hand held  
infra-red transmitter system • Automatic line  
tune • Adaptable to any brand television • One  
year warranty service.

**\$139.95**

## CABLE TV ACCESSORIES

2 set coupler	2.95
Coax Cable 100'	9.95
4 set coupler	4.50
F Connectors	.25
Matching transformer	.59
TV Game Switch	3.95
VHF-UHF AMP-28DB	29.95
Crimp Tool for F Conn.	8.95

## COMPUTER CARE KIT

The Preventative maintenance kit for the office and home computer

Contains: Precision Duster, Zero Charge Anti-Static Screen and Keyboard cleaner Zero Charge Anti-Stat.



## SGL WABER \$35.95

Protect your computer and electronic equipment from voltage spikes

DG115P

DG115S  
(6 Outlet)  
\$45.95



## WINEGARD FM CAR ANTENNA BOOSTER



Amplifies FM radio signals an average of 18dB (8 times). Improves car radio reception and extends range to allow greater selection of stations. Switch and indicator light attaches to lower edge of dash. 24' cable with Motorola plugs provided. Installs in minutes. Great for window antennas.

\$26.95

## REFURBISHED MONITORS

9", 12", Commercial Grade as low as

**\$39.95**



### SEMICONDUCTOR SPECIAL—

ECG Equivalent—Thorderson

TM125—15	TM5021—12	TM5127—53
TM712—1.06	TM5070—17	TM531—8.95
TM1155—2.92	TM955M—80	TM5444—1.06
TM123A—22	TM142A—16	TM5455—53
TM5804—40	TM941D—53	TM145A—17

White Quantities Last

## BECKMAN CIRCUITMATE 20

8 functions and 30 ranges - Diode/transistor test function - auto-polarity, auto-zero, and auto-decimal - 10 Amps AC and DC Current Capability - Transistor Gain Test (hFE) - Conductance



**\$64.95**

## Jerrold 36 Channel Remote CATV Converter

w/on/off Fine Tuning \$94.95  
58 Channel Wireless \$109.95



## 40 Channel VHF to UHF Block Converter

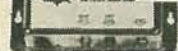

28.95 Ea.  
24.95 4 & up

Deluxe Version - Features fine tuning knob, matching X former & 2 cables \$38.95

Dealers Welcome

Visa, MC, BAC, Amex. All above

prices include 4% cash discount.

C.O.D. money order, check Add for

Shipping

Min. Order \$25.00	
International shipping Add'l.	to 75.00 \$2.50
Prices subject to change	76.00 to 250.00 \$4.50
without notice.	251.00 to 500.00 \$6.00
COD 2.00 Extra	501.00 to 750.00 \$8.50
*Add'l. shipping	751.00 to 1000.00 \$12.00
for monitors	Over 1000.00 \$15.50

(516) Mon Th Tu W F Sa  
499-9500 9-8 9-6 9:30-5

# ADVERTISING INDEX

RADIO-ELECTRONICS does not assume any responsibility for errors that may appear in the index below.

### Free Information Number

46	Acorn	99
3	Active Electronics	136
80	Advance Computer Products	117
-	Advance Electronics	13
12	All Electronics	126
67	AMC Sales	102
21	Appliance Service	99
87	AP Products	Cover 3
60	BBC Metrawatt	Cover 2
10	Beckman Instruments	89-92
-	Beta	141
77	B & K	31
-	Bullet	121
7	Calvert	29
8	Cambridge Learning	24
-	C & D	100
18	CEI	111
34	Chaney Electronics	140
37	Chemtronics	14
-	CIE	34-37
-	Command Products	106
86,35	Communications Electronics	108,2
88	Components Express Inc.	121
56	Contact East	99
68	Computer Products Peripherals	136
-	Daetron	22
65	Digi Key	134,135
11	Digitron	140
53	Direct Video	102
99	Dokay Computer Products	138,139
54	DTI	14
22	EICO	100
59,-	Electronic Book Club	21,109,110
6	Electronic Specialists, Inc.	140
33	Electronic Warehouse	33
78	Electronic Warehouse Corp.	102
51	ETCO	126
39	Etronix	140
-	ETT	113,114
40	Firestik II	106
-	John Fluke MFJ CO. Inc.	7
-	Fordham	25,39
76	Formula International	137
-	Galaxy	106
-	GBC T.V.	100
71,73,74	Gladstone	22,94
96	Global Specialties	24
4	Glouster Computer	106
69	Goldsmith Scientific	108
-	Grantham College of Engineering	40
50	Halix	108
75	Hal-Tronix	140
15,20	Heath	Cover 2,53-55
85	Hickok	28
-	ICS	107
94	Illinois Audio	100
28	Instrument Mart	20
41	Jameco	122,123
49	JDR	128-131
70	Jenson Tool	99
63	J & W Electronics	99
48	Kikusui	9
44	L.I. Public Wholesalers	118
93	McIntosh	26
66	MFJ	126
95	Mouser Electronics	132
16	Multitech Electronics Inc.	11
-	NESDA	112
-	Netronics RD LTD.	93
90	Network Sales Inc.	136
-	NRI	16-19
-	NTS	70-73
62	OptoElectronics Inc.	15

52	Paia	102
38	Phillips ECG	27
29,83	Phillips/KCS	120
97	Pomona	Cover 4
30	Professional Video Inc.	116
43	PTS	105
61	Radio Shack	127
79	Ramsey Electronics	125
57,17	Random Access	98,99
27	R.F. Electronics	132
19	Regency Electronics Inc.	1
-	Scientific Systems	132
25	SCR	116
64,55	SEI	120,133
82	Sintec	12
58	Solder Craft	106
23	Solid State Sales	119
36	Spartan	142
-	Symmetric Sound Systems	98
100	Tab Books	32
-	Tektronix	5
5	Telton	98
89	Video Electronics	99
9	Video Guard	116
91	VIZ	30
13	Westeck	132

THE BEST PLACE to BUY, SELL or TRADE NEW and USED EQUIPMENT

**NUTS & VOLTS MAGAZINE**  
BOX 1111-E • PLACENTIA, CA 92670  
(714) 632-7721

Join Thousands of Readers Nationwide  
Every Month

ONE YEAR U.S. SUBSCRIPTIONS  
\$7.00 - 3rd Class • \$12.50 - 1st Class

\$25.00 - Lifetime - 3rd Class

**NUTS & VOLTS**  
HAM GEAR  
COMPUTERS  
SOFTWARE  
SCANNERS • OPTICS  
TEST EQUIPMENT  
MICROWAVE  
SATELLITE  
AUDIO VISUAL  
NEW PRODUCTS  
COMPONENTS • KITS  
ANTIQUE ELECT.  
PUBLICATIONS  
PLANS • SERVICES

**TECHNI-TOOL inc.**

**TOOLS—TOOL KITS**  
**FREE CATALOG**  
**CALL (215) 825-4990**

EXPERIENCE • QUALITY • VARIETY

**This publication is available in microform.**

University Microfilms International

Please send additional information  
Name \_\_\_\_\_  
Institution \_\_\_\_\_  
Street \_\_\_\_\_  
City \_\_\_\_\_  
State \_\_\_\_\_ Zip \_\_\_\_\_

300 North Zeeb Road  
Dept. P.R.  
Ann Arbor, MI. 48106  
U.S.A.

30-32 Mortimer Street  
Dept. P.R.  
London W1N 7RA  
England

RADIO-ELECTRONICS



# IT WASN'T OUR IDEA TO ADD TWO NEW SIZES TO OUR LINE OF ACE BREADBOARDS. IT WAS YOURS.

Good idea! You told us you wanted to build larger projects. And, that you needed bigger solderless breadboards to build them.

Well, our two new A P PRODUCTS All Circuit Evaluators are just what you had in mind.

The ACE 245 has 25% more capacity than our previous largest breadboard. It has a circuit building matrix of 4520 solderless, plug-in tie-points. And, if bigger is better our new ACE 254 has a circuit building matrix of 5424 solderless tie-points.

**For the A P PRODUCTS  
dealer near you  
call Toll Free  
800-321-9668.  
In Ohio, call collect  
(216) 354-2101.**



A P PRODUCTS INCORPORATED

9450 Pineneedle Dr. • Box 540 • Mentor, Ohio 44061-0540 • [216] 354-2101 • TWX: 810-425-2250

In Europe, contact A P PRODUCTS GmbH • Bäumlesweg 21 • D-7031 Weil 1 • West Germany • Phone: [07157] 62424 • TLX: 841 07 23384

CIRCLE 87 ON FREE INFORMATION CARD



# THE POMONA PROMISE

We provide the design engineer with the best patch cords made in this country.  
Or anywhere.

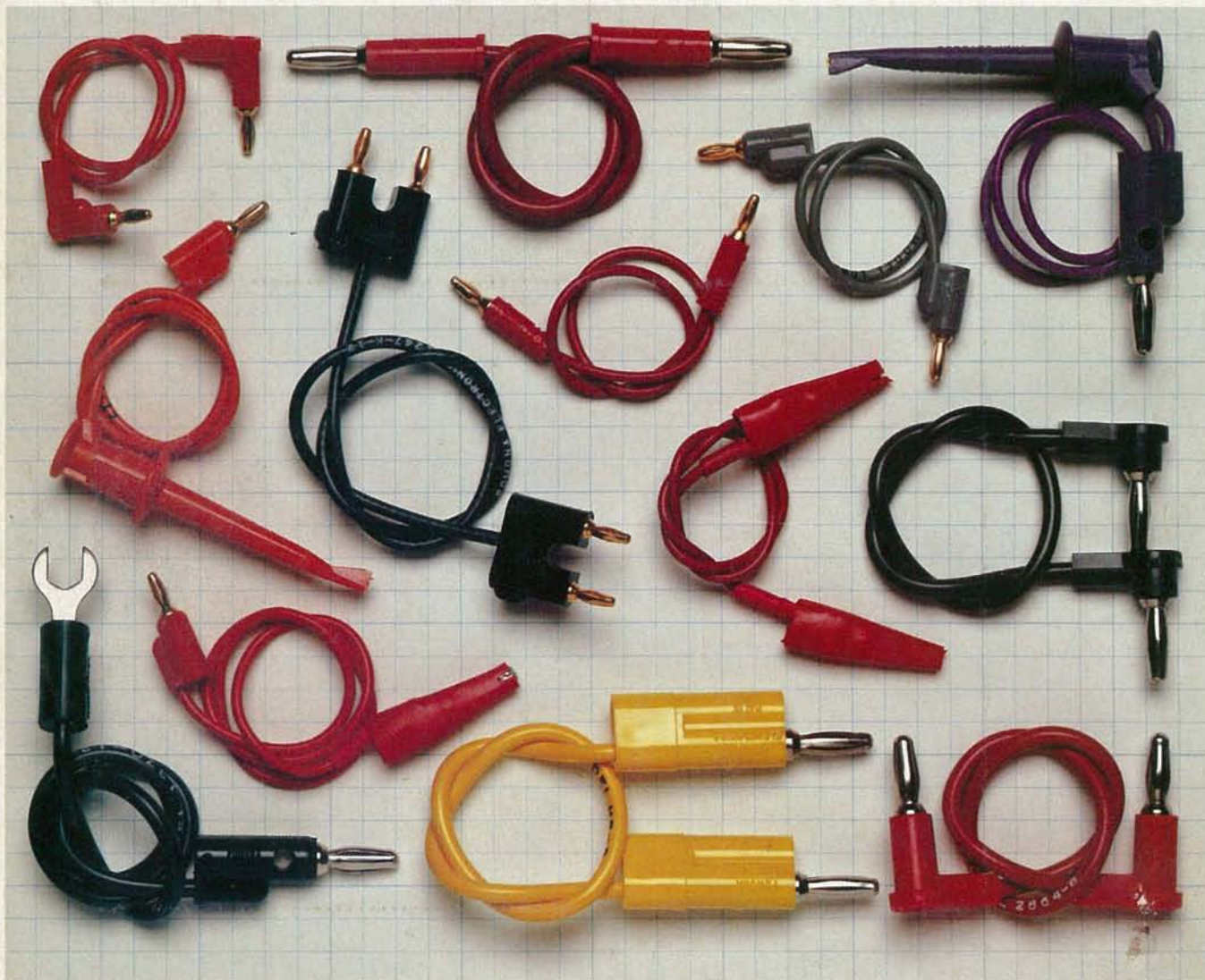

Quite a promise, you say?

Well, quite a promise it is.

It was made before we designed our first patch cord. We decided our patch cords would occupy only one position in the market. The top.

Right now, there isn't a knowing professional in the electronics business who won't tell you we kept our promise.

Today, we offer you a variety of patch cords so extensive we feel we've got just the kind you need. And you know what, if we don't,

we'll design one for you.

At ITT Pomona Electronics, we know there is no such thing as standing pat. We also know that your needs change and your expectations become greater as the demands become more severe. To this end we will continue to create a better way. A better product.

That's a promise.

All of our products are described and illustrated in our General Catalog, and it's free. Just call (714) 623-3463 or 623-6751. TWX 910-581-3822. Write to us at

CIRCLE 97 ON FREE INFORMATION CARD

ITT Pomona Electronics, a Division of ITT Corporation, 1500 E. Ninth St., Pomona, CA 91766.

In Europe: ITT CANNON BELGIUM S.A./N.V. Rue Colonel Bourg Str. 105 Space A (B.3) 1140 Brussels, Belgium. Phone: 02-735-6094.

Our products are available through your favorite electronics parts distributor.

**ITT** Pomona Electronics