

# ARMY AVIATION

OFFICIAL PUBLICATION OF THE ARMY AVIATION ASSOCIATION OF AMERICA • OCTOBER 31, 1999 • \$3.00

## Collins ARC-210.

Saturn capable.

DAMA compliant.

GATM ready.

NSA endorsed.

Networked today.

**Rockwell  
Collins**



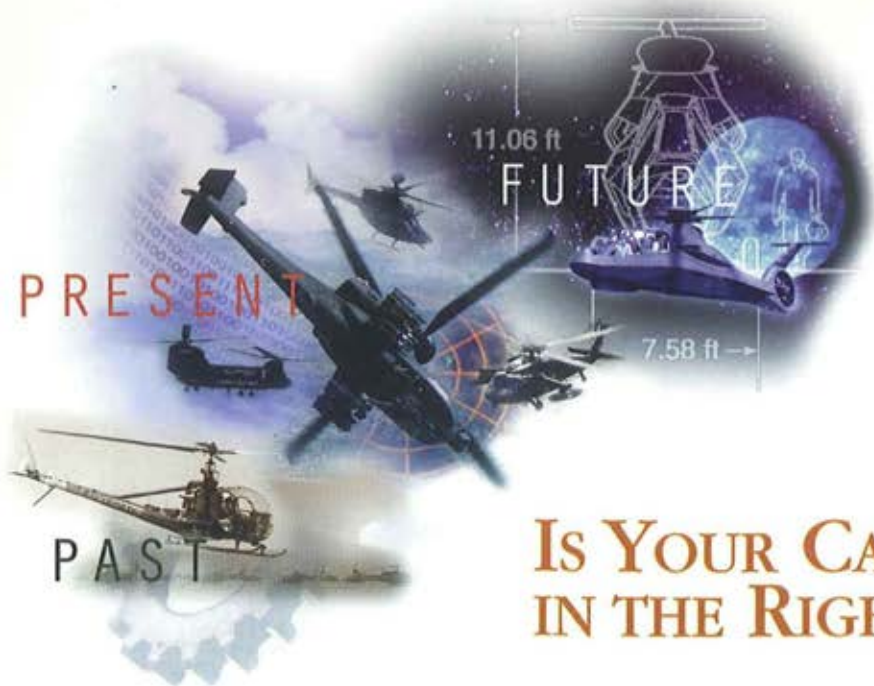

## IS YOUR CAREER HEADED IN THE RIGHT DIRECTION?

Sometimes it's easier to get by on past accomplishments, but for those men and women eager to reach for the stars it often means expanding their knowledge. Let the power of education help propel your career to new heights through awards sponsored by the AAAA Scholarship Foundation.

Educational grants and loans are available for assistance in obtaining a degree, specialized skills or technical knowledge. Awarded annually, scholarships are presented in one, two or four year grants ranging from \$1,000 to \$15,000. Qualified applicants compete in both open and dedicated award categories, thereby increasing the chances of winning. Dedicated award categories include: spouse, company-grade officers, warrant officers, enlisted persons, Department of the Army civilians, freshman candidates for an undergraduate degree in aeronautical sciences, upper classmen and graduate. These awards have helped hundreds of AAAA members and their families realize their full potential.

TO LEARN WHAT OPPORTUNITIES  
ARE AVAILABLE, PLEASE CONTACT:

AAAA SCHOLARSHIP  
FOUNDATION, INC.  
49 Richmondville Ave.  
Westport, CT 06880-2000  
(203) 226-8184  
Fax: (203) 222-9863  
aaaa@quad-a.org



## EDUCATION. YOUR FUTURE DEPENDS ON IT.

**Publisher**  
Lynn Coakley

**Editor in Chief**  
William R. Harris, Jr.

**Editor**  
Stephen Harding

**Contributing Editor**  
Lisa Eichhorn

**Production Manager**  
Barbara Ross

**Circulation Manager**  
Mary Ann Stirling

**Circulation Assistants**  
Debbie Coley  
Mary Ellen Kother  
Deb Simons

**Advertising**  
Robert C. Lachowski



## on the cover

**Paid Advertisement.** Collins ARC-210 is the only airborne comm system to win full DAMA compliance, NSA endorsements and full JITC certification. The system's flexible, multi-mode architecture makes it Saturn-capable and fully interoperable with VHF, UHF, line-of-sight and SAT-COM operations. Discover the future today. Call (319) 295-5100 or fax (319) 295-4777.

*Caption provided by advertiser.*

Each year approximately 200 Regular Army soldiers are offered admission to the **U.S. Military Academy** at West Point, N.Y., or the U.S. Military Academy Preparatory School at Fort Monmouth, N.J. Although some soldiers are offered direct admission to West Point, the majority attend USMAPS. Prep school applicants must be U.S. citizens, unmarried with no legal obligation to support dependents, high school graduates, under 23 years of age prior to July 1 of the year entering USMA (under 22 years of age prior to July 1 of the year entering the prep school). Interested soldiers should contact Maj. Rob Young at (DSN) 688-5780 or (914) 938-5780, or via e-mail at tr9618@westpoint-emh2.army.mil.

**The Naval Research Laboratory (NRL)** is installing the first production-representative Army Airborne Command and Control System (A2C2S) in a UH-60A Black Hawk helicopter. The A2C2S will provide commanders with airborne command-and-control capability, including voice and data equipment that provides battlefield information processing and connectivity equivalent to a tactical command post and battle command vehicle.

**The Department of Energy's Sandia National Laboratories** and **General Atomics Aeronautical Systems** have unveiled a new, 115-pound synthetic aperture radar system intended for use aboard unmanned aerial vehicles. The system, dubbed Lynx, is an all-weather sensor capable of providing real-time photo-like images through clouds, rain or fog, in both daylight and darkness, at ranges up to 85 kilometers.

Computer game developer and publisher **NovaLogic** has formed a wholly owned subsidiary, NovaLogic Systems Inc. (NSI), intended to provide the company's software technologies to military and civilian training agencies. Under a cooperative research and development agreement with the Army Research Institute, NSI is creating a PC-based image generator and database for use as a desktop trainer for helicopter crews and a mission-rehearsal aid for Army aviators.

**LandSea Systems Inc.** has been awarded a contract worth up to \$480 million to supply the Air Force with Aero-1 Inmarsat Satcoms through 2007. The device gives cockpit crews continuous satellite communications over three channels and provides voice, fax, modem and packet data communications that are more secure and accessible than radio frequency. The Aero-1 uses the highly reliable Inmarsat Global Beam and Spot Beam satellite network and the ARINC and SITA network.

**The Boeing Sikorsky RAH-66 Comanche Joint Program Office**, which will move from Philadelphia to Huntsville, Ala., next July, has delivered to the Army a \$3.1 billion proposal for the initiation early next year of the Comanche program's engineering and manufacturing development (EMD) phase. Under the proposal, which includes the construction of 13 RAH-66s for testing and evaluation, the EMD phase would begin in March 2000 upon completion of a successful Defense Acquisition Board Milestone II review and would run through December 2006.

Three aviation units were among the 44 active Army, Reserve and National Guard organizations that received **Chief of Staff, Army, Supply Excellence Awards** at a September ceremony in Alexandria, Va. Company C, 25th Aviation Regiment, 25th Infantry Division, at Wheeler Army Air Field, Hawaii, was named a runner-up in the "Active Army TDA (Large)" category; the 6th Battalion, 101st Avn. Regt., 101st Airborne Div., at Fort Campbell, Ky., was a runner-up in the "MTOE Battalion Without Property Book" category; and Co. B, 193rd Avn. Regt., at Wheeler AAF was named the winner in the "National Guard Supply Support Activity (Small)" category.

# contents

Vol. 48 No. 10

OCTOBER 31, 1999

## FEATURES:



- 6 Protecting the Force  
*by Maj. Gen. Anthony Jones*
- 8 Aviation Soldiers Put to the Test  
*by CSM Edward Iannone*
- 32 Hunter in the Balkans  
*by Bill Smithson*
- 35 Aviators Aid Flood-Relief Effort  
*by Staff Sgt. Michael Westerfield*



## SPECIAL FOCUS: Aircraft Survivability and Avionic, Aviation Electronics Combat and Aviation Safety & Life Support

- 10 Aviation Electronics Combat Ready for the 21st Century  
*by Larry D. Johnston*
- 17 Aircraft Survivability Equipment: An Update to the Field  
*by Dr. Steven L. Messervy and Lt. Col. C. Henry Flick (Ret.)*
- 26 Aircraft Survivability: A Joint Approach  
*by Lt. Col. Charles R. Schwartz Jr. and Philip Weinberg*
- 28 High Frequency Radio  
An Old Friend Returns Stronger than Ever  
*by Chris Wantuck and Jerry Sweitzer*
- 30 Making Have Quick Work  
*by Maj. Scot MacKenzie*



## DEPARTMENTS:

AAAA New Members.....	39	Briefings .....	3
AAAA News .....	39	Calendar.....	42
Arrivals & Departures .....	38	People on the Move.....	37
Book Review .....	36	Tips from Tops .....	36

ARMY AVIATION is the official journal of the Army Aviation Association of America (AAAA). The views expressed in this publication are those of the individual authors, not the Department of Defense or its elements. The content does not necessarily reflect the official U.S. Army position nor the position of the AAAA or the staff of Army Aviation Publications, Inc., (AAPI). Title reg<sup>®</sup> in U.S. Patent office. Registration Number 1,533,053. SUBSCRIPTION DATA: ARMY AVIATION (ISSN 0004-248X) is published monthly, except April and September by AAPI, 49 Richmondville Avenue, Westport, CT 06880-2000. Tel: (203) 226-8184, FAX: (203) 222-9863, E-Mail: [aaaa@quad-a.org](mailto:aaaa@quad-a.org). Army Aviation Magazine E-Mail: [magazine@quad-a.org](mailto:magazine@quad-a.org). Website: <http://www.quad-a.org>. Subscription rates for non-AAAA members: \$30, one year; \$58, two years; add \$10 per year for foreign addresses other than military APOs. Single copy price: \$3.00. ADVERTISING: Display and classified advertising rates are listed in SRDS Business Publications, Classification 90. POSTMASTER: Periodicals postage paid at Westport, CT and other offices. Send address changes to AAPI, 49 Richmondville Ave., Westport, CT 06880-2000.

# VOICE AND DATA RECORDER • VADR™

SMITHS INDUSTRIES TOTAL SYSTEM SOLUTION



Smiths Industries systems increase the capabilities of pilots and their equipment. They improve the management of information in the air and on the ground, providing a tactical and competitive advantage. Smiths Industries is a development partner committed to innovation, investment and lifetime support – for commercial and defense priorities worldwide.

Please call for the Smiths Industries Aerospace Guide.  
(USA): (616) 241 8643; (UK): (44-181) 457 8203.

*Flexible configurations of voice and data recording offered by the Smiths Industries Voice and Data Recorder bring modern recorder technology to platforms previously limited by the weight and bulk of traditional recording systems.*

*The compact, lightweight, and affordable VADR™ is available in a variety of configurations.*

 **SMITHS INDUSTRIES**  
Aerospace

# Protecting the **FORCE**

By Maj. Gen. Anthony Jones

**P**rotecting the force is one of the most basic and intuitive responsibilities of commanders and leaders, and is ingrained in our training philosophies and doctrine. Over the past few years that fundamental concept has expanded and evolved in the aftermath of terrorist attacks on U.S. military and other government organizations. We must change our mind-set and place force protection — with a command emphasis — at the forefront of our mission planning, both at home station and when deployed.

After the bombing of the Khobar Towers in Saudi Arabia Secretary of Defense William Perry appointed Gen. Downing, former commander of U.S. Special Operations Command, to assess the circumstances surrounding the bombing and to recommend improvements in force protection. In September 1996 the Downing Task Force released 26 findings, of which five pertained directly to the Army. A month later the chairman of the joint staff activated a 37-member organiza-

*We cannot afford to be apathetic or complacent towards force protection issues.*

tion, J-34, to implement recommendations from the Downing Task Force findings. This brought about a whole new focus and approach to protecting the force.

We cannot afford to be apathetic or complacent towards force protection issues. We must take the appropriate measures to protect our force, to conserve the fighting strength of our units and to protect critical warfighting equipment and the lives of our soldiers. Commanders and leaders at all levels must be proactively involved with protecting their soldiers, civilians, family members and resources.

To accomplish this we must be able to implement the Army's Force Protection Program. Army Regulation 525-13, "Antiterrorism/Force Protec-

tion," outlines the responsibilities, — from major commands down to individuals — for the implementation of the Army's force-protection policies and for accomplishing directed training requirements. Again, it is the responsibility of commanders and leaders to implement force protection-policies in accordance with AR 525-13. The overriding component of the Army's force-protection policies are education and training.

Antiterrorism and force-protection training is mandated for nearly all segments of the Army, depending on where soldiers are and where they may be going. Level I through Level IV training is specified by AR 525-13 for certain population segments and leaders. Common core force-protection training is incorporated Armywide into the programs of instruction for professional-development courses to teach basic techniques and situational awareness at the appropriate levels. Antiterrorism and force-protection training is reaching Army Aviation Center sol-

diers enrolled in the Advanced Non-commissioned Officer Course, Warrant Officer Basic Course, Warrant Officer Advance Course, Aviation Officer Basic Course, Aviation Captains Career Course, and the Aviation Pre-Command Course for battalion and brigade commanders. Pre-commissioning and Primary Leadership Development Course programs of instruction are also including basic force-protection training to instill force-protection awareness early in the careers of our young soldiers and leaders.

A goal of the Army program is to make force-protection planning second nature at all levels of command. Commanders must develop detailed plans to protect the force during predeployment, deployment, employment/sustainment

and redeployment. Leaders and planners can identify force-protection requirements through an intensive mission-analysis process. Requirements are different for every situation. Commanders and staffs should use standard Army methodologies in the planning process to identify force-protection requirements: METT-T; threat and vulnerability assessments; and civil/political planning factors in a particular area of operations. Most importantly, we must ensure that safety and risk management are also thoroughly integrated at all steps of the planning, training and mission execution.

As a combined-arms branch we must not only be aggressive and proactive in accomplishing mandatory training and thorough planning, we must focus on our warfighting mission and how to implement force-protection measures in aviation operations and doctrine. Whether the mission is a stability and support operation in Albania or conventional warfare on a worldwide front, the aviation branch must be ready, trained and able to effectively implement force-protection measures to protect our fighting force and limited assets. As a branch and combat multiplier, we must improve basic soldier skills to strengthen discipline and build confidence in our soldiers, whether in garrison or the field. An aviation unit proficient in basic soldier skills is already far ahead in protecting the force and maintaining combat effectiveness.

Our aircraft and personnel are high-payoff targets for terrorists or any other adversary, and as such must be protected to the utmost of our ability. Unit commanders should emphasize assembly-area operations during home-station training, from initial occupation through continuous improvement. Develop and rehearse detailed standard operating procedures at all levels. As units, become proficient in security operations — fighting positions, sectors of fire, crew-served weapons place-

# What do these platforms have in common?



## A path to lower O&S costs, increased mission readiness, and enhanced safety through use of the BFGoodrich\* IMD-HUMS.

The BFGoodrich next generation Dual-Use Integrated Mechanical Diagnostics-Health and Usage Management System (IMD-HUMS) has been selected for the S76 and S92 civil helicopters, the US Navy SH-60 and CH-60 fleet, the USMC/USN CH-53E Superstallion fleet, the USMC Bell AH-1Z and UH-1Y Upgrades, and the US Army UH-60 Blackhawk.

The BFGoodrich solution *is* different...find out why by contacting:

**BFGoodrich**  
Aerospace  
Aircraft Integrated Systems



100 Pantan Road, Vergennes, VT 05491, USA • Telephone 802-877-2911 • Fax 802-877-4113  
54 Middlesex Turnpike, Bedford, MA 01730 USA • Telephone 781-275-4545 • Fax 781-275-5035

\*Vibro-Meter, (a Meggitt Company), is a partner of BFGoodrich Aerospace in the IMD-HUMS development, deployment and support.

ment, perimeter security, actions on contact and more. We must always be vigilant and never become complacent!

Physically securing and protecting our force is only half the battle; the other half is conducting aviation operations safely and to a high standard of excellence. Proper maintenance, fighter management, aircrew training, mission planning, safety, and discipline all play a significant role in protecting the force. We must train to a high standard to accomplish tough, real-world missions, day or night, in adverse weather. Incorporating

risk assessment and risk management in the planning and execution of training and real-world missions is essential. Leaders at all levels must be proficient at integrating risk management into troop-leading procedures before conducting any type of operation.

To be successful in protecting the force we must utilize the expertise organic to our organizations: leaders; safety officers and NCOs; maintenance and armament officers and NCOs; S2, S4 and force-protection officers; and others, including the col-

lective experience and knowledge of our NCOs and soldiers. Take advantage of the resources available to you. Do not lose sight of the big picture. Protecting the force is our responsibility — to our soldiers, their families and our nation — to preserve a trained and ready fighting force!

*Above the Best!*



*Maj. Gen. Anthony R. Jones is commanding general of the U.S. Army Aviation Center at Fort Rucker, Ala., and chief of the aviation branch.*

## Aviation Soldiers Put to the Test

Wartime is the true test of any soldier. From the Revolutionary War to Operation Desert Storm, the Army has provided exemplary battlefield soldiers. Constant training and conditioning are the major requirements to keep anyone in the military physically and mentally sharp. All soldiers are required to attend Basic Training, but not all soldiers push themselves to exceed the standards set by those around them.

Sgt. Mark W. Crane has continually set goals and pushed himself and others to reach them. While assigned to Company K, 158th Aviation Regiment, at Fort Carson, Colo., he successfully recovered numerous aircraft that had made emergency landings around the Pegosa Springs and Denver areas. As part of Co. B, 1st Battalion, 501st Avn. Regt., in Korea, Crane deployed many times. His company responded to North Korean spy submarines that crossed the demilitarized zone. After becoming the non-commissioned officer in charge of a detachment south of Seoul, he and the soldiers under him supported all forces in the southern peninsula.

Accomplishments such as these are what led to Crane's winning of the

Sikorsky Aircraft Superior Maintenance Award for Outstanding Maintenance Procedures. During times of peace in our nation one of the principal ways soldiers are recognized is by appearing before boards of fellow non-commissioned and commissioned officers. After volunteering for the 82nd Airborne Division and attending jump school, Crane won multiple recognitions including: Battalion NCO of the Quarter, Battalion NCO of the Year, Brigade NCO of the Month and Brigade NCO of the Quarter. Taking on the additional role of squad leader, Crane has recently led his squad to complete a phase in 43 days — 17 days above Department of the Army standards.

In just five years Crane has managed to influence the Army and set an example for all soldiers who follow him. His numerous awards include the Army Commendation Medal, the Army Achievement Medal, the Good Conduct Medal, the Primary Leadership Development ribbon, the National Defense ribbon, the Army Service ribbon and the Overseas Service ribbon.

by CSM Edward Iannone,  
Aviation Branch CSM, Fort Rucker, Ala.

## If you're starting to think you'll never get your college degree, think again.

### Introducing The Degree Completion Program from Embry-Riddle Aeronautical University.

Between Army life and life in general, finding the time to go back to college may seem like one of those priorities that has slipped among your rankings of things to accomplish. But now completing your college studies has never been more convenient.

The Embry-Riddle Aeronautical University Degree Completion Program has been designed to fit comfortably into the busy schedule of Army Warrant Officers. Classes are scheduled at the most convenient times at the most convenient locations. Permissive TDY makes it even easier to participate in the program and college credits may be awarded for your military experience.

Success is often a matter of degrees. So give it some thought. Get the whole story by contacting the Embry-Riddle representative at any of these bases:

Fort Bragg	Fort Eustis	Fort Lewis	Fort Wainwright
Fort Campbell	Fort Irwin	Fort Rucker	Wheeler AAB, Hawaii
Fort Carson	Fort Knox	Hunter/Stewart	

Or call 1-800-522-6787

**EMBRY-RIDDLE**  
Aeronautical University  
[www.embryriddle.edu](http://www.embryriddle.edu)



# BUILT TO SURVIVE ARMY LIFE.

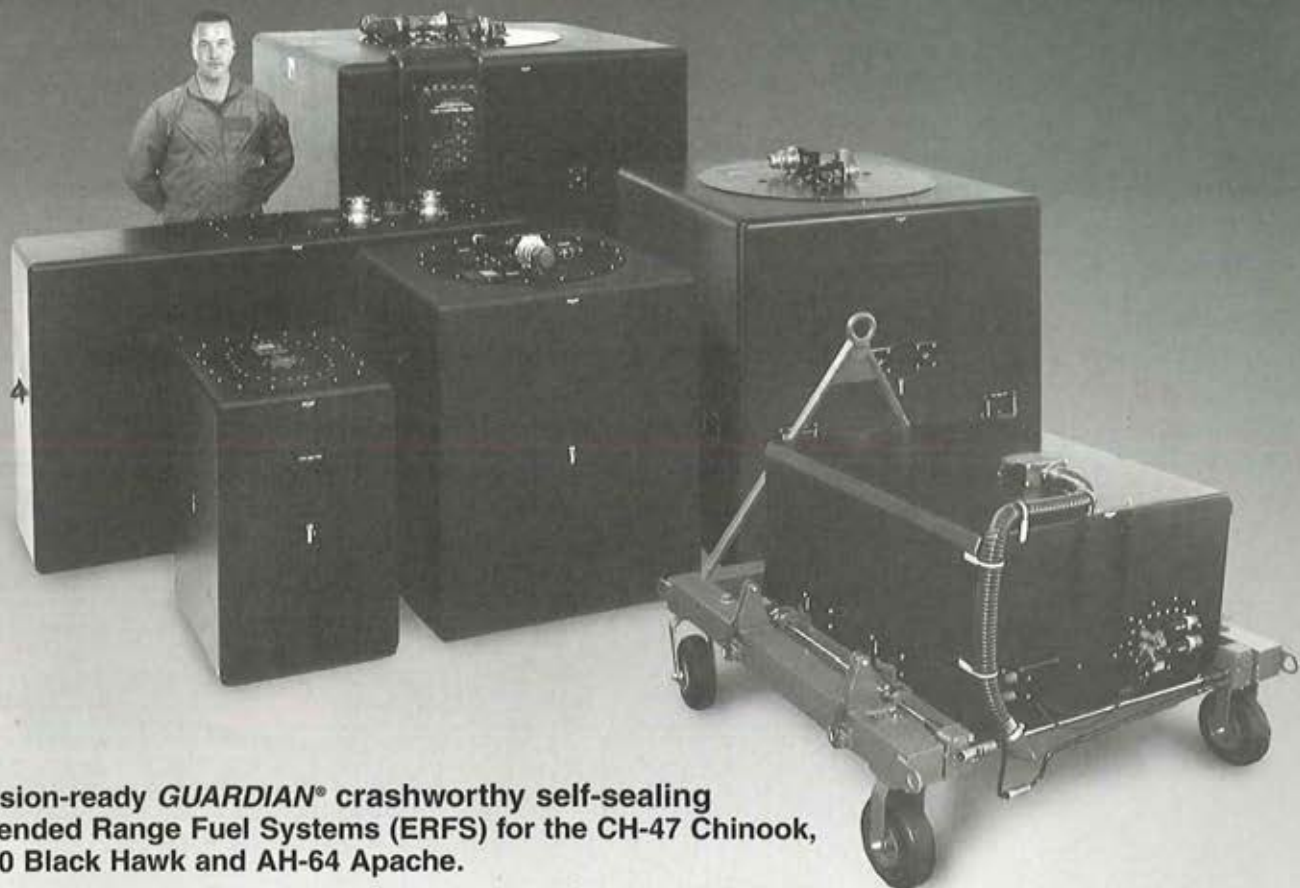

Mission-ready **GUARDIAN**® crashworthy self-sealing Extended Range Fuel Systems (ERFS) for the CH-47 Chinook, H-60 Black Hawk and AH-64 Apache.



## MISSION FLEXIBILITY

The U.S. Army ERFS II provides up to three 800 gallon tanks and a Forward Area Refueling Equipment (FARE) kit for the CH-47D Chinook helicopter.

The **GUARDIAN**® 200 single-tank ERFS is interchangeable with the **GUARDIAN**® 185 two-tank ERFS in the H-60 Black Hawk helicopter.

The **GUARDIAN**® 130 ERFS provides 130 gallons of additional fuel and replaces the ammunition storage magazine in the AH-64 Apache helicopter.

For complete information call (480) 967-5185, fax (480) 968-3019, Email [robertsonaviation@worldnet.att.net](mailto:robertsonaviation@worldnet.att.net), or write 1024 E. Vista Del Cerro, Tempe AZ 85281

# ROBERTSON

AVIATION

Range Extension Fuel Systems

# AVIATION ELECTRONICS COMBAT READY for the 21<sup>st</sup> Century

By Larry D. Johnston

Simply defined, "avionics" is all electronic hardware and software that collectively enable an aircrew to navigate, communicate, control and maintain situational awareness. The U.S. Army Project Manager for Aviation Electronic Combat (PM-AEC) is chartered by the Program Executive Officer (PEO)-Aviation to provide common avionics across all Army aviation platforms. Common avionics give users reduced development costs, larger production rates, lower unit costs, increased logistics support bases and resulting lower total ownership costs.



## Project Manager Aviation Electronic Combat ORGANIZATIONAL STRUCTURE

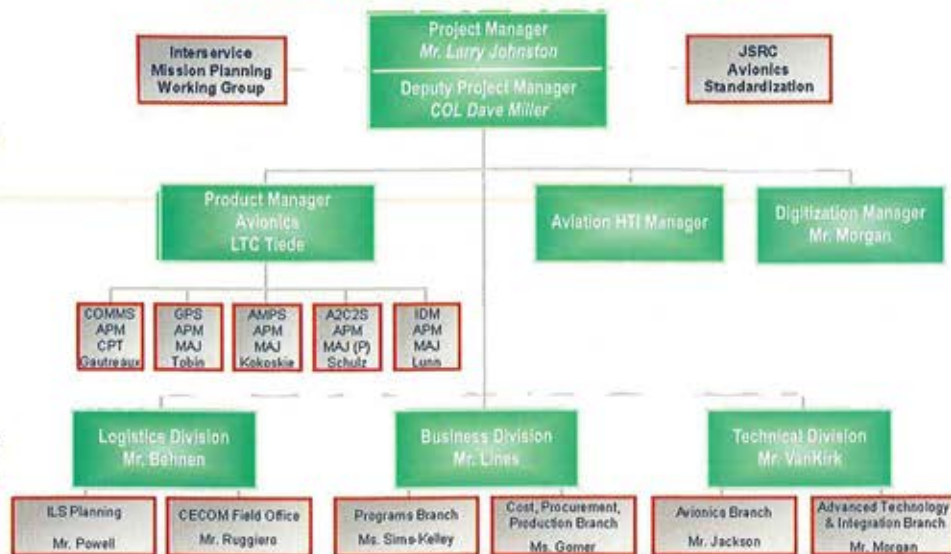

There are some avionics, of course, which must be tailored to the mission of a particular aircraft platform, or which do not lend themselves to commonality. However, for the majority of the avionics components PM-AEC provides a best-value service to consolidate requirements, develop products and field state-of-the-art equipment to our troops. In addition to providing avionics acquisition management, PM-AEC provides oversight and coordination of Battlefield Digitization and Horizontal Technology Integration (HTI) efforts for all aviation PMs. HTI is a natural mission for PM-AEC, since our product focus is to bring common solutions to unique problems. We are expanding our efforts to become the coordinator for all types of common hardware

applications, ensuring technical information and HTI opportunities are shared among all platforms.

Battlefield digitization also falls naturally into our mission area. It involves aviation's preparation for, and participation in, the "digitized battlefield" - one of the Army's top priorities. Digitization has been defined as "the application of information technology to acquire, exchange and employ timely digital information tailored to the need of each decision-maker, shooter and supporter, thereby allowing a clear and accurate vision of the battlespace." It is primarily focused toward improving the ability of our forces to communicate and operate effectively in a cohesive manner; in other words, its focus is on interoperability. The goal is to hori-

zontally and vertically integrate the Army's diversified battlefield operating systems into an interlocking information-exchange network.

Army aviation provides 31 percent of a heavy division's combat power mobility, thereby making its integration into Force XXI objectives imperative. Digital forces will routinely conduct missions in areas of operation of considerable breadth and depth. Army aviation is diligently working to provide aircraft capable of operating with all digitized forces to acquire and attack targets out to ranges in excess of 200 kilometers.

Army aviation's digitization efforts are coordinated in the Advanced Technology and Integration (ATI) Branch of the Technical Management Division. Team members are active in

"I know there are radar-guided weapons waiting for me. Fortunately, I have help from my self-protection system."



Today's pilots face unprecedented dangers. That's why, at ITT Industries, we're committed to being a leader in RF self-protection systems. We engineer and manufacture integrated electronic warfare suites that provide pilots with the most advanced threat warning, situational awareness and electronic countermeasures capabilities.

**"Whatever you fly, we have you covered."**

We protect the widest range of aircraft, from fighters and bombers to helicopters and special operations platforms.

Our EW capabilities range from combat-proven systems like the ALQ-172 and ALQ-165 ASPJ to the next-generation ALQ-211 SIRFC and ALQ-214 IDECM RFCM.

As weapons grow in sophistication and lethality, we continue to provide the critical technology edge for survivability & mission success.



**ITT Industries**  
*Engineered for life*

Armywide digitization working groups and Integrated Product Teams (IPT) to obtain and disseminate information, set policy and direction for the aviation community, and ensure aviation requirements are considered in the development of the Tactical Internet (TI).

Our current focus is on supporting the 4th Infantry Division, designated

conduct sequences of exercises that certify aviation systems interoperability with the other weapons platforms and C4I systems.

A quick review of PM-AEC's major products will provide their up-to-date status and detail how they support modernization of Army aviation to win the battles of the 21st century.

with flight instruments to provide precise location with 16-meter accuracy. It operates in pure-Doppler, GPS-only, or mixed navigation modes and holds up to 100 preprogrammed waypoints. The two fleets are currently 87 percent equipped with a completion target of Fiscal Year 2001 (FY 01).

The EGI, used in the AH-64A/D,



### Aviation-Missile Technical & Integration Facility

- ◆ Software integration
- ◆ Problem isolation
- ◆ System certification
- ◆ Coordination with all digitization efforts
- ◆ Integrated simulation and training

AMTIF

Conference Room

as the First Digitized Division (FDD), which will participate in the Division Capstone Exercise (DCX) at the National Training Center (NTC) to evaluate the battlefield effectiveness of this digitized force structure. The division's 4th Aviation Brigade will provide AH-64D and OH-58D aircraft capable of transmitting and receiving digital command-and-control (C2) messages on the TI.

In order to ensure that all Army command, control, communications, computer and intelligence (C4I) systems are interoperable, the Army Acquisition Executive directed that systems fielded to the FDD must certify their Joint Variable Message Format (JVMF) messaging set at the Central Technical Support Facility (CTSF) at Fort Hood, Texas. PM-AEC will host and support the aviation and missile systems' certification at the Aviation-Missile Technical Integration Facility (AMTIF), an integral part of the CTSF complex, in support of PMs within PEO-Aviation and the Deputy for Systems Acquisition, U.S. Army Aviation and Missile Command (AMCOM). The 6,888 square-foot facility, which houses laboratory, communications and work areas, opened in January 1999 and is occupied by various PM representatives. PMs will use the AMTIF as a low-cost means to

## Navigation Systems

Navigation Systems are a primary PM-AEC product. Two Global Positioning Satellite (GPS) programs, the Doppler GPS Navigation System (DGNS) and the Embedded GPS-Inertial (EGI), are currently under our auspices.

DGNS combines the AN/ASN-128A Doppler navigation system with a GPS module embedded in the Systems Display Controller (SDC) to provide unprecedented navigation accuracy. Used in the UH-60A/L Black Hawk and CH-47D Chinook helicopters, the DGNS is integrated

with flight instruments to provide precise location data at 16-meter accuracy and velocity information at 0.8 meter-per-second accuracy with a Mean Time Between Failures (MTBF) of 6,500 hours. Both GPS systems provide universal timing for, and are integrated with, on-board systems to facilitate communications, target acquisition and situational awareness.

Emerging battlefield and civil air-

### GPS Navigation System

**DGNS**

**EGI**

- ◆ Doppler Embedded GPS (DGNS)
  - ◆ Modified Doppler system
  - ◆ UH60/CH47
  - ◆ GPS module embedded in SDC
  - ◆ Can operate in either busbed or non-busbed integrations
  - ◆ Pure Doppler, GPS-only, and mixed navigation modes
- ◆ Embedded GPS Inertial (EGI)
  - ◆ 1553 buss compatible
  - ◆ AH64A/D, OH58D, MH60K/L, MH47D/E, numerous AF, Navy aircraft
  - ◆ High MTBF: 6500 hours
  - ◆ Pure inertial, GPS-only and blended navigation modes

Enlisted Now Eligible

Since 1922,  
**we've been there**  
for our nation's military.



**O**ur business has always focused on providing financial security to members of the military and their families. As a matter of fact, United Services Automobile Association was founded by military personnel for military personnel. Initially offering reliable auto insurance, today, USAA's products and services have grown to include a full range of excellent insurance and financial products.

**And we're  
still there today.**



Join Forces with USAA®

INSURANCE • BANKING • INVESTING • MEMBER SERVICES

1 - 8 0 0 - 5 3 1 - U S A A

Applicants to the USAA group of property and casualty insurance companies must meet certain membership eligibility requirements before purchasing for the first time. Generally those eligible include personnel in the U.S. military services on active duty, in the Selected Reserves, or in the National Guard; and those who have been retired or separated for two years or less. Formerly dependent children of P&C group members are also eligible to apply. Please call 1-800-531-8080 to determine if you are eligible.

## Navwar Objectives



The Improved Data Modem (IDM) is Army aviation's link to digital communications and the TI, the Digital Battlefield's integrated communication network.

space requirements present challenges which mandate upgrades to the EGI and DGNS. These new challenges include overcoming GPS jamming, enhancing GPS security, operating aircraft in low visibility, and gaining or maintaining Army access to civil airspace conditions. Our EGI/ DGNS pre-planned product-improvement (P3I) effort will meet all navigational requirements. Requirements of the Department of Defense (DOD)-wide Navigation Warfare (NAVWAR) program to mitigate GPS jamming and "spoofing" will drive significant changes to installed GPS modules. This modernization initiative also includes a new method for the secure "keying" of navigation systems.

Weather conditions that create low or zero visibility have long been a hindrance to military operations. The Joint Precision Approach and Landing System (JPALS) provides a GPS-based capability when weather conditions make visual approaches impossible. We are determining solutions which meet the rotary-wing requirements of Category I precision approach (200 feet decision height).

Our third goal, in concert with civil-aviation authorities, is to create a system that will safely accommodate ever-increasing air traffic with greater efficiency. The Global Air Traffic Management (GATM) program modifies and procures avionics to meet the demands of new civil-airspace regulations and ensures continued Army access to controlled airspace.

## Communication

The Improved Data Modem (IDM) is Army aviation's link to digital communications and the TI, the Digital Battlefield's integrated communication network. The IDM's speed of transmission (up to 400 kbps) allows a greater volume of information exchange while minimizing "on-the-air" time. In its current configuration the IDM permits transmission and receipt of digital messages in Air Force Applications Program Development System (AFAPDS), United States Message Text Format (USMTF) or Tactical Fire Control (TACFIRE) formats. The actual speed of message transmission is limited by the range, bandwidth and capability of the Single Channel Ground and Airborne Radio System (SINCGARS) (VHF-FM) or Have Quick (UHF-AM)

## IDM / EBC Platforms

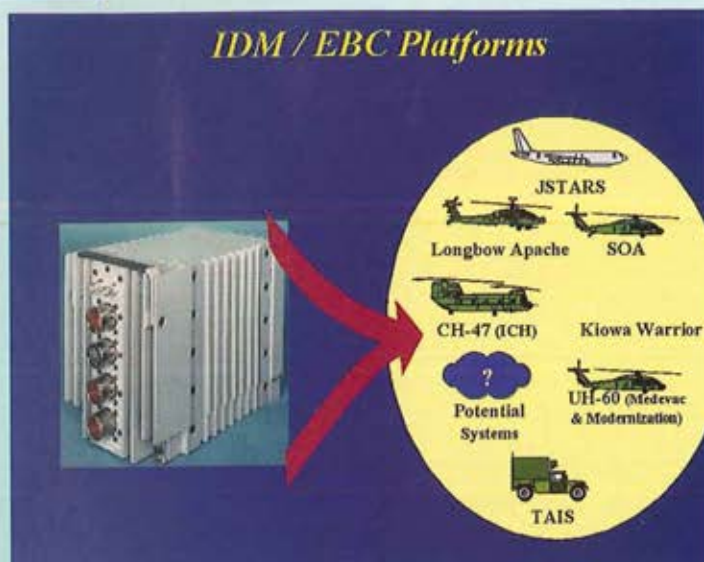

radios in use by field units. An IDM P3I incorporates the Army's Embedded Battle Command (EBC) system and allows for digital message flow in JVMFs. Phase I of this effort will implement a select set of JVMF messages in the OH-58D Kiowa Warrior and AH-64D Apache Longbow for the FDD DCX in the second quarter of FY 01. Phase II implements full EBC functionality (all JVMF messages as well as situational awareness) for the entire aviation fleet, beginning with the OH-58D and AH-64D in the second quarter of FY 02.

The AN/ARC-220 High Frequency (HF) Radio allows Army aviation to communicate while operating at nap-of-the-earth (NOE) altitudes at ranges of up to 300 kilometers -capabilities well beyond current tactical UHF and VHF radios. The ability to communi-

## High Frequency Radio AN/ARC-220

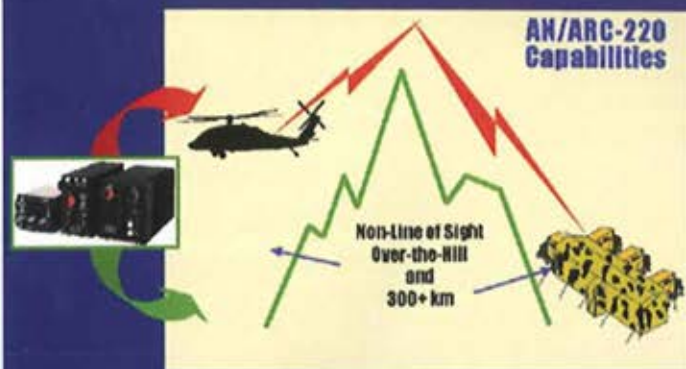

*The Aviation Mission Planning System (AMPS) is Army aviation's common mission planner and data loader. AMPS is a proven system, having been in the field for five years.*

cate while flying NOE reduces susceptibility to enemy detection and increases the likelihood of mission success, making the AN/ARC-220 an essential addition to the fleet. The AN/ARC-220 incorporates Automatic Link Establishment (ALE), Electronic Counter Counter-Measure (ECCM) features, pilot directed position reporting and a digital message transmit/receive capability. A Concept Evaluation Program (CEP) will demonstrate the ability to integrate the radio's digital message capability with the TI next year. The AN/ARC-220 HF and its ground version, the AN/VRC-100, are currently being fielded to the CH-47 Chinook fleet, including those aircraft assigned to the 160th Special Operations Aviation Regiment. Integration and testing continues this year for the Black Hawk, Kiowa Warrior and Apache fleets.

The Joint Tactical Radio System (JTRS) is DOD-wide effort to reduce the number of tactical radios by replacing them with a smaller family of modular, multi-mode, multi-channel, software-reprogrammable radios. This radio system must emulate multiple military waveforms, such as SINCGARS, Have Quick, Enhanced Position Location Reporting System (EPLRS), Satellite Command (SATCOM) and HF, as well as commercial AM and FM. Each member of the JTRS family falls into one of four domains: ground, airborne, man-portable or maritime. JTRS promises to decrease size, weight and power

requirements of discrete legacy radios, and will provide Army aviation the much-needed EPLRS waveform to improve TI connectivity. Because of its open-architecture design, future complex waveforms and wide-band frequency solutions can be incorporated without the significant integration effort expended on federated radios of the past. Army aviation leads the demand for JTRS with an expected fielding in FY 04 to the Apache Longbow fleet.

### Mission Planning

The Aviation Mission Planning System (AMPS) is Army aviation's common mission planner and data loader. AMPS is a proven system, having been in the field for five years. It is used to plan missions, then uses a Data Transfer Cartridge to initialize the navigation, communications and weapon systems for all aircraft and load map data to aircraft with map sys-

tems. Besides displaying map data on the Lightweight Computer Unit (LCU) screen, AMPS enables the planner to develop routes and control measures. However, AMPS is undergoing a facelift. The software is being converted to the Microsoft NT operating system and by adding the capability to exchange data with the Army Tactical Command and Control System (ATCCS) Maneuver Control System (MCS), the aviation mission planner can download operations plans and orders from higher headquarters to assess both friendly and enemy situation information.

AMPS currently generates 3D computer images of the terrain using Digital Terrain Elevation Data (DTED) and digital maps. A key feature of the AMPS is its ability to graphically portray "threat domes," based on the reported locations of threat weapon systems, to help the planner and pilot select routes that minimize exposure to

### AMPS Functions & Interfaces

- ◆ Automates routine mission planning tasks allowing more time for detailed planning
- ◆ Provides connectivity to Army Tactical Command & Control Systems
- ◆ Transfers mission planning data to aircraft
- ◆ Provides map dissemination for Army Aviation to platform level

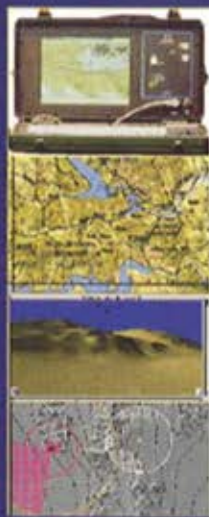

threat systems. Pilots use these images to augment mission rehearsals. Flying a virtual mission route is possible with the addition of a commercial based accelerator card, a capability recently demonstrated by Task Force Hawk in Albania. The long-awaited aircraft Performance Planning Module is in service and a common Digital Transfer Device (DTD) is being studied. AMPS' evolutionary acquisition strategy has and will continue to bring current technology to the field rapidly and reliably.

## Command and Control

The Army Airborne Command and Control System (A2C2S) provides the Army's only airborne on-the-move C2 for maneuver commanders at corps, division and brigade levels. It will also be used by attack aviation battalion commanders in deep-strike operations. A2C2S is hosted in a UH-60 helicopter and provides seamless connectivity to the TI or legacy C2 systems through a robust communications suite and five fully automated, reconfigurable workstations. These workstations host the programs and data necessary for complete situational awareness and suc-

cessful battle command: the MCS, the All Source Analysis System (ASAS), the Army Field Artillery Tactical Data System (AFATDS), the Force XXI Battle Command Brigade and Below (FBCB2) and the AMPS. Collaborative planning is enhanced through the use of two centrally located, large-screen displays. A video matrix switch allows operators to share screen views with each other. The A2C2S will be fielded with a basis of issue of six per corps and division, beginning in FY 04 to the 1st Cavalry Div. at Fort Hood.

The growing importance of communications, navigation, command and control, mission planning and aircraft-modernization design influence has become paramount to the aviation community as the Army vision turns toward Army XXI and the Army 2010



The Army Airborne Command and Control System (A2C2S) provides the Army's only airborne on-the-move C2 for maneuver commanders at corps, division and brigade levels.

and Beyond. The men and women of PM-AEC continue to provide dedicated cost-effective acquisition of high-technology products, enhancing every aviator's ability to fight and win.



Larry D. Johnston is the project manager for aviation electronic combat in the Program Executive Office, Aviation, at Redstone Arsenal, Ala.

## FEEL THE POWER!

### Earmark Radio Headsets...

**BLOCK OUT NOISE.  
KEEP FLIGHTLINE  
GROUND CREWS IN  
CONTINUOUS  
COMMUNICATION.**



Do more in less time with Earmark duplex headsets! No more unreliable hand signals. Have two mechanics talk to each other from the cockpit to the tail rotor, even at high noise levels, to easily balance rotors without being hindered by a hardwired cord. Direct feedback on sling conditions gives the pilot more confidence and lets operations proceed faster with less risk! Coordinate the off-loading of material safer and smoother! With Earmark duplex headsets, you can do more, faster. Increase productivity!

For more information and a FREE trial, call our Product Specialists at (888) EARMARK (327-6275).



**EARMARK®**

1125 Dixwell Avenue, Hamden, CT 06514  
Phone (203) 777-2130, Fax (203) 777-2886  
<http://www.earmark.com>

FLG4B

## REDEFINING the HEAT of Battle

### A.I.R.I.D. SYSTEM

A SOLUTION  
TO COMBAT IDENTIFICATION!

Sometimes the most difficult problems require the simplest solutions. Here is an active thermal system which will provide positive ID of friendly forces. It will cause no discomfort to the individual, and be detectable only by special devices.

### A.T.L.A.S. SYSTEM

The A.T.L.A.S. System is designed as a nighttime tactical landing aid for helicopters equipped with thermal imaging equipment. It is the only such system in existence. It has been tested, proven and is available. It replaces visual light inverted "Y"s. It is man-portable and is fuel, ammo and personnel safe. It is deployable in minimum time in a tactical environment.

Heatmax, Inc., Military Division • P.O. Box 1191 • Dalton, Georgia 30722  
US and Canada: 1-800-HEATMAX • International: 706-226-1800 • fax: 706-226-2195





# Aircraft Survivability Equipment:

## An Update to the Field

By Dr. Steven L. Messervy  
and Lt. Col. C. Henry Flick (Ret.)

**T**he Joint Project Office (JPO) for Aircraft Survivability Equipment (ASE) and Advanced Threat Infrared Countermeasures (ATIRCM)/Common Missile Warning System (CMWS) systems, is assigned to the U.S. Army Program Executive Officer — Aviation. The JPO is one of a small number of Department of Defense organizations involved in developing countermeasures to conventional air-defense weapons and the most extensively deployed and lethal threat to aviation today, the short-range, surface-to-air and air-to-air guided missile. The JPO's goal is to acquire for joint commanders the effective means to defeat all types of current and future threats to the aviation force and ensure mission success.

### Why ASE?

In recent years a new-technology missile several times more accurate and lethal than conventional air-defense weapons, and much easier to deploy, has appeared in large numbers. More than 20 nations are known to produce man-portable, shoulder-fired, infrared (IR) homing weapons capable of effective engagements up to 10 kilometers in range and 4.5 kilometers in altitude from launch sites. Their air-to-air counterpart fire-and-forget systems have ranges up to 20 kilometers. More than 100,000 of just two types of these systems, the Russian SA-7 Grail and SA-14 Gremlin surface-to-air missiles (SAMs) were produced and deployed in some 38 countries by 1993. Virtually every defense force in the world possesses or can easily acquire a variety of these electro-optic (EO)/IR anti-aircraft missiles on international arms markets.

And, finally, a third technology — the laser — has enhanced the lethality of both gun and missile systems used against surface and aerial platforms. The laser is now employed in three battlefield roles: laser rangefinder, laser target designator and laser beamrider. Used on a variety of U.S. and foreign systems, the laser has significantly increased the threat against low-flying aircraft. The worldwide threat facing both rotary- and fixed-wing aircraft from hostile nations, terrorists and low-intensity conflict "freedom fighters" has never been greater.

### JPO Mission

The mission of the JPO for ASE/ATIRCM/CMWS is to develop a family of systems designed to counter the threats mentioned above in the IR, radio frequency (RF) and laser-guided system arenas. The JPO currently manages six ASE systems from its offices at Redstone Arsenal, Ala. These include the currently fielded AVR-2A(V) Laser Detecting Set, AN/APR-39A Radar Warning Receiver and AN/ALQ-144A(V)3 IR Countermeasures System, as well as the developmental AN/ALQ-211 Suite of Integrated Radio Frequency Countermeasures (SIRFC) and the AN/ALQ-212 Advanced Threat Infrared Countermeasures/Common Missile Warning System (ATIRCM/CMWS) system. The sixth system is the Aircraft Survivability Equipment Trainer (ASET) IV. This article will provide system descriptions, current status, capabilities and planning schedules for each of these systems.

### The AVR-2A(V)

The AVR-2A Laser Detecting Set is a passive laser-warning system which receives, processes and displays threat information resulting from aircraft illumination by threat laser-aided weapons. As shown on Figure 1 below, the AVR-2A consists of four sensors mounted on the aircraft surface plus one internally mounted central interface unit.

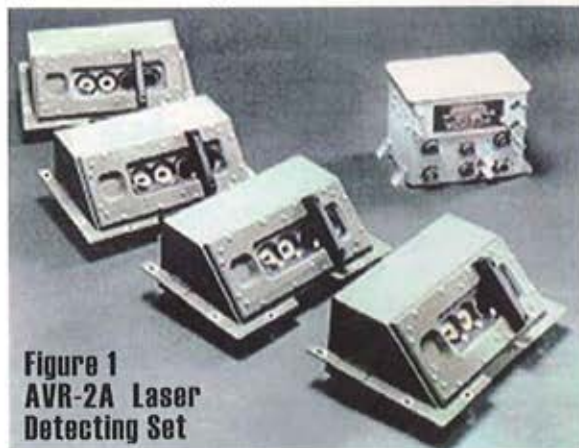

Figure 1  
AVR-2A Laser  
Detecting Set

**Figure 2**  
**AN/APR-39A(V)2 Radar**  
**Warning Receiver**



The AVR-2A is currently installed on U.S. Army and Navy aircraft including the OH-64A/D, OH-58D, MH-47E, MH-60K, AH-1S, MV-22, CV-22, SH-60R, HH-60H, AH-1W/Z and UH-1N/Y. Future installations of the system are planned on RAH-66, CH-47F, UH-60L, and C-130 aircraft. The United Kingdom has obtained the AVR-2A through Foreign Military Sales (FMS) for installation on the EH-101 and WAH-64D (UK). Other potential FMS customers include the Netherlands and Taiwan.

The AVR-2A detects and categorizes laser threats as either rangefinders, target designators or beamriders. It also identifies the direction of the threat, prioritizes threats according to lethality, and displays threat data to the aircrew both visually and audibly. This information is currently displayed on the AN/APR-39A(V) or multifunction display on the OH-58D. Ultimately, AVR-2A data will be fused through SIRFC and displayed to the aircrew on the multifunction display or a dedicated Aircraft Survivability Equipment Display (ASED). The AVR-2A can also be used for training by serving as a MILES/AGES receiver.

A horizontal technology insertion approach on improvements incorporated on the AN/VVR-1 Ground Laser Warning Set will be applied to the AVR-2A through an engineering change proposal on order to improve system performance and correct the ARC-220 EMI issues. This Enhanced AVR-2A will increase system performance against improved and emerging threat systems, significantly improve angle-of-arrival information, include 1553 data bus interfaces, provide improved EMI protection, reduce power consumption, reduce weight, be a lower-drag configuration, and have a reduced system cost.

The AVR-2A is currently unfunded in the POM. The prime contractor is Raytheon Systems Company.

### **AN/APR-39A**

The Army's current principal radar signal detecting device is the AN/APR-39A Radar Warning Receiver. It warns pilots of radar-directed threat air-defense systems by general category [gun, missile type, and radar mode (search, acquisition, or track)].

The system has been fielded in two versions, the AN/APR-39A(V)1 and (V)2. The first version is

deployed on Army AH-1F, AH-64A/D, CH-47D, MH-47E, UH-60A/L/Q, MH-60K and OH-58C/D helicopters. The latter will be installed on Navy and Marine Corps AH-1W, UH-1N, V-22, CH-46, CH-53 and KC-130 aircraft. The system utilizes a digital processor, alphanumeric display and a synthetic voice simultaneously to warn aircrews of radar-directed air defense systems. Its 10 line-replaceable units consist of a control unit, an indicator, a processor, two identical receivers, two left-spiral antennas, two right-spiral antennas and one blade antenna.

Both versions of the AN/APR-39A are designed for use on low- and slow-flying fixed- and rotary-wing aircraft. The (V)2 has an improved frequency tag ambiguity resolution, a greater capability against pulsed Doppler threat radars, a continuous-wave radar capability, and improved detection capabilities against long-range search radars. The less capable (V)1 model detector, considered to be too costly to redesign and upgrade, will be replaced by the AN/ALQ-211 SIRFC system currently in engineering and manufacturing development.

The AN/APR-39A system is considered to have reached its full potential and is no longer economically upgradeable and no upgrades are currently planned. Available Army aviation funding will be used to develop and field the much more capable SIRFC system.

### **AN/ALQ-144A(V)1/3**

The AN/ALQ-144A(V)1/3 IR Countermeasures System (CMS) is an active, continuously operating, omni-directional, electronically fired IR jammer that provides IR jamming against several known IR threat missile systems. It is designed for use on helicopters to confuse or decoy threat IR missile systems. The system was designed in the 1980s and has been upgraded throughout its operational life in reaction to threat system changes.



**Figure 3**  
**AN/ALQ-144A(V)1/3 IR Countermeasures Set**

AN/AAQ-24(V) / ARI 18246  
NEMESIS

A thoroughly tested Directional IRCM system proven to provide protection for aircraft ranging from small helicopters to C-130s.

In production today, NEMESIS has conclusively proven that it can detect, acquire, hand off, track and jam infrared missiles in Bands 1 and 4. The lamp-based NEMESIS system has successfully completed rigorous testing, including UK test helicopter and USSOCOM C-130 flight trials and autonomous live fire tests with all system configurations. Further, Northrop Grumman is prepared to offer NEMESIS with laser capabilities. In August 1999, the Northrop Grumman/Fibertek Viper™ Mid-Infrared Laser acquired, tracked and produced optical breaklock in all seeker engagements during a UH-60 Black Hawk helicopter demonstration. Together, NEMESIS and Viper™ ensure protection from the infrared threat well into the 21st century.

Northrop Grumman.  
Smart defense. Smart technologies.



**NORTHROP GRUMMAN**

**GEC-Marconi**  
Radar and Defence Systems

**BOEING**

**BRITISH AEROSPACE**  
Systems and Equipment

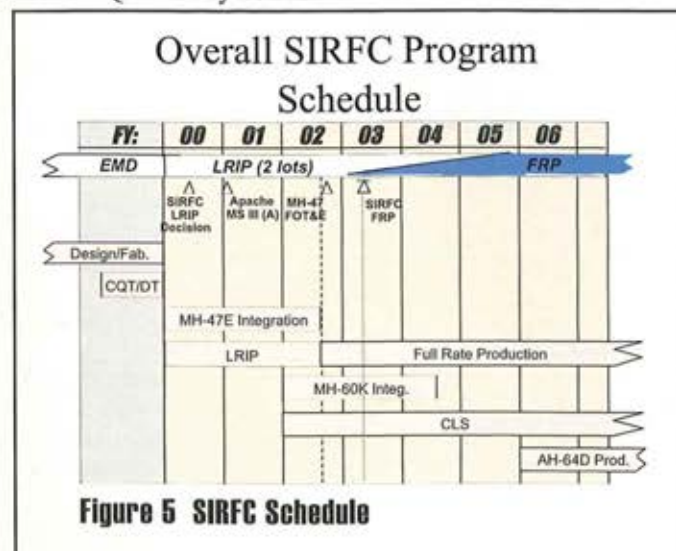

**Figure 4 AN/ALQ-211 SIRFC System Configuration**

The AN/ALQ-144(V)1 system is currently installed on OH-58D, UH-60A/L/Q, EH-60A and MH-60K aircraft. The AN/ALQ-144(V)3 system is installed on AH-64A/D and AH-1F aircraft.

The AN/ALQ-144A(V) is currently in production for Army UH-60Ls and foreign military sales customers.

Recently, an equipment change proposal was approved for the AN/ALQ-144A to enhance the system's effectiveness against known IR threats. This improvement was initially incorporated on the AH-64A and UH-60 aircraft deployed to Albania as part of Task Force Hawk. No additional upgrades are currently planned for the AN/ALQ-144A by PM ASE.



**Figure 5 SIRFC Schedule**

### Currently Fielded and Developing Systems

All the systems described above have been fielded for several years and, as should be expected, various problems and shortcomings relative to evolving threat systems have been identified. Some of these issues have

been addressed through field modifications and upgrades to the systems, while others are judged too costly and/or better dealt with through end-item replacements. The AN/APR-39A and the AN/ALQ-144A(V)1/3 are programmed for replacement by the SIRFC and ATIRCM/CMWS systems, respectively. The following paragraphs will describe these developing systems in some detail.

### AN/ALQ-211

The Army is in the later stages of a development program to enhance aircraft survivability against a growing worldwide threat of RF-guided air-defense systems. The resultant AN/ALQ-211 SIRFC — now in the final test and evaluation stage of Engineering and Manufacturing Development (EMD) — is intended to provide self-protection against radar-guided anti-aircraft artillery (AAA), SAMs and airborne-intercept (AI) for all Army aircraft, including the AH-64, UH/MH-60 and CH/MH-47.

The SIRFC provides situational awareness, sensor fusion, resource management, target identification, target location, target cueing and preemptive and terminal mode Electronic Countermeasures (ECM) against fire-control radars and semi-active missiles for both air-to-air and surface-to-air weapons. These threats

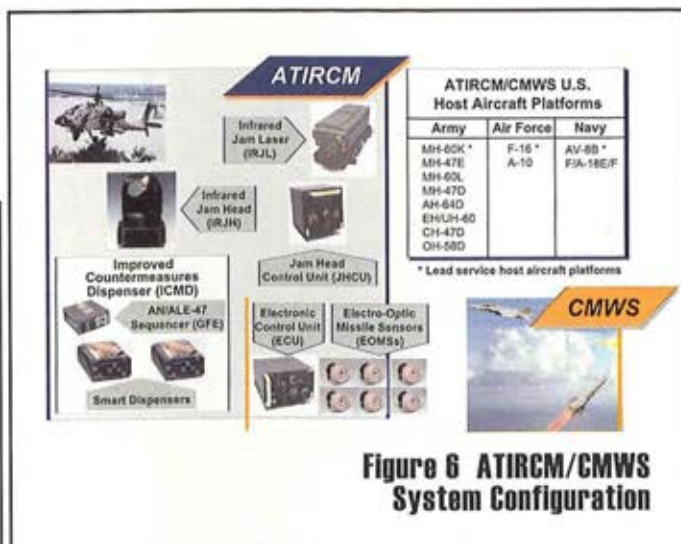

**Figure 6 ATIRCM/CMWS System Configuration**

include pulse radar, pulse Doppler and continuous wave (CW) radars in a wide operational frequency range. SIRFC consists of two basic integrated functions: an Advanced Radar Warning Receiver (ARWR) and an Advanced Threat Radar Jammer (ATRJ). The system is comprised of four LRUs (see Fig. 4).

The SIRFC consists of eight major components: a Receiver-Processor (LRU-1), a Countermeasures-Transmitter (LRU-2), a Modulator-Receiver (LRU-3) and an Antenna Group (LRU-4). The Antenna Group (LRU-4) consists of four quadrant antenna assemblies (receive), four quadrant amplifier converters (receive),

one omni-directional antenna (blade); one amplifier converter (blade); one RF transmit switch and four quadrant antennas (transmit).

The PM-ATIRCM/CMWS/ASE has overall responsibility for managing the SIRFC program under the Army Program Executive Officer (PEO) for Aviation, and has established the JPO at Redstone Arsenal. Execution of the SIRFC program is currently with the PM-ASE (soon to be renamed PM-RF Countermeasures), also at Redstone Arsenal. The SIRFC Milestone II and the EMD contract for SIRFC both occurred in the third quarter of fiscal year 1995. Low-Rate Initial Production (LRIP) is planned for 3QFY00.

The objective of the SIRFC EMD program phase is to design, fabricate, integrate, test and correct deficiencies in a suite of integrated RF countermeasures system. Five EMD systems are being built for qualification, integration and testing on the AH-64D Longbow Apache and the Navy/Air Force CV-22 special operations aircraft. Full systems will be used for testing. An LRIP of 10 SIRFC systems is planned as a ramp-up for full production.

SIRFC initial installation is completed for the AH-64D and currently under flight test at China Lake, Calif. The Air Force, through the Navy, is integrating the SIRFC on the CV-22, and the first flight for the SIRFC-equipped CV-22 is planned for May 2000. Other planned platforms for SIRFC installation are the MH-47E and MH/EH/UH-60 aircraft. PM-ASE has just awarded a contract to ITT Avionics for integration on the MH-47E.

LRIP, as mentioned earlier, is a planned initial buy of 10 SIRFC systems in FY00-02, with follow-on full rate

production starting in FY03 after a successful Milestone III decision.

Several allied nations have expressed interest in SIRFC and agreements have been signed with Australia for research-and-development cooperation. The objectives of international cooperative efforts are to provide state-of-the-art ASE to our allies and enhance interoperability on future battlefields. Other nations interested in acquiring SIRFC systems include Singapore, the United Arab Emirates, Egypt, the Netherlands and Turkey.

### AN/ALQ-212

The Army JPO is leading a triservice development program to enhance aircraft survivability against the growing worldwide threat of IR guided missiles. The program, now in advanced EMD, is known as the AN/ALQ-212 Advanced Threat Infrared Countermeasures (ATIRCM) system, which includes the AN/AAR-57 Common Missile Warning System (CMWS). These systems together provide automatic, passive missile detection, threat-type declaration, crew warning, false-alarm suppression and cues to such other on-board systems as countermeasure decoy dispensers. Army ATIRCM/CMWS adds active, directional countermeasures via a laser, an arc lamp, and an Improved Countermeasures Dispenser (ICMD).

The ATIRCM/CMWS consists of six major components: an Electro-Optic Missile Sensor (EOMS), an Electronic Control Unit (ECU) (the CMWS Sensor Processor), an Infrared Jam Head (IRJH), a Jam Head Control Unit (JHCU) (the Jammer Processor), an IR Jam



## Preparing America for an Affordable 21st Century

**TELEDYNE BROWN ENGINEERING**  
An Allegheny Teledyne Company

*Your first choice for technical and programmatic support*

- System Engineering
- Modeling and Simulation
- Systems Integration
- Information Technology
- Software Engineering
- Hardware Development

[www.tbe.com](http://www.tbe.com)

Laser (IRJL) with articulated arm/optical coupler for beam path, and the ICMD (see Figure 1 above). The ICMD consists of one ALE-47 sequencer plus two "smart" dispensers capable of automatically sensing the payloads present. The baseline ATIRCM/CMWS system includes one ECU, four EOMSs, one JHCU, one IRJL, two IRJHs and one ICMD. The system is programmed to be deployed initially on Army MH-60K Black Hawks, Air Force F-16 Falcons and Marine Corps AV-8B Harriers. When fully tested and proven on these aircraft the system will be installed on a range of other tactical platforms as listed in Figure 1 above.

The ATIRCM/CMWS program will improve existing countermeasures by combining the functions of the missile detector, IR jammer and decoy dispenser to permit more effective countermeasures against a greater number of IR and RF threats. The ATIRCM/CMWS is being built using a modular concept to allow tailoring of the system configuration to each aircraft. The CMWS component system will detect incoming missiles and, upon declaration of a valid threat, provide an appropriate command for initiation of on-board expendables.

When the component system is installed on Army helicopters the command would be sent to either the active jammer or countermeasure dispenser. When installed on USAF and USN/USMC tactical aircraft the command would be sent to the Countermeasures Dispenser System (CMDS). The CMWS, when installed on tactical aircraft, will also provide audio and/or visual warning to the aircrew to permit initiation of appropriate defensive maneuvers in conjunction with manual or automatic countermeasures dispensing. Component modularity will also permit product improvement to each subsystem independently of the other, thus allowing for system growth to defeat new types of threats.

In 1995 the Army was developing ATIRCM for its helicopters while the Air Force and Navy were simultaneously developing a multiservice capability, known as the Advanced Missile Warning (AMW) system, to provide missile warning for fixed-wing aircraft. Realizing that common threat baselines and overlapping performance requirements offered potential areas for cooperation, the undersecretary of defense for acquisition and technology approved a recommendation from the Service Acquisition Executives (SAE) for a streamlined, joint-program acquisition strategy to develop CMWS as a component system of ATIRCM. ATIRCM/CMWS became an Acquisition Category (ACAT) IC program with the Army Acquisition Executive (AAE) as the Milestone Decision Authority (MDA) in consultation with the other SAEs. The effort is supported by the USAF Program Executive Officer for Fighters and Bombers (AFPEO/FB) and the USN PEO for Tactical Aircraft [PEO (T)]. The ATIRCM/CMWS Milestone I/II was conducted in 3QFY95, the contract for ATIRCM/CMWS was awarded in 4QFY95, and Milestone III is planned for 4QFY03.

Ancillary programs of ATIRCM/CMWS [Advanced IR Countermeasures Munitions (AIRCMM) and Advanced Visual Electro-optical Signature and

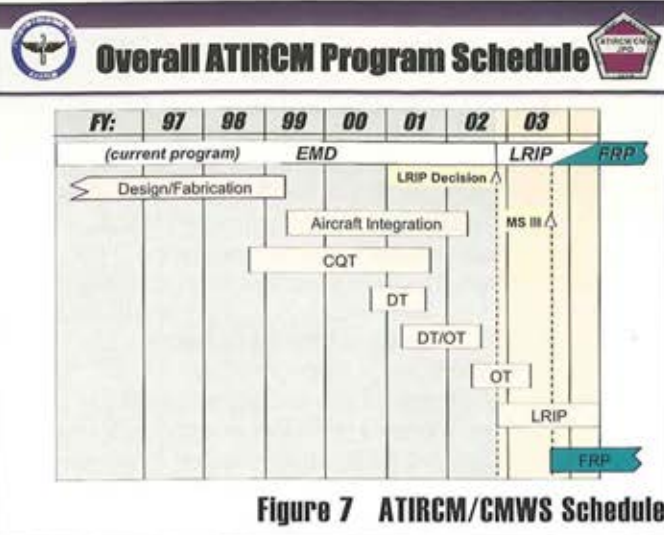

Figure 7 ATIRCM/CMWS Schedule

Suppression Analysis (AVESSA) passive features] are acquisition programs with the Army PEO-Aviation as the MDA. The AIRCMM is a new-development set of flare decoys developed to counter existing and advanced IR threats. With its payload-identification capability, it will allow for automatic dispensing, time-sequenced routines to counter the advanced threat. PM-ASE/ATIRCM/CMWS also has overall responsibility for managing these ancillary programs.

The program has recently undergone a major restructuring effort. The program was reviewed and approved by the program's Tri-Service General Officer Executive Steering Group on July 13. The group reviewed and provided guidance to the JPO on a range of current issues. The current ATIRCM/CMWS program schedule is shown in Fig. 7. The first fully-integrated ATIRCM/CMWS EMD system was demonstrated by the prime contractor (Sanders, a Lockheed Martin Company) in April 1998 and Contractor Qualification Testing (CQT) began in July 1998. During CQT, the system is subjected to a series of tests designed to prove its operation under extreme conditions. Air-vehicle integration on the Army EH/MH-60 began earlier in 1998.

Developmental test, beginning in FY00, will consist of Production Qualification Test (PQT) (contractor/government) prior to Milestone III and a Production Verification Test (PVT) (contractor/government) prior to Materiel Release. Modeling and simulation, using both hardware-in-the-loop and fully digital models, is being used throughout development to minimize risk and reduce testing. The Army's Operational Test and Evaluation Command (USAOPTEC) will provide a System Assessment (SA) as input to both Milestone III and Materiel Release. The Air Force's 46th Test Squadron at Eglin Air Force Base, Fla., and the Aircraft Division of the Naval Air Warfare Center will also provide developmental test reports for Milestone III.

Developmental test and Multiservice Operational Test and Evaluation, consisting of Combined DT/Operational Test (OT) and Dedicated OT, will be used to provide a combined System Evaluation Report as input to Milestone III. Combined DT/OT will consist of two parts; the first includes all data requirements necessary

for the evaluation to support the LRIP decision, and the second is the production decision.

Two phases of OT — rotary-wing (RW) and fixed-wing (FW) — are being conducted during the EMD phase to address each service's test and evaluation requirements. The acquisition strategy requires that a minimum of one RW and one FW platform undergo integration and testing prior to Milestone III. At the conclusion of the RW phase, USAOPTEC will provide a system evaluation report. At the conclusion of the FW phase AFOTEC and OPTEVFOR will prepare separate evaluation reports for their respective aircraft. USAOPTEC will combine the three evaluation reports for submission to the office of the secretary of defense and for input to the Milestone III decision.

The simulation strategy supports the life-cycle management and evolution of ATIRCM/CMWS through the simulation of end-to-end (E2E) engagements of SAM threats against ATIRCM/CMWS-equipped RW and FW aircraft. The near-term focus is the support of developmental and operational testing and Military Worth Studies/Analysis of Alternatives processes that lead to the Milestone III acquisition decision. The mid- to far-term focus is post-production training, combat development and performance predictions on follow-on platform integration.

The scope includes a family of simulations that range from those currently under development to those already developed — from one (missile) versus one (aircraft) to many versus many; from very high fidelity to low fidelity; and from strictly digital, constructive sim-

ulations to hardware-in-the-loop (HITL) simulations, as appropriate.

EMD quantities currently being procured and delivered, as noted above, will be used for system integration and tests on designated lead platforms. LRIP is a planned initial production buy in FY02, with follow-on full rate production starting in FY03 after a successful Milestone III decision. First unit equipped (FUE) in the field is expected to be at the end of FY03 or early FY04.

Several allied nations have expressed interest in the program and agreements have been signed with the United Kingdom and Australia for research-and-development cooperation. Current contracts with the UK were signed in 1997 and include ASE for the Apache and Replacement Maritime Patrol Aircraft. Other nations interested in acquiring ATIRCM/CMWS systems include Belgium, Denmark, The Netherlands, Norway, Portugal and Turkey.

### The RF/IR Countermeasures Integration Strategy

Army aviation's near- and long-term goals include a phased integration of ASE systems. The objective is a full ASE integrated suite that includes the SIRFC for RF countermeasures, ATIRCM/CMWS for IR countermeasures, and the AVR-2A (Horizontal Technology Insertion) system for laser countermeasures.

As the integration of systems is accomplished, several benefits will be realized aboard Army tactical aircraft:

- The SIRFC Sensor Fusion Processor will establish the class of the incoming threat missile and automatically

# ARINC

Military  
and  
Commercial  
Aviation

Communications, navigation,  
networks, avionics standards,  
hardware and software systems integration,  
aircraft modifications

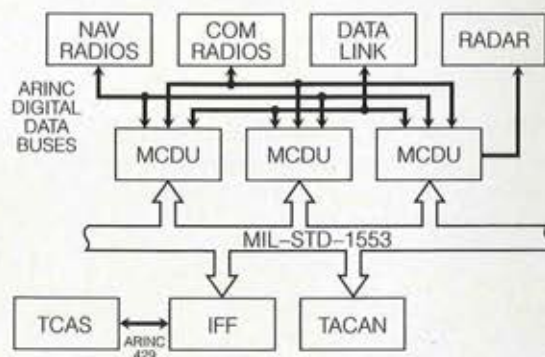

ARINC Incorporated  
6703 Odyssey Drive, Suite 104  
Huntsville, AL 35806  
Tel: 205 922 1022  
Fax: 205 922 1026  
Web site: [www.arinc.com](http://www.arinc.com)

A RECOGNIZED NAME IN AVIATION SINCE 1929

select the optimum countermeasure response, while increasing pilot confidence in threat identification.

- Resource (munitions) allocations will be maximized.
- Situational awareness will be improved.
- Pilot workload will be reduced.
- Aircraft weight will be reduced.
- Life-cycle costs will be decreased.

Near-term strategies will concentrate ASE efforts on aviation force-modernization aircraft (CH-47F, MH-47E, MH-60K, UH-60X, AH-64D and RAH-66). Investments in older ASE legacy systems will be minimized. Development and fielding of SIRFC and the Suite of Integrated IR Countermeasures (SIIRCM) (ATIRCM/ CMWS, including the Improved Countermeasures ICMD plus advanced flares plus passive signature-reduction measures) systems will be accelerated. Longer-term strategies include not only the development of an integrated SIRFC/SIIRCM suite, but also an integrated ASE/avionics suite, and training packages to support the new ASE equipment and evolving tactics.



**Figure 8 ASET IV**

The overall ASE strategy will entail four key actions:

- A-Kits will be provided for all aircraft.
- Full B-Kits will be dedicated to special operations and AH-64D Apache Longbow aircraft.
- The AVR-2A will be provided for National Guard AH-64A aircraft.
- A pool of non-dedicated, rotatable B-Kits will be created for CH-47F and UH-60L+/Q/X aircraft. The B-Kit pool would be maintained at central locations and issued as needed for training and deployments.

Although the SIIRCM, SIRFC and AVR-2A systems are now separate programs, they are expected to be combined for future planning and budgeting purposes. As advanced ASE suites are fielded, older legacy systems will be cannibalized to support remaining fleet requirements. And finally, CH-47D and OH-58D aircraft will be supported by legacy ASE systems until replaced in the field by the CH-47F and RAH-66, respectively.

### **AN/TPQ-45**

The ASE training-device strategy is a building-block concept to train Army aviators on the proper employment

of ASE. The ASE Trainer (ASET) IV, shown in Fig. 8 below, is a set of tactical threat emitting training devices that teach realistic force-on-force and collective-team training under the "train as you fight" concept.

Each system consists of two IR SAM threat simulators, one RF SAM threat simulator, two AAA threat simulators, and a command-and-control vehicle. Six MAN-Portable Air Defense Systems (MANPADS) are normally deployed with the ASET IV, but are not part of the system. The five threat simulators and command-and-control vehicle are mounted on six M1097 Humvees, which are designed to emulate a mechanized brigade-based air-defense network. These components are shown on Fig. 9 below.

The ASET IV can be used with all aircraft equipped with ASE systems. For the Army these include the AH-1F, UH-1H/V, RC-12, CH-47D, MH-47E, OH-58C/D, EH-0A, MH-60K, UH-60A/L/Q and AH-64A/D.

The ASET IV provides tactical training against SAM and AAA threats, and permits home station train-up prior to training center rotation. The system stimulates ASE and records the counter-countermeasures response and can operate with or without instrumentation. The ASET IV threat emitters of the RF SAM and AAA have the characteristics of enemy threat radar, and will trigger the radar-warning systems and activate the jammers on board "Blue" aircraft. The emission of a jamming signal by the aircraft can be detected and analyzed on the ASET IV for effectiveness and subsequent simulation of a realistic jamming response. Additional realism is added to the exercise by equipping the vehicles with Multiple Integrated Laser Engagement Systems-Air Defense (MILES-AD), which provide "kill and be killed" capability and "flash-bang" weapons effects.

The ASET IV program completed its production, and has also received congressional plus-ups in FY98 and FY99 for upgrades to the systems. The Threat Simulator Management Office (TSMO) provides support for the program, while Sierra Technologies is the prime contractor.

Planned upgrades to ASET IV to provide night-fighting capability via an IR camera, to upgrade the threats and to upgrade to Operator Training (OT) Interactive Multimedia Instruction (IMI) were partially funded and began during FY98. An FY00 proposal, which is currently unfunded, has been prepared for completion of the upgrades.

Production of the eighth and final system was completed in February 1998. Fielding of systems to the training centers has been completed with one system going to the Combat Maneuver Training Center at Hohenfels, Germany, in October 1996; one system going to the Joint Readiness Training Center at Fort Polk, La., in December 1996; and three systems going to the National Training Center at Fort Irwin, Calif., in February 1998.

Fielding to Fort Bragg, N.C., Fort Hood, Texas, and Fort Campbell, Ky., is on hold due to a shortage of sustainment funding. However, these three systems are being upgraded to match the currently fielded configuration. The IR camera upgrade is scheduled to be complete by December 2000, the IR SAM upgrade by December 2001, the RF SAM upgrade by December 2001 and the AAA upgrade by September 2000.



FIGURE 9

**ASET IV Components**  
Upper left — IR SAM simulator,  
middle — command and control vehicle,  
upper right — RF SAM simulator,  
lower left — AAA threat simulator,  
lower right — MANPAD.



### Summary

ASE successfully combines a range of state-of-the-art technologies and leading-edge capabilities into an effective integrated aviation defensive system. Its capabilities are essential to the success of our nation's aviation forces and missions in the 21st century. The potential for loss of aviator lives and equipment to existing missile threats is too great to be discounted or ignored. Preservation of the force commander's freedom of movement throughout the battle space is imperative. Aviation asset survival is essential to America's 21st-century warfighting strategy, which is to fight and win against superior numbers and to support Operations Other Than War (OOTW) and contingency operations worldwide.



*Dr. Steven L. Messervy is the project manager, ASE/ATIRCM/CMWS, in the Joint Project Office at Redstone Arsenal, Ala. Lt. Col. C. Henry Flick (Ret.) is employed by CAS Inc. of Huntsville, Ala., in support of the ASE/ATIRCM/CMWS Joint Project Office.*

**Practice EW evasive tactics all year round...**

**Advanced Multiple Threat Emitter - AMTE**

AD-4801

Live EW training is paramount to survivability in today's battlefields proliferated with air defense missiles, guns and IR guided weapons. Be prepared for your next major training rotation or real combat event with Sierra's Advanced Multiple Threat Emitter (AMTE) System. A single AMTE platform can stimulate aircraft warning systems for search, acquisition, tracking and missile guidance commands of today's most lethal RF and IR threats.

AMTE can provide affordable air superiority, survivability and tactical proficiency training at any location.

**SR**  
**Sierra Research**  
a division of SierraTech, Inc.

485 Cayuga Rd • Buffalo, New York 14225  
(716) 631-7872 • www.stisierra.com  
email: ewsales@stisierra.com  
ISO 9001 Certified

# AIRCRAFT SURVIVABILITY: A Joint Approach

By Lt. Col. Charles R. Schwarz Jr. and Philip Weinberg

**D**uring the Vietnam War more than 5,000 American aircraft, including over 2,500 helicopters, were shot down. In an effort to provide a multi-service approach to reducing aircraft losses in combat (that is, to improve aircraft survivability), the office of the secretary of defense sponsored a "Test and Evaluation of Aircraft Survivability (TEAS) Program," which in 1971 led to the creation and chartering of the Joint Technical Coordinating Group on Aircraft Survivability (JTCG/AS).

The JTCG/AS' purpose was, and is, to reduce the vulnerability of aircraft to non-nuclear threats, coordinate service research and advanced development programs, and maintain a liaison with the military services to insure that data and systems criteria are made available to the developers of new aircraft. The JTCG/AS was initially only responsible for the vulnerability portion of survivability, but its mission was soon changed to include countermeasures.

The JTCG/AS strives to take a balanced approach to survivability technology development. It sponsors research and development (R&D) projects at various military R&D facilities, in susceptibility reduction, vulnerability reduction and methodology development and improvements. The fiscal year 2000 program, as well as the program for the past several years, is almost equally divided among the three subgroups (methodology, susceptibility reduction and vulnerability reduction).

**T**his year, \$935,000 is going directly to Army facilities to do survivability R&D. However, about \$2.5 million is being spent on technologies that could benefit rotorcraft and Army concerns, such as Man Portable Air Defense Systems (MANPADS) missile vulnerability reduction and improvement/advanced technology for the Advanced Tactical Infrared Countermeasures (ATIRCM) and Common Missile Warning Systems (CMWS) projects. Over its 28-year history, JTCG/AS has invested approximately \$150 million in aircraft survivability R&D.

The JTCG/AS is directly connected to each service, and is concerned about advancing the aircraft survivability technology base that will improve the survivability of all U.S. military aircraft. Dr. Steven Messervy, the program manager for ATIRCM/CMWS and Aircraft Survivability Equipment, is the Army's principal member. LTC Charles Schwarz is assigned to Messervy's office, but is the Army military representative and current director of the JTCG/AS Central Office. Mr. Joseph Jolley is the Army's civilian in the Central Office. He is assigned to Fort Eustis,

Va., but like Schwarz is stationed full time in the JTCG/AS Central Office. Jolley is the director of the Vulnerability Reduction Subgroup and is working daily on responding to the Office of the Secretary of Defense inquiry on vulnerability-reduction techniques that would improve aircraft survivability to MANPADS.

**T**he mission of the JTCG/AS is to develop improved aircraft survivability technology so that aircraft designers have the tools to design and build more survivable aircraft. In 1991 the JTCG/AS Charter was revised, this time being approved by the Joint Aeronautical Commanders Group. In this charter, survivability is emphasized as both susceptibility and vulnerability reduction. The JTCG/AS does not play a direct role in the operational aspects of mission planning, namely tactics and mission planning. However, the JTCG/AS does provide the tools to tactics developers and mission planners so operators maintain the flexibility to be survivable while performing effective missions.

Some recent JTCG/AS projects that have a direct impact on Army aircraft survivability include support to the National Ground Intelligence Center (NGIC) for upgrading and publishing users manuals for the Radar-Directed Gun Systems Simulation (RADGUNS). The release of this intelligence community model, for use by system designers and analysts, was a major breakthrough for the JTCG/AS. Now, users outside of the intelligence community are able to use the same model and not fear their results would be challenged because of intelligence conflicts. The JTCG/AS has also supported various Army laboratories in developing advanced armor schemes.

Ullage explosion and dry-bay fires are common vulnerabilities of both rotary- and fixed-wing aircraft. The JTCG/AS was instrumental in the development of the technologies that led to current On Board Inert Gas Generating Systems (OBIGGS) that preclude explosive mixtures in fuel tanks. The JTCG/AS has been heavily

involved in the evaluation of alternate agents and technologies, like the use of automotive air bag inert gas generators, to replace Halon in dry bay and other fire-extinguisher applications. In response to a request by the secretary of defense, the JTCG/AS has been begun developing and evaluating vulnerability-reduction techniques for the MANPADS threat, and the development of new methodologies to more accurately model the threat. The MANPADS is both a combat and terrorism threat.

Survivability, simply put, means not being hit, and if hit not being killed. The "not being hit" portion is handled by the Susceptibility Reduction Subgroup. Situational awareness, radar and missile warning, countermeasures, and chaff or flares are the parts of the equation handled by the JTCG/AS. Electromagnetic (radar and infrared) and optical (laser) countermeasures and expendables that try to confuse the acquisition, targeting and guidance are active countermeasures being evaluated and developed under JTCG/AS funding. Stealth and low-observable platforms are passive methods that work at minimizing the time that the enemy has to fire its anti-aircraft weapons. Many JTCG/AS project engineers work closely in these passive technologies, but because of their limited access controls JTCG/AS funding has been very minimal.

A lot of work is going into developing countermeasure techniques for the next generation missile seekers. We are trying to have techniques available before new seekers are deployed, such as the work at the Naval Research Laboratory on focal-plane arrays. We are also funding technology to assist the ATIRCM/CMWS programs. In the early 1990s we supported work at the Night Vision and Electronics Sensors Directorate at Fort Monmouth, N.J., to

develop an improved high accuracy directional finding radar receiver. The development lead to a product that could easily be retrofitted into a current system. In 1993 we published the "Countermeasures Handbook for Aircraft Survivability" to update and replace our 1976 version. Anyone needing a copy of this three-volume classified document should contact the Survivability/ Vulnerability Information Analysis Center (SURVIAC) to request a copy.

Another major purpose of the JTCG/AS is to insure that technology developments are made available to the services and industry so that they can be incorporated into weapon-system designs. Final project reports and model developer and user manuals are products of these projects, and a synopsis of these documents can be found in the annual JTCG/AS bibliography. We also publish our annual program book, which contains the statement of work for each active project. Copies of specific reports or manuals are available from SURVIAC. Visit our web site, <http://jtcg.jcte.jcs.mil:9101/>, to find out more about the JTCG/AS and our publications.

The JTCG/AS was chartered 28 years ago to improve the survivability of aircraft, and coordinate and conduct research in aircraft survivability. With today's reduced budgets, the JTCG/AS continues to play a major role in providing seed and transitional funds to projects that have multi-service interests and focuses on both the susceptibility- and vulnerability-reduction issues.



*Army Lt. Col. Charles R. Schwarz Jr., a senior Army aviator, is director of the JTCG/AS Central Office. Mr. Philip Weinberg is director of the organization's Susceptibility Reduction Subgroup.*

# CONAX LIFE SUPPORT

## "YOUR LIFE....OUR BUSINESS"

### Vacuum Packed Life Rafts

- 1 Man
- 7 Man
- 12 Man
- 20 Man

### Vacuum Packed Survival Equipment

- Sleeping Bags
- Clothing
- Shelters

**CONAX florida**

*A Cobham plc company*



### Aircrew Flotation System - Inflation Devices

### Aircrew Restraint Systems - Water Activated Release

### Aircraft Emergency Flotation System Actuator

2801 75th St., N. - St. Petersburg, FL 33710  
Phone: 727-345-8000 / Fax: 727-345-4217

[www.conaxfl.com](http://www.conaxfl.com)

# High Frequency Radio: FREQUENCY

An Old Friend Returns Stronger Than Ever

By Chris Wantuck and Jerry Sweitzer

Long-distance (beyond-line-of-sight) communications remains the tactical "Achilles Heel" in Army aviation. The physics of electrical line-of-sight work against rotary wing tactical aircraft that must fly low to avoid enemy engagement. Army aviation's daily experiences in the Balkans amply demonstrate these shortcomings, which are exacerbated in rugged terrain.

Army aviation has been working on this problem for more than 28 years. No breakthrough technologies have emerged to solve the problem, though there may be some promise in such low or medium earth orbiting satellites as Iridium, ICO, GlobalStar, Ellipso and so on. The Army's Transportation Corps is taking full advantage of these commercial systems by using them to track trucks, ships and rail cars. Army aviation's requirements call for communications security (COMSEC) and transmission security (TRANSEC), also known as Electronic Counter Countermeasures (ECCM). Until the Department of Defense can launch a suite of satellites that meets these criteria, commercial satellites are not a viable solution. In the interim, Army aviation has chosen to field an old system with new technology.

High frequency (HF) radio traces its roots back nearly a century and has been shown to be both vital and finicky. HF works beyond line of sight by using the ionosphere. The rays of the sun affect the ionized particles in the Earth's upper atmosphere 50 to 200 miles above the surface. It is these bands or regions of particles that reflect some of the radio's electromotive force and send it back to the surface. Certain frequencies (usually lower ones) thus

perform well in the morning and require the radio operator to select higher frequencies over the course of the day. The dynamics of this phenomena traditionally have been too difficult to deal with reliably. This constant change in the optimum frequency has earned HF a poor reputation.

A new technology, automatic link establishment (ALE), performs the channel search automatically based on a list of authorized frequencies. ALE starts by trying the last known good channel and computing the channel's quality before allowing the operator to continue. Once a good channel is selected the radio emits a tone announcing to the operator that the connection has been made and un-squelches the radio so the two parties can talk. This process is much like dialing a telephone. Each radio has a telephone number (address). It dials up the address, "presses send," the radio finds a workable channel, makes the connection, and the two parties can communicate. For multiple parties, a group address is selected. If the distant radio is busy ALE tries other stations in a predetermined priority.

The AN/ARC-220 with ALE is the Army's newest all-digital HF radio. It is an all-software-driven radio using advanced Digital Signal Processor (DSP) technology. This means the radio can handle digital messages and images, albeit at a 2400bps rate (relatively slow when compared to other tactical communications).

The AN/ARC-220 is fielded with the KY-100 COMSEC device and the radio has a built in ECCM function. Fielding of the AN/ARC-220 commenced in late 1997 on MH-47 and MH-60 aircraft, followed by CH-47D

installations in April 1999 and UH-1V installations in July 1999. This will be followed by installations into UH-60 A/L beginning in January 2000. AH-64 Apaches and OH-58D Kiowa Warriors won't see their ARC-220s for at least another year. Integration testing on these aircraft is underway and the 1st Battalion, 229th Aviation, at Fort Bragg, N.C., will receive 12 ARC-220 installations to evaluate this fall.

The Army is developing a tactical internet over which the position of friendly forces is interchanged digitally so that commanders at each level have a "relevant" picture of the battlefield displayed on a mission computer. Relevant is the key word in this system. A company commander's area of influence is not the same as that of a division commander. This situation awareness (SA) information flows through a series of radios and routers. Each operational facility on the battlefield has a tactical internet address and gets this SA information automatically based on a predetermined user interface requirement. The radio systems used are all line-of-sight. Army aviation may never be in line-of-sight radio range with one of these radios. The very reason the Army has an aviation force is to travel over distances and cover larger areas of terrain with fewer assets in less time. This mission by its very nature negates the use of line-of-sight radios. So how is the Army's aviation force included in the SA picture?

Army aviation planning currently provides commanders the relative position of aircraft based on the plan. This is a very poor and inaccurate way to judge the position of aviation forces. Command-and-control aircraft are often employed to observe these positions and report back via line-of-sight radio. This is a more accurate method but still relies on line-of-sight radios. Using HF, however, aviation units can report their positions to their tactical operations centers (TOCs), which in turn can transfer the information onto the internet.

To do this the Army must develop a scheme whereby tactical internet addresses are converted to ALE addresses and vice versa. The U.S. Army Training and Doctrine Command (TRADOC) has recently approved a Concept Exploration Plan (CEP) under the Battle Labs at the Aviation Center at Fort Rucker, Ala., the Signal Center

at Fort Gordon, Ga., and the Communications-Electronics Command (CECOM) at Fort Monmouth, N.J. Demonstrations and simulations will be performed throughout fiscal year 2000 to gather interoperability and network loading information. As part of the CEP CECOM and the AN/ARC-220's manufacturer, Rockwell Collins, are developing several software programs to handle the conversions and display the SA.

#### TYING IT ALL TOGETHER

The first requirement is to define what information will ultimately be exchanged, given that HF has a limited data rate. The Aviation Center has identified fourteen operational messages to be exchanged, including position reports and calls for fire. Pictures can also be sent via HF, which will be demonstrated during this CEP. The key is to remember that SA must be detailed enough to be usable, but must not overwhelm the intended users. For example, reporting center-of-mass SA for three armor companies 70 kilometers away can be done in the form of three icons rather than as individual platforms. Conversely, the other three helicopters in the platoon should each be identified.

How often should position reports be

sent to the Aviation Tactical Operations Center (AVTOC) is another question which requires exploration. The big issue with using HF for sending and receiving SA is the linking of time, data rate, amount of information, message time out, and the like. During FORCE XXI tests it was found to be too easy to overwhelm a radio's capacity by constantly sending retries of old SA information. As part of the CEP, HF radios located in places like the AVTOC will be connected to Internet routers, which in turn will be controlled by a host computer running special software. Remember that the HF radio runs slower, and a primary purpose of this host computer will therefore be to act like a traffic cop, filtering and reporting the essential information.

The aviation company's SA information (represented as two icons, one for each platoon) is received and distributed to units such as air defense via the ground forces tactical internet. When one radio is busy (remember ALE?) the next priority station will exchange the information and again route it through the ground forces tactical internet. Reciprocally, pertinent ground forces' SA information or command and control messages are routed through the tactical internet and sent out to selected airframes over HF.

Once received, it is redistributed by the improved data modem (IDM) a special on-board router through the airframes' VHF line-of-sight (LOS) radio.

#### CONCLUSION

The AN/ARC-220 digital HF radio will greatly add to the aviator's ability to communicate when beyond LOS with minimal in-flight intervention. The use of special electronic protocols and techniques will enable combined-arms forces to interchange vital position and command-and-control messages. Ground commanders will have more timely access to position and status information of aviation forces and, conversely, aviation forces will have updated information on friendly and hostile ground units. This will aid engineers and their customers in striking the right balance of information content, benefiting Army aviators and battlefield commanders.



*Chris Wantuck is an electrical engineer in the Space and Terrestrial Communications Directorate of CECOM's Research, Development and Engineering Center at Fort Monmouth, N.J. Jerry Sweitzer is the tactical radio and avionics coordinator in the Directorate of Combat Developments at the U.S. Army Aviation Center, Fort Rucker, Ala.*

# Airborne AND Accessible

## TT-3068A AERO-M SATELLITE COMMUNICATIONS SYSTEM

- Single Channel
- Voice, Fax & Data
- Secure Telephones (STU III)
- Worldwide via INMARSAT
- Antenna with Integrated Navigation Reference



Affordable Satellite Communications Available At



LandSea Systems, Inc.

Satellite Communications

TEL: 757.468.0448 FAX: 757.468.0625  
www.landseasystems.com  
EMAIL: aerom@landseasystems.com



# MAKING HAVE QUICK WORK

By Maj. Scot MacKenzie

## Making HAVE QUICK Work is a Challenge.

Surprised? To clarify the statement, let's begin by setting the stage. Take a 75 to 100-aircraft package consisting of UH-60s, CH-47s, AH-64s, OH-58s and a couple of command and control (C2) aircraft. Now throw in some ground aviation elements, multiple pick-up and landing zones (PZ/LZs), an infantry brigade task force, a 150 km air route, more than 100 sling loads and 6 to 8 hours of mission time.

Sound a bit far fetched? Not at all. What I've described is an air-assault operation in the 101st Airborne Division and, let me tell you, it's nothing short of challenging. Implicit in the air-assault mission is a critical communications task for the division's aviation community: make air and ground Ultra High Frequency (UHF) radios frequency hop throughout the entire operation. Up to this point we have avoided using HAVE QUICK for major assaults due to the size and complexity of such missions. Fortunately, we are changing our UHF operations by implementing new training and procedures that are designed to solve the HAVE QUICK challenges in the air assault division.

## The Challenge

Getting pilots to routinely use the radio in the frequency hopping, or HAVE QUICK mode, is the biggest challenge associated with the radio. This is interesting considering that HAVE QUICK has been around for nearly 20 years and is the Department of Defense and NATO standard for frequency-hopping UHF radios. It is in nearly every tactical aircraft in all our services, as well as those of many of our allies, and is routinely used during joint and combined operations. We should know how to use it, right? Think again.

As an aviation brigade signal officer, I've seen too many pilots avoid

the frequency-hopping mode and use their HAVE QUICKs in the single-channel mode. Compounding the problem is that many of our aircraft do not have a dedicated secure device for the UHF, and some are not even wired for one. This situation means that mission-sensitive traffic is not only single channel, but nonsecure. It certainly won't take a very sophisticated enemy to jam or monitor our single-channel traffic and this could prove disastrous for our soldiers.

For all the right reasons — security, anti-jam capability, survivability and the joint and combined implications — we're making a major push to integrate HAVE QUICK into our training. The key is to start small at the platoon and company levels and build towards very large air-assault operations.

## Reality Check

Why have we ignored HAVE QUICK for so long? It's predominantly due to a lack of training and to the prevailing belief that making HAVE QUICK work during air assaults is impossible. The primary reason I hear is that making the radio work reliably is "too hard" — too hard to load, too hard to get GPS time-synchronized, too hard to understand. Pilots are convinced it won't work and feel it's simply a hassle.

I agree with the argument concerning loading but my agreement ends there. What pilots need are the right tools to operate the radio, a crash course in operator training and some time to build proficiency and confidence. I firmly believe that this entire issue is about training and a commitment by our pilots to properly use the radio. Our goal should be to make pilots just as proficient with HAVE QUICK as they are with SINGARS. Remember, it was not that many years ago that we were equally skeptical about SINGARS and we've

since made operating that radio nearly second nature.

## Make the ANCD Work!

That's the message I heard from the pilots. They already load their SINGARS and IFF with the ANCD, so why not use the same box to load the HAVE QUICK? Makes sense to me. Manual-loading procedures are very easy to find but can be difficult to perform, are time consuming and are highly prone to human error.

Another way to load the radio is with the KYK-13. This device certainly works but so few are now authorized that this is not a feasible solution anymore. ANCDs are prevalent on the flight line now and should be used to their maximum potential. The problem we had with this option is that no one here knew how to load HAVE QUICK data with an ANCD and many told me that it simply did not work. Tribal wisdom strikes again!

My solution was to call the primary users of HAVE QUICK — the Air Force. It didn't take long to locate an ANCD program that was developed specifically to load the aviation HAVE QUICK radio, the AN/ARC-164. The program, called Fill 4.09, is easy to load on an ANCD and even easier to use when loading a HAVE QUICK radio. It loads both training and operational Word of Day (WOD) data, cuts loading time by half and eliminates pilot miscues inherent during manual loading. Fill 4.09 is a go-to-war program that has significantly eliminated the reasons why pilots can't load the radio and has helped me emphasize HAVE QUICK use across the division. Once we got the software, it was time to develop a checklist and begin training.

## New Checklist and Software is the Key

The checklist is a work in progress that has changed many times based on pilot feedback. I started with an

old kneeboard-sized checklist for manual loading and modified it to include the new ANCD procedures. I gave it to pilots who had little or no knowledge of the system to see if they could load the radio simply by following the checklist.

**B**ottom line: The checklist and software work and can be understood immediately. These two items are the key to promoting use of the radio and are essential in dispelling myths that the radio is too hard to load. Configuring your ANCDs with the FILL 4.09 software and training WODs is initially time consuming but it's a one-time set-up because training WODs do not change monthly. It's a "set it and forget it" operation that is well worth the effort. The loading procedures have been trained to four aviation battalions in the 159th Aviation Brigade and passed to our sister brigade, the 101st Avn. Bde. The intent is to adopt the software and loading procedures as the division standard for UHF communications. The challenge now is to aggressively train with the radio and determine how we can solve the single biggest challenge with HAVE QUICK during air assault operations: synchronizing time.

### Clearing the TOD Hurdle

Synchronizing the time of day (TOD) is the greatest challenge we have in implementing HAVE QUICK on any air-assault operation. Not having the correct time can lock an aircraft radio out of a frequency-hopping net and jeopardize safety and situational awareness during a mission.

Unlike SINGARS, where time must be manually loaded through the face of the radio, HAVE QUICK receives TOD directly from the aircraft internal GPS (ASN/128-B) or GPS time sent over the air. Receiving TOD from internal GPS is operationally feasible since well over 90 percent of the division's aircraft have GPS hard-wired to the radio and all have access to the same satellite time.

You might think that a hard-wired GPS feed is better than the manual method required by SINGARS. However, the problems in synchronizing time among 75 to 100 aircraft are greater than you might imagine. Some GPS systems don't track enough satellites, which results in an

inaccurate time feed. Other aircraft have older GPS systems that don't feed time to the radio. GPS units break or users forget to update TOD in their own radios, which is not automatic after initial start up.

For these reasons aircraft will always need to receive time from another user that is communicating in the designated HAVE QUICK net. This process, known as the "mick-ey," may have to be implemented at various times during an air assault since TOD begins to drift after four hours and missions may take 6 to 8 hours. Ground UHF radios and C2 console aircraft also need a mickey because they do not have hard-wired GPS. It's just not as easy as loading a WOD, getting internal TOD and going active on a HAVE QUICK net.

Unlike SINGARS, using HAVE QUICK means that you may have to get TOD assistance from another user. The sheer number and rapid movement of the aircraft during an air assault make the task daunting but not impossible. We are experimenting now by using the C2 aircraft as the single source for time during a mission, and possibly tasking flight leads with bringing in individual users who've

dropped off the net. Developing the necessary tactics, techniques and procedures will be essential to solving the TOD challenge.

### Conclusion

We've come a long way in "jump-starting" HAVE QUICK operations in the world's only air-assault division. The pilot training, HAVE QUICK ANCD software and a valid user checklist have been instrumental in dispelling myths about HAVE QUICK. Pilots know it's the right thing to do and we're committed to making it work within the framework of our mission. Remember, knowing how to HAVE QUICK is not a gee-whiz, nice-to-know thing that you do as a temporary training event. This is a readiness issue that will protect the lives of our crews and soldiers during combat. If you have no other incentive, let this be your reason for making HAVE QUICK work in your unit.



*Maj. Scot MacKenzie is the brigade signal officer for the 159th Avn. Bde., 101st Avn. Div., at Fort Campbell, Ky.*

## Increased Survivability!



### Your Inertia Reel Must Function Properly To Protect You In A Survivable Accident

- ▶ The MA-16 locks securely on sudden strap acceleration as well as omni-directional vehicle impact.
- ▶ The Dual-Locking system of the Koch MA-16 greatly increases the survivability of a severe impact accident.
- ▶ The Koch MA-16 Inertia Reel is qualified to MIL-R-8236 Rev. F and listed on the QPL8326F.
- ▶ P/N 015-870145-3-16, NSN1680-01-437-0396

## Call Us Today With Your Requirements!



### H. KOCH & SONS CO.

5410 E. La Palma Ave • P.O. Box 68005 • Anaheim, CA 92817-0805  
Tel: (714) 779-7000 • Fax: (714) 779-7141  
Email: sales@hkoch.com Web: www.hkoch.com

# Hunter in the Balkans



By Bill Smithson

**T**he RQ-5A Hunter unmanned aerial vehicle (UAV) is deployed to the Balkans and is working with North Atlantic Treaty Organization (NATO) forces over Kosovo. Macedonia-based Hunters began flying missions over Kosovo on April 4, 1999, and are continuing their outstanding performance in support of the peacekeeping mission. The Hunter system's mission in the Balkans has been accomplished through more than 2,600 hours flight time to date — a figure that boosts the type's total flight hours since 1991 to nearly 12,000. More importantly, the Hunter's performance in the Balkans has clearly demonstrated the value of UAVs in a war zone.

The Hunter's ability to penetrate enemy airspace and remain over target areas is essential to warfighters and represents a vital link to other reconnaissance vehicles and platforms. The UAV's imaging systems allow commanders to detect, identify and track hostile activity in sufficient time to target those activities with lethal weapon systems or maneuver against or around them, as appropriate, and to conduct battle damage assessment. The Hunter enhances the commander's ability to locate and identify friendly forces to avoid unnecessary loss of life while locating actual enemy targets. Through the on-going payload demonstration program the Hunter will soon demonstrate the capability to detect biological and chemical weapons; the capability to see into dense jungles; and the capability to provide low cost, reliable communications across the battlefield.

Hunter has proven to be an invaluable surveillance tool for commanders, for it eliminates the need to put a pilot in harm's way. Imagery and data that once took hours to process and communicate are now being processed in a matter of minutes. For the first time this provides com-

manders and target analysts with virtual real-time information on battlefield conditions and potential targets.

The Balkans high altitude, mountainous terrain, poor weather conditions and the relatively sophisticated air defenses in the region provided an extreme test for the Hunter. Due to line-of-sight constraints, the Hunter system operated a majority of missions in a relay mode, requiring a minimum of two air vehicles (AVs) flying simultaneously for extended range.

**T**he Kosovo mission constitutes the first time the Army's Hunter unit has conducted operations outside the continental United States (OCONUS). For the past four years the Hunter system, operated by the 15th Military Intelligence Battalion at Fort Hood, Texas, has participated in the Army's digitized unit experiments and has supported rotations at the National Training Center (NTC) at Fort Irwin, Calif. The last NTC rotation was conducted in mid-February of this year, one week before the unit was ordered to Europe to support the NATO mission in the Balkans.

## Deployment

The Hunter system and the 15th MI Bn. were at the disposal of NATO's Supreme Allied Commander Europe, Gen. Wesley Clark. The system was deployed with soldiers from the 15th MI Bn. and Fort Hood-based personnel from the Air Force's 3rd Weather Squadron. The UAV's prime contractor, TRW, provided depot support through the Contractor Logistic Support (CLS) contract, as well as deploying a collocated team of technical operators and maintainers from the TRW depot in



# ***THE ARMY DESERVES OPERATIONAL FLEXIBILITY AND GROWTH IN TACTICAL AIRBORNE SURVEILLANCE SYSTEMS...***



***...GA-ASI  
CAN PROVIDE IT TODAY***

***Prowler II™ Tactical UAV was designed to meet the operational needs of the Army both today and tomorrow.***

- **Combat-Proven Technology**
- **Operations From Semi-Prepared Surfaces**
- **Heavy Fuel Engine**
- **Small Logistic Footprint for Operations by Forward-Deployed Maneuver Forces**
- **EO/IR or SAR Payload**
- **Highly Mobile**
- **>18 Hour Endurance Provides Maximum Mission Flexibility**



**Designed to be Operated by  
Army Technicians  
for the Army**



**AERONAUTICAL SYSTEMS**

General Atomics Aeronautical Systems, Inc.  
16761 Via Del Campo Court • San Diego, CA 92127 • (619) 455-2810

Sierra Vista, Ariz. The equipment taken from long term storage and made ready for the war effort included air vehicles, ground control stations (GCSs)/mission planning stations (MPSs), ground data terminals (GDTs), multimission optronic stabilized payload (MOSP) and other associated ground-support equipment.

TRW's depot facility worked around the clock to prepare and maintenance-test the equipment before it was shipped via military and commercial aircraft. Contractor personnel also ensured that essential spare parts were shipped with the subsystems, and established and maintained a spares pipeline via a regional logistics support center, shipping daily to the forward location.

## Lessons Learned

Lessons learned from the deployment will benefit future UAV operations. Some of these lessons included activities pertaining to communications, operations, logistics, and personnel and training.

- **Communications** — UHF radio communications were needed for air traffic control (ATC) coordination. The STU-III phones and SIPRNET e-mail were used for secure communications, while local portable communication needs were met with Motorola hand-held radios and the normal use of the Hunter system's PRC-126 radios for the GCS/MPS to the line chief. The Joint Broadcast System (JBS) was used to deliver live video feeds to local commanders, the Pentagon and other essential areas.

- **Operations** — Wartime operations in NATO-controlled airspace absolutely require Mode IV IFF. More than half the missions were launched before the target sets were established, and these often changed within the first 30 minutes of the mission, making prior mission planning ineffective. ATC restrictions imposed on Hunters inbound for landing dictated holding areas, and often these holding areas were overrun by severe weather and thunderstorms. More reasonable priority should therefore be negotiated with ATC to prevent excessive holding delays. Hunter operators need better tactical identification training, and mission payload operators need better discipline in search and scan techniques when given an area to investigate.

- **Logistics** — It is very important to establish the logistics deployment procedures and practices early, since they are liable to change whenever the responsible unit changes staff. Packing and shipping of material need to be provided/obtained as part of the deployment prepara-

***The Hunter system's mission in the Balkans has been accomplished through more than 2,600 hours flight time to date — a figure that boosts the type's total flight hours since 1991 to nearly 12,000.***

tions. Saving packaging materials from incoming items is a must, since this may be the only material available when it comes time to return the replaced items to depot. Standard parts shipping containers would be helpful, especially if they can withstand the tightening of tie-down straps used on air cargo pallets.

- **Personnel/Training** — The unit personnel gained proficiency in all areas, but very few will rotate back to school to return the experience gained to the instructor knowledge base. Recent graduates needed better procedural discipline in order to establish a firm "routine." Paperwork discipline needs improvement at both the unit level and training level, and unit-specific paperwork requirements need to be presented to arriving soldiers in a more timely manner. Additional maintenance training had to be conducted on-the-job for many new soldiers.

The Hunter Tactical Unmanned Aerial Vehicle (TUAV) Project Office has initiated the appropriate corrective actions with regard to those lessons learned that fall within its control.

It must be noted that the Project Office has taken actions in the past to improve the reliability of the Hunter System hardware/software, which has far exceeded its specification requirements. The Hunter system's operational availability requirement is 0.85, while the current demonstrated operational availability is 0.98.



*Bill Smithson works in the TUAV Program Management Office at Redstone Arsenal, Ala.*

### Statement of Ownership, Management, And Circulation (Required by 39, U.S.C. 3685)

Title of publication: Army Aviation (ISSN 0004-248X). Date of filing: September 1999. Frequency of issue: Monthly, except April and September (10). Annual subscription price: \$30.00. Location of known office of publication: 49 Richmondville Avenue, Westport, CT 06880-2000. Location of headquarters or general business office of the publisher: Same. Publisher: Lynn Coakley, 49 Richmondville Avenue, Westport, CT 06880-2000. Editor in Chief: William R. Harris, Jr. Editor: Stephen Harding. Owner: Lynn Coakley, 168 Long Lots Road, Westport, CT 06880. Known bondholders, mortgagees, and other security holders owning or holding 1% or more of the total amount of bonds, mortgages or other securities: None.

The average no. of copies each issue during the preceding 12 months, and the actual number of copies of the issue published nearest to the filing date (latter appears in parenthesis) were: a. Total No. copies (Net Press Run): 13,550 (13,164); b. Paid Circulation: (1) Sales through dealers, carriers, street vendors, and counter sales: NA (NA); (2) Paid or Requested Mail Subscriptions 12,492 (12,277); c. Total Paid and/or Requested Circulation: 12,492 (12,277); d. Free distribution by mail: Samples, complimentary, and other free copies: 321 (312); e. Free Distribution Outside the Mail (Carrier or Other Means): 611 (475); f. Total Free Distribution (sum of 15D and 15e): 932 (787); g. Total Distribution (sum of 15C and 15f): 13,424 (13,064); h. Copies Not Distributed (2) Office Use, Leftovers, Spoiled: 126 (100); (2) Return from news Agents: NA (NA); i. total (Sum of 15g, 15h(1), and 15h(2)): 13,550 (13,164); Percent Paid and/or Requested Circulation (15c/15gx100): 93.32% (93.98%).

I certify that the statements made by me in this statement and dated September 30, 1999 are correct and complete.

Lynn Coakley, Publisher



# AVIATORS Aid Flood-Relief EFFORT

by Staff Sgt. Michael Westerfield

When Hurricane Floyd displaced thousands of families in North Carolina with some of the worst flooding ever recorded, active-duty units from Fort Bragg joined other military commands in rescue and humanitarian-relief efforts.

Rising waters closed off more than 300 roads, isolating many small communities. Some residents later had to be evacuated as the relentless water continued to climb.

"A lot of people were lucky to get out alive," said Mitch Stensland, personnel director for Tarboro High School, which was turned into an area shelter housing about 2,000 residents. "They come to these shelters and we do what we can to take care of their needs."

The storm shattered the flood record set in 1919. President Bill Clinton declared two-thirds of eastern North Carolina a disaster area. The Federal Emergency Management Agency began coordinating the emergency delivery of food, water, medical supplies, clothing and other supplies to the hundreds of shelters scattered throughout North Carolina.

Civilian aid agencies and National Guard units normally handle these types of disasters, officials said, but the tremendous size of the flood required more help. So FEMA called on XVIII Airborne Corps and Fort Bragg, N.C., for assistance.

Because most of the roads and bridges in the region were impassable, helicopters were desperately needed to move people and supplies. So among the equipment the Army provided were seven CH-47 Chinook helicopters, each of which could carry more than four tons of supplies on each mission. The aircraft made two or more resupply missions every day for as long as they were needed.

The active-duty soldiers performed rescue operations and delivered food, medical supplies and fresh water to thousands of people spread out at flood shelters and islands of dry land across the eastern North Carolina flood plains.

"Our helicopter brought two tons of Meals Ready to Eat and 3,000 pounds of water on this trip and expect to make a couple more trips today," said Capt. Timothy C. Viles of Fort Bragg's Company C, 159th Aviation Battalion. "It brings some satisfaction to help people less fortunate to get back on their feet."

The Fort Bragg soldiers worked in concert with National Guard and civilian relief agencies to ensure all the flood survivors were taken care of.

"This is the reason I joined the National Guard," said Sgt. Chris Smith of Co. F, 130th Avn. Bn. "This is the first time I've activated to actually help my neighbors. We've evacuated a dialysis patient and a kid who got hurt by a generator. We've delivered insulin and other supplies to the flood shelters."

For many residents of Tarboro, one of the hardest hit communities, the Chinooks also brought a first taste of MREs. Though some military veterans said the meals were better than the C-rations they remembered, others were less impressed. And many had trouble simply getting to the food.

Helicopter crewmembers helped by giving a quick MRE class and answering questions. The soldiers shared a few secrets to make the meals even better.

"It feels gratifying to see someone smile, to make their day," said CWO 3 John Hagar, a Co. B, 159th Avn., pilot. "It's worth the effort to see them happy to get water."



*Staff Sgt. Michael Westerfield is assigned to the Public Affairs Office at Fort Bragg, N.C.*

## AIR-BORN

Though active Army and Army National Guard aircraft participated in a range of missions in the wake of Hurricane Floyd, perhaps one of the most memorable involved a UH-60 Black Hawk from the Tennessee Army National Guard's Medical Detachment.

The aircraft was tasked to pick up a pregnant woman in labor at the New Hanover Airport in Wilmington, N.C., after flooding precluded ground ambulance travel from her local medical center in Doshier, N.C., to the New Hanover Hospital.

The crew, flying with night-vision goggles, made the pick-up and started for the hospital. The baby wouldn't wait, however, and 20 feet from the ground and 30 seconds before touch down the woman successfully gave birth to a baby girl. — **MSgt. Bob Haskell, National Guard Bureau Public Affairs Office.**

## ARMY AVIATION BOOK REVIEW

Reviewed by  
Maj. Gen. Ben L. Harrison (Ret.)

### Year of the Snake

One Helicopter Pilot's Story of a Year in  
Vietnam's Mekong Delta, Vinh Long 1965-66  
By W. Bailey Jones  
225 pages Shade Tree Publishers

This is a story of ordinary Americans who became extra-ordinary. It's a story about Army aviation and the pilots, air crewmen, and maintenance and service troopers who volunteered to go to war for their country. Sure, there was a draft, but in 1965 and 1966 it was a professional Army and these men, virtually all of them, had to apply for and volunteer to get into aviation units.

The book comes together from daily journal notes by Bailey Jones. He courageously decided these straightforward notes would not be edited for "political correctness" or to spare those who did not perform up to standards. Identifying it as one helicopter pilot's story of 1965 and 1966 in the Mekong Delta is quite appropriate. It was the Vietnam War, but there were literally hundreds of Vietnam wars. Which Vietnam war depended on your personal job, your unit, your leaders, your operational area, the time on the clock from 1961 to 1973 and, tragically, the U.S. national leadership at the time.

"Year of the Snake" is an easy and entertaining read. It brings a profound lesson for military and national leaders for those who are wise to see it. Wars are won by warriors and not just weapons as everyone knows - or do they?

Bailey Jones tells of numerous occasions when air crews unflinchingly rushed to the aid of troops in contact, villagers under siege and wounded soldiers needing evacuation. It's left for the reader to contrast this raw bravery under fire with the great national reluctance to put troops in harm's way in Kosovo.

We need to take heed of Gen. George S. Patton's writings on "the warrior soul." For example, in the January 1931 issue of the Infantry Journal Patton wrote:

*"Success in war lurks invisible in that vitalizing spark, intangible, yet as evident as lightning - the warrior's soul... It is the cold glitter of the attacker's eyes, not the point of the questing bayonet, that breaks the line. It is the fierce determination of the driver to close with the enemy, not the mechanical perfection of the tank. It is the cataclysmic ecstasy of conflict in the flier, not the perfection of the machine gun which drops the enemy in flames."*

Bailey Jones writes unabashedly of the pure joy of blowing the bad guy to bits. Patton's ecstasy! He reports time and time again of air crews possessed of warrior souls looking, at great personal risk, for enemies to kill. This is honest writing. Let's hope we learn from it.

Copies of this publication are available  
through the Army Aviation Book Store  
on page 43 of this issue.

### INTERNATIONAL LIAISON PILOT AND AIRCRAFT ASSN (ILPA)

16518 Ledgestone  
San Antonio, TX 78232



#### "LIAISON SPOKEN HERE"

Bill Stratton - Editor  
210-490-ILPA (4572)  
Send For A Free Copy  
Of The Newsletter

## Tips from TOPS

BY COL. JERRY CREWS, USA, RET.

### Don't Overlook Job Fairs

#### These events can open doors to great opportunities.

Many military officers avoid attending job fairs because they do not know what they want to do or because some fairs appear to be outside their areas of interest. But attending a job fair can give you new ideas and opportunities. As TROA member CWO Richard Gotz, USA-Ret., recently said in a letter to TOPS "Opportunities can come from organizations you may least expect to relate to your background. I think if you are willing to engage in dialogue with any potential employer (regardless of the industry), opportunities can surely occur."

Another member, CWO3 Roger Minyard, USA-Ret., received a call from a Ford Motor Company representative five months after he attended a job fair; he prepared well for the interview and is now employed as a line supervisor in one of Ford's "stamping" departments (a position with which he had zero experience when hired). I've heard many similar stories of officers finding success through job fairs.

Some fairs have a specific career-field focus, such as information technology, education, logistics, or management and business professionals; others are open to any job title. A trucking-industry job fair may offer challenging positions as maintenance managers, trainers, operations managers, financial officers, human resource managers, and so on. As Gotz suggests, be willing to talk with anyone and everyone when you visit these job fairs; sometimes "chemistry" will outweigh what you assume are the professional requirements of a job. As a former service-member, you can handle just about any civilian job, but only if you know about it and try.

Scan local newspapers and professional magazines to find out about upcoming job fairs. Once you find a fair to attend, consider it your first interview; you may quickly be out of the running for a potential job if you are not prepared or present yourself poorly. Wear appropriate attire - whatever that is for your particular industry and part of the country. You may have three doctorates, but if you dress like PeeWee Herman, you will be eliminated in a second.

At one job fair I visited recently, approximately 80 firms were represented. Not one male in the recruiting booths wore an earring, had a ponytail, or needed a shave. Many were dressed "business casual" (open shirts and slacks), but none wore hiking boots or running shoes. The men and women in these booths represented their companies with a professional appearance. As an attendee, you should follow their lead.

Arrive early, take a stack of networking resumes, and have a list of references in case they are requested. Recruiters may ask one or two job-specific questions to give you an opportunity to sell yourself in a 30-second answer; then they want you to move on so they can meet with others. Talking with human resources folks at a booth can be a real challenge because you are trying to isolate them for a few minutes and sell yourself while others are standing making noise in the background. Pay attention to your instincts, and if you are wasting time with a potential employer, be polite and move on.

Don't waste time; talk to as many potential employers as possible. If you have done your homework, move directly to the companies you are interested in, but don't miss an opportunity to talk with others, time permitting. You don't know where a job lead will come from. If you can't talk with some people, get their business cards and leave your resume; you can always e-mail or write later, and in the meantime, they may see something in your resume that whets their appetite to call you after they get back to their offices.

*Editor's Note: Army Aviation is seeking good-news announcements of aviation-related professionals who are on the move. If you or your organization have an upcoming change of leadership (at the battalion or squadron level, or higher for MTOE and TDA units), please forward the information to Barbara Ross, care of the AAAA National Office.*



Secretary of Defense William S. Cohen has announced that President Bill Clinton has nominated:

**Lt. Gen. John W. Hendrix**, United States Army, for appointment to the grade of general and assignment as commanding general, U.S. Army Forces Command, Fort McPherson, Ga. Hendrix has been commanding general of V Corps, U.S. Army, Europe, and Seventh Army since July 1997.

**Maj. Gen. Kevin P. Byrnes**, USA, for appointment to the grade of lieutenant general and assignment as Army assistant vice chief of staff in Washington, D.C. Byrnes has been commanding general of the 1st Cavalry Division at Fort Hood, Texas, since July 1997.

**Maj. Gen. James C. Riley**, USA, for appointment to the grade of lieutenant general and assignment as commanding general, V Corps and USAREUR/7A. He has been commanding general of the 3rd Infantry Div. and Fort Stewart, Ga., since June 1997.

**Maj. Gen. John A. Van Alstyne**, USA, for appointment to the grade of lieutenant general and assignment as deputy commanding general for initial entry training, U.S. Army Training and Doctrine Command, Fort Monroe, Va. Van Alstyne has been commanding general, U.S. Army Training Center and Fort Jackson, S.C., since July 1997.

Chief of Staff the Army Gen. Eric K. Shinseki has announced the assignments of the following general officers:

**Brig. Gen. Raymond D. Barrett Jr.**, from assistant division commander (support), 2nd Inf. Div., Eighth U.S. Army, Korea, to commanding general, U.S. Army Training Center and Fort Jackson, S.C., with a report date to be determined.

**Brig. Gen. Walter L. Sharp**, from deputy director for global/multilateral issues and international-American affairs, J-5, The Joint Staff, in Washington, D.C., to commanding general, 3rd Inf. Div. and Fort Stewart, Ga., with a report date to be determined.

**Col. John A. Yingling**, from deputy assistant commandant for futures, U.S. Army Field Artillery Center, Fort Sill, Okla., to assistant division commander (support), 2nd Inf. Div., Eighth U.S. Army, Korea, with a report date to be determined.

**Gen. Henry H. Shelton**, USA, was confirmed by the Senate on Sept. 24 for reappointment as chairman of the Joint Chiefs of Staff in Washington, D.C.

**Brig. Gen. Franklin L. Hagenbeck**, former assistant division commander (operations) for the 101st Airborne Division at Fort Campbell, Ky., will become deputy director for global/multilateral issues/international-American affairs, J-5, on the Joint Staff, in Washington, D.C., with a report date to be determined.

The following Army National Guard officers were confirmed by the Senate on Sept. 29, 1999, for promotion to the grades indicated.

To major general:  
**Brig. Gen. Peter J. Gravett**  
**Brig. Gen. Walter F. Pudlowski Jr.**  
**Brig. Gen. Frederic J. Raymond**

To brigadier general:  
**Col. Lewis E. Brown**  
**Col. Dan M. Colglazier**  
**Col. James A. Cozine**  
**Col. David C. Godwin**  
**Col. Carl N. Grant**  
**Col. Herman G. Kirven Jr.**  
**Col. Roberto Marrero-Corletto**  
**Col. William J. Marshall III**  
**Col. Terrill K. Moffett**  
**Col. Harold J. Nevin Jr.**  
**Col. Jeffrey L. Pierson**  
**Col. Ronald S. Stokes**  
**Col. Gregory J. Vadnais**

## AVIATION EDUTAINMENT

What's New on the Web, TV & PC



Forms, Publications, Magazines, etc:

**USAPA Electronic Pubs and Forms:**  
<http://www.usapa.army.mil>  
 (ARs, Pams, Cirs, OFs, SFs, DD, and DA forms; Pubs Order System)

**Standard Forms (OFs):**  
<http://web1.whs.osd.mil/icdhome/sfeforms.htm>  
 (Contains some forms not included on USAPA web site)

**Army Doctrine and Training Digital Library:**  
<http://www.adtdl.army.mil> (Information on Army schools and Army documents)

**Army Reserve Magazine:**  
<http://www.army.mil/usar/armag/armag.htm>

**Military Periodicals:**  
<http://www.dtic.mil/search97doc/aulimp/main.htm>  
 (Index to Military Periodicals)

**Pay and Finance:**

**OCAR Pay Support Center:**  
<http://www.army.mil/usar/psc/ocarhp.htm> (Links to important USAR pay information)

**Army Financial Operations:**  
<http://www.asafm.army.mil/financial.htm>

## CFC•CFC•CFC•CFC

The AAAA Scholarship Foundation, Inc. (AAAASFI) is part of the **Combined Federal Campaign (CFC)**, a workplace charitable fund drive conducted by the U.S. government for all federal employees. It is the single largest workplace fund drive in the country, raising approximately \$195 million in pledges annually.

In 1999, the AAAASFI received a total of 152 applications and awarded 90 grants and five loans for a total of \$175,000. These awards are made on the basis of academic merit only and the applications are scrubbed to remove all references to the names and ranks of their AAAA member relative.

Don't forget, all overhead costs are borne by the AAAA so that 100% of your contribution (net CFC charges) go directly to AAAA Scholarship Foundation awards. Help us reward more of these outstanding students with even larger awards.

Please consider making a CFC-sponsored contribution to the AAAA Scholarship Foundation this year.

Tax-deductible donations may also be made directly to the  
**AAAA SCHOLARSHIP FOUNDATION, INC.**

49 Richmondville Avenue, Westport, CT 06880-2000  
 E-Mail: [aaaa@quad-a.org](mailto:aaaa@quad-a.org) Telephone: (203) 226-8184 FAX: (203) 222-9863

**Combined Federal Campaign**



**COLONELS**

**Booze, David R.**, 7010 E. High Meadows Rd, Black Hawk, SD 57718.  
**Broome, Doyle D. Jr.**, 602 Gorgas Road, Wahiawa, HI 96786.  
**COL Timothy J. Casey**, 530 Golden Bell Rd, Bates City, MO 64011.  
**Jerauld, Gary D.**, 52 Bomford Drive, Redstone Arsenal, AL 35808.EM: jerauld@peoavn.redstone.army.mil  
**Rini, Thomas J.**, 9201 Dorothy Lane, Springfield, VA 22153.  
**Schwoebel, Charles G.**, P.O. Box 6779, Arlington, VA 22206.  
**Sealock, Gratton O.**, US Embassy Canberra, PSC 277, Box 174, APO AP 96549.EM: sealockg@hotmail.com or arma@tpg.com.au

**LT. COLONELS**

**Boland, James A., Jr.**, 5675 Wigmore Drive, Columbus, OH 43235.  
**Buchanan, Lewis E.**, Univ. of SC (ROTC), Columbia, SC 29308.EM: BuchananL@gwm.sc.edu  
**Casey, James M.**, 309 Holly Street, Destin, FL 32540.  
**Disney, Paul R.**, 445 Baldwin Road, Wahiawa, HI 96786.  
**Golden, Walter M. Jr.**, 38 Bow Street, Lexington, MA 02420.  
**Jones, Raymond D.**, P.O. Box 1369, APO AP 96555.  
**Morehead, Edwin C.**, 12532 Belfield Ct., Woodbridge, VA 22192.  
**Phillips, William N.**, 605A Berry Court, Mountain View, CA 94043.  
**Williamitis, Gregory M.**, 263 F Street, Carlisle, PA 17013.

**MAJORS**

**Blum, Gustavo E.**, 504 Larkin Lane, Montgomery, AL 36109.EM: blumgustavo@hq.oplec.army.mil  
**Bogle, Stephen E.**, 2859 NW 76th Avenue, Ankeny, IA 50021.  
**Brownlee, Emory W.**, 31 3rd Infantry Road, Fort Leavenworth, KS 66027.  
**Clawson, Michael N.**, 316 Gatewood Lane, Grayslake, IL 60030.EM: Michael.Clawson@usarc-emh2.army.mil  
**Crabb, Jeffrey A.**, 3 Oak Brook Court, Stafford, VA 22554.EM: jeffrey.crabb@sarda.army.mil  
**Garner, James H.**, 6508 Jacob's Creek Circle, Fayetteville, NC 28306.  
**Hottell, Kevin D.**, 5717-B Brown Avenue, Fort Knox, KY 40121.  
**Laver, Matthew M.**, CMR 477, Box 1786, APO AE 09165.EM: 127asbsp6@asb127hq.1ad.army.mil  
**O'Donnell, Vernon E.**, 425 Cedar Street, Maxwell AFB, AL 36113.EM: odonnellv@stewart.army.mil  
**Orecchio, Joseph M.**, 7567 Firethorn Dr, Fayetteville, NC 28311.  
**Rapavi, Michael J.**, HHT, 2-6 CAV, CMR 416, Box 280, APO AE 09140.EM: rapaviator@aol.com  
**Reist, Paul K.**, 321 Pope Ave #4, Fort Leavenworth, KS 66027.  
**Schodowski, Michael L.**, 104 Lakeshore Drive, Enterprise, AL 36330.  
**Sewall, Robert D.**, 4613 N.E. Dearborn Ave., Lawton, OK 73507.  
**Stinger, Russell E.**, 216 Pin Oak Drive, Harker Heights, TX 76548.EM: stinger@earthlink.net  
**Trivette, Michael R.**, 4937 Eaton Street, Denver, CO 80212.  
**Webster, James D.**, 7827 Wintercross Lane, Springfield, VA 22152.  
**White, Christopher**, 3208 Brechlin Rd, Fayetteville, NC 28303.

**CAPTAINS**

**Austin, Daniel J.**, 203 Circular St., Saratoga Springs, NY 12866.  
**Ballew, Steven A.**, 4047B Soda Mountain Drive, Fort Irwin, CO 92310.EM: ballew@mscomm.com  
**Bianchi, Joseph S.**, 6 Woodcrest Dr, Mount Holly, NJ 08060.

**Campbell, Charles B.**, 118 Patterson Road, Hanscom AFB, MA 01731.EM: cbcamp@aol.com  
**Cline, Nathan S.**, 103 Key Bend Drive, Enterprise, AL 36330.EM: s\_cline@yahoo.com  
**Czehowski, Shawn B.**, HHD, 164th ATS Group, Unit #15276, APO AP 96205.  
**Dalcourt, Charles J.**, 5304 Tessie Terrace, Apt. 213, Alexandria, VA 22309.EM: chasda1000@aol.com  
**David, Richard N.**, 107 Mazak, Fort Bragg, NC 28307.EM: davidclan@earthlink.net  
**Fleeher, Jeffrey J.**, 300 Greenwood Avenue, Apt. C23, Clarksville, TN 37040.EM: jfleeher@hotmail.com  
**Griffin, Camille D.**, CMR 415, Box 3281, APO AE 09114.  
**Harris, Marilyn R.**, 2408 W. Flower Avenue, Fullerton, CA 92833.EM: jmkharris@aol.com  
**Henderson, Dale L.**, 11766 Gascony Place, Woodbridge, VA 22192.  
**James, Gregory K.**, P.O. Box 8568, Seaside, CA 93955.EM: jamesgr@juno.com  
**Jeffries, Sharon A.**, A Co 601st ASB, OJGII (Camp Able Sentry), APO AE 09790.  
**Kimball, Raymond A.**, HHC/1-10Avn Comanche Base, Operation Joint Forge, APO AE 09789.  
**Lawrence, Ryan C.**, 910 Whirlaway Drive, Copperas Cove, TX 76522.EM: huseyit@aol.com  
**Lee, Jong-Hyuk**, HHC, 1-2 Avn, Unit 15008, APO AP 96208.EM: loej@usfk.korea.army.mil  
**Lynch, Christopher**, 1728 E. Laguna Drive, Tempe, AZ 85282.EM: apachequill@uswest.net  
**Mastlen, Randy G.**, 209 Bonn Road, Seaside, CA 93955.EM: 106240.3052@compuserve.com  
**Miguel, Fernando D.**, 330 Porterfield Ct, Fayetteville, NC 28301.  
**Nerstheimer, Michael E.**, 19 Winslow Road #1, Belmont, MA 02478.  
**Rodesky, Terry J.**, 3103 Rt. M, Jefferson City, MO 65101.  
**Stiller, Albert H.**, 6604 NW Hidden Valley Rd., Parkville, MO 64152.EM: stillal@aol.com

**1ST LIEUTENANTS**

**Asborno, Anthony J.**, B Co, 5/158 Avn, PSC 103, Box 4656, APO AE 09603.EM: aasborno@hotmail.com  
**Laster, Edwin A.**, 1441 B Circle Drive, Fort Campbell, KY 42223.EM: e\_laster@hotmail.com  
**Mallory, Thomas D.**, 661 McKay Road, Gray, GA 31032.EM: dustoffdax@hotmail.com  
**Musico, Darren E.**, 2501 Bacon Ranch Road, No. 312, Killeen, TX 76542.EM: armyaviator@mail.com  
**Suhr, Stephen A.**, 94-099 Manawa Pl. N103, Waipahu, HI 96797.  
**Wright, Jason P.**, 59-611 Keiki Road, Unit C, Haleiwa, HI 96712.

**2ND LIEUTENANTS**

**Abel, Matthew D.**, 2802 Rocky Branch, Enterprise, AL 36330.EM: matthewabel@hotmail.com  
**Bell, Jerry**, 1938 Whirlaway Circle, Clarksville, TN 37042.EM: bell1998@hotmail.com  
**Cornett, Misty M.**, 1849 Palamino Drive, Clarksville, TN 37042.EM: cornym@hotmail.com  
**Fennema, Lee S.**, CMR 454, Box 2271, APO AE 09250.EM: ifennema@hotmail.com  
**Loeb, Jeremy D.**, HHC, 1-52d Avn, Unit #15266, Box 701, APO AP 96205.EM: loebav@yahoo.com  
**Mann, Nathan M.**, 1500 Shellfield Road, Apt. 521, Enterprise, AL 36330.EM: nalemann77@hotmail.com  
**Martin, Elizabeth A.**, 639 Ashley Oaks Drive, Clarksville, TN 37042.EM: libzonsignore@hotmail.com  
**Raus, Eric J.**, CMR 3, Box 7844, Fort Rucker, AL 36362.  
**Sander, Jennifer L.**, Bldg. 788 #6 Ringold St., Wahiawa, HI 96786.EM: sanderj@hotmail.com  
**Sanford Hayden**, Virginia B., 4401 Bluestem Lane, Killeen, TX 76542.EM: virg\_sanford@hotmail.com  
**Stechshulte, Scott R.**, 58 Woodfield Pl, Enterprise, AL 36330.

**CW5s/MW4s**

**Struck, Thomas T.**, P.O. Box 512, Fort Drum, NY 13603.

**CW4s**

**Denmark, Wayne A.**, 917 Bickerton Court, Newport News, VA 23608.EM: denmarkw@zama-emh2.army.mil  
**Robinson, David A.**, 126 Oak Point Trail, Savannah, GA 31419.

**CW3s**

**Harper, Timothy W.**, Am'cn Embsy ABU DHABI UAE, APACHE TAFT DOS Pouch Rm., Washington, D.C. 20521.EM: apachesip@hotmail.com  
**Phillabaum, John E.**, HHC, 1-52nd Avn, Unit 15266, Box #436, APO AP 96205.EM: philla@snowhill.com  
**Triplett, Al**, 1 Plymouth Court, St. Louis, MO 63134.

**CW2s**

**Carman, Edward F.**, 112 Foxdale Drive, Toccoa, GA 30577.  
**Richards, Brett A.**, CMR 464, Box 344, APO AE 09226.EM: buford@snowhill.com

**WO1s**

**Bentzel, Christopher**, 246 North Weavertown Road, Bird-In-Hand, PA 17505.  
**Piland, John D.**, 71AM Windham Drive, Apt. 503, Daleville, AL 36322.

**SERGEANTS**

**Duggan, James J. SSG**, 29 Chamberlane Road, Wethersfield, CT 06109.  
**Gates, Clarence L. 1SG**, PSC 42, Box 83, APO AA 34042.  
**Huffman, Michael W. SGM**, HHC 17th Avn Bde, APO AP 96205.  
**Riethmiller, Bradley A. SGT**, 2915 Pine Avenue, Apt 1B, Erie, PA 16508.

**SPECIALISTS**

**Gammon, William P. SFC**, 5544-2 Hood Dr, Fort Riley, KS 66442.  
**Kather, Earlene SFC**, B Co 2-52nd Avn Regt., Unit 15212, Box C48, APO AP 96271.EM: earlenekather@hotmail.com

**DACs**

**Barton II, James D. Mr.**, OMC/AV (AMELO), Unit 649001, Box 34, APO AE 09839.EM: barto2@omceg.centcom.mil  
**Bond, Michael H. Mr.**, 633 Atalania, Webster Groves, MO 63119.  
**Speidel, Karen S. Ms.**, USDAO Bangkok, Box 50, APO AP 96546.

**CIVILIAN**

**Motley, Campbell M.**, 4 Fox Croft, Williamsburg, VA 23188.EM: cmotley@cambor.com  
**Beatty, Daniel J. LTC**, 12196 Stanley Canyon Road, Colorado Springs, CO 80921.  
**Brophy, William S. COL**, 1165 Simmons Road, O'Fallon, IL 62269.  
**Bryson, William L. LTC**, 4713 Wainwright Circle, Owings Mills, MD 21117.  
**Dawson, Lawrence E. MAJ**, 414 Colonial Street, Jefferson City, TN 37760.  
**Eldridge, Dennis W. LTC**, P.O. Box 39, Bedford, KY 40006.  
**Kerr, R. Dennis BG**, P.O. Box 926, Warwick, NY 10990.EM: rdenkerr@aol.com  
**Noack, Richard R. COL**, 29018 Angel Fire Drive, Fair Oaks Ranch, TX 78015.  
**Van Winkle, Daniel G. LTC**, 825 Thrasher Drive, Viera, FL 32955.EM: daniel.g.vanwinkle@lmco.com  
**Wagner, Randy D. MW4**, 22465 N. 53rd Lane, Glendale, AZ 85306.  
**Walker, Robin C. COL**, 3304 Reta Cove, Round Rock, TX 78664.

# AAAA NEWS

## NEW MEMBERS

**AIR ASSAULT CHAPTER  
FORT CAMPBELL, KY**  
LTC Gary B. Brown  
CPT Andrew B. Decker

**ALOHA CHAPTER  
HONOLULU, HI**

SPC Bryant E. Alcorn  
SPC Ifejiika Animalulu  
SPC Kevin L. Bolin  
SGT Donald D. Bond  
CSM Rafael A. Castro  
SPC John P. Chrzik  
SGT Lilianna Concepcion  
SPC Rubin C. Covington  
SSG Maria L. Denzine  
SPC Lynn P. Dugan  
PFC Dana D. Dunn  
SGT Jeremiah Eaton  
SPC Emilio O. Echalarz  
SPC Donald Ellis  
SPC Pablo Fel  
PVT Paul F. Fisher  
CPT Kathryn R. Funk  
SPC Aaron C. Governatori  
MAJ William B. Grimes  
SGT James D. Hagans  
SGT Thomas Hale  
PFC Lawrence P. Harper  
SPC Daniele Henderson  
SSG Clyde P. Hippensteel  
SPC Sonia L. Howard  
SPC Nichole C. Ince  
SPC Julie A. Ingold  
SPC Joshua Jefferies  
SGT Richard Johnson  
SPC Thomas Jones  
MAJ Yvette J. Kelley  
SGT Dustin Koch  
SPC Justin Kragenbrenbrink  
SPC Clinton Lopez  
SPC Alfred A. Magpayo  
SPC Jason M. McGill  
SGT George D. Miller

SPC Carlos M. Monlor  
CPT Charles I. Montana III  
PFC David Patterson  
SPC Jason Pierschbacher  
SPC Amanda Plumley  
SPC Lewis A. Romero  
SPC James Samora  
SGT Daniel Sandoval  
SPC Adam Schaefer  
SGT Michah Smith  
SGT Mark A. Thomas  
SGT Stephen I. Tonge  
SPC Thomas G. Tun  
SGT Joshua Walter

**ARIZONA CHAPTER  
MESA, AZ**  
MAJ Frederick E. Ferguson, Ret

**AVIATION CENTER CHAPTER  
FORT RUCKER, AL**

WO1 William K. Akin  
2LT Robert B. Anderson  
WO1 John J. Bilton  
2LT Craig A. Blow  
2LT James E. Bluman  
2LT Aaron L. Caldwell  
CPT Mark T. Calhoun  
2LT Jennifer L. Cannan  
WO1 William G. Clare  
2LT Lance J. Culver  
2LT Michael E. Cushwa  
WO1 Delano J. Davis  
2LT Matthew L. Dyer  
Ms. Andrea L. Emery  
WO1 Steve A. Evon  
SFC Thomas C. Farley, Ret.  
2LT Jarat L. Ford  
2LT Matthew F. Frombach  
WO1 Chris D. Gauthier  
2LT Anthony F. Giordano  
CW4 David L. Hacker  
WO1 William H. Heath  
2LT Corey M. James

2LT Todd A. Johnson  
2LT Ryan C. Kendall  
2LT Shawn P. Kilcoyne  
2LT Nathan P. Krump  
2LT Jacob R. Landry  
WO1 Ross D. Lewallen  
CW4 Douglas S. Maciver  
2LT Jeffrey D. Mix  
CW3 Daniel J. Mordarsk  
WO1 Michael J. Morris  
WO1 Julie L. Opfer  
2LT Jonathan M. Palin  
2LT Bob M. Perchard  
WO1 Eugene T. Reynolds  
WO1 Sean T. Richards  
2LT Shana L. Richardson  
WO1 James S. Roach  
WO1 Robert C. Russell  
2LT Daniel L. Scott  
2LT Michael R. Scott  
2LT James W. Shupe  
LTC Andrew Newman Simkins  
2LT David B. Smith  
WO1 Justin S. Swofford  
2LT John Syers  
SGT Lydia M. Thompson  
WO1 Eric W. Totten  
2LT Roger P. Waleski  
WO1 April C. Wallace  
WO1 Clyde Wylie  
Mr. Robert J. Wynkoop

**BLACK KNIGHTS CHAPTER  
WEST POINT, NY**

LTC Roger J. Barros  
CDT Sean M. Buckner

**CEDAR RAPIDS CHAPTER  
CEDAR RAPIDS, IOWA**  
Mr. Stephen R. Spitz

**CENTRAL FLORIDA CHAPTER  
ORLANDO, FL**  
LTC Roland M. Dixon

**COLONIAL VIRGINIA CHAPTER  
FORT EUSTIS, VA**

SFC Randolph L. Adams  
SFC Jeffrey E. Barlow  
SFC Myron A. Cabey  
Mr. Theodore C. Cors  
SSG Anthony W. Fausbus  
MSG Lenard J. A. Fensom  
SSG John L. Fox  
SGT Robert Lee Galling Jr Ret  
CW3 Timothy A. Lilley  
SSG Christopher A. Marker  
SFC Osualdo Martell  
SFC Wilbert Purcell  
SSG Troy D. Robinson  
SFC Dwayne A. Tigs  
SSG Robert L. Williams

**EDWIN A LINK MEMORIAL CHAP  
BINGHAMTON NY AREA**  
Mr. Douglas R. Becker

**GREATER ATLANTA CHAPTER  
ATLANTA, GA**  
LTC Donald B. Skipper, Ret.

**HIGH DESERT CHAPTER  
FORT IRWIN, CA**  
SFC(P) Steven D. Fisher

**IRON MIKE CHAPTER  
FORT BRAGG, NC**  
CPT Phillip P. Monbleau

**MID-AMERICA CHAPTER  
FORT RILEY, KS**  
CW3 Mark D. Otterstatter  
CW3 Craig S. Richardson

**MONMOUTH CHAPTER  
FORT MONMOUTH, NJ**  
Ms. Kathleen M. Reidy  
Mr. Luis O. Rodriguez

**OREGON TRAIL CHAPTER  
SALEM, OREGON**  
MSG Owen K. Gotchall  
SFC Michael C. Hagan  
COL Jerral D. Harchenko  
MAJ Frederick F. Mentzer, Ret

**PHANTOM CORPS CHAPTER  
FORT HOOD, TX**  
CW4 Floyd S. Werner, Jr.

**SAVANNAH CHAPTER  
FT. STEWART/HUNTER AAF, GA**  
Mr. Steven W. Lindsey  
CW5 Robert B. Stitt

**TENNESSEE VALLEY CHAPTER  
HUNTSVILLE, AL**  
PV2 Elijah L. Varga

**WASHINGTON-POTOMAC  
CHAPTER  
WASHINGTON, DC**

LTG Joseph E.  
DeFrancisco, Ret  
MAJ David N. Gereski  
Mr. William W. Hansen  
CPT Edward J. Lizurick  
Ms. Rebekah E. Nottingham  
LTC Jesus G. Ramirez  
LTC Joe Shanney

**MEMBERS WITHOUT  
CHAPTER AFFILIATION**  
CPT Johnathon W. Ballard, Sr.  
1LT Anthony F. Barnett  
Mr. Piet Ephraim  
CW4 Jim R. Gately  
COL William R. Holland  
CPT Jon Langione, Ret.  
MAJ James D. Schrote



## Lost Members

Help us find our Lost Members. We'll give you an additional month on your AAAA membership free for each member you help us locate. Simply write, call or E-mail us with the Lost Member's current address. Army Aviation Magazine, 49 Richmondville Avenue, Westport, CT 06880-2000. Tele: (203) 226-8184; FAX: (203) 222-9863; E-Mail: magazine@quad-a.org.

Basse, Alexander J, CPT  
Bush, J. David, LTC  
Campbell, Todd A., WO1  
Dunn, Bryan G., 2LT  
Giddings, Jill N., CDT  
Gonzalez, Jonathan G., SPC  
Hamilton, Todd R., CDT  
Hogan, Russell J., 2LT  
Jeffries, Erica L., CDT  
Keller, Frederick G., 2LT  
Lonnemann, Matthew R., SPC  
Maizner, Frank D., CDT  
Marubu, Maryann, PFC  
Mayers, Donald, SGT  
Mazingo, Phillip W., 2LT  
Meyers, Frederick, SPC(SGT)  
Paul, Frank W., CW3  
Paustovski, Igor, SPC  
Polk, George W., SFC  
Roe, Marc A., 2LT  
Schuck, Gerald P., CDT  
Scott, Brian, SPC(SGT)  
Starnes, Tommy D., CW3  
Viachakis, Johnny M., CDT  
Young, Kimberly A., CW3  
Zaldumbide, Eduardo, MAJ



### *Cruising in a Different Kind of Machine*

Retired Brig. Gen. Jack W. Hemingway and his wife, Shirley, know a fine automobile when they see one - or two. The Killeen, Texas, residents are the proud owners of a number of Model A Fords. Pictured are a 1929 "Fordor" sedan owned since 1977, and the second, a 1929 "Fordor" station wagon acquired two years ago.

The Hemingways and their classic pair were featured in a recent edition of *The Restorer*, a publication of the Model A Car Club of America. A 40-year member of AAAA, Jack belongs to the Phantom Corps Chapter.

## Special Compensation for Severely Disabled Retirees: Are You Eligible?

The authorization conferees' approved of the new special compensation for certain severely disabled retirees. Many of you may want to know whether you would qualify for the extra \$100 to \$300 per month.

The eligibility rules are very tight, and many won't qualify. To be eligible, a member must have:

- 1) Completed at least 20 years of uniformed service "that are creditable for purposes of computing the amount of retired pay" (see comments below);
- 2) Retired for reasons other than disability; and
- 3) Received a disability rating of at least 70 percent from the Department of Veterans Affairs within four years after leaving uniformed service.

The two main issues arising in light of these requirements concern their effect on Reserve retirees and military disability retirees.

First, Department of Defense sources indicate it is not yet certain whether Reserve and Guard retirees will be eligible. The assessment of The Military Coalition (TMC) and The Retired Officer's Association (TROA) is that they should be, since the terminology used is "uniformed service" rather than "active duty uniformed service."

But DOD lawyers are reviewing whether the word "creditable" in the phrase "creditable for purposes of computing the amount of retired pay" requires 20 years of full-time duty. If they render the latter interpretation, TMC will be asking Congress to review the matter.

The second problem is that members who received military disability retirements from their uniformed service are not eligible, regardless of any subsequent disability award from the VA. There have been two possible rationales offered for this exclusion:

- 1) The primary argument for relief from the current law has been that military retired pay and VA disability compensation are paid for different reasons: The retired pay is for length of service and the VA disability compensation is for disability. This is clearly true for nondisability retirees, but more nebulous for disability retirees, since part of their retired pay is for disability, too. There was some concern that these members might be seen as receiving multiple forms of disability compensation for the same disability.
- 2) Many disability retirees already receive greater retired pay than members with equal grade and service who received nondisability service retirements. For example, a member receiving a nondisability retirement after 20 years receives 50 percent of basic pay, whereas a military disability retiree with equal grade and service who has a disability rating of 80 percent or greater receives 75 percent of basic pay. Thus, the proposal was aimed mainly at helping those severely disabled retirees currently receiving relatively smaller compensation.

But it's clear there are lots of cases that these arguments don't fit, and that another look at the language is needed to ensure equity among various categories of retirees. TROA will be working with Congress in an effort to address this matter for military disability retirees.

## Cola Projection Update

The Bureau of Labor Statistics recently announced the Consumer Price Index (CPI) number for August. This is important because the CPI is the basis for the upcoming (effective Dec. 1) COLA for Social Security, military retired pay, SBP, VA disability compensation, etc.

The December COLA now looks like it's going to be either 2.3 percent or 2.4 percent. We won't know for sure until the final September CPI figures come out in the middle of October.

If the September CPI growth exactly matches the August increase, the COLA will be 2.4 percent (rounded up from 2.375). If inflation slows down a little in September, the COLA could be 2.3 percent. If inflation takes a bigger jump in September, it might get up to 2.5 percent.

## House and Senate Conferees Have Agreed on Compromise Legislation

On September 25th the House passed the final version of the Compromise fiscal year 2000 Defense Authorization Act by an overwhelming vote of 375 to 45. It still must be approved by the full Senate and signed into law by the president.

Assuming the Senate passes it as expected, it will take a couple of days for administrative clearance to the White House. Then President Bill Clinton will have 10 days from arrival to sign or veto it, or it will become law in the absence of any presidential action.

Among its many provisions, it would:

- upgrade pay raises and repeal retired pay cutbacks for members currently on active and reserve duty,
- repeal retired pay penalties for retired officers working as federal civilians,
- establish requirements for military health care improvements, and
- establish a new special compensation for certain severely disabled retirees.



## LEGISLATIVE REPORT

Col. Sylvester C. Berdux, Jr. (Ret.)  
AAAA Representative to  
The Military Coalition (TMC)

If the Clinton Administration vetoes the bill over a proposed Energy Department reorganization, negotiations on a revised bill could continue into October. We expect no changes in personnel or benefit provisions, though.

## Veterans Millennium Health Care Act

The House concluded its action on H.R. 2116, the Veterans Millennium Health Care Act, which provides a comprehensive blueprint for addressing the health care needs of veterans in the 21st century. Some of its innovative provisions include:

- Establishing a long-term care benefit for any veteran with a 50 percent or higher disability or a service-connected need for such care and providing them the highest priority for placement in VA nursing homes.
- Lifts the six-month limit on the VA providing adult day health care.
- Authorizes the VA to furnish respite care services under contract in the veterans' homes or any other setting.
- Requiring VA to increase home and community-based long-term care.
- Establishing a new health-care enrollment category for non-disabled military retirees eligible for TRICARE, essentially guaranteeing them care, as opposed to their current "space available" status.
- Allowing the VA to adjust copayments for such services as pharmaceuticals, eyeglasses, etc., subject to certain restrictions.
- Authorizing VA to cover emergency costs for uninsured veterans.
- Directing VA to realign inefficient facilities, and reinvest the savings locally to improve veterans' access to care.
- Requiring the VA to report to Congress on the feasibility of a pilot program to provide veterans with assisted-living services.

These initiatives cover the broad spectrum of programs long sought by TMC and other veterans' organizations and would ensure that this nation is responsive to those who have served in armed conflicts for almost a century. Early this month, TMC sent a letter to members of the House urging them to vote FOR this important legislation.

## FEHBP-65 Lawsuit Won't Delay Test Implementation

The Office of Personnel Management (OPM) announced that the upcoming test of enrolling Medicare-eligible uniformed services beneficiaries in the Federal Employees Health Benefits Program (FEHBP-65) will not be affected by a pending lawsuit filed by BlueCross BlueShield Association. The FEHBP-65 enrollment window for eligible beneficiaries at the eight test sites will run from Nov. 8 through Dec. 13. Health care delivery will start on Jan. 1. The FEHBP-65 demonstration sites are: Dover AFB, Del.; Roosevelt Roads, Puerto Rico; Fort Knox, Ky.; Greensboro, N.C.; Dallas, Texas; Humboldt County, Calif.; Camp Pendleton, Calif., and New Orleans, La.

## TRICARE Supplemental Test Sites Announced

DOD has announced that the fourth demonstration program Congress authorized for testing delivery of health care to Medicare-eligibles will begin next spring in the vicinity of Cherokee, Texas, and Santa Clara, Calif.

Qualifying beneficiaries at those locations will be able to purchase TRICARE as supplemental coverage to Medicare. Like most supplementals, the TRICARE supplemental plan would cover Medicare copays, but not the \$100 annual Medicare outpatient deductible. It would reimburse participants up to 115 percent of Medicare allowable charges and provide unlimited prescription drugs coverage, with normal TRICARE copays. Pharmacy copays are 20 percent in TRICARE network retail pharmacies (25 percent in non-network pharmacies) and \$8 for a 90-day supply through the National Mail-Order Pharmacy.

DOD envisions that the TRICARE supplemental coverage will have a premium of about \$500 per person per year - significantly lower than commercial supplementals or FEHBP.

The demonstration program will run from spring of 2000 to Dec. 31, 2002 (the exact date remains to be determined). Enrollees must be members or former members of the uniformed services, or their dependents - including dependents of service members who died while on active duty for more than 30 days. Enrollees must be: a) 65 years of age or older; b) entitled to hospital insurance benefits under Medicare Part A; c) enrolled in Medicare Part B; and d) reside in a demonstration program area, as defined by residence ZIP code. You can find the list of eligible ZIP codes on TROA's website at [www.troa.org/Legislative/Supplement/TestSites.asp](http://www.troa.org/Legislative/Supplement/TestSites.asp).



# Solicitation now under way for CY99 AAAA National Awards: Nominations due at the AAAA National Office on or before January 15, 2000

## "Award Presentations"

Eight AAAA National Awards for accomplishments made during calendar year 1999 will be presented at the 2000 AAAA Annual Convention in Fort Worth, Texas. Senior members of the U.S. Army will be invited to present the AAAA's top awards to the 1999 winners.

### "Outstanding Aviation Unit Award"

Sponsored by The Boeing Company, this award is presented annually by the AAAA "to the active Army aviation unit that has made an outstanding contribution to or innovation in the employment of Army aviation over and above the normal mission assigned to the unit during the awards period encompassing the previous calendar year." Any active Army aviation unit that has met the foregoing criteria is eligible for consideration.

### "USAR Aviation Unit Award"

Sponsored by AlliedSignal Aerospace, this award is presented annually by the AAAA "to the U.S. Army Reserve aviation unit that has made an outstanding contribution to or innovation in the employment of Army aviation over and above the normal mission assigned to the unit during the awards period encompassing the previous calendar year." Any U.S. Army Reserve aviation unit or organization that has met the foregoing criteria is eligible for this award.

### "Joseph P. Cribbins DAC of the Year Award"

Sponsored by The Boeing Company, this award is named for Mr. Joseph P. Cribbins, the award's first recipient in 1976. It is presented annually by AAAA "to the DAC who has made an outstanding individual contribution to Army aviation in the awards period encompassing the previous CY." A candidate for this award must be a current Department of the Army civilian.

### "Aviation Soldier of the Year Award"

Sponsored by Bell Helicopter Textron, this award is presented annually by AAAA "to the enlisted man serving in an Army aviation assignment who has made an outstanding individual contribution to Army aviation during the awards period encompassing the previous calendar year." Membership in AAAA is not a requirement. A candidate for this award must be serving in an Army aviation assignment in the active U.S. Army or the reserve components, and must have made an outstanding individual achievement.

### "James H. McClellan Aviation Safety Award"

Sponsored by GE Aircraft Engines in memory of James H. McClellan, a former Army aviator who was killed in a civil aviation accident in 1958, this award is presented annually "to an individual who has made an outstanding individual contribution to Army aviation safety in the previous calendar year." The award is NOT intended to be given for the accumulation of operational hours without accidents by any aviation unit.

### "The Robert M. Leich Award"

Sponsored by the Northrop Grumman Corporation ESSD, this award is named in memory of Brig. Gen. Robert M. Leich, USAR, the AAAA's first president (1957-59) and its Awards Committee Chairman for 23 years. It is presented annually to a unit for sustained contributions to Army aviation, to a unit or an individual for a unique, one-time outstanding performance.



### "ARNG Aviation Unit Award"

Sponsored by Allied Signal Aerospace, this award is presented annually by the AAAA "to the Army National Guard aviation unit that has made an outstanding contribution to or innovation in the employment of Army aviation over and above the normal mission assigned to the unit during the awards period encompassing the previous calendar year." Any Army National Guard aviation unit or organization that has met the foregoing criteria is eligible for consideration.

### "Army Aviator of the Year"

Sponsored by the Sikorsky Division of United Technologies Corporation, this award is presented annually through the AAAA "to the Army aviator who has made an outstanding individual contribution to Army aviation during the Awards period encompassing the previous calendar year." Membership in AAAA is not a requirement for consideration. A candidate for this award must be a rated Army aviator in the active U.S. Army or reserve components, and must have made an outstanding individual achievement.

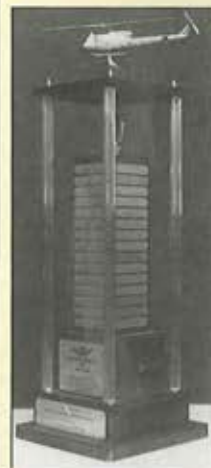

**ACCOMPANYING DATA FOR INDIVIDUAL AWARDS:** The official "Nomination Form for Submission of All AAAA National Awards" is the only form used by the Awards Committee in its selection of annual AAAA National Awards winners. Copies may be obtained from any chapter secretary or by writing to AAAA, 49 Richmondville Avenue, Westport, CT 06880-2000 or by calling the AAAA National Office, (203) 226-8184.

The forms should be accompanied by a recent photo and biographical sketch of the nominee. Photos of the commander and the senior NCO must accompany each unit nomination. The "Nomination Form for Submission of all AAAA National Awards" and the accompanying photo(s) must be received at the AAAA National Office on or before January 15. Please use stiffeners to protect the photo(s) being submitted. Awards nominations materials including photographs cannot be returned.

# AAAA NEWS

## New Chapter Officers

### Air Assault:

Capt. Sheila J. White, Secretary.

### Aviation Center:

Capt. Thomas C. Martin, V.P. Awards.

### Connecticut:

Ms. Maureen M. Fino, V.P. Programs.

### High Desert:

Lt. Col. Douglas R. Eller, President.

### Iron Mike:

Col. William M. Jacobs, Pres.;  
Lt. Col. Peter E. Curry, Sr. VP; Lt. Col.  
Pauline Knapp, Treasurer.

### Mid-America:

CWO 4 David J. McMahon, Treas.

### Morning Calm:

Maj. David M. Krall, Secretary.

### North Country:

Capt. James Nugent, Jr., Treasurer.

### Rising Sun:

Lt. Col. Michael O. Grant, Pres.;  
CWO 2 Mark A. Barrieault, Sr. V.P.;  
Maj. Jack E. Sturgeon, Secy; 1 Lt.  
Charles Lee Moore, Jr., Treas.; Capt.  
Michael R. Severson, V.P.  
Membership Enrollment;

Capt. Jennifer K. Swift, V.P. Programs;  
Spc. Jade L. Beranek, VP Enlisted  
Affairs; CWO 2 Eugene K. Okita, V.P.  
Chapter Awards.

### Savannah:

Maj. Joel E. Roberts, V.P. Awards.

## AAAA Soldiers of the Month

A Chapter Program to Recognize  
Outstanding Aviation Soldiers  
on a Monthly Basis

### PV2 Elijah L. Varga

August 1999  
(Tennessee Valley Chapter)

### SPC Lashonda Washington

September 1999  
(Tennessee Valley Chapter)

## AAAA Distinguished Instructor of the Quarter

A Chapter Program to Recognize  
Outstanding Aviation Instructors  
on a Quarterly Basis

### SSG Francisco R. Yargas

3rd Qtr. FY99  
(Colonial Virginia Chapter)

## AAAA Non-Commissioned Officer of the Quarter

A Chapter Program to Recognize  
Outstanding NCO's on a  
Quarterly Basis

### SGT Lydia M. Thompson

3rd Qtr. FY99  
(USAAVNC Chapter)

Sgt. Elizabeth A. Fisher  
1st Qtr. FY2000  
(Tennessee Valley Chapter)

## AAAA Post Soldier of the Quarter

A Chapter Program to Recognize  
Outstanding Post Soldiers  
on a Quarterly Basis

### SPC Raphael E. Lopez

3rd Quarter FY99  
(USAAVNC Chapter)

## New AAAA Life Members

1 Lt. Anthony J. Cassino  
Lt. Col. B. Shannon Davis  
Lt. Col. Richard G. Dickson, Ret.  
SSG Nathan D. Garlach  
CWO 5 Thomas P. Gadowski  
1st Lt. Heather L. Maki  
CWO 2 Allen C. Robinson  
Capt. Michael K. Snedden  
CWO 4 Michael R. Sparks, Ret.  
CSM Benjamin F. Sunde, Ret.

## In Memoriam

Lt. Col. Randall W. Cason

## New AAAA Bronze Order of St. Michael Recipients

CWO 4 Mark S. Alderson  
1SG Jesus Ruiz

1SG James M. Weber  
CWO 4 Henry J. Gregorich  
CWO 3 Melanie Keuhn  
CWO 4 Gregory A. Goodall  
Col, Ret., Bobby H. Freeman  
CWO 3 Loren S. Courtney  
CSM Sergio Villafane  
1SG Jeffery Troy  
Capt. Pete Ross  
Capt. James J. Myrick  
Maj. David A. Palmer  
Maj. Paul W. Bricker  
CWO 3 Gary A. Graham  
CSM Jackie L. Collins  
CWO 5 Bill Muller  
CWO 4 Joel K. Milbern  
Richard L. Campbell  
Lt. Col. James A. Towe  
Lt. Col. James R. Burch II  
CWO 4 Henry H. Hower, Jr.  
Lt. Col. Michael J. Strang  
CWO 5 James M. Pranger  
Lt. Col. (CH) R. Russell Walker  
Maj. David E. Laack, Ret.  
SGM Henson Bedeau  
CWO 4 Mark S. Alderson

## Aces

The following members have been  
recognized as Aces for their signing up  
five new members each.

Maj. Robert M. Cumbie  
CWO 2 Fred K. Weigel

## TOP CHAPTERS

The 1 October 1999 Membership Enrollment Competition standings have the following chapters ahead with two months left in the CY99 contest ending 31 December. The rankings are based on CY99 net membership gain.

Master Chapter (170+ Members)	Senior Chapters (80-169 Members)	AAAA Chapter (25-79 Members)
1. Tennessee Valley Chapter .....93	1. Pikes Peak Chapter .....15	1. Cedar Rapids Chapter .....25
2. Washington-Potomac Chapter ....36	2. Savannah Chapter .....13	2. America's First Coast .....20
3. Phantom Corps Chapter .....24	3. Delaware Valley Chapter .....5	3. Rhine Valley Chapter .....15

## TOP GUNS as of 1 OCTOBER 1999

The member who sponsors the greatest number of new members during the contest year ending 31 December 1999 wins an all expense-paid trip to the AAAA Annual Convention, as well as a \$300 cash award, and receives a plaque. Please note that the Top Gun program has been expanded to include prizes for 2nd place, \$400; 3rd place, \$300; 4th place, \$200; 5th place, \$100.

Mr. William J. Cannon .....471	MAJ John C. Sauer .....55	CWO 3 Roger A. Graf .....29
Mr. John H. Bae .....69	COL John J. Stanko, Jr., Ret. ....30	SGM Kenneth G. Rich .....29

☛ Nov. 30-Dec. 3. AAAA ASE and Avionics Symposium, Hilton Mesa Pavillion, Mesa, AZ.

☛ Dec. 8. The Lindbergh Chapter Christmas Party, 1130 Hours at the Echo Country Club, Normandy, MO. All AAAA members and their guests are invited. Free drinks and door prizes. Contact Paul Hendrickson, Lindbergh chapter president, 314-928-0359.

☛ Jan. 10-12. AUSA/AAAA Aviation Symposium, Fairfax, VA.

☛ Jan. 15. AAAA Morning Calm Chapter Aviation Ball, Hyatt Hotel, Seoul, Korea.

☛ Jan. 28. AAAA Scholarship Executive Committee Meeting, Arlington, VA.

☛ Jan. 28-29. AAAA Awards Selection Meeting, Arlington, VA.

☛ Jan. 31-Feb. 4. Aviation Leaders Training Conference, Fort Rucker, AL.

☛ Mar. 29-Apr. 1, 2000. The 2000 AAAA Annual Convention, Fort Worth Convention Center, Fort Worth, Texas.



# ARMYAVIATION Book Store

## U.S. Army Aircraft Since 1947

An Illustrated Reference  
by Stephen Harding

This is the only comprehensive guide to the 124 types of helicopters, fixed-wing aircraft and experimental flying machines used by the U.S. Army since 1947. The author includes information on aircraft serials, markings, weapon systems, operational history and other technical data. Illustrated with more than 220 color and black and white photographs. [Schiffer Publishing Ltd. Size: 8 1/2" x 11", 264 pages, hard cover, ISBN: 9-7643-0190-X].



## Breaking the Phalanx

by Douglas A. Macgregor

This work proposes the reorganization of America's ground forces on the strategic, operational and tactical levels. The analysis argues that a new Army warfighting organization will not only be more deployable and effective in joint operations; reorganized information-age ground forces will be significantly less expensive to operate, maintain and modernize than the Army's current Cold War division-based organizations. [Praeger Publishers, Size: 6" x 9 1/8", paperback, 283 pages, ISBN: 0-275-957942].



## We Were Soldiers Once ... And Young

by Harold G. Moore & Joseph L. Galloway

We Were Soldiers Once ... and Young presents a picture of men facing the ultimate challenge, dealing with it in ways they would have found unimaginable only a few hours earlier. It reveals man's most heroic and horrendous endeavor. [Harper Collins Publishers, Size: 5 1/2" x 8", 483 pages, paperback, ISBN: 0-06097576-8].

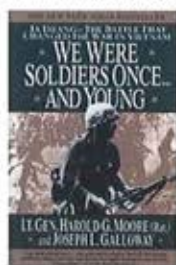

## Army Aviation in Vietnam 1961-1963

An Illustrated History of Unit Insignia, Aircraft Camouflage & Markings

by Ralph B. Young

Army aviation came of age in Vietnam and experienced an incredible proliferation of unit insignia and markings on both its fixed- and rotary-wing aircraft. This comprehensive volume surveys the vast array of camouflage schemes and official and unofficial markings - including patches, mottoes and call signs - that graced Army aircraft during the early years of American involvement in Southeast Asia. Well written and lavishly illustrated, Army Aviation in Vietnam, 1961-1963 is a must-have work for any serious student of Army aviation history. [The Huey Company, Inc., Size: 8 1/2" x 11", 124 pages, hard cover and paperback, ISBN: 0-9671980-0-3].

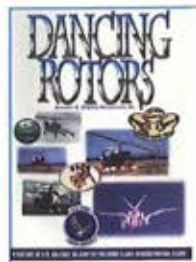
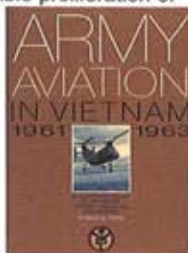

## Dancing Rotors

by Harry E. (Ned) Gilliland, Jr.

Dancing Rotors documents the evolution of U.S. military helicopter precision flight demonstration teams from 1948 through 1976. A wealth of very unique helicopter history, heretofore untold, is now within the reach of every helo enthusiast. [Aerofax, Inc., size: 8 1/2" x 11", 483 pages, paperback, ISBN: 0942548-57-4].

## Black Hawk Down

by Mark Bowden

Black Hawk Down is the gripping story of the October 1993 battle in Mogadishu, Somalia. Bowden captures the harrowing ordeal through the eyes and words of the young men who fought the battle, a battle that ultimately led to the posthumous awarding of two Medals of Honor. [Atlantic Monthly Press, hardcover, ISBN: 0-87113-738-0]

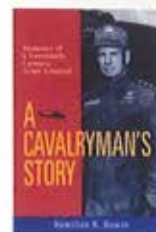

## A Cavalryman's Story

Memoirs of a Twentieth Century Army  
General Hamilton H. Howze

A Cavalryman's Story is the memoir of a professional soldier recognized today as the father of U.S. Army Airmobile tactics and doctrine. As the first director of Army aviation, Howze promoted the concept to industry, the government, and the public. His vision came to fruition in the 1960s when he presided over the U.S. Army Tactical Mobility Requirements Board, known as the Howze Board, which proved the viability of sky cavalry in combat. [Smithsonian Institution Press, Size: 6"x9", 316 pages, hard cover, ISBN: 1-56098-664-6].

## Year of the Snake

One Helicopter Pilot's Story of a Year in  
Vietnam's Mekong Delta, Vinh Long 1965-1966

By W. Bailey Jones

Based on the author's journal entries, Year of the Snake presents a gripping account of the daily activities of one of the first armed helicopter units to serve in Vietnam. Valuable for its insights on the war, its depictions of early gunship operations and its thoughtful analysis of armed helicopter tactics and techniques, Year of the Snake is both an important historical resource and an entertaining memoir. [Shade Tree Publishers, size: 8.5" X 11", paperback, ISBN: 0-967073-1-6.]

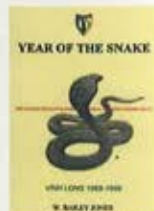

## Year of the Horse: Vietnam

1st Cavalry in the Highland 1965-1967

by Col. Kenneth D. Mertel (USA, Ret.)

Year of the Horse: Vietnam is the day-to-day story of the 1st Battalion, Airborne, 8th Cavalry Division. Mertel pays tribute to the many acts of heroism of his men, who lived, worked and fought together in some of the world's most inhospitable conditions. [Schiffer Publishing Ltd., Size: 6"x9", 384 pages, hard cover, 59 color photographs, 9 maps; ISBN: 0-7643-0190-X].



## ORDER YOUR BOOKS TODAY!

Name: \_\_\_\_\_

Address: \_\_\_\_\_

City, State, Zip: \_\_\_\_\_

Tele: \_\_\_\_\_ Fax: \_\_\_\_\_

I prefer to pay by:

Check \_\_\_\_\_ MasterCard \_\_\_\_\_ Visa \_\_\_\_\_

Credit Card # \_\_\_\_\_ Exp. \_\_\_\_\_

Signature: \_\_\_\_\_

Black Hawk Down - Bowden # \_\_\_\_\_ \$34.00\* \$ \_\_\_\_\_

U.S. Army Aircraft - Harding # \_\_\_\_\_ \$50.00\* \$ \_\_\_\_\_

Army Aviation in Vietnam 1961-1963

Hardcover # \_\_\_\_\_ \$45.00 \$ \_\_\_\_\_

Paperback # \_\_\_\_\_ \$29.95 \$ \_\_\_\_\_

Year of the Horse: Vietnam - Mertel # \_\_\_\_\_ \$40.00\* \$ \_\_\_\_\_

A Cavalryman's Story - Howze # \_\_\_\_\_ \$32.95\* \$ \_\_\_\_\_

Breaking The Phalanx - Macgregor # \_\_\_\_\_ \$29.95\* \$ \_\_\_\_\_

Dancing Rotors - Gilliland # \_\_\_\_\_ \$29.95\* \$ \_\_\_\_\_

We Were Soldiers Once ... And Young - Moore/Galloway # \_\_\_\_\_ \$21.00\* \$ \_\_\_\_\_

Year of the Snake - Jones # \_\_\_\_\_ \$30.00\* \$ \_\_\_\_\_

\*(prices include shipping/handling fee) TOTAL \$ \_\_\_\_\_

Place your order now to receive your free copy of  
"Army Aviation Cub to Comanche"

Please return this form, with payment to:

Army Aviation Publications, Inc.

49 Richmondville Avenue, Westport, CT 06880-2000

Tele: (203) 226-8184 FAX: (203) 222-9863

Allow 6-8 Weeks For Shipment

\*Add 6% Sales Tax If Shipping to Connecticut



*BOEING*



FOR SOME, THIS IS NOT A PRETTY PICTURE.



Together, the RAH-66 Comanche and the AH-64D Apache Longbow can help the U.S. Army dominate the battlefields of the 21st century. The Comanche's advanced technology provides critical reconnaissance, and the Apache's precision weapons system supplies overwhelming firepower. The complementary capabilities of the Comanche and Apache give our battlefield commanders what they need to overcome hostile forces while protecting our own.