

2022–2023 Global Product Catalog

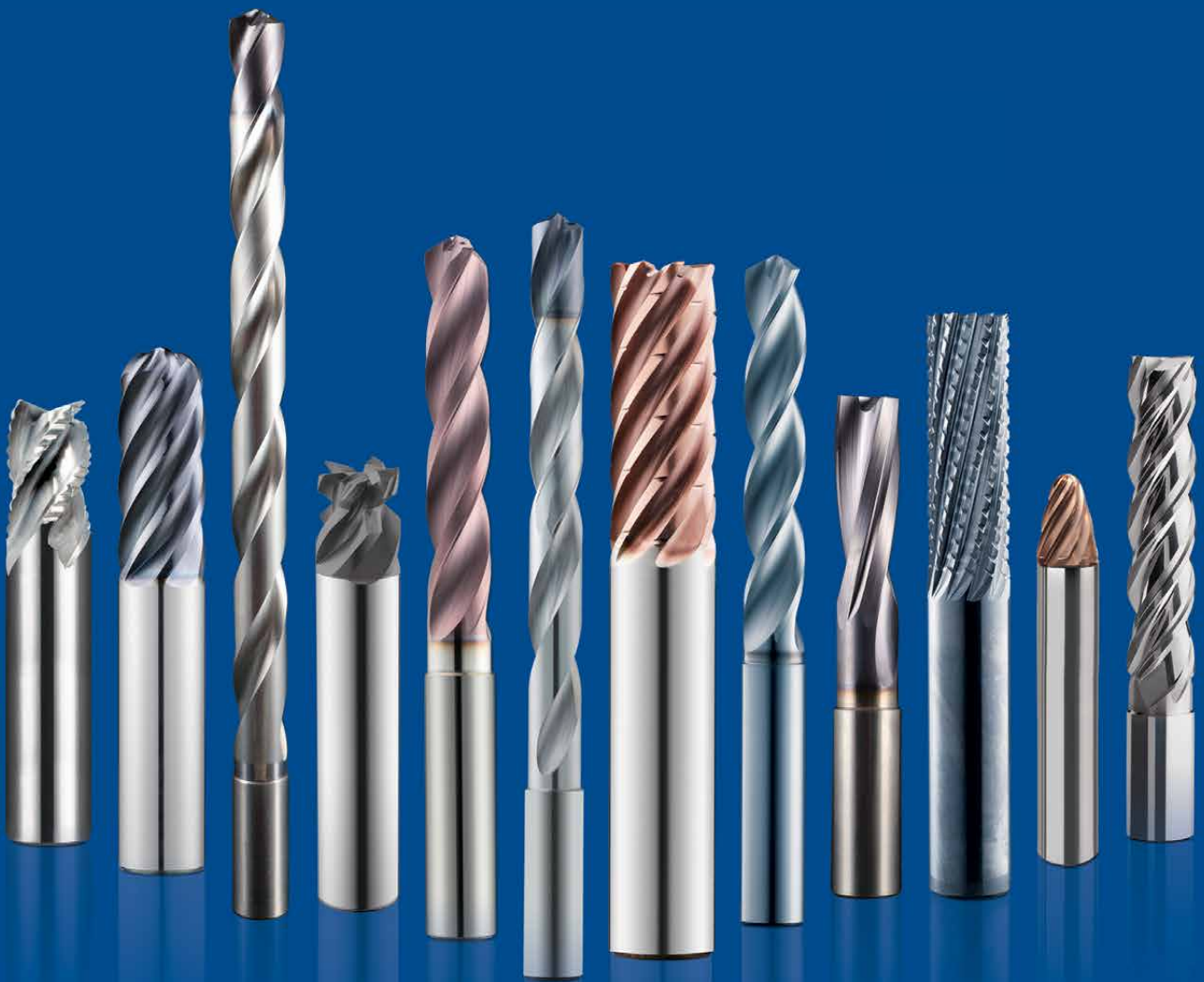



VALUE AT THE SPINDLE®

KYOCERA SGS Precision Tools (KSPT) is an ISO 9001:2015 Certified manufacturer of industry leading round solid carbide cutting tools. State of the art manufacturing and warehouse facilities have the capacity and processes to meet the quality and delivery demands of customers in all markets around the world. Complete inspections performed within its metallurgical lab and manufacturing quality departments ensure the use of high quality carbide and reliable manufacturing consistency regardless of when a cutting tool is produced.

KSPT is proud to have pioneered some of the world's most advanced cutting technologies due to rigorous testing of tools, coatings, and materials within its Global Innovation Center. It is this commitment to innovation that has launched patented products and technologies like the Z-Carb with its variable geometry and cutting edge preparation, Series 43 APR® and APF® ultra high performance aluminum cutting tools, and the JetStream coolant technology.

SGS has become an important part of the KYOCERA Precision Tools family, and while the name has changed, one thing has not. Its dedicated people and their relentless commitment to the customer. KSPT Technical Sales Engineers, Application Specialists, and Distribution Partners blanket the globe, delivering reliable service and support to all market segments. It is these people and products that drive innovative application strategies and cutting tool technologies into the end user, continually exceeding expectations and providing the most Value at the Spindle®.



Table of Contents

KYOCERA SGS Precision Tools	2	HOLE MAKING	
KYOCERA SGS Precision Tools Europe Ltd. . .	4	High Performance Drills	178
Global Innovation Center	5	Drill Matrix	182
Tooling Services	6	General Application Drills	332
Tech Hub	7	General Application Countersinks	358
Medical Division	8	General Application Reamers	374
Tool Wizard®	9		
		ROUTING	
OVERVIEW		High Performance Routers	386
Common Legend	10	General Application Routers	396
End Mill Legend	12		
Drill Legend	13	TECHNICAL INFORMATION	
Router Legend	14	EDP Index	400
		KSPT Reference Information	421
COATINGS	15	Decimal Equivalent Chart	422
		Hardness Conversion Chart	423
MILLING			
High Performance End Mills	16		
End Mill Matrix	22		
High Performance Aluminum End Mills . . .	128		
General Application End Mills	272		





MORE THAN JUST ANOTHER CUTTING TOOL SUPPLIER

KYOCERA SGS PRECISION TOOLS EUROPE, LTD.

The state of the art KYOCERA SGS Precision Tools Europe facility is located in Wokingham, England and is focused on the manufacture of special cutting tools, high accuracy form tools, tool modifications and regrinds. A highly skilled team of professionals specialize in the supply and support of high performance tools for the Aerospace, Medical, Power Generation and Motorsport markets.



KYOCERA SGS Precision Tools Europe also offers a full range of end mill and drill products as follows:

- Multi-Million Euro Warehouse Stocking Full Range of Catalog Products
- Same Day Shipment on Stock Items
- Multi-Lingual Sales and Technical Support
- Online Portal for Stock Availability
- High Performance Product and Application Training, Including the New KYOCERA SGS Tool Clinic

Additional services provided at this facility include:

- A Fast Track for Special Tools Via Our Rapid Response Centre
- Product Research and Development
- Product Engineering and Tool Application Support
- CAD/CAM Software Support

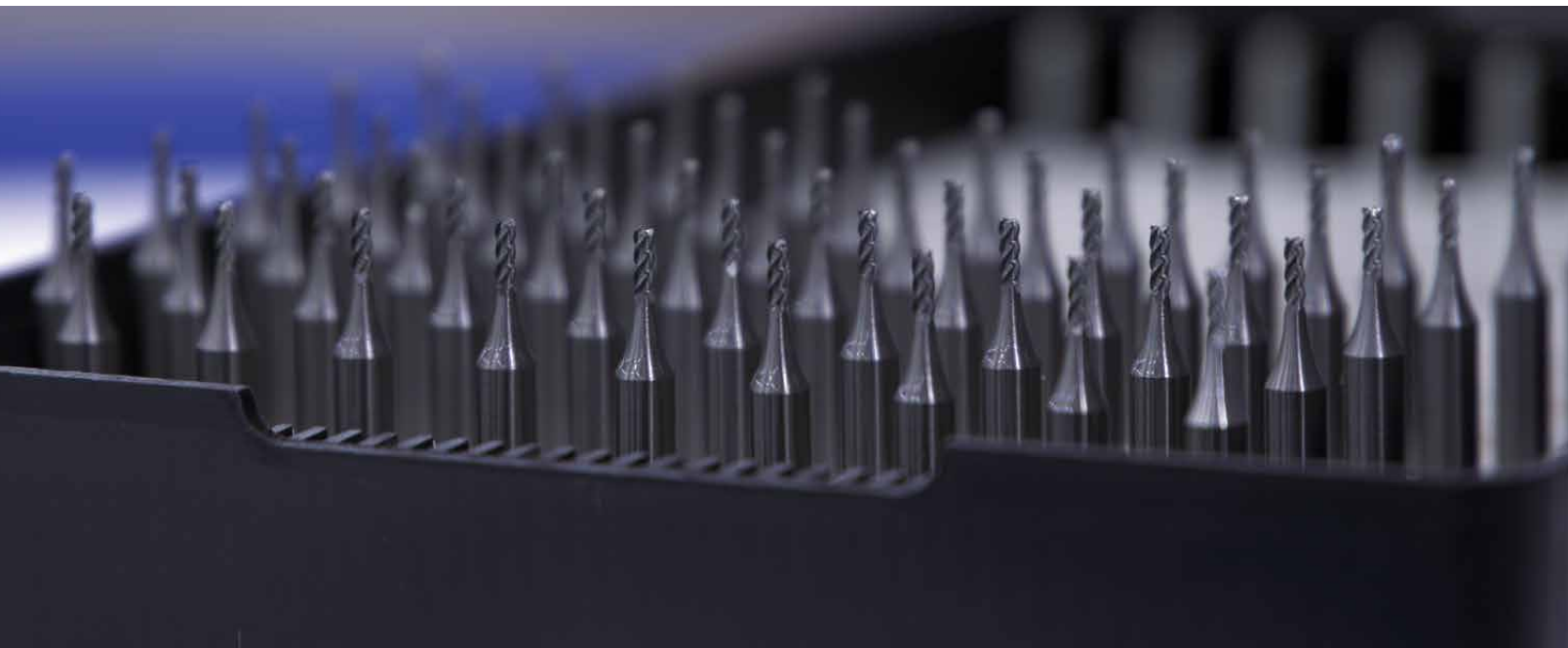



GLOBAL INNOVATION CENTER

CUTTING TOOL INNOVATION

One of the main goals of the KSPT Global Innovation Center is to bring value to the customer's spindle; one of the ways this is achieved is by producing innovative cutting tool geometries. Using the most advanced technology and techniques available in today's market, KSPT is dedicated to developing new products that will take the industry to the next level.

- State of the art cutting tool measuring and monitoring technology
- Continuous market research and training to stay up to date
- Unique and complex tool designs

TECHNICAL TRAINING & EDUCATION

The KSPT Global Innovation Center sets out to involve our trainees in engaging and challenging training regardless of where they are at in their career with a balance of demonstrations, presentations, and hands-on challenges.

- Our own KSPT team members go through the same core training we provide to our valued distribution partners
- Two levels of KSPT Campus tool clinics available
- On-site and online customer training

APPLICATION SUPPORT AND TESTING

At the KSPT Global Innovation Center, we understand that every application comes with its own challenges and at the end of the day, the customer wants to minimize the cost. This is where our R&D lab, engineers, and range of machining elements come into play. We can closely replicate the customer's application and provide feedback on how we suggest approaching it, all without the need to halt production in their own shop.

- A wide range of tool holding, fixturing, material, coolants/delivery methods, and machines
- Technical support and troubleshooting by phone, email, or web call
- Research and development



TOOLING SERVICES

KSPT is committed to providing superior tooling services in the areas of Reconditioning, Recoating, Regrinding, Specials and Alterations. These services are offered to provide unique solutions and enhanced tool life with involvement from the KSPT Technical Support Team.

KSPT proudly offers Tooling Services in North America and Europe.



KSPT TOOLING SERVICES FACILITIES

UNITED STATES OF AMERICA KSPT

150 Marc Drive
Cuyahoga Falls, Ohio 44223 U.S.A.
customer service -
US and Canada: (330) 686-5700
fax - US & Canada: (800) 447-4017
international fax: (330) 686-2146

KYOCERA SGS Precision Tools West Coast Service Center

1832 W. Collins Ave.
Orange, California 92867
phone: (714) 363-3701
fax: (714) 363-3711
email: sgswest@kyocera-sgstool.com

EUROPE KSPTE

10 Ashville Way
Wokingham, Berkshire
RG41 2PL England
phone: (44) 1189-795-200
fax: (44) 1189-795-295
e-mail: SalesEU@kyocera-sgstool.com

KYOCERA SGS Precision Tools Tech Hub

149 Slayton Avenue
Danville, Virginia 24540
US and Canada: (434) 791-2020
Fax US & Canada: (434) 791-2044
web: www.kyocera-sgstool.com/tech-hub



BEFORE

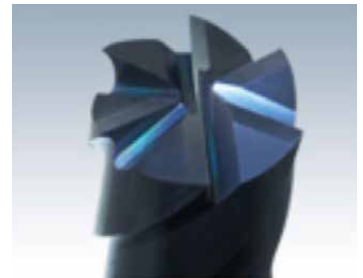

AFTER

KYOCERA SGS Tech Hub

The KYOCERA SGS Tech Hub (KSTH) is a division of KYOCERA SGS Precision Tools Inc. created to focus on custom high-performance cutting tool solutions. The state-of-the-art custom facility is designed with the purpose and resources to provide MORE than a cutting tool. KSTH provides a complete scope of services and works with customers to tailor solutions from conception to application and beyond.

CUSTOM CUTTING TOOL SOLUTIONS

KSTH considers each opportunity as a priority project and understands the challenges special tailored tooling present to our end users. Our sole focus is supporting a culture required for applying custom solutions yielding a return on investment with our technical expertise, resources, and structure. Besides KSTH providing quotation requests typically within a 24-hour period, we also offer:

- Competitive Deliveries
- Improved Value Proposition
- Global Resources and Technology
- Full Project Proposal and Management
- Approval Drawings
- Solid Models
- Process Plans
- Cutting Strategies and Simulations
- Quality Assurance Documentation (ISO 9001:2015 Certified)
- Strategic Industry Partnerships for Complete Solution Proposals
- Onsite Application and Optimization Support
- Cradle to Grave Product Support
- Constant Access to KSTH Staff

The Tech Hub division was created with the vision of providing a specialized facility, staff, resources, and culture around developing and providing custom tailored solution to customers on an application by application basis. Each solution designed and optimized for an application not a market, not a material, and not a part, but specific to the unique demands of each application. Making the extraordinary, ordinary at the Tech Hub!

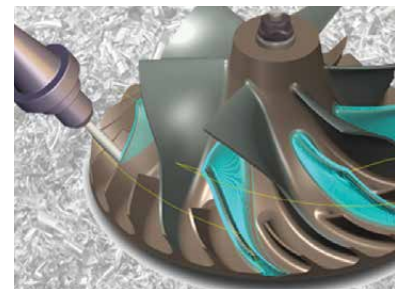
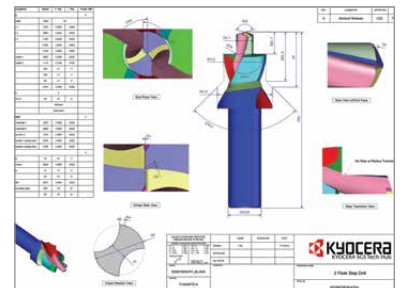

KYOCERA SGS Tech Hub

149 Slayton Avenue
Danville, Virginia 24540
US and Canada: (434) 791-2020
Fax US & Canada: (434) 791-2044
web: www.kyocera-techhub.com





KYOCERA SGS Precision Tools Medical Division

WHO WE ARE

With over 20 years of industry experience, KSPT Medical produces unique, customer designed orthopedic devices using highly trained engineers dedicated to new technology. KSPT Medical is a division of KYOCERA SGS Precision Tools, who proudly pioneered some of the world's most advanced metal cutting technology and sells to more than 60 countries. With over 20 years of industry experience, KSPT Medical Division is ISO 13485:2016 Certified and is FDA Registered in the production of medical devices in the orthopedic marketplace.

ENGINEERING

We approach each opportunity as a project and manage it as such. We pride ourselves on engineering each project to the specific needs of our customers. Providing quotes often within 24 hours and following through with detailed drawings, solid models, process plans, and program simulations if needed. Our goal is to work hand in hand with the end user and maintain constant communication to customize our support to their needs.

MACHINING CAPABILITIES

- GRINDING
- MILLING
- TURNING
- PROFILING
- BENDING
- Services Offered; Welding, Various Coatings, Anodizing, Passivation, Electropolishing, Laser Etching and HeatTreating



KYOCERA SGS Precision Tools Medical Division

201 S. Towerview Dr.
Columbia City, Indiana 46725
phone: (260) 244-7677
fax: (260) 244-7466
www.ksptmedical.com

To Request a Quote:
rfq@kyocera-sgstool.com

Customer Service and Orders:
salesmd@kyocera-sgstool.com



REGISTERED ISO 13485:2016 Certified



VALUE AT THE SPINDLE[®]

An interactive and dynamic platform to help select the correct SGS tool for the operation and provide optimal machining parameters.

- A quick and reliable 3 step process:
 1. Choose the material
 2. Enter the application
 3. From the list of recommended results, choose the tool that best fits your machining needs
- Speed & Feed rates will be generated based on application parameters combined with the selected tool's capabilities in the desired material.

TO SIGN UP FOR THE TOOLWIZARD[®]:

1. Visit Toolwizard.kyocera-sgstool.com
2. Register for an account
3. Start calculating
4. Start saving!



 **Common Legend**
 **Leyenda habitual**
 **Légende commune**
 **Gemeinsame Legende**

TO ORDER: Please specify quantity and EDP number.

PARA SU PEDIDO: Por favor especifique cantidad y número de EDP.

POUR COMMANDER: Veuillez préciser la quantité et le code article EDP.

BESTELLEN: Bitte Menge und EDV-Nummer angeben.

RETURN POLICY: An RMA number must accompany all product returns.
Contact your Customer Service Representative for an RMA number.

DEVOLUCIONES: Todo material devuelto debe ir acompañado de un número de RMA correspondiente.
Para solicitarlo, póngase en contacto con su Representante de Atención al Cliente.

POLITIQUE DE RETOUR: Tous les produits retournés doivent être accompagnés d'un numéro RMA.
Contacter votre interlocuteur commercial pour obtenir un numéro RMA.

RÜCKNAHMEGARANTIE: Eine RMA-Nummer (Rücksendegenehmigung) muss bei allen Produktrücksendungen beiliegen.
Wenden Sie sich bitte an Ihren Kundendienstmitarbeiter für RMA-Nummer.

REGULATION SAFETY GLASSES SHOULD ALWAYS BE WORN WHEN USING HIGH-SPEED CUTTING EQUIPMENT

DEBEN USARSE GAFAS PROTECTORAS CUANDO SE UTILICEN EQUIPOS DE ALTA VELOCIDAD

DES LUNETTES DE SÉCURITE DOIVENT ÊTRE IMPÉRATIVEMENT PORTÉES LORS D'UTILISATION D'OUTILS À GRANDE VITESSE

BEI SCHNELL LAUFENDEN SPANABHEBENDEN MASCHINEN MÜSSEN IMMER DIE VORGESCHRIEBENEN SICHERHEITSBRILLEN GETRAGEN WERDEN



WARNING: This product can expose you to chemicals including Cobalt, which is known to the State of California to cause cancer. For more information go to www.p65warnings.ca.gov



ADVERTENCIA: Este producto puede exponerlo a químicos como el Cobalto, reconocido como cancerígeno en el estado de California. Para más información visite esta página web: www.p65warnings.ca.gov



ATTENTION: Ce produit vous expose aux produits chimiques incluant le Cobalt, qui est reconnu par l'Etat de Californie à être une cause de cancer. Pour plus d'information veuillez regarder sur: www.p65warnings.ca.gov



WARNUNG: Dieses Produkt kann Sie mit Chemikalien wie Kobalt aussetzen, das dem Staat Kalifornien als krebserregend bekannt ist. Für weitere Informationen, besuchen Sie: www.p65warnings.ca.gov

**INTELLECTUAL PROPERTY
PROPIEDAD INTELECTUAL
PROPRIÉTÉ INTELLECTUELLE
GEISTIGES EIGENTUM**

KYOCERA SGS Precision Tools holds more than 20 patents globally. Please visit our website at www.kyocera-sgstool.com to learn more.

KYOCERA SGS Precision Tools posee más de 20 patentes a nivel mundial. Para más información, visite nuestra página web www.kyocera-sgstool.com.

KYOCERA SGS Precision Tools possède plus de 20 brevets mondialement reconnus. Pour plus d'information, veuillez consulter notre site web www.kyocera-sgstool.com.

KYOCERA SGS Precision Tools besitzt mehr als 20 Patente weltweit. Bitte besuchen Sie unsere Webseite www.kyocera-sgstool.com für weitere Informationen.

Common Legend

Leyenda habitual

Légende commune

Gemeinsame Legende

MATERIALS MATERIALES MATÉRIAUX WERKSTOFFE



Steels (P)
Aceros
Aciers
Stähle



Stainless Steels (M)
Aceros Inoxidables
Aciers inoxydables
Nichtrostende Stähle



Cast Iron (K)
Acero de Fundición
Fonte
Grauguss



Non-Ferrous (N)
No Férricos
Non Ferreux
Nichteisenmetalle



High Temp Alloys (S)
Aleaciones Termorresistentes
Alliages hautes températures
Warmfeste Legierungen



Hardened Steels (H)
Aceros Endurecidos
Aciers Trempés
Gehärteter Stahl

TOOL LENGTH LONGITUDES DE HERRAMIENTAS LONGUEUR DE L'OUTIL WERKZEUGLÄNGE



Stub
Corta
Court
Kurze Bauform



Regular
Media
Moyen
Standard



Long
Larga
Long
Lang



Long Reach Neck
Larga con cuello
Détalonnage longue
portée
Freischliff



Extra Long
Extra-larga
Extra-long
Extra-Long

FLUTES FILOS DENTS SCHNEIDEN



2 Flutes
2 Filos
2 Dents
2 Schneiden



3 Flutes
3 Filos
3 Dents
3 Schneiden



4 Flutes
4 Filos
4 Dents
4 Schneiden



5 Flutes
5 Filos
5 Dents
5 Schneiden



6 Flutes
6 Filos
6 Dents
6 Schneiden



7 Flutes
7 Filos
7 Dents
7 Schneiden



8 Flutes
8 Filos
8 Dents
8 Schneiden



9 Flutes
9 Filos
9 Dents
9 Schneiden



10 Flutes
10 Filos
10 Dents
10 Schneiden



11 Flutes
11 Filos
11 Dents
11 Schneiden



12 Flutes
12 Filos
12 Dents
12 Schneiden

End Mill Legend Leyenda fresas Légende fraise Fräser-Legende

END CONFIGURATIONS CONFIGURACIONES DE LA PUNTA FORME DE L'OUTIL EN BOUT ENDENAUSFÜHRUNG



Ball
Esférica
Boule
Kugelkopf



Corner
Plana con
borde romo
Rayon
mit Eckenradius



Square
Plana
Non rayonné
Scharfkantig



Linear taper
Perfil Cónico
Conique Droit
Linear Kege



Tapered Circle
Segment
Perfil Cónico de
Segmento Circular
Conique Segment
de Cercle
Tonnen Segment



Picatinny Recoil
Groove
Fresa Riel Picatinny
Rainure Décalée
Picatinny
Picatinny Rückstoss
Nut



Picatinny Dovetail
Form
Fresa de Forma
Picatinny Cola de
Milano
Queue d'aronde
Picatinny
Picatinny Schwal-
benschwanz Form

SHANK TYPE TIPO DE VÁSTAGO TYPE DE QUEUE SCHAFTART



Common
Normal
Dégagée
Standard



Straight
Recto
Cylindrique
Gerade



WELDON
Drive Flat
Plano en el zanco
Entrainement
méplat
Spannfläche



DIN6535 HB
Drive Flat
DIN 6535 HB
Plano en el zanco
DIN 6535 HB
Entrainement
méplat DIN 6535 HB
Spannfläche
DIN 6535 HB



Right Spiral
Hélice con corte
a la derecha
Hélice droite
Rechtsspirale



Left Spiral
Hélice con corte
a la izquierda
Hélice gauche
Linksspirale



Variable Right Spiral
Hélice con corte a
la derecha y ángulo
variable
Hélice droite variable
Rechtsspirale,
variabel

COOLANT OPTIONS OPCIONES DE REFRIGERACIÓN OPTIONS DE REFRROIDISSEMENT KÜHLSCHMIERMITTEL-OPTIONEN



Internal Coolant
Refrigeración interna
Refrroidissement
interne
Innenkühlung



JetStream Coolant
Slots
Ranuras de refrigeración
JetStream
Fentes de refroidissement
JetStream
JetStream-
Kühlmittelschlitze



Positive
Positivo
Positif
Positiv



Neutral
Neutro
Neutre
Neutral



Negative
Negativo
Négatif
Negativ



Variable
Variable
Variable
Variabel



Flute Spacing
Unequal
Espaciado
desigual de los
filos
Denture décalée
Nutenabstand
Ungleich



Chip Breaker
Rompevirutas
Brise-copeaux
Spanteiler

RAKE ANGLE ANGULO DE DESPRENDIMIENTO ANGLE DE COUPE SPANWINKEL

ADDITIONAL GEOMETRY GEOMETRÍAS ADICIONALES GÉOMÉTRIE SUPPLÉMENTAIRE WEITERE BAUFORMEN

All tools are in Right Cut Direction unless noted
Todas las herramientas son con corte a la derecha a menos que se indique lo contrario
Tous les outils ont une coupe à droite, sauf indications contraires
Alle Werkzeuge sind rechtsschneidend, soweit nicht anders angegeben

All tools are straight or non-tapered unless noted
Todas las herramientas son rectas o no cónicas a menos que se indique lo contrario
Tous les outils sont droits ou non coniques, sauf indication contraire
Alle Werkzeuge sind gerade oder nicht konisch, sofern nicht anders angegeben

Drill Legend

Leyenda brocas

Légende perçage

Bohrer-Legende

SHANK TYPE TIPO DE VÁSTAGO TYPE DE TIGE SCHAFTART



Common
Normal
Dégagée
Standard



Straight
Recto
Cylindrique
Gerade

REACH ALCANCE LONGUEUR NUTZLÄNGE

3xD

3xD Reach
Alcance 3xD
Longueur 3xD
3xD Nutzlänge

5xD

5xD Reach
Alcance 5xD
Longueur 5xD
5xD Nutzlänge

8xD

8xD Reach
Alcance 8xD
Longueur 8xD
8xD Nutzlänge

12xD

12xD Reach
Alcance 12xD
Longueur 12xD
12xD Nutzlänge

HELIX ANGLES ANGULOS DE LAS HELICES ANGLES DE L'HÉLICE SPANWINKEL



Right Spiral
Hélice con corte
a la derecha
Hélice à droite
Rechtsspirale



None
Ninguno
Aucun
gerade genutet



Internal Coolant
Refrigeración interna
Refroidissement interne
Innenkühlung



External Coolant
Refrigeración externa
Refroidissement externe
Auskühlung

POINT ANGLE ÁNGULO DE PUNTA POINT D'ANGLE SPITZENWINKEL



Drill Point
Angulo de la Punta
Point de perçage
Bohrspitze



Point Angle
Ángulo de punta
Angle de pointe
Spitzenwinkel



Chamfer Angle
Ángulo de chafilán
Angle de chanfrein
Fasenwinkel

NUMBER OF MARGINS NÚMERO DE MÁRGENES NOMBRE DE MARGES ANZAHL DER RÄNDER



2 Margins
2 Márgenes
2 Marges
2 Ränder



3 Margins
3 Márgenes
3 Marges
3 Ränder



4 Margins
4 Márgenes
4 Marges
4 Ränder

NUMBER OF FLUTES FILOS DENTS SCHNEIDEN



1 Flute
1 Filo
1 Dent
1 Schneiden



2 Flutes
2 Filos
2 Dents
2 Schneiden



3 Flutes
3 Filos
3 Dents
3 Schneiden

Router Legend Leyenda ranuradores Légende détourage Konturenfräser-Legende

SHANK TYPE TIPO DE VÁSTAGO TYPE DE TIGE SCHAFTART



Straight
Recto
Cylindrique
Gerade

RAKE ANGLE ANGULO DE DESPRENDIMIENTO ANGLE DE PENTE SPANWINKEL



Positive
Positivo
Positif
Positiv



Neutral
Neutro
Neutre
Neutral



Negative
Negativo
Négatif
Negativ



Variable
Variable
Variable
Variabel

HELIX ANGLES ANGULOS DE LAS HELICES ANGLES DE L'HÉLICE SPANWINKEL



Right Spiral
Hélice con corte
a la derecha
Hélice à droite
Rechtsspirale



Left Spiral
Hélice con corte
a la izquierda
Hélice à gauche
Linksspirale

ADDITIONAL GEOMETRY GEOMETRÍAS ADICIONALES GÉOMÉTRIE SUPPLÉMENTAIRE WEITERE BAUFORMEN



Left Hand Cut Direction
Fresado sentido izquierda
Coupe vers la gauche
Rechtsschneidend











Right Hand Cut Direction
Fresado sentido derecha
Coupe vers la droite
Linksschneidend



Chip Breaker
Rompevirutas
Brise-copeaux
Spanbrecher

Ti-NAMITE® and Di-NAMITE® Tool Coatings are specifically engineered for KSPT solid carbide rotary tools. The coating lineup includes proprietary processes that result in optimized tool life and increased speed and feed rates in a variety of applications.



	Coating	Identifying Color	Layer Structure	Thickness	Hardness (HV)	Coefficient of Friction (Fretting)	Thermal Stability	General Information
	Titanium Nitride (TiN)	gold	Multilayer	1–5 microns	2200	0.40–0.65	600°C / 1112°F	A general purpose coating with good adhesion and abrasion resistant properties. Suitable for a wide variety of materials.
	Aluminum Titanium Nitride (AlTiN)	dark grey	Nano structure	1–5 microns	3700	0.30	1100°C / 2010°F	Excellent thermal and chemical resistance allows for dry cutting and improvements in performance of carbide. The coating has a high hardness giving great protection against abrasive wear and erosion.
	Titanium DiBoride (TiB ₂)	light grey-silver	Monolayer	1–2 microns	4000	0.10–0.20	850°C / 1562°F	This ceramic based coating ensures a smooth surface and a low affinity to cold welding or edge build up, which makes it optimal for aluminum and copper applications. It has high toughness and high hardness.
	Titanium Carbonitride (TiCN)	pink-red	Multilayer	1–5 microns	3000	0.30–0.45	400°C / 752°F	A very wear resistant coating with high toughness and shock resistance. Good in interrupted cuts found in applications like milling.
	Proprietary (TX)	black	Nano Composite	1–5 microns	3600	0.45	1150°C / 2100°F	The structural design of Ti-Namite-X is adapted to meet a diverse range of applications; everything from high- and low-alloy steels to hardened materials (up to 65 HRC core hardness). Ti-Namite-X is suitable for operations which require high cutting speeds, high temperatures at the cutting edge, and high metal removal rates.
	Crystalline Diamond (Diamond)	black	Monolayer	6–20 microns	>8000	0.15–0.20	800°C / 1470°F	This is the hardest coating available with the best abrasion resistance. It is carbon based so it is limited in application capabilities. This coating is suitable for machining highly abrasive, non-ferrous materials such as CFRP and graphite.
	Proprietary (TM)	copper	Nano Composite	1–5 microns	3600	0.45	1150°C / 2100°F	Features include high wear resistance, reduced friction, and excellent prevention of edge build up. This coating provides superior material removal rates and tool life when used in high performance operations with difficult to machine materials like titanium.
	Proprietary (TH)	copper	Nano Composite	1–5 microns	3800	0.30	1100°C / 2010°F	This coating demonstrates a superior combination of hardness and adhesion in hard machining of molds and dies and machining high-alloy stainless steels for high temperature applications such as turbines. The smooth surface ensures optimum surface quality and decreases the temperature in the cutting zone by reducing friction.

Other coatings available upon request.

High Performance End Mills



Milling

HIGH PERFORMANCE END MILLS	SERIES	DESCRIPTION	PAGE	S&F PAGE
Z-Carb-HPR	Z5	5 Flute Rougher Square End Fractional	30	35
	Z5CR	5 Flute Rougher Corner Radius Fractional	30	35
	Z5MCR	5 Flute Rougher Corner Radius Metric	37	39
Z-Carb-AP	Z1PCR	4 Flute Variable Rake Corner Radius Fractional	41	46
	Z1PLC	4 Flute Variable Rake Long Reach Corner Radius Fractional	44	46
	Z1PLB	4 Flute Variable Rake Ball End Long Reach Fractional	45	46
	Z1MPCR	4 Flute Variable Rake Corner Radius Metric	48	51
	Z1MPIC	4 Flute Variable Rake Intermediate Reach Corner Radius Metric	50	51
	Z1MPLC	4 Flute Variable Rake Long Reach Corner Radius Metric	50	51
	Z-Carb	Z1	4 Flute Variable Geometry Square End Fractional	41
Z16CR		4 Flute Variable Geometry Corner Radius Fractional	41	46
Z1B		4 Flute Variable Geometry Ball End Fractional	53	54
Z1M		4 Flute Variable Geometry Square End Metric	48	51
Z1MB		4 Flute Variable Geometry Ball End Metric	56	57
Z-Carb-HTA	ZH1CR	4 Flute Variable Geometry High Temp Alloys Corner Radius Fractional	59	60
	ZH1MCR	4 Flute Variable Geometry High Temp Alloys Corner Radius Metric	61	62
	ZH1MCRS	4 Flute Variable Geometry High Temp Alloys Stub Corner Radius Metric	61	62
Z-Carb-MD	ZD1CR	4 Flute Variable Geometry Hard Materials Long Reach Corner Radius Fractional	63	64
	ZD1MCR	4 Flute Variable Geometry Hard Materials Long Reach Corner Radius Metric	63	64
V-Carb	55	5 Flute Finisher & Semi-Finisher Square End Fractional	65	68
	55CR	5 Flute Finisher & Semi-Finisher Corner Radius Fractional	65	68
	55M	5 Flute Finisher & Semi-Finisher Square End Metric	70	74
	55MCR	5 Flute Finisher & Semi-Finisher Corner Radius Metric	70	74
	55B	5 Flute Finisher & Semi-Finisher Ball End Fractional	67	68
	55MB	5 Flute Finisher & Semi-Finisher Ball End Metric	73	74
T-Carb®	51	6 Flute High Speed Machining Square End Fractional	76	79
	51CR	6 Flute High Speed Machining Corner Radius Fractional	76	79
	51L	6 Flute High Speed Machining Square End Long Reach Fractional	77	79
	51LC	6 Flute High Speed Machining Long Reach Corner Radius Fractional	77	79
	51B	6 Flute High Speed Machining Ball End Fractional	78	79
	51LB	6 Flute High Speed Machining Ball End Long Reach Fractional	78	79
	51M	6 Flute High Speed Machining Square End Metric	81	84
	51MCR	6 Flute High Speed Machining Corner Radius Metric	81	84
	51ML	6 Flute High Speed Machining Square End Long Reach Metric	82	84
	51MLC	6 Flute High Speed Machining Long Reach Corner Radius Metric	82	84

Speed & Feed Recommendations listed after each series

HIGH PERFORMANCE END MILLS	SERIES	DESCRIPTION	PAGE	S&F PAGE
	51MB	6 Flute High Speed Machining Ball End Metric	83	84
	51MLB	6 Flute High Speed Machining Ball End Long Reach Metric	83	84
H-Carb	77	7 Flute High Efficiency Square End Fractional	86	88
	77CR	7 Flute High Efficiency Corner Radius Fractional	86	88
	77M	7 Flute High Efficiency Square End Metric	90	92
	77MCR	7 Flute High Efficiency Corner Radius Metric	90	92
Multi-Carb	66	Multi-Flute Finisher Square End Fractional	94	95
	66CR	Multi-Flute Finisher Corner Radius Fractional	94	95
	66M	Multi-Flute Finisher Square End Metric	97	99
	66MCR	Multi-Flute Finisher Corner Radius Metric	97	99
	67B	Multi-Flute Finisher Tapered Circle Segment Barrel Tool Metric	101	102
Series 33	33CR	3 Flute Difficult to Machine Materials Corner Radius Fractional	103	104
	33MCR	3 Flute Difficult to Machine Materials Corner Radius Metric	106	107
Series 7	7	4 Flute Variable Geometry Long Length Square End Fractional	109	111
	7M	4 Flute Variable Geometry Long Length Square End Metric	112	113
	7B	4 Flute Variable Geometry Long Length Ball End Fractional	110	111
	7MB	4 Flute Variable Geometry Long Length Ball End Metric	112	113
Turbo-Carb	56B	2 Flute Contouring Long Reach Ball End Fractional	114	115
	56MB	2 Flute Contouring Long Reach Ball End Metric	114	115
Power-Carb®	57	6 Flute Finisher Square End Fractional	116	117
	57M	6 Flute Finisher Square End Metric	116	118
CFRP Slow Helix	27	4 Flute Slow Helix Square End Fractional	119	120
	27M	4 Flute Slow Helix Square End Metric	119	121
Picatinny Rail Tools	PRT	3 Flute Non-Ferrous Recoil Groove Tool Fractional	122	124
	PRT	5 Flute Non-Ferrous Dovetail Form Tool Fractional	125	127
	PRT	3 Flute Ferrous Recoil Groove Tool Fractional	122	123
	PRT	5 Flute Ferrous Dovetail Form Tool Fractional	125	126

Speed & Feed Recommendations listed after each series

FRESAS DE ALTO RENDIMIENTO	SERIE	DESCRIPCIÓN	PÁGINA	S&F PÁGINA	
Z-Carb-HPR	Z5	5 filis, desbastador, punta cuadrada, fraccional	30	35	
	Z5CR	5 filis, desbastador, radio angulado, fraccional	30	35	
	Z5MCR	5 filis, desbastador, radio angulado, métrico	37	39	
Z-Carb-AP	Z1PCR	4 filis, inclinación variable, radio angulado, fraccional	41	46	
	Z1PLC	4 filis, inclinación variable, largo alcance, radio angulado, fraccional	44	46	
	Z1PLB	4 filis, inclinación variable, punta esférica, largo alcance, fraccional	45	46	
	Z1MPCR	4 filis, inclinación variable, radio angulado, métrico	48	51	
	Z1MPIC	4 filis, inclinación variable, medio alcance, radio angulado, métrico	50	51	
	Z1MPLC	4 filis, inclinación variable, largo alcance, radio angulado, métrico	50	51	
	Z1	4 filis, geometría variable, punta cuadrada, fraccional	41	46	
	Z16CR	4 filis, geometría variable, radio angulado, fraccional	41	46	
Z-Carb	Z1B	4 filis, geometría variable, punta esférica, fraccional	53	54	
	Z1M	4 filis, geometría variable, punta cuadrada, métrico	48	51	
	Z1MB	4 filis, geometría variable, punta esférica, métrico	56	57	
Z-Carb-HTA	ZH1CR	4 filis, geometría variable, aleaciones termorresistentes, radio angulado, fraccional	59	60	
	ZH1MCR	4 filis, geometría variable, aleaciones termorresistentes, radio angulado, métrico	61	62	
	ZH1MCRS	4 filis, geometría variable, aleaciones termorresistentes, versión corta, radio angulado, métrico	61	62	
Z-Carb-MD	ZD1CR	4 filis, geometría variable, materiales duros, largo alcance, radio angulado, fraccional	63	64	
	ZD1MCR	4 filis, geometría variable, materiales duros, largo alcance, radio angulado, métrico	63	64	
V-Carb	55	5 filis, acabador y semiacabador, punta cuadrada, fraccional	65	68	
	55CR	5 filis, acabador y semiacabador, radio angulado, fraccional	65	68	
	55M	5 filis, acabador y semiacabador, punta cuadrada, métrico	70	74	
	55MCR	5 filis, acabador y semiacabador, radio angulado, métrico	70	74	
	55B	5 filis, acabador y semiacabador, punta esférica, fraccional	67	68	
	55MB	5 filis, acabador y semiacabador, punta esférica, métrico	73	74	
	51	6 filis, mecanizado de alta velocidad, punta cuadrada, fraccional	76	79	
T-Carb®	51CR	6 filis mecanizado de alta velocidad, radio angulado, fraccional	76	79	
	51L	6 filis, mecanizado de alta velocidad, punta cuadrada, largo alcance, fraccional	77	79	
	51LC	6 filis mecanizado de alta velocidad, largo alcance, radio angulado, fraccional	77	79	
	51B	6 filis, fresa esférica para mecanizados de alta velocidad, fraccional	78	79	
	51LB	6 filis, fresa esférica larga para mecanizados de alta velocidad, fraccional	78	79	
	51M	6 filis, mecanizado de alta velocidad, punta cuadrada, métrico	81	84	
	51MCR	6 filis mecanizado de alta velocidad, radio angulado, métrico	81	84	
	51ML	6 filis, mecanizado de alta velocidad, punta cuadrada, largo alcance, métrico	82	84	
	51MLC	6 filis mecanizado de alta velocidad, largo alcance, radio angulado, métrico	82	84	
	51MB	6 filis, fresa esférica para mecanizados de alta velocidad, métrico	83	84	
	51MLB	6 filis, fresa esférica larga para mecanizados de alta velocidad, métrico	83	84	
	H-Carb	77	7 filis de alta eficiencia, punta cuadrada, fraccional	86	88
		77CR	7 filis de alta eficiencia, radio angulado, fraccional	86	88
77M		7 filis métrica de alta eficiencia, punta cuadrada, métrico	90	92	
77MCR		7 filis métrica de alta eficiencia, radio angulado, métrico	90	92	
Multi-Carb		66	Filo múltiple, acabador, punta cuadrada, fraccional	94	95
	66CR	Filo múltiple, acabador, radio angulado, fraccional	94	95	
	66M	Filo múltiple, acabador, punta cuadrada, métrico	97	99	
	66MCR	Filo múltiple, acabador, radio angulado, métrico	97	99	
	67B	Fresa cónica circular multi-filos tipo barril, métrica	101	102	
	Serie 33	33CR	3 filis, materiales difíciles de mecanizar, radio angulado, fraccional	103	104
33MCR		3 filis, materiales difíciles de mecanizar, radio angulado, métrico	106	107	
Serie 7	7	4 filis, geometría variable, longitud larga, punta cuadrada, fraccional	109	111	
	7M	4 filis, geometría variable, longitud larga, punta cuadrada, métrico	112	113	
	7B	4 filis, geometría variable, longitud larga, punta esférica, fraccional	110	111	
	7MB	4 filis, geometría variable, longitud larga, punta esférica, métrico	112	113	
Turbo-Carb	56B	2 filis, contorneado, largo alcance, punta esférica, fraccional	114	115	
	56MB	2 filis, contorneado, largo alcance, punta esférica, métrico	114	115	
Power-Carb®	57	6 filis, acabador, punta cuadrada, fraccional	116	117	
	57M	6 filis, acabador, punta cuadrada, métrico	116	118	
Helicoidal de avance lento CFRP	27	4 filis, helicoidal de avance lento, punta cuadrada, fraccional	119	120	
	27M	4 filis, helicoidal de avance lento, punta cuadrada, métrico	119	121	
Herramientas de riel Picatinny	PRT	Herramienta de ranura de retroceso no ferrosa de 3 filis fraccional	122	124	
	PRT	Herramienta de forma de cola de milano no ferrosa de 5 filis fraccional	125	127	
	PRT	Herramienta de ranura de retroceso ferrosa de 3 filis fraccional	122	123	
	PRT	Herramienta de cola de milano ferrosa de 5 filis fraccional	125	126	

Recomendaciones de velocidades y avances mostradas tras cada serie

FRAISES A DETOURER UNIVERSELLES	SÉRIES	DESCRIPTION	PAGE	S&F PAGE
Z-Carb-HPR	Z5	5 dents non rayonné pour l'ébauche (fractionnel)	30	35
	Z5CR	5 dents rayonnée pour l'ébauche (fractionnel)	30	35
	Z5MCR	5 dents rayonnée pour l'ébauche (métrique)	37	39
Z-Carb-AP	Z1PCR	4 dents pas décalé et hélice variable rayonnés (fractionnel)	41	46
	Z1PLC	4 dents pas décalé et hélice variable rayonnés (fractionnel)	44	46
	Z1PLB	4 dents à vague de coupe variable longue portée à bout hémisphérique (fractionnel)	45	46
	Z1MPCR	4 dents pas décalé et hélice variable rayonnés (métrique)	48	51
	Z1MPC	4 dents pas décalé, hélice variable, détalonné, rayonnés (métrique)	50	51
	Z1MPLC	4 dents pas décalé et hélice variable rayonnés (métrique)	50	51
	Z1	4 dents géométrie variable non rayonné (fractionnel)	41	46
	Z16CR	4 dents géométrie variable rayonné (fractionnel)	41	46
	Z-Carb	Z1B	4 dents géométrie variable à bout hémisphérique (fractionnel)	53
Z1M		4 dents géométrie variable non rayonné (métrique)	48	51
Z1MB		4 dents géométrie variable à bout hémisphérique (métrique)	56	57
Z-Carb-HTA	ZH1CR	4 dents géométrie variable alliages haute température rayonné (fractionnel)	59	60
	ZH1MCR	4 dents géométrie variable alliages haute température rayonné (métrique)	61	62
	ZH1MCRS	4 dents géométrie variable, alliages haute température, longueur de l'outil court, rayonné (métrique)	61	62
Z-Carb-MD	ZD1CR	4 dents géométrie variable matériaux durs longue portée rayonné (fractionnel)	63	64
	ZD1MCR	4 dents géométrie variable matériaux durs longue portée rayonné (métrique)	63	64
V-Carb	55	5 dents en bout de finition et semi-finition plat (fractionnel)	65	68
	55CR	5 dents en bout finition et semi-finition rayonné (fractionnel)	65	68
	55M	5 dents en bout de finition et semi-finition plat (métrique)	70	74
	55MCR	5 dents en bout finition et semi-finition rayonné (métrique)	70	74
	55B	5 dents en bout de finition et semi-finition hémisphérique (fractionnel)	67	68
	55MB	5 dents en bout de finition et semi-finition hémisphérique (métrique)	73	74
	51	6 dents pour usinage grande vitesse non rayonné (fractionnel)	76	79
T-Carb®	51CR	6 dents pour usinage grande vitesse rayonné (fractionnel)	76	79
	51L	6 dents pour usinage grande vitesse non rayonné extra longue (fractionnel)	77	79
	51LC	6 dents pour usinage grande vitesse extra longue rayonné (fractionnel)	77	79
	51B	6 dents hémisphérique UGV dimensions cotes (fractionnel)	78	79
	51LB	6 dents hémisphérique détalonnée UGV dimensions cotes (fractionnel)	78	79
	51M	6 dents pour usinage grande vitesse non rayonné (métrique)	81	84
	51MCR	6 dents pour usinage grande vitesse rayonné (métrique)	81	84
	51ML	6 dents pour usinage grande vitesse non rayonné extra longue (métrique)	82	84
	51MLC	6 dents pour usinage grande vitesse extra longue rayonné (métrique)	82	84
	51MB	6 dents hémisphérique UGV dimensions cotes (métrique)	83	84
	51MLB	6 dents hémisphérique détalonnée UGV dimensions cotes (métrique)	83	84
	H-Carb	77	7 dents hautes performances droite côtes (fractionnel)	86
77CR		7 dents hautes performances torique côtes (fractionnel)	86	88
77M		7 dents hautes performances droite côtes (métrique)	90	92
77MCR		7 dents hautes performances torique côtes (métrique)	90	92
Multi-Carb	66	Multi-dents non rayonné pour finition (fractionnel)	94	95
	66CR	Multi-dents rayonné pour finition (fractionnel)	94	95
	66M	Multi-dents non rayonné pour finition (métrique)	97	99
	66MCR	Multi-dents rayonné pour finition (métrique)	97	99
	67B	Fraise tonneau à segments de cercle cotes (métrique)	101	102
Série 33	33CR	3 dents rayonné pour l'ébauche dans tous les matériaux sauf non-ferreux (fractionnel)	103	104
	33MCR	3 dents rayonné pour l'ébauche dans tous les matériaux sauf non-ferreux (métrique)	106	107
Série 7	7	4 dents géométrie variable à queue longue non rayonné (fractionnel)	109	111
	7M	4 dents géométrie variable à queue longue non rayonné (métrique)	112	113
	7B	4 dents géométrie variable à queue longue à bout hémisphérique (fractionnel)	110	111
	7MB	4 dents géométrie variable à queue longue à bout hémisphérique (métrique)	112	113
Turbo-Carb	56B	2 dents contournage longue portée à bout hémisphérique (fractionnel)	114	115
	56MB	2 dents contournage longue portée à bout hémisphérique (métrique)	114	115
Power-Carb®	57	6 dents en bout de finition plat (fractionnel)	116	117
	57M	6 dents en bout de finition plat (métrique)	116	118
CFRP hélice lente	27	4 dents hélice lente non rayonné (fractionnel)	119	120
	27M	4 dents hélice lente non rayonné (métrique)	119	121
Outils de rail Picatinny	PRT	Outil de rainure de recul non ferreux à 3 dents (fractionnel)	122	124
	PRT	Outil de forme en queue d'aronde non ferreux à 5 dents (fractionnel)	125	127
	PRT	Outil de rainure de recul ferreux à 3 dents (fractionnel)	122	123
	PRT	Outil en queue d'aronde ferreux à 5 dents (fractionnel)	125	126

Recommandations de vitesse et avance indiquées après chaque série

HOCHLEISTUNGS-SCHAFTFRÄSER	SERIE	BESCHREIBUNG	SEITE	S&F SEITE
Z-Carb-HPR	Z5	Zölliger Schrufffräser mit 5 Schneiden ohne Eckenradien	30	35
	Z5CR	Zölliger Schrufffräser mit 5 Schneiden und Eckenradien	30	35
	Z5MCR	Schrufffräser mit 5 Schneiden und Eckenradien	37	39
Z-Carb-AP	Z1PCR	Zölliger Fräser mit 4 variablen Schneiden und Eckenradien	41	46
	Z1PLC	Zölliger Langlochfräser mit 4 variablen Schneiden und Eckenradien	44	46
	Z1PLB	Zölliger Radiuschaftfräser mit 4 Schneiden und variablem Spanwinkel	45	46
	Z1MPCR	Fräser mit 4 Schneiden und variablen Spanwinkel	48	51
	Z1MPIC	Fräser mittlerer Länge mit 4 variablen Schneiden und Eckenradien	50	51
	Z1MPLC	Langlochfräser mit 4 variablen Schneiden und Eckenradien	50	51
	Z1	Zölliger Schaftfräser mit 4 Schneiden ohne Eckenradien und variabler Form	41	46
	Z16CR	Zölliger Fräser mit 4 variablen Schneiden und Eckenradien	41	46
Z-Carb	Z1B	Zölliger Radiuschaftfräser mit 4 Schneiden und variabler Form	53	54
	Z1M	Schaftfräser mit 4 Schneiden ohne Eckenradien und variabler Form	48	51
	Z1MB	Radiuschaftfräser mit 4 Schneiden und variabler Form	56	57
Z-Carb-HTA	ZH1CR	Hochwarmfester zölliger Fräser mit 4 variablen Schneiden und Eckenradien	59	60
	ZH1MCR	Hochwarmfester Fräser mit 4 variablen Schneiden und Eckenradien	61	62
	ZH1MCRS	Hochwarmfester Fräser mit 4 variablen Schneiden und Eckenradien	61	62
Z-Carb-MD	ZD1CR	Zölliger Langlochfräser mit 4 variablen Schneiden, Eckenradien und Form aus Hartmetall	63	64
	ZD1MCR	Langlochfräser mit 4 variablen Schneiden, Eckenradien und Form aus Hartmetall	63	64
V-Carb	55	Zölliger Schlicht- und Halbschlichtfräser mit 5 Schneiden ohne Eckenradien und variabler Form	65	68
	55CR	Zölliger Schlicht- und Halbschlichtfräser mit 5 Schneiden ohne Eckenradien	65	68
	55M	Schlicht- und Halbschlichtfräser mit 5 Schneiden ohne Eckenradien und variabler Form	70	74
	55MCR	Schlicht- und Halbschlichtfräser mit 5 Schneiden und Eckenradien	70	74
	55B	Schlicht- und Halbschlicht-Radiuschaftfräser mit 5 Schneiden ohne Eckenradien	67	68
	55MB	Schlicht- und Halbschlicht-Radiuschaftfräser mit 5 Schneiden und variabler Form	73	74
T-Carb®	51	Zölliger Schaftfräser für die Hochgeschwindigkeitsbearbeitung mit 6 Schneiden ohne Eckenradien	76	79
	51CR	Zölliger Fräser für die Hochgeschwindigkeitsbearbeitung mit 6 Schneiden und Eckenradien	76	79
	51L	Zölliger Langloch-Schaftfräser aus Schnellstahl mit 6 Schneiden ohne Eckenradien	77	79
	51B	6-Schneider Vollradiusfräser für Hochgeschwindigkeitsbearbeitung	77	79
	51LB	6-Schneider Vollradiusfräser mit Freischliff für Hochgeschwindigkeitsbearbeitung	78	79
	51ML	Langloch-Schaftfräser aus Schnellstahl mit 6 Schneiden ohne Eckenradien	78	79
	51M	Schaftfräser für die Hochgeschwindigkeitsbearbeitung mit 6 Schneiden ohne Eckenradien	81	84
	51MCR	Fräser für die Hochgeschwindigkeitsbearbeitung mit 6 Schneiden und Eckenradien aus Schnellstahl	81	84
	51LC	Zölliger Langlochfräser für die Hochgeschwindigkeitsbearbeitung mit 6 Schneiden und Eckenradien	82	84
	51MLC	Langlochfräser für die Hochgeschwindigkeitsbearbeitung mit 6 Schneiden und Eckenradien	82	84
	51MB	6-Schneider Vollradiusfräser für Hochgeschwindigkeitsbearbeitung	83	84
	51MLB	6-Schneider Vollradiusfräser mit Freischliff für Hochgeschwindigkeitsbearbeitung	83	84
H-Carb	77	Zölliger Hocheffizienter mit 7 Schneiden ohne Eckenradien	86	88
	77CR	Zölliger Hocheffizienter mit 7 Schneiden und Eckenradien	86	88
	77M	Hocheffizienter mit 7 Schneiden ohne Eckenradien	90	92
	77MCR	Hocheffizienter mit 7 Schneiden und Eckenradien	90	92
Multi-Carb	66	Zölliger mehrschneidiger Schlichtfräser ohne Eckenradien	94	95
	66CR	Zölliger mehrschneidiger Schlichtfräser mit Eckenradien	94	95
	66M	mehrschneidiger Schlichtfräser ohne Eckenradien	97	99
	66MCR	mehrschneidiger Schlichtfräser mit Eckenradien	97	99
	67B	Metrischer mehrschneidiger Schlichtfräser, Tonnenfräser	101	102
Serie 33	33CR	Zölliger Fräser mit 3 Schneiden und Eckenradien für schwerspanbare Werkstoffe	103	104
	33MCR	Fräser mit 3 Schneiden und Eckenradien für schwerspanbare Werkstoffe	106	107
Serie 7	7	Zölliger Langloch-Schaftfräser mit 4 Schneiden ohne Eckenradien und variabler Form	109	111
	7M	Langloch-Schaftfräser mit 4 Schneiden ohne Eckenradien und variabler Form	112	113
	7B	Zölliger Langloch-Radiuschaftfräser mit 4 Schneiden und variabler Form	110	111
	7MB	Langloch-Radiuschaftfräser mit 4 Schneiden und variabler Form	112	113
Turbo-Carb	56B	Zölliger Langloch-Profil-Radiuschaftfräser mit 2 Schneiden	114	115
	56MB	Langloch-Profil-Radiuschaftfräser mit 2 Schneiden	114	115
Power-Carb®	57	Zölliger Schlichtfräser mit 6 Schneiden ohne Eckenradien	116	117
	57M	Schlichtfräser mit 6 Schneiden ohne Eckenradien	116	118
CFRP Slow Helix	27	Zölliger Schaftfräser mit 4 steilen Schneiden ohne Eckenradien	119	120
	27M	Schaftfräser mit 4 steilen Schneiden ohne Eckenradien	119	121
Picatinny	PRT	3 Flöte Nichteisen-Rückstoßnut Nut Grove Bruchteil	122	124
Schienenwerkzeuge	PRT	5 Flöte Nichteisen-Schwalbenschwanzform-Werkzeug Bruchteil	125	127
	PRT	3 Rillen-Eisenrückstoß-Nutwerkzeug fraktioniert	122	123
	PRT	5 Flöte Eisen Schwalbenschwanz Werkzeug gebrochen	125	126

Empfehlungen für Drehzahl & Vorschub im Anhang zu jeder Serie

End Mill Matrix

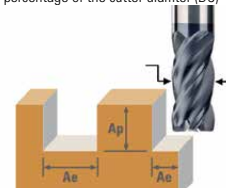
Preferred materials for each Series are designated below.			Coolant required in these materials Plunging not recommended in these materials																	
<p>Cut depths (Ae & Ap) are based on a percentage of the cutter diameter (DC)</p>  <p>Material hardness and machinability affect speed, feed, and cut depths. Long flute or long reach tools require reduced rates and cut depths.</p>			Material																	
			Low Carbon ≤ 20 HRC	Medium Carbon, Alloy 20 to 35 HRC	High Carbon, Alloy 35 to 45 HRC	Ferritic & Martensitic ≤ 45 HRC	Austenitic & Duplex ≤ 25 HRC	Precipitation Hardened ≤ 45 HRC	Low Alloy, Grey, Ductile ≤ 25 HRC	Med-High Alloy, Nodular 25 to 35 HRC	High Alloy, Nodular ≥ 35 HRC	Aluminum Alloys	Copper Alloys	Plastics, Composites	Titanium Alloys ≤ 45 HRC	Iron, Nickel, Cobalt Alloys ≤ 45 HRC	Refractory Alloys, Mo, Ta, W ≤ 35 HRC	High Carbon, Med Alloy 45 to 50 HRC	Tool, Mold & Die 45 to 55 HRC	Tool, Mold & Die 55 to 65 HRC
Name	Series	Page	Steel			Stainless Steel			Cast Iron			Non Ferrous			HRSA			Hard Steel		
Series 33	33	103	★	★	★	★	★	☆	★	★	☆				★	☆	☆	○	○	
Z-Carb-AP	Z1P	41	★	★	★	★	★	★	★	★	★				★	★	★	☆	○	
Z-Carb-HTA	ZH1	59	★	★	★	★	★	★	★	★	★				★	★	★	☆	○	
Series 7	7	109	★	★	★	★	★	★	★	★	★				★	★	☆	☆	○	
Z-Carb HPR	Z5	30	★	★	★	★	★	★	★	★	★				★	★	★	☆	○	
V-Carb	55	65	★	★	★	★	★	★	★	★	★				★	★	☆	○	○	
T-Carb®	51	76	★	★	★	★	★	★	★	★	★				★	★	★	☆	○	
H-Carb	77	86	★	★	★	★	★	★	★	★	★				★	★	★	☆	○	
Multi Carb	66	94	★	★	★	★	☆	★	★	★	★				★	★	★	☆	○	
Multi Carb-B	67B	101	★	★	★	★	★	★	★	★	★				★	★	★	☆	○	
Picatinny Groove F	PRT	122	★	★	★	★	★	★							★					
Picatinny Dovetail F	PRT	125	★	★	★	★	★	★							★					
Turbo Carb	56B	114	★	★	★				★	★	★							★	★	★
Z-Carb-MD	ZD1	63			☆					☆	★							★	★	★
Power-Carb®	57	116									☆							★	★	★
Ski-Carb	44	173										★	☆	○						
S-Carb® 2 Flute	47	166										★	★	○						
S-Carb® 3 Flute	43	144										★	★	○						
S-Carb® APR-3	43APR-3	133										★	★	○						
S-Carb® APR-4	43APR-4	136										★	★	○						
S-Carb® APF	43APF	138										★	★	○						
S-Carb® APF-B	43APF-B	142										★	★	☆						
Picatinny Groove NF	PRT	122										★								
Picatinny Dovetail NF	PRT	125										★								
Slow Helix	27	119											☆	★						
CCR	20-CCR	386																★		
CCR Coarse	31-CCR	390																★		
Compression Router	25	393																★		
Up Cut Router	21	396										☆	○	★						
Down Cut Router	22	397										☆	○	★						

End Mill Matrix

Preferred Cut Type for Series ★ Best ☆ Better ○ Good (blank) Not Recommended						Preferred Entry Method for Series			Preferred Tool Path for Series	
Unless blank, a high quality wall or floor finish can be achieved with any Series with adjusted speed & feed.						Speed & Feed are based on ramp angle.			For rough milling, HEM tool paths are usually preferred in most situations, however, Standard paths may be more efficient using suitable tools with moderate to heavy cut types.	
Heavy	Moderate	Light	Fine	Finish-Wall	Finish - Floor	Plunge	Straight Ramp	Helical Ramp	Standard Path	HEM Path
Ae = 1 to .4 x DC Ap ≤ 1 x DC	Ae = .4 to .25 x DC Ap ≤ 1.5 x DC	Ae = .25 to .1 x DC Ap ≤ 2.5 x DC	Ae = .1 to .02 x DC Ap ≤ 4.5 x DC	Ae ≤ .02 x DC any Ap	Ae ≥ .5 x DC Ap ≤ .02 x DC	Ap ≤ 1 x DC lower feed rates	Ap ≤ 2 x DC medium feed rates	Ap ≤ 4 x DC higher feed rates	Standard Path	HEM Path
★	★	☆	☆	○	☆	☆	★	★	★	☆
★	★	☆	☆	○	☆	☆	★	★	★	☆
★	★	☆	☆	○	☆	☆	★	★	★	☆
○	○	○	★	★	☆		○	☆	○	☆
☆	★	★	☆	☆	★		★	★	★	★
○	☆	★	★	★	★		○	☆	☆	★
○	○	☆	★	★	★		○	★	○	★
○	○	○	★	★	★		○	★	○	★
			★	★			○	○	★	
★	★	★	★	★	★				★	
★	★	★	★	★	★				★	
○	○	☆	★	★		○	○	★	★	★
★	★	☆	☆	☆	☆		☆	★	☆	★
○	○	☆	★	★	★		○	☆	☆	★
☆	☆	☆	★	★	☆	☆	★	★	★	☆
★	★	☆	☆	○	☆	☆	★	★	★	☆
★	★	☆	☆	☆	★	☆	★	★	★	☆
★	★	☆	☆		★	☆	★	★	★	☆
★	★	☆	☆		★	☆	★	★	★	☆
○	○	☆	★	★	★	○	☆	★	☆	★
			★	★	☆	○	○		★	
★	★	★	★	★	★				★	
★	★	★	★	★	★				★	
○	○	☆	★	★	☆	○	☆	★	★	☆
★	★	☆	☆		☆	○	☆	★	★	☆
★	★	☆	☆		☆	○	☆	★	★	☆
○	○	☆	☆	★	☆	○	☆	★	★	☆
★	★	☆	☆	○	☆	○	☆	★	★	☆
○	○	☆	☆	☆	☆				★	☆

End Mill Matrix

Name	Series	Page	Flute Count	Cut Diameter Range inch mm	Cut Length Availability (x DC) **	Reach Option (x DC) **	End Styles Square Radius Ball
Series 33	33	103	3	0.125 to 1 3 to 20	2.25 to 3	–	R
Z-Carb-AP	Z1P	41	4	0.0156 to 1 1 to 25	1 to 3.25	2.5 to 8.5	S, R, B
Z-Carb-HTA	ZH1	59	4	0.250 to 1 6 to 20	1.25 to 3	–	R
Series 7	7	109	4	0.125 to 1 3 to 25	2.25 to 8.25	–	S, B
Z-Carb HPR	Z5	30	5	0.125 – 1 6 – 25	1 to 3	–	S, R
V-Carb	55	65	5	0.125 to 1 6 to 20	1.25 to 5	–	S, R, B
T-Carb®	51	76	6	0.250 to 1 6 to 20	1.25 to 3	3.25 to 5.5	S, R
H-Carb	77	86	7	0.250 to 1 6 to 25	2.5 to 4	–	S, R
Multi Carb	66	94	7, 9, 11	0.188 to 1 6 to 25	1.5 to 3.25	–	S, R
Multi Carb-B	67	101	4, 6, 8	– 6 to 16	1.2 to 1.9	–	B
Picatinny Groove F	PRT	122	3	0.2100 –	0.56	–	S
Picatinny Dovetail F	PRT	125	5	0.6050 –	0.68	–	S
Turbo Carb	56B	114	2	0.031 to 0.750 1 to 20	1	2 to 2.25	B
Z-Carb-MD	ZD1	63	4	0.118 to 0.750 5 to 20	1 to 1.25	2.25 to 5	R
Power-Carb®	57	116	6	0.250 to 0.500 6 to 20	2 to 2.25	–	S
Ski-Carb	44	173	2	0.250 to 1 3 to 20	1.25 to 7	–	S, R
S-Carb® 2 Flute	47	166	2	0.125 to 1 3 to 25	1 to 3	3 to 9	S, B
S-Carb® 3 Flute	43	144	3	0.125 to 1 3 to 25	1 to 7	2.25 to 8.5	S, R, B
S-Carb® APR-3	43APR-3	133	3	0.750 to 1 12 to 26	1.25 to 1.75	3 to 4	S, R
S-Carb® APR-4	43APR-4	136	4	20 to 25	1.25 to 1.75	2.25 to 3.5	S, R
S-Carb® APF	43APF	138	4	0.500 to 0.750 6 to 25	2.5 to 4	3 to 5	S, R
S-Carb® APF-B	43APF-B	142	3, 4	– 6 to 16	1.2 to 1.9	–	B
Picatinny Groove NF	PRT	122	3	0.2100 –	0.56	–	S
Picatinny Dovetail NF	PRT	125	3	0.6050 –	0.68	–	S
Slow Helix	27	119	4	0.250 to 0.750 6 to 16	1.75 to 4	–	S
CCR	20-CCR	386	5, 8, 10, 12	0.250 to 0.500 2 to 12	2.75 to 4	–	S
CCR Coarse	31-CCR	390	5, 7, 8, 10	0.250 to 0.500 6 to 12	2.75 to 4	–	S
Compression Router	25	393	4, 6, 8	0.250 to 0.500 6 to 12	2.75 to 4	–	S
Up Cut Router	21	396	2	0.125 to 0.750 3 to 12	2.5 to 4.25	–	S
Down Cut Router	22	397	2	0.125 to 0.750 3 to 12	2.5 to 4.25	–	S

End Mill Matrix

	Chipbreaker Option	Shank Option Solid Round Weldon Flat Jet Stream Coolant Hole	Center Cutting	Helix Angle	Flute Index	Coating	Maximum Recommended Ramp Angle ***
	By Request	SR, WF	Yes	32 / 48	Unequal	Ti-NAMITE®-A	90
	By Request	SR, WF, JS	Yes	35 / 38	Unequal	Ti-NAMITE®-X	90
	By Request	SR, WF	Yes	38 / 41	Unequal	Ti-NAMITE®-A	20
	By Request	SR	Yes	38	Unequal	Ti-NAMITE®-A	1
	By Request	SR, WF, CH	No	37	Unequal	Ti-NAMITE®-M Ti-NAMITE®-A	7
	By Request	SR, WF	Yes	45	Unequal	Ti-NAMITE®-A	5
	By Request	SR	Yes	41	Unequal	Ti-NAMITE®-X	3
	In Stock Available	SR	No	37	Unequal	Ti-NAMITE®-M Ti-NAMITE®-A	1
	By Request	SR	No	35	Equal	Ti-NAMITE®-X	1
	By Request	SR	Yes	varies	Equal	Ti-NAMITE®-H	1
	Not Available	SR	Yes	35	Unequal	Ti-NAMITE®-M	-
	Not Available	SR	No	37	Unequal	Ti-NAMITE®-M	-
	By Request	SR	Yes	30	Equal	Ti-NAMITE®-X	25
	By Request	SR	Yes	42 / 45	Unequal	Ti-NAMITE®-X	2
	By Request	SR	Yes	45	Equal	Ti-NAMITE®-X	1
	By Request	SR, WF	Yes	45	Equal	uncoated or Ti-NAMITE®-B	90
	By Request	SR	Yes	35	Equal	uncoated or Ti-NAMITE®-B	90
	In Stock Available	SR	Yes	38	Equal	uncoated or Ti-NAMITE®-B	90
	Standard	CH	Yes	38	Unequal	Ti-NAMITE®-B	90
	Standard	CH	Yes	38 / 41	Unequal	Ti-NAMITE®-B	90
	By Request	CH	Yes	38 / 41	Unequal	Ti-NAMITE®-B	25
	By Request	SR	Yes	varies	Equal	Ti-NAMITE®-B	1
	Not Available	SR	Yes	38	Equal	Ti-NAMITE®-B	-
	Not Available	SR	No	38	Equal	Ti-NAMITE®-B	-
	By Request	SR	Yes	10, 12	Unequal	uncoated or Di-NAMITE®	5
	Standard	SR	Based upon end style	15	Equal	uncoated or Di-NAMITE®	5 (for end cut styles)
	Standard	SR	Based upon end style	15	Equal	uncoated or Di-NAMITE®	5 (for end cut styles)
	By Request	SR	Yes	30	Equal	uncoated or Di-NAMITE®	5
	By Request	SR	Yes	35	Equal	various optional	90
	By Request	SR	Yes	35	Equal	various optional	-

Application Tips

Tool	<ul style="list-style-type: none"> Whenever possible, select an end mill with the largest diameter, shortest flute length, and shortest overall length for the best rigidity Long flute tools are not intended for pocketing, slotting, or heavy profiling – limit Ae to .02D High Performance tools minimize cycle time and extend tool life
Tool Holders	<ul style="list-style-type: none"> Holders with adequate gripping pressure and TIR are required Stub holders or zero length collet style holders are recommended for heavy stock removal When using solid holders, hand ground screw flats are not recommended
Workpiece	<ul style="list-style-type: none"> Secure clamping of the workpiece will reduce chatter and deflection
Machine	<ul style="list-style-type: none"> Spindle must be in optimum condition for precise TIR and maximum tool life Sufficient horsepower is required to perform at recommended speeds and feeds Reduce rates for low power machines to prevent workpiece and / or tool damage
Coolant	<ul style="list-style-type: none"> Avoid re-milling chips through use of air blast or liquid coolant as necessary Maintain clean coolant with appropriate concentration General recommendations: <ul style="list-style-type: none"> —Water Soluble Oil or Air Blast: Tool Steels, Mold & Die Steels, Carbon or Alloy Steels —Water Soluble Oil: Stainless Steels, Titanium, High Temperature Alloys, Non-Ferrous Alloys
Methods	<ul style="list-style-type: none"> Climb milling is generally preferred Attention to programming details, tool holders, TIR, balance, fixturing, etc. improve cutting tool performance and extend tool life

END MILLING GUIDELINE

DC = cutting diameter APMX = flute length

Speeds and Feeds for Cut Types are based on Radial Width (A_e) and Axial Depth (A_p)

Reductions to Speeds and Feeds may be necessary when:

- Ae and Ap exceed recommendations
- Using long flute or extended reach tools
- Using long tool holders
- Machining materials harder than listed

ENTRY METHODS

Pre-Drilled Hole



Pre-drilling is the preferred entry method for most applications.

Helical Ramp



Straight Ramp

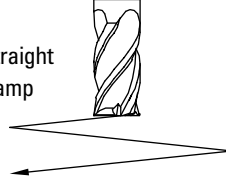

Alternative methods are helical and straight ramping. High ramp angles require reduced feed. Lower ramp angles will allow higher feed rates and extend tool life. Use slotting speeds and feeds for ramp angles of 1° to 2°. Reduce feed to 25% when ramp angles approach 6°. General purpose tools and/or difficult to machine materials will require lower ramp angles and reduced feed.

Plunge



Plunge only in non-ferrous and short-chipping materials using slotting speeds and 25% slotting feeds.

Herramientas	<ul style="list-style-type: none"> • Siempre que sea posible, seleccione la herramienta de mayor diámetro y menor longitud total y de filo para obtener una mayor rigidez. • Las herramientas con filos largos no son recomendadas para operaciones de apertura de cajas en el maquinado, operación de ranurado o perfilado pesado – limitar la profundidad radial (Ae) a .02D • Las herramientas de alto desempeño minimizan el tiempo de ciclo del maquinado y extienden la vida útil de la herramienta
Portaherramientas	<ul style="list-style-type: none"> • Los Portaherramientas deberán tener buena presión de amarre para la sujeción de la herramienta y una concetricidad máxima indicada (TIR) • Se recomienda usar portaherramientas de amarre directo cortos, o de boquilla con longitud cero para lograr un máximo arranque de viruta • Cuando se utilicen portaherramientas de amarre directo, no se recomienda hacer manualmente el plano para la sujeción del tornillo en el zanco de la herramienta
Pieza a maquinar	<ul style="list-style-type: none"> • La buena sujeción de la pieza a maquinar reducirá la vibración y la desviación de la herramienta
Máquina	<ul style="list-style-type: none"> • El husillo de la maquina debe estar en condiciones optimas, para asegurar la concetricidad de giro (TIR) y asegurar el máximo rendimiento de la herramienta • Para lograr los avances y velocidades recomendados, se necesita suficiente potencia (HP) en la maquina • Reducir los parámetros de corte en maquinas de baja potencia (HP) para prevenir el daño en la herramienta o pieza de trabajo
Refrigeración	<ul style="list-style-type: none"> • Evite el re-maquinado de virutas usando aire a presión o líquido refrigeración según sea necesario • Mantener limpio la refrigeración con su concentración adecuada • Recomendaciones generales: <ul style="list-style-type: none"> –Para el maquinado de aceros de herramienta, para Moldes y Dados o Aleaciones de Bajo Carbón, utilice Aceite Soluble en Agua o aire a presión –Para el maquinado de Aleaciones Inoxidables, Aleaciones Termorresistentes, Titanio y Aleaciones No Ferrosas, utilice solamente Aceite Soluble en Agua
Métodos	<ul style="list-style-type: none"> • Se recomienda el maquinado en sentido ascendente o trepado • El cuidado en los detalles de la programación, la concetricidad de giro (TIR) el balance de los portaherramientas, la sujeción de la pieza a maquinar, etc. son factores que contribuyen a prolongar la vida de la herramienta

GUÍAS DE FRESADO

DC = diámetro de corte APMX = largo de filo

Las velocidades y avances para cortes están basados en la profundidad radial (A_e), y profundidad axial (A_p)

Reducciones en velocidades y avances serán necesarias cuando:

- Ae y Ap exceda las recomendaciones
- Se utilicen filos largos o herramientas de largo alcance
- Se utilicen portaherramientas largos
- Se maquinen materiales más duros que los recomendados

MÉTODOS DE ENTRADA

Barreno previo



Preferentemente usar un barreno previo como método de entrada para la mayor parte de las aplicaciones.

Rampa helicoidal



Rampa recta

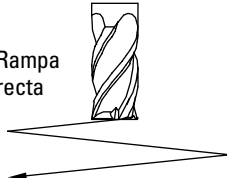

Los métodos alternativos son las rampas helicoidales y rectas. Un ángulo elevado de rampa necesita un avance reducido. Un ángulo de rampa inferior permitirá tasas de avance más elevadas y una mayor duración de la herramienta. Usar velocidades y alcances de ranurado para ángulos de rampa de 1° a 2°. Disminuir el avance un 25% cuando los ángulos de rampa se aproximan a 6°. Las herramientas de uso general y/o materiales difíciles de mecanizar precisarán ángulos de rampa inferiores y un avance reducido.

Agujero o Barrenado



Este método se puede utilizar únicamente en materiales no ferrosos y materiales de formación de virutas cortas, usando la velocidad de ranurado y el 25% de su avance.

Conseils relatifs à l'application

Outil	<ul style="list-style-type: none"> • Chaque fois que possible, choisissez une fraise de plus grand diamètre possible, la plus courte possible, elle garantira la meilleure rigidité • Les outils longs ne sont pas optimum pour l'ébauche, le pocketing, le rainurage – Ae limité à 0,02 D • Les outils Haute performance optimisent les temps de cycle et de augmentent la durée de vie
Porte-outils	<ul style="list-style-type: none"> • Des attachements à serrage puissant et à faux rond précis sont recommandés • Attachements à méplats ou pinces à serrage nominale sont recommandées pour les ébauches • Lorsque vous utilisez des attachement rigides, les serrage de l'outil par vis ne sont pas recommandés
Pièce	<ul style="list-style-type: none"> • Le système de fixation et de bridage de la pièce devra permettre de réduire les vibrations et la déformation
Machine	<ul style="list-style-type: none"> • Broche doit être en bon état optimal au niveau de son faux rond • Suffisamment puissance est nécessaire pour effectuer à des vitesses recommandées et se nourrit • Réduire les efforts pour les machines de faible puissance pour éviter l'endommagement de la pièce et / ou de l'outil
Liquide de refroidissement	<ul style="list-style-type: none"> • Évitez les recyclage de copeaux par l'utilisation de soufflage d'air comprimé ou de liquide de refroidissement. • Maintenir le lubrifiant propre à la concentration appropriée • Recommandations générales – <ul style="list-style-type: none"> –Huile soluble ou Air comprimé: aciers à outils, aciers pour moules, aciers au carbone ou alliés –Huile soluble: aciers inoxydables, titane, alliages à haute température, alliages non ferreux
Méthodes	<ul style="list-style-type: none"> • L'usinage en avalant est généralement préconisé • Attention à la programmation, porte-outils, faux rond, équilibrage, fixation, etc améliorent les performances de l'outil en coupe et prolonge la durée de vie

GUIDE DU FRAISAGE

DC = diamètre de coupe APMX = longueur de coupe

Vitesses & avances pour ces cas d'usinage sont basées sur l'engagement radial (A_e), et axial (A_p)

La réduction de la vitesse et de l'avance doit être nécessaire quand:

- Les engagements Ae et Ap sont importants
- Des dentures longues ou des séries longues sont utilisées
- Des attachement longs sont utilisés
- Lors d'usinage de matériaux durs

TYPES D'ENTREE MATIERE

Preperçage



Le préperçage est la méthode préférable dans la plupart de applications.

Ramping
hélicoïdal



Ramping
droit

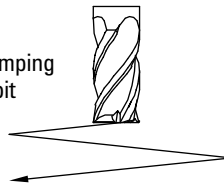

Les autres méthodes sont un ramping hélicoïdal et un ramping droit. Les angles de ramping élevés exigent une avance inférieure. Les angles de ramping inférieurs permettent les taux d'avance supérieurs et prolongeront la vie de l'outil. Utilisez des avances et vitesses de mortaisage pour les angles de ramping de 1° à 2°. Réduisez l'avance à 25 % lorsque les angles de ramping avoisinent 6°. Les outils tout usage et/ou les matériaux difficiles à usiner exigeront des angles de ramping inférieurs et une charge réduite.

Plongée



Plongée uniquement dans les non ferreux. Vitesse rainurage et avances réduites de 25%.

Werkzeug	<ul style="list-style-type: none"> • Wählen Sie möglichst immer den Schafffräser mit dem größten Durchmesser, der kürzesten Schneide und Gesamtlänge, um eine hohe Steifigkeit zu erhalten • Langlochschaftfräser sind nicht zum Taschen-, Schlitz- oder Profilfräsen bestimmt – die Dehnung auf Ae 0,2 der Streckgrenze nicht überschreiten • Hochleistungswerkzeuge minimieren die Bearbeitungszeit und verlängern die Werkzeugstandzeit
Werkzeughalter	<ul style="list-style-type: none"> • Es werden Spannzangen mit genauem Rundlauf benötigt • Steilkegel oder bündige Spannfutter werden bei hohem Materialabtrag empfohlen • Von der Verwendung fester handverschraubter Halterungen wird abgeraten
Werkstück	<ul style="list-style-type: none"> • Sicheres Werkzeugspannen verringert Vibrationen und das Auswandern aus der Spannvorrichtung
Werkzeugmaschine	<ul style="list-style-type: none"> • Die Spindel muss in optimalem Zustand sein, um einen genauen Rundlauf und maximale Standzeit zu erzielen • Für die empfohlenen Drehzahlen und Vorschubgeschwindigkeiten ist genügend Leistung bereitzustellen • Bei leistungsschwachen Antrieben sind die Werte zu verringern, um Beschädigungen am Werkstück und/oder Werkzeug zu vermeiden
Kühlmittel	<ul style="list-style-type: none"> • Das Stauen der Späne durch Luftstrahl oder flüssige Kühlmittel möglichst verhindern • Kühlmittel in geeigneter Konzentration verwenden • Allgemeine Empfehlungen: <ul style="list-style-type: none"> – Wasser-Öl-Emulsionen oder Luftstrahl: Werkzeugstähle, Form- und Schneidstähle, unlegierte oder legierte Stähle – Wasser-Öl-Emulsion: Nichtrostender Stahl, Titan, Warmfeste Legierungen, Nichteisenlegierungen
Verfahren	<ul style="list-style-type: none"> • Vorzugsweise Gleichlaufräsen anwenden • Das Beachten der Fräsparameter, Werkzeughalter, Rundlauf, Auswuchten, Einspannen, usw. verbessert die Schnittleistung und verlängert die Standzeit

RICHTWERTE ZUM FRÄSEN

DC = Fräsdurchmesser APMX = Schnittlänge

Drehzahl und Vorschub für Fräsarbeiten hängen von Radialbreite (A_e) und Frästiefe (A_p) ab

Drehzahl und Vorschub müssen ggfs. verringert werden wenn:

- die empfohlenen Werte für Ae und Ap überschritten werden
- lange Schneiden oder Langschaftfräser verwendet werden
- lange Werkzeughalter verwendet werden
- die Werkstoffe härter als vorgesehen sind

VORBEREITUNGEN

Vorbohrung



Vorbohren ist in den meisten Fällen ratsam.

Zirkulareintauchfräsen



Schrägeintauchfräsen



Alternative Verfahren sind Zirkulareintauchen und Schrägeintauchen. Starke Tauchwinkel erfordern verringerte Vorschubgeschwindigkeiten. Geringe Tauchwinkel ermöglichen höhere Vorschubgeschwindigkeiten und verlängern die Standzeit. Verwenden Sie die Drehzahlen und Vorschübe zum Schlitzfräsen für Tauchwinkel von 1° bis 2°. Den Vorschub auf 25 % verringern, wenn der Tauchwinkel 6° erreicht. Standardwerkzeuge und / oder schwer zu bearbeitende Werkstoffe verlangen kleine Tauchwinkel und verringerte Vorschubgeschwindigkeiten.

Stechen



Stechen Sie in Nichteisenmetalle und kurzspanende Werkstoffe nur mit Schlitzfräsdrehzahl und 25 % der Schlitzvorschubgeschwindigkeit ein.

FRACTIONAL Z-Carb-HPR

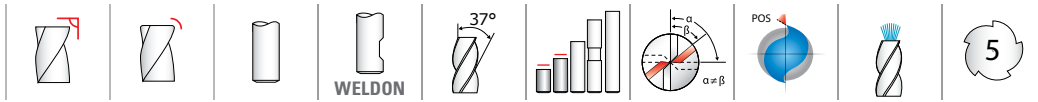

Z5 • Z5CR FRACTIONAL SERIES

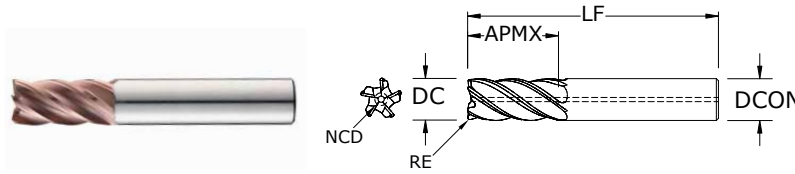

TOLERANCES (inch)

1/8–1/4 DIAMETER
DC = +0.0000/–0.0012
DCON = h_6
RE = +0.0000/–0.0020
>1/4–3/8 DIAMETER
DC = +0.0000/–0.0016
DCON = h_6
RE = +0.0000/–0.0020
>3/8–1 DIAMETER
DC = +0.0000/–0.0020
DCON = h_6
RE = +0.0000/–0.0020

- An ideal balance of helix, indexing, flute depth, rake and relief
- Variable indexing for chatter suppression and patented edge geometry for shearing and strength
- Chatter-free geometry allows deep cutting and high speed machining
- Central coolant hole delivers coolant effectively to the cutting zone enhancing chip removal when pocketing or slotting
- Excels at roughing, ramping, high speed machining and finishing in a variety of materials
- Enhanced corner geometry with tight tolerance corner radii
- Recommended for materials ≤ 45 HRc (≤ 420 Bhn)

- STEELS
- STAINLESS STEELS
- CAST IRON
- HIGH TEMP ALLOYS

For patent information visit www.ksptpatents.com

inch						EDP NO.					
CUTTING DIAMETER DC	LENGTH OF CUT APMX	OVERALL LENGTH LF	SHANK DIAMETER DCON	CORNER RADIUS RE	NON-CUTTING CENTER DIAMETER NCD	Ti-NAMITE®-A (TA)	Ti-NAMITE®-A (TA) W/FLAT	Ti-NAMITE®-A (TA) W/INTERNAL COOLANT	Ti-NAMITE®-M (TM)	Ti-NAMITE®-M (TM) W/FLAT	Ti-NAMITE®-M (TM) W/INTERNAL COOLANT
1/8	1/4	1-1/2	1/8	–	0.0440	38500	–	–	37000	–	–
1/8	1/4	1-1/2	1/8	0.010	0.0440	38771	–	–	38770	–	–
1/8	1/4	1-1/2	1/8	0.015	0.0440	38525	–	–	37001	–	–
1/8	1/4	1-1/2	1/8	0.030	0.0290	38773	–	–	38772	–	–
1/8	3/8	1-1/2	1/8	–	0.0440	37180	–	–	37002	–	–
1/8	3/8	1-1/2	1/8	0.010	0.0440	38775	–	–	38774	–	–
1/8	3/8	1-1/2	1/8	0.015	0.0440	37181	–	–	37003	–	–
1/8	3/8	1-1/2	1/8	0.030	0.0290	38777	–	–	38776	–	–
3/16	5/16	2	3/16	–	0.0660	38501	–	–	37004	–	–
3/16	5/16	2	3/16	0.010	0.0660	38779	–	–	38778	–	–
3/16	5/16	2	3/16	0.015	0.0660	38526	–	–	37005	–	–
3/16	5/16	2	3/16	0.030	0.0660	38781	–	–	38780	–	–
3/16	1/2	2	3/16	–	0.0660	37182	–	–	37006	–	–
3/16	1/2	2	3/16	0.010	0.0660	38783	–	–	38782	–	–
3/16	1/2	2	3/16	0.015	0.0660	37183	–	–	37007	–	–
3/16	1/2	2	3/16	0.030	0.0660	38785	–	–	38784	–	–
1/4	3/8	2-1/2	1/4	–	0.0880	38502	–	–	37008	–	–
1/4	3/8	2-1/2	1/4	0.010	0.0880	38787	–	–	38786	–	–
1/4	3/8	2-1/2	1/4	0.015	0.0880	38527	–	–	37009	–	–
1/4	3/8	2-1/2	1/4	0.030	0.0880	38528	–	–	37010	–	–
1/4	3/8	2-1/2	1/4	0.060	0.0880	38789	–	–	38788	–	–
1/4	3/8	2-1/2	1/4	0.090	0.0880	38791	–	–	38790	–	–
1/4	1/2	2-1/2	1/4	–	0.0880	37184	–	–	37011	–	–
1/4	1/2	2-1/2	1/4	0.010	0.0880	38793	–	–	38792	–	–
1/4	1/2	2-1/2	1/4	0.015	0.0880	37185	–	–	37012	–	–
1/4	1/2	2-1/2	1/4	0.030	0.0880	37186	–	–	37013	–	–
1/4	1/2	2-1/2	1/4	0.060	0.0880	38795	–	–	38794	–	–
1/4	1/2	2-1/2	1/4	0.090	0.0880	38797	–	–	38796	–	–

continued on next page

TOLERANCES (inch)

1/8-1/4 DIAMETER

DC = +0.0000/-0.0012

DCON = h₆

RE = +0.0000/-0.0020

>1/4-3/8 DIAMETER

DC = +0.0000/-0.0016

DCON = h₆

RE = +0.0000/-0.0020

>3/8-1 DIAMETER

DC = +0.0000/-0.0020

DCON = h₆

RE = +0.0000/-0.0020

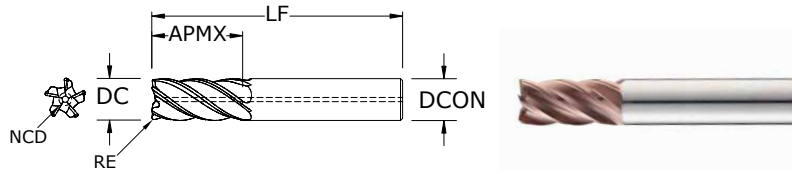
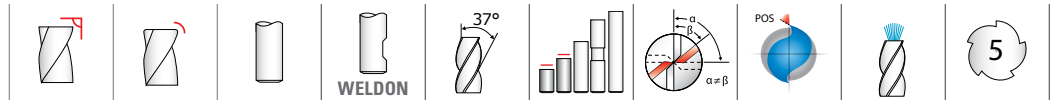

Z5 • Z5CR
FRACTIONAL SERIES

inch						EDP NO.					
CUTTING DIAMETER DC	LENGTH OF CUT APMX	OVERALL LENGTH LF	SHANK DIAMETER DCON	CORNER RADIUS RE	NON-CUTTING CENTER DIAMETER NCD	Ti-NAMITE®-A (TA)	Ti-NAMITE®-A (TA) W/FLAT	Ti-NAMITE®-A (TA) W/INTERNAL COOLANT	Ti-NAMITE®-M (TM)	Ti-NAMITE®-M (TM) W/FLAT	Ti-NAMITE®-M (TM) W/INTERNAL COOLANT
5/16	7/16	2-1/2	5/16	-	0.1090	38503	-	-	37014	-	-
5/16	7/16	2-1/2	5/16	0.010	0.1090	38799	-	-	38798	-	-
5/16	7/16	2-1/2	5/16	0.015	0.1090	38529	-	-	37015	-	-
5/16	7/16	2-1/2	5/16	0.030	0.1090	38801	-	-	38800	-	-
5/16	7/16	2-1/2	5/16	0.060	0.1090	38803	-	-	38802	-	-
5/16	7/16	2-1/2	5/16	0.090	0.0640	38805	-	-	38804	-	-
5/16	5/8	2-1/2	5/16	-	0.1090	38504	-	-	37016	-	-
5/16	5/8	2-1/2	5/16	0.010	0.1090	38807	-	-	38806	-	-
5/16	5/8	2-1/2	5/16	0.015	0.1090	38530	-	-	37017	-	-
5/16	5/8	2-1/2	5/16	0.030	0.1090	38809	-	-	38808	-	-
5/16	5/8	2-1/2	5/16	0.060	0.1090	38811	-	-	38810	-	-
5/16	5/8	2-1/2	5/16	0.090	0.0640	38813	-	-	38812	-	-
3/8	1/2	2-1/2	3/8	-	0.1310	38505	-	-	37018	-	-
3/8	1/2	2-1/2	3/8	0.010	0.1310	38815	-	-	38814	-	-
3/8	1/2	2-1/2	3/8	0.015	0.1310	38531	-	-	37019	-	-
3/8	1/2	2-1/2	3/8	0.030	0.1310	38532	-	-	37020	-	-
3/8	1/2	2-1/2	3/8	0.060	0.1310	38817	-	-	38816	-	-
3/8	1/2	2-1/2	3/8	0.090	0.0830	38819	-	-	38818	-	-
3/8	3/4	2-1/2	3/8	-	0.1310	37187	-	-	37021	-	-
3/8	3/4	2-1/2	3/8	0.010	0.1310	38821	-	-	38820	-	-
3/8	3/4	2-1/2	3/8	0.015	0.1310	37188	-	-	37022	-	-
3/8	3/4	2-1/2	3/8	0.030	0.1310	37189	37174	-	37023	-	-
3/8	3/4	2-1/2	3/8	0.060	0.1310	38823	-	-	38822	-	-
3/8	3/4	2-1/2	3/8	0.090	0.0830	38825	-	-	38824	-	-
7/16	5/8	2-1/2	7/16	0.015	0.1530	37164	-	-	37160	-	-
7/16	5/8	2-1/2	7/16	0.030	0.1530	37165	-	-	37161	-	-
7/16	7/8	2-3/4	7/16	0.015	0.1530	37166	-	-	37162	-	-
7/16	7/8	2-3/4	7/16	0.030	0.1530	37167	-	-	37163	-	-

CONTINUED

continued on next page

FRACTIONAL Z-Carb-HPR

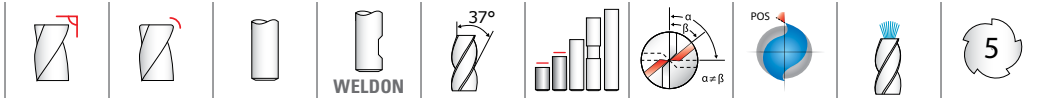

Z5 • Z5CR FRACTIONAL SERIES

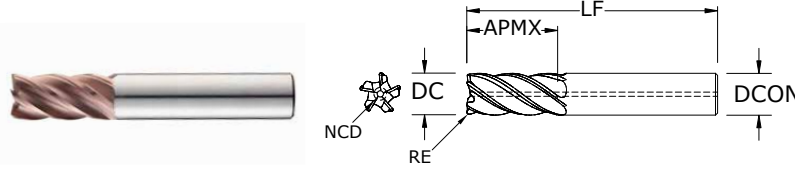

TOLERANCES (inch)

1/8-1/4 DIAMETER
DC = +0.0000/-0.0012
DCON = h_6
RE = +0.0000/-0.0020
>1/4-3/8 DIAMETER
DC = +0.0000/-0.0016
DCON = h_6
RE = +0.0000/-0.0020
>3/8-1 DIAMETER
DC = +0.0000/-0.0020
DCON = h_6
RE = +0.0000/-0.0020

CONTINUED

- An ideal balance of helix, indexing, flute depth, rake and relief
- Variable indexing for chatter suppression and patented edge geometry for shearing and strength
- Chatter-free geometry allows deep cutting and high speed machining
- Central coolant hole delivers coolant effectively to the cutting zone enhancing chip removal when pocketing or slotting
- Excels at roughing, ramping, high speed machining and finishing in a variety of materials
- Enhanced corner geometry with tight tolerance corner radii
- Recommended for materials ≤ 45 HRc (≤ 420 Bhn)

- STEELS
- STAINLESS STEELS
- CAST IRON
- HIGH TEMP ALLOYS

For patent information visit www.ksptpatents.com

inch						EDP NO.					
CUTTING DIAMETER DC	LENGTH OF CUT APMX	OVERALL LENGTH LF	SHANK DIAMETER DCON	CORNER RADIUS RE	NON-CUTTING CENTER DIAMETER NCD	Ti-NAMITE®-A (TA)	Ti-NAMITE®-A (TA) W/FLAT	Ti-NAMITE®-A (TA) W/INTERNAL COOLANT	Ti-NAMITE®-M (TM)	Ti-NAMITE®-M (TM) W/FLAT	Ti-NAMITE®-M (TM) W/INTERNAL COOLANT
						1/2	5/8	3	1/2	-	0.1750
1/2	5/8	3	1/2	0.010	0.1750	38827	38829	38831	38826	38828	38830
1/2	5/8	3	1/2	0.015	0.1750	38533	38578	37330	37025	37031	37331
1/2	5/8	3	1/2	0.030	0.1750	38534	38579	37332	37026	37032	37333
1/2	5/8	3	1/2	0.060	0.1750	38535	38580	37334	37027	37033	37335
1/2	5/8	3	1/2	0.090	0.1750	38536	38581	37337	37028	37034	37338
1/2	5/8	3	1/2	0.120	0.1750	38537	38582	37339	37029	37035	37340
1/2	1	3	1/2	-	0.1750	38507	38513	37322	37036	37042	37323
1/2	1	3	1/2	0.010	0.1750	38833	38835	38837	38832	38834	38836
1/2	1	3	1/2	0.015	0.1750	38538	38583	37341	37037	37043	37342
1/2	1	3	1/2	0.030	0.1750	38539	38584	37343	37038	37044	37344
1/2	1	3	1/2	0.060	0.1750	38540	38585	37345	37039	37045	37346
1/2	1	3	1/2	0.090	0.1750	38541	38586	37348	37040	37046	37349
1/2	1	3	1/2	0.120	0.1750	38542	38587	37350	37041	37047	37351
1/2	1-1/4	3-1/4	1/2	-	0.1750	37190	37194	37325	37048	37054	37324
1/2	1-1/4	3-1/4	1/2	0.010	0.1750	38839	38841	38843	38838	38840	38842
1/2	1-1/4	3-1/4	1/2	0.015	0.1750	37191	37195	37352	37049	37055	37353
1/2	1-1/4	3-1/4	1/2	0.030	0.1750	37192	37196	37354	37050	37056	37355
1/2	1-1/4	3-1/4	1/2	0.060	0.1750	37193	37197	37356	37051	37057	37357
1/2	1-1/4	3-1/4	1/2	0.090	0.1750	38543	38588	37359	37052	37058	37360
1/2	1-1/4	3-1/4	1/2	0.120	0.1750	38544	38589	37361	37053	37059	37362
5/8	3/4	3-1/2	5/8	-	0.2190	38508	38514	38518	37060	37067	37260
5/8	3/4	3-1/2	5/8	0.010	0.2190	38845	38847	38849	38844	38846	38848
5/8	3/4	3-1/2	5/8	0.015	0.2190	38545	38590	38623	37061	37068	37261
5/8	3/4	3-1/2	5/8	0.030	0.2190	38546	38591	38624	37062	37069	37262
5/8	3/4	3-1/2	5/8	0.060	0.2190	38547	38592	38625	37063	37070	37263
5/8	3/4	3-1/2	5/8	0.090	0.2190	38548	38593	38626	37064	37071	37264
5/8	3/4	3-1/2	5/8	0.120	0.2190	38549	38594	38627	37065	37072	37265
5/8	3/4	3-1/2	5/8	0.190	0.2190	38550	38595	38628	37066	37073	37266
5/8	1-1/4	3-1/2	5/8	-	0.2190	37198	37202	38519	37074	37081	37267

continued on next page

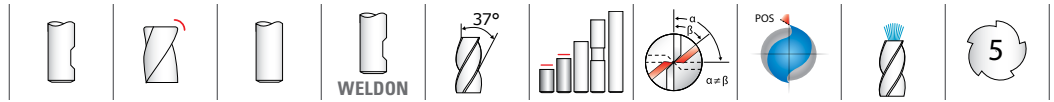

TOLERANCES (inch)

1/8–1/4 DIAMETER

DC = +0.0000/–0.0012

DCON = h_6

RE = +0.0000/–0.0020

>1/4–3/8 DIAMETER

DC = +0.0000/–0.0016

DCON = h_6

RE = +0.0000/–0.0020

>3/8–1 DIAMETER

DC = +0.0000/–0.0020

DCON = h_6

RE = +0.0000/–0.0020

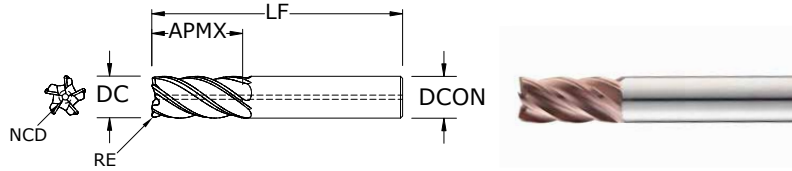

Z5 • Z5CR
FRACTIONAL SERIES

inch						EDP NO.					
CUTTING DIAMETER DC	LENGTH OF CUT APMX	OVERALL LENGTH LF	SHANK DIAMETER DCON	CORNER RADIUS RE	NON-CUTTING CENTER DIAMETER NCD	Ti-NAMITE®-A (TA)		Ti-NAMITE®-A (TA) W/INTERNAL COOLANT		Ti-NAMITE®-M (TM) W/INTERNAL COOLANT	
						TA	TA W/FLAT	TA	TA W/INTERNAL COOLANT	TM	TM W/FLAT
5/8	1-1/4	3-1/2	5/8	0.010	0.2190	38851	38853	38855	38850	38852	38854
5/8	1-1/4	3-1/2	5/8	0.015	0.2190	37199	37203	38629	37075	37082	37268
5/8	1-1/4	3-1/2	5/8	0.030	0.2190	37200	37204	38630	37076	37083	37269
5/8	1-1/4	3-1/2	5/8	0.060	0.2190	37201	37205	38631	37077	37084	37270
5/8	1-1/4	3-1/2	5/8	0.090	0.2190	38551	38596	38632	37078	37085	37271
5/8	1-1/4	3-1/2	5/8	0.120	0.2190	38552	38597	38633	37079	37086	37272
5/8	1-1/4	3-1/2	5/8	0.190	0.2190	38553	38598	38634	37080	37087	37273
3/4	7/8	4	3/4	–	0.2630	38509	38515	38520	37088	37095	37274
3/4	7/8	4	3/4	0.010	0.2630	38857	38859	38861	38856	38858	38860
3/4	7/8	4	3/4	0.030	0.2630	38554	38599	38635	37089	37096	37275
3/4	7/8	4	3/4	0.060	0.2630	38555	38600	38636	37090	37097	37276
3/4	7/8	4	3/4	0.090	0.2630	38556	38601	38637	37091	37098	37277
3/4	7/8	4	3/4	0.120	0.2630	38557	38602	38638	37092	37099	37278
3/4	7/8	4	3/4	0.190	0.2630	38558	38603	38639	37093	37100	37279
3/4	7/8	4	3/4	0.250	0.2630	38559	38604	38640	37094	37101	37280
3/4	1-1/2	4	3/4	–	0.2630	37206	37210	38521	37102	37109	37281
3/4	1-1/2	4	3/4	0.010	0.2630	38863	38865	38867	38862	38864	38866
3/4	1-1/2	4	3/4	0.030	0.2630	37207	37211	38641	37103	37110	37282
3/4	1-1/2	4	3/4	0.060	0.2630	37208	37212	38642	37104	37111	37283
3/4	1-1/2	4	3/4	0.090	0.2630	38560	38605	38643	37105	37112	37284
3/4	1-1/2	4	3/4	0.120	0.2630	37209	37213	38644	37106	37113	37285
3/4	1-1/2	4	3/4	0.190	0.2630	38561	38606	38645	37107	37114	37286
3/4	1-1/2	4	3/4	0.250	0.2630	38562	38607	38646	37108	37115	37287
3/4	1-5/8	4	3/4	0.030	0.2630	37222	–	–	37223	–	–
3/4	1-5/8	4	3/4	0.060	0.2630	37224	–	–	37225	–	–
3/4	1-5/8	4	3/4	0.090	0.2630	37226	–	–	37227	–	–
3/4	1-5/8	4	3/4	0.120	0.2630	37228	–	–	37229	–	–
3/4	2	4-1/2	3/4	0.030	0.2630	37230	–	–	37231	–	–
3/4	2	4-1/2	3/4	0.060	0.2630	37232	–	–	37233	–	–
3/4	2	4-1/2	3/4	0.090	0.2630	37234	–	–	37235	–	–

continued on next page

FRACTIONAL Z-Carb-HPR

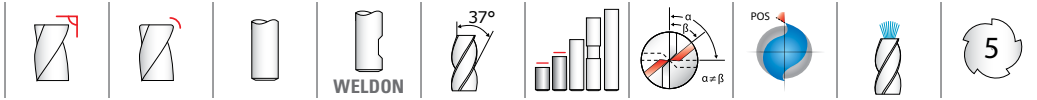

Z5 • Z5CR FRACTIONAL SERIES

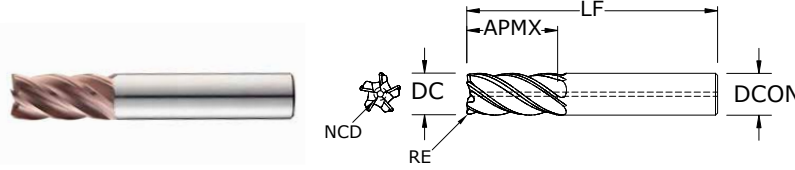

TOLERANCES (inch)

1/8–1/4 DIAMETER
DC = +0.0000/–0.0012
DCON = h_6
RE = +0.0000/–0.0020
>1/4–3/8 DIAMETER
DC = +0.0000/–0.0016
DCON = h_6
RE = +0.0000/–0.0020
>3/8–1 DIAMETER
DC = +0.0000/–0.0020
DCON = h_6
RE = +0.0000/–0.0020

CONTINUED

- An ideal balance of helix, indexing, flute depth, rake and relief
- Variable indexing for chatter suppression and patented edge geometry for shearing and strength
- Chatter-free geometry allows deep cutting and high speed machining
- Central coolant hole delivers coolant effectively to the cutting zone enhancing chip removal when pocketing or slotting
- Excels at roughing, ramping, high speed machining and finishing in a variety of materials
- Enhanced corner geometry with tight tolerance corner radii
- Recommended for materials ≤ 45 HRC (≤ 420 Bhn)

- STEELS
- STAINLESS STEELS
- CAST IRON
- HIGH TEMP ALLOYS

For patent information visit www.ksptpatents.com

inch						EDP NO.					
CUTTING DIAMETER DC	LENGTH OF CUT APMX	OVERALL LENGTH LF	SHANK DIAMETER DCON	CORNER RADIUS RE	NON-CUTTING CENTER DIAMETER NCD	Ti-NAMITE®-A (TA)	Ti-NAMITE®-A (TA) W/FLAT	Ti-NAMITE®-A (TA) W/INTERNAL COOLANT	Ti-NAMITE®-M (TM)	Ti-NAMITE®-M (TM) W/FLAT	Ti-NAMITE®-M (TM) W/INTERNAL COOLANT
3/4	2	4-1/2	3/4	0.120	0.2630	37236	–	–	37237	–	–
1	1-1/8	4	1	–	0.3500	38510	38516	38522	37116	37123	37288
1	1-1/8	4	1	0.010	0.3500	38869	38871	38873	38868	38870	38872
1	1-1/8	4	1	0.030	0.3500	38563	38608	38647	37117	37124	37289
1	1-1/8	4	1	0.060	0.3500	38564	38609	38648	37118	37125	37290
1	1-1/8	4	1	0.090	0.3500	38565	38610	38649	37119	37126	37291
1	1-1/8	4	1	0.120	0.3500	38566	38611	38650	37120	37127	37292
1	1-1/8	4	1	0.190	0.3500	38567	38612	38651	37121	37128	37293
1	1-1/8	4	1	0.250	0.3500	38568	38613	38652	37122	37129	37294
1	1-1/2	4	1	–	0.3500	37214	37218	38523	37130	37137	37295
1	1-1/2	4	1	0.010	0.3500	38875	38877	38879	38874	38876	38878
1	1-1/2	4	1	0.030	0.3500	37215	37219	38653	37131	37138	37296
1	1-1/2	4	1	0.060	0.3500	37216	37220	38654	37132	37139	37297
1	1-1/2	4	1	0.090	0.3500	38569	38614	38655	37133	37140	37298
1	1-1/2	4	1	0.120	0.3500	37217	37221	38656	37134	37141	37299
1	1-1/2	4	1	0.190	0.3500	38570	38615	38657	37135	37142	37300
1	1-1/2	4	1	0.250	0.3500	38571	38616	38658	37136	37143	37301
1	2	4-1/2	1	–	0.3500	38511	38517	38524	37144	37151	37302
1	2	4-1/2	1	0.010	0.3500	38881	38883	38885	38880	38882	38884
1	2	4-1/2	1	0.030	0.3500	38572	38617	38659	37145	37152	37303
1	2	4-1/2	1	0.060	0.3500	38573	38618	38660	37146	37153	37304
1	2	4-1/2	1	0.090	0.3500	38574	38619	38661	37147	37154	37305
1	2	4-1/2	1	0.120	0.3500	38575	38620	38662	37148	37155	37306
1	2	4-1/2	1	0.190	0.3500	38576	38621	38663	37149	37156	37307
1	2	4-1/2	1	0.250	0.3500	38577	38622	38664	37150	37157	37308

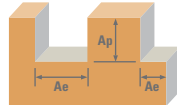

Series	Z5, Z5CR	Hardness	Ae x DC	Ap x DC	Vc (sfm)	DC • in								
						1/8	1/4	3/8	1/2	5/8	3/4	1		
P	CARBON STEELS 1018, 1040, 1080, 1090, 10L50, 1140, 1212, 12L15, 1525, 1536	≤ 275 Bhn or ≤ 28 HRc	Profile	≤ 0.5	≤ 1.5	555 (444-666)	RPM	16961	8480	5654	4240	3392	2827	2120
							Fz	0.00046	0.0012	0.0023	0.0031	0.0034	0.0037	0.0043
							Feed (ipm)	39.0	50.9	65.0	65.7	57.7	52.3	45.6
		≤ 275 Bhn or ≤ 28 HRc	Slot	1	≤ 1	440 (352-528)	RPM	13446	6723	4482	3362	2689	2241	1681
							Fz	0.00046	0.0012	0.0023	0.0031	0.0034	0.0037	0.0043
							Feed (ipm)	30.9	40.3	51.5	52.1	45.7	41.5	36.1
	ALLOY STEELS 4140, 4150, 4320, 5120, 5150, 8630, 86L20, 50100	≤ 375 Bhn or ≤ 40 HRc	Profile	≤ 0.5	≤ 1.5	315 (252-378)	RPM	9626	4813	3209	2407	1925	1604	1203
							Fz	0.00034	0.0009	0.0017	0.0023	0.0026	0.0028	0.0032
							Feed (ipm)	16.4	21.7	27.3	27.7	25.0	22.5	19.3
		≤ 375 Bhn or ≤ 40 HRc	Slot	1	≤ 1	250 (200-300)	RPM	7640	3820	2547	1910	1528	1273	955
							Fz	0.00034	0.0009	0.0017	0.0023	0.0026	0.0028	0.0032
							Feed (ipm)	13.0	17.2	21.6	22.0	19.9	17.8	15.3
TOOL STEELS A2, D2, H13, L2, M2, P20, S7, T15, W2	≤ 375 Bhn or ≤ 40 HRc	Profile	≤ 0.5	≤ 1.5	185 (148-222)	RPM	5654	2827	1885	1413	1131	942	707	
						Fz	0.00028	0.0007	0.0014	0.0018	0.0020	0.0022	0.0026	
						Feed (ipm)	7.9	9.9	13.2	12.7	11.3	10.4	9.2	
	≤ 375 Bhn or ≤ 40 HRc	Slot	1	≤ 1	145 (116-174)	RPM	4431	2216	1477	1108	886	739	554	
						Fz	0.00028	0.0007	0.0014	0.0018	0.0020	0.0022	0.0026	
						Feed (ipm)	6.2	7.8	10.3	10.0	8.9	8.1	7.2	
M	STAINLESS STEELS (FREE MACHINING) 303, 416, 420F, 430F, 440F	≤ 275 Bhn or ≤ 28 HRc	Profile	≤ 0.5	≤ 1.5	490 (392-588)	RPM	14974	7487	4991	3744	2995	2496	1872
							Fz	0.00034	0.0009	0.0017	0.0023	0.0026	0.0028	0.0032
							Feed (ipm)	25.5	33.7	42.4	43.1	38.9	34.9	29.9
		≤ 275 Bhn or ≤ 28 HRc	Slot	1	≤ 1	390 (312-468)	RPM	11918	5959	3973	2980	2384	1986	1490
							Fz	0.00034	0.0009	0.0017	0.0023	0.0026	0.0028	0.0032
							Feed (ipm)	20.3	26.8	33.8	34.3	31.0	27.8	23.8
	STAINLESS STEELS (DIFFICULT) 304, 304L, 316, 316L	≤ 275 Bhn or ≤ 28 HRc	Profile	≤ 0.5	≤ 1.5	340 (272-408)	RPM	10390	5195	3463	2598	2078	1732	1299
							Fz	0.00027	0.0007	0.0014	0.0018	0.0020	0.0022	0.0025
							Feed (ipm)	14.0	18.2	24.2	23.4	20.8	19.0	16.2
		≤ 275 Bhn or ≤ 28 HRc	Slot	1	≤ 1	270 (216-324)	RPM	8251	4126	2750	2063	1650	1375	1031
							Fz	0.00027	0.0007	0.0014	0.0018	0.0020	0.0022	0.0025
							Feed (ipm)	11.1	14.4	19.3	18.6	16.5	15.1	12.9
STAINLESS STEELS (PH) 13-8 PH, 15-5PH, 17-4 PH, CUSTOM 450	≤ 325 Bhn or ≤ 35 HRc	Profile	≤ 0.5	≤ 1.5	310 (248-372)	RPM	9474	4737	3158	2368	1895	1579	1184	
						Fz	0.00027	0.0007	0.0014	0.0018	0.0020	0.0022	0.0025	
						Feed (ipm)	12.8	16.6	22.1	21.3	18.9	17.4	14.8	
	≤ 325 Bhn or ≤ 35 HRc	Slot	1	≤ 1	250 (200-300)	RPM	7640	3820	2547	1910	1528	1273	955	
						Fz	0.00027	0.0007	0.0014	0.0018	0.0020	0.0022	0.0025	
						Feed (ipm)	10.3	13.4	17.8	17.2	15.3	14.0	11.9	
K	CAST IRONS (LOW & MEDIUM ALLOY) Gray, Malleable, Ductile	≤ 220 Bhn or ≤ 19 HRc	Profile	≤ 0.5	≤ 1.5	445 (356-534)	RPM	13599	6800	4533	3400	2720	2267	1700
							Fz	0.00042	0.0011	0.0021	0.0028	0.0031	0.0034	0.0039
							Feed (ipm)	28.6	37.4	47.6	47.6	42.2	38.5	33.1
		≤ 220 Bhn or ≤ 19 HRc	Slot	1	≤ 1	355 (284-426)	RPM	10849	5424	3616	2712	2170	1808	1356
							Fz	0.00042	0.0011	0.0021	0.0028	0.0031	0.0034	0.0039
							Feed (ipm)	22.8	29.8	38.0	38.0	33.6	30.7	26.4
	CAST IRONS (HIGH ALLOY) Gray, Malleable, Ductile	≤ 260 Bhn or ≤ 26 HRc	Profile	≤ 0.5	≤ 1.5	340 (272-408)	RPM	10390	5195	3463	2598	2078	1732	1299
							Fz	0.00031	0.0008	0.0016	0.0021	0.0023	0.0025	0.0029
							Feed (ipm)	16.1	21.8	27.7	27.3	23.9	21.6	18.8
		≤ 260 Bhn or ≤ 26 HRc	Slot	1	≤ 1	270 (216-324)	RPM	8251	4126	2750	2063	1650	1375	1031
							Fz	0.00031	0.0008	0.0016	0.0021	0.0023	0.0025	0.0029
							Feed (ipm)	12.8	17.3	22.0	21.7	19.0	17.2	15.0

continued on next page

FRACTIONAL Z-Carb-HPR

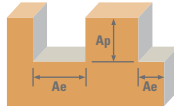

Series Z5, Z5CR Fractional	Hardness	Profile Ae x DC	Ap x DC	Vc (sfm)	DC • in							
					1/8	1/4	3/8	1/2	5/8	3/4	1	
HIGH TEMP ALLOYS (NICKEL, COBALT, IRON BASE) Inconel 601, 617, 625, Incoloy, Monel 400	≤ 300 Bhn or ≤ 32 HRc	Profile Ae ≤ 0.5, Ap ≤ 1.5	80 (64-96)	RPM	2445	1222	815	611	489	407	306	
				Fz	0.00025	0.00068	0.00128	0.00170	0.00187	0.00204	0.00238	
				Feed (ipm)	3.1	4.2	5.2	5.2	4.6	4.2	3.6	
		Slot Ae 1, Ap ≤ 1		RPM	1986	993	662	497	397	331	248	
				Fz	0.00025	0.00068	0.00128	0.00170	0.00187	0.00204	0.00238	
				Feed (ipm)	2.5	3.4	4.2	4.2	3.7	3.4	3.0	
	HIGH TEMP ALLOYS (NICKEL, COBALT, IRON BASE) Inconel 718, X-750, Incoloy, Waspaloy, Hastelloy, Rene	≤ 400 Bhn or ≤ 43 HRc	Profile Ae ≤ 0.5, Ap ≤ 1.5	62 (50-74)	RPM	1895	947	632	474	379	316	237
					Fz	0.00018	0.00048	0.00090	0.00120	0.00130	0.00140	0.00170
					Feed (ipm)	1.7	2.3	2.8	2.8	2.5	2.2	2.0
			Slot Ae 1, Ap ≤ 1		RPM	1528	764	509	382	306	255	191
					Fz	0.00018	0.00048	0.00090	0.00120	0.00130	0.00140	0.00170
					Feed (ipm)	1.4	1.8	2.3	2.3	2.0	1.8	1.6
TITANIUM ALLOYS Pure Titanium, Ti6Al4V, Ti6Al2Sn4Zr2Mo, Ti4Al4Mo2Sn0.5Si		≤ 350 Bhn or ≤ 38 HRc	Profile Ae ≤ 0.5, Ap ≤ 1.5	215 (172-258)	RPM	6570	3285	2190	1643	1314	1095	821
					Fz	0.0003	0.0008	0.0015	0.0020	0.0022	0.0024	0.0028
					Feed (ipm)	9.9	13.1	16.4	16.4	14.5	13.1	11.5
			Slot Ae 1, Ap ≤ 1		RPM	5195	2598	1732	1299	1039	866	649
					Fz	0.0003	0.0008	0.0015	0.0020	0.0022	0.0024	0.0028
					Feed (ipm)	7.8	10.4	13.0	13.0	11.4	10.4	9.1
	TITANIUM ALLOYS (DIFFICULT) Ti10V2Fe3Al, Ti5Al5V5Mo3Cr, Ti7Al4Mo, Ti3Al8V6Cr4Zr4Mo, Ti6Al6V6Sn, Ti15V3Cr3Sn3Al	≤ 420 Bhn or ≤ 45 HRc	Profile Ae ≤ 0.5, Ap ≤ 1.5	75 (60-90)	RPM	2292	1146	764	573	458	382	287
					Fz	0.0003	0.0008	0.0015	0.0020	0.0022	0.0024	0.0028
					Feed (ipm)	3.4	4.6	5.7	5.7	5.0	4.6	4.0
			Slot Ae 1, Ap ≤ 1		RPM	1834	917	611	458	367	306	229
					Fz	0.0003	0.0008	0.0015	0.0020	0.0022	0.0024	0.0028
					Feed (ipm)	2.8	3.7	4.6	4.6	4.0	3.7	3.2

Bhn (Brinell) HRc (Rockwell C)

rpm = Vc x 3.82 / DC

ipm = Fz x 5 x rpm

ramp up to 5 degrees using slotting speed and feed rates. Do not plunge.

reduce speed and feed for materials harder than listed

reduce feed and Ae when finish milling (.02 x DC maximum)

feed rates listed have chip thinning adjustments included where applicable

refer to the SGS Tool Wizard® for complete technical information (www.kyocera-sgstoool.com)

TOLERANCES (mm)

6 DIAMETER

DC = +0,000/-0,030

DCON = h₆

RE = +0,000/-0,050

>6-10 DIAMETER

DC = +0,000/-0,040

DCON = h₆

RE = +0,000/-0,050

>10-25 DIAMETER

DC = +0,000/-0,050

DCON = h₆

RE = +0,000/-0,050

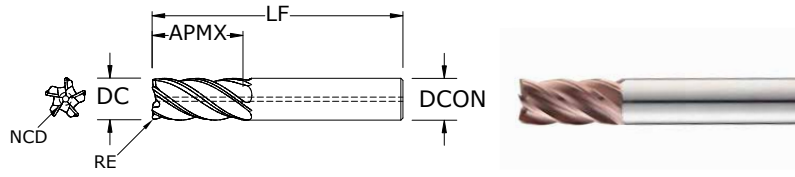
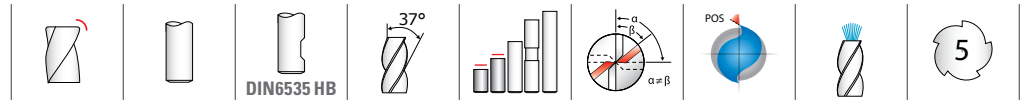

Z5MCR
METRIC SERIES

mm						EDP NO.					
CUTTING DIAMETER DC	LENGTH OF CUT APMX	OVERALL LENGTH LF	SHANK DIAMETER DCON	CORNER RADIUS RE	NON-CUTTING CENTER DIAMETER NCD	Ti-NAMITE®-A (TA)	Ti-NAMITE®-A (TA) W/FLAT	Ti-NAMITE®-A (TA) W/INTERNAL COOLANT	Ti-NAMITE®-M (TM)	Ti-NAMITE®-M (TM) W/FLAT	Ti-NAMITE®-M (TM) W/INTERNAL COOLANT
6,0	9,0	54,0	6,0	0,5	2,11	48000	-	-	47000	-	-
6,0	13,0	57,0	6,0	0,3	2,11	48001	-	-	47001	-	-
6,0	13,0	57,0	6,0	0,5	2,11	47120	-	-	47002	-	-
6,0	13,0	57,0	6,0	1,0	2,11	48002	-	-	47003	-	-
6,0	13,0	57,0	6,0	1,5	2,11	48003	-	-	47004	-	-
8,0	11,0	58,0	8,0	0,5	2,79	48004	-	-	47005	-	-
8,0	18,0	63,0	8,0	0,5	2,79	47121	-	-	47006	-	-
8,0	18,0	63,0	8,0	1,0	2,79	47122	-	-	47007	-	-
8,0	18,0	63,0	8,0	1,5	2,79	48005	-	-	47008	-	-
8,0	18,0	63,0	8,0	2,0	2,79	48006	-	-	47009	-	-
10,0	13,0	66,0	10,0	1,0	3,51	48007	-	-	47010	-	-
10,0	22,0	72,0	10,0	0,5	3,51	47123	-	-	47011	-	-
10,0	22,0	72,0	10,0	1,0	3,51	47124	-	-	47012	-	-
10,0	22,0	72,0	10,0	1,5	3,51	48008	-	-	47013	-	-
10,0	22,0	72,0	10,0	2,0	3,51	48009	-	-	47014	-	-
10,0	22,0	72,0	10,0	2,5	3,51	48010	-	-	47015	-	-
12,0	15,0	73,0	12,0	1,0	4,19	48011	48029	-	47016	47024	-
12,0	26,0	83,0	12,0	0,5	4,19	47125	47128	47160	47017	47025	47161
12,0	26,0	83,0	12,0	0,76	4,19	47126	47129	47162	47018	47026	47163
12,0	26,0	83,0	12,0	1,0	4,19	47127	47130	47164	47019	47027	47165
12,0	26,0	83,0	12,0	1,5	4,19	48012	48030	47166	47020	47028	47167
12,0	26,0	83,0	12,0	2,0	4,19	48013	48031	47168	47021	47029	47169
12,0	26,0	83,0	12,0	2,5	4,19	48014	48032	47170	47022	47030	47171
12,0	26,0	83,0	12,0	3,0	4,19	48015	48033	47172	47023	47031	47173
16,0	19,0	82,0	16,0	1,0	5,59	48016	48034	48056	47032	47039	47046
16,0	19,0	82,0	16,0	1,5	5,59	48070	-	-	48071	-	-
16,0	35,0	92,0	16,0	1,0	5,59	47131	48035	47134	47033	47040	47047
16,0	35,0	92,0	16,0	1,5	5,59	48017	48036	48057	47034	47041	47048

- An ideal balance of helix, indexing, flute depth, rake and relief
- Variable indexing for chatter suppression and patented edge geometry for shearing and strength
- Chatter-free geometry allows deep cutting and high speed machining
- Central coolant hole delivers coolant effectively to the cutting zone enhancing chip removal when pocketing or slotting
- Enhanced corner geometry with tight tolerance corner radii
- Excels at roughing, ramping, high speed machining and finishing in a variety of materials
- Recommended for materials ≤ 45 HRC (≤ 420 Bhn)

- STEELS**
- STAINLESS STEELS**
- CAST IRON**
- HIGH TEMP ALLOYS**

For patent information visit www.ksptpatents.com

continued on next page

METRIC Z-Carb-HPR

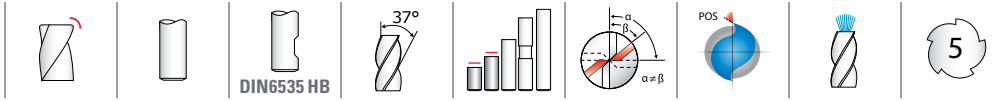

TOLERANCES (mm)

6 DIAMETER
DC = +0,000/-0,030
DCON = h ₆
RE = +0,000/-0,050
>6-10 DIAMETER
DC = +0,000/-0,040
DCON = h ₆
RE = +0,000/-0,050
>10-25 DIAMETER
DC = +0,000/-0,050
DCON = h ₆
RE = +0,000/-0,050

Z5MCR METRIC SERIES

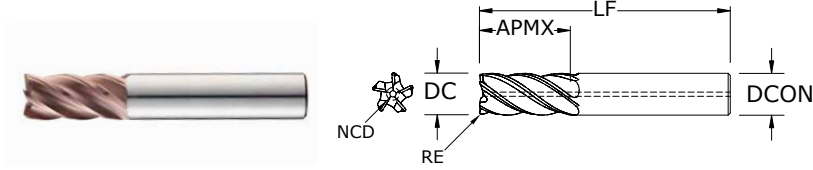

CONTINUED

- An ideal balance of helix, indexing, flute depth, rake and relief
- Variable indexing for chatter suppression and patented edge geometry for shearing and strength
- Chatter-free geometry allows deep cutting and high speed machining
- Central coolant hole delivers coolant effectively to the cutting zone enhancing chip removal when pocketing or slotting
- Enhanced corner geometry with tight tolerance corner radii
- Excels at roughing, ramping, high speed machining and finishing in a variety of materials
- Recommended for materials ≤ 45 HRC (≤ 420 Bhn)

- STEELS
- STAINLESS STEELS
- CAST IRON
- HIGH TEMP ALLOYS

For patent information visit www.ksptpatents.com

mm						EDP NO.					
CUTTING DIAMETER DC	LENGTH OF CUT APMX	OVERALL LENGTH LF	SHANK DIAMETER DCON	CORNER RADIUS RE	NON-CUTTING CENTER DIAMETER NCD	Ti-NAMITE®-A (TA)	Ti-NAMITE®-A (TA) W/FLAT	Ti-NAMITE®-A (TA) W/INTERNAL COOLANT	Ti-NAMITE®-M (TM)	Ti-NAMITE®-M (TM) W/FLAT	Ti-NAMITE®-M (TM) W/INTERNAL COOLANT
16,0	35,0	92,0	16,0	2,0	5,59	47132	48037	47135	47035	47042	47049
16,0	35,0	92,0	16,0	2,5	5,59	48018	48038	48058	47036	47043	47050
16,0	35,0	92,0	16,0	3,0	5,59	47133	48039	47136	47037	47044	47051
16,0	35,0	92,0	16,0	4,0	5,59	48019	48040	48059	47038	47045	47052
20,0	23,0	92,0	20,0	1,0	7,01	48020	48041	48060	47053	47061	47069
20,0	43,0	104,0	20,0	1,0	7,01	47137	48042	47140	47054	47062	47070
20,0	43,0	104,0	20,0	1,5	7,01	48021	48043	48061	47055	47063	47071
20,0	43,0	104,0	20,0	2,0	7,01	47138	48044	47141	47056	47064	47072
20,0	43,0	104,0	20,0	2,5	7,01	48022	48045	48062	47057	47065	47073
20,0	43,0	104,0	20,0	3,0	7,01	47139	48046	47142	47058	47066	47074
20,0	43,0	104,0	20,0	4,0	7,01	48023	48047	48063	47059	47067	47075
20,0	43,0	104,0	20,0	5,0	7,01	48024	48048	48064	47060	47068	47076
25,0	28,0	100,0	25,0	1,0	8,76	48025	48049	48065	47077	47084	47091
25,0	53,0	121,0	25,0	1,0	8,76	47143	48050	47146	47078	47085	47092
25,0	53,0	121,0	25,0	2,0	8,76	47144	48051	47147	47079	47086	47093
25,0	53,0	121,0	25,0	2,5	8,76	48026	48052	48066	47080	47087	47094
25,0	53,0	121,0	25,0	3,0	8,76	47145	48053	47148	47081	47088	47095
25,0	53,0	121,0	25,0	4,0	8,76	48027	48054	48067	47082	47089	47096
25,0	53,0	121,0	25,0	5,0	8,76	48028	48055	48068	47083	47090	47097

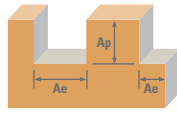

Series Z5MCR Metric	Hardness	Profile Ae x DC	Slot Ap x DC	Vc (m/min)	DC • mm								
					6	8	10	12	16	20	25		
P CARBON STEELS 1018, 1040, 1080, 1090, 10L50, 1140, 1212, 12L15, 1525, 1536	≤ 275 Bhn or ≤ 28 HRc	Profile ≤ 0.5	≤ 1.5	169 (135-203)	RPM	8967	6725	5380	4484	3363	2690	2152	
					Fz	0.029	0.049	0.061	0.074	0.087	0.099	0.108	
					Feed (mm/min)	1291	1650	1650	1668	1463	1327	1157	
		Slot 1	≤ 1	134 (107-161)	RPM	7109	5332	4265	3555	2666	2133	1706	
					Fz	0.029	0.049	0.061	0.074	0.087	0.099	0.108	
					Feed (mm/min)	1024	1308	1308	1322	1160	1052	917	
	≤ 375 Bhn or ≤ 40 HRc	Profile ≤ 0.5	≤ 1.5	96 (77-115)	RPM	5089	3817	3054	2545	1909	1527	1221	
					Fz	0.022	0.036	0.045	0.055	0.067	0.075	0.080	
					Feed (mm/min)	550	692	692	702	635	570	489	
		Slot 1	≤ 1	76 (61-91)	RPM	4039	3029	2424	2020	1515	1212	969	
					Fz	0.022	0.036	0.045	0.055	0.067	0.075	0.080	
					Feed (mm/min)	436	549	549	557	504	452	388	
M TOOL STEELS A2, D2, H13, L2, M2, P20, S7, T15, W2	≤ 375 Bhn or ≤ 40 HRc	Profile ≤ 0.5	≤ 1.5	56 (45-68)	RPM	2989	2242	1793	1495	1121	897	717	
					Fz	0.017	0.030	0.037	0.043	0.051	0.059	0.065	
					Feed (mm/min)	251	335	335	323	287	263	233	
		Slot 1	≤ 1	44 (35-53)	RPM	2343	1757	1406	1171	879	703	562	
					Fz	0.017	0.030	0.037	0.043	0.051	0.059	0.065	
					Feed (mm/min)	197	262	262	253	225	206	183	
	K STAINLESS STEELS (FREE MACHINING) 303, 416, 420F, 430F, 440F	≤ 275 Bhn or ≤ 28 HRc	Profile ≤ 0.5	≤ 1.5	149 (119-179)	RPM	7917	5938	4750	3958	2969	2375	1900
						Fz	0.022	0.036	0.045	0.055	0.067	0.075	0.080
						Feed (mm/min)	855	1077	1077	1092	988	887	760
			Slot 1	≤ 1	119 (95-143)	RPM	6301	4726	3781	3151	2363	1890	1512
						Fz	0.022	0.036	0.045	0.055	0.067	0.075	0.080
						Feed (mm/min)	680	857	857	869	786	706	605
≤ 275 Bhn or ≤ 28 HRc		Profile ≤ 0.5	≤ 1.5	104 (83-124)	RPM	5493	4120	3296	2747	2060	1648	1318	
					Fz	0.017	0.030	0.037	0.043	0.051	0.059	0.063	
					Feed (mm/min)	461	615	615	593	527	483	412	
		Slot 1	≤ 1	82 (66-99)	RPM	4362	3272	2617	2181	1636	1309	1047	
					Fz	0.017	0.030	0.037	0.043	0.051	0.059	0.063	
					Feed (mm/min)	366	489	489	471	419	384	327	
≤ 325 Bhn or ≤ 35 HRc	Profile ≤ 0.5	≤ 1.5	94 (76-113)	RPM	5009	3756	3005	2504	1878	1503	1202		
				Fz	0.017	0.030	0.037	0.043	0.051	0.059	0.063		
				Feed (mm/min)	421	561	561	541	481	441	376		
	Slot 1	≤ 1	76 (61-91)	RPM	4039	3029	2424	2020	1515	1212	969		
				Fz	0.017	0.030	0.037	0.043	0.051	0.059	0.063		
				Feed (mm/min)	339	452	452	436	388	355	303		
K CAST IRONS (LOW & MEDIUM ALLOY) Gray, Malleable, Ductile	≤ 220 Bhn or ≤ 19 HRc	Profile ≤ 0.5	≤ 1.5	136 (109-163)	RPM	7190	5392	4314	3595	2696	2157	1726	
					Fz	0.026	0.045	0.056	0.067	0.079	0.091	0.098	
					Feed (mm/min)	949	1208	1208	1208	1070	978	841	
		Slot 1	≤ 1	108 (87-130)	RPM	5736	4302	3441	2868	2151	1721	1377	
					Fz	0.026	0.045	0.056	0.067	0.079	0.091	0.098	
					Feed (mm/min)	757	964	964	964	853	780	671	
	≤ 260 Bhn or ≤ 26 HRc	Profile ≤ 0.5	≤ 1.5	104 (83-124)	RPM	5493	4120	3296	2747	2060	1648	1318	
					Fz	0.020	0.034	0.043	0.050	0.059	0.067	0.073	
					Feed (mm/min)	554	703	703	692	606	549	478	
		Slot 1	≤ 1	82 (66-99)	RPM	4362	3272	2617	2181	1636	1309	1047	
					Fz	0.020	0.034	0.043	0.050	0.059	0.067	0.073	
					Feed (mm/min)	440	558	558	550	482	436	380	

continued on next page

Z-Carb-HPR

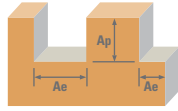

Series Z5MCR Metric	Hardness	Ae x DC	Ap x DC	Vc (m/min)	DC • mm								
					6	8	10	12	16	20	25		
S	HIGH TEMP ALLOYS (NICKEL, COBALT, IRON BASE) Inconel 601, 617, 625, Incoloy, Monel 400	Profile 	≤ 0.5	≤ 1.5	24 (20-29)	RPM	1293	969	776	646	485	388	310
						Fz	0.0160	0.0272	0.0340	0.0409	0.0478	0.0531	0.0599
						Feed (mm/min)	103	132	132	132	116	103	93
		Slot 	1	≤ 1	20 (16-24)	RPM	1050	788	630	525	394	315	252
						Fz	0.0160	0.0272	0.0340	0.0409	0.0478	0.0531	0.0599
						Feed (mm/min)	84	107	107	107	94	84	75
	HIGH TEMP ALLOYS (NICKEL, COBALT, IRON BASE) Inconel 718, X-750, Incoloy, Waspaloy, Hastelloy, Rene	Profile 	≤ 0.5	≤ 1.5	19 (15-23)	RPM	1002	751	601	501	376	301	240
						Fz	0.0112	0.0192	0.0239	0.0284	0.0333	0.0371	0.0420
						Feed (mm/min)	56	72	72	71	63	56	50
		Slot 	1	≤ 1	15 (12-18)	RPM	808	606	485	404	303	242	194
						Fz	0.0112	0.0192	0.0239	0.0284	0.0333	0.0371	0.0420
						Feed (mm/min)	45	58	58	57	50	45	41
TITANIUM ALLOYS Pure Titanium, Ti6Al4V, Ti6Al2Sn4Zr2Mo, Ti4Al4Mo2Sn0.5Si	Profile 	≤ 0.5	≤ 1.5	66 (52-79)	RPM	3474	2605	2084	1737	1303	1042	834	
					Fz	0.019	0.032	0.040	0.048	0.056	0.064	0.070	
					Feed (mm/min)	333	417	417	417	367	333	292	
	Slot 	1	≤ 1	52 (41-62)	RPM	2747	2060	1648	1373	1030	824	659	
					Fz	0.019	0.032	0.040	0.048	0.056	0.064	0.070	
					Feed (mm/min)	264	330	330	330	290	264	231	
TITANIUM ALLOYS (DIFFICULT) Ti10V2Fe3Al, Ti5Al5V5Mo3Cr, Ti7Al4Mo, Ti3Al8V6Cr4Zr4Mo, Ti6Al6V6Sn, Ti15V3 Cr3Sn3Al	Profile 	≤ 0.5	≤ 1.5	23 (18-27)	RPM	1212	909	727	606	454	364	291	
					Fz	0.019	0.032	0.040	0.048	0.056	0.064	0.071	
					Feed (mm/min)	116	145	145	145	128	116	103	
	Slot 	1	≤ 1	18 (15-22)	RPM	969	727	582	485	364	291	233	
					Fz	0.019	0.032	0.040	0.048	0.056	0.064	0.071	
					Feed (mm/min)	93	116	116	116	102	93	83	

Bhn (Brinell) HRC (Rockwell C)
 rpm = (Vc x 1000) / (DC x 3.14)
 mm/min = Fz x 5 x rpm
 ramp up to 5 degrees using slotting speed and feed rates. Do not plunge.
 reduce speed and feed for materials harder than listed
 reduce feed and Ae when finish milling (.02 x DC maximum)
 feed rates listed have chip thinning adjustments included where applicable
 refer to the SGS Tool Wizard® for complete technical information (www.kyocera-sgstool.com)



FRACTIONAL Z-Carb-AP • Z-Carb

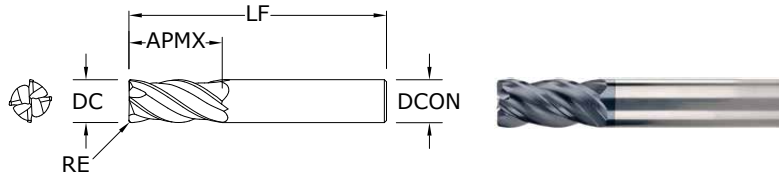
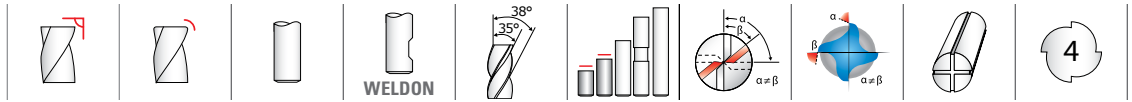

Z1PCR • Z1 • Z16CR FRACTIONAL SERIES

TOLERANCES (inch)

≤1/8 DIAMETER

DC = +0.0005/-0.0005

DCON = h_6

RE = +0.000/-0.0010

>1/4-1/4 DIAMETER

DC = +0.000/-0.0012

DCON = h_6

RE = +0.000/-0.0020

>1/4-3/8 DIAMETER

DC = +0.000/-0.0016

DCON = h_6

RE = +0.000/-0.0020

>3/8-1 DIAMETER

DC = +0.000/-0.0020

DCON = h_6

RE = +0.000/-0.0020

STEELS

STAINLESS STEELS

CAST IRON

HIGH TEMP ALLOYS

For patent information visit www.ksptpatents.com

CUTTING DIAMETER DC	LENGTH OF CUT APMX	OVERALL LENGTH LF	SHANK DIAMETER DCON	CORNER RADIUS RE	EDP NO.			SERIES
					Ti-NAMITE®-X	Ti-NAMITE®-X W/FLAT	JetStream	
1/64	1/32	1-1/2	1/8	0.002	36874*	-	-	Z1PCR
1/32	5/64	1-1/2	1/8	0.005	36875*	-	-	Z1PCR
3/64	7/64	1-1/2	1/8	0.005	36876*	-	-	Z1PCR
1/16	3/16	1-1/2	1/8	0.005	36872*	-	-	Z1PCR
5/64	3/16	1-1/2	1/8	0.005	36877*	-	-	Z1PCR
3/32	9/32	1-1/2	1/8	0.010	36873*	-	-	Z1PCR
7/64	3/8	1-1/2	1/8	0.010	36878*	-	-	Z1PCR
1/8	1/4	1-1/2	1/8	0.015	36505	-	-	Z16CR
1/8	3/8	1-1/2	1/8	-	36404	-	-	Z1
1/8	3/8	1-1/2	1/8	0.010	36370	-	-	Z1PCR
1/8	3/8	1-1/2	1/8	0.015	36851	-	-	Z1PCR
5/32	5/16	2	3/16	0.015	36506	-	-	Z16CR
5/32	7/16	2	3/16	-	36406	-	-	Z1
3/16	3/8	2	3/16	0.015	36507	-	-	Z16CR
3/16	7/16	2	3/16	-	36408	-	-	Z1
3/16	7/16	2	3/16	0.010	36371	-	-	Z1PCR
3/16	7/16	2	3/16	0.015	36852	-	-	Z1PCR
3/16	7/16	2	3/16	0.030	36722	-	-	Z1PCR
7/32	3/8	2	1/4	0.020	36508	-	-	Z16CR
7/32	7/16	2-1/2	1/4	-	36410	-	-	Z1
1/4	7/16	2	1/4	0.020	36509	-	-	Z16CR
1/4	1/2	2-1/2	1/4	-	36416	-	-	Z1
1/4	1/2	2-1/2	1/4	0.010	36372	-	-	Z1PCR
1/4	1/2	2-1/2	1/4	0.015	36723	-	-	Z1PCR
1/4	1/2	2-1/2	1/4	0.020	36853	-	-	Z1PCR
1/4	1/2	2-1/2	1/4	0.030	36373	-	-	Z1PCR
1/4	3/4	2-1/2	1/4	-	36596	-	-	Z1
1/4	3/4	2-1/2	1/4	0.010	36599	-	-	Z1PCR
1/4	3/4	2-1/2	1/4	0.015	36600	-	-	Z1PCR
1/4	3/4	2-1/2	1/4	0.020	36854	-	-	Z1PCR
1/4	3/4	2-1/2	1/4	0.030	36601	-	-	Z1PCR
9/32	5/8	2-1/2	5/16	-	36418	-	-	Z1

*Variable flute spacing. Helix and rake do not vary.

continued on next page

- Variable rake geometry alters and controls the cutting dynamic taking chatter suppression to an unprecedented level
- Unequal helix design changes the cutting angle to improve harmonics
- Unequal flute spacing helps to disrupt the rhythmic pattern created by the cutting edge helping to suppress damaging harmonics
- Enhanced corner geometry with tight tolerance corner radii
- Recommended for materials ≤ 45 HRc (≤ 420 Bhn)

Z-Carb-AP • Z-Carb

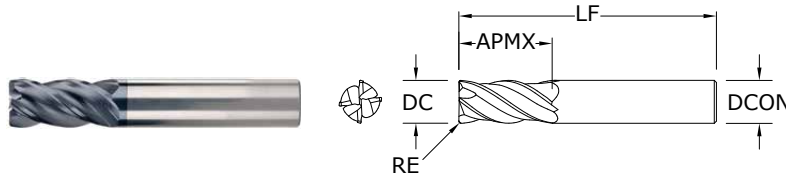
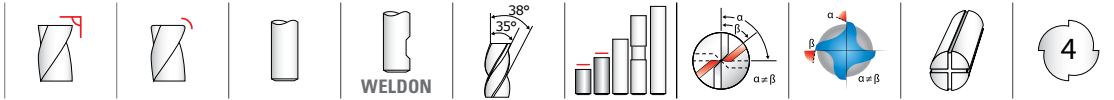

Z1PCR • Z1 • Z16CR

FRACTIONAL SERIES

CONTINUED

CUTTING DIAMETER DC	LENGTH OF CUT APMX	inch			EDP NO.			SERIES
		OVERALL LENGTH LF	SHANK DIAMETER DCON	CORNER RADIUS RE	Ti-NAMITE®-X	Ti-NAMITE®-X W/FLAT	JetStream	
5/16	1/2	2	5/16	0.020	36511	-	-	Z16CR
5/16	13/16	2-1/2	5/16	-	36420	-	-	Z1
5/16	13/16	2-1/2	5/16	0.015	36724	-	-	Z1PCR
5/16	13/16	2-1/2	5/16	0.020	36855	-	-	Z1PCR
5/16	13/16	2-1/2	5/16	0.030	36374	-	-	Z1PCR
11/32	13/16	2-1/2	3/8	-	36422	-	-	Z1
3/8	5/8	2	3/8	0.020	36513	-	-	Z16CR
3/8	7/8	2-1/2	3/8	-	36424	36530	-	Z1
3/8	7/8	2-1/2	3/8	0.010	36375	36701	-	Z1PCR
3/8	7/8	2-1/2	3/8	0.015	36725	36736	-	Z1PCR
3/8	7/8	2-1/2	3/8	0.020	36856	36864	-	Z1PCR
3/8	7/8	2-1/2	3/8	0.030	36376	36702	-	Z1PCR
3/8	7/8	2-1/2	3/8	0.060	36727	36738	-	Z1PCR
13/32	15/16	2-3/4	7/16	-	36426	36531	-	Z1
7/16	5/8	2-1/2	7/16	0.020	36515	-	-	Z16CR
7/16	1	2-3/4	7/16	-	36428	36532	-	Z1
7/16	1	2-3/4	7/16	0.020	36857	36865	-	Z1PCR
15/32	1	3	1/2	-	36430	36533	-	Z1
1/2	5/8	2-1/2	1/2	0.030	36517	-	-	Z16CR
1/2	1	3	1/2	-	36432	36534	36826	Z1
1/2	1	3	1/2	0.010	36378	36704	36804	Z1PCR
1/2	1	3	1/2	0.015	36729	36740	36810	Z1PCR
1/2	1	3	1/2	0.030	36858	36866	36805	Z1PCR
1/2	1	3	1/2	0.060	36380	36706	36811	Z1PCR
1/2	1	3	1/2	0.090	36381	36707	36812	Z1PCR
1/2	1	3	1/2	0.125	36731	36742	36813	Z1PCR
1/2	1-1/4	3-1/4	1/2	-	36597	36598	-	Z1
1/2	1-1/4	3-1/4	1/2	0.010	36602	36603	-	Z1PCR
1/2	1-1/4	3-1/4	1/2	0.015	36604	36605	-	Z1PCR
1/2	1-1/4	3-1/4	1/2	0.030	36859	36867	-	Z1PCR
1/2	1-1/4	3-1/4	1/2	0.060	36610	36611	-	Z1PCR
1/2	1-1/4	3-1/4	1/2	0.090	36612	36613	-	Z1PCR
1/2	1-1/4	3-1/4	1/2	0.125	36614	36615	-	Z1PCR
9/16	1-1/8	3-1/2	9/16	-	36436	36535	36827	Z1

TOLERANCES (inch)

- ≤1/8 DIAMETER**
- DC = +0.0005/-0.0005
- DCON = h₆
- RE = +0.000/-0.0010
- >1/8-1/4 DIAMETER**
- DC = +0.000/-0.0012
- DCON = h₆
- RE = +0.000/-0.0020
- >1/4-3/8 DIAMETER**
- DC = +0.000/-0.0016
- DCON = h₆
- RE = +0.000/-0.0020
- >3/8-1 DIAMETER**
- DC = +0.000/-0.0020
- DCON = h₆
- RE = +0.000/-0.0020

- STEELS
- STAINLESS STEELS
- CAST IRON
- HIGH TEMP ALLOYS

For patent information visit www.ksptpatents.com

continued on next page



FRACTIONAL Z-Carb-AP • Z-Carb

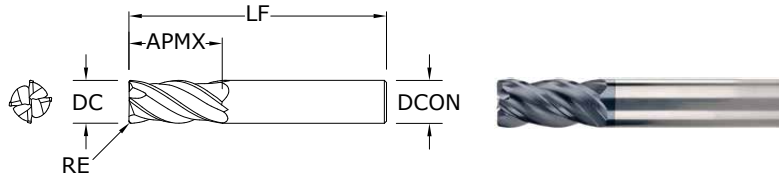
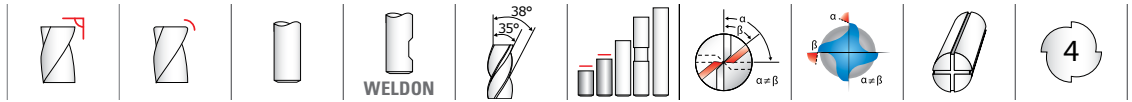

Z1PCR • Z1 • Z16CR

FRACTIONAL SERIES

TOLERANCES (inch)

≤1/8 DIAMETER

DC = +0.0005/-0.0005

DCON = h_6

RE = +0.000/-0.0010

>1/8-1/4 DIAMETER

DC = +0.000/-0.0012

DCON = h_6

RE = +0.000/-0.0020

>1/4-3/8 DIAMETER

DC = +0.000/-0.0016

DCON = h_6

RE = +0.000/-0.0020

>3/8-1 DIAMETER

DC = +0.000/-0.0020

DCON = h_6

RE = +0.000/-0.0020

STEELS

STAINLESS STEELS

CAST IRON

HIGH TEMP ALLOYS

For patent information visit www.ksptpatents.com

CUTTING DIAMETER DC	LENGTH OF CUT APMX	OVERALL LENGTH LF	SHANK DIAMETER DCON	CORNER RADIUS RE	EDP NO.			SERIES
					Ti-NAMITE®-X	Ti-NAMITE®-X W/FLAT	JetStream	
9/16	1-1/8	3-1/2	9/16	0.030	36860	36868	36806	Z1PCR
5/8	3/4	3	5/8	0.040	36519	-	-	Z16CR
5/8	1-1/4	3-1/2	5/8	-	36440	36536	36828	Z1
5/8	1-1/4	3-1/2	5/8	0.030	36383	36709	36814	Z1PCR
5/8	1-1/4	3-1/2	5/8	0.040	36861	36869	36807	Z1PCR
5/8	1-1/4	3-1/2	5/8	0.060	36384	36710	36815	Z1PCR
5/8	1-1/4	3-1/2	5/8	0.090	36385	36711	36816	Z1PCR
5/8	1-1/4	3-1/2	5/8	0.125	36733	36744	36817	Z1PCR
3/4	1	3	3/4	0.040	36520	-	-	Z16CR
3/4	1-1/2	4	3/4	-	36442	36537	36829	Z1
3/4	1-1/2	4	3/4	0.030	36386	36712	36818	Z1PCR
3/4	1-1/2	4	3/4	0.040	36862	36870	36808	Z1PCR
3/4	1-1/2	4	3/4	0.060	36387	36713	36819	Z1PCR
3/4	1-1/2	4	3/4	0.090	36388	36714	36820	Z1PCR
3/4	1-1/2	4	3/4	0.125	36389	36715	36821	Z1PCR
1	1-1/2	4	1	-	36444	36538	36830	Z1
1	1-1/2	4	1	0.030	36390	36716	36822	Z1PCR
1	1-1/2	4	1	0.040	36863	36871	36809	Z1PCR
1	1-1/2	4	1	0.060	36391	36717	36823	Z1PCR
1	1-1/2	4	1	0.090	36392	36718	36824	Z1PCR
1	1-1/2	4	1	0.125	36393	36719	36825	Z1PCR

- Variable rake geometry alters and controls the cutting dynamic taking chatter suppression to an unprecedented level
- Unequal helix design changes the cutting angle to improve harmonics
- Unequal flute spacing helps to disrupt the rhythmic pattern created by the cutting edge helping to suppress damaging harmonics
- Enhanced corner geometry with tight tolerance corner radii
- Recommended for materials ≤ 45 HRc (≤ 420 Bhn)

FRACTIONAL Z-Carb-AP

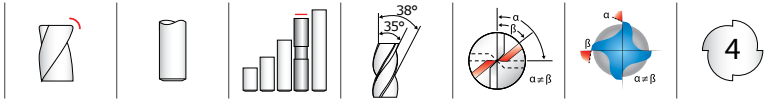

Z1PLC FRACTIONAL SERIES

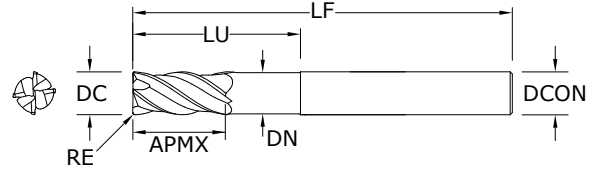

- Variable rake geometry alters and controls the cutting dynamic taking chatter suppression to an unprecedented level
- Unequal helix design changes the cutting angle to improve harmonics
- Unequal flute spacing helps to disrupt the rhythmic pattern created by the cutting edge helping to suppress damaging harmonics
- Long reach design allows for deeper and faster cuts
- Enhanced corner geometry with tight tolerance corner radii
- Recommended for materials ≤ 45 HRC (≤ 420 Bhn)

CUTTING DIAMETER DC	LENGTH OF CUT APMX	OVERALL LENGTH LF	inch				CORNER RADIUS RE	EDP NO. Ti-NAMITE®-X
			SHANK DIAMETER DCON	REACH LU	NECK DIAMETER DN			
1/4	1/2	2-1/2	1/4	1-1/8	.230	.020	36447	
1/4	1/2	3-1/2	1/4	1-5/8	.230	.020	36448	
1/4	1/2	4	1/4	1-1/4	.230	.020	36450	
1/4	1/2	4	1/4	2-1/8	.230	.020	36449	
5/16	13/16	3	5/16	1-3/8	.293	.020	36453	
5/16	13/16	4	5/16	2	.293	.020	36454	
5/16	13/16	4	5/16	1-5/8	.293	.020	36452	
3/8	7/8	3	3/8	1-5/8	.355	.020	36457	
3/8	7/8	5	3/8	1-7/8	.355	.020	36456	
3/8	7/8	4	3/8	2-3/8	.355	.020	36458	
7/16	1	6	7/16	2	.418	.020	36460	
1/2	1	4	1/2	2	.480	.030	36463	
1/2	1	5	1/2	3	.480	.030	36464	
1/2	1	6	1/2	2-1/4	.480	.030	36462	
9/16	1-1/8	6	9/16	2-1/2	.543	.030	36466	
5/8	1-1/4	5	5/8	2-1/2	.605	.040	36468	
5/8	1-1/4	6	5/8	3-3/4	.605	.040	36469	
5/8	1-1/4	6	5/8	3	.605	.040	36470	
3/4	1-1/2	6	3/4	3-1/2	.730	.040	36472	
1	1-1/2	6	1	3	.980	.040	36475	
1	1-1/2	6	1	4	.980	.040	36474	

TOLERANCES (inch)

1/4 DIAMETER

DC = +0.0000/-0.0012
DCON = h_6
RE = +0.000/-0.005

>1/4-3/8 DIAMETER

DC = +0.0000/-0.0016
DCON = h_6
RE = +0.000/-0.005

>3/8-1 DIAMETER

DC = +0.0000/-0.0020
DCON = h_6
RE = +0.000/-0.005

- STEELS
- STAINLESS STEELS
- CAST IRON
- HIGH TEMP ALLOYS

For patent information visit www.ksptpatents.com

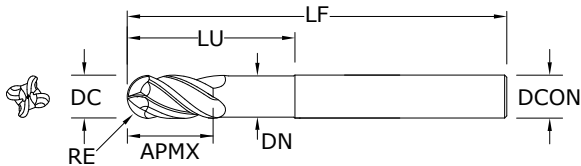

Z1PLB
FRACTIONAL SERIES

TOLERANCES (inch)

1/4 DIAMETER

DC = +0.0000/-0.0012

DCON = h₆

RE = +0.0000/-0.0006

>1/4-3/8 DIAMETER

DC = +0.0000/-0.0016

DCON = h₆

RE = +0.0000/-0.0008

>3/8-1 DIAMETER

DC = +0.0000/-0.0020

DCON = h₆

RE = +0.0000/-0.0010

STEELS

STAINLESS STEELS

CAST IRON

HIGH TEMP ALLOYS

For patent information visit www.ksptpatents.com

inch						EDP NO.
CUTTING DIAMETER DC	LENGTH OF CUT APMX	OVERALL LENGTH LF	SHANK DIAMETER DCON	REACH LU	NECK DIAMETER DN	Ti-NAMITE®-X
1/4	1/2	4	1/4	1-1/4	.230	36480
5/16	13/16	4	5/16	1-5/8	.293	36482
3/8	7/8	5	3/8	1-7/8	.355	36486
7/16	1	6	7/16	2	.418	38490
1/2	1	6	1/2	2-1/4	.480	38492
9/16	1-1/8	6	9/16	2-1/2	.543	38496
5/8	1-1/4	6	5/8	3	.605	36500
3/4	1-1/2	6	3/4	3-1/2	.730	36502
1	1-1/2	6	1	4	.980	36504

RE = 1/2 Cutting Diameter (DC)

- Variable rake geometry alters and controls the cutting dynamic taking chatter suppression to an unprecedented level
- Unequal helix design changes the cutting angle to improve harmonics
- Long reach design allows for deeper and faster cuts
- Ball end design ideal for finishing operations in complex workpieces
- Recommended for materials ≤ 45 HRc (≤ 420 Bhn)

FRACTIONAL Z-Carb-AP

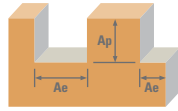

Series
Z1, Z16CR, Z1PCR,
Z1PLC, Z1PLB
Fractional

Material	Hardness	Ae x DC	Ap x DC	Vc (sfm)	DC • in									
					1/64	1/8	1/4	3/8	1/2	5/8	3/4	1		
CARBON STEELS 1018, 1040, 1080, 1090, 10L50, 1140, 1212, 12L15, 1525, 1536	≤ 275 Bhn or ≤ 28 HRc	≤ 0.5	≤ 1.5	555 (444-666)	Profile	RPM	135904	16961	8480	5654	4240	3392	2827	2120
					Fz	0.00005	0.00046	0.0012	0.0023	0.0031	0.0034	0.0037	0.0043	
					Feed (ipm)	27.2	31.2	40.7	52.0	52.6	46.1	41.8	36.5	
					Slot	RPM	107744	13446	6723	4482	3362	2689	2241	1681
					Fz	0.00005	0.00046	0.0012	0.0023	0.0031	0.0034	0.0037	0.0043	
					Feed (ipm)	21.5	24.7	32.3	41.2	41.7	36.6	33.2	28.9	
ALLOY STEELS 4140, 4150, 4320, 5120, 5150, 8630, 86L20, 50100	≤ 375 Bhn or ≤ 40 HRc	≤ 0.5	≤ 1.5	315 (252-378)	Profile	RPM	77135	9626	4813	3209	2407	1925	1604	1203
					Fz	0.00004	0.00034	0.0009	0.0017	0.0023	0.0026	0.0028	0.0032	
					Feed (ipm)	12.3	13.1	17.3	21.8	22.1	20.0	18.0	15.4	
					Slot	RPM	61218	7640	3820	2547	1910	1528	1273	955
					Fz	0.00004	0.00034	0.0009	0.0017	0.0023	0.0026	0.0028	0.0032	
					Feed (ipm)	9.8	10.4	13.8	17.3	17.6	15.9	14.3	12.2	
TOOL STEELS A2, D2, H13, L2, M2, P20, S7, T15, W2	≤ 375 Bhn or ≤ 40 HRc	≤ 0.5	≤ 1.5	185 (148-222)	Profile	RPM	45301	5654	2827	1885	1413	1131	942	707
					Fz	0.00003	0.00028	0.0007	0.0014	0.0018	0.0020	0.0022	0.0026	
					Feed (ipm)	5.4	6.3	7.9	10.6	10.2	9.0	8.3	7.3	
					Slot	RPM	35506	4431	2216	1477	1108	886	739	554
					Fz	0.00003	0.00028	0.0007	0.0014	0.0018	0.0020	0.0022	0.0026	
					Feed (ipm)	4.3	5.0	6.2	8.3	8.0	7.1	6.5	5.8	
STAINLESS STEELS (FREE MACHINING) 303, 416, 420F, 430F, 440F	≤ 275 Bhn or ≤ 28 HRc	≤ 0.5	≤ 1.5	490 (392-588)	Profile	RPM	119987	14974	7487	4991	3744	2995	2496	1872
					Fz	0.00004	0.00034	0.0009	0.0017	0.0023	0.0026	0.0028	0.0032	
					Feed (ipm)	19.2	20.4	27.0	33.9	34.4	31.1	28.0	24.0	
					Slot	RPM	95500	11918	5959	3973	2980	2384	1986	1490
					Fz	0.00004	0.00034	0.0009	0.0017	0.0023	0.0026	0.0028	0.0032	
					Feed (ipm)	15.3	16.2	21.5	27.0	27.4	24.8	22.2	19.1	
STAINLESS STEELS (DIFFICULT) 304, 304L, 316, 316L	≤ 275 Bhn or ≤ 28 HRc	≤ 0.5	≤ 1.5	340 (272-408)	Profile	RPM	83256	10390	5195	3463	2598	2078	1732	1299
					Fz	0.00003	0.00027	0.0007	0.0014	0.0018	0.0020	0.0022	0.0025	
					Feed (ipm)	10.0	11.2	14.5	19.4	18.7	16.6	15.2	13.0	
					Slot	RPM	66115	8251	4126	2750	2063	1650	1375	1031
					Fz	0.00003	0.00027	0.0007	0.0014	0.0018	0.0020	0.0022	0.0025	
					Feed (ipm)	7.9	8.9	11.6	15.4	14.9	13.2	12.1	10.3	
STAINLESS STEELS (PH) 13-8 PH, 15-5 PH, 17-4 PH, Custom 450	≤ 325 Bhn or ≤ 35 HRc	≤ 0.5	≤ 1.5	310 (248-372)	Profile	RPM	75910	9474	4737	3158	2368	1895	1579	1184
					Fz	0.00003	0.00027	0.0007	0.0014	0.0018	0.0020	0.0022	0.0025	
					Feed (ipm)	9.1	10.2	13.3	17.7	17.1	15.2	13.9	11.8	
					Slot	RPM	61218	7640	3820	2547	1910	1528	1273	955
					Fz	0.00003	0.00027	0.0007	0.0014	0.0018	0.0020	0.0022	0.0025	
					Feed (ipm)	7.3	8.3	10.7	14.3	13.8	12.2	11.2	9.6	

continued on next page

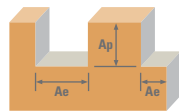

Series
Z1, Z16CR, Z1PCR,
Z1PLC, Z1PLB
Fractional

Series	Hardness	Ae x DC	Ap x DC	Vc (sfm)	DC • in										
					1/64	1/8	1/4	3/8	1/2	5/8	3/4	1			
K	CAST IRONS (LOW & MEDIUM ALLOY) Gray, Malleable, Ductile	≤ 220 Bhn or ≤ 19 HRc	Profile	≤ 0.5	≤ 1.5	445	RPM	108968	13599	6800	4533	3400	2720	2267	1700
						(356-534)	Fz	0.00005	0.00042	0.0011	0.0021	0.0028	0.0031	0.0034	0.0039
						Feed (ipm)	21.8	22.8	29.9	38.1	38.1	33.7	30.8	26.5	
			Slot	1	≤ 1	355	RPM	86929	10849	5424	3616	2712	2170	1808	1356
						(284-426)	Fz	0.00005	0.00042	0.0011	0.0021	0.0028	0.0031	0.0034	0.0039
						Feed (ipm)	17.4	18.2	23.9	30.4	30.4	26.9	24.6	21.2	
	CAST IRONS (HIGH ALLOY) Gray, Malleable, Ductile	≤ 260 Bhn or ≤ 26 HRc	Profile	≤ 0.5	≤ 1.5	340	RPM	83256	10390	5195	3463	2598	2078	1732	1299
						(272-408)	Fz	0.00004	0.00031	0.0008	0.0016	0.0021	0.0023	0.0025	0.0029
						Feed (ipm)	13.3	12.9	17.5	22.2	21.8	19.1	17.3	15.1	
			Slot	1	≤ 1	270	RPM	66115	8251	4126	2750	2063	1650	1375	1031
						(216-324)	Fz	0.00004	0.00031	0.0008	0.0016	0.0021	0.0023	0.0025	0.0029
						Feed (ipm)	10.6	10.2	13.9	17.6	17.3	15.2	13.8	12.0	
S	HIGH TEMP ALLOYS (NICKEL, COBALT, IRON BASE) Inconel 601, 617, 625, Incoloy, Monel 400	≤ 300 Bhn or ≤ 32 HRc	Profile	≤ 0.5	≤ 1.5	80	RPM	19590	2445	1222	815	611	489	407	306
						(64-96)	Fz	0.00003	0.00025	0.0007	0.0013	0.0017	0.0019	0.0020	0.0024
						Feed (ipm)	2.4	2.4	3.3	4.2	4.2	3.7	3.3	2.9	
			Slot	1	≤ 1	65	RPM	15917	1986	993	662	497	397	331	248
						(52-78)	Fz	0.00003	0.00025	0.0007	0.0013	0.0017	0.0019	0.0020	0.0024
						Feed (ipm)	1.9	2.0	2.7	3.4	3.4	3.0	2.7	2.4	
	HIGH TEMP ALLOYS (NICKEL, COBALT, IRON BASE) Inconel 718, X-750, Incoloy, Waspaloy, Hastelloy, Rene	≤ 400 Bhn or ≤ 43 HRc	Profile	≤ 0.5	≤ 1.5	62	RPM	15182	1895	947	632	474	379	316	237
						(50-74)	Fz	0.00002	0.00018	0.0005	0.0009	0.0012	0.0013	0.0014	0.0017
						Feed (ipm)	1.2	1.4	1.8	2.3	2.3	2.0	1.8	1.6	
			Slot	1	≤ 1	50	RPM	12244	1528	764	509	382	306	255	191
						(40-60)	Fz	0.00002	0.00018	0.0005	0.0009	0.0012	0.0013	0.0014	0.0017
						Feed (ipm)	1.0	1.1	1.5	1.8	1.8	1.6	1.4	1.3	
TITANIUM ALLOYS Pure Titanium, Ti6Al4V, Ti6Al2Sn4Zr2Mo, Ti4Al4Mo2Sn0.5Si	≤ 350 Bhn or ≤ 38 HRc	Profile	≤ 0.5	≤ 1.5	215	RPM	52647	6570	3285	2190	1643	1314	1095	821	
					(172-258)	Fz	0.00003	0.0003	0.0008	0.0015	0.0020	0.0022	0.0024	0.0028	
					Feed (ipm)	6.3	7.9	10.5	13.1	13.1	11.6	10.5	9.2		
		Slot	1	≤ 1	170	RPM	41628	5195	2598	1732	1299	1039	866	649	
					(136-204)	Fz	0.00003	0.0003	0.0008	0.0015	0.0020	0.0022	0.0024	0.0028	
					Feed (ipm)	5.0	6.2	8.3	10.4	10.4	9.1	8.3	7.3		
TITANIUM ALLOYS (DIFFICULT) Ti10V2Fe3Al, Ti5Al5V5Mo3Cr, Ti7Al4Mo, Ti3Al8V6Cr4Zr4Mo, Ti6Al6V6Sn, Ti15V3 Cr3Sn3Al	≤ 420 Bhn or ≤ 45 HRc	Profile	≤ 0.5	≤ 1.5	75	RPM	18365	2292	1146	764	573	458	382	287	
					(60-90)	Fz	0.00003	0.0003	0.0008	0.0015	0.0020	0.0022	0.0024	0.0028	
					Feed (ipm)	2.2	2.8	3.7	4.6	4.6	4.0	3.7	3.2		
		Slot	1	≤ 1	60	RPM	14692	1834	917	611	458	367	306	229	
					(48-72)	Fz	0.00003	0.0003	0.0008	0.0015	0.0020	0.0022	0.0024	0.0028	
					Feed (ipm)	1.8	2.2	2.9	3.7	3.7	3.2	2.9	2.6		

Bhn (Brinell) HRc (Rockwell C)

rpm = Vc x 3.82 / DC

ipm = Fz x 4 x rpm

maximum Slotting Ap for Z1PCR <1/8 diameter and all Z1PLC / Z1PLB is .25 x DC

maximum Profile Ae for Z1PCR <1/8 diameter and all Z1PLC / Z1PLB is .20 x DC

reduce speed and feed for materials harder than listed

reduce feed and Ae when finish milling (.02 x DC maximum)

feed rates listed have chip thinning adjustments included where applicable

refer to the SGS Tool Wizard® for complete technical information (www.kyocera-sgstoool.com)

Z-Carb-AP • Z-Carb

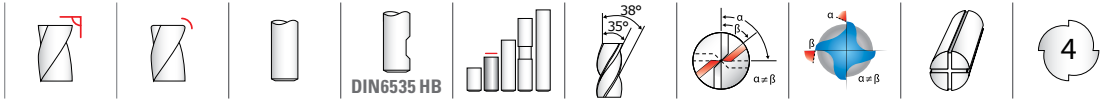

Z1MPCR • Z1M

METRIC SERIES

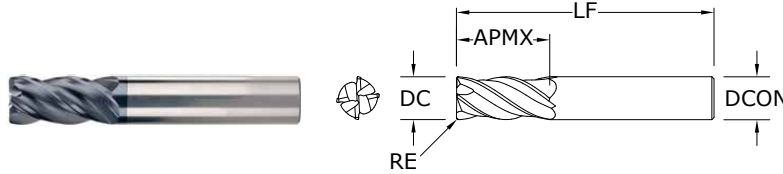

- Variable rake geometry alters and controls the cutting dynamic taking chatter suppression to an unprecedented level
- Unequal helix design changes the cutting angle to improve harmonics
- Unequal flute spacing helps to disrupt the rhythmic pattern created by the cutting edge helping to suppress damaging harmonics
- Enhanced corner geometry with tight tolerance corner radii
- Recommended for materials ≤ 45 HRc (≤ 420 Bhn)

CUTTING DIAMETER DC	LENGTH OF CUT APMX	mm			EDP NO.			SERIES
		OVERALL LENGTH LF	SHANK DIAMETER DCON	CORNER RADIUS RE	Ti-NAMITE®-X	Ti-NAMITE®-X W/FLAT	JetStream	
1,0	3,0	57,0	6,0	0,1	46873*	—	—	Z1MPCR
1,5	4,5	57,0	6,0	0,1	46849*	—	—	Z1MPCR
2,0	6,0	57,0	6,0	0,2	46850*	—	—	Z1MPCR
2,5	7,0	57,0	6,0	0,2	46874*	—	—	Z1MPCR
3,0	8,0	57,0	6,0	—	46357	—	—	Z1M
3,0	8,0	57,0	6,0	0,3	46851	—	—	Z1MPCR
3,0	8,0	57,0	6,0	0,5	46880	—	—	Z1MPCR
4,0	11,0	57,0	6,0	—	46358	—	—	Z1M
4,0	11,0	57,0	6,0	0,3	46852	—	—	Z1MPCR
4,0	11,0	57,0	6,0	0,5	46881	—	—	Z1MPCR
5,0	13,0	57,0	6,0	—	46359	—	—	Z1M
5,0	13,0	57,0	6,0	0,3	46853	—	—	Z1MPCR
6,0	13,0	57,0	6,0	—	46360	—	—	Z1M
6,0	13,0	57,0	6,0	0,25	46882	—	—	Z1MPCR
6,0	13,0	57,0	6,0	0,5	46854	—	—	Z1MPCR
6,0	13,0	57,0	6,0	1,0	46855	—	—	Z1MPCR
6,0	13,0	57,0	6,0	1,5	46884	—	—	Z1MPCR
8,0	19,0	63,0	8,0	—	46362	—	—	Z1M
8,0	19,0	63,0	8,0	0,5	46856	—	—	Z1MPCR
8,0	19,0	63,0	8,0	1,0	46857	—	—	Z1MPCR
8,0	19,0	63,0	8,0	1,5	46886	—	—	Z1MPCR
8,0	19,0	63,0	8,0	2,0	46887	—	—	Z1MPCR
10,0	22,0	72,0	10,0	—	46364	—	—	Z1M
10,0	22,0	72,0	10,0	0,5	46858	—	—	Z1MPCR
10,0	22,0	72,0	10,0	1,0	46859	—	—	Z1MPCR
10,0	22,0	72,0	10,0	1,5	46889	—	—	Z1MPCR
10,0	22,0	72,0	10,0	2,0	46890	—	—	Z1MPCR
10,0	22,0	72,0	10,0	2,5	46891	—	—	Z1MPCR
12,0	26,0	83,0	12,0	—	46366	—	—	Z1M
12,0	26,0	83,0	12,0	0,5	46860	46909	—	Z1MPCR
12,0	26,0	83,0	12,0	0,75	46861	46910	46493	Z1MPCR
12,0	26,0	83,0	12,0	1,0	46893	46911	—	Z1MPCR

*Variable flute spacing. Helix and rake do not vary.

continued on next page

TOLERANCES (mm)

<3 DIAMETER

DC = +0,012/-0,012
 DCON = h₆
 RE = +0,000/-0,025

>3-6 DIAMETER

DC = +0,000/-0,030
 DCON = h₆
 RE = +0,000/-0,050

>6-10 DIAMETER

DC = +0,000/-0,040
 DCON = h₆
 RE = +0,000/-0,050

>10-25 DIAMETER

DC = +0,000/-0,050
 DCON = h₆
 RE = +0,000/-0,050

- STEELS
- STAINLESS STEELS
- CAST IRON
- HIGH TEMP ALLOYS

For patent information visit www.kspatents.com



METRIC Z-Carb-AP • Z-Carb

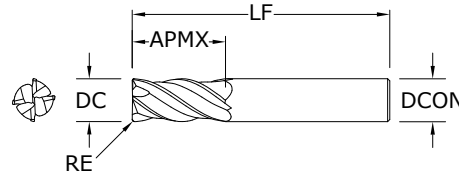
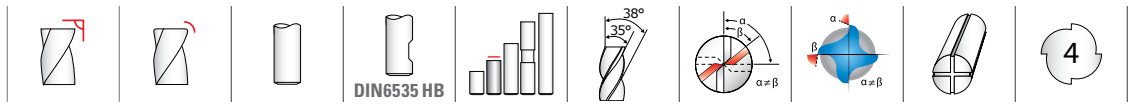

Z1MPCR • Z1M METRIC SERIES

TOLERANCES (mm)

<3 DIAMETER

DC = +0,012/-0,012

DCON = h_6

RE = +0,000/-0,025

>3-6 DIAMETER

DC = +0,000/-0,030

DCON = h_6

RE = +0,000/-0,050

>6-10 DIAMETER

DC = +0,000/-0,040

DCON = h_6

RE = +0,000/-0,050

>10-25 DIAMETER

DC = +0,000/-0,050

DCON = h_6

RE = +0,000/-0,050

STEELS

STAINLESS STEELS

CAST IRON

HIGH TEMP ALLOYS

For patent information visit
www.ksptpatents.com

CUTTING DIAMETER DC	LENGTH OF CUT APMX	OVERALL LENGTH LF	SHANK DIAMETER DCON	CORNER RADIUS RE	EDP NO.			SERIES
					Ti-NAMITE®-X	Ti-NAMITE®-X W/FLAT	JetStream	
12,0	26,0	83,0	12,0	1,5	46894	46912	—	Z1MPCR
12,0	26,0	83,0	12,0	2,0	46895	46913	—	Z1MPCR
12,0	26,0	83,0	12,0	2,5	46896	46914	—	Z1MPCR
12,0	26,0	83,0	12,0	3,0	42718	46915	42719	Z1MPCR
14,0	26,0	83,0	14,0	—	46368	46506	—	Z1M
14,0	26,0	83,0	14,0	1,0	46862	46916	46494	Z1MPCR
16,0	32,0	92,0	16,0	—	46370	46507	—	Z1M
16,0	32,0	92,0	16,0	1,0	46863	46917	46495	Z1MPCR
16,0	32,0	92,0	16,0	1,5	46898	46918	—	Z1MPCR
16,0	32,0	92,0	16,0	2,0	46899	46919	—	Z1MPCR
16,0	32,0	92,0	16,0	2,5	46900	46920	—	Z1MPCR
16,0	32,0	92,0	16,0	3,0	46864	46921	42721	Z1MPCR
16,0	32,0	92,0	16,0	4,0	46867	46944	—	Z1MPCR
18,0	32,0	92,0	18,0	—	46372	46508	—	Z1M
20,0	38,0	104,0	20,0	—	46374	46509	—	Z1M
20,0	38,0	104,0	20,0	1,0	46865	46922	46497	Z1MPCR
20,0	38,0	104,0	20,0	1,5	46903	46923	—	Z1MPCR
20,0	38,0	104,0	20,0	2,0	46904	46924	—	Z1MPCR
20,0	38,0	104,0	20,0	2,5	46905	46925	—	Z1MPCR
20,0	38,0	104,0	20,0	3,0	42722	46926	42723	Z1MPCR
20,0	38,0	104,0	20,0	4,0	46868	46945	—	Z1MPCR
20,0	38,0	104,0	20,0	5,0	46869	46946	—	Z1MPCR
25,0	38,0	104,0	25,0	—	46376	46510	—	Z1M
25,0	38,0	104,0	25,0	1,0	46866	46927	46498	Z1MPCR

- Variable rake geometry alters and controls the cutting dynamic taking chatter suppression to an unprecedented level
- Unequal helix design changes the cutting angle to improve harmonics
- Unequal flute spacing helps to disrupt the rhythmic pattern created by the cutting edge helping to suppress damaging harmonics
- Enhanced corner geometry with tight tolerance corner radii
- Recommended for materials ≤ 45 HRc (≤ 420 Bhn)

METRIC Z-Carb-AP

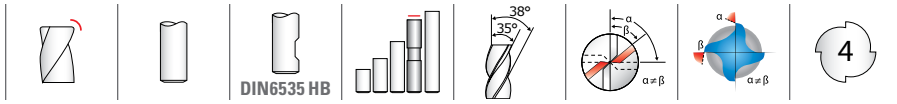

Z1MPIC • Z1MPLC METRIC SERIES

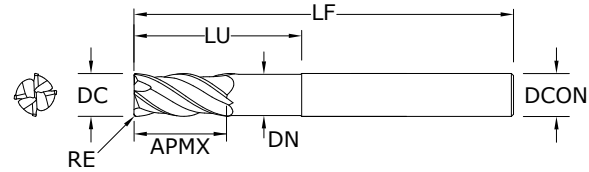

- Variable rake geometry alters and controls the cutting dynamic taking chatter suppression to an unprecedented level
- Unequal helix design changes the cutting angle to improve harmonics
- Unequal flute spacing helps to disrupt the rhythmic pattern created by the cutting edge helping to suppress damaging harmonics
- Long reach design allows for deeper and faster cuts
- Enhanced corner geometry with tight tolerance corner radii
- Recommended for materials ≤ 45 HRc (≤ 420 Bhn)

CUTTING DIAMETER DC	LENGTH OF CUT APMX	OVERALL LENGTH LF	mm				EDP NO.	
			SHANK DIAMETER DCON	REACH LU	NECK DIAMETER DN	CORNER RADIUS RE	Ti-NAMITE®-X	Ti-NAMITE®-X W/FLAT
6,0	8,0	75,0	6,0	24,0	5,49	0,5	46821	—
8,0	10,0	75,0	8,0	32,0	7,49	1,0	46822	—
8,0	10,0	75,0	8,0	32,0	7,49	2,0	46823	—
10,0	12,0	100,0	10,0	40,0	9,50	1,0	46824	—
10,0	12,0	100,0	10,0	40,0	9,50	2,0	46825	—
12,0	15,0	100,0	12,0	48,0	11,48	1,0	46826	46928
12,0	15,0	100,0	12,0	48,0	11,48	1,5	46827	46929
12,0	15,0	100,0	12,0	48,0	11,48	2,0	46828	46930
12,0	15,0	100,0	12,0	48,0	11,48	3,0	46829	46931
12,0	26,0	83,0	12,0	36,0	11,48	2,5	—	42731
12,0	26,0	83,0	12,0	36,0	11,48	3,0	—	42732
12,0	26,0	83,0	12,0	36,0	11,48	4,0	—	42733
16,0	32,0	92,0	16,0	42,0	15,49	2,5	—	42734
16,0	32,0	92,0	16,0	42,0	15,49	4,0	—	42735
16,0	32,0	92,0	16,0	42,0	15,49	6,0	—	42736
16,0	20,0	115,0	16,0	65,0	15,49	1,0	46830	46932
16,0	20,0	115,0	16,0	65,0	15,49	1,5	46831	46933
16,0	20,0	115,0	16,0	65,0	15,49	2,0	46832	46934
16,0	20,0	115,0	16,0	65,0	15,49	3,0	46833	46935
16,0	20,0	115,0	16,0	65,0	15,49	4,0	46834	46936
16,0	20,0	115,0	16,0	65,0	15,49	5,0	46835	46937
20,0	24,0	140,0	20,0	80,0	19,48	1,0	46836	46938
20,0	24,0	140,0	20,0	80,0	19,48	1,5	46837	46939
20,0	24,0	140,0	20,0	80,0	19,48	2,0	46838	46940
20,0	24,0	140,0	20,0	80,0	19,48	3,0	46839	46941
20,0	24,0	140,0	20,0	80,0	19,48	4,0	46840	46942
20,0	24,0	140,0	20,0	80,0	19,48	5,0	46841	46943
20,0	38,0	104,0	20,0	52,0	19,48	2,5	—	42737
20,0	38,0	104,0	20,0	52,0	19,48	4,0	—	42738
20,0	38,0	104,0	20,0	52,0	19,48	6,0	—	42739

TOLERANCES (mm)

6 DIAMETER

DC = +0,000/-0,030

DCON = h_6

RE = +0,000/-0,050

>6-10 DIAMETER

DC = +0,000/-0,040

DCON = h_6

RE = +0,000/-0,050

>10-20 DIAMETER

DC = +0,000/-0,050

DCON = h_6



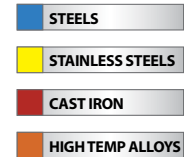

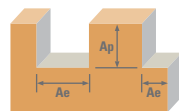

RE = +0,000/-0,050



For patent information visit www.ksptpatents.com



Series
Z1M, Z1MPCR,
Z1MPIC, Z1MPLC
Metric

Series	Hardness	Ae x DC	Ap x DC	Vc (m/min)	DC • mm										
					1	3	6	8	10	12	16	20	25		
P CARBON STEELS 1018, 1040, 1080, 1090, 10L50, 1140, 1212, 12L15, 1525, 1536	≤ 275 Bhn or ≤ 28 HRc	Profile 	≤ 0.5	≤ 1.5	169	RPM	53803	17934	8967	6725	5380	4484	3363	2690	2152
					(135-203)	Fz	0.0030	0.0109	0.029	0.049	0.061	0.074	0.087	0.099	0.108
					Feed (mm/min)	646	782	1040	1318	1313	1327	1170	1065	930	
					134	RPM	42654	14218	7109	5332	4265	3555	2666	2133	1706
					(107-161)	Fz	0.0030	0.0109	0.029	0.049	0.061	0.074	0.087	0.099	0.108
					Feed (mm/min)	512	620	825	1045	1041	1052	928	845	737	
	≤ 375 Bhn or ≤ 40 HRc	Slot 	1	≤ 1	96	RPM	30537	10179	5089	3817	3054	2545	1909	1527	1221
					(77-115)	Fz	0.0023	0.0081	0.022	0.036	0.045	0.055	0.067	0.075	0.080
					Feed (mm/min)	281	330	448	550	550	560	511	458	391	
					76	RPM	24235	8078	4039	3029	2424	2020	1515	1212	969
					(61-91)	Fz	0.0023	0.0081	0.022	0.036	0.045	0.055	0.067	0.075	0.080
					Feed (mm/min)	223	262	355	436	436	444	406	364	310	
≤ 375 Bhn or ≤ 40 HRc	Profile 	≤ 0.5	≤ 1.5	56	RPM	17934	5978	2989	2242	1793	1495	1121	897	717	
				(45-68)	Fz	0.0018	0.0066	0.017	0.030	0.037	0.043	0.051	0.059	0.065	
				Feed (mm/min)	129	158	203	269	265	257	229	212	187		
				44	RPM	14057	4686	2343	1757	1406	1171	879	703	562	
				(35-53)	Fz	0.0018	0.0066	0.017	0.030	0.037	0.043	0.051	0.059	0.065	
				Feed (mm/min)	101	124	159	211	208	201	179	166	146		
M STAINLESS STEELS (FREE MACHINING) 303, 416, 420F, 430F, 440F	≤ 275 Bhn or ≤ 28 HRc	Profile 	≤ 0.5	≤ 1.5	149	RPM	47501	15834	7917	5938	4750	3958	2969	2375	1900
					(119-179)	Fz	0.0023	0.0081	0.022	0.036	0.045	0.055	0.067	0.075	0.080
					Feed (mm/min)	437	513	697	855	855	871	796	713	608	
					119	RPM	37807	12602	6301	4726	3781	3151	2363	1890	1512
					(95-143)	Fz	0.0023	0.0081	0.022	0.036	0.045	0.055	0.067	0.075	0.080
					Feed (mm/min)	348	408	555	681	681	693	633	567	484	
	≤ 275 Bhn or ≤ 28 HRc	Slot 	1	≤ 1	104	RPM	32960	10987	5493	4120	3296	2747	2060	1648	1318
					(83-124)	Fz	0.0018	0.0064	0.017	0.030	0.037	0.043	0.051	0.059	0.063
					Feed (mm/min)	237	281	374	494	488	472	420	389	332	
					82	RPM	26174	8725	4362	3272	2617	2181	1636	1309	1047
					(66-99)	Fz	0.0018	0.0064	0.017	0.030	0.037	0.043	0.051	0.059	0.063
					Feed (mm/min)	188	223	297	393	387	375	334	309	264	
≤ 325 Bhn or ≤ 35 HRc	Profile 	≤ 0.5	≤ 1.5	94	RPM	30052	10017	5009	3756	3005	2504	1878	1503	1202	
				(76-113)	Fz	0.0018	0.0064	0.017	0.030	0.037	0.043	0.051	0.059	0.063	
				Feed (mm/min)	216	256	341	451	445	431	383	355	303		
				76	RPM	24235	8078	4039	3029	2424	2020	1515	1212	969	
				(61-91)	Fz	0.0018	0.0064	0.017	0.030	0.037	0.043	0.051	0.059	0.063	
				Feed (mm/min)	174	207	275	364	359	347	309	286	244		

continued on next page

Z-Carb-AP

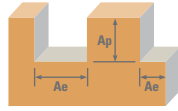

Series
Z1M, Z1MPCR,
Z1MPLC, Z1MPLC
Metric

Metric	Hardness	Ae x DC	Ap x DC	Vc (m/min)	DC • mm											
					1	3	6	8	10	12	16	20	25			
K	CAST IRONS (LOW & MEDIUM ALLOY) Gray, Malleable, Ductile	≤ 220 Bhn or ≤ 19 HRc	Profile	≤ 0.5	≤ 1.5	136	RPM	43139	14380	7190	5392	4314	3595	2696	2157	1726
						Fz	0.0028	0.0099	0.026	0.045	0.056	0.067	0.079	0.091	0.098	
						Feed (mm/min)	483	569	748	971	966	963	852	785	676	
			Slot	1	≤ 1	108	RPM	34414	11471	5736	4302	3441	2868	2151	1721	1377
						Fz	0.0028	0.0099	0.026	0.045	0.056	0.067	0.079	0.091	0.098	
						Feed (mm/min)	385	454	597	774	771	769	680	626	540	
	CAST IRONS (HIGH ALLOY) Gray, Malleable, Ductile	≤ 260 Bhn or ≤ 26 HRc	Profile	≤ 0.5	≤ 1.5	104	RPM	32960	10987	5493	4120	3296	2747	2060	1648	1318
						Fz	0.0020	0.0074	0.020	0.034	0.043	0.050	0.059	0.067	0.074	
						Feed (mm/min)	264	325	439	560	567	549	486	442	390	
			Slot	1	≤ 1	82	RPM	26174	8725	4362	3272	2617	2181	1636	1309	1047
						Fz	0.0020	0.0074	0.020	0.034	0.043	0.050	0.059	0.067	0.074	
						Feed (mm/min)	209	258	349	445	450	436	386	351	310	
S	HIGH TEMP ALLOYS (NICKEL, COBALT, IRON BASE) Inconel 601, 617, 625, Incoloy, Monel 400	≤ 300 Bhn or ≤ 32 HRc	Profile	≤ 0.5	≤ 1.5	24	RPM	7755	2585	1293	969	776	646	485	388	310
						Fz	0.0018	0.0061	0.016	0.027	0.034	0.041	0.048	0.053	0.060	
						Feed (mm/min)	56	63	83	105	105	106	93	82	74	
			Slot	1	≤ 1	20	RPM	6301	2100	1050	788	630	525	394	315	252
						Fz	0.0018	0.0061	0.016	0.027	0.034	0.041	0.048	0.053	0.060	
						Feed (mm/min)	45	51	67	85	86	86	76	67	60	
	HIGH TEMP ALLOYS (NICKEL, COBALT, IRON BASE) Inconel 718, X-750, Incoloy, Waspaloy, Hastelloy, Rene	≤ 400 Bhn or ≤ 43 HRc	Profile	≤ 0.5	≤ 1.5	19	RPM	6010	2003	1002	751	601	501	376	301	240
						Fz	0.0013	0.0043	0.011	0.019	0.024	0.028	0.033	0.037	0.042	
						Feed (mm/min)	31	34	44	57	58	56	50	44	40	
			Slot	1	≤ 1	15	RPM	4847	1616	808	606	485	404	303	242	194
						Fz	0.0013	0.0043	0.011	0.019	0.024	0.028	0.033	0.037	0.042	
						Feed (mm/min)	25	28	36	46	47	45	40	36	33	
TITANIUM ALLOYS Pure Titanium, Ti6Al4V, Ti6Al2Sn4Zr2Mo, Ti4Al4Mo2Sn0.5Si	≤ 350 Bhn or ≤ 38 HRc	Profile	≤ 0.5	≤ 1.5	66	RPM	20842	6947	3474	2605	2084	1737	1303	1042	834	
					Fz	0.0020	0.0071	0.019	0.032	0.040	0.048	0.056	0.064	0.070		
					Feed (mm/min)	167	197	264	333	333	333	292	267	233		
		Slot	1	≤ 1	52	RPM	16480	5493	2747	2060	1648	1373	1030	824	659	
					Fz	0.0020	0.0071	0.019	0.032	0.040	0.048	0.056	0.064	0.070		
					Feed (mm/min)	132	156	209	264	264	264	231	211	185		
TITANIUM ALLOYS (DIFFICULT) Ti10V2Fe3Al, Ti5Al5V5Mo3Cr, Ti7Al4Mo, Ti3Al8V6Cr4Zr4Mo, Ti6Al6V6Sn, Ti15V3 Cr3Sn3Al	≤ 420 Bhn or ≤ 45 HRc	Profile	≤ 0.5	≤ 1.5	23	RPM	7271	2424	1212	909	727	606	454	364	291	
					Fz	0.0020	0.0071	0.019	0.032	0.040	0.048	0.056	0.064	0.070		
					Feed (mm/min)	58	69	92	116	116	116	102	93	81		
		Slot	1	≤ 1	18	RPM	5816	1939	969	727	582	485	364	291	233	
					Fz	0.0020	0.0071	0.019	0.032	0.040	0.048	0.056	0.064	0.070		
					Feed (mm/min)	47	55	74	93	93	93	81	74	65		

Bhn (Brinell) HRc (Rockwell C)
 rpm = (Vc x 1000) / (DC x 3.14)
 mm/min = Fz x 4 x rpm
 maximum Slotting Ap for Z1PCR <3mm diameter and all Z1MPLC / Z1MPLB is .25 x DC
 maximum Profile Ae for Z1PCR <3mm diameter and all Z1MPLC / Z1MPLB is .20 x DC
 reduce speed and feed for materials harder than listed
 reduce feed and Ae when finish milling (.02 x DC maximum)
 feed rates listed have chip thinning adjustments included where applicable
 refer to the SGS Tool Wizard® for complete technical information (www.kyocera-sgstool.com)

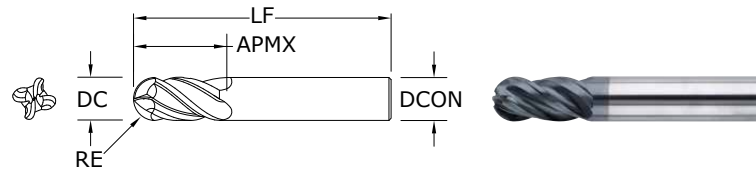
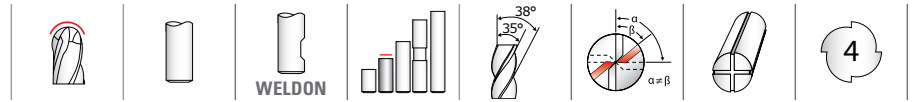

Z1B FRACTIONAL SERIES

TOLERANCES (inch)

1/8–1/4 DIAMETER

DC = +0.0000/–0.0012

DCON = h_6

RE = +0.0000/–0.0006

>1/4–3/8 DIAMETER

DC = +0.0000/–0.0016

DCON = h_6

RE = +0.0000/–0.0008

>3/8–1 DIAMETER

DC = +0.0000/–0.0020

DCON = h_6

RE = +0.0000/–0.0010

STEELS

STAINLESS STEELS

CAST IRON

HIGH TEMP ALLOYS

For patent information visit www.ksptpatents.com





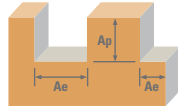

CUTTING DIAMETER DC	LENGTH OF CUT APMX	OVERALL LENGTH LF	SHANK DIAMETER DCON	EDP NO.		
				Ti-NAMITE®-X (TX)	Ti-NAMITE®-X (TX) W/FLAT	JetStream
1/8	3/8	1-1/2	1/8	36358	–	–
5/32	7/16	2	3/16	36357	–	–
3/16	7/16	2	3/16	36359	–	–
7/32	7/16	2-1/2	1/4	36361	–	–
1/4	1/2	2-1/2	1/4	36344	–	–
1/4	3/4	2-1/2	1/4	36590	–	–
9/32	5/8	2-1/2	5/16	36353	–	–
5/16	13/16	2-1/2	5/16	36345	–	–
11/32	13/16	2-1/2	3/8	36354	–	–
3/8	7/8	2-1/2	3/8	36346	36539	–
13/32	15/16	2-3/4	7/16	36355	36540	–
7/16	1	2-3/4	7/16	36347	36541	–
15/32	1	3	1/2	36356	36542	–
1/2	1	3	1/2	36348	36543	36846
1/2	1-1/4	3-1/4	1/2	36591	36592	–
9/16	1-1/8	3-1/2	9/16	36349	36544	36847
5/8	1-1/4	3-1/2	5/8	36350	36545	36848
3/4	1-1/2	4	3/4	36351	36546	36849
1	1-1/2	4	1	36352	36547	36850

RE = 1/2 Cutting Diameter (DC)

- Unequal helix design reduces damaging harmonics by changing the angle at which each cutting edge enters and exits the material
- Unequal flute spacing helps to disrupt the rhythmic pattern created by the cutting edge helping to suppress damaging harmonics
- Optimal material removal rates through increased feed and depths of cut
- Ball end design ideal for finishing operations in complex workpieces
- Recommended for materials ≤ 45 HRc (≤ 420 Bhn)

FRACTIONAL Z-Carb



Series Z1B Fractional	Hardness	Ae x DC	Ap x DC	Vc (sfm)	DC • in									
					1/8	1/4	3/8	1/2	5/8	3/4	1			
P CARBON STEELS 1018, 1040, 1080, 1090, 10L50, 1140, 1212, 12L15, 1525, 1536	≤ 275 Bhn or ≤ 28 HRc	Profile 	≤ 0.5	≤ 1.5	555	RPM	16961	8480	5654	4240	3392	2827	2120	
					(444-666)	Fz	0.0004	0.0010	0.0019	0.0025	0.0031	0.0032	0.0035	
					440	RPM	13446	6723	4482	3362	2689	2241	1681	
					(352-528)	Fz	0.0004	0.0010	0.0019	0.0025	0.0031	0.0032	0.0035	
						Feed (ipm)	25.8	33.9	43.0	42.4	42.1	36.5	29.7	
	≤ 375 Bhn or ≤ 40 HRc	Slot 	1	≤ 1	315	RPM	9626	4813	3209	2407	1925	1604	1203	
					(252-378)	Fz	0.0003	0.0008	0.0014	0.0019	0.0024	0.0025	0.0027	
					250	RPM	7640	3820	2547	1910	1528	1273	955	
					(200-300)	Fz	0.0003	0.0008	0.0014	0.0019	0.0024	0.0025	0.0027	
						Feed (ipm)	10.8	15.4	18.0	18.3	18.5	16.0	13.0	
M TOOL STEELS A2, D2, H13, L2, M2, P20, S7, T15, W2	≤ 375 Bhn or ≤ 40 HRc	Profile 	≤ 0.5	≤ 1.5	185	RPM	5654	2827	1885	1413	1131	942	707	
					(148-222)	Fz	0.0002	0.0005	0.0010	0.0013	0.0016	0.0017	0.0018	
					145	RPM	4431	2216	1477	1108	886	739	554	
					(116-174)	Fz	0.0002	0.0005	0.0010	0.0013	0.0016	0.0017	0.0018	
						Feed (ipm)	4.5	5.7	7.5	7.3	7.2	6.4	5.1	
	M STAINLESS STEELS (FREE MACHINING) 303, 416, 420F, 430F, 440F	≤ 275 Bhn or ≤ 28 HRc	Profile 	≤ 0.5	≤ 1.5	490	RPM	14974	7487	4991	3744	2995	2496	1872
						(392-588)	Fz	0.0003	0.0007	0.0014	0.0018	0.0023	0.0024	0.0025
						390	RPM	11918	5959	3973	2980	2384	1986	1490
						(312-468)	Fz	0.0003	0.0007	0.0014	0.0018	0.0023	0.0024	0.0025
							Feed (ipm)	18.0	21.0	28.0	27.0	27.6	24.0	18.7
≤ 275 Bhn or ≤ 28 HRc		Slot 	1	≤ 1	340	RPM	10390	5195	3463	2598	2078	1732	1299	
					(272-408)	Fz	0.0002	0.0006	0.0011	0.0014	0.0018	0.0019	0.0020	
					270	RPM	8251	4126	2750	2063	1650	1375	1031	
					(216-324)	Fz	0.0002	0.0006	0.0011	0.0014	0.0018	0.0019	0.0020	
						Feed (ipm)	14.3	16.7	22.2	21.5	21.9	19.1	14.9	
M STAINLESS STEELS (DIFFICULT) 304, 304L, 316, 316L	≤ 275 Bhn or ≤ 28 HRc	Profile 	≤ 0.5	≤ 1.5	310	RPM	9474	4737	3158	2368	1895	1579	1184	
					(248-372)	Fz	0.0002	0.0006	0.0011	0.0014	0.0018	0.0019	0.0020	
					250	RPM	7640	3820	2547	1910	1528	1273	955	
					(200-300)	Fz	0.0002	0.0006	0.0011	0.0014	0.0018	0.0019	0.0020	
						Feed (ipm)	7.6	11.4	13.9	13.3	13.6	12.0	9.5	
	≤ 325 Bhn or ≤ 35 HRc	Slot 	1	≤ 1	310	RPM	9474	4737	3158	2368	1895	1579	1184	
					(248-372)	Fz	0.0002	0.0006	0.0011	0.0014	0.0018	0.0019	0.0020	
					250	RPM	7640	3820	2547	1910	1528	1273	955	
					(200-300)	Fz	0.0002	0.0006	0.0011	0.0014	0.0018	0.0019	0.0020	
						Feed (ipm)	6.1	9.2	11.2	10.7	11.0	9.7	7.6	

continued on next page

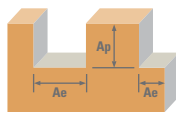

Series	Z1B Fractional	Hardness	Ae x DC	Ap x DC	Vc (sfm)	DC • in							
						1/8	1/4	3/8	1/2	5/8	3/4	1	
K	CAST IRONS (LOW & MEDIUM ALLOY) Gray, Malleable, Ductile	≤ 220 Bhn or ≤ 19 HRc	Profile ≤ 0.5	≤ 1.5	445	RPM	13599	6800	4533	3400	2720	2267	1700
					(356-534)	Fz	0.0004	0.0010	0.0018	0.0024	0.0030	0.0031	0.0034
						Feed (ipm)	19.0	27.2	32.6	32.6	28.1	23.1	
					355	RPM	10849	5424	3616	2712	2170	1808	1356
					(284-426)	Fz	0.0004	0.0010	0.0018	0.0024	0.0030	0.0031	0.0034
						Feed (ipm)	15.2	21.7	26.0	26.0	22.4	18.4	
	CAST IRONS (HIGH ALLOY) Gray, Malleable, Ductile	≤ 260 Bhn or ≤ 26 HRc	Profile ≤ 0.5	≤ 1.5	340	RPM	10390	5195	3463	2598	2078	1732	1299
					(272-408)	Fz	0.0003	0.0007	0.0014	0.0018	0.0023	0.0024	0.0025
						Feed (ipm)	12.5	14.5	19.4	18.7	19.1	16.6	13.0
					270	RPM	8251	4126	2750	2063	1650	1375	1031
					(216-324)	Fz	0.0003	0.0007	0.0014	0.0018	0.0023	0.0024	0.0025
						Feed (ipm)	9.9	11.6	15.4	14.9	15.2	13.2	10.3
S	HIGH TEMP ALLOYS (NICKEL, COBALT, IRON BASE) Inconel 601, 617, 625, Incoloy, Monel 400	≤ 300 Bhn or ≤ 32 HRc	Profile ≤ 0.5	≤ 1.5	80	RPM	2445	1222	815	611	489	407	306
					(64-96)	Fz	0.0002	0.0004	0.0008	0.0010	0.0013	0.0014	0.0015
						Feed (ipm)	2.2	2.0	2.6	2.4	2.5	2.3	1.8
					65	RPM	1986	993	662	497	397	331	248
					(52-78)	Fz	0.0002	0.0004	0.0008	0.0010	0.0013	0.0014	0.0015
						Feed (ipm)	1.6	1.6	2.1	2.0	2.1	1.9	1.5
	HIGH TEMP ALLOYS (NICKEL, COBALT, IRON BASE) Inconel 718, X-750, Incoloy, Waspaloy, Hastelloy, Rene	≤ 400 Bhn or ≤ 43 HRc	Profile ≤ 0.5	≤ 1.5	62	RPM	1895	947	632	474	379	316	237
					(50-74)	Fz	0.0001	0.0003	0.0005	0.0007	0.0008	0.0009	0.0010
						Feed (ipm)	0.8	1.1	1.3	1.3	1.2	1.1	0.9
					50	RPM	1497	749	499	374	299	250	187
					(40-60)	Fz	0.0001	0.0003	0.0005	0.0007	0.0008	0.0009	0.0010
						Feed (ipm)	0.6	0.9	1.0	1.0	1.0	0.9	0.7
TITANIUM ALLOYS Pure Titanium, Ti6Al4V, Ti6Al2Sn4Zr2Mo, Ti4Al4Mo2Sn0.5Si	≤ 350 Bhn or ≤ 38 HRc	Profile ≤ 0.5	≤ 1.5	215	RPM	6570	3285	2190	1643	1314	1095	821	
				(172-258)	Fz	0.0002	0.0005	0.0010	0.0013	0.0016	0.0017	0.0018	
					Feed (ipm)	5.3	6.6	8.8	8.5	8.4	7.4	5.9	
				170	RPM	5195	2598	1732	1299	1039	866	649	
				(136-204)	Fz	0.0002	0.0005	0.0010	0.0013	0.0016	0.0017	0.0018	
					Feed (ipm)	4.2	5.2	6.9	6.8	6.6	5.9	4.7	
TITANIUM ALLOYS (DIFFICULT) Ti10V2Fe3Al, Ti5Al5V5Mo3Cr, Ti7Al4Mo, Ti3Al8V6Cr4Zr4Mo, Ti6Al6V6Sn, Ti15V3Cr3Sn3Al	≤ 420 Bhn or ≤ 45 HRc	Profile ≤ 0.5	≤ 1.5	75	RPM	2292	1146	764	573	458	382	287	
				(60-90)	Fz	0.0002	0.0005	0.0010	0.0013	0.0016	0.0017	0.0018	
					Feed (ipm)	1.8	2.3	3.1	3.0	2.9	2.6	2.1	
				60	RPM	1834	917	611	458	367	306	229	
				(48-72)	Fz	0.0002	0.0005	0.0010	0.0013	0.0016	0.0017	0.0018	
					Feed (ipm)	1.5	1.8	2.4	2.4	2.3	2.1	1.7	

Bhn (Brinell) HRc (Rockwell C)
 rpm = Vc x 3.82 / DC
 ipm = Fz x 4 x rpm
 reduce speed and feed for materials harder than listed
 reduce feed and Ae when finish milling (.02 x DC maximum)
 refer to the SGS Tool Wizard® for complete technical information (www.kyocera-sgstoool.com)

METRIC Z-Carb

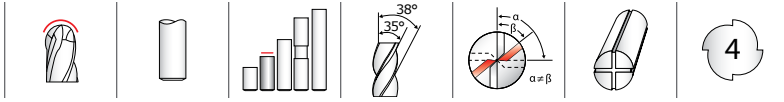

Z1MB METRIC SERIES

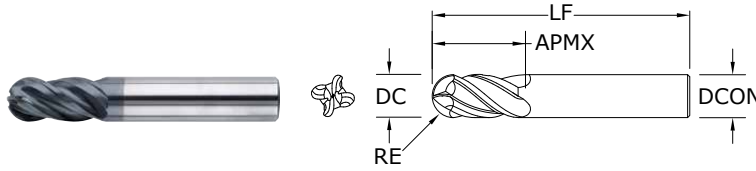

- Unequal helix design reduces damaging harmonics by changing the angle at which each cutting edge enters and exits the material
- Unequal flute spacing helps to disrupt the rhythmic pattern created by the cutting edge helping to suppress damaging harmonics
- Optimal material removal rates through increased feed and depths of cut
- Ball end design ideal for finishing operations in complex workpieces
- Recommended for materials ≤ 45 HRc (≤ 420 Bhn)

CUTTING DIAMETER DC	LENGTH OF CUT APMX	mm		EDP NO.	
		OVERALL LENGTH LF	SHANK DIAMETER DCON	Ti-NAMITE [®] -X (TX)	JetStream
3,0	8,0	57,0	6,0	46354	—
4,0	11,0	57,0	6,0	46355	—
5,0	13,0	57,0	6,0	46356	—
6,0	13,0	57,0	6,0	46343	—
8,0	19,0	63,0	8,0	46344	—
10,0	22,0	72,0	10,0	46345	—
12,0	26,0	83,0	12,0	46346	—
14,0	26,0	83,0	14,0	46347	46518
16,0	32,0	92,0	16,0	46348	46519
18,0	32,0	92,0	18,0	46349	46520
20,0	38,0	104,0	20,0	46350	46521
25,0	38,0	104,0	25,0	46351	46522

RE = 1/2 Cutting Diameter (DC)

TOLERANCES (mm)

3–6 DIAMETER

DC = $+0,000/-0,030$
DCON = h_6

RE = $+0,000/-0,015$

>6–10 DIAMETER

DC = $+0,000/-0,040$

DCON = h_6

RE = $+0,000/-0,020$

>10–25 DIAMETER

DC = $+0,000/-0,050$

DCON = h_6

RE = $+0,000/-0,025$

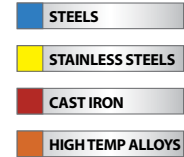

For patent information visit www.kspatents.com

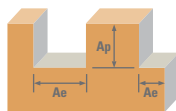

Series Z1MB Metric	Hardness	Ae x DC	Ap x DC	Vc (m/min)	DC • mm										
					3	6	8	10	12	16	20	25			
CARBON STEELS 1018, 1040, 1080, 1090, 10L50, 1140, 1212, 12L15, 1525, 1536	≤ 275 Bhn or ≤ 28 HRc	Profile 	≤ 0.5	≤ 1.5	169	RPM	17934	8967	6725	5380	4484	3363	2690	2152	
					(135-203)	Fz	0.009	0.024	0.041	0.051	0.060	0.079	0.086	0.088	
					Feed (mm/min)	654	861	1091	1090	1076	1067	927	753		
		Slot 	1	≤ 1	134	RPM	14218	7109	5332	4265	3555	2666	2133	1706	
					(107-161)	Fz	0.009	0.024	0.041	0.051	0.060	0.079	0.086	0.088	
					Feed (mm/min)	519	682	865	864	853	846	735	597		
	ALLOY STEELS 4140, 4150, 4320, 5120, 5150, 8630, 86L20, 50100	≤ 375 Bhn or ≤ 40 HRc	Profile 	≤ 0.5	≤ 1.5	96	RPM	10179	5089	3817	3054	2545	1909	1527	1221
						(77-115)	Fz	0.007	0.019	0.030	0.037	0.046	0.061	0.067	0.068
						Feed (mm/min)	274	391	456	456	464	469	407	330	
			Slot 	1	≤ 1	76	RPM	8078	4039	3029	2424	2020	1515	1212	969
						(61-91)	Fz	0.007	0.019	0.030	0.037	0.046	0.061	0.067	0.068
						Feed (mm/min)	217	310	362	362	368	372	323	262	
TOOL STEELS A2, D2, H13, L2, M2, P20, S7, T15, W2		≤ 375 Bhn or ≤ 40 HRc	Profile 	≤ 0.5	≤ 1.5	56	RPM	5978	2989	2242	1793	1495	1121	897	717
						(45-68)	Fz	0.005	0.012	0.021	0.027	0.031	0.041	0.045	0.045
						Feed (mm/min)	115	143	191	191	186	184	163	129	
			Slot 	1	≤ 1	44	RPM	4686	2343	1757	1406	1171	879	703	562
						(35-53)	Fz	0.005	0.012	0.021	0.027	0.031	0.041	0.045	0.045
						Feed (mm/min)	90	112	150	150	146	144	127	101	
	STAINLESS STEELS (FREE MACHINING) 303, 416, 420F, 430F, 440F	≤ 275 Bhn or ≤ 28 HRc	Profile 	≤ 0.5	≤ 1.5	149	RPM	15834	7917	5938	4750	3958	2969	2375	1900
						(119-179)	Fz	0.007	0.017	0.030	0.037	0.043	0.059	0.064	0.063
						Feed (mm/min)	456	532	709	709	684	699	608	475	
			Slot 	1	≤ 1	119	RPM	12602	6301	4726	3781	3151	2363	1890	1512
						(95-143)	Fz	0.007	0.017	0.030	0.037	0.043	0.059	0.064	0.063
						Feed (mm/min)	363	423	565	565	544	557	484	378	
STAINLESS STEELS (DIFFICULT) 304, 304L, 316, 316L		≤ 275 Bhn or ≤ 28 HRc	Profile 	≤ 0.5	≤ 1.5	104	RPM	10987	5493	4120	3296	2747	2060	1648	1318
						(83-124)	Fz	0.005	0.014	0.023	0.029	0.034	0.046	0.051	0.050
						Feed (mm/min)	211	316	387	387	369	380	334	264	
			Slot 	1	≤ 1	82	RPM	8725	4362	3272	2617	2181	1636	1309	1047
						(66-99)	Fz	0.005	0.014	0.023	0.029	0.034	0.046	0.051	0.050
						Feed (mm/min)	168	251	307	307	293	302	265	209	
	STAINLESS STEELS (PH) 13-8 PH, 15-5 PH, 17-4 PH, Custom 450	≤ 325 Bhn or ≤ 35 HRc	Profile 	≤ 0.5	≤ 1.5	94	RPM	10017	5009	3756	3005	2504	1878	1503	1202
						(76-113)	Fz	0.005	0.014	0.023	0.029	0.034	0.046	0.051	0.050
						Feed (mm/min)	192	288	353	353	337	346	305	240	
			Slot 	1	≤ 1	76	RPM	8078	4039	3029	2424	2020	1515	1212	969
						(61-91)	Fz	0.005	0.014	0.023	0.029	0.034	0.046	0.051	0.050
						Feed (mm/min)	155	233	284	284	271	279	246	194	

continued on next page

METRIC Z-Carb

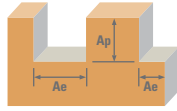

Series Z1MB Metric	Hardness	Ae x DC	Ap x DC	Vc (m/min)	DC • mm									
					3	6	8	10	12	16	20	25		
K	CAST IRONS (LOW & MEDIUM ALLOY) Gray, Malleable, Ductile	≤ 220 Bhn or ≤ 19 HRc	Profile ≤ 0.5	≤ 1.5	136	RPM	14380	7190	5392	4314	3595	2696	2157	1726
					(109-163)	Fz	0.008	0.024	0.038	0.048	0.058	0.077	0.083	0.085
					Feed (mm/min)	483	690	828	828	828	828	713	587	
					108	RPM	11471	5736	4302	3441	2868	2151	1721	1377
					(87-130)	Fz	0.008	0.024	0.038	0.048	0.058	0.077	0.083	0.085
					Feed (mm/min)	385	551	661	661	661	661	569	468	
	CAST IRONS (HIGH ALLOY) Gray, Malleable, Ductile	≤ 260 Bhn or ≤ 26 HRc	Profile ≤ 0.5	≤ 1.5	104	RPM	10987	5493	4120	3296	2747	2060	1648	1318
					(83-124)	Fz	0.007	0.017	0.030	0.037	0.043	0.059	0.064	0.063
					Feed (mm/min)	316	369	492	492	475	485	422	330	
					82	RPM	8725	4362	3272	2617	2181	1636	1309	1047
					(66-99)	Fz	0.007	0.017	0.030	0.037	0.043	0.059	0.064	0.063
					Feed (mm/min)	251	293	391	391	377	385	335	262	
S	HIGH TEMP ALLOYS (NICKEL, COBALT, IRON BASE) Inconel 601, 617, 625, Incoloy, Monel 400	≤ 300 Bhn or ≤ 32 HRc	Profile ≤ 0.5	≤ 1.5	24	RPM	2585	1293	969	776	646	485	388	310
					(20-29)	Fz	0.005	0.010	0.017	0.021	0.024	0.033	0.037	0.038
					Feed (mm/min)	55	50	66	53	62	65	58	47	
					20	RPM	2100	1050	788	630	525	394	315	252
					(16-24)	Fz	0.005	0.010	0.017	0.021	0.024	0.033	0.037	0.038
					Feed (mm/min)	40	40	54	54	50	52	47	38	
	HIGH TEMP ALLOYS (NICKEL, COBALT, IRON BASE) Inconel 718, X-750, Incoloy, Waspaloy, Hastelloy, Rene	≤ 400 Bhn or ≤ 43 HRc	Profile ≤ 0.5	≤ 1.5	19	RPM	2003	1002	751	601	501	376	301	240
					(15-23)	Fz	0.002	0.007	0.011	0.013	0.017	0.020	0.024	0.025
					Feed (mm/min)	19	29	32	32	34	31	29	24	
					15	RPM	1583	792	594	475	396	297	238	190
					(12-18)	Fz	0.002	0.007	0.011	0.013	0.017	0.020	0.024	0.025
					Feed (mm/min)	15	23	25	25	27	24	23	19	
TITANIUM ALLOYS Pure Titanium, Ti6Al4V, Ti6Al2Sn4Zr2Mo, Ti4Al4Mo2Sn0.5Si	≤ 350 Bhn or ≤ 38 HRc	Profile ≤ 0.5	≤ 1.5	66	RPM	6947	3474	2605	2084	1737	1303	1042	834	
				(52-79)	Fz	0.005	0.012	0.021	0.027	0.031	0.041	0.045	0.045	
				Feed (mm/min)	133	167	222	222	217	213	189	150		
				52	RPM	5493	2747	2060	1648	1373	1030	824	659	
				(41-62)	Fz	0.005	0.012	0.021	0.027	0.031	0.041	0.045	0.045	
				Feed (mm/min)	105	132	176	176	171	169	149	119		
TITANIUM ALLOYS (DIFFICULT) Ti10V2Fe3Al, Ti5Al5V5Mo3Cr, Ti7Al4Mo, Ti3Al8V6Cr4Zr4Mo, Ti6Al6V6Sn, Ti15V3 Cr3Sn3Al	≤ 420 Bhn or ≤ 45 HRc	Profile ≤ 0.5	≤ 1.5	23	RPM	2424	1212	909	727	606	454	364	291	
				(18-27)	Fz	0.005	0.012	0.021	0.027	0.031	0.041	0.045	0.045	
				Feed (mm/min)	47	58	78	78	76	74	66	52		
				18	RPM	1939	969	727	582	485	364	291	233	
				(15-22)	Fz	0.005	0.012	0.021	0.027	0.031	0.041	0.045	0.045	
				Feed (mm/min)	37	47	62	62	60	60	53	42		

Bhn (Brinell) HRc (Rockwell C)
 $rpm = (Vc \times 1000) / (DC \times 3.14)$
 $mm/min = Fz \times 4 \times rpm$
 reduce speed and feed for materials harder than listed
 reduce feed and Ae when finish milling (.02 x DC maximum)
 feed rates listed have chip thinning adjustments included where applicable
 refer to the SGS Tool Wizard® for complete technical information (www.kyocera-sgstool.com)

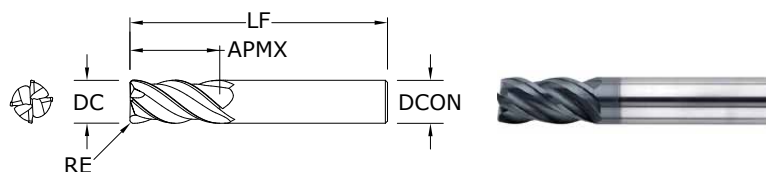
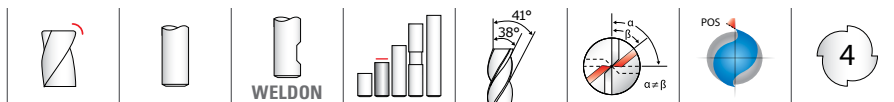

ZH1CR
FRACTIONAL SERIES

TOLERANCES (inch)

1/4 DIAMETER

DC = +0.0000/-0.0012

DCON = h_6

RE = +0.0000/-0.0020

>1/4-3/8 DIAMETER

DC = +0.0000/-0.0016

DCON = h_6

RE = +0.0000/-0.0020

>3/8-1 DIAMETER

DC = +0.0000/-0.0020

DCON = h_6

RE = +0.0000/-0.0020

HIGH TEMP ALLOYS







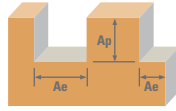

For patent
information visit
www.ksptpatents.com

CUTTING DIAMETER DC	LENGTH OF CUT APMX	inch			EDP NO.	
		OVERALL LENGTH LF	SHANK DIAMETER DCON	CORNER RADIUS RE	Ti-NAMITE®-A (AlTiN)	Ti-NAMITE®-A (AlTiN) W/FLAT
1/4	1/2	2-1/2	1/4	.020	36570	—
1/4	3/4	2-1/2	1/4	.020	36616	—
5/16	13/16	2-1/2	5/16	.020	36571	—
3/8	7/8	2-1/2	3/8	.020	36572	36555
7/16	1	2-3/4	7/16	.020	36573	36556
1/2	1	3	1/2	.030	36574	36557
1/2	1-1/4	3-1/4	1/2	.030	36618	36617
9/16	1-1/8	3-1/2	9/16	.030	36575	36558
5/8	1-1/4	3-1/2	5/8	.040	36576	36559
3/4	1-1/2	4	3/4	.040	36577	36560
1	1-1/2	4	1	.040	36578	36561

- The original Z-Carb design with an enhanced core and higher helix suited for the demands of high temperature alloys
- Unequal flute spacing helps to disrupt the rhythmic pattern created by the cutting edge helping to suppress damaging harmonics
- Optimal material removal rates through increased feed and depths of cut for difficult to machine materials
- Enhanced corner geometry with tight tolerance corner radii
- Recommended for materials ≤ 45 HRc (≤ 420 Bhn)

FRACTIONAL Z-Carb-HTA



Series ZH1CR Fractional	Hardness	Ae x DC	Ap x DC	Vc (sfm)	Diameter (DC) (inch)					
					1/4	3/8	1/2	3/4	1	
HIGH TEMP ALLOYS (NICKEL, COBALT, IRON BASE) Inconel 601, 617, 625, Incoloy, Monel 400	Profile  ≤ 300 Bhn or ≤ 32 HRc	≤ 0.5	≤ 1.5	85	RPM	1299	866	649	433	325
				(68-102)	Fz	0.0007	0.0012	0.0017	0.0020	0.0023
					Feed (ipm)	3.6	4.2	4.4	3.5	3.0
	Slot  1	≤ 1	70	RPM	1070	713	535	357	267	
			(56-84)	Fz	0.0007	0.0012	0.0017	0.0020	0.0023	
				Feed (ipm)	3.0	3.4	3.6	2.9	2.5	
HIGH TEMP ALLOYS (NICKEL, COBALT, IRON BASE) Inconel 718, X-750, Incoloy, Waspaloy, Hastelloy, Rene	Profile  ≤ 400 Bhn or ≤ 43 HRc	≤ 0.5	≤ 1.5	70	RPM	1070	713	535	357	267
				(56-84)	Fz	0.0005	0.0009	0.0012	0.0014	0.0016
					Feed (ipm)	2.1	2.6	2.6	2.0	1.7
	Slot  1	≤ 1	55	RPM	840	560	420	280	210	
			(44-66)	Fz	0.0005	0.0009	0.0012	0.0014	0.0016	
				Feed (ipm)	1.7	2.0	2.0	1.6	1.3	
TITANIUM ALLOYS Pure Titanium, Ti6Al4V, Ti6Al2Sn4Zr2Mo, Ti4Al4Mo2Sn0.5Si	Profile  ≤ 350 Bhn or ≤ 38 HRc	≤ 0.5	≤ 1.5	215	RPM	3285	2190	1643	1095	821
				(172-258)	Fz	0.0008	0.0015	0.0020	0.0024	0.0028
					Feed (ipm)	10.5	13.1	13.1	10.5	9.2
	Slot  1	≤ 1	170	RPM	2598	1732	1299	866	649	
			(136-204)	Fz	0.0008	0.0015	0.0020	0.0024	0.0028	
				Feed (ipm)	8.3	10.4	10.4	8.3	7.3	
TITANIUM ALLOYS (DIFFICULT) Ti10V2Fe3Al, Ti5Al5V5Mo3Cr, Ti7Al4Mo, Ti3Al8V6Cr4Zr4Mo, Ti6Al6V6Sn, Ti15V3 Cr3Sn3Al	Profile  ≤ 420 Bhn or ≤ 45 HRc	≤ 0.5	≤ 1.5	75	RPM	1146	764	573	382	287
				(60-90)	Fz	0.0008	0.0015	0.0020	0.0024	0.0028
					Feed (ipm)	3.7	4.6	4.6	3.7	3.2
	Slot  1	≤ 1	60	RPM	917	611	458	306	229	
			(48-72)	Fz	0.0008	0.0015	0.0020	0.0024	0.0028	
				Feed (ipm)	2.9	3.7	3.7	2.9	2.6	

Bhn (Brinell) HRc (Rockwell C)

$rpm = Vc \times 3.82 / DC$

$ipm = Fz \times 4 \times rpm$

reduce speed and feed for materials harder than listed

reduce feed and Ae when finish milling (.02 x DC maximum)

feed rates listed have chip thinning adjustments included where applicable

refer to the SGS Tool Wizard® for complete technical information (www.kyocera-sgstool.com)

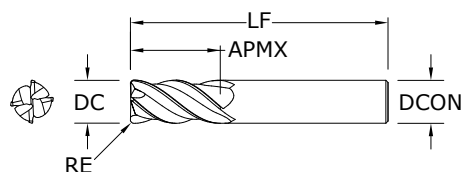

**ZH1MCRS •
ZH1MCR**
METRIC SERIES

TOLERANCES (mm)

6 DIAMETER

DC = +0,000/-0,030

DCON = h_6

RE = +0,000/-0,050

>6-10 DIAMETER

DC = +0,000/-0,040

DCON = h_6

RE = +0,000/-0,050

>10-20 DIAMETER

DC = +0,000/-0,050

DCON = h_6

RE = +0,000/-0,050

HIGH TEMP ALLOYS





For patent
information visit
www.ksptpatents.com

CUTTING DIAMETER DC	LENGTH OF CUT APMX	mm			EDP NO.	
		OVERALL LENGTH LF	SHANK DIAMETER DCON	CORNER RADIUS RE	Ti-NAMITE®-A (AlTiN)	Ti-NAMITE®-A (AlTiN) W/FLAT
6,0	10,0	54,0	6,0	0,5	—	42712
6,0	13,0	57,0	6,0	0,5	46450	—
6,0	13,0	57,0	6,0	1,0	46451	—
6,0	13,0	57,0	6,0	1,5	46452	—
8,0	12,0	58,0	8,0	0,5	—	42713
8,0	19,0	63,0	8,0	0,5	46453	—
8,0	19,0	63,0	8,0	1,0	46454	—
8,0	19,0	63,0	8,0	1,5	46455	—
10,0	14,0	66,0	10,0	0,5	—	42714
10,0	22,0	72,0	10,0	0,5	46456	—
10,0	22,0	72,0	10,0	1,0	46457	—
10,0	22,0	72,0	10,0	1,5	46458	—
10,0	22,0	72,0	10,0	2,0	46459	—
12,0	16,0	73,0	12,0	0,7	—	42715
12,0	26,0	83,0	12,0	0,5	46460	46471
12,0	26,0	83,0	12,0	1,0	46461	46472
12,0	26,0	83,0	12,0	1,5	46462	46473
12,0	26,0	83,0	12,0	2,0	46463	46474
12,0	26,0	83,0	12,0	3,0	46464	46475
16,0	22,0	82,0	16,0	1,0	—	42716
16,0	32,0	92,0	16,0	1,5	46465	46476
16,0	32,0	92,0	16,0	2,0	46466	46477
16,0	32,0	92,0	16,0	3,0	46467	46478
16,0	32,0	92,0	16,0	4,0	46482	46483
20,0	26,0	92,0	20,0	1,0	—	42717
20,0	38,0	104,0	20,0	3,0	46468	46479
20,0	38,0	104,0	20,0	4,0	46469	46480
20,0	38,0	104,0	20,0	5,0	46470	46481

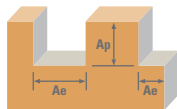
- The original Z-Carb design with an enhanced core and higher helix suited for the demands of high temperature alloys
- Unequal flute spacing helps to disrupt the rhythmic pattern created by the cutting edge helping to suppress damaging harmonics
- Optimal material removal rates through increased feed and depths of cut for difficult to machine materials
- Enhanced corner geometry with tight tolerance corner radii
- Recommended for materials ≤ 45 HRc (≤ 420 Bhn)

Z-Carb-HTA



Series ZH1MCRS, ZH1MCR Metric	Hardness	Ae x DC	Ap x DC	Vc (m/min)	DC • mm					
					6	10	12	20		
HIGH TEMP ALLOYS (NICKEL, COBALT, IRON BASE) Inconel 601, 617, 625, Incoloy, Monel 400	≤ 300 Bhn or ≤ 32 HRc	Profile 	≤ 0.5	≤ 1.5	26	RPM	1373	824	687	412
					(21-31)	Fz	0.017	0.032	0.041	0.053
						Feed (mm/min)	93	105	113	87
					21	RPM	1131	679	565	339
					(17-26)	Fz	0.017	0.032	0.041	0.053
						Feed (mm/min)	77	87	93	72
HIGH TEMP ALLOYS (NICKEL, COBALT, IRON BASE) Inconel 718, X-750, Incoloy, Waspaloy, Hastelloy, Rene	≤ 400 Bhn or ≤ 43 HRc	Profile 	≤ 0.5	≤ 1.5	21	RPM	1131	679	565	339
					(17-26)	Fz	0.012	0.024	0.029	0.037
						Feed (mm/min)	54	65	66	50
					17	RPM	889	533	444	267
					(13-20)	Fz	0.012	0.024	0.029	0.037
						Feed (mm/min)	43	51	52	39
TITANIUM ALLOYS Pure Titanium, Ti6Al4V, Ti6Al2Sn4Zr2Mo, Ti4Al4Mo2Sn0.5Si	≤ 350 Bhn or ≤ 38 HRc	Profile 	≤ 0.5	≤ 1.5	66	RPM	3474	2084	1737	1042
					(52-79)	Fz	0.019	0.041	0.049	0.057
						Feed (mm/min)	264	342	340	238
					52	RPM	2747	1648	1373	824
					(41-62)	Fz	0.019	0.041	0.049	0.057
						Feed (mm/min)	209	270	269	188
TITANIUM ALLOYS (DIFFICULT) Ti10V2Fe3Al, Ti5Al5V5Mo3Cr, Ti7Al4Mo, Ti3Al8V6Cr4Zr4Mo, Ti6Al6V6Sn, Ti15V3 Cr3Sn3Al	≤ 420 Bhn or ≤ 45 HRc	Profile 	≤ 0.5	≤ 1.5	23	RPM	1212	727	606	364
					(18-27)	Fz	0.019	0.041	0.049	0.057
						Feed (mm/min)	92	119	119	83
					18	RPM	969	582	485	291
					(15-22)	Fz	0.019	0.041	0.049	0.057
						Feed (mm/min)	74	95	95	66

Bhn (Brinell) HRc (Rockwell C)
 rpm = (Vc x 1000) / (DC x 3.14)
 ipm = Fz x 4 x rpm
 reduce speed and feed for materials harder than listed
 reduce feed and Ae when finish milling (.02 x DC maximum)
 feed rates listed have chip thinning adjustments included where applicable
 refer to the SGS Tool Wizard® for complete technical information (www.kyocera-sgstool.com)

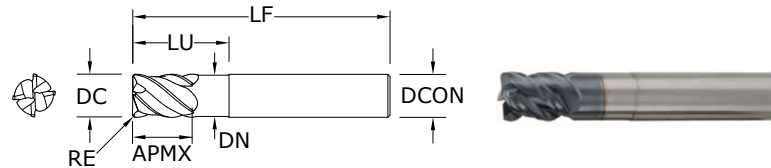

ZD1CR FRACTIONAL SERIES

TOLERANCES (inch)

1/8-1/4 DIAMETER

DC = +0.0000/-0.0012

DCON = h_6

RE = +0.0000/-0.0020

>1/4-3/8 DIAMETER

DC = +0.0000/-0.0016

DCON = h_6

RE = +0.0000/-0.0020

>3/8-3/4 DIAMETER

DC = +0.0000/-0.0020

DCON = h_6

RE = +0.0000/-0.0020

STEELS

HARDENED STEELS

For patent information visit www.ksptpatents.com

CUTTING DIAMETER DC	LENGTH OF CUT APMX	OVERALL LENGTH LF	inch				CORNER RADIUS RE	EDP NO. Ti-NAMITE®-X
			SHANK DIAMETER DCON	REACH LU	NECK DIAMETER DN			
1/8	5/32	2-1/2	1/4	1/2	.110	.010	36780	
3/16	7/32	2-1/2	1/4	3/4	.172	.020	36781	
1/4	9/32	2-1/2	1/4	3/4	.235	.020	36782	
5/16	13/32	2-1/2	5/16	1	.297	.040	36783	
3/8	15/32	2-1/2	3/8	1	.360	.040	36784	
7/16	9/16	2-3/4	7/16	1	.422	.040	36785	
1/2	5/8	3	1/2	1-1/4	.485	.040	36786	
1/2	5/8	4-1/2	1/2	2-1/4	.485	.040	36787	
5/8	3/4	3-1/2	5/8	1-1/2	.610	.040	36788	
5/8	3/4	4-1/2	5/8	2-1/4	.610	.040	36789	
5/8	3/4	5-1/2	5/8	3-1/4	.610	.040	36790	
3/4	15/16	4	3/4	1-3/4	.735	.060	36791	
3/4	15/16	4-1/2	3/4	2-1/4	.735	.060	36792	
3/4	15/16	5-1/2	3/4	3-1/4	.735	.060	36793	

- The original Z-Carb design with negative rake, heavy core, and higher helix for strength and shearing of hard mold & die materials
- Unequal flute spacing helps to disrupt the rhythmic pattern created by the cutting edge helping to suppress damaging harmonics
- Enhanced corner geometry with tight tolerance corner radii
- Recommended for materials 35-60HRC (327 to 654 Bhn)

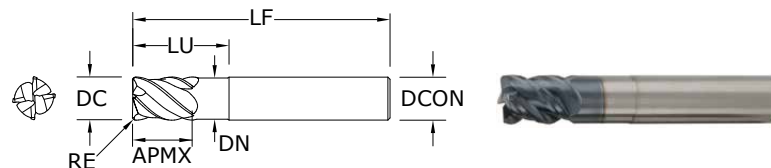

ZD1MCR METRIC SERIES

TOLERANCES (mm)

3-6 DIAMETER

DC = +0,000/-0,030

DCON = h_6

RE = +0,000/-0,050

>6-10 DIAMETER

DC = +0,000/-0,040

DCON = h_6

RE = +0,000/-0,050

>10-20 DIAMETER

DC = +0,000/-0,050

DCON = h_6

RE = +0,000/-0,050

STEELS

HARDENED STEELS

For patent information visit www.ksptpatents.com

CUTTING DIAMETER DC	LENGTH OF CUT APMX	OVERALL LENGTH LF	mm				CORNER RADIUS RE	EDP NO. Ti-NAMITE®-X
			SHANK DIAMETER DCON	REACH LU	NECK DIAMETER DN			
3,0	4,0	57,0	6,0	15,0	2,62	0,2	46560	
4,0	5,0	57,0	6,0	15,0	3,61	0,3	46561	
5,0	6,0	57,0	6,0	15,0	4,60	0,5	46562	
6,0	7,0	57,0	6,0	15,0	5,61	1,0	46563	
8,0	10,0	63,0	8,0	25,0	7,62	1,0	46564	
10,0	12,0	72,0	10,0	30,0	9,60	1,0	46565	
12,0	15,0	83,0	12,0	35,0	11,61	1,0	46566	
16,0	20,0	92,0	16,0	45,0	15,60	1,5	46567	
20,0	24,0	104,0	20,0	55,0	19,61	2,0	46568	

- The original Z-Carb design with negative rake, heavy core, and higher helix for strength and shearing of hard mold & die materials
- Unequal flute spacing helps to disrupt the rhythmic pattern created by the cutting edge helping to suppress damaging harmonics
- Enhanced corner geometry with tight tolerance corner radii
- Recommended for materials 35-60HRC (327 to 654 Bhn)

FRACTIONAL & METRIC Z-Carb-MD

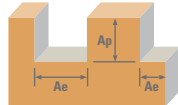

Series ZD1CR Fractional	Hardness	Ae x DC	Ap x DC	Vc (sfm)	Diameter (DC) (inch)							
					1/8	1/4	3/8	1/2	5/8	3/4		
P	TOOL STEELS A2, D2, H13, L2, M2, P20, S7, T15, W2 ≤ 375 Bhn or ≤ 40 HRc	Profile 	≤ 0.4	≤ 1	405	RPM	12377	6188	4126	3094	2475	2063
					(324-486)	Fz	0.0005	0.0012	0.0023	0.0030	0.0039	0.0042
						Feed (ipm)	24.8	29.7	38.0	37.1	38.6	34.7
		Slot 	1	≤ 0.4	320	RPM	9779	4890	3260	2445	1956	1630
					(256-384)	Fz	0.0005	0.0012	0.0023	0.0030	0.0039	0.0042
						Feed (ipm)	19.6	23.5	30.0	29.3	30.5	27.4
H	TOOL STEELS A2, D2, H13, L2, M2, P20, S7, T15, W2 ≤ 475 Bhn or ≤ 50 HRc	Profile 	≤ 0.4	≤ 1	210	RPM	6418	3209	2139	1604	1284	1070
					(168-252)	Fz	0.0004	0.0010	0.0019	0.0025	0.0032	0.0035
						Feed (ipm)	10.3	12.8	16.3	16.0	16.4	15.0
		Slot 	1	≤ 0.4	170	RPM	5195	2598	1732	1299	1039	866
					(136-204)	Fz	0.0004	0.0010	0.0019	0.0025	0.0032	0.0035
						Feed (ipm)	8.3	10.4	13.2	13.0	13.3	12.1
P	TOOL STEELS A2, D2, H13, L2, M2, P20, S7, T15, W2 ≤ 655 Bhn or ≤ 60 HRc	Profile 	≤ 0.4	≤ 1	90	RPM	2750	1375	917	688	550	458
					(72-108)	Fz	0.0002	0.0005	0.0010	0.0013	0.0017	0.0018
						Feed (ipm)	2.2	2.8	3.7	3.6	3.7	3.3
		Slot 	1	≤ 0.4	70	RPM	2139	1070	713	535	428	357
					(56-84)	Fz	0.0002	0.0005	0.0010	0.0013	0.0017	0.0018
						Feed (ipm)	1.7	2.1	2.9	2.8	2.9	2.6

Bhn (Brinell) HRc (Rockwell C)
 $rpm = Vc \times 3.82 / DC$
 $ipm = Fz \times 4 \times rpm$
 reduce speed and feed for materials harder than listed
 reduce feed and Ae when finish milling (.02 x DC maximum)
 feed rates listed have chip thinning adjustments included where applicable
 refer to the SGS Tool Wizard® for complete technical information (www.kyocera-sgstool.com)

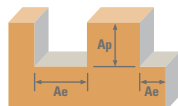

Series ZD1MCR Metric	Hardness	Ae x DC	Ap x DC	Vc (m/min)	Diameter (DC) (mm)								
					3	6	8	10	12	16	20		
P	TOOL STEELS A2, D2, H13, L2, M2, P20, S7, T15, W2 ≤ 375 Bhn or ≤ 40 HRc	Profile 	≤ 0.4	≤ 1	123	RPM	13087	6544	4908	3926	3272	2454	1963
					(99-148)	Fz	0.012	0.029	0.049	0.061	0.072	0.083	0.112
						Feed (mm/min)	628	754	963	963	942	817	879
		Slot 	1	≤ 0.4	98	RPM	10340	5170	3878	3102	2585	1939	1551
					(78-117)	Fz	0.012	0.029	0.049	0.061	0.072	0.083	0.112
						Feed (mm/min)	496	596	761	761	744	645	695
H	TOOL STEELS A2, D2, H13, L2, M2, P20, S7, T15, W2 ≤ 475 Bhn or ≤ 50 HRc	Profile 	≤ 0.4	≤ 1	64	RPM	6786	3393	2545	2036	1696	1272	1018
					(51-77)	Fz	0.010	0.024	0.041	0.051	0.060	0.068	0.093
						Feed (mm/min)	261	326	413	413	407	347	380
		Slot 	1	≤ 0.4	52	RPM	5493	2747	2060	1648	1373	1030	824
					(41-62)	Fz	0.010	0.024	0.041	0.051	0.060	0.068	0.093
						Feed (mm/min)	211	264	334	334	330	281	308
P	TOOL STEELS A2, D2, H13, L2, M2, P20, S7, T15, W2 ≤ 655 Bhn or ≤ 60 HRc	Profile 	≤ 0.4	≤ 1	27	RPM	2908	1454	1091	872	727	545	436
					(22-33)	Fz	0.005	0.012	0.021	0.027	0.031	0.036	0.048
						Feed (mm/min)	56	70	93	93	91	79	84
		Slot 	1	≤ 0.4	21	RPM	2262	1131	848	679	565	424	339
					(17-26)	Fz	0.005	0.012	0.021	0.027	0.031	0.036	0.048
						Feed (mm/min)	43	54	72	72	71	62	65

Bhn (Brinell) HRc (Rockwell C)
 $rpm = (Vc \times 1000) / (DC \times 3.14)$
 $ipm = Fz \times 4 \times rpm$
 reduce speed and feed for materials harder than listed
 reduce feed and Ae when finish milling (.02 x DC maximum)
 feed rates listed have chip thinning adjustments included where applicable
 refer to the SGS Tool Wizard® for complete technical information (www.kyocera-sgstool.com)

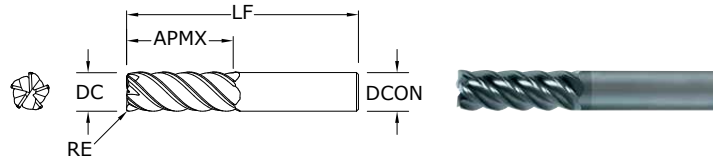
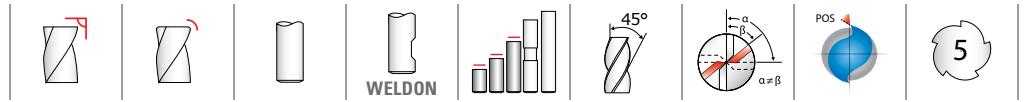

55 • 55CR

FRACTIONAL SERIES

TOLERANCES (inch)

DC = +0.0000/-0.0020

DCON = h_6

RE = +0.0000/-0.0020

- STEELS
- STAINLESS STEELS
- CAST IRON
- HIGHTEMP ALLOYS

For patent information visit www.ksptpatents.com

CUTTING DIAMETER DC	LENGTH OF CUT APMX	inch			EDP NO.	
		OVERALL LENGTH LF	SHANK DIAMETER DCON	CORNER RADIUS RE	Ti-NAMITE®-A (AITiN)	Ti-NAMITE®-A (AITiN) W/FLAT
1/8	1/4	1-1/2	1/8	—	32672	—
1/8	1/4	1-1/2	1/8	.010	32606	—
1/8	1/2	1-1/2	1/8	—	32655	—
1/8	1/2	1-1/2	1/8	.010	32607	—
5/32	5/16	2	3/16	.010	32608	—
5/32	9/16	2	3/16	—	32656	—
5/32	9/16	2	3/16	.010	32609	—
3/16	5/16	2	3/16	—	32673	—
3/16	5/16	2	3/16	.010	32610	—
3/16	5/8	2	3/16	—	32657	—
3/16	5/8	2	3/16	.010	32611	—
7/32	3/8	2	1/4	.015	32612	—
7/32	3/4	2-1/2	1/4	.015	32613	—
7/32	3/4	2-1/2	1/4	—	32658	—
1/4	3/8	2	1/4	.015	32614	—
1/4	3/8	2	1/4	—	32674	—
1/4	3/4	2-1/2	1/4	—	32659	—
1/4	3/4	2-1/2	1/4	.015	32615	—
1/4	1-1/4	4	1/4	.015	32616	—
5/16	7/16	2	5/16	—	32675	—
5/16	7/16	2	5/16	.015	32619	—
5/16	13/16	2-1/2	5/16	—	32660	—
5/16	13/16	2-1/2	5/16	.015	32620	—
5/16	1-1/4	4	5/16	.015	32621	—
3/8	1/2	2	3/8	—	32676	32677
3/8	1/2	2	3/8	.015	32625	32591
3/8	1/2	2	3/8	.030	32592	32593
3/8	1	2-1/2	3/8	—	32661	32662
3/8	1	2-1/2	3/8	.015	32626	32628
3/8	1	2-1/2	3/8	.030	32573	32574
3/8	1-1/2	4	3/8	.015	32627	—
3/8	1-1/2	4	3/8	.030	32569	—

continued on next page

- Unequal indexing, high helix and an ideal rake and relief combination for unmatched finishing capability
- The choice when peak finish quality is the requirement
- Enhanced corner geometry with tight tolerance corner radii
- Recommended for materials ≤ 45 HRc (≤ 420 Bhn)

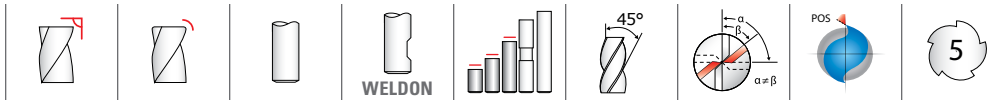

**55 •
55CR**
FRACTIONAL SERIES

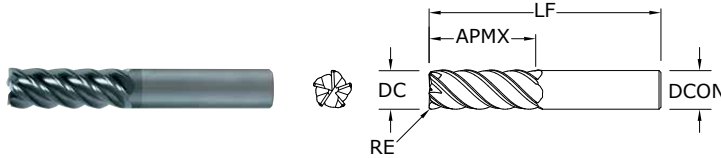

CONTINUED

CUTTING DIAMETER DC	LENGTH OF CUT APMX	inch			EDP NO.	
		OVERALL LENGTH LF	SHANK DIAMETER DCON	CORNER RADIUS RE	Ti-NAMITE®-A (AlTiN)	Ti-NAMITE®-A (AlTiN) W/FLAT
7/16	1	2-3/4	7/16	—	32663	—
7/16	1	2-3/4	7/16	.015	32632	—
7/16	2	4	7/16	.015	32633	—
1/2	5/8	2-1/2	1/2	—	32678	32679
1/2	5/8	2-1/2	1/2	.030	32594	32595
1/2	5/8	2-1/2	1/2	.060	32596	32597
1/2	1-1/4	3	1/2	—	32664	32665
1/2	1-1/4	3	1/2	.030	32575	32576
1/2	1-1/4	3	1/2	.060	32577	32578
1/2	2	4	1/2	.030	32685	—
1/2	2	4	1/2	.060	32686	—
5/8	3/4	3	5/8	—	32680	32681
5/8	3/4	3	5/8	.030	32598	32599
5/8	3/4	3	5/8	.060	32600	32601
5/8	1-5/8	3-1/2	5/8	—	32666	32667
5/8	1-5/8	3-1/2	5/8	.030	32579	32580
5/8	1-5/8	3-1/2	5/8	.060	32581	32582
5/8	2-1/2	5	5/8	.030	32570	—
5/8	2-1/2	5	5/8	.060	32687	—
3/4	1	3	3/4	—	32682	32683
3/4	1	3	3/4	.030	32602	32603
3/4	1	3	3/4	.060	32604	32605
3/4	1-5/8	4	3/4	—	32668	32669
3/4	1-5/8	4	3/4	.030	32583	32584
3/4	1-5/8	4	3/4	.060	32585	32586
3/4	3-1/4	6	3/4	.030	32571	—
3/4	3-1/4	6	3/4	.060	32688	—
1	1-1/2	4	1	—	32670	32671
1	1-1/2	4	1	.030	32587	32588
1	1-1/2	4	1	.060	32589	32590
1	2-5/8	6	1	.030	32572	—
1	2-5/8	6	1	.060	32689	—

TOLERANCES (inch)

DC = +0.0000/-0.0020
DCON = \pm .0005
RE = +0.0000/-0.0020

- STEELS
- STAINLESS STEELS
- CAST IRON
- HIGH TEMP ALLOYS

For patent information visit www.kspatents.com

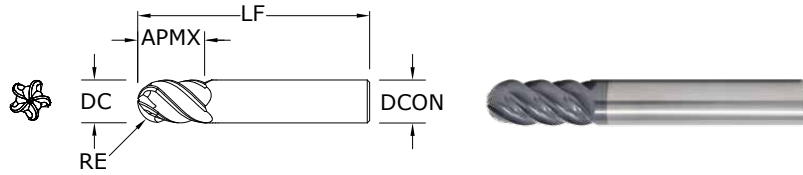

55B FRACTIONAL SERIES

TOLERANCES (inch)

DC = +0.0000/-0.0020

DCON = h_6

RE = +0.0005/-0.0010

STEELS

STAINLESS STEELS

CAST IRON

HIGHTEMP ALLOYS

For patent information visit www.ksptpatents.com

inch				EDP NO.
CUTTING DIAMETER DC	LENGTH OF CUT APMX	OVERALL LENGTH LF	SHANK DIAMETER DCON	Ti-NAMITE®-A (AITiN)
1/4	3/4	2-1/2	1/4	32500
5/16	13/16	2-1/2	5/16	32501
3/8	1	2-1/2	3/8	32502
1/2	1-1/4	3	1/2	32503
5/8	1-5/8	3-1/2	5/8	32504
3/4	1-5/8	4	3/4	32505
1	1-1/2	4	1	32506

RE = 1/2 Cutting Diameter (DC)

- Unequal indexing, high helix and an ideal rake and relief combination for unmatched finishing capability
- The choice when peak finish quality is the requirement
- Ball end design ideal for finishing operations in complex workpieces
- Recommended for materials ≤ 45 HRc (≤ 420 Bhn)

FRACTIONAL V-Carb

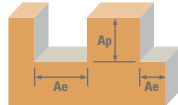

Series 55, 55CR, 55B Fractional	Hardness	Ae x DC	Ap x DC	Vc (sfm)	DC • in								
					1/8	1/4	3/8	1/2	5/8	3/4	1		
CARBON STEELS 1018, 1040, 1080, 1090, 10L50, 1140, 1212, 12L15, 1525, 1536	≤ 275 Bhn or ≤ 28 HRc	Profile 	≤ 0.25	≤ 1.5	385	RPM	11766	5883	3922	2941	2353	1961	1471
					(308-462)	Fz	0.0004	0.0009	0.0017	0.0023	0.0029	0.0028	0.0032
					630	RPM	19253	9626	6418	4813	3851	3209	2407
					(504-756)	Fz	0.0007	0.0018	0.0034	0.0046	0.0057	0.0055	0.0064
						Feed (ipm)	67.4	86.6	109.1	110.7	109.7	88.2	77.0
	≤ 375 Bhn or ≤ 40 HRc	Profile 	≤ 0.25	≤ 1.5	325	RPM	9932	4966	3311	2483	1986	1655	1242
					(260-390)	Fz	0.0003	0.0007	0.0013	0.0017	0.0022	0.0021	0.0024
					530	RPM	16197	8098	5399	4049	3239	2699	2025
					(424-636)	Fz	0.0005	0.0014	0.0026	0.0034	0.0043	0.0041	0.0048
						Feed (ipm)	42.1	56.7	70.2	68.8	69.6	55.3	48.6
TOOL STEELS A2, D2, H13, L2, M2, P20, S7, T15, W2	≤ 375 Bhn or ≤ 40 HRc	Profile 	≤ 0.25	≤ 1.5	175	RPM	5348	2674	1783	1337	1070	891	669
					(140-210)	Fz	0.0002	0.0005	0.0010	0.0013	0.0016	0.0017	0.0018
					290	RPM	8862	4431	2954	2216	1772	1477	1108
					(232-348)	Fz	0.0004	0.0010	0.0019	0.0025	0.0032	0.0033	0.0035
						Feed (ipm)	17.7	22.2	28.1	27.7	28.4	24.4	19.4
STAINLESS STEELS (FREE MACHINING) 303, 416, 420F, 430F, 440F	≤ 275 Bhn or ≤ 28 HRc	Profile 	≤ 0.25	≤ 1.5	370	RPM	11307	5654	3769	2827	2261	1885	1413
					(296-444)	Fz	0.0003	0.0007	0.0013	0.0017	0.0022	0.0023	0.0024
					560	RPM	17114	8557	5705	4278	3423	2852	2139
					(448-672)	Fz	0.0005	0.0014	0.0026	0.0034	0.0043	0.0044	0.0048
						Feed (ipm)	44.5	59.9	74.2	72.7	73.6	62.7	51.3
	≤ 275 Bhn or ≤ 28 HRc	Profile 	≤ 0.25	≤ 1.5	255	RPM	7793	3896	2598	1948	1559	1299	974
					(204-306)	Fz	0.0002	0.0006	0.0012	0.0016	0.0020	0.0021	0.0023
					385	RPM	11766	5883	3922	2941	2353	1961	1471
					(308-462)	Fz	0.0005	0.0013	0.0024	0.0032	0.0040	0.0041	0.0045
						Feed (ipm)	28.2	38.2	47.1	47.1	47.1	40.2	33.1
STAINLESS STEELS (PH) 13-8 PH, 15-5 PH, 17-4 PH, Custom 450	≤ 325 Bhn or ≤ 35 HRc	Profile 	≤ 0.25	≤ 1.5	235	RPM	7182	3591	2394	1795	1436	1197	898
					(188-282)	Fz	0.0002	0.0006	0.0010	0.0014	0.0017	0.0018	0.0019
					355	RPM	10849	5424	3616	2712	2170	1808	1356
					(284-426)	Fz	0.0004	0.0011	0.0021	0.0028	0.0034	0.0036	0.0039
						Feed (ipm)	22.2	29.8	38.0	38.0	36.9	32.5	26.4

continued on next page

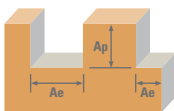

Series	Hardness	Profile	Ae x DC	Ap x DC	Vc (sfm)	DC • in							
						1/8	1/4	3/8	1/2	5/8	3/4	1	
Series 55, 55CR, 55B Fractional	CAST IRONS (LOW & MEDIUM ALLOY) Gray, Malleable, Ductile	Profile	≤ 0.25	≤ 1.5	470	RPM	14363	7182	4788	3591	2873	2394	1795
					(376-564)	Fz	0.0004	0.0009	0.0017	0.0023	0.0029	0.0030	0.0032
						Feed (ipm)	25.1	32.3	40.7	41.3	41.7	35.9	28.7
		HSM	≤ 0.05	≤ 2	705	RPM	21545	10772	7182	5386	4309	3591	2693
					(564-846)	Fz	0.0007	0.0018	0.0034	0.0046	0.0057	0.0059	0.0064
						Feed (ipm)	75.4	97.0	122.1	123.9	122.8	105.9	86.2
	CAST IRONS (HIGH ALLOY) Gray, Malleable, Ductile	Profile	≤ 0.25	≤ 1.5	360	RPM	11002	5501	3667	2750	2200	1834	1375
					(288-432)	Fz	0.0003	0.0007	0.0013	0.0017	0.0022	0.0023	0.0024
						Feed (ipm)	14.3	19.3	23.8	23.4	24.2	21.1	16.5
		HSM	≤ 0.05	≤ 2	540	RPM	16502	8251	5501	4126	3300	2750	2063
					(432-648)	Fz	0.0005	0.0014	0.0026	0.0034	0.0043	0.0044	0.0048
						Feed (ipm)	42.9	57.8	71.5	70.1	71.0	60.5	49.5
HIGH TEMP ALLOYS (NICKEL, COBALT, IRON BASE) Inconel 601, 617, 625, Incoloy, Monel 400	Profile	≤ 0.25	≤ 1.5	70	RPM	2139	1070	713	535	428	357	267	
				(56-84)	Fz	0.0002	0.0006	0.0010	0.0014	0.0017	0.0018	0.0019	
					Feed (ipm)	2.2	3.2	3.6	3.7	3.6	3.2	2.5	
	HSM	≤ 0.05	≤ 2	107	RPM	3270	1635	1090	817	654	545	409	
				(86-128)	Fz	0.0004	0.0011	0.0021	0.0028	0.0034	0.0036	0.0039	
					Feed (ipm)	6.7	9.0	11.4	11.4	11.1	9.8	8.0	
HIGH TEMP ALLOYS (NICKEL, COBALT, IRON BASE) Inconel 718, X-750, Incoloy, Waspaloy, Hastelloy, Rene	Profile	≤ 0.25	≤ 1.5	55	RPM	1681	840	560	420	336	280	210	
				(44-66)	Fz	0.0002	0.0004	0.0008	0.0010	0.0013	0.0014	0.0015	
					Feed (ipm)	1.3	1.7	2.2	2.1	2.2	2.0	1.6	
	HSM	≤ 0.05	≤ 2	85	RPM	2598	1299	866	649	520	433	325	
				(68-102)	Fz	0.0003	0.0008	0.0015	0.0021	0.0026	0.0027	0.0029	
					Feed (ipm)	4.0	5.2	6.5	6.8	6.8	5.8	4.7	
TITANIUM ALLOYS Pure Titanium, Ti6Al4V, Ti6Al2Sn4Zr2Mo, Ti4Al4Mo2Sn0.5Si	Profile	≤ 0.25	≤ 1.5	235	RPM	7182	3591	2394	1795	1436	1197	898	
				(188-282)	Fz	0.0002	0.0006	0.0012	0.0016	0.0020	0.0021	0.0023	
					Feed (ipm)	7.2	10.8	14.4	14.4	14.4	12.6	10.3	
	HSM	≤ 0.05	≤ 2	390	RPM	11918	5959	3973	2980	2384	1986	1490	
				(312-468)	Fz	0.0005	0.0013	0.0024	0.0032	0.0040	0.0041	0.0045	
					Feed (ipm)	29.8	38.7	47.7	47.7	47.7	40.7	33.5	
TITANIUM ALLOYS (DIFFICULT) Ti10V2Fe3Al, Ti5Al5V5Mo3Cr, Ti7Al4Mo, Ti3Al8V6Cr4Zr4Mo, Ti6Al6V6Sn, Ti15V3 Cr3Sn3Al	Profile	≤ 0.25	≤ 1.5	85	RPM	2598	1299	866	649	520	433	325	
				(68-102)	Fz	0.0002	0.0006	0.0012	0.0016	0.0020	0.0021	0.0023	
					Feed (ipm)	2.6	3.9	5.2	5.2	5.2	4.5	3.7	
	HSM	≤ 0.05	≤ 2	140	RPM	4278	2139	1426	1070	856	713	535	
				(112-168)	Fz	0.0005	0.0013	0.0024	0.0032	0.0040	0.0042	0.0045	
					Feed (ipm)	10.7	13.9	17.1	17.1	17.1	15.0	12.0	

Bhn (Brinell) HRC (Rockwell C) HSM (High Speed Machining)
 rpm = Vc x 3.82 / DC
 ipm = Fz x 5 x rpm
 reduce speed and feed for materials harder than listed
 reduce feed and Ae when finish milling (.02 x DC maximum)
 reduce Ap to 1 x DC (maximum) when profile milling with long or extra long flute length tools
 feed rates listed have chip thinning adjustments included where applicable
 refer to the SGS Tool Wizard® for complete technical information (www.kyocera-sgtool.com)

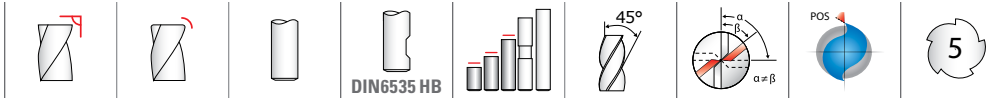

**55M •
55MCR**
METRIC SERIES

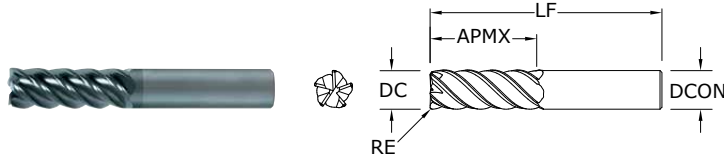

- Unequal indexing, high helix and an ideal rake and relief combination for unmatched finishing capability
- The choice when peak finish quality is the requirement
- Enhanced corner geometry with tight tolerance corner radii
- Recommended for materials ≤ 45 HRc (≤ 420 Bhn)

CUTTING DIAMETER DC	LENGTH OF CUT APMX	mm			EDP NO.	
		OVERALL LENGTH LF	SHANK DIAMETER DCON	CORNER RADIUS RE	Ti-NAMITE®-A (AITiN)	Ti-NAMITE®-A (AITiN) W/FLAT
6,0	12,0	50,0	6,0	—	42606	—
6,0	12,0	50,0	6,0	0,5	42660	—
6,0	19,0	63,0	6,0	—	42607	—
6,0	19,0	63,0	6,0	0,25	42661	—
6,0	19,0	63,0	6,0	0,5	42662	—
6,0	19,0	63,0	6,0	1,0	42663	—
6,0	19,0	63,0	6,0	1,5	42664	—
6,0	25,0	75,0	6,0	—	42608	—
6,0	25,0	75,0	6,0	0,5	42665	—
8,0	12,0	50,0	8,0	—	42609	—
8,0	12,0	50,0	8,0	0,5	42666	—
8,0	20,0	63,0	8,0	—	42610	—
8,0	20,0	63,0	8,0	0,5	42667	—
8,0	20,0	63,0	8,0	1,0	42668	—
8,0	20,0	63,0	8,0	1,5	42669	—
8,0	20,0	63,0	8,0	2,0	42670	—
8,0	25,0	75,0	8,0	—	42611	—
8,0	25,0	75,0	8,0	0,5	42671	—
10,0	16,0	50,0	10,0	—	42612	—
10,0	16,0	50,0	10,0	0,5	42672	—
10,0	22,0	75,0	10,0	—	42622	42613
10,0	22,0	75,0	10,0	0,5	42673	—
10,0	22,0	75,0	10,0	1,0	42674	—
10,0	22,0	75,0	10,0	1,5	42675	—
10,0	22,0	75,0	10,0	2,0	42676	—
10,0	22,0	75,0	10,0	2,5	42677	—
10,0	38,0	100,0	10,0	—	42614	—
10,0	38,0	100,0	10,0	0,5	42678	—
12,0	19,0	63,0	12,0	—	42615	—
12,0	19,0	63,0	12,0	0,5	42679	—
12,0	25,0	75,0	12,0	—	42616	42623
12,0	25,0	75,0	12,0	0,5	42680	—
12,0	25,0	75,0	12,0	1,0	42681	—
12,0	25,0	75,0	12,0	1,5	42682	—
12,0	25,0	75,0	12,0	2,0	42683	—
12,0	25,0	75,0	12,0	2,5	42684	—

TOLERANCES (inch)

DC = +0.0000/-0.0020
 DCON = ± 0.0000
 RE = +0.0000/-0.0020

- STEELS
- STAINLESS STEELS
- CAST IRON
- HIGH TEMP ALLOYS

For patent information visit www.ksptpatents.com

continued on next page

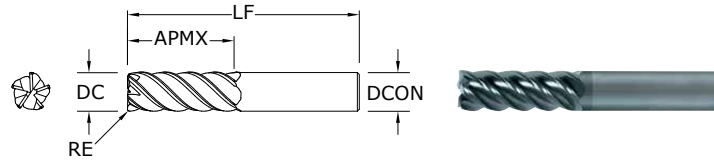
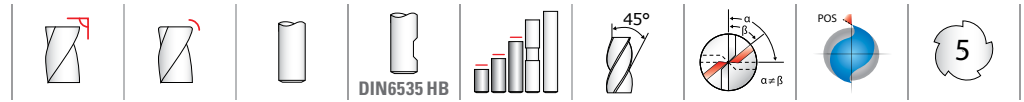

**55M •
55MCR**
METRIC SERIES

TOLERANCES (mm)

DC = +0,000/-0,050

DCON = h_6

RE = +0,000/-0,050

- STEELS
- STAINLESS STEELS
- CAST IRON
- HIGH TEMP ALLOYS

For patent information visit www.ksptpatents.com

CUTTING DIAMETER DC	LENGTH OF CUT APMX	mm			EDP NO.	
		OVERALL LENGTH LF	SHANK DIAMETER DCON	CORNER RADIUS RE	Ti-NAMITE®-A (AITIN)	Ti-NAMITE®-A (AITIN) W/FLAT
12,0	25,0	75,0	12,0	3,0	42685	—
12,0	50,0	100,0	12,0	—	42617	—
12,0	50,0	100,0	12,0	0,5	42686	—
12,0	50,0	100,0	12,0	3,0	42630	—
12,0	50,0	100,0	12,0	4,0	42631	—
16,0	32,0	89,0	16,0	—	42618	42624
16,0	32,0	89,0	16,0	1,0	42687	—
16,0	32,0	89,0	16,0	1,5	42688	—
16,0	32,0	89,0	16,0	2,0	42689	—
16,0	32,0	89,0	16,0	2,5	42690	—
16,0	32,0	89,0	16,0	3,0	42691	—
16,0	32,0	89,0	16,0	4,0	42692	—
16,0	50,0	100,0	16,0	—	42626	—
16,0	50,0	100,0	16,0	2,0	42656	—
16,0	50,0	100,0	16,0	2,5	42657	—
16,0	50,0	100,0	16,0	3,0	42658	—
16,0	50,0	100,0	16,0	4,0	42659	—
16,0	50,0	100,0	16,0	5,0	42628	—
16,0	75,0	150,0	16,0	—	42619	—
16,0	75,0	150,0	16,0	1,0	42693	—
16,0	75,0	150,0	16,0	3,0	42632	—
16,0	75,0	150,0	16,0	4,0	42633	—
20,0	38,0	100,0	20,0	—	42620	42625
20,0	38,0	100,0	20,0	1,0	42694	—
20,0	38,0	100,0	20,0	1,5	42695	—
20,0	38,0	100,0	20,0	2,0	42696	—
20,0	38,0	100,0	20,0	2,5	42697	—
20,0	38,0	100,0	20,0	3,0	42698	—
20,0	38,0	100,0	20,0	4,0	42699	—
20,0	38,0	100,0	20,0	5,0	42700	—
20,0	38,0	100,0	20,0	6,0	42648	—
20,0	50,0	100,0	20,0	—	42627	—
20,0	50,0	100,0	20,0	2,0	42649	—
20,0	50,0	100,0	20,0	2,5	42650	—
20,0	50,0	100,0	20,0	3,0	42651	—
20,0	50,0	100,0	20,0	4,0	42652	—

- Unequal indexing, high helix and an ideal rake and relief combination for unmatched finishing capability
- The choice when peak finish quality is the requirement
- Enhanced corner geometry with tight tolerance corner radii
- Recommended for materials ≤ 45 HRC (≤ 420 Bhn)

continued on next page

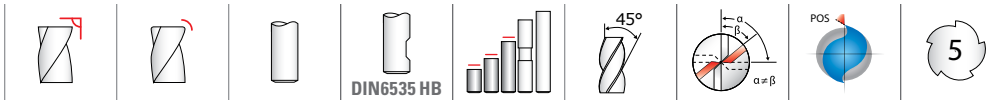

**55M •
55MCR**
METRIC SERIES

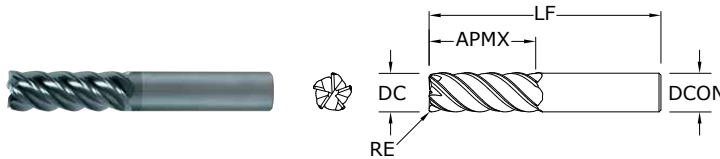

- Unequal indexing, high helix and an ideal rake and relief combination for unmatched finishing capability
- The choice when peak finish quality is the requirement
- Enhanced corner geometry with tight tolerance corner radii
- Recommended for materials ≤ 45 HRc (≤ 420 Bhn)

CUTTING DIAMETER DC	LENGTH OF CUT APMX	mm			EDP NO.	
		OVERALL LENGTH LF	SHANK DIAMETER DCON	CORNER RADIUS RE	Ti-NAMITE®-A (AlTiN)	Ti-NAMITE®-A (AlTiN) W/FLAT
20,0	50,0	100,0	20,0	5,0	42653	—
20,0	50,0	100,0	20,0	6,0	42654	—
20,0	75,0	150,0	20,0	—	42621	—
20,0	75,0	150,0	20,0	1,0	42701	—
20,0	75,0	150,0	20,0	2,0	42702	—
20,0	75,0	150,0	20,0	3,0	42703	—
20,0	75,0	150,0	20,0	4,0	42704	—
20,0	75,0	150,0	20,0	5,0	42705	—
20,0	75,0	150,0	20,0	6,0	42655	—

TOLERANCES (mm)

DC = $+0,000/-0,050$
 DCON = h_6
 RE = $+0,000/-0,050$

- STEELS
- STAINLESS STEELS
- CAST IRON
- HIGH TEMP ALLOYS

For patent information visit
www.ksptpatents.com

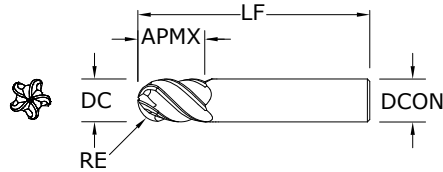

55MB
METRIC SERIES

TOLERANCES (mm)

DC = +0,000/-0,050

DCON = h_6

RE = +0,000/-0,050

STEELS

STAINLESS STEELS

CAST IRON

HIGHTEMP ALLOYS

For patent information visit www.ksptpatents.com

	mm			EDP NO.
CUTTING DIAMETER DC	LENGTH OF CUT APMX	OVERALL LENGTH LF	SHANK DIAMETER DCON	Ti-NAMITE®-A (AITiN)
6,0	13,0	57,0	6,0	42750
8,0	19,0	63,0	8,0	42751
10,0	22,0	72,0	10,0	42752
12,0	26,0	83,0	12,0	42753
16,0	32,0	92,0	16,0	42754
20,0	38,0	104,0	20,0	42755

RE = 1/2 Cutting Diameter (DC)

- Unequal indexing, high helix and an ideal rake and relief combination for unmatched finishing capability
- The choice when peak finish quality is the requirement
- Ball end design ideal for finishing operations in complex workpieces
- Recommended for materials ≤ 45 HRC (≤ 420 Bhn)

METRIC V-Carb

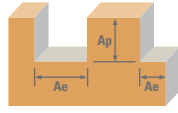

Series 55M, 55MCR, 55MB						DC • mm						
Metric	Hardness	Ae x DC	Ap x DC	Vc (m/min)		6	8	10	12	16	20	
P	CARBON STEELS 1018, 1040, 1080, 1090, 10L50, 1140, 1212, 12L15, 1525, 1536	Profile 	≤ 0.25	≤ 1.5	117	RPM	6220	4665	3732	3110	2333	1866
					(94-141)	Fz	0.022	0.036	0.061	0.070	0.072	0.085
						Feed (mm/min)	672	846	1145	1082	836	796
		HSM 	≤ 0.05	≤ 2	192	RPM	10179	7634	6107	5089	3817	3054
					(154-230)	Fz	0.043	0.073	0.123	0.137	0.141	0.154
						Feed (mm/min)	2198	2769	3746	3481	2687	2345
	ALLOY STEELS 4140, 4150, 4320, 5120, 5150, 8630, 86L20, 50100	Profile 	≤ 0.25	≤ 1.5	99	RPM	5251	3938	3151	2626	1969	1575
					(79-119)	Fz	0.017	0.028	0.045	0.053	0.054	0.064
						Feed (mm/min)	441	546	571	693	529	504
		HSM 	≤ 0.05	≤ 2	162	RPM	8563	6422	5138	4282	3211	2569
					(129-194)	Fz	0.034	0.055	0.091	0.103	0.105	0.128
						Feed (mm/min)	1438	1781	2329	2209	1685	1644
TOOL STEELS A2, D2, H13, L2, M2, P20, S7, T15, W2	Profile 	≤ 0.25	≤ 1.5	53	RPM	2827	2121	1696	1414	1060	848	
				(43-64)	Fz	0.012	0.021	0.035	0.038	0.044	0.048	
					Feed (mm/min)	170	226	294	271	231	204	
	HSM 	≤ 0.05	≤ 2	88	RPM	4686	3514	2811	2343	1757	1406	
				(71-106)	Fz	0.024	0.041	0.067	0.077	0.084	0.093	
					Feed (mm/min)	562	712	937	900	742	656	
M	STAINLESS STEELS (FREE MACHINING) 303, 416, 420F, 430F, 440F	Profile 	≤ 0.25	≤ 1.5	113	RPM	5978	4484	3587	2989	2242	1793
					(90-135)	Fz	0.017	0.028	0.045	0.053	0.059	0.064
						Feed (mm/min)	502	622	813	789	660	574
		HSM 	≤ 0.05	≤ 2	171	RPM	9048	6786	5429	4524	3393	2714
					(137-205)	Fz	0.034	0.055	0.091	0.103	0.113	0.128
						Feed (mm/min)	1520	1882	2461	2334	1911	1737
	STAINLESS STEELS (DIFFICULT) 304, 304L, 316, 316L	Profile 	≤ 0.25	≤ 1.5	78	RPM	4120	3090	2472	2060	1545	1236
					(62-93)	Fz	0.014	0.026	0.043	0.048	0.054	0.061
						Feed (mm/min)	297	396	527	494	415	379
		HSM 	≤ 0.05	≤ 2	117	RPM	6220	4665	3732	3110	2333	1866
					(94-141)	Fz	0.031	0.051	0.085	0.096	0.105	0.120
						Feed (mm/min)	970	1194	1592	1493	1224	1120
STAINLESS STEELS (PH) 13-8 PH, 15-5 PH, 17-4 PH, Custom 450	Profile 	≤ 0.25	≤ 1.5	72	RPM	3797	2848	2278	1898	1424	1139	
				(57-86)	Fz	0.014	0.021	0.037	0.041	0.046	0.051	
					Feed (mm/min)	273	304	425	387	328	289	
	HSM 	≤ 0.05	≤ 2	108	RPM	5736	4302	3441	2868	2151	1721	
				(87-130)	Fz	0.026	0.045	0.075	0.082	0.092	0.104	
					Feed (mm/min)	757	964	1285	1170	991	895	

continued on next page

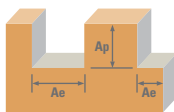

Series	Hardness	Ae x DC	Ap x DC	Vc (m/min)	DC • mm							
					6	8	10	12	16	20		
55M, 55MCR, 55MB Metric	CAST IRONS (LOW & MEDIUM ALLOY) Gray, Malleable, Ductile	Profile	≤ 0.25	≤ 1.5	143	RPM	7594	5695	4556	3797	2848	2278
					(115-172)	Fz	0.022	0.036	0.061	0.070	0.077	0.085
					Feed (mm/min)	820	1033	1397	1321	1093	972	
		HSM	≤ 0.05	≤ 2	215	RPM	11391	8543	6834	5695	4271	3417
					(172-258)	Fz	0.043	0.073	0.123	0.137	0.151	0.171
					Feed (mm/min)	2460	3099	4192	3895	3226	2916	
	CAST IRONS (HIGH ALLOY) Gray, Malleable, Ductile	Profile	≤ 0.25	≤ 1.5	110	RPM	5816	4362	3490	2908	2181	1745
					(88-132)	Fz	0.017	0.028	0.045	0.053	0.059	0.064
					Feed (mm/min)	489	605	791	768	642	558	
		HSM	≤ 0.05	≤ 2	165	RPM	8725	6544	5235	4362	3272	2617
					(132-198)	Fz	0.034	0.055	0.091	0.103	0.113	0.128
					Feed (mm/min)	1466	1815	2373	2251	1843	1675	
HIGH TEMP ALLOYS (NICKEL, COBALT, IRON BASE) Inconel 601, 617, 625, Incoloy, Monel 400	≤ 300 Bhn or ≤ 32 HRc	Profile	≤ 0.25	≤ 1.5	21	RPM	1131	848	679	565	424	339
					(17-26)	Fz	0.014	0.021	0.037	0.041	0.046	0.051
					Feed (mm/min)	81	90	127	115	98	86	
		HSM	≤ 0.05	≤ 2	33	RPM	1729	1297	1037	864	648	519
					(26-39)	Fz	0.026	0.045	0.075	0.082	0.092	0.104
					Feed (mm/min)	228	290	387	353	299	270	
	≤ 400 Bhn or ≤ 43 HRc	Profile	≤ 0.25	≤ 1.5	17	RPM	889	666	533	444	333	267
					(13-20)	Fz	0.010	0.017	0.027	0.031	0.036	0.040
					Feed (mm/min)	43	57	71	69	60	53	
		HSM	≤ 0.05	≤ 2	26	RPM	1373	1030	824	687	515	412
					(21-31)	Fz	0.019	0.032	0.056	0.062	0.069	0.077
					Feed (mm/min)	132	165	231	214	178	159	
TITANIUM ALLOYS (DIFFICULT) Ti10V2Fe3Al, Ti5Al5V5Mo3Cr, Ti7Al4Mo, Ti3Al8V6Cr4Zr4Mo, Ti6Al6V6Sn, Ti15V3 Cr3Sn3Al	≤ 350 Bhn or ≤ 38 HRc	Profile	≤ 0.25	≤ 1.5	72	RPM	3797	2848	2278	1898	1424	1139
					(57-86)	Fz	0.014	0.026	0.043	0.048	0.054	0.061
					Feed (mm/min)	273	365	486	456	383	349	
		HSM	≤ 0.05	≤ 2	119	RPM	6301	4726	3781	3151	2363	1890
					(95-143)	Fz	0.031	0.051	0.085	0.096	0.105	0.120
					Feed (mm/min)	983	1210	1613	1512	1240	1134	
	≤ 420 Bhn or ≤ 45 HRc	Profile	≤ 0.25	≤ 1.5	26	RPM	1373	1030	824	687	515	412
					(21-31)	Fz	0.014	0.026	0.043	0.048	0.054	0.061
					Feed (mm/min)	99	132	176	165	138	126	
		HSM	≤ 0.05	≤ 2	43	RPM	2262	1696	1357	1131	848	679
					(34-51)	Fz	0.031	0.051	0.085	0.096	0.108	0.120
					Feed (mm/min)	353	434	579	543	456	407	

Bhn (Brinell) HRc (Rockwell C) HSM (High Speed Machining)
 $rpm = (Vc \times 1000) / (DC \times 3.14)$
 $mm/min = Fz \times 5 \times rpm$
 reduce speed and feed for materials harder than listed
 reduce feed and Ae when finish milling (.02 x DC maximum)
 reduce Ap to 1 x DC (maximum) when profile milling with long or extra long flute length tools
 feed rates listed have chip thinning adjustments included where applicable
 refer to the SGS Tool Wizard® for complete technical information (www.kyocera-sgstooll.com)

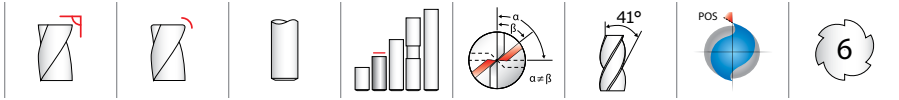

**51 •
51CR**
FRACTIONAL SERIES

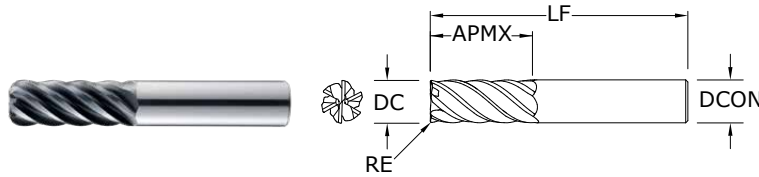

- Engineered for High Speed Milling using Trochoidal and Peel Milling techniques
- Eccentric relief provides superior strength and smoother surface finish
- Enhanced corner geometry with tight tolerance corner radii
- Recommended for materials ≤ 45 HRc (≤ 420 Bhn)

CUTTING DIAMETER DC	LENGTH OF CUT APMX	inch			CORNER RADIUS RE	EDP NO. Ti-NAMITE®-X (TX)
		OVERALL LENGTH LF	SHANK DIAMETER DCON			
1/4	3/4	2-1/2	1/4	-	35100	
1/4	3/4	2-1/2	1/4	.015	35112	
1/4	3/4	2-1/2	1/4	.030	35150	
3/8	1	2-1/2	3/8	-	35101	
3/8	1	2-1/2	3/8	.015	35113	
3/8	1	2-1/2	3/8	.030	35114	
1/2	1-1/4	3	1/2	-	35102	
1/2	1-1/4	3	1/2	.015	35151	
1/2	1-1/4	3	1/2	.030	35115	
1/2	1-1/4	3	1/2	.060	35152	
1/2	1-1/4	3	1/2	.090	35116	
1/2	1-1/4	3	1/2	.120	35117	
5/8	1-5/8	3-1/2	5/8	-	35103	
5/8	1-5/8	3-1/2	5/8	.015	35153	
5/8	1-5/8	3-1/2	5/8	.030	35118	
5/8	1-5/8	3-1/2	5/8	.060	35154	
5/8	1-5/8	3-1/2	5/8	.090	35119	
5/8	1-5/8	3-1/2	5/8	.120	35120	
5/8	1-5/8	3-1/2	5/8	.190	35155	
3/4	1-5/8	4	3/4	-	35104	
3/4	1-5/8	4	3/4	.030	35121	
3/4	1-5/8	4	3/4	.060	35156	
3/4	1-5/8	4	3/4	.090	35122	
3/4	1-5/8	4	3/4	.120	35123	
3/4	1-5/8	4	3/4	.190	35157	
3/4	1-5/8	4	3/4	.250	35158	
1	2-5/8	6	1	-	35105	
1	2-5/8	6	1	.030	35124	
1	2-5/8	6	1	.060	35159	
1	2-5/8	6	1	.090	35125	
1	2-5/8	6	1	.120	35126	
1	2-5/8	6	1	.190	35160	
1	2-5/8	6	1	.250	35161	

TOLERANCES (inch)

DC = +0.0000/-0.0020
DCON = h_6
RE = +0.0000/-0.0020

- STEELS
- STAINLESS STEELS
- CAST IRON
- HIGH TEMP ALLOYS

For patent information visit
www.ksptpatents.com

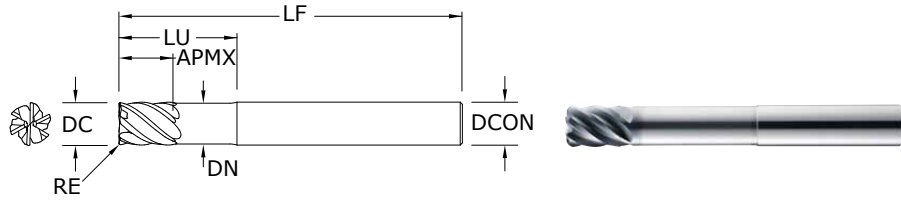
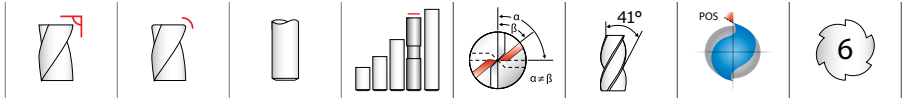

**51L •
51LC**
FRACTIONAL SERIES

TOLERANCES (inch)

DC = +0.0000/-0.0020
 DCON = h₆
 RE = +0.0000/-0.0020

- STEELS
- STAINLESS STEELS
- CAST IRON
- HIGHTEMP ALLOYS

For patent information visit www.ksptpatents.com

CUTTING DIAMETER DC	LENGTH OF CUT APMX	OVERALL LENGTH LF	inch				CORNER RADIUS RE	EDP NO. Ti-NAMITE®-X (TX)
			SHANK DIAMETER DCON	REACH LU	NECK DIAMETER DN			
1/4	3/8	4	1/4	1-1/8	.237	—	35106	
1/4	3/8	4	1/4	1-1/8	.237	.015	35127	
1/4	3/8	4	1/4	1-1/8	.237	.030	35180	
3/8	1/2	4	3/8	2-1/8	.356	—	35107	
3/8	1/2	4	3/8	2-1/8	.356	.015	35128	
3/8	1/2	4	3/8	2-1/8	.356	.030	35129	
1/2	5/8	4	1/2	2-1/4	.475	—	35108	
1/2	5/8	4	1/2	2-1/4	.475	.015	35181	
1/2	5/8	4	1/2	2-1/4	.475	.030	35130	
1/2	5/8	4	1/2	2-1/4	.475	.060	35182	
1/2	5/8	4	1/2	2-1/4	.475	.090	35131	
1/2	5/8	4	1/2	2-1/4	.475	.120	35132	
5/8	3/4	5	5/8	2-1/2	.594	—	35109	
5/8	3/4	5	5/8	2-1/2	.594	.015	35183	
5/8	3/4	5	5/8	2-1/2	.594	.030	35133	
5/8	3/4	5	5/8	2-1/2	.594	.060	35184	
5/8	3/4	5	5/8	2-1/2	.594	.090	35134	
5/8	3/4	5	5/8	2-1/2	.594	.120	35135	
5/8	3/4	5	5/8	2-1/2	.594	.190	35185	
3/4	1	6	3/4	3-3/8	.712	—	35110	
3/4	1	6	3/4	3-3/8	.712	.030	35136	
3/4	1	6	3/4	3-3/8	.712	.060	35186	
3/4	1	6	3/4	3-3/8	.712	.090	35137	
3/4	1	6	3/4	3-3/8	.712	.120	35138	
3/4	1	6	3/4	3-3/8	.712	.190	35187	
3/4	1	6	3/4	3-3/8	.712	.250	35188	
1	1-1/4	6	1	3-3/8	.950	—	35111	
1	1-1/4	6	1	3-3/8	.950	.030	35139	
1	1-1/4	6	1	3-3/8	.950	.060	35189	
1	1-1/4	6	1	3-3/8	.950	.090	35140	
1	1-1/4	6	1	3-3/8	.950	.120	35141	
1	1-1/4	6	1	3-3/8	.950	.190	35190	
1	1-1/4	6	1	3-3/8	.950	.250	35191	

- Engineered for High Speed Milling using Trochoidal and Peel Milling techniques
- Eccentric relief provides superior strength and smoother surface finish
- Necked design with blended diameter transitions provide clearance to reach
- Enhanced corner geometry with tight tolerance corner radii
- Recommended for materials ≤ 45 HRC (≤ 420 Bhn)

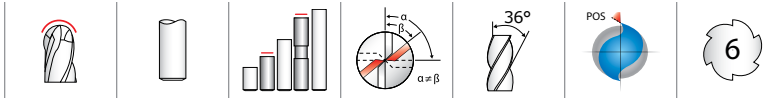

51B

FRACTIONAL SERIES

- Engineered for High Speed Milling using Trochoidal and Peel Milling techniques
- Faceted relief provides superior strength and smoother surface finish
- Ball end design ideal for finishing operations in complex workpieces
- Recommended for materials ≤ 45 HRc (≤ 420 Bhn)

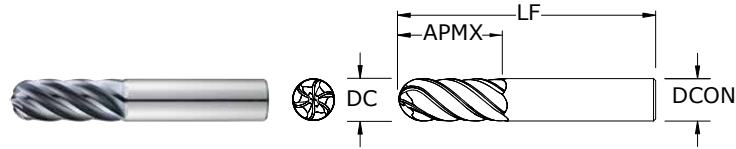

inch				EDP NO.
CUTTING DIAMETER DC	LENGTH OF CUT APMX	OVERALL LENGTH LF	SHANK DIAMETER DCON	Ti-NAMITE®-X (TX)
1/4	3/4	2-1/2	1/4	35220
3/8	1	2-1/2	3/8	35222
1/2	1-1/4	3	1/2	35224
5/8	1-5/8	3-1/2	5/8	35226
3/4	1-5/8	4	3/4	35228
1	2-5/8	6	1	35230

RE=1/2 Cutting Diameter (DC)

TOLERANCES (inch)

1/4–3/8 DIAMETER

DC = +0.0000/–0.0016

DCON = h_6

RE = +0.0000/–0.0010

1/2–1 DIAMETER

DC = +0.000/–0.0020

DCON = h_6

RE = +0.0000/–0.0010

- STEELS
- STAINLESS STEELS
- CAST IRON
- HIGH TEMP ALLOYS

For patent information visit www.ksptpatents.com

51LB

FRACTIONAL SERIES

- Engineered for High Speed Milling using Trochoidal and Peel Milling techniques
- Faceted relief provides superior strength and smoother surface finish
- Ball end design ideal for finishing operations in complex workpieces
- Recommended for materials ≤ 45 HRc (≤ 420 Bhn)

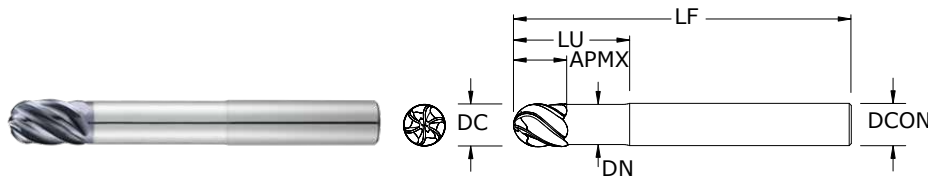

inch						EDP NO.
CUTTING DIAMETER DC	LENGTH OF CUT APMX	OVERALL LENGTH LF	SHANK DIAMETER DCON	REACH LU	NECK DIAMETER DN	Ti-NAMITE®-X (TX)
1/4	3/8	4	1/4	1-1/8	.237	35221
3/8	1/2	4	3/8	2-1/8	.356	35223
1/2	5/8	4	1/2	2-1/4	.475	35225
5/8	3/4	5	5/8	2-1/2	.594	35227
3/4	1	6	3/4	3-3/8	.712	35229
1	1-1/4	6	1	3-3/4	.950	35231

RE=1/2 Cutting Diameter (DC)

TOLERANCES (inch)

1/4–3/8 DIAMETER

DC = +0.0000/–0.0016

DCON = h_6

RE = +0.0000/–0.0010

1/2–1 DIAMETER

DC = +0.000/–0.0020

DCON = h_6

RE = +0.0000/–0.0010

- STEELS
- STAINLESS STEELS
- CAST IRON
- HIGH TEMP ALLOYS

For patent information visit www.ksptpatents.com

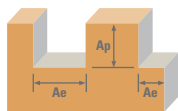

Series
51, 51CR, 51L,
51LC, 51B, 51LB
Fractional

	Hardness	Ae x DC	Ap x DC	Vc (sfm)	DC • in							
					1/4	3/8	1/2	5/8	3/4	1		
P	CARBON STEELS 1018, 1040, 1080, 1090, 10L50, 1140, 1212, 12L15, 1525, 1536	Profile 	≤ 0.1	≤ 1	720	RPM	11002	7334	5501	4401	3667	2750
					(576-864)	Fz	0.0020	0.0035	0.0050	0.0055	0.0061	0.0071
					Feed (ipm)	132	154	165	145	134	117	
		HSM 	≤ 0.05	≤ 2	915	RPM	13981	9321	6991	5592	4660	3495
					(732-1098)	Fz	0.0028	0.0053	0.0070	0.0077	0.0085	0.0100
					Feed (ipm)	235	296	294	258	238	210	
	ALLOY STEELS 4140, 4150, 4320, 5120, 5150, 8630, 86L20, 50100	Profile 	≤ 0.1	≤ 1	490	RPM	7487	4991	3744	2995	2496	1872
					(392-588)	Fz	0.0015	0.0029	0.0038	0.0042	0.0046	0.0054
					Feed (ipm)	67	87	85	75	69	61	
		HSM 	≤ 0.05	≤ 2	620	RPM	9474	6316	4737	3789	3158	2368
					(496-744)	Fz	0.0021	0.0039	0.0052	0.0057	0.0062	0.0073
					Feed (ipm)	119	148	148	130	117	104	
TOOL STEELS A2, D2, H13, L2, M2, P20, S7, T15, W2	Profile 	≤ 0.1	≤ 1	240	RPM	3667	2445	1834	1467	1222	917	
				(192-288)	Fz	0.0012	0.0023	0.0030	0.0034	0.0037	0.0043	
				Feed (ipm)	26	34	33	30	27	24		
	HSM 	≤ 0.05	≤ 2	305	RPM	4660	3107	2330	1864	1553	1165	
				(244-366)	Fz	0.0017	0.0032	0.0042	0.0046	0.0050	0.0059	
				Feed (ipm)	48	60	59	51	47	41		
M	STAINLESS STEELS (FREE MACHINING) 303, 416, 420F, 430F, 440F	Profile 	≤ 0.1	≤ 1	510	RPM	7793	5195	3896	3117	2598	1948
					(459-561)	Fz	0.0015	0.0028	0.0038	0.0041	0.0045	0.0053
					Feed (ipm)	70	87	89	77	70	62	
		HSM 	≤ 0.05	≤ 2	650	RPM	9932	6621	4966	3973	3311	2483
					(585-715)	Fz	0.0021	0.0038	0.0051	0.0056	0.0061	0.0072
					Feed (ipm)	125	151	152	133	121	107	
	STAINLESS STEELS (DIFFICULT) 304, 304L, 316, 316L	Profile 	≤ 0.1	≤ 1	350	RPM	5348	3565	2674	2139	1783	1337
					(315-385)	Fz	0.0012	0.0023	0.0030	0.0033	0.0036	0.0042
					Feed (ipm)	39	49	48	42	39	34	
		HSM 	≤ 0.05	≤ 2	450	RPM	6876	4584	3438	2750	2292	1719
					(405-495)	Fz	0.0017	0.0032	0.0042	0.0046	0.0050	0.0059
					Feed (ipm)	70	88	87	76	69	61	
STAINLESS STEELS (PH) 13-8 PH, 15-5 PH, 17-4 PH, Custom 450	Profile 	≤ 0.1	≤ 1	325	RPM	4966	3311	2483	1986	1655	1242	
				(293-358)	Fz	0.0012	0.0023	0.0030	0.0033	0.0036	0.0042	
				Feed (ipm)	36	46	45	39	36	31		
	HSM 	≤ 0.05	≤ 2	410	RPM	6265	4177	3132	2506	2088	1566	
				(369-451)	Fz	0.0017	0.0032	0.0042	0.0046	0.0050	0.0059	
				Feed (ipm)	64	80	79	69	63	55		

continued on next page

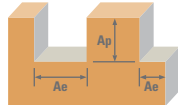

Series
51, 51CR, 51L,
51LC, 51B, 51LB
Fractional

K	Hardness	Profile Ae x DC	Ap x DC	Vc (sfm)	DC • in						
					1/4	3/8	1/2	5/8	3/4	1	
CAST IRONS (LOW & MEDIUM ALLOY) Gray, Malleable, Ductile	≤ 220 Bhn or ≤ 19 HRc	Profile ≤ 0.25	≤ 1.5	575	RPM	8786	5857	4393	3514	2929	2197
				(460-690)	Fz	0.0018	0.0035	0.0045	0.0050	0.0055	0.0064
					Feed (ipm)	94.9	123.0	118.6	105.4	96.6	84.3
	HSM ≤ 0.05	≤ 2	730	RPM	11154	7436	5577	4462	3718	2789	
			(584-876)	Fz	0.0025	0.0047	0.0064	0.0070	0.0076	0.0089	
				Feed (ipm)	167.3	209.7	214.2	187.4	169.5	148.9	
CAST IRONS (HIGH ALLOY) Gray, Malleable, Ductile	≤ 260 Bhn or ≤ 26 HRc	Profile ≤ 0.25	≤ 1.5	430	RPM	6570	4380	3285	2628	2190	1643
				(344-516)	Fz	0.0018	0.0035	0.0045	0.0050	0.0055	0.0064
					Feed (ipm)	71.0	92.0	88.7	78.8	72.3	63.1
	HSM ≤ 0.05	≤ 2	545	RPM	8328	5552	4164	3331	2776	2082	
			(436-654)	Fz	0.0025	0.0047	0.0064	0.0070	0.0076	0.0089	
				Feed (ipm)	124.9	156.6	159.9	139.9	126.6	111.2	
HIGH TEMP ALLOYS (NICKEL, COBALT, IRON BASE) Inconel 601, 617, 625, Incoloy, Monel 400	≤ 300 Bhn or ≤ 32 HRc	Profile ≤ 0.1	≤ 1	105	RPM	1604	1070	802	642	535	401
				(84-126)	Fz	0.0014	0.0027	0.0036	0.0039	0.0043	0.0050
					Feed (ipm)	13	17	17	15	14	12
	HSM ≤ 0.05	≤ 2	130	RPM	1986	1324	993	795	662	497	
			(104-156)	Fz	0.0016	0.0036	0.0048	0.0053	0.0058	0.0067	
				Feed (ipm)	19	29	29	25	23	20	
HIGH TEMP ALLOYS (NICKEL, COBALT, IRON BASE) Inconel 718, X-750, Incoloy, Waspaloy, Hastelloy, Rene	≤ 400 Bhn or ≤ 43 HRc	Profile ≤ 0.1	≤ 1	80	RPM	1222	815	611	489	407	306
				(64-96)	Fz	0.0010	0.0018	0.0025	0.0027	0.0029	0.0034
					Feed (ipm)	7	9	9	8	7	6
	HSM ≤ 0.05	≤ 2	100	RPM	1528	1019	764	611	509	382	
			(80-120)	Fz	0.0013	0.0025	0.0034	0.0037	0.0041	0.0047	
				Feed (ipm)	12	15	16	14	13	11	
TITANIUM ALLOYS Pure Titanium, Ti6Al4V, Ti6Al2Sn4Zr2Mo, Ti4Al4Mo2Sn0.5Si	≤ 350 Bhn or ≤ 38 HRc	Profile ≤ 0.1	≤ 1	280	RPM	4278	2852	2139	1711	1426	1070
				(224-336)	Fz	0.0010	0.0018	0.0025	0.0027	0.0029	0.0034
					Feed (ipm)	26	31	32	28	25	22
	HSM ≤ 0.05	≤ 2	355	RPM	5424	3616	2712	2170	1808	1356	
			(284-426)	Fz	0.0013	0.0025	0.0034	0.0037	0.0041	0.0047	
				Feed (ipm)	42	54	55	48	44	38	
TITANIUM ALLOYS (DIFFICULT) Ti10V2Fe3Al, Ti5Al5V5Mo3Cr, Ti7Al4Mo, Ti3Al8V6Cr4Zr4Mo, Ti6Al6V6Sn, Ti15V3 Cr3Sn3Al	≤ 420 Bhn or ≤ 45 HRc	Profile ≤ 0.1	≤ 1	155	RPM	2368	1579	1184	947	789	592
				(124-186)	Fz	0.0010	0.0018	0.0025	0.0027	0.0029	0.0034
					Feed (ipm)	14	17	18	15	14	12
	HSM ≤ 0.05	≤ 2	200	RPM	3056	2037	1528	1222	1019	764	
			(160-240)	Fz	0.0013	0.0025	0.0034	0.0037	0.0041	0.0047	
				Feed (ipm)	24	31	31	27	25	22	

Bhn (Brinell) HRc (Rockwell C) HSM (High Speed Machining)
 $rpm = Vc \times 3.82 / DC$
 $ipm = Fz \times 6 \times rpm$
 reduce speed and feed for materials harder than listed
 reduce feed and Ae when finish milling (.02 x DC maximum)
 feed rates listed have chip thinning adjustments included where applicable
 refer to the SGS Tool Wizard® for complete technical information (www.kyocera-sgstool.com)

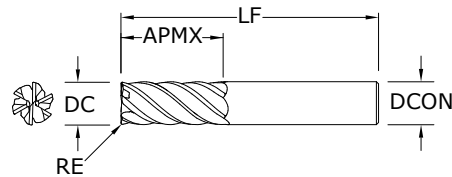
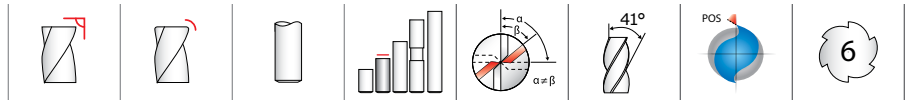

51M • 51MCR

METRIC SERIES

TOLERANCES (mm)

DC = +0,000/-0,050

 DCON = h₆

RE = +0,000/-0,050

- STEELS
- STAINLESS STEELS
- CAST IRON
- HIGH TEMP ALLOYS

For patent information visit www.ksptpatents.com

CUTTING DIAMETER DC	LENGTH OF CUT APMX	mm			CORNER RADIUS RE	EDP NO. Ti-NAMITE®-X (TX)
		OVERALL LENGTH LF	SHANK DIAMETER DCON			
6,0	19,0	63,0	6,0	—	45100	
6,0	19,0	63,0	6,0	0,5	45112	
6,0	19,0	63,0	6,0	1,0	45170	
6,0	19,0	63,0	6,0	1,5	45171	
8,0	20,0	63,0	8,0	—	45101	
8,0	20,0	63,0	8,0	0,5	45113	
8,0	20,0	63,0	8,0	1,0	45114	
8,0	20,0	63,0	8,0	1,2	45150	
8,0	20,0	63,0	8,0	1,5	45172	
8,0	20,0	63,0	8,0	2,0	45173	
10,0	22,0	75,0	10,0	—	45102	
10,0	22,0	75,0	10,0	0,5	45174	
10,0	22,0	75,0	10,0	1,0	45115	
10,0	22,0	75,0	10,0	1,5	45116	
10,0	22,0	75,0	10,0	2,0	45117	
10,0	22,0	75,0	10,0	2,5	45175	
12,0	26,0	83,0	12,0	—	45103	
12,0	26,0	83,0	12,0	0,5	45176	
12,0	26,0	83,0	12,0	0,76	45177	
12,0	26,0	83,0	12,0	1,0	45118	
12,0	26,0	83,0	12,0	1,5	45119	
12,0	26,0	83,0	12,0	2,0	45120	
12,0	26,0	83,0	12,0	2,5	45178	
12,0	26,0	83,0	12,0	3,0	45179	
16,0	32,0	92,0	16,0	—	45104	
16,0	32,0	92,0	16,0	1,0	45121	
16,0	32,0	92,0	16,0	1,5	45122	
16,0	32,0	92,0	16,0	2,0	45123	
16,0	32,0	92,0	16,0	2,5	45180	
16,0	32,0	92,0	16,0	3,0	45181	
16,0	32,0	92,0	16,0	4,0	45182	
20,0	38,0	104,0	20,0	—	45105	
20,0	38,0	104,0	20,0	1,0	45124	
20,0	38,0	104,0	20,0	1,5	45125	
20,0	38,0	104,0	20,0	2,0	45126	
20,0	38,0	104,0	20,0	2,5	45183	
20,0	38,0	104,0	20,0	3,0	45184	
20,0	38,0	104,0	20,0	4,0	45185	
20,0	38,0	104,0	20,0	5,0	45186	

- Engineered for High Speed Milling using Trochoidal and Peel Milling techniques
- Eccentric relief provides superior strength and smoother surface finish
- Enhanced corner geometry with tight tolerance corner radii
- Recommended for materials ≤ 45 HRc (≤ 420 Bhn)

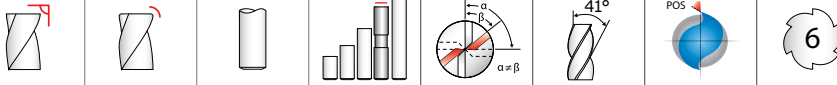

**51ML •
51MLC**
METRIC SERIES

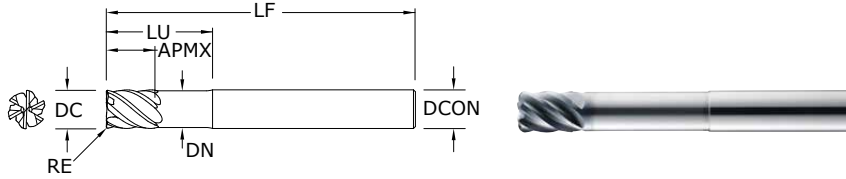

- Engineered for High Speed Milling using Trochoidal and Peel Milling techniques
- Eccentric relief provides superior strength and smoother surface finish
- Necked design with blended diameter transitions provide clearance to reach
- Enhanced corner geometry with tight tolerance corner radii
- Recommended for materials ≤ 45 HRc (≤ 420 Bhn)

mm							EDP NO.
CUTTING DIAMETER DC	LENGTH OF CUT APMX	OVERALL LENGTH LF	SHANK DIAMETER DCON	REACH LU	NECK DIAMETER DN	CORNER RADIUS RE	Ti-NAMITE®-X (TX)
6,0	8,0	75,0	6,0	32,0	5,69	–	45106
6,0	8,0	75,0	6,0	32,0	5,69	0,5	45127
6,0	8,0	75,0	6,0	32,0	5,69	1,0	45187
6,0	8,0	75,0	6,0	32,0	5,69	1,5	45188
8,0	10,0	75,0	8,0	32,0	7,59	–	45107
8,0	10,0	75,0	8,0	32,0	7,59	0,5	45128
8,0	10,0	75,0	8,0	32,0	7,59	1,0	45129
8,0	10,0	75,0	8,0	32,0	7,59	1,5	45189
8,0	10,0	75,0	8,0	32,0	7,59	2,0	45190
10,0	12,0	100,0	10,0	40,0	9,50	–	45108
10,0	12,0	100,0	10,0	40,0	9,50	0,5	45191
10,0	12,0	100,0	10,0	40,0	9,50	1,0	45130
10,0	12,0	100,0	10,0	40,0	9,50	1,5	45131
10,0	12,0	100,0	10,0	40,0	9,50	2,0	45132
10,0	12,0	100,0	10,0	40,0	9,50	2,5	45192
12,0	15,0	100,0	12,0	48,0	11,38	–	45109
12,0	15,0	100,0	12,0	48,0	11,38	0,5	45193
12,0	15,0	100,0	12,0	48,0	11,38	0,76	45194
12,0	15,0	100,0	12,0	48,0	11,38	1,0	45133
12,0	15,0	100,0	12,0	48,0	11,38	1,5	45134
12,0	15,0	100,0	12,0	48,0	11,38	2,0	45135
12,0	15,0	100,0	12,0	48,0	11,38	2,5	45195
12,0	15,0	100,0	12,0	48,0	11,38	3,0	45196
16,0	20,0	115,0	16,0	65,0	15,19	–	45110
16,0	20,0	115,0	16,0	65,0	15,19	1,0	45136
16,0	20,0	115,0	16,0	65,0	15,19	1,5	45137
16,0	20,0	115,0	16,0	65,0	15,19	2,0	45138
16,0	20,0	115,0	16,0	65,0	15,19	2,5	45197
16,0	20,0	115,0	16,0	65,0	15,19	3,0	45198
16,0	20,0	115,0	16,0	65,0	15,19	4,0	45199
20,0	24,0	150,0	20,0	80,0	19,00	–	45111
20,0	24,0	150,0	20,0	80,0	19,00	1,0	45139
20,0	24,0	150,0	20,0	80,0	19,00	1,5	45140
20,0	24,0	150,0	20,0	80,0	19,00	2,0	45141
20,0	24,0	150,0	20,0	80,0	19,00	2,5	45200
20,0	24,0	150,0	20,0	80,0	19,00	3,0	45201
20,0	24,0	150,0	20,0	80,0	19,00	4,0	45202
20,0	24,0	150,0	20,0	80,0	19,00	5,0	45203

TOLERANCES (mm)

DC = +0,000/-0,050
DCON = h_6
RE = +0,000/-0,050

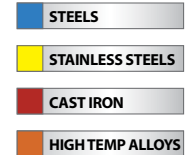

For patent information visit www.ksptpatents.com

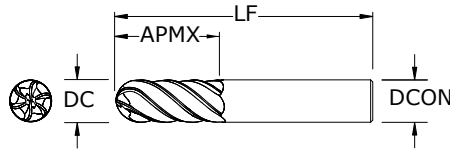
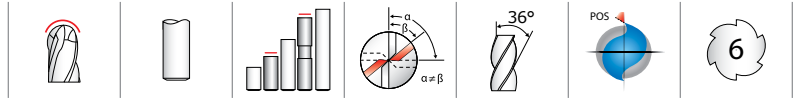
51MB
 METRIC SERIES

TOLERANCES (mm)

6,0–10,0 DIAMETER
 DC = +0,000/–0,040
 DCON = h₆
 RE = +0,000/–0,025

12,0–20,0 DIAMETER
 DC = +0,000/–0,050
 DCON = h₆
 RE = +0,000/–0,025

- STEELS
- STAINLESS STEELS
- CAST IRON
- HIGH TEMP ALLOYS

For patent information visit www.kspatents.com

mm				EDP NO.
CUTTING DIAMETER DC	LENGTH OF CUT APMX	OVERALL LENGTH LF	SHANK DIAMETER DCON	Ti-NAMITE®-X (TX)
6,0	19,0	63,0	6,0	45204
8,0	20,0	63,0	8,0	45206
10,0	22,0	75,0	10,0	45208
12,0	26,0	83,0	12,0	45210
16,0	32,0	92,0	16,0	45212
20,0	38,0	104,0	20,0	45214

RE=1/2 Cutting Diameter (DC)

- Engineered for High Speed Milling using Trochoidal and Peel Milling techniques
- Faceted relief provides superior strength and smoother surface finish
- Ball end design ideal for finishing operations in complex workpieces
- Recommended for materials ≤ 45 HRc (≤ 420 Bhn)

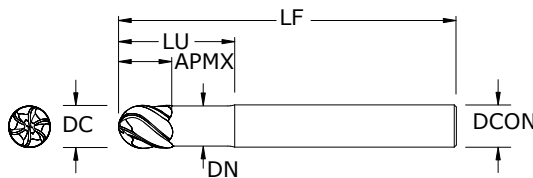
51MLB
 METRIC SERIES

TOLERANCES (mm)

6,0–10,0 DIAMETER
 DC = +0,000/–0,040
 DCON = h₆
 RE = +0,000/–0,025

12,0–20,0 DIAMETER
 DC = +0,000/–0,050
 DCON = h₆
 RE = +0,000/–0,025

- STEELS
- STAINLESS STEELS
- CAST IRON
- HIGH TEMP ALLOYS

For patent information visit www.kspatents.com

mm						EDP NO.
CUTTING DIAMETER DC	LENGTH OF CUT APMX	OVERALL LENGTH LF	SHANK DIAMETER DCON	REACH LU	NECK DIAMETER DN	Ti-NAMITE®-X (TX)
6,0	8,0	75,0	6,0	32,0	5,68	45205
8,0	10,0	75,0	8,0	32,0	7,58	45207
10,0	12,0	100,0	10,0	40,0	9,49	45209
12,0	15,0	100,0	12,0	48,0	11,37	45211
16,0	20,0	115,0	16,0	65,0	15,18	45213
20,0	24,0	150,0	20,0	80,0	18,99	45215

RE=1/2 Cutting Diameter (DC)

- Engineered for High Speed Milling using Trochoidal and Peel Milling techniques
- Faceted relief provides superior strength and smoother surface finish
- Ball end design ideal for finishing operations in complex workpieces
- Recommended for materials ≤ 45 HRc (≤ 420 Bhn)

Series
51M, 51MCR,
51ML, 51MLC,
51MB, 51MLB
Metric

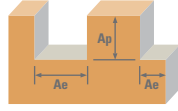

Material	Hardness	Profile	Ae x DC	Ap x DC	Vc (m/min)	DC • mm						
						6	8	10	12	16	20	
P CARBON STEELS 1018, 1040, 1080, 1090, 10L50, 1140, 1212, 12L15, 1525, 1536	≤ 275 Bhn or ≤ 28 HRc	Profile	≤ 0.1	≤ 1	219	RPM	11633	8725	6980	5816	4362	3490
					(176-263)	Fz	0.048	0.075	0.093	0.120	0.141	0.163
					Feed (mm/min)	3350	3909	3909	4188	3685	3406	
		HSM	≤ 0.05	≤ 2	279	RPM	14784	11088	8870	7392	5544	4435
					(223-335)	Fz	0.067	0.113	0.141	0.168	0.197	0.227
					Feed (mm/min)	5960	7523	7522	7450	6557	6032	
	≤ 375 Bhn or ≤ 40 HRc	Profile	≤ 0.1	≤ 1	149	RPM	7917	5938	4750	3958	2969	2375
					(119-179)	Fz	0.036	0.062	0.077	0.091	0.108	0.123
					Feed (mm/min)	1710	2204	2204	2166	1915	1748	
		HSM	≤ 0.05	≤ 2	189	RPM	10017	7513	6010	5009	3756	3005
					(151-227)	Fz	0.050	0.083	0.104	0.125	0.146	0.165
					Feed (mm/min)	3029	3751	3750	3750	3289	2981	
TOOL STEELS A2, D2, H13, L2, M2, P20, S7, T15, W2	≤ 375 Bhn or ≤ 40 HRc	Profile	≤ 0.1	≤ 1	73	RPM	3878	2908	2327	1939	1454	1163
					(59-88)	Fz	0.029	0.049	0.061	0.072	0.087	0.099
					Feed (mm/min)	670	856	856	838	759	689	
	HSM	≤ 0.05	≤ 2	93	RPM	4928	3696	2957	2464	1848	1478	
				(74-112)	Fz	0.041	0.068	0.085	0.101	0.118	0.133	
				Feed (mm/min)	1206	1514	1514	1490	1306	1183		
M STAINLESS STEELS (FREE MACHINING) 303, 416, 420F, 430F, 440F	≤ 275 Bhn or ≤ 28 HRc	Profile	≤ 0.1	≤ 1	155	RPM	8240	6180	4944	4120	3090	2472
					(140-171)	Fz	0.036	0.060	0.075	0.091	0.105	0.120
					Feed (mm/min)	1780	2215	2215	2254	1946	1780	
		HSM	≤ 0.05	≤ 2	198	RPM	10502	7877	6301	5251	3938	3151
					(178-218)	Fz	0.050	0.081	0.101	0.122	0.143	0.163
					Feed (mm/min)	3176	3832	3831	3856	3387	3075	
	≤ 275 Bhn or ≤ 28 HRc	Profile	≤ 0.1	≤ 1	107	RPM	5655	4241	3393	2827	2121	1696
					(96-117)	Fz	0.029	0.049	0.061	0.072	0.084	0.096
					Feed (mm/min)	977	1249	1249	1221	1075	977	
		HSM	≤ 0.05	≤ 2	137	RPM	7271	5453	4362	3635	2726	2181
					(123-151)	Fz	0.041	0.068	0.085	0.101	0.118	0.133
					Feed (mm/min)	1780	2234	2234	2198	1926	1745	
≤ 325 Bhn or ≤ 35 HRc	Profile	≤ 0.1	≤ 1	99	RPM	5251	3938	3151	2626	1969	1575	
				(89-109)	Fz	0.029	0.049	0.061	0.072	0.084	0.096	
				Feed (mm/min)	907	1160	1159	1134	998	907		
	HSM	≤ 0.05	≤ 2	125	RPM	6624	4968	3975	3312	2484	1987	
				(112-137)	Fz	0.041	0.068	0.085	0.101	0.118	0.133	
				Feed (mm/min)	1621	2035	2035	2003	1755	1590		

continued on next page

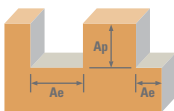

Series
51M, 51MCR,
51ML, 51MLC,
51MB, 51MLB
Metric

	Hardness	Ae x DC	Ap x DC	Vc (m/min)	DC • mm							
					6	8	10	12	16	20		
K	CAST IRONS (LOW & MEDIUM ALLOY) Gray, Malleable, Ductile	Profile 	≤ 0.25	≤ 1.5	575	RPM	9290	6968	5574	4645	3484	2787
					(460-690)	Fz	0.043	0.075	0.093	0.108	0.128	0.147
					Feed (mm/min)	2408	3122	3122	3010	2675	2453	
		HSM 	≤ 0.05	≤ 2	730	RPM	11795	8846	7077	5897	4423	3538
					(584-876)	Fz	0.060	0.100	0.125	0.154	0.179	0.203
					Feed (mm/min)	4246	5322	5322	5434	4755	4303	
	CAST IRONS (HIGH ALLOY) Gray, Malleable, Ductile	Profile 	≤ 0.25	≤ 1.5	430	RPM	6947	5211	4168	3474	2605	2084
					(344-516)	Fz	0.043	0.075	0.093	0.108	0.128	0.147
					Feed (mm/min)	1801	2335	2334	2251	2001	1834	
		HSM 	≤ 0.05	≤ 2	545	RPM	8806	6604	5283	4403	3302	2642
					(436-654)	Fz	0.060	0.100	0.125	0.154	0.179	0.203
					Feed (mm/min)	3170	3974	3973	4057	3550	3212	
S	HIGH TEMP ALLOYS (NICKEL, COBALT, IRON BASE) Inconel 601, 617, 625, Incoloy, Monel 400	Profile 	≤ 0.1	≤ 1	32	RPM	1696	1272	1018	848	636	509
					(26-38)	Fz	0.034	0.058	0.072	0.086	0.100	0.115
					Feed (mm/min)	342	440	440	440	381	350	
		HSM 	≤ 0.05	≤ 2	40	RPM	2100	1575	1260	1050	788	630
					(32-48)	Fz	0.038	0.077	0.096	0.115	0.136	0.155
					Feed (mm/min)	484	726	726	726	641	585	
	HIGH TEMP ALLOYS (NICKEL, COBALT, IRON BASE) Inconel 718, X-750, Incoloy, Waspaloy, Hastelloy, Rene	Profile 	≤ 0.1	≤ 1	24	RPM	1293	969	776	646	485	388
					(20-29)	Fz	0.024	0.038	0.048	0.060	0.069	0.077
					Feed (mm/min)	186	223	223	233	201	180	
		HSM 	≤ 0.05	≤ 2	30	RPM	1616	1212	969	808	606	485
					(24-37)	Fz	0.031	0.053	0.067	0.082	0.095	0.109
					Feed (mm/min)	302	388	388	395	344	318	
TITANIUM ALLOYS Pure Titanium, Ti6Al4V, Ti6Al2Sn4Zr2Mo, Ti4Al4Mo2Sn0.5Si	Profile 	≤ 0.1	≤ 1	85	RPM	4524	3393	2714	2262	1696	1357	
				(68-102)	Fz	0.024	0.038	0.048	0.060	0.069	0.077	
				Feed (mm/min)	651	782	782	814	704	630		
	HSM 	≤ 0.05	≤ 2	108	RPM	5736	4302	3441	2868	2151	1721	
				(87-130)	Fz	0.031	0.053	0.067	0.082	0.095	0.109	
				Feed (mm/min)	1074	1377	1377	1404	1222	1129		
TITANIUM ALLOYS (DIFFICULT) Ti10V2Fe3Al, Ti5Al5V5Mo3Cr, Ti7Al4Mo, Ti3Al8V6Cr4Zr4Mo, Ti6Al6V6Sn, Ti15V3 Cr3Sn3Al	Profile 	≤ 0.1	≤ 1	47	RPM	2504	1878	1503	1252	939	751	
				(38-57)	Fz	0.024	0.038	0.048	0.060	0.069	0.077	
				Feed (mm/min)	361	433	433	451	389	349		
	HSM 	≤ 0.05	≤ 2	61	RPM	3231	2424	1939	1616	1212	969	
				(49-73)	Fz	0.031	0.053	0.067	0.082	0.095	0.109	
				Feed (mm/min)	605	776	776	791	689	636		

Bhn (Brinell) HRc (Rockwell C) HSM (High Speed Machining)
 $rpm = (Vc \times 1000) / (DC \times 3.14)$
 $mm/min = Fz \times 6 \times rpm$
 reduce speed and feed for materials harder than listed
 reduce feed and Ae when finish milling (.02 x DC maximum)
 feed rates listed have chip thinning adjustments included where applicable
 refer to the SGS Tool Wizard® for complete technical information (www.kyocera-sgstool.com)



**77 •
77CR**
FRACTIONAL SERIES

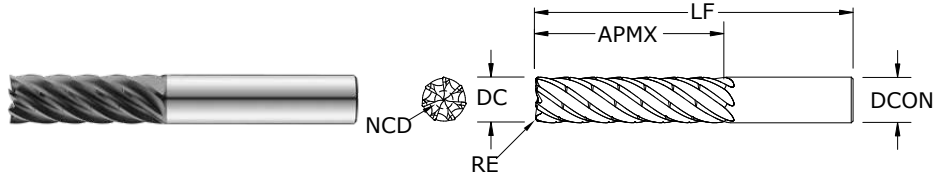

- Specializes in deep axial trochoidal and high-speed milling applications
- Optimized core improves rigidity, chip flow and reduces deflection
- Chip Breaker design breaks up chips from the long flute length allowing for better chip flow and evacuation in deep pocketing operations
- Recommended for materials ≤ 45 HRc (≤ 420 Bhn)

inch						EDP NO.			
CUTTING DIAMETER DC	LENGTH OF CUT APMX	OVERALL LENGTH LF	SHANK DIAMETER DCON	CORNER RADIUS RE	NON-CUTTING DIAMETER NCD	Ti-NAMITE®-A (TA) EDP NO.	Ti-NAMITE®-A (TA) CHIP BREAKER EDP NO.	Ti-NAMITE®-M (TM) EDP NO.	Ti-NAMITE®-M (TM) CHIP BREAKER EDP NO.
1/4	5/8	2-1/2	1/4	—	0.0845	77100	77102	77101	77103
1/4	5/8	2-1/2	1/4	.015	0.0845	77104	77106	77105	77107
1/4	5/8	2-1/2	1/4	.030	0.0845	77108	77110	77109	77111
1/4	3/4	2-1/2	1/4	—	0.0845	77112	77114	77113	77115
1/4	3/4	2-1/2	1/4	.015	0.0845	77116	77118	77117	77119
1/4	3/4	2-1/2	1/4	.030	0.0845	77120	77122	77121	77123
1/4	1	3	1/4	—	0.0845	77124	77126	77125	77127
1/4	1	3	1/4	.015	0.0845	77128	77130	77129	77131
1/4	1	3	1/4	.030	0.0845	77132	77134	77133	77135
3/8	15/16	3	3/8	—	0.1268	77136	77138	77137	77139
3/8	15/16	3	3/8	.015	0.1268	77140	77142	77141	77143
3/8	15/16	3	3/8	.030	0.1268	77144	77146	77145	77147
3/8	1-1/8	3-1/4	3/8	—	0.1268	77148	77150	77149	77151
3/8	1-1/8	3-1/4	3/8	.015	0.1268	77152	77154	77153	77155
3/8	1-1/8	3-1/4	3/8	.030	0.1268	77156	77158	77157	77159
3/8	1-1/2	3-1/2	3/8	—	0.1268	77160	77162	77161	77163
3/8	1-1/2	3-1/2	3/8	.015	0.1268	77164	77166	77165	77167
3/8	1-1/2	3-1/2	3/8	.030	0.1268	77168	77170	77169	77171
1/2	1-1/4	3-1/4	1/2	—	0.1690	77172	77174	77173	77175
1/2	1-1/4	3-1/4	1/2	.030	0.1690	77176	77178	77177	77179
1/2	1-1/4	3-1/4	1/2	.060	0.1690	77180	77182	77181	77183
1/2	1-1/2	3-1/2	1/2	—	0.1690	77184	77186	77185	77187
1/2	1-1/2	3-1/2	1/2	.030	0.1690	77188	77190	77189	77191
1/2	1-1/2	3-1/2	1/2	.060	0.1690	77192	77194	77193	77195
1/2	2	4	1/2	—	0.1690	77196	77198	77197	77199
1/2	2	4	1/2	.030	0.1690	77200	77202	77201	77203
1/2	2	4	1/2	.060	0.1690	77204	77206	77205	77207
5/8	1-9/16	3-3/4	5/8	—	0.2113	77208	77210	77209	77211
5/8	1-9/16	3-3/4	5/8	.030	0.2113	77212	77214	77213	77215
5/8	1-9/16	3-3/4	5/8	.060	0.2113	77216	77218	77217	77219

TOLERANCES (inch)

- 1/4 DIAMETER**
 DC = +0.0000/-0.0012
 DCON = h₆
 RE = +0.000/-0.002
- >1/4-3/8 DIAMETER**
 DC = +0.0000/-0.0016
 DCON = h₆
 RE = +0.000/-0.002
- >3/8-1 DIAMETER**
 DC = +0.0000/-0.0020
 DCON = h₆
 RE = +0.000/-0.002

- STEELS
- STAINLESS STEELS
- CAST IRON
- HIGH TEMP ALLOYS

For patent information visit www.ksptpatents.com

continued on next page

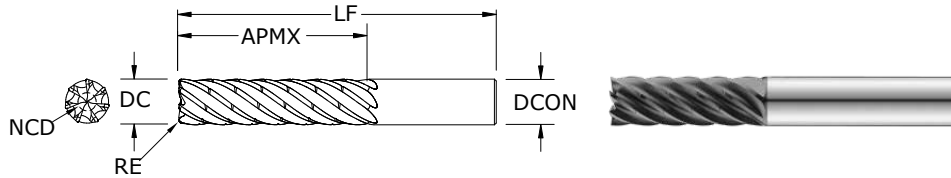

**77 •
77CR**
FRACTIONAL SERIES

TOLERANCES (inch)

1/4 DIAMETER

DC = +0.0000/-0.0012
DCON = h₆
RE = +0.000 / -0.002

>1/4-3/8 DIAMETER

DC = +0.0000/-0.0016
DCON = h₆
RE = +0.000 / -0.002

>3/8-1 DIAMETER

DC = +0.0000/-0.0020
DCON = h₆
RE = +0.000 / -0.002

- STEELS
- STAINLESS STEELS
- CAST IRON
- HIGH TEMP ALLOYS

For patent information visit www.ksptpatents.com

inch							EDP NO.			
CUTTING DIAMETER DC	LENGTH OF CUT APMX	OVERALL LENGTH LF	SHANK DIAMETER DCON	CORNER RADIUS RE	NON-CUTTING CENTER DIAMETER NCD	Ti-NAMITE®-A (TA) EDP NO.	Ti-NAMITE®-A (TA) CHIP BREAKER EDP NO.	Ti-NAMITE®-M (TM) EDP NO.	Ti-NAMITE®-M (TM) CHIP BREAKER EDP NO.	
5/8	1-7/8	4	5/8	-	0.2113	77220	77222	77221	77223	
5/8	1-7/8	4	5/8	.030	0.2113	77224	77226	77225	77227	
5/8	1-7/8	4	5/8	.060	0.2113	77228	77230	77229	77231	
5/8	2-1/2	4-1/2	5/8	-	0.2113	77232	77234	77233	77235	
5/8	2-1/2	4-1/2	5/8	.030	0.2113	77236	77238	77237	77239	
5/8	2-1/2	4-1/2	5/8	.060	0.2113	77240	77242	77241	77243	
3/4	1-7/8	4	3/4	-	0.2535	77244	77246	77245	77247	
3/4	1-7/8	4	3/4	.030	0.2535	77248	77250	77249	77251	
3/4	1-7/8	4	3/4	.060	0.2535	77252	77254	77253	77255	
3/4	1-7/8	4	3/4	.120	0.2535	77256	77258	77257	77259	
3/4	2-1/4	4-1/2	3/4	-	0.2535	77260	77262	77261	77263	
3/4	2-1/4	4-1/2	3/4	.030	0.2535	77264	77266	77265	77267	
3/4	2-1/4	4-1/2	3/4	.060	0.2535	77268	77270	77269	77271	
3/4	2-1/4	4-1/2	3/4	.120	0.2535	77272	77274	77273	77275	
3/4	3	5-1/4	3/4	-	0.2535	77276	77278	77277	77279	
3/4	3	5-1/4	3/4	.030	0.2535	77280	77282	77281	77283	
3/4	3	5-1/4	3/4	.060	0.2535	77284	77286	77285	77287	
3/4	3	5-1/4	3/4	.120	0.2535	77288	77290	77289	77291	
1	2-1/2	5-1/2	1	-	0.3380	77292	77294	77293	77295	
1	2-1/2	5-1/2	1	.030	0.3380	77296	77298	77297	77299	
1	2-1/2	5-1/2	1	.060	0.3380	77300	77302	77301	77303	
1	2-1/2	5-1/2	1	.120	0.3380	77304	77306	77305	77307	
1	3	6	1	-	0.3380	77308	77310	77309	77311	
1	3	6	1	.030	0.3380	77312	77314	77313	77315	
1	3	6	1	.060	0.3380	77316	77318	77317	77319	
1	3	6	1	.120	0.3380	77320	77322	77321	77323	
1	4	7	1	-	0.3380	77324	77326	77325	77327	
1	4	7	1	.030	0.3380	77328	77330	77329	77331	
1	4	7	1	.060	0.3380	77332	77334	77333	77335	
1	4	7	1	.120	0.3380	77336	77338	77337	77339	

CONTINUED

FRACTIONAL H-Carb

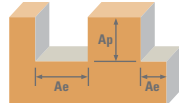

Series 77, 77CR Fractional		Hardness	Ae x D ₁		Ap x D ₁	Vc (sfm)	D ₁ • inch						
							1/4	3/8	1/2	5/8	3/4	1	
CARBON STEELS 1018, 1040, 1080, 1090, 10L50, 1140, 1212, 12L15, 1525, 1536	≤ 275 Bhn or ≤ 28 HRC	HSM	2.5xD		816 (653-979)	RPM	11552	7701	5776	4621	3851	2888	
			Fz	0.0015		0.0024	0.0031	0.0035	0.0038	0.0042			
		Feed (ipm)	121	129	125	113	102	85					
		HSM	3xD		845 (676-1014)	Fz	0.0017	0.0027	0.0035	0.0040	0.0043	0.0047	
			Feed (ipm)	136		146	140	129	116	95			
		HSM	4xD		756 (605-907)	Fz	0.0018	0.0028	0.0036	0.0041	0.0044	0.0049	
	Feed (ipm)		146	151		146	133	119	99				
	ALLOY STEELS 4140, 4150, 4320, 5120, 5150, 8630, 86L20, 50100	≤ 375 Bhn or ≤ 40 HRC	HSM	2.5xD		595 (476-714)	RPM	8419	5613	4210	3368	2806	2105
				Fz	0.0009		0.0019	0.0026	0.0028	0.0031	0.0035		
Feed (ipm)			53	75	77	66	61	52					
HSM			3xD		616 (493-739)	Fz	0.0010	0.0021	0.0030	0.0033	0.0035	0.0039	
			Feed (ipm)	59		83	88	78	69	57			
HSM			4xD		551 (441-661)	Fz	0.0011	0.0022	0.0031	0.0034	0.0036	0.0041	
		Feed (ipm)	65	86		91	80	71	60				
TOOL STEELS A2, D2, H13, L2, M2, P20, S7, T15, W2		≤ 375 Bhn or ≤ 40 HRC	HSM	2.5xD		272 (218-326)	RPM	3851	2567	1925	1540	1284	963
				Fz	0.0006		0.0011	0.0014	0.0017	0.0020	0.0024		
	Feed (ipm)		16	20	19	18	18	16					
	HSM		3xD		282 (226-338)	Fz	0.0007	0.0012	0.0016	0.0019	0.0022	0.0027	
			Feed (ipm)	19		22	22	20	20	18			
	HSM		4xD		252 (202-302)	Fz	0.0007	0.0013	0.0017	0.0020	0.0023	0.0028	
		Feed (ipm)	19	23		23	22	21	19				
	STAINLESS STEELS (FREE MACHINING) 303, 416, 420F, 430F, 440F	≤ 275 Bhn or ≤ 28 HRC	HSM	2.5xD		646 (517-775)	RPM	9137	6092	4569	3655	3046	2284
				Fz	0.0009		0.0017	0.0023	0.0025	0.0028	0.0032		
Feed (ipm)			58	72	74	64	60	51					
HSM			3xD		669 (535-803)	Fz	0.0010	0.0019	0.0026	0.0029	0.0031	0.0036	
			Feed (ipm)	64		81	83	74	66	58			
HSM			4xD		598 (478-718)	Fz	0.0011	0.0020	0.0027	0.0030	0.0033	0.0037	
		Feed (ipm)	70	85		86	77	70	59				
STAINLESS STEELS (DIFFICULT) 304, 304L, 316, 316L		≤ 275 Bhn or ≤ 28 HRC	HSM	2.5xD		425 (340-510)	RPM	6020	4014	3010	2408	2007	1505
				Fz	0.0007		0.0014	0.0019	0.0023	0.0026	0.0030		
	Feed (ipm)		29	39	40	39	37	32					
	HSM		3xD		440 (352-528)	Fz	0.0008	0.0016	0.0021	0.0025	0.0029	0.0034	
			Feed (ipm)	34		45	44	42	41	36			
	HSM		4xD		394 (315-473)	Fz	0.0008	0.0016	0.0022	0.0026	0.0030	0.0035	
		Feed (ipm)	34	45		46	44	42	37				
	STAINLESS STEELS (PH) 13-8 PH, 15-5PH, 17-4 PH, CUSTOM 450	≤ 325 Bhn or ≤ 35 HRC	HSM	2.5xD		408 (326-490)	RPM	5776	3851	2888	2310	1925	1444
				Fz	0.0007		0.0014	0.0019	0.0023	0.0026	0.0030		
Feed (ipm)			28	38	38	37	35	30					
HSM			3xD		422 (338-506)	Fz	0.0008	0.0016	0.0021	0.0025	0.0029	0.0034	
			Feed (ipm)	32		43	42	40	39	34			
HSM			4xD		378 (302-454)	Fz	0.0008	0.0016	0.0022	0.0026	0.0030	0.0035	
		Feed (ipm)	32	43		44	42	40	35				

continued on next page

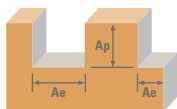

Series 77, 77CR Fractional	Hardness	Ae x D ₁	Ap x D ₁	Vc (sfm)	D ₁ • inch						
					1/4	3/8	1/2	5/8	3/4	1	
K CAST IRONS (LOW & MEDIUM ALLOY) Gray, Malleable, Ductile	≤ 220 Bhn or ≤ 19 HRc	HSM 	2.5xD	714 (571-857)	RPM	10100	6733	5050	4040	3367	2525
					Fz	0.0010	0.0018	0.0024	0.0028	0.0033	0.0037
		HSM 	3xD	739 (591-887)	Fz	0.0011	0.0020	0.0027	0.0033	0.0037	0.0042
					Feed (ipm)	71	85	85	79	78	65
		HSM 	4xD	661 (529-793)	Fz	0.0012	0.0021	0.0028	0.0034	0.0039	0.0043
					Feed (ipm)	78	94	95	93	87	73
	≤ 260 Bhn or ≤ 26 HRc	HSM 	2.5xD	425 (340-510)	RPM	6020	4014	3010	2408	2007	1505
					Fz	0.0007	0.0014	0.0019	0.0023	0.0026	0.0030
		HSM 	3xD	440 (352-528)	Fz	0.0008	0.0016	0.0021	0.0025	0.0029	0.0037
					Feed (ipm)	29	39	40	39	37	32
		HSM 	4xD	394 (315-473)	Fz	0.0008	0.0016	0.0022	0.0026	0.0030	0.0035
					Feed (ipm)	34	45	44	42	41	39
S HIGH TEMP ALLOYS (NICKEL, COBALT, IRON BASE) Inconel 601, 617, 625, Incoloy, Monel 400	≤ 300 Bhn or ≤ 32 HRc	HSM 	2.5xD	136 (109-163)	RPM	1925	1284	963	770	642	481
					Fz	0.0006	0.0011	0.0016	0.0018	0.0021	0.0025
		HSM 	3xD	141 (113-169)	Fz	0.0007	0.0012	0.0018	0.0021	0.0024	0.0028
					Feed (ipm)	8	10	11	10	9	8
		HSM 	4xD	126 (101-151)	Fz	0.0007	0.0013	0.0018	0.0022	0.0025	0.0029
					Feed (ipm)	9	11	12	11	11	9
	≤ 400 Bhn or ≤ 43 HRc	HSM 	2.5xD	85 (68-102)	RPM	1207	805	604	483	402	302
					Fz	0.0005	0.0009	0.0013	0.0015	0.0018	0.0022
		HSM 	3xD	88 (70-106)	Fz	0.0005	0.0010	0.0015	0.0018	0.0020	0.0025
					Feed (ipm)	4	5	5	5	5	5
		HSM 	4xD	79 (63-95)	Fz	0.0006	0.0011	0.0015	0.0018	0.0021	0.0026
					Feed (ipm)	4	6	6	6	6	5
TITANIUM ALLOYS (DIFFICULT) Ti10V2Fe3Al, Ti5Al5V5Mo3Cr, Ti7Al4Mo, Ti3Al8V6Cr4Zr4Mo, Ti6Al6V6Sn, Ti15V3 Cr3Sn3Al	≤ 350 Bhn or ≤ 38 HRc	HSM 	2.5xD	289 (231-347)	RPM	4095	2730	2048	1638	1365	1024
					Fz	0.0008	0.0015	0.0021	0.0024	0.0028	0.0032
		HSM 	3xD	299 (239-359)	Fz	0.0009	0.0017	0.0023	0.0025	0.0028	0.0036
					Feed (ipm)	23	29	30	28	27	23
		HSM 	4xD	268 (214-322)	Fz	0.0009	0.0018	0.0024	0.0029	0.0033	0.0037
					Feed (ipm)	26	32	33	29	27	26
	≤ 420 Bhn or ≤ 45 HRc	HSM 	2.5xD	170 (136-204)	RPM	2399	1599	1199	960	800	600
					Fz	0.0008	0.0015	0.0021	0.0024	0.0028	0.0032
		HSM 	3xD	176 (141-211)	Fz	0.0009	0.0017	0.0023	0.0025	0.0028	0.0036
					Feed (ipm)	13	17	18	16	16	13
		HSM 	4xD	157 (126-188)	Fz	0.0009	0.0018	0.0024	0.0029	0.0033	0.0037
					Feed (ipm)	15	19	19	17	16	15

Bhn (Brinell) HRc (Rockwell C) HSM (High Speed Machining)
 rpm = Vc x 3.82 / DC
 ipm = Fz x 7 x rpm
 reduce speed and feed for materials harder than listed
 reduce feed and Ae when finish milling (.02 x DC maximum)
 feed rates listed have chip thinning adjustments included where applicable
 refer to the SGS Tool Wizard® for complete technical information (www.kyocera-sgstoool.com)



77M • 77MCR
METRIC SERIES

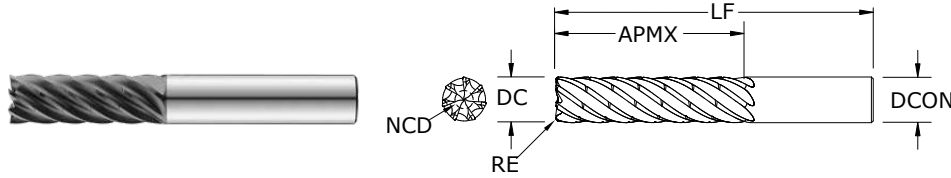

- Specializes in deep axial trochoidal and high-speed milling applications
- Optimized core improves rigidity, chip flow and reduces deflection
- Chip Breaker design breaks up chips from the long flute length allowing for better chip flow and evacuation in deep pocketing operations
- Recommended for materials ≤ 45 HRc (≤ 420 Bhn)

mm						EDP NO.			
CUTTING DIAMETER DC	LENGTH OF CUT APMX	OVERALL LENGTH LF	SHANK DIAMETER DCON	CORNER RADIUS RE	NON-CUTTING CENTER DIAMETER NCD	Ti-NAMITE®-A (TA) EDP NO.	Ti-NAMITE®-A (TA) CHIP BREAKER EDP NO.	Ti-NAMITE®-M (TM) EDP NO.	Ti-NAMITE®-M (TM) CHIP BREAKER EDP NO.
6,0	15,0	63,0	6,0	–	2,03	74300	74302	74301	74303
6,0	15,0	63,0	6,0	0,3	2,03	74304	74306	74305	74307
6,0	15,0	63,0	6,0	0,5	2,03	74308	74310	74309	74311
6,0	18,0	63,0	6,0	–	2,03	74316	74318	74317	74319
6,0	18,0	63,0	6,0	0,3	2,03	74320	74322	74321	74323
6,0	18,0	63,0	6,0	0,5	2,03	74324	74326	74325	74327
6,0	24,0	75,0	6,0	–	2,03	74332	74334	74333	74335
6,0	24,0	75,0	6,0	0,3	2,03	74336	74338	74337	74339
6,0	24,0	75,0	6,0	0,5	2,03	74340	74342	74341	74343
8,0	20,0	75,0	8,0	–	2,71	74348	74350	74349	74351
8,0	20,0	75,0	8,0	0,5	2,71	74352	74354	74353	74355
8,0	20,0	75,0	8,0	1,0	2,71	74356	74358	74357	74359
8,0	20,0	75,0	8,0	2,0	2,71	74360	74362	74361	74363
8,0	24,0	75,0	8,0	–	2,71	74364	74366	74365	74367
8,0	24,0	75,0	8,0	0,5	2,71	74368	74370	74369	74371
8,0	24,0	75,0	8,0	1,0	2,71	74372	74374	74373	74375
8,0	24,0	75,0	8,0	2,0	2,71	74376	74378	74377	74379
8,0	32,0	85,0	8,0	–	2,71	74380	74382	74381	74383
8,0	32,0	85,0	8,0	0,5	2,71	74384	74386	74385	74387
8,0	32,0	85,0	8,0	1,0	2,71	74388	74390	74389	74391
8,0	32,0	85,0	8,0	2,0	2,71	74392	74394	74393	74395
10,0	25,0	75,0	10,0	–	3,38	74396	74398	74397	74399
10,0	25,0	75,0	10,0	0,5	3,38	74400	74402	74401	74403
10,0	25,0	75,0	10,0	1,0	3,38	74404	74406	74405	74407
10,0	30,0	80,0	10,0	–	3,38	74408	74410	74409	74411
10,0	30,0	80,0	10,0	0,5	3,38	74412	74414	74413	74415
10,0	30,0	80,0	10,0	1,0	3,38	74416	74418	74417	74419
10,0	40,0	100,0	10,0	–	3,38	74420	74422	74421	74423
10,0	40,0	100,0	10,0	0,5	3,38	74424	74426	74425	74427
10,0	40,0	100,0	10,0	1,0	3,38	74428	74430	74429	74431
12,0	30,0	83,0	12,0	–	4,06	74432	74434	74433	74435
12,0	30,0	83,0	12,0	0,5	4,06	74436	74438	74437	74439
12,0	30,0	83,0	12,0	1,0	4,06	74440	74442	74441	74443
12,0	36,0	83,0	12,0	–	4,06	74444	74446	74445	74447
12,0	36,0	83,0	12,0	0,5	4,06	74448	74450	74449	74451
12,0	36,0	83,0	12,0	1,0	4,06	74452	74454	74453	74455

TOLERANCES (mm)

- 6 DIAMETER**
 DC = +0,000/-0,030
 DCON = h_6
 RE = +0,000 / -0,050
- >6-10 DIAMETER**
 DC = +0,000/-0,040
 DCON = h_6
 RE = +0,000 / -0,050
- >10-25 DIAMETER**
 DC = +0,000/-0,050
 DCON = h_6
 RE = +0,000 / -0,050

- STEELS
- STAINLESS STEELS
- CAST IRON
- HIGH TEMP ALLOYS

For patent information visit www.ksptpatents.com

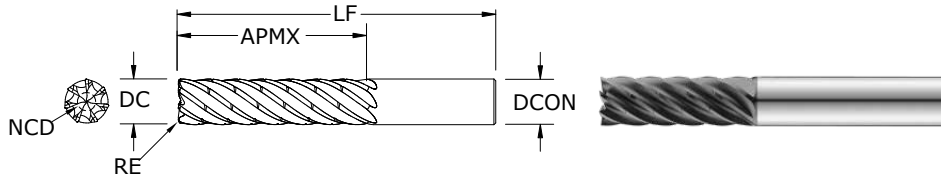

**77M •
77MCR**
METRIC SERIES

TOLERANCES (mm)

6 DIAMETER

DC = +0,000/-0,030
DCON = h₆
RE = +0,000 / -0,050

>6-10 DIAMETER

DC = +0,000/-0,040
DCON = h₆
RE = +0,000 / -0,050

>10-25 DIAMETER

DC = +0,000/-0,050
DCON = h₆
RE = +0,000 / -0,050

STEELS

STAINLESS STEELS

CAST IRON

HIGH TEMP ALLOYS

For patent information visit
www.ksptpatents.com

mm						EDP NO.			
CUTTING DIAMETER DC	LENGTH OF CUT APMX	OVERALL LENGTH LF	SHANK DIAMETER DCON	CORNER RADIUS RE	NON-CUTTING CENTER DIAMETER NCD	Ti-NAMITE®-A (TA) EDP NO.	Ti-NAMITE®-A (TA) CHIP BREAKER EDP NO.	Ti-NAMITE®-M (TM) EDP NO.	Ti-NAMITE®-M (TM) CHIP BREAKER EDP NO.
12,0	48,0	100,0	12,0	—	4,06	74456	74458	74457	74459
12,0	48,0	100,0	12,0	0,5	4,06	74460	74462	74461	74463
12,0	48,0	100,0	12,0	1,0	4,06	74464	74466	74465	74467
16,0	40,0	92,0	16,0	—	5,41	74468	74470	74469	74471
16,0	40,0	92,0	16,0	0,5	5,41	74472	74474	74473	74475
16,0	40,0	92,0	16,0	1,0	5,41	74476	74478	74477	74479
16,0	48,0	100,0	16,0	—	5,41	74480	74482	74481	74483
16,0	48,0	100,0	16,0	0,5	5,41	74484	74486	74485	74487
16,0	48,0	100,0	16,0	1,0	5,41	74488	74490	74489	74491
16,0	64,0	115,0	16,0	—	5,41	74492	74494	74493	74495
16,0	64,0	115,0	16,0	0,5	5,41	74496	74498	74497	74499
16,0	64,0	115,0	16,0	1,0	5,41	74500	74502	74501	74503
20,0	50,0	100,0	20,0	—	6,76	74504	74506	74505	74507
20,0	50,0	100,0	20,0	0,5	6,76	74508	74510	74509	74511
20,0	50,0	100,0	20,0	1,0	6,76	74512	74514	74513	74515
20,0	50,0	100,0	20,0	2,0	6,76	74516	74518	74517	74519
20,0	60,0	115,0	20,0	—	6,76	74520	74522	74521	74523
20,0	60,0	115,0	20,0	0,5	6,76	74524	74526	74525	74527
20,0	60,0	115,0	20,0	1,0	6,76	74528	74530	74529	74531
20,0	60,0	115,0	20,0	2,0	6,76	74532	74534	74533	74535
20,0	80,0	140,0	20,0	—	6,76	74536	74538	74537	74539
20,0	80,0	140,0	20,0	0,5	6,76	74540	74542	74541	74543
20,0	80,0	140,0	20,0	1,0	6,76	74544	74546	74545	74547
20,0	80,0	140,0	20,0	2,0	6,76	74548	74550	74549	74551
25,0	63,0	135,0	25,0	—	8,45	74552	74554	74553	74555
25,0	63,0	135,0	25,0	1,0	8,45	74556	74558	74557	74559
25,0	63,0	135,0	25,0	2,0	8,45	74560	74562	74561	74563
25,0	63,0	135,0	25,0	3,0	8,45	74564	74566	74565	74567
25,0	75,0	150,0	25,0	—	8,45	74568	74570	74569	74571
25,0	75,0	150,0	25,0	1,0	8,45	74572	74574	74573	74575
25,0	75,0	150,0	25,0	2,0	8,45	74576	74578	74577	74579
25,0	75,0	150,0	25,0	3,0	8,45	74580	74582	74581	74583
25,0	100,0	170,0	25,0	—	8,45	74584	74586	74585	74587
25,0	100,0	170,0	25,0	1,0	8,45	74588	74590	74589	74591
25,0	100,0	170,0	25,0	2,0	8,45	74592	74594	74593	74595
25,0	100,0	170,0	25,0	3,0	8,45	74596	74598	74597	74599

CONTINUED

METRIC H-Carb

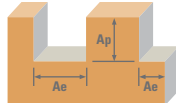

Series 77M, 77MCR Metric	Hardness	Ae x D ₁	Ap x D ₁	Vc (m/min)	D ₁ • mm								
					6	8	10	12	16	20	25		
CARBON STEELS 1018, 1040, 1080, 1090, 10L50, 1140, 1212, 12L15, 1525, 1536	≤ 275 Bhn or ≤ 28 HRc	HSM 	2.5xD	284	RPM	12208	9156	7325	6104	4578	3662	2930	
			≤ 0.2 ≤ APMX	(227-341)	Fz	0.0413	0.0411	0.0640	0.0711	0.0889	0.1013	0.1050	
			Feed (mm/min)	3529	2634	3282	3038	2849	2597	2154			
		HSM 	3xD	257	Fz	0.0347	0.0461	0.0717	0.0797	0.0996	0.1135	0.1176	
			≤ 0.15 ≤ APMX	(206-308)	Feed (mm/min)	2965	2955	3676	3405	3192	2910	2412	
			HSM 	4xD	230	Fz	0.0362	0.0480	0.0747	0.0830	0.1037	0.1182	0.0919
	ALLOY STEELS 4140, 4150, 4320, 5120, 5150, 8630, 86L20, 50100	≤ 375 Bhn or ≤ 40 HRc	HSM 	2.5xD	132	RPM	8068	6051	4841	4034	3025	2420	1936
				≤ 0.2 ≤ APMX	(106-159)	Fz	0.0213	0.0285	0.0512	0.0610	0.0711	0.0827	0.0875
				Feed (mm/min)	1203	1207	1735	1723	1506	1401	1186		
			HSM 	3xD	138	Fz	0.0239	0.0319	0.0574	0.0683	0.0797	0.0926	0.0980
				≤ 0.15 ≤ APMX	(111-166)	Feed (mm/min)	1350	1351	1945	1929	1688	1569	1328
				HSM 	4xD	152	Fz	0.0249	0.0332	0.0597	0.0711	0.0830	0.0964
TOOL STEELS A2, D2, H13, L2, M2, P20, S7, T15, W2		≤ 375 Bhn or ≤ 40 HRc	HSM 	2.5xD	83	RPM	4087	3065	2452	2044	1533	1226	981
				≤ 0.2 ≤ APMX	(66-100)	Fz	0.0140	0.0183	0.0294	0.0356	0.0457	0.0560	0.0625
				Feed (mm/min)	401	393	505	509	490	481	429		
			HSM 	3xD	86	Fz	0.0157	0.0205	0.0330	0.0398	0.0512	0.0627	0.0700
				≤ 0.15 ≤ APMX	(69-103)	Feed (mm/min)	449	440	566	569	549	538	481
				HSM 	4xD	77	Fz	0.0163	0.0213	0.0344	0.0415	0.0533	0.0653
	STAINLESS STEELS (FREE MACHINING) 303, 416, 420F, 430F, 440F	≤ 275 Bhn or ≤ 28 HRc	HSM 	2.5xD	197	RPM	9660	7245	5796	4830	3623	2898	2318
				≤ 0.2 ≤ APMX	(158-236)	Fz	0.0216	0.0285	0.0448	0.0533	0.0635	0.0747	0.0800
				Feed (mm/min)	1461	1445	1818	1803	1610	1515	1298		
			HSM 	3xD	204	Fz	0.0242	0.0319	0.0502	0.0598	0.0711	0.0837	0.0896
				≤ 0.15 ≤ APMX	(163-245)	Feed (mm/min)	1636	1618	2037	2022	1803	1698	1454
				HSM 	4xD	182	Fz	0.0252	0.0332	0.0523	0.0622	0.0741	0.0871
STAINLESS STEELS (DIFFICULT) 304, 304L, 316, 316L		≤ 275 Bhn or ≤ 28 HRc	HSM 	2.5xD	130	RPM	6369	4777	3822	3185	2389	1911	1529
				≤ 0.2 ≤ APMX	(104-156)	Fz	0.0168	0.0221	0.0371	0.0432	0.0584	0.0693	0.0750
				Feed (mm/min)	749	739	993	963	976	927	803		
			HSM 	3xD	134	Fz	0.0188	0.0248	0.0416	0.0484	0.0655	0.0777	0.0840
				≤ 0.15 ≤ APMX	(107-161)	Feed (mm/min)	838	829	1113	1079	1095	1039	899
				HSM 	4xD	120	Fz	0.0196	0.0258	0.0433	0.0504	0.0682	0.0809
	STAINLESS STEELS (PH) 13-8 PH, 15-5PH, 17-4 PH, CUSTOM 450	≤ 325 Bhn or ≤ 35 HRc	HSM 	2.5xD	124	RPM	6104	4578	3662	3052	2289	1831	1465
				≤ 0.2 ≤ APMX	(99-149)	Fz	0.0168	0.0221	0.0371	0.0432	0.0584	0.0693	0.0750
				Feed (mm/min)	718	708	952	923	936	888	769		
			HSM 	3xD	129	Fz	0.0188	0.0248	0.0416	0.0484	0.0655	0.0777	0.0840
				≤ 0.15 ≤ APMX	(103-155)	Feed (mm/min)	803	795	1066	1034	1050	996	861
				HSM 	4xD	115	Fz	0.0196	0.0258	0.0433	0.0504	0.0682	0.0809
≤ 0.1 ≤ APMX		(92-138)	Feed (mm/min)	837	827	1110	1077	1093	1037	897			

continued on next page

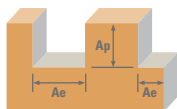

Series 77M, 77MCR Metric	Hardness	Ae x D ₁		Ap x D ₁	Vc (m/min)	D ₁ • mm							
		6	8			10	12	16	20	25			
K CAST IRONS (LOW & MEDIUM ALLOY) Gray, Malleable, Ductile	≤ 220 Bhn or ≤ 19 HRc	HSM	2.5xD		218 (174-262)	RPM	10722	8041	6433	5361	4021	3217	2573
			Fz	0.0239		0.0315	0.0474	0.0559	0.0762	0.0880	0.0925		
			Feed (mm/min)	1794		1773	2135	2098	2145	1981	1666		
		HSM	3xD		225 (180-270)	Fz	0.0268	0.0353	0.0531	0.0626	0.0854	0.0986	0.1036
			Feed (mm/min)	2011		1987	2391	2349	2404	2220	1866		
			4xD			202 (162-242)	Fz	0.0279	0.0368	0.0553	0.0652	0.0889	0.1027
	Feed (mm/min)	2094	2071	2490	2447		2502	2312	1944				
	≤ 0.1 ≤ APMX		RPM	6369	4777		3822	3185	2389	1911	1529		
	≤ 260 Bhn or ≤ 26 HRc	HSM	2.5xD		130 (104-156)	Fz	0.0168	0.0221	0.0371	0.0432	0.0584	0.0693	0.0750
			Feed (mm/min)	749		739	993	963	976	927	803		
			3xD			134 (107-161)	Fz	0.0188	0.0248	0.0416	0.0484	0.0655	0.0777
		Feed (mm/min)	838	829	1113		1079	1095	1039	899			
4xD		120 (96-144)	Fz	0.0196	0.0258		0.0433	0.0504	0.0682	0.0809	0.0875		
Feed (mm/min)			874	863	1158	1124	1140	1082	936				
≤ 0.1 ≤ APMX			RPM	2017	1513	1210	1008	756	605	484			
S HIGH TEMP ALLOYS (NICKEL, COBALT, IRON BASE) Inconel 601, 617, 625, Incoloy, Monel 400	≤ 300 Bhn or ≤ 32 HRc	HSM	2.5xD		41 (33-49)	Fz	0.0140	0.0183	0.0294	0.0356	0.0457	0.0560	0.0625
			Feed (mm/min)	198		194	249	251	242	237	212		
			3xD			43 (34-52)	Fz	0.0157	0.0205	0.0330	0.0398	0.0512	0.0627
	Feed (mm/min)	222	217	280	281		271	266	237				
	4xD		38 (30-46)	Fz	0.0163		0.0213	0.0344	0.0415	0.0533	0.0653	0.0729	
	Feed (mm/min)	230		226	291	293	282	277	247				
≤ 0.1 ≤ APMX		RPM		1274	955	764	637	478	382	306			
≤ 400 Bhn or ≤ 43 HRc	HSM	2.5xD		26 (21-31)	Fz	0.0114	0.0152	0.0243	0.0305	0.0381	0.0480	0.0550	
		Feed (mm/min)	102		102	130	136	127	128	118			
		3xD			27 (22-32)	Fz	0.0128	0.0171	0.0273	0.0342	0.0427	0.0538	0.0616
	Feed (mm/min)	114	114	146		152	143	144	132				
	4xD		24 (19-29)	Fz		0.0133	0.0178	0.0284	0.0356	0.0445	0.0560	0.0642	
	Feed (mm/min)	119		119	152	159	149	150	137				
≤ 0.1 ≤ APMX		RPM		4352	3264	2611	2176	1632	1306	1045			
TITANIUM ALLOYS Pure Titanium, Ti6Al4V, Ti6Al2Sn4Zr2Mo, Ti4Al4Mo2Sn0.5Si	≤ 350 Bhn or ≤ 38 HRc	HSM	2.5xD		88 (70-106)	Fz	0.0191	0.0254	0.0397	0.0483	0.0635	0.0747	0.0800
			Feed (mm/min)	582		580	726	736	725	683	585		
			3xD			91 (73-109)	Fz	0.0213	0.0285	0.0445	0.0541	0.0711	0.0837
	Feed (mm/min)	649	651	813	824		812	765	655				
	4xD		82 (66-98)	Fz	0.0222		0.0296	0.0463	0.0563	0.0741	0.0871	0.0933	
	Feed (mm/min)	676		676	846	858	847	796	682				
≤ 0.1 ≤ APMX		RPM		2548	1911	1529	1274	955	764	611			
TITANIUM ALLOYS (DIFFICULT) Ti10V2Fe3Al, Ti5Al5V5Mo3Cr, Ti7Al4Mo, Ti3Al8V6Cr4Zr4Mo, Ti6Al6V6Sn, Ti15V3 Cr3Sn3Al	≤ 420 Bhn or ≤ 45 HRc	HSM	2.5xD		52 (42-62)	Fz	0.0163	0.0254	0.0397	0.0483	0.0635	0.0747	0.0800
			Feed (mm/min)	291		340	425	431	425	400	342		
			3xD			54 (43-65)	Fz	0.0182	0.0285	0.0445	0.0541	0.0711	0.0837
	Feed (mm/min)	325	381	476	482		476	448	384				
	4xD		48 (38-58)	Fz	0.0190		0.0296	0.0463	0.0563	0.0741	0.0871	0.0933	
	Feed (mm/min)	339		396	495	502	496	466	399				
≤ 0.1 ≤ APMX		RPM		2548	1911	1529	1274	955	764	611			

Bhn (Brinell) HRc (Rockwell C) HSM (High Speed Machining)
 rpm = (Vc x 1000) / (DC x 3.14)
 mm/min = Fz x 7 x rpm
 reduce speed and feed for materials harder than listed
 reduce feed and Ae when finish milling (.02 x DC maximum)
 feed rates listed have chip thinning adjustments included where applicable
 refer to the SGS Tool Wizard® for complete technical information (www.kyocera-sgtool.com)

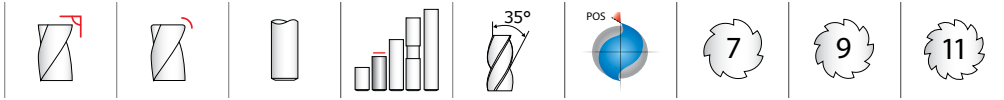

**66 •
66CR**
FRACTIONAL SERIES

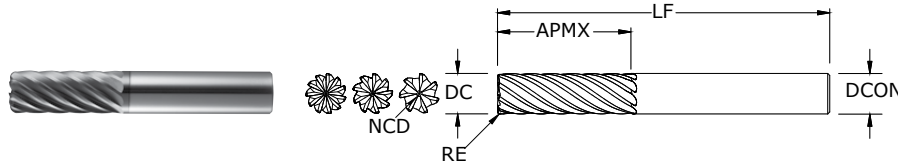

- Heavy core and rigid design allow for straight walls
- High flute count design results in smoother cutting performance and enhanced tool life in precise finishing applications
- Enhanced corner geometry with tight tolerance corner radii
- Recommended for materials ≤ 45 HRc (≤ 420 Bhn)

inch							EDP NO.
CUTTING DIAMETER DC	LENGTH OF CUT APMX	OVERALL LENGTH LF	SHANK DIAMETER DCON	CORNER RADIUS RE	NON-CUTTING CENTER DIAMETER NCD	NO. OF FLUTES	Ti-NAMITE®-X
3/16	5/8	2	3/16	—	0.0550	7	36620
3/16	5/8	2	3/16	.010	0.0550	7	36627
1/4	3/4	2-1/2	1/4	—	0.0650	7	36621
1/4	3/4	2-1/2	1/4	.015	0.0650	7	36628
3/8	1	3	3/8	—	0.0810	7	36622
3/8	1	3	3/8	.015	0.0810	7	36629
1/2	1-1/4	3	1/2	—	0.1340	9	36623
1/2	1-1/4	3	1/2	.030	0.1340	9	36630
1/2	1-1/4	3	1/2	.090	0.1340	9	36631
1/2	1-1/4	3	1/2	.120	0.1340	9	36632
5/8	1-5/8	3-1/2	5/8	—	0.1150	9	36624
5/8	1-5/8	3-1/2	5/8	.030	0.1150	9	36633
5/8	1-5/8	3-1/2	5/8	.090	0.1150	9	36634
5/8	1-5/8	3-1/2	5/8	.120	0.1150	9	36635
3/4	1-5/8	4	3/4	—	0.1750	11	36625
3/4	1-5/8	4	3/4	.030	0.1750	11	36636
3/4	1-5/8	4	3/4	.090	0.1750	11	36637
3/4	1-5/8	4	3/4	.120	0.1750	11	36638
1	2	6	1	—	0.3000	11	36626
1	2	6	1	.030	0.3000	11	36639
1	2	6	1	.090	0.3000	11	36640
1	2	6	1	.120	0.3000	11	36641

Neck Option Available

TOLERANCES (inch)

DC = +0.0000/−0.0020
DCON = h_6
RE = +0.0000/−0.0020

- STEELS
- STAINLESS STEELS
- CAST IRON
- HIGH TEMP ALLOYS

For patent information visit www.ksptpatents.com

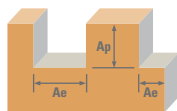

Series	Hardness	Ae x DC	Ap x DC	Vc (sfm)	DC • in								
					3/16	1/4	3/8	1/2	5/8	3/4	1		
Series 66, 66CR Fractional CARBON STEELS 1018, 1040, 1080, 1090, 10L50, 1140, 1212, 12L15, 1525, 1536 ALLOY STEELS 4140, 4150, 4320, 5120, 5150, 8630, 86L20, 50100 TOOL STEELS A2, D2, H13, L2, M2, P20, S7, T15, W2 STAINLESS STEELS (FREE MACHINING) 303, 416, 420F, 430F, 440F STAINLESS STEELS (DIFFICULT) 304, 304L, 316, 316L STAINLESS STEELS (PH) 13-8 PH, 15-5 PH, 17-4 PH, Custom 450	≤ 275 Bhn or ≤ 28 HRc	Profile 	≤ 0.05	≤ 1	635	RPM	12937	9703	6469	4851	3881	3234	2426
					(508-762)	Fz	0.0008	0.0012	0.0022	0.0030	0.0037	0.0038	0.0042
						Feed (ipm)	72.4	81.5	99.6	131.0	129.2	135.2	112.1
		Finish 	≤ 0.02	≤ 2	762	RPM	15524	11643	7762	5822	4657	3881	2911
					(610-914)	Fz	0.0006	0.0010	0.0018	0.0024	0.0030	0.0030	0.0034
						Feed (ipm)	69.5	78.2	95.6	125.7	124.1	129.8	107.6
	≤ 375 Bhn or ≤ 40 HRc	Profile 	≤ 0.05	≤ 1	360	RPM	7334	5501	3667	2750	2200	1834	1375
					(288-432)	Fz	0.0006	0.0009	0.0017	0.0023	0.0029	0.0030	0.0032
						Feed (ipm)	30.8	34.7	43.6	56.9	57.4	60.5	48.4
		Finish 	≤ 0.02	≤ 2	432	RPM	8801	6601	4401	3300	2640	2200	1650
					(346-518)	Fz	0.0005	0.0007	0.0014	0.0018	0.0023	0.0024	0.0026
						Feed (ipm)	29.6	33.3	41.9	54.7	55.1	58.1	46.5
≤ 375 Bhn or ≤ 40 HRc	Profile 	≤ 0.05	≤ 1	290	RPM	5908	4431	2954	2216	1772	1477	1108	
				(232-348)	Fz	0.0004	0.0006	0.0012	0.0016	0.0020	0.0021	0.0022	
					Feed (ipm)	16.5	18.6	24.8	31.9	31.9	34.1	26.8	
	Finish 	≤ 0.02	≤ 2	348	RPM	7090	5317	3545	2659	2127	1772	1329	
				(278-418)	Fz	0.0003	0.0005	0.0010	0.0013	0.0016	0.0017	0.0018	
					Feed (ipm)	15.9	17.9	23.8	30.6	30.6	32.8	25.7	
≤ 275 Bhn or ≤ 28 HRc	Profile 	≤ 0.05	≤ 1	560	RPM	11409	8557	5705	4278	3423	2852	2139	
				(448-672)	Fz	0.0006	0.0009	0.0017	0.0023	0.0029	0.0030	0.0032	
					Feed (ipm)	47.9	53.9	67.9	88.6	89.3	94.1	75.3	
	Finish 	≤ 0.02	≤ 2	448	RPM	9127	6845	4564	3423	2738	2282	1711	
				(358-538)	Fz	0.0005	0.0007	0.0014	0.0018	0.0023	0.0024	0.0026	
					Feed (ipm)	30.7	34.5	43.4	56.7	57.2	60.2	48.2	
≤ 275 Bhn or ≤ 28 HRc	Profile 	≤ 0.05	≤ 1	385	RPM	7844	5883	3922	2941	2353	1961	1471	
				(308-462)	Fz	0.0005	0.0007	0.0014	0.0018	0.0023	0.0024	0.0026	
					Feed (ipm)	27.5	28.8	38.4	47.7	48.7	51.8	42.1	
	Finish 	≤ 0.02	≤ 2	462	RPM	9412	7059	4706	3530	2824	2353	1765	
				(370-554)	Fz	0.0004	0.0006	0.0011	0.0014	0.0018	0.0019	0.0021	
					Feed (ipm)	26.4	27.7	36.9	45.7	46.8	49.7	40.4	
≤ 325 Bhn or ≤ 35 HRc	Profile 	≤ 0.05	≤ 1	355	RPM	7233	5424	3616	2712	2170	1808	1356	
				(284-426)	Fz	0.0005	0.0007	0.0014	0.0018	0.0023	0.0024	0.0026	
					Feed (ipm)	25.3	26.6	35.4	43.9	44.9	47.7	38.8	
	Finish 	≤ 0.02	≤ 2	426	RPM	8679	6509	4340	3255	2604	2170	1627	
				(341-511)	Fz	0.0004	0.0006	0.0011	0.0014	0.0018	0.0019	0.0021	
					Feed (ipm)	24.3	25.5	34.0	42.2	43.1	45.8	37.2	

continued on next page

FRACTIONAL Multi-Carb

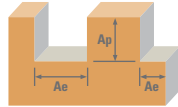

Series 66, 66CR Fractional	Hardness	Ae x DC	Ap x DC	Vc (sfm)	DC • in									
					3/16	1/4	3/8	1/2	5/8	3/4	1			
K	CAST IRONS (LOW & MEDIUM ALLOY) Gray, Malleable, Ductile	≤ 220 Bhn or ≤ 19 HRc	Profile 	≤ 0.05	≤ 1	705	RPM	14363	10772	7182	5386	4309	3591	2693
						(564-846)	Fz	0.0008	0.0012	0.0022	0.0030	0.0037	0.0038	0.0042
						846	RPM	17236	12927	8618	6463	5171	4309	3232
			Finish 	≤ 0.02	≤ 2	(677-1015)	Fz	0.0006	0.0010	0.0018	0.0024	0.0030	0.0030	0.0034
						846	RPM	17236	12927	8618	6463	5171	4309	3232
						846	RPM	17236	12927	8618	6463	5171	4309	3232
	CAST IRONS (HIGH ALLOY) Gray, Malleable, Ductile	≤ 260 Bhn or ≤ 26 HRc	Profile 	≤ 0.05	≤ 1	540	RPM	11002	8251	5501	4126	3300	2750	2063
						(432-648)	Fz	0.0006	0.0009	0.0017	0.0023	0.0029	0.0030	0.0032
						648	RPM	13202	9901	6601	4951	3961	3300	2475
			Finish 	≤ 0.02	≤ 2	(518-778)	Fz	0.0005	0.0007	0.0014	0.0018	0.0023	0.0024	0.0026
						648	RPM	13202	9901	6601	4951	3961	3300	2475
						648	RPM	13202	9901	6601	4951	3961	3300	2475
S	HIGH TEMP ALLOYS (NICKEL, COBALT, IRON BASE) Inconel 601, 617, 625, Incoloy, Monel 400	≤ 300 Bhn or ≤ 32 HRc	Profile 	≤ 0.05	≤ 1	105	RPM	2139	1604	1070	802	642	535	401
						(84-126)	Fz	0.0005	0.0007	0.0014	0.0018	0.0023	0.0024	0.0026
						126	RPM	2567	1925	1284	963	770	642	481
			Finish 	≤ 0.02	≤ 2	(101-151)	Fz	0.0004	0.0006	0.0011	0.0014	0.0018	0.0019	0.0021
						126	RPM	2567	1925	1284	963	770	642	481
						126	RPM	2567	1925	1284	963	770	642	481
	HIGH TEMP ALLOYS (NICKEL, COBALT, IRON BASE) Inconel 718, X-750, Incoloy, Waspaloy, Hastelloy, Rene	≤ 400 Bhn or ≤ 43 HRc	Profile 	≤ 0.05	≤ 1	85	RPM	1732	1299	866	649	520	433	325
						(68-102)	Fz	0.0003	0.0005	0.0009	0.0011	0.0014	0.0015	0.0016
						102	RPM	2078	1559	1039	779	623	520	390
			Finish 	≤ 0.02	≤ 2	(82-122)	Fz	0.0002	0.0004	0.0007	0.0009	0.0011	0.0012	0.0013
						102	RPM	2078	1559	1039	779	623	520	390
						102	RPM	2078	1559	1039	779	623	520	390
TITANIUM ALLOYS Pure Titanium, Ti6Al4V, Ti6Al2Sn4Zr2Mo, Ti4Al4Mo2Sn0.5Si	≤ 350 Bhn or ≤ 38 HRc	Profile 	≤ 0.05	≤ 1	390	RPM	7946	5959	3973	2980	2384	1986	1490	
					(312-468)	Fz	0.0005	0.0008	0.0015	0.0021	0.0026	0.0027	0.0029	
					468	RPM	9535	7151	4767	3576	2860	2384	1788	
		Finish 	≤ 0.02	≤ 2	(374-562)	Fz	0.0004	0.0006	0.0012	0.0017	0.0021	0.0022	0.0023	
					468	RPM	9535	7151	4767	3576	2860	2384	1788	
					468	RPM	9535	7151	4767	3576	2860	2384	1788	
TITANIUM ALLOYS (DIFFICULT) Ti10V2Fe3Al, Ti5Al5V5Mo3Cr, Ti7Al4Mo, Ti3Al8V6Cr4Zr4Mo, Ti6Al6V6Sn, Ti15V3 Cr3Sn3Al	≤ 420 Bhn or ≤ 45 HRc	Profile 	≤ 0.05	≤ 1	140	RPM	2852	2139	1426	1070	856	713	535	
					(112-168)	Fz	0.0005	0.0008	0.0015	0.0021	0.0026	0.0027	0.0029	
					168	RPM	3423	2567	1711	1284	1027	856	642	
		Finish 	≤ 0.02	≤ 2	(134-202)	Fz	0.0004	0.0006	0.0012	0.0017	0.0021	0.0022	0.0023	
					168	RPM	3423	2567	1711	1284	1027	856	642	
					168	RPM	3423	2567	1711	1284	1027	856	642	

Bhn (Brinell) HRc (Rockwell C)
 $rpm = Vc \times 3.82 / DC$
 $ipm = Fz \times \text{number of flutes} \times rpm$
 reduce speed and feed for materials harder than listed
 feed rates listed have chip thinning adjustments included where applicable
 refer to the SGS Tool Wizard® for complete technical information (www.kyocera-sgstoool.com)



**66M •
66MCR**
METRIC SERIES

TOLERANCES (mm)

DC = +0,000/-0,050
DCON = h_6
RE = +0,000/-0,050

- STEELS
- STAINLESS STEELS
- CAST IRON
- HIGH TEMP ALLOYS

For patent information visit www.ksptpatents.com

mm							EDP NO.
CUTTING DIAMETER DC	LENGTH OF CUT APMX	OVERALL LENGTH LF	SHANK DIAMETER DCON	CORNER RADIUS RE	NON-CUTTING CENTER DIAMETER NCD	NO. OF FLUTES	Ti-NAMITE®-X
6,0	19,0	63,0	6,0	—	1,63	7	46620
6,0	19,0	63,0	8,0	0,5	1,63	7	46627
6,0	19,0	63,0	6,0	1,0	1,63	7	46628
8,0	20,0	63,0	8,0	—	1,78	7	46621
8,0	20,0	63,0	8,0	0,5	1,78	7	46629
8,0	20,0	63,0	8,0	1,0	1,78	7	46630
8,0	20,0	63,0	8,0	1,5	1,78	7	46631
10,0	22,0	75,0	10,0	—	2,03	7	46622
10,0	22,0	75,0	10,0	0,5	2,03	7	46632
10,0	22,0	75,0	10,0	1,0	2,03	7	46633
10,0	22,0	75,0	10,0	1,5	2,03	7	46634
10,0	22,0	75,0	10,0	2,0	2,03	7	46635
12,0	26,0	83,0	12,0	—	3,45	9	46623
12,0	26,0	83,0	12,0	1,0	3,45	9	46636
12,0	26,0	83,0	12,0	1,5	3,45	9	46637
12,0	26,0	83,0	12,0	2,0	3,45	9	46638
12,0	26,0	83,0	12,0	2,5	3,45	9	46639
12,0	26,0	83,0	12,0	3,0	3,45	9	46640
16,0	32,0	92,0	16,0	—	2,92	9	46624
16,0	32,0	92,0	16,0	1,0	2,92	9	46641
16,0	32,0	92,0	16,0	1,5	2,92	9	46642
16,0	32,0	92,0	16,0	2,0	2,92	9	46643
16,0	32,0	92,0	16,0	2,5	2,92	9	46644
16,0	32,0	92,0	16,0	3,0	2,92	9	46645
16,0	32,0	92,0	16,0	4,0	2,92	9	46646
20,0	38,0	104,0	20,0	—	4,57	11	46625
20,0	38,0	104,0	20,0	1,0	4,57	11	46647
20,0	38,0	104,0	20,0	1,5	4,57	11	46648
20,0	38,0	104,0	20,0	2,0	4,57	11	46649
20,0	38,0	104,0	20,0	2,5	4,57	11	46650
20,0	38,0	104,0	20,0	3,0	4,57	11	46651
20,0	38,0	104,0	20,0	4,0	4,57	11	46652

- Heavy core and rigid design allow for straight walls
- High flute count design results in smoother cutting performance and enhanced tool life in precise finishing applications
- Enhanced corner geometry with tight tolerance corner radii
- Recommended for materials ≤ 45 HRC (≤ 420 Bhn)

continued on next page

Neck Option Available

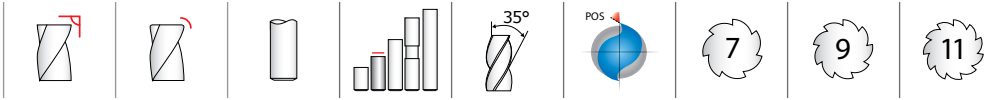

66M • 66MCR
METRIC SERIES

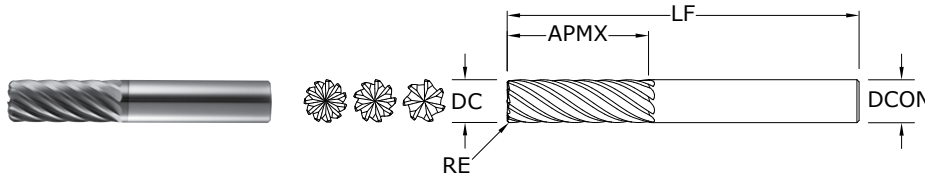

CONTINUED

mm							EDP NO.
CUTTING DIAMETER DC	LENGTH OF CUT APMX	OVERALL LENGTH LF	SHANK DIAMETER DCON	CORNER RADIUS RE	NON-CUTTING CENTER DIAMETER NCD	NO. OF FLUTES	Ti-NAMITE®-X
20,0	38,0	104,0	20,0	5,0	4,57	11	46653
25,0	38,0	104,0	25,0	—	7,49	11	46626
25,0	38,0	104,0	25,0	1,0	7,49	11	46654
25,0	38,0	104,0	25,0	1,5	7,49	11	46655
25,0	38,0	104,0	25,0	2,0	7,49	11	46656
25,0	38,0	104,0	25,0	2,5	7,49	11	46657
25,0	38,0	104,0	25,0	3,0	7,49	11	46658
25,0	38,0	104,0	25,0	4,0	7,49	11	46659
25,0	38,0	104,0	25,0	5,0	7,49	11	46660

Neck Option Available

TOLERANCES (mm)

DC = +0,000/-0,050
DCON = h₆
RE = +0,000/-0,050

- STEELS
- STAINLESS STEELS
- CAST IRON
- HIGH TEMP ALLOYS

For patent information visit www.ksptpatents.com

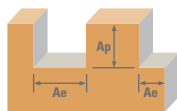

Series 66M, 66MCR	Metric	Hardness	Ae x DC	Ap x DC	Vc (m/min)	DC • mm								
						6	8	10	12	16	20	25		
P	CARBON STEELS 1018, 1040, 1080, 1090, 10L50, 1140, 1212, 12L15, 1525, 1536	≤ 275 Bhn or ≤ 28 HRc	Profile 	≤ 0.05	≤ 1	194	RPM	10260	7695	6156	5130	3847	3078	2462
						(155-232)	Fz	0.029	0.047	0.059	0.072	0.095	0.101	0.105
						Feed (mm/min)	2068	2528	2528	3324	3280	3431	2844	
		Finish 	≤ 0.02	≤ 2	232	RPM	12312	9234	7387	6156	4617	3693	2955	
					(186-279)	Fz	0.023	0.038	0.047	0.058	0.076	0.081	0.084	
					Feed (mm/min)	1985	2427	2427	3191	3149	3294	2730		
	ALLOY STEELS 4140, 4150, 4320, 5120, 5150, 8630, 86L20, 50100	≤ 375 Bhn or ≤ 40 HRc	Profile 	≤ 0.05	≤ 1	110	RPM	5816	4362	3490	2908	2181	1745	1396
						(88-132)	Fz	0.022	0.036	0.045	0.055	0.074	0.080	0.080
						Feed (mm/min)	879	1108	1107	1445	1457	1536	1229	
		Finish 	≤ 0.02	≤ 2	132	RPM	6980	5235	4188	3490	2617	2094	1675	
					(105-158)	Fz	0.017	0.029	0.036	0.044	0.059	0.064	0.064	
					Feed (mm/min)	844	1063	1063	1387	1399	1474	1179		
TOOL STEELS A2, D2, H13, L2, M2, P20, S7, T15, W2	≤ 375 Bhn or ≤ 40 HRc	Profile 	≤ 0.05	≤ 1	88	RPM	4686	3514	2811	2343	1757	1406	1125	
					(71-106)	Fz	0.014	0.026	0.032	0.038	0.051	0.056	0.055	
					Feed (mm/min)	472	630	630	810	810	866	680		
	Finish 	≤ 0.02	≤ 2	106	RPM	5623	4217	3374	2811	2108	1687	1349		
				(85-127)	Fz	0.012	0.020	0.026	0.031	0.041	0.045	0.044		
				Feed (mm/min)	453	605	605	777	777	831	653			
M	STAINLESS STEELS (FREE MACHINING) 303, 416, 420F, 430F, 440F	≤ 275 Bhn or ≤ 28 HRc	Profile 	≤ 0.05	≤ 1	171	RPM	9048	6786	5429	4524	3393	2714	2171
						(137-205)	Fz	0.022	0.036	0.045	0.055	0.074	0.080	0.080
						Feed (mm/min)	1368	1723	1723	2247	2267	2389	1911	
		Finish 	≤ 0.02	≤ 2	137	RPM	7238	5429	4343	3619	2714	2171	1737	
					(109-164)	Fz	0.017	0.029	0.036	0.044	0.059	0.064	0.064	
					Feed (mm/min)	875	1103	1103	1438	1451	1529	1223		
	STAINLESS STEELS (DIFFICULT) 304, 304L, 316, 316L	≤ 275 Bhn or ≤ 28 HRc	Profile 	≤ 0.05	≤ 1	117	RPM	6220	4665	3732	3110	2333	1866	1493
						(94-141)	Fz	0.017	0.030	0.037	0.043	0.059	0.064	0.065
						Feed (mm/min)	731	975	975	1209	1236	1314	1067	
		Finish 	≤ 0.02	≤ 2	141	RPM	7465	5598	4479	3732	2799	2239	1791	
					(113-169)	Fz	0.013	0.024	0.030	0.035	0.047	0.051	0.052	
					Feed (mm/min)	702	17	936	1161	1187	1261	1025		
STAINLESS STEELS (PH) 13-8 PH, 15-5 PH, 17-4 PH, Custom 450	≤ 325 Bhn or ≤ 35 HRc	Profile 	≤ 0.05	≤ 1	108	RPM	5736	4302	3441	2868	2151	1721	1377	
					(87-130)	Fz	0.017	0.030	0.037	0.043	0.059	0.064	0.065	
					Feed (mm/min)	674	899	899	1115	1140	1211	984		
	Finish 	≤ 0.02	≤ 2	130	RPM	6883	5162	4130	3441	2581	2065	1652		
				(104-156)	Fz	0.013	0.024	0.030	0.035	0.047	0.051	0.052		
				Feed (mm/min)	647	863	863	1070	1094	1163	945			

continued on next page

Multi-Carb

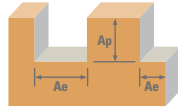

Series 66M, 66MCR Metric	Hardness	Ae x DC	Ap x DC	Vc (m/min)	DC • mm														
					6	8	10	12	16	20	25								
K	CAST IRONS (LOW & MEDIUM ALLOY) Gray, Malleable, Ductile	≤ 220 Bhn or ≤ 19 HRc	Profile 	≤ 0.05	≤ 1	215	RPM	11391	8543	6834	5695	4271	3417	2734					
						(172-258)	Fz	0.029	0.047	0.059	0.072	0.095	0.101	0.105					
						258	RPM	13669	10252	8201	6834	5126	4101	3281					
						(206-309)	Fz	0.023	0.038	0.047	0.058	0.076	0.081	0.084					
		Finish 	≤ 0.02	≤ 2	2204	2695	2694	3543	3496	3657	3031								
					Feed (mm/min)	2204	2695	2694	3543	3496	3657	3031							
					S	CAST IRONS (HIGH ALLOY) Gray, Malleable, Ductile	≤ 260 Bhn or ≤ 26 HRc	Profile 	≤ 0.05	≤ 1	165	RPM	8725	6544	5235	4362	3272	2617	2094
											(132-198)	Fz	0.022	0.036	0.045	0.055	0.074	0.080	0.080
198	RPM	10470	7852	6282							5235	3926	3141	2513					
(158-237)	Fz	0.017	0.029	0.036							0.044	0.059	0.064	0.064					
	Finish 	≤ 0.02	≤ 2	1266		1595	1595	2080	2099	2211	1769								
				Feed (mm/min)		1266	1595	1595	2080	2099	2211	1769							
				HIGH TEMP ALLOYS (NICKEL, COBALT, IRON BASE) Inconel 601, 617, 625, Incoloy, Monel 400		≤ 300 Bhn or ≤ 32 HRc	Profile 	≤ 0.05	≤ 1	32	RPM	1696	1272	1018	848	636	509	407	
										(26-38)	Fz	0.017	0.030	0.037	0.043	0.059	0.064	0.065	
38	RPM	2036	1527		1221					1018	763	611	489						
(31-46)	Fz	0.013	0.024		0.030					0.035	0.047	0.051	0.052						
	Finish 	≤ 0.02	≤ 2	192	255	255	317	324	344	279									
				Feed (mm/min)	192	255	255	317	324	344	279								
				HIGH TEMP ALLOYS (NICKEL, COBALT, IRON BASE) Inconel 718, X-750, Incoloy, Waspaloy, Hastelloy, Rene	≤ 400 Bhn or ≤ 43 HRc	Profile 	≤ 0.05	≤ 1	26	RPM	1373	1030	824	687	515	412	330		
									(21-31)	Fz	0.012	0.019	0.024	0.026	0.036	0.040	0.040		
31	RPM	1648	1236						989	824	618	494	396						
(25-37)	Fz	0.010	0.015						0.019	0.021	0.029	0.032	0.032						
	Finish 	≤ 0.02	≤ 2	111	133	133	157	159	174	139									
				Feed (mm/min)	111	133	133	157	159	174	139								
				TITANIUM ALLOYS Pure Titanium, Ti6Al4V, Ti6Al2Sn4Zr2Mo, Ti4Al4Mo2Sn0.5Si	≤ 350 Bhn or ≤ 38 HRc	Profile 	≤ 0.05	≤ 1	119	RPM	6301	4726	3781	3151	2363	1890	1512		
									(95-143)	Fz	0.019	0.032	0.040	0.050	0.067	0.072	0.073		
143	RPM	7561	5671						4537	3781	2836	2268	1815						
(114-171)	Fz	0.015	0.026						0.032	0.040	0.053	0.058	0.058						
	Finish 	≤ 0.02	≤ 2	813	1016	1016	1372	1359	1437	1158									
				Feed (mm/min)	813	1016	1016	1372	1359	1437	1158								
				TITANIUM ALLOYS (DIFFICULT) Ti10V2Fe3Al, Ti5Al5V5Mo3Cr, Ti7Al4Mo, Ti3Al8V6Cr4Zr4Mo, Ti6Al6V6Sn, Ti15V3 Cr3Sn3Al	≤ 420 Bhn or ≤ 45 HRc	Profile 	≤ 0.05	≤ 1	43	RPM	2262	1696	1357	1131	848	679	543		
									(34-51)	Fz	0.019	0.032	0.040	0.050	0.067	0.072	0.073		
51	RPM	2714	2036						1629	1357	1018	814	651						
(41-61)	Fz	0.015	0.026						0.032	0.040	0.053	0.058	0.058						
	Finish 	≤ 0.02	≤ 2	292	365	365	492	488	516	416									
				Feed (mm/min)	292	365	365	492	488	516	416								

Bhn (Brinell) HRc (Rockwell C)
 rpm = (Vc x 1000) / (DC x 3.14)
 mm/min = Fz x number of flutes x rpm
 reduce speed and feed for materials harder than listed
 feed rates listed have chip thinning adjustments included where applicable
 refer to the SGS Tool Wizard® for complete technical information (www.kyocera-sgstool.com)



METRIC Multi-Carb

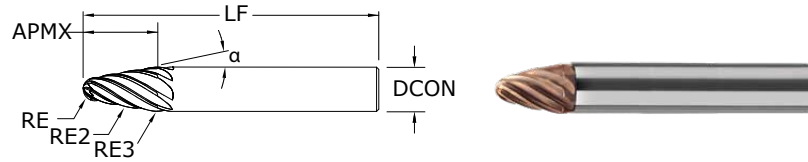
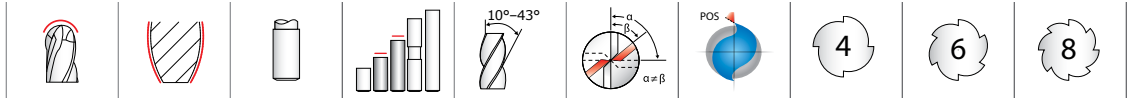

67B METRIC SERIES

TOLERANCES (mm)

DCON = h_6
RE = $+0,010/-0,010$

- STEELS
- STAINLESS STEELS
- CAST IRON
- HIGH TEMP ALLOYS

For patent information visit www.ksptpatents.com

mm								EDP NO.
SHANK DIAMETER DCON	LENGTH OF CUT APMX	OVERALL LENGTH LF	CENTERLINE ANGLE α	TIP RADIUS RE	TAPERED RADIUS RE2	BLENDED RADIUS RE3	NO. OF FLUTES	Ti-NAMITE®-H
6,0	9,5	58,0	17.5°	1,0	250,0	3,0	4	45700
6,0	8,0	58,0	17.5°	1,5	250,0	3,0	4	45701
8,0	10,5	80,0	20.0°	1,5	250,0	4,0	4	45702
8,0	9,5	80,0	20.0°	2,0	250,0	4,0	4	45703
10,0	12,5	89,0	20.0°	2,0	250,0	5,0	6	45704
10,0	11,5	89,0	20.0°	2,5	250,0	5,0	6	45705
12,0	13,5	100,0	20.0°	3,0	250,0	6,0	8	45706
12,0	14,4	100,0	20.0°	2,5	250,0	6,0	8	45707
12,0	20,0	100,0	14.0°	2,0	60,0	6,0	6	45708
16,0	31,0	109,0	12.5°	2,0	1000,0	5,0	6	45709
16,0	27,5	109,0	12.5°	3,0	1000,0	5,0	8	45710
16,0	24,0	109,0	12.5°	4,0	1000,0	5,0	8	45711
16,0	21,0	109,0	15.0°	4,0	1000,0	5,0	8	45712
16,0	18,5	109,0	20.0°	4,0	1500,0	8,0	8	45713
16,0	28,5	109,0	10.0°	4,0	1000,0	5,0	8	45714
16,0	19,0	109,0	20.0°	3,0	750,0	5,0	8	45715
16,0	15,0	109,0	30.0°	2,0	750,0	3,0	6	45716
16,0	18,5	109,0	20.0°	3,0	60,0	5,0	8	45717

- Designed to significantly improve traditional ball end applications
- Highly efficient at finishing and semi-finishing profiling
- Main application areas include profiling and pocket milling
- Especially suited to machining deep pockets and hard-to-reach areas without using long-reach tools
- Their versatility also allows for machining profiles and blends with one tool
- Recommended for materials ≤ 45 HRc (≤ 420 Bhn)

Multi-Carb

DCON	6		8		10		12		16	
Ae max	0,20	0,45	0,25	0,55	0,30	0,60	0,35	0,65	0,40	0,70
Diameter	3,0	6,0	4,0	8,0	5,0	10,0	6,0	12,0	8,0	16,0

Metric	Hardness (HRc)	Vc (m/min)	Cut Zone	RE	RE2	RE	RE2	RE	RE2	RE	RE2	RE	RE2
P Alloy Steels	≤28 (155-232)	194	RPM	20583	10292	15438	7719	12350	6175	10292	5146	7719	3859
		Fz	0,013	0,030	0,017	0,040	0,021	0,050	0,025	0,060	0,033	0,080	
		Feed (mm/min)	1029	1235	1029	1235	1544	1853	1544	1853	1544	1853	
	≤40 (88-132)	110	RPM	11671	5836	8753	4377	7003	3501	5836	2918	4377	2188
		Fz	0,008	0,020	0,013	0,030	0,017	0,040	0,021	0,050	0,029	0,070	
		Feed (mm/min)	389	467	438	525	700	840	729	875	766	919	
P Tool Steels	≤35 (69-118)	93	RPM	9867	4934	7400	3700	5920	2960	4934	2467	3700	1850
		Fz	0,013	0,030	0,017	0,040	0,021	0,050	0,025	0,060	0,033	0,080	
		Feed (mm/min)	493	592	493	592	740	888	740	888	740	888	
	≤45 (51-77)	64	RPM	6790	3395	5093	2546	4074	2037	3395	1698	2546	1273
		Fz	0,008	0,020	0,013	0,030	0,017	0,040	0,021	0,050	0,025	0,060	
		Feed (mm/min)	226	272	255	306	407	489	424	509	382	458	
M Stainless Steels	≤28 (94-141)	117	RPM	12414	6207	9310	4655	7448	3724	6207	3103	4655	2328
		Fz	0,013	0,030	0,017	0,040	0,021	0,050	0,025	0,060	0,029	0,070	
		Feed (mm/min)	621	745	621	745	931	1117	931	1117	815	978	
	≤35 (87-130)	108	RPM	11459	5729	8594	4297	6875	3438	5729	2865	4297	2149
		Fz	0,008	0,020	0,013	0,030	0,017	0,040	0,021	0,050	0,025	0,060	
		Feed (mm/min)	382	458	430	516	688	825	716	859	645	773	
S High Temperature Alloys	≤32 (26-38)	32	RPM	3395	1698	2546	1273	2037	1019	1698	849	1273	637
		Fz	0,008	0,020	0,013	0,030	0,017	0,040	0,021	0,050	0,025	0,060	
		Feed (mm/min)	113	136	127	153	204	244	212	255	191	229	
	≤43 (21-31)	26	RPM	2759	1379	2069	1034	1655	828	1379	690	1034	517
		Fz	0,004	0,010	0,008	0,020	0,013	0,030	0,017	0,040	0,021	0,050	
		Feed (mm/min)	46	55	69	83	124	149	138	166	129	155	
S Titanium Alloys	≤35 (85-133)	109	RPM	11565	5782	8674	4337	6939	3469	5782	2891	4337	2168
		Fz	0,013	0,030	0,017	0,040	0,021	0,050	0,025	0,060	0,029	0,070	
		Feed (mm/min)	578	694	578	694	867	1041	867	1041	759	911	
	≤45 (44-61)	53	RPM	5623	2812	4217	2109	3374	1687	2812	1406	2109	1054
		Fz	0,008	0,020	0,013	0,030	0,017	0,040	0,021	0,050	0,025	0,060	
		Feed (mm/min)	187	225	211	253	337	405	351	422	316	380	

$rpm = (Vc \times 1000) / (DC \times 3.14)$

$Feed = Fz \times \text{No. of teeth} \times rpm$

Adjust speed and feed according to material hardness

Consider rpm according to cutting area of tool being utilized

Avoid using tip of the tool where possible due to reduced chip space

Be aware of max cut Ae, especially on the lower portion of the tool

Medical applications:

- Titanium can be cut dry while keeping cut size to a minimum and providing good chip evacuation (air blast)
- For cobalt chrome applications, a surface speed of 45M/min is a guide (It can also be cut dry as per cobalt) refer to the SGS Tool Wizard® for complete technical information (www.kyocera-sgstool.com)

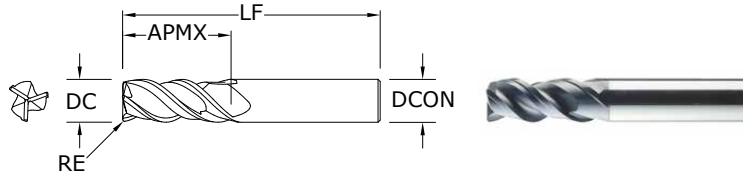

33CR
FRACTIONAL SERIES

TOLERANCES (inch)

1/8–1/4 DIAMETER

DC = +0.0000/–0.0012

DCON = h_6

RE = +0.0000/–0.0020

>1/4–3/8 DIAMETER

DC = +0.0000/–0.0016

DCON = h_6

RE = +0.0000/–0.0020

>3/8–1 DIAMETER

DC = +0.0000/–0.0020

DCON = h_6

RE = +0.0000/–0.0020

STEELS

STAINLESS STEELS

CAST IRON

HIGH TEMP ALLOYS

For patent information visit
www.ksptpatents.com

CUTTING DIAMETER DC	LENGTH OF CUT APMX	inch			CORNER RADIUS RE	EDP NO. Ti-NAMITE®-A (AITiN)
		OVERALL LENGTH LF	SHANK DIAMETER DCON			
1/8	3/8	2-1/2	1/4	.015	33345	
3/16	9/16	2-1/2	1/4	.015	33346	
1/4	3/4	2-1/2	1/4	.020	33347	
5/16	13/16	2-1/2	5/16	.020	33348	
3/8	1	2-1/2	3/8	.020	33349	
7/16	1-1/8	2-3/4	7/16	.020	33350	
1/2	1-1/4	3-1/4	1/2	.030	33351	
5/8	1-1/2	3-1/2	5/8	.040	33352	
3/4	1-3/4	4	3/4	.040	33353	
1	2-1/4	5	1	.040	33354	

- Specially engineered step core design provides stability for aggressive ramping and rigidity when flutes are completely engaged
- Open design at axial end accommodates material flow and load reduction during machining operations
- Enhanced corner geometry with tight tolerance corner radii
- Recommended for materials \leq 45 HRc (\leq 420 Bhn)

FRACTIONAL Series 33

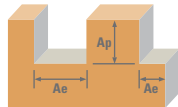

Series 33CR Fractional	Hardness	Ae x DC	Ap x DC	Vc (sfm)	DC • in								
					1/8	1/4	3/8	1/2	5/8	3/4	1		
CARBON STEELS 1018, 1040, 1080, 1090, 10L50, 1140, 1212, 12L15, 1525, 1536	≤ 275 Bhn or ≤ 28 HRc	Profile 	≤ 0.5	≤ 1.5	550	RPM	16808	8404	5603	4202	3362	2801	2101
					(440-660)	Fz	0.0005	0.0012	0.0023	0.0031	0.0039	0.0040	0.0043
						Feed (ipm)	25.2	30.3	38.7	39.1	39.3	33.6	27.1
		Slot 	1	≤ 1	440	RPM	13446	6723	4482	3362	2689	2241	1681
					(352-528)	Fz	0.0005	0.0012	0.0023	0.0031	0.0039	0.0040	0.0043
						Feed (ipm)	20.2	24.2	30.9	31.3	31.5	26.9	21.7
ALLOY STEELS 4140, 4150, 4320, 5120, 5150, 8630, 86L20, 50100	≤ 375 Bhn or ≤ 40 HRc	Profile 	≤ 0.5	≤ 1.5	315	RPM	9626	4813	3209	2407	1925	1604	1203
					(252-378)	Fz	0.0004	0.0009	0.0017	0.0023	0.0029	0.0030	0.0032
						Feed (ipm)	11.6	13.0	16.4	16.6	16.7	14.4	11.6
		Slot 	1	≤ 1	250	RPM	7640	3820	2547	1910	1528	1273	955
					(200-300)	Fz	0.0004	0.0009	0.0017	0.0023	0.0029	0.0030	0.0032
						Feed (ipm)	9.2	10.3	13.0	13.2	13.3	11.5	9.2
TOOL STEELS A2, D2, H13, L2, M2, P20, S7, T15, W2	≤ 375 Bhn or ≤ 40 HRc	Profile 	≤ 0.5	≤ 1.5	185	RPM	5654	2827	1885	1413	1131	942	707
					(148-222)	Fz	0.0003	0.0007	0.0014	0.0018	0.0023	0.0024	0.0025
						Feed (ipm)	5.1	5.9	7.9	7.6	7.8	6.8	5.3
		Slot 	1	≤ 1	145	RPM	4431	2216	1477	1108	886	739	554
					(116-174)	Fz	0.0003	0.0007	0.0014	0.0018	0.0023	0.0024	0.0025
						Feed (ipm)	4.0	4.7	6.2	6.0	6.1	5.3	4.2
STAINLESS STEELS (FREE MACHINING) 303, 416, 420F, 430F, 440F	≤ 275 Bhn or ≤ 28 HRc	Profile 	≤ 0.5	≤ 1.5	490	RPM	14974	7487	4991	3744	2995	2496	1872
					(392-588)	Fz	0.0004	0.0010	0.0019	0.0025	0.0031	0.0032	0.0035
						Feed (ipm)	17.1	22.5	28.5	28.1	27.9	24.0	19.7
		Slot 	1	≤ 1	390	RPM	11918	5959	3973	2980	2384	1986	1490
					(312-468)	Fz	0.0004	0.0010	0.0019	0.0025	0.0031	0.0032	0.0035
						Feed (ipm)	13.6	17.9	22.6	22.3	22.2	19.1	15.6
STAINLESS STEELS (DIFFICULT) 304, 304L, 316, 316L	≤ 275 Bhn or ≤ 28 HRc	Profile 	≤ 0.5	≤ 1.5	340	RPM	10390	5195	3463	2598	2078	1732	1299
					(272-408)	Fz	0.0003	0.0008	0.0015	0.0020	0.0025	0.0026	0.0028
						Feed (ipm)	9.4	12.5	15.6	15.6	15.6	13.5	10.9
		Slot 	1	≤ 1	270	RPM	8251	4126	2750	2063	1650	1375	1031
					(216-324)	Fz	0.0003	0.0008	0.0015	0.0020	0.0025	0.0026	0.0028
						Feed (ipm)	7.4	9.9	12.4	12.4	12.4	10.7	8.7
STAINLESS STEELS (PH) 13-8 PH, 15-5 PH, 17-4 PH, Custom 450	≤ 325 Bhn or ≤ 35 HRc	Profile 	≤ 0.5	≤ 1.5	310	RPM	9474	4737	3158	2368	1895	1579	1184
					(248-372)	Fz	0.0003	0.0008	0.0015	0.0020	0.0025	0.0026	0.0028
						Feed (ipm)	8.5	11.4	14.2	14.2	14.2	12.3	9.9
		Slot 	1	≤ 1	250	RPM	7640	3820	2547	1910	1528	1273	955
					(200-300)	Fz	0.0003	0.0008	0.0015	0.0020	0.0025	0.0026	0.0028
						Feed (ipm)	6.9	9.2	11.5	11.5	11.5	9.9	8.0

continued on next page

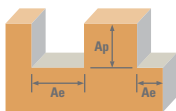

Series 33CR Fractional	Hardness	Ae x DC	Ap x DC	Vc (sfm)	DC • in									
					1/8	1/4	3/8	1/2	5/8	3/4	1			
K	CAST IRONS (LOW & MEDIUM ALLOY) Gray, Malleable, Ductile	≤ 220 Bhn or ≤ 19 HRc	Profile 	≤ 0.5	≤ 1.5	445	RPM	13599	6800	4533	3400	2720	2267	1700
						(356-534)	Fz	0.0004	0.0011	0.0021	0.0028	0.0035	0.0036	0.0039
							Feed (ipm)	14.3	22.4	28.6	28.6	28.6	24.5	19.9
			Slot 	1	≤ 1	355	RPM	10849	5424	3616	2712	2170	1808	1356
						(284-426)	Fz	0.0004	0.0011	0.0021	0.0028	0.0035	0.0036	0.0039
							Feed (ipm)	11.4	17.9	22.8	22.8	22.8	19.5	15.9
	CAST IRONS (HIGH ALLOY) Gray, Malleable, Ductile	≤ 260 Bhn or ≤ 26 HRc	Profile 	≤ 0.5	≤ 1.5	340	RPM	10390	5195	3463	2598	2078	1732	1299
						(272-408)	Fz	0.0003	0.0008	0.0016	0.0021	0.0026	0.0027	0.0029
							Feed (ipm)	9.4	12.5	16.6	16.4	16.2	14.0	11.3
			Slot 	1	≤ 1	270	RPM	8251	4126	2750	2063	1650	1375	1031
						(216-324)	Fz	0.0003	0.0008	0.0016	0.0021	0.0026	0.0027	0.0029
							Feed (ipm)	7.4	9.9	13.2	13.0	12.9	11.1	9.0
S	HIGH TEMP ALLOYS (NICKEL, COBALT, IRON BASE) Inconel 601, 617, 625, Incoloy, Monel 400	≤ 300 Bhn or ≤ 32 HRc	Profile 	≤ 0.5	≤ 1.5	80	RPM	2445	1222	815	611	489	407	306
						(64-96)	Fz	0.0003	0.0007	0.0013	0.0017	0.0021	0.0022	0.0024
							Feed (ipm)	1.9	2.6	3.2	3.1	3.1	2.7	2.2
			Slot 	1	≤ 1	65	RPM	1986	993	662	497	397	331	248
						(52-78)	Fz	0.0003	0.0007	0.0013	0.0017	0.0021	0.0022	0.0024
							Feed (ipm)	1.5	2.1	2.6	2.5	2.5	2.2	1.8
	HIGH TEMP ALLOYS (NICKEL, COBALT, IRON BASE) Inconel 718, X-750, Incoloy, Waspaloy, Hastelloy, Rene	≤ 400 Bhn or ≤ 43 HRc	Profile 	≤ 0.5	≤ 1.5	62	RPM	1895	947	632	474	379	316	237
						(50-74)	Fz	0.0002	0.0005	0.0009	0.0012	0.0015	0.0016	0.0017
							Feed (ipm)	1.1	1.4	1.7	1.7	1.7	1.5	1.2
			Slot 	1	≤ 1	49	RPM	1497	749	499	374	299	250	187
						(39-59)	Fz	0.0002	0.0005	0.0009	0.0012	0.0015	0.0016	0.0017
							Feed (ipm)	0.9	1.1	1.3	1.3	1.3	1.2	1.0
TITANIUM ALLOYS Pure Titanium, Ti6Al4V, Ti6Al2Sn4Zr2Mo, Ti4Al4Mo2Sn0.5Si	≤ 350 Bhn or ≤ 38 HRc	Profile 	≤ 0.5	≤ 1.5	215	RPM	6570	3285	2190	1643	1314	1095	821	
					(172-258)	Fz	0.0003	0.0008	0.0015	0.0020	0.0025	0.0026	0.0028	
						Feed (ipm)	5.9	7.9	9.9	9.9	9.9	8.5	6.9	
		Slot 	1	≤ 1	170	RPM	5195	2598	1732	1299	1039	866	649	
					(136-204)	Fz	0.0003	0.0008	0.0015	0.0020	0.0025	0.0026	0.0028	
						Feed (ipm)	4.7	6.2	7.8	7.8	7.8	6.8	5.5	
TITANIUM ALLOYS (DIFFICULT) Ti10V2Fe3Al, Ti5Al5V5Mo3Cr, Ti7Al4Mo, Ti3Al8V6Cr4Zr4Mo, Ti6Al6V6Sn, Ti15V3 Cr3Sn3Al	≤ 420 Bhn or ≤ 45 HRc	Profile 	≤ 0.5	≤ 1.5	75	RPM	2292	1146	764	573	458	382	287	
					(60-90)	Fz	0.0003	0.0008	0.0015	0.0020	0.0025	0.0026	0.0028	
						Feed (ipm)	2.1	2.8	3.4	3.4	3.4	3.0	2.4	
		Slot 	1	≤ 1	60	RPM	1834	917	611	458	367	306	229	
					(48-72)	Fz	0.0003	0.0008	0.0015	0.0020	0.0025	0.0026	0.0028	
						Feed (ipm)	1.7	2.2	2.8	2.8	2.8	2.4	1.9	

Bhn (Brinell) HRc (Rockwell C)

rpm = Vc x 3.82 / DC

ipm = Fz x 3 x rpm

reduce speed and feed for materials harder than listed

reduce feed and Ae when finish milling (.02 x DC maximum)

feed rates listed have chip thinning adjustments included where applicable

refer to the SGS Tool Wizard® for complete technical information (www.kyocera-sgstooll.com)



33MCR

METRIC SERIES

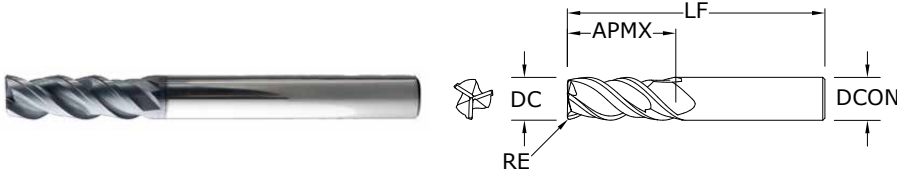

- Specially engineered step core design provides stability for aggressive ramping and rigidity when flutes are completely engaged
- Open design at axial end accommodates material flow and load reduction during machining operations
- Enhanced corner geometry with tight tolerance corner radii
- Recommended for materials ≤ 45 HRc (≤ 420 Bhn)

CUTTING DIAMETER DC	LENGTH OF CUT APMX	mm			CORNER RADIUS RE	EDP NO. Ti-NAMITE®-A (AlTiN)
		OVERALL LENGTH LF	SHANK DIAMETER DCON			
3,0	9,0	57,0	6,0	0,3	43445	
3,0	9,0	57,0	6,0	0,5	43470	
4,0	12,0	57,0	6,0	0,3	43446	
4,0	12,0	57,0	6,0	0,5	43471	
5,0	15,0	57,0	6,0	0,3	43447	
5,0	15,0	57,0	6,0	0,5	43472	
6,0	18,0	57,0	6,0	0,5	43448	
6,0	18,0	57,0	6,0	1,0	43473	
6,0	18,0	57,0	6,0	1,5	43474	
6,0	18,0	57,0	6,0	2,0	43475	
8,0	20,0	63,0	8,0	0,5	43449	
8,0	20,0	63,0	8,0	1,0	43476	
8,0	20,0	63,0	8,0	1,5	43477	
8,0	20,0	63,0	8,0	2,0	43478	
10,0	27,0	72,0	10,0	0,5	43450	
10,0	27,0	72,0	10,0	1,0	43479	
10,0	27,0	72,0	10,0	1,5	43480	
10,0	27,0	72,0	10,0	2,0	43481	
10,0	27,0	72,0	10,0	2,5	43482	
12,0	30,0	83,0	12,0	0,5	43451	
12,0	30,0	83,0	12,0	1,0	43483	
12,0	30,0	83,0	12,0	1,5	43484	
12,0	30,0	83,0	12,0	2,0	43485	
12,0	30,0	83,0	12,0	2,5	43486	
12,0	30,0	83,0	12,0	3,0	43487	
12,0	30,0	83,0	12,0	4,0	43488	
16,0	38,0	92,0	16,0	1,0	43452	
16,0	38,0	92,0	16,0	1,5	43489	
16,0	38,0	92,0	16,0	2,0	43490	
16,0	38,0	92,0	16,0	2,5	43491	
16,0	38,0	92,0	16,0	3,0	43492	
16,0	38,0	92,0	16,0	4,0	43493	
20,0	46,0	104,0	20,0	1,0	43453	
20,0	46,0	104,0	20,0	2,0	43494	
20,0	46,0	104,0	20,0	2,5	43495	
20,0	46,0	104,0	20,0	3,0	43496	
20,0	46,0	104,0	20,0	4,0	43497	

TOLERANCES (mm)

3-6 DIAMETER

DC = +0,000/-0,030
 DCON = h_6
 RE = +0,000/-0,050

>6-10 DIAMETER

DC = +0,000/-0,040
 DCON = h_6
 RE = +0,000/-0,050

>10-20 DIAMETER

DC = +0,000/-0,050
 DCON = h_6
 RE = +0,000/-0,050

- STEELS
- STAINLESS STEELS
- CAST IRON
- HIGH TEMP ALLOYS

For patent information visit www.kspatents.com

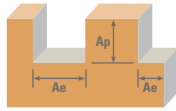





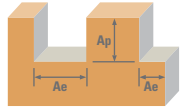

Series 33MCR Metric	Hardness	Ae x DC	Ap x DC	Vc (m/min)	DC • mm								
					3	6	8	10	12	16	20		
P CARBON STEELS 1018, 1040, 1080, 1090, 10L50, 1140, 1212, 12L15, 1525, 1536	≤ 275 Bhn or ≤ 28 HRc	Profile 	≤ 0.5	≤ 1.5	168	RPM	17773	8886	6665	5332	4443	3332	2666
					(134-201)	Fz	0.012	0.029	0.049	0.061	0.074	0.100	0.107
					Feed (mm/min)	640	768	981	981	992	998	853	
		Slot 	1	≤ 1	134	RPM	14218	7109	5332	4265	3555	2666	2133
					(107-161)	Fz	0.012	0.029	0.049	0.061	0.074	0.100	0.107
					Feed (mm/min)	512	614	785	785	793	798	682	
	≤ 375 Bhn or ≤ 40 HRc	Profile 	≤ 0.5	≤ 1.5	96	RPM	10179	5089	3817	3054	2545	1909	1527
					(77-115)	Fz	0.010	0.022	0.036	0.045	0.055	0.074	0.080
					Feed (mm/min)	293	330	415	415	421	425	366	
		Slot 	1	≤ 1	76	RPM	8078	4039	3029	2424	2020	1515	1212
					(61-91)	Fz	0.010	0.022	0.036	0.045	0.055	0.074	0.080
					Feed (mm/min)	233	262	330	330	334	337	291	
≤ 375 Bhn or ≤ 40 HRc	Profile 	≤ 0.5	≤ 1.5	56	RPM	5978	2989	2242	1793	1495	1121	897	
				(45-68)	Fz	0.007	0.017	0.030	0.037	0.043	0.059	0.064	
				Feed (mm/min)	129	151	201	201	194	198	172		
	Slot 	1	≤ 1	44	RPM	4686	2343	1757	1406	1171	879	703	
				(35-53)	Fz	0.007	0.017	0.030	0.037	0.043	0.059	0.064	
				Feed (mm/min)	101	118	157	157	152	155	135		
M STAINLESS STEELS (FREE MACHINING) 303, 416, 420F, 430F, 440F	≤ 275 Bhn or ≤ 28 HRc	Profile 	≤ 0.5	≤ 1.5	149	RPM	15834	7917	5938	4750	3958	2969	2375
					(119-179)	Fz	0.009	0.024	0.041	0.051	0.060	0.079	0.085
					Feed (mm/min)	433	570	722	722	712	707	608	
		Slot 	1	≤ 1	119	RPM	12602	6301	4726	3781	3151	2363	1890
					(95-143)	Fz	0.009	0.024	0.041	0.051	0.060	0.079	0.085
					Feed (mm/min)	345	454	575	575	567	563	484	
	≤ 275 Bhn or ≤ 28 HRc	Profile 	≤ 0.5	≤ 1.5	104	RPM	10987	5493	4120	3296	2747	2060	1648
					(83-124)	Fz	0.007	0.019	0.032	0.040	0.048	0.064	0.069
					Feed (mm/min)	237	316	396	396	395	396	343	
		Slot 	1	≤ 1	82	RPM	8725	4362	3272	2617	2181	1636	1309
					(66-99)	Fz	0.007	0.019	0.032	0.040	0.048	0.064	0.069
					Feed (mm/min)	188	251	314	314	314	314	272	
≤ 325 Bhn or ≤ 35 HRc	Profile 	≤ 0.5	≤ 1.5	94	RPM	10017	5009	3756	3005	2504	1878	1503	
				(76-113)	Fz	0.007	0.019	0.032	0.040	0.048	0.064	0.069	
				Feed (mm/min)	216	288	361	361	361	361	313		
	Slot 	1	≤ 1	76	RPM	8078	4039	3029	2424	2020	1515	1212	
				(61-91)	Fz	0.007	0.019	0.032	0.040	0.048	0.064	0.069	
				Feed (mm/min)	174	233	291	291	291	291	252		

continued on next page

Series 33



Series 33MCR Metric	Hardness	Ae x DC	Ap x DC	Vc (m/min)	DC • mm									
					3	6	8	10	12	16	20			
K	CAST IRONS (LOW & MEDIUM ALLOY) Gray, Malleable, Ductile	≤ 220 Bhn or ≤ 19 HRc	Profile 	≤ 0.5	≤ 1.5	136	RPM	14380	7190	5392	4314	3595	2696	2157
						(109-163)	Fz	0.008	0.026	0.045	0.056	0.067	0.090	0.096
						Feed (mm/min)	362	569	725	725	725	725	621	
						108	RPM	11471	5736	4302	3441	2868	2151	1721
						(87-130)	Fz	0.008	0.026	0.045	0.056	0.067	0.090	0.096
						Feed (mm/min)	289	454	578	578	578	578	496	
	CAST IRONS (HIGH ALLOY) Gray, Malleable, Ductile	≤ 260 Bhn or ≤ 26 HRc	Profile 	≤ 0.5	≤ 1.5	104	RPM	10987	5493	4120	3296	2747	2060	1648
						(83-124)	Fz	0.007	0.019	0.034	0.043	0.050	0.067	0.072
						Feed (mm/min)	237	316	422	422	415	411	356	
						82	RPM	8725	4362	3272	2617	2181	1636	1309
						(66-99)	Fz	0.007	0.019	0.034	0.043	0.050	0.067	0.072
						Feed (mm/min)	188	251	335	335	330	327	283	
S	HIGH TEMP ALLOYS (NICKEL, COBALT, IRON BASE) Inconel 601, 617, 625, Incoloy, Monel 400	≤ 300 Bhn or ≤ 32 HRc	Profile 	≤ 0.5	≤ 1.5	24	RPM	2585	1293	969	776	646	485	388
						(20-29)	Fz	0.006	0.017	0.028	0.035	0.041	0.054	0.059
						Feed (mm/min)	48	65	81	65	79	78	68	
						20	RPM	2100	1050	788	630	525	394	315
						(16-24)	Fz	0.006	0.017	0.028	0.035	0.041	0.054	0.059
						Feed (mm/min)	39	53	66	66	64	64	55	
	HIGH TEMP ALLOYS (NICKEL, COBALT, IRON BASE) Inconel 718, X-750, Incoloy, Waspaloy, Hastelloy, Rene	≤ 400 Bhn or ≤ 43 HRc	Profile 	≤ 0.5	≤ 1.5	19	RPM	2003	1002	751	601	501	376	301
						(15-23)	Fz	0.005	0.012	0.019	0.024	0.029	0.038	0.043
						Feed (mm/min)	29	36	43	43	43	43	38	
						15	RPM	1583	792	594	475	396	297	238
						(12-18)	Fz	0.005	0.012	0.019	0.024	0.029	0.038	0.043
						Feed (mm/min)	23	28	34	34	34	34	30	
TITANIUM ALLOYS Pure Titanium, Ti6Al4V, Ti6Al2Sn4Zr2Mo, Ti4Al4Mo2Sn0.5Si	≤ 350 Bhn or ≤ 38 HRc	Profile 	≤ 0.5	≤ 1.5	66	RPM	6947	3474	2605	2084	1737	1303	1042	
					(52-79)	Fz	0.007	0.019	0.032	0.040	0.048	0.064	0.069	
					Feed (mm/min)	150	200	250	250	250	250	217		
					52	RPM	5493	2747	2060	1648	1373	1030	824	
					(41-62)	Fz	0.007	0.019	0.032	0.040	0.048	0.064	0.069	
					Feed (mm/min)	119	158	198	198	198	198	171		
TITANIUM ALLOYS (DIFFICULT) Ti10V2Fe3Al, Ti5Al5V5Mo3Cr, Ti7Al4Mo, Ti3Al8V6Cr4Zr4Mo, Ti6Al6V6Sn, Ti15V3 Cr3Sn3Al	≤ 420 Bhn or ≤ 45 HRc	Profile 	≤ 0.5	≤ 1.5	23	RPM	2424	1212	909	727	606	454	364	
					(18-27)	Fz	0.007	0.019	0.032	0.040	0.048	0.064	0.069	
					Feed (mm/min)	52	70	87	87	87	87	76		
					18	RPM	1939	969	727	582	485	364	291	
					(15-22)	Fz	0.007	0.019	0.032	0.040	0.048	0.064	0.069	
					Feed (mm/min)	42	56	70	70	70	70	60		

Bhn (Brinell) HRc (Rockwell C)
 rpm = (Vc x 1000) / (DC x 3.14)
 mm/min = Fz x 3 x rpm
 reduce speed and feed for materials harder than listed
 reduce feed and Ae when finish milling (.02 x DC maximum)
 feed rates listed have chip thinning adjustments included where applicable
 refer to the SGS Tool Wizard® for complete technical information (www.kyocera-sgstool.com)



7
FRACTIONAL SERIES

TOLERANCES (inch)

DC = +0.0000/-0.0020

DCON = h₆

STEELS

STAINLESS STEELS

CAST IRON

HIGH TEMP ALLOYS

For patent information visit www.ksptpatents.com

CUTTING DIAMETER DC	LENGTH OF CUT APMX	inch		SHANK DIAMETER DCON	EDP NO. TI-NAMITE®-X
		OVERALL LENGTH LF			
1/8	3/4	2-1/4		1/8	70470
1/8	1	3		1/8	70471
3/16	3/4	2-1/2		3/16	70472
3/16	1-1/8	3		3/16	70473
1/4	1-1/8	3		1/4	70474
1/4	1-1/2	4		1/4	70475
5/16	1-1/8	3		5/16	70476
5/16	1-5/8	4		5/16	70477
3/8	1-1/8	3		3/8	70478
3/8	1-3/4	4		3/8	70479
7/16	2	4-1/2		7/16	70480
7/16	3	6		7/16	70481
1/2	2	4-1/2		1/2	70482
1/2	3	6		1/2	70483
5/8	2-1/4	5		5/8	70484
5/8	3	6		5/8	70485
3/4	2-1/4	5		3/4	70486
3/4	3	6		3/4	70487
1	2-1/4	5		1	70488
1	3	6		1	70489

- Variable pitch allows for improved chatter suppression along with improved surface finish and enhanced tool life
- Raised land and increased core diameter designed to enhance tool life and decrease tool deflection
- Recommended for materials ≤ 45 HRc (≤ 420 Bhn)

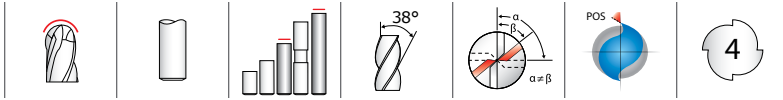

7B
FRACTIONAL SERIES

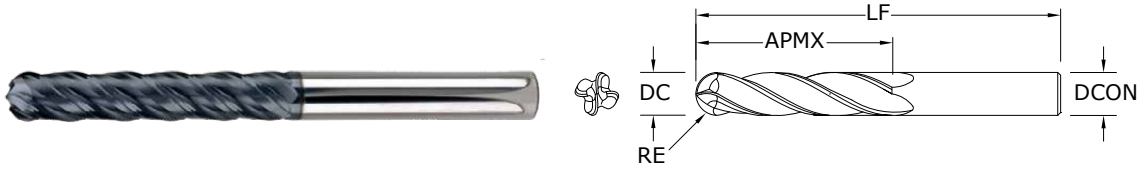

- Variable pitch allows for improved chatter suppression along with improved surface finish and enhanced tool life
- Raised land and increased core diameter designed to enhance tool life and decrease tool deflection
- Ball end design ideal for finishing operations in complex workpieces
- Recommended for materials ≤ 45 HRc (≤ 420 Bhn)

	inch			EDP NO.
CUTTING DIAMETER DC	LENGTH OF CUT APMX	OVERALL LENGTH LF	SHANK DIAMETER DCON	Ti-NAMITE®-X
1/8	3/4	2-1/4	1/8	70441
1/8	1	3	1/8	70442
3/16	3/4	2-1/2	3/16	70444
3/16	1-1/8	3	3/16	70445
1/4	1-1/8	3	1/4	70447
1/4	1-1/2	4	1/4	70448
5/16	1-1/8	3	5/16	70450
5/16	1-5/8	4	5/16	70451
3/8	1-1/8	3	3/8	70453
3/8	1-3/4	4	3/8	70454
7/16	2	4-1/2	7/16	70456
7/16	3	6	7/16	70457
1/2	2	4-1/2	1/2	70459
1/2	3	6	1/2	70460
5/8	2-1/4	5	5/8	70462
5/8	3	6	5/8	70463
3/4	2-1/4	5	3/4	70465
3/4	3	6	3/4	70466
1	2-1/4	5	1	70468
1	3	6	1	70469

RE = 1/2 Cutting Diameter (DC)

TOLERANCES (inch)

DC = +0.0000/-0.0020
 DCON = h_6
 RE = +0.0000/-0.0010

- STEELS
- STAINLESS STEELS
- CAST IRON
- HIGH TEMP ALLOYS

For patent information visit www.ksptpatents.com

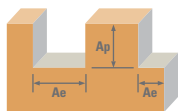

Series 7, 7B	Fractional	Hardness	Finish	Ae x DC	Ap x DC	Vc (sfm)	DC • in							
							1/8	1/4	3/8	1/2	5/8	3/4	1	
P	CARBON STEELS 1018, 1040, 1080, 1090, 10L50, 1140, 1212, 12L15, 1525, 1536	≤ 275 Bhn or ≤ 28 HRc		≤ 0.02	≤ 2	480	RPM	14669	7334	4890	3667	2934	2445	1834
		(384-576)				Fz	0.0004	0.0010	0.0019	0.0025	0.0032	0.0033	0.0035	
		Feed (ipm)				23.5	29.3	37.2	36.7	37.6	32.3	25.7		
	ALLOY STEELS 4140, 4150, 4320, 5120, 5150, 8630, 86L20, 50100	≤ 375 Bhn or ≤ 40 HRc		≤ 0.02	≤ 2	275	RPM	8404	4202	2801	2101	1681	1401	1051
		(220-330)				Fz	0.0003	0.0007	0.0014	0.0018	0.0023	0.0024	0.0026	
		Feed (ipm)				10.1	11.8	15.7	15.1	15.5	13.4	10.9		
TOOL STEELS A2, D2, H13, L2, M2, P20, S7, T15, W2	≤ 375 Bhn or ≤ 40 HRc		≤ 0.02	≤ 2	230	RPM	7029	3514	2343	1757	1406	1171	879	
	(184-276)				Fz	0.0002	0.0006	0.0012	0.0016	0.0020	0.0021	0.0022		
	Feed (ipm)				5.6	8.4	11.2	11.2	11.2	9.8	7.7			
M	STAINLESS STEELS (FREE MACHINING) 303, 416, 420F, 430F, 440F	≤ 275 Bhn or ≤ 28 HRc		≤ 0.02	≤ 2	420	RPM	12835	6418	4278	3209	2567	2139	1604
		(336-504)				Fz	0.0004	0.0010	0.0019	0.0025	0.0032	0.0033	0.0035	
		Feed (ipm)				20.5	25.7	32.5	32.1	32.9	28.2	22.5		
	STAINLESS STEELS (DIFFICULT) 304, 304L, 316, 316L	≤ 275 Bhn or ≤ 28 HRc		≤ 0.02	≤ 2	290	RPM	8862	4431	2954	2216	1772	1477	1108
		(232-348)				Fz	0.0003	0.0007	0.0014	0.0018	0.0023	0.0024	0.0026	
		Feed (ipm)				10.6	12.4	16.5	16.0	16.3	14.2	11.5		
STAINLESS STEELS (PH) 13-8 PH, 15-5 PH, 17-4 PH, Custom 450	≤ 325 Bhn or ≤ 35 HRc		≤ 0.02	≤ 2	265	RPM	8098	4049	2699	2025	1620	1350	1012	
	(212-318)				Fz	0.0003	0.0007	0.0014	0.0018	0.0023	0.0024	0.0026		
	Feed (ipm)				9.7	11.3	15.1	14.6	14.9	13.0	10.5			
K	CAST IRONS (LOW & MEDIUM ALLOY) Gray, Malleable, Ductile	≤ 220 Bhn or ≤ 19 HRc		≤ 0.02	≤ 2	605	RPM	18489	9244	6163	4622	3698	3081	2311
		(484-726)				Fz	0.0006	0.0015	0.0028	0.0037	0.0046	0.0047	0.0051	
		Feed (ipm)				44.4	55.5	69.0	68.4	68.0	57.9	47.1		
	CAST IRONS (HIGH ALLOY) Gray, Malleable, Ductile	≤ 260 Bhn or ≤ 26 HRc		≤ 0.02	≤ 2	465	RPM	14210	7105	4737	3553	2842	2368	1776
		(372-558)				Fz	0.0004	0.0011	0.0021	0.0028	0.0034	0.0036	0.0039	
		Feed (ipm)				22.7	31.3	39.8	39.8	38.7	34.1	27.7		
S	HIGH TEMP ALLOYS (NICKEL, COBALT, IRON BASE) Inconel 601, 617, 625, Incoloy, Monel 400	≤ 300 Bhn or ≤ 32 HRc		≤ 0.02	≤ 2	80	RPM	2445	1222	815	611	489	407	306
		(64-96)				Fz	0.0003	0.0007	0.0014	0.0018	0.0023	0.0024	0.0026	
		Feed (ipm)				2.9	3.4	4.6	4.4	4.5	3.9	3.2		
	HIGH TEMP ALLOYS (NICKEL, COBALT, IRON BASE) Inconel 718, X-750, Incoloy, Waspaloy, Hastelloy, Rene	≤ 400 Bhn or ≤ 43 HRc		≤ 0.02	≤ 2	65	RPM	1986	993	662	497	397	331	248
		(52-78)				Fz	0.0002	0.0006	0.0010	0.0014	0.0017	0.0018	0.0019	
		Feed (ipm)				1.6	2.4	2.6	2.8	2.7	2.4	1.9		
TITANIUM ALLOYS Pure Titanium, Ti6Al4V, Ti6Al2Sn4Zr2Mo, Ti4Al4Mo2Sn0.5Si	≤ 350 Bhn or ≤ 38 HRc		≤ 0.02	≤ 2	300	RPM	9168	4584	3056	2292	1834	1528	1146	
	(240-360)				Fz	0.0004	0.0011	0.0021	0.0028	0.0034	0.0036	0.0039		
	Feed (ipm)				14.7	20.2	25.7	25.7	24.9	22.0	17.9			
TITANIUM ALLOYS (DIFFICULT) Ti10V2Fe3Al, Ti5Al5V5Mo3Cr, Ti7Al4Mo, Ti3Al8V6Cr4Zr4Mo, Ti6Al6V6Sn, Ti15V3 Cr3Sn3Al	≤ 420 Bhn or ≤ 45 HRc		≤ 0.02	≤ 2	105	RPM	3209	1604	1070	802	642	535	401	
	(84-126)				Fz	0.0004	0.0011	0.0021	0.0028	0.0034	0.0036	0.0039		
	Feed (ipm)				5.1	7.1	9.0	9.0	8.7	7.7	6.3			

Bhn (Brinell) HRc (Rockwell C)

rpm = Vc x 3.82 / DC

ipm = Fz x 4 x rpm

reduce speed and feed for materials harder than listed

feed rates listed have chip thinning adjustments included where applicable

refer to the SGS Tool Wizard® for complete technical information (www.kyocera-sgstool.com)

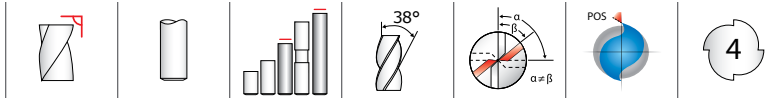

7M
METRIC SERIES

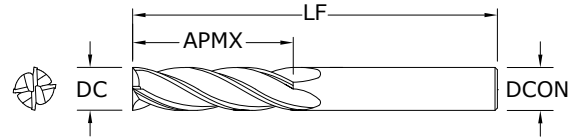

- Variable pitch allows for improved chatter suppression along with improved surface finish and enhanced tool life
- Raised land and increased core diameter designed to enhance tool life and decrease tool deflection
- Recommended for materials ≤ 45 HRC (≤ 420 Bhn)

mm				EDP NO.
CUTTING DIAMETER DC	LENGTH OF CUT APMX	OVERALL LENGTH LF	SHANK DIAMETER DCON	Ti-NAMITE®-X
3,0	25,0	75,0	3,0	70551
4,0	25,0	75,0	4,0	70552
5,0	25,0	75,0	5,0	70553
6,0	25,0	75,0	6,0	70554
8,0	25,0	75,0	8,0	70555
10,0	38,0	100,0	10,0	70556
12,0	50,0	100,0	12,0	70557
12,0	75,0	150,0	12,0	70558
14,0	75,0	150,0	14,0	70559
16,0	75,0	150,0	16,0	70560
18,0	75,0	150,0	18,0	70561
20,0	75,0	150,0	20,0	70562
25,0	75,0	150,0	25,0	70563

TOLERANCES (mm)

DC = $+0,000/+0,050$
DCON = h_6

- STEELS
- STAINLESS STEELS
- CAST IRON
- HIGH TEMP ALLOYS

For patent information visit www.ksptpatents.com

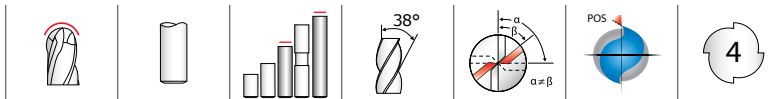

7MB
METRIC SERIES

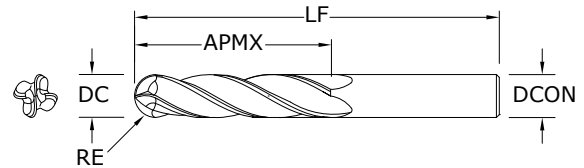

- Variable pitch allows for improved chatter suppression along with improved surface finish and enhanced tool life
- Raised land and increased core diameter designed to enhance tool life and decrease tool deflection
- Ball end design ideal for finishing operations in complex workpieces
- Recommended for materials ≤ 45 HRC (≤ 420 Bhn)

mm				EDP NO.
CUTTING DIAMETER DC	LENGTH OF CUT APMX	OVERALL LENGTH LF	SHANK DIAMETER DCON	Ti-NAMITE®-X
3,0	25,0	75,0	3,0	70527
4,0	25,0	75,0	4,0	70529
5,0	25,0	75,0	5,0	70531
6,0	25,0	75,0	6,0	70533
8,0	25,0	75,0	8,0	70535
10,0	38,0	100,0	10,0	70537
12,0	50,0	100,0	12,0	70539
12,0	75,0	150,0	12,0	70540
14,0	75,0	150,0	14,0	70542
16,0	75,0	150,0	16,0	70544
18,0	75,0	150,0	18,0	70546
20,0	75,0	150,0	20,0	70548
25,0	75,0	150,0	25,0	70550

RE = 1/2 Cutting Diameter (DC)

TOLERANCES (mm)

DC = $+0,000/+0,050$
DCON = h_6
RE = $+0,000/-0,025$

- STEELS
- STAINLESS STEELS
- CAST IRON
- HIGH TEMP ALLOYS

For patent information visit www.ksptpatents.com

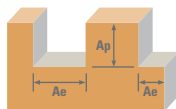

Series 7M, 7MB Metric	Hardness	Finish	Ae x DC	Ap x DC	Vc (m/min)	DC • mm									
						3	6	8	10	12	16	20	25		
P	CARBON STEELS 1018, 1040, 1080, 1090, 10L50, 1140, 1212, 12L15, 1525, 1536	≤ 275 Bhn or ≤ 28 HRc	Finish	≤ 0.02	≤ 2	146	RPM	15511	7755	5816	4653	3878	2908	2327	1861
						(117-176)	Fz	0.0166	0.043	0.075	0.093	0.110	0.125	0.147	0.160
						Feed (mm/min)	1030	1334	1745	1731	1706	1454	1368	1191	
	ALLOY STEELS 4140, 4150, 4320, 5120, 5150, 8630, 86L20, 50100	≤ 375 Bhn or ≤ 40 HRc	Finish	≤ 0.02	≤ 2	84	RPM	8886	4443	3332	2666	2222	1666	1333	1066
						(67-101)	Fz	0.0122	0.034	0.051	0.069	0.082	0.091	0.109	0.120
						Feed (mm/min)	434	604	680	736	729	606	581	512	
TOOL STEELS A2, D2, H13, L2, M2, P20, S7, T15, W2	≤ 375 Bhn or ≤ 40 HRc	Finish	≤ 0.02	≤ 2	70	RPM	7432	3716	2787	2230	1858	1394	1115	892	
					(56-84)	Fz	0.0070	0.019	0.040	0.043	0.048	0.057	0.064	0.070	
					Feed (mm/min)	208	282	446	384	357	318	285	250		
M	STAINLESS STEELS (FREE MACHINING) 303, 416, 420F, 430F, 440F	≤ 275 Bhn or ≤ 28 HRc	Finish	≤ 0.02	≤ 2	128	RPM	13572	6786	5089	4072	3393	2545	2036	1629
						(102-154)	Fz	0.0086	0.024	0.040	0.048	0.058	0.065	0.077	0.087
						Feed (mm/min)	467	651	814	782	787	662	627	567	
	STAINLESS STEELS (DIFFICULT) 304, 304L, 316, 316L	≤ 275 Bhn or ≤ 28 HRc	Finish	≤ 0.02	≤ 2	88	RPM	9371	4686	3514	2811	2343	1757	1406	1125
						(71-106)	Fz	0.0082	0.022	0.037	0.045	0.048	0.060	0.072	0.078
						Feed (mm/min)	307	412	520	506	450	422	405	351	
STAINLESS STEELS (PH) 13-8 PH, 15-5 PH, 17-4 PH, Custom 450	≤ 325 Bhn or ≤ 35 HRc	Finish	≤ 0.02	≤ 2	81	RPM	8563	4282	3211	2569	2141	1606	1284	1028	
					(65-97)	Fz	0.0070	0.019	0.029	0.040	0.048	0.055	0.064	0.070	
					Feed (mm/min)	240	325	372	411	411	353	329	288		
K	CAST IRONS (LOW & MEDIUM ALLOY) Gray, Malleable, Ductile	≤ 220 Bhn or ≤ 19 HRc	Finish	≤ 0.02	≤ 2	184	RPM	19550	9775	7331	5865	4887	3666	2932	2346
						(148-221)	Fz	0.0132	0.036	0.052	0.075	0.089	0.099	0.117	0.130
						Feed (mm/min)	1032	1408	1525	1759	1740	1452	1372	1220	
	CAST IRONS (HIGH ALLOY) Gray, Malleable, Ductile	≤ 260 Bhn or ≤ 26 HRc	Finish	≤ 0.02	≤ 2	142	RPM	15026	7513	5635	4508	3756	2817	2254	1803
						(113-170)	Fz	0.0132	0.036	0.052	0.075	0.089	0.099	0.117	0.130
						Feed (mm/min)	793	1082	1172	1352	1337	1116	1055	938	
S	HIGH TEMP ALLOYS (NICKEL, COBALT, IRON BASE) Inconel 601, 617, 625, Incoloy, Monel 400	≤ 300 Bhn or ≤ 32 HRc	Finish	≤ 0.02	≤ 2	24	RPM	2585	1293	969	776	646	485	388	310
						(20-29)	Fz	0.0072	0.019	0.029	0.037	0.046	0.053	0.061	0.085
						Feed (mm/min)	74	98	112	90	119	103	95	105	
	HIGH TEMP ALLOYS (NICKEL, COBALT, IRON BASE) Inconel 718, X-750, Incoloy, Waspaloy, Hastelloy, Rene	≤ 400 Bhn or ≤ 43 HRc	Finish	≤ 0.02	≤ 2	20	RPM	2100	1050	788	630	525	394	315	252
						(16-24)	Fz	0.0075	0.016	0.021	0.030	0.038	0.044	0.051	0.070
						Feed (mm/min)	63	67	66	76	80	69	64	71	
TITANIUM ALLOYS Pure Titanium, Ti6Al4V, Ti6Al2Sn4Zr2Mo, Ti4Al4Mo2Sn0.5Si	≤ 350 Bhn or ≤ 38 HRc	Finish	≤ 0.02	≤ 2	91	RPM	9694	4847	3635	2908	2424	1818	1454	1163	
					(73-110)	Fz	0.0091	0.024	0.040	0.050	0.060	0.070	0.080	0.088	
					Feed (mm/min)	353	465	51	59	582	509	465	409		
TITANIUM ALLOYS (DIFFICULT) Ti10V2Fe3Al, Ti5Al5V5Mo3Cr, Ti7Al4Mo, Ti3Al8V6Cr4Zr4Mo, Ti6Al6V6Sn, Ti15V3 Cr3Sn3Al	≤ 420 Bhn or ≤ 45 HRc	Finish	≤ 0.02	≤ 2	32	RPM	3393	1696	1272	1018	848	636	509	407	
					(26-38)	Fz	0.0082	0.019	0.029	0.037	0.046	0.053	0.061	0.085	
					Feed (mm/min)	111	129	148	151	156	135	124	138		

Bhn (Brinell) HRc (Rockwell C)

rpm = (Vc x 1000) / (DC x 3.14)

mm/min = Fz x 4 x rpm

reduce speed and feed for materials harder than listed

feed rates listed have chip thinning adjustments included where applicable

refer to the SGS Tool Wizard® for complete technical information (www.kyocera-sgstool.com)



56B FRACTIONAL SERIES

- Short flute length and rigid design to reduce deflection
- S-Gash Ball geometry minimizes load and heat produced during the cutting process, ultimately enhancing tool life
- Ideal for machining complex contoured shapes in hardened steels
- Recommended for materials 35 to 60 HRc (327 to 654 Bhn)

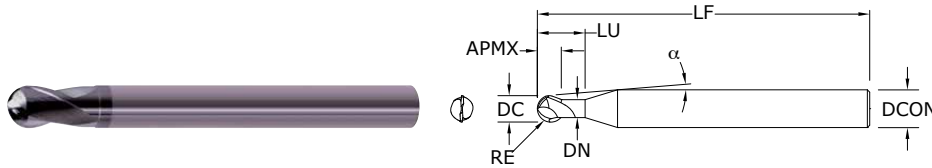

CUTTING DIAMETER DC	LENGTH OF CUT APMX	OVERALL LENGTH LF	inch				EDP NO.
			SHANK DIAMETER DCON	CENTER LINE ANGLE α	REACH LU	NECK DIAMETER DN	
1/32	1/32	3	1/4	8°20'	1/16	.025	93272
1/16	1/16	3	1/4	7°40'	1/8	.055	93273
3/32	3/32	3	1/4	6°50'	3/16	.085	93274
1/8	1/8	3	1/4	6°	1/4	.114	93275
3/16	3/16	3	1/4	3°35'	3/8	.171	93276
1/4	1/4	3-1/2	1/4	-	1/2	.230	93277
5/16	5/16	4	5/16	-	5/8	.292	93278
3/8	3/8	4	3/8	-	3/4	.355	93279
1/2	1/2	4-1/2	1/2	-	1	.480	93280
5/8	5/8	5-1/2	5/8	-	1-1/4	.610	93281
3/4	3/4	6-1/2	3/4	-	1-1/2	.735	93282

Extended Neck Option Available, contact your local KSPT representative for more information.
RE = 1/2 Cutting Diameter (DC)

TOLERANCES (inch)

- 1/32-3/32 DIAMETER**
 DC = +0.0000/-0.0010
 DCON = h₆
 RE = +0.0000/-0.0005
- >3/32-1/4 DIAMETER**
 DC = +0.0000/-0.0012
 DCON = h₆
 RE = +0.0000/-0.0006
- >1/4-3/8 DIAMETER**
 DC = +0.0000/-0.0016
 DCON = h₆
 RE = +0.0000/-0.0008
- >3/8-3/4 DIAMETER**
 DC = +0.0000/-0.0020
 DCON = h₆
 RE = +0.0000/-0.0010

- STEELS
- HARDENED STEELS

For patent information visit www.ksptpatents.com

56MB METRIC SERIES

- Short flute length and rigid design to reduce deflection
- S-Gash Ball geometry minimizes load and heat produced during the cutting process, ultimately enhancing tool life
- Ideal for machining complex contoured shapes in hardened steels
- Recommended for materials 35 to 60 HRc (327 to 654 Bhn)

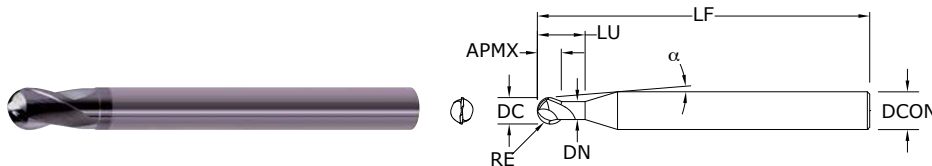

CUTTING DIAMETER DC	LENGTH OF CUT APMX	OVERALL LENGTH LF	mm				EDP NO.
			SHANK DIAMETER DCON	CENTER LINE ANGLE α	REACH LU	NECK DIAMETER DN	
1,0	1,0	76,0	6,0	8°10'	2,0	0,91	91349
1,5	1,5	76,0	6,0	7°45'	3,0	1,37	91350
2,0	2,0	76,0	6,0	7°10'	4,0	1,83	91351
2,5	2,5	76,0	6,0	6°35'	5,0	2,29	91352
3,0	3,0	76,0	6,0	6°	6,0	2,72	91353
4,0	4,0	76,0	6,0	4°30'	8,0	3,63	91354
5,0	5,0	89,0	6,0	2°30'	10,0	4,55	91355
6,0	6,0	89,0	6,0	-	12,0	5,49	91356
8,0	8,0	102,0	8,0	-	16,0	7,49	91357
10,0	10,0	102,0	10,0	-	20,0	9,47	91358
12,0	12,0	114,0	12,0	-	24,0	11,48	91359
16,0	16,0	140,0	16,0	-	32,0	15,62	91360
20,0	20,0	165,0	20,0	-	40,0	19,61	91361

Extended Neck Option Available, contact your local KSPT representative for more information.
RE = 1/2 Cutting Diameter (DC)

TOLERANCES (mm)

- 1-2,5 DIAMETER**
 DC = +0,000/-0,025
 DCON = h₆
 RE = +0,000/-0,0013
- >2,5-6 DIAMETER**
 DC = +0,000/-0,030
 DCON = h₆
 RE = +0,000/-0,0013
- >6-10 DIAMETER**
 DC = +0,000/-0,040
 DCON = h₆
 RE = +0,000/-0,0020
- >10-20 DIAMETER**
 DC = +0,000/-0,050
 DCON = h₆
 RE = +0,000/-0,0025

- STEELS
- HARDENED STEELS

For patent information visit www.ksptpatents.com

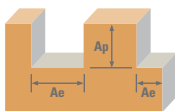

Series 56B	Fractional	Hardness	Ae x DC	Ap x DC	Vc (sfm)	DC • in								
						1/32	1/16	1/8	3/16	1/4	3/8	1/2	3/4	
P	TOOL STEELS MOLD AND DIE STEEL 300M, 4340, 52100, HP-9-4-20, M50, A2, D2, H13, L2, M2, P20, S7, T15, W2	Rough ≤ 375 Bhn or ≤ 40 HRc	Rough ≤ 0.4	≤ 0.1	625	RPM	76400	38200	19100	12733	9550	6367	4775	3183
					Fz	0.0006	0.0015	0.0030	0.0040	0.0050	0.0080	0.0100	0.0120	
					Feed (ipm)	92	115	115	102	96	102	96	76	
		HSM ≤ 40 HRc	HSM ≤ 0.4	≤ 0.03	950	RPM	116128	58064	29032	19355	14516	9677	7258	4839
					Fz	0.0007	0.0017	0.0033	0.0044	0.0060	0.0088	0.0110	0.0130	
					Feed (ipm)	163	197	192	170	174	170	160	126	
H	TOOL STEELS MOLD AND DIE STEEL 300M, 4340, 52100, HP-9-4-20, M50, A2, D2, H13, L2, M2, P20, S7, T15, W2	Rough ≤ 475 Bhn or ≤ 50 HRc	Rough ≤ 0.4	≤ 0.05	750	RPM	91680	45840	22920	15280	11460	7640	5730	3820
					Fz	0.0005	0.0011	0.0023	0.0030	0.0038	0.0060	0.0075	0.0085	
					Feed (ipm)	92	101	105	92	87	92	86	65	
		HSM ≤ 50 HRc	HSM ≤ 0.4	≤ 0.02	1150	RPM	140576	70288	35144	23429	17572	11715	8786	5857
					Fz	0.0006	0.0012	0.0025	0.0033	0.0042	0.0066	0.0082	0.0100	
					Feed (ipm)	169	169	176	155	148	155	144	117	
H	TOOL STEELS MOLD AND DIE STEEL 300M, 4340, 52100, HP-9-4-20, M50, A2, D2, H13, L2, M2, P20, S7, T15, W2	Rough ≤ 655 Bhn or ≤ 60 HRc	Rough ≤ 0.4	≤ 0.04	500	RPM	61120	30560	15280	10187	7640	5093	3820	2547
					Fz	0.0004	0.0008	0.0017	0.0023	0.0029	0.0045	0.0057	0.0063	
					Feed (ipm)	49	49	52	47	44	46	44	32	
		HSM ≤ 60 HRc	HSM ≤ 0.4	≤ 0.01	1000	RPM	122240	61120	30560	20373	15280	10187	7640	5093
					Fz	0.0005	0.0009	0.0019	0.0025	0.0032	0.0050	0.0063	0.0071	
					Feed (ipm)	122	110	116	102	98	102	96	72	

Bhn (Brinell) HRc (Rockwell C) HSM (High Speed Machining)
 $rpm = Vc \times 3.82 / DC$
 $ipm = Fz \times 2 \times rpm$
 reduce speed and feed for materials harder than listed
 reduce feed and Ae when finish milling (.02 x DC maximum)
 feed rates listed have chip thinning adjustments included where applicable
 refer to the SGS Tool Wizard® for complete technical information (www.kyocera-sgstool.com)

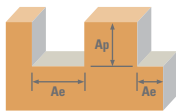

Series 56MB	Metric	Hardness	Ae x DC	Ap x DC	Vc (m/min)	DC • mm								
						1	1.5	3	5	6	10	12	20	
P	TOOL STEELS MOLD AND DIE STEEL 300M, 4340, 52100, HP-9-4-20, M50, A2, D2, H13, L2, M2, P20, S7, T15, W2	Rough ≤ 375 Bhn or ≤ 40 HRc	Rough ≤ 0.4	≤ 0.1	191	RPM	60748	40498	20249	12150	10125	6075	5062	3037
					Fz	0.015	0.038	0.076	0.102	0.127	0.203	0.254	0.305	
					Feed (mm/min)	1822	3078	3078	2479	2572	2466	2572	1853	
		HSM ≤ 40 HRc	HSM ≤ 0.4	≤ 0.03	290	RPM	92235	61490	46117	18447	15372	9223	7686	4612
					Fz	0.018	0.043	0.084	0.112	0.117	0.224	0.279	0.330	
					Feed (mm/min)	3320	5288	7748	4132	3597	4132	4289	3044	
H	TOOL STEELS MOLD AND DIE STEEL 300M, 4340, 52100, HP-9-4-20, M50, A2, D2, H13, L2, M2, P20, S7, T15, W2	Rough ≤ 475 Bhn or ≤ 50 HRc	Rough ≤ 0.4	≤ 0.05	229	RPM	72833	48556	24278	14567	12139	7283	6069	3642
					Fz	0.013	0.028	0.058	0.076	0.097	0.152	0.191	0.216	
					Feed (mm/min)	1894	2719	2816	2214	2355	2214	2319	1573	
		HSM ≤ 50 HRc	HSM ≤ 0.4	≤ 0.02	351	RPM	111636	74424	37212	22327	18606	11164	9303	5582
					Fz	0.015	0.030	0.064	0.084	0.107	0.168	0.208	0.254	
					Feed (mm/min)	3349	4465	4763	3751	3982	3751	3870	2836	
H	TOOL STEELS MOLD AND DIE STEEL 300M, 4340, 52100, HP-9-4-20, M50, A2, D2, H13, L2, M2, P20, S7, T15, W2	Rough ≤ 655 Bhn or ≤ 60 HRc	Rough ≤ 0.4	≤ 0.04	152	RPM	48344	32229	16115	9669	8057	4834	4029	2417
					Fz	0.010	0.020	0.043	0.058	0.074	0.114	0.145	0.160	
					Feed (mm/min)	967	1289	1386	1122	1192	1102	1168	773	
		HSM ≤ 60 HRc	HSM ≤ 0.4	≤ 0.01	305	RPM	97005	64670	32335	19401	16168	9701	8084	4850
					Fz	0.013	0.023	0.048	0.064	0.081	0.127	0.160	0.180	
					Feed (mm/min)	2522	2975	3104	2483	2619	2464	2587	1746	

Bhn (Brinell) HRc (Rockwell C) HSM (High Speed Machining)
 $rpm = (Vc \times 1000) / (DC \times 3.14)$
 $mm/min = Fz \times 2 \times rpm$
 reduce speed and feed for materials harder than listed
 reduce feed and Ae when finish milling (.02 x DC maximum)
 feed rates listed have chip thinning adjustments included where applicable
 refer to the SGS Tool Wizard® for complete technical information (www.kyocera-sgstool.com)

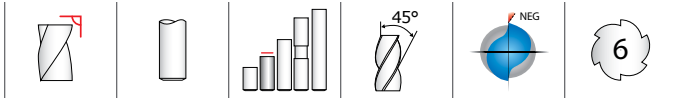

57

FRACTIONAL SERIES

- Ideal in Trochoidal milling applications in hardened steels and dry machining
- Short flute length and large core design to reduce deflection
- Unsurpassed edge strength with extreme negative rake and eccentric relief
- Recommended for materials 45 to 65 HRc (421 to 739 Bhn)

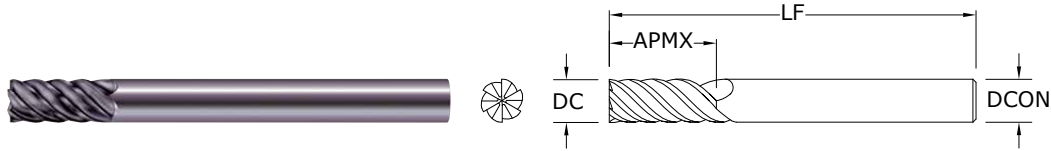

inch				EDP NO.
CUTTING DIAMETER DC	LENGTH OF CUT APMX	OVERALL LENGTH LF	SHANK DIAMETER DCON	Ti-NAMITE®-X
1/4	17/32	3-1/2	1/4	36140
5/16	11/16	4	5/16	36141
3/8	13/16	4	3/8	36142
1/2	1-3/32	4-1/2	1/2	36143

Neck Option Available

TOLERANCES (inch)

- 1/4 DIAMETER**
DC = +0.0000/-0.0012
DCON = h₆
- 5/16 DIAMETER**
DC = +0.0000/-0.0016
DCON = h₆
- 3/8 DIAMETER**
DC = +0.0000/-0.0016
DCON = h₆
- 1/2 DIAMETER**
DC = +0.0000/-0.0020
DCON = h₆

- STEELS
- HARDENED STEELS

For patent information visit www.ksptpatents.com

57M

METRIC SERIES

- Ideal in Trochoidal milling applications in hardened steels and dry machining
- Short flute length and large core design to reduce deflection
- Unsurpassed edge strength with extreme negative rake and eccentric relief
- Recommended for materials 45 to 65 HRc (421 to 739 Bhn)

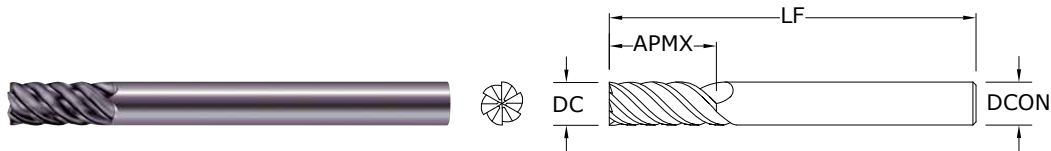

mm				EDP NO.
CUTTING DIAMETER DC	LENGTH OF CUT APMX	OVERALL LENGTH LF	SHANK DIAMETER DCON	Ti-NAMITE®-X
6,0	13,0	89,0	6,0	46140
8,0	18,0	102,0	8,0	46141
10,0	22,0	102,0	10,0	46142
12,0	26,0	114,0	12,0	46143
16,0	32,0	140,0	16,0	46145
20,0	38,0	165,0	20,0	46147

Neck Option Available

TOLERANCES (mm)

- 6 DIAMETER**
DC = +0,000/-0,030
DCON = h₆
- 8 DIAMETER**
DC = +0,000/-0,040
DCON = h₆
- 10 DIAMETER**
DC = +0,000/-0,040
DCON = h₆
- 12-20 DIAMETER**
DC = +0,000/-0,050
DCON = h₆

- STEELS
- HARDENED STEELS

For patent information visit www.ksptpatents.com

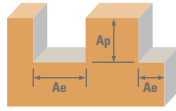

Series 57 Fractional	Hardness	Ae x DC	Ap x DC	Vc (sfm)	DC • in						
					1/4	5/16	3/8	1/2			
P	TOOL STEELS MOLD AND DIE STEEL 300M, 4340, 52100, HP-9-4-20, M50, A2, D2, H13, L2, M2, P20, S7, T15, W2 ≤ 420 Bhn or ≤ 45 HRc	Slot 	1	≤ 0.3	215	RPM	3285	2628	2190	1643	
					(172-258)	Fz	0.0013	0.0019	0.0025	0.0031	
					Feed (ipm)	26	30	33	31		
		Profile 	≤ 0.1	≤ 1.5	265	RPM	4049	3239	2699	2025	
					(212-318)	Fz	0.0018	0.0026	0.0035	0.0044	
					Feed (ipm)	44	51	57	53		
		HSM 	≤ 0.04	≤ 1.5	560	RPM	8557	6845	5705	4278	
					(448-672)	Fz	0.0022	0.0033	0.0044	0.0055	
					Feed (ipm)	113	136	151	141		
H	TOOL STEELS MOLD AND DIE STEEL 300M, 4340, 52100, HP-9-4-20, M50, A2, D2, H13, L2, M2, P20, S7, T15, W2 ≤ 560 Bhn or ≤ 55 HRc	Slot 	1	≤ 0.3	120	RPM	1834	1467	1222	917	
					(96-144)	Fz	0.0010	0.0015	0.0020	0.0025	
					Feed (ipm)	11	13	15	14		
		Profile 	≤ 0.1	≤ 1.5	150	RPM	2292	1834	1528	1146	
					(120-180)	Fz	0.0014	0.0021	0.0028	0.0035	
					Feed (ipm)	19	23	26	24		
		HSM 	≤ 0.04	≤ 1.5	490	RPM	7487	5990	4991	3744	
					(392-588)	Fz	0.0018	0.0026	0.0035	0.0044	
					Feed (ipm)	81	93	105	99		
		TOOL STEELS MOLD AND DIE STEEL 300M, 4340, 52100, HP-9-4-20, M50, A2, D2, H13, L2, M2, P20, S7, T15, W2 ≤ 740 Bhn or ≤ 65 HRc	Slot 	1	≤ 0.3	65	RPM	993	795	662	497
						(52-78)	Fz	0.0008	0.0011	0.0015	0.0019
						Feed (ipm)	5	5	6	6	
Profile 	≤ 0.1		≤ 1.5	80	RPM	1222	978	815	611		
				(64-96)	Fz	0.0011	0.0016	0.0021	0.0026		
				Feed (ipm)	8	9	10	10			
HSM 	≤ 0.04	≤ 1.5	250	RPM	3820	3056	2547	1910			
			(200-300)	Fz	0.0013	0.0019	0.0025	0.0031			
			Feed (ipm)	30	35	38	36				

Bhn (Brinell) HRc (Rockwell C) HSM (High Speed Machining)
 $rpm = Vc \times 3.82 / DC$
 $ipm = Fz \times 6 \times rpm$
 reduce speed and feed for materials harder than listed
 reduce feed and Ae when finish milling (.02 x DC maximum)
 feed rates listed have chip thinning adjustments included where applicable
 refer to the SGS Tool Wizard® for complete technical information (www.kyocera-sgtool.com)

Power-Carb®

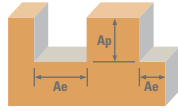

Series 57M	Metric	Hardness	Ae x DC	Ap x DC	Vc (m/min)	DC • mm							
						6	8	10	12	16	20		
P	TOOL STEELS MOLD AND DIE STEEL 300M, 4340, 52100, HP-9-4-20, M50, A2, D2, H13, L2, M2, P20, S7, T15, W2	Slot 	1	≤ 0.3	66	RPM	3499	2624	2099	1749	1312	1050	
					(53-79)	Fz	0.032	0.048	0.064	0.079	0.094	0.109	
					Feed (mm/min)	672	756	806	829	740	686		
		Profile 	≤ 0.1	≤ 1.5	81	RPM	4294	3220	2576	2147	1610	1288	
					(65-97)	Fz	0.046	0.066	0.089	0.112	0.132	0.152	
					Feed (mm/min)	1185	1275	1376	1443	1275	1175		
		HSM 	≤ 0.04	≤ 1.5	171	RPM	9064	6798	5439	4532	3399	2719	
					(137-205)	Fz	0.056	0.084	0.112	0.140	0.170	0.200	
					Feed (mm/min)	3046	3426	3655	3807	3467	3263		
H	TOOL STEELS MOLD AND DIE STEEL 300M, 4340, 52100, HP-9-4-20, M50, A2, D2, H13, L2, M2, P20, S7, T15, W2	Slot 	1	≤ 0.3	37	RPM	1961	1471	1177	981	735	588	
					(30-44)	Fz	0.025	0.038	0.051	0.064	0.077	0.090	
					Feed (mm/min)	294	335	360	377	340	318		
		Profile 	≤ 0.1	≤ 1.5	46	RPM	2438	1829	1463	1219	914	732	
					(37-55)	Fz	0.036	0.053	0.071	0.089	0.107	0.125	
					Feed (mm/min)	527	582	623	651	587	549		
		HSM 	≤ 0.04	≤ 1.5	149	RPM	7898	5924	4739	3949	2962	2369	
					(119-179)	Fz	0.046	0.066	0.089	0.112	0.135	0.158	
					Feed (mm/min)	2180	2346	2531	2654	2399	2246		
		TOOL STEELS MOLD AND DIE STEEL 300M, 4340, 52100, HP-9-4-20, M50, A2, D2, H13, L2, M2, P20, S7, T15, W2	Slot 	1	≤ 0.3	20	RPM	1060	795	636	530	398	318
						(16-24)	Fz	0.020	0.028	0.038	0.048	0.058	0.068
						Feed (mm/min)	127	134	145	153	138	130	
Profile 	≤ 0.1		≤ 1.5	24	RPM	1272	954	763	636	477	382		
				(19-29)	Fz	0.028	0.041	0.053	0.066	0.078	0.090		
				Feed (mm/min)	214	235	243	252	223	206			
HSM 	≤ 0.04	≤ 1.5	76	RPM	4029	3021	2417	2014	1511	1209			
			(61-91)	Fz	0.033	0.048	0.064	0.079	0.094	0.109			
			Feed (mm/min)	798	870	928	955	852	790				

Bhn (Brinell) HRc (Rockwell C) HSM (High Speed Machining)
 rpm = (Vc x 1000) / (DC x 3.14)
 mm/min = Fz x 6 x rpm
 reduce speed and feed for materials harder than listed
 reduce feed and Ae when finish milling (.02 x DC maximum)
 feed rates listed have chip thinning adjustments included where applicable
 refer to the SGS Tool Wizard® for complete technical information (www.kyocera-sgstool.com)

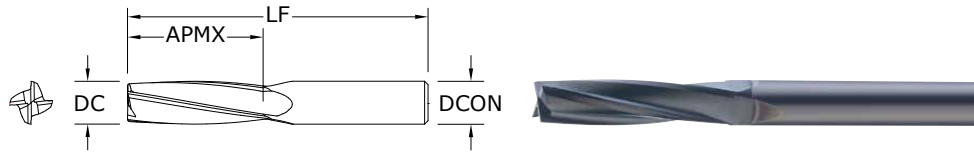
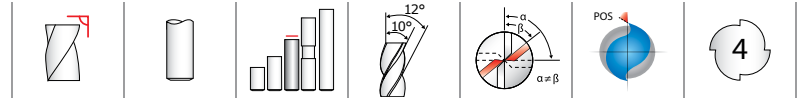

27

FRACTIONAL SERIES

TOLERANCES (inch)

DC = +0.0000/-0.0030
 DCON = h_6

NON-FERROUS

For patent information visit www.ksptpatents.com

CUTTING DIAMETER DC	LENGTH OF CUT APMX	OVERALL LENGTH LF	SHANK DIAMETER DCON	EDP NO.	
				UNCOATED	Di-NAMITE® (Diamond)
1/4	1	2-1/2	1/4	72978	72979
3/8	1-1/8	2-1/2	3/8	72980	72981
1/2	1-1/2	3-1/2	1/2	72982	72983
3/4	1-3/8	4	3/4	72984	72985

- Slow helix design adds strength to the edge allowing ease for milling highly abrasive materials
- Two levels of chatter suppression: variable helix and indexing
- Excels at roughing (slotting, profiling) and finishing in a variety of plastics and composites

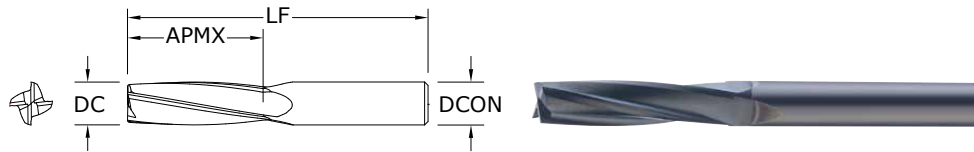

27M

METRIC SERIES

TOLERANCES (mm)

DC = +0,000/-0,080
 DCON = h_6

NON-FERROUS

For patent information visit www.ksptpatents.com

CUTTING DIAMETER DC	LENGTH OF CUT APMX	OVERALL LENGTH LF	SHANK DIAMETER DCON	EDP NO.	
				UNCOATED	Di-NAMITE® (Diamond)
6,0	25,0	63,0	6,0	83056	83057
8,0	25,0	63,0	8,0	83058	83059
10,0	28,0	63,0	10,0	83060	83061
12,0	38,0	89,0	12,0	83062	83063
16,0	48,0	115,0	16,0	83064	83065

- Slow helix design adds strength to the edge allowing ease for milling highly abrasive materials
- Two levels of chatter suppression: variable helix and indexing
- Excels at roughing (slotting, profiling) and finishing in a variety of plastics and composites

FRACTIONAL Series 27

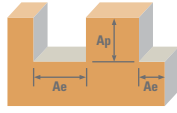

Series 27 Fractional			Vc (sfm)	DC • in				
				1/4	3/8	1/2	3/4	
	Ae x DC	Ap x DC						
CFRP, AFRP (CARBON FIBER, ARAMID FIBER)	Slot 	1 ≤ 1	400	RPM	6112	4075	3056	2037
			(320-480)	Fz	0.0016	0.0030	0.0040	0.0048
				Feed (ipm)	39	49	49	39
	Profile 	≤ 0.5 ≤ 1.5	500	RPM	7640	5093	3820	2547
			(400-600)	Fz	0.0016	0.0030	0.0040	0.0048
				Feed (ipm)	49	61	61	49
	HSM 	≤ 0.5 ≤ 2	825	RPM	12606	8404	6303	4202
			(660-990)	Fz	0.0037	0.0069	0.0092	0.0110
				Feed (ipm)	187	232	232	185
GFRP (FIBERGLASS)	Slot 	1 ≤ 1	320	RPM	4890	3260	2445	1630
			(256-384)	Fz	0.0016	0.0030	0.0040	0.0048
				Feed (ipm)	31	39	39	31
	Profile 	≤ 0.5 ≤ 1.5	400	RPM	6112	4075	3056	2037
			(320-480)	Fz	0.0016	0.0030	0.0040	0.0048
				Feed (ipm)	39	49	49	39
	HSM 	≤ 0.5 ≤ 2	660	RPM	10085	6723	5042	3362
			(528-792)	Fz	0.0037	0.0069	0.0092	0.0110
				Feed (ipm)	149	186	186	148
N CARBON, GRAPHITE	Slot 	1 ≤ 1	480	RPM	7334	4890	3667	2445
			(384-576)	Fz	0.0020	0.0038	0.0050	0.0060
				Feed (ipm)	59	74	73	59
	Profile 	≤ 0.5 ≤ 1.5	600	RPM	9168	6112	4584	3056
			(480-720)	Fz	0.0020	0.0038	0.0050	0.0060
				Feed (ipm)	73	93	92	73
	HSM 	≤ 0.5 ≤ 2	990	RPM	15127	10085	7564	5042
			(792-1188)	Fz	0.0046	0.0086	0.0115	0.0138
				Feed (ipm)	278	347	348	278
PLASTICS	Slot 	1 ≤ 1	800	RPM	12224	8149	6112	4075
			(640-690)	Fz	0.0020	0.0038	0.0050	0.0060
				Feed (ipm)	98	124	122	98
	Profile 	≤ 0.5 ≤ 1.5	1000	RPM	15280	10187	7640	5093
			(800-1200)	Fz	0.0020	0.0038	0.0050	0.0060
				Feed (ipm)	122	155	153	122
	HSM 	≤ 0.5 ≤ 2	1650	RPM	25212	16808	12606	8404
			(1320-1980)	Fz	0.0046	0.0086	0.0115	0.0138
				Feed (ipm)	464	578	580	464
MACHINABLE CERAMICS MACHINABLE GLASS	Slot 	1 ≤ 1	40	RPM	611	407	306	204
			(32-48)	Fz	0.0008	0.0015	0.0020	0.0024
				Feed (ipm)	2.0	2.4	2.4	2.0
	Profile 	≤ 0.5 ≤ 1.5	50	RPM	764	509	382	255
			(40-60)	Fz	0.0008	0.0015	0.0020	0.0024
				Feed (ipm)	2.4	3.1	3.1	2.4
	HSM 	≤ 0.5 ≤ 2	85	RPM	1299	866	649	433
			(68-102)	Fz	0.0018	0.0034	0.0046	0.0055
				Feed (ipm)	9.4	11.8	11.9	9.5

HSM (High Speed Machining)
 $rpm = Vc \times 3.82 / DC$
 $ipm = Fz \times 4 \times rpm$
 adjust parameters based on resin type and fiber structure
 reduce speed when overheating causes melting or damage to resin
 reduce feed if delamination or fraying occur
 finish cuts typically required reduced feed and cutting depths

rates shown are for use without coolant; rates may be increased with coolant
 dust collection is vital when machining dry
 diamond coating will increase tool life in graphite and composite materials
 feed rates listed have chip thinning adjustments included where applicable
 refer to the SGS Tool Wizard® for complete technical information
www.kyocera-sgstool.com

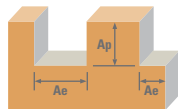

Series 27M Metric	Ae x DC	Ap x DC	Vc (m/min)	DC • mm						
				6	8	10	12	16		
CFRP, AFRP (CARBON FIBER, ARAMID FIBER)	Slot 	1	≤ 1	120	RPM	6361	4771	3817	3181	2385
				(96-164)	Fz	0.040	0.065	0.075	0.100	0.120
				Feed (mm/min)	1018	1240	1145	1272	1145	
	Profile 	≤ 0.5	≤ 1.5	150	RPM	7951	5963	4771	3976	2982
				(120-180)	Fz	0.040	0.065	0.075	0.100	0.120
				Feed (mm/min)	1272	1550	1431	1590	1431	
	HSM 	≤ 0.5	≤ 2	250	RPM	13252	9939	7951	6626	4970
				(200-300)	Fz	0.095	0.145	0.175	0.235	0.280
				Feed (mm/min)	5036	5765	5566	6228	5566	
GFRP (FIBERGLASS)	Slot 	1	≤ 1	100	RPM	5301	3976	3181	2650	1988
				(80-120)	Fz	0.040	0.065	0.075	0.100	0.120
				Feed (mm/min)	848	1034	954	1060	954	
	Profile 	≤ 0.5	≤ 1.5	120	RPM	6361	4771	3817	3181	2385
				(96-164)	Fz	0.040	0.065	0.075	0.100	0.120
				Feed (mm/min)	1018	1240	1145	1272	1145	
	HSM 	≤ 0.5	≤ 2	200	RPM	10602	7951	6361	5301	3976
				(160-240)	Fz	0.095	0.145	0.175	0.235	0.280
				Feed (mm/min)	4029	4612	4453	4983	4453	
N CARBON, GRAPHITE	Slot 	1	≤ 1	145	RPM	7686	5765	4612	3843	2882
				(116-174)	Fz	0.050	0.080	0.095	0.125	0.150
				Feed (mm/min)	1537	1845	1752	1922	1729	
	Profile 	≤ 0.5	≤ 1.5	185	RPM	9807	7355	5884	4903	3677
				(148-222)	Fz	0.050	0.080	0.095	0.125	0.150
				Feed (mm/min)	1961	2354	2236	2452	2206	
	HSM 	≤ 0.5	≤ 2	300	RPM	15903	11927	9542	7951	5963
				(240-360)	Fz	0.115	0.185	0.220	0.290	0.350
				Feed (mm/min)	7315	8826	8397	9223	8349	
PLASTICS	Slot 	1	≤ 1	245	RPM	12987	9740	7792	6494	4870
				(196-294)	Fz	0.050	0.080	0.095	0.125	0.150
				Feed (mm/min)	2597	3117	2961	3247	2922	
	Profile 	≤ 0.5	≤ 1.5	305	RPM	16168	12126	9701	8084	6063
				(244-366)	Fz	0.050	0.080	0.095	0.125	0.150
				Feed (mm/min)	3234	3880	3686	4042	3638	
	HSM 	≤ 0.5	≤ 2	505	RPM	26769	20077	16062	13385	10038
				(404-606)	Fz	0.115	0.185	0.220	0.290	0.350
				Feed (mm/min)	12314	14857	14134	15526	14054	
MACHINABLE CERAMICS MACHINABLE GLASS	Slot 	1	≤ 1	10	RPM	530	398	318	265	199
				(8-12)	Fz	0.020	0.035	0.045	0.050	0.060
				Feed (mm/min)	42	56	57	53	48	
	Profile 	≤ 0.5	≤ 1.5	15	RPM	795	596	477	398	298
				(12-18)	Fz	0.020	0.035	0.045	0.050	0.060
				Feed (mm/min)	64	83	86	80	72	
	HSM 	≤ 0.5	≤ 2	25	RPM	1325	994	795	663	497
				(20-30)	Fz	0.045	0.075	0.085	0.115	0.140
				Feed (mm/min)	239	298	270	305	278	

HSM (High Speed Machining)
 $rpm = Vc \times 3.82 / DC$
 $mm/min = Fz \times 4 \times rpm$
 adjust parameters based on resin type and fiber structure
 reduce speed when overheating causes melting or damage to resin
 reduce feed if delamination or fraying occur
 finish cuts typically required reduced feed and cutting depths

rates shown are for use without coolant; rates may be increased with coolant
 dust collection is vital when machining dry
 diamond coating will increase tool life in graphite and composite materials
 feed rates listed have chip thinning adjustments included where applicable
 refer to the SGS Tool Wizard® for complete technical information
www.kyocera-sgstool.com

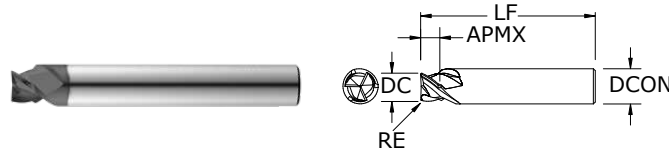
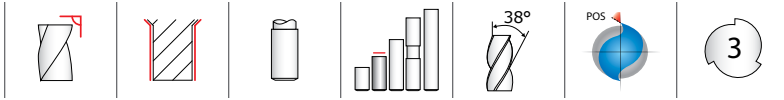

Ferrous Recoil Groove Tool

FRACTIONAL SERIES

- Open Flute design improves chip removal at high feed rates
- Specially engineered flute shape for improved chip control
- Circular land improves surface finish and chatter suppression
- Symmetrical end gashing improves balance in high speed operations
- Meets MIL-STD 1913

CUTTING DIAMETER DC	SHANK DIAMETER DCON	inch			EDP NO.	
		LENGTH OF CUT APMX	OVERALL LENGTH LF	CORNER RADIUS RE	Ti-NAMITE®-A (TA)	Ti-NAMITE®-M (TM)
0.2100	1/4	0.118	1-3/4	.010	33360	33361

TOLERANCES (inch)

DC = +0.0080/-0.0000
 APMX = +0.0060/-0.0000
 DCON = h₆
 RE = +0.0000/-0.0005

- STEELS
- STAINLESS STEELS
- CAST IRON
- HIGH TEMP ALLOYS

For patent information visit www.ksptpatents.com

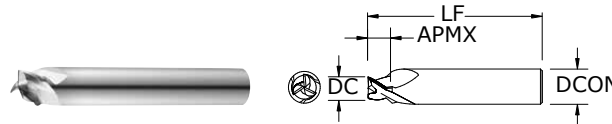
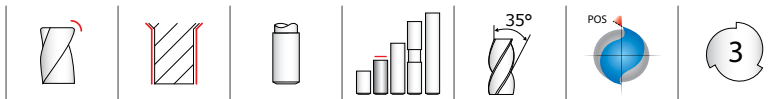

Non-Ferrous Recoil Groove Tool

FRACTIONAL SERIES

- Open Flute design improves chip removal at high feed rates
- Circular land improves surface finish and chatter suppression
- Symmetrical end gashing improves balance in high speed operations
- 45 degree chamfer enables slot and deburr in one operation
- Meets MIL-STD 1913

CUTTING DIAMETER DC	SHANK DIAMETER DCON	inch			EDP NO.	
		LENGTH OF CUT APMX	OVERALL LENGTH LF	CORNER RADIUS RE	UNCOATED	Ti-NAMITE®-B (TiB ₂)
0.2100	1/4	0.118	1-3/4		34760	34761

TOLERANCES (inch)

DC = +0.0080/-0.0000
 APMX = +0.0060/-0.0000
 DCON = h₆

- NON-FERROUS

For patent information visit www.ksptpatents.com

Picatinny Rail Ferrous Recoil Groove Tool

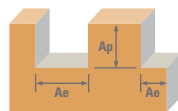





Picatinny Rail Recoil Groove Tool 3 Flute Made to MIL-STD-1913			Hardness	Ae x DC	Ap x DC	Vc (sfm)	DC • in	
							0.2100	
P	CARBON STEELS 1018, 1040, 1080, 1090, 10L50, 1140, 1212, 12L15, 1525, 1536	≤ 275 Bhn or ≤ 28 HRc	Slot 	0.210	0.118	440 (352-528)	RPM	8004
							Fz	0.0009
							Feed (ipm)	22.99
	ALLOY STEELS 4140, 4150, 4320, 5120, 5150, 8630, 86L20, 50100	≤ 375 Bhn or ≤ 40 HRc	Slot 	0.210	0.118	250 (200-300)	RPM	4548
							Fz	0.0006
							Feed (ipm)	9.79
	TOOL STEELS A2, D2, H13, L2, M2, P20, S7, T15, W2	≤ 375 Bhn or ≤ 40 HRc	Slot 	0.210	0.118	145 (116-174)	RPM	2638
							Fz	0.0005
							Feed (ipm)	4.47
M	STAINLESS STEELS (FREE MACHINING) 303, 416, 420F, 430F, 440F	≤ 275 Bhn or ≤ 28 HRc	Slot 	0.210	0.118	390 (312-468)	RPM	7094
							Fz	0.0007
							Feed (ipm)	17.01
	STAINLESS STEELS (DIFFICULT) 304, 304L, 316, 316L	≤ 275 Bhn or ≤ 28 HRc	Slot 	0.210	0.118	270 (216-324)	RPM	4911
							Fz	0.0006
							Feed (ipm)	9.41
STAINLESS STEELS (PH) 13-8 PH, 15-5 PH, 17-4 PH, Custom 450	≤ 325 Bhn or ≤ 35 HRc	Slot 	0.210	0.118	250 (200-300)	RPM	4548	
						Fz	0.0006	
						Feed (ipm)	8.74	
K	CAST IRONS (LOW & MEDIUM ALLOY) Gray, Malleable, Ductile	≤ 220 Bhn or ≤ 19 HRc	Slot 	0.210	0.118	270 (216-324)	RPM	4911
							Fz	0.0006
							Feed (ipm)	9.41
S	HIGH TEMP ALLOYS (NICKEL, COBALT, IRON BASE) Inconel 601, 617, 625, Incoloy, Monel 400	≤ 300 Bhn or ≤ 32 HRc	Slot 	0.210	0.118	65 (52-78)	RPM	1182
							Fz	0.0005
							Feed (ipm)	2.00
	HIGH TEMP ALLOYS (NICKEL, COBALT, IRON BASE) Inconel 718, X-750, Incoloy, Waspaloy, Hastelloy, Rene	≤ 400 Bhn or ≤ 43 HRc	Slot 	0.210	0.118	49 (39-59)	RPM	891
							Fz	0.0004
							Feed (ipm)	1.05
	TITANIUM ALLOYS Pure Titanium, Ti6Al4V, Ti6Al2Sn4Zr2Mo, Ti4Al4Mo2Sn0.5Si	≤ 350 Bhn or ≤ 38 HRc	Slot 	0.210	0.118	170 (136-204)	RPM	3092
							Fz	0.0006
Feed (ipm)							5.89	
TITANIUM ALLOYS (DIFFICULT) Ti10V2Fe3Al, Ti5Al5V5Mo3Cr, Ti7Al4Mo, Ti3Al8V6Cr4Zr4Mo, Ti6Al6V6Sn, Ti15V3 Cr3Sn3Al	≤ 420 Bhn or ≤ 45 HRc	Slot 	0.210	0.118	60 (48-72)	RPM	1091	
						Fz	0.0006	
						Feed (ipm)	2.09	

Bhn (Brinell) HRc (Rockwell C)
 when recommended speed exceeds your capability, use maximum available and recalculate ipm
 $rpm = Vc \times 3.82 / DC$
 $ipm = Fz \times 3 \times rpm$
 reduce speed and feed for materials harder than listed
 reduce feed and Ae when finish milling (.02 x DC maximum)
 refer to the SGS Tool Wizard® for complete technical information (www.kyocera-sgstool.com)

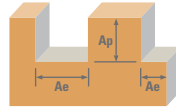
Picatinny Rail Non-Ferrous Recoil Groove Tool

Picatinny Rail
Non-Ferrous Recoil
Groove Tool
3 Flute
Made to MIL-STD-1913



	Hardness	Slot	Ae x DC	Ap x DC	Vc (sfm)	DC • in		
						0.2100		
N	ALUMINUM ALLOYS 2017, 2024, 356, 6061, 7075	≤ 150 Bhn or ≤ 88 HRb	Slot 	0.210	0.118	1600 (1280-1920)	RPM	29105
							Fz	0.0026
							Feed (ipm)	227.89
	ALUMINUM DIE CAST ALLOYS (HIGH SILICONE) A-390, A-392, B-390	≤ 125 Bhn or ≤ 77 HRb	Slot 	0.210	0.118	600 (480-720)	RPM	10914
							Fz	0.0026
							Feed (ipm)	85.46
	COPPER ALLOYS Alum Bronze, C110, Muntz Brass	≤ 140 Bhn or ≤ 3 HRc	Slot 	0.210	0.118	345 (276-414)	RPM	6276
							Fz	0.0022
							Feed (ipm)	40.79
	PLASTICS Polycarbonate, PVC, Polypropylene		Slot 	0.210	0.118	1600 (1280-1920)	RPM	29105
							Fz	0.0044
							Feed (ipm)	380.58

Bhn (Brinell) HRc (Rockwell C) HRb (Rockwell B)
 when recommended speed exceeds your capability, use maximum available and recalculate ipm
 $rpm = Vc \times 3.82 / DC$
 $ipm = Fz \times 3 \times rpm$
 reduce speed and feed for materials harder than listed
 reduce feed and Ae when finish milling (.02 x DC maximum)
 refer to the SGS Tool Wizard® for complete technical information (www.kyocera-sgstool.com)

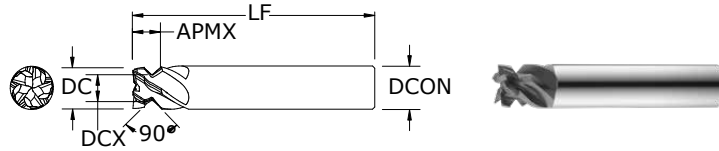
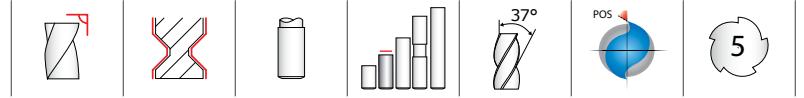

Ferrous Dovetail Form Tool

FRACTIONAL SERIES

TOLERANCES (inch)

DC = +0.0010/-0.0010

DCON = h₆

- STEELS
- STAINLESS STEELS
- CAST IRON
- HIGH TEMP ALLOYS

For patent information visit www.ksptpatents.com

CUTTING DIAMETER DC	INNER CUTTING DIAMETER DCX	SHANK DIAMETER DCON	LENGTH OF CUT APMX	OVERALL LENGTH LF	EDP NO.	
					Ti-NAMITE®-A (TA)	Ti-NAMITE®-M (TM)
0.6050	0.384	5/8	0.410	3-1/2	37391	37390

- Five-flute design allows for higher machining parameters
- Open end work design allows for increased chip space
- Square end configuration with enhanced corner strength to improve corner durability
- Meets MIL-STD 1913

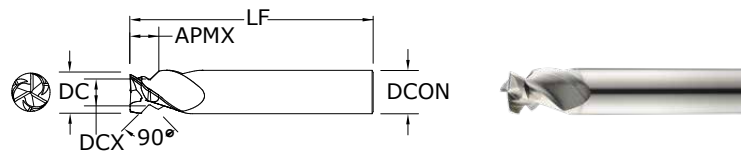
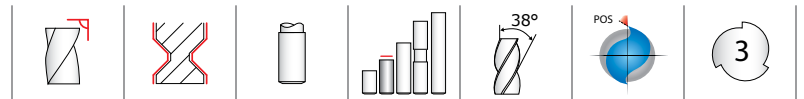

Non-Ferrous Dovetail Form Tool

FRACTIONAL SERIES

TOLERANCES (inch)

DC = +0.0010/-0.0010

DCON = h₆

- NON-FERROUS

For patent information visit www.ksptpatents.com

CUTTING DIAMETER DC	INNER CUTTING DIAMETER DCX	SHANK DIAMETER DCON	LENGTH OF CUT APMX	OVERALL LENGTH LF	EDP NO.	
					UNCOATED	Ti-NAMITE®-B (TiB ₂)
0.6050	0.384	5/8	0.410	3-1/2	34762	34763

- Open Flute design improves chip removal at high feed rates
- Specially engineered flute shape for improved chip control
- Circular land improves surface finish and chatter suppression
- Symmetrical end gashing improves balance in high speed operations
- Meets MIL-STD 1913

Picatinny Rail Ferrous Dovetail Form Tool

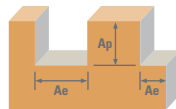



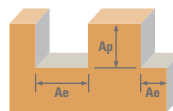

Picatinny Rail Dovetail Form Tool 5 Flute Made to MIL-STD-1913			Hardness	Ae x DC	Ap x DC	Vc (sfm)	DC • in 0.6050	
P	CARBON STEELS 1018, 1040, 1080, 1090, 10L50, 1140, 1212, 12L15, 1525, 1536	≤ 275 Bhn or ≤ 28 HRc	Profile 	≤ .50	APMX	450 (360-540)	RPM	2841
						Fz	0.0032	
						Feed (ipm)	46.03	
	ALLOY STEELS 4140, 4150, 4320, 5120, 5150, 8630, 86L20, 50100	≤ 375 Bhn or ≤ 40 HRc	Profile 	≤ .50	APMX	260 (208-312)	RPM	1642
						Fz	0.0024	
						Feed (ipm)	19.68	
	TOOL STEELS A2, D2, H13, L2, M2, P20, S7, T15, W2	≤ 375 Bhn or ≤ 40 HRc	Profile 	≤ .50	APMX	145 (116-174)	RPM	916
						Fz	0.0019	
						Feed (ipm)	8.60	
M	STAINLESS STEELS (FREE MACHINING) 303, 416, 420F, 430F, 440F	≤ 275 Bhn or ≤ 28 HRc	Profile 	≤ .50	APMX	400 (320-480)	RPM	2526
						Fz	0.0024	
						Feed (ipm)	30.28	
	STAINLESS STEELS (DIFFICULT) 304, 304L, 316, 316L	≤ 275 Bhn or ≤ 28 HRc	Profile 	≤ .50	APMX	280 (224-336)	RPM	1768
						Fz	0.0019	
						Feed (ipm)	16.61	
	STAINLESS STEELS (PH) 13-8 PH, 15-5 PH, 17-4 PH, Custom 450	≤ 325 Bhn or ≤ 35 HRc	Profile 	≤ .50	APMX	260 (208-312)	RPM	1642
						Fz	0.0019	
						Feed (ipm)	15.42	
K	CAST IRONS (LOW & MEDIUM ALLOY) Gray, Malleable, Ductile	≤ 220 Bhn or ≤ 19 HRc	Profile 	≤ .50	APMX	280 (224-336)	RPM	1768
						Fz	0.0029	
						Feed (ipm)	25.78	
S	HIGH TEMP ALLOYS (NICKEL, COBALT, IRON BASE) Inconel 601, 617, 625, Incoloy, Monel 400	≤ 300 Bhn or ≤ 32 HRc	Profile 	≤ .50	APMX	75 (60-90)	RPM	474
						Fz	0.0018	
						Feed (ipm)	4.22	
	HIGH TEMP ALLOYS (NICKEL, COBALT, IRON BASE) Inconel 718, X-750, Incoloy, Waspaloy, Hastelloy, Rene	≤ 400 Bhn or ≤ 43 HRc	Profile 	≤ .50	APMX	60 (48-72)	RPM	379
						Fz	0.0013	
						Feed (ipm)	2.39	
	TITANIUM ALLOYS Pure Titanium, Ti6Al4V, Ti6Al2Sn4Zr2Mo, Ti4Al4Mo2Sn0.5Si	≤ 350 Bhn or ≤ 38 HRc	Profile 	≤ .50	APMX	180 (144-216)	RPM	1137
						Fz	0.0021	
						Feed (ipm)	11.97	
TITANIUM ALLOYS (DIFFICULT) Ti10V2Fe3Al, Ti5Al5V5Mo3Cr, Ti7Al4Mo, Ti3Al8V6Cr4Zr4Mo, Ti6Al6V6Sn, Ti15V3 Cr3Sn3Al	≤ 420 Bhn or ≤ 45 HRc	Profile 	≤ .50	APMX	70 (56-84)	RPM	442	
					Fz	0.0021		
					Feed (ipm)	4.65		

Bhn (Brinell) HRc (Rockwell C)
 when recommended speed exceeds your capability, use maximum available and recalculate ipm
 $rpm = Vc \times 3.82 / DC$
 $ipm = Fz \times 5 \times rpm$
 reduce speed and feed for materials harder than listed
 reduce feed and Ae when finish milling (.02 x DC maximum)
 refer to the SGS Tool Wizard® for complete technical information (www.kyocera-sgstool.com)

Picatinny Rail Non-Ferrous Dovetail Form Tool



**Picatinny Rail
Dovetail Form Tool
3 Flute
Made to MIL-STD-1913**

	Hardness	Profile	Ae x DC	Ap x DC	Vc (sfm)	DC • in		
							0.6050	
N	ALUMINUM ALLOYS 2017, 2024, 356, 6061, 7075	≤ 150 Bhn or ≤ 88 HRb	Profile 	≤ .50	APMX	2000 (1600-2400)	RPM	12628
							Fz	0.0056
							Feed (ipm)	211.39
	ALUMINUM DIE CAST ALLOYS (HIGH SILICONE) A-390, A-392, B-390	≤ 125 Bhn or ≤ 77 HRb	Profile 	≤ .50	APMX	750 (600-900)	RPM	4736
							Fz	0.0056
							Feed (ipm)	79.27
	COPPER ALLOYS Alum Bronze, C110, Muntz Brass	≤ 140 Bhn or ≤ 3 HRc	Profile 	≤ .50	APMX	430 (344-516)	RPM	2715
							Fz	0.0046
							Feed (ipm)	37.72
	PLASTICS Polycarbonate, PVC, Polypropylene		Profile 	≤ .50	APMX	2000 (1600-2400)	RPM	12628
							Fz	0.0093
							Feed (ipm)	353.03

Bhn (Brinell) HRc (Rockwell C) HRb (Rockwell B)
 when recommended speed exceeds your capability, use maximum available and recalculate ipm
 $rpm = Vc \times 3.82 / DC$
 $ipm = Fz \times 3 \times rpm$
 reduce speed and feed for materials harder than listed
 reduce feed and Ae when finish milling (.02 x DC maximum)
 refer to the SGS Tool Wizard® for complete technical information (www.kyocera-sgstool.com)

High Performance Aluminum End Mills



Milling

HIGH PERFORMANCE ALUMINUM END MILLS	SERIES	DESCRIPTION	PAGE	S&F PAGE	
S-Carb APR® & APF®	43APR-3	3 Flute Advanced Productivity Rougher Fractional	133	134	
	43APR-3	3 Flute Advanced Productivity Rougher Metric	135	137	
	43APR-4	4 Flute Advanced Productivity Rougher Metric	136	137	
	43APF	4 Flute Advanced Productivity Finisher Fractional	138	139	
	43MAPF	4 Flute Advanced Productivity Finisher Metric	140	141	
S-Carb APF-B®	43APF-B	Multi-Flute Advanced Productivity Finisher Metric	142	143	
S-Carb® (3 Flute)	43	3 Flute Non-Ferrous Square End Fractional	144	156	
	43CR	3 Flute Non-Ferrous Corner Radius Fractional	144	156	
	43L	3 Flute Non-Ferrous Square End Long Reach Fractional	148	156	
	43LC	3 Flute Non-Ferrous Corner Radius End Long Reach Fractional	148	156	
	43EC	3 Flute Non-Ferrous Square End Extra Long Reach Fractional	151	156	
	43B	3 Flute Non-Ferrous Ball End Fractional	152	156	
	43LB	3 Flute Non-Ferrous Ball End Long Reach Fractional	153	156	
	43EB	3 Flute Non-Ferrous Ball End Extra Long Reach Fractional	153	156	
	43M	3 Flute Non-Ferrous Square End Metric (Unpolished Flutes)	157	165	
	43M	3 Flute Non-Ferrous Square End Metric (Polished Flutes)	157	165	
	43MCR	3 Flute Non-Ferrous Corner Radius Metric (Unpolished Flutes)	157	165	
	43MCR	3 Flute Non-Ferrous Corner Radius Metric (Polished Flutes)	157	165	
	43MCR	3 Flute Non-Ferrous Corner Radius 4xD Metric (Polished Flutes)	157	165	
	43ML	3 Flute Non-Ferrous Square End Long Reach Metric	160	165	
	43MLC	3 Flute Non-Ferrous Long Reach Corner Radius Metric (Unpolished Flutes)	160	165	
	43MLC	3 Flute Non-Ferrous Long Reach Corner Radius Metric (Polished Flutes)	160	165	
	43MB	3 Flute Non-Ferrous Ball End Metric (Polished Flutes)	162	165	
	S-Carb® Rougher (3 Flute)	43CB	3 Flute Rougher Non-Ferrous Chip Breaker Fractional	154	156
		43LCB	3 Flute Rougher Non-Ferrous Chip Breaker Long Reach Fractional	155	156
		43MCB	3 Flute Rougher Non-Ferrous Chip Breaker Metric	164	165
S-Carb® (2 Flute)	47	2 Flute Non-Ferrous Square End Fractional	166	169	
	47L	2 Flute Non-Ferrous Square End Long Reach Fractional	167	169	
	47B	2 Flute Non-Ferrous Ball End Fractional	168	169	
	47LB	2 Flute Non-Ferrous Ball End Long Reach Fractional	168	169	
	47M	2 Flute Non-Ferrous Square End Metric	170	172	
	47ML	2 Flute Non-Ferrous Square End Long Reach Metric	170	172	
	47MB	2 Flute Non-Ferrous Ball End Metric	171	172	
	47MLB	2 Flute Non-Ferrous Ball End Long Reach Metric	171	172	
Ski-Carb	44	2 Flute Non-Ferrous Materials Square End Fractional	173	174	
	44M	2 Flute Non-Ferrous Materials Square End Metric	173	174	
	45	2 Flute Non-Ferrous Materials Long Reach Corner Radius Fractional	176	177	

Speed & Feed Recommendations listed after each series

Fresado

FRESAS DE ALTO RENDIMIENTO PARA ALUMINIO	SERIE	DESCRIPCIÓN	PÁGINA	S&F PÁGINA	
S-Carb APR® y APF®	43APR-3	3 filos, productividad avanzada, desbastador, fraccional	133	134	
	43APR-3	3 filos, productividad avanzada, desbastador, métrico	135	137	
	43APR-4	4 filos, productividad avanzada, desbastador, métrico	136	137	
	43APF	4 filos, productividad avanzada, acabador, fraccional	138	139	
	43MAPF	4 filos, productividad avanzada, acabador, métrico	140	141	
S-Carb APF-B®	43APF-B	Fresa Cónica Circular Multi-Filos tipo Barril, métrica	142	143	
S-Carb® (3 filos)	43	3 filos, no férrico, punta cuadrada, fraccional	144	156	
	43CR	3 filos, no férrico, radio angulado, fraccional	144	156	
	43L	3 filos, no férrico, punta cuadrada, largo alcance, fraccional	148	156	
	43LC	3 filos, no férricos, largo alcance, radio angulado, fraccional	148	156	
	43EC	3 filos, no férrico, punta cuadrada, alcance extralargo, fraccional	151	156	
	43B	3 filos, no férrico, punta esférica, fraccional	152	156	
	43LB	3 filos, no férrico, punta esférica, largo alcance, fraccional	153	156	
	43EB	3 filos, no férrico, punta esférica, alcance extralargo, fraccional	153	156	
	43M	3 filos, no férrico, punta cuadrada, métrico (filos no pulidos)	157	165	
	43M	3 filos, no férrico, punta cuadrada, métrico (filos pulidos)	157	165	
	43MCR	3 filos, no férrico, radio angulado, métrico (filos no pulidos)	157	165	
	43MCR	3 filos, no férrico, radio angulado, métrico (filos pulidos)	157	165	
	43MCR	3 filos, no férrico, radio angulado 4xD, métrico (filos pulidos)	157	165	
	43ML	3 filos, no férrico, punta cuadrada, largo alcance, métrico	160	165	
	43MLC	3 filos, no férrico, largo alcance, radio angulado, métrico (filos no pulidos)	160	165	
	43MLC	3 filos, no férrico, largo alcance, radio angulado, métrico (filos pulidos)	160	165	
	43MB	3 filos, no férrico, punta esférica, métrico (filos pulidos)	162	165	
	Desbastador S-Carb® (3 filos)	43CB	3 filos, desbastador, no férrico, rompevirutas, fraccional	154	156
		43LCB	3 filos, desbastador, no férrico, rompevirutas, largo alcance, fraccional	155	156
43MCB		3 filos, desbastador, no férrico, rompevirutas, métrico	164	165	
S-Carb® (2 filos)	47	2 filos, no férrico, punta cuadrada, fraccional	166	169	
	47L	2 filos, no férrico, punta cuadrada, largo alcance, fraccional	167	169	
	47B	2 filos, no férrico, punta esférica, fraccional	168	169	
	47LB	2 filos, no férrico, punta esférica, largo alcance, fraccional	168	169	
	47M	2 filos, no férrico, punta cuadrada, métrico	170	172	
	47ML	2 filos, no férrico, punta cuadrada, largo alcance, métrico	170	172	
	47MB	2 filos, no férrico, punta esférica, métrico	171	172	
	47MLB	2 filos, no férrico, punta esférica, largo alcance, métrico	171	172	
Ski-Carb	44	2 filos, materiales no férricos, punta cuadrada, fraccional	173	174	
	44M	2 filos, materiales no férricos, punta cuadrada, métrico	173	174	
	45	2 filos, materiales no férricos, largo alcance, radio angulado, fraccional	176	177	

Recomendaciones de velocidades y avances mostradas tras cada serie

FRAISE HAUTE PERFORMANCE POUR ALUMINIUM	SÉRIES	DESCRIPTION	PAGE	S&F PAGE	
S-Carb APR®/APF®	43APR-3	3 dents productivité avancée d'ébauche (fractionnel)	133	134	
	43APR-3	3 dents productivité avancée d'ébauche (métrique)	135	137	
	43APR-4	4 dents productivité avancée d'ébauche (métrique)	136	137	
	43APF	4 dents productivité avancée de finition (fractionnel)	138	139	
	43MAPF	4 dents productivité avancée de finition (métrique)	140	141	
S-Carb APF-B®	43APF-B	Fraise multi dents finition pour productivité avancée cotes (métrique)	142	143	
S-Carb® (3 dents)	43	3 dents non-ferreux non rayonné (fractionnel)	144	156	
	43CR	3 dents non-ferreux rayonné (fractionnel)	144	156	
	43L	3 dents non-ferreux non rayonné longue portée (fractionnel)	148	156	
	43LC	3 dents non-ferreux longue portée rayonné (fractionnel)	148	156	
	43EC	3 dents non-ferreux non rayonné portée extra-longue (fractionnel)	151	156	
	43B	3 dents non-ferreux à bout hémisphérique (fractionnel)	152	156	
	43LB	3 dents non-ferreux à bout hémisphérique longue portée (fractionnel)	153	156	
	43EB	3 dents non-ferreux à bout hémisphérique portée extra-longue (fractionnel)	153	156	
	43M	3 dents non-ferreux non rayonné (métrique) (goujures non polies)	157	165	
	43M	3 dents non-ferreux non rayonné (métrique) (goujures polies)	157	165	
	43MCR	3 dents matériaux non-ferreux rayonné (métrique) (goujures non polies)	157	165	
	43MCR	3 dents matériaux non-ferreux rayonné (métrique) (goujures polies)	157	165	
	43MCR	3 dents matériaux non-ferreux rayonné 4xD (métrique) (goujures polies)	157	165	
	43MLC	3 dents non-ferreux longue portée rayonné (métrique) (goujures non polies)	160	165	
	43MLC	3 dents non-ferreux longue portée rayonné (métrique) (goujures polies)	160	165	
	43ML	3 dents non-ferreux non rayonné longue portée (métrique)	160	165	
	43MB	3 dents non-ferreux à bout hémisphérique (métrique) (goujures polies)	162	165	
	S-Carb® d'ébauche (3 dents)	43CB	3 dents d'ébauche non-ferreux brise-copeaux (fractionnel)	154	156
		43LCB	3 dents d'ébauche non-ferreux brise-copeaux longue portée (fractionnel)	155	156
		43MCB	3 dents d'ébauche non-ferreux brise-copeaux (métrique)	164	165
	S-Carb® (2 dents)	47	2 dents non-ferreux non rayonné (fractionnel)	166	169
		47L	2 dents non-ferreux non rayonné longue portée (fractionnel)	167	169
		47B	2 dents non-ferreux à bout hémisphérique (fractionnel)	168	169
47LB		2 dents non-ferreux à bout hémisphérique longue portée (fractionnel)	168	169	
47M		2 dents non-ferreux non rayonné (métrique)	170	172	
47ML		2 dents non-ferreux non rayonné longue portée (métrique)	170	172	
47MB		2 dents non-ferreux à bout hémisphérique (métrique)	171	172	
47MLB		2 dents non-ferreux à bout hémisphérique longue portée (métrique)	171	172	
Ski-Carb		44	2 dents matériaux non-ferreux non rayonné (fractionnel)	173	174
	44M	2 dents matériaux non-ferreux non rayonné (métrique)	173	174	
	45	2 dents matériaux non-ferreux longue portée rayonné (fractionnel)	176	177	

Recommandations de vitesse et avance indiquées après chaque série

HOCHLEISTUNGSSCHAFTFRÄSER FÜR ALUMINIUM	SERIE	BESCHREIBUNG	SEITE	S&F SEITE	
S-Carb APR® & APF®	43APR-3	Hochleistungs-Schruppfräser mit 3 Schneiden	133	134	
	43APR-3	Hochleistungs-Schruppfräser mit 3 Schneiden (Erweiterung)	135	137	
	43APR-4	Hochleistungs-Schruppfräser mit 4 Schneiden	136	137	
	43APF	Zölliger Hochleistungs-Schlichtfräser mit 4 Schneiden	138	139	
	43MAPF	Hochleistungs-Schlichtfräser mit 4 Schneiden	140	141	
S-Carb APF-B®	43APF-B	Metrischer mehrschneidiger Hochleistungsschlichtfräser	142	143	
S-Carb® (3 Schneiden)	43	Zölliger NE-Schaftfräser mit 3 Schneiden ohne Eckenradien	144	156	
	43CR	Zölliger NE-Fräser mit 3 Schneiden und Eckenradien	144	156	
	43L	Zölliger NE-Langloch-Schaftfräser mit 3 Schneiden ohne Eckenradien	148	156	
	43LC	Zölliger Langlochfräser mit 3 Schneiden und Eckenradien	148	156	
	43EC	Zölliger NE-Superlangloch-Schaftfräser mit 3 Schneiden ohne Eckenradien	151	156	
	43B	Zölliger NE-Radiuschaftfräser mit 3 Schneiden	152	156	
	43LB	Zölliger NE-Langloch-Radiuschaftfräser mit 3 Schneiden	153	156	
	43EB	Zölliger NE-Superlangloch-Radiuschaftfräser mit 3 Schneiden	153	156	
	43M	NE-Schaftfräser mit 3 unpolierten Schneiden ohne Eckenradien	157	165	
	43M	NE-Schaftfräser mit 3 polierten Schneiden ohne Eckenradien	157	165	
	43MCR	NE-Fräser mit 3 unpolierten Schneiden und Eckenradien	157	165	
	43MCR	NE-Fräser mit 3 polierten Schneiden und Eckenradien	157	165	
	43MCR	NE-Fräser 4xD mit 3 polierten Schneiden und Eckenradien	157	165	
	43ML	NE-Langloch-Schaftfräser mit 3 Schneiden ohne Eckenradien	160	165	
	43MLC	NE-Langlochfräser mit 3 unpolierten Schneiden und Eckenradien	160	165	
	43MLC	NE-Langlochfräser mit 3 polierten Schneiden und Eckenradien	160	165	
	43MB	NE-Radiuschaftfräser mit 3 polierten Schneiden	162	165	
	S-Carb® Schruppfräser (3 Schneiden)	43CB	Zölliger NE-Schruppfräser mit 3 Schneiden und Spanbrechern	154	156
		43LCB	Zölliger NE-Langloch-Schruppfräser mit 3 Spanteilernuten	155	156
		43MCB	NE-Schruppfräser mit 3 Schneiden und Spanbrechern	164	165
S-Carb® (2 Schneiden)	47	Zölliger NE-Schaftfräser mit 2 Schneiden ohne Eckenradien	166	169	
	47L	Zölliger NE-Langloch-Schaftfräser mit 2 Schneiden ohne Eckenradien	167	169	
	47B	Zölliger NE-Radiuschaftfräser mit 2 Schneiden	168	169	
	47LB	Zölliger NE-Langloch-Radiuschaftfräser mit 2 Schneiden	168	169	
	47M	NE-Schaftfräser mit 2 Schneiden ohne Eckenradien	170	172	
	47ML	NE-Langloch-Schaftfräser mit 2 Schneiden ohne Eckenradien	170	172	
	47MB	NE-Radiuschaftfräser mit 2 Schneiden	171	172	
	47MLB	NE-Langloch-Radiuschaftfräser mit 2 Schneiden	171	172	
	Ski-Carb	44	Zölliger NE-Schaftfräser mit 2 Schneiden ohne Eckenradien	173	174
44M		NE-Schaftfräser mit 2 Schneiden ohne Eckenradien	173	174	
45		Zölliger Langlochfräser mit 2 Schneidenn und Eckenradien für Nichteisenmetalle	176	177	

Empfehlungen für Drehzahl & Vorschub im Anhang zu jeder Serie

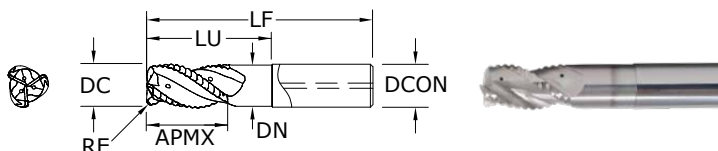
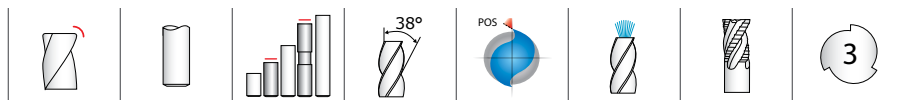

43APR-3
FRACTIONAL SERIES

TOLERANCES (inch)

1/2-1 DIAMETER

DC = -0.0004/-0.004

DCON = h₆

RE = +/-0.002

NON-FERROUS

For patent information visit www.ksptpatents.com

CUTTING DIAMETER DC	LENGTH OF CUT APMX	OVERALL LENGTH LF	inch				CORNER RADIUS RE	EDP NO. Ti-NAMITE®-B (TiB ₂)
			SHANK DIAMETER DCON	REACH LU	NECK DIAMETER DN			
1/2	1	3-1/4	1/2	1-1/2	.474	.030	34100	
1/2	1	3-1/4	1/2	1-1/2	.474	.060	34101	
1/2	1	3-1/4	1/2	1-1/2	.474	.090	34102	
1/2	1	3-1/4	1/2	1-1/2	.474	.120	34103	
5/8	1-3/8	3-5/8	5/8	2	.594	.030	34104*	
5/8	1-3/8	3-5/8	5/8	2	.594	.060	34105*	
5/8	1-3/8	3-5/8	5/8	2	.594	.090	34106*	
5/8	1-3/8	3-5/8	5/8	2	.594	.120	34107*	
5/8	1-3/8	4-1/4	5/8	2-5/8	.594	.030	34108*	
5/8	1-3/8	4-1/4	5/8	2-5/8	.594	.060	34109*	
5/8	1-3/8	4-1/4	5/8	2-5/8	.594	.090	34110*	
5/8	1-3/8	4-1/4	5/8	2-5/8	.594	.120	34111*	
3/4	1-3/8	3-5/8	3/4	1-3/4	.713	.030	34112	
3/4	1-3/8	3-5/8	3/4	1-3/4	.713	.060	34113	
3/4	1-3/8	3-5/8	3/4	1-3/4	.713	.090	34114	
3/4	1-3/8	3-5/8	3/4	1-3/4	.713	.120	34115	
3/4	1-3/8	4-3/8	3/4	2-1/2	.713	.030	34116*	
3/4	1-3/8	4-3/8	3/4	2-1/2	.713	.060	34117*	
3/4	1-3/8	4-3/8	3/4	2-1/2	.713	.090	34118*	
3/4	1-3/8	4-3/8	3/4	2-1/2	.713	.120	34119*	
3/4	1-3/8	5-1/8	3/4	3-1/4	.713	.030	34120*	
3/4	1-3/8	5-1/8	3/4	3-1/4	.713	.060	34121*	
3/4	1-3/8	5-1/8	3/4	3-1/4	.713	.090	34122*	
3/4	1-3/8	5-1/8	3/4	3-1/4	.713	.120	34123*	
1	1-3/4	4-1/2	1	2-1/2	.949	.030	34124	
1	1-3/4	4-1/2	1	2-1/2	.949	.060	34125	
1	1-3/4	4-1/2	1	2-1/2	.949	.090	34126	
1	1-3/4	4-1/2	1	2-1/2	.949	.120	34127	
1	1-3/8	5-1/4	1	3-1/4	.949	.030	34128*	
1	1-3/8	5-1/4	1	3-1/4	.949	.060	34129*	
1	1-3/8	5-1/4	1	3-1/4	.949	.090	34130*	
1	1-3/8	5-1/4	1	3-1/4	.949	.120	34131*	
1	1-3/8	6-1/4	1	4-1/4	.949	.030	34132*	
1	1-3/8	6-1/4	1	4-1/4	.949	.060	34133*	
1	1-3/8	6-1/4	1	4-1/4	.949	.090	34134*	
1	1-3/8	6-1/4	1	4-1/4	.949	.120	34135*	

- Ultra high-productivity rougher for Aluminum alloys, specifically for aircraft components
- Designed for machine tools with capability of 12 L³ per minute material removal rates
- New 3 flute variable geometry with side exit coolant holes
- Open fluting for deep slotting and profiling
- Recommended for materials ≤ 150 Bhn (≤ 7 HRC)

*Variable Helix

FRACTIONAL S-Carb APR®

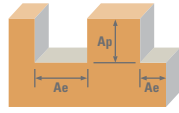

Series 43APR-3 Fractional		Ae x DC	Ap x DC	Vc (sfm)	DC • inch			
					APR-3			
N	ALUMINIUM ALLOYS 6068, 7075	Slot 	1	≤ 1	5250 (980-6900)	0.75	1	
						RPM	26740	20055
						Fz	0.0055	0.0059
		Feed (ipm)	441	355				
		Profile 	≤ 0.5	≤ 1.5	5900 (980-6900)	RPM	30051	22538
						Fz	0.0063	0.0067
						Feed (ipm)	568	453
		HSM 	≤ 0.1	≤ 2	6900 (980-6900)	RPM	35144	26358
						Fz	0.0075	0.0079
Feed (ipm)	791					625		

Series 43APR-3L Fractional		Ae x DC	Ap x DC	Vc (sfm)	DC • inch					
					APR-3 LONG					
N	ALUMINIUM ALLOYS 6068, 7075	Slot 	1	≤ 1	3280 (980-6900)	0.5	0.625	0.75	1	
						RPM	25059	20047	16706	12530
						Fz	0.0039	0.0043	0.0047	0.0051
		Feed (ipm)	293	259	236	192				
		Profile 	≤ 0.5	≤ 1.5	3950 (980-6900)	RPM	30178	24142	20119	15089
						Fz	0.0047	0.0051	0.0055	0.0059
						Feed (ipm)	426	369	332	267
		HSM 	≤ 0.1	≤ 2	4600 (980-6900)	RPM	35144	28115	23429	17572
						Fz	0.0055	0.0059	0.0063	0.0067
Feed (ipm)	580					498	443	353		

RPM stated may be outside of most machine tools in the smaller sizes, adjust the surface speed but maintain the Fz
 For best results use the peak power of the specific machine torque chart.
 Typically 10hp is required to remove 45 cubic inches of material (MRR).
 Eg. >> (Ae x Ap x Feed) >> Therefore Full slotting 1" dia: 1 x 1 x 355 = 355 cubic inches, so it needs a min of 78hp.
 Larger cuts and chip load consume more power.
 Review the power chart of each machine to determine MAX power for ultimate performance.
 Example below shows peak power @ 10,000 rpm.
 The new coolant supply is designed for MQL as well as normal emulsion coolant on the same data.
 Ensure max MQL flow prior to cutting.
 refer to the SGS Tool Wizard® for complete technical information (www.kyocera-sgstool.com)

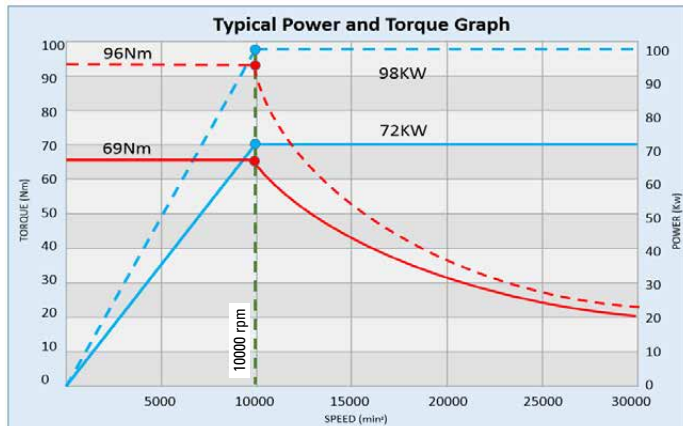

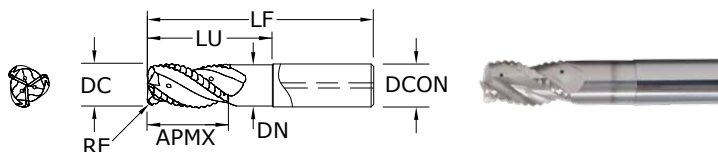
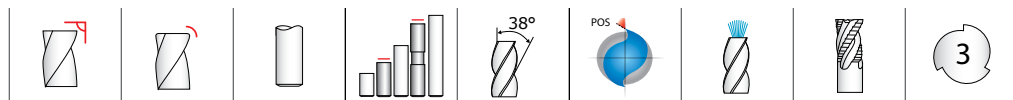

43APR-3
METRIC SERIES

TOLERANCES (mm)

12–25 DIAMETER

DC = $-0,010/-0,100$

DCON = h_6

RE = $+/-0,05$

NON-FERROUS

For patent information visit www.ksptpatents.com

mm							EDP NO.
CUTTING DIAMETER DC	LENGTH OF CUT APMX	OVERALL LENGTH LF	SHANK DIAMETER DCON	REACH LU	NECK DIAMETER DN	CORNER RADIUS RE	Ti-NAMITE®-B (TiB ₂)
12,0	26,0	83,0	12,0	39,0	11,40	1,0	44976*
12,0	26,0	83,0	12,0	39,0	11,40	2,0	44977*
12,0	26,0	83,0	12,0	39,0	11,40	3,0	44978*
12,0	26,0	83,0	12,0	39,0	11,40	4,0	44979*
12,0	26,0	95,0	12,0	—	—	—	44975*
16,0	35,0	92,0	16,0	—	—	—	44980*
16,0	35,0	92,0	16,0	51,0	15,20	2,0	44981*
16,0	35,0	92,0	16,0	51,0	15,20	3,0	44982*
16,0	35,0	92,0	16,0	51,0	15,20	4,0	44983*
16,0	35,0	108,0	16,0	67,0	15,20	2,0	44985*
16,0	35,0	108,0	16,0	67,0	15,20	3,0	44986*
16,0	35,0	108,0	16,0	67,0	15,20	4,0	44987*
16,0	35,0	124,0	16,0	—	—	—	44984*
20,0	35,0	86,0	20,0	—	—	—	44990
20,0	35,0	86,0	20,0	45,0	19,00	3,0	44991
20,0	35,0	86,0	20,0	45,0	19,00	4,0	44992
20,0	35,0	106,0	20,0	—	—	—	44993*
20,0	35,0	106,0	20,0	65,0	19,00	2,0	44994*
20,0	35,0	106,0	20,0	65,0	19,00	3,0	44995*
20,0	35,0	106,0	20,0	65,0	19,00	4,0	44996*
20,0	35,0	106,0	20,0	65,0	19,00	5,0	44997*
20,0	35,0	145,0	20,0	—	—	—	45020*
20,0	35,0	125,0	20,0	84,0	19,00	2,0	45021*
20,0	35,0	125,0	20,0	84,0	19,00	3,0	45022*
20,0	35,0	125,0	20,0	84,0	19,00	4,0	45023*
25,0	43,0	108,0	25,0	—	—	—	44998
25,0	43,0	108,0	25,0	60,0	23,75	2,0	44999
25,0	43,0	108,0	25,0	60,0	23,75	3,0	45000
25,0	43,0	108,0	25,0	60,0	23,75	4,0	45001
25,0	35,0	140,0	25,0	—	—	—	45002*
25,0	35,0	140,0	25,0	80,0	23,75	3,0	45003*
25,0	35,0	140,0	25,0	90,0	23,75	3,0	45004*
25,0	35,0	151,0	25,0	105,0	23,75	3,0	45025*
25,0	35,0	176,0	25,0	—	—	—	45024*

- Ultra high-productivity rougher for Aluminum alloys, specifically for aircraft components
- Designed for machine tools with capability of 12 L³ per minute material removal rates
- New 3 flute variable geometry with side exit coolant holes
- Open fluting for deep slotting and profiling
- Recommended for materials ≤ 150 Bhn (≤ 7 HRC)

*Variable Helix

METRIC

S-Carb APR[®]

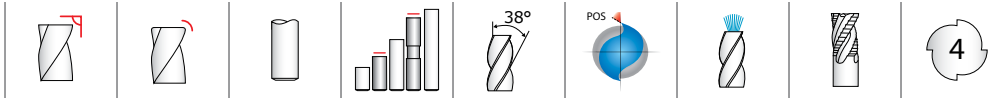

43APR-4 METRIC SERIES

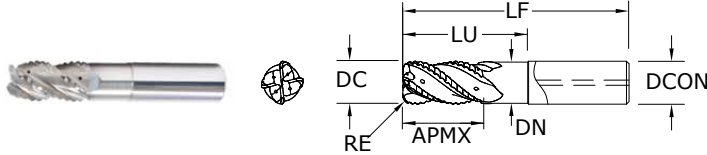

- Ultra high-productivity rougher for Aluminum alloys, specifically for aircraft components
- Designed for machine tools with capability of 12 L³ per minute material removal rates
- 4 flute variable geometry with side exit coolant holes
- Open fluting for deep slotting and profiling
- Recommended for materials ≤ 150 Bhn (≤ 7 HRC)

mm							EDP NO.
CUTTING DIAMETER DC	LENGTH OF CUT APMX	OVERALL LENGTH LF	SHANK DIAMETER DCON	REACH LU	NECK DIAMETER DN	CORNER RADIUS RE	Ti-NAMITE [®] -B (TiB ₂)
20,0	35,0	86,0	20,0	–	19,00	–	45005
20,0	35,0	86,0	20,0	45,0	19,00	3,0	45006
20,0	35,0	86,0	20,0	45,0	19,00	4,0	45007
20,0	35,0	106,0	20,0	–	19,00	–	45008
20,0	35,0	106,0	20,0	65,0	19,00	2,0	45009
20,0	35,0	106,0	20,0	65,0	19,00	3,0	45010
20,0	35,0	106,0	20,0	65,0	19,00	4,0	45011
20,0	35,0	106,0	20,0	65,0	19,00	5,0	45012
25,0	43,0	108,0	25,0	–	23,75	–	45013
25,0	43,0	108,0	25,0	60,0	23,75	2,0	45014
25,0	43,0	108,0	25,0	60,0	23,75	3,0	45015
25,0	43,0	108,0	25,0	60,0	23,75	4,0	45016
25,0	35,0	140,0	25,0	–	23,75	–	45017
25,0	35,0	140,0	25,0	80,0	23,75	3,0	45018
25,0	35,0	140,0	25,0	90,0	23,75	3,0	45019

TOLERANCES (mm)

20–25 DIAMETER
 DC = –0,010/–0,100
 DCON = h₆
 RE = ±0,050

NON-FERROUS

For patent information visit www.ksptpatents.com

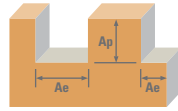

Series 43APR-3 43APR-4 Metric	Ae x DC	Ap x DC	Vc (m/min)	DC • mm					
				APR-3		APR-4			
				20	25	20	25		
N ALUMINIUM ALLOYS 6068, 7075	Slot 	1	≤ 1	1600	RPM	25461	20369	25461	20369
				(300-2100)	Fz	0.14	0.15	0.12	0.13
				Feed (mm/min)	10694	9166	12222	10592	
	Profile 	≤ 0.5	≤ 1.5	1800	RPM	28644	22915	28644	22915
				(300-2100)	Fz	0.16	0.17	0.14	0.15
				Feed (mm/min)	13749	11687	16041	13749	
	HSM 	≤ 0.25	≤ 2	2100	RPM	33418	26735	33418	26735
				(300-2100)	Fz	0.19	0.20	0.16	0.17
				Feed (mm/min)	19048	16041	21388	18180	

Series 43APR-3 43APR-4 Metric	Ae x DC	Ap x DC	Vc (m/min)	DC • mm					
				APR-3 LONG					
				12	16	20	25		
N ALUMINIUM ALLOYS 6068, 7075	Slot 	1	≤ 1	1600	RPM	26522	19892	15913	12731
				(300-2100)	Fz	0.10	0.11	0.12	0.13
				Feed (mm/min)	7957	6564	5729	4965	
	Profile 	≤ 0.5	≤ 1.5	1800	RPM	31827	23870	19096	15277
				(300-2100)	Fz	0.12	0.13	0.14	0.15
				Feed (mm/min)	11458	9309	8020	6875	
	HSM 	≤ 0.25	≤ 2	2100	RPM	37131	27849	22279	17823
				(300-2100)	Fz	0.14	0.15	0.16	0.17
				Feed (mm/min)	15595	12532	10694	9090	

RPM stated may be outside of most machine tools in the smaller sizes, adjust the surface speed but maintain the Fz
 For best results use the peak power of the specific machine torque chart.
 Typically 10kw is required to remove 1 litre of material (MMR).
 Eg. >> (Ae x Ap x Feed) / 1000000 >> Therefore Full slotting Ø25: 25 x 25 x 7333 = 4.58 Litres so it needs a min of 46Kw.
 Larger cuts and chip load consume more power.
 Review the power chart of each machine to determine MAX power for ultimate performance.
 Example below shows peak power @ 10,000 rpm.
 The APR-4 design is for ultimate metal removal but typically requires more power, and is also better suited to horizontal machines.
 The new coolant supply is designed for MQL as well as normal emulsion coolant on the same data.
 Ensure max MQL flow prior to cutting.
 refer to the SGS Tool Wizard® for complete technical information (www.kyocera-sgstool.com)

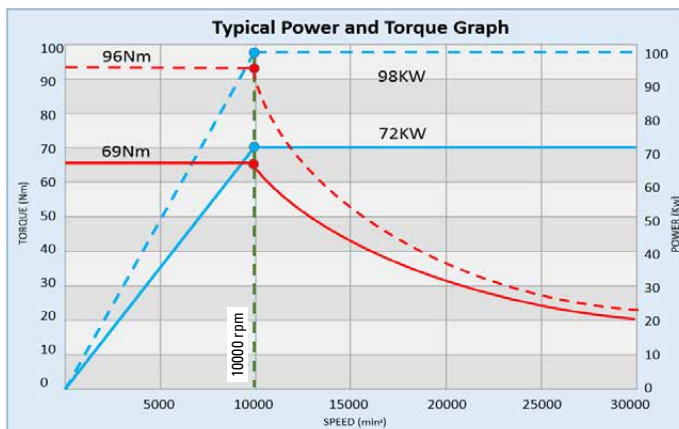

FRACTIONAL S-Carb APF®

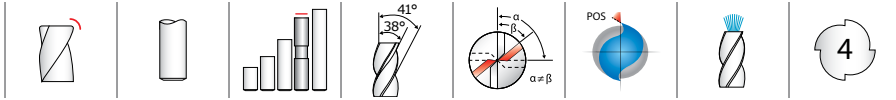

43APF FRACTIONAL SERIES

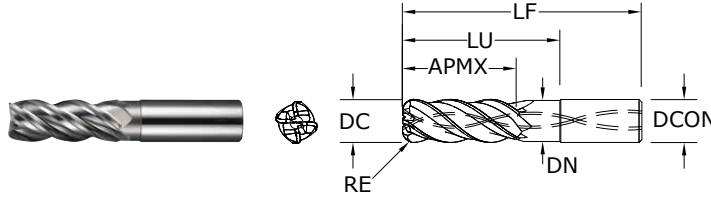

- Ultra high-productivity finisher for Aluminum alloys, specifically for aircraft components
- Two levels of chatter suppression: variable helix and indexing
- Designed for single axial pass semi-finishing and finishing
- Polished flutes maximize chip evacuation and provides enhanced finish
- Recommended for materials ≤ 150 Bhn (≤ 7 HRC)

CUTTING DIAMETER DC	LENGTH OF CUT APMX	OVERALL LENGTH LF	inch				CORNER RADIUS RE	EDP NO.
			SHANK DIAMETER DCON	REACH LU	NECK DIAMETER DN	Ti-NAMITE®-B (TiB ₂)		
1/2	1-1/4	3-1/4	1/2	1-5/8	.478	.030	34016	
1/2	1-1/4	3-1/4	1/2	1-5/8	.478	.060	34017	
1/2	1-1/4	3-1/4	1/2	1-5/8	.478	.090	34018	
1/2	1-1/4	3-1/4	1/2	1-5/8	.478	.120	34019	
1/2	2	4	1/2	2-3/8	.478	.030	34020	
1/2	2	4	1/2	2-3/8	.478	.060	34021	
1/2	2	4	1/2	2-3/8	.478	.090	34022	
1/2	2	4	1/2	2-3/8	.478	.120	34023	
3/4	1-7/8	4-1/4	3/4	2-3/8	.728	.030	34024	
3/4	1-7/8	4-1/4	3/4	2-3/8	.728	.060	34025	
3/4	1-7/8	4-1/4	3/4	2-3/8	.728	.090	34026	
3/4	1-7/8	4-1/4	3/4	2-3/8	.728	.120	34027	
3/4	3	5-3/8	3/4	3-1/2	.728	.030	34028	
3/4	3	5-3/8	3/4	3-1/2	.728	.060	34029	
3/4	3	5-3/8	3/4	3-1/2	.728	.090	34030	
3/4	3	5-3/8	3/4	3-1/2	.728	.120	34031	

Available on request: • JetStream Technology

TOLERANCES (inch)

1/2–3/4 DIAMETER

DC = $-0.0004/-0.0020$

DCON = h_6





RE = $+0.0012/-0.0012$

NON-FERROUS

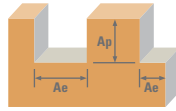
For patent information visit

www.kspatents.com



Series 43APF Fractional	Hardness	Profile	Ae x DC	Ap x DC	Vc (sfm)	DC • in			
						1/2	3/4		
N	ALUMINUM ALLOYS 2024, 5052, 5086, 6061, 6063, 7075	≤ 150 Bhn or ≤ 88 HRb	Profile 	≤ 0.1	≤ 2.5	2625	RPM	20055	13370
						(2100-3150)	Fz	0.0030	0.0050
							Feed (in/min)	241	267
	ALUMINUM ALLOYS (LITHIUM)* 2090, 2091, 2099, 2195, 2199, 2297, 8090	≤ 150 Bhn or ≤ 88 HRb	Profile 	≤ 0.1	≤ 4	2625	RPM	20055	13370
						(2100-3150)	Fz	0.0020	0.0040
							Feed (in/min)	160	214
ALUMINUM ALLOYS (LITHIUM)* 2090, 2091, 2099, 2195, 2199, 2297, 8090	≤ 150 Bhn or ≤ 88 HRb	Profile 	≤ 0.1	≤ 2.5	1970	RPM	15051	10034	
					(1576-2364)	Fz	0.0030	0.0050	
						Feed (in/min)	181	201	
ALUMINUM ALLOYS (LITHIUM)* 2090, 2091, 2099, 2195, 2199, 2297, 8090	≤ 150 Bhn or ≤ 88 HRb	Profile 	≤ 0.1	≤ 4	1970	RPM	15051	10034	
					(1576-2364)	Fz	0.0020	0.0040	
						Feed (in/min)	120	161	

Bhn (Brinell) HRb (Rockwell B)
 surface speed is dependent on machine spindle and fixturing
 balancing is recommended at ultra high surface speeds
 tool life may be reduced when machining Lithium Alloys
 $rpm = Vc \times 3.82 / DC$
 $ipm = Fz \times 4 \times rpm$
 maximum recommended depths shown
 reduce speed and feed for materials harder than listed
 finish cuts typically require reduced feed and cutting depths of 0.02 X DC maximum
 ramp angle = 6° (feed rate = 50%)
 plunging not recommended
 refer to the SGS Tool Wizard® for complete technical information (www.kyocera-sgstool.com)

S-Carb APF®

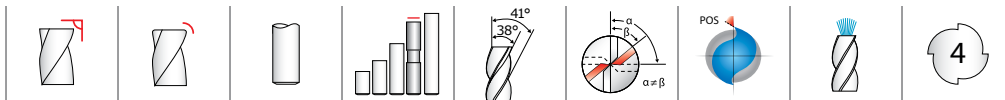

43MAPF METRIC SERIES

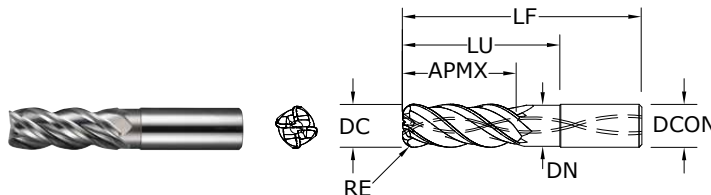

- Ultra high-productivity finisher for Aluminum alloys, specifically for aircraft components
- Two levels of chatter suppression: variable helix and indexing
- Designed for single axial pass semi-finishing and finishing
- Polished flutes maximize chip evacuation and provides enhanced finish
- Recommended for materials ≤ 150 Bhn (≤ 7 HRC)

mm							EDP NO.
CUTTING DIAMETER DC	LENGTH OF CUT APMX	OVERALL LENGTH LF	SHANK DIAMETER DCON	REACH LU	NECK DIAMETER DN	CORNER RADIUS RE	Ti-NAMITE®-B (TiB ₂)
6,0	24,0	58,0	6,0	30,0	5,70	—	44627
8,0	32,0	64,0	8,0	40,0	7,60	—	44628
10,0	40,0	80,0	10,0	50,0	9,50	—	44629
12,0	30,0	83,0	12,0	40,0	11,40	—	44630
12,0	30,0	83,0	12,0	40,0	11,40	2,0	44745
12,0	30,0	83,0	12,0	40,0	11,40	3,0	44746
12,0	30,0	83,0	12,0	40,0	11,40	4,0	44747
12,0	30,0	83,0	12,0	50,0	11,40	0,5	44641
12,0	30,0	83,0	12,0	50,0	11,40	5,0	44642
12,0	48,0	100,0	12,0	62,0	11,40	—	44631
12,0	48,0	100,0	12,0	62,0	11,40	2,0	44748
12,0	48,0	100,0	12,0	62,0	11,40	3,0	44749
12,0	48,0	100,0	12,0	62,0	11,40	4,0	44750
16,0	40,0	92,0	16,0	51,0	15,20	—	44634
16,0	40,0	92,0	16,0	51,0	15,20	2,0	44751
16,0	40,0	92,0	16,0	51,0	15,20	3,0	44752
16,0	40,0	92,0	16,0	51,0	15,20	4,0	44753
16,0	42,0	93,0	16,0	51,0	15,20	5,0	44643
16,0	64,0	125,0	16,0	82,0	15,20	—	44635
16,0	64,0	125,0	16,0	82,0	15,20	2,0	44754
16,0	64,0	125,0	16,0	82,0	15,20	3,0	44755
16,0	64,0	125,0	16,0	82,0	15,20	4,0	44756
20,0	50,0	108,0	20,0	63,0	19,00	—	44636
20,0	50,0	108,0	20,0	63,0	19,00	3,0	44757
20,0	50,0	108,0	20,0	63,0	19,00	4,0	44758
20,0	50,0	108,0	20,0	63,0	19,00	5,0	44759
20,0	80,0	150,0	20,0	102,0	19,00	—	44637
20,0	80,0	150,0	20,0	102,0	19,00	3,0	44760
20,0	80,0	150,0	20,0	102,0	19,00	4,0	44761
20,0	80,0	150,0	20,0	102,0	19,00	5,0	44762
25,0	63,0	130,0	25,0	79,0	23,75	—	44638
25,0	63,0	130,0	25,0	79,0	23,75	3,0	44763
25,0	63,0	130,0	25,0	79,0	23,75	4,0	44764
25,0	63,0	130,0	25,0	79,0	23,75	5,0	44765
25,0	100,0	175,0	25,0	120,0	23,75	—	44639
25,0	100,0	175,0	25,0	120,0	23,75	3,0	44766
25,0	100,0	175,0	25,0	120,0	23,75	4,0	44767
25,0	100,0	175,0	25,0	120,0	23,75	5,0	44768

Available on request: • JetStream Technology

TOLERANCES (mm)

6–25 DIAMETER

DC = -0,010/-0,050

DCON = h₆

RE = +0,03/-0,03

NON-FERROUS

For patent information visit www.ksptpatents.com

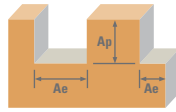

Series 43MAPF Metric	Hardness	Profile	Ae x DC	Ap x DC	Vc (m/min)	DC • mm							
						6	8	10	12	16	20	25	
N	ALUMINUM ALLOYS 2024, 5052, 5086, 6061, 6063, 7075	Profile 	≤ 0.1	≤ 2.5	800	RPM	42440	31830	25464	21220	15915	12732	10186
					(640-960)	Fz	0.050	0.055	0.060	0.070	0.100	0.140	0.170
					Feed (mm/min)	8488	7003	6111	5942	6366	7130	6926	
		Profile 	≤ 0.1	≤ 4	800	RPM	42440	31830	25464	21220	15915	12732	10186
					(640-960)	Fz	0.040	0.045	0.050	0.050	0.070	0.100	0.120
					Feed (mm/min)	6790	5729	5093	4244	4456	5093	4889	
N	ALUMINUM ALLOYS (LITHIUM)* 2090, 2091, 2099, 2195, 2199, 2297, 8090	Profile 	≤ 0.1	≤ 2.5	600	RPM	31830	23873	19098	15915	11936	9549	7639
					(480-720)	Fz	0.050	0.055	0.060	0.070	0.100	0.140	0.170
					Feed (mm/min)	6366	5252	4584	4456	4774	5347	5195	
		Profile 	≤ 0.1	≤ 4	600	RPM	31830	23873	19098	15915	11936	9549	7639
					(480-720)	Fz	0.040	0.045	0.050	0.050	0.070	0.100	0.120
					Feed (mm/min)	5093	4297	3820	3183	3342	3820	3667	

Bhn (Brinell) HRb (Rockwell B)

surface speed is dependent on machine spindle and fixturing

balancing is recommended at ultra high surface speeds

*tool life may be reduced when machining Lithium Alloys

$$\text{rpm} = (\text{Vc} \times 1000) / (\text{DC} \times 3.14)$$

$$\text{mm/min} = \text{Fz} \times 4 \times \text{rpm}$$

maximum recommended depths shown

reduce speed and feed for materials harder than listed

finish cuts typically require reduced feed and cutting depths of 0.02 X DC maximum

ramp angle = 6° (feed rate = 50%)

plunging not recommended

refer to the SGS Tool Wizard® for complete technical information (www.kyocera-sgstool.com)

METRIC

S-Carb APF-B®

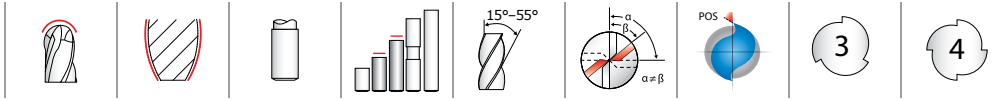

APF-B METRIC SERIES

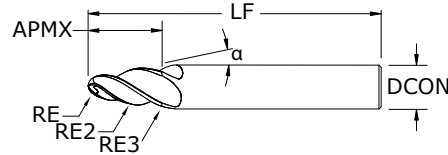

- Designed to significantly improve traditional ball end applications
- Highly efficient at finishing and semi-finishing profiling
- Main application areas include profiling and pocket milling
- Especially suited to machining deep pockets and hard-to-reach areas without using long-reach tools
- Their versatility also allows for machining profiles and blends with one tool
- Recommended for materials ≤ 150 Bhn (≤ 7 HRC)

mm								EDP NO.
SHANK DIAMETER DCON	LENGTH OF CUT APMX	OVERALL LENGTH LF	CENTERLINE ANGLE α	TIP RADIUS RE	TAPERED RADIUS RE2	BLENDED RADIUS RE3	NO. OF FLUTES	Ti-NAMITE®-B (TiB ₂)
6,0	9,5	58,0	17.5°	1,0	250,0	3,0	3	45718
6,0	8,0	58,0	17.5°	1,5	250,0	3,0	3	45719
8,0	10,5	80,0	20°	1,5	250,0	4,0	3	45720
8,0	9,5	80,0	20°	2,0	250,0	4,0	3	45721
10,0	12,5	89,0	20°	2,0	250,0	5,0	3	45722
10,0	11,5	89,0	20°	2,5	250,0	5,0	3	45723
12,0	13,5	100,0	20°	3,0	250,0	6,0	4	45724
12,0	14,4	100,0	20°	2,5	250,0	6,0	4	45725
12,0	20,0	100,0	14°	2,0	60,0	6,0	4	45726
16,0	31,0	109,0	12.5°	2,0	1000,0	5,0	4	45727
16,0	27,5	109,0	12.5°	3,0	1000,0	5,0	4	45728
16,0	24,0	109,0	12.5°	4,0	1000,0	5,0	4	45729
16,0	21,0	109,0	15°	4,0	1000,0	5,0	4	45730
16,0	18,5	109,0	20°	4,0	1500,0	8,0	4	45731
16,0	28,5	109,0	10°	4,0	1000,0	5,0	4	45732
16,0	19,0	109,0	20°	3,0	750,0	5,0	4	45733
16,0	15,0	109,0	30°	2,0	750,0	3,0	4	45734
16,0	18,5	109,0	20°	3,0	60,0	5,0	4	45735

TOLERANCES (mm)

DCON = h_6
RE = $-0,010/-0,010$

NON-FERROUS

For patent information visit www.ksptpatents.com

			DCON	6		8		10		12		16	
			Ae max	0,20	0,45	0,25	0,55	0,30	0,60	0,35	0,65	0,40	0,70
			Diameter	3,0	6,0	4,0	8,0	5,0	10,0	6,0	12,0	8,0	16,0
Metric	Hardness (HRb)	Vc (m/min)	Cut Zone	RE	RE2	RE	RE2	RE	RE2	RE	RE2	RE	RE2
N Aluminum	≤88 (388-632)	510	RPM	54111	27056	40583	20292	32467	16233	27056	13528	20292	10146
			Fz	0,017	0,040	0,021	0,050	0,025	0,060	0,033	0,080	0,042	0,100
			Feed (mm/min)	2706	3247	2536	3044	2435	2922	3607	4329	3382	4058
	≥88 (284-376)	330	RPM	35013	17507	26260	13130	21008	10504	17507	8753	13130	6565
			Fz	0,013	0,030	0,017	0,040	0,021	0,050	0,025	0,060	0,033	0,080
			Feed (mm/min)	1313	1576	1313	1576	1313	1576	1751	2101	1751	2101

$$\text{rpm} = (\text{Vc} \times 1000) / (\text{DC} \times 3.14)$$

$$\text{Feed} = \text{Fz} \times \text{No. of flutes} \times \text{rpm}$$

Adjust speed and feed cutting

Adjust rates according to cutting area of tool being used

Avoid using tip of the tool where possible due to reduced chip space

Be aware of max cut Ae, especially on the lower portion of the tool

refer to the SGS Tool Wizard® for complete technical information (www.kyocera-sgstool.com)

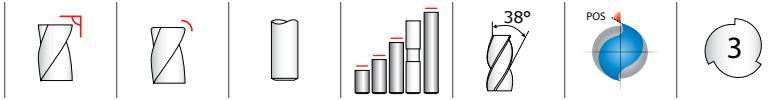

**43 •
43CR**
FRACTIONAL SERIES

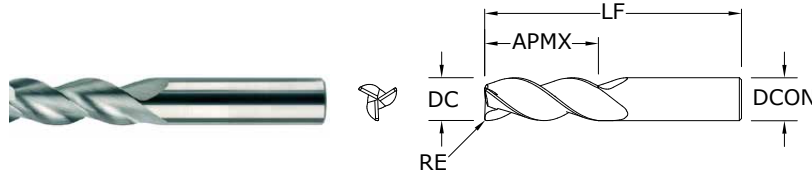

- Circular land allows for increased control at various speed and feed rates and reduces chatter
- Symmetrical end gashing for excellent balance at high speeds and aggressive plunging capability
- Open fluting for deep slotting and profiling
- Enhanced corner geometry with tight tolerance corner radii
- Recommended for materials ≤ 150 Bhn (≤ 7 HRC)

CUTTING DIAMETER DC	LENGTH OF CUT APMX	inch			EDP NO.	
		OVERALL LENGTH LF	SHANK DIAMETER DCON	CORNER RADIUS RE	UNCOATED	Ti-NAMITE®-B (TiB ₂)
1/8	3/8	1-1/2	1/8	—	34701	34728
1/8	3/8	1-1/2	1/8	.010	34771	34793
3/16	5/16	2-1/2	3/16	—	34822	34857
3/16	9/16	2	3/16	—	34702	34729
3/16	9/16	2	3/16	.010	34772	34794
3/16	3/4	2-1/2	3/16	—	34823	34858
1/4	3/8	2	1/4	—	34703	34730
1/4	3/8	2-1/2	1/4	.010	35575	35665
1/4	3/8	2-1/2	1/4	.015	35576	35666
1/4	3/8	2-1/2	1/4	.030	35577	35667
1/4	3/8	2-1/2	1/4	.060	35578	35668
1/4	1/2	2-1/2	1/4	—	34824	34859
1/4	3/4	2-1/2	1/4	—	34704	34731
1/4	3/4	2-1/2	1/4	.010	34773	34795
1/4	3/4	2-1/2	1/4	.015	35579	35669
1/4	3/4	2-1/2	1/4	.030	34774	34796
1/4	3/4	2-1/2	1/4	.060	35580	35670
1/4	1	3	1/4	—	34825	34860
1/4	1	3	1/4	.010	35581	35671
1/4	1	3	1/4	.015	35582	35672
1/4	1	3	1/4	.030	35583	35673
1/4	1	3	1/4	.060	35584	35674
1/4	1-1/4	3-1/2	1/4	—	34705	34732
1/4	1-3/4	4	1/4	—	34826	34861
5/16	7/16	2	5/16	—	34706	34733
5/16	5/8	2-1/2	5/16	—	34707	34734
5/16	5/8	2-1/2	5/16	.030	34775	34797
5/16	1-1/4	4	5/16	—	34708	34735
3/8	1/2	2	3/8	—	34709	34736
3/8	1/2	3	3/8	.010	35585	35675
3/8	1/2	3	3/8	.015	35586	35676
3/8	1/2	3	3/8	.030	35587	35677
3/8	1/2	3	3/8	.060	35588	35678
3/8	1/2	3	3/8	.090	35589	35679
3/8	1	2-1/2	3/8	—	34710	34737
3/8	1	2-1/2	3/8	.010	34776	34798

TOLERANCES (inch)

- 1/8–3/16 DIAMETER**
 DC = +0.0000/–0.00032
 DCON = h₆
 RE = +0.0000/–0.0020
- 1/4–3/8 DIAMETER**
 DC = +0.0000/–0.00035
 DCON = h₆
 RE = +0.0000/–0.0020
- 1/2–5/8 DIAMETER**
 DC = +0.0000/–0.00043
 DCON = h₆
 RE = +0.0000/–0.0020
- 3/4–1 DIAMETER**
 DC = +0.0000/–0.00051
 DCON = h₆
 RE = +0.0000/–0.0020

NON-FERROUS

For patent information visit www.ksptpatents.com

continued on next page

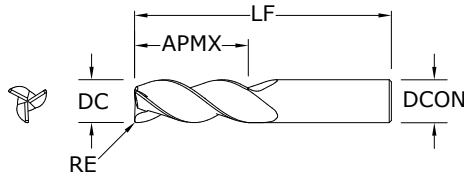
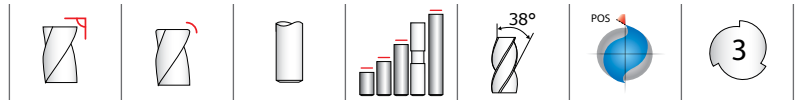

43 •
43CR
FRACTIONAL SERIES

CONTINUED

TOLERANCES (inch)

1/8–3/16 DIAMETER

DC = +0.0000/–0.00032

DCON = h₆

RE = +0.0000/–0.0020

1/4–3/8 DIAMETER

DC = +0.0000/–0.00035

DCON = h₆

RE = +0.0000/–0.0020

1/2–5/8 DIAMETER

DC = +0.0000/–0.00043

DCON = h₆

RE = +0.0000/–0.0020

3/4–1 DIAMETER

DC = +0.0000/–0.00051

DCON = h₆

RE = +0.0000/–0.0020

NON-FERROUS

For patent
information visit
www.ksptpatents.com

CUTTING DIAMETER DC	LENGTH OF CUT APMX	inch			EDP NO.	
		OVERALL LENGTH LF	SHANK DIAMETER DCON	CORNER RADIUS RE	UNCOATED	Ti-NAMITE®-B (TiB ₂)
3/8	1	2-1/2	3/8	.030	34777	34799
3/8	1	2-1/2	3/8	.060	32761	32825
3/8	1	3	3/8	.015	35590	35680
3/8	1	3	3/8	.090	35591	35681
3/8	1-1/4	3-1/2	3/8	–	34827	34862
3/8	1-1/2	3-1/2	3/8	–	34711	34738
3/8	1-1/2	4	3/8	.010	35592	35682
3/8	1-1/2	4	3/8	.015	35593	35683
3/8	1-1/2	4	3/8	.030	35594	35684
3/8	1-1/2	4	3/8	.060	35595	35685
3/8	1-1/2	4	3/8	.090	35596	35686
3/8	2	4	3/8	–	34828	34863
1/2	5/8	2-1/2	1/2	–	34712	34739
1/2	5/8	3	1/2	.010	35597	35687
1/2	5/8	3	1/2	.015	35598	35688
1/2	5/8	3	1/2	.030	35599	35689
1/2	5/8	3	1/2	.060	35600	35690
1/2	5/8	3	1/2	.090	35601	35691
1/2	5/8	3	1/2	.120	35602	35692
1/2	1	3	1/2	–	34830	34865
1/2	1	3	1/2	.010	35603	35693
1/2	1	3	1/2	.015	35604	35694
1/2	1	3	1/2	.030	35605	35695
1/2	1	3	1/2	.060	35606	35696
1/2	1	3	1/2	.090	35607	35697
1/2	1	3	1/2	.120	35608	35698
1/2	1-1/4	3	1/2	.015	35609	35699
1/2	1-1/4	3-1/4	1/2	–	34713	34740
1/2	1-1/4	3-1/4	1/2	.010	34778	34800
1/2	1-1/4	3-1/4	1/2	.030	34779	34801
1/2	1-1/4	3-1/4	1/2	.060	34780	34802
1/2	1-1/4	3-1/4	1/2	.090	34781	34803
1/2	1-1/4	3-1/4	1/2	.120	32766	32830
1/2	1-5/8	4	1/2	–	34831	34866
1/2	1-5/8	4	1/2	.010	35610	35700
1/2	1-5/8	4	1/2	.015	35611	35701

continued on next page

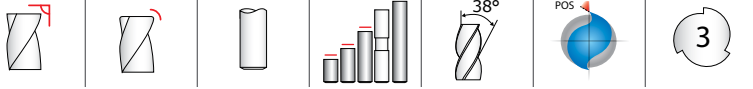

**43 •
43CR**
FRACTIONAL SERIES

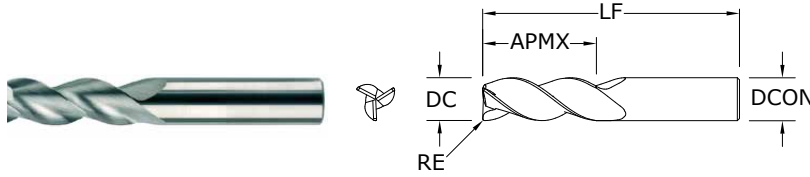

CONTINUED

CUTTING DIAMETER DC	LENGTH OF CUT APMX	inch			EDP NO.	
		OVERALL LENGTH LF	SHANK DIAMETER DCON	CORNER RADIUS RE	UNCOATED	Ti-NAMITE®-B (TiB ₂)
1/2	1-5/8	4	1/2	.030	35612	35702
1/2	1-5/8	4	1/2	.060	35613	35703
1/2	1-5/8	4	1/2	.090	35614	35704
1/2	1-5/8	4	1/2	.120	35615	35705
1/2	2	4	1/2	—	34714	34741
1/2	2	4	1/2	.010	35616	35706
1/2	2	4	1/2	.015	35617	35707
1/2	2	4	1/2	.030	35618	35708
1/2	2	4	1/2	.060	35619	35709
1/2	2	4	1/2	.090	35620	35710
1/2	2	4	1/2	.120	35621	35711
1/2	2-1/2	5	1/2	—	34832	34867
1/2	3-1/8	6	1/2	—	34715	34742
5/8	3/4	3	5/8	—	34716	34743
5/8	3/4	3-1/2	5/8	.030	35622	35712
5/8	3/4	3-1/2	5/8	.060	35623	35713
5/8	3/4	3-1/2	5/8	.090	35624	35714
5/8	3/4	3-1/2	5/8	.120	35625	35715
5/8	1-5/8	3-3/4	5/8	—	34717	34744
5/8	1-5/8	3-3/4	5/8	.030	34782	34804
5/8	1-5/8	3-3/4	5/8	.060	34783	34805
5/8	1-5/8	3-3/4	5/8	.090	34784	34806
5/8	1-5/8	3-3/4	5/8	.120	35626	35716
5/8	2-1/8	4	5/8	—	34833	34868
5/8	2-1/2	5	5/8	—	34718	34745
5/8	3-1/4	6	5/8	—	34834	34869
5/8	3-3/4	6	5/8	—	34719	34746
3/4	1	3	3/4	—	34720	34747
3/4	1	4	3/4	.030	35627	35717
3/4	1	4	3/4	.060	35628	35718
3/4	1	4	3/4	.090	35629	35719
3/4	1	4	3/4	.120	35630	35720
3/4	1	4	3/4	.190	35631	35721
3/4	1	4	3/4	.250	35632	35722
3/4	1-5/8	4	3/4	—	34721	34748
3/4	1-5/8	4	3/4	.030	34785	34807

TOLERANCES (inch)

- 1/8–3/16 DIAMETER**
 DC = +0.0000/–0.00032
 DCON = h₆
 RE = +0.0000/–0.0020
- 1/4–3/8 DIAMETER**
 DC = +0.0000/–0.00035
 DCON = h₆
 RE = +0.0000/–0.0020
- 1/2–5/8 DIAMETER**
 DC = +0.0000/–0.00043
 DCON = h₆
 RE = +0.0000/–0.0020
- 3/4–1 DIAMETER**
 DC = +0.0000/–0.00051
 DCON = h₆
 RE = +0.0000/–0.0020

NON-FERROUS

For patent information visit www.ksptpatents.com

continued on next page

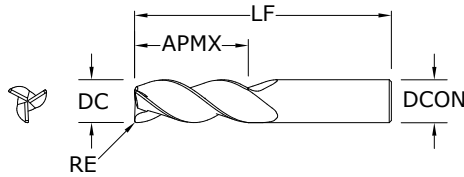
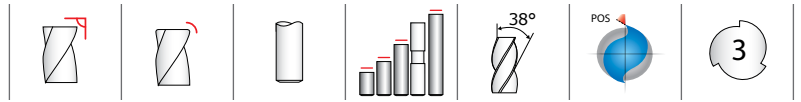

43 •
43CR
FRACTIONAL SERIES

CONTINUED

TOLERANCES (inch)

1/8–3/16 DIAMETER

DC = +0.0000/–0.00032

DCON = h₆

RE = +0.0000/–0.0020

1/4–3/8 DIAMETER

DC = +0.0000/–0.00035

DCON = h₆

RE = +0.0000/–0.0020

1/2–5/8 DIAMETER

DC = +0.0000/–0.00043

DCON = h₆

RE = +0.0000/–0.0020

3/4–1 DIAMETER

DC = +0.0000/–0.00051

DCON = h₆

RE = +0.0000/–0.0020

NON-FERROUS

For patent
information visit
www.ksptpatents.com

CUTTING DIAMETER DC	LENGTH OF CUT APMX	inch			EDP NO.	
		OVERALL LENGTH LF	SHANK DIAMETER DCON	CORNER RADIUS RE	UNCOATED	Ti-NAMITE®-B (TiB ₂)
3/4	1-5/8	4	3/4	.060	34786	34808
3/4	1-5/8	4	3/4	.090	34787	34809
3/4	1-5/8	4	3/4	.120	34815	34817
3/4	1-5/8	4	3/4	.190	35633	35723
3/4	1-5/8	4	3/4	.250	35634	35724
3/4	2-1/4	5	3/4	–	34722	34749
3/4	2-1/4	5	3/4	.030	35635	35725
3/4	2-1/4	5	3/4	.060	35636	35726
3/4	2-1/4	5	3/4	.090	35637	35727
3/4	2-1/4	5	3/4	.120	35638	35728
3/4	2-1/4	5	3/4	.190	35639	35729
3/4	2-1/4	5	3/4	.250	35640	35730
3/4	2-1/2	5	3/4	–	34758	34765
3/4	3-1/4	6	3/4	–	34723	34750
1	1-1/4	4	1	–	34724	34751
1	1-1/4	5	1	.030	35641	35731
1	1-1/4	5	1	.060	35642	35732
1	1-1/4	5	1	.090	35643	35733
1	1-1/4	5	1	.120	35644	35734
1	1-1/4	5	1	.190	35645	35735
1	1-1/4	5	1	.250	35646	35736
1	2	4-1/2	1	–	34725	34752
1	2	4-1/2	1	.030	34789	34811
1	2	4-1/2	1	.060	34790	34812
1	2	4-1/2	1	.090	34791	34813
1	2	4-1/2	1	.120	34816	34818
1	2	5	1	.190	35647	35737
1	2	5	1	.250	35648	35738
1	2-5/8	6	1	–	34726	34753
1	3-1/4	6	1	–	34727	34754
1	3-1/4	6	1	.030	35649	35739
1	3-1/4	6	1	.060	35650	35740
1	3-1/4	6	1	.090	35651	35741
1	3-1/4	6	1	.120	35652	35742
1	3-1/4	6	1	.190	35653	35743
1	3-1/4	6	1	.250	35654	35744
1	4-1/8	7	1	–	34835	34870

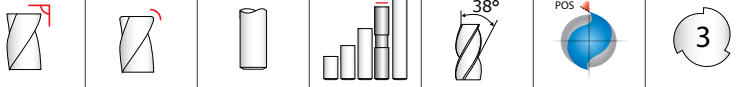

**43L •
43LC**

FRACTIONAL SERIES

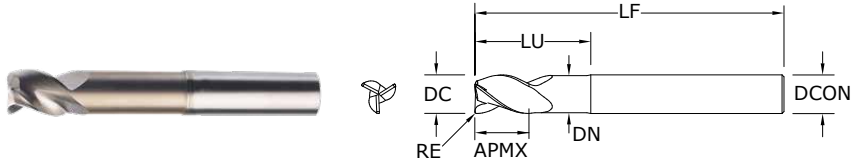

- Circular land allows for increased control at various speed and feed rates and reduces chatter
- Symmetrical end gashing for excellent balance at high speeds and aggressive plunging capability
- Open fluting for deep slotting and profiling
- Necked design with blended diameter transitions provide clearance to reach
- Enhanced corner geometry with tight tolerance corner radii
- Recommended for materials ≤ 150 Bhn (≤ 7 HRC)

CUTTING DIAMETER DC	LENGTH OF CUT APMX	OVERALL LENGTH LF	inch				EDP NO.	
			SHANK DIAMETER DCON	REACH LU	NECK DIAMETER DN	CORNER RADIUS RE	UNCOATED	Ti-NAMITE®-B (TiB ₂)
1/8	5/32	3	1/8	1/2	.105	—	32700	32725
1/8	5/32	3	1/8	1/2	.105	.010	32751	32815
1/8	5/32	3	1/8	3/4	.105	—	32691	34888
3/16	7/32	3	3/16	1/2	.167	—	32701	32726
3/16	7/32	3	3/16	1/2	.167	.010	32752	32816
3/16	7/32	3	3/16	3/4	.167	—	32692	34889
1/4	3/8	2-1/2	1/4	3/4	.230	.015	35787	36235
1/4	3/8	2-1/2	1/4	3/4	.230	.060	35788	36236
1/4	3/8	4	1/4	3/4	.230	—	32702	32727
1/4	3/8	4	1/4	3/4	.230	.010	32753	32817
1/4	3/8	4	1/4	3/4	.230	.030	32754	32818
1/4	3/8	4	1/4	1-1/2	.230	—	32703	32728
1/4	3/8	4	1/4	1-1/2	.230	.010	32755	32819
1/4	3/8	4	1/4	1-1/2	.230	.030	32756	32820
1/4	3/8	4	1/4	2-1/8	.230	—	32704	32729
1/4	3/8	4	1/4	2-1/8	.230	.010	32757	32821
1/4	3/8	4	1/4	2-1/8	.230	.030	32758	32822
5/16	7/16	4	5/16	1-1/8	.292	—	32705	32730
5/16	7/16	4	5/16	1-1/8	.292	.030	32759	32823
5/16	7/16	4	5/16	2-1/8	.292	—	32706	32731
5/16	7/16	4	5/16	2-1/8	.292	.030	32760	32824
3/8	1/2	3	3/8	1-1/8	.355	.015	35791	36239
3/8	1/2	3	3/8	1-1/8	.355	.090	35792	36240
3/8	1/2	4	3/8	1-1/8	.355	—	32707	32732
3/8	1/2	4	3/8	1-1/8	.355	.030	32762	32826
3/8	1/2	4	3/8	1-1/8	.355	.060	32763	32827
3/8	1/2	4	3/8	2-1/8	.355	—	32708	32733
3/8	1/2	4	3/8	2-1/8	.355	.030	32764	32828
3/8	1/2	4	3/8	2-1/8	.355	.060	32765	32829
1/2	5/8	3	1/2	1-3/8	.480	.015	35795	36243
1/2	5/8	4	1/2	1-3/8	.480	—	32709	32734
1/2	5/8	4	1/2	1-3/8	.480	.030	32767	32831
1/2	5/8	4	1/2	1-3/8	.480	.060	32768	32832
1/2	5/8	4	1/2	1-3/8	.480	.090	32769	32833
1/2	5/8	4	1/2	1-3/8	.480	.120	32770	32834
1/2	5/8	4	1/2	2-1/4	.480	.015	35796	36244

TOLERANCES (inch)

- 1/8–3/16 DIAMETER**
DC = +0.0000/–0.00032
DCON = h₆
RE = +0.0000/–0.0020
- 1/4–3/8 DIAMETER**
DC = +0.0000/–0.00035
DCON = h₆
RE = +0.0000/–0.0020
- 1/2–5/8 DIAMETER**
DC = +0.0000/–0.00043
DCON = h₆
RE = +0.0000/–0.0020
- 3/4–1 DIAMETER**
DC = +0.0000/–0.00051
DCON = h₆
RE = +0.0000/–0.0020

NON-FERROUS

For patent information visit
www.ksptpatents.com

continued on next page

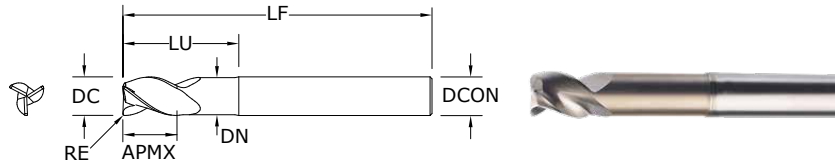
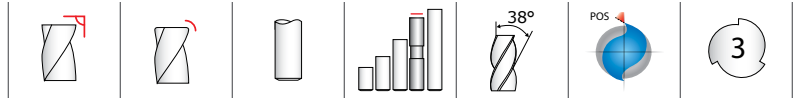

**43L •
43LC**
FRACTIONAL SERIES

CONTINUED

TOLERANCES (inch)

1/8–3/16 DIAMETER

DC = +0.0000/–0.00032

DCON = h₆

RE = +0.0000/–0.0020

1/4–3/8 DIAMETER

DC = +0.0000/–0.00035

DCON = h₆

RE = +0.0000/–0.0020

1/2–5/8 DIAMETER

DC = +0.0000/–0.00043

DCON = h₆

RE = +0.0000/–0.0020

3/4–1 DIAMETER

DC = +0.0000/–0.00051

DCON = h₆

RE = +0.0000/–0.0020

NON-FERROUS

For patent
information visit
www.ksptpatents.com

CUTTING DIAMETER DC	LENGTH OF CUT APMX	OVERALL LENGTH LF	inch				CORNER RADIUS RE	EDP NO.	
			SHANK DIAMETER DCON	REACH LU	NECK DIAMETER DN	UNCOATED		Ti-NAMITE®-B (TiB ₂)	
1/2	5/8	6	1/2	2-1/8	.480	–	32710	32735	
1/2	5/8	6	1/2	2-1/8	.480	.030	32771	32835	
1/2	5/8	6	1/2	2-1/8	.480	.060	32772	32836	
1/2	5/8	6	1/2	2-1/8	.480	.090	32773	32837	
1/2	5/8	6	1/2	2-1/8	.480	.120	32774	32838	
1/2	5/8	6	1/2	3-3/8	.480	–	32711	32736	
1/2	5/8	6	1/2	3-3/8	.480	.030	32775	32839	
1/2	5/8	6	1/2	3-3/8	.480	.060	32776	32840	
1/2	5/8	6	1/2	3-3/8	.480	.090	32777	32841	
1/2	5/8	6	1/2	3-3/8	.480	.120	32778	32842	
1/2	5/8	6	1/2	4-1/4	.480	–	32697	34894	
5/8	3/4	4	5/8	1-3/4	.605	–	32712	32737	
5/8	3/4	4	5/8	1-3/4	.605	.030	32779	32843	
5/8	3/4	4	5/8	1-3/4	.605	.060	32780	32844	
5/8	3/4	4	5/8	1-3/4	.605	.090	32781	32845	
5/8	3/4	4	5/8	1-3/4	.605	.120	32782	32846	
5/8	3/4	4	5/8	2-3/8	.605	–	32713	32738	
5/8	3/4	4	5/8	2-3/8	.605	.030	32783	32847	
5/8	3/4	4	5/8	2-3/8	.605	.060	32784	32848	
5/8	3/4	4	5/8	2-3/8	.605	.090	32785	32849	
5/8	3/4	4	5/8	2-3/8	.605	.120	32786	32850	
5/8	3/4	6	5/8	3-3/8	.605	–	32714	32739	
5/8	3/4	6	5/8	3-3/8	.605	.030	32787	32851	
5/8	3/4	6	5/8	3-3/8	.605	.060	32788	32852	
5/8	3/4	6	5/8	3-3/8	.605	.090	32789	32853	
5/8	3/4	6	5/8	3-3/8	.605	.120	32790	32854	
5/8	3/4	6	5/8	4-3/8	.605	–	32698	34895	
3/4	1	4	3/4	1-3/4	.730	–	32715	32740	
3/4	1	4	3/4	1-3/4	.730	.030	32791	32855	
3/4	1	4	3/4	1-3/4	.730	.060	32792	32856	
3/4	1	4	3/4	1-3/4	.730	.090	32793	32857	
3/4	1	4	3/4	1-3/4	.730	.120	32794	32858	
3/4	1	4	3/4	2	.730	.190	35803	36251	
3/4	1	4	3/4	2	.730	.250	35804	36252	
3/4	1	6	3/4	2-3/8	.730	–	32716	32741	
3/4	1	6	3/4	2-3/8	.730	.030	32795	32859	

continued on next page

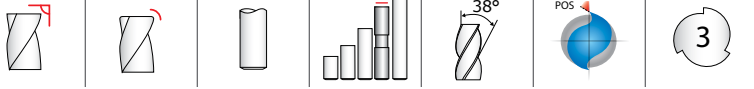

**43L •
43LC**
FRACTIONAL SERIES

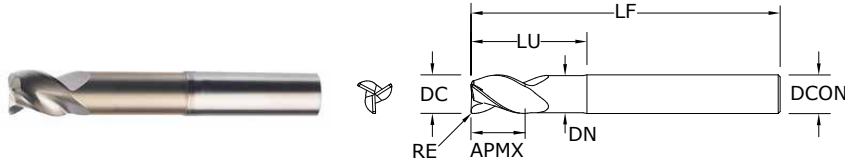

CONTINUED

CUTTING DIAMETER DC	LENGTH OF CUT APMX	OVERALL LENGTH LF	inch				EDP NO.	
			SHANK DIAMETER DCON	REACH LU	NECK DIAMETER DN	CORNER RADIUS RE	UNCOATED	Ti-NAMITE®-B (TiB ₂)
3/4	1	6	3/4	2-3/8	.730	.060	32796	32860
3/4	1	6	3/4	2-3/8	.730	.090	32797	32861
3/4	1	6	3/4	2-3/8	.730	.120	32798	32862
3/4	1	6	3/4	3-3/8	.730	—	32717	32742
3/4	1	6	3/4	3-3/8	.730	.030	32799	32863
3/4	1	6	3/4	3-3/8	.730	.060	32800	32864
3/4	1	6	3/4	3-3/8	.730	.090	32801	32865
3/4	1	6	3/4	3-3/8	.730	.120	32802	32866
3/4	1	6	3/4	4-3/8	.730	—	32699	34896
1	1-1/4	5	1	2-5/8	.980	.190	35809	36257
1	1-1/4	5	1	2-5/8	.980	.250	35810	36258
1	1-1/4	6	1	2-3/8	.980	—	32718	32743
1	1-1/4	6	1	2-3/8	.980	.030	32803	32867
1	1-1/4	6	1	2-3/8	.980	.060	32804	32868
1	1-1/4	6	1	2-3/8	.980	.090	32805	32869
1	1-1/4	6	1	2-3/8	.980	.120	32806	32870
1	1-1/4	6	1	3-3/8	.980	—	32719	32744
1	1-1/4	6	1	3-3/8	.980	.030	32807	32871
1	1-1/4	6	1	3-3/8	.980	.060	32808	32872
1	1-1/4	6	1	3-3/8	.980	.090	32809	32873
1	1-1/4	6	1	3-3/8	.980	.120	32810	32874
1	1-1/4	6	1	3-3/8	.980	.190	35811	36259
1	1-1/4	6	1	3-3/8	.980	.250	35812	36260
1	1-1/4	7	1	4-3/8	.980	—	32720	32745

TOLERANCES (inch)

- 1/8–3/16 DIAMETER**
DC = +0.0000/–0.00032
DCON = h₆
RE = +0.0000/–0.0020
- 1/4–3/8 DIAMETER**
DC = +0.0000/–0.00035
DCON = h₆
RE = +0.0000/–0.0020
- 1/2–5/8 DIAMETER**
DC = +0.0000/–0.00043
DCON = h₆
RE = +0.0000/–0.0020
- 3/4–1 DIAMETER**
DC = +0.0000/–0.00051
DCON = h₆
RE = +0.0000/–0.0020

NON-FERROUS

For patent information visit www.kspatents.com

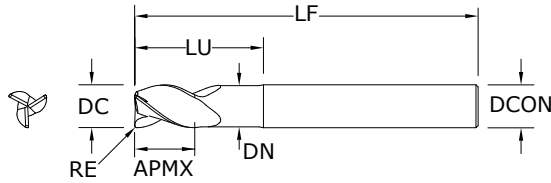
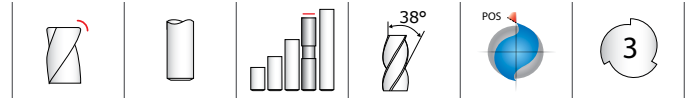

43EC
FRACTIONAL SERIES

TOLERANCES (inch)

1/4–3/8 DIAMETER

DC = +0.0000/-0.00035

DCON = h_6

RE = +0.0000/-0.0020

1/2–5/8 DIAMETER

DC = +0.0000/-0.00043

DCON = h_6

RE = +0.0000/-0.0020

3/4–1 DIAMETER

DC = +0.0000/-0.00051

DCON = h_6

RE = +0.0000/-0.0020

NON-FERROUS

For patent information visit www.ksptpatents.com

CUTTING DIAMETER DC	LENGTH OF CUT APMX	OVERALL LENGTH LF	inch				EDP NO.	
			SHANK DIAMETER DCON	REACH LU	NECK DIAMETER DN	CORNER RADIUS RE	UNCOATED	Ti-NAMITE®-B (TiB ₂)
1/4	3/8	3	1/4	1-1/8	.230	.015	35789	36237
1/4	3/8	3	1/4	1-1/8	.230	.060	35790	36238
3/8	1/2	4	3/8	2-1/8	.355	.015	35793	36241
3/8	1/2	4	3/8	2-1/8	.355	.090	35794	36242
1/2	5/8	5	1/2	3-3/8	.480	.015	35797	36245
1/2	5/8	6	1/2	4-1/4	.480	.015	35798	36246
1/2	5/8	6	1/2	4-1/4	.480	.030	35799	36247
1/2	5/8	6	1/2	4-1/4	.480	.060	35800	36248
1/2	5/8	6	1/2	4-1/4	.480	.090	35801	36249
1/2	5/8	6	1/2	4-1/4	.480	.120	35802	36250
3/4	1	6	3/4	3-3/8	.730	.190	35805	36253
3/4	1	6	3/4	3-3/8	.730	.250	35806	36254
1	1-1/4	7	1	4-3/8	.980	.030	35813	36261
1	1-1/4	7	1	4-3/8	.980	.060	35814	36262
1	1-1/4	7	1	4-3/8	.980	.090	35815	36263
1	1-1/4	7	1	4-3/8	.980	.120	35816	36264
1	1-1/4	7	1	4-3/8	.980	.190	35817	36265
1	1-1/4	7	1	4-3/8	.980	.250	35818	36266

- Circular land allows for increased control at various speed and feed rates and reduces chatter
- Symmetrical end gashing for excellent balance at high speeds and aggressive plunging capability
- Open fluting for deep slotting and profiling
- Necked design with blended diameter transitions provide clearance to reach
- Enhanced corner geometry with tight tolerance corner radii
- Recommended for materials ≤ 150 Bhn (≤ 7 HRC)



43B

FRACTIONAL SERIES

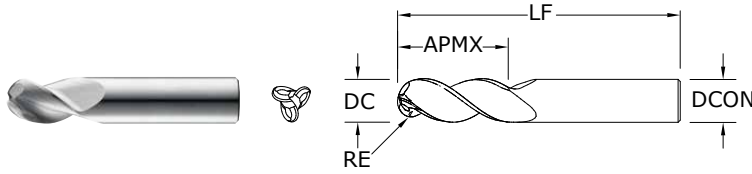

- Circular land allows for increased control at various speed and feed rates and reduces chatter
- Open fluting for deep slotting and profiling
- Ball end design ideal for finishing operations in complex workpieces
- Recommended for materials ≤ 150 Bhn (≤ 7 HRC)

CUTTING DIAMETER DC	inch			EDP NO.	
	LENGTH OF CUT APMX	OVERALL LENGTH LF	SHANK DIAMETER DCON	UNCOATED	Ti-NAMITE®-B (TiB ₂)
1/4	3/8	2	1/4	34916	34972
1/4	3/4	2-1/2	1/4	34917	34973
1/4	1	3	1/4	34918	34974
3/8	1/2	2	3/8	34919	34975
3/8	1	2-1/2	3/8	34920	34976
3/8	1-1/2	3-1/2	3/8	34921	34977
1/2	5/8	2-1/2	1/2	34922	34978
1/2	1	3	1/2	34923	34979
1/2	1-1/4	3	1/2	34924	34980
1/2	1-5/8	4	1/2	34925	34981
1/2	2	4	1/2	34926	34982
5/8	3/4	3	5/8	34927	34983
5/8	1-5/8	4	5/8	34928	34984
3/4	1	3	3/4	34929	34985
3/4	1-5/8	4	3/4	34930	34986
3/4	2-1/4	5	3/4	34931	34987
1	1-1/4	4	1	34932	34988
1	2	5	1	34933	34989
1	3-1/4	6	1	34934	34990

RE = 1/2 Cutting Diameter (DC)

TOLERANCES (inch)

- 1/4–3/8 DIAMETER**
 DC = +0.0000/–0.00035
 DCON = h₆
 RE = +0.0005/–0.0005
- 1/2–5/8 DIAMETER**
 DC = +0.0000/–0.00043
 DCON = h₆
 RE = +0.0005/–0.0005
- 3/4–1 DIAMETER**
 DC = +0.0000/–0.00051
 DCON = h₆
 RE = +0.0005/–0.0005

NON-FERROUS

For patent information visit www.ksptpatents.com

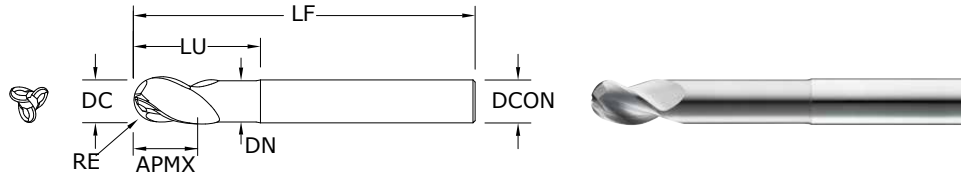
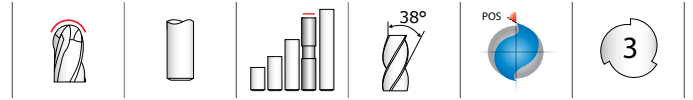

43LB
FRACTIONAL SERIES

TOLERANCES (inch)

1/4–3/8 DIAMETER

DC = +0.0000/–0.00035

DCON = h_6

RE = +0.0005/–0.0005

1/2–5/8 DIAMETER

DC = +0.0000/–0.00043

DCON = h_6

RE = +0.0005/–0.0005

3/4–1 DIAMETER

DC = +0.0000/–0.00051

DCON = h_6

RE = +0.0005/–0.0005

CUTTING DIAMETER DC	LENGTH OF CUT APMX	OVERALL LENGTH LF	SHANK DIAMETER DCON	REACH LU	NECK DIAMETER DN	EDP NO.	
						UNCOATED	Ti-NAMITE®-B (TiB ₂)
1/4	3/8	2-1/2	1/4	3/4	.230	34941	35005
3/8	1/2	3	3/8	1-1/8	.355	34943	35007
1/2	5/8	3	1/2	1-3/8	.480	34945	35009
1/2	5/8	4	1/2	2-1/4	.480	34946	35010
5/8	3/4	4	5/8	1-5/8	.605	34949	35013
3/4	1	4	3/4	2	.730	34951	35015
1	1-1/4	5	1	2-5/8	.980	34954	35018
1	1-1/4	6	1	3-3/8	.980	34955	35019

RE = 1/2 Cutting Diameter (DC)

- Circular land allows for increased control at various speed and feed rates and reduces chatter
- Open fluting for deep slotting and profiling
- Necked design with blended diameter transitions provide clearance to reach
- Ball end design ideal for finishing operations in complex workpieces
- Recommended for materials ≤ 150 Bhn (≤ 7 HRC)

NON-FERROUS

For patent information visit www.ksptpatents.com

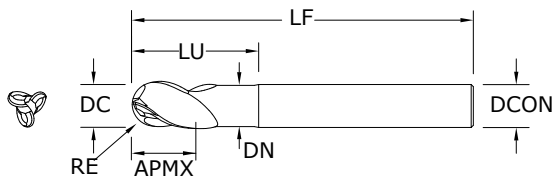
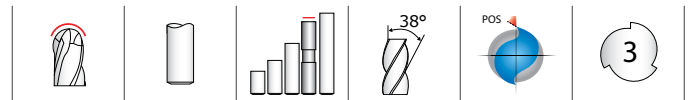

43EB
FRACTIONAL SERIES

TOLERANCES (inch)

1/4–3/8 DIAMETER

DC = +0.0000/–0.00035

DCON = h_6

RE = +0.0005/–0.0005

1/2–5/8 DIAMETER

DC = +0.0000/–0.00043

DCON = h_6

RE = +0.0005/–0.0005

3/4–1 DIAMETER

DC = +0.0000/–0.00051

DCON = h_6

RE = +0.0005/–0.0005

CUTTING DIAMETER DC	LENGTH OF CUT APMX	OVERALL LENGTH LF	SHANK DIAMETER DCON	REACH LU	NECK DIAMETER DN	EDP NO.	
						UNCOATED	Ti-NAMITE®-B (TiB ₂)
1/4	3/8	3	1/4	1-1/8	.230	34942	35006
3/8	1/2	4	3/8	2-1/8	.355	34944	35008
1/2	5/8	5	1/2	3-3/8	.480	34947	35011
1/2	5/8	6	1/2	4-1/4	.480	34948	35012
5/8	3/4	6	5/8	3-3/8	.605	34950	35014
3/4	1	6	3/4	3-3/8	.730	34952	35016
1	1-1/4	7	1	4-3/8	.980	34956	35020

RE = 1/2 Cutting Diameter (DC)

- Circular land allows for increased control at various speed and feed rates and reduces chatter
- Open fluting for deep slotting and profiling
- Necked design with blended diameter transitions provide clearance to reach
- Ball end design ideal for finishing operations in complex workpieces
- Recommended for materials ≤ 150 Bhn (≤ 7 HRC)

NON-FERROUS

For patent information visit www.ksptpatents.com



43CB
FRACTIONAL SERIES

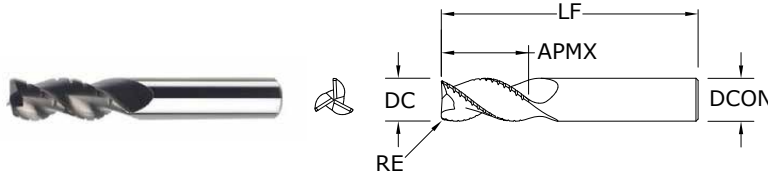

- Circular land allows for increased control at various speed and feed rates and reduces chatter
- Symmetrical end gashing for excellent balance at high speeds and aggressive plunging capability
- Chip breakers reduce machine loads up to 15% for increased roughing feed rate capability
- Open fluting for deep slotting and profiling
- Recommended for materials ≤ 150 Bhn (≤ 7 HRC)

CUTTING DIAMETER DC	LENGTH OF CUT APMX	inch			EDP NO.	
		OVERALL LENGTH LF	SHANK DIAMETER DCON	CORNER RADIUS RE	UNCOATED	Ti-NAMITE®-B (TiB ₂)
1/4	3/8	2-1/2	1/4	.020	33390	33450
1/4	1/2	2-1/2	1/4	.020	33391	33451
1/4	3/4	2-1/2	1/4	.020	33392	33452
1/4	1	3	1/4	.020	33393	33453
1/4	1-1/4	3-1/2	1/4	.020	33394	33454
1/4	1-3/4	4	1/4	.020	33395	33455
5/16	7/16	2-1/2	5/16	.020	33396	33456
5/16	11/16	2-1/2	5/16	.020	33397	33457
5/16	1	3	5/16	.020	33398	33458
5/16	2-1/8	4	5/16	.020	33400	33460
3/8	1/2	3	3/8	.020	33401	33461
3/8	1	2-1/2	3/8	.020	33400	33405
3/8	1-1/4	3-1/2	3/8	.020	33402	33462
3/8	1-1/2	4	3/8	.020	33403	33463
3/8	2	4	3/8	.020	33404	33464
1/2	5/8	3	1/2	.030	33406	33466
1/2	1	3	1/2	.030	33407	33467
1/2	1-1/4	3-1/4	1/2	.030	33401	33406
1/2	1-5/8	4	1/2	.030	33408	33468
1/2	2	4	1/2	.030	33409	33469
1/2	2-1/2	5	1/2	.030	33410	33470
1/2	3-1/8	6	1/2	.030	33411	33471
5/8	3/4	3-1/2	5/8	.030	33412	33472
5/8	1-5/8	3-3/4	5/8	.030	33402	33407
5/8	2-1/8	4	5/8	.030	33413	33473
5/8	3-1/4	6	5/8	.030	33415	33475
5/8	3-3/4	6	5/8	.030	33416	33476
3/4	1	4	3/4	.030	33417	33477
3/4	1-5/8	4	3/4	.030	33403	33408
3/4	2-1/4	5	3/4	.030	33418	33478
3/4	3-1/4	6	3/4	.030	33419	33479
3/4	4	6	3/4	.030	33420	33480
1	1-1/4	5	1	.030	33421	33481
1	2	4-1/2	1	.030	33404	33409
1	2-5/8	6	1	.030	33422	33482
1	3-1/4	6	1	.030	33423	33483
1	4-1/8	7	1	.030	33424	33484

TOLERANCES (inch)

- 1/4–3/8 DIAMETER**
DC = +0.0000/–0.00035
DCON = h₆
RE = +0.0000/–0.0020
- 1/2–5/8 DIAMETER**
DC = +0.0000/–0.00043
DCON = h₆
RE = +0.0000/–0.0020
- 3/4–1 DIAMETER**
DC = +0.0000/–0.00051
DCON = h₆
RE = +0.0000/–0.0020

NON-FERROUS

For patent information visit www.ksptpatents.com

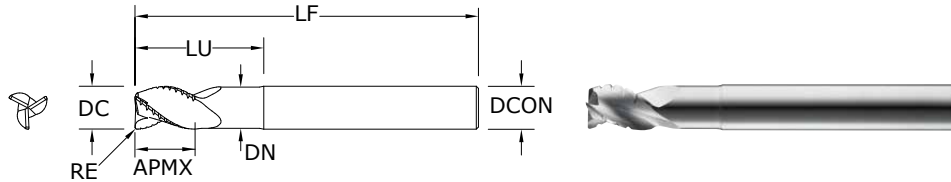

43LCB
FRACTIONAL SERIES

TOLERANCES (inch)

1/4–3/8 DIAMETER

DC = +0.0000/–0.00035

DCON = h_6

RE = +0.0000/–0.0020

1/2–5/8 DIAMETER

DC = +0.0000/–0.00043

DCON = h_6

RE = +0.0000/–0.0020

3/4–1 DIAMETER

DC = +0.0000/–0.00051

DCON = h_6

RE = +0.0000/–0.0020

NON-FERROUS

For patent information visit
www.ksptpatents.com

CUTTING DIAMETER DC	LENGTH OF CUT APMX	OVERALL LENGTH LF	inch				CORNER RADIUS RE	EDP NO.	
			SHANK DIAMETER DCON	REACH LU	NECK DIAMETER DN	UNCOATED		Ti-NAMITE®-B (TiB ₂)	
1/4	3/8	4	1/4	3/4	.230	.020	33500	33540	
1/4	3/8	4	1/4	1-1/8	.230	.020	33501	33541	
1/4	3/8	4	1/4	2-1/8	.230	.020	33502	33542	
5/16	7/16	4	5/16	1-1/8	.292	.020	33503	33543	
5/16	7/16	4	5/16	2-1/8	.292	.020	33504	33544	
3/8	1/2	4	3/8	1-1/8	.355	.020	33507	33547	
3/8	1/2	4	3/8	2-1/8	.355	.020	33508	33548	
1/2	5/8	4	1/2	1-3/8	.480	.030	33511	33551	
1/2	5/8	4	1/2	2-1/4	.480	.030	–	33552	
1/2	5/8	6	1/2	3-3/8	.480	.030	33513	33553	
1/2	5/8	6	1/2	4-1/4	.480	.030	33514	33554	
5/8	3/4	4	5/8	1-5/8	.605	.030	33515	33555	
5/8	3/4	6	5/8	2-3/8	.605	.030	33516	33556	
5/8	3/4	6	5/8	3-3/8	.605	.030	33517	33557	
5/8	3/4	6	5/8	4-3/8	.605	.030	33518	33558	
3/4	1	4	3/4	2	.730	.030	33519	33559	
3/4	1	6	3/4	2-1/2	.730	.030	33520	33560	
3/4	1	6	3/4	3-3/8	.730	.030	33521	33561	
3/4	1	6	3/4	4-3/8	.730	.030	33522	33562	
1	1-1/4	6	1	2-5/8	.980	.030	33523	33563	
1	1-1/4	6	1	3-3/8	.980	.030	33524	33564	
1	1-1/4	7	1	4-3/8	.980	.030	33525	33565	

- Circular land allows for increased control at various speed and feed rates and reduces chatter
- Symmetrical end gashing for excellent balance at high speeds and aggressive plunging capability
- Chip breakers reduce machine loads up to 15% for increased roughing feed rate capability
- Open fluting for deep slotting and profiling
- Necked design with blended diameter transitions provide clearance to reach
- Recommended for materials ≤ 150 Bhn (≤ 7 HRC)

Series
43CR, 43CB, 43LC,
43, 43L, 43LCB, 43B,
43LB, 43ELB, 43EC
Fractional

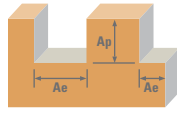

Hardness	Ae x DC	Ap x DC	Vc (sfm)	DC • in									
				1/8	1/4	3/8	1/2	5/8	3/4	1			
ALUMINUM ALLOYS 2024, 5052, 5086, 6061, 6073, 7075	Slot 	1	≤ 1	1600	RPM	48896	24448	16299	12224	9779	8149	6112	
				(1280-1920)	Fz	0.0009	0.0025	0.0045	0.0060	0.0065	0.0070	0.0085	
					Feed (ipm)	132	183	220	220	191	171	156	
	≤ 150 Bhn or ≤ 88 HRb	Profile 	≤ 0.5	≤ 1.5	2000	RPM	61120	30560	20373	15280	12224	10187	7640
					(1600-2400)	Fz	0.0009	0.0025	0.0045	0.0060	0.0065	0.0070	0.0085
						Feed (ipm)	165	229	275	275	238	214	195
	HSM 	≤ 0.05	≤ 2	(2640-3960)	3300	RPM	100848	50424	33616	25212	20170	16808	12606
						Fz	0.0021	0.0055	0.0105	0.0140	0.0150	0.0165	0.0195
						Feed (ipm)	635	832	1059	1059	908	832	737
ALUMINUM DIE CAST ALLOYS (HIGH SILICONE) A-390, A-392, B-390	Slot 	1	≤ 1	600	RPM	18336	9168	6112	4584	3667	3056	2292	
				(480-720)	Fz	0.0009	0.0025	0.0045	0.0060	0.0065	0.0070	0.0085	
					Feed (ipm)	50	69	83	83	72	64	58	
	≤ 125 Bhn or ≤ 77 HRb	Profile 	≤ 0.5	≤ 1.5	750	RPM	22920	11460	7640	5730	4584	3820	2865
					(600-900)	Fz	0.0009	0.0025	0.0045	0.0060	0.0065	0.0070	0.0085
						Feed (ipm)	62	86	103	103	89	80	73
	HSM 	≤ 0.05	≤ 2	(992-1488)	1240	RPM	37894	18947	12631	9474	7579	6316	4737
						Fz	0.0021	0.0055	0.0105	0.0140	0.0150	0.0165	0.0195
						Feed (ipm)	239	313	398	398	341	313	277
COPPER ALLOYS Aluminum Bronze Brass Naval Brass Red Brass	Slot 	1	≤ 1	865	RPM	26434	13217	8811	6609	5287	4406	3304	
				(692-1038)	Fz	0.0008	0.0020	0.0040	0.0050	0.0055	0.0060	0.0070	
					Feed (ipm)	63	79	106	99	87	79	69	
	≤ 140 Bhn or ≤ 3 HRc	Profile 	≤ 0.5	≤ 1.5	1080	RPM	33005	16502	11002	8251	6601	5501	4126
					(864-1296)	Fz	0.0008	0.0020	0.0040	0.0050	0.0055	0.0060	0.0070
						Feed (ipm)	79	99	132	124	109	99	87
	HSM 	≤ 0.05	≤ 2	(1424-2136)	1780	RPM	54397	27198	18132	13599	10879	9066	6800
						Fz	0.0017	0.0045	0.0085	0.0115	0.0125	0.0140	0.0160
						Feed (ipm)	277	367	462	469	408	381	326
COPPER ALLOYS Beryllium Copper C110, Malleable Bronze, Tin Bronze	Slot 	1	≤ 1	345	RPM	10543	5272	3514	2636	2109	1757	1318	
				(276-414)	Fz	0.0008	0.0020	0.0040	0.0050	0.0055	0.0060	0.0070	
					Feed (ipm)	25	32	42	40	35	32	28	
	≤ 200 Bhn or ≤ 23 HRc	Profile 	≤ 0.5	≤ 1.5	430	RPM	13141	6570	4380	3285	2628	2190	1643
					(344-516)	Fz	0.0008	0.0020	0.0040	0.0050	0.0055	0.0060	0.0070
						Feed (ipm)	32	39	53	49	43	39	34
	HSM 	≤ 0.05	≤ 2	(568-852)	710	RPM	21698	10849	7233	5424	4340	3616	2712
						Fz	0.0017	0.0045	0.0085	0.0115	0.0125	0.0140	0.0160
						Feed (ipm)	111	146	184	187	163	152	130
PLASTICS ABS, Polycarbonate, PVC, Polypropylene	Slot 	1	≤ 1	1600	RPM	48896	24448	16299	12224	9779	8149	6112	
				(1280-1920)	Fz	0.0015	0.0040	0.0075	0.0100	0.0110	0.0120	0.0140	
					Feed (ipm)	220	293	367	367	323	293	257	
	Profile 	≤ 0.5	≤ 1.5	(1600-2400)	2000	RPM	61120	30560	20373	15280	12224	10187	7640
						Fz	0.0015	0.0040	0.0075	0.0100	0.0110	0.0120	0.0140
						Feed (ipm)	275	367	458	458	403	367	321
	HSM 	≤ 0.05	≤ 2	(2640-3960)	3300	RPM	100848	50424	33616	25212	20170	16808	12606
						Fz	0.0034	0.0090	0.0170	0.0230	0.0250	0.0275	0.0320
						Feed (ipm)	1029	1361	1714	1740	1513	1387	1210

Bhn (Brinell) HRc (Rockwell C) HRb (Rockwell B) HSM (High Speed Machining)
 $rpm = Vc \times 3.82 / DC$
 $ipm = Fz \times 3 \times rpm$
 reduce speed and feed for materials harder than listed
 reduce cut depth and feed by 50% for long flute and long reach tools
 reduce feed and Ae when finish milling (.02 x DC maximum)
 refer to the SGS Tool Wizard® for complete technical information (www.kyocera-sgstool.com)

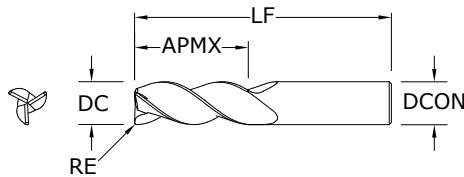
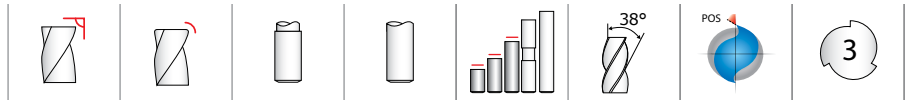

**43M •
43MCR**
METRIC SERIES

TOLERANCES (mm)

≤6 DIAMETER

DC = +0,000/-0,008

DCON = h₆

RE = +0,000/-0,050

>6-10 DIAMETER

DC = +0,000/-0,009

DCON = h₆

RE = +0,000/-0,050

>10-18 DIAMETER

DC = +0,000/-0,011

DCON = h₆

RE = +0,000/-0,050

>18-20 DIAMETER

DC = +0,000/-0,013

DCON = h₆

RE = +0,000/-0,050

NON-FERROUS

For patent information visit
www.ksptpatents.com

CUTTING DIAMETER DC	LENGTH OF CUT APMX	mm			EDP NO.	
		OVERALL LENGTH LF	SHANK DIAMETER DCON	CORNER RADIUS RE	UNCOATED	Ti-NAMITE®-B (TiB ₂)
3,0	8,0	52,0	6,0	—	—	44890
4,0	11,0	55,0	6,0	—	—	44891
5,0	13,0	57,0	6,0	—	—	44892
6,0	13,0	57,0	6,0	—	44701	44715
6,0	13,0	57,0	6,0	1,5	—	44732
6,0	13,0	57,0	6,0	0,5	—	44902
6,0	13,0	57,0	6,0	1,0	—	44894
6,0	13,0	72,0	6,0	—	44702	44716
6,0	13,0	72,0	6,0	0,8	—	44842
6,0	13,0	72,0	6,0	1,2	—	44843
6,0	24,0	75,0	6,0	—	—	44893
6,0	24,0	75,0	6,0	0,5	—	44844
6,0	24,0	75,0	6,0	1,0	—	44845
8,0	19,0	63,0	8,0	—	44703	44717
8,0	19,0	63,0	8,0	0,3	—	44846
8,0	19,0	63,0	8,0	0,5	—	44847
8,0	19,0	63,0	8,0	1,0	—	44848
8,0	19,0	63,0	8,0	1,5	—	44849
8,0	32,0	75,0	8,0	—	—	44895
8,0	32,0	75,0	8,0	0,5	—	44850
8,0	32,0	75,0	8,0	1,0	—	44851
8,0	32,0	75,0	8,0	1,5	—	44852
8,0	32,0	75,0	8,0	2,0	—	44853
10,0	22,0	72,0	10,0	—	44705	44719
10,0	22,0	72,0	10,0	0,3	—	44854
10,0	22,0	72,0	10,0	0,5	—	44855
10,0	22,0	72,0	10,0	1,0	—	44856
10,0	22,0	72,0	10,0	1,5	—	44857
10,0	40,0	100,0	10,0	—	—	44896
10,0	40,0	100,0	10,0	0,5	—	44858

continued on next page

- Circular land allows for increased control at various speed and feed rates and reduces chatter
- Symmetrical end gashing for excellent balance at high speeds and aggressive plunging capability
- Open fluting for deep slotting and profiling
- Enhanced corner geometry with tight tolerance corner radii
- Recommended for materials ≤ 150 Bhn (≤ 7 HRC)

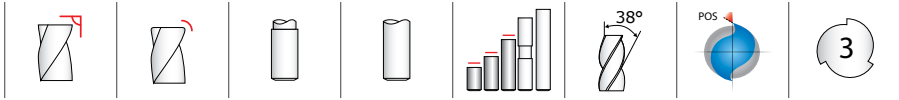

**43M •
43MCR**
METRIC SERIES

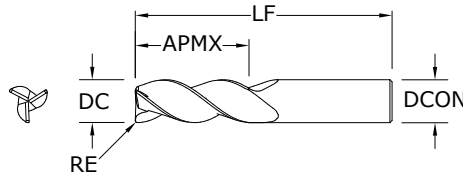

CONTINUED

CUTTING DIAMETER DC	LENGTH OF CUT APMX	mm			EDP NO.	
		OVERALL LENGTH LF	SHANK DIAMETER DCON	CORNER RADIUS RE	UNCOATED	Ti-NAMITE®-B (TiB ₂)
10,0	40,0	100,0	10,0	1,0	—	44859
10,0	40,0	100,0	10,0	1,5	—	44860
10,0	40,0	100,0	10,0	2,0	—	44861
12,0	26,0	83,0	12,0	—	44708	44722
12,0	26,0	83,0	12,0	1,5	44814	44733
12,0	26,0	83,0	12,0	2,0	44815	44826
12,0	26,0	83,0	12,0	2,5	44816	44827
12,0	26,0	83,0	12,0	3,0	44817	44734
12,0	48,0	100,0	12,0	—	—	44897
12,0	48,0	100,0	12,0	0,5	—	44862
12,0	48,0	100,0	12,0	1,0	—	44863
12,0	48,0	100,0	12,0	1,5	—	44864
12,0	48,0	100,0	12,0	2,0	—	44865
12,0	48,0	100,0	12,0	2,5	—	44866
12,0	48,0	100,0	12,0	3,0	—	44867
14,0	30,0	89,0	14,0	—	—	44898
14,0	30,0	89,0	14,0	1,0	—	44868
14,0	30,0	89,0	14,0	2,0	—	44869
14,0	30,0	89,0	14,0	3,0	—	44870
16,0	32,0	92,0	16,0	—	44711	44725
16,0	32,0	92,0	16,0	1,5	44818	44735
16,0	32,0	92,0	16,0	2,0	44819	44828
16,0	32,0	92,0	16,0	2,5	44820	44829
16,0	32,0	92,0	16,0	3,0	44821	44736
16,0	32,0	92,0	16,0	4,0	—	44871
16,0	64,0	125,0	16,0	—	—	44900
16,0	64,0	125,0	16,0	0,5	—	44872
16,0	64,0	125,0	16,0	1,0	—	44873
16,0	64,0	125,0	16,0	1,5	—	44874
16,0	64,0	125,0	16,0	2,0	—	44875
16,0	64,0	125,0	16,0	2,5	—	44876
16,0	64,0	125,0	16,0	3,0	—	44877

continued on next page

TOLERANCES (mm)

≤6 DIAMETER

DC = +0,000/-0,008

DCON = h₆

RE = +0,000/-0,050

>6-10 DIAMETER

DC = +0,000/-0,009

DCON = h₆

RE = +0,000/-0,050

>10-18 DIAMETER

DC = +0,000/-0,011

DCON = h₆

RE = +0,000/-0,050

>18-20 DIAMETER

DC = +0,000/-0,013

DCON = h₆

RE = +0,000/-0,050

NON-FERROUS

For patent information visit www.ksptpatents.com

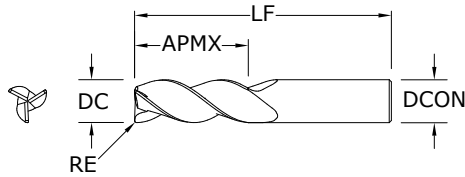
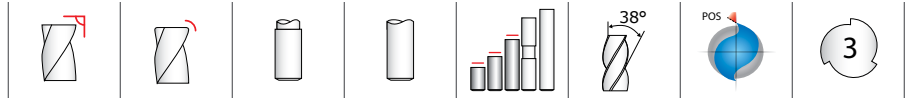

**43M •
43MCR**
METRIC SERIES

CUTTING DIAMETER DC	LENGTH OF CUT APMX	mm			EDP NO.	
		OVERALL LENGTH LF	SHANK DIAMETER DCON	CORNER RADIUS RE	UNCOATED	Ti-NAMITE®-B (TiB ₂)
16,0	64,0	125,0	16,0	4,0	—	44878
20,0	38,0	104,0	20,0	—	44714	44728
20,0	38,0	104,0	20,0	2,0	44822	44830
20,0	38,0	104,0	20,0	2,5	44823	44831
20,0	38,0	104,0	20,0	3,0	44824	44737
20,0	38,0	104,0	20,0	4,0	—	44879
20,0	80,0	150,0	20,0	—	—	44901
20,0	80,0	150,0	20,0	0,5	—	44880
20,0	80,0	150,0	20,0	1,0	—	44881
20,0	80,0	150,0	20,0	1,5	—	44882
20,0	80,0	150,0	20,0	2,0	—	44883
20,0	80,0	150,0	20,0	2,5	—	44884
20,0	80,0	150,0	20,0	3,0	—	44885
20,0	80,0	150,0	20,0	4,0	—	44886
25,0	50,0	125,0	25,0	—	—	44731

CONTINUED

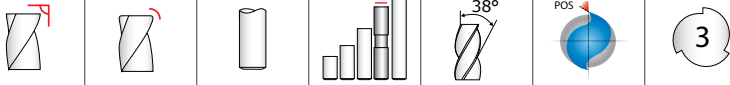

**43ML •
43MLC**
METRIC SERIES

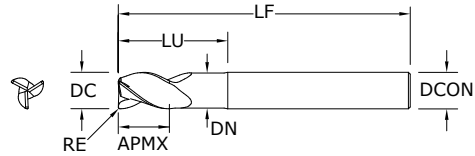

- Circular land allows for increased control at various speed and feed rates and reduces chatter
- Symmetrical end gashing for excellent balance at high speeds and aggressive plunging capability
- Open fluting for deep slotting and profiling
- Necked design with blended diameter transitions provide clearance to reach
- Enhanced corner geometry with tight tolerance corner radii
- Recommended for materials ≤ 150 Bhn (≤ 7 HRC)

CUTTING DIAMETER DC	LENGTH OF CUT APMX	OVERALL LENGTH LF	mm				EDP NO.	
			SHANK DIAMETER DCON	REACH LU	NECK DIAMETER DN	CORNER RADIUS RE	UNCOATED	Ti-NAMITE®-B (TiB ₂)
6,0	10,0	63,0	6,0	20,0	5,49	0,5	44769	44789
6,0	10,0	63,0	6,0	20,0	5,49	1,0	44770	44790
6,0	10,0	75,0	6,0	20,0	5,49	–	–	42706
6,0	13,0	72,0	6,0	30,0	5,49	0,5	44771	44791
6,0	13,0	72,0	6,0	30,0	5,49	1,0	44772	44792
8,0	12,0	75,0	8,0	25,0	7,49	–	–	42707
8,0	12,0	75,0	8,0	25,0	7,49	0,3	44773	44793
8,0	12,0	75,0	8,0	25,0	7,49	0,5	44774	44794
8,0	12,0	75,0	8,0	25,0	7,49	0,8	–	44950
8,0	12,0	75,0	8,0	25,0	7,49	1,0	44775	44795
8,0	12,0	75,0	8,0	25,0	7,49	1,2	–	44951
8,0	12,0	75,0	8,0	25,0	7,49	1,5	44776	44796
8,0	12,0	75,0	8,0	25,0	7,49	1,6	–	44952
10,0	14,0	100,0	10,0	35,0	9,48	–	–	42708
10,0	14,0	100,0	10,0	35,0	9,48	0,3	44777	44797
10,0	14,0	100,0	10,0	35,0	9,48	0,5	44778	44798
10,0	14,0	100,0	10,0	35,0	9,48	1,0	44779	44799
10,0	14,0	100,0	10,0	35,0	9,48	1,5	44780	44800
10,0	14,0	100,0	10,0	35,0	9,50	0,8	–	44953
10,0	14,0	100,0	10,0	35,0	9,50	1,2	–	44954
10,0	14,0	100,0	10,0	35,0	9,50	1,6	–	44955
10,0	14,0	100,0	10,0	35,0	9,50	2,4	–	44956
12,0	16,0	100,0	12,0	40,0	11,48	–	–	42709
12,0	16,0	100,0	12,0	40,0	11,48	0,5	44781	44801
12,0	16,0	100,0	12,0	40,0	11,48	0,8	–	44957
12,0	16,0	100,0	12,0	40,0	11,48	1,0	44782	44802
12,0	16,0	100,0	12,0	40,0	11,48	1,2	–	44958
12,0	16,0	100,0	12,0	40,0	11,48	1,5	44783	44803
12,0	16,0	100,0	12,0	40,0	11,48	1,6	–	44959
12,0	16,0	100,0	12,0	40,0	11,48	2,0	44784	44804
12,0	16,0	100,0	12,0	40,0	11,48	2,4	–	44960
12,0	16,0	100,0	12,0	40,0	11,48	2,5	44832	44839
12,0	16,0	100,0	12,0	40,0	11,48	3,0	44833	44738
12,0	16,0	100,0	12,0	40,0	11,48	4,0	44834	44741

TOLERANCES (mm)

- 6 DIAMETER**
DC = +0,000/-0,008
DCON = h₆
- >6-10 DIAMETER**
DC = +0,000/-0,009
DCON = h₆
RE = +0,000/-0,050
- >10-18 DIAMETER**
DC = +0,000/-0,011
DCON = h₆
RE = +0,000/-0,050
- >18-20 DIAMETER**
DC = +0,000/-0,013
DCON = h₆
RE = +0,000/-0,050

NON-FERROUS

For patent information visit www.kspatents.com

continued on next page

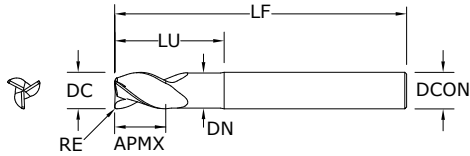
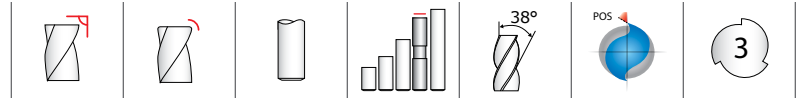

**43ML •
43MLC**
METRIC SERIES

CUTTING DIAMETER DC	LENGTH OF CUT APMX	OVERALL LENGTH LF	mm				EDP NO.	
			SHANK DIAMETER DCON	REACH LU	NECK DIAMETER DN	CORNER RADIUS RE	UNCOATED	Ti-NAMITE®-B (TiB ₂)
14,0	18,0	125,0	14,0	45,0	13,49	–	–	44899
14,0	18,0	125,0	14,0	45,0	13,49	1,0	–	44961
14,0	18,0	125,0	14,0	45,0	13,49	2,0	–	44962
14,0	18,0	125,0	14,0	45,0	13,49	3,0	–	44963
14,0	18,0	125,0	14,0	45,0	13,49	4,0	–	44964
16,0	20,0	125,0	16,0	50,0	15,47	–	–	42710
16,0	20,0	125,0	16,0	50,0	15,47	2,0	44785	44805
16,0	20,0	125,0	16,0	50,0	15,47	2,5	44835	44840
16,0	20,0	125,0	16,0	50,0	15,47	3,0	44836	44739
16,0	20,0	125,0	16,0	50,0	15,47	4,0	44786	44806
16,0	20,0	125,0	16,0	50,0	15,49	0,8	–	44965
16,0	20,0	125,0	16,0	50,0	15,49	1,2	–	44966
16,0	20,0	125,0	16,0	50,0	15,49	1,6	–	44967
16,0	20,0	125,0	16,0	50,0	15,49	2,4	–	44968
16,0	20,0	125,0	16,0	50,0	15,49	3,2	–	44969
20,0	25,0	150,0	20,0	65,0	19,46	–	–	42711
20,0	25,0	150,0	20,0	65,0	19,46	2,0	44787	44807
20,0	25,0	150,0	20,0	65,0	19,46	2,4	–	44973
20,0	25,0	150,0	20,0	65,0	19,46	2,5	44837	44841
20,0	25,0	150,0	20,0	65,0	19,46	3,0	44838	44740
20,0	25,0	150,0	20,0	65,0	19,46	4,0	44788	44808
20,0	25,0	150,0	20,0	65,0	19,48	0,8	–	44970
20,0	25,0	150,0	20,0	65,0	19,48	1,2	–	44971
20,0	25,0	150,0	20,0	65,0	19,48	1,6	–	44972
20,0	25,0	150,0	20,0	65,0	19,48	3,2	–	44974

CONTINUED

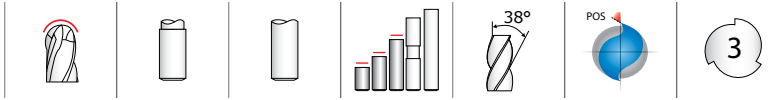

43MB
METRIC SERIES

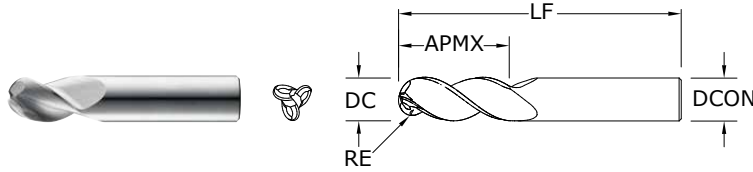

- Circular land allows for increased control at various speed and feed rates and reduces chatter
- Open fluting for deep slotting and profiling
- Ball end design ideal for finishing operations in complex workpieces
- Recommended for materials ≤ 150 Bhn (≤ 7 HRC)

mm				EDP NO.
CUTTING DIAMETER DC	LENGTH OF CUT APMX	OVERALL LENGTH LF	SHANK DIAMETER DCON	Ti-NAMITE®-B (TiB ₂)
3,0	4,5	57,0	6,0	44916
4,0	6,0	57,0	6,0	44919
5,0	7,5	57,0	6,0	44922
6,0	9,0	57,0	6,0	44925
8,0	12,0	63,0	8,0	44928
10,0	15,0	75,0	10,0	44931
12,0	18,0	83,0	12,0	44934
16,0	24,0	100,0	16,0	44937
20,0	30,0	108,0	20,0	44940
25,0	37,5	127,0	25,0	44943

RE = 1/2 Cutting Diameter (DC)

TOLERANCES (mm)

- 3 DIAMETER**
DC = +0,000/-0,006
DCON = h₆
RE = +0,0127/-0,0127
- >3-6 DIAMETER**
DC = +0,000/-0,008
DCON = h₆
RE = +0,0127/-0,0127
- >6-10 DIAMETER**
DC = +0,000/-0,009
DCON = h₆
RE = +0,0127/-0,0127
- >10-18 DIAMETER**
DC = +0,000/-0,011
DCON = h₆
RE = +0,0127/-0,0127
- >18-25 DIAMETER**
DC = +0,000/-0,013
DCON = h₆
RE = +0,0127/-0,0127

NON-FERROUS

For patent information visit www.ksptpatents.com

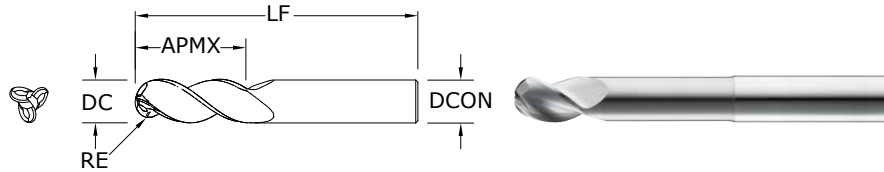
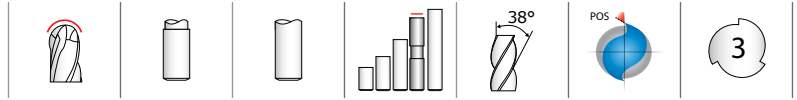

43MB
METRIC SERIES

TOLERANCES (mm)

3 DIAMETER

DC = +0,000/-0,006

DCON = h₆

RE = +0,0127/-0,0127

>3-6 DIAMETER

DC = +0,000/-0,008

DCON = h₆

RE = +0,0127/-0,0127

>6-10 DIAMETER

DC = +0,000/-0,009

DCON = h₆

RE = +0,0127/-0,0127

>10-18 DIAMETER

DC = +0,000/-0,011

DCON = h₆

RE = +0,0127/-0,0127

>18-25 DIAMETER

DC = +0,000/-0,013

DCON = h₆

RE = +0,0127/-0,0127

NON-FERROUS

For patent information visit www.ksptpatents.com

mm							EDP NO.
CUTTING DIAMETER DC	LENGTH OF CUT APMX	OVERALL LENGTH LF	SHANK DIAMETER DCON	REACH LU	NECK DIAMETER DN	Ti-NAMITE®-B (TiB ₂)	
3,0	6,0	57,0	6,0	10,0	2,74	44917	
3,0	9,0	57,0	6,0	16,0	2,74	44918	
4,0	8,0	57,0	6,0	13,0	3,73	44920	
4,0	12,0	57,0	6,0	21,0	3,73	44921	
5,0	10,0	63,0	6,0	16,0	4,50	44923	
5,0	15,0	63,0	6,0	26,0	4,50	44924	
6,0	12,0	63,0	6,0	19,0	5,49	44926	
6,0	18,0	75,0	6,0	31,0	5,49	44927	
8,0	16,0	75,0	8,0	25,0	7,49	44929	
8,0	24,0	83,0	8,0	41,0	7,49	44930	
10,0	20,0	83,0	10,0	31,0	9,50	44932	
10,0	30,0	100,0	10,0	51,0	9,50	44933	
12,0	24,0	100,0	12,0	37,0	11,48	44935	
12,0	36,0	130,0	12,0	61,0	11,48	44936	
16,0	32,0	130,0	16,0	49,0	15,49	44938	
16,0	48,0	150,0	16,0	81,0	15,49	44939	
20,0	40,0	130,0	20,0	61,0	19,48	44941	
20,0	60,0	150,0	20,0	101,0	19,48	44942	
25,0	50,0	152,0	25,0	76,0	24,49	44944	
25,0	75,0	170,0	25,0	126,0	24,49	44945	

RE = 1/2 Cutting Diameter (DC)

- Circular land allows for increased control at various speed and feed rates and reduces chatter
- Open fluting for deep slotting and profiling
- Ball end design ideal for finishing operations in complex workpieces
- Recommended for materials ≤ 150 Bhn (≤ 7 HRC)

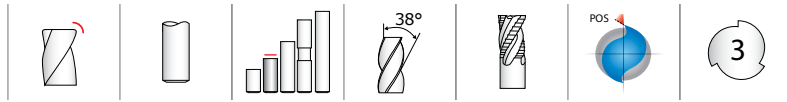

43MCB
METRIC SERIES

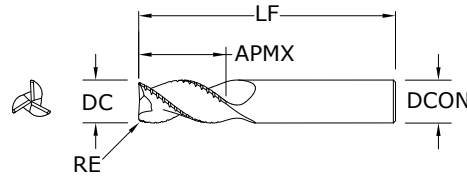

- Circular land allows for increased control at various speed and feed rates and reduces chatter
- Symmetrical end gashing for excellent balance at high speeds and aggressive plunging capability
- Chip breakers reduce machine loads up to 15% for increased roughing feed rate capability
- Open fluting for deep slotting and profiling
- Recommended for materials ≤ 150 Bhn (≤ 7 HRC)

CUTTING DIAMETER DC	LENGTH OF CUT APMX	mm			EDP NO.	
		OVERALL LENGTH LF	SHANK DIAMETER DCON	CORNER RADIUS RE	UNCOATED	Ti-NAMITE®-B (TiB ₂)
6,0	19,0	63,0	6,0	0,5	44298	44299
8,0	19,0	63,0	8,0	0,3	44300	44305
10,0	22,0	72,0	10,0	0,3	44301	44306
12,0	26,0	83,0	12,0	1,0	44302	44307
16,0	32,0	92,0	16,0	1,0	44303	44308
20,0	38,0	104,0	20,0	1,0	44304	44309

TOLERANCES (mm)

- >6–10 DIAMETER**
DC = +0,000/–0,009
DCON = h₆
RE = +0,000/–0,050
- >10–18 DIAMETER**
DC = +0,000/–0,011
DCON = h₆
RE = +0,000/–0,050
- >18–20 DIAMETER**
DC = +0,000/–0,013
DCON = h₆
RE = +0,000/–0,050

NON-FERROUS

For patent information visit www.ksptpatents.com

Series
43M, 43MB, 43MCR,
43ML, 43MLC,
43MCB
Metric

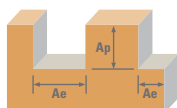

Metric	Hardness	Ae x DC	Ap x DC	Vc (m/min)	DC • mm								
					3	6	10	12	16	20	25		
ALUMINUM ALLOYS 2024, 5052, 5086, 6061, 6073, 7075	≤ 150 Bhn or ≤ 88 HRb	Slot 	1	≤ 1	490	RPM	52022	26011	15607	13005	9754	7803	6243
					(392-588)	Fz	0.022	0.060	0.120	0.144	0.166	0.187	0.213
						Feed (mm/min)	3371	4682	5618	5618	4869	4370	3980
	Profile 	≤ 0.5	≤ 1.5	610	RPM	64762	32381	19429	16190	12143	9714	7771	
				(488-732)	Fz	0.022	0.060	0.120	0.144	0.166	0.187	0.213	
					Feed (mm/min)	4196	5828	6994	6994	6061	5440	4955	
	HSM 	≤ 0.05	≤ 2	1005	RPM	106698	53349	32009	26674	20006	16005	12804	
				(804-1206)	Fz	0.050	0.132	0.280	0.336	0.384	0.440	0.488	
					Feed (mm/min)	16131	21124	26888	26885	23046	21126	18726	
ALUMINUM DIE CAST ALLOYS (HIGH SILICONE) A-390, A-392, B-390	≤ 125 Bhn or ≤ 77 HRb	Slot 	1	≤ 1	185	RPM	19641	9820	5892	4910	3683	2946	2357
					(148-222)	Fz	0.022	0.060	0.120	0.144	0.166	0.187	0.213
						Feed (mm/min)	1273	1768	2121	2121	1838	1650	1503
	Profile 	≤ 0.5	≤ 1.5	230	RPM	24418	12209	7326	6105	4578	3663	2930	
				(184-276)	Fz	0.022	0.060	0.120	0.144	0.166	0.187	0.213	
					Feed (mm/min)	1582	2197	2637	2637	2285	2051	1868	
	HSM 	≤ 0.05	≤ 2	380	RPM	40343	20172	12103	10086	7564	6052	4841	
				(304-456)	Fz	0.050	0.132	0.280	0.336	0.384	0.440	0.488	
					Feed (mm/min)	6099	7987	10166	10166	8714	7988	7081	
COPPER ALLOYS Aluminum Bronze Brass Naval Brass Red Brass	≤ 140 Bhn or ≤ 3 HRc	Slot 	1	≤ 1	265	RPM	28134	14067	8440	7034	5275	4220	3376
					(212-318)	Fz	0.019	0.048	0.107	0.120	0.141	0.160	0.175
						Feed (mm/min)	1620	2025	2701	2532	2228	2026	1773
	Profile 	≤ 0.5	≤ 1.5	330	RPM	35035	17518	10511	8759	6569	5255	4204	
				(264-396)	Fz	0.019	0.048	0.107	0.120	0.141	0.160	0.175	
					Feed (mm/min)	2018	2522	3363	3153	2775	2523	2207	
	HSM 	≤ 0.05	≤ 2	545	RPM	57861	28930	17358	14465	10849	8679	6943	
				(436-654)	Fz	0.041	0.108	0.227	0.276	0.320	0.373	0.400	
					Feed (mm/min)	7082	9373	11804	11976	10415	9721	8332	
COPPER ALLOYS Beryllium Copper C110, Manganese Bronze, Tin Bronze	≤ 200 Bhn or ≤ 23 HRc	Slot 	1	≤ 1	105	RPM	11148	5574	3344	2787	2090	1672	1338
					(84-126)	Fz	0.019	0.048	0.107	0.120	0.141	0.160	0.175
						Feed (mm/min)	642	803	1070	1003	883	803	702
	Profile 	≤ 0.5	≤ 1.5	130	RPM	13802	6901	4141	3450	2588	2070	1656	
				(104-156)	Fz	0.019	0.048	0.107	0.120	0.141	0.160	0.175	
					Feed (mm/min)	795	994	1325	1242	1093	994	870	
	HSM 	≤ 0.05	≤ 2	215	RPM	22826	11413	6848	5706	4280	3424	2739	
				(172-258)	Fz	0.041	0.108	0.227	0.276	0.320	0.373	0.400	
					Feed (mm/min)	2794	3697	4656	4725	4109	3835	3287	
PLASTICS ABS, Polycarbonate, PVC, Polypropylene	≤ 150 Bhn or ≤ 88 HRb	Slot 	1	≤ 1	490	RPM	52022	26011	15607	13005	9754	7803	6243
					(392-588)	Fz	0.036	0.096	0.200	0.240	0.282	0.320	0.350
						Feed (mm/min)	5618	7490	9364	9363	8240	7491	6555
	Profile 	≤ 0.5	≤ 1.5	610	RPM	64762	32381	19429	16190	12143	9714	7771	
				(488-732)	Fz	0.036	0.096	0.200	0.240	0.282	0.320	0.350	
					Feed (mm/min)	6994	9325	11657	11656	10258	9326	8160	
	HSM 	≤ 0.05	≤ 2	1005	RPM	106698	53349	32009	26674	20006	16005	12804	
				(804-1206)	Fz	0.082	0.216	0.453	0.552	0.640	0.733	0.800	
					Feed (mm/min)	26117	34567	43532	44169	38410	35210	30730	

Bhn (Brinell) HRc (Rockwell C) HRb (Rockwell B) HSM (High Speed Machining)
 $rpm = (Vc \times 1000) / (DC \times 3.14)$
 $mm/min = Fz \times 3 \times rpm$
 reduce speed and feed for materials harder than listed
 reduce cut depth and feed by 50% for long flute and long reach tools
 reduce feed and Ae when finish milling (.02 x DC maximum)
 refer to the SGS Tool Wizard® for complete technical information (www.kyocera-sgtool.com)

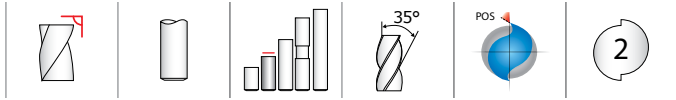

47

FRACTIONAL SERIES

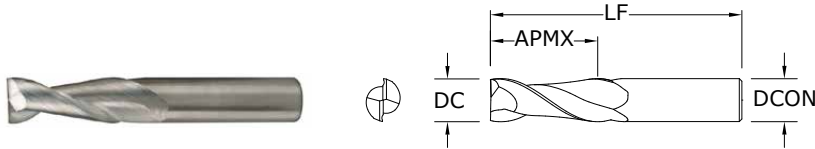

- Circular land reduces edge aggressiveness for varied speed and feed rates
- 2 Flutes effectively manage the large size and volume of chips produced during the aggressive machining process
- Excellent balance at high speeds and aggressive plunging capability
- Recommended for materials ≤ 150 Bhn (≤ 7 HRC)

CUTTING DIAMETER DC	inch			EDP NO.	
	LENGTH OF CUT APMX	OVERALL LENGTH LF	SHANK DIAMETER DCON	UNCOATED	Ti-NAMITE®-B (TiB ₂)
1/8	3/8	1-1/2	1/8	34620	34660
3/16	9/16	2	3/16	34621	34661
1/4	3/4	2-1/2	1/4	34622	34662
5/16	13/16	2-1/2	5/16	34623	34663
3/8	1	2-1/2	3/8	34624	34664
1/2	1-1/4	3-1/4	1/2	34625	34665
5/8	1-5/8	3-3/4	5/8	34626	34666
3/4	1-5/8	4	3/4	34627	34667
1	2	4-1/2	1	34628	34668

TOLERANCES (inch)

- 1/8–3/16 DIAMETER**
DC = +0.0000/–0.00032
DCON = h₆
- 1/4–3/8 DIAMETER**
DC = +0.0000/–0.00035
DCON = h₆
- 1/2–5/8 DIAMETER**
DC = +0.0000/–0.00043
DCON = h₆
- 3/4–1 DIAMETER**
DC = +0.0000/–0.00051
DCON = h₆

NON-FERROUS

For patent information visit www.ksptpatents.com

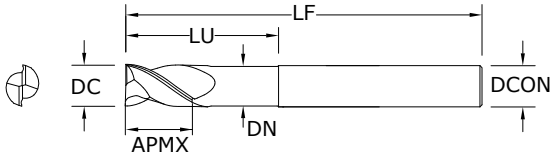
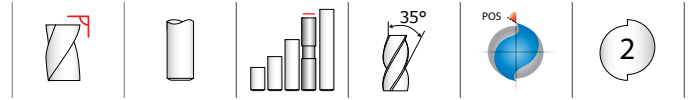

47L
FRACTIONAL SERIES

TOLERANCES (inch)

1/4–3/8 DIAMETER

DC = +0.0000/–0.00035

DCON = h_6

1/2–5/8 DIAMETER

DC = +0.0000/–0.00043

DCON = h_6

3/4–1 DIAMETER

DC = +0.0000/–0.00051

DCON = h_6

NON-FERROUS

For patent information visit
www.ksptpatents.com

CUTTING DIAMETER DC	LENGTH OF CUT APMX	inch				NECK DIAMETER DN	EDP NO.	
		OVERALL LENGTH LF	SHANK DIAMETER DCON	REACH LU	UNCOATED		Ti-NAMITE®-B (TiB ₂)	
1/4	3/8	4	1/4	2-1/8	.235	34640	34678	
3/8	1/2	4	3/8	2-1/8	.360	34641	34679	
1/2	5/8	6	1/2	2-1/8	.485	34642	34680	
1/2	5/8	6	1/2	3-3/8	.485	34643	34681	
5/8	3/4	6	5/8	2-3/8	.610	34644	34682	
5/8	3/4	6	5/8	3-3/8	.610	34645	34683	
3/4	1	6	3/4	2-1/2	.735	34646	34684	
3/4	1	6	3/4	3-3/8	.735	34647	34685	

- Circular land reduces edge aggressiveness for varied speed and feed rates
- 2 Flutes effectively manage the large size and volume of chips produced during the aggressive machining process
- Excellent balance at high speeds and aggressive plunging capability
- Necked design with blended diameter transitions provide clearance to reach
- Recommended for materials ≤ 150 Bhn (≤ 7 HRC)

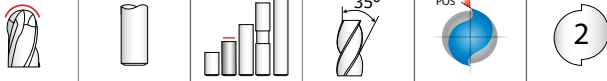

47B
FRACTIONAL SERIES

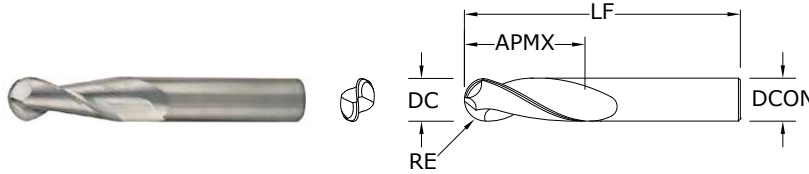

- Circular land reduces edge aggressiveness for varied speed and feed rates
- 2 Flutes effectively manage the large size and volume of chips produced during the aggressive machining process
- Excellent balance at high speeds and aggressive plunging capability
- Ball end design ideal for finishing operations in complex workpieces
- Recommended for materials ≤ 150 Bhn (≤ 7 HRC)

CUTTING DIAMETER DC	LENGTH OF CUT APMX	OVERALL LENGTH LF	SHANK DIAMETER DCON	EDP NO.	
				UNCOATED	Ti-NAMITE®-B (TiB ₂)
1/8	3/8	1-1/2	1/8	34630	34669
3/16	9/16	2	3/16	34631	34670
1/4	3/4	2-1/2	1/4	34632	34671
5/16	13/16	2-1/2	5/16	34633	34672
3/8	1	2-1/2	3/8	34634	34673
1/2	1-1/4	3-1/4	1/2	34635	34674
5/8	1-5/8	3-3/4	5/8	34636	34675
3/4	1-5/8	4	3/4	34637	34676
1	2	4-1/2	1	34638	34677

RE = 1/2 Cutting Diameter (DC)

TOLERANCES (inch)

- 1/8–3/16 DIAMETER**
DC = +0.0000/–0.00032
DCON = h₆
RE = +.0005/–.0005
- 1/4–3/8 DIAMETER**
DC = +0.0000/–0.00035
DCON = h₆
RE = +.0005/–.0005
- 1/2–5/8 DIAMETER**
DC = +0.0000/–0.00043
DCON = h₆
RE = +.0005/–.0005
- 3/4–1 DIAMETER**
DC = +0.0000/–0.00051
DCON = h₆
RE = +.0005/–.0005

NON-FERROUS

For patent information visit www.ksptpatents.com



47LB
FRACTIONAL SERIES



- Circular land reduces edge aggressiveness for varied speed and feed rates
- 2 Flutes effectively manage the large size and volume of chips produced during the aggressive machining process
- Excellent balance at high speeds and aggressive plunging capability
- Necked design with blended diameter transitions provide clearance to reach
- Ball end design ideal for finishing operations in complex workpieces
- Recommended for materials ≤ 150 Bhn (≤ 7 HRC)

CUTTING DIAMETER DC	LENGTH OF CUT APMX	OVERALL LENGTH LF	SHANK DIAMETER DCON	REACH LU	NECK DIAMETER DN	EDP NO.	
						UNCOATED	Ti-NAMITE®-B (TiB ₂)
1/4	3/8	4	1/4	2-1/8	.235	34650	34686
3/8	1/2	4	3/8	2-1/8	.360	34651	34687
1/2	5/8	6	1/2	2-1/8	.485	34652	34688
1/2	5/8	6	1/2	3-3/8	.485	34653	34689
5/8	3/4	6	5/8	2-3/8	.610	34655	34691
5/8	3/4	6	5/8	3-3/8	.610	34654	34690
3/4	1	6	3/4	2-1/2	.735	34656	34693
3/4	1	6	3/4	3-3/8	.735	34657	34692

RE = 1/2 Cutting Diameter (DC)

TOLERANCES (inch)

- 1/4–3/8 DIAMETER**
DC = +0.0000/–0.00035
DCON = h₆
RE = +.0005/–.0005
- 1/2–5/8 DIAMETER**
DC = +0.0000/–0.00043
DCON = h₆
RE = +.0005/–.0005
- 3/4–1 DIAMETER**
DC = +0.0000/–0.00051
DCON = h₆
RE = +.0005/–.0005

NON-FERROUS

For patent information visit www.ksptpatents.com

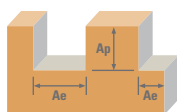

Series
47, 47B, 47L, 47LB
Fractional

Hardness

Ae x DC Ap x DC

Vc
(sfm)

DC • in

1/8 1/4 3/8 1/2 5/8 3/4 1

	Hardness	Ae x DC	Ap x DC	Vc (sfm)	DC • in							
					1/8	1/4	3/8	1/2	5/8	3/4	1	
ALUMINUM ALLOYS 2024, 5052, 5086, 6061, 6073, 7075	Slot 	1	≤ 1	1600	RPM	48896	24448	16299	12224	9779	8149	6112
				(1280-1920)	Fz	0.0009	0.0025	0.0045	0.0060	0.0065	0.0070	0.0085
					Feed (ipm)	88	122	147	147	127	114	104
	Profile 	≤ 0.5	≤ 1.5	2000	RPM	61120	30560	20373	15280	12224	10187	7640
				(1600-2400)	Fz	0.0009	0.0025	0.0045	0.0060	0.0065	0.0070	0.0085
					Feed (ipm)	110	153	183	183	159	143	130
	HSM 	≤ 0.05	≤ 2	3300	RPM	100848	50424	33616	25212	20170	16808	12606
				(2640-3960)	Fz	0.0021	0.0055	0.0105	0.0140	0.0150	0.0165	0.0195
					Feed (ipm)	424	555	706	706	605	555	492
ALUMINUM DIE CAST ALLOYS (HIGH SILICONE) A-390, A-392, B-390	Slot 	1	≤ 1	600	RPM	18336	9168	6112	4584	3667	3056	2292
				(480-720)	Fz	0.0009	0.0025	0.0045	0.0060	0.0065	0.0070	0.0085
					Feed (ipm)	33	46	55	55	48	43	39
	Profile 	≤ 0.5	≤ 1.5	750	RPM	22920	11460	7640	5730	4584	3820	2865
				(600-900)	Fz	0.0009	0.0025	0.0045	0.0060	0.0065	0.0070	0.0085
					Feed (ipm)	41	57	69	69	60	53	49
	HSM 	≤ 0.05	≤ 2	1240	RPM	37894	18947	12631	9474	7579	6316	4737
				(992-1488)	Fz	0.0021	0.0055	0.0105	0.0140	0.0150	0.0165	0.0195
					Feed (ipm)	159	208	265	265	227	208	185
COPPER ALLOYS Aluminum Bronze Naval Brass Red Brass	Slot 	1	≤ 1	865	RPM	26434	13217	8811	6609	5287	4406	3304
				(692-1038)	Fz	0.0008	0.0020	0.0040	0.0050	0.0055	0.0060	0.0070
					Feed (ipm)	42	53	70	66	58	53	46
	Profile 	≤ 0.5	≤ 1.5	1080	RPM	33005	16502	11002	8251	6601	5501	4126
				(864-1296)	Fz	0.0008	0.0020	0.0040	0.0050	0.0055	0.0060	0.0070
					Feed (ipm)	53	66	88	83	73	66	58
	HSM 	≤ 0.05	≤ 2	1780	RPM	54397	27198	18132	13599	10879	9066	6800
				(1424-2136)	Fz	0.0017	0.0045	0.0085	0.0115	0.0125	0.0140	0.0160
					Feed (ipm)	185	245	308	313	272	254	218
COPPER ALLOYS Beryllium Copper C110, Manganese Bronze, Tin Bronze	Slot 	1	≤ 1	345	RPM	10543	5272	3514	2636	2109	1757	1318
				(276-414)	Fz	0.0008	0.0020	0.0040	0.0050	0.0055	0.0060	0.0070
					Feed (ipm)	17	21	28	26	23	21	18
	Profile 	≤ 0.5	≤ 1.5	430	RPM	13141	6570	4380	3285	2628	2190	1643
				(344-516)	Fz	0.0008	0.0020	0.0040	0.0050	0.0055	0.0060	0.0070
					Feed (ipm)	21	26	35	33	29	26	23
	HSM 	≤ 0.05	≤ 2	710	RPM	21698	10849	7233	5424	4340	3616	2712
				(568-852)	Fz	0.0017	0.0045	0.0085	0.0115	0.0125	0.0140	0.0160
					Feed (ipm)	74	98	123	125	108	101	87
PLASTICS ABS, Polycarbonate, PVC, Polypropylene	Slot 	1	≤ 1	1600	RPM	48896	24448	16299	12224	9779	8149	6112
				(1280-1920)	Fz	0.0015	0.0040	0.0075	0.0100	0.0110	0.0120	0.0140
					Feed (ipm)	147	196	244	244	215	196	171
	Profile 	≤ 0.5	≤ 1.5	2000	RPM	61120	30560	20373	15280	12224	10187	7640
				(1600-2400)	Fz	0.0015	0.0040	0.0075	0.0100	0.0110	0.0120	0.0140
					Feed (ipm)	183	244	306	306	269	244	214
	HSM 	≤ 0.05	≤ 2	3300	RPM	100848	50424	33616	25212	20170	16808	12606
				(2640-3960)	Fz	0.0034	0.0090	0.0170	0.0230	0.0250	0.0275	0.0320
					Feed (ipm)	686	908	1143	1160	1008	924	807

Bhn (Brinell) HRc (Rockwell C) HRb (Rockwell B) HSM (High Speed Machining)
 rpm = Vc x 3.82 / DC
 ipm = Fz x 2 x rpm
 reduce speed and feed for materials harder than listed
 reduce cut depth and feed by 50% for long flute and long reach tools
 reduce feed and Ae when finish milling (.02 x DC maximum)
 refer to the SGS Tool Wizard® for complete technical information (www.kyocera-sgstoool.com)



47M
METRIC SERIES

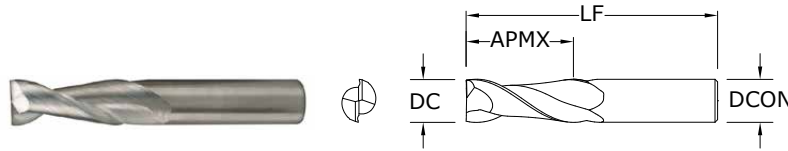

- Circular land reduces edge aggressiveness for varied speed and feed rates
- 2 Flutes effectively manage the large size and volume of chips produced during the aggressive machining process
- Excellent balance at high speeds and aggressive plunging capability
- Recommended for materials ≤ 150 Bhn (≤ 7 HRC)

mm				EDP NO.	
CUTTING DIAMETER DC	LENGTH OF CUT APMX	OVERALL LENGTH LF	SHANK DIAMETER DCON	UNCOATED	Ti-NAMITE®-B (TiB ₂)
3,0	8,0	38,0	3,0	44550	44587
4,0	11,0	50,0	4,0	44551	44588
5,0	13,0	50,0	5,0	44552	44589
6,0	13,0	57,0	6,0	44553	44590
8,0	19,0	63,0	8,0	44554	44591
10,0	22,0	72,0	10,0	44555	44592
12,0	26,0	83,0	12,0	44556	44593
14,0	26,0	83,0	14,0	44557	44594
16,0	32,0	92,0	16,0	44558	44595
20,0	38,0	104,0	20,0	44559	44596
25,0	38,0	104,0	25,0	44560	44597

TOLERANCES (mm)

3 DIAMETER

DC = +0,000/-0,006
DCON = h₆

>3-6 DIAMETER

DC = +0,000/-0,008
DCON = h₆

>6-10 DIAMETER

DC = +0,000/-0,009
DCON = h₆

>10-18 DIAMETER

DC = +0,000/-0,012
DCON = h₆

>18-25 DIAMETER

DC = +0,000/-0,013
DCON = h₆

NON-FERROUS

For patent information visit www.ksptpatents.com

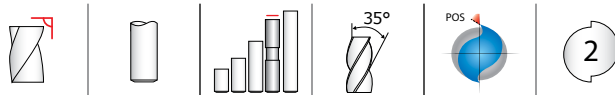

47ML
METRIC SERIES

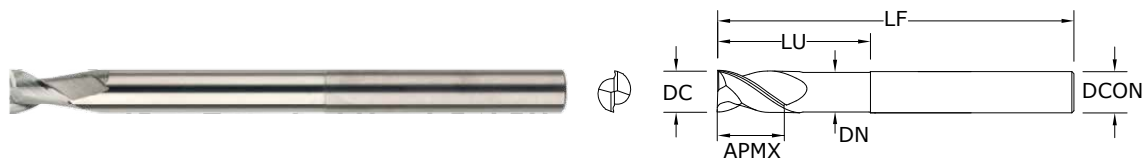

- Circular land reduces edge aggressiveness for varied speed and feed rates
- 2 Flutes effectively manage the large size and volume of chips produced during the aggressive machining process
- Excellent balance at high speeds and aggressive plunging capability
- Necked design with blended diameter transitions provide clearance to reach
- Recommended for materials ≤ 150 Bhn (≤ 7 HRC)

mm					EDP NO.		
CUTTING DIAMETER DC	LENGTH OF CUT APMX	OVERALL LENGTH LF	SHANK DIAMETER DCON	REACH LU	NECK DIAMETER DN	UNCOATED	Ti-NAMITE®-B (TiB ₂)
6,0	10,0	100,0	6,0	54,0	5,62	44561	44609
8,0	12,0	100,0	8,0	54,0	7,62	44562	44610
10,0	12,0	100,0	10,0	54,0	9,62	44563	44611
12,0	16,0	150,0	12,0	80,0	11,62	44564	44612
16,0	20,0	150,0	16,0	80,0	15,62	44565	44613
20,0	25,0	150,0	20,0	80,0	19,62	44566	44614

TOLERANCES (mm)

6 DIAMETER

DC = +0,000/-0,008
DCON = h₆

>6-10 DIAMETER

DC = +0,000/-0,009
DCON = h₆

>10-18 DIAMETER

DC = +0,000/-0,011
DCON = h₆

>18-20 DIAMETER

DC = +0,000/-0,013
DCON = h₆

NON-FERROUS

For patent information visit www.ksptpatents.com

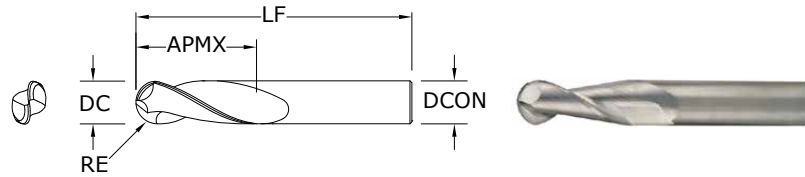
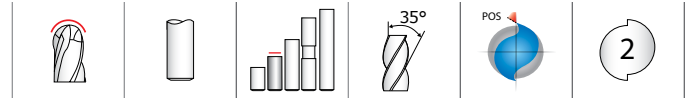

47MB
METRIC SERIES

TOLERANCES (mm)

3 DIAMETER
DC = +0,000/-0,006
DCON = h₆
RE = +0,0127/-0,0127

>3-6 DIAMETER
DC = +0,000/-0,008
DCON = h₆
RE = +0,0127/-0,0127

>6-10 DIAMETER
DC = +0,000/-0,009
DCON = h₆
RE = +0,0127/-0,0127

>10-18 DIAMETER
DC = +0,000/-0,012
DCON = h₆
RE = +0,0127/-0,0127

>18-25 DIAMETER
DC = +0,000/-0,013
DCON = h₆
RE = +0,0127/-0,0127

CUTTING DIAMETER DC	LENGTH OF CUT APMX	OVERALL LENGTH LF	SHANK DIAMETER DCON	EDP NO.	
				UNCOATED	Ti-NAMITE®-B (TiB ₂)
3,0	8,0	38,0	3,0	44570	44598
4,0	11,0	50,0	4,0	44571	44599
5,0	13,0	50,0	5,0	44572	44600
6,0	13,0	57,0	6,0	44573	44601
8,0	19,0	63,0	8,0	44574	44602
10,0	22,0	72,0	10,0	44575	44603
12,0	26,0	83,0	12,0	44576	44604
14,0	26,0	83,0	14,0	44577	44605
16,0	32,0	92,0	16,0	44578	44606
20,0	37,3	104,0	20,0	44579	44607
25,0	38,0	104,0	25,0	44580	44608

- Circular land reduces edge aggressiveness for varied speed and feed rates
- 2 Flutes effectively manage the large size and volume of chips produced during the aggressive machining process
- Excellent balance at high speeds and aggressive plunging capability
- Ball end design ideal for finishing operations in complex workpieces
- Recommended for materials ≤ 150 Bhn (≤ 7 HRC)

RE = 1/2 Cutting Diameter (DC)

NON-FERROUS

For patent information visit www.ksptpatents.com

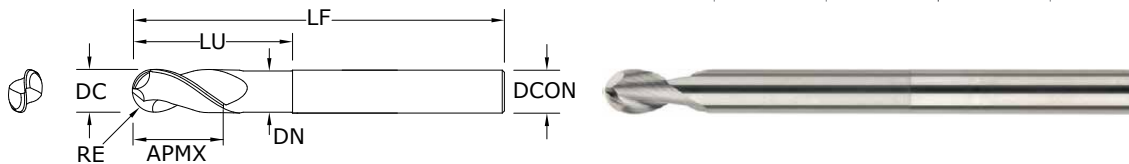
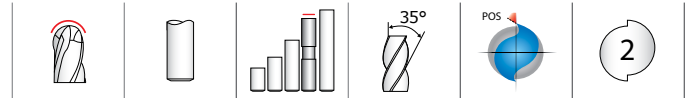

47MLB
METRIC SERIES

TOLERANCES (mm)

6 DIAMETER
DC = +0,000/-0,008
DCON = h₆
RE = +0,0127/-0,0127

>6-10 DIAMETER
DC = +0,000/-0,009
DCON = h₆
RE = +0,0127/-0,0127

>10-18 DIAMETER
DC = +0,000/-0,011
DCON = h₆
RE = +0,0127/-0,0127

>18-20 DIAMETER
DC = +0,000/-0,013
DCON = h₆
RE = +0,0127/-0,0127

CUTTING DIAMETER DC	LENGTH OF CUT APMX	OVERALL LENGTH LF	SHANK DIAMETER DCON	REACH LU	NECK DIAMETER DN	EDP NO.	
						UNCOATED	Ti-NAMITE®-B (TiB ₂)
6,0	10,0	100,0	6,0	54,0	5,62	44581	44615
8,0	12,0	100,0	8,0	54,0	7,62	44582	44616
10,0	12,0	100,0	10,0	54,0	9,62	44583	44617
12,0	16,0	150,0	12,0	80,0	11,62	44584	44618
16,0	20,0	150,0	16,0	80,0	15,62	44585	44619
20,0	25,0	150,0	20,0	80,0	19,62	44586	44620









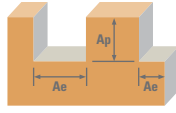





- Circular land reduces edge aggressiveness for varied speed and feed rates
- 2 Flutes effectively manage the large size and volume of chips produced during the aggressive machining process
- Excellent balance at high speeds and aggressive plunging capability
- Necked design with blended diameter transitions provide clearance to reach
- Ball end design ideal for finishing operations in complex workpieces
- Recommended for materials ≤ 150 Bhn (≤ 7 HRC)

RE = 1/2 Cutting Diameter (DC)

NON-FERROUS

For patent information visit www.ksptpatents.com



Series 47M, 47MB, 47ML, 47MLB Metric	Hardness	Ae x DC	Ap x DC	Vc (m/min)	DC • mm								
					3	6	10	12	16	20	25		
ALUMINUM ALLOYS 2024, 5052, 5086, 6061, 6073, 7075	≤ 150 Bhn or ≤ 88 HRb	Slot 	1	≤ 1	490	RPM	52022	26011	15607	13005	9754	7803	6243
					(392-588)	Fz	0.022	0.060	0.120	0.144	0.166	0.187	0.213
						Feed (mm/min)	2247	3121	3746	3745	3246	2913	2653
	≤ 150 Bhn or ≤ 88 HRb	Profile 	≤ 0.5	≤ 1.5	610	RPM	64762	32381	19429	16190	12143	9714	7771
					(488-732)	Fz	0.022	0.060	0.120	0.144	0.166	0.187	0.213
						Feed (mm/min)	2797	3885	4663	4662	4041	3627	3303
	≤ 150 Bhn or ≤ 88 HRb	HSM 	≤ 0.05	≤ 2	1005	RPM	106698	53349	32009	26674	20006	16005	12804
					(804-1206)	Fz	0.050	0.132	0.280	0.336	0.384	0.440	0.488
						Feed (mm/min)	10754	14083	17925	17924	15364	14084	12484
ALUMINUM DIE CAST ALLOYS (HIGH SILICONE) A-390, A-392, B-390	≤ 125 Bhn or ≤ 77 HRb	Slot 	1	≤ 1	185	RPM	19641	9820	5892	4910	3683	2946	2357
					(148-222)	Fz	0.022	0.060	0.120	0.144	0.166	0.187	0.213
						Feed (mm/min)	848	1178	1414	1414	1226	1100	1002
	≤ 125 Bhn or ≤ 77 HRb	Profile 	≤ 0.5	≤ 1.5	230	RPM	24418	12209	7326	6105	4578	3663	2930
					(184-276)	Fz	0.022	0.060	0.120	0.144	0.166	0.187	0.213
						Feed (mm/min)	1055	1465	1758	1758	1524	1367	1245
	≤ 125 Bhn or ≤ 77 HRb	HSM 	≤ 0.05	≤ 2	380	RPM	40343	20172	12103	10086	7564	6052	4841
					(304-456)	Fz	0.050	0.132	0.280	0.336	0.384	0.440	0.488
						Feed (mm/min)	4066	5325	6778	6777	5809	5325	4720
COPPER ALLOYS Aluminum Bronze Brass Naval Brass Red Brass	≤ 140 Bhn or ≤ 3 HRc	Slot 	1	≤ 1	265	RPM	28134	14067	8440	7034	5275	4220	3376
					(212-318)	Fz	0.019	0.048	0.107	0.120	0.141	0.160	0.175
						Feed (mm/min)	1080	1350	1801	1688	1485	1350	1182
	≤ 140 Bhn or ≤ 3 HRc	Profile 	≤ 0.5	≤ 1.5	330	RPM	35035	17518	10511	8759	6569	5255	4204
					(264-396)	Fz	0.019	0.048	0.107	0.120	0.141	0.160	0.175
						Feed (mm/min)	1345	1682	2242	2102	1850	1682	1472
	≤ 140 Bhn or ≤ 3 HRc	HSM 	≤ 0.05	≤ 2	545	RPM	57861	28930	17358	14465	10849	8679	6943
					(436-654)	Fz	0.041	0.108	0.227	0.276	0.320	0.373	0.400
						Feed (mm/min)	4721	6248	7869	7984	6943	6480	5555
COPPER ALLOYS Beryllium Copper C110, Manganese Bronze, Tin Bronze	≤ 200 Bhn or ≤ 23 HRc	Slot 	1	≤ 1	105	RPM	11148	5574	3344	2787	2090	1672	1338
					(84-126)	Fz	0.019	0.048	0.107	0.120	0.141	0.160	0.175
						Feed (mm/min)	428	535	713	669	589	535	468
	≤ 200 Bhn or ≤ 23 HRc	Profile 	≤ 0.5	≤ 1.5	130	RPM	13802	6901	4141	3450	2588	2070	1656
					(104-156)	Fz	0.019	0.048	0.107	0.120	0.141	0.160	0.175
						Feed (mm/min)	530	662	883	828	729	662	580
	≤ 200 Bhn or ≤ 23 HRc	HSM 	≤ 0.05	≤ 2	215	RPM	22826	11413	6848	5706	4280	3424	2739
					(172-258)	Fz	0.041	0.108	0.227	0.276	0.320	0.373	0.400
						Feed (mm/min)	1862	2465	3104	3150	2739	2556	2191
PLASTICS ABS, Polycarbonate, PVC, Polypropylene		Slot 	1	≤ 1	490	RPM	52022	26011	15607	13005	9754	7803	6243
					(392-588)	Fz	0.036	0.096	0.200	0.240	0.282	0.320	0.350
						Feed (mm/min)	3745	4994	6243	6242	5493	4994	4370
		Profile 	≤ 0.5	≤ 1.5	610	RPM	64762	32381	19429	16190	12143	9714	7771
					(488-732)	Fz	0.036	0.096	0.200	0.240	0.282	0.320	0.350
						Feed (mm/min)	4662	6217	7771	7771	6839	6217	5440
		HSM 	≤ 0.05	≤ 2	1005	RPM	106698	53349	32009	26674	20006	16005	12804
					(804-1206)	Fz	0.082	0.216	0.453	0.552	0.640	0.733	0.800
						Feed (mm/min)	17412	23045	29022	29446	25607	23473	20487

Bhn (Brinell) HRc (Rockwell C) HRb (Rockwell B) HSM (High Speed Machining)
 $rpm = (Vc \times 1000) / (DC \times 3.14)$
 $mm/min = Fz \times 2 \times rpm$
 reduce speed and feed for materials harder than listed
 reduce cut depth and feed by 50% for long flute and long reach tools
 reduce feed and Ae when finish milling (.02 x DC maximum)
 refer to the SGS Tool Wizard® for complete technical information (www.kyocera-sgstool.com)

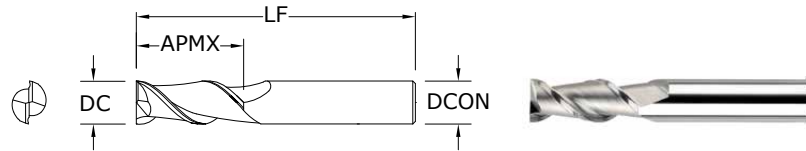

44

FRACTIONAL SERIES

TOLERANCES (inch)

1/4–3/8 DIAMETER

DC = +0.0000/–0.00035

DCON = h₆

1/2–5/8 DIAMETER

DC = +0.0000/–0.00043

DCON = h₆

3/4–1 DIAMETER

DC = +0.0000/–0.00051

DCON = h₆

NON-FERROUS

For patent information visit www.ksptpatents.com

inch				EDP NO.			
CUTTING DIAMETER DC	LENGTH OF CUT APMX	OVERALL LENGTH LF	SHANK DIAMETER DCON	UNCOATED W/FLAT	Ti-NAMITE®-B (TiB ₂) W/FLAT	UNCOATED	Ti-NAMITE®-B (TiB ₂)
1/4	3/4	2-7/16	3/8	34501	34502	32033	32053
1/4	1-1/4	3-1/16	3/8	34503	34504	32034	32054
1/4	1-3/4	3-9/16	3/8	34505	34506	32035	32055
5/16	1-3/8	3-1/8	3/8	34507	34508	32036	32056
3/8	3/4	2-1/2	3/8	34509	34510	32037	32057
3/8	1-1/2	3-1/4	3/8	34511	34512	32038	32058
3/8	2-1/2	4-1/4	3/8	34513	34514	32039	32059
1/2	1-1/4	3-1/4	1/2	34515	34516	32040	32060
1/2	2	4	1/2	34517	34518	32041	32061
1/2	3	5	1/2	34519	34520	32042	32062
5/8	1-5/8	3-3/4	5/8	34521	34522	32043	32063
5/8	2-1/2	4-5/8	5/8	34523	34524	32044	32064
3/4	1-5/8	3-7/8	3/4	34525	34526	32045	32065
3/4	3	5-1/4	3/4	34527	34528	32046	32066
3/4	4	6-1/4	3/4	34529	34530	32047	32067
1	2	4-1/2	1	34531	34532	32048	32068
1	4	6-1/2	1	34533	34534	32049	32069

- Polished ski land with primary and secondary flute wall design minimizes chip interference by directing chips away from secondary flute
- Circular land allows for increased control at various speed and feed rates ultimately reducing chatter
- Recommended for materials ≤ 150 Bhn (≤ 7 HRC)

Contact your KSPT Sales Representative for more information on Corner Radius options.

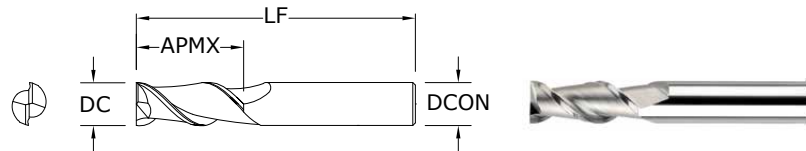

44M

METRIC SERIES

TOLERANCES (mm)

≤3 DIAMETER

DC = +0,000/–0,006

DCON = h₆

>3–6 DIAMETER

DC = +0,000/–0,008

DCON = h₆

>6–10 DIAMETER

DC = +0,000/–0,009

DCON = h₆

>10–18 DIAMETER

DC = +0,000/–0,011

DCON = h₆

>18–20 DIAMETER

DC = +0,000/–0,013

DCON = h₆

NON-FERROUS

For patent information visit www.ksptpatents.com

mm				EDP NO.			
CUTTING DIAMETER DC	LENGTH OF CUT APMX	OVERALL LENGTH LF	SHANK DIAMETER DCON	UNCOATED W/FLAT	UNCOATED	Ti-NAMITE®-B (TiB ₂) W/FLAT	Ti-NAMITE®-B (TiB ₂)
3,0	8,0	52,0	6,0	44505	49663	44506	49674
4,0	11,0	55,0	6,0	44509	49664	44510	49675
5,0	13,0	57,0	6,0	44513	49665	44514	49676
6,0	13,0	57,0	6,0	44517	49666	44518	49677
8,0	19,0	69,0	10,0	44521	49667	44522	49678
10,0	22,0	72,0	10,0	44525	49668	44526	49679
12,0	26,0	83,0	12,0	44529	49669	44530	49680
14,0	26,0	83,0	14,0	44533	49670	44534	49681
16,0	32,0	92,0	16,0	44537	49671	44538	49682
18,0	32,0	92,0	18,0	44541	49672	44542	49683
20,0	38,0	104,0	20,0	44545	49673	44546	49684

- Polished ski land with primary and secondary flute wall design minimizes chip interference by directing chips away from secondary flute
- Circular land allows for increased control at various speed and feed rates ultimately reducing chatter
- Recommended for materials ≤ 150 Bhn (≤ 7 HRC)

Contact your KSPT Sales Representative for more information on Corner Radius options.

FRACTIONAL Ski-Carb

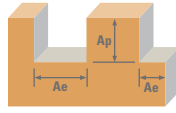

Series 44 Fractional	Hardness	Ae x DC Ap x DC		Vc (sfm)	DC • in									
		1/8	1/4		3/8	1/2	5/8	3/4	1					
ALUMINUM ALLOYS 2024, 5052, 5086, 6061, 6073, 7075	≤ 150 Bhn or ≤ 88 HRb	Slot 	1	≤ 1	1600 (1280-1920)	RPM	48896	24448	16299	12224	9779	8149	6112	
						Fz	0.0009	0.0025	0.0045	0.0060	0.0065	0.0070	0.0085	
						Feed (ipm)	88	122	147	147	127	114	104	
		Profile 	≤ 0.5	≤ 1.5	2000 (1600-2400)	RPM	61120	30560	20373	15280	12224	10187	7640	
						Fz	0.0009	0.0025	0.0045	0.0060	0.0065	0.0070	0.0085	
						Feed (ipm)	110	153	183	183	159	143	130	
	HSM 	≤ 0.05	≤ 2	3300 (2640-3960)	RPM	100848	50424	33616	25212	20170	16808	12606		
					Fz	0.0021	0.0055	0.0105	0.0140	0.0150	0.0165	0.0195		
					Feed (ipm)	424	555	706	706	605	555	492		
	ALUMINUM DIE CAST ALLOYS (HIGH SILICONE) A-390, A-392, B-390	≤ 125 Bhn or ≤ 77 HRb	Slot 	1	≤ 1	600 (480-720)	RPM	18336	9168	6112	4584	3667	3056	2292
							Fz	0.0009	0.0025	0.0045	0.0060	0.0065	0.0070	0.0085
							Feed (ipm)	33	46	55	55	48	43	39
Profile 			≤ 0.5	≤ 1.5	750 (600-900)	RPM	22920	11460	7640	5730	4584	3820	2865	
						Fz	0.0009	0.0025	0.0045	0.0060	0.0065	0.0070	0.0085	
						Feed (ipm)	41	57	69	69	60	53	49	
HSM 		≤ 0.05	≤ 2	1240 (992-1488)	RPM	37894	18947	12631	9474	7579	6316	4737		
					Fz	0.0021	0.0055	0.0105	0.0140	0.0150	0.0165	0.0195		
					Feed (ipm)	159	208	265	265	227	208	185		
COPPER ALLOYS Aluminum Bronze Brass Naval Brass Red Brass		≤ 140 Bhn or ≤ 3 HRc	Slot 	1	≤ 1	865 (692-1038)	RPM	26434	13217	8811	6609	5287	4406	3304
							Fz	0.0008	0.0020	0.0040	0.0050	0.0055	0.0060	0.0070
							Feed (ipm)	42	53	70	66	58	53	46
	Profile 		≤ 0.5	≤ 1.5	1080 (864-1296)	RPM	33005	16502	11002	8251	6601	5501	4126	
						Fz	0.0008	0.0020	0.0040	0.0050	0.0055	0.0060	0.0070	
						Feed (ipm)	53	66	88	83	73	66	58	
	HSM 	≤ 0.05	≤ 2	1780 (1424-2136)	RPM	54397	27198	18132	13599	10879	9066	6800		
					Fz	0.0017	0.0045	0.0085	0.0115	0.0125	0.0140	0.0160		
					Feed (ipm)	185	245	308	313	272	254	218		
	COPPER ALLOYS Beryllium Copper C110, Manganese Bronze, Tin Bronze	≤ 200 Bhn or ≤ 23 HRc	Slot 	1	≤ 1	345 (276-414)	RPM	10543	5272	3514	2636	2109	1757	1318
							Fz	0.0008	0.0020	0.0040	0.0050	0.0055	0.0060	0.0070
							Feed (ipm)	17	21	28	26	23	21	18
Profile 			≤ 0.5	≤ 1.5	430 (344-516)	RPM	13141	6570	4380	3285	2628	2190	1643	
						Fz	0.0008	0.0020	0.0040	0.0050	0.0055	0.0060	0.0070	
						Feed (ipm)	21	26	35	33	29	26	23	
HSM 		≤ 0.05	≤ 2	710 (568-852)	RPM	21698	10849	7233	5424	4340	3616	2712		
					Fz	0.0017	0.0045	0.0085	0.0115	0.0125	0.0140	0.0160		
					Feed (ipm)	74	98	123	125	108	101	87		
PLASTICS ABS, Polycarbonate, PVC, Polypropylene			Slot 	1	≤ 1	1600 (1280-1920)	RPM	48896	24448	16299	12224	9779	8149	6112
							Fz	0.0015	0.0040	0.0075	0.0100	0.0110	0.0120	0.0140
							Feed (ipm)	147	196	244	244	215	196	171
	Profile 		≤ 0.5	≤ 1.5	2000 (1600-2400)	RPM	61120	30560	20373	15280	12224	10187	7640	
						Fz	0.0015	0.0040	0.0075	0.0100	0.0110	0.0120	0.0140	
						Feed (ipm)	183	244	306	306	269	244	214	
	HSM 	≤ 0.05	≤ 2	3300 (2640-3960)	RPM	100848	50424	33616	25212	20170	16808	12606		
					Fz	0.0034	0.0090	0.0170	0.0230	0.0250	0.0275	0.0320		
					Feed (ipm)	686	908	1143	1160	1008	924	807		

Bhn (Brinell) HRc (Rockwell C) HRb (Rockwell B) HSM (High Speed Machining)
 $rpm = Vc \times 3.82 / DC$
 $ipm = Fz \times 2 \times rpm$
 reduce speed and feed for materials harder than listed
 reduce cut depth and feed by 50% for long flute and long reach tools
 reduce feed and Ae when finish milling (.02 x DC maximum)
 refer to the SGS Tool Wizard® for complete technical information (www.kyocera-sgstool.com)

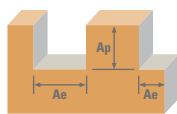

Series 44M Metric	Hardness	Ae x DC	Ap x DC	Vc (m/min)	DC • mm								
					3	6	10	12	16	20	25		
ALUMINUM ALLOYS 2024, 5052, 5086, 6061, 6073, 7075	≤ 150 Bhn or ≤ 88 HRb	Slot 	1	≤ 1	490 (392-588)	RPM	52022	26011	15607	13005	9754	7803	6243
						Fz	0.022	0.060	0.120	0.144	0.166	0.187	0.213
						Feed (mm/min)	2247	3121	3746	3745	3246	2913	2653
	Profile 	≤ 0.5	≤ 1.5	610 (488-732)	RPM	64762	32381	19429	16190	12143	9714	7771	
					Fz	0.022	0.060	0.120	0.144	0.166	0.187	0.213	
					Feed (mm/min)	2797	3885	4663	4662	4041	3627	3303	
	HSM 	≤ 0.05	≤ 2	1005 (804-1206)	RPM	106698	53349	32009	26674	20006	16005	12804	
					Fz	0.050	0.132	0.280	0.336	0.384	0.440	0.488	
					Feed (mm/min)	10754	14083	17925	17924	15364	14084	12484	
ALUMINUM DIE CAST ALLOYS (HIGH SILICONE) A-390, A-392, B- 390	≤ 125 Bhn or ≤ 77 HRb	Slot 	1	≤ 1	185 (148-222)	RPM	19641	9820	5892	4910	3683	2946	2357
						Fz	0.022	0.060	0.120	0.144	0.166	0.187	0.213
						Feed (mm/min)	848	1178	1414	1414	1226	1100	1002
	Profile 	≤ 0.5	≤ 1.5	230 (184-276)	RPM	24418	12209	7326	6105	4578	3663	2930	
					Fz	0.022	0.060	0.120	0.144	0.166	0.187	0.213	
					Feed (mm/min)	1055	1465	1758	1758	1524	1367	1245	
	HSM 	≤ 0.05	≤ 2	380 (304-456)	RPM	40343	20172	12103	10086	7564	6052	4841	
					Fz	0.050	0.132	0.280	0.336	0.384	0.440	0.488	
					Feed (mm/min)	4066	5325	6778	6777	5809	5325	4720	
COPPER ALLOYS Aluminum Bronze Brass Naval Brass Red Brass	≤ 140 Bhn or ≤ 3 HRc	Slot 	1	≤ 1	265 (212-318)	RPM	28134	14067	8440	7034	5275	4220	3376
						Fz	0.019	0.048	0.107	0.120	0.141	0.160	0.175
						Feed (mm/min)	1080	1350	1801	1688	1485	1350	1182
	Profile 	≤ 0.5	≤ 1.5	330 (264-396)	RPM	35035	17518	10511	8759	6569	5255	4204	
					Fz	0.019	0.048	0.107	0.120	0.141	0.160	0.175	
					Feed (mm/min)	1345	1682	2242	2102	1850	1682	1472	
	HSM 	≤ 0.05	≤ 2	545 (436-654)	RPM	57861	28930	17358	14465	10849	8679	6943	
					Fz	0.041	0.108	0.227	0.276	0.320	0.373	0.400	
					Feed (mm/min)	4721	6248	7869	7984	6943	6480	5555	
COPPER ALLOYS Beryllium Copper C110, Manganese Bronze, Tin Bronze	≤ 200 Bhn or ≤ 23 HRc	Slot 	1	≤ 1	105 (84-126)	RPM	11148	5574	3344	2787	2090	1672	1338
						Fz	0.019	0.048	0.107	0.120	0.141	0.160	0.175
						Feed (mm/min)	428	535	713	669	589	535	468
	Profile 	≤ 0.5	≤ 1.5	130 (104-156)	RPM	13802	6901	4141	3450	2588	2070	1656	
					Fz	0.019	0.048	0.107	0.120	0.141	0.160	0.175	
					Feed (mm/min)	530	662	883	828	729	662	580	
	HSM 	≤ 0.05	≤ 2	215 (172-258)	RPM	22826	11413	6848	5706	4280	3424	2739	
					Fz	0.041	0.108	0.227	0.276	0.320	0.373	0.400	
					Feed (mm/min)	1862	2465	3104	3150	2739	2556	2191	
PLASTICS ABS, Polycarbonate, PVC, Polypropylene	Slot 	1	≤ 1	490 (392-588)	RPM	52022	26011	15607	13005	9754	7803	6243	
					Fz	0.036	0.096	0.200	0.240	0.282	0.320	0.350	
					Feed (mm/min)	3745	4994	6243	6242	5493	4994	4370	
	Profile 	≤ 0.5	≤ 1.5	610 (488-732)	RPM	64762	32381	19429	16190	12143	9714	7771	
					Fz	0.036	0.096	0.200	0.240	0.282	0.320	0.350	
					Feed (mm/min)	4662	6217	7771	7771	6839	6217	5440	
	HSM 	≤ 0.05	≤ 2	1005 (804-1206)	RPM	106698	53349	32009	26674	20006	16005	12804	
					Fz	0.082	0.216	0.453	0.552	0.640	0.733	0.800	
					Feed (mm/min)	17412	23045	29022	29446	25607	23473	20487	

Bhn (Brinell) HRc (Rockwell C) HRb (Rockwell B) HSM (High Speed Machining)
 $rpm = (Vc \times 1000) / (DC \times 3.14)$
 $mm/min = Fz \times 2 \times rpm$
 reduce speed and feed for materials harder than listed
 reduce cut depth and feed by 50% for long flute and long reach tools
 reduce feed and Ae when finish milling (.02 x DC maximum)
 refer to the SGS Tool Wizard® for complete technical information (www.kyocera-sgstool.com)



45
FRACTIONAL SERIES

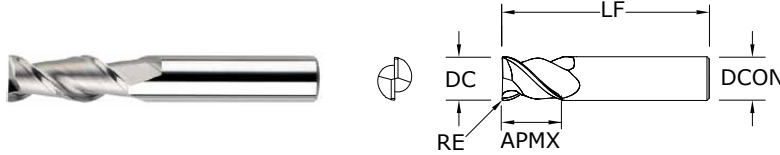

- Polished ski land with primary and secondary flute wall design minimizes chip interference by directing chips away from secondary flute
- Circular land allows for increased control at various speed and feed rates ultimately reducing chatter
- Recommended for materials ≤ 150 Bhn (≤ 7 HRC)

CUTTING DIAMETER DC	LENGTH OF CUT APMX	inch			EDP NO.			
		OVERALL LENGTH LF	SHANK DIAMETER DCON	CORNER RADIUS RE	UNCOATED W/FLAT	UNCOATED	Ti-NAMITE®-B (TiB ₂) W/FLAT	Ti-NAMITE®-B (TiB ₂)
1/4	3/8	2-1/2	3/8	.010	91257	91250	91242	91235
5/16	7/16	2-1/2	3/8	.012	91258	91251	91243	91236
3/8	9/16	2-1/2	3/8	.015	91259	91252	91244	91237
1/2	3/4	3	1/2	.020	91260	91253	91245	91238
5/8	7/8	3-1/2	5/8	.025	91261	91254	91246	91239
3/4	1	4	3/4	.030	91262	91255	91247	91240
1	1-1/4	4	1	.040	91263	91256	91248	91241

Contact your KSPT representative for reach options.

TOLERANCES (inch)

- 1/4–3/8 DIAMETER**
DC = +0.0000/–0.00035
DCON = h₆
RE = +0.0000/–0.0020
- 1/2–5/8 DIAMETER**
DC = +0.0000/–0.00043
DCON = h₆
RE = +0.0000/–0.0020
- 3/4–1 DIAMETER**
DC = +0.0000/–0.00051
DCON = h₆
RE = +0.0000/–0.0020

NON-FERROUS

For patent information visit
www.ksptpatents.com

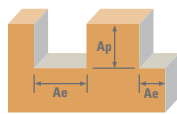

Series 45 Fractional	Hardness	Ae x DC	Ap x DC	Vc (sfm)	DC • in							
					1/4	3/8	1/2	5/8	3/4	1		
ALUMINUM ALLOYS 2024, 5052, 5086, 6061, 6073, 7075	≤ 150 Bhn or ≤ 88 HRb	Slot 	1	≤ 1	1600	RPM	24448	16299	12224	9779	8149	6112
					(1280-1920)	Fz	0.0025	0.0045	0.0060	0.0065	0.0070	0.0085
						Feed (ipm)	122	147	147	127	114	104
	Profile 	≤ 0.5	≤ 1.5	2000	RPM	30560	20373	15280	12224	10187	7640	
				(1600-2400)	Fz	0.0025	0.0045	0.0060	0.0065	0.0070	0.0085	
					Feed (ipm)	153	183	183	159	143	130	
	HSM 	≤ 0.05	≤ 2	3300	RPM	50424	33616	25212	20170	16808	12606	
				(2640-3960)	Fz	0.0055	0.0105	0.0140	0.0150	0.0165	0.0195	
					Feed (ipm)	555	706	706	605	555	492	
ALUMINUM DIE CAST ALLOYS (HIGH SILICONE) A-390, A-392, B-390	≤ 125 Bhn or ≤ 77 HRb	Slot 	1	≤ 1	600	RPM	9168	6112	4584	3667	3056	2292
					(480-720)	Fz	0.0025	0.0045	0.0060	0.0065	0.0070	0.0085
						Feed (ipm)	46	55	55	48	43	39
	Profile 	≤ 0.5	≤ 1.5	750	RPM	11460	7640	5730	4584	3820	2865	
				(600-900)	Fz	0.0025	0.0045	0.0060	0.0065	0.0070	0.0085	
					Feed (ipm)	57	69	69	60	53	49	
	HSM 	≤ 0.05	≤ 2	1240	RPM	18947	12631	9474	7579	6316	4737	
				(992-1488)	Fz	0.0055	0.0105	0.0140	0.0150	0.0165	0.0195	
					Feed (ipm)	208	265	265	227	208	185	
COPPER ALLOYS Aluminum Bronze Brass Naval Brass Red Brass	≤ 140 Bhn or ≤ 3 HRc	Slot 	1	≤ 1	865	RPM	13217	8811	6609	5287	4406	3304
					(692-1038)	Fz	0.0020	0.0040	0.0050	0.0055	0.0060	0.0070
						Feed (ipm)	53	70	66	58	53	46
	Profile 	≤ 0.5	≤ 1.5	1080	RPM	16502	11002	8251	6601	5501	4126	
				(864-1296)	Fz	0.0020	0.0040	0.0050	0.0055	0.0060	0.0070	
					Feed (ipm)	66	88	83	73	66	58	
	HSM 	≤ 0.05	≤ 2	1780	RPM	27198	18132	13599	10879	9066	6800	
				(1424-2136)	Fz	0.0045	0.0085	0.0115	0.0125	0.0140	0.0160	
					Feed (ipm)	245	308	313	272	254	218	
COPPER ALLOYS Beryllium Copper C110, Manganese Bronze, Tin Bronze	≤ 200 Bhn or ≤ 23 HRc	Slot 	1	≤ 1	345	RPM	5272	3514	2636	2109	1757	1318
					(276-414)	Fz	0.0020	0.0040	0.0050	0.0055	0.0060	0.0070
						Feed (ipm)	21	28	26	23	21	18
	Profile 	≤ 0.5	≤ 1.5	430	RPM	6570	4380	3285	2628	2190	1643	
				(344-516)	Fz	0.0020	0.0040	0.0050	0.0055	0.0060	0.0070	
					Feed (ipm)	26	35	33	29	26	23	
	HSM 	≤ 0.05	≤ 2	710	RPM	10849	7233	5424	4340	3616	2712	
				(568-852)	Fz	0.0045	0.0085	0.0115	0.0125	0.0140	0.0160	
					Feed (ipm)	98	123	125	108	101	87	
PLASTICS ABS, Polycarbonate, PVC, Polypropylene	≤ 150 Bhn or ≤ 88 HRb	Slot 	1	≤ 1	1600	RPM	24448	16299	12224	9779	8149	6112
					(1280-1920)	Fz	0.0040	0.0075	0.0100	0.0110	0.0120	0.0140
						Feed (ipm)	196	244	244	215	196	171
	Profile 	≤ 0.5	≤ 1.5	2000	RPM	30560	20373	15280	12224	10187	7640	
				(1600-2400)	Fz	0.0040	0.0075	0.0100	0.0110	0.0120	0.0140	
					Feed (ipm)	244	306	306	269	244	214	
	HSM 	≤ 0.05	≤ 2	3300	RPM	50424	33616	25212	20170	16808	12606	
				(2640-3960)	Fz	0.0090	0.0170	0.0230	0.0250	0.0275	0.0320	
					Feed (ipm)	908	1143	1160	1008	924	807	

Bhn (Brinell) HRc (Rockwell C) HRb (Rockwell B) HSM (High Speed Machining)
 $rpm = Vc \times 3.82 / DC$
 $ipm = Fz \times 2 \times rpm$
 reduce speed and feed for materials harder than listed
 reduce cut depth and feed by 50% for long flute and long reach tools
 reduce feed and Ae when finish milling (.02 x DC maximum)
 refer to the SGS Tool Wizard® for complete technical information (www.kyocera-sgtool.com)

High Performance Drills



Hole Making

HIGH PERFORMANCE DRILLS	SERIES	DESCRIPTION	APPLICATION		PAGE	S&F PAGE						
			● PREFERRED	○ ALTERNATE								
Hi-PerCarb®	142P (3XD)	2 Flute Internal Coolant 4 Margin 3XD	●		188	202						
	142P (5XD)	2 Flute Internal Coolant 4 Margin 5XD	●		191	202						
	142P (8XD)	2 Flute Internal Coolant 4 Margin 8XD	●		194	202						
	142P (12XD)	2 Flute Internal Coolant 4 Margin 12XD	●		198	202						
	143M-S (3XD)	2 Flute Internal Coolant 2 Margin 3XD	●	●	206	214						
	143M-S (5XD)	2 Flute Internal Coolant 2 Margin 5XD	●	●	210	214						
	141K (5xD)	3 Flute Internal Coolant 3 Margin 5xD	●		218	222						
	131N (3xD)	3 Flute External Coolant 3 Margin 3xD		●	223	231						
	131N (5xD)	3 Flute External Coolant 3 Margin 5xD		●	227	231						
	135 (3xD)	2 Flute External Coolant 4 Margin 3xD	●	●	○	○	●	●	●	●	234	240
	135 (5xD)	2 Flute External Coolant 4 Margin 5xD	●	●	○	○	●	●	●	●	244	250
	146U (3xD)	2 Flute External Coolant 4 Margin 3xD	●	●	●	●	●	●	●	●	254	268
	146U (5xD)	2 Flute External Coolant 4 Margin 5xD	●	●	●	●	●	●	●	●	259	268
	136U (2xD)	2 Flute External Coolant 4 Margin 2xD	●	●	●	●	●	●	●	●	264	268
	CFRP 8 Facet	120	2 Flute External Coolant 4 Margin CFRP			●					232	233

Speed & Feed Recommendations listed after each series

Taladrado

BROCAS DE ALTO RENDIMIENTO	SERIE	DESCRIPCIÓN	APLICACIÓN		PÁGINA	S&F PÁGINA			
			● PREFERIDO	○ ALTERNATIVO					
Hi-PerCarb®	142P (3XD)	2 filos, refrigeración interna, 4 margen, 3XD	●		188	202			
	142P (5XD)	2 filos, refrigeración interna, 4 margen, 5XD	●		191	202			
	142P (8XD)	2 filos, refrigeración interna, 4 margen, 8XD	●		194	202			
	142P (12XD)	2 filos, refrigeración interna, 4 margen, 12XD	●		198	202			
	143M-S (3XD)	2 filos, refrigeración interna, 2 margen, 3XD	●	●	206	214			
	143M-S (5XD)	2 filos, refrigeración interna, 2 margen, 5XD	●	●	210	214			
	141K (5xD)	3 filos, refrigeración interna, 3 margen, 5xD		●	218	222			
	131N (3xD)	3 filos, refrigeración externa, 3 margen, 3xD		●	223	231			
	131N (5xD)	3 filos, refrigeración externa, 3 margen, 5xD		●	227	231			
	135 (3xD)	2 filos, refrigeración externa, 4 margen, 3xD	●	●	●	●	●	234	240
	135 (5xD)	2 filos, refrigeración externa, 4 margen, 5xD	●	●	●	●	●	244	250
	146U (3xD)	2 filos, refrigeración externa, 4 margen, 3xD	●	●	●	●	●	254	268
	146U (5xD)	2 filos, refrigeración externa, 4 margen, 5xD	●	●	●	●	●	259	268
	136U (2xD)	2 filos, refrigeración externa, 4 margen, 2xD	●	●	●	●	●	264	268
	De 8 caras CFRP	120	2 filos, refrigeración externa, 4 margen, CFRP		●	232	233		

Recomendaciones de velocidades y avances mostradas tras cada serie

Outils de perçage

FORETS HAUTE PERFORMANCE	SÉRIES	DESCRIPTION	APPLICATION		PAGE	S&F PAGE			
			● PRÉFÉRÉ	○ ALTERNER					
Hi-PerCarb®	142P (3XD)	2 dents trou d'huile 4 listel 3XD	●		188	202			
	142P (5XD)	2 dents trou d'huile 4 listel 5XD	●		191	202			
	142P (8XD)	2 dents trou d'huile 4 listel 8XD	●		194	202			
	142P (12XD)	2 dents trou d'huile 4 listel 12XD	●		198	202			
	143M-S (3XD)	2 dents trou d'huile 2 listel 3XD	●	●	206	214			
	143M-S (5XD)	2 dents trou d'huile 2 listel 5XD	●	●	210	214			
	141K (5xD)	3 dents refroidissement interne à 3 listel 5xD		●	218	222			
	131N (3xD)	3 dents refroidissement externe à 3 listel 3xD		●	223	231			
	131N (5xD)	3 dents refroidissement externe à 3 listel 5xD		●	227	231			
	135 (3xD)	2 dents refroidissement externe à 4 listel 3xD	●	●	●	●	●	234	240
	135 (5xD)	2 dents refroidissement externe à 4 listel 5xD	●	●	●	●	●	244	250
	146U (3xD)	2 dents refroidissement externe à 4 listel 3xD	●	●	●	●	●	254	268
	146U (5xD)	2 dents refroidissement externe à 4 listel 5xD	●	●	●	●	●	259	268
	136U (2xD)	2 dents refroidissement externe à 4 listel 2xD	●	●	●	●	●	264	268
	CFRP à 8 facettes	120	2 dents refroidissement externe à 4 listel CFRP		●	232	233		

Recommandations de vitesse et avance indiquées après chaque série

Bohren

HOCHLEISTUNGS-BOHRER	SERIE	BESCHREIBUNG	ANWENDUNG		SEITE	S&F SEITE			
			● BEVORZUGT	○ WECHSELN					
Hi-PerCarb®	142P (3XD)	Doppelfasenbohrer mit 4 Schneiden und Innenkühlung, 3xD	●		188	202			
	142P (3XD)	Doppelfasenbohrer mit 4 Schneiden und Innenkühlung, 5xD	●		191	202			
	142P (3XD)	Doppelfasenbohrer mit 4 Schneiden und Innenkühlung, 8xD	●		194	202			
	142P (12XD)	Doppelfasenbohrer mit 4 Schneiden und Innenkühlung, 12xD	●		198	202			
	143M-S (3XD)	2 Einfasenbohrer mit 2 Schneiden und Innenkühlung, 3xD	●	●	206	214			
	143M-S (5XD)	2 Einfasenbohrer mit 2 Schneiden und Innenkühlung, 5xD	●	●	210	214			
	141K (5xD)	Dreifasenbohrer 5xD mit 3 Schneiden und Innenkühlung		●	218	222			
	131N (3xD)	Dreifasenbohrer 3xD mit 3 Schneiden und Außenkühlung		●	223	231			
	131N (5xD)	Dreifasenbohrer 5xD mit 3 Schneiden und Außenkühlung		●	227	231			
	135 (3xD)	Doppelfasenbohrer 3xD mit 4 Schneiden und Außenkühlung	●	●	●	●	●	234	240
	135 (5xD)	Doppelfasenbohrer 5xD mit 4 Schneiden und Außenkühlung	●	●	●	●	●	244	250
	146U (3xD)	Doppelfasenbohrer 3xD mit 4 Schneiden und Außenkühlung	●	●	●	●	●	254	268
	146U (5xD)	Doppelfasenbohrer 5xD mit 4 Schneiden und Außenkühlung	●	●	●	●	●	259	268
	136U (2xD)	Doppelfasenbohrer 2xD mit 4 Schneiden und Außenkühlung	●	●	●	●	●	264	268
	CFRP 8 Facet	120	Doppelfasenbohrer CFRP mit 4 Schneiden und Außenkühlung		●	232	233		

Empfehlungen für Drehzahl & Vorschub im Anhang zu jeder Serie

Drill Matrix

Item				Preferred Cut Type for Series ★ Best ☆ Better ○ Good (blank) Not Recommended																		
				Material																		
				Low Carbon ≤ 20 HRC	Medium Carbon, Alloy 20 to 35 HRC	High Carbon, Alloy 35 to 45 HRC	Ferritic & Martensitic ≤ 45 HRC	Austenitic & Duplex ≤ 25 HRC	Precipitation Hardened ≤ 45 HRC	Low Alloy, Grey, Ductile ≤ 25 HRC	Med-High Alloy, Nodular 25 to 35 HRC	High Alloy, Nodular ≥ 35 HRC	Aluminum Alloys	Copper Alloys	Plastics, Composites	Titanium Alloys ≤ 45 HRC	Iron, Nickel, Cobalt Alloys ≤ 45 HRC	Refractory Alloys, Mo, Ta, W ≤ 35 HRC	High Carbon, Med Alloy 45 to 50 HRC	Tool, Mold & Die 45 to 55 HRC	Tool, Mold & Die 55 to 65 HRC	
Name / Series	Tool Type	Coolant Delivery	Page	Steel			Stainless Steel			Cast Iron			Non Ferrous		HRSA			Hard Steel				
Hi-PerCarb® 142P	High Performance Drill	Internal	188	★	★	★	☆	☆	☆	☆	☆	☆	☆	★			☆	☆	☆	★	☆	☆
Hi-PerCarb® 143M-S	High Performance Drill	Internal	206	☆			★	★	★	☆	☆	☆	○	★			★	★	★			
Hi-PerCarb® 141K	High Performance Drill	Internal	218	☆	☆	☆	○		○	★	★	★	☆	☆			○		○			
Hi-PerCarb® 131N	High Performance Drill	External	223							○			★	★	☆	○						
Series 120	High Performance Drill	External	232												★							
Hi-PerCarb® 135	High Performance Drill	External	234	★	★	★	★	☆	★	☆	☆	☆	○	○			☆	☆	☆	★	☆	☆
Hi-PerCarb® 146U	High Performance Drill	Internal	254	★	★	★	★	★	★	★	★	★	★	★	★	★	★	★	★	★	★	
Hi-PerCarb® 136U	High Performance Drill	External	264	★	★	★	★	★	★	★	★	★	★	★	★	★	★	★	★	★	★	
Series 120	High Performance Drill	External	232												★							
Series 106	General Application Drill	External	348	○	○	○						☆							★	★	☆	
Series 101	General Application Drill	External	336	○	○	○	○	○	○	○	○	○	○	○	○	○	○	○				
Series 103	General Application Drill	External	352	○	○	○	○	○	○	○	☆	☆	○			○	○	○				
Series 108	General Application Drill	External	341	★	☆	☆	☆	☆	☆	☆	☆	☆		○	○	☆	☆	☆				
Series 301, 301M	Drill & Countersink	External	358	☆	☆	☆	☆	☆	☆	☆	☆	☆	☆	☆	☆	☆	○	○	☆	○	○	
Series 601	Countersink	External	364	○	○	○	○	★	○	☆	☆	☆	★	☆	○	○	○	○				
Series 603	Countersink	External	367	☆	☆	☆	☆	★	☆	★	☆	☆	★	★	☆	☆	☆	☆	○			
Series 606	Countersink	External	370	★	★	★	★	★	★	★	★	★	○	★	★	★	★	★	☆	☆	○	
Series 200	Reamer	External	374	★	★	★	★	★	★	★	★	★	★	★	★	★	★	★	★	★	○	
Series 201M	Reamer	External	378	★	★	★	★	★	★	★	★	★	★	★	★	★	★	★	★	★	○	

Drill Matrix

Attributes										
<p>Material hardness and machinability affect speed, feed, and cut depths. For dimensional and finish quality, a low TIR of the tool-holder assembly in the machine is critical: less than 0.1% drill diameter is preferred. Spot drilling is not necessary in most situations if the drilling surface is machined flat; spot drill point angle should be greater than drill point angle. Liquid coolant (internal or external) such as oil based or synthetic is highly recommended for all drilling applications. For proper cooling, lubrication and chip evacuation, ensure the coolant is supplied throughout the entire depth of the hole. When liquid coolant cannot be applied for applications such as plastics or composites, clear the swarf with air or vacuum. Depending on material machinability, a peck cycle may be necessary for external coolant drills beyond 2x or 3x depths.</p>										
Diameter Range inch	Diameter Range mm	Tolerance	Length	Point Angle °	Self Centering	Flute Count	Margins	Helix Angle °	Shank	Coating
0.1250 0.7500	3,00 16,00	DC + / +	3x, 5x, 8x, 12x	137	yes	2	4	30	Common	Ti-NAMITE®-X
0.1250 0.7500	3,00 16,00	DC + / +	3x, 5x	136	yes	2	2	30	Common	Ti-NAMITE®-A
0.1250 0.7500	3,00 16,00	DC + / +	5x	124	yes	3	3	30	Common	Ti-NAMITE®-X
0.1250 0.7500	3,00 16,00	DC + / +	3x, 5x	124	yes	3	3	30	Common	Ti-NAMITE®-B
0.0980 0.5000	2,70 12,00	DC 0 / -	3x	145, 90	yes	2	4	20	Common	Di-NAMITE®
0.0156 0.9219	1,25 22,00	DC + / +	3x, 5x	145	yes	2	4	32	Common	Ti-NAMITE®-A
0.1250 0.8125	3,00 20,50	DC + / +	3x, 5x	180	yes	2	4	15	Common	Ti-NAMITE®-X
0.0625 0.8125	1,50 20,50	DC + / +	2x	180	yes	2	4	15	Common	Ti-NAMITE®-X
0.0980 0.5000	2,70 12,00	DC + / -	3x	145, 90	yes	2	4	20	Common	Di-Namite®
0.0400 0.5000	1,00 12,00	DC 0 / -	3x	140	yes	2	2	0	Straight	Ti-NAMITE®-A or uncoated
0.0135 0.5000	0,70 12,00	DC 0 / -	5x	118	no	2	2	20	Straight	Ti-NAMITE®-A or uncoated
0.1065 0.7500	3,00 20,00	DC 0 / -	3x	150	yes	3	3	30	Straight	Ti-NAMITE®-A or uncoated
-	0,50 16,00	DC 0 / -	3x	118	yes	2	2	20	Straight	Ti-NAMITE®-A or uncoated
0.0250 0.2188	0,50 5,00	DC + / 0	spot	118, 60	yes	2	2	0	Straight	Ti-NAMITE®-A or uncoated
0.1250 1.0000	-	DC + / -	spot	60, 82, or 90	yes	1	-	0	Common	uncoated
0.1250 1.0000	-	DC + / -	spot	60, 82, or 90	yes	3	-	0	Common	uncoated
0.1250 1.0000	-	DC + / -	spot	60, 82, or 90	yes	6	6	0	Common	uncoated
0.0469 0.5000	-	DC + / 0	varies	-	-	4 or 6	4 or 6	0	Straight	uncoated
-	1,00 10,00	DC + / 0	varies	-	-	4 or 6	4 or 6	0	Straight	uncoated

Drilling Operations

Coolant Recommendations

- Coolant works to mobilize chips away from the cut zone, reduce the heat created during the cutting process and minimize friction.
- It is important to optimize the coolant pressure and position in order to gain the full benefits coolant offers the cutting process.
- Proper coolant application promotes greater operating parameters, greater material removal rates, improved surface finishes, predictable tool life, reduced power consumption and reduced cycle times.
- Pressure is important, but more importantly is consistency of the pressure and application onto the tool; intermittent cooling of carbide leads to thermal stressing of the material and the formation of “microcracks.”
- Proper cleanliness and filtration of coolants is important in order for the coolant to maintain its beneficial properties, and also to avoid a reduction in coolant pressure or the possibility of clogging the coolant channels in coolant through drills.

RECOMMENDED COOLANT PRESSURE
BY DIAMETER – psi

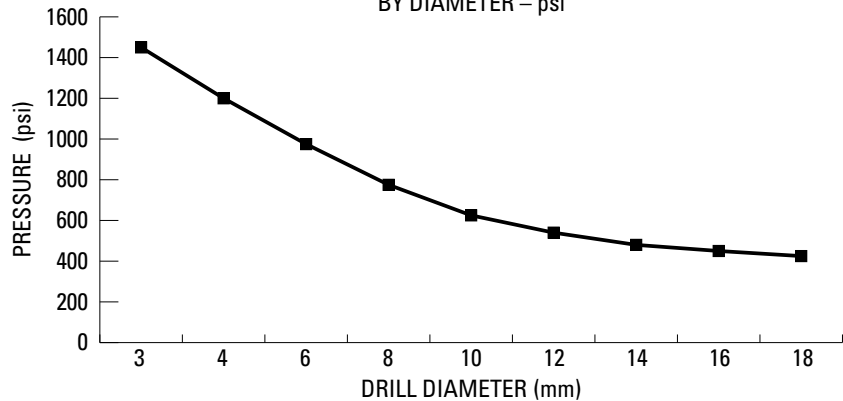

RECOMMENDED COOLANT PRESSURE
BY DIAMETER – bar

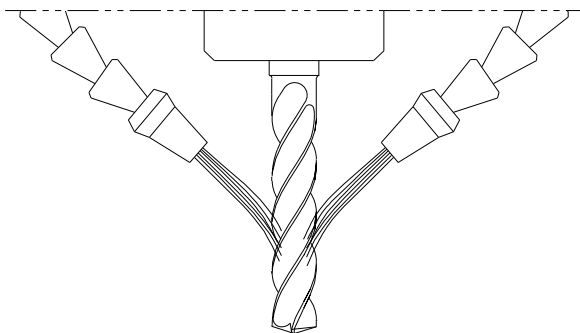
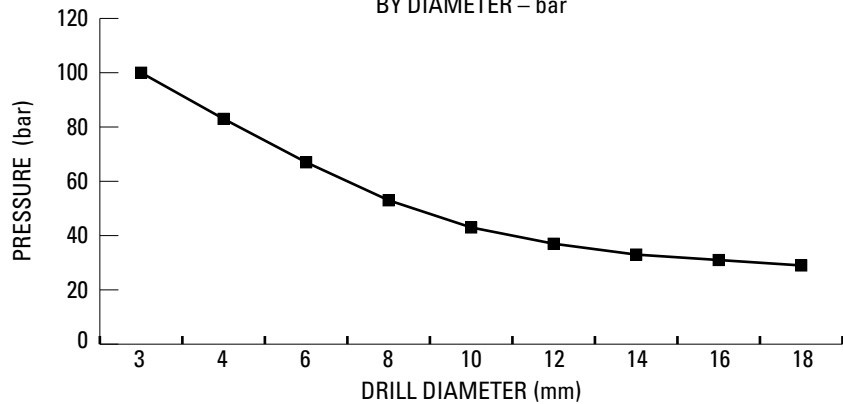

LARGE TIP – LOW VELOCITY
NO COVERAGE AT MAXIMUM DEPTH

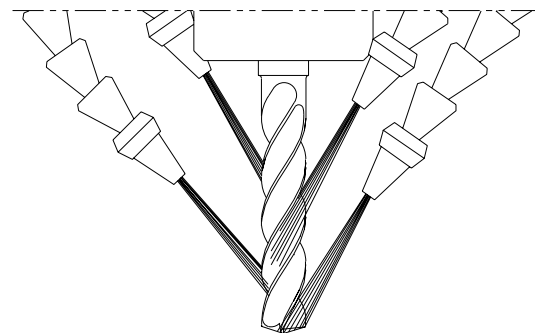

SMALL TIP – HIGH VELOCITY
COMPLETE COVERAGE

- Reducing the nozzle size helps maximize the cooling benefits of the unique double margin design on the Hi-PerCarb drill by increasing velocity. Aim the nozzles in line with the secondary flute located between the two margins as well as the flute for best results.

Recomendaciones en operación de taladrado

- El líquido de refrigeración actúa movilizandando las virutas fuera de la zona de corte, disminuyendo el calor generado durante el proceso de corte y minimizando la fricción.
- Es importante optimizar la presión de la refrigeración y la posición para poder obtener todos los beneficios del refrigerante durante el proceso de corte.
- Una aplicación apropiada de la refrigeración fomenta mayores parámetros de operación, mayores índices de eliminación de material, acabados de superficie mejorados, una duración de la herramienta más predecible, bajo consumo de energía y un tiempo de ciclo reducido.
- La presión del refrigerante es importante, pero lo es más el flujo continuo aplicado a la herramienta; una refrigeración intermitente en el carburo puede ocasionar un estrés térmico en el material y la formación de "micro-fisuras".
- Una limpieza y filtración adecuadas son importantes para que el refrigerante mantenga sus propiedades y beneficios; por otra parte, se evita la reducción de la presión o la posibilidad de obstruir los canales de refrigeración de la broca.

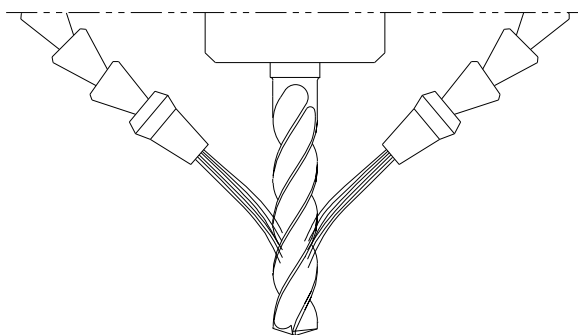
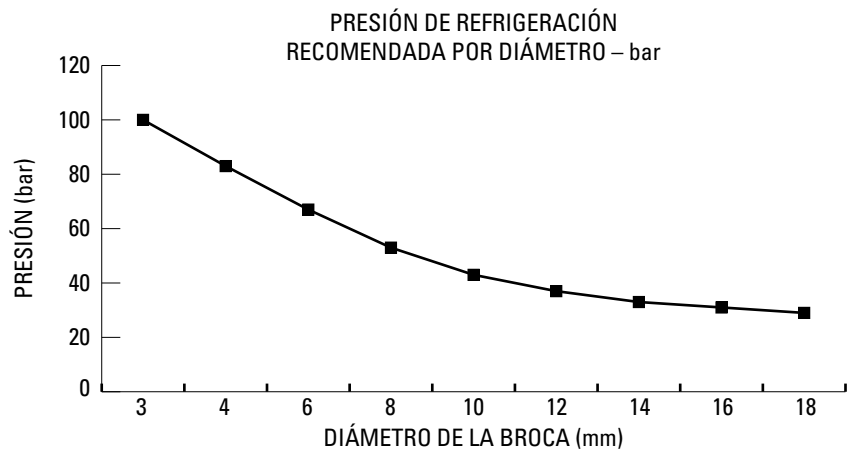
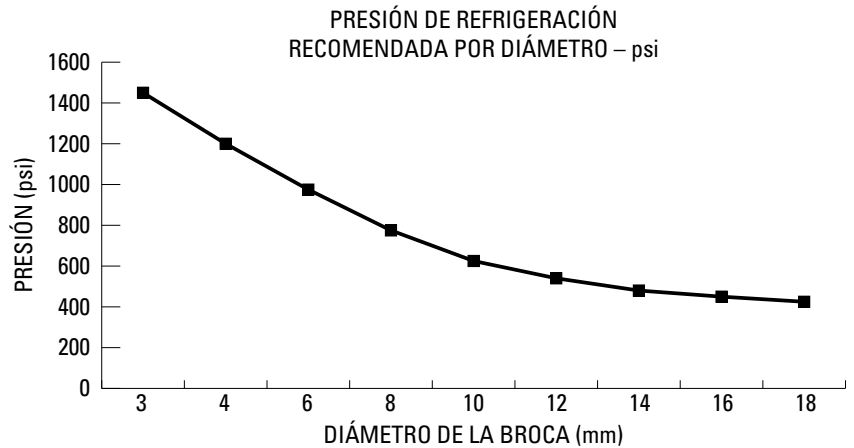

PUNTA GRANDE – BAJA VELOCIDAD
SIN ALCANCE A PROFUNDIDAD MÁXIMA

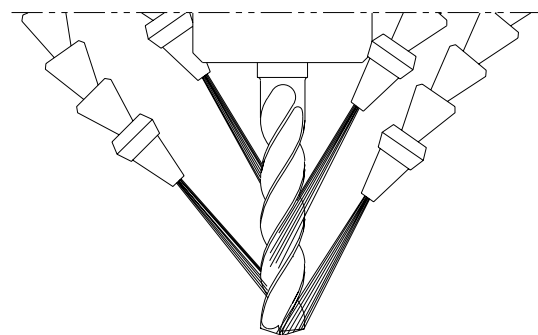

PUNTA PEQUEÑA – ALTA VELOCIDAD
COMPLETO ALCANCE

- Reducir el tamaño de la boquilla ayuda a maximizar los beneficios de refrigeración del exclusivo diseño de doble margen de la broca. Hi-PerCarb aumentando la velocidad. Coloque las boquillas en línea con el segundo filo que se encuentra entre los dos márgenes y también el filo para obtener mejores resultados.

Opérations de perçage

Recommandations en matière de refroidissement

- Le liquide de refroidissement sert à éloigner les copeaux de la zone de coupe, à réduire la chaleur dégagée durant la coupe et à minimiser la friction.
- Il est important d'optimiser la pression et la position du réfrigérant pour en retirer les bénéfices maximums durant la coupe.
- L'application adéquate de réfrigérant se traduit par des paramètres opératoires supérieurs, des taux d'élimination supérieurs des matériaux, de plus belles finitions des surfaces, une durée de vie des outils prévisible, moins de consommation d'énergie et des temps de cycle réduits.
- La pression est importante, mais une pression régulière et l'application sur l'outil sont des facteurs encore plus importants ; le refroidissement intermittent du carbure se traduit par des contraintes thermiques pour le matériau et la formation de microfissures.
- La propreté et le filtrage adéquats des réfrigérants sont importants pour qu'ils conservent leur propriétés, mais aussi pour éviter la réduction de pression du réfrigérant ou le risque d'obturation des conduits à réfrigérant dans les perceuses à réfrigérant intégré.

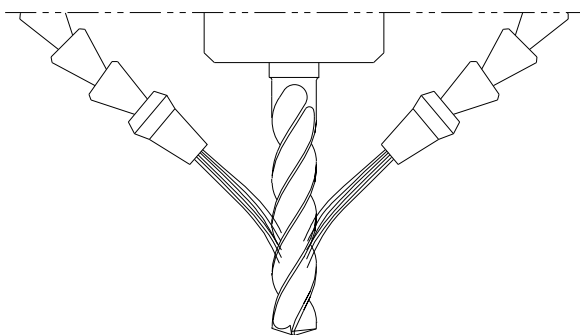
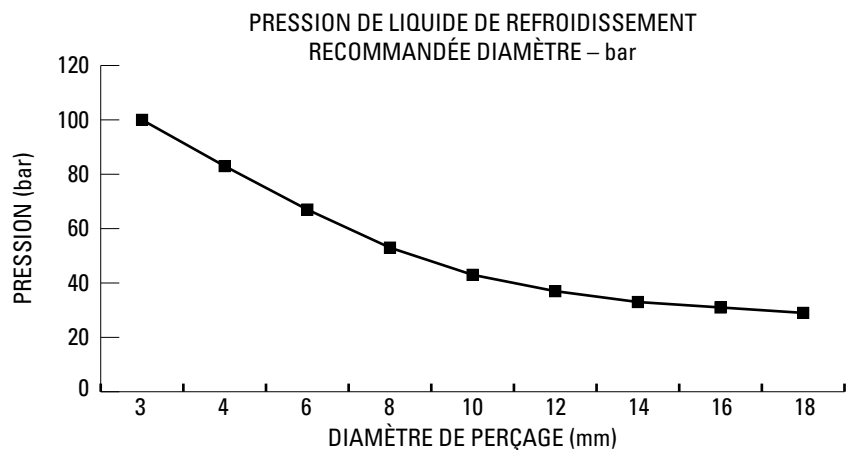
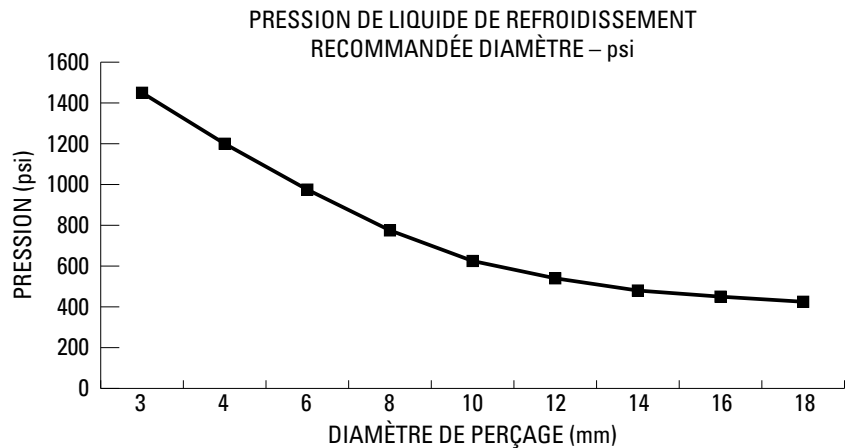

POINTE LARGE – BASSE VITESSE
PAS DE COUVERTURE À LA PROFONDEUR MAXIMUM

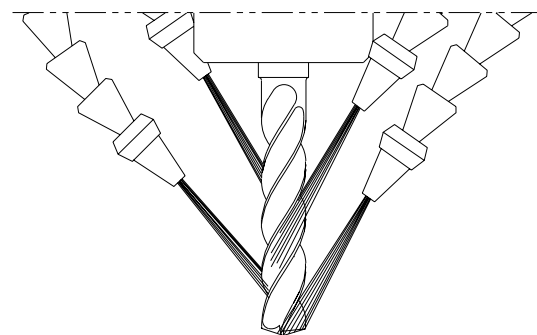

POINTE FINE – GRANDE VITESSE
COUVERTURE COMPLÈTE

- La réduction de la taille de l'embout permet de maximiser les bienfaits du refroidissement du concept à double listel original de la perceuse Hi-PerCarb en augmentant la vitesse. Pour les meilleurs résultats, orientez les embouts dans l'axe de la goujure secondaire située entre les deux listels, de même que la goujure primaire.

🇩🇪 Bohrarbeiten Kühlmittelempfehlungen

- Kühlmittel dienen dazu, die Späne aus dem Schneidenbereich zu entfernen, die beim Schneiden erzeugte Wärme abzutransportieren und die Reibung zu verringern.
- Es kommt darauf an, den Kühlschmiermitteldruck und die Zufuhr zu optimieren, um alle Vorteile beim Bohren nutzen zu können.
- Der richtige Kühlschmiermitteleinsatz ermöglicht höhere Schnittparameter, höheren Materialabtrag, bessere Oberflächengüte, vorhersehbare Standzeiten und geringere Leistungsaufnahme und Laufzeiten.
- Der Druck ist wichtig, aber wichtiger ist dessen Konstanz und die Zufuhr zum Werkzeug. Unterbrochene Kühlung des Hartmetalls führt zur thermischen Belastung und Bildung von "Mikrorissen".
- Kühlmittel sind sauber zu halten und zu filtern, damit die Qualität des Kühlmittels erhalten bleibt und der Kühlmitteldruck durch Verstopfung der Kühlmittelkanäle im Bohrer nicht absinkt.

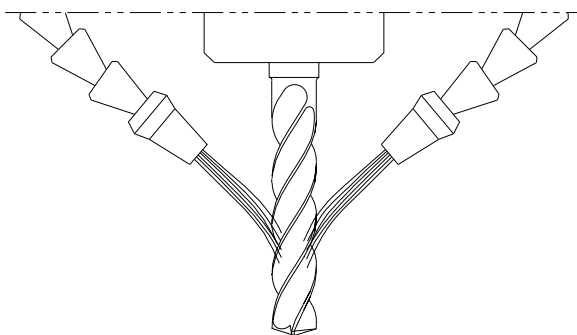
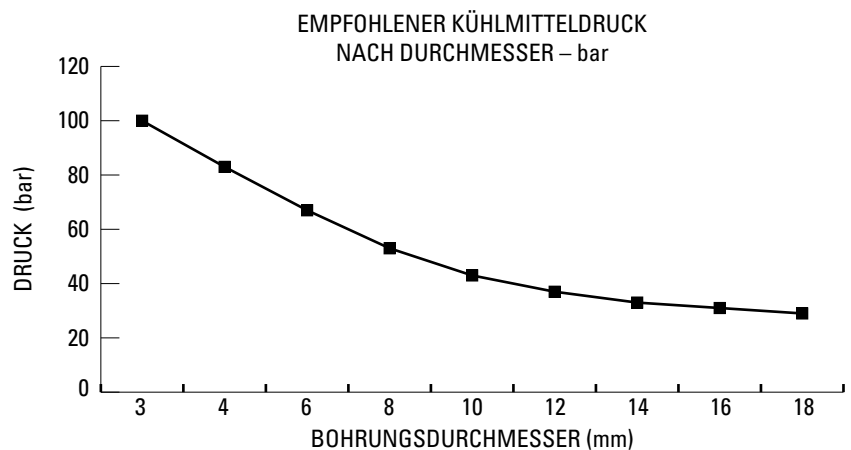
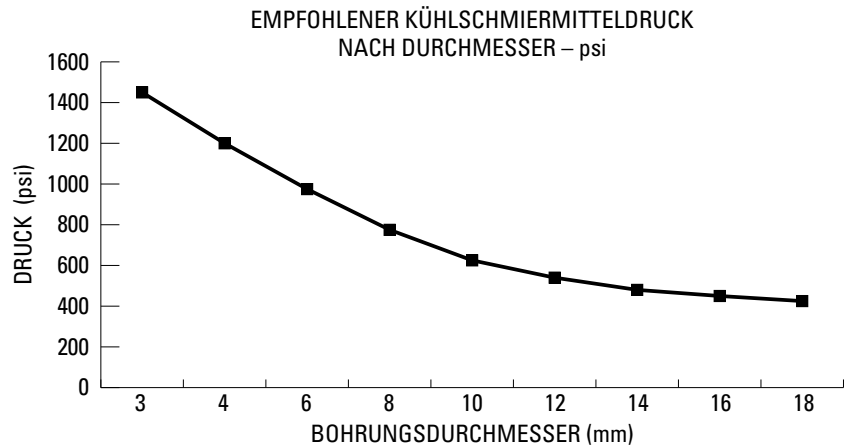

BREITE QUERSCHNEIDE – GERINGE DREHZAHL
KEINE VOLLSTÄNDIGE BENETZUNG BEI MAX. BOHRUNGSTIEFE

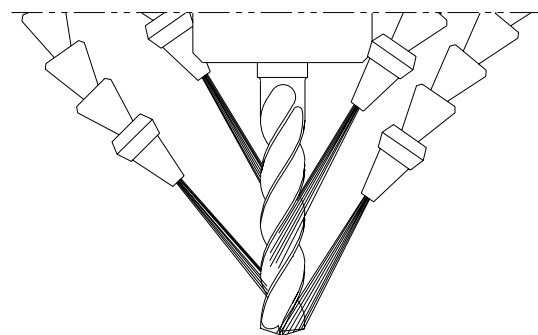

SCHMALE QUERSCHNEIDE – HOHE DREHZAHL
VOLLSTÄNDIGE BENETZUNG

- Durch Verringern der Düsengröße können die vorteilhaften Eigenschaften der Doppelfase genutzt werden, um die Drehzahl des Hi-PerCarb-Bohrers zu steigern. Richten Sie die Düsen auf die Nebennut zwischen beiden Fasen sowie auf die Schneiden aus, um beste Ergebnisse zu erzielen.



3xD



142P 3xD

FRACTIONAL & METRIC SERIES

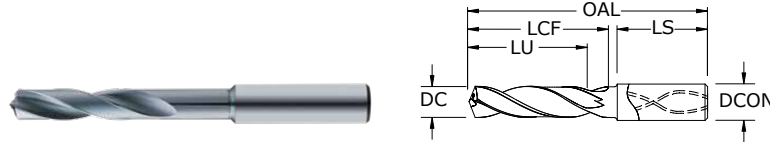

- High-performance point design stabilizes on entry for exceptional hole size and cylindricity while also allowing for low thrust force and extended tool life
- Internal coolant hole improves coolant flow to extend tool life and aid in chip evacuation
- 4-margin design improves hole straightness and roundness while providing improved stability for difficult applications like cross holes and when exiting on angle
- Proprietary Ti-NAMITE®-X coating and industry leading carbide substrate provides exceptional wear resistance and toughness for demanding applications
- Recommended for materials ≤ 50HRc (475 Bhn)

inch & mm								EDP NO.
DECIMAL DC	METRIC DC	FRACTIONAL/ LETTER/WIRE DC	SHANK DIAMETER DCON	OVERALL LENGTH OAL	FLUTE LENGTH LCF	USABLE LENGTH LU	SHANK LENGTH LS	Ti-NAMITE®-X (TX)
0.1181	3,000 mm		6,0	62,0	20,0	15,0	36,0	66400
0.1220	3,100 mm		6,0	62,0	20,0	15,0	36,0	66401
0.1250	3,175 mm	1/8	6,0	62,0	20,0	15,0	36,0	56400
0.1260	3,200 mm		6,0	62,0	20,0	15,0	36,0	66402
0.1299	3,300 mm		6,0	62,0	20,0	15,0	36,0	66403
0.1339	3,400 mm		6,0	62,0	20,0	15,0	36,0	66404
0.1360	3,454 mm	#29	6,0	62,0	20,0	15,0	36,0	56401
0.1378	3,500 mm		6,0	62,0	20,0	15,0	36,0	66405
0.1406	3,571 mm	9/64	6,0	62,0	20,0	15,0	36,0	56402
0.1417	3,600 mm		6,0	62,0	20,0	15,0	36,0	66406
0.1457	3,700 mm		6,0	62,0	20,0	15,0	36,0	66407
0.1496	3,800 mm		6,0	66,0	24,0	18,0	36,0	66408
0.1535	3,900 mm		6,0	66,0	24,0	18,0	36,0	66409
0.1562	3,967 mm	5/32	6,0	66,0	24,0	18,0	36,0	56403
0.1575	4,000 mm		6,0	66,0	24,0	18,0	36,0	66410
0.1590	4,039 mm	#21	6,0	66,0	24,0	18,0	36,0	56404
0.1614	4,100 mm		6,0	66,0	24,0	18,0	36,0	66411
0.1654	4,200 mm		6,0	66,0	24,0	18,0	36,0	66412
0.1693	4,300 mm		6,0	66,0	24,0	18,0	36,0	66413
0.1719	4,366 mm	11/64	6,0	66,0	24,0	17,0	36,0	56405
0.1732	4,400 mm		6,0	66,0	24,0	17,0	36,0	66414
0.1772	4,500 mm		6,0	66,0	24,0	17,0	36,0	66415
0.1811	4,600 mm		6,0	66,0	24,0	17,0	36,0	66416
0.1850	4,699 mm	#13	6,0	66,0	24,0	17,0	36,0	66417
0.1875	4,763 mm	3/16	6,0	66,0	28,0	21,0	36,0	56406
0.1890	4,801 mm	#12	6,0	66,0	28,0	21,0	36,0	66418
0.1929	4,900 mm		6,0	66,0	28,0	21,0	36,0	66419
0.1969	5,000 mm		6,0	66,0	28,0	20,0	36,0	66420
0.2008	5,100 mm		6,0	66,0	28,0	20,0	36,0	66421
0.2031	5,159 mm	13/64	6,0	66,0	28,0	20,0	36,0	56407
0.2047	5,200 mm		6,0	66,0	28,0	20,0	36,0	66422
0.2087	5,300 mm		6,0	66,0	28,0	20,0	36,0	66423
0.2126	5,400 mm		6,0	66,0	28,0	20,0	36,0	66424
0.2165	5,500 mm		6,0	66,0	28,0	20,0	36,0	66425
0.2188	5,558 mm	7/32	6,0	66,0	28,0	20,0	36,0	56408
0.2205	5,600 mm		6,0	66,0	28,0	20,0	36,0	66426
0.2244	5,700 mm		6,0	66,0	28,0	19,0	36,0	66427
0.2283	5,800 mm		6,0	66,0	28,0	19,0	36,0	66428
0.2323	5,900 mm		6,0	66,0	28,0	19,0	36,0	66429
0.2344	5,954 mm	15/64	6,0	66,0	28,0	19,0	36,0	56409
0.2362	6,000 mm		6,0	66,0	28,0	19,0	36,0	66430
0.2402	6,100 mm		8,0	79,0	34,0	25,0	36,0	66431
0.2441	6,200 mm		8,0	79,0	34,0	25,0	36,0	66432
0.2480	6,300 mm		8,0	79,0	34,0	25,0	36,0	66433

TOLERANCES (inch)

- ≤.1181 DIAMETER
DC = +.00008/+0.00047
DCON = h₆
- >.1181-.2362 DIAMETER
DC = +.00016/+0.00063
DCON = h₆
- >.2362-.3937 DIAMETER
DC = +.00024/+0.00083
DCON = h₆
- >.3937-.7087 DIAMETER
DC = +.00028/+0.00098
DCON = h₆
- >.7087-1.1811 DIAMETER
DC = +.00031/+0.00114
DCON = h₆

TOLERANCES (mm)

- ≤3 DIAMETER
DC = +0,002/+0,012
DCON = h₆
- >3-6 DIAMETER
DC = +0,004/+0,016
DCON = h₆
- >6-10 DIAMETER
DC = +0,006/+0,021
DCON = h₆
- >10-18 DIAMETER
DC = +0,007/+0,025
DCON = h₆
- >18-30 DIAMETER
DC = +0,008/+0,029
DCON = h₆

- STEELS
- STAINLESS STEELS
- CAST IRON
- NON-FERROUS
- HIGH TEMP ALLOYS
- HARDENED STEELS

For patent information visit www.ksptpatents.com

continued on next page



142P 3xD

FRACTIONAL & METRIC SERIES

DECIMAL DC	METRIC DC	inch & mm						EDP NO.
		FRACTIONAL/ LETTER/WIRE DC	SHANK DIAMETER DCON	OVERALL LENGTH OAL	FLUTE LENGTH LCF	USABLE LENGTH LU	SHANK LENGTH LS	Ti-NAMITE®-X (TX)
0.2500	6,350 mm	1/4 E #0	8,0	79,0	34,0	24,0	36,0	56410
0.2520	6,400 mm		8,0	79,0	34,0	24,0	36,0	66434
0.2559	6,500 mm		8,0	79,0	34,0	24,0	36,0	66435
0.2570	6,528 mm	F	8,0	79,0	34,0	24,0	36,0	56411
0.2598	6,600 mm		8,0	79,0	34,0	24,0	36,0	66436
0.2638	6,700 mm		8,0	79,0	34,0	24,0	36,0	66437
0.2656	6,746 mm	17/64	8,0	79,0	34,0	24,0	36,0	56412
0.2677	6,800 mm		8,0	79,0	34,0	24,0	36,0	66438
0.2717	6,900 mm		8,0	79,0	34,0	24,0	36,0	66439
0.2756	7,000 mm		8,0	79,0	34,0	24,0	36,0	66440
0.2795	7,100 mm		8,0	79,0	41,0	30,0	36,0	66441
0.2812	7,142 mm	9/32	8,0	79,0	41,0	30,0	36,0	56413
0.2835	7,200 mm		8,0	79,0	41,0	30,0	36,0	66442
0.2874	7,300 mm		8,0	79,0	41,0	30,0	36,0	66443
0.2913	7,400 mm		8,0	79,0	41,0	30,0	36,0	66444
0.2953	7,500 mm		8,0	79,0	41,0	30,0	36,0	66445
0.2969	7,541 mm	19/64	8,0	79,0	41,0	30,0	36,0	56414
0.2992	7,600 mm		8,0	79,0	41,0	30,0	36,0	66446
0.3031	7,700 mm		8,0	79,0	41,0	29,0	36,0	66447
0.3071	7,800 mm		8,0	79,0	41,0	29,0	36,0	66448
0.3110	7,900 mm		8,0	79,0	41,0	29,0	36,0	66449
0.3125	7,938 mm	5/16	8,0	79,0	41,0	29,0	36,0	56415
0.3150	8,000 mm		8,0	79,0	41,0	29,0	36,0	66450
0.3189	8,100 mm		10,0	89,0	47,0	35,0	40,0	66451
0.3228	8,200 mm		10,0	89,0	47,0	35,0	40,0	66452
0.3268	8,300 mm		10,0	89,0	47,0	35,0	40,0	66453
0.3281	8,334 mm	21/64	10,0	89,0	47,0	34,0	40,0	56416
0.3307	8,400 mm		10,0	89,0	47,0	34,0	40,0	66454
0.3320	8,433 mm	Q	10,0	89,0	47,0	34,0	40,0	56417
0.3346	8,500 mm		10,0	89,0	47,0	34,0	40,0	66455
0.3386	8,600 mm		10,0	89,0	47,0	34,0	40,0	66456
0.3425	8,700 mm		10,0	89,0	47,0	34,0	40,0	66457
0.3438	8,733 mm	11/32	10,0	89,0	47,0	34,0	40,0	56418
0.3465	8,800 mm		10,0	89,0	47,0	34,0	40,0	66458
0.3504	8,900 mm		10,0	89,0	47,0	34,0	40,0	66459
0.3543	9,000 mm		10,0	89,0	47,0	34,0	40,0	66460
0.3583	9,100 mm		10,0	89,0	47,0	33,0	40,0	66461
0.3594	9,129 mm	23/64	10,0	89,0	47,0	33,0	40,0	56419
0.3622	9,200 mm		10,0	89,0	47,0	33,0	40,0	66462
0.3661	9,300 mm		10,0	89,0	47,0	33,0	40,0	66463
0.3680	9,347 mm	U	10,0	89,0	47,0	33,0	40,0	56420
0.3701	9,400 mm		10,0	89,0	47,0	33,0	40,0	66464
0.3740	9,500 mm		10,0	89,0	47,0	33,0	40,0	66465
0.3750	9,525 mm	3/8	10,0	89,0	47,0	33,0	40,0	56421
0.3780	9,600 mm		10,0	89,0	47,0	33,0	40,0	66466
0.3819	9,700 mm		10,0	89,0	47,0	32,0	40,0	66467
0.3858	9,800 mm		10,0	89,0	47,0	32,0	40,0	66468
0.3898	9,900 mm		10,0	89,0	47,0	32,0	40,0	66469
0.3906	9,921 mm	25/64	10,0	89,0	47,0	32,0	40,0	56422
0.3937	10,000 mm		10,0	89,0	47,0	32,0	40,0	66470
0.3976	10,100 mm		12,0	102,0	55,0	40,0	45,0	66471
0.4016	10,200 mm		12,0	102,0	55,0	40,0	45,0	66472
0.4055	10,300 mm		12,0	102,0	55,0	40,0	45,0	66473
0.4062	10,317 mm	13/32	12,0	102,0	55,0	40,0	45,0	56423

CONTINUED

continued on next page



3xD



142P 3xD

FRACTIONAL & METRIC SERIES

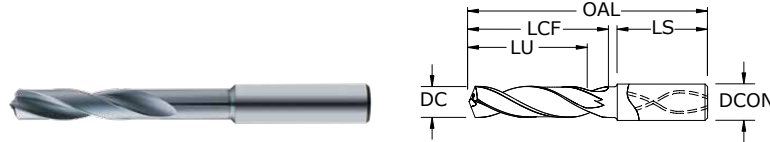

- High-performance point design stabilizes on entry for exceptional hole size and cylindricity while also allowing for low thrust force and extended tool life
- Internal coolant hole improves coolant flow to extend tool life and aid in chip evacuation
- 4-margin design improves hole straightness and roundness while providing improved stability for difficult applications like cross holes and when exiting on angle
- Proprietary Ti-NAMITE®-X coating and industry leading carbide substrate provides exceptional wear resistance and toughness for demanding applications
- Recommended for materials ≤ 50HRc (475 Bhn)

		inch & mm						EDP NO.
DECIMAL DC	METRIC DC	FRACTIONAL/ LETTER/WIRE DC	SHANK DIAMETER DCON	OVERALL LENGTH OAL	FLUTE LENGTH LCF	USABLE LENGTH LU	SHANK LENGTH LS	Ti-NAMITE®-X (TX)
0.4095	10,400 mm		12,0	102,0	55,0	39,0	45,0	66474
0.4134	10,500 mm		12,0	102,0	55,0	39,0	45,0	66475
0.4173	10,600 mm		12,0	102,0	55,0	39,0	45,0	66476
0.4213	10,700 mm		12,0	102,0	55,0	39,0	45,0	66477
0.4219	10,716 mm	27/64	12,0	102,0	55,0	39,0	45,0	56424
0.4252	10,800 mm		12,0	102,0	55,0	39,0	45,0	66478
0.4291	10,900 mm		12,0	102,0	55,0	39,0	45,0	66479
0.4331	11,000 mm		12,0	102,0	55,0	39,0	45,0	66480
0.4370	11,100 mm		12,0	102,0	55,0	38,0	45,0	66481
0.4375	11,113 mm	7/16	12,0	102,0	55,0	38,0	45,0	56425
0.4409	11,200 mm		12,0	102,0	55,0	38,0	45,0	66482
0.4449	11,300 mm		12,0	102,0	55,0	38,0	45,0	66483
0.4488	11,400 mm		12,0	102,0	55,0	38,0	45,0	66484
0.4528	11,500 mm		12,0	102,0	55,0	38,0	45,0	66485
0.4567	11,600 mm		12,0	102,0	55,0	38,0	45,0	66486
0.4606	11,700 mm		12,0	102,0	55,0	37,0	45,0	66487
0.4646	11,800 mm		12,0	102,0	55,0	37,0	45,0	66488
0.4685	11,900 mm		12,0	102,0	55,0	37,0	45,0	66489
0.4688	11,908 mm	15/32	12,0	102,0	55,0	37,0	45,0	56426
0.4724	12,000 mm		12,0	102,0	55,0	37,0	45,0	66490
0.4844	12,304 mm	31/64	14,0	107,0	60,0	41,0	45,0	56427
0.4921	12,500 mm		14,0	107,0	60,0	41,0	45,0	66491
0.5000	12,700 mm	1/2	14,0	107,0	60,0	41,0	45,0	56428
0.5039	12,800 mm		14,0	107,0	60,0	41,0	45,0	66492
0.5118	13,000 mm		14,0	107,0	60,0	41,0	45,0	66493
0.5156	13,096 mm	33/64	14,0	107,0	60,0	40,0	45,0	56429
0.5315	13,500 mm		14,0	107,0	60,0	40,0	45,0	66494
0.5433	13,800 mm		14,0	107,0	60,0	39,0	45,0	66495
0.5512	14,000 mm		14,0	107,0	60,0	39,0	45,0	66496
0.5625	14,288 mm	9/16	16,0	115,0	65,0	43,0	48,0	56430
0.5709	14,500 mm		16,0	115,0	65,0	43,0	48,0	66497
0.5781	14,684 mm	37/64	16,0	115,0	65,0	43,0	48,0	56431
0.5827	14,800 mm		16,0	115,0	65,0	43,0	48,0	66498
0.5906	15,000 mm		16,0	115,0	65,0	42,0	48,0	66499
0.6102	15,500 mm		16,0	115,0	65,0	42,0	48,0	66500
0.6221	15,800 mm		16,0	115,0	65,0	41,0	48,0	66501
0.6250	15,875 mm	5/8	16,0	115,0	65,0	41,0	48,0	56432
0.6299	16,000 mm		16,0	115,0	65,0	41,0	48,0	66502
0.6562	16,667 mm	21/32	18,0	123,0	73,0	47,0	48,0	56433
0.6875	17,463 mm	11/16	18,0	123,0	73,0	47,0	48,0	56434
0.7500	19,050 mm	3/4	20,0	131,0	79,0	50,0	50,0	56435

TOLERANCES (inch)

- ≤.1181 DIAMETER
DC = +.00008/+0.00047
DCON = h₆
- >.1181-.2362 DIAMETER
DC = +.00016/+0.00063
DCON = h₆
- >.2362-.3937 DIAMETER
DC = +.00024/+0.00083
DCON = h₆
- >.3937-.7087 DIAMETER
DC = +.00028/+0.00098
DCON = h₆
- >.7087-1.1811 DIAMETER
DC = +.00031/+0.00114
DCON = h₆

TOLERANCES (mm)

- ≤3 DIAMETER
DC = +0,002/+0,012
DCON = h₆
- >3-6 DIAMETER
DC = +0,004/+0,016
DCON = h₆
- >6-10 DIAMETER
DC = +0,006/+0,021
DCON = h₆
- >10-18 DIAMETER
DC = +0,007/+0,025
DCON = h₆
- >18-30 DIAMETER
DC = +0,008/+0,029
DCON = h₆

- STEELS
- STAINLESS STEELS
- CAST IRON
- NON-FERROUS
- HIGH TEMP ALLOYS
- HARDENED STEELS

For patent information visit www.ksptpatents.com

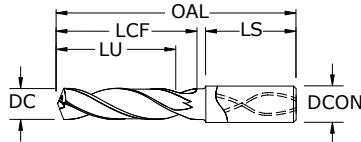

142P 5xD
FRACTIONAL & METRIC SERIES

TOLERANCES (inch)

≤.1181 DIAMETER

DC = +.00008/+0.00047

DCON = h₆

>.1181-.2362 DIAMETER

DC = +.00016/+0.00063

DCON = h₆

>.2362-.3937 DIAMETER

DC = +.00024/+0.00083

DCON = h₆

>.3937-.7087 DIAMETER

DC = +.00028/+0.00098

DCON = h₆

>.7087-1.1811 DIAMETER

DC = +.00031/+0.00114

DCON = h₆

TOLERANCES (mm)

≤3 DIAMETER

DC = +0,002/+0,012

DCON = h₆

>3-6 DIAMETER

DC = +0,004/+0,016

DCON = h₆

>6-10 DIAMETER

DC = +0,006/+0,021

DCON = h₆

>10-18 DIAMETER

DC = +0,007/+0,025

DCON = h₆

>18-30 DIAMETER

DC = +0,008/+0,029

DCON = h₆

- STEELS
- STAINLESS STEELS
- CAST IRON
- NON-FERROUS
- HIGH TEMP ALLOYS
- HARDENED STEELS

For patent information visit www.ksptpatents.com

inch & mm									EDP NO.
DECIMAL DC	METRIC DC	FRACTIONAL/ LETTER/WIRE DC	SHANK DIAMETER DCON	OVERALL LENGTH OAL	FLUTE LENGTH LCF	USABLE LENGTH LU	SHANK LENGTH LS	Ti-NAMITE®-X (TX)	
0.1181	3,000 mm		6,0	66,0	28,0	23,0	36,0	66503	
0.1220	3,100 mm		6,0	66,0	28,0	23,0	36,0	66504	
0.1250	3,175 mm	1/8	6,0	66,0	28,0	23,0	36,0	56436	
0.1260	3,200 mm		6,0	66,0	28,0	23,0	36,0	66505	
0.1299	3,300 mm		6,0	66,0	28,0	23,0	36,0	66506	
0.1339	3,400 mm		6,0	66,0	28,0	23,0	36,0	66507	
0.1360	3,454 mm	#29	6,0	66,0	28,0	23,0	36,0	56437	
0.1378	3,500 mm		6,0	66,0	28,0	23,0	36,0	66508	
0.1406	3,571 mm	9/64	6,0	66,0	28,0	23,0	36,0	56438	
0.1417	3,600 mm		6,0	66,0	28,0	23,0	36,0	66509	
0.1457	3,700 mm		6,0	66,0	28,0	23,0	36,0	66510	
0.1496	3,800 mm		6,0	74,0	36,0	29,0	36,0	66511	
0.1535	3,900 mm		6,0	74,0	36,0	29,0	36,0	66512	
0.1562	3,967 mm	5/32	6,0	74,0	36,0	29,0	36,0	56439	
0.1575	4,000 mm		6,0	74,0	36,0	29,0	36,0	66513	
0.1590	4,039 mm	#21	6,0	74,0	36,0	29,0	36,0	56440	
0.1614	4,100 mm		6,0	74,0	36,0	29,0	36,0	66514	
0.1654	4,200 mm		6,0	74,0	36,0	29,0	36,0	66515	
0.1693	4,300 mm		6,0	74,0	36,0	29,0	36,0	66516	
0.1719	4,366 mm	11/64	6,0	74,0	36,0	29,0	36,0	56441	
0.1732	4,400 mm		6,0	74,0	36,0	29,0	36,0	66517	
0.1772	4,500 mm		6,0	74,0	36,0	29,0	36,0	66518	
0.1811	4,600 mm		6,0	74,0	36,0	29,0	36,0	66519	
0.1850	4,699 mm	#13	6,0	74,0	36,0	29,0	36,0	66520	
0.1875	4,763 mm	3/16	6,0	82,0	44,0	37,0	36,0	56442	
0.1890	4,801 mm	#12	6,0	82,0	44,0	37,0	36,0	66521	
0.1929	4,900 mm		6,0	82,0	44,0	37,0	36,0	66522	
0.1969	5,000 mm		6,0	82,0	44,0	36,0	36,0	66523	
0.2008	5,100 mm		6,0	82,0	44,0	36,0	36,0	66524	
0.2031	5,159 mm	13/64	6,0	82,0	44,0	36,0	36,0	56443	
0.2047	5,200 mm		6,0	82,0	44,0	36,0	36,0	66525	
0.2087	5,300 mm		6,0	82,0	44,0	36,0	36,0	66526	
0.2126	5,400 mm		6,0	82,0	44,0	36,0	36,0	66527	
0.2165	5,500 mm		6,0	82,0	44,0	36,0	36,0	66528	
0.2188	5,558 mm	7/32	6,0	82,0	44,0	36,0	36,0	56444	
0.2205	5,600 mm		6,0	82,0	44,0	36,0	36,0	66529	
0.2244	5,700 mm		6,0	82,0	44,0	35,0	36,0	66530	
0.2283	5,800 mm		6,0	82,0	44,0	35,0	36,0	66531	
0.2323	5,900 mm		6,0	82,0	44,0	35,0	36,0	66532	
0.2344	5,954 mm	15/64	6,0	82,0	44,0	35,0	36,0	56445	
0.2362	6,000 mm		6,0	82,0	44,0	35,0	36,0	66533	
0.2402	6,100 mm		8,0	91,0	53,0	44,0	36,0	66534	
0.2441	6,200 mm		8,0	91,0	53,0	44,0	36,0	66535	

- High-performance point design stabilizes on entry for exceptional hole size and cylindricity while also allowing for low thrust force and extended tool life
- Internal coolant hole improves coolant flow to extend tool life and aid in chip evacuation
- 4 margin design improves hole straightness and roundness while providing improved stability for difficult applications like cross holes and when exiting on angle
- Proprietary Ti-NAMITE®-X coating and industry leading carbide substrate provides exceptional wear resistance and toughness for demanding applications
- Recommended for materials ≤50HRC (475 Bhn)

continued on next page



5xD



142P 5xD

FRACTIONAL & METRIC SERIES

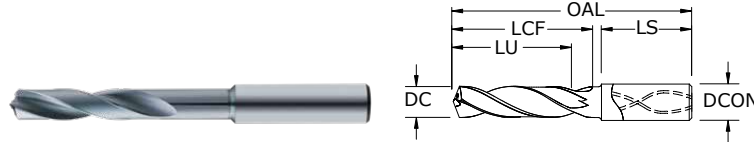

- High-performance point design stabilizes on entry for exceptional hole size and cylindricity while also allowing for low thrust force and extended tool life
- Internal coolant hole improves coolant flow to extend tool life and aid in chip evacuation
- 4-margin design improves hole straightness and roundness while providing improved stability for difficult applications like cross holes and when exiting on angle
- Proprietary Ti-NAMITE®-X coating and industry leading carbide substrate provides exceptional wear resistance and toughness for demanding applications
- Recommended for materials ≤ 50HRc (475 Bhn)

		inch & mm						EDP NO.
DECIMAL DC	METRIC DC	FRACTIONAL/ LETTER/WIRE DC	SHANK DIAMETER DCON	OVERALL LENGTH OAL	FLUTE LENGTH LCF	USABLE LENGTH LU	SHANK LENGTH LS	Ti-NAMITE®-X (TX)
0.2480	6,300 mm		8,0	91,0	53,0	44,0	36,0	66536
0.2500	6,350 mm	1/4 E #0	8,0	91,0	53,0	43,0	36,0	56446
0.2520	6,400 mm		8,0	91,0	53,0	43,0	36,0	66537
0.2559	6,500 mm		8,0	91,0	53,0	43,0	36,0	66538
0.2570	6,528 mm	F	8,0	91,0	53,0	43,0	36,0	56447
0.2598	6,600 mm		8,0	91,0	53,0	43,0	36,0	66539
0.2638	6,700 mm		8,0	91,0	53,0	43,0	36,0	66540
0.2656	6,746 mm	17/64	8,0	91,0	53,0	43,0	36,0	56448
0.2677	6,800 mm		8,0	91,0	53,0	43,0	36,0	66541
0.2717	6,900 mm		8,0	91,0	53,0	43,0	36,0	66542
0.2756	7,000 mm		8,0	91,0	53,0	42,0	36,0	66543
0.2795	7,100 mm		8,0	91,0	53,0	42,0	36,0	66544
0.2812	7,142 mm	9/32	8,0	91,0	53,0	42,0	36,0	56449
0.2835	7,200 mm		8,0	91,0	53,0	42,0	36,0	66545
0.2874	7,300 mm		8,0	91,0	53,0	42,0	36,0	66546
0.2913	7,400 mm		8,0	91,0	53,0	42,0	36,0	66547
0.2953	7,500 mm		8,0	91,0	53,0	42,0	36,0	66548
0.2969	7,541 mm	19/64	8,0	91,0	53,0	42,0	36,0	56450
0.2992	7,600 mm		8,0	91,0	53,0	42,0	36,0	66549
0.3031	7,700 mm		8,0	91,0	53,0	41,0	36,0	66550
0.3071	7,800 mm		8,0	91,0	53,0	41,0	36,0	66551
0.3110	7,900 mm		8,0	91,0	53,0	41,0	36,0	66552
0.3125	7,938 mm	5/16	8,0	91,0	53,0	41,0	36,0	56451
0.3150	8,000 mm		8,0	91,0	53,0	41,0	36,0	66553
0.3189	8,100 mm		10,0	103,0	61,0	49,0	40,0	66554
0.3228	8,200 mm		10,0	103,0	61,0	49,0	40,0	66555
0.3268	8,300 mm		10,0	103,0	61,0	49,0	40,0	66556
0.3281	8,334 mm	21/64	10,0	103,0	61,0	48,0	40,0	56452
0.3307	8,400 mm		10,0	103,0	61,0	48,0	40,0	66557
0.3320	8,433 mm	Q	10,0	103,0	61,0	48,0	40,0	56453
0.3346	8,500 mm		10,0	103,0	61,0	48,0	40,0	66558
0.3386	8,600 mm		10,0	103,0	61,0	48,0	40,0	66559
0.3425	8,700 mm		10,0	103,0	61,0	48,0	40,0	66560
0.3438	8,733 mm	11/32	10,0	103,0	61,0	48,0	40,0	56454
0.3465	8,800 mm		10,0	103,0	61,0	48,0	40,0	66561
0.3504	8,900 mm		10,0	103,0	61,0	48,0	40,0	66562
0.3543	9,000 mm		10,0	103,0	61,0	48,0	40,0	66563
0.3583	9,100 mm		10,0	103,0	61,0	47,0	40,0	66564
0.3594	9,129 mm	23/64	10,0	103,0	61,0	47,0	40,0	56455
0.3622	9,200 mm		10,0	103,0	61,0	47,0	40,0	66565
0.3661	9,300 mm		10,0	103,0	61,0	47,0	40,0	66566
0.3680	9,347 mm	U	10,0	103,0	61,0	47,0	40,0	56456
0.3701	9,400 mm		10,0	103,0	61,0	47,0	40,0	66567

continued on next page

TOLERANCES (inch)

- ≤.1181 DIAMETER
DC = +.00008/+0.00047
DCON = h₆
- >.1181-.2362 DIAMETER
DC = +.00016/+0.00063
DCON = h₆
- >.2362-.3937 DIAMETER
DC = +.00024/+0.00083
DCON = h₆
- >.3937-.7087 DIAMETER
DC = +.00028/+0.00098
DCON = h₆
- >.7087-1.1811 DIAMETER
DC = +.00031/+0.00114
DCON = h₆

TOLERANCES (mm)

- ≤3 DIAMETER
DC = +0,002/+0,012
DCON = h₆
- >3-6 DIAMETER
DC = +0,004/+0,016
DCON = h₆
- >6-10 DIAMETER
DC = +0,006/+0,021
DCON = h₆
- >10-18 DIAMETER
DC = +0,007/+0,025
DCON = h₆
- >18-30 DIAMETER
DC = +0,008/+0,029
DCON = h₆

- STEELS
- STAINLESS STEELS
- CAST IRON
- NON-FERROUS
- HIGH TEMP ALLOYS
- HARDENED STEELS

For patent information visit www.ksptpatents.com



142P 5xD

FRACTIONAL & METRIC SERIES

DECIMAL DC	METRIC DC	inch & mm						EDP NO.
		FRACTIONAL/ LETTER/WIRE DC	SHANK DIAMETER DCON	OVERALL LENGTH OAL	FLUTE LENGTH LCF	USABLE LENGTH LU	SHANK LENGTH LS	Ti-NAMITE®-X (TX)
0.3740	9,500 mm		10,0	103,0	61,0	47,0	40,0	66568
0.3750	9,525 mm	3/8	10,0	103,0	61,0	47,0	40,0	56457
0.3780	9,600 mm		10,0	103,0	61,0	47,0	40,0	66569
0.3819	9,700 mm		10,0	103,0	61,0	46,0	40,0	66570
0.3858	9,800 mm		10,0	103,0	61,0	46,0	40,0	66571
0.3898	9,900 mm		10,0	103,0	61,0	46,0	40,0	66572
0.3906	9,921 mm	25/64	10,0	103,0	61,0	46,0	40,0	56458
0.3937	10,000 mm		10,0	103,0	61,0	46,0	40,0	66573
0.3976	10,100 mm		12,0	118,0	71,0	56,0	45,0	66574
0.4016	10,200 mm		12,0	118,0	71,0	56,0	45,0	66575
0.4055	10,300 mm		12,0	118,0	71,0	56,0	45,0	66576
0.4062	10,317 mm	13/32	12,0	118,0	71,0	56,0	45,0	56459
0.4095	10,400 mm		12,0	118,0	71,0	55,0	45,0	66577
0.4134	10,500 mm		12,0	118,0	71,0	55,0	45,0	66578
0.4173	10,600 mm		12,0	118,0	71,0	55,0	45,0	66579
0.4213	10,700 mm		12,0	118,0	71,0	55,0	45,0	66580
0.4219	10,716 mm	27/64	12,0	118,0	71,0	55,0	45,0	56460
0.4252	10,800 mm		12,0	118,0	71,0	55,0	45,0	66581
0.4291	10,900 mm		12,0	118,0	71,0	55,0	45,0	66582
0.4331	11,000 mm		12,0	118,0	71,0	54,0	45,0	66583
0.4370	11,100 mm		12,0	118,0	71,0	54,0	45,0	66584
0.4375	11,113 mm	7/16	12,0	118,0	71,0	54,0	45,0	56461
0.4409	11,200 mm		12,0	118,0	71,0	54,0	45,0	66585
0.4449	11,300 mm		12,0	118,0	71,0	54,0	45,0	66586
0.4488	11,400 mm		12,0	118,0	71,0	54,0	45,0	66587
0.4528	11,500 mm		12,0	118,0	71,0	54,0	45,0	66588
0.4567	11,600 mm		12,0	118,0	71,0	54,0	45,0	66589
0.4606	11,700 mm		12,0	118,0	71,0	53,0	45,0	66590
0.4646	11,800 mm		12,0	118,0	71,0	53,0	45,0	66591
0.4685	11,900 mm		12,0	118,0	71,0	53,0	45,0	66592
0.4688	11,908 mm	15/32	12,0	118,0	71,0	53,0	45,0	56462
0.4724	12,000 mm		12,0	118,0	71,0	53,0	45,0	66593
0.4844	12,304 mm	31/64	14,0	124,0	77,0	58,0	45,0	56463
0.4921	12,500 mm		14,0	124,0	77,0	58,0	45,0	66594
0.5000	12,700 mm	1/2	14,0	124,0	77,0	58,0	45,0	56464
0.5039	12,800 mm		14,0	124,0	77,0	58,0	45,0	66595
0.5118	13,000 mm		14,0	124,0	77,0	58,0	45,0	66596
0.5156	13,096 mm	33/64	14,0	124,0	77,0	57,0	45,0	56465
0.5315	13,500 mm		14,0	124,0	77,0	57,0	45,0	66597
0.5433	13,800 mm		14,0	124,0	77,0	56,0	45,0	66598
0.5512	14,000 mm		14,0	124,0	77,0	56,0	45,0	66599
0.5625	14,288 mm	9/16	16,0	133,0	83,0	61,0	48,0	56466
0.5709	14,500 mm		16,0	133,0	83,0	61,0	48,0	66600
0.5781	14,684 mm	37/64	16,0	133,0	83,0	61,0	48,0	56467
0.5827	14,800 mm		16,0	133,0	83,0	61,0	48,0	66601
0.5906	15,000 mm		16,0	133,0	83,0	60,0	48,0	66602
0.6102	15,500 mm		16,0	133,0	83,0	60,0	48,0	66603
0.6221	15,800 mm		16,0	133,0	83,0	59,0	48,0	66604
0.6250	15,875 mm	5/8	16,0	133,0	83,0	59,0	48,0	56468
0.6299	16,000 mm		16,0	133,0	83,0	59,0	48,0	66605
0.6562	16,667 mm	21/32	18,0	143,0	93,0	68,0	48,0	56469
0.6875	17,463 mm	11/16	18,0	143,0	93,0	67,0	48,0	56470
0.7500	19,050 mm	3/4	20,0	153,0	101,0	72,0	50,0	56471

CONTINUED



142P 8xD

FRACTIONAL & METRIC SERIES

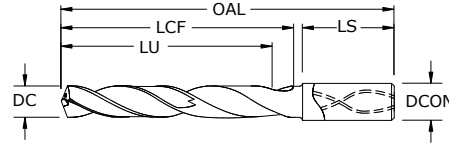

- High-performance point design stabilizes on entry for exceptional hole size and cylindricity while also allowing for low thrust force and extended tool life
- Internal coolant hole improves coolant flow to extend tool life and aid in chip evacuation
- 4-margin design improves hole straightness and roundness while providing improved stability for difficult applications like cross holes and when exiting on angle
- Proprietary Ti-NAMITE®-X coating and industry leading carbide substrate provides exceptional wear resistance and toughness for demanding applications
- Recommended for materials ≤ 50HRc (475 Bhn)

		inch & mm						EDP NO.
DECIMAL DC	METRIC DC	FRACTIONAL/ LETTER/WIRE DC	SHANK DIAMETER DCON	OVERALL LENGTH OAL	FLUTE LENGTH LCF	USABLE LENGTH LU	SHANK LENGTH LS	Ti-NAMITE®-X (TX)
0.1181	3,000 mm		6,0	72,0	34,0	29,0	36,0	66606
0.1220	3,100 mm		6,0	72,0	34,0	29,0	36,0	66607
0.1250	3,175 mm	1/8	6,0	72,0	34,0	29,0	36,0	56472
0.1260	3,200 mm		6,0	72,0	34,0	29,0	36,0	66608
0.1299	3,300 mm		6,0	72,0	34,0	29,0	36,0	66609
0.1339	3,400 mm		6,0	72,0	34,0	29,0	36,0	66610
0.1360	3,454 mm	#29	6,0	72,0	34,0	29,0	36,0	56473
0.1378	3,500 mm		6,0	72,0	34,0	29,0	36,0	66611
0.1406	3,571 mm	9/64	6,0	72,0	34,0	29,0	36,0	56474
0.1417	3,600 mm		6,0	72,0	34,0	29,0	36,0	66612
0.1457	3,700 mm		6,0	72,0	34,0	29,0	36,0	66613
0.1496	3,800 mm		6,0	81,0	43,0	37,0	36,0	66614
0.1535	3,900 mm		6,0	81,0	43,0	37,0	36,0	66615
0.1562	3,967 mm	5/32	6,0	81,0	43,0	37,0	36,0	56475
0.1575	4,000 mm		6,0	81,0	43,0	37,0	36,0	66616
0.1590	4,039 mm	#21	6,0	81,0	43,0	37,0	36,0	56476
0.1614	4,100 mm		6,0	81,0	43,0	37,0	36,0	66617
0.1654	4,200 mm		6,0	81,0	43,0	37,0	36,0	66618
0.1693	4,300 mm		6,0	81,0	43,0	37,0	36,0	66619
0.1719	4,366 mm	11/64	6,0	81,0	43,0	36,0	36,0	56477
0.1732	4,400 mm		6,0	81,0	43,0	36,0	36,0	66620
0.1772	4,500 mm		6,0	81,0	43,0	36,0	36,0	66621
0.1811	4,600 mm		6,0	81,0	43,0	36,0	36,0	66622
0.1850	4,699 mm	#13	6,0	81,0	43,0	36,0	36,0	66623
0.1875	4,763 mm	3/16	6,0	95,0	57,0	50,0	36,0	56478
0.1890	4,801 mm	#12	6,0	95,0	57,0	50,0	36,0	66624
0.1929	4,900 mm		6,0	95,0	57,0	50,0	36,0	66625
0.1969	5,000 mm		6,0	95,0	57,0	49,0	36,0	66626
0.2008	5,100 mm		6,0	95,0	57,0	49,0	36,0	66627
0.2031	5,159 mm	13/64	6,0	95,0	57,0	49,0	36,0	56479
0.2047	5,200 mm		6,0	95,0	57,0	49,0	36,0	66628
0.2087	5,300 mm		6,0	95,0	57,0	49,0	36,0	66629
0.2126	5,400 mm		6,0	95,0	57,0	49,0	36,0	66630
0.2165	5,500 mm		6,0	95,0	57,0	49,0	36,0	66631
0.2188	5,558 mm	7/32	6,0	95,0	57,0	49,0	36,0	56480
0.2205	5,600 mm		6,0	95,0	57,0	49,0	36,0	66632

TOLERANCES (inch)

- ≤.1181 DIAMETER
DC = +.00008/+0.00047
DCON = h₆
- >.1181-.2362 DIAMETER
DC = +.00016/+0.00063
DCON = h₆
- >.2362-.3937 DIAMETER
DC = +.00024/+0.00083
DCON = h₆
- >.3937-.7087 DIAMETER
DC = +.00028/+0.00098
DCON = h₆
- >.7087-1.1811 DIAMETER
DC = +.00031/+0.00114
DCON = h₆

TOLERANCES (mm)

- ≤3 DIAMETER
DC = +0,002/+0,012
DCON = h₆
- >3-6 DIAMETER
DC = +0,004/+0,016
DCON = h₆
- >6-10 DIAMETER
DC = +0,006/+0,021
DCON = h₆
- >10-18 DIAMETER
DC = +0,007/+0,025
DCON = h₆
- >18-30 DIAMETER
DC = +0,008/+0,029
DCON = h₆

- STEELS
- STAINLESS STEELS
- CAST IRON
- NON-FERROUS
- HIGH TEMP ALLOYS
- HARDENED STEELS

continued on next page

For patent information visit www.ksptpatents.com

142P 8xD

FRACTIONAL & METRIC SERIES

DECIMAL DC	METRIC DC	inch & mm						EDP NO.
		FRACTIONAL/ LETTER/WIRE DC	SHANK DIAMETER DCON	OVERALL LENGTH OAL	FLUTE LENGTH LCF	USABLE LENGTH LU	SHANK LENGTH LS	Ti-NAMITE®-X (TX)
0.2244	5,700 mm		6,0	95,0	57,0	48,0	36,0	66633
0.2283	5,800 mm		6,0	95,0	57,0	48,0	36,0	66634
0.2323	5,900 mm		6,0	95,0	57,0	48,0	36,0	66635
0.2344	5,954 mm	15/64	6,0	95,0	57,0	48,0	36,0	56481
0.2362	6,000 mm		6,0	95,0	57,0	48,0	36,0	66636
0.2402	6,100 mm		8,0	114,0	76,0	67,0	36,0	66637
0.2441	6,200 mm		8,0	114,0	76,0	67,0	36,0	66638
0.2480	6,300 mm		8,0	114,0	76,0	67,0	36,0	66639
0.2500	6,350 mm	1/4 E #0	8,0	114,0	76,0	66,0	36,0	56482
0.2520	6,400 mm		8,0	114,0	76,0	66,0	36,0	66640
0.2559	6,500 mm		8,0	114,0	76,0	66,0	36,0	66641
0.2570	6,528 mm	F	8,0	114,0	76,0	66,0	36,0	56483
0.2598	6,600 mm		8,0	114,0	76,0	66,0	36,0	66642
0.2638	6,700 mm		8,0	114,0	76,0	66,0	36,0	66643
0.2656	6,746 mm	17/64	8,0	114,0	76,0	66,0	36,0	56484
0.2677	6,800 mm		8,0	114,0	76,0	66,0	36,0	66644
0.2717	6,900 mm		8,0	114,0	76,0	66,0	36,0	66645
0.2756	7,000 mm		8,0	114,0	76,0	65,0	36,0	66646
0.2795	7,100 mm		8,0	114,0	76,0	65,0	36,0	66647
0.2812	7,142 mm	9/32	8,0	114,0	76,0	65,0	36,0	56485
0.2835	7,200 mm		8,0	114,0	76,0	65,0	36,0	66648
0.2874	7,300 mm		8,0	114,0	76,0	65,0	36,0	66649
0.2913	7,400 mm		8,0	114,0	76,0	65,0	36,0	66650
0.2953	7,500 mm		8,0	114,0	76,0	65,0	36,0	66651
0.2969	7,541 mm	19/64	8,0	114,0	76,0	65,0	36,0	56486
0.2992	7,600 mm		8,0	114,0	76,0	65,0	36,0	66652
0.3031	7,700 mm		8,0	114,0	76,0	64,0	36,0	66653
0.3071	7,800 mm		8,0	114,0	76,0	64,0	36,0	66654
0.3110	7,900 mm		8,0	114,0	76,0	64,0	36,0	66655
0.3125	7,938 mm	5/16	8,0	114,0	76,0	64,0	36,0	56487
0.3150	8,000 mm		8,0	114,0	76,0	64,0	36,0	66656
0.3189	8,100 mm		10,0	142,0	95,0	83,0	40,0	66657
0.3228	8,200 mm		10,0	142,0	95,0	83,0	40,0	66658
0.3268	8,300 mm		10,0	142,0	95,0	83,0	40,0	66659
0.3281	8,334 mm	21/64	10,0	142,0	95,0	83,0	40,0	56488
0.3307	8,400 mm		10,0	142,0	95,0	82,0	40,0	66660
0.3320	8,433 mm	Q	10,0	142,0	95,0	82,0	40,0	56489
0.3346	8,500 mm		10,0	142,0	95,0	82,0	40,0	66661
0.3386	8,600 mm		10,0	142,0	95,0	82,0	40,0	66662
0.3425	8,700 mm		10,0	142,0	95,0	82,0	40,0	66663
0.3438	8,733 mm	11/32	10,0	142,0	95,0	82,0	40,0	56490
0.3465	8,800 mm		10,0	142,0	95,0	82,0	40,0	66664
0.3504	8,900 mm		10,0	142,0	95,0	82,0	40,0	66665
0.3543	9,000 mm		10,0	142,0	95,0	82,0	40,0	66666

CONTINUED

continued on next page



142P 8xD

FRACTIONAL & METRIC SERIES

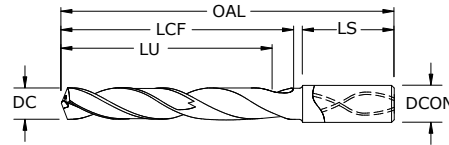

- High-performance point design stabilizes on entry for exceptional hole size and cylindricity while also allowing for low thrust force and extended tool life
- Internal coolant hole improves coolant flow to extend tool life and aid in chip evacuation
- 4-margin design improves hole straightness and roundness while providing improved stability for difficult applications like cross holes and when exiting on angle
- Proprietary Ti-NAMITE®-X coating and industry leading carbide substrate provides exceptional wear resistance and toughness for demanding applications
- Recommended for materials ≤ 50HRc (475 Bhn)

		inch & mm						EDP NO.
DECIMAL DC	METRIC DC	FRACTIONAL/ LETTER/WIRE DC	SHANK DIAMETER DCON	OVERALL LENGTH OAL	FLUTE LENGTH LCF	USABLE LENGTH LU	SHANK LENGTH LS	Ti-NAMITE®-X (TX)
0.3583	9,100 mm		10,0	142,0	95,0	81,0	40,0	66667
0.3594	9,129 mm	23/64	10,0	142,0	95,0	81,0	40,0	56491
0.3622	9,200 mm		10,0	142,0	95,0	81,0	40,0	66668
0.3661	9,300 mm		10,0	142,0	95,0	81,0	40,0	66669
0.3680	9,347 mm	U	10,0	142,0	95,0	81,0	40,0	56492
0.3701	9,400 mm		10,0	142,0	95,0	81,0	40,0	66670
0.3740	9,500 mm		10,0	142,0	95,0	81,0	40,0	66671
0.3750	9,525 mm	3/8	10,0	142,0	95,0	81,0	40,0	56493
0.3780	9,600 mm		10,0	142,0	95,0	81,0	40,0	66672
0.3819	9,700 mm		10,0	142,0	95,0	80,0	40,0	66673
0.3858	9,800 mm		10,0	142,0	95,0	80,0	40,0	66674
0.3898	9,900 mm		10,0	142,0	95,0	80,0	40,0	66675
0.3906	9,921 mm	25/64	10,0	142,0	95,0	80,0	40,0	56494
0.3937	10,000 mm		10,0	142,0	95,0	80,0	40,0	66676
0.3976	10,100 mm		12,0	162,0	114,0	99,0	45,0	66677
0.4016	10,200 mm		12,0	162,0	114,0	99,0	45,0	66678
0.4055	10,300 mm		12,0	162,0	114,0	99,0	45,0	66679
0.4062	10,317 mm	13/32	12,0	162,0	114,0	99,0	45,0	56495
0.4095	10,400 mm		12,0	162,0	114,0	98,0	45,0	66680
0.4134	10,500 mm		12,0	162,0	114,0	98,0	45,0	66681
0.4173	10,600 mm		12,0	162,0	114,0	98,0	45,0	66682
0.4213	10,700 mm		12,0	162,0	114,0	98,0	45,0	66683
0.4219	10,716 mm	27/64	12,0	162,0	114,0	98,0	45,0	56496
0.4252	10,800 mm		12,0	162,0	114,0	98,0	45,0	66684
0.4291	10,900 mm		12,0	162,0	114,0	98,0	45,0	66685
0.4331	11,000 mm		12,0	162,0	114,0	97,0	45,0	66686
0.4370	11,100 mm		12,0	162,0	114,0	97,0	45,0	66687
0.4375	11,113 mm	7/16	12,0	162,0	114,0	97,0	45,0	56497
0.4409	11,200 mm		12,0	162,0	114,0	97,0	45,0	66688
0.4449	11,300 mm		12,0	162,0	114,0	97,0	45,0	66689
0.4488	11,400 mm		12,0	162,0	114,0	97,0	45,0	66690
0.4528	11,500 mm		12,0	162,0	114,0	97,0	45,0	66691
0.4567	11,600 mm		12,0	162,0	114,0	97,0	45,0	66692
0.4606	11,700 mm		12,0	162,0	114,0	96,0	45,0	66693

TOLERANCES (inch)

- ≤.1181 DIAMETER
DC = +.00008/+0.00047
DCON = h₆
- >.1181-.2362 DIAMETER
DC = +.00016/+0.00063
DCON = h₆
- >.2362-.3937 DIAMETER
DC = +.00024/+0.00083
DCON = h₆
- >.3937-.7087 DIAMETER
DC = +.00028/+0.00098
DCON = h₆
- >.7087-1.1811 DIAMETER
DC = +.00031/+0.00114
DCON = h₆

TOLERANCES (mm)

- ≤3 DIAMETER
DC = +0,002/+0,012
DCON = h₆
- >3-6 DIAMETER
DC = +0,004/+0,016
DCON = h₆
- >6-10 DIAMETER
DC = +0,006/+0,021
DCON = h₆
- >10-18 DIAMETER
DC = +0,007/+0,025
DCON = h₆
- >18-30 DIAMETER
DC = +0,008/+0,029
DCON = h₆

- STEELS
- STAINLESS STEELS
- CAST IRON
- NON-FERROUS
- HIGH TEMP ALLOYS
- HARDENED STEELS

continued on next page

For patent information visit www.ksptpatents.com

142P 8xD

FRACTIONAL & METRIC SERIES

DECIMAL DC	METRIC DC	inch & mm						EDP NO.
		FRACTIONAL/ LETTER/WIRE DC	SHANK DIAMETER DCON	OVERALL LENGTH OAL	FLUTE LENGTH LCF	USABLE LENGTH LU	SHANK LENGTH LS	Ti-NAMITE®-X (TX)
0.4646	11,800 mm		12,0	162,0	114,0	96,0	45,0	66694
0.4685	11,900 mm		12,0	162,0	114,0	96,0	45,0	66695
0.4688	11,908 mm	15/32	12,0	162,0	114,0	96,0	45,0	56498
0.4724	12,000 mm		12,0	162,0	114,0	96,0	45,0	66696
0.4844	12,304 mm	31/64	14,0	178,0	133,0	114,0	45,0	56499
0.4921	12,500 mm		14,0	178,0	133,0	114,0	45,0	66697
0.5000	12,700 mm	1/2	14,0	178,0	133,0	114,0	45,0	56500
0.5039	12,800 mm		14,0	178,0	133,0	114,0	45,0	66698
0.5118	13,000 mm		14,0	178,0	133,0	114,0	45,0	66699
0.5156	13,096 mm	33/64	14,0	178,0	133,0	113,0	45,0	56501
0.5315	13,500 mm		14,0	178,0	133,0	113,0	45,0	66700
0.5433	13,800 mm		14,0	178,0	133,0	113,0	45,0	66701
0.5512	14,000 mm		14,0	178,0	133,0	113,0	45,0	66702
0.5625	14,288 mm	9/16	16,0	203,0	152,0	130,0	48,0	56502
0.5709	14,500 mm		16,0	203,0	152,0	130,0	48,0	66703
0.5781	14,684 mm	37/64	16,0	203,0	152,0	130,0	48,0	56503
0.5827	14,800 mm		16,0	203,0	152,0	130,0	48,0	66704
0.5906	15,000 mm		16,0	203,0	152,0	129,0	48,0	66705
0.6102	15,500 mm		16,0	203,0	152,0	129,0	48,0	66706
0.6221	15,800 mm		16,0	203,0	152,0	128,0	48,0	66707
0.6250	15,875 mm	5/8	16,0	203,0	152,0	128,0	48,0	56504
0.6299	16,000 mm		16,0	203,0	152,0	128,0	48,0	66708
0.6562	16,667 mm	21/32	18,0	222,0	171,0	145,0	48,0	56505
0.6875	17,463 mm	11/16	18,0	222,0	171,0	145,0	48,0	56506
0.7500	19,050 mm	3/4	20,0	243,0	190,0	161,0	50,0	56507

CONTINUED



142P 12xD
FRACTIONAL & METRIC SERIES

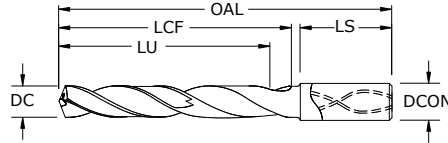

- High-performance point design stabilizes on entry for exceptional hole size and cylindricity while also allowing for low thrust force and extended tool life
- Internal coolant hole improves coolant flow to extend tool life and aid in chip evacuation
- 4-margin design improves hole straightness and roundness while providing improved stability for difficult applications like cross holes and when exiting on angle
- Proprietary Ti-NAMITE®-X coating and industry leading carbide substrate provides exceptional wear resistance and toughness for demanding applications
- Recommended for materials ≤ 50HRc (475 Bhn)

		inch & mm						EDP NO.
DECIMAL DC	METRIC DC	FRACTIONAL/ LETTER/WIRE DC	SHANK DIAMETER DCON	OVERALL LENGTH OAL	FLUTE LENGTH LCF	USABLE LENGTH LU	SHANK LENGTH LS	Ti-NAMITE®-X (TX)
0.1181	3,000 mm		6,0	87,0	49,0	44,0	36,0	66709
0.1220	3,100 mm		6,0	87,0	49,0	44,0	36,0	66710
0.1250	3,175 mm	1/8	6,0	87,0	49,0	44,0	36,0	56508
0.1260	3,200 mm		6,0	87,0	49,0	44,0	36,0	66711
0.1299	3,300 mm		6,0	87,0	49,0	44,0	36,0	66712
0.1339	3,400 mm		6,0	87,0	49,0	44,0	36,0	66713
0.1360	3,454 mm	#29	6,0	87,0	49,0	44,0	36,0	56509
0.1378	3,500 mm		6,0	87,0	49,0	44,0	36,0	66714
0.1406	3,571 mm	9/64	6,0	87,0	49,0	43,0	36,0	56510
0.1417	3,600 mm		6,0	87,0	49,0	43,0	36,0	66715
0.1457	3,700 mm		6,0	87,0	49,0	43,0	36,0	66716
0.1496	3,800 mm		6,0	100,0	62,0	56,0	36,0	66717
0.1535	3,900 mm		6,0	100,0	62,0	56,0	36,0	66718
0.1562	3,967 mm	5/32	6,0	100,0	62,0	56,0	36,0	56511
0.1575	4,000 mm		6,0	100,0	62,0	56,0	36,0	66719
0.1590	4,039 mm	#21	6,0	100,0	62,0	56,0	36,0	56512
0.1614	4,100 mm		6,0	100,0	62,0	56,0	36,0	66720
0.1654	4,200 mm		6,0	100,0	62,0	55,0	36,0	66721
0.1693	4,300 mm		6,0	100,0	62,0	55,0	36,0	66722
0.1719	4,366 mm	11/64	6,0	100,0	62,0	55,0	36,0	56513
0.1732	4,400 mm		6,0	100,0	62,0	55,0	36,0	66723
0.1772	4,500 mm		6,0	100,0	62,0	55,0	36,0	66724
0.1811	4,600 mm		6,0	100,0	62,0	55,0	36,0	66725
0.1850	4,699 mm	#13	6,0	100,0	62,0	55,0	36,0	66726
0.1875	4,763 mm	3/16	6,0	119,0	81,0	74,0	36,0	56514
0.1890	4,801 mm	#12	6,0	119,0	81,0	74,0	36,0	66727
0.1929	4,900 mm		6,0	119,0	81,0	74,0	36,0	66728
0.1969	5,000 mm		6,0	119,0	81,0	73,0	36,0	66729
0.2008	5,100 mm		6,0	119,0	81,0	73,0	36,0	66730
0.2031	5,159 mm	13/64	6,0	119,0	81,0	73,0	36,0	56515
0.2047	5,200 mm		6,0	119,0	81,0	73,0	36,0	66731
0.2087	5,300 mm		6,0	119,0	81,0	73,0	36,0	66732
0.2126	5,400 mm		6,0	119,0	81,0	73,0	36,0	66733
0.2165	5,500 mm		6,0	119,0	81,0	73,0	36,0	66734

continued on next page

TOLERANCES (inch)

- ≤.1181 DIAMETER
DC = +.00008/+0.00047
DCON = h₆
- >.1181-.2362 DIAMETER
DC = +.00016/+0.00063
DCON = h₆
- >.2362-.3937 DIAMETER
DC = +.00024/+0.00083
DCON = h₆
- >.3937-.7087 DIAMETER
DC = +.00028/+0.00098
DCON = h₆
- >.7087-1.1811 DIAMETER
DC = +.00031/+0.00114
DCON = h₆

TOLERANCES (mm)

- ≤3 DIAMETER
DC = +0,002/+0,012
DCON = h₆
- >3-6 DIAMETER
DC = +0,004/+0,016
DCON = h₆
- >6-10 DIAMETER
DC = +0,006/+0,021
DCON = h₆
- >10-18 DIAMETER
DC = +0,007/+0,025
DCON = h₆
- >18-30 DIAMETER
DC = +0,008/+0,029
DCON = h₆

- STEELS
- STAINLESS STEELS
- CAST IRON
- NON-FERROUS
- HIGH TEMP ALLOYS
- HARDENED STEELS

For patent information visit www.ksptpatents.com

142P 12xD
FRACTIONAL & METRIC SERIES

DECIMAL DC	METRIC DC	inch & mm						EDP NO.
		FRACTIONAL/ LETTER/WIRE DC	SHANK DIAMETER DCON	OVERALL LENGTH OAL	FLUTE LENGTH LCF	USABLE LENGTH LU	SHANK LENGTH LS	Ti-NAMITE [®] -X (TX)
0.2188	5,558 mm	7/32	6,0	119,0	81,0	73,0	36,0	56516
0.2205	5,600 mm		6,0	119,0	81,0	73,0	36,0	66735
0.2244	5,700 mm		6,0	119,0	81,0	72,0	36,0	66736
0.2283	5,800 mm		6,0	119,0	81,0	72,0	36,0	66737
0.2323	5,900 mm		6,0	119,0	81,0	72,0	36,0	66738
0.2344	5,954 mm	15/64	6,0	119,0	81,0	72,0	36,0	56517
0.2362	6,000 mm		6,0	119,0	81,0	72,0	36,0	66739
0.2402	6,100 mm		8,0	146,0	108,0	99,0	36,0	66740
0.2441	6,200 mm		8,0	146,0	108,0	99,0	36,0	66741
0.2480	6,300 mm		8,0	146,0	108,0	99,0	36,0	66742
0.2500	6,350 mm	1/4 E #0	8,0	146,0	108,0	98,0	36,0	56518
0.2520	6,400 mm		8,0	146,0	108,0	98,0	36,0	66743
0.2559	6,500 mm		8,0	146,0	108,0	98,0	36,0	66744
0.2570	6,528 mm	F	8,0	146,0	108,0	98,0	36,0	56519
0.2598	6,600 mm		8,0	146,0	108,0	98,0	36,0	66745
0.2638	6,700 mm		8,0	146,0	108,0	98,0	36,0	66746
0.2656	6,746 mm	17/64	8,0	146,0	108,0	98,0	36,0	56520
0.2677	6,800 mm		8,0	146,0	108,0	98,0	36,0	66747
0.2717	6,900 mm		8,0	146,0	108,0	98,0	36,0	66748
0.2756	7,000 mm		8,0	146,0	108,0	97,0	36,0	66749
0.2795	7,100 mm		8,0	146,0	108,0	97,0	36,0	66750
0.2812	7,142 mm	9/32	8,0	146,0	108,0	97,0	36,0	56521
0.2835	7,200 mm		8,0	146,0	108,0	97,0	36,0	66751
0.2874	7,300 mm		8,0	146,0	108,0	97,0	36,0	66752
0.2913	7,400 mm		8,0	146,0	108,0	97,0	36,0	66753
0.2953	7,500 mm		8,0	146,0	108,0	97,0	36,0	66754
0.2969	7,541 mm	19/64	8,0	146,0	108,0	97,0	36,0	56522
0.2992	7,600 mm		8,0	146,0	108,0	97,0	36,0	66755
0.3031	7,700 mm		8,0	146,0	108,0	96,0	36,0	66756
0.3071	7,800 mm		8,0	146,0	108,0	96,0	36,0	66757
0.3110	7,900 mm		8,0	146,0	108,0	96,0	36,0	66758
0.3125	7,938 mm	5/16	8,0	146,0	108,0	96,0	36,0	56523
0.3150	8,000 mm		8,0	146,0	108,0	96,0	36,0	66759
0.3189	8,100 mm		10,0	182,0	135,0	123,0	40,0	66760
0.3228	8,200 mm		10,0	182,0	135,0	123,0	40,0	66761
0.3268	8,300 mm		10,0	182,0	135,0	123,0	40,0	66762
0.3281	8,334 mm	21/64	10,0	182,0	135,0	123,0	40,0	56524
0.3307	8,400 mm		10,0	182,0	135,0	122,0	40,0	66763
0.3320	8,433 mm	Q	10,0	182,0	135,0	122,0	40,0	56525
0.3346	8,500 mm		10,0	182,0	135,0	122,0	40,0	66764
0.3386	8,600 mm		10,0	182,0	135,0	122,0	40,0	66765
0.3425	8,700 mm		10,0	182,0	135,0	122,0	40,0	66766

continued on next page

CONTINUED



142P 12xD
FRACTIONAL & METRIC SERIES

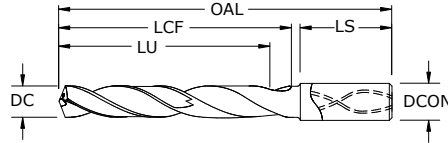

- High-performance point design stabilizes on entry for exceptional hole size and cylindricity while also allowing for low thrust force and extended tool life
- Internal coolant hole improves coolant flow to extend tool life and aid in chip evacuation
- 4-margin design improves hole straightness and roundness while providing improved stability for difficult applications like cross holes and when exiting on angle
- Proprietary Ti-NAMITE®-X coating and industry leading carbide substrate provides exceptional wear resistance and toughness for demanding applications
- Recommended for materials ≤ 50HRc (475 Bhn)

inch & mm								EDP NO.
DECIMAL DC	METRIC DC	FRACTIONAL/ LETTER/WIRE DC	SHANK DIAMETER DCON	OVERALL LENGTH OAL	FLUTE LENGTH LCF	USABLE LENGTH LU	SHANK LENGTH LS	Ti-NAMITE®-X (TX)
0.3438	8,733 mm	11/32	10,0	182,0	135,0	122,0	40,0	56526
0.3465	8,800 mm		10,0	182,0	135,0	122,0	40,0	66767
0.3504	8,900 mm		10,0	182,0	135,0	122,0	40,0	66768
0.3543	9,000 mm		10,0	182,0	135,0	122,0	40,0	66769
0.3583	9,100 mm		10,0	182,0	135,0	121,0	40,0	66770
0.3594	9,129 mm	23/64	10,0	182,0	135,0	121,0	40,0	56527
0.3622	9,200 mm		10,0	182,0	135,0	121,0	40,0	66771
0.3661	9,300 mm		10,0	182,0	135,0	121,0	40,0	66772
0.3680	9,347 mm	U	10,0	182,0	135,0	121,0	40,0	56528
0.3701	9,400 mm		10,0	182,0	135,0	121,0	40,0	66773
0.3740	9,500 mm		10,0	182,0	135,0	121,0	40,0	66774
0.3750	9,525 mm	3/8	10,0	182,0	135,0	121,0	40,0	56529
0.3780	9,600 mm		10,0	182,0	135,0	121,0	40,0	66775
0.3819	9,700 mm		10,0	182,0	135,0	120,0	40,0	66776
0.3858	9,800 mm		10,0	182,0	135,0	120,0	40,0	66777
0.3898	9,900 mm		10,0	182,0	135,0	120,0	40,0	66778
0.3906	9,921 mm	25/64	10,0	182,0	135,0	120,0	40,0	56530
0.3937	10,000 mm		10,0	182,0	135,0	120,0	40,0	66779
0.3976	10,100 mm		12,0	210,0	162,0	147,0	45,0	66780
0.4016	10,200 mm		12,0	210,0	162,0	147,0	45,0	66781
0.4055	10,300 mm		12,0	210,0	162,0	147,0	45,0	66782
0.4062	10,317 mm	13/32	12,0	210,0	162,0	147,0	45,0	56531
0.4095	10,400 mm		12,0	210,0	162,0	146,0	45,0	66783
0.4134	10,500 mm		12,0	210,0	162,0	146,0	45,0	66784
0.4173	10,600 mm		12,0	210,0	162,0	146,0	45,0	66785
0.4213	10,700 mm		12,0	210,0	162,0	146,0	45,0	66786
0.4219	10,716 mm	27/64	12,0	210,0	162,0	146,0	45,0	56532
0.4252	10,800 mm		12,0	210,0	162,0	146,0	45,0	66787
0.4291	10,900 mm		12,0	210,0	162,0	146,0	45,0	66788
0.4331	11,000 mm		12,0	210,0	162,0	145,0	45,0	66789
0.4370	11,100 mm		12,0	210,0	162,0	145,0	45,0	66790
0.4375	11,113 mm	7/16	12,0	210,0	162,0	145,0	45,0	56533
0.4409	11,200 mm		12,0	210,0	162,0	145,0	45,0	66791
0.4449	11,300 mm		12,0	210,0	162,0	145,0	45,0	66792

continued on next page

TOLERANCES (inch)

- ≤.1181 DIAMETER
DC = +.00008/+0.00047
DCON = h₆
- >.1181-.2362 DIAMETER
DC = +.00016/+0.00063
DCON = h₆
- >.2362-.3937 DIAMETER
DC = +.00024/+0.00083
DCON = h₆
- >.3937-.7087 DIAMETER
DC = +.00028/+0.00098
DCON = h₆
- >.7087-1.1811 DIAMETER
DC = +.00031/+0.00114
DCON = h₆

TOLERANCES (mm)

- ≤3 DIAMETER
DC = +0,002/+0,012
DCON = h₆
- >3-6 DIAMETER
DC = +0,004/+0,016
DCON = h₆
- >6-10 DIAMETER
DC = +0,006/+0,021
DCON = h₆
- >10-18 DIAMETER
DC = +0,007/+0,025
DCON = h₆
- >18-30 DIAMETER
DC = +0,008/+0,029
DCON = h₆

- STEELS
- STAINLESS STEELS
- CAST IRON
- NON-FERROUS
- HIGH TEMP ALLOYS
- HARDENED STEELS

For patent information visit www.ksptpatents.com

142P 12xD
FRACTIONAL & METRIC SERIES

DECIMAL DC	METRIC DC	inch & mm						EDP NO.
		FRACTIONAL/ LETTER/WIRE DC	SHANK DIAMETER DCON	OVERALL LENGTH OAL	FLUTE LENGTH LCF	USABLE LENGTH LU	SHANK LENGTH LS	Ti-NAMITE®-X (TX)
0.4488	11,400 mm		12,0	210,0	162,0	145,0	45,0	66793
0.4528	11,500 mm		12,0	210,0	162,0	145,0	45,0	66794
0.4567	11,600 mm		12,0	210,0	162,0	145,0	45,0	66795
0.4606	11,700 mm		12,0	210,0	162,0	144,0	45,0	66796
0.4646	11,800 mm		12,0	210,0	162,0	144,0	45,0	66797
0.4685	11,900 mm		12,0	210,0	162,0	144,0	45,0	66798
0.4688	11,908 mm	15/32	12,0	210,0	162,0	144,0	45,0	56534
0.4724	12,000 mm		12,0	210,0	162,0	144,0	45,0	66799
0.4844	12,304 mm	31/64	14,0	234,0	189,0	171,0	45,0	56535
0.4921	12,500 mm		14,0	234,0	189,0	170,0	45,0	66800
0.5000	12,700 mm	1/2	14,0	234,0	189,0	170,0	45,0	56536
0.5039	12,800 mm		14,0	234,0	189,0	170,0	45,0	66801
0.5118	13,000 mm		14,0	234,0	189,0	170,0	45,0	66802
0.5156	13,096 mm	33/64	14,0	234,0	189,0	169,0	45,0	56537
0.5315	13,500 mm		14,0	234,0	189,0	169,0	45,0	66803
0.5433	13,800 mm		14,0	234,0	189,0	168,0	45,0	66804
0.5512	14,000 mm		14,0	234,0	189,0	168,0	45,0	66805
0.5625	14,288 mm	9/16	16,0	267,0	216,0	195,0	48,0	56538
0.5709	14,500 mm		16,0	267,0	216,0	194,0	48,0	66806
0.5781	14,684 mm	37/64	16,0	267,0	216,0	194,0	48,0	56539
0.5827	14,800 mm		16,0	267,0	216,0	194,0	48,0	66807
0.5906	15,000 mm		16,0	267,0	216,0	193,0	48,0	66808
0.6102	15,500 mm		16,0	267,0	216,0	193,0	48,0	66809
0.6221	15,800 mm		16,0	267,0	216,0	192,0	48,0	66810
0.6250	15,875 mm	5/8	16,0	267,0	216,0	192,0	48,0	56540
0.6299	16,000 mm		16,0	267,0	216,0	192,0	48,0	66811
0.6562	16,667 mm	21/32	18,0	292,0	241,0	216,0	48,0	56541
0.6875	17,463 mm	11/16	18,0	292,0	241,0	215,0	48,0	56542
0.7500	19,050 mm	3/4	20,0	319,0	266,0	238,0	50,0	56543

CONTINUED

Series 142P Fractional	Hardness	Vc (sfm)	DC • in								
			1/8	3/16	1/4	3/8	1/2	5/8	3/4		
CARBON STEELS 1018, 1040, 1080, 1090, 10L50, 1140, 1212, 12L15, 1525, 1536	≤ 175 Bhn or ≤ 7 HRc	425	RPM	12988	8659	6494	4329	3247	2598	2165	
		(340-510)	Fr	0.0043	0.0065	0.0086	0.0129	0.0172	0.0216	0.0259	
			Feed (ipm)	56.0	56.0	56.0	56.0	56.0	56.0	56.0	
	≤ 275 Bhn or ≤ 28 HRc	380	RPM	11613	7742	5806	3871	2903	2323	1935	
		(304-456)	Fr	0.0039	0.0058	0.0078	0.0116	0.0155	0.0194	0.0233	
			Feed (ipm)	45.0	45.0	45.0	45.0	45.0	45.0	45.0	
	≤ 425 Bhn or ≤ 45 HRc	220	RPM	6723	4482	3362	2241	1681	1345	1121	
		(176-264)	Fr	0.0033	0.0049	0.0065	0.0098	0.0131	0.0164	0.0196	
			Feed (ipm)	22.0	22.0	22.0	22.0	22.0	22.0	22.0	
	P ALLOY STEELS 4140, 4150, 4320, 5120, 5150, 8630, 86L20, 50100	≤ 275 Bhn or ≤ 28 HRc	330	RPM	10085	6723	5042	3362	2521	2017	1681
			(264-396)	Fr	0.0033	0.0049	0.0065	0.0098	0.0131	0.0164	0.0196
				Feed (ipm)	33.0	33.0	33.0	33.0	33.0	33.0	33.0
≤ 375 Bhn or ≤ 40 HRc		200	RPM	6112	4075	3056	2037	1528	1222	1019	
		(160-240)	Fr	0.0028	0.0042	0.0056	0.0083	0.0111	0.0139	0.0167	
			Feed (ipm)	17.0	17.0	17.0	17.0	17.0	17.0	17.0	
≤ 425 Bhn or ≤ 45 HRc		140	RPM	4278	2852	2139	1426	1070	856	713	
		(112-168)	Fr	0.0020	0.0030	0.0040	0.0060	0.0079	0.0099	0.0119	
			Feed (ipm)	8.5	8.5	8.5	8.5	8.5	8.5	8.5	
TOOL STEELS A2, D2, H13, L2, M2, P20, S7, T15, W2		≤ 200 Bhn or ≤ 13 HRc	145	RPM	4431	2954	2216	1477	1108	886	739
			(116-174)	Fr	0.0028	0.0042	0.0056	0.0085	0.0113	0.0141	0.0169
				Feed (ipm)	12.5	12.5	12.5	12.5	12.5	12.5	12.5
	≤ 375 Bhn or ≤ 40 HRc	95	RPM	2903	1935	1452	968	726	581	484	
		(76-114)	Fr	0.0013	0.0020	0.0027	0.0040	0.0054	0.0067	0.0081	
			Feed (ipm)	3.9	3.9	3.9	3.9	3.9	3.9	3.9	
M STAINLESS STEELS (FREE MACHINING) 303, 416, 420F, 430F, 440F	≤ 185 Bhn or ≤ 9 HRc	305	RPM	9321	6214	4660	3107	2330	1864	1553	
		(244-366)	Fr	0.0026	0.0039	0.0051	0.0077	0.0103	0.0129	0.0154	
			Feed (ipm)	24.0	24.0	24.0	24.0	24.0	24.0	24.0	
	≤ 275 Bhn or ≤ 28 HRc	195	RPM	5959	3973	2980	1986	1490	1192	993	
		(156-234)	Fr	0.0020	0.0030	0.0040	0.0060	0.0081	0.0101	0.0121	
			Feed (ipm)	12.0	12.0	12.0	12.0	12.0	12.0	12.0	
	≤ 275 Bhn or ≤ 28 HRc	150	RPM	4584	3056	2292	1528	1146	917	764	
		(120-180)	Fr	0.0020	0.0030	0.0040	0.0060	0.0079	0.0099	0.0119	
			Feed (ipm)	9.1	9.1	9.1	9.1	9.1	9.1	9.1	
	STAINLESS STEELS (DIFFICULT) 304, 316, 321, 13-8 PH, 15-5PH, 17-4 PH, Custom 450	≤ 375 Bhn or ≤ 40 HRc	110	RPM	3362	2241	1681	1121	840	672	560
			(88-132)	Fr	0.0018	0.0027	0.0036	0.0054	0.0071	0.0089	0.0107
				Feed (ipm)	6.0	6.0	6.0	6.0	6.0	6.0	6.0
K CAST IRONS Gray, Malleable, Ductile	≤ 220 Bhn or ≤ 19 HRc	360	RPM	11002	7334	5501	3667	2750	2200	1834	
		(288-432)	Fr	0.0045	0.0068	0.0091	0.0136	0.0182	0.0227	0.0273	
			Feed (ipm)	50.0	50.0	50.0	50.0	50.0	50.0	50.0	
	≤ 260 Bhn or ≤ 26 HRc	335	RPM	10238	6825	5119	3413	2559	2048	1706	
		(268-402)	Fr	0.0045	0.0068	0.0091	0.0136	0.0182	0.0227	0.0273	
			Feed (ipm)	46.5	46.5	46.5	46.5	46.5	46.5	46.5	

continued on next page

Series 142P Fractional	Hardness	Vc (sfm)	DC • in								
			1/8	3/16	1/4	3/8	1/2	5/8	3/4		
N ALUMINUM ALLOYS 2017, 2024, 356, 6061, 7075	≤ 80 Bhn or ≤ 47 HRb	770	RPM	23531	15687	11766	7844	5883	4706	3922	
		(616-924)	Fr	0.0049	0.0073	0.0098	0.0147	0.0195	0.0244	0.0293	
			Feed (ipm)	115.0	115.0	115.0	115.0	115.0	115.0	115.0	
	≤ 150 Bhn or ≤ 8 HRb	660	RPM	20170	13446	10085	6723	5042	4034	3362	
		(528-792)	Fr	0.0050	0.0074	0.0099	0.0149	0.0198	0.0248	0.0297	
			Feed (ipm)	100.0	100.0	100.0	100.0	100.0	100.0	100.0	
	COPPER ALLOYS Alum Bronze, C110, Muntz Brass	≤ 140 Bhn or ≤ 3 HRc	550	RPM	16808	11205	8404	5603	4202	3362	2801
			(440-660)	Fr	0.0020	0.0030	0.0040	0.0060	0.0080	0.0100	0.0120
				Feed (ipm)	33.5	33.5	33.5	33.5	33.5	33.5	33.5
		≤ 200 Bhn or ≤ 23 HRc	440	RPM	13446	8964	6723	4482	3362	2689	2241
			(352-528)	Fr	0.0020	0.0030	0.0040	0.0060	0.0080	0.0100	0.0120
				Feed (ipm)	27.0	27.0	27.0	27.0	27.0	27.0	27.0
S HIGH TEMP ALLOYS (NICKEL, COBALT, IRON BASE) Inconel 601, 617, 625, Incoloy, Monel 400, Rene, Waspaloy	≤ 300 Bhn or ≤ 32 HRc	95	RPM	2903	1935	1452	968	726	581	484	
		(76-114)	Fr	0.0008	0.0012	0.0016	0.0024	0.0032	0.0040	0.0048	
			Feed (ipm)	2.3	2.3	2.3	2.3	2.3	2.3	2.3	
	≤ 400 Bhn or ≤ 43 HRc	50	RPM	1528	1019	764	509	382	306	255	
		(40-60)	Fr	0.0007	0.0010	0.0013	0.0020	0.0026	0.0033	0.0039	
			Feed (ipm)	1.0	1.0	1.0	1.0	1.0	1.0	1.0	
	TITANIUM ALLOYS Pure Titanium, Ti6Al4V, Ti6Al2Sn4Zr2Mo, Ti4Al4Mo2Sn0.5Si, Ti-6Al4V	≤ 275 Bhn or ≤ 28 HRc	215	RPM	6570	4380	3285	2190	1643	1314	1095
			(172-258)	Fr	0.0018	0.0026	0.0035	0.0053	0.0070	0.0088	0.0105
				Feed (ipm)	11.5	11.5	11.5	11.5	11.5	11.5	11.5
		≤ 350 Bhn or ≤ 38 HRc	160	RPM	4890	3260	2445	1630	1222	978	815
			(128-192)	Fr	0.0016	0.0024	0.0032	0.0048	0.0064	0.0080	0.0096
				Feed (ipm)	7.8	7.8	7.8	7.8	7.8	7.8	7.8
≤ 440 Bhn or ≤ 47 HRc	85	RPM	2598	1732	1299	866	649	520	433		
	(68-102)	Fr	0.0012	0.0018	0.0024	0.0036	0.0048	0.0060	0.0072		
		Feed (ipm)	3.1	3.1	3.1	3.1	3.1	3.1	3.1		
H TOOL STEELS A2, D2, H13, L2, M2, P20, S7, T15, W2	≤ 475 Bhn or ≤ 50 HRc	85	RPM	2598	1732	1299	866	649	520	433	
		(68-102)	Fr	0.0008	0.0013	0.0017	0.0025	0.0034	0.0042	0.0051	
			Feed (ipm)	2.2	2.2	2.2	2.2	2.2	2.2	2.2	

Bhn (Brinell) HRc (Rockwell C) HRb (Rockwell B)
rpm = Vc x 3.82 / DC
ipm = Fr x RPM
reduce speed and feed for materials harder than listed
refer to the SGS Tool Wizard® for complete technical information (www.kyocera-sgstool.com)

Hi-PerCarb®

Series 142P Metric	Hardness	Vc (m/min)	DC • mm								
			3	6	8	10	12	14	16		
CARBON STEELS 1018, 1040, 1080, 1090, 10L50, 1140, 1212, 12L15, 1525, 1536	≤ 175 Bhn or ≤ 7 HRc	130	RPM	13733	6867	5150	4120	3433	2943	2575	
		(104-155)	Fr	0.104	0.207	0.276	0.345	0.414	0.483	0.552	
			Feed (mm/min)	1422	1422	1422	1422	1422	1422	1422	
	≤ 275 Bhn or ≤ 28 HRc	116	RPM	12279	6140	4605	3684	3070	2631	2302	
		(93-139)	Fr	0.093	0.186	0.248	0.310	0.372	0.434	0.496	
			Feed (mm/min)	1143	1143	1143	1143	1143	1143	1143	
	≤ 425 Bhn or ≤ 45 HRc	67	RPM	7109	3555	2666	2133	1777	1523	1333	
		(54-80)	Fr	0.079	0.157	0.210	0.262	0.314	0.367	0.419	
			Feed (mm/min)	559	559	559	559	559	559	559	
	ALLOY STEELS 4140, 4150, 4320, 5120, 5150, 8630, 86L20, 50100	≤ 275 Bhn or ≤ 28 HRc	101	RPM	10664	5332	3999	3199	2666	2285	1999
			(80-121)	Fr	0.079	0.157	0.210	0.262	0.314	0.367	0.419
				Feed (mm/min)	838	838	838	838	838	838	838
		≤ 375 Bhn or ≤ 40 HRc	61	RPM	6463	3231	2424	1939	1616	1385	1212
			(49-73)	Fr	0.067	0.134	0.178	0.223	0.267	0.312	0.356
				Feed (mm/min)	432	432	432	432	432	432	432
≤ 425 Bhn or ≤ 45 HRc		43	RPM	4524	2262	1696	1357	1131	969	848	
		(34-51)	Fr	0.048	0.095	0.127	0.159	0.191	0.223	0.255	
			Feed (mm/min)	216	216	216	216	216	216	216	
TOOL STEELS A2, D2, H13, L2, M2, P20, S7, T15, W2		≤ 200 Bhn or ≤ 13 HRc	44	RPM	4686	2343	1757	1406	1171	1004	879
			(35-53)	Fr	0.068	0.136	0.181	0.226	0.271	0.316	0.361
				Feed (mm/min)	318	318	318	318	318	318	318
		≤ 375 Bhn or ≤ 40 HRc	29	RPM	3070	1535	1151	921	767	658	576
			(23-35)	Fr	0.032	0.065	0.086	0.108	0.129	0.151	0.172
				Feed (mm/min)	99	99	99	99	99	99	99
STAINLESS STEELS (FREE MACHINING) 303, 416, 420F, 430F, 440F	≤ 185 Bhn or ≤ 9 HRc	93	9856	9856	4928	3696	2957	2464	2112	1848	
		(74-112)	0.062	0.062	0.124	0.165	0.206	0.247	0.289	0.330	
			610	610	610	610	610	610	610	610	
	≤ 275 Bhn or ≤ 28 HRc	59	6301	6301	3151	2363	1890	1575	1350	1181	
		(48-71)	0.048	0.048	0.097	0.129	0.161	0.193	0.226	0.258	
			305	305	305	305	305	305	305	305	
	STAINLESS STEELS (DIFFICULT) 304, 316, 321, 13-8 PH, 15-5PH, 17-4 PH, Custom 450	≤ 275 Bhn or ≤ 28 HRc	46	4847	4847	2424	1818	1454	1212	1039	909
			(37-55)	0.048	0.048	0.095	0.127	0.159	0.191	0.223	0.254
				231	231	231	231	231	231	231	231
		≤ 375 Bhn or ≤ 40 HRc	34	3555	3555	1777	1333	1066	889	762	666
			(27-40)	0.043	0.043	0.086	0.114	0.143	0.171	0.200	0.229
				152	152	152	152	152	152	152	152
CAST IRONS Gray, Malleable, Ductile	≤ 220 Bhn or ≤ 19 HRc	110	RPM	11633	5816	4362	3490	2908	2493	2181	
		(88-132)	Fr	0.109	0.218	0.291	0.364	0.437	0.509	0.582	
			Feed (mm/min)	1270	1270	1270	1270	1270	1270	1270	
	≤ 260 Bhn or ≤ 26 HRc	102	RPM	10825	5413	4059	3248	2706	2320	2030	
		(82-123)	Fr	0.109	0.218	0.291	0.364	0.436	0.509	0.582	
			Feed (mm/min)	1181	1181	1181	1181	1181	1181	1181	

continued on next page

Series 142P Metric	Hardness	Vc (m/min)	DC • mm								
			3	6	8	10	12	14	16		
N ALUMINUM ALLOYS 2017, 2024, 356, 6061, 7075	≤ 80 Bhn or ≤ 47 HRb	235	RPM	24882	12441	9331	7465	6220	5332	4665	
		(188-282)	Fr	0.117	0.235	0.313	0.391	0.470	0.548	0.626	
			Feed (mm/min)	2921	2921	2921	2921	2921	2921	2921	
	≤ 150 Bhn or ≤ 88 HRb	201	RPM	21327	10664	7998	6398	5332	4570	3999	
		(161-241)	Fr	0.119	0.238	0.318	0.397	0.476	0.556	0.635	
			Feed (mm/min)	2540	2540	2540	2540	2540	2540	2540	
	Copper Alloys Alum Bronze, C110, Muntz Brass	≤ 140 Bhn or ≤ 3 HRc	168	RPM	17773	8886	6665	5332	4443	3808	3332
			(134-201)	Fr	0.048	0.096	0.128	0.160	0.192	0.223	0.255
				Feed (mm/min)	851	851	851	851	851	851	851
		≤ 200 Bhn or ≤ 23 HRc	134	RPM	14218	7109	5332	4265	3555	3047	2666
			(107-161)	Fr	0.048	0.096	0.129	0.161	0.193	0.225	0.257
				Feed (mm/min)	686	686	686	686	686	686	686
S HIGH TEMP ALLOYS (Nickel , Cobalt, Iron Base) Inconel 601, 617, 625, Incoloy, Monel 400, Rene, Waspaloy	≤ 300 Bhn or ≤ 32 HRc	29	RPM	3070	1535	1151	921	767	658	576	
		(23-35)	Fr	0.019	0.038	0.051	0.063	0.076	0.089	0.101	
			Feed (mm/min)	58	58	58	58	58	58	58	
	≤ 400 Bhn or ≤ 43 HRc	15	RPM	1616	808	606	485	404	346	303	
		(12-18)	Fr	0.016	0.031	0.042	0.052	0.063	0.073	0.084	
			Feed (mm/min)	25	25	25	25	25	25	25	
	TITANIUM ALLOYS Pure Titanium, Ti6Al4V, Ti6Al2Sn4Zr2Mo, Ti4Al4Mo2Sn0.5Si, Ti-6Al4V	≤ 275 Bhn or ≤ 28 HRc	66	RPM	6947	3474	2605	2084	1737	1489	1303
			(52-79)	Fr	0.042	0.084	0.112	0.140	0.168	0.196	0.224
				Feed (mm/min)	292	292	292	292	292	292	292
		≤ 350 Bhn or ≤ 38 HRc	49	RPM	5170	2585	1939	1551	1293	1108	969
			(39-59)	Fr	0.038	0.077	0.102	0.128	0.153	0.179	0.204
				Feed (mm/min)	198	198	198	198	198	198	198
≤ 440 Bhn or ≤ 47 HRc	26	RPM	2747	1373	1030	824	687	589	515		
	(21-31)	Fr	0.029	0.057	0.076	0.096	0.115	0.134	0.153		
		Feed (mm/min)	79	79	79	79	79	79	79		
H TOOL STEELS A2, D2, H13, L2, M2, P20, S7, T15, W2	≤ 475 Bhn or ≤ 50 HRc	26	RPM	2747	1373	1030	824	687	589	515	
		(21-31)	Fr	0.020	0.041	0.054	0.068	0.081	0.095	0.109	
			Feed (mm/min)	56	56	56	56	56	56	56	

(Brinell) HRc (Rockwell C) HRb (Rockwell B)
 $rpm = (Vc \times 1000) / (DC \times 3.14)$
 $mm/min = Fr \times RPM$

reduce speed and feed for materials harder than listed
refer to the SGS Tool Wizard® for complete technical information (www.kyocera-sgtool.com)



143M-S 3xD
FRACTIONAL & METRIC SERIES

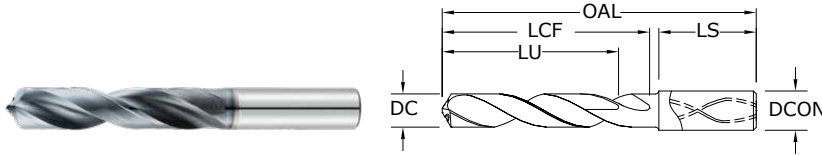

- Coolant through design improves coolant flow to extend tool life and aid in chip evacuation
- Eccentric 2-margin design reduces frictional heat and minimizes material adhesion to the margins without weakening the drill
- Computer controlled edge honing protects against chip damage
- High-performance point design stabilizes on contact for exceptional hole size and cylindricity allowing for low thrust force and extended tool life
- SGS Ti-NAMITE®-A coating provides exceptional wear and erosion resistance when drilling heat resisting alloys like Inconel, Stainless Steel, and Titanium Alloys
- Recommended for materials ≤ 50HRc (475 Bhn)

inch & mm								EDP NO.
DECIMAL DC	METRIC DC	FRACTIONAL/ LETTER/WIRE DC	SHANK DIAMETER DCON	OVERALL LENGTH OAL	FLUTE LENGTH LCF	USABLE LENGTH LU	SHANK LENGTH LS	Ti-NAMITE®-A (AITiN)
0.1181	3,000 mm		6,0	62,0	20,0	15,0	36,0	69120
0.1220	3,100 mm		6,0	62,0	20,0	15,0	36,0	69121
0.1250	3,175 mm	1/8	6,0	62,0	20,0	15,0	36,0	56800
0.1260	3,200 mm		6,0	62,0	20,0	15,0	36,0	69122
0.1299	3,300 mm		6,0	62,0	20,0	15,0	36,0	69123
0.1339	3,400 mm		6,0	62,0	20,0	15,0	36,0	69124
0.1360	3,454 mm	#29	6,0	62,0	20,0	15,0	36,0	56801
0.1378	3,500 mm		6,0	62,0	20,0	15,0	36,0	69125
0.1406	3,571 mm	9/64	6,0	62,0	20,0	15,0	36,0	56802
0.1417	3,600 mm		6,0	62,0	20,0	15,0	36,0	69126
0.1457	3,700 mm		6,0	62,0	20,0	15,0	36,0	69127
0.1496	3,800 mm		6,0	66,0	24,0	18,0	36,0	69128
0.1535	3,900 mm		6,0	66,0	24,0	18,0	36,0	69129
0.1562	3,967 mm	5/32	6,0	66,0	24,0	18,0	36,0	56803
0.1575	4,000 mm		6,0	66,0	24,0	18,0	36,0	69130
0.1590	4,039 mm	#21	6,0	66,0	24,0	18,0	36,0	56804
0.1614	4,100 mm		6,0	66,0	24,0	18,0	36,0	69131
0.1654	4,200 mm		6,0	66,0	24,0	18,0	36,0	69132
0.1693	4,300 mm		6,0	66,0	24,0	18,0	36,0	69133
0.1719	4,366 mm	11/64	6,0	66,0	24,0	17,0	36,0	56805
0.1732	4,400 mm		6,0	66,0	24,0	17,0	36,0	69134
0.1772	4,500 mm		6,0	66,0	24,0	17,0	36,0	69135
0.1811	4,600 mm		6,0	66,0	24,0	17,0	36,0	69136
0.1850	4,699 mm	#13	6,0	66,0	24,0	17,0	36,0	69137
0.1875	4,763 mm	3/16	6,0	66,0	28,0	21,0	36,0	56806
0.1890	4,801 mm	#12	6,0	66,0	28,0	21,0	36,0	69138
0.1929	4,900 mm		6,0	66,0	28,0	21,0	36,0	69139
0.1969	5,000 mm		6,0	66,0	28,0	20,0	36,0	69140
0.2008	5,100 mm		6,0	66,0	28,0	20,0	36,0	69141
0.2031	5,159 mm	13/64	6,0	66,0	28,0	20,0	36,0	56807
0.2047	5,200 mm		6,0	66,0	28,0	20,0	36,0	69142
0.2087	5,300 mm		6,0	66,0	28,0	20,0	36,0	69143
0.2126	5,400 mm		6,0	66,0	28,0	20,0	36,0	69144
0.2165	5,500 mm		6,0	66,0	28,0	20,0	36,0	69145
0.2188	5,558 mm	7/32	6,0	66,0	28,0	20,0	36,0	56808
0.2205	5,600 mm		6,0	66,0	28,0	20,0	36,0	69146

TOLERANCES (inch)

- ≤.1181 DIAMETER
DC = +.00008/+0.00047
DCON = h₆
- >.1181-.2362 DIAMETER
DC = +.00016/+0.00063
DCON = h₆
- >.2362-.3937 DIAMETER
DC = +.00024/+0.00083
DCON = h₆
- >.3937-.7087 DIAMETER
DC = +.00028/+0.00098
DCON = h₆
- >.7087-1.1811 DIAMETER
DC = +.00031/+0.00114
DCON = h₆

TOLERANCES (mm)

- ≤3 DIAMETER
DC = +0,002/+0,012
DCON = h₆
- >3-6 DIAMETER
DC = +0,004/+0,016
DCON = h₆
- >6-10 DIAMETER
DC = +0,006/+0,021
DCON = h₆
- >10-18 DIAMETER
DC = +0,007/+0,025
DCON = h₆
- >18-30 DIAMETER
DC = +0,008/+0,029
DCON = h₆

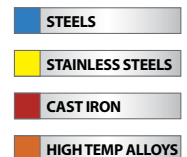

For patent information visit www.ksptpatents.com

continued on next page

143M-S 3xD
FRACTIONAL & METRIC SERIES

DECIMAL DC	METRIC DC	inch & mm						EDP NO.
		FRACTIONAL/ LETTER/WIRE DC	SHANK DIAMETER DCON	OVERALL LENGTH OAL	FLUTE LENGTH LCF	USABLE LENGTH LU	SHANK LENGTH LS	Ti-NAMITE [®] -A (AITIN)
0.2244	5,700 mm		6,0	66,0	28,0	19,0	36,0	69147
0.2283	5,800 mm		6,0	66,0	28,0	19,0	36,0	69148
0.2323	5,900 mm		6,0	66,0	28,0	19,0	36,0	69149
0.2344	5,954 mm	15/64	6,0	66,0	28,0	19,0	36,0	56809
0.2362	6,000 mm		6,0	66,0	28,0	19,0	36,0	69150
0.2402	6,100 mm		8,0	79,0	34,0	25,0	36,0	69151
0.2441	6,200 mm		8,0	79,0	34,0	25,0	36,0	69152
0.2480	6,300 mm		8,0	79,0	34,0	25,0	36,0	69153
0.2500	6,350 mm	1/4 E #0	8,0	79,0	34,0	24,0	36,0	56810
0.2520	6,400 mm		8,0	79,0	34,0	24,0	36,0	69154
0.2559	6,500 mm		8,0	79,0	34,0	24,0	36,0	69155
0.2570	6,528 mm	F	8,0	79,0	34,0	24,0	36,0	56811
0.2598	6,600 mm		8,0	79,0	34,0	24,0	36,0	69156
0.2638	6,700 mm		8,0	79,0	34,0	24,0	36,0	69157
0.2656	6,746 mm	17/64	8,0	79,0	34,0	24,0	36,0	56812
0.2677	6,800 mm		8,0	79,0	34,0	24,0	36,0	69158
0.2717	6,900 mm		8,0	79,0	34,0	24,0	36,0	69159
0.2756	7,000 mm		8,0	79,0	34,0	24,0	36,0	69160
0.2795	7,100 mm		8,0	79,0	41,0	30,0	36,0	69161
0.2812	7,142 mm	9/32	8,0	79,0	41,0	30,0	36,0	56813
0.2835	7,200 mm		8,0	79,0	41,0	30,0	36,0	69162
0.2874	7,300 mm		8,0	79,0	41,0	30,0	36,0	69163
0.2913	7,400 mm		8,0	79,0	41,0	30,0	36,0	69164
0.2953	7,500 mm		8,0	79,0	41,0	30,0	36,0	69165
0.2969	7,541 mm	19/64	8,0	79,0	41,0	30,0	36,0	56814
0.2992	7,600 mm		8,0	79,0	41,0	30,0	36,0	69166
0.3031	7,700 mm		8,0	79,0	41,0	29,0	36,0	69167
0.3071	7,800 mm		8,0	79,0	41,0	29,0	36,0	69168
0.3110	7,900 mm		8,0	79,0	41,0	29,0	36,0	69169
0.3125	7,938 mm	5/16	8,0	79,0	41,0	29,0	36,0	56815
0.3150	8,000 mm		8,0	79,0	41,0	29,0	36,0	69170
0.3189	8,100 mm		10,0	89,0	47,0	35,0	40,0	69171
0.3228	8,200 mm		10,0	89,0	47,0	35,0	40,0	69172
0.3268	8,300 mm		10,0	89,0	47,0	35,0	40,0	69173
0.3281	8,334 mm	21/64	10,0	89,0	47,0	34,0	40,0	56816
0.3307	8,400 mm		10,0	89,0	47,0	34,0	40,0	69174
0.3320	8,433 mm	Q	10,0	89,0	47,0	34,0	40,0	56817
0.3346	8,500 mm		10,0	89,0	47,0	34,0	40,0	69175
0.3386	8,600 mm		10,0	89,0	47,0	34,0	40,0	69176
0.3425	8,700 mm		10,0	89,0	47,0	34,0	40,0	69177
0.3438	8,733 mm	11/32	10,0	89,0	47,0	34,0	40,0	56818
0.3465	8,800 mm		10,0	89,0	47,0	34,0	40,0	69178
0.3504	8,900 mm		10,0	89,0	47,0	34,0	40,0	69179
0.3543	9,000 mm		10,0	89,0	47,0	34,0	40,0	69180

CONTINUED

continued on next page



143M-S 3xD
FRACTIONAL & METRIC SERIES

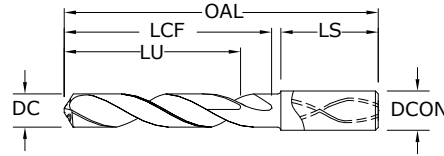

- Coolant through design improves coolant flow to extend tool life and aid in chip evacuation
- Eccentric 2-margin design reduces frictional heat and minimizes material adhesion to the margins without weakening the drill
- Computer controlled edge honing protects against chip damage
- High-performance point design stabilizes on contact for exceptional hole size and cylindricity allowing for low thrust force and extended tool life
- SGS Ti-NAMITE®-A coating provides exceptional wear and erosion resistance when drilling heat resisting alloys like Inconel, Stainless Steel, and Titanium Alloys
- Recommended for materials ≤ 50HRc (475 Bhn)

inch & mm								EDP NO.
DECIMAL DC	METRIC DC	FRACTIONAL/ LETTER/WIRE DC	SHANK DIAMETER DCON	OVERALL LENGTH OAL	FLUTE LENGTH LCF	USABLE LENGTH LU	SHANK LENGTH LS	Ti-NAMITE®-A (AITiN)
0.3583	9,100 mm		10,0	89,0	47,0	33,0	40,0	69181
0.3594	9,129 mm	23/64	10,0	89,0	47,0	33,0	40,0	56819
0.3622	9,200 mm		10,0	89,0	47,0	33,0	40,0	69182
0.3661	9,300 mm		10,0	89,0	47,0	33,0	40,0	69183
0.3680	9,347 mm	U	10,0	89,0	47,0	33,0	40,0	56820
0.3701	9,400 mm		10,0	89,0	47,0	33,0	40,0	69184
0.3740	9,500 mm		10,0	89,0	47,0	33,0	40,0	69185
0.3750	9,525 mm	3/8	10,0	89,0	47,0	33,0	40,0	56821
0.3780	9,600 mm		10,0	89,0	47,0	33,0	40,0	69186
0.3819	9,700 mm		10,0	89,0	47,0	32,0	40,0	69187
0.3858	9,800 mm		10,0	89,0	47,0	32,0	40,0	69188
0.3898	9,900 mm		10,0	89,0	47,0	32,0	40,0	69189
0.3906	9,921 mm	25/64	10,0	89,0	47,0	32,0	40,0	56822
0.3937	10,000 mm		10,0	89,0	47,0	32,0	40,0	69190
0.3976	10,100 mm		12,0	102,0	55,0	40,0	45,0	69191
0.4016	10,200 mm		12,0	102,0	55,0	40,0	45,0	69192
0.4055	10,300 mm		12,0	102,0	55,0	40,0	45,0	69193
0.4062	10,317 mm	13/32	12,0	102,0	55,0	40,0	45,0	56823
0.4095	10,400 mm		12,0	102,0	55,0	39,0	45,0	69194
0.4134	10,500 mm		12,0	102,0	55,0	39,0	45,0	69195
0.4173	10,600 mm		12,0	102,0	55,0	39,0	45,0	69196
0.4213	10,700 mm		12,0	102,0	55,0	39,0	45,0	69197
0.4219	10,716 mm	27/64	12,0	102,0	55,0	39,0	45,0	56824
0.4252	10,800 mm		12,0	102,0	55,0	39,0	45,0	69198
0.4291	10,900 mm		12,0	102,0	55,0	39,0	45,0	69199
0.4331	11,000 mm		12,0	102,0	55,0	39,0	45,0	69200
0.4370	11,100 mm		12,0	102,0	55,0	38,0	45,0	69201
0.4375	11,113 mm	7/16	12,0	102,0	55,0	38,0	45,0	56825
0.4409	11,200 mm		12,0	102,0	55,0	38,0	45,0	69202
0.4449	11,300 mm		12,0	102,0	55,0	38,0	45,0	69203
0.4488	11,400 mm		12,0	102,0	55,0	38,0	45,0	69204
0.4528	11,500 mm		12,0	102,0	55,0	38,0	45,0	69205
0.4567	11,600 mm		12,0	102,0	55,0	38,0	45,0	69206
0.4606	11,700 mm		12,0	102,0	55,0	37,0	45,0	69207
0.4646	11,800 mm		12,0	102,0	55,0	37,0	45,0	69208
0.4685	11,900 mm		12,0	102,0	55,0	37,0	45,0	69209

TOLERANCES (inch)

- ≤.1181 DIAMETER
DC = +.00008/+0.00047
DCON = h₆
- >.1181-.2362 DIAMETER
DC = +.00016/+0.00063
DCON = h₆
- >.2362-.3937 DIAMETER
DC = +.00024/+0.00083
DCON = h₆
- >.3937-.7087 DIAMETER
DC = +.00028/+0.00098
DCON = h₆
- >.7087-1.1811 DIAMETER
DC = +.00031/+0.00114
DCON = h₆

TOLERANCES (mm)

- ≤3 DIAMETER
DC = +0,002/+0,012
DCON = h₆
- >3-6 DIAMETER
DC = +0,004/+0,016
DCON = h₆
- >6-10 DIAMETER
DC = +0,006/+0,021
DCON = h₆
- >10-18 DIAMETER
DC = +0,007/+0,025
DCON = h₆
- >18-30 DIAMETER
DC = +0,008/+0,029
DCON = h₆

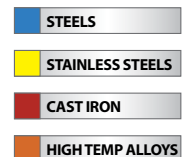

For patent information visit www.ksptpatents.com

continued on next page



143M-S 3xD
FRACTIONAL & METRIC SERIES

DECIMAL DC	METRIC DC	inch & mm						EDP NO.
		FRACTIONAL/ LETTER/WIRE DC	SHANK DIAMETER DCON	OVERALL LENGTH OAL	FLUTE LENGTH LCF	USABLE LENGTH LU	SHANK LENGTH LS	Ti-NAMITE®-A (AITiN)
0.4688	11,908 mm	15/32	12,0	102,0	55,0	37,0	45,0	56826
0.4724	12,000 mm		12,0	102,0	55,0	37,0	45,0	69210
0.4844	12,304 mm	31/64	14,0	107,0	60,0	41,0	45,0	56827
0.4921	12,500 mm		14,0	107,0	60,0	41,0	45,0	69211
0.5000	12,700 mm	1/2	14,0	107,0	60,0	41,0	45,0	56828
0.5039	12,800 mm		14,0	107,0	60,0	41,0	45,0	69212
0.5118	13,000 mm		14,0	107,0	60,0	41,0	45,0	69213
0.5156	13,096 mm	33/64	14,0	107,0	60,0	40,0	45,0	56829
0.5315	13,500 mm		14,0	107,0	60,0	40,0	45,0	69214
0.5433	13,800 mm		14,0	107,0	60,0	39,0	45,0	69215
0.5512	14,000 mm		14,0	107,0	60,0	39,0	45,0	69216
0.5625	14,288 mm	9/16	16,0	115,0	65,0	43,0	48,0	56830
0.5709	14,500 mm		16,0	115,0	65,0	43,0	48,0	69217
0.5781	14,684 mm	37/64	16,0	115,0	65,0	43,0	48,0	56831
0.5827	14,800 mm		16,0	115,0	65,0	43,0	48,0	69218
0.5906	15,000 mm		16,0	115,0	65,0	42,0	48,0	69219
0.6102	15,500 mm		16,0	115,0	65,0	42,0	48,0	69220
0.6221	15,800 mm		16,0	115,0	65,0	41,0	48,0	69221
0.6250	15,875 mm	5/8	16,0	115,0	65,0	41,0	48,0	56832
0.6299	16,000 mm		16,0	115,0	65,0	41,0	48,0	69222
0.6562	16,667 mm	21/32	18,0	123,0	73,0	47,0	48,0	56833
0.6875	17,463 mm	11/16	18,0	123,0	73,0	47,0	48,0	56834
0.7500	19,050 mm	3/4	20,0	131,0	79,0	50,0	50,0	56835

CONTINUED



5xD



143M-S 5xD

FRACTIONAL & METRIC SERIES

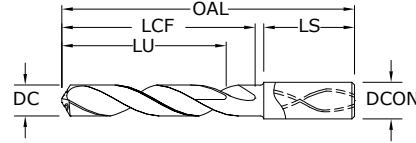

- Coolant through design improves coolant flow to extend tool life and aid in chip evacuation
- Eccentric 2-margin design reduces frictional heat and minimizes material adhesion to the margins without weakening the drill
- Computer controlled edge honing protects against chip damage
- High-performance point design stabilizes on contact for exceptional hole size and cylindricity allowing for low thrust force and extended tool life
- SGS Ti-NAMITE®-A coating provides exceptional wear and erosion resistance when drilling heat resisting alloys like Inconel, Stainless Steel, and Titanium Alloys
- Recommended for materials ≤ 50HRc (475 Bhn)

inch & mm									EDP NO.
DECIMAL DC	METRIC DC	FRACTIONAL/ LETTER/WIRE DC	SHANK DIAMETER DCON	OVERALL LENGTH OAL	FLUTE LENGTH LCF	USABLE LENGTH LU	SHANK LENGTH LS	Ti-NAMITE®-A (AITiN)	
0.1181	3,000 mm		6,0	66,0	28,0	23,0	36,0	69223	
0.1220	3,100 mm		6,0	66,0	28,0	23,0	36,0	69224	
0.1250	3,175 mm	1/8	6,0	66,0	28,0	23,0	36,0	56836	
0.1260	3,200 mm		6,0	66,0	28,0	23,0	36,0	69225	
0.1299	3,300 mm		6,0	66,0	28,0	23,0	36,0	69226	
0.1339	3,400 mm		6,0	66,0	28,0	23,0	36,0	69227	
0.1360	3,454 mm	#29	6,0	66,0	28,0	23,0	36,0	56837	
0.1378	3,500 mm		6,0	66,0	28,0	23,0	36,0	69228	
0.1406	3,571 mm	9/64	6,0	66,0	28,0	23,0	36,0	56838	
0.1417	3,600 mm		6,0	66,0	28,0	23,0	36,0	69229	
0.1457	3,700 mm		6,0	66,0	28,0	23,0	36,0	69230	
0.1496	3,800 mm		6,0	74,0	36,0	29,0	36,0	69231	
0.1535	3,900 mm		6,0	74,0	36,0	29,0	36,0	69232	
0.1562	3,967 mm	5/32	6,0	74,0	36,0	29,0	36,0	56839	
0.1575	4,000 mm		6,0	74,0	36,0	29,0	36,0	69233	
0.1590	4,039 mm	#21	6,0	74,0	36,0	29,0	36,0	56840	
0.1614	4,100 mm		6,0	74,0	36,0	29,0	36,0	69234	
0.1654	4,200 mm		6,0	74,0	36,0	29,0	36,0	69235	
0.1693	4,300 mm		6,0	74,0	36,0	29,0	36,0	69236	
0.1719	4,366 mm	11/64	6,0	74,0	36,0	29,0	36,0	56841	
0.1732	4,400 mm		6,0	74,0	36,0	29,0	36,0	69237	
0.1772	4,500 mm		6,0	74,0	36,0	29,0	36,0	69238	
0.1811	4,600 mm		6,0	74,0	36,0	29,0	36,0	69239	
0.1850	4,699 mm	#13	6,0	74,0	36,0	29,0	36,0	69240	
0.1875	4,763 mm	3/16	6,0	82,0	44,0	37,0	36,0	56842	
0.1890	4,801 mm	#12	6,0	82,0	44,0	37,0	36,0	69241	
0.1929	4,900 mm		6,0	82,0	44,0	37,0	36,0	69242	
0.1969	5,000 mm		6,0	82,0	44,0	36,0	36,0	69243	
0.2008	5,100 mm		6,0	82,0	44,0	36,0	36,0	69244	
0.2031	5,159 mm	13/64	6,0	82,0	44,0	36,0	36,0	56843	
0.2047	5,200 mm		6,0	82,0	44,0	36,0	36,0	69245	
0.2087	5,300 mm		6,0	82,0	44,0	36,0	36,0	69246	
0.2126	5,400 mm		6,0	82,0	44,0	36,0	36,0	69247	
0.2165	5,500 mm		6,0	82,0	44,0	36,0	36,0	69248	
0.2188	5,558 mm	7/32	6,0	82,0	44,0	36,0	36,0	56844	
0.2205	5,600 mm		6,0	82,0	44,0	36,0	36,0	69249	

TOLERANCES (inch)

- ≤.1181 DIAMETER
DC = +.00008/+0.00047
DCON = h₆
- >.1181-.2362 DIAMETER
DC = +.00016/+0.00063
DCON = h₆
- >.2362-.3937 DIAMETER
DC = +.00024/+0.00083
DCON = h₆
- >.3937-.7087 DIAMETER
DC = +.00028/+0.00098
DCON = h₆
- >.7087-1.1811 DIAMETER
DC = +.00031/+0.00114
DCON = h₆

TOLERANCES (mm)

- ≤3 DIAMETER
DC = +0,002/+0,012
DCON = h₆
- >3-6 DIAMETER
DC = +0,004/+0,016
DCON = h₆
- >6-10 DIAMETER
DC = +0,006/+0,021
DCON = h₆
- >10-18 DIAMETER
DC = +0,007/+0,025
DCON = h₆
- >18-30 DIAMETER
DC = +0,008/+0,029
DCON = h₆

STEELS
 STAINLESS STEELS
 CAST IRON
 HIGH TEMP ALLOYS

For patent information visit www.ksptpatents.com

continued on next page



143M-S 5xD
FRACTIONAL & METRIC SERIES

DECIMAL DC	METRIC DC	inch & mm						EDP NO.
		FRACTIONAL/ LETTER/WIRE DC	SHANK DIAMETER DCON	OVERALL LENGTH OAL	FLUTE LENGTH LCF	USABLE LENGTH LU	SHANK LENGTH LS	Ti-NAMITE®-A (AITIN)
0.2244	5,700 mm		6,0	82,0	44,0	35,0	36,0	69250
0.2283	5,800 mm		6,0	82,0	44,0	35,0	36,0	69251
0.2323	5,900 mm		6,0	82,0	44,0	35,0	36,0	69252
0.2344	5,954 mm	15/64	6,0	82,0	44,0	35,0	36,0	56845
0.2362	6,000 mm		6,0	82,0	44,0	35,0	36,0	69253
0.2402	6,100 mm		8,0	91,0	53,0	44,0	36,0	69254
0.2441	6,200 mm		8,0	91,0	53,0	44,0	36,0	69255
0.2480	6,300 mm		8,0	91,0	53,0	44,0	36,0	69256
0.2500	6,350 mm	1/4 E #0	8,0	91,0	53,0	43,0	36,0	56846
0.2520	6,400 mm		8,0	91,0	53,0	43,0	36,0	69257
0.2559	6,500 mm		8,0	91,0	53,0	43,0	36,0	69258
0.2570	6,528 mm	F	8,0	91,0	53,0	43,0	36,0	56847
0.2598	6,600 mm		8,0	91,0	53,0	43,0	36,0	69259
0.2638	6,700 mm		8,0	91,0	53,0	43,0	36,0	69260
0.2656	6,746 mm	17/64	8,0	91,0	53,0	43,0	36,0	56848
0.2677	6,800 mm		8,0	91,0	53,0	43,0	36,0	69261
0.2717	6,900 mm		8,0	91,0	53,0	43,0	36,0	69262
0.2756	7,000 mm		8,0	91,0	53,0	42,0	36,0	69263
0.2795	7,100 mm		8,0	91,0	53,0	42,0	36,0	69264
0.2812	7,142 mm	9/32	8,0	91,0	53,0	42,0	36,0	56849
0.2835	7,200 mm		8,0	91,0	53,0	42,0	36,0	69265
0.2874	7,300 mm		8,0	91,0	53,0	42,0	36,0	69266
0.2913	7,400 mm		8,0	91,0	53,0	42,0	36,0	69267
0.2953	7,500 mm		8,0	91,0	53,0	42,0	36,0	69268
0.2969	7,541 mm	19/64	8,0	91,0	53,0	42,0	36,0	56850
0.2992	7,600 mm		8,0	91,0	53,0	42,0	36,0	69269
0.3031	7,700 mm		8,0	91,0	53,0	41,0	36,0	69270
0.3071	7,800 mm		8,0	91,0	53,0	41,0	36,0	69271
0.3110	7,900 mm		8,0	91,0	53,0	41,0	36,0	69272
0.3125	7,938 mm	5/16	8,0	91,0	53,0	41,0	36,0	56851
0.3150	8,000 mm		8,0	91,0	53,0	41,0	36,0	69273
0.3189	8,100 mm		10,0	103,0	61,0	49,0	40,0	69274
0.3228	8,200 mm		10,0	103,0	61,0	49,0	40,0	69275
0.3268	8,300 mm		10,0	103,0	61,0	49,0	40,0	69276
0.3281	8,334 mm	21/64	10,0	103,0	61,0	48,0	40,0	56852
0.3307	8,400 mm		10,0	103,0	61,0	48,0	40,0	69277
0.3320	8,433 mm	Q	10,0	103,0	61,0	48,0	40,0	56853
0.3346	8,500 mm		10,0	103,0	61,0	48,0	40,0	69278
0.3386	8,600 mm		10,0	103,0	61,0	48,0	40,0	69279
0.3425	8,700 mm		10,0	103,0	61,0	48,0	40,0	69280
0.3438	8,733 mm	11/32	10,0	103,0	61,0	48,0	40,0	56854
0.3465	8,800 mm		10,0	103,0	61,0	48,0	40,0	69281
0.3504	8,900 mm		10,0	103,0	61,0	48,0	40,0	69282
0.3543	9,000 mm		10,0	103,0	61,0	48,0	40,0	69283

CONTINUED

continued on next page



143M-S 5xD
FRACTIONAL & METRIC SERIES

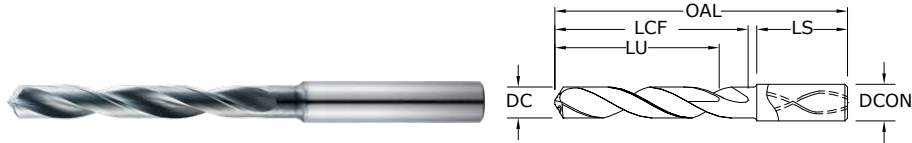

- Coolant through design improves coolant flow to extend tool life and aid in chip evacuation
- Eccentric 2-margin design reduces frictional heat and minimizes material adhesion to the margins without weakening the drill
- Computer controlled edge honing protects against chip damage
- High-performance point design stabilizes on contact for exceptional hole size and cylindricity allowing for low thrust force and extended tool life
- SGS Ti-NAMITE®-A coating provides exceptional wear and erosion resistance when drilling heat resisting alloys like Inconel, Stainless Steel, and Titanium Alloys
- Recommended for materials ≤ 50HRc (475 Bhn)

		inch & mm						EDP NO.
DECIMAL DC	METRIC DC	FRACTIONAL/ LETTER/WIRE DC	SHANK DIAMETER DCON	OVERALL LENGTH OAL	FLUTE LENGTH LCF	USABLE LENGTH LU	SHANK LENGTH LS	Ti-NAMITE®-A (AITiN)
0.3583	9,100 mm		10,0	103,0	61,0	47,0	40,0	69284
0.3594	9,129 mm	23/64	10,0	103,0	61,0	47,0	40,0	56855
0.3622	9,200 mm		10,0	103,0	61,0	47,0	40,0	69285
0.3661	9,300 mm		10,0	103,0	61,0	47,0	40,0	69286
0.3680	9,347 mm	U	10,0	103,0	61,0	47,0	40,0	56856
0.3701	9,400 mm		10,0	103,0	61,0	47,0	40,0	69287
0.3740	9,500 mm		10,0	103,0	61,0	47,0	40,0	69288
0.3750	9,525 mm	3/8	10,0	103,0	61,0	47,0	40,0	56857
0.3780	9,600 mm		10,0	103,0	61,0	47,0	40,0	69289
0.3819	9,700 mm		10,0	103,0	61,0	46,0	40,0	69290
0.3858	9,800 mm		10,0	103,0	61,0	46,0	40,0	69291
0.3898	9,900 mm		10,0	103,0	61,0	46,0	40,0	69292
0.3906	9,921 mm	25/64	10,0	103,0	61,0	46,0	40,0	56858
0.3937	10,000 mm		10,0	103,0	61,0	46,0	40,0	69293
0.3976	10,100 mm		12,0	118,0	71,0	56,0	45,0	69294
0.4016	10,200 mm		12,0	118,0	71,0	56,0	45,0	69295
0.4055	10,300 mm		12,0	118,0	71,0	56,0	45,0	69296
0.4062	10,317 mm	13/32	12,0	118,0	71,0	56,0	45,0	56859
0.4095	10,400 mm		12,0	118,0	71,0	55,0	45,0	69297
0.4134	10,500 mm		12,0	118,0	71,0	55,0	45,0	69298
0.4173	10,600 mm		12,0	118,0	71,0	55,0	45,0	69299
0.4213	10,700 mm		12,0	118,0	71,0	55,0	45,0	69300
0.4219	10,716 mm	27/64	12,0	118,0	71,0	55,0	45,0	56860
0.4252	10,800 mm		12,0	118,0	71,0	55,0	45,0	69301
0.4291	10,900 mm		12,0	118,0	71,0	55,0	45,0	69302
0.4331	11,000 mm		12,0	118,0	71,0	54,0	45,0	69303
0.4370	11,100 mm		12,0	118,0	71,0	54,0	45,0	69304
0.4375	11,113 mm	7/16	12,0	118,0	71,0	54,0	45,0	56861
0.4409	11,200 mm		12,0	118,0	71,0	54,0	45,0	69305
0.4449	11,300 mm		12,0	118,0	71,0	54,0	45,0	69306
0.4488	11,400 mm		12,0	118,0	71,0	54,0	45,0	69307
0.4528	11,500 mm		12,0	118,0	71,0	54,0	45,0	69308
0.4567	11,600 mm		12,0	118,0	71,0	54,0	45,0	69309
0.4606	11,700 mm		12,0	118,0	71,0	53,0	45,0	69310
0.4646	11,800 mm		12,0	118,0	71,0	53,0	45,0	69311
0.4685	11,900 mm		12,0	118,0	71,0	53,0	45,0	69312

TOLERANCES (inch)

- ≤.1181 DIAMETER
DC = +.00008/+0.00047
DCON = h₆
- >.1181-.2362 DIAMETER
DC = +.00016/+0.00063
DCON = h₆
- >.2362-.3937 DIAMETER
DC = +.00024/+0.00083
DCON = h₆
- >.3937-.7087 DIAMETER
DC = +.00028/+0.00098
DCON = h₆
- >.7087-1.1811 DIAMETER
DC = +.00031/+0.00114
DCON = h₆

TOLERANCES (mm)

- ≤3 DIAMETER
DC = +0,002/+0,012
DCON = h₆
- >3-6 DIAMETER
DC = +0,004/+0,016
DCON = h₆
- >6-10 DIAMETER
DC = +0,006/+0,021
DCON = h₆
- >10-18 DIAMETER
DC = +0,007/+0,025
DCON = h₆
- >18-30 DIAMETER
DC = +0,008/+0,029
DCON = h₆

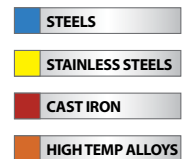

For patent information visit www.ksptpatents.com

continued on next page

143M-S 5xD
FRACTIONAL & METRIC SERIES

DECIMAL DC	METRIC DC	inch & mm						EDP NO.
		FRACTIONAL/ LETTER/WIRE DC	SHANK DIAMETER DCON	OVERALL LENGTH OAL	FLUTE LENGTH LCF	USABLE LENGTH LU	SHANK LENGTH LS	Ti-NAMITE®-A (AITIN)
0.4688	11,908 mm	15/32	12,0	118,0	71,0	53,0	45,0	56862
0.4724	12,000 mm		12,0	118,0	71,0	53,0	45,0	69313
0.4844	12,304 mm	31/64	14,0	124,0	77,0	58,0	45,0	56863
0.4921	12,500 mm		14,0	124,0	77,0	58,0	45,0	69314
0.5000	12,700 mm	1/2	14,0	124,0	77,0	58,0	45,0	56864
0.5039	12,800 mm		14,0	124,0	77,0	58,0	45,0	69315
0.5118	13,000 mm		14,0	124,0	77,0	58,0	45,0	69316
0.5156	13,096 mm	33/64	14,0	124,0	77,0	57,0	45,0	56865
0.5315	13,500 mm		14,0	124,0	77,0	57,0	45,0	69317
0.5433	13,800 mm		14,0	124,0	77,0	56,0	45,0	69318
0.5512	14,000 mm		14,0	124,0	77,0	56,0	45,0	69319
0.5625	14,288 mm	9/16	16,0	133,0	83,0	61,0	48,0	56866
0.5709	14,500 mm		16,0	133,0	83,0	61,0	48,0	69320
0.5781	14,684 mm	37/64	16,0	133,0	83,0	61,0	48,0	56867
0.5827	14,800 mm		16,0	133,0	83,0	61,0	48,0	69321
0.5906	15,000 mm		16,0	133,0	83,0	60,0	48,0	69322
0.6102	15,500 mm		16,0	133,0	83,0	60,0	48,0	69323
0.6221	15,800 mm		16,0	133,0	83,0	59,0	48,0	69324
0.6250	15,875 mm	5/8	16,0	133,0	83,0	59,0	48,0	56868
0.6299	16,000 mm		16,0	133,0	83,0	59,0	48,0	69325
0.6562	16,667 mm	21/32	18,0	143,0	93,0	68,0	48,0	56869
0.6875	17,463 mm	11/16	18,0	143,0	93,0	67,0	48,0	56870
0.7500	19,050 mm	3/4	20,0	153,0	101,0	72,0	50,0	56871

CONTINUED

FRACTIONAL
Hi-PerCarb®

Series 143M-S Fractional	Hardness	Vc (sfm)	DC • in								
			1/8	3/16	1/4	3/8	1/2	5/8	3/4		
CARBON STEELS 1018, 1040, 1080, 1090, 10L50, 1140, 1212, 12L15, 1525, 1536	≤ 175 Bhn or ≤ 7 HRc	425	RPM	12988	8659	6494	4329	3247	2598	2165	
		(340-510)	Fr	0.0039	0.0059	0.0079	0.0118	0.0157	0.0196	0.0236	
			Feed (ipm)	51.0	51.0	51.0	51.0	51.0	51.0	51.0	
	≤ 275 Bhn or ≤ 28 HRc	380	RPM	11613	7742	5806	3871	2903	2323	1935	
		(304-456)	Fr	0.0035	0.0053	0.0071	0.0106	0.0141	0.0177	0.0212	
			Feed (ipm)	41.0	41.0	41.0	41.0	41.0	41.0	41.0	
	≤ 425 Bhn or ≤ 45 HRc	220	RPM	6723	4482	3362	2241	1681	1345	1121	
		(176-264)	Fr	0.0030	0.0045	0.0059	0.0089	0.0119	0.0149	0.0178	
			Feed (ipm)	20.0	20.0	20.0	20.0	20.0	20.0	20.0	
	P ALLOY STEELS 4140, 4150, 4320, 5120, 5150, 8630, 86L20, 50100	≤ 275 Bhn or ≤ 28 HRc	330	RPM	10085	6723	5042	3362	2521	2017	1681
			(264-396)	Fr	0.0030	0.0045	0.0059	0.0089	0.0119	0.0149	0.0178
				Feed (ipm)	30.0	30.0	30.0	30.0	30.0	30.0	30.0
≤ 375 Bhn or ≤ 40 HRc		200	RPM	6112	4075	3056	2037	1528	1222	1019	
		(160-240)	Fr	0.0025	0.0038	0.0051	0.0076	0.0101	0.0127	0.0152	
			Feed (ipm)	15.5	15.5	15.5	15.5	15.5	15.5	15.5	
≤ 425 Bhn or ≤ 45 HRc		140	RPM	4278	2852	2139	1426	1070	856	713	
		(112-168)	Fr	0.0018	0.0027	0.0036	0.0054	0.0072	0.0090	0.0108	
			Feed (ipm)	7.7	7.7	7.7	7.7	7.7	7.7	7.7	
≤ 200 Bhn or ≤ 13 HRc		145	RPM	4431	2954	2216	1477	1108	886	739	
		(116-174)	Fr	0.0026	0.0039	0.0052	0.0078	0.0104	0.0130	0.0156	
			Feed (ipm)	11.5	11.5	11.5	11.5	11.5	11.5	11.5	
≤ 375 Bhn or ≤ 40 HRc	95	RPM	2903	1935	1452	968	726	581	484		
	(76-114)	Fr	0.0012	0.0018	0.0024	0.0036	0.0048	0.0060	0.0072		
		Feed (ipm)	3.5	3.5	3.5	3.5	3.5	3.5	3.5		
M STAINLESS STEELS (FREE MACHINING) 303, 416, 420F, 430F, 440F	≤ 185 Bhn or ≤ 9 HRc	325	RPM	9932	6621	4966	3311	2483	1986	1655	
		(260-390)	Fr	0.0030	0.0045	0.0060	0.0091	0.0121	0.0151	0.0181	
			Feed (ipm)	30.0	30.0	30.0	30.0	30.0	30.0	30.0	
	≤ 275 Bhn or ≤ 28 HRc	210	RPM	6418	4278	3209	2139	1604	1284	1070	
		(168-252)	Fr	0.0023	0.0035	0.0047	0.0070	0.0093	0.0117	0.0140	
			Feed (ipm)	15.0	15.0	15.0	15.0	15.0	15.0	15.0	
	≤ 275 Bhn or ≤ 28 HRc	160	RPM	4890	3260	2445	1630	1222	978	815	
		(128-192)	Fr	0.0023	0.0035	0.0047	0.0070	0.0093	0.0117	0.0140	
			Feed (ipm)	11.4	11.4	11.4	11.4	11.4	11.4	11.4	
	≤ 375 Bhn or ≤ 40 HRc	115	RPM	3514	2343	1757	1171	879	703	586	
		(92-138)	Fr	0.0021	0.0031	0.0042	0.0062	0.0083	0.0104	0.0125	
			Feed (ipm)	7.3	7.3	7.3	7.3	7.3	7.3	7.3	
STAINLESS STEELS (DIFFICULT) 304, 316, 321, 13-8 PH, 15-5PH, 17-4 PH, Custom 450	≤ 275 Bhn or ≤ 28 HRc	160	RPM	4890	3260	2445	1630	1222	978	815	
		(128-192)	Fr	0.0023	0.0035	0.0047	0.0070	0.0093	0.0117	0.0140	
			Feed (ipm)	11.4	11.4	11.4	11.4	11.4	11.4	11.4	
≤ 375 Bhn or ≤ 40 HRc	115	RPM	3514	2343	1757	1171	879	703	586		
	(92-138)	Fr	0.0021	0.0031	0.0042	0.0062	0.0083	0.0104	0.0125		
		Feed (ipm)	7.3	7.3	7.3	7.3	7.3	7.3	7.3		

continued on next page

Series	143M-S Fractional	Hardness	Vc (sfm)	DC • in							
				1/8	3/16	1/4	3/8	1/2	5/8	3/4	
K	CAST IRONS Gray, Malleable, Ductile	≤ 220 Bhn or ≤ 19 HRc	360	RPM	11002	7334	5501	3667	2750	2200	1834
			(288-432)	Fr	0.0045	0.0068	0.0091	0.0136	0.0182	0.0227	0.0273
				Feed (ipm)	50.0	50.0	50.0	50.0	50.0	50.0	50.0
		≤ 260 Bhn or ≤ 26 HRc	335	RPM	10238	6825	5119	3413	2559	2048	1706
			(268-402)	Fr	0.0045	0.0068	0.0091	0.0136	0.0182	0.0227	0.0273
				Feed (ipm)	46.5	46.5	46.5	46.5	46.5	46.5	46.5
S	HIGH TEMP ALLOYS (NICKEL , COBALT, IRON BASE) Inconel 601, 617, 625, Incoloy, Monel 400, Rene, Waspaloy	≤ 300 Bhn or ≤ 32 HRc	130	RPM	3973	2649	1986	1324	993	795	662
			(104-156)	Fr	0.0014	0.0022	0.0029	0.0043	0.0057	0.0072	0.0086
				Feed (ipm)	5.7	5.7	5.7	5.7	5.7	5.7	5.7
		≤ 400 Bhn or ≤ 43 HRc	70	RPM	2139	1426	1070	713	535	428	357
			(56-84)	Fr	0.0012	0.0018	0.0024	0.0036	0.0049	0.0061	0.0073
				Feed (ipm)	2.6	2.6	2.6	2.6	2.6	2.6	2.6
S	TITANIUM ALLOYS Pure Titanium, Ti6Al4V, Ti6Al2Sn4Zr2Mo, Ti4Al4Mo2Sn0.5Si, Ti-6Al4V	≤ 275 Bhn or ≤ 28 HRc	215	RPM	6570	4380	3285	2190	1643	1314	1095
			(172-258)	Fr	0.0018	0.0026	0.0035	0.0053	0.0070	0.0088	0.0105
				Feed (ipm)	11.5	11.5	11.5	11.5	11.5	11.5	11.5
		≤ 350 Bhn or ≤ 38 HRc	160	RPM	4890	3260	2445	1630	1222	978	815
			(128-192)	Fr	0.0016	0.0024	0.0032	0.0048	0.0064	0.0080	0.0096
				Feed (ipm)	7.8	7.8	7.8	7.8	7.8	7.8	7.8
≤ 440 Bhn or ≤ 47 HRc	85	RPM	2598	1732	1299	866	649	520	433		
	(68-102)	Fr	0.0012	0.0018	0.0024	0.0036	0.0048	0.0060	0.0072		
		Feed (ipm)	3.1	3.1	3.1	3.1	3.1	3.1	3.1		

Bhn (Brinell) HRc (Rockwell C) HRb (Rockwell B)
 rpm = Vc x 3.82 / DC
 ipm = Fr x RPM
 reduce speed and feed for materials harder than listed
 refer to the SGS Tool Wizard® for complete technical information (www.kyocera-sgstool.com)

Series 143M-S Metric	Hardness	Vc (m/min)	DC • mm								
			3	6	8	10	12	14	16		
CARBON STEELS 1018, 1040, 1080, 1090, 10L50, 1140, 1212, 12L15, 1525, 1536	≤ 175 Bhn or ≤ 7 HRc	130	RPM	13733	6867	5150	4120	3433	2943	2575	
		(104-155)	Fr	0.094	0.189	0.252	0.314	0.377	0.440	0.503	
			Feed (mm/min)	1295	1295	1295	1295	1295	1295	1295	
	≤ 275 Bhn or ≤ 28 HRc	116	RPM	12279	6140	4605	3684	3070	2631	2302	
		(93-139)	Fr	0.085	0.170	0.226	0.283	0.339	0.396	0.452	
			Feed (mm/min)	1041	1041	1041	1041	1041	1041	1041	
	≤ 425 Bhn or ≤ 45 HRc	67	RPM	7109	3555	2666	2133	1777	1523	1333	
		(54-80)	Fr	0.071	0.143	0.191	0.238	0.286	0.333	0.381	
			Feed (mm/min)	508	508	508	508	508	508	508	
	ALLOY STEELS 4140, 4150, 4320, 5120, 5150, 8630, 86L20, 50100	≤ 275 Bhn or ≤ 28 HRc	101	RPM	10664	5332	3999	3199	2666	2285	1999
			(80-121)	Fr	0.071	0.143	0.191	0.238	0.286	0.333	0.381
				Feed (mm/min)	762	762	762	762	762	762	762
≤ 375 Bhn or ≤ 40 HRc		61	RPM	6463	3231	2424	1939	1616	1385	1212	
		(49-73)	Fr	0.061	0.122	0.162	0.203	0.244	0.284	0.325	
			Feed (mm/min)	394	394	394	394	394	394	394	
≤ 425 Bhn or ≤ 45 HRc		43	RPM	4524	2262	1696	1357	1131	969	848	
		(34-51)	Fr	0.043	0.086	0.115	0.144	0.173	0.202	0.231	
			Feed (mm/min)	196	196	196	196	196	196	196	
TOOL STEELS A2, D2, H13, L2, M2, P20, S7, T15, W2		≤ 200 Bhn or ≤ 13 HRc	44	RPM	4686	2343	1757	1406	1171	1004	879
			(35-53)	Fr	0.062	0.125	0.166	0.208	0.249	0.291	0.332
				Feed (mm/min)	292	292	292	292	292	292	292
	≤ 375 Bhn or ≤ 40 HRc	29	RPM	3070	1535	1151	921	767	658	576	
		(23-35)	Fr	0.029	0.058	0.077	0.097	0.116	0.135	0.154	
			Feed (mm/min)	89	89	89	89	89	89	89	
STAINLESS STEELS (FREE MACHINING) 303, 416, 420F, 430F, 440F	≤ 185 Bhn or ≤ 9 HRc	99	RPM	10502	5251	3938	3151	2626	2250	1969	
		(79-119)	Fr	0.073	0.145	0.193	0.242	0.290	0.339	0.387	
			Feed (mm/min)	762	762	762	762	762	762	762	
	≤ 275 Bhn or ≤ 28 HRc	64	RPM	6786	3393	2545	2036	1696	1454	1272	
		(51-77)	Fr	0.056	0.112	0.150	0.187	0.225	0.262	0.299	
			Feed (mm/min)	381	381	381	381	381	381	381	
STAINLESS STEELS (DIFFICULT) 304, 316, 321, 13-8 PH, 15-5PH, 17-4 PH, Custom 450	≤ 275 Bhn or ≤ 28 HRc	49	RPM	5170	2585	1939	1551	1293	1108	969	
		(39-59)	Fr	0.056	0.112	0.149	0.187	0.224	0.261	0.299	
			Feed (mm/min)	290	290	290	290	290	290	290	
	≤ 375 Bhn or ≤ 40 HRc	35	RPM	3716	1858	1394	1115	929	796	697	
		(28-42)	Fr	0.050	0.100	0.133	0.166	0.200	0.233	0.266	
			Feed (mm/min)	185	185	185	185	185	185	185	

continued on next page

Series 143M-S Metric	Hardness	Vc (m/min)	DC • mm							
			3	6	8	10	12	14	16	
K CAST IRONS Gray, Malleable, Ductile	≤ 220 Bhn or ≤ 19 HRc	110	RPM	11633	5816	4362	3490	2908	2493	2181
		(88-132)	Fr	0.109	0.218	0.291	0.364	0.437	0.509	0.582
			Feed (mm/min)	1270	1270	1270	1270	1270	1270	1270
	≤ 260 Bhn or ≤ 26 HRc	102	RPM	10825	5413	4059	3248	2706	2320	2030
		(82-123)	Fr	0.109	0.218	0.291	0.364	0.436	0.509	0.582
			Feed (mm/min)	1181	1181	1181	1181	1181	1181	1181
S HIGH TEMP ALLOYS (Nickel , Cobalt, Iron Base) Inconel 601, 617, 625, Incoloy, Monel 400, Rene, Waspaloy	≤ 300 Bhn or ≤ 32 HRc	40	RPM	4201	2100	1575	1260	1050	900	788
		(32-48)	Fr	0.034	0.069	0.092	0.115	0.138	0.161	0.184
			Feed (mm/min)	145	145	145	145	145	145	145
	≤ 400 Bhn or ≤ 43 HRc	21	RPM	2262	1131	848	679	565	485	424
		(17-26)	Fr	0.029	0.058	0.078	0.097	0.117	0.136	0.156
			Feed (mm/min)	66	66	66	66	66	66	66
TITANIUM ALLOYS Pure Titanium, Ti6Al4V, Ti6Al2Sn4Zr2Mo, Ti4Al4Mo2Sn0.5Si, Ti-6Al4V	≤ 275 Bhn or ≤ 28 HRc	66	RPM	6947	3474	2605	2084	1737	1489	1303
		(52-79)	Fr	0.042	0.084	0.112	0.140	0.168	0.196	0.224
			Feed (mm/min)	292	292	292	292	292	292	292
	≤ 350 Bhn or ≤ 38 HRc	49	RPM	5170	2585	1939	1551	1293	1108	969
		(39-59)	Fr	0.038	0.077	0.102	0.128	0.153	0.179	0.204
			Feed (mm/min)	198	198	198	198	198	198	198
≤ 440 Bhn or ≤ 47 HRc	26	RPM	2747	1373	1030	824	687	589	515	
	(21-31)	Fr	0.029	0.057	0.076	0.096	0.115	0.134	0.153	
		Feed (mm/min)	79	79	79	79	79	79	79	

Bhn (Brinell) HRc (Rockwell C) HRb (Rockwell B)

rpm = (Vc x 1000) / (DC x 3.14)

mm/min = Fr x RPM

reduce speed and feed for materials harder than listed

refer to the SGS Tool Wizard® for complete technical information (www.kyocera-sgstool.com)



141K 5xD

FRACTIONAL & METRIC SERIES

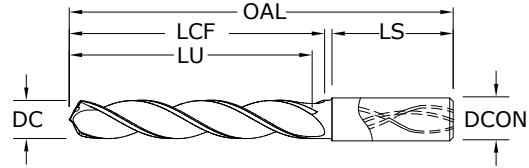

- 3-margin design improves hole stability and size control while providing superior finish, roundness and cylindricity
- Self-stabilizing pyramid point design stabilizes the drill on contact with the workpiece
- Open flute structure efficiently transports chips while maintaining strength at high feed rates
- Sculpted gash allows chips to easily flow away from the drill center
- Recommended for materials ≤ 43 HRc (≤ 400 Bhn)

inch & mm								EDP NO.
DECIMAL DC	METRIC DC	FRACTIONAL/ LETTER/WIRE DC	SHANK DIAMETER DCON	OVERALL LENGTH OAL	FLUTE LENGTH LCF	USABLE LENGTH LU	SHANK LENGTH LS	Ti-NAMITE®-M (TM)
0.1181	3,000 mm		6,0	66,0	28,0	23,0	36,0	65160
0.1220	3,100 mm		6,0	66,0	28,0	23,0	36,0	65161
0.1250	3,175 mm	1/8	6,0	66,0	28,0	23,0	36,0	55160
0.1260	3,200 mm		6,0	66,0	28,0	23,0	36,0	65162
0.1299	3,300 mm		6,0	66,0	28,0	23,0	36,0	65163
0.1339	3,400 mm		6,0	66,0	28,0	23,0	36,0	65164
0.1360	3,454 mm	#29	6,0	66,0	28,0	23,0	36,0	55161
0.1378	3,500 mm		6,0	66,0	28,0	23,0	36,0	65165
0.1406	3,571 mm	9/64	6,0	66,0	28,0	23,0	36,0	55162
0.1417	3,600 mm		6,0	66,0	28,0	23,0	36,0	65166
0.1457	3,700 mm		6,0	66,0	28,0	23,0	36,0	65167
0.1496	3,800 mm		6,0	74,0	36,0	29,0	36,0	65168
0.1535	3,900 mm		6,0	74,0	36,0	29,0	36,0	65169
0.1562	3,967 mm	5/32	6,0	74,0	36,0	29,0	36,0	55163
0.1575	4,000 mm		6,0	74,0	36,0	29,0	36,0	65170
0.1590	4,039 mm	#21	6,0	74,0	36,0	29,0	36,0	55164
0.1614	4,100 mm		6,0	74,0	36,0	29,0	36,0	65171
0.1654	4,200 mm		6,0	74,0	36,0	29,0	36,0	65172
0.1693	4,300 mm		6,0	74,0	36,0	29,0	36,0	65173
0.1719	4,366 mm	11/64	6,0	74,0	36,0	29,0	36,0	55165
0.1732	4,400 mm		6,0	74,0	36,0	29,0	36,0	65174
0.1772	4,500 mm		6,0	74,0	36,0	29,0	36,0	65175
0.1811	4,600 mm		6,0	74,0	36,0	29,0	36,0	65176
0.1850	4,699 mm	#13	6,0	74,0	36,0	29,0	36,0	65177
0.1875	4,763 mm	3/16	6,0	82,0	44,0	37,0	36,0	55166
0.1890	4,801 mm	#12	6,0	82,0	44,0	37,0	36,0	65178
0.1929	4,900 mm		6,0	82,0	44,0	37,0	36,0	65179
0.1969	5,000 mm		6,0	82,0	44,0	36,0	36,0	65180
0.2008	5,100 mm		6,0	82,0	44,0	36,0	36,0	65181
0.2031	5,159 mm	13/64	6,0	82,0	44,0	36,0	36,0	55167
0.2047	5,200 mm		6,0	82,0	44,0	36,0	36,0	65182
0.2087	5,300 mm		6,0	82,0	44,0	36,0	36,0	65183
0.2126	5,400 mm		6,0	82,0	44,0	36,0	36,0	65184
0.2165	5,500 mm		6,0	82,0	44,0	36,0	36,0	65185
0.2188	5,558 mm	7/32	6,0	82,0	44,0	36,0	36,0	55168
0.2205	5,600 mm		6,0	82,0	44,0	36,0	36,0	65186

TOLERANCES (inch)

- ≤.1181 DIAMETER**
DC = +.00008/+0.00047
DCON = h₆
- >.1181-.2362 DIAMETER**
DC = +.00016/+0.00063
DCON = h₆
- >.2362-.3937 DIAMETER**
DC = +.00024/+0.00083
DCON = h₆
- >.3937-.7087 DIAMETER**
DC = +.00028/+0.00098
DCON = h₆
- >.7087-1.1811 DIAMETER**
DC = +.00031/+0.00114
DCON = h₆

TOLERANCES (mm)

- ≤3 DIAMETER**
DC = +0,002/+0,012
DCON = h₆
- >3-6 DIAMETER**
DC = +0,004/+0,016
DCON = h₆
- >6-10 DIAMETER**
DC = +0,006/+0,021
DCON = h₆
- >10-18 DIAMETER**
DC = +0,007/+0,025
DCON = h₆

CAST IRON

For patent information visit www.ksptpatents.com

continued on next page



141K 5xD

FRACTIONAL & METRIC SERIES

DECIMAL DC	METRIC DC	inch & mm						EDP NO.
		FRACTIONAL/ LETTER/WIRE DC	SHANK DIAMETER DCON	OVERALL LENGTH OAL	FLUTE LENGTH LCF	USABLE LENGTH LU	SHANK LENGTH LS	Ti-NAMITE™-M (TM)
0.2244	5,700 mm		6,0	82,0	44,0	35,0	36,0	65187
0.2283	5,800 mm		6,0	82,0	44,0	35,0	36,0	65188
0.2323	5,900 mm		6,0	82,0	44,0	35,0	36,0	65189
0.2344	5,954 mm	15/64	6,0	82,0	44,0	35,0	36,0	55169
0.2362	6,000 mm		6,0	82,0	44,0	35,0	36,0	65190
0.2402	6,100 mm		8,0	91,0	53,0	44,0	36,0	65191
0.2441	6,200 mm		8,0	91,0	53,0	44,0	36,0	65192
0.2480	6,300 mm		8,0	91,0	53,0	44,0	36,0	65193
0.2500	6,350 mm	1/4 E #0	8,0	91,0	53,0	43,0	36,0	55170
0.2520	6,400 mm		8,0	91,0	53,0	43,0	36,0	65194
0.2559	6,500 mm		8,0	91,0	53,0	43,0	36,0	65195
0.2570	6,528 mm	F	8,0	91,0	53,0	43,0	36,0	55171
0.2598	6,600 mm		8,0	91,0	53,0	43,0	36,0	65196
0.2638	6,700 mm		8,0	91,0	53,0	43,0	36,0	65197
0.2656	6,746 mm	17/64	8,0	91,0	53,0	43,0	36,0	55172
0.2677	6,800 mm		8,0	91,0	53,0	43,0	36,0	65198
0.2717	6,900 mm		8,0	91,0	53,0	43,0	36,0	65199
0.2756	7,000 mm		8,0	91,0	53,0	42,0	36,0	65200
0.2795	7,100 mm		8,0	91,0	53,0	42,0	36,0	65201
0.2812	7,142 mm	9/32	8,0	91,0	53,0	42,0	36,0	55173
0.2835	7,200 mm		8,0	91,0	53,0	42,0	36,0	65202
0.2874	7,300 mm		8,0	91,0	53,0	42,0	36,0	65203
0.2913	7,400 mm		8,0	91,0	53,0	42,0	36,0	65204
0.2953	7,500 mm		8,0	91,0	53,0	42,0	36,0	65205
0.2969	7,541 mm	19/64	8,0	91,0	53,0	42,0	36,0	55174
0.2992	7,600 mm		8,0	91,0	53,0	42,0	36,0	65206
0.3031	7,700 mm		8,0	91,0	53,0	41,0	36,0	65207
0.3071	7,800 mm		8,0	91,0	53,0	41,0	36,0	65208
0.3110	7,900 mm		8,0	91,0	53,0	41,0	36,0	65209
0.3125	7,938 mm	5/16	8,0	91,0	53,0	41,0	36,0	55175
0.3150	8,000 mm		8,0	91,0	53,0	41,0	36,0	65210
0.3189	8,100 mm		10,0	103,0	61,0	49,0	40,0	65211
0.3228	8,200 mm		10,0	103,0	61,0	49,0	40,0	65212
0.3268	8,300 mm		10,0	103,0	61,0	49,0	40,0	65213
0.3281	8,334 mm	21/64	10,0	103,0	61,0	48,0	40,0	55176
0.3307	8,400 mm		10,0	103,0	61,0	48,0	40,0	65214
0.3320	8,433 mm	Q	10,0	103,0	61,0	48,0	40,0	55177
0.3346	8,500 mm		10,0	103,0	61,0	48,0	40,0	65215
0.3386	8,600 mm		10,0	103,0	61,0	48,0	40,0	65216
0.3425	8,700 mm		10,0	103,0	61,0	48,0	40,0	65217
0.3438	8,733 mm	11/32	10,0	103,0	61,0	48,0	40,0	55178
0.3465	8,800 mm		10,0	103,0	61,0	48,0	40,0	65218
0.3504	8,900 mm		10,0	103,0	61,0	48,0	40,0	65219
0.3543	9,000 mm		10,0	103,0	61,0	48,0	40,0	65220
0.3583	9,100 mm		10,0	103,0	61,0	47,0	40,0	65221
0.3594	9,129 mm	23/64	10,0	103,0	61,0	47,0	40,0	55179

CONTINUED

continued on next page



141K 5xD

FRACTIONAL & METRIC SERIES

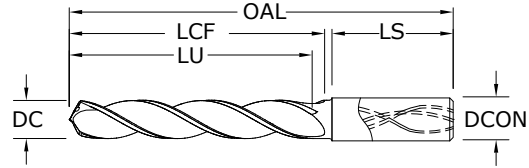

- 3-margin design improves hole stability and size control while providing superior finish, roundness and cylindricity
- Self-stabilizing pyramid point design stabilizes the drill on contact with the workpiece
- Open flute structure efficiently transports chips while maintaining strength at high feed rates
- Sculpted gash allows chips to easily flow away from the drill center
- Recommended for materials ≤ 43 HRc (≤ 400 Bhn)

inch & mm									EDP NO.
DECIMAL DC	METRIC DC	FRACTIONAL/ LETTER/WIRE DC	SHANK DIAMETER DCON	OVERALL LENGTH OAL	FLUTE LENGTH LCF	USABLE LENGTH LU	SHANK LENGTH LS	Ti-NAMITE®-M (TM)	
0.3622	9,200 mm		10,0	103,0	61,0	47,0	40,0	65222	
0.3661	9,300 mm		10,0	103,0	61,0	47,0	40,0	65223	
0.3680	9,347 mm	U	10,0	103,0	61,0	47,0	40,0	55180	
0.3701	9,400 mm		10,0	103,0	61,0	47,0	40,0	65224	
0.3740	9,500 mm		10,0	103,0	61,0	47,0	40,0	65225	
0.3750	9,525 mm	3/8	10,0	103,0	61,0	47,0	40,0	55181	
0.3780	9,600 mm		10,0	103,0	61,0	47,0	40,0	65226	
0.3819	9,700 mm		10,0	103,0	61,0	46,0	40,0	65227	
0.3858	9,800 mm		10,0	103,0	61,0	46,0	40,0	65228	
0.3898	9,900 mm		10,0	103,0	61,0	46,0	40,0	65229	
0.3906	9,921 mm	25/64	10,0	103,0	61,0	46,0	40,0	55182	
0.3937	10,000 mm		10,0	103,0	61,0	46,0	40,0	65230	
0.3976	10,100 mm		12,0	118,0	71,0	56,0	45,0	65231	
0.4016	10,200 mm		12,0	118,0	71,0	56,0	45,0	65232	
0.4055	10,300 mm		12,0	118,0	71,0	56,0	45,0	65233	
0.4062	10,317 mm	13/32	12,0	118,0	71,0	56,0	45,0	55183	
0.4095	10,400 mm		12,0	118,0	71,0	55,0	45,0	65234	
0.4134	10,500 mm		12,0	118,0	71,0	55,0	45,0	65235	
0.4173	10,600 mm		12,0	118,0	71,0	55,0	45,0	65236	
0.4213	10,700 mm		12,0	118,0	71,0	55,0	45,0	65237	
0.4219	10,716 mm	27/64	12,0	118,0	71,0	55,0	45,0	55184	
0.4252	10,800 mm		12,0	118,0	71,0	55,0	45,0	65238	
0.4291	10,900 mm		12,0	118,0	71,0	55,0	45,0	65239	
0.4331	11,000 mm		12,0	118,0	71,0	54,0	45,0	65240	
0.4370	11,100 mm		12,0	118,0	71,0	54,0	45,0	65241	
0.4375	11,113 mm	7/16	12,0	118,0	71,0	54,0	45,0	55185	
0.4409	11,200 mm		12,0	118,0	71,0	54,0	45,0	65242	
0.4449	11,300 mm		12,0	118,0	71,0	54,0	45,0	65243	
0.4488	11,400 mm		12,0	118,0	71,0	54,0	45,0	65244	
0.4528	11,500 mm		12,0	118,0	71,0	54,0	45,0	65245	
0.4567	11,600 mm		12,0	118,0	71,0	54,0	45,0	65246	
0.4606	11,700 mm		12,0	118,0	71,0	53,0	45,0	65247	
0.4646	11,800 mm		12,0	118,0	71,0	53,0	45,0	65248	
0.4685	11,900 mm		12,0	118,0	71,0	53,0	45,0	65249	
0.4688	11,908 mm	15/32	12,0	118,0	71,0	53,0	45,0	55186	
0.4724	12,000 mm		12,0	118,0	71,0	53,0	45,0	65250	

TOLERANCES (inch)

- ≤.1181 DIAMETER**
DC = +.00008/+0.00047
DCON = h_6
- >.1181-.2362 DIAMETER**
DC = +.00016/+0.00063
DCON = h_6
- >.2362-.3937 DIAMETER**
DC = +.00028/+0.00083
DCON = h_6
- >.3937-.7087 DIAMETER**
DC = +.00028/+0.00098
DCON = h_6
- >.7087-1.1811 DIAMETER**
DC = +.00031/+0.00114
DCON = h_6

TOLERANCES (mm)

- ≤3 DIAMETER**
DC = +0,002/+0,012
DCON = h_6
- >3-6 DIAMETER**
DC = +0,004/+0,016
DCON = h_6
- >6-10 DIAMETER**
DC = +0,006/+0,021
DCON = h_6
- >10-18 DIAMETER**
DC = +0,007/+0,025
DCON = h_6

CAST IRON

For patent information visit www.ksptpatents.com

continued on next page



141K 5xD

FRACTIONAL & METRIC SERIES

DECIMAL DC	METRIC DC	inch & mm						EDP NO.	
		FRACTIONAL/ LETTER/WIRE DC	SHANK DIAMETER DCON	OVERALL LENGTH OAL	FLUTE LENGTH LCF	USABLE LENGTH LU	SHANK LENGTH LS	Ti-NAMITE®-M (TM)	
0.4844	12,304 mm	31/64	14,0	124,0	77,0	58,0	45,0	55187	
0.4921	12,500 mm		14,0	124,0	77,0	58,0	45,0	65251	
0.5000	12,700 mm	1/2	14,0	124,0	77,0	58,0	45,0	55188	
0.5039	12,800 mm		14,0	124,0	77,0	58,0	45,0	65252	
0.5118	13,000 mm		14,0	124,0	77,0	58,0	45,0	65253	
0.5156	13,096 mm	33/64	14,0	124,0	77,0	57,0	45,0	55189	
0.5315	13,500 mm		14,0	124,0	77,0	57,0	45,0	65254	
0.5433	13,800 mm		14,0	124,0	77,0	56,0	45,0	65255	
0.5512	14,000 mm		14,0	124,0	77,0	56,0	45,0	65256	
0.5625	14,288 mm	9/16	16,0	133,0	83,0	61,0	48,0	55190	
0.5709	14,500 mm		16,0	133,0	83,0	61,0	48,0	65257	
0.5781	14,684 mm	37/64	16,0	133,0	83,0	61,0	48,0	55191	
0.5827	14,800 mm		16,0	133,0	83,0	61,0	48,0	65258	
0.5906	15,000 mm		16,0	133,0	83,0	60,0	48,0	65259	
0.6102	15,500 mm		16,0	133,0	83,0	60,0	48,0	65260	
0.6221	15,800 mm		16,0	133,0	83,0	59,0	48,0	65261	
0.6250	15,875 mm	5/8	16,0	133,0	83,0	59,0	48,0	55192	
0.6299	16,000 mm		16,0	133,0	83,0	59,0	48,0	65262	
0.6562	16,667 mm	21/32	18,0	143,0	93,0	68,0	48,0	55193	
0.6875	17,463 mm	11/16	18,0	143,0	93,0	67,0	48,0	55194	
0.7500	19,050 mm	3/4	20,0	153,0	101,0	72,0	50,0	55195	

CONTINUED

Hi-PerCarb®

Series 141K 5D Fractional	Hardness	Vc (sfm)	DC • in							
			1/8	3/16	1/4	3/8	1/2	5/8	3/4	
GRAY CAST IRON FERRITIC ASTM A48: CLASS 20 SAE J431C: GRADE 1800	≤ 150 Bhn or ≤ 1 HRc	450 (360-540)	RPM	13752	9168	6876	4584	3438	2750	2292
			Fr	0.0049	0.0074	0.0099	0.0148	0.0198	0.0247	0.0297
			Feed (ipm)	68	68	68	68	68	68	68
GRAY CAST IRON PEARLITIC ASTM A48: CLASS 30, 35, 40 SAE J431C: GRADE 3000	≤ 220 Bhn or ≤ 19 HRc	375 (300-450)	RPM	11460	7640	5730	3820	2865	2292	1910
			Fr	0.0039	0.0059	0.0079	0.0118	0.0157	0.0196	0.0236
			Feed (ipm)	45	45	45	45	45	45	45
COMPACTED GRAPHITE IRON	≤ 250 Bhn or ≤ 25 HRc	325 (260-390)	RPM	9932	6621	4966	3311	2483	1986	1655
			Fr	0.0039	0.0059	0.0079	0.0118	0.0157	0.0196	0.0236
			Feed (ipm)	39	39	39	39	39	39	39
MALLEABLE CAST IRON FERRITIC ASTM A220: GRADE 40010 SAE J158: GRADE M4504	≤ 160 Bhn or ≤ 3 HRc	450 (360-540)	RPM	13752	9168	6876	4584	3438	2750	2292
			Fr	0.0049	0.0074	0.0099	0.0148	0.0198	0.0247	0.0297
			Feed (ipm)	68	68	68	68	68	68	68
MALLEABLE CAST IRON MARTENSITE ASTM A220: GRADE 90001 SAE J158: GRADE M8501	≤ 320 Bhn or ≤ 34 HRc	250 (200-300)	RPM	7640	5093	3820	2547	1910	1528	1273
			Fr	0.0031	0.0047	0.0063	0.0094	0.0126	0.0157	0.0188
			Feed (ipm)	24	24	24	24	24	24	24

Bhn (Brinell) HRc (Rockwell C)
 rpm = Vc x 3.82 / DC
 ipm = Fr x rpm
 reduce speed and feed for materials harder than listed
 refer to the SGS Tool Wizard® for complete technical information (www.kyocera-sgstool.com)

METRIC

Hi-PerCarb®

Series 141K 5D Metric	Hardness	Vc (m/min)	DC • mm							
			3	6	8	10	12	14	16	
GRAY CAST IRON FERRITIC ASTM A48: CLASS 20 SAE J431C: GRADE 1800	≤ 150 Bhn or ≤ 1 HRc	137 (110-165)	RPM	14541	7271	5453	4362	3635	3116	2726
			Fr	0.119	0.237	0.316	0.395	0.475	0.554	0.633
			Feed (mm/min)	1725	1725	1725	1725	1725	1725	1725
GRAY CAST IRON PEARLITIC ASTM A48: CLASS 30, 35, 40 SAE J431C: GRADE 3000	≤ 220 Bhn or ≤ 19 HRc	114 (91-137)	RPM	12118	6059	4544	3635	3029	2597	2272
			Fr	0.094	0.189	0.252	0.315	0.378	0.441	0.504
			Feed (mm/min)	1145	1145	1145	1145	1145	1145	1145
COMPACTED GRAPHITE IRON	≤ 250 Bhn or ≤ 25 HRc	99 (79-119)	RPM	10502	5251	3938	3151	2626	2250	1969
			Fr	0.094	0.189	0.251	0.314	0.377	0.440	0.503
			Feed (mm/min)	990	990	990	990	990	990	990
MALLEABLE CAST IRON FERRITIC ASTM A220: GRADE 40010 SAE J158: GRADE M4504	≤ 160 Bhn or ≤ 3 HRc	137 (110-165)	RPM	14541	7271	5453	4362	3635	3116	2726
			Fr	0.119	0.237	0.316	0.395	0.475	0.554	0.633
			Feed (mm/min)	1725	1725	1725	1725	1725	1725	1725
MALLEABLE CAST IRON MARTENSITE ASTM A220: GRADE 90001 SAE J158: GRADE M8501	≤ 320 Bhn or ≤ 34 HRc	76 (61-91)	RPM	8078	4039	3029	2424	2020	1731	1515
			Fr	0.076	0.151	0.201	0.252	0.302	0.352	0.403
			Feed (mm/min)	610	610	610	610	610	610	610

(Brinell) HRc (Rockwell C)
 rpm = (Vc x 1000) / (DC x 3.14)
 mm/min = Fr x rpm
 reduce speed and feed for materials harder than listed
 refer to the SGS Tool Wizard® for complete technical information (www.kyocera-sgstool.com)

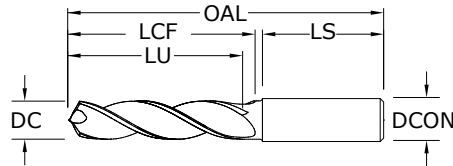

131N 3xD
FRACTIONAL & METRIC SERIES

TOLERANCES (inch)

≤.1181 DIAMETER

DC = +.00008/+0.00047

DCON = h₆

>.1181-.2362 DIAMETER

DC = +.00016/+0.00063

DCON = h₆

>.2362-.3937 DIAMETER

DC = +.00024/+0.00083

DCON = h₆

>.3937-.7087 DIAMETER

DC = +.00028/+0.00098

DCON = h₆

>.7087-1.1811 DIAMETER

DC = +.00031/+0.00114

DCON = h₆

TOLERANCES (mm)

≤3 DIAMETER

DC = +0,002/+0,012

DCON = h₆

>3-6 DIAMETER

DC = +0,004/+0,016

DCON = h₆

>6-10 DIAMETER

DC = +0,006/+0,021

DCON = h₆

>10-18 DIAMETER

DC = +0,007/+0,025

DCON = h₆

NON-FERROUS

For patent information visit
www.ksptpatents.com

		inch & mm						EDP NO.	
DECIMAL DC	METRIC DC	FRACTIONAL/ LETTER/WIRE DC	SHANK DIAMETER DCON	OVERALL LENGTH OAL	FLUTE LENGTH LCF	USABLE LENGTH LU	SHANK LENGTH LS	UNCOATED	Ti-NAMITE®-B (TiB ₂)
0.1181	3,000 mm		6,0	62,0	20,0	15,0	36,0	64600	67600
0.1220	3,100 mm		6,0	62,0	20,0	15,0	36,0	64601	67601
0.1250	3,175 mm	1/8	6,0	62,0	20,0	15,0	36,0	54600	54700
0.1260	3,200 mm		6,0	62,0	20,0	15,0	36,0	64602	67602
0.1299	3,300 mm		6,0	62,0	20,0	15,0	36,0	64603	67603
0.1339	3,400 mm		6,0	62,0	20,0	15,0	36,0	64604	67604
0.1360	3,454 mm	#29	6,0	62,0	20,0	15,0	36,0	54601	54701
0.1378	3,500 mm		6,0	62,0	20,0	15,0	36,0	64605	67605
0.1406	3,571 mm	9/64	6,0	62,0	20,0	15,0	36,0	54602	54702
0.1417	3,600 mm		6,0	62,0	20,0	15,0	36,0	64606	67606
0.1457	3,700 mm		6,0	62,0	20,0	15,0	36,0	64607	67607
0.1496	3,800 mm		6,0	66,0	24,0	18,0	36,0	64608	67608
0.1535	3,900 mm		6,0	66,0	24,0	18,0	36,0	64609	67609
0.1562	3,967 mm	5/32	6,0	66,0	24,0	18,0	36,0	54603	54703
0.1575	4,000 mm		6,0	66,0	24,0	18,0	36,0	64610	67610
0.1590	4,039 mm	#21	6,0	66,0	24,0	18,0	36,0	54604	54704
0.1614	4,100 mm		6,0	66,0	24,0	18,0	36,0	64611	67611
0.1654	4,200 mm		6,0	66,0	24,0	18,0	36,0	64612	67612
0.1693	4,300 mm		6,0	66,0	24,0	18,0	36,0	64613	67613
0.1719	4,366 mm	11/64	6,0	66,0	24,0	17,0	36,0	54605	54705
0.1732	4,400 mm		6,0	66,0	24,0	17,0	36,0	64614	67614
0.1772	4,500 mm		6,0	66,0	24,0	17,0	36,0	64615	67615
0.1811	4,600 mm		6,0	66,0	24,0	17,0	36,0	64616	67616
0.1850	4,699 mm	#13	6,0	66,0	24,0	17,0	36,0	64617	67617
0.1875	4,763 mm	3/16	6,0	66,0	28,0	21,0	36,0	54606	54706
0.1890	4,801 mm	#12	6,0	66,0	28,0	21,0	36,0	64618	67618
0.1929	4,900 mm		6,0	66,0	28,0	21,0	36,0	64619	67619
0.1969	5,000 mm		6,0	66,0	28,0	20,0	36,0	64620	67620
0.2008	5,100 mm		6,0	66,0	28,0	20,0	36,0	64621	67621
0.2031	5,159 mm	13/64	6,0	66,0	28,0	20,0	36,0	54607	54707
0.2047	5,200 mm		6,0	66,0	28,0	20,0	36,0	64622	67622
0.2087	5,300 mm		6,0	66,0	28,0	20,0	36,0	64623	67623
0.2126	5,400 mm		6,0	66,0	28,0	20,0	36,0	64624	67624
0.2165	5,500 mm		6,0	66,0	28,0	20,0	36,0	64625	67625
0.2188	5,558 mm	7/32	6,0	66,0	28,0	20,0	36,0	54608	54708
0.2205	5,600 mm		6,0	66,0	28,0	20,0	36,0	64626	67626

- 3-margin design improves hole stability and size control while providing superior finish, roundness and cylindricity
- Self-stabilizing pyramid point design stabilizes the drill on contact with the workpiece
- Open flute structure efficiently transports chips while maintaining strength at high feed rates
- Sculpted gash allows chips to easily flow away from the drill center
- Recommended for materials ≤ 175 Bhn (≤ 16 HRC)

continued on next page



131N 3xD
 FRACTIONAL & METRIC SERIES

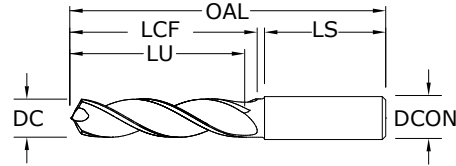

- 3-margin design improves hole stability and size control while providing superior finish, roundness and cylindricity
- Self-stabilizing pyramid point design stabilizes the drill on contact with the workpiece
- Open flute structure efficiently transports chips while maintaining strength at high feed rates
- Sculpted gash allows chips to easily flow away from the drill center
- Recommended for materials ≤ 175 Bhn (≤ 16 HRc)

DECIMAL DC	METRIC DC	inch & mm						EDP NO.	
		FRACTIONAL/ LETTER/WIRE DC	SHANK DIAMETER DCON	OVERALL LENGTH OAL	FLUTE LENGTH LCF	USABLE LENGTH LU	SHANK LENGTH LS	UNCOATED	Ti-NAMITE®-B (TiB ₂)
0.2244	5,700 mm		6,0	66,0	28,0	19,0	36,0	64627	67627
0.2283	5,800 mm		6,0	66,0	28,0	19,0	36,0	64628	67628
0.2323	5,900 mm		6,0	66,0	28,0	19,0	36,0	64629	67629
0.2344	5,954 mm	15/64	6,0	66,0	28,0	19,0	36,0	54609	54709
0.2362	6,000 mm		6,0	66,0	28,0	19,0	36,0	64630	67630
0.2402	6,100 mm		8,0	79,0	34,0	25,0	36,0	64631	67631
0.2441	6,200 mm		8,0	79,0	34,0	25,0	36,0	64632	67632
0.2480	6,300 mm		8,0	79,0	34,0	25,0	36,0	64633	67633
0.2500	6,350 mm	1/4 E #0	8,0	79,0	34,0	24,0	36,0	54610	54710
0.2520	6,400 mm		8,0	79,0	34,0	24,0	36,0	64634	67634
0.2559	6,500 mm		8,0	79,0	34,0	24,0	36,0	64635	67635
0.2570	6,528 mm	F	8,0	79,0	34,0	24,0	36,0	54611	54711
0.2598	6,600 mm		8,0	79,0	34,0	24,0	36,0	64636	67636
0.2638	6,700 mm		8,0	79,0	34,0	24,0	36,0	64637	67637
0.2656	6,746 mm	17/64	8,0	79,0	34,0	24,0	36,0	54612	54712
0.2677	6,800 mm		8,0	79,0	34,0	24,0	36,0	64638	67638
0.2717	6,900 mm		8,0	79,0	34,0	24,0	36,0	64639	67639
0.2756	7,000 mm		8,0	79,0	34,0	24,0	36,0	64640	67640
0.2795	7,100 mm		8,0	79,0	41,0	30,0	36,0	64641	67641
0.2812	7,142 mm	9/32	8,0	79,0	41,0	30,0	36,0	54613	54713
0.2835	7,200 mm		8,0	79,0	41,0	30,0	36,0	64642	67642
0.2874	7,300 mm		8,0	79,0	41,0	30,0	36,0	64643	67643
0.2913	7,400 mm		8,0	79,0	41,0	30,0	36,0	64644	67644
0.2953	7,500 mm		8,0	79,0	41,0	30,0	36,0	64645	67645
0.2969	7,541 mm	19/64	8,0	79,0	41,0	30,0	36,0	54614	54714
0.2992	7,600 mm		8,0	79,0	41,0	30,0	36,0	64646	67646
0.3031	7,700 mm		8,0	79,0	41,0	29,0	36,0	64647	67647
0.3071	7,800 mm		8,0	79,0	41,0	29,0	36,0	64648	67648
0.3110	7,900 mm		8,0	79,0	41,0	29,0	36,0	64649	67649
0.3125	7,938 mm	5/16	8,0	79,0	41,0	29,0	36,0	54615	54715
0.3150	8,000 mm		8,0	79,0	41,0	29,0	36,0	64650	67650
0.3189	8,100 mm		10,0	89,0	47,0	35,0	40,0	64651	67651
0.3228	8,200 mm		10,0	89,0	47,0	35,0	40,0	64652	67652
0.3268	8,300 mm		10,0	89,0	47,0	35,0	40,0	64653	67653
0.3281	8,334 mm	21/64	10,0	89,0	47,0	34,0	40,0	54616	54716
0.3307	8,400 mm		10,0	89,0	47,0	34,0	40,0	64654	67654

TOLERANCES (inch)

- ≤.1181 DIAMETER**
 DC = +.00008/+0.00047
 DCON = h₆
- >.1181-.2362 DIAMETER**
 DC = +.00016/+0.00063
 DCON = h₆
- >.2362-.3937 DIAMETER**
 DC = +.00024/+0.00083
 DCON = h₆
- >.3937-.7087 DIAMETER**
 DC = +.00028/+0.00098
 DCON = h₆
- >.7087-1.1811 DIAMETER**
 DC = +.00031/+0.00114
 DCON = h₆

TOLERANCES (mm)

- ≤3 DIAMETER**
 DC = +0,002/+0,012
 DCON = h₆
- >3-6 DIAMETER**
 DC = +0,004/+0,016
 DCON = h₆
- >6-10 DIAMETER**
 DC = +0,006/+0,021
 DCON = h₆
- >10-18 DIAMETER**
 DC = +0,007/+0,025
 DCON = h₆

NON-FERROUS

For patent information visit www.ksptpatents.com

continued on next page



131N 3xD
FRACTIONAL & METRIC SERIES

DECIMAL DC	METRIC DC	inch & mm						EDP NO.	
		FRACTIONAL/ LETTER/WIRE DC	SHANK DIAMETER DCON	OVERALL LENGTH OAL	FLUTE LENGTH LCF	USABLE LENGTH LU	SHANK LENGTH LS	UNCOATED	Ti-NAMITE®-B (TiB ₂)
0.3320	8,433 mm	Q	10,0	89,0	47,0	34,0	40,0	54617	54717
0.3346	8,500 mm		10,0	89,0	47,0	34,0	40,0	64655	67655
0.3386	8,600 mm		10,0	89,0	47,0	34,0	40,0	64656	67656
0.3425	8,700 mm		10,0	89,0	47,0	34,0	40,0	64657	67657
0.3438	8,733 mm	11/32	10,0	89,0	47,0	34,0	40,0	54618	54718
0.3465	8,800 mm		10,0	89,0	47,0	34,0	40,0	64658	67658
0.3504	8,900 mm		10,0	89,0	47,0	34,0	40,0	64659	67659
0.3543	9,000 mm		10,0	89,0	47,0	34,0	40,0	64660	67660
0.3583	9,100 mm		10,0	89,0	47,0	33,0	40,0	64661	67661
0.3594	9,129 mm	23/64	10,0	89,0	47,0	33,0	40,0	54619	54719
0.3622	9,200 mm		10,0	89,0	47,0	33,0	40,0	64662	67662
0.3661	9,300 mm		10,0	89,0	47,0	33,0	40,0	64663	67663
0.3680	9,347 mm	U	10,0	89,0	47,0	33,0	40,0	54620	54720
0.3701	9,400 mm		10,0	89,0	47,0	33,0	40,0	64664	67664
0.3740	9,500 mm		10,0	89,0	47,0	33,0	40,0	64665	67665
0.3750	9,525 mm	3/8	10,0	89,0	47,0	33,0	40,0	54621	54721
0.3780	9,600 mm		10,0	89,0	47,0	33,0	40,0	64666	67666
0.3819	9,700 mm		10,0	89,0	47,0	32,0	40,0	64667	67667
0.3858	9,800 mm		10,0	89,0	47,0	32,0	40,0	64668	67668
0.3898	9,900 mm		10,0	89,0	47,0	32,0	40,0	64669	67669
0.3906	9,921 mm	25/64	10,0	89,0	47,0	32,0	40,0	54622	54722
0.3937	10,000 mm		10,0	89,0	47,0	32,0	40,0	64670	67670
0.3976	10,100 mm		12,0	102,0	55,0	40,0	45,0	64671	67671
0.4016	10,200 mm		12,0	102,0	55,0	40,0	45,0	64672	67672
0.4055	10,300 mm		12,0	102,0	55,0	40,0	45,0	64673	67673
0.4062	10,317 mm	13/32	12,0	102,0	55,0	40,0	45,0	54623	54723
0.4095	10,400 mm		12,0	102,0	55,0	39,0	45,0	64674	67674
0.4134	10,500 mm		12,0	102,0	55,0	39,0	45,0	64675	67675
0.4173	10,600 mm		12,0	102,0	55,0	39,0	45,0	64676	67676
0.4213	10,700 mm		12,0	102,0	55,0	39,0	45,0	64677	67677
0.4219	10,716 mm	27/64	12,0	102,0	55,0	39,0	45,0	54624	54724
0.4252	10,800 mm		12,0	102,0	55,0	39,0	45,0	64678	67678
0.4291	10,900 mm		12,0	102,0	55,0	39,0	45,0	64679	67679
0.4331	11,000 mm		12,0	102,0	55,0	39,0	45,0	64680	67680
0.4370	11,100 mm		12,0	102,0	55,0	38,0	45,0	64681	67681
0.4375	11,113 mm	7/16	12,0	102,0	55,0	38,0	45,0	54625	54725
0.4409	11,200 mm		12,0	102,0	55,0	38,0	45,0	64682	67682
0.4449	11,300 mm		12,0	102,0	55,0	38,0	45,0	64683	67683
0.4488	11,400 mm		12,0	102,0	55,0	38,0	45,0	64684	67684
0.4528	11,500 mm		12,0	102,0	55,0	38,0	45,0	64685	67685
0.4567	11,600 mm		12,0	102,0	55,0	38,0	45,0	64686	67686
0.4606	11,700 mm		12,0	102,0	55,0	37,0	45,0	64687	67687
0.4646	11,800 mm		12,0	102,0	55,0	37,0	45,0	64688	67688
0.4685	11,900 mm		12,0	102,0	55,0	37,0	45,0	64689	67689

CONTINUED

continued on next page



131N 3xD
FRACTIONAL & METRIC SERIES

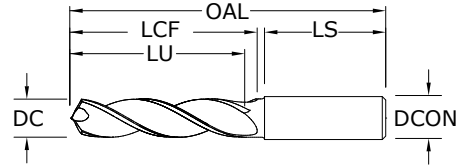

- 3-margin design improves hole stability and size control while providing superior finish, roundness and cylindricity
- Self-stabilizing pyramid point design stabilizes the drill on contact with the workpiece
- Open flute structure efficiently transports chips while maintaining strength at high feed rates
- Sculpted gash allows chips to easily flow away from the drill center
- Recommended for materials ≤ 175 Bhn (≤ 16 HRc)

DECIMAL DC	METRIC DC	inch & mm						EDP NO.	
		FRACTIONAL/ LETTER/WIRE DC	SHANK DIAMETER DCON	OVERALL LENGTH OAL	FLUTE LENGTH LCF	USABLE LENGTH LU	SHANK LENGTH LS	UNCOATED	Ti-NAMITE®-B (TiB ₂)
0.4688	11,908 mm	15/32	12,0	102,0	55,0	37,0	45,0	54626	54726
0.4724	12,000 mm		12,0	102,0	55,0	37,0	45,0	64690	67690
0.4844	12,304 mm	31/64	14,0	107,0	60,0	41,0	45,0	54627	54727
0.4921	12,500 mm		14,0	107,0	60,0	41,0	45,0	64691	67691
0.5000	12,700 mm	1/2	14,0	107,0	60,0	41,0	45,0	54628	54728
0.5039	12,800 mm		14,0	107,0	60,0	41,0	45,0	64692	67692
0.5118	13,000 mm		14,0	107,0	60,0	41,0	45,0	64693	67693
0.5156	13,096 mm	33/64	14,0	107,0	60,0	40,0	45,0	54629	54729
0.5315	13,500 mm		14,0	107,0	60,0	40,0	45,0	64694	67694
0.5433	13,800 mm		14,0	107,0	60,0	39,0	45,0	64695	67695
0.5512	14,000 mm		14,0	107,0	60,0	39,0	45,0	64696	67696
0.5625	14,288 mm	9/16	16,0	115,0	65,0	43,0	48,0	54630	54730
0.5709	14,500 mm		16,0	115,0	65,0	43,0	48,0	64697	67697
0.5781	14,684 mm	37/64	16,0	115,0	65,0	43,0	48,0	54631	54731
0.5827	14,800 mm		16,0	115,0	65,0	43,0	48,0	64698	67698
0.5906	15,000 mm		16,0	115,0	65,0	42,0	48,0	64699	67699
0.6102	15,500 mm		16,0	115,0	65,0	42,0	48,0	64700	67700
0.6221	15,800 mm		16,0	115,0	65,0	41,0	48,0	64701	67701
0.6250	15,875 mm	5/8	16,0	115,0	65,0	41,0	48,0	54632	54732
0.6299	16,000 mm		16,0	115,0	65,0	41,0	48,0	64702	67702
0.6562	16,667 mm	21/32	18,0	123,0	73,0	47,0	48,0	54633	54733
0.6875	17,463 mm	11/16	18,0	123,0	73,0	47,0	48,0	54634	54734
0.7500	19,050 mm	3/4	20,0	131,0	79,0	50,0	50,0	54635	54735

TOLERANCES (inch)

- ≤.1181 DIAMETER**
DC = +.00008/+0.00047
DCON = h₆
- >.1181-.2362 DIAMETER**
DC = +.00016/+0.00063
DCON = h₆
- >.2362-.3937 DIAMETER**
DC = +.00024/+0.00083
DCON = h₆
- >.3937-.7087 DIAMETER**
DC = +.00028/+0.00098
DCON = h₆
- >.7087-1.1811 DIAMETER**
DC = +.00031/+0.00114
DCON = h₆

TOLERANCES (mm)

- ≤3 DIAMETER**
DC = +0,002/+0,012
DCON = h₆
- >3-6 DIAMETER**
DC = +0,004/+0,016
DCON = h₆
- >6-10 DIAMETER**
DC = +0,006/+0,021
DCON = h₆
- >10-18 DIAMETER**
DC = +0,007/+0,025
DCON = h₆

NON-FERROUS

For patent information visit www.ksptpatents.com

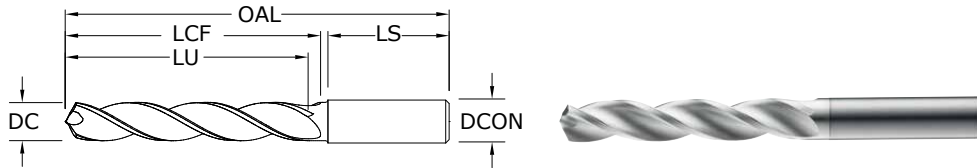

131N 5xD
FRACTIONAL & METRIC SERIES

TOLERANCES (inch)

≤.1181 DIAMETER

DC = +.00008/+0.00047

DCON = h₆

>.1181-.2362 DIAMETER

DC = +.00016/+0.00063

DCON = h₆

>.2362-.3937 DIAMETER

DC = +.00024/+0.00083

DCON = h₆

>.3937-.7087 DIAMETER

DC = +.00028/+0.00098

DCON = h₆

>.7087-1.1811 DIAMETER

DC = +.00031/+0.00114

DCON = h₆

TOLERANCES (mm)

≤3 DIAMETER

DC = +0,002/+0,012

DCON = h₆

>3-6 DIAMETER

DC = +0,004/+0,016

DCON = h₆

>6-10 DIAMETER

DC = +0,006/+0,021

DCON = h₆

>10-18 DIAMETER

DC = +0,007/+0,025

DCON = h₆

NON-FERROUS

For patent information visit
www.ksptpatents.com

		inch & mm						EDP NO.	
DECIMAL DC	METRIC DC	FRACTIONAL/ LETTER/WIRE DC	SHANK DIAMETER DCON	OVERALL LENGTH OAL	FLUTE LENGTH LCF	USABLE LENGTH LU	SHANK LENGTH LS	UNCOATED	Ti-NAMITE®-B (TiB ₂)
0.1181	3,000 mm		6,0	66,0	28,0	23,0	36,0	65000	64800
0.1220	3,100 mm		6,0	66,0	28,0	23,0	36,0	65001	64801
0.1250	3,175 mm	1/8	6,0	66,0	28,0	23,0	36,0	55000	54800
0.1260	3,200 mm		6,0	66,0	28,0	23,0	36,0	65002	64802
0.1299	3,300 mm		6,0	66,0	28,0	23,0	36,0	65003	64803
0.1339	3,400 mm		6,0	66,0	28,0	23,0	36,0	65004	64804
0.1360	3,454 mm	#29	6,0	66,0	28,0	23,0	36,0	55001	54801
0.1378	3,500 mm		6,0	66,0	28,0	23,0	36,0	65005	64805
0.1406	3,571 mm	9/64	6,0	66,0	28,0	23,0	36,0	55002	54802
0.1417	3,600 mm		6,0	66,0	28,0	23,0	36,0	65006	64806
0.1457	3,700 mm		6,0	66,0	28,0	23,0	36,0	65007	64807
0.1496	3,800 mm		6,0	74,0	36,0	29,0	36,0	65008	64808
0.1535	3,900 mm		6,0	74,0	36,0	29,0	36,0	65009	64809
0.1562	3,967 mm	5/32	6,0	74,0	36,0	29,0	36,0	55003	54803
0.1575	4,000 mm		6,0	74,0	36,0	29,0	36,0	65010	64810
0.1590	4,039 mm	#21	6,0	74,0	36,0	29,0	36,0	55004	54804
0.1614	4,100 mm		6,0	74,0	36,0	29,0	36,0	65011	64811
0.1654	4,200 mm		6,0	74,0	36,0	29,0	36,0	65012	64812
0.1693	4,300 mm		6,0	74,0	36,0	29,0	36,0	65013	64813
0.1719	4,366 mm	11/64	6,0	74,0	36,0	29,0	36,0	55005	54805
0.1732	4,400 mm		6,0	74,0	36,0	29,0	36,0	65014	64814
0.1772	4,500 mm		6,0	74,0	36,0	29,0	36,0	65015	64815
0.1811	4,600 mm		6,0	74,0	36,0	29,0	36,0	65016	64816
0.1850	4,699 mm	#13	6,0	74,0	36,0	29,0	36,0	65017	64817
0.1875	4,763 mm	3/16	6,0	82,0	44,0	37,0	36,0	55006	54806
0.1890	4,801 mm	#12	6,0	82,0	44,0	37,0	36,0	65018	64818
0.1929	4,900 mm		6,0	82,0	44,0	37,0	36,0	65019	64819
0.1969	5,000 mm		6,0	82,0	44,0	36,0	36,0	65020	64820
0.2008	5,100 mm		6,0	82,0	44,0	36,0	36,0	65021	64821
0.2031	5,159 mm	13/64	6,0	82,0	44,0	36,0	36,0	55007	54807
0.2047	5,200 mm		6,0	82,0	44,0	36,0	36,0	65022	64822
0.2087	5,300 mm		6,0	82,0	44,0	36,0	36,0	65023	64823
0.2126	5,400 mm		6,0	82,0	44,0	36,0	36,0	65024	64824
0.2165	5,500 mm		6,0	82,0	44,0	36,0	36,0	65025	64825
0.2188	5,558 mm	7/32	6,0	82,0	44,0	36,0	36,0	55008	54808
0.2205	5,600 mm		6,0	82,0	44,0	36,0	36,0	65026	64826

- 3-margin design improves hole stability and size control while providing superior finish, roundness and cylindricity
- Self-stabilizing pyramid point design stabilizes the drill on contact with the workpiece
- Open flute structure efficiently transports chips while maintaining strength at high feed rates
- Sculpted gash allows chips to easily flow away from the drill center
- Recommended for materials ≤ 175 Bhn (≤ 16 HRC)

continued on next page

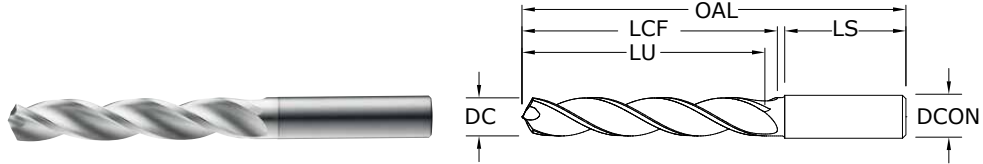

131N 5xD

FRACTIONAL & METRIC SERIES

- 3-margin design improves hole stability and size control while providing superior finish, roundness and cylindricity
- Self-stabilizing pyramid point design stabilizes the drill on contact with the workpiece
- Open flute structure efficiently transports chips while maintaining strength at high feed rates
- Sculpted gash allows chips to easily flow away from the drill center
- Recommended for materials ≤ 175 Bhn (≤ 16 HRc)

		inch & mm						EDP NO.	
DECIMAL DC	METRIC DC	FRACTIONAL/ LETTER/WIRE DC	SHANK DIAMETER DCON	OVERALL LENGTH OAL	FLUTE LENGTH LCF	USABLE LENGTH LU	SHANK LENGTH LS	UNCOATED	Ti-NAMITE®-B (TiB ₂)
0.2244	5,700 mm		6,0	82,0	44,0	35,0	36,0	65027	64827
0.2283	5,800 mm		6,0	82,0	44,0	35,0	36,0	65028	64828
0.2323	5,900 mm		6,0	82,0	44,0	35,0	36,0	65029	64829
0.2344	5,954 mm	15/64	6,0	82,0	44,0	35,0	36,0	55009	54809
0.2362	6,000 mm		6,0	82,0	44,0	35,0	36,0	65030	64830
0.2402	6,100 mm		8,0	91,0	53,0	44,0	36,0	65031	64831
0.2441	6,200 mm		8,0	91,0	53,0	44,0	36,0	65032	64832
0.2480	6,300 mm		8,0	91,0	53,0	44,0	36,0	65033	64833
0.2500	6,350 mm	1/4 E #0	8,0	91,0	53,0	43,0	36,0	55010	54810
0.2520	6,400 mm		8,0	91,0	53,0	43,0	36,0	65034	64834
0.2559	6,500 mm		8,0	91,0	53,0	43,0	36,0	65035	64835
0.2570	6,528 mm	F	8,0	91,0	53,0	43,0	36,0	55011	54811
0.2598	6,600 mm		8,0	91,0	53,0	43,0	36,0	65036	64836
0.2638	6,700 mm		8,0	91,0	53,0	43,0	36,0	65037	64837
0.2656	6,746 mm	17/64	8,0	91,0	53,0	43,0	36,0	55012	54812
0.2677	6,800 mm		8,0	91,0	53,0	43,0	36,0	65038	64838
0.2717	6,900 mm		8,0	91,0	53,0	43,0	36,0	65039	64839
0.2756	7,000 mm		8,0	91,0	53,0	42,0	36,0	65040	64840
0.2795	7,100 mm		8,0	91,0	53,0	42,0	36,0	65041	64841
0.2812	7,142 mm	9/32	8,0	91,0	53,0	42,0	36,0	55013	54813
0.2835	7,200 mm		8,0	91,0	53,0	42,0	36,0	65042	64842
0.2874	7,300 mm		8,0	91,0	53,0	42,0	36,0	65043	64843
0.2913	7,400 mm		8,0	91,0	53,0	42,0	36,0	65044	64844
0.2953	7,500 mm		8,0	91,0	53,0	42,0	36,0	65045	64845
0.2969	7,541 mm	19/64	8,0	91,0	53,0	42,0	36,0	55014	54814
0.2992	7,600 mm		8,0	91,0	53,0	42,0	36,0	65046	64846
0.3031	7,700 mm		8,0	91,0	53,0	41,0	36,0	65047	64847
0.3071	7,800 mm		8,0	91,0	53,0	41,0	36,0	65048	64848
0.3110	7,900 mm		8,0	91,0	53,0	41,0	36,0	65049	64849
0.3125	7,938 mm	5/16	8,0	91,0	53,0	41,0	36,0	55015	54815
0.3150	8,000 mm		8,0	91,0	53,0	41,0	36,0	65050	64850
0.3189	8,100 mm		10,0	103,0	61,0	49,0	40,0	65051	64851
0.3228	8,200 mm		10,0	103,0	61,0	49,0	40,0	65052	64852
0.3268	8,300 mm		10,0	103,0	61,0	49,0	40,0	65053	64853
0.3281	8,334 mm	21/64	10,0	103,0	61,0	48,0	40,0	55016	54816
0.3307	8,400 mm		10,0	103,0	61,0	48,0	40,0	65054	64854

TOLERANCES (inch)

- ≤.1181 DIAMETER**
DC = +.00008/+0.00047
DCON = h₆
- >.1181-.2362 DIAMETER**
DC = +.00016/+0.00063
DCON = h₆
- >.2362-.3937 DIAMETER**
DC = +.00024/+0.00083
DCON = h₆
- >.3937-.7087 DIAMETER**
DC = +.00028/+0.00098
DCON = h₆
- >.7087-1.1811 DIAMETER**
DC = +.00031/+0.00114
DCON = h₆

TOLERANCES (mm)

- ≤3 DIAMETER**
DC = +0,002/+0,012
DCON = h₆
- >3-6 DIAMETER**
DC = +0,004/+0,016
DCON = h₆
- >6-10 DIAMETER**
DC = +0,006/+0,021
DCON = h₆
- >10-18 DIAMETER**
DC = +0,007/+0,025
DCON = h₆

NON-FERROUS

For patent information visit www.ksptpatents.com

continued on next page



131N 5xD
FRACTIONAL & METRIC SERIES

DECIMAL DC	METRIC DC	inch & mm						EDP NO.	
		FRACTIONAL/ LETTER/WIRE DC	SHANK DIAMETER DCON	OVERALL LENGTH OAL	FLUTE LENGTH LCF	USABLE LENGTH LU	SHANK LENGTH LS	UNCOATED	Ti-NAMITE®-B (TiB ₂)
0.3320	8,433 mm	Q	10,0	103,0	61,0	48,0	40,0	55017	54817
0.3346	8,500 mm		10,0	103,0	61,0	48,0	40,0	65055	64855
0.3386	8,600 mm		10,0	103,0	61,0	48,0	40,0	65056	64856
0.3425	8,700 mm		10,0	103,0	61,0	48,0	40,0	65057	64857
0.3438	8,733 mm	11/32	10,0	103,0	61,0	48,0	40,0	55018	54818
0.3465	8,800 mm		10,0	103,0	61,0	48,0	40,0	65058	64858
0.3504	8,900 mm		10,0	103,0	61,0	48,0	40,0	65059	64859
0.3543	9,000 mm		10,0	103,0	61,0	48,0	40,0	65060	64860
0.3583	9,100 mm		10,0	103,0	61,0	47,0	40,0	65061	64861
0.3594	9,129 mm	23/64	10,0	103,0	61,0	47,0	40,0	55019	54819
0.3622	9,200 mm		10,0	103,0	61,0	47,0	40,0	65062	64862
0.3661	9,300 mm		10,0	103,0	61,0	47,0	40,0	65063	64863
0.3680	9,347 mm	U	10,0	103,0	61,0	47,0	40,0	55020	54820
0.3701	9,400 mm		10,0	103,0	61,0	47,0	40,0	65064	64864
0.3740	9,500 mm		10,0	103,0	61,0	47,0	40,0	65065	64865
0.3750	9,525 mm	3/8	10,0	103,0	61,0	47,0	40,0	55021	54821
0.3780	9,600 mm		10,0	103,0	61,0	47,0	40,0	65066	64866
0.3819	9,700 mm		10,0	103,0	61,0	46,0	40,0	65067	64867
0.3858	9,800 mm		10,0	103,0	61,0	46,0	40,0	65068	64868
0.3898	9,900 mm		10,0	103,0	61,0	46,0	40,0	65069	64869
0.3906	9,921 mm	25/64	10,0	103,0	61,0	46,0	40,0	55022	54822
0.3937	10,000 mm		10,0	103,0	61,0	46,0	40,0	65070	64870
0.3976	10,100 mm		12,0	118,0	71,0	56,0	45,0	65071	64871
0.4016	10,200 mm		12,0	118,0	71,0	56,0	45,0	65072	64872
0.4055	10,300 mm		12,0	118,0	71,0	56,0	45,0	65073	64873
0.4062	10,317 mm	13/32	12,0	118,0	71,0	56,0	45,0	55023	54823
0.4095	10,400 mm		12,0	118,0	71,0	55,0	45,0	65074	64874
0.4134	10,500 mm		12,0	118,0	71,0	55,0	45,0	65075	64875
0.4173	10,600 mm		12,0	118,0	71,0	55,0	45,0	65076	64876
0.4213	10,700 mm		12,0	118,0	71,0	55,0	45,0	65077	64877
0.4219	10,716 mm	27/64	12,0	118,0	71,0	55,0	45,0	55024	54824
0.4252	10,800 mm		12,0	118,0	71,0	55,0	45,0	65078	64878
0.4291	10,900 mm		12,0	118,0	71,0	55,0	45,0	65079	64879
0.4331	11,000 mm		12,0	118,0	71,0	54,0	45,0	65080	64880
0.4370	11,100 mm		12,0	118,0	71,0	54,0	45,0	65081	64881
0.4375	11,113 mm	7/16	12,0	118,0	71,0	54,0	45,0	55025	54825
0.4409	11,200 mm		12,0	118,0	71,0	54,0	45,0	65082	64882
0.4449	11,300 mm		12,0	118,0	71,0	54,0	45,0	65083	64883
0.4488	11,400 mm		12,0	118,0	71,0	54,0	45,0	65084	64884
0.4528	11,500 mm		12,0	118,0	71,0	54,0	45,0	65085	64885
0.4567	11,600 mm		12,0	118,0	71,0	54,0	45,0	65086	64886
0.4606	11,700 mm		12,0	118,0	71,0	53,0	45,0	65087	64887
0.4646	11,800 mm		12,0	118,0	71,0	53,0	45,0	65088	64888
0.4685	11,900 mm		12,0	118,0	71,0	53,0	45,0	65089	64889
0.4688	11,908 mm	15/32	12,0	118,0	71,0	53,0	45,0	55026	54826
0.4724	12,000 mm		12,0	118,0	71,0	53,0	45,0	65090	64890

CONTINUED

continued on next page

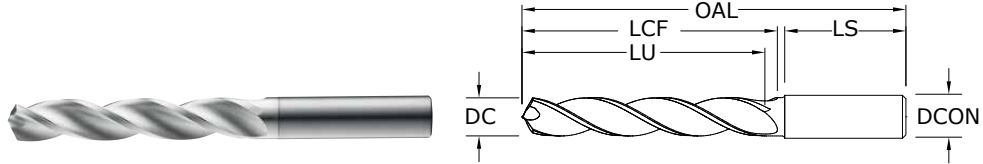

131N 5xD
FRACTIONAL & METRIC SERIES

- 3-margin design improves hole stability and size control while providing superior finish, roundness and cylindricity
- Self-stabilizing pyramid point design stabilizes the drill on contact with the workpiece
- Open flute structure efficiently transports chips while maintaining strength at high feed rates
- Sculpted gash allows chips to easily flow away from the drill center
- Recommended for materials ≤ 175 Bhn (≤ 16 HRc)

		inch & mm						EDP NO.	
DECIMAL DC	METRIC DC	FRACTIONAL/ LETTER/WIRE DC	SHANK DIAMETER DCON	OVERALL LENGTH OAL	FLUTE LENGTH LCF	USABLE LENGTH LU	SHANK LENGTH LS	UNCOATED	Ti-NAMITE®-B (TiB ₂)
0.4844	12,304 mm	31/64	14,0	124,0	77,0	58,0	45,0	55027	54827
0.4921	12,500 mm		14,0	124,0	77,0	58,0	45,0	65091	64891
0.5000	12,700 mm	1/2	14,0	124,0	77,0	58,0	45,0	55028	54828
0.5039	12,800 mm		14,0	124,0	77,0	58,0	45,0	65092	64892
0.5118	13,000 mm		14,0	124,0	77,0	58,0	45,0	65093	64893
0.5156	13,096 mm	33/64	14,0	124,0	77,0	57,0	45,0	55029	54829
0.5315	13,500 mm		14,0	124,0	77,0	57,0	45,0	65094	64894
0.5433	13,800 mm		14,0	124,0	77,0	56,0	45,0	65095	64895
0.5512	14,000 mm		14,0	124,0	77,0	56,0	45,0	65096	64896
0.5625	14,288 mm	9/16	16,0	133,0	83,0	61,0	48,0	55030	54830
0.5709	14,500 mm		16,0	133,0	83,0	61,0	48,0	65097	64897
0.5781	14,684 mm	37/64	16,0	133,0	83,0	61,0	48,0	55031	54831
0.5827	14,800 mm		16,0	133,0	83,0	61,0	48,0	65098	64898
0.5906	15,000 mm		16,0	133,0	83,0	60,0	48,0	65099	64899
0.6102	15,500 mm		16,0	133,0	83,0	60,0	48,0	65100	64900
0.6221	15,800 mm		16,0	133,0	83,0	59,0	48,0	65101	64901
0.6250	15,875 mm	5/8	16,0	133,0	83,0	59,0	48,0	55032	54832
0.6299	16,000 mm		16,0	133,0	83,0	59,0	48,0	65102	64902
0.6562	16,667 mm	21/32	18,0	143,0	93,0	68,0	48,0	55033	54833
0.6875	17,463 mm	11/16	18,0	143,0	93,0	67,0	48,0	55034	54834
0.7500	19,050 mm	3/4	20,0	153,0	101,0	72,0	50,0	55035	54835

TOLERANCES (inch)

- ≤.1181 DIAMETER
DC = +.00008/+0.00047
DCON = h₆
- >.1181-.2362 DIAMETER
DC = +.00016/+0.00063
DCON = h₆
- >.2362-.3937 DIAMETER
DC = +.00024/+0.00083
DCON = h₆
- >.3937-.7087 DIAMETER
DC = +.00028/+0.00098
DCON = h₆
- >.7087-1.1811 DIAMETER
DC = +.00031/+0.00114
DCON = h₆

TOLERANCES (mm)

- ≤3 DIAMETER
DC = +0,002/+0,012
DCON = h₆
- >3-6 DIAMETER
DC = +0,004/+0,016
DCON = h₆
- >6-10 DIAMETER
DC = +0,006/+0,021
DCON = h₆
- >10-18 DIAMETER
DC = +0,007/+0,025
DCON = h₆

NON-FERROUS

For patent information visit www.ksptpatents.com

Series 131N 3D & 5D Fractional	Hardness	Vc (sfm)	DC • in									
			1/8	3/16	1/4	3/8	1/2	5/8	3/4			
ALUMINUM ALLOYS < 12% SI 6061, 2024, 7075	≤ 150 Bhn or ≤ 88 HRb	800	RPM	24448	16299	12224	8149	6112	4890	4075		
		(640-960)	Fr	0.0055	0.0083	0.0110	0.0166	0.0221	0.0276	0.0331		
			Feed (ipm)	135	135	135	135	135	135	135		
	ALUMINUM ALLOYS > 12% SI A356.0, 390.0, 319.0	≤ 125 Bhn or ≤ 77 HRb	600	RPM	18336	12224	9168	6112	4584	3667	3056	
			(480-720)	Fr	0.0055	0.0082	0.0109	0.0164	0.0218	0.0273	0.0327	
				Feed (ipm)	100	100	100	100	100	100	100	
		COPPER ALLOYS Alum Bronze, Muntz Brass, Naval Brass	≤ 175 Bhn or ≤ 16 HRc	550	RPM	16808	11205	8404	5603	4202	3362	2801
				(440-660)	Fr	0.0020	0.0030	0.0040	0.0061	0.0081	0.0101	0.0121
					Feed (ipm)	34	34	34	34	34	34	34
PLASTICS Acrylic, PVC, Polypropylene				450	RPM	13752	9168	6876	4584	3438	2750	2292
				(360-540)	Fr	0.0025	0.0037	0.0049	0.0074	0.0099	0.0124	0.0148
					Feed (ipm)	34	34	34	34	34	34	34

Bhn (Brinell) HRc (Rockwell C) HRb (Rockwell B)
 rpm = Vc x 3.82 / DC
 ipm = Fr x rpm
 reduce speed and feed for materials harder than listed
 refer to the SGS Tool Wizard® for complete technical information (www.kyocera-sgstool.com)

Series 131N 3D & 5D Metric	Hardness	Vc (m/min)	DC • mm									
			3	6	8	10	12	14	16			
ALUMINUM ALLOYS < 12% SI 6061, 2024, 7075	≤ 150 Bhn or ≤ 88 HRb	244	RPM	25851	12926	9694	7755	6463	5540	4847		
		(195-293)	Fr	0.133	0.265	0.354	0.442	0.531	0.619	0.708		
			Feed (mm/min)	3430	3430	3430	3430	3430	3430	3430		
	ALUMINUM ALLOYS > 12% SI A356.0, 390.0, 319.0	≤ 125 Bhn or ≤ 77 HRb	183	RPM	19388	9694	7271	5816	4847	4155	3635	
			(146-219)	Fr	0.131	0.262	0.349	0.437	0.524	0.611	0.699	
				Feed (mm/min)	2540	2540	2540	2540	2540	2540	2540	
		COPPER ALLOYS Alum Bronze, Muntz Brass, Naval Brass	≤ 175 Bhn or ≤ 16 HRc	168	RPM	17773	8886	6665	5332	4443	3808	3332
				(134-201)	Fr	0.049	0.097	0.130	0.162	0.194	0.227	0.259
					Feed (mm/min)	864	864	864	864	864	864	864
PLASTICS Acrylic, PVC, Polypropylene				137	RPM	14541	7271	5453	4362	3635	3116	2726
				(110-165)	Fr	0.059	0.119	0.158	0.198	0.238	0.277	0.317
					Feed (mm/min)	864	864	864	864	864	864	864

Bhn (Brinell) HRc (Rockwell C) HRb (Rockwell B)
 rpm = (Vc x 1000) / (DC x 3.14)
 mm/min = Fr x rpm
 reduce speed and feed for materials harder than listed
 refer to the SGS Tool Wizard® for complete technical information (www.kyocera-sgstool.com)

Series 120



3xD

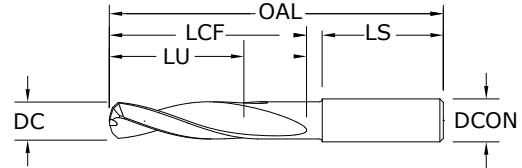

120

FRACTIONAL & METRIC SERIES

- Double margin design stabilizes the drill for greater hole accuracy and improved surface finish
- Notched point reduces thrust force over conventional designs
- 8 facet point reduces fiber breakout and delamination on exit
- 90 degree secondary chamfer angle improves hole entrance and exit quality

DECIMAL DC	METRIC DC	inch & mm						EDP NO.
		FRACTIONAL/ LETTER/WIRE DC	SHANK DIAMETER DCON	OVERALL LENGTH OAL	FLUTE LENGTH LCF	USABLE LENGTH LU	SHANK LENGTH LS	
0.0980	2,489 mm	#40	1/8	2	9/16	7/16	1-1/4	50000
0.1063	2,700 mm		6,0	63,0	20,0	16,0	32,0	50001
0.1181	3,000 mm		6,0	63,0	20,0	16,0	36,0	50002
0.1250	3,175 mm	1/8	1/4	2-1/2	3/4	9/16	1-7/16	50003
0.1260	3,200 mm		6,0	63,0	20,0	15,0	36,0	50004
0.1285	3,264 mm	#30	1/4	2-1/2	3/4	9/16	1-7/16	50005
0.1405	3,569 mm	#28	1/4	2-1/2	3/4	9/16	1-7/16	50006
0.1570	3,988 mm	#22	1/4	2-5/8	7/8	5/8	1-7/16	50007
0.1590	4,039 mm	#21	1/4	2-5/8	7/8	5/8	1-7/16	50008
0.1614	4,100 mm		6,0	66,0	24,0	18,0	36,0	50009
0.1660	4,216 mm	#19	1/4	2-5/8	7/8	5/8	1-7/16	50010
0.1719	4,366 mm	11/64	1/4	2-5/8	7/8	5/8	1-7/16	50011
0.1875	4,763 mm	3/16	1/4	2-5/8	1	23/32	1-7/16	50012
0.1910	4,851 mm	#11	1/4	2-5/8	1	23/32	1-7/16	50013
0.1990	5,055 mm	#8	1/4	2-5/8	1	23/32	1-7/16	50014
0.2010	5,105 mm	#7	1/4	2-5/8	1	23/32	1-7/16	50015
0.2210	5,613 mm	#2	1/4	2-5/8	1	21/32	1-7/16	50016
0.2362	6,000 mm		6,0	66,0	28,0	19,0	36,0	50017
0.2500	6,350 mm	1/4 E #0	1/4	3-1/8	1-5/16	15/16	1-7/16	50018
0.2510	6,380 mm		5/16	3-1/8	1-5/16	15/16	1-7/16	50019
0.2570	6,528 mm	F	5/16	3-1/8	1-5/16	15/16	1-7/16	50020
0.2720	6,909 mm	I	5/16	3-1/8	1-5/16	29/32	1-7/16	50021
0.2770	7,036 mm	J	5/16	3-1/8	1-5/16	29/32	1-7/16	50022
0.2810	7,137 mm	K	5/16	3-1/8	1-9/16	1-9/64	1-7/16	50023
0.3125	7,938 mm	5/16	5/16	3-1/8	1-9/16	1-3/32	1-7/16	50024
0.3150	8,000 mm		8,0	79,0	41,0	29,0	36,0	50025
0.3750	9,525 mm	3/8	3/8	3-1/2	1-27/32	1-9/32	1-9/16	50026
0.3770	9,576 mm	V	1/2	3-1/2	1-27/32	1-9/32	1-9/16	50027
0.3937	10,000 mm		10,0	89,0	47,0	32,0	40,0	50028
0.4375	11,113 mm	7/16	1/2	4-1/16	2-3/16	1-17/32	1-9/16	50029
0.4724	12,000 mm		12,0	102,0	55,0	37,0	45,0	50030
0.5000	12,700 mm	1/2	1/2	4-1/4	2-5/16	1-9/16	1-3/4	50031

TOLERANCES (inch)

DC = +.0000/+0.0005
DCON = h₆

TOLERANCES (mm)

DC = +0,000/+0,013
DCON = h₆

NON-FERROUS

For patent information visit www.ksptpatents.com

Series 120 Fractional	Vc (sfm)		DC • in							
			1/8	3/16	1/4	5/16	3/8	7/16	1/2	
N	320 (256-384)	CFRP, AFRP (Carbon Fiber, Aramid Fiber)	RPM	9779	6519	4890	3912	3260	2794	2445
		Fr	0.0006	0.0009	0.0012	0.0015	0.0018	0.0021	0.0024	
		Feed (ipm)	5.9	5.9	5.9	5.9	5.9	5.9	5.9	
	240 (192-288)	GFRP (Fiberglass)	RPM	7334	4890	3667	2934	2445	2096	1834
		Fr	0.0006	0.0009	0.0012	0.0015	0.0018	0.0021	0.0024	
		Feed (ipm)	4.4	4.4	4.4	4.4	4.4	4.4	4.4	
	400 (320-480)	CARBON, GRAPHITE	RPM	12224	8149	6112	4890	4075	3493	3056
		Fr	0.0008	0.0012	0.0016	0.0020	0.0024	0.0028	0.0032	
		Feed (ipm)	9.8	9.8	9.8	9.8	9.8	9.8	9.8	

rpm = Vc x 3.82 / DC
 ipm = Fr x rpm
 adjust speed and / or feed based on resin type and / or fiber structure
 refer to the SGS Tool Wizard® for complete technical information (www.kyocera-sgstool.com)

Series 120 Metric	Vc (m/min)		DC • mm							
			2.5	3	4	6	8	10	12	
N	100 (80-120)	CFRP, AFRP (Carbon Fiber, Aramid Fiber)	RPM	12722	10602	7951	5301	3976	3181	2650
		Fr	0.012	0.014	0.019	0.028	0.038	0.047	0.057	
		Feed (mm/min)	150	150	150	150	150	150	150	
	75 (65-90)	GFRP (Fiberglass)	RPM	9542	7951	5963	3976	2982	2385	1988
		Fr	0.012	0.014	0.019	0.029	0.039	0.048	0.058	
		Feed (mm/min)	115	115	115	115	115	115	115	
	120 (96-144)	CARBON, GRAPHITE	RPM	15266	12722	9542	6361	4771	3817	3181
		Fr	0.015	0.018	0.025	0.037	0.049	0.062	0.074	
		Feed (mm/min)	235	235	235	235	235	235	235	

rpm = (Vc x 1000) / (DC x 3.14)
 mm/min = Fr x rpm
 adjust speed and / or feed based on resin type and / or fiber structure
 refer to the SGS Tool Wizard® for complete technical information (www.kyocera-sgstool.com)



135 3xD

FRACTIONAL & METRIC SERIES

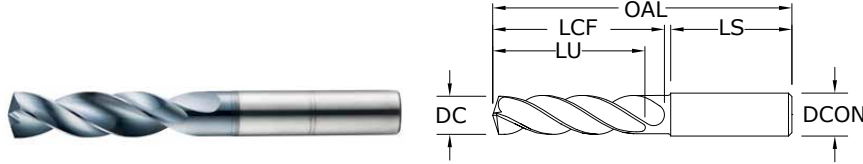

- 4-margin design improves accuracy and surface finish along with increased strength for aggressive drilling
- Specialized self-centering notched point eliminates the need for spot drilling decreasing thrust and deflection
- Engineered edge protection improves edge strength and reduces edge fatigue allowing for increased feed rates
- Recommended for materials ≤ 50 HRc (≤ 475 Bhn)

inch & mm								EDP NO.
DECIMAL DC	METRIC DC	FRACTIONAL/ LETTER/WIRE DC	SHANK DIAMETER DCON	OVERALL LENGTH OAL	FLUTE LENGTH LCF	USABLE LENGTH LU	SHANK LENGTH LS	Ti-NAMITE-A (AITiN)
0.0156	0,396 mm	1/64	1/8	1-1/2	1/8	7/64	1	51752*
0.0312	0,792 mm	1/32	1/8	1-1/2	1/4	13/64	1	51269*
0.0469	1,191 mm	3/64	1/8	1-1/2	3/8	5/16	1	51270*
0.0492	1,250 mm		3,0	38,0	9,5	8,0	25,0	64500*
0.0571	1,450 mm		3,0	38,0	9,5	7,0	25,0	64501*
0.0595	1,511 mm	#53	1/8	1-1/2	3/8	9/32	1	64502*
0.0625	1,588 mm	1/16	1/8	2	7/16	11/32	1-1/4	51271*
0.0630	1,600 mm		3,0	50,0	11,0	9,0	32,0	64503*
0.0689	1,750 mm		3,0	50,0	11,0	8,0	32,0	64504*
0.0700	1,778 mm	#50	1/8	2	7/16	21/64	1-1/4	64505*
0.0781	1,984 mm	5/64	1/8	2	1/2	25/64	1-1/4	51272*
0.0785	1,994 mm	#47	1/8	2	1/2	25/64	1-1/4	64506*
0.0807	2,050 mm		3,0	50,0	12,0	9,0	32,0	64507*
0.0810	2,057 mm	#46	1/8	2	1/2	3/8	1-1/4	64508*
0.0890	2,261 mm	#43	1/8	2	1/2	3/8	1-1/4	64509*
0.0935	2,375 mm	#42	1/8	2	1/2	23/64	1-1/4	64510*
0.0938	2,383 mm	3/32	1/8	2	1/2	23/64	1-1/4	51273
0.0980	2,489 mm	#40	1/8	2	9/16	27/64	1-1/4	51274
0.0984	2,500 mm		3,0	50,0	14,0	10,0	32,0	64511
0.0995	2,527 mm	#39	1/8	2	9/16	27/64	1-1/4	51753
0.1015	2,578 mm	#38	1/8	2	9/16	27/64	1-1/4	51754
0.1040	2,642 mm	#37	1/8	2	9/16	13/32	1-1/4	51755
0.1065	2,705 mm	#36	1/8	2	9/16	13/32	1-1/4	51756
0.1094	2,779 mm	7/64	1/8	2	5/8	15/32	1-1/4	51275
0.1100	2,794 mm	#35	1/8	2	5/8	15/32	1-1/4	51276
0.1110	2,819 mm	#34	1/8	2	5/8	15/32	1-1/4	51277
0.1130	2,870 mm	#33	1/8	2	5/8	29/64	1-1/4	51757
0.1142	2,900 mm		3,0	50,0	16,0	12,0	32,0	64512
0.1160	2,946 mm	#32	1/8	2	5/8	29/64	1-1/4	51758
0.1181	3,000 mm		6,0	62,0	20,0	16,0	36,0	63155
0.1200	3,048 mm	#31	1/8	2	5/8	29/64	1-1/4	51759
0.1220	3,100 mm		6,0	62,0	20,0	15,0	36,0	63741
0.1250	3,175 mm	1/8	1/4	2-1/2	3/4	9/16	1-7/16	51330
0.1260	3,200 mm		6,0	62,0	20,0	15,0	36,0	63156
0.1285	3,264 mm	#30	1/4	2-1/2	3/4	9/16	1-7/16	51278
0.1299	3,300 mm		6,0	62,0	20,0	15,0	36,0	63157

*Single Margin

continued on next page

TOLERANCES (inch)

- $\leq .1181$ DIAMETER
DC = $+0.0008/+0.0047$
DCON = h_6
- $>.1181-.2362$ DIAMETER
DC = $+0.0016/+0.0063$
DCON = h_6
- $>.2362-.3937$ DIAMETER
DC = $+0.0024/+0.0083$
DCON = h_6
- $>.3937-.7087$ DIAMETER
DC = $+0.0028/+0.0098$
DCON = h_6
- $>.7087-1.1811$ DIAMETER
DC = $+0.0031/+0.0114$
DCON = h_6

TOLERANCES (mm)

- ≤ 3 DIAMETER
DC = $+0,002/+0,012$
DCON = h_6
- $>3-6$ DIAMETER
DC = $+0,004/+0,016$
DCON = h_6
- $>6-10$ DIAMETER
DC = $+0,006/+0,021$
DCON = h_6
- $>10-18$ DIAMETER
DC = $+0,007/+0,025$
DCON = h_6
- $>18-30$ DIAMETER
DC = $+0,008/+0,029$
DCON = h_6

- STEELS
- STAINLESS STEELS
- CAST IRON
- NON-FERROUS
- HIGH TEMP ALLOYS
- HARDENED STEELS

For patent information visit www.ksptpatents.com



135 3xD
FRACTIONAL & METRIC SERIES

DECIMAL DC	METRIC DC	inch & mm						EDP NO. Ti-NAMITE-A (AITiN)
		FRACTIONAL/ LETTER/WIRE DC	SHANK DIAMETER DCON	OVERALL LENGTH OAL	FLUTE LENGTH LCF	USABLE LENGTH LU	SHANK LENGTH LS	
0.1339	3,400 mm		6,0	62,0	20,0	15,0	36,0	63158
0.1360	3,454 mm	#29	1/4	2-1/2	3/4	9/16	1-7/16	51331
0.1378	3,500 mm		6,0	62,0	20,0	15,0	36,0	63159
0.1405	3,569 mm	#28	1/4	2-1/2	3/4	35/64	1-7/16	51760
0.1406	3,571 mm	9/64	1/4	2-1/2	3/4	9/16	1-7/16	51332
0.1417	3,600 mm		6,0	62,0	20,0	15,0	36,0	63160
0.1440	3,658 mm	#27	1/4	2-1/2	3/4	35/64	1-7/16	51761
0.1457	3,700 mm		6,0	62,0	20,0	14,0	36,0	63161
0.1470	3,734 mm	#26	1/4	2-1/2	3/4	17/32	1-7/16	51762
0.1495	3,797 mm	#25	1/4	2-5/8	7/8	21/32	1-7/16	51333
0.1496	3,800 mm		6,0	66,0	24,0	18,0	36,0	63742
0.1520	3,861 mm	#24	1/4	2-5/8	7/8	21/32	1-7/16	51763
0.1535	3,900 mm		6,0	66,0	24,0	18,0	36,0	63743
0.1540	3,912 mm	#23	1/4	2-5/8	7/8	21/32	1-7/16	51764
0.1562	3,967 mm	5/32	1/4	2-5/8	7/8	41/64	1-7/16	51334
0.1570	3,988 mm	#22	1/4	2-5/8	7/8	41/64	1-7/16	51765
0.1575	4,000 mm		6,0	66,0	24,0	18,0	36,0	63162
0.1590	4,039 mm	#21	1/4	2-5/8	7/8	41/64	1-7/16	51335
0.1610	4,089 mm	#20	1/4	2-5/8	7/8	5/8	1-7/16	51279
0.1614	4,100 mm		6,0	66,0	24,0	18,0	36,0	63744
0.1654	4,200 mm		6,0	66,0	24,0	18,0	36,0	63163
0.1660	4,216 mm	#19	1/4	2-5/8	7/8	5/8	1-7/16	51766
0.1693	4,300 mm		6,0	66,0	24,0	18,0	36,0	63164
0.1695	4,305 mm	#18	1/4	2-5/8	7/8	5/8	1-7/16	51767
0.1719	4,366 mm	11/64	1/4	2-5/8	7/8	39/64	1-7/16	51336
0.1730	4,394 mm	#17	1/4	2-5/8	7/8	5/8	1-7/16	51768
0.1732	4,400 mm		6,0	66,0	24,0	17,0	36,0	63745
0.1770	4,496 mm	#16	1/4	2-5/8	7/8	39/64	1-7/16	51769
0.1772	4,500 mm		6,0	66,0	24,0	17,0	36,0	63165
0.1800	4,572 mm	#15	1/4	2-5/8	7/8	39/64	1-7/16	51770
0.1811	4,600 mm		6,0	66,0	24,0	17,0	36,0	63166
0.1820	4,623 mm	#14	1/4	2-5/8	7/8	39/64	1-7/16	51771
0.1850	4,699 mm	#13	1/4	2-5/8	7/8	39/64	1-7/16	51772
0.1850	4,699 mm	#13	6,0	66,0	24,0	17,0	36,0	63746
0.1875	4,763 mm	3/16	1/4	2-5/8	1	23/32	1-7/16	51337
0.1890	4,801 mm	#12	1/4	2-5/8	1	23/32	1-7/16	51773
0.1890	4,801 mm	#12	6,0	66,0	28,0	21,0	36,0	63167
0.1910	4,851 mm	#11	1/4	2-5/8	1	23/32	1-7/16	51774
0.1929	4,900 mm		6,0	66,0	28,0	21,0	36,0	63747
0.1935	4,915 mm	#10	1/4	2-5/8	1	23/32	1-7/16	51775
0.1960	4,978 mm	#9	1/4	2-5/8	1	23/32	1-7/16	51776
0.1969	5,000 mm		6,0	66,0	28,0	20,0	36,0	63168
0.1990	5,055 mm	#8	1/4	2-5/8	1	45/64	1-7/16	51777
0.2008	5,100 mm		6,0	66,0	28,0	20,0	36,0	63748
0.2010	5,105 mm	#7	1/4	2-5/8	1	45/64	1-7/16	51338
0.2031	5,159 mm	13/64	1/4	2-5/8	1	45/64	1-7/16	51339

CONTINUED

continued on next page



135 3xD

FRACTIONAL & METRIC SERIES

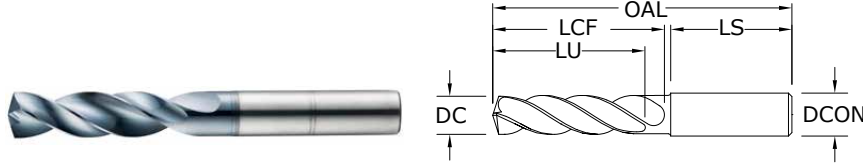

- 4-margin design improves accuracy and surface finish along with increased strength for aggressive drilling
- Specialized self-centering notched point eliminates the need for spot drilling decreasing thrust and deflection
- Engineered edge protection improves edge strength and reduces edge fatigue allowing for increased feed rates
- Recommended for materials ≤ 50 HRc (≤ 475 Bhn)

inch & mm								EDP NO.
DECIMAL DC	METRIC DC	FRACTIONAL/ LETTER/WIRE DC	SHANK DIAMETER DCON	OVERALL LENGTH OAL	FLUTE LENGTH LCF	USABLE LENGTH LU	SHANK LENGTH LS	Ti-NAMITE-A (AITiN)
0.2040	5,182 mm	#6	1/4	2-5/8	1	45/64	1-7/16	51778
0.2047	5,200 mm		6,0	66,0	28,0	20,0	36,0	63749
0.2055	5,220 mm	#5	1/4	2-5/8	1	45/64	1-7/16	51779
0.2067	5,250 mm		6,0	66,0	28,0	20,0	36,0	63169
0.2087	5,300 mm		6,0	66,0	28,0	20,0	36,0	63170
0.2090	5,309 mm	#4	1/4	2-5/8	1	11/16	1-7/16	51780
0.2126	5,400 mm		6,0	66,0	28,0	20,0	36,0	63750
0.2130	5,410 mm	#3	1/4	2-5/8	1	11/16	1-7/16	51340
0.2165	5,500 mm		6,0	66,0	28,0	20,0	36,0	63171
0.2188	5,558 mm	7/32	1/4	2-5/8	1	43/64	1-7/16	51341
0.2205	5,600 mm		6,0	66,0	28,0	20,0	36,0	63751
0.2210	5,613 mm	#2	1/4	2-5/8	1	11/16	1-7/16	51781
0.2244	5,700 mm		6,0	66,0	28,0	19,0	36,0	63752
0.2280	5,791 mm	#1	1/4	2-5/8	1	21/32	1-7/16	51782
0.2283	5,800 mm		6,0	66,0	28,0	19,0	36,0	63172
0.2323	5,900 mm		6,0	66,0	28,0	19,0	36,0	63753
0.2340	5,944 mm	A	1/4	2-5/8	1	21/32	1-7/16	51601
0.2344	5,954 mm	15/64	1/4	2-5/8	1	21/32	1-7/16	51342
0.2362	6,000 mm		6,0	66,0	28,0	19,0	36,0	63173
0.2380	6,045 mm	B	1/4	3-1/8	1-5/16	31/32	1-7/16	51602
0.2402	6,100 mm		8,0	79,0	34,0	25,0	36,0	63754
0.2420	6,147 mm	C	1/4	3-1/8	1-5/16	61/64	1-7/16	51603
0.2441	6,200 mm		8,0	79,0	34,0	25,0	36,0	63755
0.2460	6,248 mm	D	1/4	3-1/8	1-5/16	61/64	1-7/16	51604
0.2461	6,250 mm		8,0	79,0	34,0	25,0	36,0	63174
0.2480	6,300 mm		8,0	79,0	34,0	25,0	36,0	63756
0.2500	6,350 mm	1/4 E #0	1/4	3-1/8	1-5/16	15/16	1-7/16	51343
0.2520	6,400 mm		8,0	79,0	34,0	24,0	36,0	63175
0.2559	6,500 mm		8,0	79,0	34,0	24,0	36,0	63213
0.2570	6,528 mm	F	5/16	3-1/8	1-5/16	59/64	1-7/16	51344
0.2598	6,600 mm		8,0	79,0	34,0	24,0	36,0	63757
0.2610	6,629 mm	G	5/16	3-1/8	1-5/16	59/64	1-7/16	51606
0.2638	6,700 mm		8,0	79,0	34,0	24,0	36,0	63758
0.2656	6,746 mm	17/64	5/16	3-1/8	1-5/16	59/64	1-7/16	51345
0.2660	6,756 mm	H	5/16	3-1/8	1-5/16	59/64	1-7/16	51607
0.2677	6,800 mm		8,0	79,0	34,0	24,0	36,0	63176
0.2717	6,900 mm		8,0	79,0	34,0	24,0	36,0	63759
0.2720	6,909 mm	I	5/16	3-1/8	1-5/16	29/32	1-7/16	51346

TOLERANCES (inch)

- $\leq .1181$ DIAMETER
DC = $+0.0008/+0.0047$
DCON = h_6
- $>.1181-.2362$ DIAMETER
DC = $+0.0016/+0.0063$
DCON = h_6
- $>.2362-.3937$ DIAMETER
DC = $+0.0024/+0.0083$
DCON = h_6
- $>.3937-.7087$ DIAMETER
DC = $+0.0028/+0.0098$
DCON = h_6
- $>.7087-1.1811$ DIAMETER
DC = $+0.0031/+0.0114$
DCON = h_6

TOLERANCES (mm)

- ≤ 3 DIAMETER
DC = $+0,002/+0,012$
DCON = h_6
- $>3-6$ DIAMETER
DC = $+0,004/+0,016$
DCON = h_6
- $>6-10$ DIAMETER
DC = $+0,006/+0,021$
DCON = h_6
- $>10-18$ DIAMETER
DC = $+0,007/+0,025$
DCON = h_6
- $>18-30$ DIAMETER
DC = $+0,008/+0,029$
DCON = h_6

- STEELS
- STAINLESS STEELS
- CAST IRON
- NON-FERROUS
- HIGH TEMP ALLOYS
- HARDENED STEELS

For patent information visit www.ksptpatents.com

continued on next page



135 3xD
FRACTIONAL & METRIC SERIES

DECIMAL DC	METRIC DC	inch & mm						EDP NO.
		FRACTIONAL/ LETTER/WIRE DC	SHANK DIAMETER DCON	OVERALL LENGTH OAL	FLUTE LENGTH LCF	USABLE LENGTH LU	SHANK LENGTH LS	Ti-NAMITE-A (AITiN)
0.2756	7,000 mm		8,0	79,0	34,0	24,0	36,0	63177
0.2770	7,036 mm	J	5/16	3-1/8	1-5/16	29/32	1-7/16	51608
0.2795	7,100 mm		8,0	79,0	41,0	30,0	36,0	63760
0.2810	7,137 mm	K	5/16	3-1/8	1-9/16	1-9/64	1-7/16	51609
0.2812	7,142 mm	9/32	5/16	3-1/8	1-9/16	1-9/64	1-7/16	51347
0.2835	7,200 mm		8,0	79,0	41,0	30,0	36,0	63761
0.2854	7,250 mm		8,0	79,0	41,0	30,0	36,0	63178
0.2874	7,300 mm		8,0	79,0	41,0	30,0	36,0	63762
0.2900	7,366 mm	L	5/16	3-1/8	1-9/16	1-1/8	1-7/16	51610
0.2913	7,400 mm		8,0	79,0	41,0	30,0	36,0	63763
0.2950	7,493 mm	M	5/16	3-1/8	1-9/16	1-1/8	1-7/16	51611
0.2953	7,500 mm		8,0	79,0	41,0	30,0	36,0	63179
0.2969	7,541 mm	19/64	5/16	3-1/8	1-9/16	1-7/64	1-7/16	51348
0.2992	7,600 mm		8,0	79,0	41,0	30,0	36,0	63764
0.3020	7,671 mm	N	5/16	3-1/8	1-9/16	1-7/64	1-7/16	51612
0.3031	7,700 mm		8,0	79,0	41,0	29,0	36,0	63765
0.3071	7,800 mm		8,0	79,0	41,0	29,0	36,0	63180
0.3110	7,900 mm		8,0	79,0	41,0	29,0	36,0	63766
0.3125	7,938 mm	5/16	5/16	3-1/8	1-9/16	1-3/32	1-7/16	51349
0.3150	8,000 mm		8,0	79,0	41,0	29,0	36,0	63181
0.3160	8,026 mm	O	3/8	3-1/2	1-27/32	1-3/8	1-9/16	51613
0.3189	8,100 mm		10,0	89,0	47,0	35,0	40,0	63767
0.3228	8,200 mm		10,0	89,0	47,0	35,0	40,0	63768
0.3230	8,204 mm	P	3/8	3-1/2	1-27/32	1-23/64	1-9/16	51614
0.3268	8,300 mm		10,0	89,0	47,0	35,0	40,0	63769
0.3281	8,334 mm	21/64	3/8	3-1/2	1-27/32	1-23/64	1-9/16	51350
0.3307	8,400 mm		10,0	89,0	47,0	34,0	40,0	63182
0.3320	8,433 mm	Q	3/8	3-1/2	1-27/32	1-11/32	1-9/16	51351
0.3346	8,500 mm		10,0	89,0	47,0	34,0	40,0	63183
0.3386	8,600 mm		10,0	89,0	47,0	34,0	40,0	63770
0.3390	8,611 mm	R	3/8	3-1/2	1-27/32	1-11/32	1-9/16	51615
0.3425	8,700 mm		10,0	89,0	47,0	34,0	40,0	63771
0.3438	8,733 mm	11/32	3/8	3-1/2	1-27/32	1-21/64	1-9/16	51352
0.3465	8,800 mm		10,0	89,0	47,0	34,0	40,0	63184
0.3480	8,839 mm	S	3/8	3-1/2	1-27/32	1-21/64	1-9/16	51616
0.3504	8,900 mm		10,0	89,0	47,0	34,0	40,0	63772
0.3543	9,000 mm		10,0	89,0	47,0	34,0	40,0	63185
0.3580	9,093 mm	T	3/8	3-1/2	1-27/32	1-5/16	1-9/16	51617
0.3583	9,100 mm		10,0	89,0	47,0	33,0	40,0	63773
0.3594	9,129 mm	23/64	3/8	3-1/2	1-27/32	1-21/64	1-9/16	51353
0.3622	9,200 mm		10,0	89,0	47,0	33,0	40,0	63774
0.3642	9,250 mm		10,0	89,0	47,0	33,0	40,0	63186
0.3661	9,300 mm		10,0	89,0	47,0	33,0	40,0	63775
0.3680	9,347 mm	U	3/8	3-1/2	1-27/32	1-19/64	1-9/16	51354
0.3701	9,400 mm		10,0	89,0	47,0	33,0	40,0	63776
0.3740	9,500 mm		10,0	89,0	47,0	33,0	40,0	63187

CONTINUED

continued on next page



135 3xD

FRACTIONAL & METRIC SERIES

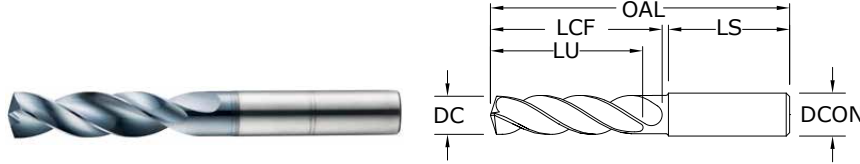

- 4-margin design improves accuracy and surface finish along with increased strength for aggressive drilling
- Specialized self-centering notched point eliminates the need for spot drilling decreasing thrust and deflection
- Engineered edge protection improves edge strength and reduces edge fatigue allowing for increased feed rates
- Recommended for materials ≤ 50 HRc (≤ 475 Bhn)

inch & mm								EDP NO.
DECIMAL DC	METRIC DC	FRACTIONAL/ LETTER/WIRE DC	SHANK DIAMETER DCON	OVERALL LENGTH OAL	FLUTE LENGTH LCF	USABLE LENGTH LU	SHANK LENGTH LS	Ti-NAMITE-A (AITiN)
0.3750	9,525 mm	3/8	3/8	3-1/2	1-27/32	1-9/32	1-9/16	51355
0.3770	9,576 mm	V	1/2	3-1/2	1-27/32	1-9/32	1-9/16	51618
0.3780	9,600 mm		10,0	89,0	47,0	33,0	40,0	63777
0.3819	9,700 mm		10,0	89,0	47,0	32,0	40,0	63778
0.3858	9,800 mm		10,0	89,0	47,0	32,0	40,0	63779
0.3860	9,804 mm	W	1/2	3-1/2	1-27/32	1-17/64	1-9/16	51619
0.4095	10,400 mm		10,0	89,0	47,0	32,0	40,0	63780
0.4130	10,490 mm	Z	1/2	3-1/2	1-27/32	1-17/64	1-9/16	51356
0.4134	10,500 mm		10,0	89,0	47,0	32,0	40,0	63188
0.4173	10,600 mm		1/2	4-1/16	2-3/16	1-19/32	1-49/64	51620
0.4213	10,700 mm		12,0	102,0	55,0	40,0	45,0	63781
0.4219	10,716 mm	27/64	12,0	102,0	55,0	40,0	45,0	63189
0.4252	10,800 mm		1/2	4-1/16	2-3/16	1-19/32	1-49/64	51621
0.4291	10,900 mm		12,0	102,0	55,0	40,0	45,0	63782
0.4331	11,000 mm		1/2	4-1/16	2-3/16	1-37/64	1-49/64	51357
0.4370	11,100 mm		12,0	102,0	55,0	39,0	45,0	63783
0.4375	11,113 mm	7/16	1/2	4-1/16	2-3/16	1-37/64	1-49/64	51622
0.4409	11,200 mm		12,0	102,0	55,0	39,0	45,0	63190
0.4429	11,250 mm		12,0	102,0	55,0	39,0	45,0	63784
0.4449	11,300 mm		12,0	102,0	55,0	39,0	45,0	63785
0.4488	11,400 mm		1/2	4-1/16	2-3/16	1-9/16	1-49/64	51358
0.4252	10,800 mm		12,0	102,0	55,0	39,0	45,0	63191
0.4291	10,900 mm		12,0	102,0	55,0	39,0	45,0	63786
0.4331	11,0 mm		12,0	102,0	55,0	39,0	45,0	63192
0.4331	11,000 mm		12,0	102,0	55,0	38,0	45,0	63787
0.4370	11,100 mm		1/2	4-1/16	2-3/16	1-17/32	1-49/64	51359
0.4375	11,113 mm	7/16	12,0	102,0	55,0	38,0	45,0	63788
0.4409	11,200 mm		12,0	102,0	55,0	38,0	45,0	63193
0.4429	11,250 mm		12,0	102,0	55,0	38,0	45,0	63789
0.4449	11,300 mm		12,0	102,0	55,0	38,0	45,0	63790
0.4488	11,400 mm		12,0	102,0	55,0	38,0	45,0	63194
0.4531	11,509 mm	29/64	1/2	4-1/16	2-3/16	1-33/64	1-49/64	51360
0.4567	11,600 mm		12,0	102,0	55,0	38,0	45,0	63791
0.4606	11,700 mm		12,0	102,0	55,0	37,0	45,0	63792
0.4646	11,800 mm		12,0	102,0	55,0	37,0	45,0	63793
0.4685	11,900 mm		12,0	102,0	55,0	37,0	45,0	63794
0.4688	11,908 mm	15/32	1/2	4-1/16	2-3/16	1-31/64	1-49/64	51361
0.4724	12,000 mm		12,0	102,0	55,0	37,0	45,0	63195

TOLERANCES (inch)

- $\leq .1181$ DIAMETER
DC = $+0.0008/+0.0047$
DCON = h_6
- $>.1181-.2362$ DIAMETER
DC = $+0.0016/+0.0063$
DCON = h_6
- $>.2362-.3937$ DIAMETER
DC = $+0.0024/+0.0083$
DCON = h_6
- $>.3937-.7087$ DIAMETER
DC = $+0.0028/+0.0098$
DCON = h_6
- $>.7087-1.1811$ DIAMETER
DC = $+0.0031/+0.0114$
DCON = h_6

TOLERANCES (mm)

- ≤ 3 DIAMETER
DC = $+0,002/+0,012$
DCON = h_6
- $>3-6$ DIAMETER
DC = $+0,004/+0,016$
DCON = h_6
- $>6-10$ DIAMETER
DC = $+0,006/+0,021$
DCON = h_6
- $>10-18$ DIAMETER
DC = $+0,007/+0,025$
DCON = h_6
- $>18-30$ DIAMETER
DC = $+0,008/+0,029$
DCON = h_6

- STEELS
- STAINLESS STEELS
- CAST IRON
- NON-FERROUS
- HIGH TEMP ALLOYS
- HARDENED STEELS

For patent information visit www.ksptpatents.com

continued on next page



135 3xD

FRACTIONAL & METRIC SERIES

DECIMAL DC	METRIC DC	inch & mm							EDP NO. Ti-NAMITE-A (AITIN)
		FRACTIONAL/ LETTER/WIRE DC	SHANK DIAMETER DCON	OVERALL LENGTH OAL	FLUTE LENGTH LCF	USABLE LENGTH LU	SHANK LENGTH LS		
0.4844	12,304 mm	31/64	1/2	4-1/4	2-5/16	1-19/32	1-49/64	51362	
0.4921	12,500 mm		14,0	107,0	60,0	41,0	45,0	63196	
0.5000	12,700 mm	1/2	1/2	4-1/4	2-5/16	1-9/16	1-49/64	51363	
0.5039	12,800 mm		14,0	107,0	60,0	41,0	45,0	63197	
0.5118	13,000 mm		14,0	107,0	60,0	41,0	45,0	63198	
0.5156	13,096 mm	33/64	5/8	4-1/4	2-5/16	1-35/64	1-49/64	51364	
0.5312	13,492 mm	17/32	5/8	4-1/4	2-5/16	1-33/64	1-49/64	51365	
0.5315	13,500 mm		14,0	107,0	60,0	40,0	45,0	63199	
0.5469	13,8 mm	35/64	5/8	4-1/4	2-5/16	1-1/2	1-49/64	51783	
0.5469	13,891 mm	35/64	14,0	107,0	60,0	39,0	45,0	63200	
0.5512	14,000 mm		5/8	4-9/16	2-1/2	1-21/32	1-57/64	51366	
0.5625	14,288 mm	9/16	16,0	115,0	65,0	43,0	48,0	63201	
0.5781	14,684 mm	37/64	5/8	4-9/16	2-1/2	1-41/64	1-57/64	51367	
0.5906	15,000 mm		16,0	115,0	65,0	42,0	48,0	63202	
0.5938	15,083 mm	19/32	5/8	4-9/16	2-1/2	1-39/64	1-57/64	51784	
0.6094	15,479 mm	39/64	5/8	4-9/16	2-1/2	1-19/32	1-57/64	51785	
0.6102	15,500 mm		16,0	115,0	65,0	42,0	48,0	63203	
0.6250	15,875 mm	5/8	5/8	4-9/16	2-1/2	1-9/16	1-57/64	51368	
0.6299	16,000 mm		16,0	115,0	65,0	41,0	48,0	63204	
0.6406	16,271 mm	41/64	3/4	4-7/8	2-3/4	1-51/64	1-57/64	51786	
0.6496	16,500 mm		18,0	123,0	73,0	48,0	48,0	63205	
0.6562	16,667 mm	21/32	3/4	4-7/8	2-3/4	1-25/32	1-57/64	51369	
0.6693	17,000 mm		18,0	123,0	73,0	47,0	48,0	63206	
0.6719	17,066 mm	43/64	3/4	4-7/8	2-3/4	1-3/4	1-57/64	51787	
0.6875	17,463 mm	11/16	3/4	4-7/8	2-3/4	1-47/64	1-57/64	51370	
0.6890	17,500 mm		18,0	123,0	73,0	47,0	48,0	63207	
0.7031	17,859 mm	45/64	3/4	4-7/8	2-3/4	1-45/64	1-57/64	51788	
0.7087	18,000 mm		18,0	123,0	73,0	46,0	48,0	63208	
0.7188	18,258 mm	23/32	3/4	4-7/8	2-3/4	1-43/64	1-57/64	51789	
0.7283	18,500 mm		20,0	131,0	79,0	51,0	50,0	63209	
0.7344	18,654 mm	47/64	3/4	4-7/8	2-3/4	1-21/32	1-57/64	51790	
0.7480	19,000 mm		20,0	131,0	79,0	51,0	50,0	63210	
0.7500	19,050 mm	3/4	3/4	5-1/4	3-1/16	1-15/16	1-31/32	51371	
0.7656	19,446 mm	49/64	7/8	5-1/4	3-1/16	1-59/64	1-31/32	51372	
0.7677	19,500 mm		20,0	131,0	79,0	50,0	50,0	63211	
0.7812	19,842 mm	25/32	7/8	6	3-11/16	2-33/64	2-1/8	51791	
0.7874	2,0000 mm		20,0	131,0	79,0	49,0	50,0	63212	
0.7969	20,241 mm	51/64	7/8	6	3-11/16	2-1/2	2-1/8	51792	
0.8071	20,500 mm		22,0	150,0	93,0	62,0	53,0	64513	
0.8125	20,638 mm	13/16	7/8	6	3-11/16	2-15/32	2-1/8	51373	
0.8268	21,000 mm		22,0	150,0	93,0	61,0	53,0	64514	
0.8661	22,000 mm		22,0	150,0	93,0	60,0	53,0	64515	
0.8750	22,225 mm	7/8	7/8	6	3-11/16	2-3/8	2-1/8	51374	
0.9219	23,416 mm	59/64	1	6	3-11/16	2-5/16	2-1/8	51375	

CONTINUED

FRACTIONAL
Hi-PerCarb®

Series 135 3D Fractional	Hardness	Vc (sfm)	DC • in								
			1/32	1/8	1/4	3/8	1/2	5/8	7/8		
CARBON STEELS 1018, 1040, 1080, 1090, 10L50, 1140, 1212, 12L15, 1525, 1536	≤ 175 Bhn or ≤ 7 HRc	385	RPM	47062	11766	5883	3922	2941	2353	1681	
		(308-462)	Fr	0.0010	0.0038	0.0076	0.0115	0.0153	0.0191	0.0268	
			Feed (ipm)	45.0	45.0	45.0	45.0	45.0	45.0	45.0	
	≤ 275 Bhn or ≤ 28 HRc	350	RPM	42784	10696	5348	3565	2674	2139	1528	
		(280-420)	Fr	0.0009	0.0036	0.0071	0.0107	0.0142	0.0178	0.0249	
			Feed (ipm)	38.0	38.0	38.0	38.0	38.0	38.0	38.0	
	≤ 425 Bhn or ≤ 45 HRc	200	RPM	24448	6112	3056	2037	1528	1222	873	
		(160-240)	Fr	0.0007	0.0029	0.0059	0.0088	0.0118	0.0147	0.0206	
			Feed (ipm)	18.0	18.0	18.0	18.0	18.0	18.0	18.0	
	ALLOY STEELS 4140, 4150, 4320, 5120, 5150, 8630, 86L20, 50100	≤ 275 Bhn or ≤ 28 HRc	300	RPM	36672	9168	4584	3056	2292	1834	1310
			(240-360)	Fr	0.0007	0.0029	0.0059	0.0088	0.0118	0.0147	0.0206
				Feed (ipm)	27.0	27.0	27.0	27.0	27.0	27.0	27.0
≤ 375 Bhn or ≤ 40 HRc		185	RPM	22614	5654	2827	1885	1413	1131	808	
		(148-222)	Fr	0.0006	0.0026	0.0051	0.0077	0.0103	0.0128	0.0180	
			Feed (ipm)	14.5	14.5	14.5	14.5	14.5	14.5	14.5	
≤ 425 Bhn or ≤ 45 HRc		130	RPM	15891	3973	1986	1324	993	795	568	
		(104-156)	Fr	0.0004	0.0018	0.0035	0.0053	0.0070	0.0088	0.0123	
			Feed (ipm)	7.0	7.0	7.0	7.0	7.0	7.0	7.0	
TOOL STEELS A2, D2, H13, L2, M2, P20, S7, T15, W2		≤ 200 Bhn or ≤ 13 HRc	130	RPM	15891	3973	1986	1324	993	795	568
			(104-156)	Fr	0.0007	0.0026	0.0053	0.0079	0.0106	0.0132	0.0185
				Feed (ipm)	10.5	10.5	10.5	10.5	10.5	10.5	10.5
	≤ 375 Bhn or ≤ 40 HRc	90	RPM	11002	2750	1375	917	688	550	393	
		(72-108)	Fr	0.0003	0.0012	0.0023	0.0035	0.0047	0.0058	0.0081	
			Feed (ipm)	3.2	3.2	3.2	3.2	3.2	3.2	3.2	
STAINLESS STEELS (FREE MACHINING) 303, 416, 420F, 430F, 440F	≤ 185 Bhn or ≤ 9 HRc	275	RPM	33616	8404	4202	2801	2101	1681	1201	
		(220-330)	Fr	0.0006	0.0026	0.0051	0.0077	0.0102	0.0128	0.0179	
			Feed (ipm)	21.5	21.5	21.5	21.5	21.5	21.5	21.5	
	≤ 275 Bhn or ≤ 28 HRc	170	RPM	20781	5195	2598	1732	1299	1039	742	
		(136-204)	Fr	0.0005	0.0020	0.0040	0.0061	0.0081	0.0101	0.0141	
			Feed (ipm)	10.5	10.5	10.5	10.5	10.5	10.5	10.5	
	STAINLESS STEELS (DIFFICULT) 304, 316, 321, 13-8 PH, 15-5PH, 17-4 PH, Custom 450	≤ 275 Bhn or ≤ 28 HRc	90	RPM	11002	2750	1375	917	688	550	393
			(72-108)	Fr	0.0005	0.0020	0.0040	0.0060	0.0080	0.0100	0.0140
				Feed (ipm)	5.5	5.5	5.5	5.5	5.5	5.5	5.5
		≤ 375 Bhn or ≤ 40 HRc	65	RPM	7946	1986	993	662	497	397	284
			(52-78)	Fr	0.0004	0.0018	0.0035	0.0053	0.0070	0.0088	0.0123
				Feed (ipm)	3.5	3.5	3.5	3.5	3.5	3.5	3.5
CAST IRONS Gray, Malleable, Ductile	≤ 220 Bhn or ≤ 19 HRc	320	RPM	39117	9779	4890	3260	2445	1956	1397	
		(256-384)	Fr	0.0012	0.0046	0.0092	0.0138	0.0184	0.0230	0.0322	
			Feed (ipm)	45.0	45.0	45.0	45.0	45.0	45.0	45.0	
	≤ 260 Bhn or ≤ 26 HRc	285	RPM	34838	8710	4355	2903	2177	1742	1244	
		(228-342)	Fr	0.0011	0.0046	0.0092	0.0138	0.0184	0.0230	0.0321	
			Feed (ipm)	40.0	40.0	40.0	40.0	40.0	40.0	40.0	

continued on next page

Series 135 3D Fractional	Hardness	Vc (sfm)	DC • in								
			1/32	1/8	1/4	3/8	1/2	5/8	7/8		
N ALUMINUM ALLOYS 2017, 2024, 356, 6061, 7075	≤ 80 Bhn or ≤ 47 HRb	700	RPM	85568	21392	10696	7131	5348	4278	3056	
		(560-840)	Fr	0.0012	0.0049	0.0098	0.0147	0.0196	0.0245	0.0344	
			Feed (ipm)	105.0	105.0	105.0	105.0	105.0	105.0	105.0	
	≤ 150 Bhn or ≤ 88 HRb	600	RPM	73344	18336	9168	6112	4584	3667	2619	
		(480-720)	Fr	0.0012	0.0050	0.0099	0.0149	0.0199	0.0248	0.0347	
			Feed (ipm)	91.0	91.0	91.0	91.0	91.0	91.0	91.0	
	COPPER ALLOYS Alum Bronze, C110, Muntz Brass	≤ 140 Bhn or ≤ 3 HRc	500	RPM	61120	15280	7640	5093	3820	3056	2183
			(400-600)	Fr	0.0005	0.0020	0.0039	0.0059	0.0079	0.0098	0.0137
				Feed (ipm)	30.0	30.0	30.0	30.0	30.0	30.0	30.0
		≤ 200 Bhn or ≤ 23 HRc	400	RPM	48896	12224	6112	4075	3056	2445	1746
			(320-480)	Fr	0.0005	0.0020	0.0040	0.0060	0.0080	0.0100	0.0140
				Feed (ipm)	24.5	24.5	24.5	24.5	24.5	24.5	24.5
S HIGH TEMP ALLOYS (NICKEL, COBALT, IRON BASE) Inconel 601, 617, 625, Incoloy, Monel 400, Rene, Waspaloy	≤ 300 Bhn or ≤ 32 HRc	55	RPM	6723	1681	840	560	420	336	240	
		(44-66)	Fr	0.0002	0.0008	0.0015	0.0023	0.0031	0.0039	0.0054	
			Feed (ipm)	1.3	1.3	1.3	1.3	1.3	1.3	1.3	
	≤ 400 Bhn or ≤ 43 HRc	30	RPM	3667	917	458	306	229	183	131	
		(24-36)	Fr	0.0002	0.0007	0.0013	0.0020	0.0026	0.0033	0.0046	
			Feed (ipm)	0.6	0.6	0.6	0.6	0.6	0.6	0.6	
	TITANIUM ALLOYS Pure Titanium, Ti6Al4V, Ti6Al2Sn4Zr2Mo, Ti4Al4Mo2Sn0.5Si, Ti-6Al4V	≤ 275 Bhn or ≤ 28 HRc	135	RPM	16502	4126	2063	1375	1031	825	589
			(108-162)	Fr	0.0004	0.0018	0.0035	0.0053	0.0071	0.0088	0.0124
				Feed (ipm)	7.3	7.3	7.3	7.3	7.3	7.3	7.3
		≤ 350 Bhn or ≤ 38 HRc	100	RPM	12224	3056	1528	1019	764	611	437
			(80-120)	Fr	0.0004	0.0016	0.0033	0.0049	0.0065	0.0082	0.0115
				Feed (ipm)	5.0	5.0	5.0	5.0	5.0	5.0	5.0
≤ 440 Bhn or ≤ 47 HRc	55	RPM	6723	1681	840	560	420	336	240		
	(44-66)	Fr	0.0003	0.0012	0.0024	0.0036	0.0048	0.0059	0.0083		
		Feed (ipm)	2.0	2.0	2.0	2.0	2.0	2.0	2.0		
H TOOL STEELS A2, D2, H13, L2, M2, P20, S7, T15, W2	≤ 475 Bhn or ≤ 50 HRc	75	RPM	9168	2292	1146	764	573	458	327	
		(60-90)	Fr	0.0002	0.0008	0.0016	0.0024	0.0031	0.0039	0.0055	
			Feed (ipm)	1.8	1.8	1.8	1.8	1.8	1.8	1.8	

Bhn (Brinell) HRc (Rockwell C) HRb (Rockwell B)

rpm = Vc x 3.82 / DC

ipm = Fr x rpm

reduce speed and feed for materials harder than listed

refer to the SGS Tool Wizard® for complete technical information (www.kyocera-sgstool.com)

Series 135 3D Metric	Hardness	Vc (m/min)	DC • mm									
			1.5	3	6	8	10	12	16	20		
CARBON STEELS 1018, 1040, 1080, 1090, 10L50, 1140, 1212, 12L15, 1525, 1536	≤ 175 Bhn or ≤ 7 HRc	117	RPM	24882	12441	6220	4665	3732	3110	2333	1866	
		(94-141)	Fr	0.047	0.094	0.189	0.252	0.315	0.378	0.504	0.630	
			Feed (mm/min)	1175	1175	1175	1175	1175	1175	1175	1175	1175
	≤ 275 Bhn or ≤ 28 HRc	107	RPM	22620	11310	5655	4241	3393	2827	2121	1696	
		(85-128)	Fr	0.043	0.086	0.172	0.229	0.286	0.343	0.457	0.572	
			Feed (mm/min)	970	970	970	970	970	970	970	970	970
	≤ 475 Bhn or ≤ 45 HRc	61	RPM	12926	6463	3231	2424	1939	1616	1212	969	
		(49-73)	Fr	0.036	0.071	0.142	0.190	0.237	0.285	0.380	0.475	
			Feed (mm/min)	460	460	460	460	460	460	460	460	460
	ALLOY STEELS 4140, 4150, 4320, 5120, 5150, 8630, 86L20, 50100	≤ 275 Bhn or ≤ 28 HRc	91	RPM	19388	9694	4847	3635	2908	2424	1818	1454
			(73-110)	Fr	0.036	0.071	0.142	0.190	0.237	0.285	0.380	0.475
				Feed (mm/min)	690	690	690	690	690	690	690	690
≤ 375 Bhn or ≤ 40 HRc		56	RPM	11956	5978	2989	2242	1793	1495	1121	897	
		(45-68)	Fr	0.031	0.061	0.122	0.163	0.204	0.244	0.326	0.407	
			Feed (mm/min)	365	365	365	365	365	365	365	365	365
≤ 425 Bhn or ≤ 45 HRc		40	RPM	8402	4201	2100	1575	1260	1050	788	630	
		(32-48)	Fr	0.021	0.042	0.083	0.111	0.139	0.167	0.222	0.278	
			Feed (mm/min)	175	175	175	175	175	175	175	175	175
TOOL STEELS A2, D2, H13, L2, M2, P20, S7, T15, W2		≤ 200 Bhn or ≤ 13 HRc	40	RPM	8402	4201	2100	1575	1260	1050	788	630
			(32-48)	Fr	0.032	0.063	0.126	0.168	0.210	0.252	0.336	0.421
				Feed (mm/min)	265	265	265	265	265	265	265	265
	≤ 375 Bhn or ≤ 40 HRc	27	RPM	5816	2908	1454	1091	872	727	545	436	
		(22-33)	Fr	0.014	0.028	0.055	0.073	0.092	0.110	0.147	0.183	
			Feed (mm/min)	80	80	80	80	80	80	80	80	80
STAINLESS STEELS (FREE MACHINING) 303, 416, 420F, 430F, 440F	≤ 185 Bhn or ≤ 9 HRc	84	RPM	17773	8886	4443	3332	2666	2222	1666	1333	
		(67-101)	Fr	0.031	0.061	0.123	0.164	0.204	0.245	0.327	0.409	
			Feed (mm/min)	545	545	545	545	545	545	545	545	545
	≤ 275 Bhn or ≤ 28 HRc	52	RPM	10987	5493	2747	2060	1648	1373	1030	824	
		(41-62)	Fr	0.024	0.047	0.095	0.126	0.158	0.189	0.252	0.316	
			Feed (mm/min)	260	260	260	260	260	260	260	260	260
	STAINLESS STEELS (DIFFICULT) 304, 316, 321, 13-8 PH, 15-5PH, 17-4 PH, Custom 450	≤ 275 Bhn or ≤ 28 HRc	27	RPM	5816	2908	1454	1091	872	727	545	436
			(22-33)	Fr	0.023	0.046	0.093	0.124	0.155	0.186	0.248	0.309
				Feed (mm/min)	135	135	135	135	135	135	135	135
		≤ 375 Bhn or ≤ 40 HRc	20	RPM	4201	2100	1050	788	630	525	394	315
			(16-24)	Fr	0.020	0.040	0.081	0.108	0.135	0.162	0.216	0.270
				Feed (mm/min)	85	85	85	85	85	85	85	85
CAST IRONS Gray, Malleable, Ductile	≤ 220 Bhn or ≤ 19 HRc	98	RPM	20681	10340	5170	3878	3102	2585	1939	1551	
		(78-117)	Fr	0.055	0.110	0.220	0.293	0.366	0.439	0.585	0.732	
			Feed (mm/min)	1135	1135	1135	1135	1135	1135	1135	1135	1135
	≤ 260 Bhn or ≤ 26 HRc	87	RPM	18419	9209	4605	3454	2763	2302	1727	1381	
		(69-104)	Fr	0.055	0.110	0.219	0.292	0.366	0.439	0.585	0.731	
			Feed (mm/min)	1010	1010	1010	1010	1010	1010	1010	1010	1010

continued on next page

Series 135 3D Metric	Hardness	Vc (m/min)	DC • mm									
			1.5	3	6	8	10	12	16	20		
N ALUMINUM ALLOYS 2017, 2024, 356, 6061, 7075	≤ 80 Bhn or ≤ 47 HRb	213	RPM	45239	22620	11310	8482	6786	5655	4241	3393	
		(171-256)	Fr	0.059	0.119	0.238	0.317	0.396	0.476	0.634	0.793	
			Feed (mm/min)	2690	2690	2690	2690	2690	2690	2690	2690	
	≤ 150 Bhn or ≤ 8 HRb	183	RPM	38777	19388	9694	7271	5816	4847	3635	2908	
		(146-219)	Fr	0.060	0.120	0.240	0.320	0.400	0.480	0.640	0.799	
			Feed (mm/min)	2325	2325	2325	2325	2325	2325	2325	2325	
	COPPER ALLOYS Alum Bronze, C110, Muntz Brass	≤ 140 Bhn or ≤ 3 HRc	152	RPM	32314	16157	8078	6059	4847	4039	3029	2424
			(122-183)	Fr	0.024	0.048	0.096	0.128	0.160	0.192	0.256	0.320
				Feed (mm/min)	776	776	776	776	776	776	776	776
		≤ 200 Bhn or ≤ 23 HRc	122	RPM	25851	12926	6463	4847	3878	3231	2424	1939
			(98-146)	Fr	0.024	0.049	0.097	0.130	0.162	0.195	0.260	0.325
				Feed (mm/min)	630	630	630	630	630	630	630	630
S HIGH TEMP ALLOYS (NICKEL, COBALT, IRON BASE) Inconel 601, 617, 625, Incoloy, Monel 400, Rene, Waspaloy	≤ 300 Bhn or ≤ 32 HRc	17	RPM	3555	1777	889	666	533	444	333	267	
		(13-20)	Fr	0.010	0.020	0.039	0.053	0.066	0.079	0.105	0.131	
			Feed (mm/min)	35	35	35	35	35	35	35	35	
	≤ 400 Bhn or ≤ 43 HRc	9	RPM	1939	969	485	364	291	242	182	145	
		(7-11)	Fr	0.008	0.015	0.031	0.041	0.052	0.062	0.083	0.103	
			Feed (mm/min)	15	15	15	15	15	15	15	15	
	TITANIUM ALLOYS Pure Titanium, Ti6Al4V, Ti6Al2Sn4Zr2Mo, Ti4Al4Mo2Sn0.5Si, Ti-6Al4V	≤ 275 Bhn or ≤ 28 HRc	41	RPM	8725	4362	2181	1636	1309	1091	818	654
			(33-49)	Fr	0.021	0.042	0.085	0.113	0.141	0.170	0.226	0.283
				Feed (mm/min)	185	185	185	185	185	185	185	185
		≤ 350 Bhn or ≤ 38 HRc	30	RPM	6463	3231	1616	1212	969	808	606	485
			(24-37)	Fr	0.019	0.039	0.077	0.103	0.129	0.155	0.206	0.258
				Feed (mm/min)	125	125	125	125	125	125	125	125
≤ 440 Bhn or ≤ 47 HRc		17	RPM	3555	1777	889	666	533	444	333	267	
		(13-20)	Fr	0.014	0.028	0.056	0.075	0.094	0.113	0.150	0.188	
			Feed (mm/min)	50	50	50	50	50	50	50	50	
H TOOL STEELS A2, D2, H13, L2, M2, P20, S7, T15, W2	≤ 475 Bhn or ≤ 50 HRc	23	RPM	4847	2424	1212	909	727	606	454	364	
		(18-27)	Fr	0.009	0.019	0.037	0.050	0.062	0.074	0.099	0.124	
			Feed (mm/min)	45	45	45	45	45	45	45	45	

Bhn (Brinell) HRc (Rockwell C) HRb (Rockwell B)

rpm = (Vc x 1000) / (DC x 3.14)

mm/min = Fr x rpm

reduce speed and feed for materials harder than listed

refer to the SGS Tool Wizard® for complete technical information (www.kyocera-sgstool.com)



135 5xD

FRACTIONAL & METRIC SERIES

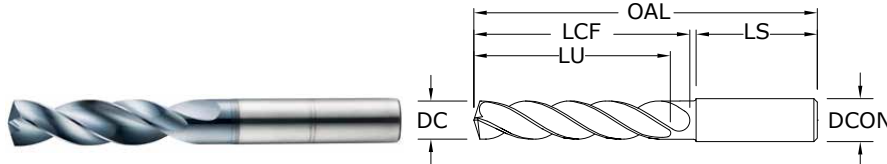

- 4-margin design improves accuracy and surface finish along with increased strength for aggressive drilling
- Specialized self-centering notched point eliminates the need for spot drilling decreasing thrust and deflection
- Engineered edge protection improves edge strength and reduces edge fatigue allowing for increased feed rates
- Recommended for materials ≤ 56 HRc (≤ 577 Bhn)

inch & mm									EDP NO.
DECIMAL DC	METRIC DC	FRACTIONAL/ LETTER/WIRE DC	SHANK DIAMETER DCON	OVERALL LENGTH OAL	FLUTE LENGTH LCF	USABLE LENGTH LU	SHANK LENGTH LS	Ti-NAMITE-A (AlTiN)	
0.0156	0,396 mm	1/64	1/8	1 1/2	5/32	1/8	1	52300*	
0.0312	0,792 mm	1/32	1/8	1 1/2	5/16	17/64	1	52301*	
0.0469	1,191 mm	3/64	1/8	1 1/2	25/64	21/64	1	52302*	
0.0492	1,250 mm		3,0	38,0	10,0	8,0	25,0	64520*	
0.0571	1,450 mm		3,0	38,0	10,0	8,0	25,0	64521*	
0.0595	1,511 mm	#53	1/8	1-1/2	25/64	5/16	1	64522*	
0.0625	1,588 mm	1/16	1/8	2	15/32	3/8	1-1/4	52303*	
0.0630	1,600 mm		3,0	50,0	12,0	10,0	32,0	64523*	
0.0689	1,750 mm		3,0	50,0	12,0	9,0	32,0	64524*	
0.0700	1,778 mm	#50	1/8	2	15/32	23/64	1-1/4	64525*	
0.0781	1,984 mm	5/64	1/8	2	35/64	7/16	1-1/4	52304*	
0.0785	1,994 mm	#47	1/8	2	35/64	7/16	1-1/4	64526*	
0.0807	2,050 mm		3,0	50,0	14,0	11,0	32,0	64527*	
0.0810	2,057 mm	#46	1/8	2	35/64	27/64	1-1/4	64528*	
0.0890	2,261 mm	#43	1/8	2	19/32	15/32	1-1/4	64529*	
0.0935	2,375 mm	#42	1/8	2	5/8	31/64	1-1/4	64530*	
0.0938	2,383 mm	3/32	1/8	2	5/8	31/64	1-1/4	52305	
0.0980	2,489 mm	#40	1/8	2	43/64	17/32	1-1/4	52306	
0.0984	2,500 mm		3,0	50,0	17,0	13,0	32,0	64531	
0.0995	2,527 mm	#39	1/8	2	43/64	17/32	1-1/4	52307	
0.1015	2,578 mm	#38	1/8	2	43/64	17/32	1-1/4	52308	
0.1040	2,642 mm	#37	1/8	2	45/64	35/64	1-1/4	52309	
0.1065	2,705 mm	#36	1/8	2	45/64	35/64	1-1/4	52310	
0.1094	2,779 mm	7/64	1/8	2	3/4	19/32	1-1/4	52311	
0.1100	2,794 mm	#35	1/8	2	3/4	19/32	1-1/4	52312	
0.1110	2,819 mm	#34	1/8	2	3/4	19/32	1-1/4	52313	
0.1130	2,870 mm	#33	1/8	2	3/4	19/32	1-1/4	52314	
0.1142	2,900 mm		3,0	50,0	19,0	15,0	32,0	64532	
0.1160	2,946 mm	#32	1/8	2	3/4	37/64	1-1/4	52315	
0.1181	3,000 mm		6,0	66,0	28,0	24,0	36,0	64100	
0.1200	3,048 mm	#31	1/8	2	3/4	37/64	1-1/4	52316	
0.1220	3,100 mm		6,0	66,0	28,0	23,0	36,0	64101	
0.1250	3,175 mm	1/8	1/4	3	1	13/16	1-7/16	51580	
0.1260	3,200 mm		6,0	66,0	28,0	23,0	36,0	64102	
0.1285	3,264 mm	#30	1/4	3	1	13/16	1-7/16	51581	
0.1299	3,300 mm		6,0	66,0	28,0	23,0	36,0	64103	

*Single Margin

continued on next page

TOLERANCES (inch)

- $\leq .1181$ DIAMETER
DC = $+0.0008/+0.0047$
DCON = h_6
- $>.1181-.2362$ DIAMETER
DC = $+0.0016/+0.0063$
DCON = h_6
- $>.2362-.3937$ DIAMETER
DC = $+0.0024/+0.0083$
DCON = h_6
- $>.3937-.7087$ DIAMETER
DC = $+0.0028/+0.0098$
DCON = h_6
- $>.7087-1.1811$ DIAMETER
DC = $+0.0031/+0.0114$
DCON = h_6

TOLERANCES (mm)

- ≤ 3 DIAMETER
DC = $+0,002/+0,012$
DCON = h_6
- $>3-6$ DIAMETER
DC = $+0,004/+0,016$
DCON = h_6
- $>6-10$ DIAMETER
DC = $+0,006/+0,021$
DCON = h_6
- $>10-18$ DIAMETER
DC = $+0,007/+0,025$
DCON = h_6
- $>18-30$ DIAMETER
DC = $+0,008/+0,029$
DCON = h_6

- STEELS
- STAINLESS STEELS
- CAST IRON
- NON-FERROUS
- HIGH TEMP ALLOYS
- HARDENED STEELS

For patent information visit www.ksptpatents.com



135 5xD

FRACTIONAL & METRIC SERIES

DECIMAL DC	METRIC DC	inch & mm						EDP NO.
		FRACTIONAL/ LETTER/WIRE DC	SHANK DIAMETER DCON	OVERALL LENGTH OAL	FLUTE LENGTH LCF	USABLE LENGTH LU	SHANK LENGTH LS	Ti-NAMITE-A (AITiN)
0.1339	3,400 mm		6,0	66,0	28,0	23,0	36,0	64104
0.1360	3,454 mm	#29	1/4	3	1	51/64	1-7/16	51582
0.1378	3,500 mm		6,0	66,0	28,0	23,0	36,0	64105
0.1405	3,569 mm	#28	1/4	3	1	51/64	1-7/16	52317
0.1406	3,571 mm	9/64	1/4	3	1	51/64	1-7/16	51583
0.1417	3,600 mm		6,0	66,0	28,0	23,0	36,0	64106
0.1440	3,658 mm	#27	1/4	3	1	51/64	1-7/16	52318
0.1457	3,700 mm		6,0	66,0	28,0	22,0	36,0	64107
0.1470	3,734 mm	#26	1/4	3	1	25/32	1-7/16	52319
0.1495	3,797 mm	#25	1/4	3-1/4	1-1/4	1-1/32	1-7/16	51584
0.1496	3,800 mm		6,0	74,0	36,0	30,0	36,0	64108
0.1520	3,861 mm	#24	1/4	3-1/4	1-1/4	1-1/32	1-7/16	52321
0.1535	3,900 mm		6,0	74,0	36,0	30,0	36,0	64109
0.1540	3,912 mm	#23	1/4	3-1/4	1-1/4	1-1/32	1-7/16	52322
0.1562	3,967 mm	5/32	1/4	3-1/4	1-1/4	1-1/64	1-7/16	51585
0.1570	3,988 mm	#22	1/4	3-1/4	1-1/4	1-1/64	1-7/16	52323
0.1575	4,000 mm		6,0	74,0	36,0	30,0	36,0	64110
0.1590	4,039 mm	#21	1/4	3-1/4	1-1/4	1-1/64	1-7/16	51586
0.1610	4,089 mm	#20	1/4	3-1/4	1-1/4	1	1-7/16	51587
0.1614	4,100 mm		6,0	74,0	36,0	30,0	36,0	64111
0.1654	4,200 mm		6,0	74,0	36,0	30,0	36,0	64112
0.1660	4,216 mm	#19	1/4	3-1/4	1-1/4	1	1-7/16	52324
0.1693	4,300 mm		6,0	74,0	36,0	30,0	36,0	64113
0.1695	4,305 mm	#18	1/4	3-1/4	1-1/4	1	1-7/16	52325
0.1719	4,366 mm	11/64	1/4	3-1/4	1-1/4	1	1-7/16	51588
0.1730	4,394 mm	#17	1/4	3-1/4	1-1/4	1	1-7/16	52326
0.1732	4,400 mm		6,0	74,0	36,0	29,0	36,0	64114
0.1772	4,500 mm		6,0	74,0	36,0	29,0	36,0	64115
0.1800	4,572 mm	#15	1/4	3-1/4	1-1/4	63/64	1-7/16	52327
0.1811	4,600 mm		6,0	74,0	36,0	29,0	36,0	64116
0.1820	4,623 mm	#14	1/4	3-1/4	1-1/4	63/64	1-7/16	52328
0.1850	4,699 mm	#13	1/4	3-1/4	1-1/4	63/64	1-7/16	52329
0.1850	4,699 mm	#13	6,0	74,0	36,0	29,0	36,0	64117
0.1875	4,763 mm	3/16	1/4	3-1/4	1-3/4	1-15/32	1-7/16	51589
0.1890	4,801 mm	#12	1/4	3-1/4	1-3/4	1-15/32	1-7/16	52330
0.1890	4,801 mm	#12	6,0	82,0	44,0	37,0	36,0	64118
0.1929	4,900 mm		6,0	82,0	44,0	37,0	36,0	64119
0.1935	4,915 mm	#10	1/4	3-1/4	1-3/4	1-15/32	1-7/16	52331
0.1960	4,978 mm	#9	1/4	3-1/4	1-3/4	1-15/32	1-7/16	52332
0.1969	5,000 mm		6,0	82,0	44,0	36,0	36,0	64120
0.1990	5,055 mm	#8	1/4	3-1/4	1-3/4	1-15/32	1-7/16	52333
0.2008	5,100 mm		6,0	82,0	44,0	36,0	36,0	64121
0.2010	5,105 mm	#7	1/4	3-1/4	1-3/4	1-29/64	1-7/16	51506
0.2031	5,159 mm	13/64	1/4	3-1/4	1-3/4	1-29/64	1-7/16	51507
0.2040	5,182 mm	#6	1/4	3 1/4	1 3/4	1-29/64	1 7/16	52334
0.2047	5,200 mm		6,0	82,0	44,0	36,0	36,0	64122

continued on next page

CONTINUED



135 5xD

FRACTIONAL & METRIC SERIES

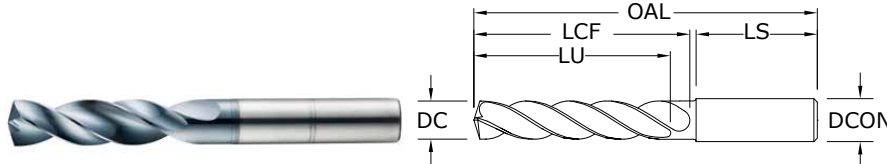

- 4-margin design improves accuracy and surface finish along with increased strength for aggressive drilling
- Specialized self-centering notched point eliminates the need for spot drilling decreasing thrust and deflection
- Engineered edge protection improves edge strength and reduces edge fatigue allowing for increased feed rates
- Recommended for materials ≤ 56 HRc (≤ 577 Bhn)

inch & mm									EDP NO.
DECIMAL DC	METRIC DC	FRACTIONAL/ LETTER/WIRE DC	SHANK DIAMETER DCON	OVERALL LENGTH OAL	FLUTE LENGTH LCF	USABLE LENGTH LU	SHANK LENGTH LS	Ti-NAMITE-A (AITiN)	
0.2055	5,220 mm	#5	1/4	3-1/4	1-3/4	1-29/64	1-7/16	51590	
0.2067	5,250 mm		6,0	82,0	44,0	36,0	36,0	64123	
0.2087	5,300 mm		6,0	82,0	44,0	36,0	36,0	64124	
0.2090	5,309 mm	#4	1/4	3-1/4	1-3/4	1-7/16	1-7/16	51508	
0.2126	5,400 mm		6,0	82,0	44,0	36,0	36,0	64125	
0.2130	5,410 mm	#3	1/4	3-1/4	1-3/4	1-7/16	1-7/16	51509	
0.2165	5,500 mm		6,0	82,0	44,0	36,0	36,0	64126	
0.2188	5,558 mm	7/32	1/4	3-1/4	1-3/4	1-27/64	1-7/16	51510	
0.2205	5,600 mm		6,0	82,0	44,0	36,0	36,0	64127	
0.2210	5,613 mm	#2	1/4	3-1/4	1-3/4	1-27/64	1-7/16	52335	
0.2244	5,700 mm		6,0	82,0	44,0	35,0	36,0	64128	
0.2280	5,791 mm	#1	1/4	3-1/4	1-3/4	1-13/32	1-7/16	52336	
0.2283	5,800 mm		6,0	82,0	44,0	35,0	36,0	64129	
0.2323	5,900 mm		6,0	82,0	44,0	35,0	36,0	64130	
0.2340	5,944 mm	A	1/4	3-1/4	1-3/4	1-13/32	1-7/16	52337	
0.2344	5,954 mm	15/64	1/4	3-1/4	1-3/4	1-13/32	1-7/16	51591	
0.2362	6,000 mm		6,0	82,0	44,0	35,0	36,0	64131	
0.2380	6,045 mm	B	1/4	3 5/8	2-5/64	1-13/32	1-7/16	52338	
0.2402	6,100 mm		8,0	91,0	53,0	44,0	36,0	64132	
0.2420	6,147 mm	C	1/4	3 5/8	2-5/64	1-13/32	1-7/16	52339	
0.2441	6,200 mm		8,0	91,0	53,0	44,0	36,0	64133	
0.2460	6,248 mm	D	1/4	3 5/8	2-5/64	1-13/32	1-7/16	52340	
0.2461	6,250 mm		8,0	91,0	53,0	44,0	36,0	64134	
0.2480	6,300 mm		8,0	91,0	53,0	44,0	36,0	64135	
0.2500	6,350 mm	1/4 E #0	1/4	3-5/8	2-5/64	1-45/64	1-7/16	51511	
0.2520	6,400 mm		8,0	91,0	53,0	43,0	36,0	64136	
0.2559	6,500 mm		8,0	91,0	53,0	43,0	36,0	64137	
0.2570	6,528 mm	F	5/16	3-5/8	2-5/64	1-45/64	1-7/16	51512	
0.2598	6,600 mm		8,0	91,0	53,0	43,0	36,0	64138	
0.2610	6,629 mm	G	5/16	3 5/8	2 5/64	1-11/16	1 7/16	52341	
0.2638	6,700 mm		8,0	91,0	53,0	43,0	36,0	64139	
0.2656	6,746 mm	17/64	5/16	3-5/8	2-5/64	1-11/16	1-7/16	51513	
0.2660	6,756 mm	H	5/16	3-5/8	2-5/64	1-11/16	1-7/16	52342	
0.2677	6,800 mm		8,0	91,0	53,0	43,0	36,0	64140	
0.2717	6,900 mm		8,0	91,0	53,0	43,0	36,0	64141	
0.2720	6,909 mm	I	5/16	3-5/8	2-5/64	1-43/64	1-7/16	51514	

continued on next page

TOLERANCES (inch)

- $\leq .1181$ DIAMETER
DC = $+0.0008/+0.0047$
DCON = h_6
- $>.1181-.2362$ DIAMETER
DC = $+0.0016/+0.0063$
DCON = h_6
- $>.2362-.3937$ DIAMETER
DC = $+0.0024/+0.0083$
DCON = h_6
- $>.3937-.7087$ DIAMETER
DC = $+0.0028/+0.0098$
DCON = h_6
- $>.7087-1.1811$ DIAMETER
DC = $+0.0031/+0.0114$
DCON = h_6

TOLERANCES (mm)

- ≤ 3 DIAMETER
DC = $+0,002/+0,012$
DCON = h_6
- $>3-6$ DIAMETER
DC = $+0,004/+0,016$
DCON = h_6
- $>6-10$ DIAMETER
DC = $+0,006/+0,021$
DCON = h_6
- $>10-18$ DIAMETER
DC = $+0,007/+0,025$
DCON = h_6
- $>18-30$ DIAMETER
DC = $+0,008/+0,029$
DCON = h_6

- STEELS
- STAINLESS STEELS
- CAST IRON
- NON-FERROUS
- HIGH TEMP ALLOYS
- HARDENED STEELS

For patent information visit www.ksptpatents.com



135 5xD
FRACTIONAL & METRIC SERIES

DECIMAL DC	METRIC DC	inch & mm						EDP NO.
		FRACTIONAL/ LETTER/WIRE DC	SHANK DIAMETER DCON	OVERALL LENGTH OAL	FLUTE LENGTH LCF	USABLE LENGTH LU	SHANK LENGTH LS	Ti-NAMITE-A (AITiN)
0.2756	7,000 mm		8,0	91,0	53,0	42,0	36,0	64142
0.2770	7,036 mm	J	5/16	3 5/8	2-5/64	1-43/64	1-7/16	52343
0.2795	7,100 mm		8,0	91,0	53,0	42,0	36,0	64143
0.2810	7,137 mm	K	5/16	3 5/8	2-5/64	1-21/32	1-7/16	52344
0.2812	7,142 mm	9/32	5/16	3-5/8	2-5/64	1-21/32	1-7/16	51515
0.2835	7,200 mm		8,0	91,0	53,0	42,0	36,0	64144
0.2854	7,250 mm		8,0	91,0	53,0	42,0	36,0	64145
0.2874	7,300 mm		8,0	91,0	53,0	42,0	36,0	64146
0.2900	7,366 mm	L	5/16	3-5/8	2-5/64	1-41/64	1-7/16	52345
0.2913	7,400 mm		8,0	91,0	53,0	42,0	36,0	64147
0.2950	7,493 mm	M	5/16	3-5/8	2-5/64	1-41/64	1-7/16	52346
0.2953	7,500 mm		8,0	91,0	53,0	42,0	36,0	64148
0.2969	7,541 mm	19/64	5/16	3-5/8	2-5/64	1-41/64	1-7/16	51516
0.2992	7,600 mm		8,0	91,0	53,0	42,0	36,0	64149
0.3020	7,671 mm	N	5/16	3-5/8	2-5/64	1-5/8	1-7/16	52347
0.3031	7,700 mm		8,0	91,0	53,0	41,0	36,0	64150
0.3071	7,800 mm		8,0	91,0	53,0	41,0	36,0	64151
0.3110	7,900 mm		8,0	91,0	53,0	41,0	36,0	64152
0.3125	7,938 mm	5/16	5/16	3-5/8	2-5/64	1-39/64	1-7/16	51517
0.3150	8,000 mm		8,0	91,0	53,0	41,0	36,0	64153
0.3160	8,026 mm	O	3/8	4	2-13/32	1-15/16	1-9/16	52348
0.3189	8,100 mm		10,0	103,0	61,0	49,0	40,0	64154
0.3228	8,200 mm		10,0	103,0	61,0	49,0	40,0	64155
0.3230	8,204 mm	P	3/8	4	2-13/32	1-59/64	1-9/16	51518
0.3268	8,300 mm		10,0	103,0	61,0	49,0	40,0	64156
0.3281	8,334 mm	21/64	3/8	4	2-13/32	1-59/64	1-9/16	51519
0.3307	8,400 mm		10,0	103,0	61,0	48,0	40,0	64157
0.3320	8,433 mm	Q	3/8	4	2-13/32	1-59/64	1-9/16	51520
0.3346	8,500 mm		10,0	103,0	61,0	48,0	40,0	64158
0.3386	8,600 mm		10,0	103,0	61,0	48,0	40,0	64159
0.3390	8,611 mm	R	3/8	4	2-13/32	1-29/32	1-9/16	52349
0.3425	8,700 mm		10,0	103,0	61,0	48,0	40,0	64160
0.3438	8,733 mm	11/32	3/8	4	2-13/32	1-57/64	1-9/16	51521
0.3465	8,800 mm		10,0	103,0	61,0	48,0	40,0	64161
0.3480	8,839 mm	S	3/8	4	2-13/32	1-57/64	1-9/16	51522
0.3504	8,900 mm		10,0	103,0	61,0	48,0	40,0	64162
0.3543	9,000 mm		10,0	103,0	61,0	48,0	40,0	64163
0.3580	9,093 mm	T	3/8	4	2 13/32	1-7/8	1 9/16	52350
0.3583	9,100 mm		10,0	103,0	61,0	47,0	40,0	64164
0.3594	9,129 mm	23/64	3/8	4	2-13/32	1-7/8	1-9/16	51523
0.3622	9,200 mm		10,0	103,0	61,0	47,0	40,0	64165
0.3642	9,250 mm		10,0	103,0	61,0	47,0	40,0	64166
0.3661	9,300 mm		10,0	103,0	61,0	47,0	40,0	64167
0.3680	9,347 mm	U	3/8	4	2-13/32	1-55/64	1-9/16	51524
0.3701	9,400 mm		10,0	103,0	61,0	47,0	40,0	64168
0.3740	9,500 mm		10,0	103,0	61,0	47,0	40,0	64169

continued on next page

CONTINUED



135 5xD

FRACTIONAL & METRIC SERIES

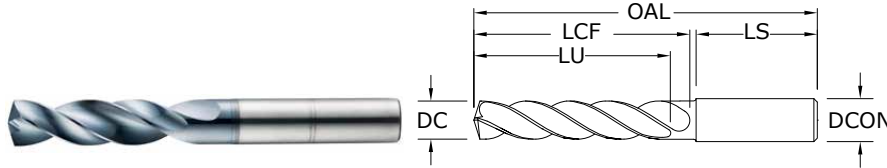

- 4-margin design improves accuracy and surface finish along with increased strength for aggressive drilling
- Specialized self-centering notched point eliminates the need for spot drilling decreasing thrust and deflection
- Engineered edge protection improves edge strength and reduces edge fatigue allowing for increased feed rates
- Recommended for materials ≤ 56 HRc (≤ 577 Bhn)

		inch & mm							EDP NO.
DECIMAL DC	METRIC DC	FRACTIONAL/ LETTER/WIRE DC	SHANK DIAMETER DCON	OVERALL LENGTH OAL	FLUTE LENGTH LCF	USABLE LENGTH LU	SHANK LENGTH LS	Ti-NAMITE-A (AITiN)	
0.3750	9,525 mm	3/8	3/8	4	2-13/32	1-27/32	1-9/16	51525	
0.3770	9,576 mm	V	1/2	4	2-13/32	1-27/32	1-9/16	52351	
0.3780	9,600 mm		10,0	103,0	61,0	47,0	40,0	64170	
0.3819	9,700 mm		10,0	103,0	61,0	46,0	40,0	64171	
0.3858	9,800 mm		10,0	103,0	61,0	46,0	40,0	64172	
0.3860	9,804 mm	W	1/2	4	2-13/32	1-53/64	1-9/16	51526	
0.3898	9,900 mm		10,0	103,0	61,0	46,0	40,0	64173	
0.3906	9,921 mm	25/64	1/2	4	2-13/32	1-53/64	1-9/16	51527	
0.3937	10,000 mm		10,0	103,0	61,0	46,0	40,0	64174	
0.3970	10,084 mm	X	1/2	4-11/16	2-3/4	2-5/32	1-49/64	52352	
0.3976	10,100 mm		12,0	118,0	71,0	56,0	45,0	64175	
0.4016	10,200 mm		12,0	118,0	71,0	56,0	45,0	64176	
0.4040	10,262 mm	Y	1/2	4-11/16	2-3/4	2-5/32	1-49/64	52353	
0.4055	10,300 mm		12,0	118,0	71,0	56,0	45,0	64177	
0.4062	10,317 mm	13/32	1/2	4-11/16	2-3/4	2-9/64	1-49/64	51528	
0.4095	10,400 mm		12,0	118,0	71,0	55,0	45,0	64178	
0.4130	10,490 mm	Z	1/2	4-11/16	2-3/4	2-9/64	1-49/64	52354	
0.4134	10,500 mm		12,0	118,0	71,0	55,0	45,0	64179	
0.4173	10,600 mm		12,0	118,0	71,0	55,0	45,0	64180	
0.4213	10,700 mm		12,0	118,0	71,0	55,0	45,0	64181	
0.4219	10,716 mm	27/64	1/2	4-11/16	2-3/4	2-1/8	1-49/64	51529	
0.4252	10,800 mm		12,0	118,0	71,0	55,0	45,0	64182	
0.4291	10,900 mm		12,0	118,0	71,0	55,0	45,0	64183	
0.4331	11,000 mm		12,0	118,0	71,0	54,0	45,0	64184	
0.4370	11,100 mm		12,0	118,0	71,0	54,0	45,0	64185	
0.4375	11,113 mm	7/16	1/2	4-11/16	2-3/4	2-3/32	1-49/64	51530	
0.4409	11,200 mm		12,0	118,0	71,0	54,0	45,0	64186	
0.4429	11,250 mm		12,0	118,0	71,0	54,0	45,0	64187	
0.4449	11,300 mm		12,0	118,0	71,0	54,0	45,0	64188	
0.4488	11,400 mm		12,0	118,0	71,0	54,0	45,0	64189	
0.4528	11,500 mm		12,0	118,0	71,0	54,0	45,0	64190	
0.4531	11,509 mm	29/64	1/2	4-11/16	2-3/4	2-5/64	1-49/64	51531	
0.4567	11,600 mm		12,0	118,0	71,0	54,0	45,0	64191	
0.4606	11,700 mm		12,0	118,0	71,0	53,0	45,0	64192	
0.4646	11,800 mm		12,0	118,0	71,0	53,0	45,0	64193	
0.4685	11,900 mm		12,0	118,0	71,0	53,0	45,0	64194	

TOLERANCES (inch)

- $\leq .1181$ DIAMETER
DC = $+0.0008/+0.0047$
DCON = h_6
- $>.1181-.2362$ DIAMETER
DC = $+0.0016/+0.0063$
DCON = h_6
- $>.2362-.3937$ DIAMETER
DC = $+0.0024/+0.0083$
DCON = h_6
- $>.3937-.7087$ DIAMETER
DC = $+0.0028/+0.0098$
DCON = h_6
- $>.7087-1.1811$ DIAMETER
DC = $+0.0031/+0.0114$
DCON = h_6

TOLERANCES (mm)

- ≤ 3 DIAMETER
DC = $+0,002/+0,012$
DCON = h_6
- $>3-6$ DIAMETER
DC = $+0,004/+0,016$
DCON = h_6
- $>6-10$ DIAMETER
DC = $+0,006/+0,021$
DCON = h_6
- $>10-18$ DIAMETER
DC = $+0,007/+0,025$
DCON = h_6
- $>18-30$ DIAMETER
DC = $+0,008/+0,029$
DCON = h_6

- STEELS
- STAINLESS STEELS
- CAST IRON
- NON-FERROUS
- HIGH TEMP ALLOYS
- HARDENED STEELS

For patent information visit www.ksptpatents.com

continued on next page



135 5xD

FRACTIONAL & METRIC SERIES

DECIMAL DC	METRIC DC	inch & mm						EDP NO.
		FRACTIONAL/ LETTER/WIRE DC	SHANK DIAMETER DCON	OVERALL LENGTH OAL	FLUTE LENGTH LCF	USABLE LENGTH LU	SHANK LENGTH LS	Ti-NAMITE-A (AITiN)
0.4688	11,908 mm	15/32	1/2	4-11/16	2-3/4	2-3/64	1-49/64	51532
0.4724	12,000 mm		12,0	118,0	71,0	53,0	45,0	64195
0.4844	12,304 mm	31/64	1/2	4-7/8	3-1/32	1-5/16	1-49/64	51533
0.4921	12,500 mm		14,0	124,0	77,0	58,0	45,0	64196
0.5000	12,700 mm	1/2	1/2	4-7/8	3-1/32	2-9/32	1-49/64	51534
0.5039	12,800 mm		14,0	124,0	77,0	58,0	45,0	64197
0.5118	13,000 mm		14,0	124,0	77,0	58,0	45,0	64198
0.5156	13,096 mm	33/64	5/8	4-7/8	3-1/32	2-17/64	1-49/64	51535
0.5312	13,492 mm	17/32	5/8	4-7/8	3-1/32	2-15/64	1-49/64	51536
0.5315	13,500 mm		14,0	124,0	77,0	57,0	45,0	64199
0.5469	13,8 mm	35/64	5/8	4-7/8	3-1/32	2-7/32	1-49/64	51537
0.5512	14,000 mm		14,0	124,0	77,0	56,0	45,0	64200
0.5625	14,288 mm	9/16	5/8	5-1/4	3-1/4	2-13/32	1-57/64	51538
0.5709	14,500 mm		16,0	133,0	83,0	61,0	48,0	64201
0.5781	14,684 mm	37/64	5/8	5-1/4	3-1/4	2-25/64	1-57/64	51539
0.5906	15,000 mm		16,0	133,0	83,0	60,0	48,0	64202
0.5938	15,083 mm	19/32	5/8	5-1/4	3-1/4	2-23/64	1-57/64	51592
0.6094	15,479 mm	39/64	5/8	5-1/4	3-1/4	2-11/32	1-57/64	51593
0.6102	15,500 mm		16,0	133,0	83,0	60,0	48,0	64203
0.6250	15,875 mm	5/8	5/8	5-1/4	3-1/4	2-5/16	1-57/64	51540
0.6299	16,000 mm		16,0	133,0	83,0	59,0	48,0	64204
0.6406	16,271 mm	41/64	3/4	5-5/8	3-5/8	2-43/64	1-57/64	51594
0.6496	16,500 mm		18,0	143,0	93,0	68,0	48,0	64205
0.6562	16,667 mm	21/32	3/4	5-5/8	3-5/8	2-41/64	1-57/64	51541
0.6693	17,000 mm		18,0	143,0	93,0	67,0	48,0	64206
0.6719	17,066 mm	43/64	3/4	5-5/8	3-5/8	2-5/8	1-57/64	51595
0.6875	17,463 mm	11/16	3/4	5-5/8	3-5/8	2-19/32	1-57/64	51542
0.6890	17,500 mm		18,0	143,0	93,0	67,0	48,0	64207
0.7031	17,859 mm	45/64	3/4	5-5/8	3-5/8	2-37/64	1-57/64	51543
0.7087	18,000 mm		18,0	143,0	93,0	66,0	48,0	64208
0.7188	18,258 mm	23/32	3/4	6	4	2-59/64	1-31/32	51596
0.7283	18,500 mm		20,0	153,0	101,0	73,0	50,0	64209
0.7344	18,654 mm	47/64	3/4	6	4	2-29/32	1-31/32	51544
0.7480	19,000 mm		20,0	153,0	101,0	73,0	50,0	64210
0.7500	19,050 mm	3/4	3/4	6	4	2-7/8	1-31/32	51545
0.7656	19,446 mm	49/64	7/8	6	4	2-55/64	1-31/32	52355
0.7677	19,500 mm		20,0	153,0	101,0	72,0	50,0	64211
0.7812	19,842 mm	25/32	7/8	6	4	2-55/64	1-31/32	52356
0.7874	20,000 mm		20,0	153,0	101,0	71,0	50,0	64212
0.7969	20,241 mm	51/64	7/8	6	4	2-13/16	1-31/32	52357
0.8071	20,500 mm		22,0	153,0	101,0	70,0	50,0	64533
0.8125	20,638 mm	13/16	7/8	6-1/2	4-1/2	3-3/32	1-31/32	52358
0.8268	21,000 mm		22,0	153,0	101,0	69,0	50,0	64534
0.8661	22,000 mm		22,0	178,0	127,0	94,0	50,0	64535
0.8750	22,225 mm	7/8	7/8	6-1/2	4-1/2	3-3/16	1-31/32	52359
0.9219	23,416 mm	59/64	1	7	5	3-5/8	2-1/8	52360

CONTINUED

FRACTIONAL
Hi-PerCarb®

Series 135 5D Fractional	Hardness	Vc (sfm)		DC • in							
				1/32	1/8	1/4	3/8	1/2	5/8	7/8	
CARBON STEELS 1018, 1040, 1080, 1090, 10L50, 1140, 1212, 12L15, 1525, 1536	≤ 175 Bhn or ≤ 7 HRc	345 (276-414)	RPM	42173	10543	5272	3514	2636	2109	1506	
			Fr	0.0010	0.0040	0.0080	0.0120	0.0159	0.0199	0.0279	
			Feed (ipm)	42.0	42.0	42.0	42.0	42.0	42.0	42.0	
	≤ 275 Bhn or ≤ 28 HRc	310 (248-372)	RPM	37894	9474	4737	3158	2368	1895	1353	
			Fr	0.0009	0.0036	0.0072	0.0108	0.0144	0.0179	0.0251	
			Feed (ipm)	34.0	34.0	34.0	34.0	34.0	34.0	34.0	
	≤ 425 Bhn or ≤ 45 HRc	180 (144-216)	RPM	22003	5501	2750	1834	1375	1100	786	
			Fr	0.0007	0.0030	0.0060	0.0090	0.0120	0.0150	0.0210	
			Feed (ipm)	16.5	16.5	16.5	16.5	16.5	16.5	16.5	
	ALLOY STEELS 4140, 4150, 4320, 5120, 5150, 8630, 86L20, 50100	≤ 275 Bhn or ≤ 28 HRc	270 (216-324)	RPM	33005	8251	4126	2750	2063	1650	1179
				Fr	0.0008	0.0030	0.0061	0.0091	0.0121	0.0151	0.0212
				Feed (ipm)	25.0	25.0	25.0	25.0	25.0	25.0	25.0
≤ 375 Bhn or ≤ 40 HRc		165 (132-198)	RPM	20170	5042	2521	1681	1261	1008	720	
			Fr	0.0006	0.0026	0.0052	0.0077	0.0103	0.0129	0.0180	
			Feed (ipm)	13.0	13.0	13.0	13.0	13.0	13.0	13.0	
≤ 425 Bhn or ≤ 45 HRc		115 (92-138)	RPM	14058	3514	1757	1171	879	703	502	
			Fr	0.0004	0.0018	0.0035	0.0053	0.0071	0.0088	0.0123	
			Feed (ipm)	6.2	6.2	6.2	6.2	6.2	6.2	6.2	
TOOL STEELS A2, D2, H13, L2, M2, P20, S7, T15, W2		≤ 200 Bhn or ≤ 13 HRc	120 (96-144)	RPM	14669	3667	1834	1222	917	733	524
				Fr	0.0006	0.0026	0.0051	0.0077	0.0103	0.0128	0.0179
				Feed (ipm)	9.4	9.4	9.4	9.4	9.4	9.4	9.4
	≤ 375 Bhn or ≤ 40 HRc	80 (64-96)	RPM	9779	2445	1222	815	611	489	349	
			Fr	0.0003	0.0012	0.0024	0.0036	0.0047	0.0059	0.0083	
			Feed (ipm)	2.9	2.9	2.9	2.9	2.9	2.9	2.9	
STAINLESS STEELS (FREE MACHINING) 303, 416, 420F, 430F, 440F	≤ 185 Bhn or ≤ 9 HRc	250 (200-300)	RPM	30560	7640	3820	2547	1910	1528	1091	
			Fr	0.0006	0.0026	0.0051	0.0077	0.0102	0.0128	0.0179	
			Feed (ipm)	19.5	19.5	19.5	19.5	19.5	19.5	19.5	
	≤ 275 Bhn or ≤ 28 HRc	150 (120-180)	RPM	18336	4584	2292	1528	1146	917	655	
			Fr	0.0005	0.0020	0.0039	0.0059	0.0079	0.0098	0.0137	
			Feed (ipm)	9.0	9.0	9.0	9.0	9.0	9.0	9.0	
STAINLESS STEELS (DIFFICULT) 304, 316, 321, 13-8 PH, 15-5PH, 17-4 PH, Custom 450	≤ 275 Bhn or ≤ 28 HRc	80 (64-96)	RPM	9779	2445	1222	815	611	489	349	
			Fr	0.0005	0.0020	0.0039	0.0059	0.0079	0.0098	0.0137	
			Feed (ipm)	4.8	4.8	4.8	4.8	4.8	4.8	4.8	
	≤ 375 Bhn or ≤ 40 HRc	55 (44-66)	RPM	6723	1681	840	560	420	336	240	
			Fr	0.0004	0.0018	0.0036	0.0054	0.0071	0.0089	0.0125	
			Feed (ipm)	3.0	3.0	3.0	3.0	3.0	3.0	3.0	
CAST IRONS Gray, Malleable, Ductile	≤ 220 Bhn or ≤ 19 HRc	300 (240-360)	RPM	36672	9168	4584	3056	2292	1834	1310	
			Fr	0.0011	0.0045	0.0089	0.0134	0.0179	0.0224	0.0313	
			Feed (ipm)	41.0	41.0	41.0	41.0	41.0	41.0	41.0	
	≤ 260 Bhn or ≤ 26 HRc	265 (212-318)	RPM	32394	8098	4049	2699	2025	1620	1157	
			Fr	0.0011	0.0046	0.0091	0.0137	0.0183	0.0228	0.0320	
			Feed (ipm)	37.0	37.0	37.0	37.0	37.0	37.0	37.0	

continued on next page

Series 135 5D Fractional	Hardness	Vc (sfm)	DC • in								
			1/32	1/8	1/4	3/8	1/2	5/8	7/8		
N ALUMINUM ALLOYS 2017, 2024, 356, 6061, 7075	≤ 80 Bhn or ≤ 47 HRb	635	RPM	77622	19406	9703	6469	4851	3881	2772	
		(508-762)	Fr	0.0012	0.0049	0.0099	0.0148	0.0198	0.0247	0.0346	
			Feed (ipm)	96.0	96.0	96.0	96.0	96.0	96.0	96.0	
	≤ 150 Bhn or ≤ 88 HRc	540	RPM	66010	16502	8251	5501	4126	3300	2357	
		(432-648)	Fr	0.0012	0.0050	0.0099	0.0149	0.0199	0.0248	0.0348	
			Feed (ipm)	82.0	82.0	82.0	82.0	82.0	82.0	82.0	
	COPPER ALLOYS Alum Bronze, C110, Muntz Brass	≤ 140 Bhn or ≤ 3 HRc	450	RPM	55008	13752	6876	4584	3438	2750	1965
			(360-540)	Fr	0.0005	0.0020	0.0040	0.0060	0.0080	0.0100	0.0140
				Feed (ipm)	27.5	27.5	27.5	27.5	27.5	27.5	27.5
		≤ 200 Bhn or ≤ 23 HRc	360	RPM	44006	11002	5501	3667	2750	2200	1572
			(288-432)	Fr	0.0005	0.0020	0.0040	0.0060	0.0080	0.0100	0.0140
				Feed (ipm)	22.0	22.0	22.0	22.0	22.0	22.0	22.0
S HIGH TEMP ALLOYS (Nickel, Cobalt, Iron Base) Inconel 601, 617, 625, Incoloy, Monel 400, Rene, Waspaloy	≤ 300 Bhn or ≤ 32 HRc	40	RPM	4890	1222	611	407	306	244	175	
		(32-48)	Fr	0.0002	0.0008	0.0016	0.0025	0.0033	0.0041	0.0057	
			Feed (ipm)	1.0	1.0	1.0	1.0	1.0	1.0	1.0	
	≤ 400 Bhn or ≤ 43 HRc	20	RPM	2445	611	306	204	153	122	87	
		(16-24)	Fr	0.0002	0.0007	0.0013	0.0020	0.0026	0.0033	0.0046	
			Feed (ipm)	0.4	0.4	0.4	0.4	0.4	0.4	0.4	
	TITANIUM ALLOYS Pure Titanium, Ti6Al4V, Ti6Al2Sn4Zr2Mo, Ti4Al4Mo2Sn0.5Si, Ti-6Al4V	≤ 275 Bhn or ≤ 28 HRc	105	RPM	12835	3209	1604	1070	802	642	458
			(84-126)	Fr	0.0005	0.0018	0.0036	0.0054	0.0072	0.0090	0.0127
				Feed (ipm)	5.8	5.8	5.8	5.8	5.8	5.8	5.8
		≤ 350 Bhn or ≤ 38 HRc	80	RPM	9779	2445	1222	815	611	489	349
			(64-96)	Fr	0.0004	0.0016	0.0032	0.0048	0.0064	0.0080	0.0112
				Feed (ipm)	3.9	3.9	3.9	3.9	3.9	3.9	3.9
≤ 440 Bhn or ≤ 47 HRc	42	RPM	5134	1284	642	428	321	257	183		
	(34-50)	Fr	0.0003	0.0012	0.0025	0.0037	0.0050	0.0062	0.0087		
		Feed (ipm)	1.6	1.6	1.6	1.6	1.6	1.6	1.6		
H TOOL STEELS A2, D2, H13, L2, M2, P20, S7, T15, W2	≤ 475 Bhn or ≤ 50 HRc	70	RPM	8557	2139	1070	713	535	428	306	
		(56-84)	Fr	0.0002	0.0008	0.0016	0.0024	0.0032	0.0040	0.0056	
			Feed (ipm)	1.7	1.7	1.7	1.7	1.7	1.7	1.7	

Bhn (Brinell) HRc (Rockwell C) HRb (Rockwell B)

rpm = Vc x 3.82 / DC

ipm = Fr x rpm

reduce speed and feed for materials harder than listed

refer to the SGS Tool Wizard® for complete technical information (www.kyocera-sgstool.com)

Series 135M 5D Metric	Hardness	Vc (m/min)	DC • mm									
			1.5	3	6	8	10	12	16	20		
P CARBON STEELS 1018, 1040, 1080, 1090, 10L50, 1140, 1212, 12L15, 1525, 1536	≤ 175 Bhn or ≤ 7 HRc	105	RPM	22297	11148	5574	4181	3344	2787	2090	1672	
		(84-126)	Fr	0.048	0.095	0.190	0.254	0.317	0.380	0.507	0.634	
			Feed (mm/min)	1060	1060	1060	1060	1060	1060	1060	1060	
	≤ 275 Bhn or ≤ 28 HRc	94	RPM	20035	10017	5009	3756	3005	2504	1878	1503	
		(76-113)	Fr	0.043	0.085	0.171	0.228	0.285	0.341	0.455	0.569	
			Feed (mm/min)	855	855	855	855	855	855	855	855	
	≤ 425 Bhn or ≤ 45 HRc	55	RPM	11633	5816	2908	2181	1745	1454	1091	872	
		(44-66)	Fr	0.036	0.071	0.143	0.190	0.238	0.285	0.381	0.476	
			Feed (mm/min)	415	415	415	415	415	415	415	415	
	P ALLOY STEELS 4140, 4150, 4320, 5120, 5150, 8630, 86L20, 50100	≤ 275 Bhn or ≤ 28 HRc	82	RPM	17449	8725	4362	3272	2617	2181	1636	1309
			(66-99)	Fr	0.036	0.072	0.143	0.191	0.239	0.287	0.382	0.478
				Feed (mm/min)	625	625	625	625	625	625	625	625
≤ 375 Bhn or ≤ 40 HRc		50	RPM	10664	5332	2666	1999	1600	1333	1000	800	
		(40-60)	Fr	0.031	0.062	0.124	0.165	0.206	0.248	0.330	0.413	
			Feed (mm/min)	330	330	330	330	330	330	330	330	
≤ 425 Bhn or ≤ 45 HRc		35	RPM	7432	3716	1858	1394	1115	929	697	557	
		(28-42)	Fr	0.022	0.043	0.086	0.115	0.144	0.172	0.230	0.287	
			Feed (mm/min)	160	160	160	160	160	160	160	160	
P TOOL STEELS A2, D2, H13, L2, M2, P20, S7, T15, W2		≤ 200 Bhn or ≤ 13 HRc	37	RPM	7755	3878	1939	1454	1163	969	727	582
			(29-44)	Fr	0.031	0.062	0.124	0.165	0.206	0.248	0.330	0.413
				Feed (mm/min)	240	240	240	240	240	240	240	240
	≤ 375 Bhn or ≤ 40 HRc	24	RPM	5170	2585	1293	969	776	646	485	388	
		(20-29)	Fr	0.015	0.029	0.058	0.077	0.097	0.116	0.155	0.193	
			Feed (mm/min)	75	75	75	75	75	75	75	75	
M STAINLESS STEELS (FREE MACHINING) 303, 416, 420F, 430F, 440F	≤ 185 Bhn or ≤ 9 HRc	76	RPM	16157	8078	4039	3029	2424	2020	1515	1212	
		(61-91)	Fr	0.031	0.061	0.123	0.163	0.204	0.245	0.327	0.408	
			Feed (mm/min)	495	495	495	495	495	495	495	495	
	≤ 275 Bhn or ≤ 28 HRc	46	RPM	9694	4847	2424	1818	1454	1212	909	727	
		(37-55)	Fr	0.024	0.047	0.095	0.127	0.158	0.190	0.253	0.316	
			Feed (mm/min)	230	230	230	230	230	230	230	230	
	M STAINLESS STEELS (DIFFICULT) 304, 316, 321, 13-8 PH, 15-5PH, 17-4 PH, Custom 450	≤ 275 Bhn or ≤ 28 HRc	24	RPM	5170	2585	1293	969	776	646	485	388
			(20-29)	Fr	0.023	0.046	0.093	0.124	0.155	0.186	0.248	0.309
				Feed (mm/min)	120	120	120	120	120	120	120	120
		≤ 375 Bhn or ≤ 40 HRc	17	RPM	3555	1777	889	666	533	444	333	267
			(13-20)	Fr	0.021	0.042	0.084	0.113	0.141	0.169	0.225	0.281
				Feed (mm/min)	75	75	75	75	75	75	75	75
K CAST IRONS Gray, Malleable, Ductile	≤ 220 Bhn or ≤ 19 HRc	91	RPM	19388	9694	4847	3635	2908	2424	1818	1454	
		(73-110)	Fr	0.054	0.108	0.217	0.289	0.361	0.433	0.578	0.722	
			Feed (mm/min)	1050	1050	1050	1050	1050	1050	1050	1050	
	≤ 260 Bhn or ≤ 26 HRc	81	RPM	17126	8563	4282	3211	2569	2141	1606	1284	
		(65-97)	Fr	0.055	0.109	0.218	0.291	0.364	0.437	0.582	0.728	
			Feed (mm/min)	935	935	935	935	935	935	935	935	

continued on next page

Series 135M 5D Metric	Hardness	Vc (m/min)	DC • mm									
			1.5	3	6	8	10	12	16	20		
N ALUMINUM ALLOYS 2017, 2024, 356, 6061, 7075	≤ 80 Bhn or ≤ 47 HRb	194	RPM	41039	20519	10260	7695	6156	5130	3847	3078	
		(155-232)	Fr	0.059	0.118	0.237	0.316	0.395	0.474	0.632	0.790	
			Feed (mm/min)	2430	2430	2430	2430	2430	2430	2430	2430	
	≤ 150 Bhn or ≤ 88 HRc	165	RPM	34899	17449	8725	6544	5235	4362	3272	2617	
		(132-198)	Fr	0.059	0.118	0.237	0.316	0.394	0.473	0.631	0.789	
			Feed (mm/min)	2065	2065	2065	2065	2065	2065	2065	2065	
	Copper Alloys Alum Bronze, C110, Muntz Brass	≤ 140 Bhn or ≤ 3 HRc	137	RPM	29082	14541	7271	5453	4362	3635	2726	2181
			(110-165)	Fr	0.027	0.053	0.107	0.142	0.178	0.213	0.284	0.355
				Feed (mm/min)	775	775	775	775	775	775	775	775
		≤ 200 Bhn or ≤ 23 HRc	110	RPM	23266	11633	5816	4362	3490	2908	2181	1745
			(88-132)	Fr	0.027	0.054	0.108	0.144	0.181	0.217	0.289	0.361
				Feed (mm/min)	630	630	630	630	630	630	630	630
S HIGH TEMP ALLOYS (Nickel, Cobalt, Iron Base) Inconel 601, 617, 625, Incoloy, Monel 400, Rene, Waspaloy	≤ 300 Bhn or ≤ 32 HRc	12	RPM	2585	1293	646	485	388	323	242	194	
		(10-15)	Fr	0.010	0.019	0.039	0.052	0.064	0.077	0.103	0.129	
			Feed (mm/min)	25	25	25	25	25	25	25	25	
	≤ 400 Bhn or ≤ 43 HRc	6	RPM	1293	646	323	242	194	162	121	97	
		(5-7)	Fr	0.007	0.014	0.028	0.037	0.046	0.056	0.074	0.093	
			Feed (mm/min)	9	9	9	9	9	9	9	9	
	TITANIUM ALLOYS Pure Titanium, Ti6Al4V, Ti6Al2Sn4Zr2Mo, Ti4Al4Mo2Sn0.5Si, Ti-6Al4V	≤ 275 Bhn or ≤ 28 HRc	32	RPM	6786	3393	1696	1272	1018	848	636	509
			(26-38)	Fr	0.021	0.043	0.085	0.114	0.142	0.171	0.228	0.285
				Feed (mm/min)	145	145	145	145	145	145	145	145
		≤ 350 Bhn or ≤ 38 HRc	24	RPM	5170	2585	1293	969	776	646	485	388
			(20-29)	Fr	0.019	0.039	0.077	0.103	0.129	0.155	0.206	0.258
				Feed (mm/min)	100	100	100	100	100	100	100	100
≤ 440 Bhn or ≤ 47 HRc		13	RPM	2714	1357	679	509	407	339	254	204	
		(10-15)	Fr	0.015	0.029	0.059	0.079	0.098	0.118	0.157	0.196	
			Feed (mm/min)	40	40	40	40	40	40	40	40	
H TOOL STEELS A2, D2, H13, L2, M2, P20, S7, T15, W2	≤ 475 Bhn or ≤ 50 HRc	21	RPM	4524	2262	1131	848	679	565	424	339	
		(17-26)	Fr	0.010	0.019	0.038	0.051	0.064	0.076	0.102	0.127	
			Feed (mm/min)	43	43	43	43	43	43	43	43	

Bhn (Brinell) HRc (Rockwell C) HRb (Rockwell B)

rpm = (Vc x 1000) / (DC x 3.14)

mm/min = Fr x rpm

reduce speed and feed for materials harder than listed

refer to the SGS Tool Wizard® for complete technical information (www.kyocera-sgstool.com)



146U 3xD
FRACTIONAL & METRIC SERIES

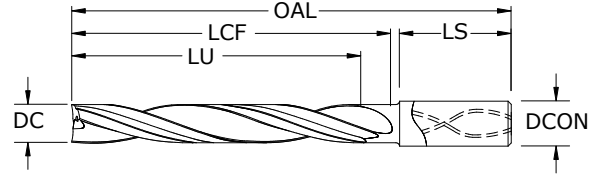

- 4-margin design improves accuracy and surface finish along with increased strength for aggressive drilling
- Specialized self-centering notched point eliminates the need for spot drilling decreasing thrust and deflection
- Engineered edge protection improves edge strength and reduces edge fatigue allowing for increased feed rates
- Recommended for materials ≤ 56 HRc (≤ 577 Bhn)

		inch & mm							EDP NO.
DECIMAL DC	METRIC DC	FRACTIONAL/ LETTER/WIRE DC	SHANK DIAMETER DCON	OVERALL LENGTH OAL	FLUTE LENGTH LCF	USABLE LENGTH LU	SHANK LENGTH LS	Ti-NAMITE®-X (TX)	
0.1181	3,000 mm		6,0	55,0	13,0	9,0	34,0	67705	
0.1220	3,100 mm		6,0	55,0	14,0	9,0	34,0	67706	
0.1250	3,175 mm	1/8	6,0	55,0	14,0	10,0	34,0	58800	
0.1260	3,200 mm		6,0	55,0	14,0	10,0	34,0	67707	
0.1299	3,300 mm		6,0	55,0	15,0	10,0	34,0	67708	
0.1339	3,400 mm		6,0	55,0	15,0	10,0	34,0	67709	
0.1360	3,454 mm	#29	6,0	55,0	16,0	10,0	34,0	58801	
0.1378	3,500 mm		6,0	55,0	16,0	11,0	34,0	67710	
0.1405	3,569 mm	#28	6,0	55,0	16,0	11,0	34,0	58802	
0.1406	3,571 mm	9/64	6,0	55,0	16,0	11,0	34,0	58803	
0.1417	3,600 mm		6,0	55,0	16,0	11,0	34,0	67711	
0.1457	3,700 mm		6,0	60,0	17,0	11,0	34,0	67712	
0.1470	3,734 mm	#26	6,0	60,0	17,0	11,0	34,0	58804	
0.1495	3,797 mm	#25	6,0	60,0	17,0	11,0	34,0	58805	
0.1496	3,800 mm		6,0	60,0	17,0	11,0	34,0	67713	
0.1520	3,861 mm	#24	6,0	60,0	17,0	12,0	34,0	58806	
0.1535	3,900 mm		6,0	60,0	18,0	12,0	34,0	67714	
0.1562	3,967 mm	5/32	6,0	60,0	18,0	12,0	34,0	58807	
0.1570	3,988 mm	#22	6,0	60,0	18,0	12,0	34,0	58808	
0.1575	4,000 mm		6,0	60,0	18,0	12,0	34,0	67715	
0.1590	4,039 mm	#21	6,0	60,0	18,0	12,0	34,0	58809	
0.1610	4,089 mm	#20	6,0	60,0	18,0	12,0	34,0	58810	
0.1614	4,100 mm		6,0	60,0	18,0	12,0	34,0	67716	
0.1654	4,200 mm		6,0	60,0	19,0	13,0	34,0	67717	
0.1693	4,300 mm		6,0	60,0	19,0	13,0	34,0	67718	
0.1719	4,366 mm	11/64	6,0	60,0	20,0	13,0	34,0	58811	
0.1732	4,400 mm		6,0	60,0	20,0	13,0	34,0	67719	
0.1770	4,496 mm	#16	6,0	60,0	20,0	13,0	34,0	58812	
0.1772	4,500 mm		6,0	60,0	20,0	14,0	34,0	67720	
0.1811	4,600 mm		6,0	60,0	21,0	14,0	34,0	67721	
0.1850	4,699 mm	#13	6,0	60,0	21,0	14,0	34,0	58813	
0.1875	4,763 mm	3/16	6,0	60,0	21,0	14,0	34,0	58814	
0.1890	4,801 mm	#12	6,0	65,0	22,0	14,0	33,0	58815	
0.1929	4,900 mm		6,0	65,0	22,0	15,0	33,0	67724	
0.1935	4,915 mm	#10	6,0	65,0	22,0	15,0	33,0	58816	
0.1969	5,000 mm		6,0	65,0	23,0	15,0	33,0	67725	

continued on next page

TOLERANCES (inch)

- ≤.1181 DIAMETER**
DC = +.00008/+0.00047
DCON = h_6
- >.1181-.2362 DIAMETER**
DC = +.00016/+0.00063
DCON = h_6
- >.2362-.3937 DIAMETER**
DC = +.00024/+0.00083
DCON = h_6
- >.3937-.7087 DIAMETER**
DC = +.00028/+0.00098
DCON = h_6
- >.7087-1.1811 DIAMETER**
DC = +.00031/+0.00114
DCON = h_6

TOLERANCES (mm)

- ≤3 DIAMETER**
DC = +0,002/+0,012
DCON = h_6
- >3-6 DIAMETER**
DC = +0,004/+0,016
DCON = h_6
- >6-10 DIAMETER**
DC = +0,006/+0,021
DCON = h_6
- >10-18 DIAMETER**
DC = +0,007/+0,025
DCON = h_6
- >18-30 DIAMETER**
DC = +0,008/+0,029
DCON = h_6

- STEELS
- STAINLESS STEELS
- CAST IRON
- NON-FERROUS
- HIGH TEMP ALLOYS
- HARDENED STEELS

For patent information visit www.ksptpatents.com



146U 3xD
FRACTIONAL & METRIC SERIES

DECIMAL DC	METRIC DC	inch & mm						EDP NO.
		FRACTIONAL/ LETTER/WIRE DC	SHANK DIAMETER DCON	OVERALL LENGTH OAL	FLUTE LENGTH LCF	USABLE LENGTH LU	SHANK LENGTH LS	Ti-NAMITE®-X (TX)
0.2008	5,100 mm		6,0	65,0	23,0	15,0	33,0	67726
0.2010	5,105 mm	#7	6,0	65,0	23,0	15,0	33,0	58817
0.2031	5,159 mm	13/64	6,0	65,0	23,0	15,0	33,0	58818
0.2047	5,200 mm		6,0	65,0	23,0	16,0	33,0	67727
0.2087	5,300 mm		6,0	65,0	24,0	16,0	33,0	67728
0.2090	5,309 mm	#4	6,0	65,0	24,0	16,0	33,0	58819
0.2126	5,400 mm		6,0	65,0	24,0	16,0	33,0	67729
0.2130	5,410 mm	#3	6,0	65,0	24,0	16,0	33,0	58820
0.2165	5,500 mm		6,0	65,0	25,0	16,0	33,0	67730
0.2188	5,558 mm	7/32	6,0	65,0	25,0	17,0	33,0	58821
0.2205	5,600 mm		6,0	65,0	25,0	17,0	33,0	67731
0.2244	5,700 mm		6,0	65,0	26,0	17,0	33,0	67732
0.2283	5,800 mm		6,0	65,0	26,0	17,0	33,0	67733
0.2323	5,900 mm		6,0	65,0	27,0	18,0	33,0	67734
0.2344	5,954 mm	15/64	6,0	65,0	27,0	18,0	33,0	58822
0.2362	6,000 mm		6,0	65,0	27,0	18,0	33,0	67735
0.2402	6,100 mm		8,0	70,0	28,0	19,0	34,0	67736
0.2441	6,200 mm		8,0	70,0	28,0	19,0	34,0	67737
0.2461	6,250 mm		8,0	70,0	28,0	19,0	34,0	67738
0.2480	6,300 mm		8,0	70,0	28,0	19,0	34,0	67739
0.2500	6,350 mm	1/4 E #0	8,0	70,0	29,0	19,0	34,0	58823
0.2520	6,400 mm		8,0	70,0	29,0	19,0	34,0	67740
0.2559	6,500 mm		8,0	70,0	29,0	19,0	34,0	67741
0.2570	6,528 mm	F	8,0	70,0	29,0	20,0	34,0	58824
0.2598	6,600 mm		8,0	70,0	30,0	20,0	34,0	67742
0.2638	6,700 mm		8,0	70,0	30,0	20,0	34,0	67743
0.2656	6,746 mm	17/64	8,0	70,0	30,0	20,0	34,0	58825
0.2677	6,800 mm		8,0	70,0	31,0	20,0	34,0	67744
0.2717	6,900 mm		8,0	70,0	31,0	21,0	34,0	67745
0.2720	6,909 mm	I	8,0	70,0	31,0	21,0	34,0	58826
0.2756	7,000 mm		8,0	75,0	32,0	21,0	34,0	67746
0.2795	7,100 mm		8,0	75,0	32,0	21,0	34,0	67747
0.2812	7,142 mm	9/32	8,0	75,0	32,0	21,0	34,0	58827
0.2835	7,200 mm		8,0	75,0	32,0	22,0	34,0	67748
0.2854	7,250 mm		8,0	75,0	33,0	22,0	34,0	67749
0.2874	7,300 mm		8,0	75,0	33,0	22,0	34,0	67750
0.2913	7,400 mm		8,0	75,0	33,0	22,0	34,0	67751
0.2953	7,500 mm		8,0	75,0	34,0	23,0	34,0	67752
0.2969	7,541 mm	19/64	8,0	75,0	34,0	23,0	34,0	58828
0.2992	7,600 mm		8,0	75,0	34,0	23,0	34,0	67753
0.3031	7,700 mm		8,0	75,0	35,0	23,0	34,0	67754
0.3071	7,800 mm		8,0	75,0	35,0	23,0	34,0	67755
0.3110	7,900 mm		8,0	75,0	36,0	24,0	34,0	67756
0.3125	7,938 mm	5/16	8,0	75,0	36,0	24,0	34,0	58829
0.3150	8,000 mm		8,0	75,0	36,0	24,0	34,0	67757
0.3189	8,100 mm		10,0	80,0	36,0	24,0	34,0	67758

CONTINUED

continued on next page

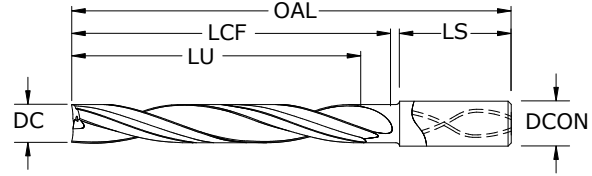

146U 3xD
FRACTIONAL & METRIC SERIES

- 4-margin design improves accuracy and surface finish along with increased strength for aggressive drilling
- Specialized self-centering notched point eliminates the need for spot drilling decreasing thrust and deflection
- Engineered edge protection improves edge strength and reduces edge fatigue allowing for increased feed rates
- Recommended for materials ≤ 56 HRc (≤ 577 Bhn)

		inch & mm							EDP NO.
DECIMAL DC	METRIC DC	FRACTIONAL/ LETTER/WIRE DC	SHANK DIAMETER DCON	OVERALL LENGTH OAL	FLUTE LENGTH LCF	USABLE LENGTH LU	SHANK LENGTH LS	Ti-NAMITE®-X (TX)	
0.3228	8,200 mm		10,0	80,0	37,0	25,0	34,0	67759	
0.3268	8,300 mm		10,0	80,0	37,0	25,0	34,0	67760	
0.3281	8,334 mm	21/64	10,0	80,0	38,0	25,0	34,0	58830	
0.3307	8,400 mm		10,0	80,0	38,0	25,0	34,0	67761	
0.3320	8,433 mm	Q	10,0	80,0	38,0	25,0	34,0	58831	
0.3346	8,500 mm		10,0	80,0	38,0	25,0	34,0	67762	
0.3386	8,600 mm		10,0	80,0	39,0	26,0	34,0	67763	
0.3425	8,700 mm		10,0	80,0	39,0	26,0	34,0	67764	
0.3438	8,733 mm	11/32	10,0	80,0	39,0	26,0	34,0	58832	
0.3465	8,800 mm		10,0	80,0	40,0	26,0	34,0	67765	
0.3504	8,900 mm		10,0	80,0	40,0	27,0	34,0	67766	
0.3543	9,000 mm		10,0	80,0	40,0	27,0	34,0	67767	
0.3583	9,100 mm		10,0	80,0	41,0	27,0	34,0	67768	
0.3594	9,129 mm	23/64	10,0	80,0	41,0	27,0	34,0	58833	
0.3622	9,200 mm		10,0	80,0	41,0	28,0	35,0	67769	
0.3661	9,300 mm		10,0	85,0	42,0	28,0	35,0	67770	
0.3680	9,347 mm	U	10,0	85,0	42,0	28,0	35,0	58834	
0.3701	9,400 mm		10,0	85,0	42,0	28,0	35,0	67771	
0.3740	9,500 mm		10,0	85,0	43,0	28,0	35,0	67772	
0.3750	9,525 mm	3/8	10,0	85,0	43,0	29,0	35,0	58835	
0.3780	9,600 mm		10,0	85,0	43,0	29,0	35,0	67773	
0.3819	9,700 mm		10,0	85,0	44,0	29,0	35,0	67774	
0.3858	9,800 mm		10,0	85,0	44,0	29,0	35,0	67775	
0.3898	9,900 mm		10,0	85,0	45,0	30,0	35,0	67776	
0.3906	9,921 mm	25/64	10,0	85,0	45,0	30,0	35,0	58836	
0.3937	10,000 mm		10,0	85,0	45,0	30,0	35,0	67777	
0.3970	10,084 mm	X	12,0	90,0	46,0	31,0	36,0	58837	
0.3976	10,100 mm		12,0	90,0	46,0	31,0	36,0	67778	
0.4016	10,200 mm		12,0	90,0	46,0	31,0	36,0	67779	
0.4040	10,262 mm	Y	12,0	90,0	46,0	31,0	36,0	58838	
0.4055	10,300 mm		12,0	90,0	46,0	31,0	36,0	67780	
0.4062	10,317 mm	13/32	12,0	90,0	46,0	31,0	36,0	58839	
0.4094	10,400 mm		12,0	90,0	47,0	31,0	36,0	67781	
0.4134	10,500 mm		12,0	90,0	47,0	32,0	36,0	67782	
0.4173	10,600 mm		12,0	90,0	48,0	32,0	36,0	67783	
0.4213	10,700 mm		12,0	90,0	48,0	32,0	36,0	67784	

continued on next page

TOLERANCES (inch)

- ≤.1181 DIAMETER**
DC = +.00008/+0.00047
DCON = h₆
- >.1181-.2362 DIAMETER**
DC = +.00016/+0.00063
DCON = h₆
- >.2362-.3937 DIAMETER**
DC = +.00024/+0.00083
DCON = h₆
- >.3937-.7087 DIAMETER**
DC = +.00028/+0.00098
DCON = h₆
- >.7087-1.1811 DIAMETER**
DC = +.00031/+0.00114
DCON = h₆

TOLERANCES (mm)

- ≤3 DIAMETER**
DC = +0,002/+0,012
DCON = h₆
- >3-6 DIAMETER**
DC = +0,004/+0,016
DCON = h₆
- >6-10 DIAMETER**
DC = +0,006/+0,021
DCON = h₆
- >10-18 DIAMETER**
DC = +0,007/+0,025
DCON = h₆
- >18-30 DIAMETER**
DC = +0,008/+0,029
DCON = h₆

- STEELS
- STAINLESS STEELS
- CAST IRON
- NON-FERROUS
- HIGH TEMP ALLOYS
- HARDENED STEELS

For patent information visit www.ksptpatents.com



146U 3xD

FRACTIONAL & METRIC SERIES

DECIMAL DC	METRIC DC	inch & mm						EDP NO.
		FRACTIONAL/ LETTER/WIRE DC	SHANK DIAMETER DCON	OVERALL LENGTH OAL	FLUTE LENGTH LCF	USABLE LENGTH LU	SHANK LENGTH LS	Ti-NAMITE®-X (TX)
0.4219	10,716 mm	27/64	12,0	90,0	48,0	32,0	36,0	58840
0.4252	10,800 mm		12,0	90,0	49,0	32,0	36,0	67785
0.4291	10,900 mm		12,0	90,0	49,0	33,0	36,0	67786
0.4331	11,000 mm		12,0	95,0	50,0	33,0	36,0	67787
0.4370	11,100 mm		12,0	95,0	50,0	33,0	36,0	67788
0.4375	11,113 mm	7/16	12,0	95,0	50,0	33,0	36,0	58841
0.4409	11,200 mm		12,0	95,0	50,0	34,0	36,0	67789
0.4449	11,300 mm		12,0	95,0	51,0	34,0	36,0	67790
0.4488	11,400 mm		12,0	95,0	51,0	34,0	36,0	67791
0.4528	11,500 mm		12,0	95,0	52,0	35,0	36,0	67792
0.4531	11,509 mm	29/64	12,0	95,0	52,0	35,0	36,0	58842
0.4567	11,600 mm		12,0	95,0	52,0	35,0	36,0	67793
0.4606	11,700 mm		12,0	95,0	53,0	35,0	36,0	67794
0.4646	11,800 mm		12,0	95,0	53,0	35,0	36,0	67795
0.4685	11,900 mm		12,0	95,0	54,0	36,0	36,0	67796
0.4688	11,908 mm	15/32	12,0	95,0	54,0	36,0	36,0	58843
0.4724	12,000 mm		12,0	95,0	54,0	36,0	36,0	67797
0.4844	12,304 mm	31/64	14,0	105,0	55,0	37,0	37,0	58844
0.4921	12,500 mm		14,0	105,0	56,0	37,0	37,0	67798
0.5000	12,700 mm	1/2	14,0	105,0	57,0	38,0	37,0	58845
0.5039	12,800 mm		14,0	105,0	58,0	38,0	37,0	67799
0.5118	13,000 mm		14,0	105,0	58,0	39,0	37,0	67800
0.5156	13,096 mm	33/64	14,0	105,0	59,0	39,0	37,0	58846
0.5312	13,492 mm	17/32	14,0	105,0	61,0	40,0	37,0	58847
0.5315	13,500 mm		14,0	105,0	61,0	41,0	37,0	67801
0.5469	13,891 mm	35/64	14,0	105,0	63,0	42,0	37,0	58848
0.5512	14,000 mm		14,0	105,0	63,0	42,0	37,0	67802
0.5625	14,288 mm	9/16	16,0	115,0	64,0	43,0	38,0	58849
0.5709	14,500 mm		16,0	115,0	65,0	44,0	38,0	67803
0.5781	14,684 mm	37/64	16,0	115,0	66,0	44,0	38,0	58850
0.5906	15,000 mm		16,0	115,0	68,0	45,0	38,0	67804
0.5938	15,083 mm	19/32	16,0	115,0	68,0	45,0	38,0	58851
0.6094	15,479 mm	39/64	16,0	115,0	70,0	46,0	38,0	58852
0.6102	15,500 mm		16,0	115,0	70,0	46,0	38,0	67805
0.6250	15,875 mm	5/8	16,0	115,0	71,0	48,0	38,0	58853
0.6299	16,000 mm		16,0	115,0	72,0	48,0	38,0	67806
0.6406	16,271 mm	41/64	18,0	130,0	73,0	49,0	44,0	58854
0.6496	16,500 mm		18,0	130,0	74,0	49,0	44,0	67807
0.6562	16,667 mm	21/32	18,0	130,0	75,0	50,0	44,0	58855
0.6693	17,000 mm		18,0	130,0	77,0	51,0	44,0	67808
0.6719	17,066 mm	43/64	18,0	130,0	77,0	51,0	44,0	58856
0.6875	17,463 mm	11/16	18,0	130,0	79,0	52,0	44,0	58857
0.6890	17,500 mm		18,0	130,0	79,0	53,0	44,0	67809
0.7031	17,859 mm	45/64	18,0	130,0	80,0	54,0	44,0	58858

CONTINUED

continued on next page



146U 3xD

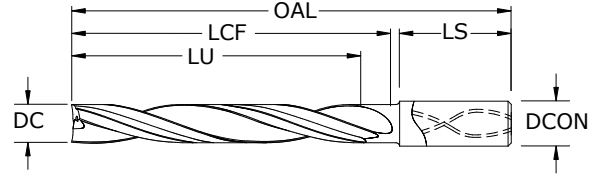

- 4-margin design improves accuracy and surface finish along with increased strength for aggressive drilling
- Specialized self-centering notched point eliminates the need for spot drilling decreasing thrust and deflection
- Engineered edge protection improves edge strength and reduces edge fatigue allowing for increased feed rates
- Recommended for materials ≤ 56 HRc (≤ 577 Bhn)

inch & mm								EDP NO.
DECIMAL DC	METRIC DC	FRACTIONAL/ LETTER/WIRE DC	SHANK DIAMETER DCON	OVERALL LENGTH OAL	FLUTE LENGTH LCF	USABLE LENGTH LU	SHANK LENGTH LS	Ti-NAMITE®-X (TX)
0.7087	18,000 mm		18,0	130,0	81,0	54,0	44,0	67810
0.7188	18,258 mm	23/32	20,0	140,0	82,0	55,0	45,0	58859
0.7283	18,500 mm		20,0	140,0	83,0	55,0	45,0	67811
0.7344	18,654 mm	47/64	20,0	140,0	84,0	56,0	45,0	58860
0.7480	19,000 mm		20,0	140,0	85,0	57,0	45,0	67812
0.7500	19,050 mm	3/4	20,0	140,0	86,0	57,0	45,0	58861
0.7656	19,446 mm	49/64	20,0	140,0	88,0	58,0	45,0	58862
0.7677	19,500 mm		20,0	140,0	88,0	58,0	45,0	67813
0.7812	19,842 mm	25/32	20,0	140,0	89,0	60,0	45,0	58863
0.7874	20,000 mm		20,0	140,0	90,0	60,0	45,0	67814
0.7969	20,241 mm	51/64	22,0	150,0	91,0	61,0	52,0	58864
0.8071	20,500 mm		22,0	150,0	92,0	62,0	52,0	67815
0.8125	20,638 mm	13/16	22,0	150,0	93,0	62,0	52,0	58865

TOLERANCES (inch)

- ≤.1181 DIAMETER**
DC = +.00008/+0.00047
DCON = h_6
- >.1181-.2362 DIAMETER**
DC = +.00016/+0.00063
DCON = h_6
- >.2362-.3937 DIAMETER**
DC = +.00024/+0.00083
DCON = h_6
- >.3937-.7087 DIAMETER**
DC = +.00028/+0.00098
DCON = h_6
- >.7087-1.1811 DIAMETER**
DC = +.00031/+0.00114
DCON = h_6

TOLERANCES (mm)

- ≤3 DIAMETER**
DC = +0,002/+0,012
DCON = h_6
- >3-6 DIAMETER**
DC = +0,004/+0,016
DCON = h_6
- >6-10 DIAMETER**
DC = +0,006/+0,021
DCON = h_6
- >10-18 DIAMETER**
DC = +0,007/+0,025
DCON = h_6
- >18-30 DIAMETER**
DC = +0,008/+0,029
DCON = h_6

- STEELS
- STAINLESS STEELS
- CAST IRON
- NON-FERROUS
- HIGH TEMP ALLOYS
- HARDENED STEELS

For patent information visit www.ksptpatents.com

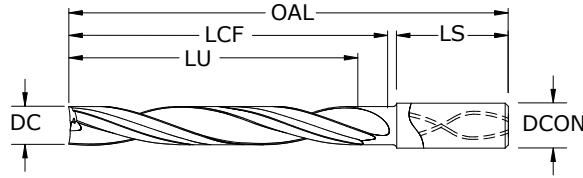

146U 5xD
FRACTIONAL & METRIC SERIES

TOLERANCES (inch)

- ≤.1181 DIAMETER**
DC = +.00008/+0.00047
DCON = h₆
- >.1181-.2362 DIAMETER**
DC = +.00016/+0.00063
DCON = h₆
- >.2362-.3937 DIAMETER**
DC = +.00024/+0.00083
DCON = h₆
- >.3937-.7087 DIAMETER**
DC = +.00028/+0.00098
DCON = h₆
- >.7087-1.1811 DIAMETER**
DC = +.00031/+0.00114
DCON = h₆

TOLERANCES (mm)

- ≤3 DIAMETER**
DC = +0,002/+0,012
DCON = h₆
- >3-6 DIAMETER**
DC = +0,004/+0,016
DCON = h₆
- >6-10 DIAMETER**
DC = +0,006/+0,021
DCON = h₆
- >10-18 DIAMETER**
DC = +0,007/+0,025
DCON = h₆
- >18-30 DIAMETER**
DC = +0,008/+0,029
DCON = h₆

- STEELS
- STAINLESS STEELS
- CAST IRON
- HIGH TEMP ALLOYS
- NON-FERROUS

For patent information visit www.kspatents.com

		inch & mm							EDP NO.
DECIMAL DC	METRIC DC	FRACTIONAL/ LETTER/WIRE DC	SHANK DIAMETER DCON	OVERALL LENGTH OAL	FLUTE LENGTH LCF	USABLE LENGTH LU	SHANK LENGTH LS	Ti-NAMITE®-X (TX)	
0.1181	3,000 mm		6,0	75,0	19,0	15,0	51,0	67816	
0.1220	3,100 mm		6,0	80,0	20,0	15,0	49,0	67817	
0.1250	3,175 mm	1/8	6,0	80,0	21,0	16,0	49,0	58866	
0.1260	3,200 mm		6,0	80,0	21,0	16,0	49,0	67818	
0.1299	3,300 mm		6,0	80,0	21,0	16,0	49,0	67819	
0.1339	3,400 mm		6,0	80,0	22,0	17,0	49,0	67820	
0.1360	3,454 mm	#29	6,0	80,0	22,0	17,0	49,0	58867	
0.1378	3,500 mm		6,0	80,0	23,0	18,0	49,0	67821	
0.1405	3,569 mm	#28	6,0	80,0	23,0	18,0	49,0	58868	
0.1406	3,571 mm	9/64	6,0	80,0	23,0	18,0	49,0	58869	
0.1417	3,600 mm		6,0	80,0	23,0	18,0	49,0	67822	
0.1457	3,700 mm		6,0	80,0	24,0	19,0	49,0	67823	
0.1470	3,734 mm	#26	6,0	80,0	24,0	19,0	49,0	58870	
0.1495	3,797 mm	#25	6,0	80,0	25,0	19,0	49,0	58871	
0.1496	3,800 mm		6,0	80,0	25,0	19,0	49,0	67824	
0.1520	3,861 mm	#24	6,0	80,0	25,0	19,0	49,0	58872	
0.1535	3,900 mm		6,0	80,0	25,0	19,0	49,0	67825	
0.1562	3,967 mm	5/32	6,0	80,0	26,0	20,0	49,0	58873	
0.1570	3,988 mm	#22	6,0	80,0	26,0	20,0	49,0	58874	
0.1575	4,000 mm		6,0	80,0	26,0	20,0	49,0	67826	
0.1590	4,039 mm	#21	6,0	80,0	26,0	20,0	49,0	58875	
0.1610	4,089 mm	#20	6,0	90,0	27,0	20,0	53,0	58876	
0.1614	4,100 mm		6,0	90,0	27,0	20,0	53,0	67827	
0.1654	4,200 mm		6,0	90,0	27,0	21,0	53,0	67828	
0.1693	4,300 mm		6,0	90,0	28,0	22,0	53,0	67829	
0.1719	4,366 mm	11/64	6,0	90,0	28,0	22,0	53,0	58877	
0.1732	4,400 mm		6,0	90,0	29,0	22,0	53,0	67830	
0.1770	4,496 mm	#16	6,0	90,0	29,0	22,0	53,0	58878	
0.1772	4,500 mm		6,0	90,0	29,0	23,0	53,0	67831	
0.1811	4,600 mm		6,0	90,0	30,0	23,0	53,0	67832	
0.1850	4,699 mm	#13	6,0	90,0	31,0	23,0	53,0	58879	
0.1875	4,763 mm	3/16	6,0	90,0	31,0	24,0	53,0	58880	
0.1890	4,801 mm	#12	6,0	90,0	31,0	24,0	53,0	58881	
0.1929	4,900 mm		6,0	90,0	32,0	24,0	53,0	67835	
0.1935	4,915 mm	#10	6,0	90,0	32,0	25,0	53,0	58882	
0.1969	5,000 mm		6,0	95,0	33,0	25,0	51,0	67836	
0.2008	5,100 mm		6,0	95,0	33,0	26,0	51,0	67837	
0.2010	5,105 mm	#7	6,0	95,0	33,0	26,0	51,0	58883	
0.2031	5,159 mm	13/64	6,0	95,0	34,0	26,0	51,0	58884	
0.2047	5,200 mm		6,0	95,0	34,0	26,0	51,0	67838	
0.2087	5,300 mm		6,0	95,0	34,0	27,0	51,0	67839	
0.2090	5,309 mm	#4	6,0	95,0	35,0	27,0	51,0	58885	

- 4-margin design improves accuracy and surface finish along with increased strength for aggressive drilling
- Specialized self-centering notched point eliminates the need for spot drilling decreasing thrust and deflection
- Engineered edge protection improves edge strength and reduces edge fatigue allowing for increased feed rates
- Recommended for materials ≤ 56 HRC (≤ 577 Bhn)

continued on next page



146U 5xD
FRACTIONAL & METRIC SERIES

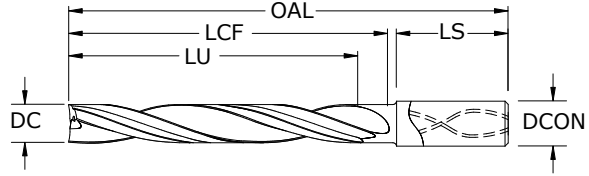

- 4-margin design improves accuracy and surface finish along with increased strength for aggressive drilling
- Specialized self-centering notched point eliminates the need for spot drilling decreasing thrust and deflection
- Engineered edge protection improves edge strength and reduces edge fatigue allowing for increased feed rates
- Recommended for materials ≤ 56 HRC (≤ 577 Bhn)

		inch & mm						EDP NO.
DECIMAL DC	METRIC DC	FRACTIONAL/ LETTER/WIRE DC	SHANK DIAMETER DCON	OVERALL LENGTH OAL	FLUTE LENGTH LCF	USABLE LENGTH LU	SHANK LENGTH LS	Ti-NAMITE®-X (TX)
0.2126	5,400 mm		6,0	95,0	35,0	27,0	51,0	67840
0.2130	5,410 mm	#3	6,0	95,0	35,0	27,0	51,0	58886
0.2165	5,500 mm		6,0	95,0	36,0	27,0	51,0	67841
0.2188	5,558 mm	7/32	6,0	95,0	36,0	28,0	51,0	58887
0.2205	5,600 mm		6,0	95,0	36,0	28,0	51,0	67842
0.2244	5,700 mm		6,0	95,0	37,0	28,0	51,0	67843
0.2283	5,800 mm		6,0	95,0	38,0	29,0	51,0	67844
0.2323	5,900 mm		6,0	95,0	38,0	30,0	51,0	67845
0.2344	5,954 mm	15/64	6,0	95,0	39,0	30,0	51,0	58888
0.2362	6,000 mm		6,0	95,0	39,0	30,0	51,0	67846
0.2402	6,100 mm		8,0	100,0	40,0	31,0	49,0	67847
0.2441	6,200 mm		8,0	100,0	40,0	31,0	49,0	67848
0.2461	6,250 mm		8,0	100,0	41,0	31,0	49,0	67849
0.2480	6,300 mm		8,0	100,0	41,0	31,0	49,0	67850
0.2500	6,350 mm	1/4 E #0	8,0	100,0	41,0	32,0	49,0	58889
0.2520	6,400 mm		8,0	100,0	42,0	32,0	49,0	67851
0.2559	6,500 mm		8,0	100,0	42,0	32,0	49,0	67852
0.2570	6,528 mm	F	8,0	100,0	42,0	33,0	49,0	58890
0.2598	6,600 mm		8,0	100,0	43,0	33,0	49,0	67853
0.2638	6,700 mm		8,0	100,0	44,0	34,0	49,0	67854
0.2656	6,746 mm	17/64	8,0	100,0	44,0	34,0	49,0	58891
0.2677	6,800 mm		8,0	100,0	44,0	34,0	49,0	67855
0.2717	6,900 mm		8,0	100,0	45,0	35,0	49,0	67856
0.2720	6,909 mm	I	8,0	100,0	45,0	35,0	49,0	58892
0.2756	7,000 mm		8,0	100,0	46,0	35,0	49,0	67857
0.2795	7,100 mm		8,0	100,0	46,0	35,0	49,0	67858
0.2812	7,142 mm	9/32	8,0	100,0	46,0	36,0	49,0	58893
0.2835	7,200 mm		8,0	110,0	47,0	36,0	53,0	67859
0.2854	7,250 mm		8,0	110,0	47,0	36,0	53,0	67860
0.2874	7,300 mm		8,0	110,0	47,0	36,0	53,0	67861
0.2913	7,400 mm		8,0	110,0	48,0	37,0	53,0	67862
0.2953	7,500 mm		8,0	110,0	49,0	38,0	53,0	67863
0.2969	7,541 mm	19/64	8,0	110,0	49,0	38,0	53,0	58894
0.2992	7,600 mm		8,0	110,0	49,0	38,0	53,0	67864
0.3031	7,700 mm		8,0	110,0	50,0	38,0	53,0	67865
0.3071	7,800 mm		8,0	110,0	51,0	39,0	53,0	67866
0.3110	7,900 mm		8,0	110,0	51,0	39,0	53,0	67867
0.3125	7,938 mm	5/16	8,0	110,0	52,0	40,0	53,0	58895
0.3150	8,000 mm		8,0	110,0	52,0	40,0	53,0	67868
0.3189	8,100 mm		10,0	115,0	53,0	41,0	51,0	67869
0.3228	8,200 mm		10,0	115,0	53,0	41,0	51,0	67870
0.3268	8,300 mm		10,0	115,0	54,0	42,0	51,0	67871

TOLERANCES (inch)

- ≤.1181 DIAMETER
DC = +.00008/+0.00047
DCON = h₆
- >.1181-.2362 DIAMETER
DC = +.00016/+0.00063
DCON = h₆
- >.2362-.3937 DIAMETER
DC = +.00024/+0.00083
DCON = h₆
- >.3937-.7087 DIAMETER
DC = +.00028/+0.00098
DCON = h₆
- >.7087-1.1811 DIAMETER
DC = +.00031/+0.00114
DCON = h₆

TOLERANCES (mm)

- ≤3 DIAMETER
DC = +0,002/+0,012
DCON = h₆
- >3-6 DIAMETER
DC = +0,004/+0,016
DCON = h₆
- >6-10 DIAMETER
DC = +0,006/+0,021
DCON = h₆
- >10-18 DIAMETER
DC = +0,007/+0,025
DCON = h₆
- >18-30 DIAMETER
DC = +0,008/+0,029
DCON = h₆

- STEELS
- STAINLESS STEELS
- CAST IRON
- NON-FERROUS
- HIGH TEMP ALLOYS
- HARDENED STEELS

continued on next page

For patent information visit www.ksptpatents.com

146U 5xD
FRACTIONAL & METRIC SERIES

DECIMAL DC	METRIC DC	inch & mm		OVERALL LENGTH OAL	FLUTE LENGTH LCF	USABLE LENGTH LU	SHANK LENGTH LS	EDP NO.
		FRACTIONAL/ LETTER/WIRE DC	SHANK DIAMETER DCON					Ti-NAMITE®-X (TX)
0.3281	8,334 mm	21/64	10,0	115,0	54,0	42,0	51,0	58896
0.3307	8,400 mm		10,0	115,0	55,0	42,0	51,0	67872
0.3320	8,433 mm	Q	10,0	115,0	55,0	42,0	51,0	58897
0.3346	8,500 mm		10,0	115,0	55,0	42,0	51,0	67873
0.3386	8,600 mm		10,0	115,0	56,0	43,0	51,0	67874
0.3425	8,700 mm		10,0	115,0	57,0	43,0	51,0	67875
0.3438	8,733 mm	11/32	10,0	115,0	57,0	44,0	51,0	58898
0.3465	8,800 mm		10,0	115,0	57,0	44,0	51,0	67876
0.3504	8,900 mm		10,0	115,0	58,0	45,0	51,0	67877
0.3543	9,000 mm		10,0	115,0	58,0	45,0	51,0	67878
0.3583	9,100 mm		10,0	115,0	59,0	46,0	51,0	67879
0.3594	9,129 mm	23/64	10,0	115,0	59,0	46,0	51,0	58899
0.3622	9,200 mm		10,0	125,0	60,0	46,0	55,0	67880
0.3661	9,300 mm		10,0	125,0	60,0	46,0	55,0	67881
0.3680	9,347 mm	U	10,0	125,0	61,0	47,0	55,0	58900
0.3701	9,400 mm		10,0	125,0	61,0	47,0	55,0	67882
0.3740	9,500 mm		10,0	125,0	62,0	47,0	55,0	67883
0.3750	9,525 mm	3/8	10,0	125,0	62,0	48,0	55,0	58901
0.3780	9,600 mm		10,0	125,0	62,0	48,0	55,0	67884
0.3819	9,700 mm		10,0	125,0	63,0	49,0	55,0	67885
0.3858	9,800 mm		10,0	125,0	64,0	49,0	55,0	67886
0.3898	9,900 mm		10,0	125,0	64,0	50,0	55,0	67887
0.3906	9,921 mm	25/64	10,0	125,0	64,0	50,0	55,0	58902
0.3937	10,000 mm		10,0	125,0	65,0	50,0	55,0	67888
0.3970	10,084 mm	X	12,0	135,0	66,0	50,0	57,0	58903
0.3976	10,100 mm		12,0	135,0	66,0	50,0	57,0	67889
0.4016	10,200 mm		12,0	135,0	66,0	51,0	57,0	67890
0.4040	10,262 mm	Y	12,0	135,0	67,0	51,0	57,0	58904
0.4055	10,300 mm		12,0	135,0	67,0	51,0	57,0	67891
0.4062	10,317 mm	13/32	12,0	135,0	67,0	52,0	57,0	58905
0.4094	10,400 mm		12,0	135,0	68,0	52,0	57,0	67892
0.4134	10,500 mm		12,0	135,0	68,0	53,0	57,0	67893
0.4173	10,600 mm		12,0	135,0	69,0	53,0	57,0	67894
0.4213	10,700 mm		12,0	135,0	70,0	54,0	57,0	67895
0.4219	10,716 mm	27/64	12,0	135,0	70,0	54,0	57,0	58906
0.4252	10,800 mm		12,0	135,0	70,0	54,0	57,0	67896
0.4291	10,900 mm		12,0	135,0	71,0	54,0	57,0	67897
0.4331	11,000 mm		12,0	135,0	72,0	55,0	57,0	67898
0.4370	11,100 mm		12,0	135,0	72,0	55,0	57,0	67899
0.4375	11,113 mm	7/16	12,0	135,0	72,0	56,0	57,0	58907
0.4409	11,200 mm		12,0	135,0	73,0	56,0	57,0	67900
0.4449	11,300 mm		12,0	135,0	73,0	57,0	57,0	67901
0.4488	11,400 mm		12,0	145,0	74,0	57,0	62,0	67902
0.4528	11,500 mm		12,0	145,0	75,0	58,0	62,0	67903
0.4531	11,509 mm	29/64	12,0	145,0	75,0	58,0	62,0	58908
0.4567	11,600 mm		12,0	145,0	75,0	58,0	62,0	67904
0.4606	11,700 mm		12,0	145,0	76,0	58,0	62,0	67905
0.4646	11,800 mm		12,0	145,0	77,0	59,0	62,0	67906
0.4685	11,900 mm		12,0	145,0	77,0	59,0	62,0	67907
0.4688	11,908 mm	15/32	12,0	145,0	77,0	60,0	62,0	58909

CONTINUED

continued on next page



146U 5xD

FRACTIONAL & METRIC SERIES

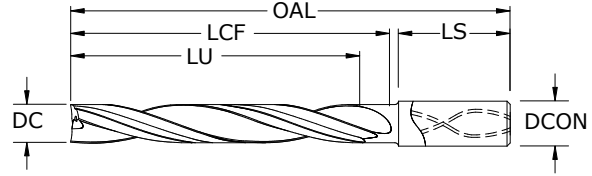

- 4-margin design improves accuracy and surface finish along with increased strength for aggressive drilling
- Specialized self-centering notched point eliminates the need for spot drilling decreasing thrust and deflection
- Engineered edge protection improves edge strength and reduces edge fatigue allowing for increased feed rates
- Recommended for materials ≤ 56 HRC (≤ 577 Bhn)

		inch & mm							EDP NO.
DECIMAL DC	METRIC DC	FRACTIONAL/ LETTER/WIRE DC	SHANK DIAMETER DCON	OVERALL LENGTH OAL	FLUTE LENGTH LCF	USABLE LENGTH LU	SHANK LENGTH LS		Ti-NAMITE®-X (TX)
0.4724	12,000 mm		12,0	145,0	78,0	60,0	62,0		67908
0.4844	12,304 mm	31/64	14,0	155,0	80,0	62,0	59,0		58910
0.4921	12,500 mm		14,0	155,0	81,0	62,0	59,0		67909
0.5000	12,700 mm	1/2	14,0	155,0	83,0	64,0	59,0		58911
0.5039	12,800 mm		14,0	155,0	83,0	64,0	59,0		67910
0.5118	13,000 mm		14,0	155,0	84,0	65,0	59,0		67911
0.5156	13,096 mm	33/64	14,0	155,0	85,0	65,0	59,0		58912
0.5312	13,492 mm	17/32	14,0	155,0	88,0	67,0	59,0		58913
0.5315	13,500 mm		14,0	155,0	88,0	68,0	59,0		67912
0.5469	13,891 mm	35/64	14,0	155,0	90,0	69,0	59,0		58914
0.5512	14,000 mm		14,0	155,0	91,0	70,0	59,0		67913
0.5625	14,288 mm	9/16	16,0	175,0	93,0	71,0	66,0		58915
0.5709	14,500 mm		16,0	175,0	94,0	73,0	66,0		67914
0.5781	14,684 mm	37/64	16,0	175,0	95,0	73,0	66,0		58916
0.5906	15,000 mm		16,0	175,0	98,0	75,0	66,0		67915
0.5938	15,083 mm	19/32	16,0	175,0	98,0	75,0	66,0		58917
0.6094	15,479 mm	39/64	16,0	175,0	101,0	77,0	66,0		58918
0.6102	15,500 mm		16,0	175,0	101,0	77,0	66,0		67916
0.6250	15,875 mm	5/8	16,0	175,0	103,0	79,0	66,0		58919
0.6299	16,000 mm		16,0	175,0	104,0	80,0	66,0		67917
0.6406	16,271 mm	41/64	18,0	195,0	106,0	81,0	73,0		58920
0.6496	16,500 mm		18,0	195,0	107,0	82,0	73,0		67918
0.6562	16,667 mm	21/32	18,0	195,0	108,0	83,0	73,0		58921
0.6693	17,000 mm		18,0	195,0	111,0	85,0	73,0		67919
0.6719	17,066 mm	43/64	18,0	195,0	111,0	85,0	73,0		58922
0.6875	17,463 mm	11/16	18,0	195,0	114,0	87,0	73,0		58923
0.6890	17,500 mm		18,0	195,0	114,0	88,0	73,0		67920
0.7031	17,859 mm	45/64	18,0	195,0	116,0	89,0	73,0		58924
0.7087	18,000 mm		18,0	195,0	117,0	90,0	73,0		67921
0.7188	18,258 mm	23/32	20,0	215,0	119,0	91,0	80,0		58925
0.7283	18,500 mm		20,0	215,0	120,0	92,0	80,0		67922
0.7344	18,654 mm	47/64	20,0	215,0	121,0	93,0	80,0		58926
0.7480	19,000 mm		20,0	215,0	123,0	95,0	80,0		67923
0.7500	19,050 mm	3/4	20,0	215,0	124,0	95,0	80,0		58927
0.7656	19,446 mm	49/64	20,0	215,0	126,0	97,0	80,0		58928
0.7677	19,500 mm		20,0	215,0	127,0	97,0	80,0		67924
0.7812	19,842 mm	25/32	20,0	215,0	129,0	99,0	80,0		58929
0.7874	20,000 mm		20,0	215,0	130,0	100,0	80,0		67925
0.7969	20,241 mm	51/64	22,0	220,0	132,0	101,0	81,0		58930
0.8071	20,500 mm		22,0	220,0	133,0	103,0	81,0		67926
0.8125	20,638 mm	13/16	22,0	220,0	134,0	103,0	81,0		58931

TOLERANCES (inch)

- ≤.1181 DIAMETER
DC = +.00008/+0.00047
DCON = h₆
- >.1181-.2362 DIAMETER
DC = +.00016/+0.00063
DCON = h₆
- >.2362-.3937 DIAMETER
DC = +.00024/+0.00083
DCON = h₆
- >.3937-.7087 DIAMETER
DC = +.00028/+0.00098
DCON = h₆
- >.7087-1.1811 DIAMETER
DC = +.00031/+0.00114
DCON = h₆

TOLERANCES (mm)

- ≤3 DIAMETER
DC = +0,002/+0,012
DCON = h₆
- >3-6 DIAMETER
DC = +0,004/+0,016
DCON = h₆
- >6-10 DIAMETER
DC = +0,006/+0,021
DCON = h₆
- >10-18 DIAMETER
DC = +0,007/+0,025
DCON = h₆
- >18-30 DIAMETER
DC = +0,008/+0,029
DCON = h₆

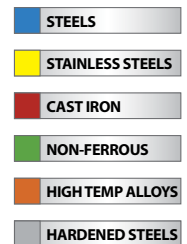

For patent information visit www.ksptpatents.com

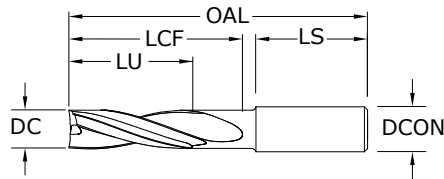

136U 2xD
FRACTIONAL & METRIC SERIES

TOLERANCES (inch)

≤.1181 DIAMETER

DC = +.00008/+0.00047

DCON = h₆

>.1181-.2362 DIAMETER

DC = +.00016/+0.00063

DCON = h₆

>.2362-.3937 DIAMETER

DC = +.00024/+0.00083

DCON = h₆

>.3937-.7087 DIAMETER

DC = +.00028/+0.00098

DCON = h₆

>.7087-1.1811 DIAMETER

DC = +.00031/+0.00114

DCON = h₆

TOLERANCES (mm)

≤3 DIAMETER

DC = +0,002/+0,012

DCON = h₆

>3-6 DIAMETER

DC = +0,004/+0,016

DCON = h₆

>6-10 DIAMETER

DC = +0,006/+0,021

DCON = h₆

>10-18 DIAMETER

DC = +0,007/+0,025

DCON = h₆

>18-30 DIAMETER

DC = +0,008/+0,029

DCON = h₆

STEELS

STAINLESS STEELS

CAST IRON

HIGH TEMP ALLOYS

NON-FERROUS

For patent information visit www.ksptpatents.com

inch & mm									EDP NO.
DECIMAL DC	METRIC DC	FRACTIONAL/ LETTER/WIRE DC	SHANK DIAMETER DCON	OVERALL LENGTH OAL	FLUTE LENGTH LCF	USABLE LENGTH LU	SHANK LENGTH LS	Ti-NAMITE®-X (TX)	
0.0591	1,500 mm		6,0	45,0	5,0	3,0	33,0	67060	
0.0625	1,588 mm	1/16	6,0	45,0	6,0	3,0	33,0	58480	
0.0630	1,600 mm		6,0	45,0	6,0	3,0	33,0	67061	
0.0669	1,700 mm		6,0	45,0	6,0	3,0	33,0	67062	
0.0709	1,800 mm		6,0	45,0	6,0	4,0	33,0	67063	
0.0748	1,900 mm		6,0	45,0	7,0	4,0	33,0	67064	
0.0781	1,984 mm	5/64	6,0	45,0	7,0	4,0	33,0	58481	
0.0787	2,000 mm		6,0	45,0	7,0	4,0	33,0	67065	
0.0827	2,100 mm		6,0	45,0	7,0	4,0	33,0	67066	
0.0866	2,200 mm		6,0	50,0	8,0	4,0	31,0	67067	
0.0906	2,300 mm		6,0	50,0	8,0	5,0	31,0	67068	
0.0938	2,383 mm	3/32	6,0	50,0	8,0	5,0	31,0	58482	
0.0945	2,400 mm		6,0	50,0	8,0	5,0	31,0	67069	
0.0984	2,500 mm		6,0	50,0	9,0	5,0	31,0	67070	
0.1015	2,578 mm	#38	6,0	50,0	9,0	5,0	31,0	58483	
0.1024	2,600 mm		6,0	50,0	9,0	5,0	31,0	67071	
0.1040	2,642 mm	#37	6,0	50,0	9,0	5,0	31,0	58484	
0.1063	2,700 mm		6,0	50,0	9,0	5,0	31,0	67072	
0.1065	2,705 mm	#36	6,0	50,0	9,0	5,0	31,0	58485	
0.1094	2,779 mm	7/64	6,0	50,0	10,0	6,0	31,0	58486	
0.1102	2,800 mm		6,0	50,0	10,0	6,0	31,0	67073	
0.1130	2,870 mm	#33	6,0	50,0	10,0	6,0	31,0	58487	
0.1142	2,900 mm		6,0	50,0	10,0	6,0	31,0	67074	
0.1181	3,000 mm		6,0	50,0	10,0	6,0	31,0	67075	
0.1220	3,100 mm		6,0	50,0	11,0	6,0	31,0	67076	
0.1250	3,175 mm	1/8	6,0	50,0	11,0	6,0	31,0	58488	
0.1260	3,200 mm		6,0	50,0	11,0	6,0	31,0	67077	
0.1299	3,300 mm		6,0	50,0	12,0	7,0	31,0	67078	
0.1339	3,400 mm		6,0	50,0	12,0	7,0	31,0	67079	
0.1360	3,454 mm	#29	6,0	50,0	12,0	7,0	31,0	58489	
0.1378	3,500 mm		6,0	50,0	12,0	7,0	31,0	67080	
0.1405	3,569 mm	#28	6,0	50,0	12,0	7,0	31,0	58490	
0.1406	3,571 mm	9/64	6,0	50,0	12,0	7,0	31,0	58491	
0.1417	3,600 mm		6,0	50,0	13,0	7,0	31,0	67081	
0.1457	3,700 mm		6,0	50,0	13,0	7,0	31,0	67082	
0.1470	3,734 mm	#26	6,0	50,0	13,0	7,0	31,0	58492	
0.1495	3,797 mm	#25	6,0	50,0	13,0	8,0	31,0	58493	
0.1496	3,800 mm		6,0	50,0	13,0	8,0	31,0	67083	

- 4-margin design improves accuracy and surface finish along with increased strength for aggressive drilling
- Specialized self-centering notched point eliminates the need for spot drilling decreasing thrust and deflection
- Engineered edge protection improves edge strength and reduces edge fatigue allowing for increased feed rates
- Recommended for materials ≤ 56 HRC (≤ 577 Bhn)

continued on next page

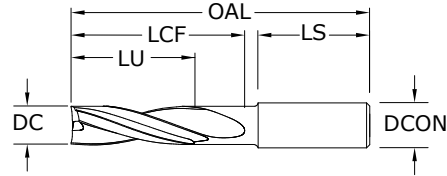

136U 2xD

FRACTIONAL & METRIC SERIES

- 4-margin design improves accuracy and surface finish along with increased strength for aggressive drilling
- Specialized self-centering notched point eliminates the need for spot drilling decreasing thrust and deflection
- Engineered edge protection improves edge strength and reduces edge fatigue allowing for increased feed rates
- Recommended for materials ≤ 56 HRC (≤ 577 Bhn)

inch & mm								EDP NO.
DECIMAL DC	METRIC DC	FRACTIONAL/ LETTER/WIRE DC	SHANK DIAMETER DCON	OVERALL LENGTH OAL	FLUTE LENGTH LCF	USABLE LENGTH LU	SHANK LENGTH LS	Ti-NAMITE®-X (TX)
0.1520	3,861 mm	#24	6,0	50,0	14,0	8,0	31,0	58494
0.1535	3,900 mm		6,0	50,0	14,0	8,0	31,0	67084
0.1562	3,967 mm	5/32	6,0	50,0	14,0	8,0	31,0	58495
0.1570	3,988 mm	#22	6,0	50,0	14,0	8,0	31,0	58496
0.1575	4,000 mm		6,0	50,0	14,0	8,0	31,0	67085
0.1590	4,039 mm	#21	6,0	50,0	14,0	8,0	31,0	58497
0.1610	4,089 mm	#20	6,0	50,0	14,0	8,0	31,0	58498
0.1614	4,100 mm		6,0	50,0	14,0	8,0	31,0	67086
0.1654	4,200 mm		6,0	60,0	15,0	8,0	34,0	67087
0.1693	4,300 mm		6,0	60,0	15,0	9,0	34,0	67088
0.1719	4,366 mm	11/64	6,0	60,0	15,0	9,0	34,0	58499
0.1732	4,400 mm		6,0	60,0	15,0	9,0	34,0	67089
0.1770	4,496 mm	#16	6,0	60,0	16,0	9,0	34,0	58500
0.1772	4,500 mm		6,0	60,0	16,0	9,0	34,0	67090
0.1811	4,600 mm		6,0	60,0	16,0	9,0	34,0	67091
0.1850	4,699 mm	#13	6,0	60,0	16,0	9,0	34,0	58501
0.1875	4,763 mm	3/16	6,0	60,0	17,0	10,0	34,0	58502
0.1890	4,801 mm	#12	6,0	60,0	17,0	10,0	34,0	58503
0.1929	4,900 mm		6,0	60,0	17,0	10,0	34,0	67094
0.1935	4,915 mm	#10	6,0	60,0	17,0	10,0	34,0	58504
0.1969	5,000 mm		6,0	60,0	18,0	10,0	34,0	67095
0.2008	5,100 mm		6,0	60,0	18,0	10,0	34,0	67096
0.2010	5,105 mm	#7	6,0	60,0	18,0	10,0	34,0	58505
0.2031	5,159 mm	13/64	6,0	60,0	18,0	10,0	34,0	58506
0.2047	5,200 mm		6,0	60,0	18,0	10,0	34,0	67097
0.2087	5,300 mm		6,0	60,0	19,0	11,0	34,0	67098
0.2090	5,309 mm	#4	6,0	60,0	19,0	11,0	34,0	58507
0.2126	5,400 mm		6,0	60,0	19,0	11,0	34,0	67099
0.2130	5,410 mm	#3	6,0	60,0	19,0	11,0	34,0	58508
0.2165	5,500 mm		6,0	60,0	19,0	11,0	34,0	67100
0.2188	5,558 mm	7/32	6,0	60,0	19,0	11,0	34,0	58509
0.2205	5,600 mm		6,0	60,0	20,0	11,0	34,0	67101
0.2244	5,700 mm		6,0	60,0	20,0	11,0	34,0	67102
0.2283	5,800 mm		6,0	60,0	20,0	12,0	34,0	67103
0.2323	5,900 mm		6,0	60,0	21,0	12,0	34,0	67104
0.2344	5,954 mm	15/64	6,0	60,0	21,0	12,0	34,0	58510
0.2362	6,000 mm		6,0	60,0	21,0	12,0	34,0	67105
0.2402	6,100 mm		8,0	70,0	22,0	13,0	37,0	67106

continued on next page

TOLERANCES (inch)

≤.1181 DIAMETER

DC = +.00008/+0.00047
DCON = h₆

>.1181-.2362 DIAMETER

DC = +.00016/+0.00093
DCON = h₆

>.2362-.3937 DIAMETER

DC = +.00024/+0.00083
DCON = h₆

>.3937-.7087 DIAMETER

DC = +.00028/+0.00098
DCON = h₆

>.7087-1.1811 DIAMETER

DC = +.00031/+0.00114
DCON = h₆

TOLERANCES (mm)

≤3 DIAMETER

DC = +0,002/+0,012
DCON = h₆

>3-6 DIAMETER

DC = +0,004/+0,016
DCON = h₆

>6-10 DIAMETER

DC = +0,006/+0,021
DCON = h₆

>10-18 DIAMETER

DC = +0,007/+0,025
DCON = h₆

>18-30 DIAMETER

DC = +0,008/+0,029
DCON = h₆

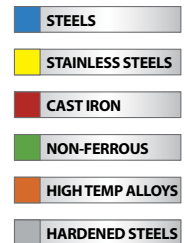

For patent information visit www.ksptpatents.com

136U 2xD
FRACTIONAL & METRIC SERIES

DECIMAL DC	METRIC DC	inch & mm						EDP NO. Ti-NAMITE [®] -X (TX)
		FRACTIONAL/ LETTER/WIRE DC	SHANK DIAMETER DCON	OVERALL LENGTH OAL	FLUTE LENGTH LCF	USABLE LENGTH LU	SHANK LENGTH LS	
0.2441	6,200 mm		8,0	70,0	22,0	12,0	37,0	67107
0.2461	6,250 mm		8,0	70,0	22,0	13,0	37,0	67108
0.2480	6,300 mm		8,0	70,0	22,0	13,0	37,0	67109
0.2500	6,350 mm	1/4 E #0	8,0	70,0	22,0	13,0	37,0	58511
0.2520	6,400 mm		8,0	70,0	22,0	13,0	37,0	67110
0.2559	6,500 mm		8,0	70,0	23,0	13,0	37,0	67111
0.2570	6,528 mm	F	8,0	70,0	23,0	13,0	37,0	58512
0.2598	6,600 mm		8,0	70,0	23,0	13,0	37,0	67112
0.2638	6,700 mm		8,0	70,0	23,0	13,0	37,0	67113
0.2656	6,746 mm	17/64	8,0	70,0	24,0	13,0	37,0	58513
0.2677	6,800 mm		8,0	70,0	24,0	14,0	37,0	67114
0.2717	6,900 mm		8,0	70,0	24,0	14,0	37,0	67115
0.2720	6,909 mm	I	8,0	70,0	24,0	14,0	37,0	58514
0.2756	7,000 mm		8,0	70,0	25,0	14,0	37,0	67116
0.2795	7,100 mm		8,0	70,0	25,0	14,0	37,0	67117
0.2812	7,142 mm	9/32	8,0	70,0	25,0	14,0	37,0	58515
0.2835	7,200 mm		8,0	70,0	25,0	14,0	37,0	67118
0.2854	7,250 mm		8,0	70,0	25,0	14,0	37,0	67119
0.2874	7,300 mm		8,0	70,0	26,0	15,0	37,0	67120
0.2913	7,400 mm		8,0	70,0	26,0	15,0	37,0	67121
0.2953	7,500 mm		8,0	70,0	26,0	15,0	37,0	67122
0.2969	7,541 mm	19/64	8,0	70,0	26,0	15,0	37,0	58516
0.2992	7,600 mm		8,0	70,0	27,0	15,0	37,0	67123
0.3031	7,700 mm		8,0	70,0	27,0	15,0	37,0	67124
0.3071	7,800 mm		8,0	70,0	27,0	16,0	37,0	67125
0.3110	7,900 mm		8,0	70,0	28,0	16,0	37,0	67126
0.3125	7,938 mm	5/16	8,0	70,0	28,0	16,0	37,0	58517
0.3150	8,000 mm		8,0	70,0	28,0	16,0	37,0	67127
0.3189	8,100 mm		10,0	80,0	29,0	17,0	40,0	67128
0.3228	8,200 mm		10,0	80,0	29,0	16,0	40,0	67129
0.3268	8,300 mm		10,0	80,0	29,0	17,0	40,0	67130
0.3281	8,334 mm	21/64	10,0	80,0	29,0	17,0	40,0	58518
0.3307	8,400 mm		10,0	80,0	29,0	17,0	40,0	67131
0.3320	8,433 mm	Q	10,0	80,0	30,0	17,0	40,0	58519
0.3346	8,500 mm		10,0	80,0	30,0	17,0	40,0	67132
0.3386	8,600 mm		10,0	80,0	30,0	17,0	40,0	67133
0.3425	8,700 mm		10,0	80,0	30,0	17,0	40,0	67134
0.3438	8,733 mm	11/32	10,0	80,0	31,0	17,0	40,0	58520
0.3465	8,800 mm		10,0	80,0	31,0	18,0	40,0	67135
0.3504	8,900 mm		10,0	80,0	31,0	18,0	40,0	67136
0.3543	9,000 mm		10,0	80,0	31,0	18,0	40,0	67137
0.3583	9,100 mm		10,0	80,0	32,0	18,0	40,0	67138
0.3594	9,129 mm	23/64	10,0	80,0	32,0	18,0	40,0	58521
0.3622	9,200 mm		10,0	80,0	32,0	18,0	40,0	67139
0.3661	9,300 mm		10,0	80,0	33,0	19,0	40,0	67140
0.3680	9,347 mm	U	10,0	80,0	33,0	19,0	40,0	58522

CONTINUED

continued on next page

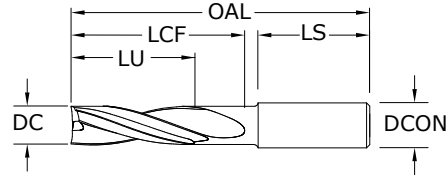

136U 2xD

FRACTIONAL & METRIC SERIES

- 4-margin design improves accuracy and surface finish along with increased strength for aggressive drilling
- Specialized self-centering notched point eliminates the need for spot drilling decreasing thrust and deflection
- Engineered edge protection improves edge strength and reduces edge fatigue allowing for increased feed rates
- Recommended for materials ≤ 56 HRC (≤ 577 Bhn)

inch & mm								EDP NO.
DECIMAL DC	METRIC DC	FRACTIONAL/ LETTER/WIRE DC	SHANK DIAMETER DCON	OVERALL LENGTH OAL	FLUTE LENGTH LCF	USABLE LENGTH LU	SHANK LENGTH LS	Ti-NAMITE®-X (TX)
0.3701	9,400 mm		10,0	80,0	33,0	19,0	40,0	67141
0.3740	9,500 mm		10,0	80,0	33,0	19,0	40,0	67142
0.3750	9,525 mm	3/8	10,0	80,0	33,0	19,0	40,0	58523
0.3780	9,600 mm		10,0	80,0	34,0	19,0	40,0	67143
0.3819	9,700 mm		10,0	80,0	34,0	19,0	40,0	67144
0.3858	9,800 mm		10,0	80,0	34,0	20,0	40,0	67145
0.3898	9,900 mm		10,0	80,0	35,0	20,0	40,0	67146
0.3906	9,921 mm	25/64	10,0	80,0	35,0	20,0	40,0	58524
0.3937	10,000 mm		10,0	80,0	35,0	20,0	40,0	67147
0.3970	10,084 mm	X	12,0	90,0	36,0	21,0	43,0	58525
0.3976	10,100 mm		12,0	90,0	36,0	21,0	43,0	67148
0.4016	10,200 mm		12,0	90,0	36,0	20,0	43,0	67149
0.4040	10,262 mm	Y	12,0	90,0	36,0	21,0	43,0	58526
0.4055	10,300 mm		12,0	90,0	36,0	21,0	43,0	67150
0.4062	10,317 mm	13/32	12,0	90,0	36,0	21,0	43,0	58527
0.4094	10,400 mm		12,0	90,0	36,0	21,0	43,0	67151
0.4134	10,500 mm		12,0	90,0	37,0	21,0	43,0	67152
0.4173	10,600 mm		12,0	90,0	37,0	21,0	43,0	67153
0.4213	10,700 mm		12,0	90,0	37,0	21,0	43,0	67154
0.4219	10,716 mm	27/64	12,0	90,0	38,0	21,0	43,0	58528
0.4252	10,800 mm		12,0	90,0	38,0	22,0	43,0	67155
0.4291	10,900 mm		12,0	90,0	38,0	22,0	43,0	67156
0.4331	11,000 mm		12,0	90,0	39,0	22,0	43,0	67157
0.4370	11,100 mm		12,0	90,0	39,0	22,0	43,0	67158
0.4375	11,113 mm	7/16	12,0	90,0	39,0	22,0	43,0	58529
0.4409	11,200 mm		12,0	90,0	39,0	22,0	43,0	67159
0.4449	11,300 mm		12,0	90,0	40,0	23,0	43,0	67160
0.4488	11,400 mm		12,0	90,0	40,0	23,0	43,0	67161
0.4528	11,500 mm		12,0	90,0	40,0	23,0	43,0	67162
0.4531	11,509 mm	29/64	12,0	90,0	40,0	23,0	43,0	58530
0.4567	11,600 mm		12,0	90,0	41,0	23,0	43,0	67163
0.4606	11,700 mm		12,0	90,0	41,0	23,0	43,0	67164
0.4646	11,800 mm		12,0	90,0	41,0	24,0	43,0	67165
0.4685	11,900 mm		12,0	90,0	42,0	24,0	43,0	67166
0.4688	11,908 mm	15/32	12,0	90,0	42,0	24,0	43,0	58531
0.4724	12,000 mm		12,0	90,0	42,0	24,0	43,0	67167
0.4844	12,304 mm	31/64	14,0	100,0	43,0	25,0	46,0	58532
0.4921	12,500 mm		14,0	100,0	44,0	25,0	46,0	67168

continued on next page

TOLERANCES (inch)

≤.1181 DIAMETER

DC = +.00008/+0.00047
DCON = h_6

>.1181-.2362 DIAMETER

DC = +.00016/+0.00093
DCON = h_6

>.2362-.3937 DIAMETER

DC = +.00024/+0.00083
DCON = h_6

>.3937-.7087 DIAMETER

DC = +.00028/+0.00098
DCON = h_6

>.7087-1.1811 DIAMETER

DC = +.00031/+0.00114
DCON = h_6

TOLERANCES (mm)

≤3 DIAMETER

DC = +0,002/+0,012
DCON = h_6

>3-6 DIAMETER

DC = +0,004/+0,016
DCON = h_6

>6-10 DIAMETER

DC = +0,006/+0,021
DCON = h_6

>10-18 DIAMETER

DC = +0,007/+0,025
DCON = h_6

>18-30 DIAMETER

DC = +0,008/+0,029
DCON = h_6

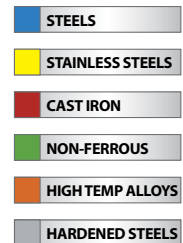

For patent information visit www.ksptpatents.com

136U 2xD
FRACTIONAL & METRIC SERIES

DECIMAL DC	METRIC DC	inch & mm						EDP NO. Ti-NAMITE®-X (TX)
		FRACTIONAL/ LETTER/WIRE DC	SHANK DIAMETER DCON	OVERALL LENGTH OAL	FLUTE LENGTH LCF	USABLE LENGTH LU	SHANK LENGTH LS	
0.5000	12,700 mm	1/2	14,0	100,0	44,0	25,0	46,0	58533
0.5039	12,800 mm		14,0	100,0	45,0	26,0	46,0	67169
0.5118	13,000 mm		14,0	100,0	45,0	26,0	46,0	67170
0.5156	13,096 mm	33/64	14,0	100,0	46,0	26,0	46,0	58534
0.5312	13,492 mm	17/32	14,0	100,0	47,0	27,0	46,0	58535
0.5315	13,500 mm		14,0	100,0	47,0	27,0	46,0	67171
0.5469	13,891 mm	35/64	14,0	100,0	49,0	28,0	46,0	58536
0.5512	14,000 mm		14,0	100,0	49,0	28,0	46,0	67172
0.5625	14,288 mm	9/16	16,0	110,0	50,0	29,0	49,0	58537
0.5709	14,500 mm		16,0	110,0	51,0	29,0	49,0	67173
0.5781	14,684 mm	37/64	16,0	110,0	51,0	29,0	49,0	58538
0.5906	15,000 mm		16,0	110,0	53,0	30,0	49,0	67174
0.5938	15,083 mm	19/32	16,0	110,0	53,0	30,0	49,0	58539
0.6094	15,479 mm	39/64	16,0	110,0	54,0	31,0	49,0	58540
0.6102	15,500 mm		16,0	110,0	54,0	31,0	49,0	67175
0.6250	15,875 mm	5/8	16,0	110,0	56,0	32,0	49,0	58541
0.6299	16,000 mm		16,0	110,0	56,0	32,0	49,0	67176
0.6406	16,271 mm	41/64	18,0	125,0	57,0	33,0	57,0	58542
0.6496	16,500 mm		18,0	125,0	58,0	33,0	57,0	67177
0.6562	16,667 mm	21/32	18,0	125,0	58,0	33,0	57,0	58543
0.6693	17,000 mm		18,0	125,0	60,0	34,0	57,0	67178
0.6719	17,066 mm	43/64	18,0	125,0	60,0	34,0	57,0	58544
0.6875	17,463 mm	11/16	18,0	125,0	61,0	35,0	57,0	58545
0.6890	17,500 mm		18,0	125,0	61,0	35,0	57,0	67179
0.7031	17,859 mm	45/64	18,0	125,0	63,0	36,0	57,0	58546
0.7087	18,000 mm		18,0	125,0	63,0	36,0	57,0	67180
0.7188	18,258 mm	23/32	20,0	135,0	64,0	37,0	60,0	58547
0.7283	18,500 mm		20,0	135,0	65,0	37,0	60,0	67181
0.7344	18,654 mm	47/64	20,0	135,0	65,0	37,0	60,0	58548
0.7480	19,000 mm		20,0	135,0	66,0	38,0	60,0	67182
0.7500	19,050 mm	3/4	20,0	135,0	67,0	38,0	60,0	58549
0.7656	19,446 mm	49/64	20,0	135,0	68,0	39,0	60,0	58550
0.7677	19,500 mm		20,0	135,0	68,0	39,0	60,0	67183
0.7812	19,842 mm	25/32	20,0	135,0	69,0	40,0	60,0	58551
0.7874	20,000 mm		20,0	135,0	70,0	40,0	60,0	67184
0.7969	20,241 mm	51/64	22,0	145,0	71,0	40,0	68,0	58552
0.8071	20,500 mm		22,0	145,0	72,0	41,0	68,0	67185
0.8125	20,638 mm	13/16	22,0	145,0	72,0	41,0	68,0	58553

CONTINUED

Series 146U, 136U Fractional	Hardness	Vc (sfm)	DC • in									
			1/16	1/8	1/4	3/8	1/2	5/8	3/4	13/16		
P CARBON STEELS 1018, 1040, 1080, 1090, 10L50, 1140, 1212, 12L15, 1525, 1536	≤ 175 Bhn or ≤ 7 HRc	285	RPM	17419	8710	4355	2903	2177	1742	1452	1340	
		(228-342)	Fr	0.0016	0.0031	0.0062	0.0093	0.0124	0.0155	0.0186	0.0202	
			Feed (ipm)	27.0	27.0	27.0	27.0	27.0	27.0	27.0	27.0	
	≤ 275 Bhn or ≤ 28 HRc	255	RPM	15586	7793	3896	2598	1948	1559	1299	1199	
		(204-306)	Fr	0.0013	0.0027	0.0054	0.0081	0.0108	0.0135	0.0162	0.0175	
			Feed (ipm)	21.0	21.0	21.0	21.0	21.0	21.0	21.0	21.0	
	≤ 425 Bhn or ≤ 45 HRc	145	RPM	8862	4431	2216	1477	1108	886	739	682	
		(116-174)	Fr	0.0011	0.0023	0.0045	0.0068	0.0090	0.0113	0.0135	0.0147	
			Feed (ipm)	10.0	10.0	10.0	10.0	10.0	10.0	10.0	10.0	
	P ALLOY STEELS 4140, 4150, 4320, 5120, 5150, 8630, 86L20, 50100	≤ 275 Bhn or ≤ 28 HRc	220	RPM	13446	6723	3362	2241	1681	1345	1121	1034
			(176-264)	Fr	0.0015	0.0030	0.0059	0.0089	0.0119	0.0149	0.0178	0.0193
				Feed (ipm)	20.0	20.0	20.0	20.0	20.0	20.0	20.0	20.0
≤ 375 Bhn or ≤ 40 HRc		135	RPM	8251	4126	2063	1375	1031	825	688	635	
		(108-162)	Fr	0.0013	0.0027	0.0053	0.0080	0.0107	0.0133	0.0160	0.0173	
			Feed (ipm)	11.0	11.0	11.0	11.0	11.0	11.0	11.0	11.0	
P TOOL STEELS A2, D2, H13, L2, M2, P20, S7, T15, W2	≤ 200 Bhn or ≤ 13 HRc	125	RPM	7640	3820	1910	1273	955	764	637	588	
		(100-150)	Fr	0.0012	0.0025	0.0050	0.0075	0.0099	0.0124	0.0149	0.0162	
			Feed (ipm)	9.5	9.5	9.5	9.5	9.5	9.5	9.5	9.5	
	≤ 375 Bhn or ≤ 40 HRc	90	RPM	5501	2750	1375	917	688	550	458	423	
		(72-108)	Fr	0.0005	0.0011	0.0022	0.0033	0.0044	0.0055	0.0065	0.0071	
			Feed (ipm)	3.0	3.0	3.0	3.0	3.0	3.0	3.0	3.0	
M STAINLESS STEELS (FREE MACHINING) 303, 416, 420F, 430F, 440F	≤ 185 Bhn or ≤ 9 HRc	265	RPM	16197	8098	4049	2699	2025	1620	1350	1246	
		(212-318)	Fr	0.0008	0.0016	0.0032	0.0048	0.0064	0.0080	0.0096	0.0104	
			Feed (ipm)	13.0	13.0	13.0	13.0	13.0	13.0	13.0	13.0	
	≤ 275 Bhn or ≤ 28 HRc	170	RPM	10390	5195	2598	1732	1299	1039	866	799	
		(136-204)	Fr	0.0006	0.0013	0.0025	0.0038	0.0050	0.0063	0.0075	0.0081	
			Feed (ipm)	6.5	6.5	6.5	6.5	6.5	6.5	6.5	6.5	
M STAINLESS STEELS (DIFFICULT) 304, 316, 321, 13-8 PH, 15-5PH, 17-4 PH, Custom 450	≤ 275 Bhn or ≤ 28 HRc	130	RPM	7946	3973	1986	1324	993	795	662	611	
		(104-156)	Fr	0.0006	0.0013	0.0025	0.0038	0.0050	0.0063	0.0076	0.0082	
			Feed (ipm)	5.0	5.0	5.0	5.0	5.0	5.0	5.0	5.0	
	≤ 375 Bhn or ≤ 40 HRc	95	RPM	5806	2903	1452	968	726	581	484	447	
		(76-114)	Fr	0.0006	0.0011	0.0023	0.0034	0.0045	0.0057	0.0068	0.0074	
			Feed (ipm)	3.3	3.3	3.3	3.3	3.3	3.3	3.3	3.3	
K GRAY CAST IRONS	≤ 220 Bhn or ≤ 19 HRc	250	RPM	15280	7640	3820	2547	1910	1528	1273	1175	
		(200-300)	Fr	0.0016	0.0031	0.0063	0.0094	0.0126	0.0157	0.0188	0.0204	
			Feed (ipm)	24.0	24.0	24.0	24.0	24.0	24.0	24.0	24.0	
	≤ 260 Bhn or ≤ 26 HRc	220	RPM	13446	6723	3362	2241	1681	1345	1121	1034	
		(176-264)	Fr	0.0015	0.0030	0.0059	0.0089	0.0119	0.0149	0.0178	0.0193	
			Feed (ipm)	20.0	20.0	20.0	20.0	20.0	20.0	20.0	20.0	

continued on next page

	Series 146U, 136U Fractional	Hardness	Vc (sfm)	DC • in								
				1/16	1/8	1/4	3/8	1/2	5/8	3/4	13/16	
N	ALUMINUM ALLOYS (WROUGHT) 2024, 6061, 7075	≤ 150 Bhn	475	RPM	29032	14516	7258	4839	3629	2903	2419	2233
		or	(380-570)	Fr	0.0016	0.0031	0.0062	0.0093	0.0124	0.0155	0.0186	0.0202
		≤ 88 HRb		Feed (ipm)	45.0	45.0	45.0	45.0	45.0	45.0	45.0	45.0
	ALUMINUM ALLOYS (CAST) A356, A380, 390	≤ 140 Bhn	380	RPM	23226	11613	5806	3871	2903	2323	1935	1787
		or	(304-456)	Fr	0.0014	0.0028	0.0055	0.0083	0.0110	0.0138	0.0165	0.0179
		≤ 3 HRc		Feed (ipm)	32.0	32.0	32.0	32.0	32.0	32.0	32.0	32.0
S	TITANIUM ALLOYS Pure Titanium, Ti6Al4V, Ti6Al2Sn4Zr2Mo, Ti4Al4Mo2Sn0.5Si, Ti-6Al4V	≤ 275 Bhn	175	RPM	10696	5348	2674	1783	1337	1070	891	823
		or	(140-210)	Fr	0.0007	0.0014	0.0028	0.0042	0.0055	0.0069	0.0083	0.0090
		≤ 28 HRc		Feed (ipm)	7.4	7.4	7.4	7.4	7.4	7.4	7.4	7.4
		≤ 350 Bhn	130	RPM	7946	3973	1986	1324	993	795	662	611
		or	(104-156)	Fr	0.0006	0.0013	0.0025	0.0038	0.0050	0.0063	0.0076	0.0082
		≤ 38 HRc		Feed (ipm)	5.0	5.0	5.0	5.0	5.0	5.0	5.0	5.0
	≤ 440 Bhn	70	RPM	4278	2139	1070	713	535	428	357	329	
	or	(56-84)	Fr	0.0005	0.0009	0.0019	0.0028	0.0037	0.0047	0.0056	0.0061	
	≤ 47 HRc		Feed (ipm)	2.0	2.0	2.0	2.0	2.0	2.0	2.0	2.0	
H	Alloy Steels 4140, 4150, 4320, 5120, 5150, 8630, 86L20, 50100	≤ 450 Bhn	95	RPM	5806	2903	1452	968	726	581	484	447
		or	(76-114)	Fr	0.0008	0.0016	0.0031	0.0047	0.0062	0.0078	0.0093	0.0101
		≤ 48 HRc		Feed (ipm)	4.5	4.5	4.5	4.5	4.5	4.5	4.5	4.5
	TOOL STEELS A2, D2, H13, L2, M2, P20, S7, T15, W2	≤ 475 Bhn	80	RPM	4890	2445	1222	815	611	489	407	376
		or	(64-96)	Fr	0.0007	0.0014	0.0029	0.0043	0.0057	0.0072	0.0086	0.0093
		≤ 50 HRc		Feed (ipm)	3.5	3.5	3.5	3.5	3.5	3.5	3.5	3.5

reduce rates when material is harder than listed, when drilling conditions are not optimum, or coolant is not available
 rates shown are for drilling into a flat surface and should be lowered using the reduction multiplier when the workpiece is angled or curved
 reduce rates 10 to 20 percent when using drills without internal coolant
 always use the shortest overhang possible
 longer drills may require a spot drill operation to avoid walking on entry
 internal coolant required in ISO S and M material groups or when drilling depth exceeds 3xD
 Bhn (Brinell) HRc (Rockwell C) HRb (Rockwell B)
 $rpm = Vc \times 3.82 / DC$
 $ipm = Fr \times rpm$
 speed and feed for materials harder than listed
 refer to the SGS Tool Wizard® for complete technical information (www.kyocera-sgstool.com)

angle °	reduction multiplier	
	speed x	feed x
up to 30	1.0	0.6
over 30	0.7	0.4

Series 146U, 136U Metric	Hardness	Vc (m/mm)	DC • mm									
			1.5	3	6	8	10	12	16	20		
P CARBON STEELS 1018, 1040, 1080, 1090, 10L50, 1140, 1212, 12L15, 1525, 1536	≤ 175 Bhn or ≤ 7 HRc	87	RPM	18419	9209	4605	3454	2763	2302	1727	1381	
		(69-104)	Fr	0.037	0.074	0.149	0.199	0.248	0.298	0.397	0.496	
			Feed (mm/min)	686	686	686	686	686	686	686	686	
	≤ 275 Bhn or ≤ 28 HRc	78	RPM	16480	8240	4120	3090	2472	2060	1545	1236	
		(62-93)	Fr	0.032	0.065	0.129	0.173	0.216	0.259	0.345	0.432	
			Feed (mm/min)	533	533	533	533	533	533	533	533	
	≤ 425 Bhn or ≤ 45 HRc	44	RPM	9371	4686	2343	1757	1406	1171	879	703	
		(35-53)	Fr	0.027	0.054	0.108	0.145	0.181	0.217	0.289	0.361	
			Feed (mm/min)	254	254	254	254	254	254	254	254	
	ALLOY STEELS 4140, 4150, 4320, 5120, 5150, 8630, 86L20, 50100	≤ 275 Bhn or ≤ 28 HRc	67	RPM	14218	7109	3555	2666	2133	1777	1333	1066
			(54-80)	Fr	0.036	0.071	0.143	0.191	0.238	0.286	0.381	0.476
				Feed (mm/min)	508	508	508	508	508	508	508	508
		≤ 375 Bhn or ≤ 40 HRc	41	RPM	8725	4362	2181	1636	1309	1091	818	654
			(33-49)	Fr	0.032	0.064	0.128	0.171	0.213	0.256	0.342	0.427
				Feed (mm/min)	279	279	279	279	279	279	279	279
TOOL STEELS A2, D2, H13, L2, M2, P20, S7, T15, W2	≤ 200 Bhn or ≤ 13 HRc	38	RPM	8078	4039	2020	1515	1212	1010	757	606	
		(30-46)	Fr	0.030	0.060	0.119	0.159	0.199	0.239	0.319	0.398	
			Feed (mm/min)	241	241	241	241	241	241	241	241	
	≤ 375 Bhn or ≤ 40 HRc	27	RPM	5816	2908	1454	1091	872	727	545	436	
		(22-33)	Fr	0.013	0.026	0.052	0.070	0.087	0.105	0.140	0.175	
			Feed (mm/min)	76	76	76	76	76	76	76	76	
M STAINLESS STEELS (FREE MACHINING) 303, 416, 420F, 430F, 440F	≤ 185 Bhn or ≤ 9 HRc	81	RPM	17126	8563	4282	3211	2569	2141	1606	1284	
		(65-97)	Fr	0.019	0.039	0.077	0.103	0.129	0.154	0.206	0.257	
			Feed (mm/min)	330	330	330	330	330	330	330	330	
	≤ 275 Bhn or ≤ 28 HRc	52	RPM	10987	5493	2747	2060	1648	1373	1030	824	
		(41-62)	Fr	0.015	0.030	0.060	0.080	0.100	0.120	0.160	0.200	
			Feed (mm/min)	165	165	165	165	165	165	165	165	
	STAINLESS STEELS (DIFFICULT) 304, 316, 321, 13-8 PH, 15-5PH, 17-4 PH, Custom 450	≤ 275 Bhn or ≤ 28 HRc	40	RPM	8402	4201	2100	1575	1260	1050	788	630
			(32-48)	Fr	0.015	0.030	0.060	0.081	0.101	0.121	0.161	0.202
				Feed (mm/min)	127	127	127	127	127	127	127	127
		≤ 375 Bhn or ≤ 40 HRc	29	RPM	6140	3070	1535	1151	921	767	576	460
			(23-35)	Fr	0.014	0.027	0.055	0.073	0.091	0.109	0.146	0.182
				Feed (mm/min)	84	84	84	84	84	84	84	84
K GRAY CAST IRONS	≤ 220 Bhn or ≤ 19 HRc	76	RPM	16157	8078	4039	3029	2424	2020	1515	1212	
		(61-91)	Fr	0.038	0.075	0.151	0.201	0.252	0.302	0.402	0.503	
			Feed (mm/min)	610	610	610	610	610	610	610	610	
	DUCTILE CAST IRONS	≤ 260 Bhn or ≤ 26 HRc	67	RPM	14218	7109	3555	2666	2133	1777	1333	1066
			(54-80)	Fr	0.036	0.071	0.143	0.191	0.238	0.286	0.381	0.476
				Feed (mm/min)	508	508	508	508	508	508	508	508

continued on next page

Series 146U, 136U Metric	Hardness	Vc (m/mm)	DC • mm									
			1.5	3	6	8	10	12	16	20		
N ALUMINUM ALLOYS (WROUGHT) 2024, 6061, 7075	≤ 150 Bhn or ≤ 88 HRb	145	RPM	30698	15349	7675	5756	4605	3837	2878	2302	
		(116-174)	Fr	0.037	0.074	0.149	0.199	0.248	0.298	0.397	0.496	
			Feed (mm/min)	1143	1143	1143	1143	1143	1143	1143	1143	
	ALUMINUM ALLOYS (CAST) A356, A380, 390	≤ 140 Bhn or ≤ 3 HRc	116	RPM	24559	12279	6140	4605	3684	3070	2302	1842
			(93-139)	Fr	0.033	0.066	0.132	0.177	0.221	0.265	0.353	0.441
				Feed (mm/min)	813	813	813	813	813	813	813	813
S TITANIUM ALLOYS Pure Titanium, Ti6Al4V, Ti6Al2Sn4Zr2Mo, Ti4Al4Mo2Sn0.5Si, Ti-6Al4V	≤ 275 Bhn or ≤ 28 HRc	53	RPM	11310	5655	2827	2121	1696	1414	1060	848	
		(43-64)	Fr	0.017	0.033	0.066	0.089	0.111	0.133	0.177	0.222	
			Feed (mm/min)	188	188	188	188	188	188	188	188	
	≤ 350 Bhn or ≤ 38 HRc	40	RPM	8402	4201	2100	1575	1260	1050	788	630	
		(32-48)	Fr	0.015	0.030	0.060	0.081	0.101	0.121	0.161	0.202	
			Feed (mm/min)	127	127	127	127	127	127	127	127	
	≤ 440 Bhn or ≤ 47 HRc	21	RPM	4524	2262	1131	848	679	565	424	339	
		(17-26)	Fr	0.011	0.022	0.045	0.060	0.075	0.090	0.120	0.150	
			Feed (mm/min)	51	51	51	51	51	51	51	51	
H Alloy Steels 4140, 4150, 4320, 5120, 5150, 8630, 86L20, 50100	≤ 450 Bhn or ≤ 48 HRc	29	RPM	6140	3070	1535	1151	921	767	576	460	
		(23-35)	Fr	0.019	0.037	0.074	0.099	0.124	0.149	0.199	0.248	
			Feed (mm/min)	114	114	114	114	114	114	114	114	
	TOOL STEELS A2, D2, H13, L2, M2, P20, S7, T15, W2	≤ 475 Bhn or ≤ 50 HRc	24	RPM	5170	2585	1293	969	776	646	485	388
			(20-29)	Fr	0.017	0.034	0.069	0.092	0.115	0.138	0.183	0.229
				Feed (mm/min)	89	89	89	89	89	89	89	89

reduce rates when material is harder than listed, when drilling conditions are not optimum, or coolant is not available
 rates shown are for drilling into a flat surface and should be lowered using the reduction multiplier when the workpiece is angled or curved
 reduce rates 10 to 20 percent when using drills without internal coolant
 always use the shortest overhang possible
 longer drills may require a spot drill operation to avoid walking on entry
 internal coolant required in ISO S and M material groups or when drilling depth exceeds 3xD
 Bhn (Brinell) HRc (Rockwell C) HRb (Rockwell B)
 $rpm = (Vc \times 1000) / (DC \times 3.14)$
 $mm/min = Fr \times rpm$
 speed and feed for materials harder than listed
 refer to the SGS Tool Wizard® for complete technical information (www.kyocera-sgstool.com)

angle °	reduction multiplier	
	speed x	feed x
up to 30	1.0	0.6
over 30	0.7	0.4

General Application End Mills



Milling

SERIES	GENERAL APPLICATION END MILLS DESCRIPTION	PAGE	S&F PAGE
3	2 Flute Square End Standard Length Fractional	280	320, 321
3L	2 Flute Square End Long Reach Fractional	280	320, 321
3EL	2 Flute Square End Extended Length Fractional	280	320, 321
3CR	2 Flute Corner Radius Standard Length Fractional	280	320, 321
3M	2 Flute Square End Standard Length Metric	285	326
3XLM	2 Flute Square End Extra Long Reach Metric	285	326
3B	2 Flute Ball End Standard Length Fractional	283	320
3LB	2 Flute Ball End Long Reach Fractional	283	320
3ELB	2 Flute Ball End Extended Length Fractional	283	320
3MB	2 Flute Ball End Standard Length Metric	286	326
3XLMB	2 Flute Ball End Extra Long Reach Metric	286	326
15	2 Flute Double End Square Stub Fractional	287	321
15M	2 Flute Double End Square Stub Metric	289	326
15B	2 Flute Double End Ball Stub Fractional	288	322
15MB	2 Flute Double End Ball Stub Metric	290	326
17	2 Flute Square End Stub Fractional	291	321
17M	2 Flute Square End Stub Metric	291	326
52	2 Flute High Shear Square End Standard Length Fractional	292	323
52M	2 Flute High Shear Square End Standard Length Metric	292	328
59	2 Flute Square End Long Reach Fractional	293	321
59M	2 Flute Square End Long Reach Metric	295	326
59B	2 Flute Ball End Long Reach Fractional	294	321
59MB	2 Flute Ball End Long Reach Metric	296	327
5	3 Flute Square End Standard Length Fractional	297	321
5M	3 Flute Square End Standard Length Metric	299	326
5XLM	3 Flute Square End Extra Long Reach Metric	299	326
5B	3 Flute Ball End Standard Length Fractional	298	321
5MB	3 Flute Ball End Standard Length Metric	300	326
5XLMB	3 Flute Ball End Extra Long Reach Metric	300	326
23	3 Flute Tapered Square End Standard Length Fractional	301	321
24	3 Flute Tapered Corner Radius Standard Length Fractional	302	321
1	4 Flute Square End Standard Length Fractional	303	320, 321
1L	4 Flute Square End Long Reach Fractional	303	320, 321
1EL	4 Flute Square End Extended Length Fractional	303	320, 321
1CR	4 Flute Corner Radius Standard Length Fractional	303	320, 321
1M	4 Flute Square End Standard Length Metric	309	326
1XLM	4 Flute Square End Extra Long Reach Metric	309	326
1MCR	4 Flute Corner Radius Standard Length Metric	309	326

Speed & Feed Recommendations listed at the end of this section

SERIES	GENERAL APPLICATION END MILLS DESCRIPTION	PAGE	S&F PAGE
1B	4 Flute Ball End Standard Length Fractional	307	320
1LB	4 Flute Ball End Long Reach Fractional	307	320
1ELB	4 Flute Ball End Extended Length Fractional	307	320
1MB	4 Flute Ball End Standard Length Metric	312	326
1XLMB	4 Flute Ball End Extra Long Reach Metric	312	326
14	4 Flute Double End Square Stub Fractional	313	321
14M	4 Flute Double End Square Stub Metric	313	326
14B	4 Flute Double End Ball Stub Fractional	314	321
14MB	4 Flute Double End Ball Stub Metric	314	326
16	4 Flute Square End Stub Fractional	303	321
16M	4 Flute Square End Stub Metric	309	326
54	4 Flute High Shear Square End Standard Length Fractional	315	323
54M	4 Flute High Shear Square End Standard Length Metric	315	328
61	Multi-Flute Coarse Pitch Rougher Fractional	316	324
61M	Multi-Flute Coarse Pitch Rougher Metric	316	330
62	Multi-Flute Fine Pitch Rougher Fractional	317	325
62M	Multi-Flute Fine Pitch Rougher Metric	317	331
End Mill Sets	2, 3, & 4 Flute Square End Series 1, 3, 5, 14, 15	318	320, 321
	2, 3, & 4 Flute Ball End Series 1B, 3B, 5B, 14B ,15B	319	320, 321

Speed & Feed Recommendations listed at the end of this section

Fresado

SERIE	DESCRIPCIÓN DE FRESAS DE USO GENERAL	PÁGINA	S&F PÁGINA
3	2 filos, punta cuadrada, longitud estándar, fraccional	280	320, 321
3L	2 filos, punta cuadrada, largo alcance, fraccional	280	320, 321
3EL	2 filos, punta cuadrada, longitud extendida, fraccional	280	320, 321
3CR	2 filos, radio angulado, longitud estándar, fraccional	280	320, 321
3M	2 filos, punta cuadrada, longitud estándar, métrico	285	326
3XLM	2 filos, punta cuadrada, alcance extralargo, métrico	285	326
3B	2 filos, punta esférica, longitud estándar, fraccional	283	320
3LB	2 filos, punta esférica, largo alcance, fraccional	283	320
3ELB	2 filos, punta esférica, longitud extendida, fraccional	283	320
3MB	2 filos, punta esférica, longitud estándar, métrico	286	326
3XLMB	2 filos, punta esférica, alcance extralargo, métrico	286	326
15	2 filos, pieza doble de punta cuadrada, fraccional	287	321
15M	2 filos, pieza doble de punta cuadrada, métrico	289	326
15B	2 filos, pieza doble de punta esférica, fraccional	288	322
15MB	2 filos, pieza doble de punta esférica, métrico	290	326
17	2 filos, pieza de punta cuadrada, fraccional	291	321

SERIE	DESCRIPCIÓN DE FRESAS DE USO GENERAL	PÁGINA	S&F PÁGINA
17M	2 filos, pieza de punta cuadrada, métrico	291	326
52	2 filos, alto rendimiento, punta cuadrada, longitud estándar, fraccional	292	323
52M	2 filos, alto rendimiento, punta cuadrada, longitud estándar, métrico	292	328
59	2 filos, punta cuadrada, largo alcance, fraccional	293	321
59M	2 filos, punta cuadrada, largo alcance, métrico	295	326
59B	2 filos, punta esférica, largo alcance, fraccional	294	321
59MB	2 filos, punta esférica, largo alcance, métrico	296	327
5	3 filos, punta cuadrada, longitud estándar, fraccional	297	321
5M	3 filos, punta cuadrada, longitud estándar, métrico	299	326
5XLM	3 filos, punta cuadrada, alcance extralargo, métrico	299	326
5B	3 filos, punta esférica, longitud estándar, fraccional	298	321
5MB	3 filos, punta esférica, longitud estándar, métrico	300	326
5XLMB	3 filos, punta esférica, alcance extralargo, métrico	300	326
23	3 filos, cónico, punta cuadrada, longitud estándar, fraccional	301	321
24	3 filos, cónico, radio angulado, longitud estándar, fraccional	302	321
1	4 filos, punta cuadrada, longitud estándar, fraccional	303	320, 321
1L	4 filos, punta cuadrada, largo alcance, fraccional	303	320, 321
1EL	4 filos, punta cuadrada, longitud extendida, fraccional	303	320, 321
1CR	4 filos, radio angulado, longitud estándar, fraccional	303	320, 321
1M	4 filos, punta cuadrada, longitud estándar, métrico	309	326
1XLM	4 filos, punta cuadrada, alcance extralargo, métrico	309	326
1MCR	4 filos, radio angulado, longitud estándar, métrico	309	326
1B	4 filos, punta esférica, longitud estándar, fraccional	307	320
1LB	4 filos, punta esférica, largo alcance, fraccional	307	320
1ELB	4 filos, punta esférica, longitud extendida, fraccional	307	320
1MB	4 filos, punta esférica, longitud estándar, métrico	312	326
1XLMB	4 filos, punta esférica, alcance extralargo, métrico	312	326
14	4 filos, pieza doble de punta cuadrada, fraccional	313	321
14M	4 filos, pieza doble de punta cuadrada, métrico	313	326
14B	4 filos, pieza doble de punta esférica, fraccional	314	321
14MB	4 filos, pieza doble de punta esférica, métrico	314	326
16	4 filos, pieza de punta cuadrada, fraccional	303	321
16M	4 filos, pieza de punta cuadrada, métrico	309	326
54	4 filos, alto rendimiento, punta cuadrada, longitud estándar, fraccional	315	323
54M	4 filos, alto rendimiento, punta cuadrada, longitud estándar, métrico	315	328
61	Filo múltiple, paso grueso, desbastador, fraccional	316	324
61M	Filo múltiple, paso grueso, desbastador, métrico	316	330
62	Filo múltiple, paso fino, desbastador, fraccional	317	325
62M	Filo múltiple, paso fino, desbastador, métrico	317	331
Juegos de fresas	2, 3 y 4 filos, punta cuadrada, series 1, 3, 5, 14, 15	318	320, 321
	2, 3 y 4 filos, punta esférica, series 1B, 3B, 5B, 14B, 15B	319	320, 321

Recomendaciones de Velocidad y Avance mostrados al final de esta sección.

Fraiseage

SÉRIES	DESCRIPTION DE FRAISES À USAGE GÉNÉRAL	PAGE	S&F PAGE
3	2 dents non rayonné longueur standard (fractionnel)	280	320, 321
3L	2 dents non rayonné longue portée (fractionnel)	280	320, 321
3EL	2 dents non rayonné extra-long (fractionnel)	280	320, 321
3CR	2 dents rayonné longueur standard (fractionnel)	280	320, 321
3M	2 dents non rayonné longueur standard (métrique)	285	326
3XLM	2 dents non rayonné portée extra-longue (métrique)	285	326
3B	2 dents à bout hémisphérique longueur standard (fractionnel)	283	320
3LB	2 dents à bout hémisphérique longue portée (fractionnel)	283	320
3ELB	2 dents à bout hémisphérique extra-long (fractionnel)	283	320
3MB	2 dents à bout hémisphérique longueur standard (métrique)	286	326
3XLMB	2 dents à bout hémisphérique portée extra-longue (métrique)	286	326
15	2 dents à double bouts plats court (fractionnel)	287	321
15M	2 dents à double bouts plats court (métrique)	289	326
15B	2 dents à double bouts hémisphériques court (fractionnel)	288	322
15MB	2 dents à double bouts hémisphériques court (métrique)	290	326
17	2 dents non rayonné court (fractionnel)	291	321
17M	2 dents non rayonné court (métrique)	291	326
52	2 dents cisaillement élevé non rayonné longueur standard (fractionnel)	292	323
52M	2 dents cisaillement élevé non rayonné longueur standard (métrique)	292	328
59	2 dents non rayonné longue portée (fractionnel)	293	321
59M	2 dents non rayonné longue portée (métrique)	295	326
59B	2 dents à bout hémisphérique longue portée (fractionnel)	294	321
59MB	2 dents à bout hémisphérique longue portée (métrique)	296	327
5	3 dents non rayonné longueur standard (fractionnel)	297	321
5M	3 dents non rayonné longueur standard (métrique)	299	326
5XLM	3 dents non rayonné portée extra-longue (métrique)	299	326
5B	3 dents à bout hémisphérique longueur standard (fractionnel)	298	321
5MB	3 dents à bout hémisphérique longueur standard (métrique)	300	326
5XLMB	3 dents à bout hémisphérique portée extra-longue (métrique)	300	326
23	3 dents conique non rayonné longueur standard (fractionnel)	301	321
24	3 dents conique rayonné longueur standard (fractionnel)	302	321
1	4 dents non rayonné longueur standard (fractionnel)	303	320, 321
1L	4 dents non rayonné longue portée (fractionnel)	303	320, 321
1EL	4 dents non rayonné extra-long (fractionnel)	303	320, 321
1CR	4 dents rayonné longueur standard (fractionnel)	303	320, 321
1M	4 dents non rayonné longueur standard (métrique)	309	326
1XLM	4 dents non rayonné portée extra-longue (métrique)	309	326
1MCR	4 dents rayonné longueur standard (métrique)	309	326
1B	4 dents à bout hémisphérique longueur standard (fractionnel)	307	320
1LB	4 dents à bout hémisphérique longue portée (fractionnel)	307	320

SÉRIES	DESCRIPTION DE FRAISES À USAGE GÉNÉRAL	PAGE	S&F PAGE
1ELB	4 dents à bout hémisphérique extra-long (fractionnel)	307	320
1MB	4 dents à bout hémisphérique longueur standard (métrique)	312	326
1XLMB	4 dents à bout hémisphérique portée extra-longue (métrique)	312	326
14	4 dents à double bouts plats court (fractionnel)	313	321
14M	4 dents à double bouts plats court (métrique)	313	326
14B	4 dents à double bouts hémisphériques court (fractionnel)	314	321
14MB	4 dents à double bouts hémisphériques court (métrique)	314	326
16	4 dents non rayonné court (fractionnel)	303	321
16M	4 dents non rayonné court (métrique)	309	326
54	4 dents cisaillement élevé non rayonné longueur standard (fractionnel)	315	323
54M	4 dents cisaillement élevé non rayonné longueur standard (métrique)	315	328
61	Multi-dents à pas gros d'ébauche (fractionnel)	316	324
61M	Multi-dents à pas gros d'ébauche (métrique)	316	330
62	Multi-dents à pas fin d'ébauche (fractionnel)	317	325
62M	Multi-dents à pas fin d'ébauche (métrique)	317	331
Jeux de fraises	2, 3, & 4 Série goujure non rayonné 1,3,5,14,15	318	320, 321
	2, 3, & 4 Série goujure à bout hémisphérique 15B, 15MB, 15B, 15MB, 15B, 15MB	319	320, 321

Les avances et les vitesses recommandées se trouvent à la fin du chapitre.

SERIE	BESCHREIBUNG DER STANDARD-SCHAFTFRÄSER	SEITE	S&F SEITE
3	Zölliger Schaftfräser mit 2 Schneiden ohne Eckenradien, Standardlänge	280	320, 321
3L	Zölliger Langloch-Schaftfräser mit 2 Schneiden ohne Eckenradien	280	320, 321
3EL	Zölliger Schaftfräser mit 2 Schneiden ohne Eckenradien, extra lang	280	320, 321
3CR	Zölliger Schaftfräser mit 2 Schneiden mit Eckenradien, Standardlänge	280	320, 321
3M	Schaftfräser mit 2 Schneiden ohne Eckenradien, Standardlänge	285	326
3XLM	Langloch-Schaftfräser mit 2 Schneiden ohne Eckenradien	285	326
3B	Zölliger Radiuschaftfräser mit 2 Schneiden, Standardlänge	283	320
3LB	Zölliger Langloch-Radiuschaftfräser mit 2 Schneiden	283	320
3ELB	Zölliger Schaftfräser mit 2 Schneiden, Extra lang	283	320
3MB	Schaftfräser mit 2 Schneiden, Standardlänge	286	326
3XLMB	Superlangloch-Schaftfräser mit 2 Schneiden	286	326
15	Zölliger Schaftfräser mit 2 Schneiden, kurze Ausführung	287	321
15M	Schaftfräser mit 2 Schneiden, kurze Ausführung	289	326
15B	Zölliger Doppelend-Radiuschaftfräser mit 2 Schneiden, kurze Ausführung	288	322
15MB	Doppelend-Radiuschaftfräser mit 2 Schneiden, kurze Ausführung	290	326
17	Zölliger Schaftfräser mit 2 Schneiden ohne Eckenradien, kurze Ausführung	291	321
17M	Schaftfräser mit 2 Schneiden ohne Eckenradien, kurze Ausführung	291	326
52	Zölliger Schaftfräser hoher Scherfestigkeit mit 2 Schneiden ohne Eckenradien, Standardlänge	292	323
52M	Schaftfräser hoher Scherfestigkeit mit 2 Schneiden ohne Eckenradien, Standardlänge	292	328
59	Zölliger Langloch-Schaftfräser mit 2 Schneiden ohne Eckenradien	293	321
59M	Langloch-Schaftfräser mit 2 Schneiden ohne Eckenradien	295	326
59B	Zölliger Langloch-Radiuschaftfräser mit 2 Schneiden	294	321
59MB	Langloch-Radiuschaftfräser mit 2 Schneiden	296	327
5	Zölliger Schaftfräser mit 3 Schneiden ohne Eckenradien, Standardlänge	297	321
5M	Schaftfräser mit 3 Schneiden ohne Eckenradien, Standardlänge	299	326
5XLM	Langloch-Schaftfräser mit 3 Schneiden ohne Eckenradien	299	326
5B	Zölliger Schaftfräser mit 3 Schneiden, Standardlänge	298	321
5MB	Schaftfräser mit 3 Schneiden, Standardlänge	300	326
5XLMB	Langloch-Schaftfräser mit 3 Schneiden	300	326
23	Zölliger Schaftfräser mit 3 Schneiden ohne Eckenradien, Standardlänge	301	321
24	Zölliger Schaftfräser mit 3 Schneiden mit Eckenradien, Standardlänge	302	321
1	Zölliger Schaftfräser mit 4 Schneiden ohne Eckenradien, Standardlänge	303	320, 321
1L	Zölliger Langloch-Schaftfräser mit 4 Schneiden ohne Eckenradien	303	320, 321
1EL	Zölliger Schaftfräser mit 4 Schneiden ohne Eckenradien, extra lang	303	320, 321
1CR	Zölliger Schaftfräser mit 4 Schneiden mit Eckenradien, Standardlänge	303	320, 321
1M	Schaftfräser mit 4 Schneiden ohne Eckenradien, Standardlänge	309	326
1XLM	Superlangloch-Schaftfräser mit 4 Schneiden ohne Eckenradien	309	326
1MCR	Schaftfräser mit 4 Schneiden mit Eckenradien, Standardlänge	309	326
1B	Zölliger Schaftfräser mit 4 Schneiden, Standardlänge	307	320

SERIE	BESCHREIBUNG DER STANDARD-SCHAFTFRÄSER	SEITE	S&F SEITE
1LB	Zölliger Langloch-Radiuschaftfräser mit 4 Schneiden	307	320
1ELB	Zölliger Schaftfräser mit 4 Schneiden, Extra lang	307	320
1MB	Schaftfräser mit 4 Schneiden, Standardlänge	312	326
1XLMB	Langloch-Radiuschaftfräser mit 4 Schneiden	312	326
14	Zölliger Schaftfräser mit 4 Schneiden, kurze Ausführung	313	321
14M	Schaftfräser mit 4 Schneiden, kurze Ausführung	313	326
14B	Zölliger Doppelend-Radiuschaftfräser mit 4 Schneiden, kurze Ausführung	314	321
14MB	Doppelend-Radiuschaftfräser mit 4 Schneiden, kurze Ausführung	314	326
16	Zölliger Schaftfräser mit 4 Schneiden ohne Eckenradien, kurze Ausführung	303	321
16M	Schaftfräser mit 4 Schneiden ohne Eckenradien, kurze Ausführung	309	326
54	Zölliger Schaftfräser hoher Scherfestigkeit mit 4 Schneiden ohne Eckenradien, Standardlänge	315	323
54M	Schaftfräser hoher Scherfestigkeit mit 4 Schneiden ohne Eckenradien, Standardlänge	315	328
61	Zölliger mehrschneidiger fein verzahnter Schruppfräser	316	324
61M	Mehrschneidiger fein verzahnter Schruppfräser	316	330
62	Zölliger mehrschneidiger fein verzahnter Schruppfräser	317	325
62M	Mehrschneidiger fein verzahnter Schruppfräser	317	331
Richtwerte zum Fräsen	Schaftfräser mit 2, 3 und 4 Schneiden ohne Eckenradien, Serien 1, 3, 5, 14, 15	318	320, 321
	Radiuschaftfräser mit 2, 3 und 4 Schneiden, Serien 1B, 3B, 5B, 14B, 15B	319	320, 321

Schnittwertempfehlungen finden Sie am Ende dieses Abschnitts

2 Flute Square End • 2 Flute Corner Radius

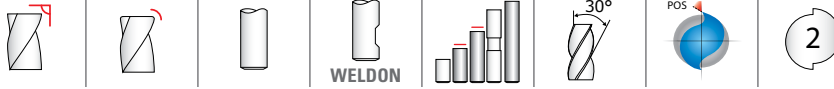

**3•3L•
3EL•3CR**
FRACTIONAL SERIES

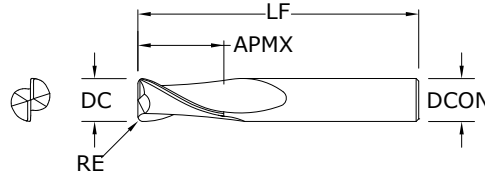

TOLERANCES (inch)

<1/8 DIAMETER

DC = +0.000/-0.001
DCON = h₆

≥1/8 DIAMETER

DC = +0.000/-0.002
3CR DC = -0.001/-0.002
DCON = h₆
RE = +0.000/-0.002

- STEELS
- STAINLESS STEELS
- CAST IRON
- NON-FERROUS
- HIGH TEMP ALLOYS

For patent information visit www.ksptpatents.com

CUTTING DIAMETER DC	LENGTH OF CUT APMX	inch				WELDON FLAT	EDP NO.				SERIES
		OVERALL LENGTH LF	SHANK DIAMETER DCON	CORNER RADIUS RE	UNCOATED		Ti-NAMITE® (TiN)	Ti-NAMITE®-C (TiCN)	Ti-NAMITE®-A (AlTiN)		
1/64	1/32	1-1/2	1/8	—	30301	39301	39501	30397	3		
1/32	5/64	1-1/2	1/8	—	30303	39303	39503	30398	3		
3/64	7/64	1-1/2	1/8	—	30305	39305	39505	30399	3		
*1/16	3/16	1-1/2	1/8	—	30307	39307	39507	30400	3		
5/64	3/16	1-1/2	1/8	—	30309	39309	39509	30435	3		
3/32	9/32	1-1/2	1/8	—	30311	39311	39511	30436	3		
7/64	3/8	1-1/2	1/8	—	30313	39313	39513	30437	3		
1/8	3/8	1-1/2	1/8	—	30377	39377	39577	30469	3		
*1/8	1/2	1-1/2	1/8	—	30315	39315	39515	30438	3		
1/8	1/2	1-1/2	1/8	.015	38201	38202	38315	38357	3CR		
1/8	1/2	1-1/2	1/8	.020	38203	38204	38316	38358	3CR		
1/8	3/4	2-1/4	1/8	—	33341	31800	31810	31850	3L		
1/8	1	3	1/8	—	33343	31938	31948	31958	3EL		
9/64	1/2	2	3/16	—	30317	39317	39517	30439	3		
5/32	1/2	2	3/16	—	30319	39319	39519	30440	3		
11/64	5/8	2	3/16	—	30321	39321	39521	30441	3		
*3/16	5/8	2	3/16	—	30323	39323	39523	30442	3		
3/16	5/8	2	3/16	.015	38209	38210	38317	38359	3CR		
3/16	5/8	2	3/16	.020	38211	38212	38318	38360	3CR		
3/16	5/8	2	3/16	.030	38213	38214	38319	38361	3CR		
3/16	3/4	2-1/2	3/16	—	33301	31820	31825	31851	3L		
3/16	1-1/8	3	3/16	—	33321	31939	31949	31959	3EL		
13/64	5/8	2-1/2	1/4	—	30325	39325	39525	30443	3		
7/32	5/8	2-1/2	1/4	—	30327	39327	39527	30444	3		
15/64	3/4	2-1/2	1/4	—	30329	39329	39529	30445	3		
*1/4	3/4	2-1/2	1/4	—	30331	39331	39531	30446	3		
1/4	3/4	2-1/2	1/4	.015	38219	38220	38320	38362	3CR		
1/4	3/4	2-1/2	1/4	.020	38221	38222	38321	38363	3CR		
1/4	3/4	2-1/2	1/4	.030	38223	38224	38322	38364	3CR		
1/4	3/4	2-1/2	1/4	.045	38225	38226	38323	38365	3CR		
1/4	1-1/8	3	1/4	—	33303	31802	31812	31852	3L		
1/4	1-1/2	4	1/4	—	33323	31940	31950	31960	3EL		
17/64	3/4	2-1/2	5/16	—	30333	39333	39533	30447	3		
9/32	3/4	2-1/2	5/16	—	30335	39335	39535	30448	3		

continued on next page

2 Flute Square End • 2 Flute Corner Radius

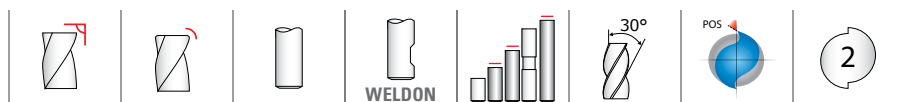

TOLERANCES (inch)

<1/8 DIAMETER

DC = +0.000 / -0.001

DCON = h_6

≥1/8 DIAMETER

DC = +0.000 / -0.002

3CR DC = -0.001 / -0.002

DCON = h_6

RE = +0.000 / -0.002

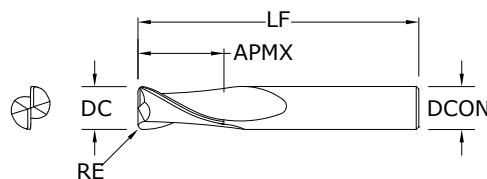

**3•3L•
3EL•3CR**
FRACTIONAL SERIES

CUTTING DIAMETER DC	LENGTH OF CUT APMX	inch				WELDON FLAT	EDP NO.				SERIES
		OVERALL LENGTH LF	SHANK DIAMETER DCON	CORNER RADIUS RE			UNCOATED	Ti-NAMITE® (TiN)	Ti-NAMITE®-C (TiCN)	Ti-NAMITE®-A (AlTiN)	
19/64	13/16	2-1/2	5/16	-		30337	39337	39537	30449	3	
*+5/16	13/16	2-1/2	5/16	-		30339	39339	39539	30450	3	
5/16	13/16	2-1/2	5/16	.015		38231	38232	38324	38366	3CR	
5/16	13/16	2-1/2	5/16	.020		38233	38234	38325	38367	3CR	
5/16	13/16	2-1/2	5/16	.030		38235	38236	38326	38368	3CR	
5/16	13/16	2-1/2	5/16	.045		38237	38238	38327	38369	3CR	
5/16	1-1/8	3	5/16	-		33305	31821	31826	31853	3L	
5/16	1-5/8	4	5/16	-		33325	31941	31951	31961	3EL	
21/64	1	2-1/2	3/8	-		30341	39341	39541	30451	3	
11/32	1	2-1/2	3/8	-		30343	39343	39543	30452	3	
23/64	1	2-1/2	3/8	-		30345	39345	39545	30453	3	
*+3/8	1	2-1/2	3/8	-		30347	39347	39547	30454	3	
3/8	1	2-1/2	3/8	.015	•	38245	38246	38328	38370	3CR	
3/8	1	2-1/2	3/8	.020	•	38247	38248	38329	38371	3CR	
3/8	1	2-1/2	3/8	.030	•	38249	38250	38330	38372	3CR	
3/8	1	2-1/2	3/8	.045	•	38251	38252	38331	38373	3CR	
3/8	1-1/8	3	3/8	-		33307	31804	31814	31854	3L	
3/8	1-3/4	4	3/8	-		33327	31942	31952	31962	3EL	
25/64	1	2-3/4	7/16	-		30349	39349	39549	30455	3	
13/32	1	2-3/4	7/16	-		30351	39351	39551	30456	3	
27/64	1	2-3/4	7/16	-		30353	39353	39553	30457	3	
7/16	1	2-3/4	7/16	-		30355	39355	39555	30458	3	
7/16	2	4-1/2	7/16	-		33309	31822	31827	31855	3L	
7/16	3	6	7/16	-		33329	31943	31953	31963	3EL	
29/64	1	3	1/2	-		30357	39357	39557	30459	3	
15/32	1	3	1/2	-		30359	39359	39559	30460	3	
31/64	1	3	1/2	-		30361	39361	39561	30461	3	
*+1/2	1	3	1/2	-		30363	39363	39563	30462	3	
1/2	1	3	1/2	.015	•	38259	38260	38332	38374	3CR	
1/2	1	3	1/2	.020	•	38261	38262	38333	38375	3CR	
1/2	1	3	1/2	.030	•	38263	38264	38334	38376	3CR	
1/2	1	3	1/2	.045	•	38265	38266	38335	38377	3CR	
1/2	1	3	1/2	.060	•	38267	38268	38336	38378	3CR	
1/2	2	4-1/2	1/2	-		33311	31806	31816	31856	3L	

continued on next page

CONTINUED

- STEELS
- STAINLESS STEELS
- CAST IRON
- NON-FERROUS
- HIGH TEMP ALLOYS

For patent information visit www.ksptpatents.com

2 Flute Square End • 2 Flute Corner Radius

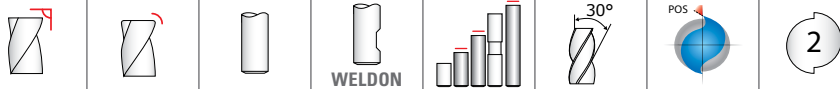

**3•3L•
3EL•3CR**
FRACTIONAL SERIES

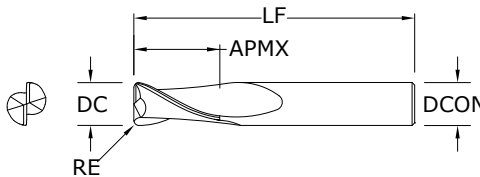

TOLERANCES (inch)

<1/8 DIAMETER

DC = +0.000/-0.001

DCON = h₆

≥1/8 DIAMETER

DC = +0.000/-0.002

3CR DC = -0.001/-0.002

DCON = h₆

RE = +0.000/-0.002

CONTINUED

- STEELS
- STAINLESS STEELS
- CAST IRON
- NON-FERROUS
- HIGH TEMP ALLOYS

For patent information visit www.ksptpatents.com

CUTTING DIAMETER DC	LENGTH OF CUT APMX	inch				WELDON FLAT	EDP NO.				SERIES
		OVERALL LENGTH LF	SHANK DIAMETER DCON	CORNER RADIUS RE	UNCOATED		Ti-NAMITE® (TiN)	Ti-NAMITE®-C (TiCN)	Ti-NAMITE®-A (AlTiN)		
1/2	3	6	1/2	—		33331	31944	31954	31964	3EL	
9/16	1-1/8	3-1/2	9/16	—		30365	39365	39565	30463	3	
5/8	1-1/4	3-1/2	5/8	—		30367	39367	39567	30464	3	
5/8	1-1/4	3-1/2	5/8	.015	•	38273	38274	38337	38379	3CR	
5/8	1-1/4	3-1/2	5/8	.020	•	38275	38276	38338	38380	3CR	
5/8	1-1/4	3-1/2	5/8	.030	•	38277	38278	38339	38381	3CR	
5/8	1-1/4	3-1/2	5/8	.045	•	38279	38280	38340	38382	3CR	
5/8	1-1/4	3-1/2	5/8	.060	•	38281	38282	38341	38383	3CR	
5/8	1-1/4	3-1/2	5/8	.090	•	38283	38284	38342	38384	3CR	
5/8	2-1/4	5	5/8	—		33313	31823	31817	31857	3L	
5/8	3	6	5/8	—		33333	31945	31955	31965	3EL	
11/16	1-3/8	4	3/4	—		30369	39369	39569	30465	3	
3/4	1-1/2	4	3/4	—		30371	39371	39571	30466	3	
3/4	1-1/2	4	3/4	.015	•	38287	38288	38343	38385	3CR	
3/4	1-1/2	4	3/4	.020	•	38289	38290	38344	38386	3CR	
3/4	1-1/2	4	3/4	.030	•	38291	38292	38345	38387	3CR	
3/4	1-1/2	4	3/4	.045	•	38293	38294	38346	38388	3CR	
3/4	1-1/2	4	3/4	.060	•	38295	38296	38347	38389	3CR	
3/4	1-1/2	4	3/4	.090	•	38297	38298	38348	38390	3CR	
3/4	1-1/2	4	3/4	.125	•	38299	38300	38349	38391	3CR	
3/4	2-1/4	5	3/4	—		33315	31808	31818	31858	3L	
3/4	3	6	3/4	—		33335	31946	31956	31966	3EL	
7/8	1-1/2	4	7/8	—		30373	39373	39573	30467	3	
1	1-1/2	4	1	—		30375	39375	39575	30468	3	
1	1-1/2	4	1	.015	•	38301	38302	38350	38392	3CR	
1	1-1/2	4	1	.020	•	38303	38304	38351	38393	3CR	
1	1-1/2	4	1	.030	•	38305	38306	38352	38394	3CR	
1	1-1/2	4	1	.045	•	38307	38308	38353	38395	3CR	
1	1-1/2	4	1	.060	•	38309	38310	38354	38396	3CR	
1	1-1/2	4	1	.090	•	38311	38312	38355	38397	3CR	
1	1-1/2	4	1	.125	•	38313	38314	38356	38398	3CR	
1	2-1/4	5	1	—		33317	31824	31819	31859	3L	
1	3	6	1	—		33337	31947	31957	31967	3EL	
*Series 3 Set				—		30389	39389	39589	30470	3	

† Di-NAMITE® coating offered standard for this configuration. Please contact your KSPT Representative for more information.

FRACTIONAL 2 Flute Ball End

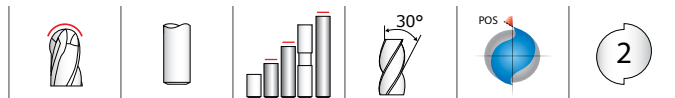

TOLERANCES (inch)

<1/8 DIAMETER

DC = +0.000/-0.001

DCON = h_6

RE = +0.000/-0.0005

≥1/8 DIAMETER

DC = +0.000/-0.002

DCON = h_6

RE = +0.000/-0.001

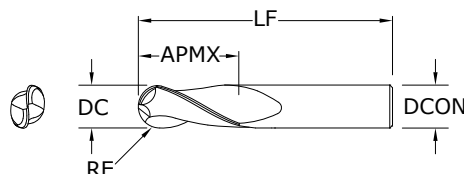

**3B•3LB•
3ELB**
FRACTIONAL SERIES

inch				EDP NO.				SERIES
CUTTING DIAMETER DC	LENGTH OF CUT APMX	OVERALL LENGTH LF	SHANK DIAMETER DCON	UNCOATED	Ti-NAMITE® (TiN)	Ti-NAMITE®-C (TiCN)	Ti-NAMITE®-A (AlTiN)	
1/64	1/32	1-1/2	1/8	30302	39302	39502	30471	3B
1/32	5/64	1-1/2	1/8	30304	39304	39504	30472	3B
3/64	7/64	1-1/2	1/8	30306	39306	39506	30473	3B
1/16	3/16	1-1/2	1/8	30308	39308	39508	30474	3B
5/64	3/16	1-1/2	1/8	30310	39310	39510	30475	3B
3/32	9/32	1-1/2	1/8	30312	39312	39512	30476	3B
7/64	3/8	1-1/2	1/8	30314	39314	39514	30477	3B
1/8	3/8	1-1/2	1/8	30378	39378	39578	30599	3B
*1/8	1/2	1-1/2	1/8	30316	39316	39516	30478	3B
1/8	3/4	2-1/4	1/8	33342	31830	31840	31890	3LB
1/8	1	3	1/8	33344	31968	31978	31988	3ELB
9/64	1/2	2	3/16	30318	39318	39518	30479	3B
5/32	1/2	2	3/16	30320	39320	39520	30480	3B
11/64	5/8	2	3/16	30322	39322	39522	30481	3B
*3/16	5/8	2	3/16	30324	39324	39524	30482	3B
3/16	3/4	2-1/2	3/16	33302	31831	31841	31891	3LB
3/16	1-1/8	3	3/16	33322	31969	31979	31989	3ELB
13/64	5/8	2-1/2	1/4	30326	39326	39526	30483	3B
7/32	5/8	2-1/2	1/4	30328	39328	39528	30484	3B
15/64	3/4	2-1/2	1/4	30330	39330	39530	30485	3B
*1/4	3/4	2-1/2	1/4	30332	39332	39532	30486	3B
1/4	1-1/8	3	1/4	33304	31832	31842	31892	3LB
1/4	1-1/2	4	1/4	33324	31970	31980	31990	3ELB
17/64	3/4	2-1/2	5/16	30334	39334	39534	30487	3B
9/32	3/4	2-1/2	5/16	30336	39336	39536	30488	3B
19/64	13/16	2-1/2	5/16	30338	39338	39538	30489	3B
*5/16	13/16	2-1/2	5/16	30340	39340	39540	30490	3B
5/16	1-1/8	3	5/16	33306	31833	31843	31893	3LB
5/16	1-5/8	4	5/16	33326	31971	31981	31991	3ELB
21/64	1	2-1/2	3/8	30342	39342	39542	30491	3B
11/32	1	2-1/2	3/8	30344	39344	39544	30492	3B
23/64	1	2-1/2	3/8	30346	39346	39546	30493	3B

continued on next page

- STEELS
- STAINLESS STEELS
- CAST IRON
- NON-FERROUS
- HIGH TEMP ALLOYS

For patent information visit www.ksptpatents.com

2 Flute Ball End



**3B•3LB•
3ELB**
FRACTIONAL SERIES

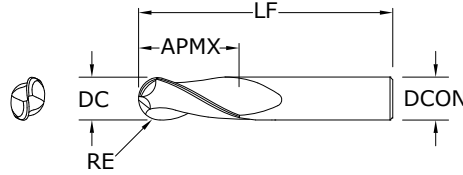

TOLERANCES (inch)

<1/8 DIAMETER

DC = +0.000/-0.001

DCON = h₆

RE = +0.000/-0.0005

≥1/8 DIAMETER

DC = +0.000/-0.002

DCON = h₆

RE = +0.000/-0.001

STEELS

STAINLESS STEELS

CAST IRON

NON-FERROUS

HIGH TEMP ALLOYS

For patent information visit www.ksptpatents.com

CUTTING DIAMETER DC	LENGTH OF CUT APMX	OVERALL LENGTH LF	SHANK DIAMETER DCON	EDP NO.				SERIES
				UNCOATED	Ti-NAMITE® (TiN)	Ti-NAMITE®-C (TiCN)	Ti-NAMITE®-A (AlTiN)	
*3/8	1	2-1/2	3/8	30348	39348	39548	30494	3B
3/8	1-1/8	3	3/8	33308	31834	31844	31894	3LB
3/8	1-3/4	4	3/8	33328	31972	31982	31992	3ELB
25/64	1	2-3/4	7/16	30350	39350	39550	30495	3B
13/32	1	2-3/4	7/16	30352	39352	39552	30496	3B
27/64	1	2-3/4	7/16	30354	39354	39554	30497	3B
7/16	1	2-3/4	7/16	30356	39356	39556	30498	3B
7/16	2	4-1/2	7/16	33310	31835	31845	31895	3LB
7/16	3	6	7/16	33330	31973	31983	31993	3ELB
29/64	1	3	1/2	30358	39358	39558	30499	3B
15/32	1	3	1/2	30360	39360	39560	30500	3B
31/64	1	3	1/2	30362	39362	39562	30591	3B
*1/2	1	3	1/2	30364	39364	39564	30592	3B
1/2	2	4-1/2	1/2	33312	31836	31846	31896	3LB
1/2	3	6	1/2	33332	31974	31984	31994	3ELB
9/16	1-1/8	3-1/2	9/16	30366	39366	39566	30593	3B
5/8	1-1/4	3-1/2	5/8	30368	39368	39568	30594	3B
5/8	2-1/4	5	5/8	33314	31837	31847	31897	3LB
5/8	3	6	5/8	33334	31975	31985	31995	3ELB
11/16	1-3/8	4	3/4	30370	39370	39570	30595	3B
3/4	1-1/2	4	3/4	30372	39372	39572	30596	3B
3/4	2-1/4	5	3/4	33316	31838	31848	31898	3LB
3/4	3	6	3/4	33336	31976	31986	31996	3ELB
7/8	1-1/2	4	7/8	30374	39374	39574	30597	3B
1	1-1/2	4	1	30376	39376	39576	30598	3B
1	2-1/4	5	1	33318	31839	31849	31899	3LB
1	3	6	1	33338	31977	31987	31997	3ELB
*Series 3B Set				30390	39390	39590	30600	3B

RE = 1/2 Cutting Diameter (DC)

2 Flute Square End

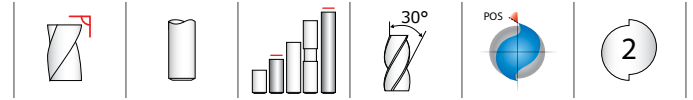

TOLERANCES (mm)

<3 DIAMETER

DC = +0,0000/-0.0254
 DCON = h₆

≥3 DIAMETER

DC = +0,0000/-0.0508
 DCON = h₆
 RE = +0,0000/-0.0508

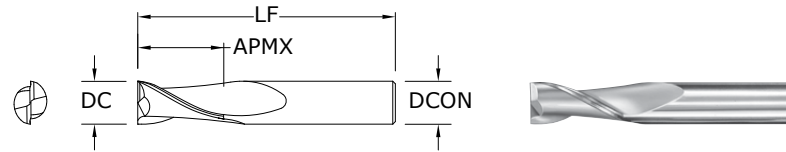

**3M.
3XLM**
METRIC SERIES

mm				EDP NO.				SERIES
CUTTING DIAMETER DC	LENGTH OF CUT APMX	OVERALL LENGTH LF	SHANK DIAMETER DCON	UNCOATED	Ti-NAMITE® (TiN)	Ti-NAMITE®-C (TiCN)	Ti-NAMITE®-A (AlTiN)	
1,0	4,0	38,0	3,0	40305	48628	48650	48671	3M
1,5	4,5	38,0	3,0	40309	48629	48651	48672	3M
2,0	6,3	38,0	3,0	40313	48630	48652	48673	3M
2,5	9,5	38,0	3,0	40317	48631	48653	48674	3M
3,0	12,0	38,0	3,0	40321	48632	48654	48675	3M
3,0	25,0	75,0	3,0	43301	49427	49440	49453	3XLM
3,5	12,0	50,0	4,0	40325	48633	48655	48676	3M
4,0	14,0	50,0	4,0	40329	48634	48656	48677	3M
4,0	25,0	75,0	4,0	43303	49428	49441	49454	3XLM
4,5	16,0	50,0	6,0	40333	48635	48657	48678	3M
5,0	16,0	50,0	6,0	40337	48636	48658	48679	3M
5,0	25,0	75,0	5,0	43307	49430	49443	49456	3XLM
6,0	19,0	50,0	6,0	40341	48637	48659	48680	3M
6,0	25,0	75,0	6,0	43305	49429	49442	49455	3XLM
7,0	19,0	63,0	8,0	40345	48638	48660	48681	3M
8,0	20,0	63,0	8,0	40349	48639	48661	48682	3M
8,0	25,0	75,0	8,0	43315	49431	49444	49457	3XLM
9,0	22,0	75,0	10,0	40353	48640	48662	48683	3M
10,0	22,0	75,0	10,0	40357	48641	48663	48684	3M
10,0	38,0	100,0	10,0	43325	49432	49445	49458	3XLM
11,0	25,0	75,0	12,0	40361	48642	48664	48685	3M
12,0	25,0	75,0	12,0	40365	48643	48665	48686	3M
12,0	50,0	100,0	12,0	43335	49433	49446	49459	3XLM
12,0	75,0	150,0	12,0	43345	49434	49447	49460	3XLM
14,0	32,0	89,0	14,0	40369	48644	48666	48687	3M
14,0	75,0	150,0	14,0	43355	49435	49448	49461	3XLM
16,0	32,0	89,0	16,0	40373	48645	48667	48688	3M
16,0	75,0	150,0	16,0	43365	49436	49449	49462	3XLM
18,0	38,0	100,0	18,0	40377	48646	48668	48689	3M
18,0	75,0	150,0	18,0	43375	49437	49450	49463	3XLM
20,0	38,0	100,0	20,0	40381	48647	48669	48690	3M
20,0	75,0	150,0	20,0	43385	49438	49451	49464	3XLM
25,0	38,0	100,0	25,0	40385	48648	48670	48691	3M
25,0	75,0	150,0	25,0	43395	49439	49452	49465	3XLM

- STEELS
- STAINLESS STEELS
- CAST IRON
- NON-FERROUS
- HIGH TEMP ALLOYS

For patent information visit www.kspatents.com

METRIC

2 Flute Ball End

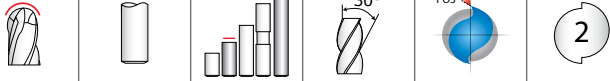

**3MB•
3XLMB**
METRIC SERIES

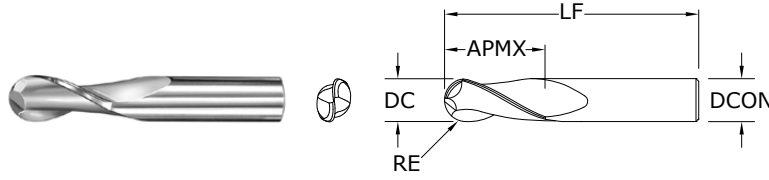

TOLERANCES (mm)

<3 DIAMETER

DC = +0,0000 / -0,0254

DCON = h₆

RE = +0,0000 / -0,0127

≥3 DIAMETER

DC = +0,0000 / -0,0508

DCON = h₆

RE = +0,0000 / -0,0254

- STEELS
- STAINLESS STEELS
- CAST IRON
- NON-FERROUS
- HIGH TEMP ALLOYS

For patent information visit www.ksptpatents.com

CUTTING DIAMETER DC	mm			EDP NO.				SERIES
	LENGTH OF CUT APMX	OVERALL LENGTH LF	SHANK DIAMETER DCON	UNCOATED	Ti-NAMITE® (TiN)	Ti-NAMITE®-C (TiCN)	Ti-NAMITE®-A (AlTiN)	
1,0	4,0	38,0	3,0	40306	48692	48714	48735	3MB
1,5	4,5	38,0	3,0	40310	48693	48715	48736	3MB
2,0	6,3	38,0	3,0	40314	48694	48716	48737	3MB
2,5	9,5	38,0	3,0	40318	48695	48717	48738	3MB
3,0	12,0	38,0	3,0	40322	48696	48718	48739	3MB
3,0	25,0	75,0	3,0	43302	49544	49557	49570	3XLMB
3,5	12,0	50,0	4,0	40326	48697	48719	48740	3MB
4,0	14,0	50,0	4,0	40330	48698	48720	48741	3MB
4,0	25,0	75,0	4,0	43304	49545	49558	49571	3XLMB
4,5	16,0	50,0	6,0	40334	48699	48721	48742	3MB
5,0	16,0	50,0	6,0	40338	48700	48722	48743	3MB
5,0	25,0	75,0	5,0	43308	49547	49560	49573	3XLMB
6,0	19,0	50,0	6,0	40342	48701	48723	48744	3MB
6,0	25,0	75,0	6,0	43306	49546	49559	49572	3XLMB
7,0	19,0	63,0	8,0	40346	48702	48724	48745	3MB
8,0	20,0	63,0	8,0	40350	48703	48725	48746	3MB
8,0	25,0	75,0	8,0	43316	49548	49561	49574	3XLMB
9,0	22,0	75,0	10,0	40354	48704	48726	48747	3MB
10,0	22,0	75,0	10,0	40358	48705	48727	48748	3MB
10,0	38,0	100,0	10,0	43326	49549	49562	49575	3XLMB
11,0	25,0	75,0	12,0	40362	48706	48728	48749	3MB
12,0	25,0	75,0	12,0	40366	48707	48729	48750	3MB
12,0	50,0	100,0	12,0	43336	49550	49563	49576	3XLMB
12,0	75,0	150,0	12,0	43346	49551	49564	49577	3XLMB
14,0	32,0	89,0	14,0	40370	48708	48730	48751	3MB
14,0	75,0	150,0	14,0	43356	49552	49565	49578	3XLMB
16,0	32,0	89,0	16,0	40374	48709	48731	48752	3MB
16,0	75,0	150,0	16,0	43366	49553	49566	49579	3XLMB
18,0	38,0	100,0	18,0	40378	48710	48732	48753	3MB
18,0	75,0	150,0	18,0	43376	49554	49567	49580	3XLMB
20,0	38,0	100,0	20,0	40382	48711	48733	48754	3MB
20,0	75,0	150,0	20,0	43386	49555	49568	49581	3XLMB
25,0	38,0	100,0	25,0	40386	48712	48734	48755	3MB
25,0	75,0	150,0	25,0	43396	49556	49569	49582	3XLMB

RE = 1/2 Cutting Diameter (DC)

FRACTIONAL 2 Flute Double End

TOLERANCES (inch)

<1/8 DIAMETER

DC = +0.000/-0.001

DCON = h_6

≥1/8 DIAMETER

DC = +0.000/-0.002

DCON = h_6

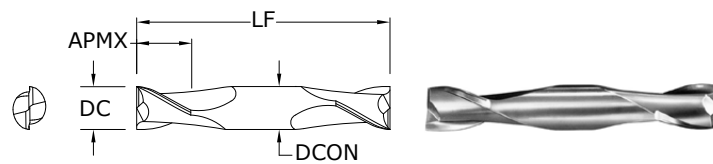

15
FRACTIONAL SERIES

inch				EDP NO.			
CUTTING DIAMETER DC	LENGTH OF CUT APMX	OVERALL LENGTH LF	SHANK DIAMETER DCON	UNCOATED	Ti-NAMITE® (TiN)	Ti-NAMITE®-C (TiCN)	Ti-NAMITE®-A (AlTiN)
1/32	1/16	1-1/2	1/8	31501	31541	39651	31316
3/64	3/32	1-1/2	1/8	31503	31543	39653	31317
1/16	1/8	1-1/2	1/8	31505	31545	39655	31318
5/64	1/8	1-1/2	1/8	31507	31547	39657	31319
3/32	3/16	1-1/2	1/8	31509	31549	39659	31320
7/64	3/16	1-1/2	1/8	31511	31551	39661	31321
*1/8	1/4	1-1/2	1/8	31513	31553	39663	31322
9/64	5/16	2	3/16	31515	31555	39665	31323
5/32	5/16	2	3/16	31517	31557	39667	31324
11/64	5/16	2	3/16	31519	31559	39669	31325
*3/16	3/8	2	3/16	31521	31561	39671	31326
13/64	1/2	2-1/2	1/4	31523	31563	39673	31327
7/32	1/2	2-1/2	1/4	31525	31565	39675	31328
15/64	1/2	2-1/2	1/4	31527	31567	39677	31329
*1/4	1/2	2-1/2	1/4	31529	31569	39679	31330
9/32	1/2	2-1/2	5/16	31531	31571	39681	31331
*5/16	1/2	2-1/2	5/16	31533	31573	39683	31332
*3/8	9/16	2-1/2	3/8	31535	31575	39685	31333
7/16	9/16	2-3/4	7/16	31537	31577	39687	31334
*1/2	5/8	3	1/2	31539	31579	39689	31335
*Series 15 Set				31589	31581	39691	31336

- STEELS
- STAINLESS STEELS
- CAST IRON
- NON-FERROUS
- HIGH TEMP ALLOYS

For patent information visit www.ksptpatents.com

2 Flute Double End Ball End

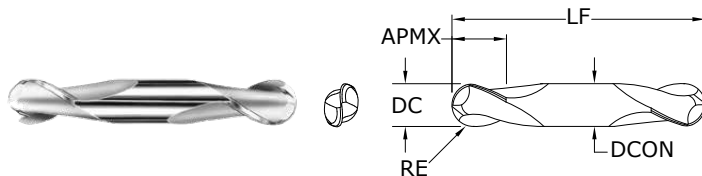
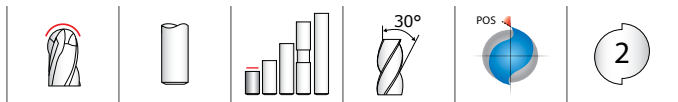

TOLERANCES (inch)

<1/8 DIAMETER

DC = +0.000/-0.001

DCON = h_6

RE = +0.000/-0.0005

≥1/8 DIAMETER

DC = +0.000/-0.002

DCON = h_6

RE = +0.000/-0.001

15B

FRACTIONAL SERIES

STEELS

STAINLESS STEELS

CAST IRON

NON-FERROUS

HIGH TEMP ALLOYS

For patent information visit www.ksptpatents.com

CUTTING DIAMETER DC	inch			EDP NO.			
	LENGTH OF CUT APMX	OVERALL LENGTH LF	SHANK DIAMETER DCON	UNCOATED	Ti-NAMITE® (TiN)	Ti-NAMITE®-C (TiCN)	Ti-NAMITE®-A (AlTiN)
1/32	1/16	1-1/2	1/8	31502	31542	39652	31337
3/64	3/32	1-1/2	1/8	31504	31544	39654	31338
1/16	1/8	1-1/2	1/8	31506	31546	39656	31339
5/64	1/8	1-1/2	1/8	31508	31548	39658	31340
3/32	3/16	1-1/2	1/8	31510	31550	39660	31341
7/64	3/16	1-1/2	1/8	31512	31552	39662	31342
*1/8	1/4	1-1/2	1/8	31514	31554	39664	31343
9/64	5/16	2	3/16	31516	31556	39666	31344
5/32	5/16	2	3/16	31518	31558	39668	31345
11/64	5/16	2	3/16	31520	31560	39670	31346
*3/16	3/8	2	3/16	31522	31562	39672	31347
13/64	1/2	2-1/2	1/4	31524	31564	39674	31348
7/32	1/2	2-1/2	1/4	31526	31566	39676	31349
15/64	1/2	2-1/2	1/4	31528	31568	39678	31350
*1/4	1/2	2-1/2	1/4	31530	31570	39680	31351
9/32	1/2	2-1/2	5/16	31532	31572	39682	31352
*5/16	1/2	2-1/2	5/16	31534	31574	39684	31353
*3/8	9/16	2-1/2	3/8	31536	31576	39686	31354
7/16	9/16	2-3/4	7/16	31538	31578	39688	31355
*1/2	5/8	3	1/2	31540	31580	39690	31356
*Series 15B Set				31590	31582	39692	31357

RE = 1/2 Cutting Diameter (DC)

2 Flute Double End

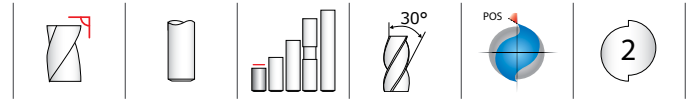

TOLERANCES (mm)

<3 DIAMETER

DC = +0,0000 / -0,0254

DCON = h₆

≥3 DIAMETER

DC = +0,0000 / -0,0508

DCON = h₆

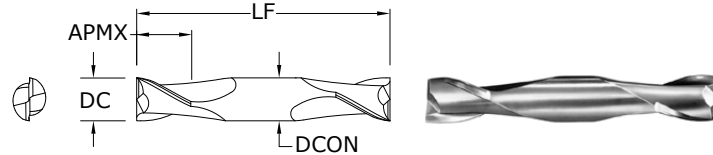

15M
METRIC SERIES

CUTTING DIAMETER DC	LENGTH OF CUT APMX	mm		EDP NO.			
		OVERALL LENGTH LF	SHANK DIAMETER DCON	UNCOATED	Ti-NAMITE® (TiN)	Ti-NAMITE®-C (TiCN)	Ti-NAMITE®-A (AlTiN)
1,0	2,0	38,0	3,0	41505	49010	49031	49052
1,5	3,0	38,0	3,0	41509	49011	49032	49053
2,0	4,0	38,0	3,0	41513	49012	49033	49054
2,5	5,0	38,0	3,0	41517	49013	49034	49055
3,0	6,0	38,0	3,0	41521	49014	49035	49056
3,5	7,0	50,0	4,0	41525	49015	49036	49057
4,0	8,0	50,0	4,0	41529	49016	49037	49058
4,5	9,5	63,0	4,5	41533	49017	49038	49059
5,0	10,0	63,0	5,0	41537	49018	49039	49060
6,0	12,0	63,0	6,0	41541	49019	49040	49061
7,0	12,0	63,0	8,0	41545	49020	49041	49062
8,0	12,0	63,0	8,0	41549	49021	49042	49063
9,0	14,0	75,0	9,0	41553	49022	49043	49064
10,0	14,0	75,0	10,0	41557	49023	49044	49065
11,0	14,0	75,0	12,0	41561	49024	49045	49066
12,0	16,0	75,0	12,0	41565	49025	49046	49067

- STEELS
- STAINLESS STEELS
- CAST IRON
- NON-FERROUS
- HIGH TEMP ALLOYS

For patent information visit www.ksptpatents.com

METRIC

2 Flute Double End Ball End

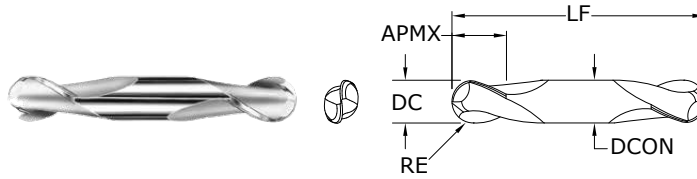
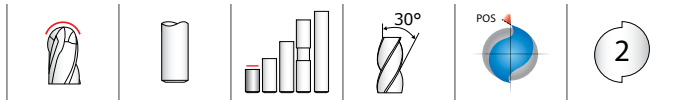

TOLERANCES (mm)

<3 DIAMETER

DC = +0,0000/-0.0254

DCON = h₆

RE = +0,0000/-0.0127

≥3 DIAMETER

DC = +0,0000/-0.0508

DCON = h₆

RE = +0,0000/-0.0254

15MB
METRIC SERIES

- STEELS
- STAINLESS STEELS
- CAST IRON
- NON-FERROUS
- HIGH TEMP ALLOYS

For patent information visit www.ksptpatents.com

CUTTING DIAMETER DC	LENGTH OF CUT APMX	OVERALL LENGTH LF	SHANK DIAMETER DCON	EDP NO.			
				UNCOATED	Ti-NAMITE® (TiN)	Ti-NAMITE®-C (TiCN)	Ti-NAMITE®-A (AlTiN)
1,0	2,0	38,0	3,0	41506	49073	49094	49115
1,5	3,0	38,0	3,0	41510	49074	49095	49116
2,0	4,0	38,0	3,0	41514	49075	49096	49117
2,5	5,0	38,0	3,0	41518	49076	49097	49118
3,0	6,0	38,0	3,0	41522	49077	49098	49119
3,5	7,0	50,0	4,0	41526	49078	49099	49120
4,0	8,0	50,0	4,0	41530	49079	49100	49121
4,5	9,5	63,0	4,5	41534	49080	49101	49122
5,0	10,0	63,0	5,0	41538	49081	49102	49123
6,0	12,0	63,0	6,0	41542	49082	49103	49124
7,0	12,0	63,0	8,0	41546	49083	49104	49125
8,0	12,0	63,0	8,0	41550	49084	49105	49126
9,0	14,0	75,0	9,0	41554	49085	49106	49127
10,0	14,0	75,0	10,0	41558	49086	49107	49128
11,0	14,0	75,0	12,0	41562	49087	49108	49129
12,0	16,0	75,0	12,0	41566	49088	49109	49130

RE = 1/2 Cutting Diameter (DC)

2 Flute Square End Stub

TOLERANCES (inch)

<1/8 DIAMETER

DC = +0.000/-0.001
 DCON = h₆

≥1/8 DIAMETER

DC = +0.000/-0.002
 DCON = h₆

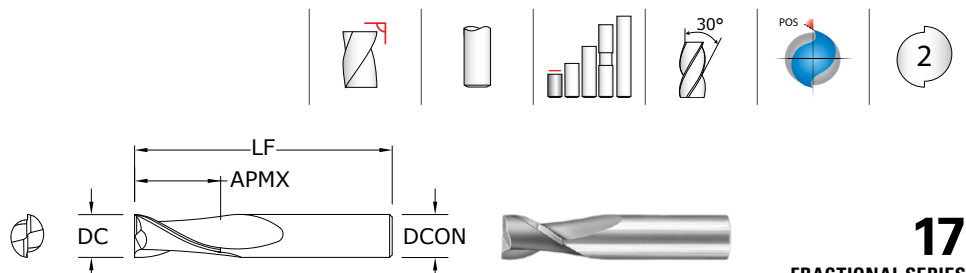

17
 FRACTIONAL SERIES

inch				EDP NO.			
CUTTING DIAMETER DC	LENGTH OF CUT APMX	OVERALL LENGTH LF	SHANK DIAMETER DCON	UNCOATED	Ti-NAMITE® (TiN)	Ti-NAMITE®-C (TiCN)	Ti-NAMITE®-A (AlTiN)
1/16	1/8	1-1/2	1/8	31701	31750	31303	31358
3/32	3/16	1-1/2	1/8	31703	31751	31304	31359
1/8	1/4	1-1/2	1/8	31705	31752	31305	31360
5/32	5/16	2	3/16	31707	31753	31306	31361
3/16	3/8	2	3/16	31709	31754	31307	31362
7/32	7/16	2	1/4	31711	31755	31308	31363
1/4	1/2	2	1/4	31713	31756	31309	31364
5/16	1/2	2	5/16	31715	31757	31310	31365
3/8	5/8	2	3/8	31717	31758	31311	31366
7/16	5/8	2-1/2	7/16	31719	31759	31312	31367
1/2	5/8	2-1/2	1/2	31721	31760	31313	31368
5/8	3/4	3	5/8	31723	31761	31314	31369
3/4	1	3	3/4	31725	31762	31315	31370

- STEELS
- STAINLESS STEELS
- CAST IRON
- NON-FERROUS
- HIGH TEMP ALLOYS

For patent information visit www.ksptpatents.com

TOLERANCES (mm)

<3 DIAMETER

DC = +0,0000/-0,0254
 DCON = h₆

≥3 DIAMETER

DC = +0,0000/-0,0508
 DCON = h₆

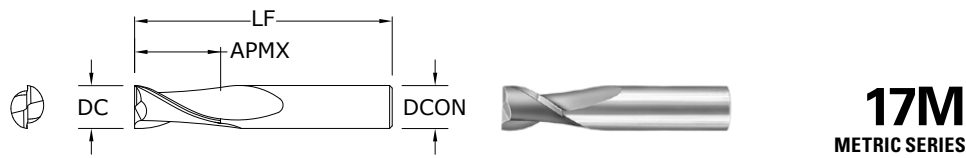

17M
 METRIC SERIES

mm				EDP NO.			
CUTTING DIAMETER DC	LENGTH OF CUT APMX	OVERALL LENGTH LF	SHANK DIAMETER DCON	UNCOATED	Ti-NAMITE® (TiN)	Ti-NAMITE®-C (TiCN)	Ti-NAMITE®-A (AlTiN)
1,0	2,0	38,0	3,0	41705	49262	49283	49304
1,5	3,0	38,0	3,0	41709	49263	49284	49305
2,0	4,0	38,0	3,0	41713	49264	49285	49306
2,5	5,0	38,0	3,0	41717	49265	49286	49307
3,0	6,0	38,0	3,0	41721	49266	49287	49308
3,5	7,0	50,0	4,0	41725	49267	49288	49309
4,0	8,0	50,0	4,0	41729	49268	49289	49310
4,5	9,5	50,0	4,5	41733	49269	49290	49311
5,0	10,0	50,0	5,0	41737	49270	49291	49312
6,0	12,0	50,0	6,0	41741	49271	49292	49313
7,0	12,0	50,0	8,0	41745	49272	49293	49314
8,0	12,0	50,0	8,0	41749	49273	49294	49315
9,0	14,0	50,0	9,0	41753	49274	49295	49316
10,0	16,0	50,0	10,0	41757	49275	49296	49317
11,0	19,0	63,0	12,0	41761	49276	49297	49318
12,0	19,0	63,0	12,0	41765	49277	49298	49319

- STEELS
- STAINLESS STEELS
- CAST IRON
- NON-FERROUS
- HIGH TEMP ALLOYS

For patent information visit www.ksptpatents.com

2 Flute High Shear



52 FRACTIONAL SERIES

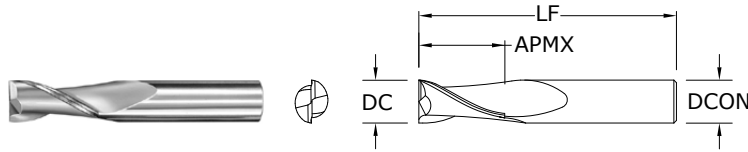

TOLERANCES (inch)

<1/8 DIAMETER
 DC = +0.000/-0.001
 DCON = h₆
≥1/8 DIAMETER
 DC = +0.000/-0.002
 DCON = h₆

NON-FERROUS

For patent information visit www.ksptpatents.com

CUTTING DIAMETER DC	LENGTH OF CUT APMX	OVERALL LENGTH LF	SHANK DIAMETER DCON	EDP NO.	
				UNCOATED	Ti-NAMITE®-C (TiCN)
1/16	3/16	1-1/2	1/8	35273	35300
3/32	3/8	1-1/2	1/8	35275	35301
1/8	7/16	1-1/2	1/8	35277	35302
5/32	9/16	2	3/16	35278	35303
3/16	9/16	2	3/16	35279	35304
7/32	5/8	2-1/2	1/4	35280	35305
1/4	3/4	2-1/2	1/4	35281	35306
9/32	3/4	2-1/2	5/16	35282	35307
5/16	13/16	2-1/2	5/16	35283	35308
3/8	7/8	2-1/2	3/8	35285	35309
7/16	1	2-3/4	7/16	35287	35310
1/2	1	3	1/2	35289	35311
9/16	1-1/8	3-1/2	9/16	35291	35312
5/8	1-1/4	3-1/2	5/8	35293	35313
3/4	1-1/2	4	3/4	35295	35314
1	1-1/2	4	1	35297	35315

52M METRIC SERIES

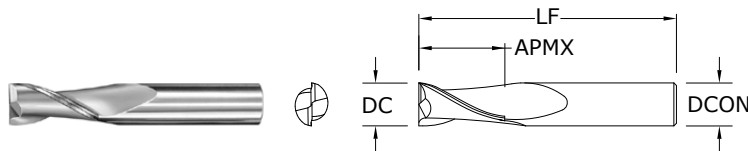

TOLERANCES (mm)

<3 DIAMETER
 DC = +0,0000/-0,0254
 DCON = h₆
≥3 DIAMETER
 DC = +0.0000/-0,0508
 DCON = h₆

NON-FERROUS

For patent information visit www.ksptpatents.com

CUTTING DIAMETER DC	LENGTH OF CUT APMX	OVERALL LENGTH LF	SHANK DIAMETER DCON	EDP NO.	
				UNCOATED	Ti-NAMITE®-C (TiCN)
3,0	7,0	38,0	3,0	45277	49829
3,5	7,0	57,0	6,0	45279	49830
4,0	8,0	57,0	6,0	45281	49831
4,5	8,0	57,0	6,0	45283	49832
5,0	10,0	57,0	6,0	45285	49833
6,0	10,0	57,0	6,0	45287	49834
8,0	16,0	63,0	8,0	45289	49835
10,0	19,0	72,0	10,0	45291	49836
12,0	22,0	83,0	12,0	45293	49837
14,0	22,0	83,0	14,0	45295	49838
16,0	26,0	92,0	16,0	45297	49839
20,0	32,0	104,0	20,0	45299	49840

2 Flute Square End Long Reach

TOLERANCES (inch)

1/8–1/4 DIAMETER

DC = +0.0000 / -0.0012
 DCON = h₆

>1/4–3/8 DIAMETER

DC = +0.0000 / -0.0016
 DCON = h₆

>3/8–3/4 DIAMETER

DC = +0.0000 / -0.0020
 DCON = h₆

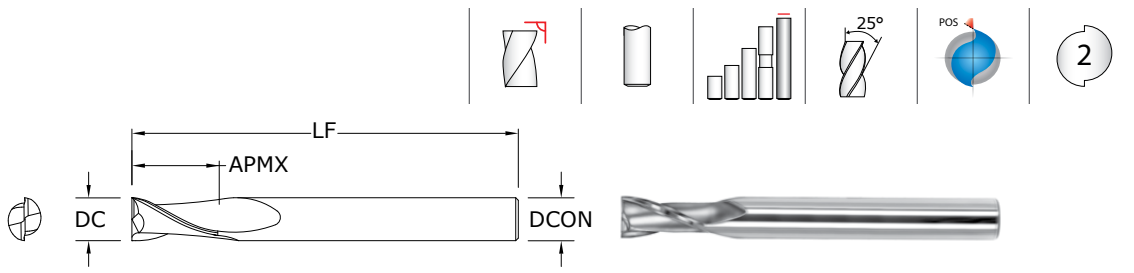

59

FRACTIONAL SERIES

CUTTING DIAMETER DC	inch			EDP NO.		
	LENGTH OF CUT APMX	OVERALL LENGTH LF	SHANK DIAMETER DCON	Ti-NAMITE® (TiN)	Ti-NAMITE®-C (TiCN)	Ti-NAMITE®-A (AlTiN)
1/8	3/8	2-1/2	1/4	32280	32260	32270
3/16	9/16	3	1/4	32281	32261	32271
1/4	5/8	3-1/2	1/4	32282	32262	32272
5/16	11/16	4	5/16	32283	32263	32273
3/8	7/8	4	3/8	32284	32264	32274
1/2	1	4-1/2	1/2	32285	32265	32275
5/8	1-1/8	5	5/8	32286	32266	32276
3/4	1-3/8	5-1/4	3/4	32287	32267	32277

Neck Option Available

- STEELS
- STAINLESS STEELS
- CAST IRON
- NON-FERROUS
- HIGH TEMP ALLOYS

For patent information visit www.ksptpatents.com

2 Flute Ball End Long Reach

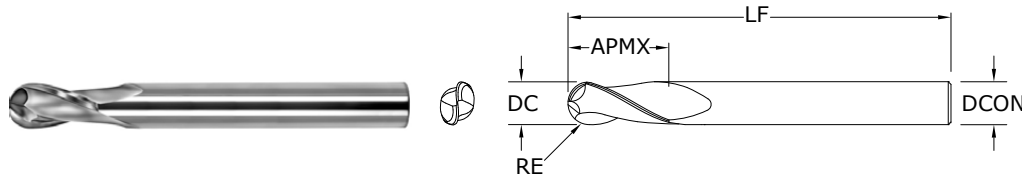
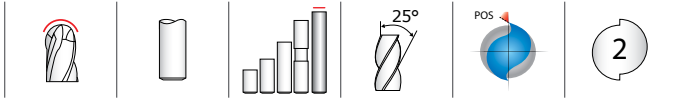

TOLERANCES (inch)

1/8–1/4 DIAMETER

DC = +0.0000/-0.0012

DCON = h_6

RE = +0.0000/-0.0006

>1/4–3/8 DIAMETER

DC = +0.0000/-0.0016

DCON = h_6

RE = +0.0000/-0.0008

>3/8–3/4 DIAMETER

DC = +0.0000/-0.0020

DCON = h_6

RE = +0.0000/-0.0010

59B

FRACTIONAL SERIES

STEELS

STAINLESS STEELS

CAST IRON

NON-FERROUS

HIGH TEMP ALLOYS

For patent information visit www.ksptpatents.com

inch				EDP NO.		
CUTTING DIAMETER DC	LENGTH OF CUT APMX	OVERALL LENGTH LF	SHANK DIAMETER DCON	Ti-NAMITE® (TiN)	Ti-NAMITE®-C (TiCN)	Ti-NAMITE®-A (AlTiN)
1/8	3/8	2-1/2	1/4	32210	32290	32200
3/16	9/16	3	1/4	32211	32291	32201
1/4	5/8	3-1/2	1/4	32212	32292	32202
5/16	11/16	4	5/16	32213	32293	32203
3/8	7/8	4	3/8	32214	32294	32204
1/2	1	4-1/2	1/2	32215	32295	32205
5/8	1-1/8	5	5/8	32216	32296	32206
3/4	1-3/8	5-1/4	3/4	32217	32297	32207

Neck Option Available
RE = 1/2 Cutting Diameter (DC)

2 Flute Square End Long Reach

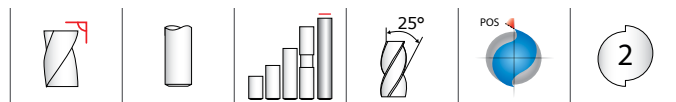

TOLERANCES (mm)

3-6 DIAMETER

DC = +0,0000 / -0,0254

DCON = h₆

>6-10 DIAMETER

DC = +0,0000 / -0,0406

DCON = h₆

>10-20 DIAMETER

DC = +0,0000 / -0,0508

DCON = h₆

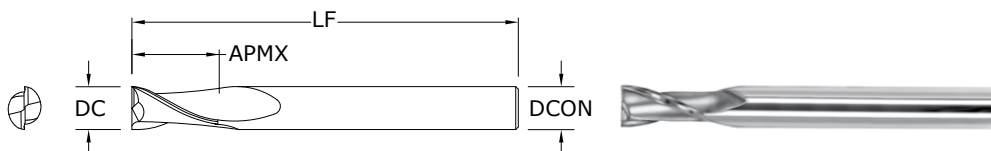

59M
METRIC SERIES

mm				EDP NO.			
CUTTING DIAMETER DC	LENGTH OF CUT APMX	OVERALL LENGTH LF	SHANK DIAMETER DCON	UNCOATED	Ti-NAMITE® (TiN)	Ti-NAMITE®-C (TiCN)	Ti-NAMITE®-A (AlTiN)
3,0	9,0	60,0	6,0	43910	43920	43930	43950
4,0	12,0	70,0	6,0	43911	43921	43931	43951
6,0	15,0	80,0	6,0	43912	43922	43932	43952
8,0	20,0	89,0	8,0	43913	43923	43933	43953
10,0	25,0	100,0	10,0	43914	43924	43934	43954
12,0	30,0	110,0	12,0	43915	43925	43935	43955
14,0	35,0	120,0	16,0	43916	43926	43936	43956
16,0	40,0	120,0	16,0	43917	43927	43937	43957
18,0	40,0	130,0	20,0	43918	43928	43938	43958
20,0	45,0	130,0	20,0	43919	43929	43939	43959

Neck Option Available

- STEELS
- STAINLESS STEELS
- CAST IRON
- NON-FERROUS
- HIGH TEMP ALLOYS

For patent information visit www.ksptpatents.com

METRIC

2 Flute Ball End Long Reach

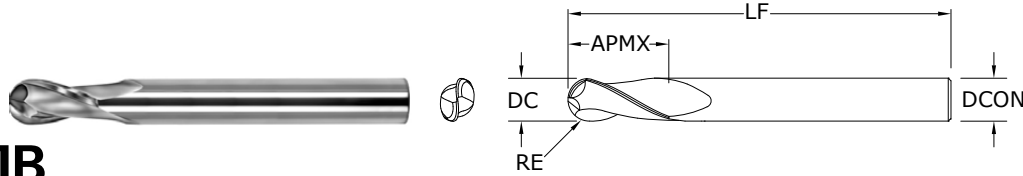
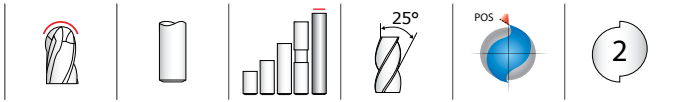

59MB
METRIC SERIES

TOLERANCES (mm)

3-6 DIAMETER

DC = +0,0000 / -0,0254

DCON = h_6

RE = +0,0000 / -0,0127

>6-10 DIAMETER

DC = +0,0000 / -0,0406

DCON = h_6

RE = +0,0000 / -0,0203

>10-20 DIAMETER

DC = +0,0000 / -0,0508

DCON = h_6

RE = +0,0000 / -0,0254

- STEELS
- STAINLESS STEELS
- CAST IRON
- NON-FERROUS
- HIGH TEMP ALLOYS

For patent information visit www.ksptpatents.com

CUTTING DIAMETER DC	mm			EDP NO.			
	LENGTH OF CUT APMX	OVERALL LENGTH LF	SHANK DIAMETER DCON	UNCOATED	Ti-NAMITE® (TiN)	Ti-NAMITE®-C (TiCN)	Ti-NAMITE®-A (AlTiN)
3,0	9,0	60,0	6,0	43900	49622	49632	49642
4,0	12,0	70,0	6,0	43901	49623	49633	49643
6,0	15,0	80,0	6,0	43902	49624	49634	49644
8,0	20,0	89,0	8,0	43903	49625	49635	49645
10,0	25,0	100,0	10,0	43904	49626	49636	49646
12,0	30,0	110,0	12,0	43905	49627	49637	49647
14,0	35,0	120,0	16,0	43906	49628	49638	49648
16,0	40,0	120,0	16,0	43907	49629	49639	49649
18,0	40,0	130,0	20,0	43908	49630	49640	49650
20,0	45,0	130,0	20,0	43909	49631	49641	49651

Neck Option Available
RE = 1/2 Cutting Diameter (DC)

3 Flute Square End

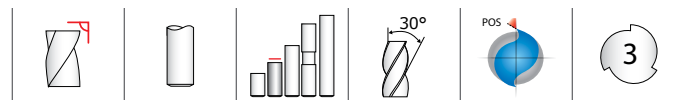

TOLERANCES (inch)

<1/8 DIAMETER

DC = +0.000/-0.001

DCON = h₆

≥1/8 DIAMETER

DC = +0.000/-0.002

DCON = h₆

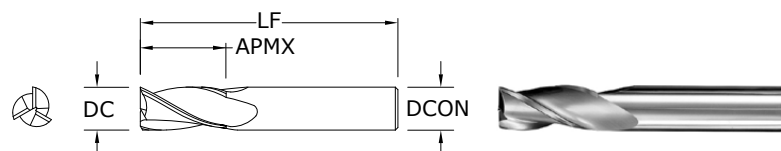

5

FRACTIONAL SERIES

inch				EDP NO.			
CUTTING DIAMETER DC	LENGTH OF CUT APMX	OVERALL LENGTH LF	SHANK DIAMETER DCON	UNCOATED	Ti-NAMITE® (TiN)	Ti-NAMITE®-C (TiCN)	Ti-NAMITE®-A (AlTiN)
1/64	1/32	1-1/2	1/8	30501	39701	30771	30811
1/32	5/64	1-1/2	1/8	30503	39703	30772	30812
3/64	7/64	1-1/2	1/8	30505	39705	30773	30813
1/16	3/16	1-1/2	1/8	30507	39707	30774	30814
5/64	3/16	1-1/2	1/8	30509	39709	30775	30815
3/32	9/32	1-1/2	1/8	30511	39711	30776	30816
7/64	3/8	1-1/2	1/8	30513	39713	30777	30817
1/8	3/8	1-1/2	1/8	30577	39777	30809	30849
*1/8	1/2	1-1/2	1/8	30515	39715	30778	30818
9/64	1/2	2	3/16	30517	39717	30779	30819
5/32	1/2	2	3/16	30519	39719	30780	30820
11/64	5/8	2	3/16	30521	39721	30781	30821
*3/16	5/8	2	3/16	30523	39723	30782	30822
13/64	5/8	2-1/2	1/4	30525	39725	30783	30823
7/32	5/8	2-1/2	1/4	30527	39727	30784	30824
15/64	3/4	2-1/2	1/4	30529	39729	30785	30825
*1/4	3/4	2-1/2	1/4	30531	39731	30786	30826
17/64	3/4	2-1/2	5/16	30533	39733	30787	30827
9/32	3/4	2-1/2	5/16	30535	39735	30788	30828
19/64	13/16	2-1/2	5/16	30537	39737	30789	30829
*5/16	13/16	2-1/2	5/16	30539	39739	30790	30830
21/64	1	2-1/2	3/8	30541	39741	30791	30831
11/32	1	2-1/2	3/8	30543	39743	30792	30832
23/64	1	2-1/2	3/8	30545	39745	30793	30833
*3/8	1	2-1/2	3/8	30547	39747	30794	30834
25/64	1	2-3/4	7/16	30549	39749	30795	30835
13/32	1	2-3/4	7/16	30551	39751	30796	30836
27/64	1	2-3/4	7/16	30553	39753	30797	30837
7/16	1	2-3/4	7/16	30555	39755	30798	30838
29/64	1	3	1/2	30557	39757	30799	30839
15/32	1	3	1/2	30559	39759	30800	30840
31/64	1	3	1/2	30561	39761	30801	30841
*1/2	1	3	1/2	30563	39763	30802	30842
9/16	1-1/8	3-1/2	9/16	30565	39765	30803	30843
5/8	1-1/4	3-1/2	5/8	30567	39767	30804	30844
11/16	1-3/8	4	3/4	30569	39769	30805	30845
3/4	1-1/2	4	3/4	30571	39771	30806	30846
7/8	1-1/2	4	7/8	30573	39773	30807	30847
1	1-1/2	4	1	30575	39775	30808	30848
*Series 5 Set				30589	39789	30810	30850

- STEELS
- STAINLESS STEELS
- CAST IRON
- NON-FERROUS
- HIGH TEMP ALLOYS

For patent information visit www.ksptpatents.com

3 Flute Ball End



5B FRACTIONAL SERIES

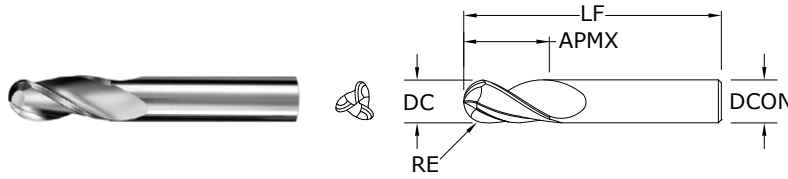

TOLERANCES (inch)

<1/8 DIAMETER

DC = +0.000/-0.001

DCON = h_6

RE = +0.000/-0.0005

≥1/8 DIAMETER

DC = +0.000/-0.002

DCON = h_6

RE = +0.000/-0.001

- STEELS
- STAINLESS STEELS
- CAST IRON
- NON-FERROUS
- HIGH TEMP ALLOYS

For patent information visit www.ksptpatents.com

inch				EDP NO.			
CUTTING DIAMETER DC	LENGTH OF CUT APMX	OVERALL LENGTH LF	SHANK DIAMETER DCON	UNCOATED	Ti-NAMITE® (TiN)	Ti-NAMITE®-C (TiCN)	Ti-NAMITE®-A (AlTiN)
1/64	1/32	1-1/2	1/8	30502	30851	30602	31130
1/32	5/64	1-1/2	1/8	30504	30852	30604	31131
3/64	7/64	1-1/2	1/8	30506	30853	30606	31132
1/16	3/16	1-1/2	1/8	30508	30854	30608	31133
5/64	3/16	1-1/2	1/8	30510	30855	30610	31134
3/32	9/32	1-1/2	1/8	30512	30856	30612	31135
7/64	3/8	1-1/2	1/8	30514	30857	30902	31136
1/8	3/8	1-1/2	1/8	30578	30889	30943	31168
*1/8	1/2	1-1/2	1/8	30516	30858	30904	31137
9/64	1/2	2	3/16	30518	30859	30906	31138
5/32	1/2	2	3/16	30520	30860	30908	31139
11/64	5/8	2	3/16	30522	30861	30910	31140
*3/16	5/8	2	3/16	30524	30862	30912	31141
13/64	5/8	2-1/2	1/4	30526	30863	30914	31142
7/32	5/8	2-1/2	1/4	30528	30864	30916	31143
15/64	3/4	2-1/2	1/4	30530	30865	30918	31144
*1/4	3/4	2-1/2	1/4	30532	30866	30920	31145
17/64	3/4	2-1/2	5/16	30534	30867	30921	31146
9/32	3/4	2-1/2	5/16	30536	30868	30922	31147
19/64	13/16	2-1/2	5/16	30538	30869	30923	31148
*5/16	13/16	2-1/2	5/16	30540	30870	30924	31149
21/64	1	2-1/2	3/8	30542	30871	30925	31150
11/32	1	2-1/2	3/8	30544	30872	30926	31151
23/64	1	2-1/2	3/8	30546	30873	30927	31152
*3/8	1	2-1/2	3/8	30548	30874	30928	31153
25/64	1	2-3/4	7/16	30550	30875	30929	31154
13/32	1	2-3/4	7/16	30552	30876	30930	31155
27/64	1	2-3/4	7/16	30554	30877	30931	31156
7/16	1	2-3/4	7/16	30556	30878	30932	31157
29/64	1	3	1/2	30558	30879	30933	31158
15/32	1	3	1/2	30560	30880	30934	31159
31/64	1	3	1/2	30562	30881	30935	31160
*1/2	1	3	1/2	30564	30882	30936	31161
9/16	1-1/8	3-1/2	9/16	30566	30883	30937	31162
5/8	1-1/4	3-1/2	5/8	30568	30884	30938	31163
11/16	1-3/8	4	3/4	30570	30885	30939	31164
3/4	1-1/2	4	3/4	30572	30886	30940	31165
7/8	1-1/2	4	7/8	30574	30887	30941	31166
1	1-1/2	4	1	30576	30888	30942	31167
				30590	30900	30944	31169

*Series 5B Set
RE = 1/2 Cutting Diameter (DC)

3 Flute Square End

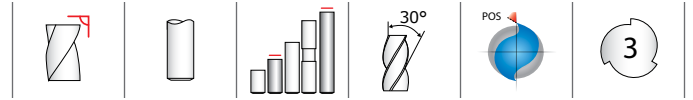

TOLERANCES (mm)

<3 DIAMETER

DC = +0,0000/-0,0254

DCON = h₆

≥3 DIAMETER

DC = +0,0000/-0,0508

DCON = h₆

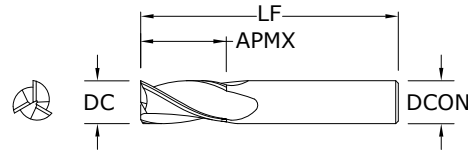

**5M•
5XLM**
METRIC SERIES

mm				EDP NO.				SERIES
CUTTING DIAMETER DC	LENGTH OF CUT APMX	OVERALL LENGTH LF	SHANK DIAMETER DCON	UNCOATED	Ti-NAMITE® (TiN)	Ti-NAMITE®-C (TiCN)	Ti-NAMITE®-A (AlTiN)	
1,0	4,0	38,0	3,0	40505	48756	48778	48799	5M
1,5	4,5	38,0	3,0	40509	48757	48779	48800	5M
2,0	6,3	38,0	3,0	40513	48758	48780	48801	5M
2,5	9,5	38,0	3,0	40517	48759	48781	48802	5M
3,0	12,0	38,0	3,0	40521	48760	48782	48803	5M
3,0	25,0	75,0	3,0	43501	49466	49479	49492	5XLM
3,5	12,0	50,0	4,0	40525	48761	48783	48804	5M
4,0	14,0	50,0	4,0	40529	48762	48784	48805	5M
4,0	25,0	75,0	4,0	43503	49467	49480	49493	5XLM
4,5	16,0	50,0	6,0	40533	48763	48785	48806	5M
5,0	16,0	50,0	6,0	40537	48764	48786	48807	5M
5,0	25,0	75,0	5,0	43507	49469	49482	49495	5XLM
6,0	19,0	50,0	6,0	40541	48765	48787	48808	5M
6,0	25,0	75,0	6,0	43505	49468	49481	49494	5XLM
7,0	19,0	63,0	8,0	40545	48766	48788	48809	5M
8,0	20,0	63,0	8,0	40549	48767	48789	48810	5M
8,0	25,0	75,0	8,0	43515	49470	49483	49496	5XLM
9,0	22,0	75,0	10,0	40553	48768	48790	48811	5M
10,0	22,0	75,0	10,0	40557	48769	48791	48812	5M
10,0	38,0	100,0	10,0	43525	49471	49484	49497	5XLM
11,0	25,0	75,0	12,0	40561	48770	48792	48813	5M
12,0	25,0	75,0	12,0	40565	48771	48793	48814	5M
12,0	50,0	100,0	12,0	43535	49472	49485	49498	5XLM
12,0	75,0	150,0	12,0	43545	49473	49486	49499	5XLM
14,0	32,0	89,0	14,0	40569	48772	48794	48815	5M
14,0	75,0	150,0	14,0	43555	49474	49487	49500	5XLM
16,0	32,0	89,0	16,0	40573	48773	48795	48816	5M
16,0	75,0	150,0	16,0	43565	49475	49488	49501	5XLM
18,0	38,0	100,0	18,0	40577	48774	48796	48817	5M
18,0	75,0	150,0	18,0	43575	49476	49489	49502	5XLM
20,0	38,0	100,0	20,0	40581	48775	48797	48818	5M
20,0	75,0	150,0	20,0	43585	49477	49490	49503	5XLM
25,0	38,0	100,0	25,0	40585	48776	48798	48819	5M
25,0	75,0	150,0	25,0	43595	49478	49491	49504	5XLM

- STEELS
- STAINLESS STEELS
- CAST IRON
- NON-FERROUS
- HIGH TEMP ALLOYS

For patent information visit www.ksptpatents.com

3 Flute Ball End

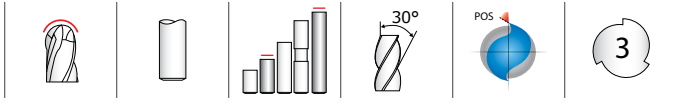

5MB• 5XLMB

METRIC SERIES

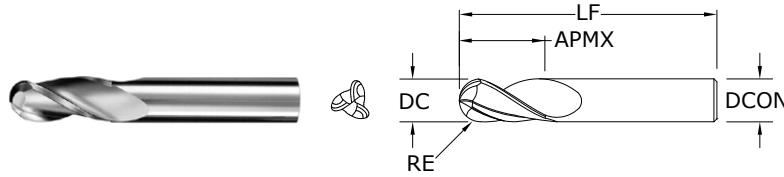

TOLERANCES (mm)

<3 DIAMETER
 DC = +0,0000/-0.0254
 DCON = h₆
 RE = +0,0000/-0.0127

≥3 DIAMETER
 DC = +0,0000/-0.0508
 DCON = h₆
 RE = +0,0000/-0.0254

- STEELS
- STAINLESS STEELS
- CAST IRON
- NON-FERROUS
- HIGH TEMP ALLOYS

For patent information visit www.ksptpatents.com

mm				EDP NO.				SERIES
CUTTING DIAMETER DC	LENGTH OF CUT APMX	OVERALL LENGTH LF	SHANK DIAMETER DCON	UNCOATED	Ti-NAMITE® (TiN)	Ti-NAMITE®-C (TiCN)	Ti-NAMITE®-A (AlTiN)	
1,0	4,0	38,0	3,0	40506	48820	48842	48863	5MB
1,5	4,5	38,0	3,0	40510	48821	48843	48864	5MB
2,0	6,3	38,0	3,0	40514	48822	48844	48865	5MB
2,5	9,5	38,0	3,0	40518	48823	48845	48866	5MB
3,0	12,0	38,0	3,0	40522	48824	48846	48867	5MB
3,0	25,0	75,0	3,0	43502	49583	49596	49609	5XLMB
3,5	12,0	50,0	4,0	40526	48825	48847	48868	5MB
4,0	14,0	50,0	4,0	40530	48826	48848	48869	5MB
4,0	25,0	75,0	4,0	43504	49584	49597	49610	5XLMB
4,5	16,0	50,0	6,0	40534	48827	48849	48870	5MB
5,0	16,0	50,0	6,0	40538	48828	48850	48871	5MB
5,0	25,0	75,0	5,0	43508	49586	49599	49612	5XLMB
6,0	19,0	50,0	6,0	40542	48829	48851	48872	5MB
6,0	25,0	75,0	6,0	43506	49585	49598	49611	5XLMB
7,0	19,0	63,0	8,0	40546	48830	48852	48873	5MB
8,0	20,0	63,0	8,0	40550	48831	48853	48874	5MB
8,0	25,0	75,0	8,0	43516	49587	49600	49613	5XLMB
9,0	22,0	75,0	10,0	40554	48832	48854	48875	5MB
10,0	22,0	75,0	10,0	40558	48833	48855	48876	5MB
10,0	38,0	100,0	10,0	43526	49588	49601	49614	5XLMB
11,0	25,0	75,0	12,0	40562	48834	48856	48877	5MB
12,0	25,0	75,0	12,0	40566	48835	48857	48878	5MB
12,0	50,0	100,0	12,0	43536	49589	49602	49615	5XLMB
12,0	75,0	150,0	12,0	43546	49590	49603	49616	5XLMB
14,0	32,0	89,0	14,0	40570	48836	48858	48879	5MB
14,0	75,0	150,0	14,0	43556	49591	49604	49617	5XLMB
16,0	32,0	89,0	16,0	40574	48837	48859	48880	5MB
16,0	75,0	150,0	16,0	43566	49592	49605	49618	5XLMB
18,0	38,0	100,0	18,0	40578	48838	48860	48881	5MB
18,0	75,0	150,0	18,0	43576	49593	49606	49619	5XLMB
20,0	38,0	100,0	20,0	40582	48839	48861	48882	5MB
20,0	75,0	150,0	20,0	43586	49594	49607	49620	5XLMB
25,0	38,0	100,0	25,0	40586	48840	48862	48883	5MB
25,0	75,0	150,0	25,0	43596	49595	49608	49621	5XLMB

RE = 1/2 Cutting Diameter (DC)

Tapered Square End

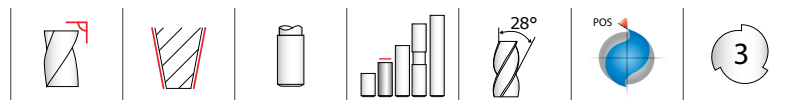

TOLERANCES (inch)

DC = +0.001 / -0.002

DCON = h₆

α = +10' / -10'

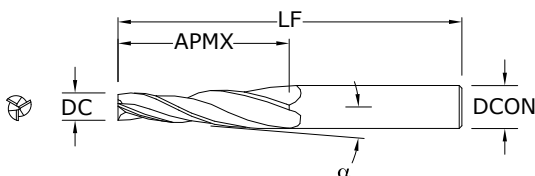

23

FRACTIONAL SERIES

inch					EDP NO.			
SHANK DIAMETER DCON	CENTER LINE ANGLE α	SMALL DIAMETER DC	LENGTH OF CUT APMX	OVERALL LENGTH LF	UNCOATED	Ti-NAMITE® (TiN)	Ti-NAMITE®-C (TiCN)	Ti-NAMITE®-A (AlTiN)
1/4	1°	1/8	1-1/2	3	32301	32370	32302	32345
1/4	1°30'	1/8	1-1/2	3	32303	32371	32304	32346
1/4	2°	1/8	1-1/4	3	32305	32372	32306	32347
1/4	3°	1/8	1	3	32307	32373	32308	32348
1/4	5°	1/8	3/4	3	32309	32374	32310	32349
1/4	7°	1/8	1/2	3	32311	32375	32312	32350
1/4	10°	3/32	1/2	3	32313	32376	32314	32351
3/8	1°	3/16	1-3/4	3-1/2	32315	32377	32316	32352
3/8	1°30'	3/16	1-3/4	3-1/2	32317	32378	32318	32353
3/8	2°	3/16	1-3/4	3-1/2	32319	32379	32320	32354
3/8	3°	5/32	1-3/4	3-1/2	32321	32380	32322	32355
3/8	5°	1/8	1-1/2	3-1/2	32323	32381	32324	32356
3/8	7°	1/8	1	3-1/2	32325	32382	32326	32357
3/8	10°	1/8	3/4	3-1/2	32327	32383	32328	32358
1/2	1°	1/4	2	4	32329	32384	32330	32359
1/2	2°	1/4	2	4	32333	32385	32334	32360
1/2	3°	1/4	2	4	32335	32386	32336	32361
1/2	5°	1/4	1-1/4	4	32337	32387	32338	32362
1/2	7°	3/16	1-1/4	4	32339	32388	32340	32363
1/2	10°	1/8	1	4	32341	32389	32342	32364

- STEELS
- STAINLESS STEELS
- CAST IRON
- NON-FERROUS
- HIGH TEMP ALLOYS

For patent information visit www.ksptpatents.com

Tapered Ball End

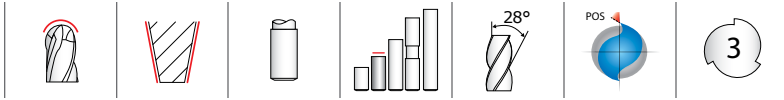

24 FRACTIONAL SERIES

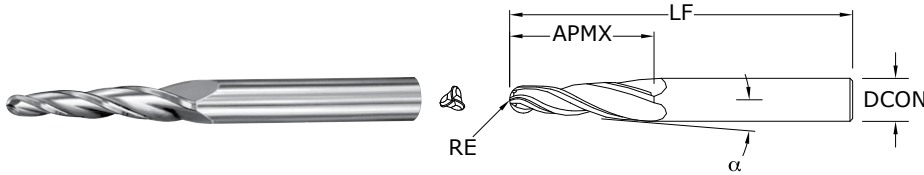

TOLERANCES (inch)

DCON = h_6
 RE = $+0.0000/-0.0010$
 α = $+10' / -10'$

- STEELS
- STAINLESS STEELS
- CAST IRON
- NON-FERROUS
- HIGH TEMP ALLOYS

For patent information visit www.ksptpatents.com

SHANK DIAMETER DCON	CENTER LINE ANGLE α	inch			EDP NO.			
		RADIUS RE	LENGTH OF CUT APMX	OVERALL LENGTH LF	UNCOATED	Ti-NAMITE® (TiN)	Ti-NAMITE®-C (TiCN)	Ti-NAMITE®-A (AlTiN)
1/4	1°	.062	1-1/2	3	32402	32403	32445	32470
1/4	1°30'	.062	1-1/2	3	32404	32405	32446	32471
1/4	2°	.062	1-1/4	3	32406	32407	32447	32472
1/4	3°	.062	1	3	32408	32409	32448	32473
1/4	5°	.062	3/4	3	32410	32411	32449	32474
1/4	7°	.062	1/2	3	32412	32413	32450	32475
1/4	10°	.047	1/2	3	32414	32415	32451	32476
3/8	1°	.093	1-3/4	3-1/2	32416	32417	32452	32477
3/8	1°30'	.093	1-3/4	3-1/2	32418	32419	32453	32478
3/8	2°	.093	1-3/4	3-1/2	32420	32421	32454	32479
3/8	3°	.078	1-3/4	3-1/2	32422	32423	32455	32480
3/8	5°	.062	1-1/2	3-1/2	32424	32425	32456	32481
3/8	7°	.062	1	3-1/2	32426	32427	32457	32482
3/8	10°	.062	3/4	3-1/2	32428	32429	32458	32483
1/2	1°	.125	2	4	32430	32431	32459	32484
1/2	2°	.125	2	4	32434	32435	32460	32485
1/2	3°	.125	2	4	32436	32437	32461	32486
1/2	5°	.125	1-1/4	4	32438	32439	32462	32487
1/2	7°	.093	1-1/4	4	32440	32441	32463	32488
1/2	10°	.062	1	4	32442	32443	32464	32489

4 Flute Square End • 4 Flute Corner Radius

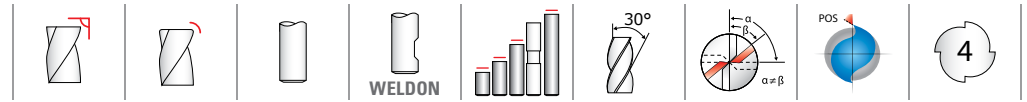

TOLERANCES (inch)

<1/8 DIAMETER

DC = +0.000 / -0.001
 DCON = h₆

≥1/8 DIAMETER

DC = +0.000 / -0.002
 1CR DC = -0.001 / -0.002
 DCON = h₆
 RE = +0.000 / -0.002

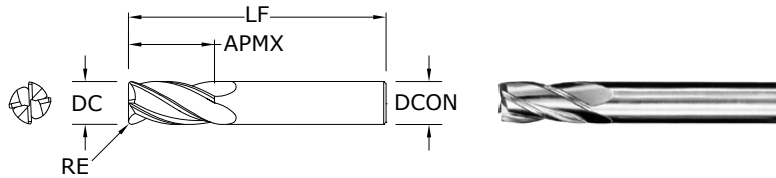

**1 • 1L • 1EL •
 1CR • 16**
 FRACTIONAL SERIES

inch						EDP NO.				SERIES
CUTTING DIAMETER DC	LENGTH OF CUT APMX	OVERALL LENGTH LF	SHANK DIAMETER DCON	CORNER RADIUS RE	WELDON FLAT	UNCOATED	Ti-NAMITE® (TiN)	Ti-NAMITE®-C (TiCN)	Ti-NAMITE®-A (AlTiN)	
1/64	1/32	1-1/2	1/8	-		30101	39101	39001	30191	1
1/32	5/64	1-1/2	1/8	-		30103	39103	39003	30192	1
3/64	7/64	1-1/2	1/8	-		30105	39105	39005	30193	1
1/16	1/8	1-1/2	1/8	-		31601	31650	31238	31251	16
† 1/16	3/16	1-1/2	1/8	-		30107	39107	39007	30194	1
5/64	3/16	1-1/2	1/8	-		30109	39109	39009	30195	1
3/32	3/16	1-1/2	1/8	-		31603	31651	31239	31252	16
3/32	9/32	1-1/2	1/8	-		30111	39111	39011	30196	1
7/64	3/8	1-1/2	1/8	-		30113	39113	39013	30197	1
1/8	1/4	1-1/2	1/8	-		31605	31652	31240	31253	16
1/8	3/8	1-1/2	1/8	-		30177	39177	39077	30029	1
*† 1/8	1/2	1-1/2	1/8	-		30115	39115	39015	30198	1
1/8	1/2	1-1/2	1/8	.015		38001	38002	38115	38157	1CR
1/8	1/2	1-1/2	1/8	.020		38003	38004	38116	38158	1CR
1/8	3/4	2-1/4	1/8	-		33141	31727	31737	31747	1L
1/8	1	3	1/8	-		33143	31860	31870	31880	1EL
9/64	1/2	2	3/16	-		30117	39117	39017	30199	1
5/32	5/16	2	3/16	-		31607	31653	31241	31254	16
5/32	1/2	2	3/16	-		30119	39119	39019	30000	1
11/64	5/8	2	3/16	-		30121	39121	39021	30001	1
3/16	3/8	2	3/16	-		31609	31654	31242	31255	16
*† 3/16	5/8	2	3/16	-		30123	39123	39023	30002	1
3/16	5/8	2	3/16	.015		38009	38010	38117	38159	1CR
3/16	5/8	2	3/16	.020		38011	38012	38118	38160	1CR
3/16	5/8	2	3/16	.030		38013	38014	38119	38161	1CR
3/16	3/4	2-1/2	3/16	-		33101	31728	31738	31748	1L
3/16	1-1/8	3	3/16	-		33121	31861	31871	31881	1EL
13/64	5/8	2-1/2	1/4	-		30125	39125	39025	30003	1
7/32	7/16	2	1/4	-		31611	31655	31243	31256	16
7/32	5/8	2-1/2	1/4	-		30127	39127	39027	30004	1
15/64	3/4	2-1/2	1/4	-		30129	39129	39029	30005	1
1/4	1/2	2	1/4	-		31613	31656	31244	31257	16
*† 1/4	3/4	2-1/2	1/4	-		30131	39131	39031	30006	1
1/4	3/4	2-1/2	1/4	-	•	30300	-	-	-	1

- STEELS
- STAINLESS STEELS
- CAST IRON
- NON-FERROUS
- HIGH TEMP ALLOYS

For patent information visit www.ksptpatents.com

continued on next page

4 Flute Square End • 4 Flute Corner Radius

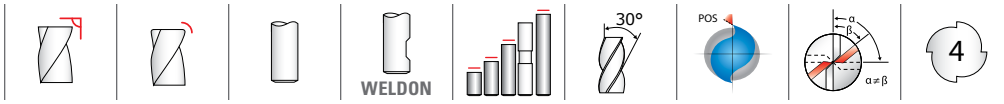

**1•1L•1EL•
1CR•16**
FRACTIONAL SERIES

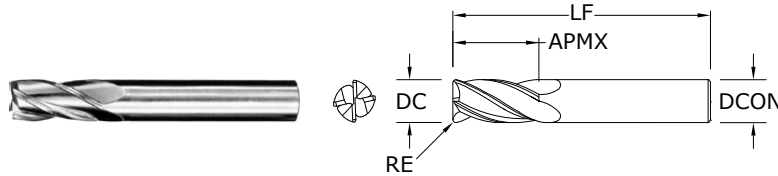

TOLERANCES (inch)

<1/8 DIAMETER

DC = +0.000/-0.001

DCON = h₆

≥1/8 DIAMETER

DC = +0.000/-0.002

1CR DC = -0.001/-0.002

DCON = h₆

RE = +0.000/-0.002

CONTINUED

- STEELS
- STAINLESS STEELS
- CAST IRON
- NON-FERROUS
- HIGH TEMP ALLOYS

For patent information visit www.kspatents.com

CUTTING DIAMETER DC	LENGTH OF CUT APMX	inch				WELDON FLAT	EDP NO.				SERIES
		OVERALL LENGTH LF	SHANK DIAMETER DCON	CORNER RADIUS RE			UNCOATED	Ti-NAMITE® (TiN)	Ti-NAMITE®-C (TiCN)	Ti-NAMITE®-A (AlTiN)	
1/4	3/4	2-1/2	1/4	.015		38019	38020	38120	38162	1CR	
1/4	3/4	2-1/2	1/4	.020		38021	38022	38121	38163	1CR	
1/4	3/4	2-1/2	1/4	.030		38023	38024	38122	38164	1CR	
1/4	3/4	2-1/2	1/4	.045		38025	38026	38123	38165	1CR	
1/4	1-1/8	3	1/4	—		33103	31729	31739	31749	1L	
1/4	1-1/2	4	1/4	—		33123	31862	31872	31882	1EL	
17/64	3/4	2-1/2	5/16	—		30133	39133	39033	30007	1	
9/32	3/4	2-1/2	5/16	—		30135	39135	39035	30008	1	
19/64	13/16	2-1/2	5/16	—		30137	39137	39037	30009	1	
5/16	1/2	2	5/16	—		31615	31657	31245	31258	16	
*15/16	13/16	2-1/2	5/16	—		30139	39139	39039	30010	1	
5/16	13/16	2-1/2	5/16	.015		38031	38032	38124	38166	1CR	
5/16	13/16	2-1/2	5/16	.020		38033	38034	38125	38167	1CR	
5/16	13/16	2-1/2	5/16	.030		38035	38036	38126	38168	1CR	
5/16	13/16	2-1/2	5/16	.045		38037	38038	38127	38169	1CR	
5/16	1-1/8	3	5/16	—		33105	31730	31740	31763	1L	
5/16	1-5/8	4	5/16	—		33125	31863	31873	31883	1EL	
21/64	1	2-1/2	3/8	—		30141	39141	39041	30011	1	
11/32	1	2-1/2	3/8	—		30143	39143	39043	30012	1	
23/64	1	2-1/2	3/8	—		30145	39145	39045	30013	1	
3/8	5/8	2	3/8	—		31617	31658	31246	31259	16	
*13/8	1	2-1/2	3/8	—		30147	39147	39047	30014	1	
3/8	1	2-1/2	3/8	—	•	30179	—	—	30379	1	
3/8	1	2-1/2	3/8	.015	•	38045	38046	38128	38170	1CR	
3/8	1	2-1/2	3/8	.020	•	38047	38048	38129	38171	1CR	
3/8	1	2-1/2	3/8	.030	•	38049	38050	38130	38172	1CR	
3/8	1	2-1/2	3/8	.045	•	38051	38052	38131	38173	1CR	
3/8	1-1/8	3	3/8	—		33107	31731	31741	31764	1L	
3/8	1-3/4	4	3/8	—		33127	31864	31874	31884	1EL	
25/64	1	2-3/4	7/16	—		30149	39149	39049	30015	1	
13/32	1	2-3/4	7/16	—		30151	39151	39051	30016	1	
27/64	1	2-3/4	7/16	—		30153	39153	39053	30017	1	

continued on next page

4 Flute Square End • 4 Flute Corner Radius

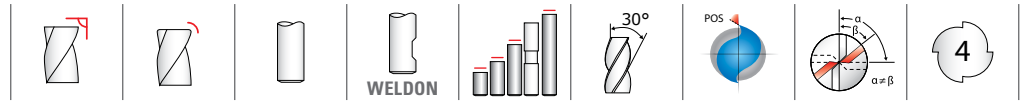

TOLERANCES (inch)

<1/8 DIAMETER

DC = +0.000/-0.001
 DCON = h₆

≥1/8 DIAMETER

DC = +0.000/-0.002
 1CR DC = -0.001/-0.002
 DCON = h₆
 RE = +0.000/-0.002

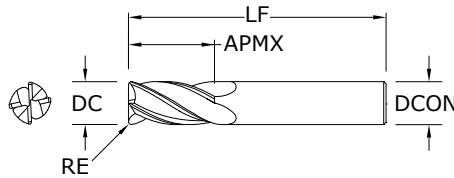

**1 • 1L • 1EL •
 1CR • 16**
 FRACTIONAL SERIES

inch						EDP NO.				SERIES
CUTTING DIAMETER DC	LENGTH OF CUT APMX	OVERALL LENGTH LF	SHANK DIAMETER DCON	CORNER RADIUS RE	WELDON FLAT	UNCOATED	Ti-NAMITE® (TiN)	Ti-NAMITE®-C (TiCN)	Ti-NAMITE®-A (AlTiN)	
7/16	5/8	2-1/2	7/16	-		31619	31659	31247	31260	16
7/16	1	2-3/4	7/16	-		30155	39155	39055	30018	1
7/16	2	4-1/2	7/16	-		33109	31732	31742	31765	1L
7/16	3	6	7/16	-		33129	31865	31875	31885	1EL
29/64	1	3	1/2	-		30157	39157	39057	30019	1
15/32	1	3	1/2	-		30159	39159	39059	30020	1
31/64	1	3	1/2	-		30161	39161	39061	30021	1
1/2	5/8	2-1/2	1/2	-		31621	31660	31248	31261	16
*1/2	1	3	1/2	-		30163	39163	39063	30022	1
1/2	1	3	1/2	-	•	30180	-	-	30380	1
1/2	1	3	1/2	.015	•	38059	38060	38132	38174	1CR
1/2	1	3	1/2	.020	•	38061	38062	38133	38175	1CR
1/2	1	3	1/2	.030	•	38063	38064	38134	38176	1CR
1/2	1	3	1/2	.045	•	38065	38066	38135	38177	1CR
1/2	1	3	1/2	.060	•	38067	38068	38136	38178	1CR
1/2	2	4-1/2	1/2	-		33111	31733	31743	31766	1L
1/2	3	6	1/2	-		33131	31866	31876	31886	1EL
9/16	1-1/8	3-1/2	9/16	-		30165	39165	39065	30023	1
5/8	3/4	3	5/8	-		31623	31661	31249	31262	16
5/8	1-1/4	3-1/2	5/8	-		30167	39167	39067	30024	1
5/8	1-1/4	3-1/2	5/8	-	•	30181	-	-	30381	1
5/8	1-1/4	3-1/2	5/8	.015	•	38073	38074	38137	38179	1CR
5/8	1-1/4	3-1/2	5/8	.020	•	38075	38076	38138	38180	1CR
5/8	1-1/4	3-1/2	5/8	.030	•	38077	38078	38139	38181	1CR
5/8	1-1/4	3-1/2	5/8	.045	•	38079	38080	38140	38182	1CR
5/8	1-1/4	3-1/2	5/8	.060	•	38081	38082	38141	38183	1CR
5/8	1-1/4	3-1/2	5/8	.090	•	38083	38084	38142	38184	1CR
5/8	2-1/4	5	5/8	-		33113	31734	31744	31767	1L
5/8	3	6	5/8	-		33133	31867	31877	31887	1EL
11/16	1-3/8	4	3/4	-		30169	39169	39069	30025	1
3/4	1	3	3/4	-		31625	31662	31250	31263	16
3/4	1-1/2	4	3/4	-		30171	39171	39071	30026	1

CONTINUED

- STEELS
- STAINLESS STEELS
- CAST IRON
- NON-FERROUS
- HIGH TEMP ALLOYS

For patent information visit www.ksptpatents.com

continued on next page

4 Flute Square End • 4 Flute Corner Radius

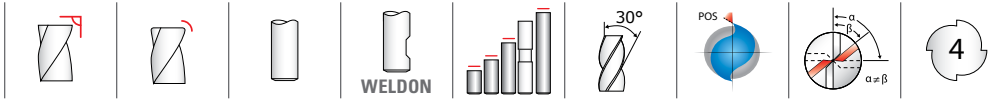

**1•1L•1EL •
1CR • 16**
FRACTIONAL SERIES

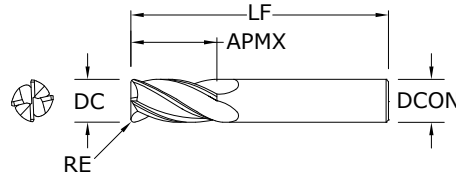

TOLERANCES (inch)

<1/8 DIAMETER

DC = +0.000 / -0.001

DCON = h₆

≥1/8 DIAMETER

DC = +0.000 / -0.002

1CR DC = -0.001 / -0.002

DCON = h₆

RE = +0.000 / -0.002

CONTINUED

- STEELS
- STAINLESS STEELS
- CAST IRON
- NON-FERROUS
- HIGH TEMP ALLOYS

For patent information visit www.ksptpatents.com

CUTTING DIAMETER DC	LENGTH OF CUT APMX	inch				WELDON FLAT	EDP NO.				SERIES
		OVERALL LENGTH LF	SHANK DIAMETER DCON	CORNER RADIUS RE			UNCOATED	Ti-NAMITE® (TiN)	Ti-NAMITE®-C (TiCN)	Ti-NAMITE®-A (AlTiN)	
3/4	1-1/2	4	3/4	—	•	30182	—	—	30382	1	
3/4	1-1/2	4	3/4	.015	•	38087	38088	38143	38185	1CR	
3/4	1-1/2	4	3/4	.020	•	38089	38090	38144	38186	1CR	
3/4	1-1/2	4	3/4	.030	•	38091	38092	38145	38187	1CR	
3/4	1-1/2	4	3/4	.045	•	38093	38094	38146	38188	1CR	
3/4	1-1/2	4	3/4	.060	•	38095	38096	38147	38189	1CR	
3/4	1-1/2	4	3/4	.090	•	38097	38098	38148	38190	1CR	
3/4	1-1/2	4	3/4	.125	•	38099	38100	38149	38191	1CR	
3/4	2-1/4	5	3/4	—		33115	31735	31745	31768	1L	
3/4	3	6	3/4	—		33135	31868	31878	31888	1EL	
7/8	1-1/2	4	7/8	—		30173	39173	39073	30027	1	
1	1-1/2	4	1	—		30175	39175	39075	30028	1	
1	1-1/2	4	1	—		30183	—	—	30383	1	
1	1-1/2	4	1	.015	•	38101	38102	38150	38192	1CR	
1	1-1/2	4	1	.020	•	38103	38104	38151	38193	1CR	
1	1-1/2	4	1	.030	•	38105	38106	38152	38194	1CR	
1	1-1/2	4	1	.045	•	38107	38108	38153	38195	1CR	
1	1-1/2	4	1	.060	•	38109	38110	38154	38196	1CR	
1	1-1/2	4	1	.090	•	38111	38112	38155	38197	1CR	
1	1-1/2	4	1	.125	•	38113	38114	38156	38198	1CR	
1	2-1/4	5	1	—		33117	31736	31746	31769	1L	
1	3	6	1	—		33137	31869	31879	31889	1EL	
*Series 1 Set							30189	39189	39089	30030	1

† Di-NAMITE® coating offered standard for this configuration. Please contact your KSPT Representative for more information.

FRACTIONAL 4 Flute Ball End

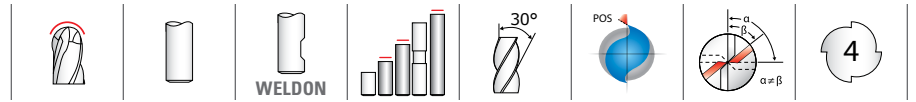

TOLERANCES (inch)

<1/8 DIAMETER

DC = +0.000/-0.001

DCON = h_6

RE = +0.000/-0.0005

≥1/8 DIAMETER

DC = +0.000/-0.002

DCON = h_6

RE = +0.000/-0.001

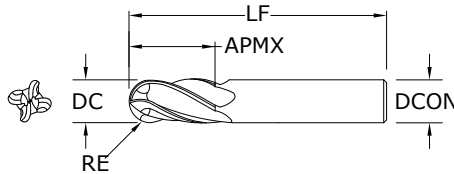

**1B • 1LB •
1ELB**
FRACTIONAL SERIES

CUTTING DIAMETER DC	LENGTH OF CUT APMX	inch			EDP NO.				SERIES
		OVERALL LENGTH LF	SHANK DIAMETER DCON	WELDON FLAT	UNCOATED	Ti-NAMITE® (TiN)	Ti-NAMITE®-C (TiCN)	Ti-NAMITE®-A (AlTiN)	
1/64	1/32	1-1/2	1/8		30102	39102	39002	30031	1B
1/32	5/64	1-1/2	1/8		30104	39104	39004	30032	1B
3/64	7/64	1-1/2	1/8		30106	39106	39006	30033	1B
+1/16	3/16	1-1/2	1/8		30108	39108	39008	30034	1B
5/64	3/16	1-1/2	1/8		30110	39110	39010	30035	1B
3/32	9/32	1-1/2	1/8		30112	39112	39012	30036	1B
7/64	3/8	1-1/2	1/8		30114	39114	39014	30037	1B
*1/8	3/8	1-1/2	1/8		30178	39178	39078	30069	1B
+1/8	1/2	1-1/2	1/8		30116	39116	39016	30038	1B
1/8	3/4	2-1/4	1/8		33142	31770	31780	31790	1LB
1/8	1	3	1/8		33144	31900	31918	31928	1ELB
9/64	1/2	2	3/16		30118	39118	39018	30039	1B
5/32	1/2	2	3/16		30120	39120	39020	30040	1B
11/64	5/8	2	3/16		30122	39122	39022	30041	1B
*+3/16	5/8	2	3/16		30124	39124	39024	30042	1B
3/16	3/4	2-1/2	3/16		33102	31771	31781	31791	1LB
3/16	1-1/8	3	3/16		33122	31902	31919	31929	1ELB
13/64	5/8	2-1/2	1/4		30126	39126	39026	30043	1B
7/32	5/8	2-1/2	1/4		30128	39128	39028	30044	1B
15/64	3/4	2-1/2	1/4		30130	39130	39030	30045	1B
*+1/4	3/4	2-1/2	1/4		30132	39132	39032	30046	1B
1/4	1-1/8	3	1/4		33104	31772	31782	31792	1LB
1/4	1-1/2	4	1/4		33124	31904	31920	31930	1ELB
17/64	3/4	2-1/2	5/16		30134	39134	39034	30047	1B
9/32	3/4	2-1/2	5/16		30136	39136	39036	30048	1B
19/64	13/16	2-1/2	5/16		30138	39138	39038	30049	1B
*+5/16	13/16	2-1/2	5/16		30140	39140	39040	30050	1B
5/16	1-1/8	3	5/16		33106	31773	31783	31793	1LB
5/16	1-5/8	4	5/16		33126	31906	31921	31931	1ELB
21/64	1	2-1/2	3/8		30142	39142	39042	30051	1B
11/32	1	2-1/2	3/8		30144	39144	39044	30052	1B
23/64	1	2-1/2	3/8		30146	39146	39046	30053	1B

RE = 1/2 Cutting Diameter (DC)

continued on next page

- STEELS
- STAINLESS STEELS
- CAST IRON
- NON-FERROUS
- HIGH TEMP ALLOYS

For patent information visit
www.ksptpatents.com

4 Flute Ball End



1B • 1LB • 1ELB
FRACTIONAL SERIES

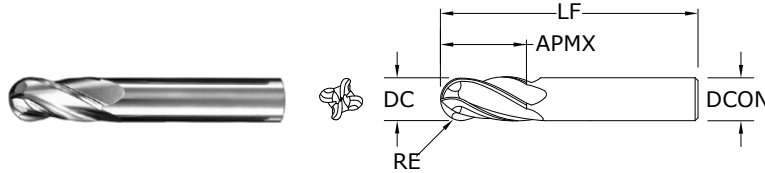

TOLERANCES (inch)

<1/8 DIAMETER

DC = +0.000/-0.001

DCON = h₆

RE = +0.000/-0.0005

≥1/8 DIAMETER

DC = +0.000/-0.002

DCON = h₆

RE = +0.000/-0.001

CONTINUED

- STEELS
- STAINLESS STEELS
- CAST IRON
- NON-FERROUS
- HIGH TEMP ALLOYS

For patent information visit www.ksptpatents.com

CUTTING DIAMETER DC	LENGTH OF CUT APMX	inch			WELDON FLAT	EDP NO.				SERIES
		OVERALL LENGTH LF	SHANK DIAMETER DCON	UNCOATED		Ti-NAMITE® (TiN)	Ti-NAMITE®-C (TiCN)	Ti-NAMITE®-A (AlTiN)		
*13/8	1	2-1/2	3/8		30148	39148	39048	30054	1B	
3/8	1	2-1/2	3/8	•	30184	-	-	30384	1B	
3/8	1-1/8	3	3/8		33108	31774	31784	31794	1LB	
3/8	1-3/4	4	3/8		33128	31908	31922	31932	1ELB	
25/64	1	2-3/4	7/16		30150	39150	39050	30055	1B	
13/32	1	2-3/4	7/16		30152	39152	39052	30056	1B	
27/64	1	2-3/4	7/16		30154	39154	39054	30057	1B	
7/16	1	2-3/4	7/16		30156	39156	39056	30058	1B	
7/16	2	4-1/2	7/16		33110	31775	31785	31795	1LB	
7/16	3	6	7/16		33130	31910	31923	31933	1ELB	
29/64	1	3	1/2		30158	39158	39058	30059	1B	
15/32	1	3	1/2		30160	39160	39060	30060	1B	
31/64	1	3	1/2		30162	39162	39062	30061	1B	
*1/2	1	3	1/2		30164	39164	39064	30062	1B	
1/2	1	3	1/2	•	30185	-	-	30385	1B	
1/2	2	4-1/2	1/2		33112	31776	31786	31796	1LB	
1/2	3	6	1/2		33132	31912	31924	31934	1ELB	
9/16	1-1/8	3-1/2	9/16		30166	39166	39066	30063	1B	
5/8	1-1/4	3-1/2	5/8		30168	39168	39068	30064	1B	
5/8	1-1/4	3-1/2	5/8	•	30186	-	-	30386	1B	
5/8	2-1/4	5	5/8		33114	31777	31787	31797	1LB	
5/8	3	6	5/8		33134	31914	31925	31935	1ELB	
11/16	1-3/8	4	3/4		30170	39170	39070	30065	1B	
3/4	1-1/2	4	3/4		30172	39172	39072	30066	1B	
3/4	1-1/2	4	3/4	•	30187	-	-	30387	1B	
3/4	2-1/4	5	3/4		33116	31778	31788	31798	1LB	
3/4	3	6	3/4		33136	31916	31926	31936	1ELB	
7/8	1-1/2	4	7/8		30174	39174	39074	30067	1B	
1	1-1/2	4	1		30176	39176	39076	30068	1B	
1	1-1/2	4	1	•	30188	-	-	30388	1B	
1	2-1/4	5	1		33118	31779	31789	31799	1LB	
1	3	6	1		33138	31917	31927	31937	1ELB	
*Series 1B Set					30190	39190	39090	30070	1B	

RE = 1/2 Cutting Diameter (DC)

† Di-NAMITE® coating offered standard for this configuration. Please contact your KSPT Representative for more information.

4 Flute Square End • 4 Flute Corner Radius

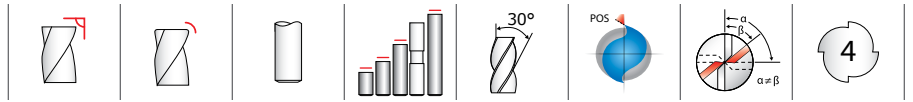

TOLERANCES (mm)

<3 DIAMETER

DC = +0,0000 / -0,0254
 DCON = h₆

≥3 DIAMETER

DC = +0,0000 / -0,0508
 DCON = h₆
 RE = +0,0000 / -0,0508

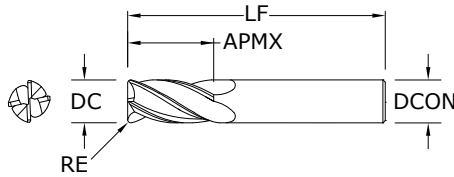

1M • 1XLM • 1MCR • 16M
 METRIC SERIES

CUTTING DIAMETER DC	LENGTH OF CUT APMX	mm			EDP NO.				SERIES
		OVERALL LENGTH LF	CORNER RADIUS RE	SHANK DIAMETER DCON	UNCOATED	Ti-NAMITE® (TiN)	Ti-NAMITE®-C (TiCN)	Ti-NAMITE®-A (AlTiN)	
1,0	2,0	38,0	–	3,0	41605	49136	49157	49178	16M
1,0	4,0	38,0	–	3,0	40105	48500	48522	48543	1M
1,5	3,0	38,0	–	3,0	41609	49137	49158	49179	16M
1,5	4,5	38,0	–	3,0	40109	48501	48523	48544	1M
2,0	4,0	38,0	–	3,0	41613	49138	49159	49180	16M
2,0	6,3	38,0	–	3,0	40113	48502	48524	48545	1M
2,5	5,0	38,0	–	3,0	41617	49139	49160	49181	16M
2,5	9,5	38,0	–	3,0	40117	48503	48525	48546	1M
3,0	6,0	38,0	–	3,0	41621	49140	49161	49182	16M
3,0	12,0	38,0	–	3,0	40121	48504	48526	48547	1M
3,0	25,0	75,0	–	3,0	43101	49388	49401	49414	1XLM
3,5	7,0	50,0	–	4,0	41625	49141	49162	49183	16M
3,5	12,0	50,0	–	4,0	40125	48505	48527	48548	1M
4,0	8,0	50,0	–	4,0	41629	49142	49163	49184	16M
4,0	14,0	50,0	–	4,0	40129	48506	48528	48549	1M
4,0	14,0	50,0	0,25	4,0	–	–	–	40000	1MCR
4,0	14,0	50,0	0,50	4,0	–	–	–	40001	1MCR
4,0	14,0	50,0	1,00	4,0	–	–	–	40003	1MCR
4,0	25,0	75,0	–	4,0	43103	49389	49402	49415	1XLM
4,5	9,5	50,0	–	4,5	41633	49143	49164	49185	16M
4,5	16,0	50,0	–	6,0	40133	48507	48529	48550	1M
5,0	10,0	50,0	–	5,0	41637	49144	49165	49186	16M
5,0	16,0	50,0	–	6,0	40137	48508	48530	48551	1M
5,0	16,0	50,0	0,25	6,0	–	–	–	40004	1MCR
5,0	16,0	50,0	0,50	6,0	–	–	–	40005	1MCR
5,0	16,0	50,0	1,00	6,0	–	–	–	40007	1MCR
5,0	25,0	75,0	–	5,0	43107	49391	49404	49417	1XLM
6,0	12,0	50,0	–	6,0	41641	49145	49166	49187	16M
6,0	19,0	50,0	–	6,0	40141	48509	48531	48552	1M
6,0	19,0	50,0	0,25	6,0	–	–	–	40009	1MCR
6,0	19,0	50,0	0,50	6,0	–	–	–	40010	1MCR
6,0	19,0	50,0	0,75	6,0	–	–	–	40011	1MCR

- STEELS
- STAINLESS STEELS
- CAST IRON
- NON-FERROUS
- HIGH TEMP ALLOYS

For patent information visit www.ksptpatents.com

continued on next page

4 Flute Square End • 4 Flute Corner Radius

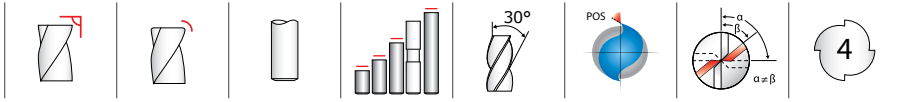

**1M • 1XLM •
1MCR • 16M**
METRIC SERIES

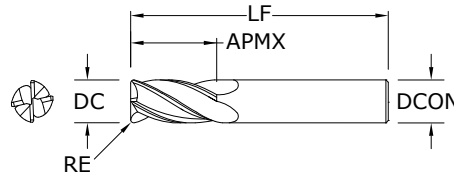

TOLERANCES (mm)

<3 DIAMETER
DC = +0,0000/-0,0254
DCON = h₆

≥3 DIAMETER
DC = +0,0000/-0,0508
DCON = h₆
RE = +0,0000/-0,0508

CONTINUED

- STEELS
- STAINLESS STEELS
- CAST IRON
- NON-FERROUS
- HIGH TEMP ALLOYS

For patent information visit www.ksptpatents.com

CUTTING DIAMETER DC	LENGTH OF CUT APMX	mm			EDP NO.				SERIES
		OVERALL LENGTH LF	CORNER RADIUS RE	SHANK DIAMETER DCON	UNCOATED	Ti-NAMITE® (TiN)	Ti-NAMITE®-C (TiCN)	Ti-NAMITE®-A (AlTiN)	
6,0	19,0	50,0	1,00	6,0	—	—	—	40012	1MCR
6,0	25,0	75,0	—	6,0	43105	49390	49403	49416	1XLM
7,0	12,0	50,0	—	8,0	41645	49146	49167	49188	16M
7,0	19,0	63,0	—	8,0	40145	48510	48532	48553	1M
8,0	12,0	50,0	—	8,0	41649	49147	49168	49189	16M
8,0	20,0	63,0	—	8,0	40149	48511	48533	48554	1M
8,0	20,0	63,0	0,50	8,0	—	—	—	40015	1MCR
8,0	20,0	63,0	0,75	8,0	—	—	—	40016	1MCR
8,0	20,0	63,0	1,00	8,0	—	—	—	40017	1MCR
8,0	20,0	63,0	1,50	8,0	—	—	—	40019	1MCR
8,0	20,0	63,0	2,00	8,0	—	—	—	40020	1MCR
8,0	25,0	75,0	—	8,0	43115	49392	49405	49418	1XLM
9,0	14,0	50,0	—	9,0	41653	49148	49169	49190	16M
9,0	22,0	75,0	—	10,0	40153	48512	48534	48555	1M
10,0	16,0	50,0	—	10,0	41657	49149	49170	49191	16M
10,0	22,0	75,0	—	10,0	40157	48513	48535	48556	1M
10,0	22,0	75,0	0,50	10,0	—	—	—	40021	1MCR
10,0	22,0	75,0	1,00	10,0	—	—	—	40023	1MCR
10,0	22,0	75,0	1,50	10,0	—	—	—	40024	1MCR
10,0	22,0	75,0	2,00	10,0	—	—	—	40025	1MCR
10,0	38,0	100,0	—	10,0	43125	49393	49406	49419	1XLM
11,0	19,0	63,0	—	12,0	41661	49150	49171	49192	16M
11,0	25,0	75,0	—	12,0	40161	48514	48536	48557	1M
12,0	19,0	63,0	—	12,0	40165	49151	49172	49193	16M
12,0	25,0	75,0	—	12,0	41665	48515	48537	48558	1M
12,0	25,0	75,0	0,50	12,0	—	—	—	40028	1MCR
12,0	25,0	75,0	1,00	12,0	—	—	—	40030	1MCR
12,0	25,0	75,0	1,50	12,0	—	—	—	40031	1MCR
12,0	25,0	75,0	2,00	12,0	—	—	—	40032	1MCR
12,0	50,0	100,0	—	12,0	43135	49394	49407	49420	1XLM
12,0	75,0	150,0	—	12,0	43145	49395	49408	49421	1XLM
14,0	32,0	89,0	—	14,0	40169	48516	48538	48559	1M
14,0	75,0	150,0	—	14,0	43155	49396	49409	49422	1XLM
16,0	32,0	89,0	—	16,0	40173	48517	48539	48560	1M
16,0	32,0	89,0	0,50	16,0	—	—	—	40035	1MCR
16,0	32,0	89,0	1,00	16,0	—	—	—	40037	1MCR

continued on next page

4 Flute Square End • 4 Flute Corner Radius

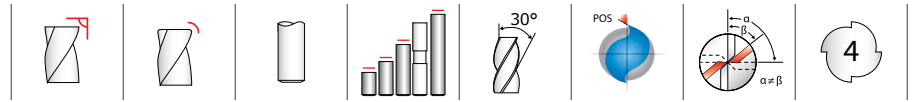

TOLERANCES (mm)

<3 DIAMETER

DC = +0,0000 / -0,0254
 DCON = h₆

≥3 DIAMETER

DC = +0,0000 / -0,0508
 DCON = h₆
 RE = +0,0000 / -0,0508

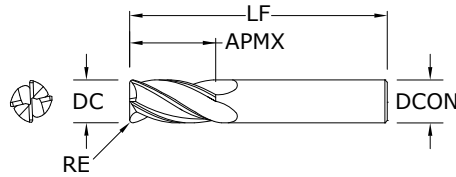

**1M • 1XLM •
 1MCR • 16M**
 METRIC SERIES

CUTTING DIAMETER DC	LENGTH OF CUT APMX	mm			EDP NO.				SERIES
		OVERALL LENGTH LF	CORNER RADIUS RE	SHANK DIAMETER DCON	UNCOATED	Ti-NAMITE® (TiN)	Ti-NAMITE®-C (TiCN)	Ti-NAMITE®-A (AlTiN)	
16,0	32,0	89,0	1,50	16,0	—	—	—	40038	1MCR
16,0	32,0	89,0	2,00	16,0	—	—	—	40039	1MCR
16,0	75,0	150,0	—	16,0	43165	49397	49410	49423	1XLM
18,0	38,0	100,0	—	18,0	40177	48518	48540	48561	1M
18,0	75,0	150,0	—	18,0	43175	49398	49411	49424	1XLM
20,0	38,0	100,0	—	20,0	40181	48519	48541	48562	1M
20,0	75,0	150,0	—	20,0	43185	49399	49412	49425	1XLM
25,0	38,0	100,0	—	25,0	40185	48520	48542	48563	1M
25,0	75,0	150,0	—	25,0	43195	49400	49413	49426	1XLM

CONTINUED

- STEELS
- STAINLESS STEELS
- CAST IRON
- NON-FERROUS
- HIGH TEMP ALLOYS

For patent information visit www.ksptpatents.com

METRIC

4 Flute Ball End

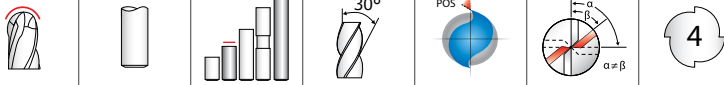

**1MB•
1XLMB**
METRIC SERIES

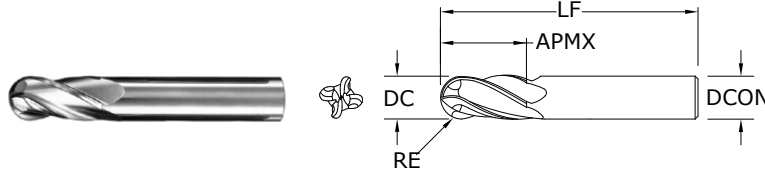

TOLERANCES (mm)

<3 DIAMETER
 DC = +0,0000 / -0.0254
 RE = +0,0000 / -0.0127

≥3 DIAMETER
 DC = +0,0000 / -0.0508
 DCON = h₆
 RE = +0,0000 / -0.0254

- STEELS
- STAINLESS STEELS
- CAST IRON
- NON-FERROUS
- HIGH TEMP ALLOYS

For patent information visit www.ksptpatents.com

CUTTING DIAMETER DC	LENGTH OF CUT APMX	OVERALL LENGTH LF	SHANK DIAMETER DCON	EDP NO.				SERIES
				UNCOATED	Ti-NAMITE® (TiN)	Ti-NAMITE®-C (TiCN)	Ti-NAMITE®-A (AlTiN)	
1,0	4,0	38,0	3,0	40106	48564	48586	48607	1MB
1,5	4,5	38,0	3,0	40110	48565	48587	48608	1MB
2,0	6,3	38,0	3,0	40114	48566	48588	48609	1MB
2,5	9,5	38,0	3,0	40118	48567	48589	48610	1MB
3,0	12,0	38,0	3,0	40122	48568	48590	48611	1MB
3,0	25,0	75,0	3,0	43102	49505	49518	49531	1XLMB
3,5	12,0	50,0	4,0	40126	48569	48591	48612	1MB
4,0	14,0	50,0	4,0	40130	48570	48592	48613	1MB
4,0	25,0	75,0	4,0	43104	49506	49519	49532	1XLMB
4,5	16,0	50,0	6,0	40134	48571	48593	48614	1MB
5,0	16,0	50,0	6,0	40138	48572	48594	48615	1MB
5,0	25,0	75,0	5,0	43108	49508	49521	49534	1XLMB
6,0	19,0	50,0	6,0	40142	48573	48595	48616	1MB
6,0	25,0	75,0	6,0	43106	49507	49520	49533	1XLMB
7,0	19,0	63,0	8,0	40146	48574	48596	48617	1MB
8,0	20,0	63,0	8,0	40150	48575	48597	48618	1MB
8,0	25,0	75,0	8,0	43116	49509	49522	49535	1XLMB
9,0	22,0	75,0	10,0	40154	48576	48598	48619	1MB
10,0	22,0	75,0	10,0	40158	48577	48599	48620	1MB
10,0	38,0	100,0	10,0	43126	49510	49523	49536	1XLMB
11,0	25,0	75,0	12,0	40162	48578	48600	48621	1MB
12,0	25,0	75,0	12,0	40166	48579	48601	48622	1MB
12,0	50,0	100,0	12,0	43136	49511	49524	49537	1XLMB
12,0	75,0	150,0	12,0	43146	49512	49525	49538	1XLMB
14,0	32,0	89,0	14,0	40170	48580	48602	48623	1MB
14,0	75,0	150,0	14,0	43156	49513	49526	49539	1XLMB
16,0	32,0	89,0	16,0	40174	48581	48603	48624	1MB
16,0	75,0	150,0	16,0	43166	49514	49527	49540	1XLMB
18,0	38,0	100,0	18,0	40178	48582	48604	48625	1MB
18,0	75,0	150,0	18,0	43176	49515	49528	49541	1XLMB
20,0	38,0	100,0	20,0	40182	48583	48605	48626	1MB
20,0	75,0	150,0	20,0	43186	49516	49529	49542	1XLMB
25,0	38,0	100,0	25,0	40186	48584	48606	48627	1MB
25,0	75,0	150,0	25,0	43196	49517	49530	49543	1XLMB

RE = 1/2 Cutting Diameter (DC)

4 Flute Double End

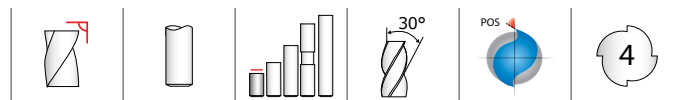

TOLERANCES (inch)

<1/8 DIAMETER

DC = +0.000/-0.001

DCON = h₆

≥1/8 DIAMETER

DC = +0.000/-0.002

DCON = h₆

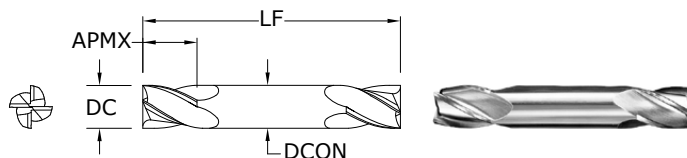

14
FRACTIONAL SERIES

inch				EDP NO.			
CUTTING DIAMETER DC	LENGTH OF CUT APMX	OVERALL LENGTH LF	SHANK DIAMETER DCON	UNCOATED	Ti-NAMITE® (TiN)	Ti-NAMITE®-C (TiCN)	Ti-NAMITE®-A (AlTiN)
1/32	1/16	1-1/2	1/8	31401	31441	39601	31170
3/64	3/32	1-1/2	1/8	31403	31443	39603	31171
1/16	1/8	1-1/2	1/8	31405	31445	39605	31172
5/64	1/8	1-1/2	1/8	31407	31447	39607	31173
3/32	3/16	1-1/2	1/8	31409	31449	39609	31174
7/64	3/16	1-1/2	1/8	31411	31451	39611	31175
*1/8	1/4	1-1/2	1/8	31413	31453	39613	31176
9/64	5/16	2	3/16	31415	31455	39615	31177
5/32	5/16	2	3/16	31417	31457	39617	31178
11/64	5/16	2	3/16	31419	31459	39619	31179
*3/16	3/8	2	3/16	31421	31461	39621	31180
13/64	1/2	2-1/2	1/4	31423	31463	39623	31181
7/32	1/2	2-1/2	1/4	31425	31465	39625	31182
15/64	1/2	2-1/2	1/4	31427	31467	39627	31183
*1/4	1/2	2-1/2	1/4	31429	31469	39629	31184
9/32	1/2	2-1/2	5/16	31431	31471	39631	31185
*5/16	1/2	2-1/2	5/16	31433	31473	39633	31186
*3/8	9/16	2-1/2	3/8	31435	31475	39635	31187
7/16	9/16	2-3/4	7/16	31437	31477	39637	31188
*1/2	5/8	3	1/2	31439	31479	39639	31189
*Series 14 Set				31489	31481	39641	31190

- STEELS
- STAINLESS STEELS
- CAST IRON
- NON-FERROUS
- HIGH TEMP ALLOYS

For patent information visit www.ksptpatents.com

TOLERANCES (mm)

<3 DIAMETER

DC = +0,0000/-0,0254

DCON = h₆

≥3 DIAMETER

DC = +0,0000/-0,0508

DCON = h₆

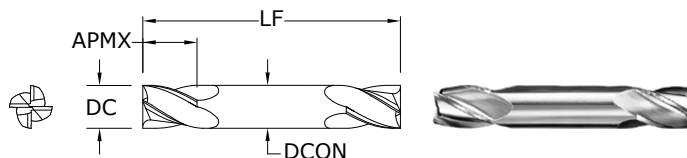

14M
METRIC SERIES

mm				EDP NO.			
CUTTING DIAMETER DC	LENGTH OF CUT APMX	OVERALL LENGTH LF	SHANK DIAMETER DCON	UNCOATED	Ti-NAMITE® (TiN)	Ti-NAMITE®-C (TiCN)	Ti-NAMITE®-A (AlTiN)
1,0	2,0	38,0	3,0	41405	48884	48905	48926
1,5	3,0	38,0	3,0	41409	48885	48906	48927
2,0	4,0	38,0	3,0	41413	48886	48907	48928
2,5	5,0	38,0	3,0	41417	48887	48908	48929
3,0	6,0	38,0	3,0	41421	48888	48909	48930
3,5	7,0	50,0	4,0	41425	48889	48910	48931
4,0	8,0	50,0	4,0	41429	48890	48911	48932
4,5	9,5	63,0	4,5	41433	48891	48912	48933
5,0	10,0	63,0	5,0	41437	48892	48913	48934
6,0	12,0	63,0	6,0	41441	48893	48914	48935
7,0	12,0	63,0	8,0	41445	48894	48915	48936
8,0	12,0	63,0	8,0	41449	48895	48916	48937
9,0	14,0	75,0	9,0	41453	48896	48917	48938
10,0	14,0	75,0	10,0	41457	48897	48918	48939
11,0	14,0	75,0	12,0	41461	48898	48919	48940
12,0	16,0	75,0	12,0	41465	48899	48920	48941

- STEELS
- STAINLESS STEELS
- CAST IRON
- NON-FERROUS
- HIGH TEMP ALLOYS

For patent information visit www.ksptpatents.com

4 Flute Double End Ball End

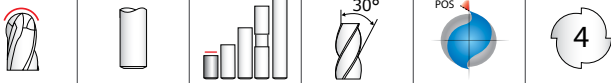

14B

FRACTIONAL SERIES

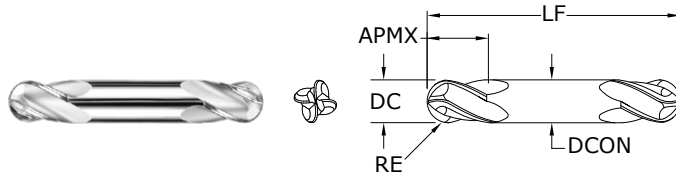

TOLERANCES (inch)

<1/8 DIAMETER
 DC = +0.000 / -0.001
 DCON = h₆
 RE = +0.000 / -0.005

≥1/8 DIAMETER
 DC = +0.000 / -0.002
 DCON = h₆
 RE = +0.000 / -0.001

- STEELS
- STAINLESS STEELS
- CAST IRON
- NON-FERROUS
- HIGH TEMP ALLOYS

For patent information visit www.ksptpatents.com

inch				EDP NO.			
CUTTING DIAMETER DC	LENGTH OF CUT APMX	OVERALL LENGTH LF	SHANK DIAMETER DCON	UNCOATED	Ti-NAMITE® (TiN)	Ti-NAMITE®-C (TiCN)	Ti-NAMITE®-A (AlTiN)
1/32	1/16	1-1/2	1/8	31402	31442	39602	31218
3/64	3/32	1-1/2	1/8	31404	31444	39604	31219
1/16	1/8	1-1/2	1/8	31406	31446	39606	31220
5/64	1/8	1-1/2	1/8	31408	31448	39608	31221
3/32	3/16	1-1/2	1/8	31410	31450	39610	31222
7/64	3/16	1-1/2	1/8	31412	31452	39612	31223
*1/8	1/4	1-1/2	1/8	31414	31454	39614	31224
9/64	5/16	2	3/16	31416	31456	39616	31225
5/32	5/16	2	3/16	31418	31458	39618	31226
11/64	5/16	2	3/16	31420	31460	39620	31227
*3/16	3/8	2	3/16	31422	31462	39622	31228
13/64	1/2	2-1/2	1/4	31424	31464	39624	31229
7/32	1/2	2-1/2	1/4	31426	31466	39626	31230
15/64	1/2	2-1/2	1/4	31428	31468	39628	31231
*1/4	1/2	2-1/2	1/4	31430	31470	39630	31232
9/32	1/2	2-1/2	5/16	31432	31472	39632	31233
*5/16	1/2	2-1/2	5/16	31434	31474	39634	31234
*3/8	9/16	2-1/2	3/8	31436	31476	39636	31235
7/16	9/16	2-3/4	7/16	31438	31478	39638	31236
*1/2	5/8	3	1/2	31440	31480	39640	31237
				31490	31482	39642	31217

*Series 14B Set
 RE = 1/2 Cutting Diameter (DC)

TOLERANCES (mm)

<3 DIAMETER
 DC = +0,0000 / -0,0254
 DCON = h₆
 RE = +0,0000 / -0,0127

≥3 DIAMETER
 DC = +0,0000 / -0,0508
 DCON = h₆
 RE = +0,0000 / -0,0254

14MB

METRIC SERIES

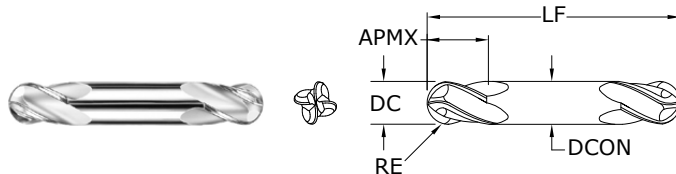

- STEELS
- STAINLESS STEELS
- CAST IRON
- NON-FERROUS
- HIGH TEMP ALLOYS

For patent information visit www.ksptpatents.com

mm				EDP NO.			
CUTTING DIAMETER DC	LENGTH OF CUT APMX	OVERALL LENGTH LF	SHANK DIAMETER DCON	UNCOATED	Ti-NAMITE® (TiN)	Ti-NAMITE®-C (TiCN)	Ti-NAMITE®-A (AlTiN)
1,0	2,0	38,0	3,0	41406	48947	48968	48989
1,5	3,0	38,0	3,0	41410	48948	48969	48990
2,0	4,0	38,0	3,0	41414	48949	48970	48991
2,5	5,0	38,0	3,0	41418	48950	48971	48992
3,0	6,0	38,0	3,0	41422	48951	48972	48993
3,5	7,0	50,0	4,0	41426	48952	48973	48994
4,0	8,0	50,0	4,0	41430	48953	48974	48995
4,5	9,5	63,0	4,5	41434	48954	48975	48996
5,0	10,0	63,0	5,0	41438	48955	48976	48997
6,0	12,0	63,0	6,0	41442	48956	48977	48998
7,0	12,0	63,0	8,0	41446	48957	48978	48999
8,0	12,0	63,0	8,0	41450	48958	48979	49000
9,0	14,0	75,0	9,0	41454	48959	48980	49001
10,0	14,0	75,0	10,0	41458	48960	48981	49002
11,0	14,0	75,0	12,0	41462	48961	48982	49003
12,0	16,0	75,0	12,0	41466	48962	48983	49004

RE = 1/2 Cutting Diameter (DC)

FRACTIONAL & METRIC 4 Flute High Shear

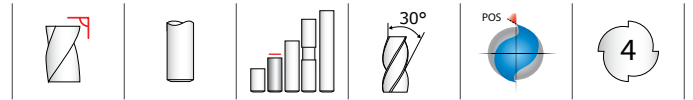

TOLERANCES (inch)

<1/8 DIAMETER

DC = +0.000/-0.001

DCON = h₆

≥1/8 DIAMETER

DC = +0.000/-0.002

DCON = h₆

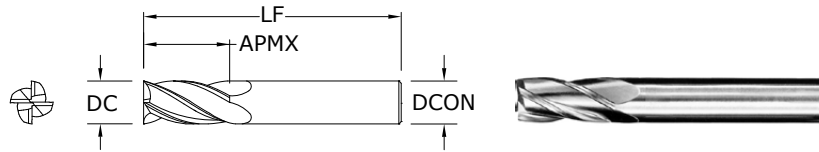

54
FRACTIONAL SERIES

CUTTING DIAMETER DC	LENGTH OF CUT APMX	OVERALL LENGTH LF	SHANK DIAMETER DCON	EDP NO.	
				UNCOATED	Ti-NAMITE®-C (TiCN)
1/16	3/16	1-1/2	1/8	35473	35500
3/32	3/8	1-1/2	1/8	35475	35501
1/8	7/16	1-1/2	1/8	35477	35502
5/32	9/16	2	3/16	35478	35503
3/16	9/16	2	3/16	35479	35504
7/32	5/8	2-1/2	1/4	35480	35505
1/4	3/4	2-1/2	1/4	35481	35506
9/32	3/4	2-1/2	5/16	35482	35507
5/16	13/16	2-1/2	5/16	35483	35508
3/8	7/8	2-1/2	3/8	35485	35509
7/16	1	2-3/4	7/16	35487	35510
1/2	1	3	1/2	35489	35511
9/16	1-1/8	3-1/2	9/16	35491	35512
5/8	1-1/4	3-1/2	5/8	35493	35513
3/4	1-1/2	4	3/4	35495	35514
1	1-1/2	4	1	35497	35515

NON-FERROUS

For patent information visit www.ksptpatents.com

TOLERANCES (mm)

<3 DIAMETER

DC = +0,0000/-0,0254

DCON = h₆

≥3 DIAMETER

DC = +0,0000/-0,0508

DCON = h₆

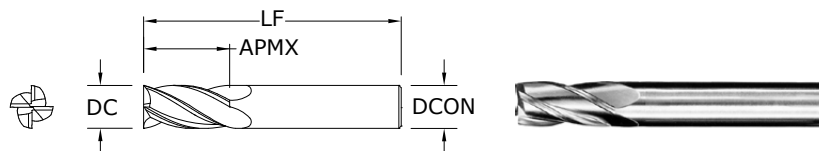

54M
METRIC SERIES

CUTTING DIAMETER DC	LENGTH OF CUT APMX	OVERALL LENGTH LF	SHANK DIAMETER DCON	EDP NO.	
				UNCOATED	Ti-NAMITE®-C (TiCN)
3,0	8,0	38,0	3,0	45477	45478
3,5	10,0	57,0	6,0	45479	45480
4,0	11,0	57,0	6,0	45481	45482
4,5	11,0	57,0	6,0	45483	45484
5,0	13,0	57,0	6,0	45485	45486
6,0	13,0	57,0	6,0	45487	45488
8,0	19,0	63,0	8,0	45489	45490
10,0	22,0	72,0	10,0	45491	45492
12,0	26,0	83,0	12,0	45493	45494
14,0	26,0	83,0	14,0	45495	45496
16,0	32,0	92,0	16,0	45497	45498
20,0	38,0	104,0	20,0	45499	45500

NON-FERROUS

For patent information visit www.ksptpatents.com

Single End Roughers (Coarse Pitch)

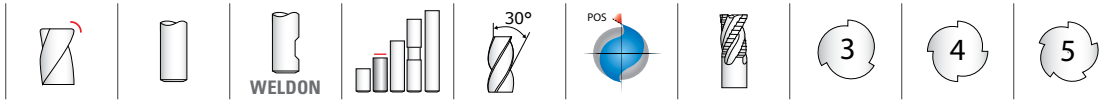

61 FRACTIONAL SERIES

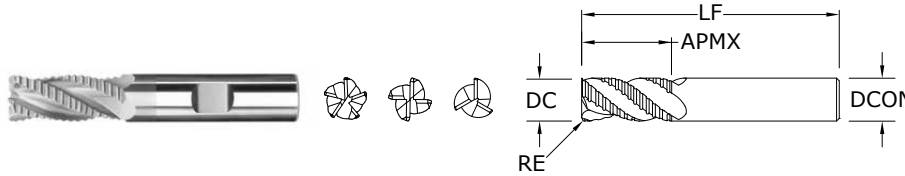

TOLERANCES (inch)

DC = +0.0000/-0.0040
 DCON = h₆
 RE = +0.0050/-0.0050

- STEELS
- CAST IRON

For patent information visit www.kspatents.com

CUTTING DIAMETER DC	LENGTH OF CUT APMX	OVERALL LENGTH LF	inch			EDP NO.		
			SHANK DIAMETER DCON	CORNER RADIUS RE	NO. OF FLUTES	Ti-NAMITE® (TiN)	Ti-NAMITE®-C (TiCN)	Ti-NAMITE®-A (AlTiN)
*1/4	3/4	2-1/2	1/4	.045	3	36107	36106	36110
*5/16	3/4	2-1/2	5/16	.045	3	36109	36108	36111
3/8	7/8	2-1/2	3/8	.060	3	36113	36112	36114
1/2	1	3	1/2	.060	4	36117	36116	36118
5/8	1-1/4	3-1/2	5/8	.060	4	36121	36120	36122
3/4	1-5/8	4	3/4	.060	4	36125	36124	36126
1	1-3/4	4	1	.060	5	36129	36128	36130

*Without Flat

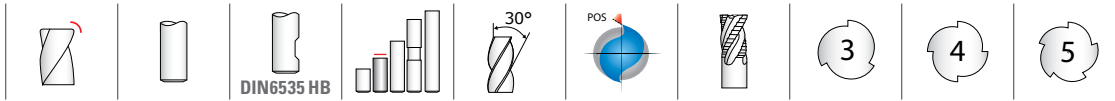

61M METRIC SERIES



TOLERANCES (mm)

DC = +0,000/-0,100
 DCON = h₆
 RE = +0,127/-0,127

- STEELS
- CAST IRON

For patent information visit www.kspatents.com

CUTTING DIAMETER DC	LENGTH OF CUT APMX	OVERALL LENGTH LF	mm			EDP NO.		
			SHANK DIAMETER DCON	CORNER RADIUS RE	NO. OF FLUTES	Ti-NAMITE® (TiN)	Ti-NAMITE®-C (TiCN)	Ti-NAMITE®-A (AlTiN)
6,0	19,0	63,0	6,0	1,14	3	46107	46106	46110
8,0	19,0	63,0	8,0	1,14	3	46109	46108	46111
10,0	22,0	72,0	10,0	1,52	3	46113	46112	46114
12,0	26,0	83,0	12,0	1,52	4	46117	46116	46118
16,0	32,0	92,0	16,0	1,52	4	46121	46120	46122
20,0	38,0	104,0	20,0	1,52	4	46129	46128	46132
25,0	44,0	104,0	25,0	1,52	5	46131	46130	46133

Single End Roughers (Fine Pitch)

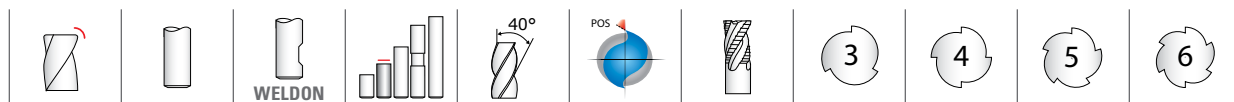

TOLERANCES (inch)

DC = +0.0000/-0.0040
 DCON = h₆
 RE = +0.0050/-0.0050

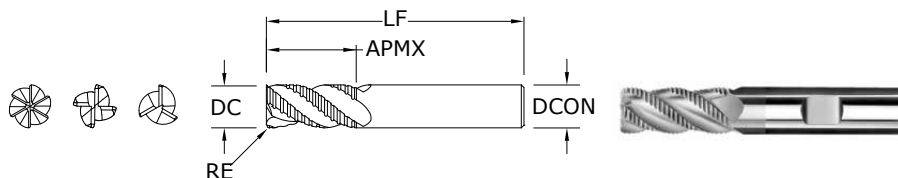

62
 FRACTIONAL SERIES

inch						EDP NO.		
CUTTING DIAMETER DC	LENGTH OF CUT APMX	OVERALL LENGTH LF	SHANK DIAMETER DCON	CORNER RADIUS RE	NO. OF FLUTES	Ti-NAMITE® (TiN)	Ti-NAMITE®-C (TiCN)	Ti-NAMITE®-A (AlTiN)
*1/4	3/4	2-1/2	1/4	.045	3	36207	36206	36210
*5/16	3/4	2-1/2	5/16	.045	3	36209	36208	36211
3/8	7/8	2-1/2	3/8	.060	3	36213	36212	36214
1/2	1	3	1/2	.060	4	36217	36216	36218
5/8	1-1/4	3-1/2	5/8	.060	4	36221	36220	36222
3/4	1-5/8	4	3/4	.060	4	36225	36224	36226
1	1-3/4	4	1	.060	6	36229	36228	36230

*Without Flat

STAINLESS STEELS

HIGH TEMP ALLOYS

For patent information visit www.ksptpatents.com

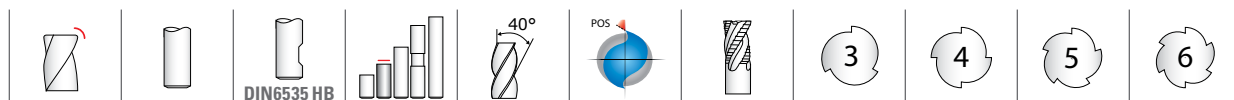

TOLERANCES (mm)

DC = +0,000 / -0,100
 DCON = h₆
 RE = +0,127/-0,127

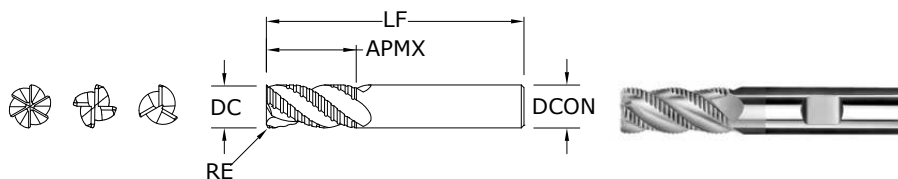

62M
 METRIC SERIES

mm						EDP NO.		
CUTTING DIAMETER DC	LENGTH OF CUT APMX	OVERALL LENGTH LF	SHANK DIAMETER DCON	CORNER RADIUS RE	NO. OF FLUTES	Ti-NAMITE® (TiN)	Ti-NAMITE®-C (TiCN)	Ti-NAMITE®-A (AlTiN)
6,0	19,0	63,0	6,0	1,14	3	46207	46206	46210
8,0	19,0	63,0	8,0	1,14	3	46209	46208	46211
10,0	22,0	72,0	10,0	1,52	3	46213	46212	46214
12,0	26,0	83,0	12,0	1,52	4	46217	46216	46218
16,0	32,0	92,0	16,0	1,52	4	46221	46220	46222
20,0	38,0	104,0	20,0	1,52	4	46229	46228	46232
25,0	44,0	104,0	25,0	1,52	5	46231	46230	46233

STAINLESS STEELS

HIGH TEMP ALLOYS

For patent information visit www.ksptpatents.com

End Mill Sets

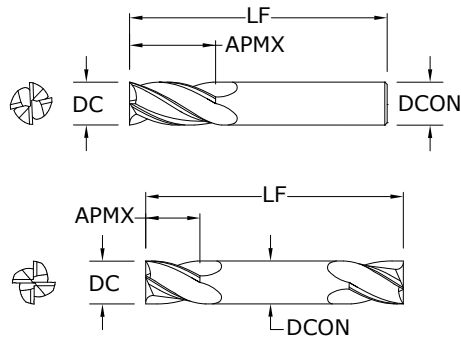

Pictured:
Series 1 4 Flute
Single End Square
Endmill Set

CUTTING DIAMETER DC	SINGLE END LENGTH OF CUT APMX	DOUBLE END LENGTH OF CUT APMX	OVERALL LENGTH LF	SHANK DIAMETER DCON
1/8	1/2	1/4	1-1/2	1/8
3/16	5/8	3/8	2	3/16
1/4	3/4	1/2	2-1/2	1/4
5/16	13/16	1/2	2-1/2	5/16
3/8	1	9/16	2-1/2	3/8
1/2	1	5/8	3	1/2

Square End

FRACTIONAL SERIES



For patent information visit www.ksptpatents.com

DESCRIPTION	EDP NO.			
	UNCOATED	Ti-NAMITE® (TiN)	Ti-NAMITE®-C (TiCN)	Ti-NAMITE®-A (AlTiN)
Series 1 – 4 Flute, Single End	30189	39189	39089	30030
Series 3 – 2 Flute, Single End	30389	39389	39589	30470
Series 5 – 3 Flute, Single End	30589	39789	30810	30850
Series 14 – 4 Flute, Double End	31489	31481	39641	31190
Series 15 – 2 Flute, Double End	31589	31581	39691	31336

FRACTIONAL End Mill Sets

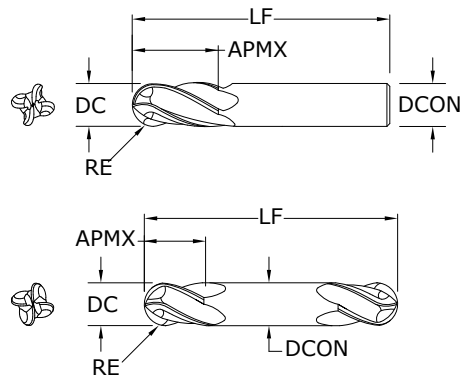

Pictured:
Series 1 4 Flute Single
End Ball Endmill Set

CUTTING DIAMETER DC	SINGLE END LENGTH OF CUT APMX	DOUBLE END LENGTH OF CUT APMX	OVERALL LENGTH LF	SHANK DIAMETER DCON
1/8	1/2	1/4	1-1/2	1/8
3/16	5/8	3/8	2	3/16
1/4	3/4	1/2	2-1/2	1/4
5/16	13/16	1/2	2-1/2	5/16
3/8	1	9/16	2-1/2	3/8
1/2	1	5/8	3	1/2

RE = 1/2 Cutting Diameter (DC)

Ball End FRACTIONAL SERIES

DESCRIPTION	EDP NO.			
	UNCOATED	Ti-NAMITE® (TiN)	Ti-NAMITE®-C (TiCN)	Ti-NAMITE®-A (AlTiN)
Series 1B – 4 Flute, Single End	30190	39190	39090	30070
Series 3B – 2 Flute, Single End	30390	39390	39590	30600
Series 5B – 3 Flute, Single End	30590	30900	30944	31169
Series 14B – 4 Flute, Double End	31490	31482	39642	31217
Series 15B – 2 Flute, Double End	31590	31582	39692	31357





For patent
information visit
www.ksptpatents.com

2 Flute: Square & Ball End

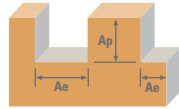
4 Flute: Square & Ball End



Diamond 1, 1B, 3, 3B Fractional	Ae x DC	Ap x DC	Vc (sfm)	DC • in							
				1/8	1/4	5/16	3/8	1/2			
GRAPHITE Ultrafine, Superfine	Profile 	≤ 0.25	≤ 1.5	720	RPM	22003	11002	8801	7334	5501	
				(576-864)	Fz	0.0009	0.0023	0.0036	0.0043	0.0058	
					Feed 2 flutes (ipm)	38.3	50.6	63.4	63.1	63.8	
					Feed 4 flutes (ipm)	76.6	101.2	126.7	126.2	127.6	
					580	RPM	17725	8862	7090	5908	4431
				(464-696)	Fz	0.0075	0.0020	0.0031	0.0038	0.0050	
	Feed 2 flutes (ipm)	265.9	35.4		44.0	44.9	44.3				
	Feed 4 flutes (ipm)	531.7	70.9		87.9	89.8	88.6				
	COMPOSITES FRP, CFRP, GRP	Profile 	≤ 0.25		≤ 1.5	385	RPM	11766	5883	4706	3922
				(308-462)		Fz	0.0005	0.0014	0.0022	0.0026	0.0035
						Feed 2 flutes (ipm)	12.2	16.5	20.7	20.4	20.6
						Feed 4 flutes (ipm)	24.5	32.9	41.4	40.8	41.2
350						RPM	10696	5348	4278	3565	2674
(280-420)				Fz		0.0005	0.0012	0.0019	0.0023	0.0030	
		Feed 2 flutes (ipm)	9.6	12.8	16.3	16.4	16.0				
		Feed 3 flutes (ipm)	19.3	25.7	32.5	32.8	32.1				
		PLASTICS Polycarbonate, PVC, Polypropylene	Profile 	≤ 0.25	≤ 1.5	1200	RPM	36672	18336	14669	12224
(960-1440)						Fz	0.0009	0.0023	0.0036	0.0043	0.0058
						Feed 2 flutes (ipm)	63.8	84.3	105.6	105.1	106.3
						Feed 4 flutes (ipm)	127.6	168.7	211.2	210.3	212.7
	960					RPM	29338	14669	11735	9779	7334
(768-1152)	Fz					0.0008	0.0020	0.0031	0.0038	0.0050	
	Feed 2 flutes (ipm)		44.0	58.7	72.8	74.3	73.3				
	Feed 3 flutes (ipm)		88.0	117.4	145.5	148.6	146.7				

rpm = (Vc x 3.82) / DC
 ipm = Fz x number of flutes x rpm
 finish cuts typically require reduced feed and cut depths (.02 x D maximum)
 refer to the SGS Tool Wizard® for complete technical information (www.kyocera-sgstool.com)

2 Flute: Square, Double, Stub, Long, Ball, Corner Radius

3 Flute: Square, Ball, Tapered

4 Flute: Square, Double, Stub, Ball, Corner Radius

Tapered: Square, Radius

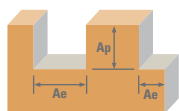

Series
1, 3, 5, 14, 15, 16,
17, 23, 24, 59
Fractional

Material	Hardness	Flutes	Ae x DC	Ap x DC	Vc (sfm)	DC • in	DC • in										
							1/64	1/32	1/16	1/8	1/4	3/8	1/2	3/4	1		
CARBON STEELS 1018, 1040, 1080, 1090, 10L50, 1140, 1212, 12L15, 1525, 1536	≤ 175 Bhn or ≤ 7 HRc	Profile	2	≤ 0.50	≤ 1.5	460	RPM	112461	56230	28115	14058	7029	4686	3514	2343	1757	
							Fz	0.00003	0.00006	0.00013	0.0003	0.0008	0.0015	0.0020	0.0024	0.0028	
							Feed (ipm)	6.7	6.7	7.3	8.4	11.2	14.1	14.1	11.2	9.8	
		Slot	2	1	≤ 1	335	RPM	81901	40950	20475	10238	5119	3413	2559	1706	1280	
							Fz	0.00003	0.00006	0.00013	0.0003	0.0008	0.0015	0.0020	0.0024	0.0028	
							Feed (ipm)	4.9	4.9	5.3	6.1	8.2	10.2	10.2	8.2	7.2	
	ALLOY STEELS 4140, 4150, 4320, 5120, 5150, 8630, 86L20, 50100	≤ 275 Bhn or ≤ 28 HRc	Profile	2	≤ 0.50	≤ 1.5	(368-552)	RPM	81901	40950	20475	10238	5119	3413	2559	1706	1280
								Fz	0.00002	0.00005	0.00009	0.0002	0.0006	0.0011	0.0015	0.0018	0.0021
								Feed (ipm)	3.3	4.1	3.7	4.1	6.1	7.5	7.7	6.1	5.4
			Slot	2	1	≤ 1	245	RPM	59898	29949	14974	7487	3744	2496	1872	1248	936
								Fz	0.00002	0.00005	0.00009	0.0002	0.0006	0.0011	0.0015	0.0018	0.0021
								Feed (ipm)	2.4	3.0	2.7	3.0	4.5	5.5	5.6	4.5	3.9
TOOL STEELS A2, D2, H13, L2, M2, P20, S7, T15, W2		≤ 250 Bhn or ≤ 24 HRc	Profile	2	≤ 0.50	≤ 1.5	315	RPM	77011	38506	19253	9626	4813	3209	2407	1604	1203
								Fz	0.00002	0.00005	0.00009	0.0002	0.0006	0.0011	0.0015	0.0018	0.0021
								Feed (ipm)	3.1	3.9	3.5	3.9	5.8	7.1	7.2	5.8	5.1
			Slot	2	1	≤ 1	230	RPM	56230	28115	14058	7029	3514	2343	1757	1171	879
								Fz	0.00002	0.00005	0.00009	0.0002	0.0006	0.0011	0.0015	0.0018	0.0021
								Feed (ipm)	2.2	2.8	2.5	2.8	4.2	5.2	5.3	4.2	3.7
	STAINLESS STEELS (FREE MACHINING) 303, 416, 420F, 430F 440F	≤ 275 Bhn or ≤ 28 HRc	Profile	2	≤ 0.50	≤ 1.5	(296-444)	RPM	90458	45229	22614	11307	5654	3769	2827	1885	1413
								Fz	0.00002	0.00005	0.00009	0.0002	0.0006	0.0011	0.0015	0.0018	0.0021
								Feed (ipm)	3.6	4.5	4.1	4.5	6.8	8.3	8.5	6.8	5.9
			Slot	2	1	≤ 1	270	RPM	66010	33005	16502	8251	4126	2750	2063	1375	1031
								Fz	0.00002	0.00005	0.00009	0.0002	0.0006	0.0011	0.0015	0.0018	0.0021
								Feed (ipm)	2.6	3.3	3.0	3.3	5.0	6.1	6.2	5.0	4.3
STAINLESS STEELS (DIFFICULT) 304, 304L, 316, 316L, 17-4 PH, 15-5, 13-4, Custom 450		≤ 275 Bhn or ≤ 28 HRc	Profile	2	≤ 0.50	≤ 1.5	255	RPM	62342	31171	15586	7793	3896	2598	1948	1299	974
								Fz	0.00002	0.00004	0.00008	0.0002	0.0005	0.0009	0.0012	0.0014	0.0017
								Feed (ipm)	2.5	2.5	2.5	2.6	3.9	4.7	4.7	3.6	3.3
			Slot	2	1	≤ 1	185	RPM	45229	22614	11307	5654	2827	1885	1413	942	707
								Fz	0.00002	0.00004	0.00008	0.0002	0.0005	0.0009	0.0012	0.0014	0.0017
								Feed (ipm)	1.8	1.8	1.8	1.9	2.8	3.4	3.4	2.6	2.4
	CAST IRONS Gray, Malleable, Ductile	≤ 220 Bhn or ≤ 19 HRc	Profile	2	≤ 0.50	≤ 1.5	335	RPM	81901	40950	20475	10238	5119	3413	2559	1706	1280
								Fz	0.00003	0.00006	0.00013	0.0003	0.0008	0.0015	0.0020	0.0024	0.0028
								Feed (ipm)	4.9	4.9	5.3	6.1	8.2	10.2	10.2	8.2	7.2
			Slot	2	1	≤ 1	245	RPM	59898	29949	14974	7487	3744	2496	1872	1248	936
								Fz	0.00003	0.00006	0.00013	0.0003	0.0008	0.0015	0.0020	0.0024	0.0028
								Feed (ipm)	3.6	3.6	3.9	4.5	6.0	7.5	7.5	6.0	5.2
ALUMINUM ALLOYS 2017, 2024, 356, 6061, 7075		≤ 150 Bhn or ≤ 88 HRb	Profile	2	≤ 0.50	≤ 1.5	880	RPM	215142	107571	53786	26893	13446	8964	6723	4482	3362
								Fz	0.00006	0.00013	0.00025	0.0006	0.0016	0.0030	0.0040	0.0048	0.0056
								Feed (ipm)	25.8	28.0	26.9	32.3	43.0	53.8	53.8	43.0	37.6
		Slot	2	1	≤ 1	640	RPM	156467	78234	39117	19558	9779	6519	4890	3260	2445	
							Fz	0.00006	0.00013	0.00025	0.0006	0.0016	0.0030	0.0040	0.0048	0.0056	
							Feed (ipm)	18.8	20.3	19.6	23.5	31.3	39.1	39.1	31.3	27.4	

continued on next page

FRACTIONAL

2 Flute: Square, Double, Stub, Long, Ball, Corner Radius

3 Flute: Square, Ball, Tapered

4 Flute: Square, Double, Stub, Ball, Corner Radius

Tapered: Square, Radius

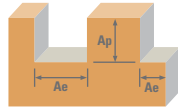

Series
1, 3, 5, 14, 15, 16,
17, 23, 24, 59
Fractional

Hardness

Flutes

Ae x DC

Ap x DC

Vc
(sfm)

DC • in

1/64 1/32 1/16 1/8 1/4 3/8 1/2 3/4 1

Material	Hardness	Flutes	Ae x DC	Ap x DC	Vc (sfm)	DC • in												
						1/64	1/32	1/16	1/8	1/4	3/8	1/2	3/4	1				
COPPER ALLOYS Alum Bronze, C110, Muntz Brass	≤ 140 Bhn or ≤ 3 HRc	Profile	2	≤ 0.50	≤ 1.5	485	RPM	118573	59286	29643	14822	7411	4941	3705	2470	1853		
						Fz	0.0003	0.0006	0.0013	0.003	0.008	0.015	0.020	0.024	0.028			
						Feed (ipm)	7.1	7.1	7.7	8.9	11.9	14.8	14.8	11.9	10.4			
							10.7	10.7	11.6	13.3	17.8	22.2	22.2	17.8	15.6			
							14.2	14.2	15.4	17.8	23.7	29.6	29.6	23.7	20.8			
						Slot	3	≤ 0.25	≤ 1.5	350	RPM	85568	42784	21392	10696	5348	3565	2674
		Fz	0.0003	0.0006	0.0013					0.003	0.008	0.015	0.020	0.024	0.028			
		Feed (ipm)	5.1	5.1	5.6					6.4	8.6	10.7	10.7	8.6	7.5			
			7.7	7.7	8.3					9.6	12.8	16.0	16.0	12.8	11.2			
			10.3	10.3	11.1					12.8	17.1	21.4	21.4	17.1	15.0			
		PLASTICS Polycarbonate, PVC, Polypropylene		Profile	2					≤ 0.50	≤ 1.5	880	RPM	215142	107571	53786	26893	13446
						Fz	0.0006	0.0013	0.0025			0.006	0.016	0.030	0.040	0.048	0.056	
Feed (ipm)	25.8					28.0	26.9	32.3	43.0			53.8	53.8	43.0	37.6			
	38.7					42.0	40.3	48.4	64.5			80.7	80.7	64.5	56.5			
	51.6					55.9	53.8	64.5	86.1			107.6	107.6	86.1	75.3			
Slot	3					≤ 0.25	≤ 1.5	640	RPM			156467	78234	39117	19558	9779	6519	4890
				Fz	0.0006			0.0013	0.0025	0.006	0.016	0.030	0.040	0.048	0.056			
				Feed (ipm)	18.8			20.3	19.6	23.5	31.3	39.1	39.1	31.3	27.4			
					28.2			30.5	29.3	35.2	46.9	58.7	58.7	46.9	41.1			
					37.6			40.7	39.1	46.9	62.6	78.2	78.2	62.6	54.8			
				GRAPHITE				Profile	2	≤ 0.50	≤ 1.5	660	RPM	161357	80678	40339	20170	10085
Fz	0.0006					0.0013	0.0025					0.006	0.016	0.030	0.040	0.048	0.056	
Feed (ipm)	19.4	21.0	20.2			24.2	32.3					40.3	40.3	32.3	28.2			
	29.0	31.5	30.3			36.3	48.4					60.5	60.5	48.4	42.4			
	38.7	42.0	40.3			48.4	64.5					80.7	80.7	64.5	56.5			
Slot	3	≤ 0.25	≤ 1.5			480	RPM					117350	58675	29338	14669	7334	4890	3667
						Fz	0.0006	0.0013	0.0025	0.006	0.016	0.030	0.040	0.048	0.056			
						Feed (ipm)	14.1	15.3	14.7	17.6	23.5	29.3	29.3	23.5	20.5			
							21.1	22.9	22.0	26.4	35.2	44.0	44.0	35.2	30.8			
							28.2	30.5	29.3	35.2	46.9	58.7	58.7	46.9	41.1			
						HIGH TEMP ALLOYS (NICKEL, COBALT, IRON BASE) Inconel 601, 617, 625, 718, Incoloy 800, Monel 400, Rene, Waspalloy	≤ 300 Bhn or ≤ 32 HRc	Profile	2	≤ 0.50	≤ 1.5	65	RPM	15891	7946	3973	1986	993
Fz	0.0002	0.0003	0.0006									0.002	0.004	0.008	0.010	0.012	0.014	
Feed (ipm)	0.6	0.5	0.5	0.7	0.7							1.1	1.0	0.8	0.7			
	1.0	0.7	0.7	1.1	1.0							1.6	1.5	1.2	1.0			
	1.3	1.0	1.0	1.4	1.4							2.1	2.0	1.6	1.4			
Slot	3	≤ 0.25	≤ 1.5	45	RPM							11002	5501	2750	1375	688	458	344
				Fz	0.0002			0.0003	0.0006	0.002	0.004	0.008	0.010	0.012	0.014			
				Feed (ipm)	0.4			0.3	0.3	0.5	0.5	0.7	0.7	0.6	0.5			
					0.7			0.5	0.5	0.7	0.7	1.1	1.0	0.8	0.7			
					0.9			0.7	0.7	1.0	1.0	1.5	1.4	1.1	1.0			
				TITANIUM ALLOYS Ti6Al4V, Ti6Al2Sn4Zr2Mo, Ti4Al4Mo2Sn0.5Si, Ti10V2Fe3Al, Ti5Al3Mo3Cr, Ti7Al4Mo, Ti3Al8V6Cr4Zr4Mo, Ti6Al6V6Sn, Ti152 Cr3Sn3Al	≤ 350 Bhn or ≤ 38 HRc			Profile	2	≤ 0.50	≤ 1.5	180	RPM	44006	22003	11002	5501	2750
Fz	0.0002	0.0004	0.0008									0.002	0.005	0.009	0.012	0.014	0.017	
Feed (ipm)	1.8	1.8	1.8			2.2	2.8					3.3	3.3	2.6	2.3			
	2.6	2.6	2.6			3.3	4.1					5.0	5.0	3.9	3.5			
	3.5	3.5	3.5			4.4	5.5					6.6	6.6	5.1	4.7			
Slot	3	≤ 0.25	≤ 1.5			130	RPM					31782	15891	7946	3973	1986	1324	993
						Fz	0.0002	0.0004	0.0008	0.002	0.005	0.009	0.012	0.014	0.017			
						Feed (ipm)	1.3	1.3	1.3	1.6	2.0	2.4	2.4	1.9	1.7			
							1.9	1.9	1.9	2.4	3.0	3.6	3.6	2.8	2.5			
							2.5	2.5	2.5	3.2	4.0	4.8	4.8	3.7	3.4			

Bhn (Brinell) HRc (Rockwell C) HRb (Rockwell B)

rpm = (Vc x 3.82) / DC

ipm = Fz x number of flutes x rpm

reduce speed and feed for materials harder than listed

for tapered end mills, base the speed on the largest diameter contacting

the workpiece and the feed on the smallest diameter

limit cut depths of long and extra long flute mills to .05 x DC when slotting

or profiling

reduce feed and Ae when finish milling (.02 x DC maximum)

refer to the SGS Tool Wizard® for complete technical information

www.kyocera-sgstool.com

2 Flute: High Shear 4 Flute: High Shear

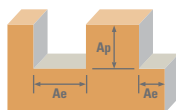







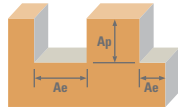

Series 52, 54 Fractional	Hardness	Flutes	Ae x DC	Ap x DC	Vc (sfm)	DC • in							
						1/8	1/4	3/8	1/2	3/4	1		
ALUMINUM ALLOYS 2024, 5052, 5086, 6061, 6063, 7075	≤ 150 Bhn or ≤ 88 HRb	Profile	2	≤ 0.3	≤ 1.5	1360	RPM	41562	20781	13854	10390	6927	5195
						(1088-1632)	Fz	0.00069	0.0018	0.0034	0.0046	0.0055	0.0064
							Feed (ipm)	57.4	74.8	94.2	95.6	76.2	66.5
		4	≤ 0.3	≤ 1.5	1090	RPM	33310	16655	11103	8328	5552	4164	
					(872-1308)	Fz	0.00063	0.0017	0.0032	0.0042	0.0050	0.0059	
						Feed (ipm)	42.0	56.6	71.1	70.0	55.5	49.1	
	4	1	≤ 0.25	510	RPM	15586	7793	5195	3896	2598	1948		
				(408-612)	Fz	0.00069	0.0018	0.0034	0.0046	0.0055	0.0064		
					Feed (ipm)	21.5	28.1	35.3	35.8	28.6	24.9		
	4	≤ 0.3	≤ 1.5	410	RPM	12530	6265	4177	3132	2088	1566		
				(328-492)	Fz	0.00063	0.0017	0.0032	0.0042	0.0050	0.0059		
					Feed (ipm)	15.8	21.3	26.7	26.3	20.9	18.5		
4	1	≤ 0.25	590	RPM	18030	9015	6010	4508	3005	2254			
			(472-708)	Fz	0.00039	0.0010	0.0020	0.0026	0.0031	0.0037			
				Feed (ipm)	14.1	18.0	24.0	23.4	18.6	16.7			
4	≤ 0.3	≤ 1.5	475	RPM	14516	7258	4839	3629	2419	1815			
			(380-570)	Fz	0.00036	0.0010	0.0018	0.0024	0.0029	0.0034			
				Feed (ipm)	10.5	14.5	17.4	17.4	14.0	12.3			
4	1	≤ 0.25	235	RPM	7182	3591	2394	1795	1197	898			
			(188-282)	Fz	0.00039	0.0010	0.0020	0.0026	0.0031	0.0037			
				Feed (ipm)	5.6	7.2	9.6	9.3	7.4	6.6			
4	≤ 0.3	≤ 1.5	190	RPM	5806	2903	1935	1452	968	726			
			(152-228)	Fz	0.00036	0.0010	0.0018	0.0024	0.0029	0.0034			
				Feed (ipm)	4.2	5.8	7.0	7.0	5.6	4.9			
4	1	≤ 0.25	1600	RPM	48896	24448	16299	12224	8149	6112			
			(1280-1920)	Fz	0.00110	0.0030	0.0056	0.0074	0.0089	0.0100			
				Feed (ipm)	107.6	146.7	182.5	180.9	145.1	122.2			
4	≤ 0.3	≤ 1.5	1280	RPM	39117	19558	13039	9779	6519	4890			
			(1024-1536)	Fz	0.00100	0.0027	0.0051	0.0068	0.0082	0.0095			
				Feed (ipm)	78.2	105.6	133.0	133.0	106.9	92.9			
4	1	≤ 0.25	720	RPM	22003	11002	7334	5501	3667	2750			
			(576-864)	Fz	0.00082	0.0022	0.0041	0.0055	0.0065	0.0076			
				Feed (ipm)	36.1	48.4	60.1	60.5	47.7	41.8			
4	≤ 0.3	≤ 1.5	575	RPM	17572	8786	5857	4393	2929	2197			
			(460-690)	Fz	0.00075	0.0020	0.0037	0.0050	0.0060	0.0070			
				Feed (ipm)	26.4	35.1	43.3	43.9	35.1	30.8			
4	1	≤ 0.25	720	RPM	22003	11002	7334	5501	3667	2750			
			(576-864)	Fz	0.00082	0.0022	0.0041	0.0055	0.0065	0.0076			
				Feed (ipm)	36.1	48.4	60.1	60.5	47.7	41.8			
4	≤ 0.3	≤ 1.5	575	RPM	17572	8786	5857	4393	2929	2197			
			(460-690)	Fz	0.00075	0.0020	0.0037	0.0050	0.0060	0.0070			
				Feed (ipm)	26.4	35.1	43.3	43.9	35.1	30.8			
4	1	≤ 0.25	720	RPM	22003	11002	7334	5501	3667	2750			
			(576-864)	Fz	0.00082	0.0022	0.0041	0.0055	0.0065	0.0076			
				Feed (ipm)	36.1	48.4	60.1	60.5	47.7	41.8			
4	≤ 0.3	≤ 1.5	575	RPM	17572	8786	5857	4393	2929	2197			
			(460-690)	Fz	0.00075	0.0020	0.0037	0.0050	0.0060	0.0070			
				Feed (ipm)	26.4	35.1	43.3	43.9	35.1	30.8			
4	1	≤ 0.25	720	RPM	22003	11002	7334	5501	3667	2750			
			(576-864)	Fz	0.00082	0.0022	0.0041	0.0055	0.0065	0.0076			
				Feed (ipm)	36.1	48.4	60.1	60.5	47.7	41.8			
4	≤ 0.3	≤ 1.5	575	RPM	17572	8786	5857	4393	2929	2197			
			(460-690)	Fz	0.00075	0.0020	0.0037	0.0050	0.0060	0.0070			
				Feed (ipm)	26.4	35.1	43.3	43.9	35.1	30.8			

Bhn (Brinell) HRc (Rockwell C) HRb (Rockwell B)
 rpm = (Vc x 3.82) / DC
 ipm = Fz x number of flutes x rpm
 reduce speed and feed for materials harder than listed
 reduce feed and Ae when finish milling (.02 x DC maximum)
 refer to the SGS Tool Wizard® for complete technical information (www.kyocera-sgstool.com)

Single End Roughers (Coarse Pitch)





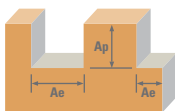

Series	Hardness	Ae x DC	Ap x DC	Vc (sfm)	RPM	DC • in				
						1/4	3/8	1/2	3/4	1
61 Fractional P K	CARBON STEELS 1018, 1040, 1080, 1090, 10L50, 1140, 1212, 12L15, 1525, 1536 ≤ 175 Bhn or ≤ 7 HRc	Profile  ≤ 0.5 ≤ 1.5	500 (400-600)	RPM	7640	5093	3820	2547	1910	
				Fz	0.0006	0.0011	0.0014	0.0017	0.0020	
				Feed (ipm)	13.8	16.8	21.4	17.3	19.1	
		Slot  1 ≤ 1	400 (320-480)	RPM	6112	4075	3056	2037	1528	
				Fz	0.0006	0.0011	0.0014	0.0017	0.0020	
				Feed (ipm)	11.0	13.4	17.1	13.9	15.3	
	ALLOY STEELS 4140, 4150, 4320, 5120, 5150, 8630, 86L20, 50100 ≤ 275 Bhn or ≤ 28 HRc	Profile  ≤ 0.5 ≤ 1.5	365 (292-438)	RPM	5577	3718	2789	1859	1394	
				Fz	0.0004	0.0008	0.0011	0.0013	0.0015	
				Feed (ipm)	6.7	8.9	12.3	9.7	10.5	
		Slot  1 ≤ 1	295 (236-354)	RPM	4508	3005	2254	1503	1127	
				Fz	0.0004	0.0008	0.0011	0.0013	0.0015	
				Feed (ipm)	5.4	7.2	9.9	7.8	8.5	
TOOL STEELS A2, D2, H13, L2, M2, P20, S7, T15, W2 ≤ 250 Bhn or ≤ 24 HRc	Profile  ≤ 0.5 ≤ 1.5	345 (276-414)	RPM	5272	3514	2636	1757	1318		
			Fz	0.0006	0.0009	0.0015	0.0018	0.0021		
			Feed (ipm)	9.5	9.5	15.8	12.7	13.8		
	Slot  1 ≤ 1	275 (220-330)	RPM	4202	2801	2101	1401	1051		
			Fz	0.0006	0.0009	0.0015	0.0018	0.0021		
			Feed (ipm)	7.6	7.6	12.6	10.1	11.0		
CAST IRONS Gray, Malleable, Ductile ≤ 220 Bhn or ≤ 19 HRc	Profile  ≤ 0.5 ≤ 1.5	365 (292-438)	RPM	5577	3718	2789	1859	1394		
			Fz	0.0008	0.0015	0.0020	0.0024	0.0028		
			Feed (ipm)	13.4	16.7	22.3	17.8	19.5		
	Slot  1 ≤ 1	295 (236-354)	RPM	4508	3005	2254	1503	1127		
			Fz	0.0008	0.0015	0.0020	0.0024	0.0028		
			Feed (ipm)	10.8	13.5	18.0	14.4	15.8		

Bhn (Brinell) HRc (Rockwell C)
 rpm = (Vc x 3.82) / DC
 ipm = Fz x number of flutes x rpm
 reduce speed and feed for materials harder than listed
 refer to the SGS Tool Wizard® for complete technical information (www.kyocera-sgstool.com)

Single End Roughers (Fine Pitch)



Series	62 Fractional	Hardness	Ae x DC	Ap x DC	Vc (sfm)	DC • in						
						1/4	3/8	1/2	3/4	1		
M	STAINLESS STEELS (FREE MACHINING) 303, 416, 420F, 430F, 440F	≤ 275 Bhn or ≤ 28 HRc	Profile 	≤ 0.5	≤ 1.5	405	RPM	6188	4126	3094	2063	1547
						(324-486)	Fz	0.0006	0.0011	0.0015	0.0019	0.0021
							Feed (ipm)	11.1	13.6	18.6	15.7	19.5
						325	RPM	4966	3311	2483	1655	1242
						(260-390)	Fz	0.0006	0.0011	0.0015	0.0019	0.0021
							Feed (ipm)	8.9	10.9	14.9	12.6	15.6
	STAINLESS STEELS (DIFFICULT) 304, 304L, 316, 316L, 17-4PH, 15-5PH, 13-4PH, Custom 450	≤ 275 Bhn or ≤ 28 HRc	Profile 	≤ 0.5	≤ 1.5	280	RPM	4278	2852	2139	1426	1070
						(224-336)	Fz	0.0005	0.0009	0.0012	0.0015	0.0017
							Feed (ipm)	6.4	7.7	10.3	8.6	10.9
						225	RPM	3438	2292	1719	1146	860
						(180-270)	Fz	0.0005	0.0009	0.0012	0.0015	0.0017
							Feed (ipm)	5.2	6.2	8.3	6.9	8.8
S	HIGH TEMP ALLOYS (NICKEL, COBALT, IRON BASE) Inconel 601, 617, 625, Incoloy 800, Monel 400, Rene, Waspalloy	≤ 300 Bhn or ≤ 32 HRc	Profile 	≤ 0.5	≤ 1.5	70	RPM	1070	713	535	357	267
						(56-84)	Fz	0.0004	0.0008	0.0010	0.0013	0.0014
							Feed (ipm)	1.3	1.7	2.1	1.9	2.2
						56	RPM	856	570	428	285	214
						(45-67)	Fz	0.0004	0.0008	0.0010	0.0013	0.0014
							Feed (ipm)	1.0	1.4	1.7	1.5	1.8
	TITANIUM ALLOYS Ti6Al4V, Ti6Al2Sn4Zr2Mo, Ti4Al4Mo2Sn0.5Si, Ti10V2Fe3Al, Ti5Al53Mo3Cr, Ti7Al4Mo, Ti3Al8V6Cr4Zr4Mo, Ti6Al6V6Sn, Ti152 Cr3Sn3Al	≤ 350 Bhn or ≤ 38 HRc	Profile 	≤ 0.5	≤ 1.5	155	RPM	2368	1579	1184	789	592
						(124-186)	Fz	0.0005	0.0009	0.0012	0.0015	0.0017
							Feed (ipm)	3.6	4.3	5.7	4.7	6.0
						195	RPM	2980	1986	1490	993	745
						(156-234)	Fz	0.0005	0.0009	0.0012	0.0015	0.0017
							Feed (ipm)	4.5	5.4	7.2	6.0	7.6

Bhn (Brinell) HRc (Rockwell C)
 rpm = (Vc x 3.82) / DC
 ipm = Fz x number of flutes x rpm
 reduce speed and feed for materials harder than listed
 refer to the SGS Tool Wizard® for complete technical information (www.kyocera-sgstool.com)

METRIC

2 Flute: Square, Double, Stub, Long Reach, Ball

3 Flute: Square, Long Reach, Ball

4 Flute: Square, Double, Stub, Long Reach, Ball, Corner Radius

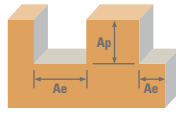

Series
1M, 3M, 5M,
14M, 15M, 16M,
17M, 59M
Metric

Series	Hardness	Flutes	Ae x DC	Ap x DC	Vc (m/min)	DC • mm										
						0.4	0.75	1.5	3	6	10	12	20	25		
P CARBON STEELS 1018, 1040, 1080, 1090, 10L50, 1140, 1212, 12L15, 1525, 1536	≤ 175 Bhn or ≤ 7 HRc	Profile	2	≤ 0.50	≤ 1.5	140	RPM	111483	59458	29729	14864	7432	4459	3716	2230	1784
							Fz	0.0008	0.0015	0.0031	0.007	0.019	0.040	0.048	0.064	0.070
							Feed (mm/min)	178	178	184	208	282	357	357	285	250
		Slot	2	1	≤ 1	102	RPM	81189	43301	21650	10825	5413	3248	2706	1624	1299
							Fz	0.0008	0.0015	0.0031	0.007	0.019	0.040	0.048	0.064	0.070
							Feed (mm/min)	130	130	134	152	206	260	260	208	182
	≤ 275 Bhn or ≤ 28 HRc	Profile	2	≤ 0.50	≤ 1.5	75	RPM	81189	43301	21650	10825	5413	3248	2706	1624	1299
							Fz	0.0005	0.0012	0.0022	0.006	0.014	0.029	0.036	0.048	0.052
							Feed (mm/min)	81	104	95	130	152	188	195	156	135
		Slot	2	1	≤ 1	75	RPM	59377	31668	15834	7917	3958	2375	1979	1188	950
							Fz	0.0005	0.0012	0.0022	0.006	0.014	0.029	0.036	0.048	0.052
							Feed (mm/min)	59	76	70	95	111	138	143	114	99
M TOOL STEELS A2, D2, H13, L2, M2, P20, S7, T15, W2	≤ 250 Bhn or ≤ 24 HRc	Profile	2	≤ 0.50	≤ 1.5	96	RPM	76342	40715	20358	10179	5089	3054	2545	1527	1221
							Fz	0.0005	0.0012	0.0022	0.006	0.014	0.029	0.036	0.048	0.052
							Feed (mm/min)	76	98	90	122	143	177	183	147	127
		Slot	2	1	≤ 1	70	RPM	55741	29729	14864	7432	3716	2230	1858	1115	892
							Fz	0.0005	0.0012	0.0022	0.006	0.014	0.029	0.036	0.048	0.052
							Feed (mm/min)	56	71	65	89	104	129	134	107	93
	≤ 275 Bhn or ≤ 28 HRc	Profile	2	≤ 0.50	≤ 1.5	113	RPM	89671	47825	23912	11956	5978	3587	2989	1793	1435
							Fz	0.0005	0.0012	0.0022	0.006	0.014	0.029	0.036	0.048	0.052
							Feed (mm/min)	90	115	105	143	167	208	215	172	149
		Slot	2	1	≤ 1	82	RPM	65436	34899	17449	8725	4362	2617	2181	1309	1047
							Fz	0.0005	0.0012	0.0022	0.006	0.014	0.029	0.036	0.048	0.052
							Feed (mm/min)	65	84	77	105	122	152	157	126	109
≤ 275 Bhn or ≤ 28 HRc	Profile	2	≤ 0.50	≤ 1.5	78	RPM	61800	32960	16480	8240	4120	2472	2060	1236	989	
						Fz	0.0005	0.0010	0.0019	0.004	0.012	0.024	0.029	0.037	0.042	
						Feed (mm/min)	62	66	63	66	99	119	119	91	83	
	Slot	2	1	≤ 1	56	RPM	44836	23912	11956	5978	2989	1793	1495	897	717	
						Fz	0.0005	0.0010	0.0019	0.004	0.012	0.024	0.029	0.037	0.042	
						Feed (mm/min)	45	48	45	48	72	86	87	66	60	
K CAST IRONS Gray, Malleable, Ductile	≤ 220 Bhn or ≤ 19 HRc	Profile	2	≤ 0.50	≤ 1.5	102	RPM	81189	43301	21650	10825	5413	3248	2706	1624	1299
							Fz	0.0008	0.0015	0.0031	0.007	0.019	0.040	0.048	0.064	0.070
							Feed (mm/min)	130	130	134	152	206	260	260	208	182
		Slot	2	1	≤ 1	75	RPM	59377	31668	15834	7917	3958	2375	1979	1188	950
							Fz	0.0008	0.0015	0.0031	0.007	0.019	0.040	0.048	0.064	0.070
							Feed (mm/min)	95	95	98	111	150	190	190	152	133

continued on next page

2 Flute: Square, Double, Stub, Long Reach, Ball 3 Flute: Square, Long Reach, Ball 4 Flute: Square, Double, Stub, Long Reach, Ball, Corner Radius

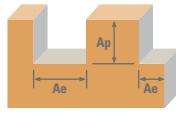

Series
1M, 3M, 5M,
14M, 15M, 16M,
17M, 59M
Metric

Series	Hardness	Flutes	Ae x DC	Ap x DC	Vc (m/min)	DC • mm										
						0.4	0.75	1.5	3	6	10	12	20	25		
ALUMINUM ALLOYS 2017, 2024, 356, 6061, 7075	≤ 150 Bhn or ≤ 88 HRc	Profile			268	RPM	213272	113745	56872	28436	14218	8531	7109	4265	3412	
					(215-322)	Fz	0.0015	0.0032	0.0060	0.014	0.038	0.080	0.096	0.128	0.140	
			2	≤ 0.50	≤ 1.5	Feed (mm/min)	640	728	682	796	1081	1365	1365	1092	955	
		3	≤ 0.25	≤ 1.5	RPM	155107	82724	41362	20681	10340	6204	5170	3102	2482		
				(156-234)	Fz	0.0015	0.0032	0.0060	0.014	0.038	0.080	0.096	0.128	0.140		
		2	1	≤ 1	Feed (mm/min)	465	529	496	579	786	993	993	794	695		
				3	1	≤ 0.5	698	794	745	869	1179	1489	1489	1191	1042	
	COPPER ALLOYS Alum Bronze, C110, Muntz Brass	≤ 140 Bhn or ≤ 3 HRc	Profile			148	RPM	117542	62689	31344	15672	7836	4702	3918	2351	1881
						(118-177)	Fz	0.0008	0.0015	0.0031	0.007	0.019	0.040	0.048	0.064	0.070
				2	≤ 0.50	≤ 1.5	Feed (mm/min)	188	188	194	219	298	376	376	301	263
			3	≤ 0.25	≤ 1.5	RPM	282	282	292	329	447	564	564	451	395	
						4	≤ 0.25	≤ 1.5	376	376	389	439	596	752	752	602
				RPM	84824	45239	22620	11310	5655	3393	2827	1696	1357			
			Fz	0.0008	0.0015	0.0031	0.007	0.019	0.040	0.048	0.064	0.070				
			2	1	≤ 1	Feed (mm/min)	136	136	140	158	215	271	271	190		
			3	1	≤ 0.5	204	204	210	238	322	407	407	326	285		
			4	1	≤ 0.4	271	271	280	317	430	543	543	434	380		
PLASTICS Polycarbonate, PVC, Polypropylene			Profile			268	RPM	213272	113745	56872	28436	14218	8531	7109	4265	3412
						(215-322)	Fz	0.0015	0.0032	0.0060	0.014	0.038	0.080	0.096	0.128	0.140
	2			≤ 0.50	≤ 1.5	Feed (mm/min)	640	728	682	796	1081	1365	1365	1092	955	
	3		≤ 0.25	≤ 1.5	RPM	960	1092	1024	1194	1621	2047	2047	1638	1433		
				4	≤ 0.25	≤ 1.5	1280	1456	1365	1592	2161	2730	2730	2184	1911	
				RPM	155107	82724	41362	20681	10340	6204	5170	3102	2482			
				Fz	0.0015	0.0032	0.0060	0.014	0.038	0.080	0.096	0.128	0.140			
				2	1	≤ 1	Feed (mm/min)	465	529	496	579	786	993	993	794	695
				3	1	≤ 0.5	698	794	745	869	1179	1489	1489	1191	1042	
				4	1	≤ 0.4	931	1059	993	1158	1572	1985	1985	1588	1392	
	GRAPHITE		Profile			201	RPM	159954	85309	42654	21327	10664	6398	5332	3199	2559
						(161-241)	Fz	0.0015	0.0032	0.0060	0.014	0.038	0.080	0.096	0.128	0.140
2				≤ 0.50	≤ 1.5	Feed (mm/min)	480	546	512	597	810	1024	1024	819	717	
3			≤ 0.25	≤ 1.5	RPM	720	819	768	896	1216	1536	1536	1228	1075		
				4	≤ 0.25	≤ 1.5	960	1092	1024	1194	1621	2047	2047	1638	1433	
				RPM	116330	62043	31021	15511	7755	4653	3878	2327	1861			
			Fz	0.0015	0.0032	0.0060	0.014	0.038	0.080	0.096	0.128	0.140				
			2	1	≤ 1	Feed (mm/min)	349	397	372	434	589	745	745	596	521	
			3	1	≤ 0.5	523	596	558	651	884	1117	1117	893	782		
			4	1	≤ 0.4	698	794	745	869	1179	1489	1489	1191	1042		
HIGH TEMP ALLOYS (NICKEL, COBALT, IRON BASE) Inconel 601, 617, 625, 718, Incoloy 800, Monel 400, Rene, Waspalloy		≤ 300 Bhn or ≤ 32 HRc	Profile			20	RPM	15753	8402	4201	2100	1050	630	525	315	252
						(16-24)	Fz	0.0005	0.0007	0.0014	0.004	0.010	0.021	0.024	0.032	0.035
	2			≤ 0.50	≤ 1.5	Feed (mm/min)	16	12	12	17	21	26	25	20	18	
	3		≤ 0.25	≤ 1.5	RPM	24	18	18	25	32	40	38	30	26		
				4	≤ 0.25	≤ 1.5	32	24	24	34	42	53	50	40	35	
				RPM	10906	5816	2908	1454	727	436	364	218	174			
				Fz	0.0005	0.0007	0.0014	0.004	0.010	0.021	0.024	0.032	0.035			
				2	1	≤ 1	Feed (mm/min)	11	8	8	12	15	18	17	14	12
				3	1	≤ 0.5	16	12	12	17	22	27	26	21	18	
				4	1	≤ 0.4	22	16	16	23	29	37	35	28	24	
	TITANIUM ALLOYS Ti6Al4V, Ti6Al2Sn4Zr2Mo, Ti4Al4Mo2Sn0.5Si, Ti10V2Fe3Al, Ti5Al53Mo3Cr, Ti7Al4Mo, Ti3Al8V6Cr4Zr4Mo, Ti6Al6V6Sn, Ti152 Cr3Sn3Al	≤ 350 Bhn or ≤ 38 HRc	Profile			55	RPM	43624	23266	11633	5816	2908	1745	1454	872	698
						(44-66)	Fz	0.0005	0.0010	0.0019	0.004	0.012	0.024	0.029	0.037	0.042
2				≤ 0.50	≤ 1.5	Feed (mm/min)	44	47	44	47	70	84	84	65	59	
3			≤ 0.25	≤ 1.5	RPM	65	70	66	70	105	126	127	97	88		
				4	≤ 0.25	≤ 1.5	87	93	88	93	140	168	169	129	117	
				RPM	31506	16803	8402	4201	2100	1260	1050	630	504			
			Fz	0.0005	0.0010	0.0019	0.004	0.012	0.024	0.029	0.037	0.042				
			2	1	≤ 1	Feed (mm/min)	32	34	32	34	50	60	61	47	42	
			3	1	≤ 0.5	47	50	48	50	76	91	91	70	64		
			4	1	≤ 0.4	63	67	64	67	101	121	122	93	85		

Bhn (Brinell) HRc (Rockwell C)
rpm = (Vc x 1000) / (DC x 3.14)
mm/min = Fz x number of flutes x rpm
reduce speed and feed for materials harder than listed

limit cut depths of long and extra long flute mills to .05 x DC when slotting or profiling
reduce feed and Ae when finish milling (.02 x DC maximum)
refer to the SGS Tool Wizard® for complete technical information
www.kyocera-sgstool.com

2 Flute: High Shear 4 Flute: High Shear

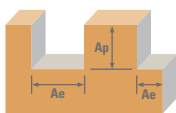

Series 52M, 54M Metric	Hardness	Flutes	Ae x DC	Ap x DC	Vc (m/min)	DC • mm									
						3	6	10	12	20	25				
ALUMINUM ALLOYS 2024, 5052, 5086, 6061, 6063, 7075	≤ 150 Bhn or ≤ 88 HRb	Profile 	2	≤ 0.3	≤ 1.5	415	RPM	43947	21973	13184	10987	6592	5274		
						(332-497)	Fz	0.0166	0.043	0.091	0.110	0.147	0.160		
		4	≤ 0.3	≤ 1.5	332	RPM	35222	17611	10567	8806	5283	4227			
						Feed (mm/min)	1459	1890	2399	2417	1938	1688			
		Slot 	2	1	≤ 1	(266-399)	Fz	0.0151	0.041	0.085	0.101	0.133	0.148		
							Feed (mm/min)	1064	1444	1796	1779	1405	1251		
		4	1	≤ 0.25	125	RPM	13249	6624	3975	3312	1987	1590			
						Fz	0.0151	0.041	0.085	0.101	0.133	0.148			
		ALUMINUM DIE CAST ALLOYS (HIGH SILICON) A-390, A-392, B-390	≤ 125 Bhn or ≤ 77 HRb	Profile 	2	≤ 0.3	≤ 1.5	155	RPM	16480	8240	4944	4120	2472	1978
								(124-187)	Fz	0.0166	0.043	0.091	0.110	0.147	0.160
4	≤ 0.3			≤ 1.5	125	RPM	13249	6624	3975	3312	1987	1590			
						Feed (mm/min)	547	709	900	906	727	633			
Slot 	2			1	≤ 1	(100-150)	Fz	0.0151	0.041	0.085	0.101	0.133	0.148		
							Feed (mm/min)	400	543	676	669	529	471		
4	1			≤ 0.25	180	RPM	19065	9533	5720	4766	2860	2288			
						Fz	0.0094	0.024	0.053	0.062	0.083	0.093			
COPPER ALLOYS Aluminum Bronze, Muntz Brass, Naval, Brass, Red Brass	≤ 140 Bhn or ≤ 3 HRc			Profile 	2	≤ 0.3	≤ 1.5	180	RPM	19065	9533	5720	4766	2860	2288
								(144-216)	Fz	0.0094	0.024	0.053	0.062	0.083	0.093
		4	≤ 0.3	≤ 1.5	145	RPM	15349	7675	4605	3837	2302	1842			
						Feed (mm/min)	358	458	606	591	475	426			
		Slot 	2	1	≤ 1	(116-174)	Fz	0.0086	0.024	0.048	0.058	0.077	0.085		
							Feed (mm/min)	264	368	442	445	355	313		
		4	1	≤ 0.25	72	RPM	7594	3797	2278	1898	1139	911			
						Fz	0.0094	0.024	0.053	0.062	0.083	0.093			
		COPPER ALLOYS Beryllium Copper, C110, Manganese Bronze, Tin Bronze	≤ 200 Bhn or ≤ 23 HRc	Profile 	2	≤ 0.3	≤ 1.5	72	RPM	7594	3797	2278	1898	1139	911
								(57-86)	Fz	0.0094	0.024	0.053	0.062	0.083	0.093
4	≤ 0.3			≤ 1.5	58	RPM	6140	3070	1842	1535	921	737			
						Feed (mm/min)	143	182	241	235	189	169			
Slot 	2			1	≤ 1	(46-69)	Fz	0.0086	0.024	0.048	0.058	0.077	0.085		
							Feed (mm/min)	106	147	177	178	142	125		
4	1			≤ 0.25	211	RPM	211	295	354	356	284	250			
						Fz	0.0086	0.024	0.048	0.058	0.077	0.085			

continued on next page

2 Flute: High Shear 4 Flute: High Shear

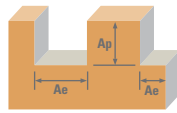

Series 52M, 54M Metric	Hardness	Flutes	Ae x DC	Ap x DC	Vc (m/min)	DC • mm								
						3	6	10	12	20	25			
PLASTICS ABS, Polycarbonate, PVC, Polypropylene	Profile	2	≤ 0.3	≤ 1.5	488	RPM	51702	25851	15511	12926	7755	6204		
					Fz	0.0264	0.072	0.149	0.178	0.237	0.250			
		4	≤ 0.3	≤ 1.5	(390-585)	Feed	2730	3723	4622	4601	3676	3102		
					(mm/min)	5460	7445	9244	9203	7352	6204			
		Slot	2	1	≤ 1	390	RPM	41362	20681	12409	10340	6204	4963	
						Fz	0.0240	0.065	0.136	0.163	0.210	0.238		
	4		1	≤ 0.25	(312-468)	Feed	1985	2689	3375	3371	2606	2363		
					(mm/min)	3971	5377	6750	6742	5212	4725			
	PLASTICS Fiberglass, Glass Filled		Profile	2	≤ 0.3	≤ 1.5	219	RPM	23266	11633	6980	5816	3490	2792
							Fz	0.0197	0.053	0.109	0.132	0.173	0.190	
		4		≤ 0.3	≤ 1.5	(176-263)	Feed	917	1233	1522	1536	1208	1061	
						(mm/min)	1833	2466	3043	3071	2415	2122		
Slot		2		1	≤ 1	175	RPM	18580	9290	5574	4645	2787	2230	
						Fz	0.0180	0.048	0.101	0.120	0.160	0.175		
		4	1	≤ 0.25	(140-210)	Feed	669	892	1126	1115	892	780		
					(mm/min)	1338	1784	2252	2230	1784	1561			

Bhn (Brinell) HRc (Rockwell C) HRb (Rockwell B)
 rpm = (Vc x 1000) / (DC x 3.14)
 mm/min = Fz x number of flutes x rpm
 reduce speed and feed for materials harder than listed
 reduce feed and Ae when finish milling (.02 x DC maximum)
 refer to the SGS Tool Wizard® for complete technical information (www.kyocera-sgstool.com)

Single End Roughers (Coarse Pitch)

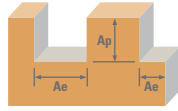



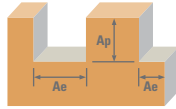

Series 61M Metric	Hardness	Ae x DC	Ap x DC	Vc (m/min)	DC • mm						
					6	10	12	20	25		
P	CARBON STEELS 1018, 1040, 1080, 1090, 10L50, 1140, 1212, 12L15, 1525, 1536	≤ 175 Bhn or ≤ 7 HRc	Profile ≤ 0.5	≤ 1.5	152	RPM	8078	4847	4039	2424	1939
					(122-183)	Fz	0.014	0.029	0.034	0.045	0.050
						Feed (mm/min)	339	422	549	436	485
					122	RPM	6463	3878	3231	1939	1551
					(98-146)	Fz	0.014	0.029	0.034	0.045	0.050
						Feed (mm/min)	271	337	439	349	388
	ALLOY STEELS 4140, 4150, 4320, 5120, 5150, 8630, 86L20, 50100	≤ 275 Bhn or ≤ 28 HRc	Profile ≤ 0.5	≤ 1.5	111	RPM	5897	3538	2949	1769	1415
					(89-134)	Fz	0.010	0.021	0.026	0.035	0.038
						Feed (mm/min)	177	223	307	248	269
					90	RPM	4766	2860	2383	1430	1144
					(72-108)	Fz	0.010	0.021	0.026	0.035	0.038
						Feed (mm/min)	143	180	248	200	217
TOOL STEELS A2, D2, H13, L2, M2, P20, S7, T15, W2	≤ 250 Bhn or ≤ 24 HRc	Profile ≤ 0.5	≤ 1.5	105	RPM	5574	3344	2787	1672	1338	
				(84-126)	Fz	0.014	0.024	0.036	0.048	0.053	
					Feed (mm/min)	234	241	401	321	355	
				84	RPM	4443	2666	2222	1333	1066	
				(67-101)	Fz	0.014	0.024	0.036	0.048	0.053	
					Feed (mm/min)	187	192	320	256	283	
K	CAST IRONS Gray, Malleable, Ductile	≤ 220 Bhn or ≤ 19 HRc	Profile ≤ 0.5	≤ 1.5	111	RPM	5897	3538	2949	1769	1415
					(89-134)	Fz	0.019	0.040	0.048	0.064	0.070
						Feed (mm/min)	336	425	566	453	495
					90	RPM	4766	2860	2383	1430	1144
					(72-108)	Fz	0.019	0.040	0.048	0.064	0.070
						Feed (mm/min)	272	343	458	366	400

Bhn (Brinell) HRc (Rockwell C)
 rpm = (Vc x 1000) / (DC x 3.14)
 mm/min = Fz x number of flutes x rpm
 reduce speed and feed for materials harder than listed
 refer to the SGS Tool Wizard® for complete technical information (www.kyocera-sgstool.com)

Single End Roughers (Fine Pitch)



Series 62M	Metric	Hardness	Ae x DC	Ap x DC	Vc (m/min)	DC • mm						
						6	10	12	20	25		
M	STAINLESS STEELS (FREE MACHINING) 303, 416, 420F, 430F, 440F	≤ 275 Bhn or ≤ 28 HRc	Profile 	≤ 0.5	≤ 1.5	123	RPM	6544	3926	3272	1963	1570
						(99-148)	Fz	0.014	0.029	0.036	0.051	0.053
							Feed (mm/min)	283	345	471	398	495
						99	RPM	5251	3151	2626	1575	1260
						(79-119)	Fz	0.014	0.029	0.036	0.051	0.053
							Feed (mm/min)	227	277	378	319	397
	STAINLESS STEELS (DIFFICULT) 304, 304L, 316, 316L, 17-4PH, 15-5PH, 13-4PH, Custom 450	≤ 275 Bhn or ≤ 28 HRc	Profile 	≤ 0.5	≤ 1.5	85	RPM	4524	2714	2262	1357	1086
						(68-102)	Fz	0.012	0.024	0.029	0.040	0.043
							Feed (mm/min)	163	195	261	217	277
						69	RPM	3635	2181	1818	1091	872
						(55-82)	Fz	0.012	0.024	0.029	0.040	0.043
							Feed (mm/min)	131	157	209	174	222
S	HIGH TEMP ALLOYS (NICKEL, COBALT, IRON BASE) Inconel 601, 617, 625, Incoloy 800, Monel 400, Rene, Waspalloy	≤ 300 Bhn or ≤ 32 HRc	Profile 	≤ 0.5	≤ 1.5	21	RPM	1131	679	565	339	271
						(17-26)	Fz	0.010	0.021	0.024	0.035	0.035
							Feed (mm/min)	33	43	54	47	57
						17	RPM	905	543	452	271	217
						(14-20)	Fz	0.010	0.021	0.024	0.035	0.035
							Feed (mm/min)	26	35	43	38	46
	TITANIUM ALLOYS Ti6Al4V, Ti6Al2Sn4Zr2Mo, Ti4Al4Mo2Sn0.5Si, Ti10V2Fe3Al, Ti5Al53Mo3Cr, Ti7Al4Mo, Ti3Al8V6Cr4Zr4Mo, Ti6Al6V6Sn, Ti152 Cr3Sn3Al	≤ 350 Bhn or ≤ 38 HRc	Profile 	≤ 0.5	≤ 1.5	47	RPM	2504	1503	1252	751	601
						(38-57)	Fz	0.012	0.024	0.029	0.040	0.043
							Feed (mm/min)	90	108	144	120	153
						59	RPM	3151	1890	1575	945	756
						(48-71)	Fz	0.012	0.024	0.029	0.040	0.043
							Feed (mm/min)	113	136	181	151	193

Bhn (Brinell) HRc (Rockwell C)
 rpm = (Vc x 1000) / (DC x 3.14)
 mm/min = Fz x number of flutes x rpm
 reduce speed and feed for materials harder than listed
 refer to the SGS Tool Wizard® for complete technical information (www.kyocera-sgstool.com)

General Application Drills



Hole Making

GENERAL APPLICATION DRILLS	SERIES	DESCRIPTION	PAGE	S&F PAGE
2 Flute	101	2 Flute Slow Spiral	336	344
Short Length Self Centering (DIN6539)	108M Plus	2 Flute Short Length DIN 6539	341	346
Straight Flute	106	Straight Flute 140 Point Geometry	348	351
3 Flute with 150 Point Geometry	103	3 Flute 150 Point Geometry	352	356

GENERAL APPLICATION COUNTERSINKS	SERIES	DESCRIPTION	PAGE	S&F PAGE
Combined Drill & Countersink	301	2 Flute Straight Flute Combined Drill and Countersink Fractional	358	361
	301M	2 Flute Straight Flute Combined Drill and Countersink Metric	358	362
Single Flute Countersink	601	Single Flute Fractional	364	365
3 Flute Countersink	603	3 Flute Fractional	367	368
6 Flute Countersink	606	6 Flute Fractional	370	371

GENERAL APPLICATION REAMERS	SERIES	DESCRIPTION	PAGE	S&F PAGE
Straight Flute Accu-Reamer	200	Accu-Reamer	374	376
Straight Flute Reamer	201M	Metric Reamer	378	379

Speed & Feed Recommendations listed after each series

Taladrado

BROCAS DE USO GENERAL	SERIE	DESCRIPCIÓN	PÁGINA	S&F PÁGINA
2 filos	101	2 filos, espiral de avance lento	336	344
Autocentrante de longitud corta (DIN6539)	108M Plus	2 filos, longitud corta, DIN 6539	341	346
Filo recto	106	Filo recto, geometría de 140 puntos	348	351
3 filos con geometría de 150 puntos	103	3 filos, geometría de 150 puntos	352	356

BROCAS DE USO AVELLANADORES	SERIE	DESCRIPCIÓN	PÁGINA	S&F PÁGINA
Broca y avellanador combinados	301	2 filos, filo recto, broca y avellanador combinados, fraccional	358	361
	301M	2 filos, filo recto, broca y avellanador combinados, métrico	358	362
Avellanador de filo único	601	Filo único, fraccional	364	365
Avellanador de 3 filos	603	3 filos, fraccional	367	368
Avellanador de 6 filos	606	6 filos, fraccional	370	371

BROCAS DE USO ESCARIADORES	SERIE	DESCRIPCIÓN	PÁGINA	S&F PÁGINA
Escariador Accu de filo recto	200	Escariador Accu	374	376
Escariador de filo recto	201M	Escariador métrico	378	379

Recomendaciones de velocidades y avances mostradas tras cada serie

Outils de perçage

FORETS UNIVERSELS	SÈRIES	DESCRIPTION	PAGE	S&F PAGE
2 dents	101	2 dents à spirale lente	336	344
Court autocentrant (DIN 6539)	108M Plus	2 dents court DIN 6539	341	346
Denture droite	106	Denture droite à angle de pointe 140°	348	351
3 dents à angle de pointe 150°	103	3 dents à angle de pointe 150°	352	356

FORETS À FRAISER	SÈRIES	DESCRIPTION	PAGE	S&F PAGE
Foret et foret à fraiser combinés	301	2 dents denture droite foret et foret à fraiser combinés (fractionnel)	358	361
	301M	2 dents denture droite foret et foret à fraiser combinés (métrique)	358	362
Foret à fraiser à dent simple	601	Foret à dent simple (fractionnel)	364	365
Foret à fraiser 3 dents	603	3 dents (fractionnel)	367	368
Foret à fraiser 6 dents	606	6 dents (fractionnel)	370	371

FORETS À ALÉSOIRS	SÈRIES	DESCRIPTION	PAGE	S&F PAGE
Alésoir denture droite Accu-Reamer	200	Alésoir Accu-Reamer	374	376
Alésoir denture droite	201M	Alésoir (métrique)	378	379

Recommandations de vitesse et avance indiquées après chaque série

STANDARD-BOHRER	SERIE	BESCHREIBUNG	SEITE	S&F SEITE
2 Schneiden	101	2 Schneiden mit kleinem Spanwinkel	336	344
Kurze Bauform Selbstzentrierung (DIN 6539)	108M Plus	2 Schneiden Kurze Bauform DIN 6539	341	346
Gerade Schneiden	106	Gerade Schneiden Spitzengeometrie 140	348	351
3 Schneiden mit Spitzengeometrie 150	103	3 Schneiden Spitzengeometrie 150	352	356

STANDARD-BOHRER	SERIE	BESCHREIBUNG	SEITE	S&F SEITE
Senkbohrer	301	Zölliger Senkbohrer mit 2 geraden Schneiden	358	361
	301M	Metrischer Senkbohrer mit 2 geraden Schneiden	358	362
Senker mit 1 Schneide	601	Zölliger Bohrer mit 1 Schneide	364	365
Senkbohrer mit 1 Schneide	603	Zölliger Bohrer mit 3 Schneiden	367	368
Senkbohrer mit 6 Schneiden	606	Zölliger Bohrer mit 6 Schneiden	370	371

STANDARD-BOHRER	SERIE	BESCHREIBUNG	SEITE	S&F SEITE
Reibahlen mit gerader Schneide	200	Accu-Reamer	374	376
Reibahle mit gerader Schneide	201M	Metrische Reibahle	378	379

Empfehlungen für Drehzahl & Vorschub im Anhang zu jeder Serie

2 Flute Drills • Metric: DIN 338

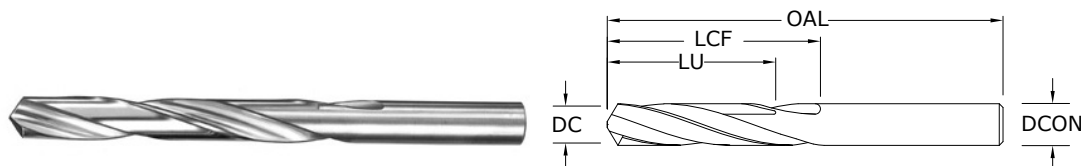
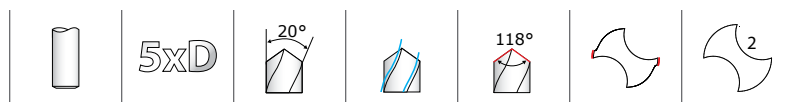

Pictured:
Series 101 Drill Set



101

FRACTIONAL & METRIC SERIES

DECIMAL DC/DCON	METRIC DC/DCON	inch & mm				USABLE LENGTH LU	EDP NO.	
		FRACTIONAL/ LETTER/WIRE DC	OVERALL LENGTH OAL	FLUTE LENGTH LCF	UNCOATED		Ti-NAMITE®-A (AITIN)	
0.0135	0,340 mm	#80	3/4	3/16	—	51080	57076	
0.0145	0,370 mm	#79	3/4	3/16	—	51079	57077	
0.0156	0,400 mm	1/64	3/4	3/16	—	51101	57078	
0.0160	0,410 mm	#78	3/4	3/16	—	51078	57079	
0.0180	0,460 mm	#77	3/4	3/16	—	51077	57080	
0.0200	0,510 mm	#76	7/8	1/4	—	51076	57081	
0.0210	0,530 mm	#75	7/8	1/4	—	51075	57082	
0.0225	0,570 mm	#74	7/8	1/4	—	51074	57083	
0.0240	0,610 mm	#73	7/8	1/4	—	51073	57084	
0.0250	0,640 mm	#72	1	5/16	—	51072	57085	
0.0260	0,660 mm	#71	1	5/16	—	51071	57086	
0.0276	0,700 mm		28,0	9,0	—	61001	68268	
0.0280	0,710 mm	#70	1-1/4	1/2	—	51070	57087	
0.0292	0,740 mm	#69	1-1/4	1/2	—	51069	57088	
0.0310	0,790 mm	#68	1-1/4	1/2	—	51068	57089	
0.0312	0,790 mm	1/32	1-1/4	1/2	—	51102	57090	
0.0315	0,800 mm		30,0	10,0	—	61003	68269	
0.0320	0,810 mm	#67	1-1/4	1/2	—	51067	57091	
0.0330	0,840 mm	#66	1-1/4	1/2	—	51066	57092	
0.0350	0,890 mm	#65	1-3/8	5/8	1/2	51065	57093	
0.0354	0,900 mm		32,0	11,0	8,0	61005	68270	
0.0360	0,910 mm	#64	1-3/8	5/8	1/2	51064	57094	
0.0370	0,940 mm	#63	1-3/8	5/8	1/2	51063	57095	
0.0380	0,970 mm	#62	1-3/8	5/8	1/2	51062	57096	
0.0390	0,990 mm	#61	1-3/8	5/8	1/2	51061	57097	
0.0394	1,000 mm		34,0	12,0	9,0	61007	68271	
0.0400	1,020 mm	#60	1-1/2	3/4	39/64	51060	57098	
0.0410	1,040 mm	#59	1-1/2	3/4	39/64	51059	57099	
0.0420	1,070 mm	#58	1-1/2	3/4	39/64	51058	57100	
0.0430	1,090 mm	#57	1-1/2	3/4	39/64	51057	57101	
0.0433	1,000 mm		36,0	14,0	11,0	61052	68294	
0.0465	1,180 mm	#56	1-1/2	3/4	39/64	51056	57102	
0.0469	1,190 mm	3/64	1-1/2	3/4	39/64	51103	57103	
0.0472	1,200 mm		38,0	16,0	12,0	61053	68295	
0.0512	1,300 mm		38,0	16,0	12,0	61054	68296	
0.0520	1,320 mm	#55	1-1/2	3/4	39/64	51055	57104	
0.0550	1,400 mm	#54	1-1/2	3/4	39/64	51054	57105	
0.0551	1,400 mm		40,0	18,0	14,0	61055	68297	
0.0591	1,500 mm		40,0	18,0	14,0	61009	68272	
0.0595	1,510 mm	#53	1-1/2	3/4	39/64	51053	57106	
0.0625	1,590 mm	*1/16	1-1/2	3/4	39/64	51104	57107	
0.0630	1,600 mm		43,0	20,0	16,0	61056	68298	
0.0635	1,610 mm	#52	1-1/2	3/4	39/64	51052	57108	
0.0669	1,700 mm		43,0	20,0	17,0	61057	68299	

TOLERANCES (inch)

DC = +0.0000/-0.0005

TOLERANCES (mm)

DC = +0.0000/-0.0127

- STEELS
- STAINLESS STEELS
- CAST IRON
- NON-FERROUS
- HIGH TEMP ALLOYS
- HARDENED STEELS

For patent information visit www.ksptpatents.com

continued on next page

2 Flute Drills • Metric: DIN 338

101

FRACTIONAL & METRIC SERIES

CONTINUED

DECIMAL DC/DCON	METRIC DC/DCON	inch & mm				EDP NO.	
		FRACTIONAL/ LETTER/WIRE DC	OVERALL LENGTH OAL	FLUTE LENGTH LCF	USABLE LENGTH LU	UNCOATED	TI-NAMITE®-A (AITIN)
0.0670	1,700 mm	#51	1-1/2	3/4	39/64	51051	57109
0.0700	1,780 mm	#50	1-3/4	7/8	45/64	51050	57110
0.0709	1,800 mm		46,0	22,0	17,0	61058	68300
0.0730	1,850 mm	#49	1-3/4	7/8	45/64	51049	57111
0.0748	1,900 mm		46,0	22,0	17,0	61059	68301
0.0760	1,930 mm	#48	1-3/4	7/8	45/64	51048	57112
0.0781	1,980 mm	5/64	1-3/4	7/8	45/64	51105	57113
0.0785	1,990 mm	#47	1-3/4	7/8	45/64	51047	57114
0.0787	2,000 mm		49,0	24,0	19,0	61011	68273
0.0810	2,060 mm	#46	1-3/4	7/8	45/64	51046	57115
0.0820	2,080 mm	#45	1-3/4	7/8	45/64	51045	57116
0.0827	2,100 mm		49,0	24,0	19,0	61060	68302
0.0860	2,180 mm	#44	2	1	51/64	51044	57117
0.0866	2,200 mm		53,0	27,0	21,0	61061	68303
0.0890	2,260 mm	#43	2	1	51/64	51043	57118
0.0906	2,300 mm		53,0	27,0	21,0	61062	68304
0.0935	2,370 mm	#42	2	1	51/64	51042	57119
0.0938	2,380 mm	3/32	2	1	51/64	51106	57120
0.0945	2,400 mm		57,0	30,0	24,0	61063	68305
0.0960	2,440 mm	#41	2	1	51/64	51041	57121
0.0980	2,490 mm	#40	2	1	51/64	51040	57122
0.0984	2,500 mm		57,0	30,0	24,0	61013	68274
0.0995	2,530 mm	#39	2-1/4	1-1/4	1	51039	57123
0.1015	2,580 mm	#38	2-1/4	1-1/4	1	51038	57124
0.1024	2,600 mm		57,0	30,0	24,0	61064	68306
0.1040	2,640 mm	#37	2-1/4	1-1/4	1	51037	57125
0.1063	2,700 mm		61,0	33,0	26,0	61065	68307
0.1065	2,710 mm	#36	2-1/4	1-1/4	1	51036	57126
0.1094	2,780 mm	7/64	2-1/4	1-1/4	1	51107	57127
0.1100	2,790 mm	#35	2-1/4	1-1/4	1	51035	57128
0.1102	2,800 mm		61,0	33,0	26,0	61066	68308
0.1110	2,820 mm	#34	2-1/4	1-1/4	1	51034	57129
0.1130	2,870 mm	#33	2-1/4	1-1/4	1	51033	57130
0.1142	2,900 mm		61,0	33,0	26,0	61067	68309
0.1160	2,950 mm	#32	2-1/4	1-1/4	1	51032	57131
0.1181	3,000 mm		61,0	33,0	26,0	61015	68275
0.1200	3,050 mm	#31	2-1/4	1-1/4	1	51031	57132
0.1220	3,100 mm		65,0	36,0	28,0	61068	68310
0.1250	3,180 mm	*1/8	2-1/4	1-1/4	1	51108	57133
0.1260	3,200 mm		65,0	36,0	28,0	61069	68311
0.1285	3,260 mm	#30	2-1/4	1-1/4	1	51030	57134
0.1299	3,300 mm		65,0	36,0	28,0	61070	68312
0.1339	3,400 mm		70,0	39,0	31,0	61071	68313
0.1360	3,450 mm	#29	2-1/2	1-3/8	1-7/64	51029	57135
0.1378	3,500 mm		70,0	39,0	31,0	61017	68276
0.1405	3,570 mm	#28	2-1/2	1-3/8	1-7/64	51028	57136
0.1406	3,570 mm	9/64	2-1/2	1-3/8	1-7/64	51109	57137
0.1417	3,600 mm		70,0	39,0	31,0	61072	68314
0.1440	3,660 mm	#27	2-1/2	1-3/8	1-7/64	51027	57138
0.1457	3,700 mm		70,0	39,0	31,0	61073	68315
0.1470	3,730 mm	#26	2-1/2	1-3/8	1-7/64	51026	57139
0.1495	3,800 mm	#25	2-1/2	1-3/8	1-7/64	51025	57140
0.1496	3,800 mm		75,0	43,0	34,0	61074	68316
0.1520	3,860 mm	#24	2-1/2	1-3/8	1-7/64	51024	57141

continued on next page

2 Flute Drills • Metric: DIN 338



5xD

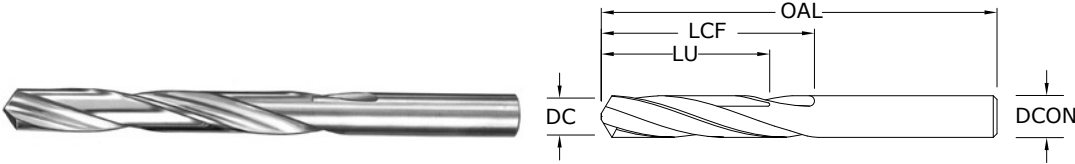

Pictured:
Series 101 Drill Set



101

FRACTIONAL & METRIC SERIES

CONTINUED

DECIMAL DC/DCON	METRIC DC/DCON	inch & mm				EDP NO.	
		FRACTIONAL/ LETTER/WIRE DC	OVERALL LENGTH OAL	FLUTE LENGTH LCF	USABLE LENGTH LU	UNCOATED	Ti-NAMITE®-A (AITIN)
0.1535	3,900 mm		75,0	43,0	34,0	61075	68317
0.1540	3,910 mm	#23	2-1/2	1-3/8	1-7/64	51023	57142
0.1562	3,970 mm	5/32	2-1/2	1-3/8	1-7/64	51110	57143
0.1570	3,990 mm	#22	2-1/2	1-3/8	1-7/64	51022	57144
0.1575	4,000 mm		75,0	43,0	34,0	61019	68277
0.1590	4,040 mm	#21	2-1/2	1-3/8	1-7/64	51021	57145
0.1610	4,090 mm	#20	2-1/2	1-3/8	1-7/64	51020	57146
0.1614	4,100 mm		75,0	43,0	34,0	61076	68318
0.1654	4,200 mm		75,0	43,0	34,0	61077	68319
0.1660	4,220 mm	#19	2-3/4	1-5/8	1-19/64	51019	57147
0.1693	4,300 mm		80,0	47,0	37,0	61078	68320
0.1695	4,310 mm	#18	2-3/4	1-5/8	1-19/64	51018	57148
0.1719	4,370 mm	11/64	2-3/4	1-5/8	1-19/64	51111	57149
0.1730	4,390 mm	#17	2-3/4	1-5/8	1-19/64	51017	57150
0.1732	4,400 mm		80,0	47,0	37,0	61079	68321
0.1770	4,500 mm	#16	2-3/4	1-5/8	1-19/64	51016	57151
0.1772	4,500 mm		80,0	47,0	37,0	61021	68278
0.1800	4,570 mm	#15	2-3/4	1-5/8	1-19/64	51015	57152
0.1811	4,600 mm		80,0	47,0	37,0	61080	68322
0.1820	4,620 mm	#14	2-3/4	1-5/8	1-19/64	51014	57153
0.1850	4,700 mm		80,0	47,0	37,0	61081	68323
0.1850	4,700 mm	#13	2-3/4	1-5/8	1-19/64	51013	57154
0.1875	4,760 mm	*3/16	2-3/4	1-5/8	1-19/64	51112	57155
0.1890	4,800 mm		86,0	52,0	41,0	61082	68324
0.1890	4,800 mm	#12	2-3/4	1-5/8	1-19/64	51012	57156
0.1910	4,850 mm	#11	2-3/4	1-5/8	1-19/64	51011	57157
0.1929	4,900 mm		86,0	52,0	41,0	61083	68325
0.1935	4,910 mm	#10	2-3/4	1-5/8	1-19/64	51010	57158
0.1960	4,980 mm	#9	3	1-3/4	1-13/32	51009	57159
0.1969	5,000 mm		86,0	52,0	41,0	61023	68279
0.1990	5,050 mm	#8	3	1-3/4	1-13/32	51008	57160
0.2008	5,010 mm		86,0	52,0	41,0	61084	68326
0.2010	5,110 mm	#7	3	1-3/4	1-13/32	51007	57161
0.2031	5,160 mm	13/64	3	1-3/4	1-13/32	51113	57162
0.2040	5,180 mm	#6	3	1-3/4	1-13/32	51006	57163
0.2047	5,200 mm		86,0	52,0	41,0	61085	68327
0.2055	5,220 mm	#5	3	1-3/4	1-13/32	51005	57164
0.2087	5,300 mm		86,0	52,0	41,0	61086	68328
0.2090	5,310 mm	#4	3	1-3/4	1-13/32	51004	57165
0.2126	5,400 mm		93,0	57,0	45,0	61087	68329
0.2130	5,410 mm	#3	3	1-3/4	1-13/32	51003	57166
0.2165	5,500 mm		93,0	57,0	1-13/32	61025	68280
0.2188	5,560 mm	7/32	3	1-3/4	1-13/32	51114	57167
0.2205	5,600 mm		93,0	57,0	45,0	61088	68330

continued on next page

TOLERANCES (inch)

DC = +0.0000/-0.0005

TOLERANCES (mm)

DC = +0,0000/-0,0127

- STEELS
- STAINLESS STEELS
- CAST IRON
- NON-FERROUS
- HIGH TEMP ALLOYS
- HARDENED STEELS

For patent information visit
www.ksptpatents.com

2 Flute Drills • Metric: DIN 338

101

FRACTIONAL & METRIC SERIES

CONTINUED

DECIMAL DC/DCON	METRIC DC/DCON	inch & mm				EDP NO.	
		FRACTIONAL/ LETTER/WIRE DC	OVERALL LENGTH OAL	FLUTE LENGTH LCF	USABLE LENGTH LU	UNCOATED	Ti-NAMITE®-A (AITiN)
0.2210	5,610 mm	#2	3	1-3/4	1-13/32	51002	57168
0.2244	5,700 mm		93,0	57,0	45,0	61089	68331
0.2280	5,790 mm	#1	3	1-3/4	1-13/32	51001	57169
0.2283	5,800 mm		93,0	57,0	45,0	61090	68332
0.2323	5,900 mm		93,0	57,0	45,0	61091	68333
0.2340	5,940 mm	A	3-1/4	2	1-39/64	51201	57170
0.2344	5,950 mm	15/64	3-1/4	2	1-39/64	51115	57171
0.2362	6,000 mm		93,0	57,0	45,0	61027	68281
0.2380	6,050 mm	B	3-1/4	2	1-39/64	51202	57172
0.2402	6,100 mm		101,0	63,0	50,0	61092	68334
0.2420	6,150 mm	C	3-1/4	2	1-39/64	51203	57173
0.2441	6,200 mm		101,0	63,0	50,0	61093	68335
0.2460	6,250 mm	D	3-1/4	2	1-39/64	51204	57174
0.2480	6,300 mm		101,0	63,0	50,0	61094	68336
0.2500	6,350 mm	*1/4	3-1/4	2	1-39/64	51116	57176
0.2520	6,400 mm		101,0	63,0	50,0	61095	68337
0.2559	6,500 mm		101,0	63,0	50,0	61029	68282
0.2570	6,530 mm	F	3-1/4	2	1-39/64	51206	57177
0.2598	6,600 mm		101,0	63,0	50,0	61096	68338
0.2610	6,630 mm	G	3-1/2	2-1/8	1-45/64	51207	57178
0.2638	6,700 mm		101,0	63,0	50,0	61097	68339
0.2656	6,750 mm	17/64	3-1/2	2-1/8	1-45/64	51117	57179
0.2660	6,760 mm	H	3-1/2	2-1/8	1-45/64	51208	57180
0.2677	6,800 mm		109,0	69,0	55,0	61098	68340
0.2717	6,900 mm		109,0	69,0	55,0	61099	68341
0.2720	6,910 mm	I	3-1/2	2-1/8	1-45/64	51209	57181
0.2756	7,000 mm		109,0	69,0	55,0	61031	68283
0.2770	7,040 mm	J	3-1/2	2-1/8	1-45/64	51210	57182
0.2795	7,100 mm		109,0	69,0	55,0	61100	68342
0.2810	7,140 mm	K	3-1/2	2-1/8	1-45/64	51211	57183
0.2812	7,140 mm	9/32	3-1/2	2-1/8	1-45/64	51118	57184
0.2835	7,200 mm		109,0	69,0	55,0	61101	68343
0.2874	7,300 mm		109,0	69,0	55,0	61102	68344
0.2900	7,370 mm	L	3-1/2	2-1/8	1-45/64	51212	57185
0.2913	7,400 mm		109,0	69,0	55,0	61103	68345
0.2950	7,490 mm	M	3-3/4	2-3/8	1-29/32	51213	57186
0.2953	7,500 mm		109,0	69,0	55,0	61033	68284
0.2969	7,540 mm	19/64	3-3/4	2-3/8	1-29/32	51119	57187
0.2992	7,600 mm		117,0	75,0	60,0	61104	68346
0.3020	7,670 mm	N	3-3/4	2-3/8	1-29/32	51214	57188
0.3031	7,700 mm		117,0	75,0	60,0	61105	68347
0.3071	7,800 mm		117,0	75,0	60,0	61106	68348
0.3110	7,900 mm		117,0	75,0	60,0	61107	68349
0.3125	7,940 mm	*5/16	3-3/4	2-3/8	1-29/32	51120	57189
0.3150	8,000 mm		117,0	75,0	60,0	61035	68285
0.3160	8,030 mm	O	3-3/4	2-3/8	1-29/32	51215	57190
0.3189	8,100 mm		117,0	75,0	60,0	61108	68350
0.3228	8,200 mm		117,0	75,0	60,0	61109	68351
0.3230	8,200 mm	P	3-3/4	2-3/8	1-29/32	51216	57191
0.3268	8,300 mm		117,0	75,0	60,0	61110	68352
0.3281	8,330 mm	21/64	4	2-1/2	2	51121	57192
0.3307	8,400 mm		117,0	75,0	60,0	61111	68353
0.3320	8,430 mm	Q	4	2-1/2	2	51217	57193
0.3346	8,500 mm		117,0	75,0	60,0	61037	68286

continued on next page

2 Flute Drills • Metric: DIN 338



5xD



Pictured:
Series 101 Drill Set

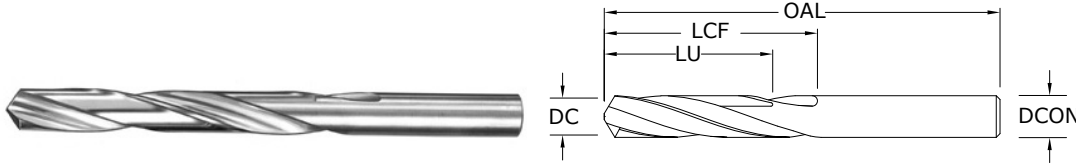

101

FRACTIONAL & METRIC SERIES

CONTINUED

DECIMAL DC/DCON	METRIC DC/DCON	FRACTIONAL/ LETTER/WIRE DC	inch & mm			EDP NO.	
			OVERALL LENGTH OAL	FLUTE LENGTH LCF	USABLE LENGTH LU	UNCOATED	TI-NAMITE®-A (AITiN)
0.3386	8,600 mm		125,0	81,0	64,0	61112	68354
0.3390	8,610 mm	R	4	2-1/2	2	51218	57194
0.3425	8,700 mm		125,0	81,0	64,0	61113	68355
0.3438	8,730 mm	11/32	4	2-1/2	2	51122	57195
0.3465	8,800 mm		125,0	81,0	64,0	61114	68356
0.3480	8,840 mm	S	4	2-1/2	2	51219	57196
0.3504	8,900 mm		125,0	81,0	64,0	61115	68357
0.3543	9,000 mm		125,0	81,0	64,0	61039	68287
0.3580	9,090 mm	T	4-1/4	2-3/4	2-13/64	51220	57197
0.3583	9,100 mm		125,0	81,0	64,0	61116	68358
0.3594	9,130 mm	23/64	4-1/4	2-3/4	2-13/64	51123	57198
0.3622	9,200 mm		125,0	81,0	64,0	61117	68359
0.3661	9,300 mm		125,0	81,0	64,0	61118	68360
0.3680	9,350 mm	U	4-1/4	2-3/4	2-13/64	51221	57199
0.3701	9,400 mm		125,0	81,0	64,0	61119	68361
0.3740	9,500 mm		125,0	81,0	64,0	61041	68288
0.3750	9,530 mm	*3/8	4-1/4	2-3/4	2-13/64	51124	57200
0.3770	9,580 mm	V	4-1/4	2-3/4	2-13/64	51222	57201
0.3780	9,600 mm		133,0	87,0	69,0	61120	68362
0.3819	9,700 mm		133,0	87,0	69,0	61121	68363
0.3858	9,800 mm		133,0	87,0	69,0	61122	68364
0.3860	9,800 mm	W	4-1/2	2-7/8	2-19/64	51223	57202
0.3898	9,900 mm		133,0	87,0	69,0	61123	68365
0.3906	9,920 mm	25/64	4-1/2	2-7/8	2-19/64	51125	57203
0.3937	10,000 mm		133,0	87,0	69,0	61043	68289
0.3970	10,080 mm	X	4-1/2	2-7/8	2-19/64	51224	57204
0.4016	10,010 mm		133,0	87,0	69,0	61124	68366
0.4040	10,260 mm	Y	4-1/2	2-7/8	2-19/64	51225	57205
0.4062	10,320 mm	13/32	4-1/2	2-7/8	2-19/64	51126	57206
0.4130	10,490 mm	Z	4-1/2	2-7/8	2-19/64	51226	57207
0.4134	10,500 mm		133,0	87,0	69,0	61045	68290
0.4219	10,720 mm	27/64	4-1/2	2-7/8	2-19/64	51127	57208
0.4331	11,000 mm		142,0	94,0	75,0	61047	68291
0.4375	11,110 mm	7/16	4-1/2	2-7/8	2-19/64	51128	57209
0.4528	11,500 mm		142,0	94,0	75,0	61049	68292
0.4531	11,510 mm	29/64	4-3/4	3	2-13/32	51129	57210
0.4688	11,910 mm	15/32	4-3/4	3	2-13/32	51130	57211
0.4724	12,000 mm		151,0	101,0	80,0	61051	68293
0.4844	12,300 mm	31/64	4-3/4	3	2-13/32	51131	57212
0.5000	12,700 mm	1/2	4-3/4	3	2-13/32	51132	57213
*Series 101 Set						61175	57351

TOLERANCES (inch)

DC = +0.0000/-0.0005

TOLERANCES (mm)

DC = +0.0000/-0.0127

- STEELS
- STAINLESS STEELS
- CAST IRON
- NON-FERROUS
- HIGH TEMP ALLOYS
- HARDENED STEELS

For patent information visit
www.ksptpatents.com

Short Length Self Centering Drills • DIN 6539

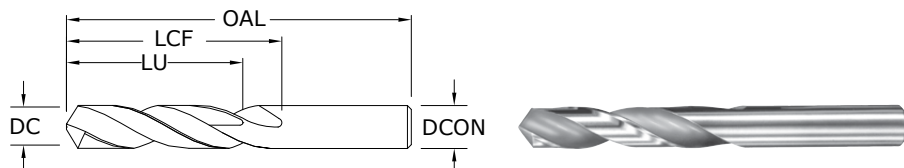
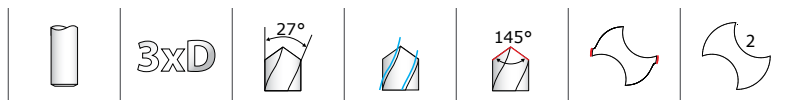

108M Plus
METRIC SERIES

TOLERANCES (mm)

≤3 DIAMETER
DC = +0,000/-0,010
DCON = h₆

>3-6 DIAMETER
DC = +0,000/-0,012
DCON = h₆

>6-10 DIAMETER
DC = +0,000/-0,015
DCON = h₆

>10-16 DIAMETER
DC = +0,000/-0,018
DCON = h₆

- STEELS
- STAINLESS STEELS
- CAST IRON
- NON-FERROUS
- HIGH TEMP ALLOYS
- HARDENED STEELS

For patent information visit www.ksptpatents.com

mm						EDP NO.	
DECIMAL DC/DCON	METRIC DC/DCON	LETTER/WIRE DC	OVERALL LENGTH OAL	FLUTE LENGTH LCF	USABLE LENGTH LU	UNCOATED	Ti-NAMITE®-A (AlTiN)
0.0197	0,500 mm		20,0	3,0	—	62001	68643
0.0217	0,550 mm		21,0	3,5	—	62003	68644
0.0236	0,600 mm		21,0	3,5	—	62005	68645
0.0256	0,650 mm		22,0	4,0	—	62007	68646
0.0276	0,700 mm		23,0	4,5	—	62009	68647
0.0295	0,750 mm		23,0	4,5	—	62011	68648
0.0315	0,800 mm		24,0	5,0	—	62013	68649
0.0335	0,850 mm		24,0	5,0	—	62015	68650
0.0354	0,900 mm		25,0	5,5	4,0	62017	68651
0.0374	0,950 mm		25,0	5,5	4,0	62019	68652
0.0394	1,000 mm		26,0	6,0	4,7	62021	68653
0.0413	1,050 mm		26,0	6,0	4,7	62023	68654
0.0433	1,100 mm		28,0	7,0	5,4	62025	68655
0.0453	1,150 mm		28,0	7,0	5,4	62027	68656
0.0472	1,200 mm		28,0	7,0	5,4	62029	68657
0.0492	1,250 mm		30,0	8,0	6,0	62031	68658
0.0512	1,300 mm		30,0	8,0	6,0	62033	68659
0.0531	1,350 mm		32,0	9,0	7,0	62035	68660
0.0551	1,400 mm		32,0	9,0	7,0	62037	68661
0.0571	1,450 mm		32,0	9,0	7,0	62039	68662
0.0591	1,500 mm		32,0	9,0	7,0	62041	68663
0.0630	1,600 mm		34,0	10,0	7,0	62043	68664
0.0669	1,700 mm		34,0	10,0	7,0	62045	68665
0.0709	1,800 mm		36,0	11,0	8,0	62047	68666
0.0748	1,900 mm		36,0	11,0	8,0	62049	68667
0.0748	2,000 mm		38,0	12,0	9,0	62051	68668
0.0827	2,100 mm		38,0	12,0	9,0	62053	68669
0.0866	2,200 mm		40,0	13,0	10,0	62055	68670
0.0906	2,300 mm		40,0	13,0	10,0	62057	68671
0.0945	2,400 mm		43,0	14,0	11,0	62059	68672
0.0984	2,500 mm		43,0	14,0	11,0	62061	68673
0.1024	2,600 mm		43,0	14,0	11,0	62063	68674
0.1063	2,700 mm		46,0	16,0	12,0	62065	68675
0.1102	2,800 mm		46,0	16,0	12,0	62067	68676

continued on next page

Short Length Self Centering Drills • DIN 6539



3xD



108M Plus

METRIC SERIES

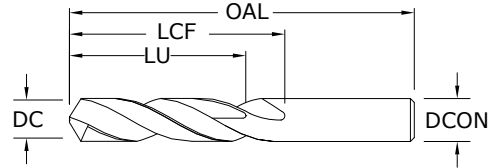

CONTINUED

			mm			EDP NO.	
DECIMAL DC/DCON	METRIC DC/DCON	LETTER/WIRE DC	OVERALL LENGTH OAL	FLUTE LENGTH LCF	USABLE LENGTH LU	UNCOATED	Ti-NAMITE®-A (AlTiN)
0.1142	2,900 mm		46,0	16,0	12,0	62069	68677
0.1181	3,000 mm		46,0	16,0	12,0	62071	68678
0.1220	3,100 mm		49,0	18,0	14,0	62073	68679
0.1260	3,200 mm		49,0	18,0	14,0	62075	68680
0.1299	3,300 mm		49,0	18,0	14,0	62077	68681
0.1339	3,400 mm		52,0	20,0	15,0	62079	68682
0.1378	3,500 mm		52,0	20,0	15,0	62081	68683
0.1417	3,600 mm		52,0	20,0	15,0	62083	68684
0.1457	3,700 mm		52,0	20,0	15,0	62085	68685
0.1496	3,800 mm		55,0	22,0	17,0	62087	68686
0.1535	3,900 mm		55,0	22,0	17,0	62089	68687
0.1575	4,000 mm		55,0	22,0	17,0	62091	68688
0.1614	4,100 mm		55,0	22,0	17,0	62093	68689
0.1654	4,200 mm		55,0	22,0	17,0	62095	68690
0.1693	4,300 mm		58,0	24,0	18,0	62097	68691
0.1732	4,400 mm		58,0	24,0	18,0	62099	68692
0.1772	4,500 mm		58,0	24,0	18,0	62101	68693
0.1811	4,600 mm		58,0	24,0	18,0	62103	68694
0.1850	4,700 mm	#13	58,0	24,0	18,0	62105	68695
0.1890	4,800 mm	#12	62,0	26,0	20,0	62107	68696
0.1929	4,900 mm		62,0	26,0	20,0	62109	68697
0.1969	5,000 mm		62,0	26,0	20,0	62111	68698
0.2008	5,100 mm		62,0	26,0	20,0	62113	68699
0.2047	5,200 mm		62,0	26,0	20,0	62115	68700
0.2087	5,300 mm		62,0	26,0	20,0	62117	68701
0.2126	5,400 mm		66,0	28,0	21,0	62119	68702
0.2165	5,500 mm		66,0	28,0	21,0	62121	68703
0.2205	5,600 mm		66,0	28,0	21,0	62123	68704
0.2244	5,700 mm		66,0	28,0	21,0	62125	68705
0.2283	5,800 mm		66,0	28,0	21,0	62127	68706
0.2323	5,900 mm		66,0	28,0	21,0	62129	68707
0.2362	6,000 mm		66,0	28,0	21,0	62131	68708

TOLERANCES (mm)

≤3 DIAMETER

DC = +0,000/-0,010
DCON = h₆

>3-6 DIAMETER

DC = +0,000/-0,012
DCON = h₆

>6-10 DIAMETER

DC = +0,000/-0,015
DCON = h₆

>10-16 DIAMETER

DC = +0,000/-0,018
DCON = h₆

- STEELS
- STAINLESS STEELS
- CAST IRON
- NON-FERROUS
- HIGH TEMP ALLOYS
- HARDENED STEELS

For patent information visit www.ksptpatents.com

continued on next page

Short Length Self Centering Drills • DIN 6539

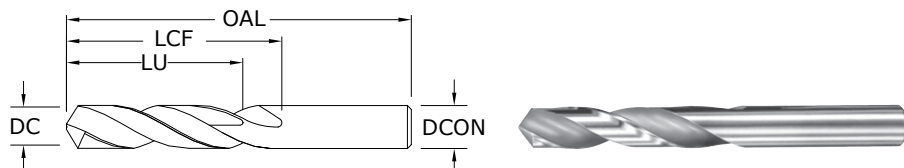
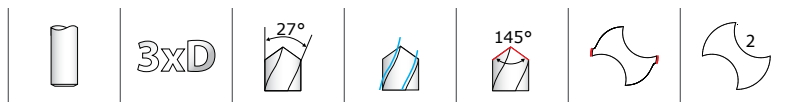

108M Plus
METRIC SERIES

TOLERANCES (mm)

≤3 DIAMETER
DC = +0,000/-0,010
DCON = h_6

>3-6 DIAMETER
DC = +0,000/-0,012
DCON = h_6

>6-10 DIAMETER
DC = +0,000/-0,015
DCON = h_6

>10-16 DIAMETER
DC = +0,000/-0,018
DCON = h_6

- STEELS
- STAINLESS STEELS
- CAST IRON
- NON-FERROUS
- HIGH TEMP ALLOYS
- HARDENED STEELS

For patent information visit www.ksptpatents.com

mm				EDP NO.		CONTINUED	
DECIMAL DC/DCON	METRIC DC/DCON	LETTER/WIRE DC	OVERALL LENGTH OAL	FLUTE LENGTH LCF	USABLE LENGTH LU	UNCOATED	Ti-NAMITE®-A (AlTiN)
0.2402	6,100 mm		70,0	31,0	23,0	62133	68709
0.2441	6,200 mm		70,0	31,0	23,0	62135	68710
0.2480	6,300 mm		70,0	31,0	23,0	62137	68711
0.2520	6,400 mm		70,0	31,0	23,0	62139	68712
0.2559	6,500 mm		70,0	31,0	23,0	62141	68713
0.2598	6,800 mm		70,0	31,0	23,0	62142	68603
0.2756	7,000 mm		74,0	34,0	25,0	62143	68718
0.2953	7,500 mm		74,0	34,0	25,0	62145	68723
0.3071	7,800 mm		79,0	37,0	27,0	62146	68604
0.3150	8,000 mm		79,0	37,0	27,0	62147	68728
0.3346	8,500 mm		79,0	37,0	27,0	62149	68733
0.3543	9,000 mm		84,0	40,0	29,0	62151	68738
0.3740	9,500 mm		84,0	40,0	29,0	62153	68743
0.3858	9,800 mm		89,0	43,0	31,0	62154	68606
0.3937	10,000 mm		89,0	43,0	31,0	62155	68748
0.4016	10,200 mm		89,0	43,0	31,0	62156	68607
0.4134	10,500 mm		89,0	43,0	31,0	62066	68753
0.4331	11,000 mm		95,0	47,0	33,0	62157	68758
0.4528	11,500 mm		95,0	47,0	33,0	62084	68763
0.4646	11,800 mm		102,0	51,0	35,0	62158	68608
0.4724	12,000 mm		102,0	51,0	35,0	62159	68768
0.4921	12,500 mm		102,0	51,0	35,0	62102	68773
0.5118	13,000 mm		102,0	51,0	35,0	62112	68778
0.5433	13,800 mm		107,0	54,0	37,0	62164	68609
0.5512	14,000 mm		107,0	54,0	37,0	62116	68780
0.5709	14,500 mm		111,0	56,0	38,0	62166	68611
0.5827	14,800 mm		111,0	56,0	38,0	62167	68612
0.5906	15,000 mm		111,0	56,0	38,0	62168	68613
0.6221	15,800 mm		115,0	58,0	38,0	62170	68614
0.6299	16,000 mm		115,0	58,0	38,0	62171	68616

2 Flute Drills

Series 101 Fractional	Hardness	Vc (sfm)	DC • in								
			1/64	1/32	1/16	1/8	1/4	3/8	1/2		
CARBON STEELS 1018, 1040, 1080, 1090, 10L50, 1140, 1212, 12L15, 1525, 1536	≤ 175 Bhn or ≤ 7 HRc	265 (212-318)	RPM	64787	32394	16197	8098	4049	2699	2025	
			Fr	0.00021	0.0004	0.0008	0.0017	0.0033	0.0050	0.0067	
			Feed (ipm)	13.5	13.5	13.5	13.5	13.5	13.5	13.5	
	≤ 300 Bhn or ≤ 32 HRc	125 (100-150)	RPM	30560	15280	7640	3820	1910	1273	955	
			Fr	0.00020	0.0004	0.0008	0.0016	0.0031	0.0047	0.0063	
			Feed (ipm)	6.0	6.0	6.0	6.0	6.0	6.0	6.0	
	≤ 425 Bhn or ≤ 45 HRc	85 (68-102)	RPM	20781	10390	5195	2598	1299	866	649	
			Fr	0.00011	0.0002	0.0004	0.0008	0.0017	0.0025	0.0034	
			Feed (ipm)	2.2	2.2	2.2	2.2	2.2	2.2	2.2	
	P ALLOY STEELS 4140, 4150, 4320, 5120, 5150, 8630, 86L20, 50100	≤ 275 Bhn or ≤ 28 HRc	230 (184-276)	RPM	56230	28115	14058	7029	3514	2343	1757
				Fr	0.00019	0.0004	0.0007	0.0015	0.0030	0.0045	0.0060
				Feed (ipm)	10.5	10.5	10.5	10.5	10.5	10.5	10.5
≤ 375 Bhn or ≤ 40 HRc		145 (116-174)	RPM	35450	17725	8862	4431	2216	1477	1108	
			Fr	0.00019	0.0004	0.0007	0.0015	0.0030	0.0045	0.0060	
			Feed (ipm)	6.6	6.6	6.6	6.6	6.6	6.6	6.6	
≤ 425 Bhn or ≤ 45 HRc		60 (48-72)	RPM	14669	7334	3667	1834	917	611	458	
			Fr	0.00008	0.0002	0.0003	0.0007	0.0013	0.0020	0.0026	
			Feed (ipm)	1.2	1.2	1.2	1.2	1.2	1.2	1.2	
TOOL STEELS A2, D2, H13, L2, M2, P20, S7, T15, W2		≤ 250 Bhn or ≤ 24 HRc	85 (68-102)	RPM	20781	10390	5195	2598	1299	866	649
				Fr	0.00011	0.0002	0.0004	0.0009	0.0018	0.0027	0.0035
				Feed (ipm)	2.3	2.3	2.3	2.3	2.3	2.3	2.3
	≤ 375 Bhn or ≤ 40 HRc	55 (44-66)	RPM	13446	6723	3362	1681	840	560	420	
			Fr	0.00005	0.0001	0.0002	0.0004	0.0008	0.0012	0.0017	
			Feed (ipm)	0.7	0.7	0.7	0.7	0.7	0.7	0.7	
M STAINLESS STEELS (FREE MACHINING) 303, 416, 420F, 430F 440F	≤ 250 Bhn or ≤ 24 HRc	210 (168-252)	RPM	51341	25670	12835	6418	3209	2139	1604	
			Fr	0.00015	0.0003	0.0006	0.0012	0.0024	0.0036	0.0048	
			Feed (ipm)	7.7	7.7	7.7	7.7	7.7	7.7	7.7	
	≤ 330 Bhn or ≤ 36 HRc	110 (88-132)	RPM	26893	13446	6723	3362	1681	1121	840	
			Fr	0.00009	0.0002	0.0004	0.0007	0.0015	0.0022	0.0030	
			Feed (ipm)	2.5	2.5	2.5	2.5	2.5	2.5	2.5	
	STAINLESS STEELS (DIFFICULT) 304, 316, 321, 13-8 PH, 15-5PH, 17-4 PH, Custom 450	≤ 275 Bhn or ≤ 28 HRc	65 (52-78)	RPM	15891	7946	3973	1986	993	662	497
				Fr	0.00010	0.0002	0.0005	0.0009	0.0018	0.0025	0.0035
				Feed (ipm)	1.7	1.7	1.7	1.7	1.7	1.7	1.7
		≤ 375 Bhn or ≤ 40 HRc	55 (44-66)	RPM	13446	6723	3362	1681	840	560	420
				Fr	0.00010	0.0002	0.0004	0.0008	0.0015	0.0023	0.0031
				Feed (ipm)	1.3	1.3	1.3	1.3	1.3	1.3	1.3
K CAST IRONS Gray, Malleable, Ductile	≤ 220 Bhn or ≤ 19 HRc	280 (224-336)	RPM	68454	34227	17114	8557	4278	2852	2139	
			Fr	0.00026	0.0005	0.0010	0.0020	0.0041	0.0061	0.0082	
			Feed (ipm)	17.5	17.5	17.5	17.5	17.5	17.5	17.5	
	≤ 330 Bhn or ≤ 36 HRc	250 (200-300)	RPM	61120	30560	15280	7640	3820	2547	1910	
			Fr	0.00025	0.0005	0.0010	0.0020	0.0041	0.0061	0.0081	
			Feed (ipm)	15.5	15.5	15.5	15.5	15.5	15.5	15.5	

continued on next page

FRACTIONAL 2 Flute Drills

Series 101 Fractional	Hardness	Vc (sfm)	DC • in								
			1/64	1/32	1/16	1/8	1/4	3/8	1/2		
N ALUMINUM ALLOYS 2017, 2024, 356, 6061, 7075	≤ 80 Bhn or ≤ 47 HRb	540	RPM	132019	66010	33005	16502	8251	5501	4126	
		(432-648)	Fr	0.00030	0.0006	0.0012	0.0024	0.0048	0.0073	0.0097	
			Feed (ipm)	40.0	40.0	40.0	40.0	40.0	40.0	40.0	
	≤ 150 Bhn or ≤ 88 HRb	455	RPM	111238	55619	27810	13905	6952	4635	3476	
		(364-546)	Fr	0.00031	0.0006	0.0013	0.0025	0.0050	0.0076	0.0101	
			Feed (ipm)	35.0	35.0	35.0	35.0	35.0	35.0	35.0	
	COPPER ALLOYS Alum Bronze, C110, Muntz Brass	≤ 140 Bhn or ≤ 3 HRc	190	RPM	46451	23226	11613	5806	2903	1935	1452
			(152-228)	Fr	0.00015	0.0003	0.0006	0.0012	0.0024	0.0036	0.0048
				Feed (ipm)	7.0	7.0	7.0	7.0	7.0	7.0	7.0
		≤ 200 Bhn or ≤ 23 HRc	175	RPM	42784	21392	10696	5348	2674	1783	1337
			(140-210)	Fr	0.00015	0.0003	0.0006	0.0012	0.0024	0.0036	0.0048
				Feed (ipm)	6.4	6.4	6.4	6.4	6.4	6.4	6.4
PLASTICS Polycarbonate, PVC	500 (400-600)	RPM	122240	61120	30560	15280	7640	5093	3820		
		Fr	0.00031	0.0006	0.0012	0.0025	0.0050	0.0075	0.0099		
		Feed (ipm)	38.0	38.0	38.0	38.0	38.0	38.0	38.0		
S HIGH TEMP ALLOYS (NICKEL, COBALT, IRON BASE) Inconel 601, 617, 625, Incoloy 800, Monel 400, Rene, Waspaloy	≤ 220 Bhn or ≤ 19 HRc	40	RPM	9779	4890	2445	1222	611	407	306	
		(32-48)	Fr	0.00010	0.0002	0.0004	0.0008	0.0016	0.0025	0.0033	
			Feed (ipm)	1.0	1.0	1.0	1.0	1.0	1.0	1.0	
	≤ 320 Bhn or ≤ 34 HRc	25	RPM	6112	3056	1528	764	382	255	191	
		(20-30)	Fr	0.00010	0.0002	0.0004	0.0008	0.0016	0.0024	0.0031	
			Feed (ipm)	0.6	0.6	0.6	0.6	0.6	0.6	0.6	
	≤ 425 Bhn or ≤ 45 HRc	20	RPM	4890	2445	1222	611	306	204	153	
		(16-24)	Fr	0.00004	0.0001	0.0002	0.0003	0.0007	0.0010	0.0013	
			Feed (ipm)	0.2	0.2	0.2	0.2	0.2	0.2	0.2	
	TITANIUM ALLOYS (DIFFICULT) Pure Titanium, Ti6Al4V, Ti6Al2Sn4Zr2Mo, Ti4Al4Mo2Sn0.5Si, Ti-6Al4V	≤ 275 Bhn or ≤ 28 HRc	85	RPM	20781	10390	5195	2598	1299	866	649
			(68-102)	Fr	0.00020	0.0004	0.0008	0.0016	0.0032	0.0049	0.0065
				Feed (ipm)	4.2	4.2	4.2	4.2	4.2	4.2	4.2
≤ 350 Bhn or ≤ 38 HRc		65	RPM	15891	7946	3973	1986	993	662	497	
		(52-78)	Fr	0.00011	0.0002	0.0004	0.0009	0.0017	0.0026	0.0034	
			Feed (ipm)	1.7	1.7	1.7	1.7	1.7	1.7	1.7	
≤ 440 Bhn or ≤ 47 HRc	55	RPM	13446	6723	3362	1681	840	560	420		
	(44-66)	Fr	0.00010	0.0002	0.0004	0.0008	0.0015	0.0023	0.0031		
		Feed (ipm)	1.3	1.3	1.3	1.3	1.3	1.3	1.3		
H TOOL STEELS A2, D2, H13, L2, M2, P20, S7, T15, W2	≤ 475 Bhn or ≤ 50 HRc	40	RPM	9779	4890	2445	1222	611	407	306	
		(32-48)	Fr	0.00005	0.0001	0.0002	0.0004	0.0008	0.0012	0.0016	
			Feed (ipm)	0.5	0.5	0.5	0.5	0.5	0.5	0.5	

Bhn (Brinell) HRc (Rockwell C) HRb (Rockwell B)
 $rpm = Vc \times 3.82 / DC$
 $ipm = Fr \times rpm$
 reduce speed and feed 30 percent when using uncoated drills
 reduce speed and feed for materials harder than listed
 refer to the SGS Tool Wizard® for complete technical information (www.kyocera-sgstool.com)

2 Flute Drills

Short Length Self Centering Drills • DIN 6539

Series 101M, 108M Metric	Hardness	Vc (m/min)	DC • mm								
			1	3	6	8	10	12	16		
CARBON STEELS 1018, 1040, 1080, 1090, 10L50, 1140, 1212, 12L15, 1525, 1536	≤ 175 Bhn or ≤ 7 HRc	81	RPM	25690	8563	4282	3211	2569	2141	1606	
		(65-97)	Fr	0.014	0.041	0.082	0.109	0.136	0.163	0.218	
			Feed (mm/min)	350	350	350	350	350	350	350	
	≤ 300 Bhn or ≤ 32 HRc	38	RPM	12118	4039	2020	1515	1212	1010	757	
		(30-46)	Fr	0.012	0.036	0.072	0.096	0.120	0.144	0.191	
			Feed (mm/min)	145	145	145	145	145	145	145	
	≤ 425 Bhn or ≤ 45 HRc	26	RPM	8240	2747	1373	1030	824	687	515	
		(21-31)	Fr	0.007	0.020	0.040	0.053	0.067	0.080	0.107	
			Feed (mm/min)	55	55	55	55	55	55	55	
	ALLOY STEELS 4140, 4150, 4320, 5120, 5150, 8630, 86L20, 50100	≤ 275 Bhn or ≤ 28 HRc	70	RPM	22297	7432	3716	2787	2230	1858	1394
			(56-84)	Fr	0.012	0.036	0.073	0.097	0.121	0.145	0.194
				Feed (mm/min)	270	270	270	270	270	270	270
≤ 375 Bhn or ≤ 40 HRc		44	RPM	14057	4686	2343	1757	1406	1171	879	
		(35-53)	Fr	0.012	0.036	0.073	0.097	0.121	0.145	0.194	
			Feed (mm/min)	170	170	170	170	170	170	170	
≤ 425 Bhn or ≤ 45 HRc		18	RPM	5816	1939	969	727	582	485	364	
		(15-22)	Fr	0.005	0.015	0.030	0.040	0.050	0.060	0.080	
			Feed (mm/min)	29	29	29	29	29	29	29	
TOOL STEELS A2, D2, H13, L2, M2, P20, S7, T15, W2		≤ 250 Bhn or ≤ 24 HRc	26	RPM	8240	2747	1373	1030	824	687	515
			(21-31)	Fr	0.007	0.020	0.040	0.053	0.067	0.080	0.107
				Feed (mm/min)	55	55	55	55	55	55	55
	≤ 375 Bhn or ≤ 40 HRc	17	RPM	5332	1777	889	666	533	444	333	
		(13-20)	Fr	0.003	0.010	0.020	0.027	0.034	0.041	0.054	
			Feed (mm/min)	18	18	18	18	18	18	18	
STAINLESS STEELS (FREE MACHINING) 303, 416, 420F, 430F 440F	≤ 250 Bhn or ≤ 24 HRc	64	RPM	20358	6786	3393	2545	2036	1696	1272	
		(51-77)	Fr	0.010	0.029	0.059	0.079	0.098	0.118	0.157	
			Feed (mm/min)	200	200	200	200	200	200	200	
	≤ 330 Bhn or ≤ 36 HRc	34	RPM	10664	3555	1777	1333	1066	889	666	
		(27-40)	Fr	0.006	0.017	0.034	0.045	0.056	0.068	0.090	
			Feed (mm/min)	60	60	60	60	60	60	60	
	STAINLESS STEELS (DIFFICULT) 304, 316, 321, 13-8 PH, 15-5PH, 17-4 PH, Custom 450	≤ 275 Bhn or ≤ 28 HRc	20	RPM	6301	2100	1050	788	630	525	394
			(16-24)	Fr	0.007	0.021	0.043	0.057	0.071	0.086	0.114
				Feed (mm/min)	45	45	45	45	45	45	45
		≤ 375 Bhn or ≤ 40 HRc	17	RPM	5332	1777	889	666	533	444	333
			(13-20)	Fr	0.007	0.020	0.039	0.053	0.066	0.079	0.105
				Feed (mm/min)	35	35	35	35	35	35	35
CAST IRONS Gray, Malleable, Ductile	≤ 220 Bhn or ≤ 19 HRc	85	RPM	27144	9048	4524	3393	2714	2262	1696	
		(68-102)	Fr	0.016	0.049	0.097	0.130	0.162	0.195	0.259	
			Feed (mm/min)	440	440	440	440	440	440	440	
	≤ 330 Bhn or ≤ 36 HRc	76	RPM	24235	8078	4039	3029	2424	2020	1515	
		(61-91)	Fr	0.017	0.050	0.099	0.132	0.165	0.198	0.264	
			Feed (mm/min)	400	400	400	400	400	400	400	

continued on next page

2 Flute Drills

Short Length Self Centering Drills • DIN 6539

Series 101M, 108M Metric	Hardness	Vc (m/min)	DC • mm								
			1	3	6	8	10	12	16		
N ALUMINUM ALLOYS 2017, 2024, 356, 6061, 7075	≤ 80 Bhn or ≤ 47 HRb	165 (132-198)	RPM	52348	17449	8725	6544	5235	4362	3272	
			Fr	0.020	0.060	0.120	0.160	0.200	0.240	0.319	
			Feed (mm/min)	1045	1045	1045	1045	1045	1045	1045	
	≤ 150 Bhn or ≤ 88 HRb	139 (111-166)	RPM	44108	14703	7351	5514	4411	3676	2757	
			Fr	0.020	0.060	0.120	0.160	0.200	0.239	0.319	
			Feed (mm/min)	880	880	880	880	880	880	880	
	COPPER ALLOYS Alum Bronze, C110, Muntz Brass	≤ 140 Bhn or ≤ 3 HRc	58 (46-69)	RPM	18419	6140	3070	2302	1842	1535	1151
				Fr	0.010	0.030	0.060	0.080	0.100	0.121	0.161
				Feed (mm/min)	185	185	185	185	185	185	185
		≤ 200 Bhn or ≤ 23 HRc	53 (43-64)	RPM	16965	5655	2827	2121	1696	1414	1060
				Fr	0.010	0.030	0.060	0.080	0.100	0.120	0.160
				Feed (mm/min)	170	170	170	170	170	170	170
PLASTICS Polycarbonate, PVC	152 (122-183)	RPM	48471	16157	8078	6059	4847	4039	3029		
		Fr	0.020	0.060	0.120	0.160	0.200	0.240	0.320		
		Feed (mm/min)	970	970	970	970	970	970	970		
S HIGH TEMP ALLOYS (NICKEL, COBALT, IRON BASE) Inconel 601, 617, 625, Incoloy 800, Monel 400, Rene, Waspaloy	≤ 220 Bhn or ≤ 19 HRc	12 (10-15)	RPM	3878	1293	646	485	388	323	242	
			Fr	0.006	0.019	0.039	0.052	0.064	0.077	0.103	
			Feed (mm/min)	25	25	25	25	25	25	25	
	≤ 320 Bhn or ≤ 34 HRc	8 (6-9)	RPM	2424	808	404	303	242	202	151	
			Fr	0.006	0.019	0.037	0.050	0.062	0.074	0.099	
			Feed (mm/min)	15	15	15	15	15	15	15	
	≤ 425 Bhn or ≤ 45 HRc	6 (5-7)	RPM	1939	646	323	242	194	162	121	
			Fr	0.005	0.015	0.031	0.041	0.052	0.062	0.083	
			Feed (mm/min)	10	10	10	10	10	10	10	
	TITANIUM ALLOYS (DIFFICULT) Pure Titanium, Ti6Al4V, Ti6Al2Sn4Zr2Mo, Ti4Al4Mo2Sn0.5Si, Ti-6Al4V	≤ 275 Bhn or ≤ 28 HRc	26 (21-31)	RPM	8240	2747	1373	1030	824	687	515
				Fr	0.013	0.040	0.080	0.107	0.133	0.160	0.214
				Feed (mm/min)	110	110	110	110	110	110	110
≤ 350 Bhn or ≤ 38 HRc		20 (16-24)	RPM	6301	2100	1050	788	630	525	394	
			Fr	0.007	0.021	0.043	0.057	0.071	0.086	0.114	
			Feed (mm/min)	45	45	45	45	45	45	45	
≤ 440 Bhn or ≤ 47 HRc	17 (13-20)	RPM	5332	1777	889	666	533	444	333		
		Fr	0.007	0.020	0.039	0.053	0.066	0.079	0.105		
		Feed (mm/min)	35	35	35	35	35	35	35		
H TOOL STEELS A2, D2, H13, L2, M2, P20, S7, T15, W2	≤ 475 Bhn or ≤ 50 HRc	12 (10-15)	RPM	3878	1293	646	485	388	323	242	
			Fr	0.003	0.009	0.019	0.025	0.031	0.037	0.050	
			Feed (mm/min)	12	12	12	12	12	12	12	

Bhn (Brinell) HRc (Rockwell C) HRb (Rockwell B)
 $rpm = (Vc \times 1000) / (DC \times 3.14)$
 $mm/min = Fr \times rpm$
 reduce speed and feed 30 percent when using uncoated drills
 reduce speed and feed for materials harder than listed
 refer to the SGS Tool Wizard® for complete technical information (www.kyocera-sgstool.com)

Straight Flute Drills • Metric: DIN 6539



106

FRACTIONAL & METRIC SERIES

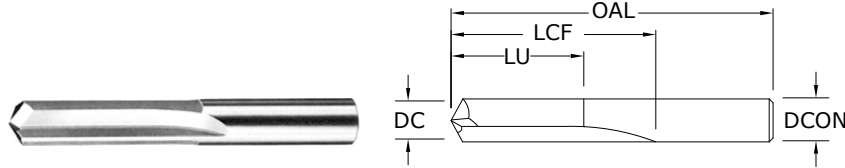

DECIMAL DC / DCON	METRIC DC / DCON	FRACTIONAL/ LETTER/WIRE DC	inch & mm			EDP NO.	
			OVERALL LENGTH OAL	FLUTE LENGTH LCF	USABLE LENGTH LU	UNCOATED	Ti-NAMITE [®] -A (AITIN)
0.0394	1,000 mm		26,0	6,0	4,5	66001	66002
0.0400	1,020 mm	#60	1-1/2	1/2	13/32	56060	56269
0.0410	1,040 mm	#59	1-1/2	1/2	13/32	56059	56268
0.0420	1,070 mm	#58	1-1/2	1/2	13/32	56058	56267
0.0430	1,090 mm	#57	1-1/2	1/2	13/32	56057	56266
0.0465	1,180 mm	#56	1-1/2	1/2	13/32	56056	56265
0.0469	1,190 mm	3/64	1-1/2	1/2	13/32	56103	56135
0.0520	1,320 mm	#55	1-1/2	1/2	13/32	56055	56264
0.0550	1,400 mm	#54	1-1/2	1/2	13/32	56054	56263
0.0591	1,500 mm		32,0	9,0	7,0	66003	66004
0.0595	1,510 mm	#53	1-1/2	1/2	13/32	56053	56262
0.0625	1,590 mm	1/16	1-1/2	5/8	1/2	56104	56136
0.0635	1,610 mm	#52	1-11/16	11/16	35/64	56052	56261
0.0670	1,700 mm	#51	1-11/16	11/16	35/64	56051	56260
0.0700	1,780 mm	#50	1-11/16	11/16	35/64	56050	56259
0.0730	1,850 mm	#49	1-11/16	11/16	35/64	56049	56258
0.0760	1,930 mm	#48	1-11/16	11/16	35/64	56048	56257
0.0781	1,980 mm	5/64	1-11/16	11/16	35/64	56105	56137
0.0785	1,990 mm	#47	1-3/4	3/4	39/64	56047	56256
0.0787	2,000 mm		38,0	12,0	9,0	66005	66006
0.0810	2,060 mm	#46	1-3/4	3/4	39/64	56046	56255
0.0820	2,080 mm	#45	1-3/4	3/4	39/64	56045	56254
0.0860	2,180 mm	#44	1-3/4	3/4	39/64	56044	56253
0.0890	2,260 mm	#43	1-3/4	3/4	39/64	56043	56252
0.0935	2,370 mm	#42	1-3/4	3/4	39/64	56042	56251
0.0938	2,380 mm	3/32	1-3/4	3/4	39/64	56106	56138
0.0960	2,440 mm	#41	1-13/16	13/16	21/32	56041	56250
0.0980	2,490 mm	#40	1-13/16	13/16	21/32	56040	56249
0.0984	2,500 mm		43,0	14,0	11,0	66007	66008
0.0995	2,530 mm	#39	1-13/16	13/16	21/32	56039	56248
0.1015	2,580 mm	#38	1-13/16	13/16	21/32	56038	56247
0.1040	2,640 mm	#37	1-13/16	13/16	21/32	56037	56246
0.1065	2,710 mm	#36	1-13/16	13/16	21/32	56036	56245
0.1094	2,780 mm	7/64	1-13/16	13/16	21/32	56107	56139
0.1100	2,790 mm	#35	1-7/8	7/8	45/64	56035	56244
0.1110	2,820 mm	#34	1-7/8	7/8	45/64	56034	56243

TOLERANCES (inch)

DC = +0.0000/-0.0005
DCON = h₆

TOLERANCES (mm)

DC = +0.0000/-0.0127
DCON = h₆

- STEELS
- CAST IRON
- HARDENED STEELS

For patent information visit www.kspatents.com

continued on next page

Straight Flute Drills • Metric: DIN 6539

106

FRACTIONAL & METRIC SERIES

CONTINUED

DECIMAL DC / DCON	METRIC DC / DCON	inch & mm				EDP NO.	
		FRACTIONAL/ LETTER/WIRE DC	OVERALL LENGTH OAL	FLUTE LENGTH LCF	USABLE LENGTH LU	UNCOATED	Ti-NAMITE®-A (AITiN)
0.1130	2,870 mm	#33	1-7/8	7/8	45/64	56033	56242
0.1160	2,950 mm	#32	1-7/8	7/8	45/64	56032	56241
0.1181	3,000 mm		46,0	16,0	12,0	66009	66010
0.1200	3,050 mm	#31	1-7/8	7/8	45/64	56031	56240
0.1250	3,180 mm	1/8	1-7/8	7/8	45/64	56108	56140
0.1285	3,260 mm	#30	1-15/16	15/16	3/4	56030	56239
0.1360	3,450 mm	#29	1-15/16	15/16	3/4	56029	56238
0.1378	3,500 mm		52,0	20,0	15,0	66011	66012
0.1405	3,570 mm	#28	1-15/16	15/16	3/4	56028	56237
0.1406	3,570 mm	9/64	1-15/16	15/16	3/4	56109	56141
0.1440	3,660 mm	#27	2-1/16	1	51/64	56027	56236
0.1470	3,730 mm	#26	2-1/16	1	51/64	56026	56235
0.1495	3,800 mm	#25	2-1/16	1	51/64	56025	56234
0.1520	3,860 mm	#24	2-1/16	1	51/64	56024	56233
0.1540	3,910 mm	#23	2-1/16	1	51/64	56023	56232
0.1562	3,970 mm	5/32	2-1/16	1	51/64	56110	56142
0.1570	3,990 mm	#22	2-1/8	1-1/16	55/64	56022	56231
0.1575	4,000 mm		55,0	22,0	17,0	66013	66014
0.1590	4,040 mm	#21	2-1/8	1-1/16	55/64	56021	56230
0.1610	4,090 mm	#20	2-1/8	1-1/16	55/64	56020	56229
0.1660	4,220 mm	#19	2-1/8	1-1/16	55/64	56019	56228
0.1695	4,310 mm	#18	2-1/8	1-1/16	55/64	56018	56227
0.1719	4,370 mm	11/64	2-1/8	1-1/16	55/64	56111	56143
0.1730	4,390 mm	#17	2-3/16	1-1/8	29/32	56017	56226
0.1770	4,500 mm	#16	2-3/16	1-1/8	29/32	56016	56225
0.1772	4,500 mm		58,0	24,0	18,0	66015	66016
0.1800	4,570 mm	#15	2-3/16	1-1/8	29/32	56015	56224
0.1820	4,620 mm	#14	2-3/16	1-1/8	29/32	56014	56223
0.1850	4,700 mm	#13	2-3/16	1-1/8	29/32	56013	56222
0.1875	4,760 mm	3/16	2-3/16	1-1/8	29/32	56112	56144
0.1890	4,800 mm	#12	2-3/16	1-1/8	29/32	56012	56221
0.1910	4,850 mm	#11	2-3/16	1-1/8	29/32	56011	56220
0.1935	4,910 mm	#10	2-3/16	1-1/8	29/32	56010	56219
0.1960	4,980 mm	#9	2-1/4	1-3/16	61/64	56009	56218
0.1969	5,000 mm		62,0	26,0	20,0	66017	66018
0.1990	5,050 mm	#8	2-1/4	1-3/16	61/64	56008	56217
0.2010	5,110 mm	#7	2-1/4	1-3/16	61/64	56007	56216
0.2031	5,160 mm	13/64	2-1/4	1-3/16	61/64	56113	56145
0.2040	5,180 mm	#6	2-3/8	1-1/4	1	56006	56215
0.2055	5,220 mm	#5	2-3/8	1-1/4	1	56005	56214
0.2090	5,310 mm	#4	2-3/8	1-1/4	1	56004	56213
0.2130	5,410 mm	#3	2-3/8	1-1/4	1	56003	56212
0.2165	5,500 mm		66,0	28,0	21,0	66019	66020
0.2188	5,560 mm	7/32	2-3/8	1-1/4	1	56114	56146
0.2210	5,610 mm	#2	2-7/16	1-5/16	1-3/64	56002	56211
0.2280	5,790 mm	#1	2-7/16	1-5/16	1-3/64	56001	56210

continued on next page

Straight Flute Drills • Metric: DIN 6539



3xD



106

FRACTIONAL & METRIC SERIES

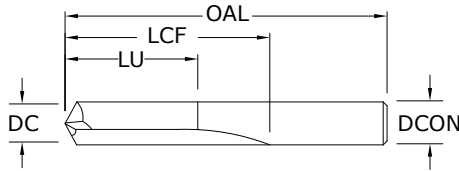

DECIMAL DC/DCON	METRIC DC/DCON	inch & mm				EDP NO.	
		FRACTIONAL/ LETTER/WIRE DC	OVERALL LENGTH OAL	FLUTE LENGTH LCF	USABLE LENGTH LU	UNCOATED	Ti-NAMITE®-A (AITiN)
0.2344	5,950 mm	15/64	2-7/16	1-5/16	1-3/64	56115	56147
0.2362	6,000 mm		66,0	28,0	21,0	66021	66045
0.2500	6,350 mm	1/4	2-1/2	1-3/8	1-7/64	56116	56148
0.2559	6,500 mm		70,0	31,0	23,0	66022	66046
0.2656	6,750 mm	17/64	2-5/8	1-7/16	1-7/64	56117	56149
0.2756	7,000 mm		74,0	34,0	25,0	66023	66024
0.2812	7,140 mm	9/32	2-11/16	1-1/2	1-13/64	56118	56150
0.2953	7,500 mm		74,0	34,0	25,0	66025	66026
0.2969	7,540 mm	19/64	2-3/4	1-9/16	1-1/4	56119	56151
0.3125	7,940 mm	5/16	2-13/16	1-5/8	1-19/64	56120	56152
0.3150	8,000 mm		79,0	37,0	27,0	66027	66028
0.3281	8,330 mm	21/64	2-15/16	1-11/16	1-23/64	56121	56153
0.3346	8,500 mm		79,0	37,0	27,0	66029	66030
0.3438	8,730 mm	11/32	3	1-11/16	1-23/64	56122	56154
0.3543	9,000 mm		84,0	40,0	29,0	66031	66032
0.3594	9,130 mm	23/64	3-1/16	1-3/4	1-13/32	56123	56155
0.3740	9,500 mm		84,0	40,0	29,0	66033	66034
0.3750	9,530 mm	3/8	3-1/8	1-13/16	1-29/64	56124	56156
0.3906	9,920 mm	25/64	3-1/4	1-7/8	1-1/2	56125	56157
0.3937	10,000 mm		89,0	43,0	31,0	66035	66036
0.4062	10,320 mm	13/32	3-5/16	1-15/16	1-35/64	56126	56158
0.4134	10,500 mm		89,0	43,0	31,0	66037	66038
0.4219	10,720 mm	27/64	3-3/8	2	1-39/64	56127	56159
0.4331	11,000 mm		95,0	47,0	33,0	66039	66040
0.4375	11,110 mm	7/16	3-7/16	2-1/16	1-21/32	56128	56160
0.4528	11,500 mm		95,0	47,0	33,0	66041	66042
0.4531	11,510 mm	29/64	3-9/16	2-1/8	1-45/64	56129	56161
0.4688	11,910 mm	15/32	3-5/8	2-1/8	1-45/64	56130	56162
0.4724	12,000 mm		102,0	51,0	35,0	66043	66044
0.4844	12,300 mm	31/64	3-11/16	2-3/16	1-3/4	56131	56163
0.5000	12,700 mm	1/2	3-3/4	2-1/4	1-51/64	56132	56164

TOLERANCES (inch)

DC = +0.0000/-0.0005
DCON = h₆

TOLERANCES (mm)

DC = +0,0000/-0,0127
DCON = h₆

- STEELS
- CAST IRON
- HARDENED STEELS

For patent information visit www.ksptpatents.com

FRACTIONAL & METRIC
Straight Flute Drills

Series 106 Fractional	Hardness	Vc (sfm)		DC • in						
				1/16	1/8	3/16	1/4	3/8	1/2	
P ALLOY STEELS 4140, 4150, 4320, 5120, 5150, 8630, 86L20, 50100	≤ 500 Bhn or ≤ 52 HRc	60 (48-72)	RPM	3667	1834	1222	917	611	458	
			Fr	0.0004	0.0007	0.0011	0.0014	0.0021	0.0028	
			Feed (ipm)	1.3	1.3	1.3	1.3	1.3	1.3	
	≤ 615 Bhn or ≤ 58 HRc	50 (40-60)	RPM	3056	1528	1019	764	509	382	
			Fr	0.0004	0.0008	0.0012	0.0016	0.0024	0.0031	
			Feed (ipm)	1.2	1.2	1.2	1.2	1.2	1.2	
	K CAST IRONS Gray, Malleable, Ductile	≤ 220 Bhn or ≤ 19 HRc	250 (200-300)	RPM	15280	7640	5093	3820	2547	1910
				Fr	0.0010	0.0020	0.0030	0.0041	0.0061	0.0081
				Feed (ipm)	15.5	15.5	15.5	15.5	15.5	15.5
≤ 330 Bhn or ≤ 36 HRc		195 (156-234)	RPM	11918	5959	3973	2980	1986	1490	
			Fr	0.0010	0.0020	0.0030	0.0040	0.0060	0.0081	
			Feed (ipm)	12.0	12.0	12.0	12.0	12.0	12.0	
H TOOL STEELS A2, D2, H13, L2, M2, P20, S7, T15, W2		≤ 500 Bhn or ≤ 52 HRc	60 (48-72)	RPM	3667	1834	1222	917	611	458
				Fr	0.0004	0.0007	0.0011	0.0014	0.0021	0.0028
				Feed (ipm)	1.3	1.3	1.3	1.3	1.3	1.3
	≤ 615 Bhn or ≤ 58 HRc	50 (40-60)	RPM	3056	1528	1019	764	509	382	
			Fr	0.0004	0.0008	0.0012	0.0016	0.0024	0.0031	
			Feed (ipm)	1.2	1.2	1.2	1.2	1.2	1.2	

Bhn (Brinell) HRc (Rockwell C)
 $rpm = Vc \times 3.82 / DC$
 $ipm = Fr \times rpm$
 reduce speed and feed 30 percent when using uncoated drills
 refer to the SGS Tool Wizard® for complete technical information (www.kyocera-sgstool.com)

Series 106M Metric	Hardness	Vc (m/min)		DC • mm						
				1	3	6	8	10	12	
P ALLOY STEELS 4140, 4150, 4320, 5120, 5150, 8630, 86L20, 50100	≤ 500 Bhn or ≤ 52 HRc	18 (15-22)	RPM	5816	1939	969	727	582	485	
			Fr	0.006	0.018	0.035	0.047	0.058	0.070	
			Feed (mm/min)	34	34	34	34	34	34	
	≤ 615 Bhn or ≤ 58 HRc	15 (12-18)	RPM	4847	1616	808	606	485	404	
			Fr	0.006	0.017	0.033	0.045	0.056	0.067	
			Feed (mm/min)	27	27	27	27	27	27	
	K CAST IRONS Gray, Malleable, Ductile	≤ 220 Bhn or ≤ 19 HRc	76 (61-91)	RPM	24235	8078	4039	3029	2424	2020
				Fr	0.016	0.048	0.096	0.128	0.160	0.192
				Feed (mm/min)	395	395	395	395	395	395
≤ 330 Bhn or ≤ 36 HRc		59 (48-71)	RPM	18904	6301	3151	2363	1890	1575	
			Fr	0.016	0.048	0.096	0.128	0.160	0.192	
			Feed (mm/min)	305	305	305	305	305	305	
H TOOL STEELS A2, D2, H13, L2, M2, P20, S7, T15, W2		≤ 500 Bhn or ≤ 52 HRc	18 (15-22)	RPM	5816	1939	969	727	582	485
				Fr	0.006	0.018	0.035	0.047	0.058	0.070
				Feed (mm/min)	34	34	34	34	34	34
	≤ 615 Bhn or ≤ 58 HRc	15 (12-18)	RPM	4847	1616	808	606	485	404	
			Fr	0.006	0.017	0.033	0.045	0.056	0.067	
			Feed (mm/min)	27	27	27	27	27	27	

Bhn (Brinell) HRc (Rockwell C)
 $rpm = (Vc \times 1000) / (DC \times 3.14)$
 $mm/min = Fr \times rpm$
 reduce speed and feed 30 percent when using uncoated drills
 refer to the SGS Tool Wizard® for complete technical information (www.kyocera-sgstool.com)

3 Flute Drills • Metric: DIN 6539



3xD
(mm)

5xD
(inch)



103

FRACTIONAL & METRIC SERIES

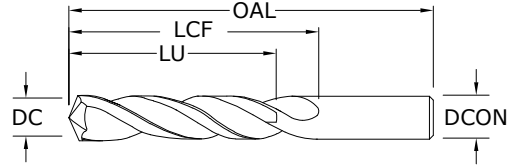

DECIMAL DC/DCON	METRIC DC/DCON	inch & mm				USABLE LENGTH LU	EDP NO.	
		FRACTIONAL/ LETTER/WIRE DC	OVERALL LENGTH OAL	FLUTE LENGTH LCF	UNCOATED		Ti-NAMITE®-A (AlTiN)	
0.1065	2,710 mm	#36	2-1/4	1-1/4	1	53036	58011	
0.1094	2,780 mm	7/64	2-1/4	1-1/4	1	53107	58012	
0.1100	2,790 mm	#35	2-1/4	1-1/4	1	53035	58013	
0.1110	2,820 mm	#34	2-1/4	1-1/4	1	53034	58014	
0.1130	2,870 mm	#33	2-1/4	1-1/4	1	53033	58015	
0.1160	2,950 mm	#32	2-1/4	1-1/4	1	53032	58016	
0.1181	3,000 mm		46,0	16,0	12,0	63000	68965	
0.1200	3,050 mm	#31	2-1/4	1-1/4	1	53031	58017	
0.1220	3,100 mm		49,0	18,0	14,0	63044	68966	
0.1250	3,180 mm	1/8	2-1/4	1-1/4	1	53108	58018	
0.1260	3,200 mm		49,0	18,0	14,0	63045	68967	
0.1285	3,260 mm	#30	2-1/4	1-1/4	1	53030	58019	
0.1299	3,300 mm		49,0	18,0	14,0	63001	68968	
0.1339	3,400 mm		52,0	20,0	15,0	63046	68969	
0.1360	3,450 mm	#29	2-1/2	1-3/8	1-7/64	53029	58020	
0.1378	3,500 mm		52,0	20,0	15,0	63002	68970	
0.1405	3,570 mm	#28	2-1/2	1-3/8	1-7/64	53028	58021	
0.1406	3,570 mm	9/64	2-1/2	1-3/8	1-7/64	53109	58022	
0.1417	3,600 mm		52,0	20,0	15,0	63047	68971	
0.1440	3,660 mm	#27	2-1/2	1-3/8	1-7/64	53027	58023	
0.1457	3,700 mm		52,0	20,0	15,0	63003	68972	
0.1470	3,730 mm	#26	2-1/2	1-3/8	1-7/64	53026	58024	
0.1495	3,800 mm	#25	2-1/2	1-3/8	1-7/64	53025	58025	
0.1496	3,800 mm		55,0	22,0	17,0	63048	68973	
0.1520	3,860 mm	#24	2-1/2	1-3/8	1-7/64	53024	58026	
0.1535	3,900 mm		55,0	22,0	17,0	63049	68974	
0.1540	3,910 mm	#23	2-1/2	1-3/8	1-7/64	53023	58027	
0.1562	3,970 mm	5/32	2-1/2	1-3/8	1-7/64	53110	58028	
0.1570	3,990 mm	#22	2-1/2	1-3/8	1-7/64	53022	58029	
0.1575	4,000 mm		55,0	22,0	17,0	63004	68975	
0.1590	4,040 mm	#21	2-1/2	1-3/8	1-7/64	53021	58030	
0.1610	4,090 mm	#20	2-1/2	1-3/8	1-7/64	53020	58031	
0.1614	4,100 mm		55,0	22,0	17,0	63050	68976	
0.1654	4,200 mm		55,0	22,0	17,0	63005	68977	
0.1660	4,220 mm	#19	2-3/4	1-5/8	1-19/64	53019	58032	
0.1693	4,300 mm		58,0	24,0	18,0	63051	68978	
0.1695	4,310 mm	#18	2-3/4	1-5/8	1-19/64	53018	58033	
0.1719	4,370 mm	11/64	2-3/4	1-5/8	1-19/64	53111	58034	
0.1730	4,390 mm	#17	2-3/4	1-5/8	1-19/64	53017	58035	
0.1732	4,400 mm		58,0	24,0	18,0	63052	68979	

TOLERANCES (inch)

DC = +0.0000/-0.0005
DCON = h₆

TOLERANCES (mm)

DC = +0.0000/-0.0127
DCON = h₆

STEELS

CAST IRON

NON-FERROUS

HARDENED STEELS

For patent information visit www.ksptpatents.com

continued on next page

3 Flute Drills • Metric: DIN 6539

103

FRACTIONAL & METRIC SERIES

DECIMAL DC / DCON	METRIC DC / DCON	inch & mm				EDP NO.	
		FRACTIONAL/ LETTER/WIRE DC	OVERALL LENGTH OAL	FLUTE LENGTH LCF	USABLE LENGTH LU	UNCOATED	Ti-NAMITE®-A (AITiN)
0.1770	4,500 mm	#16	2-3/4	1-5/8	1-19/64	53016	58036
0.1772	4,500 mm		58,0	24,0	18,0	63006	68980
0.1800	4,570 mm	#15	2-3/4	1-5/18	1-19/64	53015	58037
0.1811	4,600 mm		58,0	24,0	18,0	63053	68981
0.1820	4,620 mm	#14	2-3/4	1-5/8	1-19/64	53014	58038
0.1850	4,700 mm	#13	2-3/4	1-5/8	1-19/64	53013	58039
0.1850	4,700 mm		58,0	24,0	18,0	63054	68982
0.1875	4,760 mm	3/16	2-3/4	1-5/8	1-19/64	53112	58040
0.1890	4,800 mm	#12	2-3/4	1-5/8	1-19/64	53012	58041
0.1890	4,800 mm		62,0	26,0	20,0	63055	68983
0.1910	4,850 mm	#11	2-3/4	1-5/8	1-19/64	53011	58042
0.1929	4,900 mm		62,0	26,0	20,0	63056	68984
0.1935	4,910 mm	#10	2-3/4	1-5/8	1-19/64	53010	58043
0.1960	4,980 mm	#9	3	1-3/4	1-13/32	53009	58044
0.1969	5,000 mm		62,0	26,0	20,0	63007	68985
0.1990	5,050 mm	#8	3	1-3/4	1-13/32	53008	58045
0.2008	5,100 mm		62,0	26,0	20,0	63057	68986
0.2010	5,110 mm	#7	3	1-3/4	1-13/32	53007	58046
0.2031	5,160 mm	13/64	3	1-3/4	1-13/32	53113	58047
0.2040	5,180 mm	#6	3	1-3/4	1-13/32	53006	58048
0.2047	5,200 mm		62,0	26,0	20,0	63008	68987
0.2055	5,220 mm	#5	3	1-3/4	1-13/32	53005	58049
0.2087	5,300 mm		62,0	26,0	20,0	63058	68988
0.2090	5,310 mm	#4	3	1-3/4	1-13/32	53004	58050
0.2126	5,400 mm		66,0	28,0	21,0	63059	68989
0.2130	5,410 mm	#3	3	1-3/4	1-13/32	53003	58051
0.2165	5,500 mm		66,0	28,0	21,0	63009	68990
0.2188	5,560 mm	7/32	3	1-3/4	1-13/32	53114	58052
0.2205	5,600 mm		66,0	28,0	21,0	63060	68991
0.2210	5,610 mm	#2	3	1-3/4	1-13/32	53002	58053
0.2244	5,700 mm		66,0	28,0	21,0	63061	68992
0.2280	5,790 mm	#1	3	1-3/4	1-13/32	53001	58054
0.2283	5,800 mm		66,0	28,0	21,0	63062	68993
0.2323	5,900 mm		66,0	28,0	21,0	63063	68994
0.2340	5,940 mm	A	3-1/4	2	1-39/64	53201	58055
0.2344	5,950 mm	15/64	3-1/4	2	1-39/64	53115	58056
0.2362	6,000 mm		66,0	28,0	21,0	63010	68995
0.2380	6,050 mm	B	3-1/4	2	1-39/64	53202	58057
0.2402	6,100 mm		70,0	31,0	23,0	63064	68996
0.2420	6,150 mm	C	3-1/4	2	1-39/64	53203	58058
0.2441	6,200 mm		70,0	31,0	23,0	63011	68997
0.2460	6,250 mm	D	3-1/4	2	1-39/64	53204	58059
0.2480	6,300 mm		70,0	31,0	23,0	63065	68998
0.2500	6,350 mm	1/4	3-1/4	2	1-39/64	53116	58061
0.2520	6,400 mm		70,0	31,0	23,0	63066	68999
0.2559	6,500 mm		70,0	31,0	23,0	63012	69000
0.2570	6,530 mm	F	3-1/4	2	1-39/64	53206	58062
0.2598	6,600 mm		70,0	31,0	23,0	63067	69001
0.2610	6,630 mm	G	3-1/2	2-1/8	1-45/64	53207	58063
0.2638	6,700 mm		70,0	31,0	23,0	63068	69002

continued on next page

CONTINUED

3 Flute Drills • Metric: DIN 6539



3xD
(mm)

5xD
(inch)



103

FRACTIONAL & METRIC SERIES

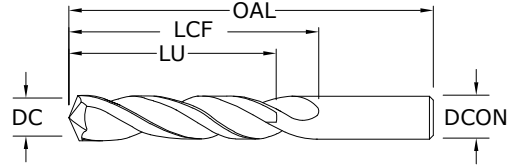

DECIMAL DC / DCON	METRIC DC / DCON	inch & mm				USABLE LENGTH LU	EDP NO.	
		FRACTIONAL/ LETTER/WIRE DC	OVERALL LENGTH OAL	FLUTE LENGTH LCF	UNCOATED		Ti-NAMITE®-A (AITIN)	
0.2656	6,750 mm	17/64	3-1/2	2-1/8	1-45/64	53117	58064	
0.2660	6,760 mm	H	3-1/2	2-1/8	1-45/64	53208	58065	
0.2677	6,800 mm		74,0	34,0	25,0	63013	69003	
0.2717	6,900 mm		74,0	34,0	25,0	63069	69004	
0.2720	6,910 mm	I	3-1/2	2-1/8	1-45/64	53209	58066	
0.2756	7,000 mm		74,0	34,0	25,0	63014	69005	
0.2770	7,040 mm	J	3-1/2	2-1/8	1-45/64	53210	58067	
0.2795	7,100 mm		74,0	34,0	25,0	63070	69006	
0.2810	7,140 mm	K	3-1/2	2-1/8	1-45/64	53211	58068	
0.2812	7,140 mm	9/32	3-1/2	2-1/8	1-45/64	53118	58069	
0.2835	7,200 mm		74,0	34,0	25,0	63015	69007	
0.2874	7,300 mm		74,0	34,0	25,0	63071	69008	
0.2900	7,370 mm	L	3-1/2	2-1/8	1-45/64	53212	58070	
0.2913	7,400 mm		74,0	34,0	25,0	63072	69009	
0.2950	7,490 mm	M	3-3/4	2-3/8	1-29/32	53213	58071	
0.2953	7,500 mm		74,0	34,0	25,0	63016	69010	
0.2969	7,540 mm	19/64	3-3/4	2-3/8	1-29/32	53119	58072	
0.2992	7,600 mm		79,0	37,0	27,0	63073	69011	
0.3020	7,670 mm	N	2-3/8	2-3/8	1-29/32	53214	58073	
0.3031	7,700 mm		79,0	37,0	27,0	63074	69012	
0.3071	7,800 mm		79,0	37,0	27,0	63075	69013	
0.3110	7,900 mm		79,0	37,0	27,0	63076	69014	
0.3125	7,940 mm	5/16	3-3/4	2-3/8	1-29/32	53120	58074	
0.3150	8,000 mm		79,0	37,0	27,0	63017	69015	
0.3160	8,030 mm	O	3-3/4	2-3/8	1-29/32	53215	58075	
0.3189	8,100 mm		79,0	37,0	27,0	63077	69016	
0.3228	8,200 mm		79,0	37,0	27,0	63018	69017	
0.3230	8,200 mm	P	3-3/4	2-3/8	1-29/32	53216	58076	
0.3268	8,300 mm		79,0	37,0	27,0	63078	69018	
0.3281	8,330 mm	21/64	4	2-1/2	2	53121	58077	
0.3307	8,400 mm		79,0	37,0	27,0	63019	69019	
0.3320	8,430 mm	Q	4	2-1/2	2	53217	58078	
0.3346	8,500 mm		79,0	37,0	27,0	63020	69020	
0.3386	8,600 mm		84,0	40,0	29,0	63021	69021	
0.3390	8,610 mm	R	4	2-1/2	2	53218	58079	
0.3425	8,700 mm		84,0	40,0	29,0	63079	69022	
0.3438	8,730 mm	11/32	4	2-1/2	2	53122	58080	
0.3465	8,800 mm		84,0	40,0	29,0	63022	69023	
0.3480	8,840 mm	S	4	2-1/2	2	53219	58081	
0.3504	8,900 mm		84,0	40,0	29,0	63080	69024	
0.3543	9,000 mm		84,0	40,0	29,0	63023	69025	
0.3580	9,090 mm	T	4-1/4	2-3/4	2-13/64	53220	58082	

TOLERANCES (inch)

DC = +0.0000/-0.0005
DCON = h₆

TOLERANCES (mm)

DC = +0,0000/-0,0127
DCON = h₆

- STEELS
- CAST IRON
- NON-FERROUS
- HARDENED STEELS

For patent information visit www.ksptpatents.com

continued on next page

3 Flute Drills • Metric: DIN 6539

103

FRACTIONAL & METRIC SERIES

CONTINUED

DECIMAL DC / DCON	METRIC DC / DCON	inch & mm				EDP NO.	
		FRACTIONAL/ LETTER/WIRE DC	OVERALL LENGTH OAL	FLUTE LENGTH LCF	USABLE LENGTH LU	UNCOATED	Ti-NAMITE®-A (AITiN)
0.3583	9,100 mm		84,0	40,0	29,0	63081	69026
0.3594	9,130 mm	23/64	4-1/4	2-3/4	2-13/64	53123	58083
0.3622	9,200 mm		84,0	40,0	29,0	63024	69027
0.3661	9,300 mm		84,0	40,0	29,0	63082	69028
0.3680	9,350 mm	U	4-1/4	2-3/4	2-13/64	53221	58084
0.3701	9,400 mm		84,0	40,0	29,0	63083	69029
0.3740	9,500 mm		84,0	40,0	29,0	63025	69030
0.3750	9,530 mm	3/8	4-1/4	2-3/4	2-13/64	53124	58085
0.3770	9,580 mm	V	4-1/4	2-3/4	2-13/64	53222	58086
0.3780	9,600 mm		89,0	43,0	31,0	63084	69031
0.3819	9,700 mm		89,0	43,0	31,0	63085	69032
0.3858	9,800 mm		89,0	43,0	31,0	63086	69033
0.3860	9,800 mm	W	4-1/2	2-7/8	2-19/64	53223	58087
0.3898	9,900 mm		89,0	43,0	31,0	63087	69034
0.3906	9,920 mm	25/64	4-1/2	2-7/8	2-19/64	53125	58088
0.3937	10,000 mm		89,0	43,0	31,0	63026	69035
0.3970	10,080 mm	X	4-1/2	2-7/8	2-19/64	53224	58089
0.3976	10,100 mm		89,0	43,0	31,0	63088	69036
0.4016	10,200 mm		89,0	43,0	31,0	63027	69037
0.4040	10,260 mm	Y	4-1/2	2-7/8	2-19/64	53225	58090
0.4062	10,320 mm	13/32	4-1/2	2-7/8	2-19/64	53126	58091
0.4094	10,400 mm		89,0	43,0	31,0	63028	69038
0.4130	10,490 mm	Z	4-1/2	2-7/8	2-19/64	53226	58092
0.4134	10,500 mm		89,0	43,0	31,0	63029	69039
0.4213	10,700 mm		95,0	47,0	33,0	63030	69040
0.4219	10,720 mm	27/64	4-1/2	2-7/8	2-19/64	53127	58093
0.4252	10,800 mm		95,0	47,0	33,0	63031	69041
0.4331	11,000 mm		95,0	47,0	33,0	63032	69042
0.4375	11,110 mm	7/16	4-1/2	2-7/8	2-19/64	53128	58094
0.4528	11,500 mm		95,0	47,0	33,0	63033	69043
0.4531	11,510 mm	29/64	4-3/4	3	2-13/32	53129	58095
0.4688	11,910 mm	15/32	4-3/4	3	2-13/32	53130	58096
0.4724	12,000 mm		102,0	51,0	35,0	63034	69044
0.4844	12,300 mm	31/64	4-3/4	3	2-13/32	53131	58097
0.4921	12,500 mm		102,0	51,0	35,0	63035	69045
0.5000	12,700 mm	1/2	4-3/4	3	2-13/32	53132	58098
0.5039	12,800 mm		102,0	51,0	35,0	63036	69046
0.5118	13,000 mm		102,0	51,0	35,0	63089	69047
0.5156	13,100 mm	33/64	4-3/4	3	2-13/32	53135	58099
0.5157	13,100 mm		102,0	51,0	35,0	63037	69048
0.5315	13,500 mm		107,0	54,0	37,0	63090	69049
0.5512	14,000 mm		107,0	54,0	37,0	63038	69050
0.5625	14,290 mm	9/16	4-3/4	3	2-13/32	53136	58100
0.5630	14,300 mm		111,0	56,0	38,0	63039	69051
0.5709	14,500 mm		111,0	56,0	38,0	63040	69052
0.5906	15,000 mm		111,0	56,0	38,0	63091	69053
0.6250	15,880 mm	5/8	5-3/4	3-1/2	2-51/64	53133	58101
0.6875	17,460 mm	11/16	5-3/4	3-1/2	2-51/64	53137	58102
0.6890	17,500 mm		123,0	62,0	40,0	63041	69054
0.7500	19,050 mm	3/4	5-3/4	4-1/4	3 13/32	53134	58103
0.7677	19,500 mm		131,0	66,0	42,0	63042	69055
0.7874	20,000 mm		131,0	66,0	42,0	63043	69056

3 Flute Drills

Series 103 Fractional	Hardness	Vc (sfm)	DC • in							
			1/8	1/4	3/8	1/2	5/8	3/4		
P CARBON STEELS 1018, 1040, 1080, 1090, 10L50, 1140, 1212, 12L15, 1525, 1536	≤ 175 Bhn or ≤ 7 HRc	295	RPM	9015	4508	3005	2254	1803	1503	
		(236-354)	Fr	0.0026	0.0051	0.0077	0.0102	0.0128	0.0153	
			Feed (ipm)	23.0	23.0	23.0	23.0	23.0	23.0	
	≤ 300 Bhn or ≤ 32 HRc	260	RPM	7946	3973	2649	1986	1589	1324	
		(208-312)	Fr	0.0023	0.0045	0.0068	0.0091	0.0113	0.0136	
			Feed (ipm)	18.0	18.0	18.0	18.0	18.0	18.0	
	≤ 425 Bhn or ≤ 45 HRc	150	RPM	4584	2292	1528	1146	917	764	
		(120-180)	Fr	0.0013	0.0026	0.0039	0.0052	0.0065	0.0079	
			Feed (ipm)	6.0	6.0	6.0	6.0	6.0	6.0	
	ALLOY STEELS 4140, 4150, 4320, 5120, 5150, 8630, 86L20, 50100	≤ 275 Bhn or ≤ 28 HRc	230	RPM	7029	3514	2343	1757	1406	1171
			(184-276)	Fr	0.0019	0.0038	0.0058	0.0077	0.0096	0.0115
				Feed (ipm)	13.5	13.5	13.5	13.5	13.5	13.5
≤ 375 Bhn or ≤ 40 HRc		145	RPM	4431	2216	1477	1108	886	739	
		(116-174)	Fr	0.0019	0.0038	0.0058	0.0077	0.0096	0.0115	
			Feed (ipm)	8.5	8.5	8.5	8.5	8.5	8.5	
≤ 425 Bhn or ≤ 45 HRc	115	RPM	3514	1757	1171	879	703	586		
	(92-138)	Fr	0.0005	0.0010	0.0015	0.0020	0.0026	0.0031		
		Feed (ipm)	1.8	1.8	1.8	1.8	1.8	1.8		
TOOL STEELS A2, D2, H13, L2, M2, P20, S7, T15, W2	≤ 250 Bhn or ≤ 24 HRc	85	RPM	2598	1299	866	649	520	433	
		(68-102)	Fr	0.0013	0.0026	0.0039	0.0052	0.0065	0.0079	
			Feed (ipm)	3.4	3.4	3.4	3.4	3.4	3.4	
	≤ 375 Bhn or ≤ 40 HRc	65	RPM	1986	993	662	497	397	331	
		(52-78)	Fr	0.0007	0.0013	0.0020	0.0026	0.0033	0.0039	
			Feed (ipm)	1.3	1.3	1.3	1.3	1.3	1.3	
K CAST IRONS Gray, Malleable, Ductile	≤ 220 Bhn or ≤ 19 HRc	250	RPM	7640	3820	2547	1910	1528	1273	
		(200-300)	Fr	0.0026	0.0052	0.0079	0.0105	0.0131	0.0157	
			Feed (ipm)	20.0	20.0	20.0	20.0	20.0	20.0	
	≤ 330 Bhn or ≤ 36 HRc	195	RPM	5959	2980	1986	1490	1192	993	
		(156-234)	Fr	0.0026	0.0052	0.0078	0.0104	0.0130	0.0156	
			Feed (ipm)	15.5	15.5	15.5	15.5	15.5	15.5	
N ALUMINUM ALLOYS 2017, 2024, 356, 6061, 7075	≤ 80 Bhn or ≤ 47 HRb	540	RPM	16502	8251	5501	4126	3300	2750	
		(432-648)	Fr	0.0032	0.0064	0.0096	0.0128	0.0161	0.0193	
			Feed (ipm)	53.0	53.0	53.0	53.0	53.0	53.0	
	≤ 150 Bhn or ≤ 88 HRb	455	RPM	13905	6952	4635	3476	2781	2317	
		(364-546)	Fr	0.0032	0.0065	0.0097	0.0129	0.0162	0.0194	
			Feed (ipm)	45.0	45.0	45.0	45.0	45.0	45.0	
COPPER ALLOYS Alum Bronze, C110, Muntz Brass	≤ 140 Bhn or ≤ 3 HRc	305	RPM	9321	4660	3107	2330	1864	1553	
		(244-366)	Fr	0.0019	0.0039	0.0058	0.0077	0.0097	0.0116	
			Feed (ipm)	18.0	18.0	18.0	18.0	18.0	18.0	
	≤ 200 Bhn or ≤ 23 HRc	160	RPM	4890	2445	1630	1222	978	815	
		(128-192)	Fr	0.0016	0.0033	0.0049	0.0065	0.0082	0.0098	
			Feed (ipm)	8.0	8.0	8.0	8.0	8.0	8.0	
H TOOL STEELS A2, D2, H13, L2, M2, P20, S7, T15, W2	≤ 475 Bhn or ≤ 50 HRc		Fr	1.3	1.3	1.3	1.3	1.3	1.3	
		50	RPM	1528	764	509	382	306	255	
		(40-60)	Fr	0.0007	0.0013	0.0020	0.0026	0.0033	0.0039	
Feed (ipm)	1.0		1.0	1.0	1.0	1.0	1.0			

Bhn (Brinell) HRc (Rockwell C) HRb (Rockwell B)
 rpm = Vc x 3.82 / DC
 ipm = Fr x rpm
 reduce speed and feed 30 percent when using uncoated drills
 reduce speed and feed for materials harder than listed
 refer to the SGS Tool Wizard® for complete technical information (www.kyocera-sgstool.com)

3 Flute Drills

Series 103M Metric	Hardness	Vc (m/min)	DC • mm							
			3	6	10	12	16	20		
P CARBON STEELS 1018, 1040, 1080, 1090, 10L50, 1140, 1212, 12L15, 1525, 1536	≤ 175 Bhn or ≤ 7 HRc	90	RPM	9533	4766	2860	2383	1787	1430	
		(72-108)	Fr	0.062	0.124	0.206	0.248	0.330	0.413	
			Feed (mm/min)	590	590	590	590	590	590	
	≤ 300 Bhn or ≤ 32 HRc	79	RPM	8402	4201	2520	2100	1575	1260	
		(63-95)	Fr	0.055	0.110	0.183	0.219	0.292	0.365	
			Feed (mm/min)	460	460	460	460	460	460	
	≤ 425 Bhn or ≤ 45 HRc	46	RPM	4847	2424	1454	1212	909	727	
		(37-55)	Fr	0.032	0.064	0.107	0.128	0.171	0.213	
			Feed (mm/min)	155	155	155	155	155	155	
	P ALLOY STEELS 4140, 4150, 4320, 5120, 5150, 8630, 86L20, 50100	≤ 275 Bhn or ≤ 28 HRc	70	RPM	7432	3716	2230	1858	1394	1115
			(56-84)	Fr	0.046	0.093	0.155	0.186	0.248	0.309
				Feed (mm/min)	345	345	345	345	345	345
≤ 375 Bhn or ≤ 40 HRc		44	RPM	4686	2343	1406	1171	879	703	
		(35-53)	Fr	0.046	0.092	0.153	0.184	0.245	0.306	
			Feed (mm/min)	215	215	215	215	215	215	
≤ 450 Bhn or ≤ 48 HRc		35	RPM	3716	1858	1115	929	697	557	
		(28-42)	Fr	0.012	0.024	0.040	0.048	0.065	0.081	
			Feed (mm/min)	45	45	45	45	45	45	
P TOOL STEELS A2, D2, H13, L2, M2, P20, S7, T15, W2		≤ 250 Bhn or ≤ 24 HRc	26	RPM	2747	1373	824	687	515	412
			(21-31)	Fr	0.031	0.062	0.103	0.124	0.165	0.206
				Feed (mm/min)	85	85	85	85	85	85
	≤ 375 Bhn or ≤ 40 HRc	20	RPM	2100	1050	630	525	394	315	
		(16-24)	Fr	0.017	0.033	0.056	0.067	0.089	0.111	
			Feed (mm/min)	35	35	35	35	35	35	
K CAST IRONS Gray, Malleable, Ductile	≤ 220 Bhn or ≤ 19 HRc	76	RPM	8078	4039	2424	2020	1515	1212	
		(61-91)	Fr	0.063	0.126	0.210	0.253	0.337	0.421	
			Feed (mm/min)	510	510	510	510	510	510	
	≤ 330 Bhn or ≤ 36 HRc	59	RPM	6301	3151	1890	1575	1181	945	
		(48-71)	Fr	0.052	0.105	0.175	0.209	0.279	0.349	
			Feed (mm/min)	330	330	330	330	330	330	
N ALUMINUM ALLOYS 2017, 2024, 356, 6061, 7075	≤ 80 Bhn or ≤ 47 HRb	165	RPM	17449	8725	5235	4362	3272	2617	
		(132-198)	Fr	0.078	0.156	0.260	0.312	0.416	0.520	
			Feed (mm/min)	1360	1360	1360	1360	1360	1360	
	≤ 150 Bhn or ≤ 7 HRc	139	RPM	14703	7351	4411	3676	2757	2205	
		(111-166)	Fr	0.078	0.156	0.261	0.313	0.417	0.521	
			Feed (mm/min)	1150	1150	1150	1150	1150	1150	
N COPPER ALLOYS Alum Bronze, C110, Muntz Brass	≤ 140 Bhn or ≤ 3 HRc	93	RPM	9856	4928	2957	2464	1848	1478	
		(74-112)	Fr	0.047	0.094	0.157	0.189	0.252	0.315	
			Feed (mm/min)	465	465	465	465	465	465	
	≤ 200 Bhn or ≤ 23 HRc	49	RPM	5170	2585	1551	1293	969	776	
		(39-59)	Fr	0.039	0.077	0.129	0.155	0.206	0.258	
			Feed (mm/min)	200	200	200	200	200	200	
H TOOL STEELS A2, D2, H13, L2, M2, P20, S7, T15, W2	≤ 475 Bhn or ≤ 50 HRc	15	RPM	1616	808	485	404	303	242	
		(12-18)	Fr	0.015	0.031	0.052	0.062	0.083	0.103	
			Feed (mm/min)	25	25	25	25	25	25	

Bhn (Brinell) HRc (Rockwell C) HRb (Rockwell B)
 rpm = (Vc x 1000) / (DC x 3.14)
 mm/min = Fr x rpm
 reduce speed and feed 30 percent when using uncoated drills
 reduce speed and feed for materials harder than listed
 refer to the SGS Tool Wizard® for complete technical information (www.kyocera-sgstoool.com)

Combined Drill & Countersink



Pictured:
Series 301 Set



301 FRACTIONAL SERIES

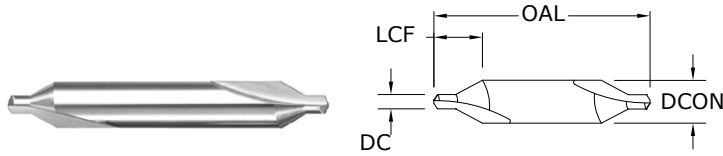

SIZE	inch				EDP NO.	
	DRILL DIAMETER DC	BODY DIAMETER DCON	OVERALL LENGTH OAL	FLUTE LENGTH LCF	UNCOATED	Ti-NAMITE®-A (AlTiN)
*00	.025	1/8	1-1/2	.125	57005	57015
*0	1/32	1/8	1-1/2	.130	57006	57016
*1	3/64	1/8	1-1/2	.135	57007	57017
*2	5/64	3/16	1-7/8	.200	57008	57018
*3	7/64	1/4	2	.280	57009	57019
*4	1/8	5/16	2-1/8	.340	57010	57020
*5	3/16	7/16	2-3/4	.475	57011	57021
*6	7/32	1/2	3	.540	57012	57022
*Series 301 Set	—	—	—	—	57075	—

TOLERANCES (inch)

DC = +0.003/-0.000
DCON = -0.0001/-0.0005

- STEELS
- STAINLESS STEELS
- CAST IRON
- NON-FERROUS
- HIGH TEMP ALLOYS
- HARDENED STEELS

For patent information visit www.ksptpatents.com

Combined Drill & Countersink

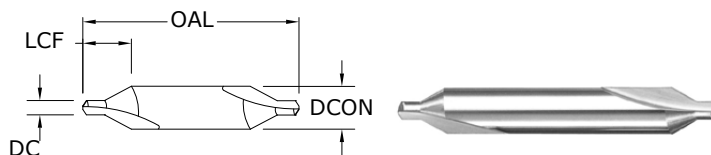
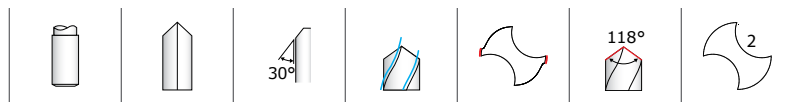

301M
METRIC SERIES

TOLERANCES (mm)

DC = +0,076/-0,000
DCON = -0,0025/-0,0127

- STEELS
- STAINLESS STEELS
- CAST IRON
- NON-FERROUS
- HIGH TEMP ALLOYS
- HARDENED STEELS

For patent information visit www.ksptpatents.com

DRILL DIAMETER DC	BODY DIAMETER DCON	mm		EDP NO.	
		OVERALL LENGTH OAL	FLUTE LENGTH LCF	UNCOATED	Ti-NAMITE®-A (AITiN)
0,5	3,15	20,0	3,0	67005	67035
0,8	3,15	20,0	3,5	67007	67037
1	3,15	31,5	3,5	67009	67039
1,25	3,15	31,5	4,0	67011	67041
1,6	4,0	35,5	5,0	67013	67043
2	5,0	40,0	6,0	67015	67045
2,5	6,3	45,0	7,0	67017	67047
3,15	8,0	50,0	9,0	67019	67049
4	10,0	56,0	11,0	67021	67051
5	12,5	63,0	14,0	67023	67053

Combined Drill & Countersink

Series 301 Fractional	Hardness	Vc (sfm)	DC • in						
			1/32	5/64	1/8	3/16	7/32		
CARBON STEELS 1018, 1040, 1080, 1090, 10L50, 1140, 1212, 12L15, 1525, 1536	≤ 175 Bhn or ≤ 7 HRc	265	RPM	8098	5399	3239	2314	2025	
		(212-318)	Fr	0.00068	0.0010	0.0017	0.0024	0.0027	
			Feed (ipm)	5.5	5.5	5.5	5.5	5.5	
	≤ 300 Bhn or ≤ 32 HRc	125	RPM	3820	2547	1528	1091	955	
		(100-150)	Fr	0.00065	0.0010	0.0016	0.0023	0.0026	
			Feed (ipm)	2.5	2.5	2.5	2.5	2.5	
	≤ 425 Bhn or ≤ 45 HRc	85	RPM	2598	1732	1039	742	649	
		(68-102)	Fr	0.00038	0.0006	0.0010	0.0013	0.0015	
			Feed (ipm)	1.0	1.0	1.0	1.0	1.0	
	ALLOY STEELS 4140, 4150, 4320, 5120, 5150, 8630, 86L20, 50100	≤ 275 Bhn or ≤ 28 HRc	230	RPM	7029	4686	2812	2008	1757
			(184-276)	Fr	0.00064	0.0010	0.0016	0.0022	0.0026
				Feed (ipm)	4.5	4.5	4.5	4.5	4.5
≤ 375 Bhn or ≤ 40 HRc		145	RPM	4431	2954	1772	1266	1108	
		(116-174)	Fr	0.00059	0.0009	0.0015	0.0021	0.0023	
			Feed (ipm)	2.6	2.6	2.6	2.6	2.6	
≤ 425 Bhn or ≤ 45 HRc		60	RPM	1834	1222	733	524	458	
		(48-72)	Fr	0.00027	0.0004	0.0007	0.0010	0.0011	
			Feed (ipm)	0.5	0.5	0.5	0.5	0.5	
TOOL STEELS A2, D2, H13, L2, M2, P20, S7, T15, W2		≤ 250 Bhn or ≤ 24 HRc	85	RPM	2598	1732	1039	742	649
			(68-102)	Fr	0.00035	0.0005	0.0009	0.0012	0.0014
				Feed (ipm)	0.9	0.9	0.9	0.9	0.9
	≤ 375 Bhn or ≤ 40 HRc	55	RPM	1681	1121	672	480	420	
		(44-66)	Fr	0.00016	0.0002	0.0004	0.0006	0.0006	
			Feed (ipm)	0.3	0.3	0.3	0.3	0.3	
STAINLESS STEELS (FREE MACHINING) 303, 416, 420F, 430F 440F	≤ 250 Bhn or ≤ 24 HRc	210	RPM	6418	4278	2567	1834	1604	
		(168-252)	Fr	0.00048	0.0007	0.0012	0.0017	0.0019	
			Feed (ipm)	3.1	3.1	3.1	3.1	3.1	
	≤ 330 Bhn or ≤ 36 HRc	110	RPM	3362	2241	1345	960	840	
		(88-132)	Fr	0.00028	0.0004	0.0007	0.0010	0.0011	
			Feed (ipm)	0.9	0.9	0.9	0.9	0.9	
	STAINLESS STEELS (DIFFICULT) 304, 316, 321, 13-8 PH, 15-5PH, 17-4 PH, Custom 450	≤ 275 Bhn or ≤ 28 HRc	65	RPM	1986	1324	795	568	497
			(52-78)	Fr	0.00036	0.0005	0.0009	0.0013	0.0014
				Feed (ipm)	0.7	0.7	0.7	0.7	0.7
		≤ 375 Bhn or ≤ 40 HRc	55	RPM	1681	1121	672	480	420
			(44-66)	Fr	0.00032	0.0005	0.0008	0.0011	0.0013
				Feed (ipm)	0.5	0.5	0.5	0.5	0.5
CAST IRONS Gray, Malleable, Ductile	≤ 220 Bhn or ≤ 19 HRc	280	RPM	8557	5705	3423	2445	2139	
		(224-336)	Fr	0.00084	0.0013	0.0021	0.0029	0.0034	
			Feed (ipm)	7.2	7.2	7.2	7.2	7.2	
	≤ 330 Bhn or ≤ 36 HRc	250	RPM	7640	5093	3056	2183	1910	
		(200-300)	Fr	0.00084	0.0013	0.0021	0.0029	0.0034	
			Feed (ipm)	6.4	6.4	6.4	6.4	6.4	

continued on next page

Combined Drill & Countersink

Series 301 Fractional	Hardness	Vc (sfm)		DC • in					
				1/32	5/64	1/8	3/16	7/32	
N ALUMINUM ALLOYS 2017, 2024, 356, 6061, 7075	≤ 80 Bhn or ≤ 47 HRb	540 (432-648)	RPM	16502	11002	6601	4715	4126	
			Fr	0.00100	0.0015	0.0025	0.0035	0.0040	
			Feed (ipm)	16.5	16.5	16.5	16.5	16.5	
	≤ 150 Bhn or ≤ 88 HRb	455 (364-546)	RPM	13905	9270	5562	3973	3476	
			Fr	0.00100	0.0015	0.0025	0.0035	0.0040	
			Feed (ipm)	13.9	13.9	13.9	13.9	13.9	
	COPPER ALLOYS Alum Bronze, C110, Muntz Brass	≤ 140 Bhn or ≤ 3 HRc	190 (152-228)	RPM	5806	3871	2323	1659	1452
				Fr	0.00048	0.0007	0.0012	0.0017	0.0019
				Feed (ipm)	2.8	2.8	2.8	2.8	2.8
		≤ 200 Bhn or ≤ 23 HRc	175 (140-210)	RPM	5348	3565	2139	1528	1337
				Fr	0.00048	0.0007	0.0012	0.0017	0.0019
				Feed (ipm)	2.6	2.6	2.6	2.6	2.6
PLASTICS Polycarbonate, PVC	500 (400-600)	RPM	15280	10187	6112	4366	3820		
		Fr	0.00100	0.0015	0.0025	0.0035	0.0040		
		Feed (ipm)	15.3	15.3	15.3	15.3	15.3		
S HIGH TEMP ALLOYS (NICKEL, COBALT, IRON BASE) Inconel 601, 617, 625, Incoloy 800, Monel 400, Rene, Waspaloy	≤ 220 Bhn or ≤ 19 HRc	40 (32-48)	RPM	1222	815	489	349	306	
			Fr	0.00036	0.0005	0.0009	0.0013	0.0014	
			Feed (ipm)	0.4	0.4	0.4	0.4	0.4	
	≤ 320 Bhn or ≤ 34 HRc	25 (20-30)	RPM	764	509	306	218	191	
			Fr	0.00033	0.0005	0.0008	0.0011	0.0013	
			Feed (ipm)	0.3	0.3	0.3	0.3	0.3	
	≤ 425 Bhn or ≤ 45 HRc	20 (16-24)	RPM	611	407	244	175	153	
			Fr	0.00016	0.0002	0.0004	0.0006	0.0007	
			Feed (ipm)	0.1	0.1	0.1	0.1	0.1	
	TITANIUM ALLOYS Pure Titanium, Ti6Al4V, Ti6Al2Sn4Zr2Mo, Ti4Al4Mo2Sn0.5Si, Ti-6Al4V	≤ 275 Bhn or ≤ 28 HRc	85 (68-102)	RPM	2598	1732	1039	742	649
				Fr	0.00064	0.0010	0.0016	0.0022	0.0026
				Feed (ipm)	1.7	1.7	1.7	1.7	1.7
≤ 350 Bhn or ≤ 38 HRc		65 (52-78)	RPM	1986	1324	795	568	497	
			Fr	0.00036	0.0005	0.0009	0.0013	0.0014	
			Feed (ipm)	0.7	0.7	0.7	0.7	0.7	
≤ 440 Bhn or ≤ 47 HRc	55 (44-66)	RPM	1681	1121	672	480	420		
		Fr	0.00032	0.0005	0.0008	0.0011	0.0013		
		Feed (ipm)	0.5	0.5	0.5	0.5	0.5		
H TOOL STEELS A2, D2, H13, L2, M2, P20, S7, T15, W2	≤ 475 Bhn or ≤ 50 HRc	40 (32-48)	RPM	1222	815	489	349	306	
			Fr	0.00016	0.0002	0.0004	0.0006	0.0007	
			Feed (ipm)	0.2	0.2	0.2	0.2	0.2	

Bhn (Brinell) HRc (Rockwell C) HRb (Rockwell B)
 rpm = Vc x 3.82 / DCON
 ipm = Fr x rpm
 reduce speed and feed 30 percent when using uncoated drills
 reduce speed and feed for materials harder than listed
 refer to the SGS Tool Wizard® for complete technical information (www.kyocera-sgstool.com)

Combined Drill & Countersink

Series 301M Metric	Hardness	Vc (m/min)	DC • mm						
			1	1.6	2.5	4	5		
CARBON STEELS 1018, 1040, 1080, 1090, 10L50, 1140, 1212, 12L15, 1525, 1536	≤ 175 Bhn or ≤ 7 HRc	81	RPM	8155	6422	4078	2569	2055	
		(65-97)	Fr	0.017	0.022	0.034	0.054	0.068	
			Feed (mm/min)	139	139	139	139	139	
	≤ 300 Bhn or ≤ 32 HRc	38	RPM	3847	3029	1923	1212	969	
		(30-46)	Fr	0.016	0.020	0.032	0.051	0.064	
			Feed (mm/min)	62	62	62	62	62	
	≤ 425 Bhn or ≤ 45 HRc	26	RPM	2616	2060	1308	824	659	
		(21-31)	Fr	0.010	0.013	0.020	0.032	0.039	
			Feed (mm/min)	26	26	26	26	26	
	ALLOY STEELS 4140, 4150, 4320, 5120, 5150, 8630, 86L20, 50100	≤ 275 Bhn or ≤ 28 HRc	70	RPM	7078	5574	3539	2230	1784
			(56-84)	Fr	0.016	0.020	0.032	0.051	0.063
				Feed (mm/min)	113	113	113	113	113
≤ 375 Bhn or ≤ 40 HRc		44	RPM	4462	3514	2231	1406	1125	
		(35-53)	Fr	0.015	0.019	0.030	0.048	0.060	
			Feed (mm/min)	67	67	67	67	67	
≤ 425 Bhn or ≤ 45 HRc		18	RPM	1847	1454	923	582	465	
		(15-22)	Fr	0.007	0.009	0.014	0.022	0.028	
			Feed (mm/min)	13	13	13	13	13	
TOOL STEELS A2, D2, H13, L2, M2, P20, S7, T15, W2		≤ 250 Bhn or ≤ 24 HRc	26	RPM	2616	2060	1308	824	659
			(21-31)	Fr	0.009	0.012	0.018	0.029	0.036
				Feed (mm/min)	24	24	24	24	24
	≤ 375 Bhn or ≤ 40 HRc	17	RPM	1693	1333	846	533	427	
		(13-20)	Fr	0.004	0.005	0.008	0.013	0.016	
			Feed (mm/min)	7	7	7	7	7	
STAINLESS STEELS (FREE MACHINING) 303, 416, 420F, 430F 440F	≤ 250 Bhn or ≤ 24 HRc	64	RPM	6463	5089	3231	2036	1629	
		(51-77)	Fr	0.012	0.015	0.024	0.038	0.048	
			Feed (mm/min)	78	78	78	78	78	
	≤ 330 Bhn or ≤ 36 HRc	34	RPM	3385	2666	1693	1066	853	
		(27-40)	Fr	0.007	0.009	0.014	0.023	0.028	
			Feed (mm/min)	24	24	24	24	24	
	STAINLESS STEELS (DIFFICULT) 304, 316, 321, 13-8 PH, 15-5PH, 17-4 PH, Custom 450	≤ 275 Bhn or ≤ 28 HRc	20	RPM	2000	1575	1000	630	504
			(16-24)	Fr	0.009	0.011	0.018	0.029	0.036
				Feed (mm/min)	18	18	18	18	18
		≤ 375 Bhn or ≤ 40 HRc	17	RPM	1693	1333	846	533	427
			(13-20)	Fr	0.008	0.011	0.017	0.026	0.033
				Feed (mm/min)	14	14	14	14	14
CAST IRONS Gray, Malleable, Ductile	≤ 220 Bhn or ≤ 19 HRc	85	RPM	8617	6786	4309	2714	2171	
		(68-102)	Fr	0.021	0.027	0.042	0.067	0.083	
			Feed (mm/min)	181	181	181	181	181	
	≤ 330 Bhn or ≤ 36 HRc	76	RPM	7694	6059	3847	2424	1939	
		(61-91)	Fr	0.021	0.027	0.042	0.067	0.084	
			Feed (mm/min)	162	162	162	162	162	

continued on next page

Combined Drill & Countersink

Series 301M Metric	Hardness	Vc (m/min)	DC • mm						
			1	1.6	2.5	4	5		
N ALUMINUM ALLOYS 2017, 2024, 356, 6061, 7075	≤ 80 Bhn or ≤ 47 HRb	165	RPM	16619	13087	8309	5235	4188	
		(132-198)	Fr	0.025	0.032	0.050	0.079	0.099	
			Feed (mm/min)	415	415	415	415	415	
	≤ 150 Bhn or ≤ 88 HRc	139	RPM	14003	11027	7001	4411	3529	
		(111-166)	Fr	0.025	0.032	0.050	0.079	0.099	
			Feed (mm/min)	350	350	350	350	350	
	COPPER ALLOYS Alum Bronze, C110, Muntz Brass	≤ 140 Bhn or ≤ 3 HRc	58	RPM	5847	4605	2924	1842	1474
			(46-69)	Fr	0.012	0.015	0.024	0.038	0.048
				Feed (mm/min)	70	70	70	70	70
		≤ 200 Bhn or ≤ 23 HRc	53	RPM	5386	4241	2693	1696	1357
			(43-64)	Fr	0.012	0.015	0.024	0.038	0.048
				Feed (mm/min)	65	65	65	65	65
PLASTICS Polycarbonate, PVC		152	RPM	15388	12118	7694	4847	3878	
		(122-183)	Fr	0.025	0.032	0.050	0.079	0.099	
			Feed (mm/min)	385	385	385	385	385	
S HIGH TEMP ALLOYS (NICKEL, COBALT, IRON BASE) Inconel 601, 617, 625, Incoloy 800, Monel 400, Rene, Waspaloy	≤ 220 Bhn or ≤ 19 HRc	12	RPM	1231	969	616	388	310	
		(10-15)	Fr	0.009	0.011	0.018	0.028	0.035	
			Feed (mm/min)	11	11	11	11	11	
	≤ 320 Bhn or ≤ 34 HRc	8	RPM	769	606	385	242	194	
		(6-9)	Fr	0.008	0.010	0.016	0.025	0.031	
			Feed (mm/min)	6	6	6	6	6	
	≤ 425 Bhn or ≤ 45 HRc	6	RPM	616	485	308	194	155	
		(5-7)	Fr	0.003	0.004	0.006	0.010	0.013	
			Feed (mm/min)	2	2	2	2	2	
	TITANIUM ALLOYS Pure Titanium, Ti6Al4V, Ti6Al2Sn4Zr2Mo, Ti4Al4Mo2Sn0.5Si, Ti-6Al4V	≤ 275 Bhn or ≤ 28 HRc	26	RPM	2616	2060	1308	824	659
			(21-31)	Fr	0.016	0.020	0.032	0.051	0.064
				Feed (mm/min)	42	42	42	42	42
≤ 350 Bhn or ≤ 38 HRc		20	RPM	2000	1575	1000	630	504	
		(16-24)	Fr	0.009	0.011	0.018	0.029	0.036	
			Feed (mm/min)	18	18	18	18	18	
≤ 440 Bhn or ≤ 47 HRc	17	RPM	1693	1333	846	533	427		
	(13-20)	Fr	0.008	0.011	0.017	0.026	0.033		
		Feed (mm/min)	14	14	14	14	14		
H TOOL STEELS A2, D2, H13, L2, M2, P20, S7, T15, W2	≤ 475 Bhn or ≤ 50 HRc	12	RPM	1231	969	616	388	310	
		(10-15)	Fr	0.004	0.005	0.008	0.013	0.016	
			Feed (mm/min)	5	5	5	5	5	

Bhn (Brinell) HRc (Rockwell C) HRb (Rockwell B)
 $rpm = (Vc \times 1000) / (DCON \times 3.14)$
 $mm/min = Fr \times rpm$
 reduce speed and feed 30 percent when using uncoated drills
 reduce speed and feed for materials harder than listed
 refer to the SGS Tool Wizard® for complete technical information (www.kyocera-sgstool.com)

Single Flute Countersink



601

FRACTIONAL SERIES

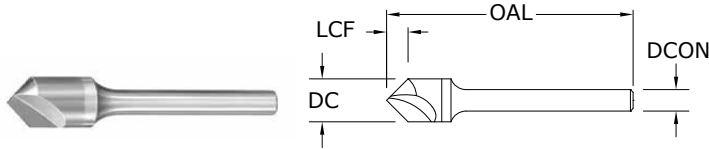

CUTTING DIAMETER DC	SHANK DIAMETER DCON	inch		EDP NO.		
		OVERALL LENGTH OAL	FLUTE LENGTH LCF	UNCOATED 60°	UNCOATED 82°	UNCOATED 90°
1/8	1/8	1-1/2	.062	—	—	74201
1/8	1/8	1-1/2	.072	—	74101	—
1/8	1/8	1-1/2	.108	74001	—	—
3/16	3/16	2	.094	—	—	74204
3/16	3/16	2	.108	—	74104	—
3/16	3/16	2	.163	74004	—	—
1/4	1/4	2	.125	—	—	74207
1/4	1/4	2	.144	—	74107	—
1/4	1/4	2	.217	74007	—	—
*3/8	1/4	2-13/16	.188	—	—	74210
*3/8	1/4	2-13/16	.216	—	74110	—
*3/8	1/4	2-13/16	.325	74010	—	—
*1/2	1/4	2-7/8	.250	—	—	74213
*1/2	1/4	2-7/8	.288	—	74113	—
*1/2	1/4	2-7/8	.433	74013	—	—
*5/8	3/8	3	.313	—	—	74216
*5/8	3/8	3	.360	—	74116	—
*5/8	3/8	3	.541	74016	—	—
*3/4	1/2	3	.375	—	—	74219
*3/4	1/2	3	.431	—	74119	—
*3/4	1/2	3	.650	74019	—	—
*1	1/2	3-1/4	.500	—	—	74222
*1	1/2	3-1/4	.575	—	74122	—
*1	1/2	3-1/4	.866	74022	—	—

*Steel Shank / Con mango de acero / Avec queue en acier / Mit Stahlschaft

TOLERANCES (inch)

1/8–1/4 DIAMETER

DC = +0.0000/–0.0005

3/8–1 DIAMETER

DC = +0.003/–0.000

Included Angle +1°/–1°

STEELS

STAINLESS STEELS

CAST IRON

NON-FERROUS

HIGH TEMP ALLOYS

HARDENED STEELS

For patent information visit

www.ksptpatents.com

Single Flute Countersink

Series 601 Fractional	Hardness	Vc (sfm)	DC • in								
			1/8	3/16	1/4	3/8	1/2	3/4	1		
CARBON STEELS 1018, 1040, 1080, 1090, 10L50, 1140, 1212, 12L15, 1525, 1536	≤ 175 Bhn or ≤ 7 HRc	125	RPM	3820	2547	1910	1273	955	637	478	
		(100-150)	Fr	0.0005	0.0008	0.0010	0.0016	0.0021	0.0031	0.0042	
			Feed (ipm)	2.0	2.0	2.0	2.0	2.0	2.0	2.0	
	≤ 300 Bhn or ≤ 32 HRc	60	RPM	1834	1222	917	611	458	306	229	
		(48-72)	Fr	0.0005	0.0007	0.0010	0.0015	0.0020	0.0029	0.0039	
			Feed (ipm)	0.9	0.9	0.9	0.9	0.9	0.9	0.9	
	≤ 425 Bhn or ≤ 45 HRc	45	RPM	1375	917	688	458	344	229	172	
		(36-54)	Fr	0.0003	0.0004	0.0006	0.0009	0.0012	0.0017	0.0023	
			Feed (ipm)	0.4	0.4	0.4	0.4	0.4	0.4	0.4	
	ALLOY STEELS 4140, 4150, 4320, 5120, 5150, 8630, 86L20, 50100	≤ 275 Bhn or ≤ 28 HRc	95	RPM	2903	1935	1452	968	726	484	363
			(76-114)	Fr	0.0004	0.0007	0.0009	0.0013	0.0018	0.0027	0.0036
				Feed (ipm)	1.3	1.3	1.3	1.3	1.3	1.3	1.3
≤ 375 Bhn or ≤ 40 HRc		60	RPM	1834	1222	917	611	458	306	229	
		(48-72)	Fr	0.0004	0.0007	0.0009	0.0013	0.0017	0.0026	0.0035	
			Feed (ipm)	0.8	0.8	0.8	0.8	0.8	0.8	0.8	
≤ 425 Bhn or ≤ 45 HRc		35	RPM	1070	713	535	357	267	178	134	
		(28-42)	Fr	0.0003	0.0004	0.0006	0.0008	0.0011	0.0017	0.0022	
			Feed (ipm)	0.3	0.3	0.3	0.3	0.3	0.3	0.3	
TOOL STEELS A2, D2, H13, L2, M2, P20, S7, T15, W2		≤ 250 Bhn or ≤ 24 HRc	35	RPM	1070	713	535	357	267	178	134
			(28-42)	Fr	0.0003	0.0004	0.0006	0.0008	0.0011	0.0017	0.0022
				Feed (ipm)	0.3	0.3	0.3	0.3	0.3	0.3	0.3
	≤ 375 Bhn or ≤ 40 HRc	25	RPM	764	509	382	255	191	127	96	
		(20-30)	Fr	0.0001	0.0002	0.0003	0.0004	0.0005	0.0008	0.0010	
			Feed (ipm)	0.1	0.1	0.1	0.1	0.1	0.1	0.1	
STAINLESS STEELS (FREE MACHINING) 303, 416, 420F, 430F 440F	≤ 250 Bhn or ≤ 24 HRc	53	RPM	1620	1080	810	540	405	270	202	
		(42-64)	Fr	0.0003	0.0005	0.0006	0.0009	0.0012	0.0019	0.0025	
			Feed (ipm)	0.5	0.5	0.5	0.5	0.5	0.5	0.5	
	≤ 330 Bhn or ≤ 36 HRc	46	RPM	1406	937	703	469	351	234	176	
		(37-55)	Fr	0.0002	0.0003	0.0004	0.0006	0.0009	0.0013	0.0017	
			Feed (ipm)	0.3	0.3	0.3	0.3	0.3	0.3	0.3	
	STAINLESS STEELS (DIFFICULT) 304, 316, 321, 13-8 PH, 15-5PH, 17-4 PH, Custom 450	≤ 275 Bhn or ≤ 28 HRc	28	RPM	856	570	428	285	214	143	107
			(22-34)	Fr	0.0004	0.0005	0.0007	0.0011	0.0014	0.0021	0.0028
				Feed (ipm)	0.3	0.3	0.3	0.3	0.3	0.3	0.3
		≤ 375 Bhn or ≤ 40 HRc	21	RPM	642	428	321	214	160	107	80
			(17-25)	Fr	0.0002	0.0002	0.0003	0.0005	0.0006	0.0009	0.0012
				Feed (ipm)	0.1	0.1	0.1	0.1	0.1	0.1	0.1
CAST IRONS Gray, Malleable, Ductile	≤ 220 Bhn or ≤ 19 HRc	105	RPM	3209	2139	1604	1070	802	535	401	
		(84-126)	Fr	0.0006	0.0009	0.0012	0.0018	0.0024	0.0036	0.0047	
			Feed (ipm)	1.9	1.9	1.9	1.9	1.9	1.9	1.9	
	≤ 330 Bhn or ≤ 36 HRc	75	RPM	2292	1528	1146	764	573	382	287	
		(60-90)	Fr	0.0006	0.0009	0.0012	0.0018	0.0024	0.0037	0.0049	
			Feed (ipm)	1.4	1.4	1.4	1.4	1.4	1.4	1.4	

continued on next page

Single Flute Countersink

Series 601 Fractional	Hardness	Vc (sfm)		DC • in							
				1/8	3/16	1/4	3/8	1/2	3/4	1	
N ALUMINUM ALLOYS 2017, 2024, 356, 6061, 7075	≤ 80 Bhn or ≤ 47 HRb	225 (180-270)	RPM	6876	4584	3438	2292	1719	1146	860	
			Fr	0.0008	0.0011	0.0015	0.0023	0.0030	0.0045	0.0061	
			Feed (ipm)	5.2	5.2	5.2	5.2	5.2	5.2	5.2	
	≤ 150 Bhn or ≤ 88 HRb	190 (152-228)	RPM	5806	3871	2903	1935	1452	968	726	
			Fr	0.0008	0.0011	0.0015	0.0023	0.0030	0.0045	0.0061	
			Feed (ipm)	4.4	4.4	4.4	4.4	4.4	4.4	4.4	
	COPPER ALLOYS Alum Bronze, C110, Muntz Brass	≤ 140 Bhn or ≤ 3 HRc	95 (76-114)	RPM	2903	1935	1452	968	726	484	363
				Fr	0.0004	0.0006	0.0008	0.0011	0.0015	0.0023	0.0030
				Feed (ipm)	1.1	1.1	1.1	1.1	1.1	1.1	1.1
		≤ 200 Bhn or ≤ 23 HRc	80 (64-96)	RPM	2445	1630	1222	815	611	407	306
				Fr	0.0004	0.0006	0.0008	0.0012	0.0016	0.0025	0.0033
				Feed (ipm)	1.0	1.0	1.0	1.0	1.0	1.0	1.0
S HIGH TEMP ALLOYS (NICKEL, COBALT, IRON BASE) Inconel 601, 617, 625, Incoloy 800, Monel 400, Rene, Waspaloy	≤ 220 Bhn or ≤ 19 HRc	18 (14-22)	RPM	550	367	275	183	138	92	69	
			Fr	0.0002	0.0003	0.0004	0.0005	0.0007	0.0011	0.0015	
			Feed (ipm)	0.1	0.1	0.1	0.1	0.1	0.1	0.1	
	≤ 320 Bhn or ≤ 34 HRc	14 (11-17)	RPM	428	285	214	143	107	71	53	
			Fr	0.0002	0.0004	0.0005	0.0007	0.0009	0.0014	0.0019	
			Feed (ipm)	0.1	0.1	0.1	0.1	0.1	0.1	0.1	
	≤ 425 Bhn or ≤ 45 HRc	12 (10-14)	RPM	367	244	183	122	92	61	46	
			Fr	0.0003	0.0004	0.0005	0.0008	0.0011	0.0016	0.0022	
			Feed (ipm)	0.1	0.1	0.1	0.1	0.1	0.1	0.1	
	TITANIUM ALLOYS Pure Titanium, Ti6Al4V, Ti6Al2Sn4Zr2Mo, Ti4Al4Mo2Sn0.5Si, Ti-6Al4V	≤ 275 Bhn or ≤ 28 HRc	36 (29-43)	RPM	1100	733	550	367	275	183	138
				Fr	0.0005	0.0007	0.0009	0.0014	0.0018	0.0027	0.0036
				Feed (ipm)	0.5	0.5	0.5	0.5	0.5	0.5	0.5
≤ 350 Bhn or ≤ 38 HRc		28 (22-34)	RPM	856	570	428	285	214	143	107	
			Fr	0.0004	0.0005	0.0007	0.0011	0.0014	0.0021	0.0028	
			Feed (ipm)	0.3	0.3	0.3	0.3	0.3	0.3	0.3	
≤ 440 Bhn or ≤ 47 HRc	21 (17-25)	RPM	642	428	321	214	160	107	80		
		Fr	0.0002	0.0002	0.0003	0.0005	0.0006	0.0009	0.0012		
		Feed (ipm)	0.1	0.1	0.1	0.1	0.1	0.1	0.1		
H TOOL STEELS A2, D2, H13, L2, M2, P20, S7, T15, W2	≤ 475 Bhn or ≤ 50 HRc	20 (16-24)	RPM	611	407	306	204	153	102	76	
			Fr	0.0002	0.0002	0.0003	0.0005	0.0007	0.0010	0.0013	
			Feed (ipm)	0.1	0.1	0.1	0.1	0.1	0.1	0.1	

Bhn (Brinell) HRc (Rockwell C) HRb (Rockwell B)
 rpm = Vc x 3.82 / DC
 ipm = Fr x rpm
 reduce speed and feed for materials harder than listed
 refer to the SGS Tool Wizard® for complete technical information (www.kyocera-sgstool.com)

3 Flute Countersink

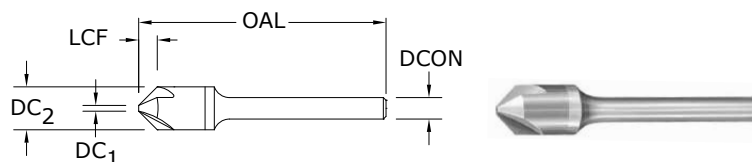

603
FRACTIONAL SERIES

TOLERANCES (inch)

1/8–1/4 DIAMETER

DC = +0.0000/–0.0005

3/8–1 DIAMETER

DC = +0.003/–0.000

Included Angle +1°/–1°

STEELS

STAINLESS STEELS

CAST IRON

NON-FERROUS

HIGH TEMP ALLOYS

HARDENED STEELS

For patent information visit www.ksptpatents.com

CUTTING DIAMETER DC ₂	SHANK DIAMETER DCON	inch			EDP NO.		
		OVERALL LENGTH OAL	FLUTE LENGTH LCF	TIP DIAMETER DC ₁	UNCOATED 60°	UNCOATED 82°	UNCOATED 90°
1/8	1/8	1-1/2	.045	.040	–	–	74225
1/8	1/8	1-1/2	.049	.040	–	74125	–
1/8	1/8	1-1/2	.078	.035	74025	–	–
3/16	3/16	2	.071	.060	–	–	74228
3/16	3/16	2	.073	.060	–	74128	–
3/16	3/16	2	.123	.045	74028	–	–
1/4	1/4	2	.090	.100	–	–	74231
1/4	1/4	2	.086	.100	–	74131	–
1/4	1/4	2	.156	.070	74031	–	–
*3/8	1/4	2-13/16	.138	.108	–	–	74234
*3/8	1/4	2-13/16	.154	.108	–	74134	–
*3/8	1/4	2-13/16	.238	.100	74034	–	–
*1/2	1/4	2-7/8	.194	.122	–	–	74237
*1/2	1/4	2-7/8	.217	.122	–	74137	–
*1/2	1/4	2-7/8	.335	.113	74037	–	–
*5/8	3/8	3	.249	.138	–	–	74240
*5/8	3/8	3	.280	.138	–	74140	–
*5/8	3/8	3	.430	.128	74040	–	–
*3/4	1/2	3	.304	.153	–	–	74243
*3/4	1/2	3	.343	.153	–	74143	–
*3/4	1/2	3	.526	.143	74043	–	–
*1	1/2	3-1/4	.421	.168	–	–	74246
*1	1/2	3-1/4	.479	.168	–	74146	–
*1	1/2	3-1/4	.729	.158	74046	–	–

*Steel Shank / Con mango de acero / Avec queue en acier / Mit Stahlschaft
NOTE: DC₁ dimension varies based on angle. Contact your KSPT representative or consult SGS Tool Wizard® for dimension information.

3 Flute Countersink

Series 603 Fractional	Hardness	Vc (sfm)	DC • in								
			1/8	3/16	1/4	3/8	1/2	3/4	1		
CARBON STEELS 1018, 1040, 1080, 1090, 10L50, 1140, 1212, 12L15, 1525, 1536	≤ 175 Bhn or ≤ 7 HRc	125	RPM	3820	2547	1910	1273	955	637	478	
		(100-150)	Fr	0.0008	0.0012	0.0016	0.0024	0.0031	0.0047	0.0063	
			Feed (ipm)	3.0	3.0	3.0	3.0	3.0	3.0	3.0	
	≤ 300 Bhn or ≤ 32 HRc	60	RPM	1834	1222	917	611	458	306	229	
		(48-72)	Fr	0.0007	0.0011	0.0014	0.0021	0.0028	0.0043	0.0057	
			Feed (ipm)	1.3	1.3	1.3	1.3	1.3	1.3	1.3	
	≤ 425 Bhn or ≤ 45 HRc	45	RPM	1375	917	688	458	344	229	172	
		(36-54)	Fr	0.0004	0.0007	0.0009	0.0013	0.0017	0.0026	0.0035	
			Feed (ipm)	0.6	0.6	0.6	0.6	0.6	0.6	0.6	
	ALLOY STEELS 4140, 4150, 4320, 5120, 5150, 8630, 86L20, 50100	≤ 275 Bhn or ≤ 28 HRc	95	RPM	2903	1935	1452	968	726	484	363
			(76-114)	Fr	0.0007	0.0010	0.0014	0.0021	0.0028	0.0041	0.0055
				Feed (ipm)	2.0	2.0	2.0	2.0	2.0	2.0	2.0
≤ 375 Bhn or ≤ 40 HRc		60	RPM	1834	1222	917	611	458	306	229	
		(48-72)	Fr	0.0007	0.0010	0.0013	0.0020	0.0026	0.0039	0.0052	
			Feed (ipm)	1.2	1.2	1.2	1.2	1.2	1.2	1.2	
≤ 425 Bhn or ≤ 45 HRc		35	RPM	1070	713	535	357	267	178	134	
		(28-42)	Fr	0.0004	0.0006	0.0007	0.0011	0.0015	0.0022	0.0030	
			Feed (ipm)	0.4	0.4	0.4	0.4	0.4	0.4	0.4	
TOOL STEELS A2, D2, H13, L2, M2, P20, S7, T15, W2		≤ 250 Bhn or ≤ 24 HRc	35	RPM	1070	713	535	357	267	178	134
			(28-42)	Fr	0.0004	0.0006	0.0007	0.0011	0.0015	0.0022	0.0030
				Feed (ipm)	0.4	0.4	0.4	0.4	0.4	0.4	0.4
	≤ 375 Bhn or ≤ 40 HRc	25	RPM	764	509	382	255	191	127	96	
		(20-30)	Fr	0.0003	0.0004	0.0005	0.0008	0.0010	0.0016	0.0021	
			Feed (ipm)	0.2	0.2	0.2	0.2	0.2	0.2	0.2	
STAINLESS STEELS (FREE MACHINING) 303, 416, 420F, 430F 440F	≤ 250 Bhn or ≤ 24 HRc	53	RPM	1620	1080	810	540	405	270	202	
		(42-64)	Fr	0.0004	0.0006	0.0009	0.0013	0.0017	0.0026	0.0035	
			Feed (ipm)	0.7	0.7	0.7	0.7	0.7	0.7	0.7	
	≤ 330 Bhn or ≤ 36 HRc	46	RPM	1406	937	703	469	351	234	176	
		(37-55)	Fr	0.0004	0.0005	0.0007	0.0011	0.0014	0.0021	0.0028	
			Feed (ipm)	0.5	0.5	0.5	0.5	0.5	0.5	0.5	
	STAINLESS STEELS (DIFFICULT) 304, 316, 321, 13-8 PH, 15-5PH, 17-4 PH, Custom 450	≤ 275 Bhn or ≤ 28 HRc	28	RPM	856	570	428	285	214	143	107
			(22-34)	Fr	0.0005	0.0007	0.0009	0.0014	0.0019	0.0028	0.0037
				Feed (ipm)	0.4	0.4	0.4	0.4	0.4	0.4	0.4
		≤ 375 Bhn or ≤ 40 HRc	21	RPM	642	428	321	214	160	107	80
			(17-25)	Fr	0.0002	0.0002	0.0003	0.0005	0.0006	0.0009	0.0012
				Feed (ipm)	0.1	0.1	0.1	0.1	0.1	0.1	0.1
CAST IRONS Gray, Malleable, Ductile	≤ 220 Bhn or ≤ 19 HRc	105	RPM	3209	2139	1604	1070	802	535	401	
		(84-126)	Fr	0.0009	0.0014	0.0018	0.0027	0.0036	0.0054	0.0072	
			Feed (ipm)	2.9	2.9	2.9	2.9	2.9	2.9	2.9	
	≤ 330 Bhn or ≤ 36 HRc	75	RPM	2292	1528	1146	764	573	382	287	
		(60-90)	Fr	0.0009	0.0014	0.0018	0.0027	0.0037	0.0055	0.0073	
			Feed (ipm)	2.1	2.1	2.1	2.1	2.1	2.1	2.1	

continued on next page

3 Flute Countersink

Series 603 Fractional	Hardness	Vc (sfm)		DC • in							
				1/8	3/16	1/4	3/8	1/2	3/4	1	
N	ALUMINUM ALLOYS 2017, 2024, 356, 6061, 7075	≤ 80 Bhn or ≤ 47 HRb	225	RPM	6876	4584	3438	2292	1719	1146	860
			(180-270)	Fr	0.0011	0.0017	0.0023	0.0034	0.0045	0.0068	0.0091
			Feed (ipm)	7.8	7.8	7.8	7.8	7.8	7.8	7.8	
		≤ 150 Bhn or ≤ 88 HRb	190	RPM	5806	3871	2903	1935	1452	968	726
			(152-228)	Fr	0.0011	0.0017	0.0022	0.0034	0.0045	0.0067	0.0090
			Feed (ipm)	6.5	6.5	6.5	6.5	6.5	6.5	6.5	
	COPPER ALLOYS Alum Bronze, C110, Muntz Brass	≤ 140 Bhn or ≤ 3 HRc	95	RPM	2903	1935	1452	968	726	484	363
			(76-114)	Fr	0.0006	0.0009	0.0012	0.0018	0.0023	0.0035	0.0047
			Feed (ipm)	1.7	1.7	1.7	1.7	1.7	1.7	1.7	
		≤ 200 Bhn or ≤ 23 HRc	80	RPM	2445	1630	1222	815	611	407	306
			(64-96)	Fr	0.0006	0.0009	0.0011	0.0017	0.0023	0.0034	0.0046
			Feed (ipm)	1.4	1.4	1.4	1.4	1.4	1.4	1.4	
S	HIGH TEMP ALLOYS (NICKEL, COBALT, IRON BASE) Inconel 601, 617, 625, Incoloy 800, Monel 400, Rene, Waspaloy	≤ 220 Bhn or ≤ 19 HRc	18	RPM	550	367	275	183	138	92	69
			(14-22)	Fr	0.0004	0.0005	0.0007	0.0011	0.0015	0.0022	0.0029
			Feed (ipm)	0.2	0.2	0.2	0.2	0.2	0.2	0.2	
		≤ 320 Bhn or ≤ 34 HRc	14	RPM	428	285	214	143	107	71	53
			(11-17)	Fr	0.0002	0.0004	0.0005	0.0007	0.0009	0.0014	0.0019
			Feed (ipm)	0.1	0.1	0.1	0.1	0.1	0.1	0.1	
	≤ 425 Bhn or ≤ 45 HRc	12	RPM	367	244	183	122	92	61	46	
		(10-14)	Fr	0.0003	0.0004	0.0005	0.0008	0.0011	0.0016	0.0022	
		Feed (ipm)	0.1	0.1	0.1	0.1	0.1	0.1	0.1		
	TITANIUM ALLOYS Pure Titanium, Ti6Al4V, Ti6Al2Sn4Zr2Mo, Ti4Al4Mo2Sn0.5Si, Ti-6Al4V	≤ 275 Bhn or ≤ 28 HRc	36	RPM	1100	733	550	367	275	183	138
			(29-43)	Fr	0.0007	0.0011	0.0015	0.0022	0.0029	0.0044	0.0058
			Feed (ipm)	0.8	0.8	0.8	0.8	0.8	0.8	0.8	
≤ 350 Bhn or ≤ 38 HRc		28	RPM	856	570	428	285	214	143	107	
		(22-34)	Fr	0.0006	0.0009	0.0012	0.0018	0.0023	0.0035	0.0047	
		Feed (ipm)	0.5	0.5	0.5	0.5	0.5	0.5	0.5		
≤ 440 Bhn or ≤ 47 HRc	21	RPM	642	428	321	214	160	107	80		
	(17-25)	Fr	0.0002	0.0002	0.0003	0.0005	0.0006	0.0009	0.0012		
	Feed (ipm)	0.1	0.1	0.1	0.1	0.1	0.1	0.1			
H	TOOL STEELS A2, D2, H13, L2, M2, P20, S7, T15, W2	≤ 475 Bhn or ≤ 50 HRc	20	RPM	611	407	306	204	153	102	76
			(16-24)	Fr	0.0002	0.0002	0.0003	0.0005	0.0007	0.0010	0.0013
			Feed (ipm)	0.1	0.1	0.1	0.1	0.1	0.1	0.1	

Bhn (Brinell) HRc (Rockwell C) HRb (Rockwell B)
 rpm = Vc x 3.82 / DC
 ipm = Fr x rpm
 reduce speed and feed for materials harder than listed
 refer to the SGS Tool Wizard® for complete technical information (www.kyocera-sgstool.com)

6 Flute Countersink

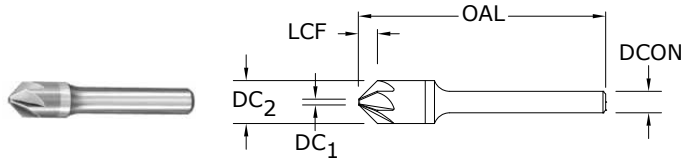

606

FRACTIONAL SERIES

CUTTING DIAMETER DC ₂	SHANK DIAMETER DCON	inch			EDP NO.		
		OVERALL LENGTH OAL	FLUTE LENGTH LCF	TIP DIAMETER DC ₁	UNCOATED 60°	UNCOATED 82°	UNCOATED 90°
1/8	1/8	1-1/2	.045	.035	—	—	74249
1/8	1/8	1-1/2	.052	.035	—	74149	—
1/8	1/8	1-1/2	.078	.035	74049	—	—
3/16	3/16	2	.071	.045	—	—	74252
3/16	3/16	2	.082	.045	—	74152	—
3/16	3/16	2	.123	.045	74052	—	—
1/4	1/4	2	.090	.070	—	—	74255
1/4	1/4	2	.104	.070	—	74155	—
1/4	1/4	2	.156	.070	74055	—	—
*3/8	1/4	2-13/16	.138	.100	—	—	74258
*3/8	1/4	2-13/16	.158	.100	—	74158	—
*3/8	1/4	2-13/16	.238	.100	74058	—	—
*1/2	1/4	2-7/8	.170	.160	—	—	74261
*1/2	1/4	2-7/8	.196	.160	—	74161	—
*1/2	1/4	2-7/8	.294	.160	74061	—	—
*5/8	3/8	3	.218	.190	—	—	74264
*5/8	3/8	3	.250	.190	—	74164	—
*5/8	3/8	3	.377	.190	74064	—	—
*3/4	1/2	3	.265	.220	—	—	74267
*3/4	1/2	3	.305	.220	—	74167	—
*3/4	1/2	3	.459	.220	74067	—	—
*1	1/2	3-1/4	.370	.260	—	—	74270
*1	1/2	3-1/4	.426	.260	—	74170	—
*1	1/2	3-1/4	.641	.260	74070	—	—

*Steel Shank / Con mango de acero / Avec queue en acier / Mit Stahlschaft
 NOTE: DC₁ dimension varies based on angle. Contact your KSPT representative or consult SGS Tool Wizard® for dimension information.

TOLERANCES (inch)

1/8–1/4 DIAMETER
 DC = +0.0000/–0.0005

3/8–1 DIAMETER
 DC = +0.003/–0.000

Included Angle +1°/–1°

- STEELS
- STAINLESS STEELS
- CAST IRON
- NON-FERROUS
- HIGH TEMP ALLOYS
- HARDENED STEELS

For patent information visit www.ksptpatents.com

6 Flute Countersink

Series 606 Fractional	Hardness	Vc (sfm)	DC • in								
			1/8	3/16	1/4	3/8	1/2	3/4	1		
CARBON STEELS 1018, 1040, 1080, 1090, 10L50, 1140, 1212, 12L15, 1525, 1536	≤ 175 Bhn or ≤ 7 HRc	125	RPM	3820	2547	1910	1273	955	637	478	
		(100-150)	Fr	0.0010	0.0016	0.0021	0.0031	0.0042	0.0063	0.0084	
			Feed (ipm)	4.0	4.0	4.0	4.0	4.0	4.0	4.0	
	≤ 300 Bhn or ≤ 32 HRc	60	RPM	1834	1222	917	611	458	306	229	
		(48-72)	Fr	0.0010	0.0015	0.0020	0.0029	0.0039	0.0059	0.0079	
			Feed (ipm)	1.8	1.8	1.8	1.8	1.8	1.8	1.8	
	≤ 425 Bhn or ≤ 45 HRc	45	RPM	1375	917	688	458	344	229	172	
		(36-54)	Fr	0.0006	0.0009	0.0012	0.0017	0.0023	0.0035	0.0047	
			Feed (ipm)	0.8	0.8	0.8	0.8	0.8	0.8	0.8	
	ALLOY STEELS 4140, 4150, 4320, 5120, 5150, 8630, 86L20, 50100	≤ 275 Bhn or ≤ 28 HRc	95	RPM	2903	1935	1452	968	726	484	363
			(76-114)	Fr	0.0009	0.0013	0.0018	0.0027	0.0036	0.0054	0.0072
				Feed (ipm)	2.6	2.6	2.6	2.6	2.6	2.6	2.6
≤ 375 Bhn or ≤ 40 HRc		60	RPM	1834	1222	917	611	458	306	229	
		(48-72)	Fr	0.0009	0.0014	0.0019	0.0028	0.0037	0.0056	0.0074	
			Feed (ipm)	1.7	1.7	1.7	1.7	1.7	1.7	1.7	
≤ 425 Bhn or ≤ 45 HRc		35	RPM	1070	713	535	357	267	178	134	
		(28-42)	Fr	0.0006	0.0008	0.0011	0.0017	0.0022	0.0034	0.0045	
			Feed (ipm)	0.6	0.6	0.6	0.6	0.6	0.6	0.6	
TOOL STEELS A2, D2, H13, L2, M2, P20, S7, T15, W2		≤ 250 Bhn or ≤ 24 HRc	35	RPM	1070	713	535	357	267	178	134
			(28-42)	Fr	0.0006	0.0008	0.0011	0.0017	0.0022	0.0034	0.0045
				Feed (ipm)	0.6	0.6	0.6	0.6	0.6	0.6	0.6
	≤ 375 Bhn or ≤ 40 HRc	25	RPM	764	509	382	255	191	127	96	
		(20-30)	Fr	0.0003	0.0004	0.0005	0.0008	0.0010	0.0016	0.0021	
			Feed (ipm)	0.2	0.2	0.2	0.2	0.2	0.2	0.2	
STAINLESS STEELS (FREE MACHINING) 303, 416, 420F, 430F 440F	≤ 250 Bhn or ≤ 24 HRc	53	RPM	1620	1080	810	540	405	270	202	
		(42-64)	Fr	0.0006	0.0009	0.0012	0.0019	0.0025	0.0037	0.0049	
			Feed (ipm)	1.0	1.0	1.0	1.0	1.0	1.0	1.0	
	≤ 330 Bhn or ≤ 36 HRc	46	RPM	1406	937	703	469	351	234	176	
		(37-55)	Fr	0.0005	0.0007	0.0010	0.0015	0.0020	0.0030	0.0040	
			Feed (ipm)	0.7	0.7	0.7	0.7	0.7	0.7	0.7	
	STAINLESS STEELS (DIFFICULT) 304, 316, 321, 13-8 PH, 15-5PH, 17-4 PH, Custom 450	≤ 275 Bhn or ≤ 28 HRc	28	RPM	856	570	428	285	214	143	107
			(22-34)	Fr	0.0007	0.0011	0.0014	0.0021	0.0028	0.0042	0.0056
				Feed (IPM)	0.6	0.6	0.6	0.6	0.6	0.6	0.6
		≤ 375 Bhn or ≤ 40 HRc	21	RPM	642	428	321	214	160	107	80
			(17-25)	Fr	0.0003	0.0005	0.0006	0.0009	0.0012	0.0019	0.0025
				Feed (IPM)	0.2	0.2	0.2	0.2	0.2	0.2	0.2

continued on next page

6 Flute Countersink

Series 606 Fractional	Hardness	Vc (sfm)		DC • in							
				1/8	3/16	1/4	3/8	1/2	3/4	1	
K CAST IRONS Gray, Malleable, Ductile	≤ 220 Bhn or ≤ 19 HRc	105 (84-126)	RPM	3209	2139	1604	1070	802	535	401	
			Fr	0.0012	0.0018	0.0024	0.0036	0.0049	0.0073	0.0097	
			Feed (ipm)	3.9	3.9	3.9	3.9	3.9	3.9	3.9	
	≤ 330 Bhn or ≤ 36 HRc	75 (60-90)	RPM	2292	1528	1146	764	573	382	287	
			Fr	0.0012	0.0018	0.0024	0.0037	0.0049	0.0073	0.0098	
			Feed (ipm)	2.8	2.8	2.8	2.8	2.8	2.8	2.8	
	N ALUMINUM ALLOYS 2017, 2024, 356, 6061, 7075	≤ 80 Bhn or ≤ 47 HRb	225 (180-270)	RPM	6876	4584	3438	2292	1719	1146	860
				Fr	0.0015	0.0022	0.0030	0.0045	0.0060	0.0090	0.0120
				Feed (ipm)	10.3	10.3	10.3	10.3	10.3	10.3	10.3
≤ 150 Bhn or ≤ 88 HRb		190 (152-228)	RPM	5806	3871	2903	1935	1452	968	726	
			Fr	0.0015	0.0022	0.0030	0.0045	0.0060	0.0090	0.0120	
			Feed (ipm)	8.7	8.7	8.7	8.7	8.7	8.7	8.7	
COPPER ALLOYS Alum Bronze, C110, Muntz Brass		≤ 140 Bhn or ≤ 3 HRc	95 (76-114)	RPM	2903	1935	1452	968	726	484	363
				Fr	0.0008	0.0011	0.0015	0.0023	0.0030	0.0045	0.0061
				Feed (ipm)	2.2	2.2	2.2	2.2	2.2	2.2	2.2
	≤ 200 Bhn or ≤ 23 HRc	80 (64-96)	RPM	2445	1630	1222	815	611	407	306	
			Fr	0.0008	0.0012	0.0016	0.0023	0.0031	0.0047	0.0062	
			Feed (ipm)	1.9	1.9	1.9	1.9	1.9	1.9	1.9	

continued on next page

6 Flute Countersink

Series 606 Fractional	Hardness	Vc (sfm)		DC • in							
				1/8	3/16	1/4	3/8	1/2	3/4	1	
S	HIGH TEMP ALLOYS (NICKEL, COBALT, IRON BASE) Inconel 601, 617, 625, Incoloy 800, Monel 400, Rene, Waspaloy	≤ 220 Bhn or ≤ 19 HRc	18	RPM	550	367	275	183	138	92	69
			(14-22)	Fr	0.0005	0.0008	0.0011	0.0016	0.0022	0.0033	0.0044
				Feed (ipm)	0.3	0.3	0.3	0.3	0.3	0.3	0.3
		≤ 320 Bhn or ≤ 34 HRc	14	RPM	428	285	214	143	107	71	53
			(11-17)	Fr	0.0005	0.0007	0.0009	0.0014	0.0019	0.0028	0.0037
				Feed (ipm)	0.2	0.2	0.2	0.2	0.2	0.2	0.2
	≤ 425 Bhn or ≤ 45 HRc	12	RPM	367	244	183	122	92	61	46	
		(10-14)	Fr	0.0003	0.0004	0.0005	0.0008	0.0011	0.0016	0.0022	
			Feed (ipm)	0.1	0.1	0.1	0.1	0.1	0.1	0.1	
	TITANIUM ALLOYS Pure Titanium, Ti6Al4V, Ti6Al2Sn4Zr2Mo, Ti4Al4Mo2Sn0.5Si, Ti-6Al4V	≤ 275 Bhn or ≤ 28 HRc	36	RPM	1100	733	550	367	275	183	138
			(29-43)	Fr	0.0009	0.0014	0.0018	0.0027	0.0036	0.0055	0.0073
				Feed (ipm)	1.0	1.0	1.0	1.0	1.0	1.0	1.0
≤ 350 Bhn or ≤ 38 HRc		28	RPM	856	570	428	285	214	143	107	
		(22-34)	Fr	0.0007	0.0011	0.0014	0.0021	0.0028	0.0042	0.0056	
			Feed (ipm)	0.6	0.6	0.6	0.6	0.6	0.6	0.6	
≤ 440 Bhn or ≤ 47 HRc	21	RPM	642	428	321	214	160	107	80		
	(17-25)	Fr	0.0003	0.0005	0.0006	0.0009	0.0012	0.0019	0.0025		
		Feed (ipm)	0.2	0.2	0.2	0.2	0.2	0.2	0.2		
H	TOOL STEELS A2, D2, H13, L2, M2, P20, S7, T15, W2	≤ 475 Bhn or ≤ 50 HRc	20	RPM	611	407	306	204	153	102	76
			(16-24)	Fr	0.0003	0.0005	0.0007	0.0010	0.0013	0.0020	0.0026
				Feed (ipm)	0.2	0.2	0.2	0.2	0.2	0.2	0.2

Bhn (Brinell) HRc (Rockwell C) HRb (Rockwell B)
 rpm = Vc x 3.82 / DC
 ipm = Fr x rpm
 reduce speed and feed for materials harder than listed
 refer to the SGS Tool Wizard® for complete technical information (www.kyocera-sgstool.com)

Straight Flute Accu-Reamer



200

FRACTIONAL SERIES

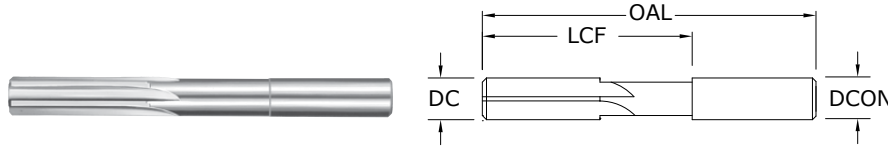

inch					EDP NO.
CUTTING DIAMETER DC	SHANK DIAMETER DCON	MAXIMUM REAM LENGTH LCF	OVERALL LENGTH OAL	NO. OF FLUTES	UNCOATED
3/64	3/64	3/4	1-1/2	4	70003
1/16	1/16	3/4	1-1/2	4	70004
5/64	5/64	1	2	4	70005
3/32	3/32	1-1/4	2-1/4	4	70006
7/64	7/64	1-1/4	2-1/4	4	70007
1/8	1/8	1-1/4	2-1/4	4	70008
9/64	9/64	1-1/2	2-1/2	4	70009
5/32	5/32	1-1/2	2-1/2	4	70010
11/64	11/64	1-3/4	2-3/4	4	70011
3/16	3/16	1-3/4	2-3/4	4	70012
13/64	13/64	2	3	4	70013
7/32	7/32	2	3	4	70014
15/64	15/64	2	3	4	70015
1/4	1/4	2	3	4	70016
17/64	17/64	2-1/4	3-1/4	6	70017
9/32	9/32	2-1/4	3-1/4	6	70018
19/64	19/64	2-1/4	3-1/4	6	70019
5/16	5/16	2-1/4	3-1/4	6	70020
21/64	21/64	2-3/8	3-1/2	6	70021
11/32	11/32	2-3/8	3-1/2	6	70022
23/64	23/64	2-3/8	3-1/2	6	70023
3/8	3/8	2-3/8	3-1/2	6	70024
25/64	25/64	2-7/8	4	6	70025
13/32	13/32	2-7/8	4	6	70026
27/64	27/64	2-7/8	4	6	70027
7/16	7/16	2-7/8	4	6	70028
29/64	29/64	2-7/8	4	6	70029
15/32	15/32	2-7/8	4	6	70030
31/64	31/64	2-7/8	4	6	70031
1/2	1/2	2-7/8	4	6	70032

TOLERANCES (inch)

DC = +0.0002/-0.0000
 DCON = +0.0002/-0.0000

- STEELS
- STAINLESS STEELS
- CAST IRON
- NON-FERROUS
- HIGH TEMP ALLOYS
- HARDENED STEELS

For patent information visit www.ksptpatents.com

continued on next page

Straight Flute Accu-Reamer

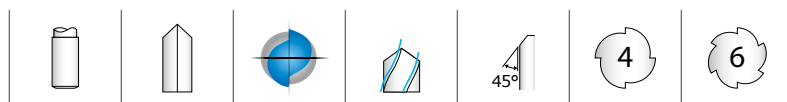

200
FRACTIONAL SERIES

inch				NO. OF FLUTES
CUTTING DIAMETER DC	SHANK DIAMETER DCON	MAXIMUM REAM LENGTH LCF	OVERALL LENGTH OAL	
.0470 – .0625	1/16	3/4	1-1/2	4
.0626 – .0781	5/64	1	2	4
.0782 – .0938	3/32	1-1/4	2-1/4	4
.0939 – .1094	7/64	1-1/4	2-1/4	4
.1095 – .1250	1/8	1-1/4	2-1/4	4
.1251 – .1406	9/64	1-1/2	2-1/2	4
.1407 – .1562	5/32	1-1/2	2-1/2	4
.1563 – .1719	11/64	1-3/4	2-3/4	4
.1720 – .1875	3/16	1-3/4	2-3/4	4
.1876 – .2031	13/64	2	3	4
.2032 – .2188	7/32	2	3	4
.2189 – .2344	15/64	2	3	4
.2345 – .2500	1/4	2	3	4
.2501 – .2656	17/64	2-1/4	3-1/4	6
.2657 – .2812	9/32	2-1/4	3-1/4	6
.2813 – .2969	19/64	2-1/4	3-1/4	6
.2970 – .3125	5/16	2-1/4	3-1/4	6
.3126 – .3281	21/64	2-3/8	3-1/2	6
.3282 – .3438	11/32	2-3/8	3-1/2	6
.3439 – .3594	23/64	2-3/8	3-1/2	6
.3595 – .3750	3/8	2-3/8	3-1/2	6
.3751 – .3906	25/64	2-7/8	4	6
.3907 – .4062	13/32	2-7/8	4	6
.4063 – .4219	27/64	2-7/8	4	6
.4220 – .4375	7/16	2-7/8	4	6
.4376 – .4531	29/64	2-7/8	4	6
.4532 – .4688	15/32	2-7/8	4	6
.4689 – .4844	31/64	2-7/8	4	6
.4845 – .5000	1/2	2-7/8	4	6

CONTINUED

SER 200 Fractional reamers can be ordered to specific diameters according to the size range of Cutting Diameter DC. Please order as:

- 200. Then the size of the cut diameter in fractional format.
- i.e. 200.0492
- Description: Series 200 size 0.0492
- For Metric sizes convert to fractional inches (i.e. $\div 25.4$)
- The above sample would be a 1.25mm size ($1.25 \div 25.4 = 0.0492$)

All other dimensions are fractional as per table including the Shank

Straight Flute Accu-Reamer

Series 200 Fractional	Hardness	Vc (sfm)	DC • in								
			1/16	1/8	3/16	1/4	5/16	3/8	1/2		
CARBON STEELS 1018, 1040, 1080, 1090, 10L50, 1140, 1212, 12L15, 1525, 1536	≤ 175 Bhn or ≤ 7 HRc	150	RPM	9168	4584	3056	2292	1834	1528	1146	
		(120-180)	Fr	0.0018	0.0035	0.0053	0.0071	0.0088	0.0106	0.0141	
			Feed (ipm)	16.5	16.0	16.2	16.3	16.1	16.2	16.2	
	≤ 300 Bhn or ≤ 32 HRc	75	RPM	4584	2292	1528	1146	917	764	573	
		(60-90)	Fr	0.0016	0.0031	0.0047	0.0062	0.0078	0.0093	0.0124	
			Feed (ipm)	7.3	7.1	7.2	7.1	7.2	7.1	7.1	
	≤ 425 Bhn or ≤ 45 HRc	55	RPM	3362	1681	1121	840	672	560	420	
		(44-66)	Fr	0.0009	0.0019	0.0028	0.0037	0.0046	0.0056	0.0074	
			Feed (ipm)	3.0	3.2	3.1	3.1	3.1	3.1	3.1	
	P ALLOY STEELS 4140, 4150, 4320, 5120, 5150, 8630, 86L20, 50100	≤ 275 Bhn or ≤ 28 HRc	115	RPM	7029	3514	2343	1757	1406	1171	879
			(92-138)	Fr	0.0015	0.0030	0.0045	0.0060	0.0075	0.0090	0.0120
				Feed (ipm)	10.5	10.5	10.5	10.5	10.5	10.5	10.5
≤ 375 Bhn or ≤ 40 HRc		70	RPM	4278	2139	1426	1070	856	713	535	
		(56-84)	Fr	0.0015	0.0030	0.0045	0.0060	0.0075	0.0090	0.0120	
			Feed (ipm)	6.4	6.4	6.4	6.4	6.4	6.4	6.4	
≤ 425 Bhn or ≤ 45 HRc		45	RPM	2750	1375	917	688	550	458	344	
		(36-54)	Fr	0.0009	0.0019	0.0028	0.0037	0.0046	0.0056	0.0074	
			Feed (ipm)	2.5	2.6	2.6	2.5	2.5	2.6	2.5	
TOOL STEELS A2, D2, H13, L2, M2, P20, S7, T15, W2		≤ 250 Bhn or ≤ 24 HRc	40	RPM	2445	1222	815	611	489	407	306
			(32-48)	Fr	0.0010	0.0020	0.0029	0.0039	0.0049	0.0059	0.0078
				Feed (ipm)	2.4	2.4	2.4	2.4	2.4	2.4	2.4
	≤ 375 Bhn or ≤ 40 HRc	25	RPM	1528	764	509	382	306	255	191	
		(20-30)	Fr	0.0006	0.0013	0.0019	0.0025	0.0031	0.0038	0.0050	
			Feed (ipm)	0.9	1.0	1.0	1.0	0.9	1.0	1.0	
M STAINLESS STEELS (FREE MACHINING) 303, 416, 420F, 430F 440F	≤ 250 Bhn or ≤ 24 HRc	75	RPM	4584	2292	1528	1146	917	764	573	
		(60-90)	Fr	0.0010	0.0020	0.0029	0.0039	0.0049	0.0059	0.0078	
			Feed (ipm)	4.6	4.6	4.4	4.5	4.5	4.5	4.5	
	≤ 330 Bhn or ≤ 36 HRc	55	RPM	3362	1681	1121	840	672	560	420	
		(44-66)	Fr	0.0008	0.0015	0.0023	0.0030	0.0038	0.0045	0.0060	
			Feed (ipm)	2.7	2.5	2.6	2.5	2.6	2.5	2.5	
	STAINLESS STEELS (DIFFICULT) 304, 316, 321, 13-8 PH, 15-5PH, 17-4 PH, Custom 450	≤ 275 Bhn or ≤ 28 HRc	35	RPM	2139	1070	713	535	428	357	267
			(28-42)	Fr	0.0010	0.0020	0.0029	0.0039	0.0049	0.0059	0.0078
				Feed (ipm)	2.1	2.1	2.1	2.1	2.1	2.1	2.1
		≤ 375 Bhn or ≤ 40 HRc	25	RPM	1528	764	509	382	306	255	191
			(20-30)	Fr	0.0006	0.0013	0.0019	0.0025	0.0031	0.0038	0.0050
				Feed (ipm)	0.9	1.0	1.0	1.0	0.9	1.0	1.0
K CAST IRONS Gray, Malleable, Ductile	≤ 220 Bhn or ≤ 19 HRc	125	RPM	7640	3820	2547	1910	1528	1273	955	
		(100-150)	Fr	0.0020	0.0040	0.0060	0.0081	0.0101	0.0121	0.0161	
			Feed (ipm)	15.3	15.3	15.3	15.5	15.4	15.4	15.4	
	≤ 330 Bhn or ≤ 36 HRc	95	RPM	5806	2903	1935	1452	1161	968	726	
		(76-114)	Fr	0.0020	0.0040	0.0060	0.0081	0.0101	0.0121	0.0161	
			Feed (ipm)	11.6	11.6	11.6	11.8	11.7	11.7	11.7	

continued on next page

Straight Flute Accu-Reamer

Series 200 Fractional	Hardness	Vc (sfm)		DC • in							
				1/16	1/8	3/16	1/4	5/16	3/8	1/2	
N ALUMINUM ALLOYS 2017, 2024, 356, 6061, 7075	≤ 80 Bhn or ≤ 47 HRb	270 (216-324)	RPM	16502	8251	5501	4126	3300	2750	2063	
			Fr	0.0025	0.0050	0.0075	0.0100	0.0125	0.0150	0.0200	
			Feed (ipm)	41.3	41.3	41.3	41.3	41.3	41.3	41.3	
	≤ 150 Bhn or ≤ 88 HRb	230 (184-276)	RPM	14058	7029	4686	3514	2812	2343	1757	
			Fr	0.0025	0.0050	0.0075	0.0100	0.0125	0.0150	0.0200	
			Feed (ipm)	35.1	35.1	35.1	35.1	35.1	35.1	35.1	
	COPPER ALLOYS Alum Bronze, C110, Muntz Brass	≤ 140 Bhn or ≤ 3 HRc	115 (92-138)	RPM	7029	3514	2343	1757	1406	1171	879
				Fr	0.0013	0.0026	0.0038	0.0051	0.0064	0.0077	0.0102
				Feed (ipm)	9.1	9.1	8.9	9.0	9.0	9.0	9.0
		≤ 200 Bhn or ≤ 23 HRc	95 (76-114)	RPM	5806	2903	1935	1452	1161	968	726
				Fr	0.0013	0.0026	0.0038	0.0051	0.0064	0.0077	0.0102
				Feed (ipm)	7.5	7.5	7.4	7.4	7.4	7.5	7.4
S HIGH TEMP ALLOYS (NICKEL, COBALT, IRON BASE) Inconel 601, 617, 625, Incoloy 800, Monel 400, Rene, Waspaloy	≤ 220 Bhn or ≤ 19 HRc	20 (16-24)	RPM	1222	611	407	306	244	204	153	
			Fr	0.0008	0.0015	0.0023	0.0030	0.0038	0.0045	0.0060	
			Feed (ipm)	1.0	0.9	0.9	0.9	0.9	0.9	0.9	
	≤ 320 Bhn or ≤ 34 HRc	15 (12-18)	RPM	917	458	306	229	183	153	115	
			Fr	0.0006	0.0013	0.0019	0.0025	0.0031	0.0038	0.0050	
			Feed (ipm)	0.6	0.6	0.6	0.6	0.6	0.6	0.6	
	≤ 425 Bhn or ≤ 45 HRc	10 (8-12)	RPM	611	306	204	153	122	102	76	
			Fr	0.0004	0.0007	0.0011	0.0015	0.0018	0.0022	0.0029	
			Feed (ipm)	0.2	0.2	0.2	0.2	0.2	0.2	0.2	
	TITANIUM ALLOYS Pure Titanium, Ti6Al4V, Ti6Al2Sn4Zr2Mo, Ti4Al4Mo2Sn0.5Si, Ti-6Al4V	≤ 275 Bhn or ≤ 28 HRc	45 (36-54)	RPM	2750	1375	917	688	550	458	344
				Fr	0.0015	0.0030	0.0045	0.0060	0.0075	0.0090	0.0120
				Feed (ipm)	4.1	4.1	4.1	4.1	4.1	4.1	4.1
≤ 350 Bhn or ≤ 38 HRc		35 (28-42)	RPM	2139	1070	713	535	428	357	267	
			Fr	0.0010	0.0020	0.0029	0.0039	0.0049	0.0059	0.0078	
			Feed (ipm)	2.1	2.1	2.1	2.1	2.1	2.1	2.1	
≤ 440 Bhn or ≤ 47 HRc	25 (20-30)	RPM	1528	764	509	382	306	255	191		
		Fr	0.0006	0.0013	0.0019	0.0025	0.0031	0.0038	0.0050		
		Feed (ipm)	0.9	1.0	1.0	1.0	0.9	1.0	1.0		
H TOOL STEELS A2, D2, H13, L2, M2, P20, S7, T15, W2	≤ 475 Bhn or ≤ 50 HRc	20 (16-24)	RPM	1222	611	407	306	244	204	153	
			Fr	0.0004	0.0008	0.0012	0.0016	0.0019	0.0023	0.0031	
			Feed (ipm)	0.5	0.5	0.5	0.5	0.5	0.5	0.5	
	≤ 655 Bhn or ≤ 60 HRc	14 (11-17)	RPM	856	428	285	214	171	143	107	
			Fr	0.0003	0.0007	0.0011	0.0014	0.0018	0.0021	0.0028	
			Feed (ipm)	0.3	0.3	0.3	0.3	0.3	0.3	0.3	

Bhn (Brinell) HRc (Rockwell C) HRb (Rockwell B)

rpm = Vc x 3.82 / DC

ipm = Fr x rpm

increase speed and feed 30 percent when using coated reamers

reduce speed and feed for materials harder than listed

refer to the SGS Tool Wizard® for complete technical information (www.kyocera-sgstool.com)

METRIC

Straight Flute Reamer



201M
METRIC SERIES

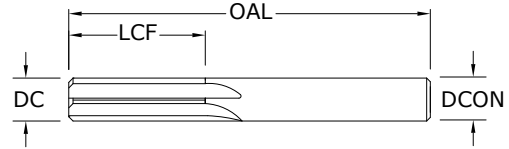

CUTTING DIAMETER DC	SHANK DIAMETER DCON	mm		NO. OF FLUTES	EDP NO.
		MAXIMUM REAM LENGTH LCF	OVERALL LENGTH OAL		UNCOATED
1,0	1,0	6,0	32,0	4	81001
1,5	1,5	9,5	38,0	4	81003
2,0	2,0	12,7	44,0	4	81005
2,5	2,5	12,7	50,0	4	81007
3,0	3,0	16,0	57,0	4	81009
3,5	3,5	19,0	63,0	4	81011
4,0	4,0	19,0	63,0	4	81013
4,5	4,5	22,0	70,0	4	81015
5,0	5,0	25,0	75,0	4	81017
5,5	5,5	25,0	75,0	4	81019
6,0	6,0	25,0	75,0	4	81021
7,0	7,0	28,0	82,0	6	81023
8,0	8,0	28,0	82,0	6	81025
9,0	9,0	31,0	89,0	6	81027
10,0	10,0	31,0	89,0	6	81029

TOLERANCES (mm)

1-6 DIAMETER
DC = +0,008/-0,000
>6-10 DIAMETER
DC = +0,010/-0,000

- STEELS
- STAINLESS STEELS
- CAST IRON
- NON-FERROUS
- HIGH TEMP ALLOYS
- HARDENED STEELS

For patent information visit www.ksptpatents.com

Straight Flute Reamer

Series 201M Metric	Hardness	Vc (m/min)	DC • mm								
			1	2	3	4	6	8	10		
CARBON STEELS 1018, 1040, 1080, 1090, 10L50, 1140, 1212, 12L15, 1525, 1536	≤ 175 Bhn or ≤ 7 HRc	46	RPM	14541	7271	4847	3635	2424	1818	1454	
		(37-55)	Fr	0.028	0.056	0.085	0.113	0.169	0.226	0.282	
			Feed (mm/min)	410	410	410	410	410	410	410	
	≤ 300 Bhn or ≤ 32 HRc	23	RPM	7271	3635	2424	1818	1212	909	727	
		(18-27)	Fr	0.025	0.050	0.074	0.099	0.149	0.198	0.248	
			Feed (mm/min)	180	180	180	180	180	180	180	
	≤ 425 Bhn or ≤ 45 HRc	17	RPM	5332	2666	1777	1333	889	666	533	
		(13-20)	Fr	0.015	0.030	0.044	0.059	0.089	0.119	0.148	
			Feed (mm/min)	79	79	79	79	79	79	79	
	ALLOY STEELS 4140, 4150, 4320, 5120, 5150, 8630, 86L20, 50100	≤ 275 Bhn or ≤ 28 HRc	35	RPM	11148	5574	3716	2787	1858	1394	1115
			(28-42)	Fr	0.024	0.048	0.072	0.096	0.144	0.192	0.240
				Feed (mm/min)	268	268	268	268	268	268	268
≤ 375 Bhn or ≤ 40 HRc		21	RPM	6786	3393	2262	1696	1131	848	679	
		(17-26)	Fr	0.024	0.048	0.072	0.096	0.144	0.192	0.240	
			Feed (mm/min)	163	163	163	163	163	163	163	
≤ 425 Bhn or ≤ 45 HRc		14	RPM	4362	2181	1454	1091	727	545	436	
		(11-16)	Fr	0.015	0.030	0.045	0.060	0.089	0.119	0.149	
			Feed (mm/min)	65	65	65	65	65	65	65	
TOOL STEELS A2, D2, H13, L2, M2, P20, S7, T15, W2		≤ 250 Bhn or ≤ 24 HRc	12	RPM	3878	1939	1293	969	646	485	388
			(10-15)	Fr	0.015	0.031	0.046	0.062	0.093	0.124	0.155
				Feed (mm/min)	60	60	60	60	60	60	60
	≤ 375 Bhn or ≤ 40 HRc	8	RPM	2424	1212	808	606	404	303	242	
		(6-9)	Fr	0.010	0.020	0.030	0.040	0.059	0.079	0.099	
			Feed (mm/min)	24	24	24	24	24	24	24	
STAINLESS STEELS (FREE MACHINING) 303, 416, 420F, 430F 440F	≤ 250 Bhn or ≤ 24 HRc	23	RPM	7271	3635	2424	1818	1212	909	727	
		(18-27)	Fr	0.015	0.030	0.045	0.059	0.089	0.119	0.149	
			Feed (mm/min)	108	108	108	108	108	108	108	
	≤ 330 Bhn or ≤ 36 HRc	17	RPM	5332	2666	1777	1333	889	666	533	
		(13-20)	Fr	0.012	0.024	0.036	0.048	0.072	0.096	0.120	
			Feed (mm/min)	64	64	64	64	64	64	64	
STAINLESS STEELS (DIFFICULT) 304, 316, 321, 13-8 PH, 15-5PH, 17-4 PH, Custom 450	≤ 275 Bhn or ≤ 28 HRc	11	RPM	3393	1696	1131	848	565	424	339	
		(9-13)	Fr	0.015	0.029	0.044	0.059	0.088	0.118	0.147	
			Feed (mm/min)	50	50	50	50	50	50	50	
	≤ 375 Bhn or ≤ 40 HRc	8	RPM	2424	1212	808	606	404	303	242	
		(6-9)	Fr	0.010	0.020	0.030	0.040	0.059	0.079	0.099	
			Feed (mm/min)	24	24	24	24	24	24	24	

continued on next page

Straight Flute Reamer

Series 201M Metric	Hardness	Vc (m/min)		DC • mm							
				1	2	3	4	6	8	10	
K	CAST IRONS Gray, Malleable, Ductile	38 (30-46)	RPM	12118	6059	4039	3029	2020	1515	1212	
			Fr	0.032	0.064	0.097	0.129	0.193	0.257	0.322	
			Feed (mm/min)	390	390	390	390	390	390	390	
	≤ 220 Bhn or ≤ 19 HRc	29 (23-35)	RPM	9209	4605	3070	2302	1535	1151	921	
			Fr	0.032	0.064	0.096	0.128	0.192	0.256	0.320	
			Feed (mm/min)	295	295	295	295	295	295	295	
	N	ALUMINUM ALLOYS 2017, 2024, 356, 6061, 7075	82 (66-99)	RPM	26174	13087	8725	6544	4362	3272	2617
				Fr	0.040	0.080	0.120	0.160	0.240	0.320	0.400
				Feed (mm/min)	1047	1047	1047	1047	1047	1047	1047
≤ 80 Bhn or ≤ 47 HRb		70 (56-84)	RPM	22297	11148	7432	5574	3716	2787	2230	
			Fr	0.040	0.080	0.120	0.160	0.240	0.320	0.400	
			Feed (mm/min)	892	892	892	892	892	892	892	
≤ 150 Bhn or ≤ 88 HRb		35 (28-42)	RPM	11148	5574	3716	2787	1858	1394	1115	
			Fr	0.020	0.041	0.061	0.081	0.122	0.163	0.204	
			Feed (mm/min)	227	227	227	227	227	227	227	
COPPER ALLOYS Alum Bronze, C110, Muntz Brass	29 (23-35)	RPM	9209	4605	3070	2302	1535	1151	921		
		Fr	0.020	0.041	0.061	0.082	0.122	0.163	0.204		
		Feed (mm/min)	188	188	188	188	188	188	188		
≤ 140 Bhn or ≤ 3 HRc	29 (23-35)	RPM	9209	4605	3070	2302	1535	1151	921		
		Fr	0.020	0.041	0.061	0.082	0.122	0.163	0.204		
		Feed (mm/min)	188	188	188	188	188	188	188		

continued on next page

Straight Flute Reamer

Series 201M Metric	Hardness	Vc (m/min)		DC • mm							
				1	2	3	4	6	8	10	
HIGH TEMP ALLOYS (NICKEL, COBALT, IRON BASE) Inconel 601, 617, 625, Incoloy 800, Monel 400, Rene, Waspaloy	≤ 220 Bhn or ≤ 19 HRc	6 (5-7)	RPM	1939	969	646	485	323	242	194	
			Fr	0.012	0.024	0.036	0.047	0.071	0.095	0.119	
			Feed (mm/min)	23	23	23	23	23	23	23	
	≤ 320 Bhn or ≤ 34 HRc	5 (4-5)	RPM	1454	727	485	364	242	182	145	
			Fr	0.010	0.021	0.031	0.041	0.062	0.083	0.103	
			Feed (mm/min)	15	15	15	15	15	15	15	
	≤ 425 Bhn or ≤ 45 HRc	3 (2-4)	RPM	969	485	323	242	162	121	97	
			Fr	0.006	0.012	0.019	0.025	0.037	0.050	0.062	
			Feed (mm/min)	6	6	6	6	6	6	6	
	S	≤ 275 Bhn or ≤ 28 HRc	14 (11-16)	RPM	4362	2181	1454	1091	727	545	436
				Fr	0.024	0.048	0.072	0.096	0.144	0.193	0.241
				Feed (mm/min)	105	105	105	105	105	105	105
≤ 350 Bhn or ≤ 38 HRc		11 (9-13)	RPM	3393	1696	1131	848	565	424	339	
			Fr	0.015	0.029	0.044	0.059	0.088	0.118	0.147	
			Feed (mm/min)	50	50	50	50	50	50	50	
≤ 440 Bhn or ≤ 47 HRc		8 (6-9)	RPM	2424	1212	808	606	404	303	242	
			Fr	0.010	0.020	0.030	0.040	0.059	0.079	0.099	
			Feed (mm/min)	24	24	24	24	24	24	24	
H		≤ 475 Bhn or ≤ 50 HRc	6 (5-7)	RPM	1939	969	646	485	323	242	194
				Fr	0.006	0.012	0.019	0.025	0.037	0.050	0.062
				Feed (mm/min)	12	12	12	12	12	12	12
	≤ 655 Bhn or ≤ 60 HRc	4 (3-5)	RPM	1272	636	424	318	212	159	127	
			Fr	0.006	0.013	0.019	0.025	0.038	0.050	0.063	
			Feed (mm/min)	8	8	8	8	8	8	8	

Bhn (Brinell) HRc (Rockwell C) HRb (Rockwell B)
 rpm = (Vc x 1000) / (DC x 3.14)
 mm/min = Fr x rpm
 increase speed and feed 30 percent when using coated reamers
 reduce speed and feed for materials harder than listed
 refer to the SGS Tool Wizard® for complete technical information (www.kyocera-sgstool.com)

Routers



Routing

HIGH PERFORMANCE ROUTERS	SERIES	DESCRIPTION	PAGE	S&F PAGE
Carbon Composite	20-CCR	Multi-Flute Carbon Composite Fractional	386	388
	20M-CCR	Multi-Flute Carbon Composite Metric	386	389
	20-CCR-LHC	Multi-Flute Carbon Composite Left Hand Cut Fractional	387	388
	20M-CCR-LHC	Multi-Flute Carbon Composite Left Hand Cut Metric	387	389
Coarse Cut Carbon Composite	31-CCR	Multi-Flute Coarse Composite Fractional	390	391
	31M-CCR	Multi-Flute Coarse Composite Metric	390	392
Compression	25	Multi-Flute Compression Fractional	393	394
	25M	Multi-Flute Compression Metric	393	395
GENERAL APPLICATION ROUTERS	SERIES	DESCRIPTION	PAGE	S&F PAGE
Up Cut	21	2 Flute Up Cut Fractional	396	398
	21M	2 Flute Up Cut Metric	396	399
Down Cut	22	2 Flute Down Cut Fractional	397	398
	22M	2 Flute Down Cut Metric	397	399

Speed & Feed Recommendations listed after each series

Ranurado

RANURADORES DE ALTO RENDIMIENTO	SERIE	DESCRIPCIÓN	PÁGINA	S&F PÁGINA
Compuesto de carbono	20-CCR	Filo múltiple, compuesto de carbono, fraccional	386	388
	20M-CCR	Filo múltiple, compuesto de carbono, métrico	386	389
	20-CCR-LHC	Filo múltiple, carbon composite corte hélice izquierda fraccional	387	388
	20M-CCR-LHC	Filo múltiple, carbon composite corte hélice izquierda métrico	387	389
Compuesto de carbono de corte grueso	31-CCR	Filo múltiple, compuesto grueso, fraccional	390	391
	31M-CCR	Filo múltiple, compuesto grueso, métrico	390	392
Compresión	25	Filo múltiple, compresión, fraccional	393	394
	25M	Filo múltiple, compresión, métrico	393	395

RANURADORES DE USO GENERAL	SERIE	DESCRIPCIÓN	PÁGINA	S&F PÁGINA
Corte ascendente	21	2 filos, corte ascendente, fraccional	396	398
	21M	2 filos, corte ascendente, métrico	396	399
Corte descendente	22	2 filos, corte descendente, fraccional	397	398
	22M	2 filos, corte descendente, métrico	397	399

Recomendaciones de velocidades y avances mostradas tras cada serie

Détourage

FRAISES A DETOURER HAUTE PERFORMANCE	SÈRIES	DESCRIPTION	PAGE	S&F PAGE
Composites carbone	20-CCR	Multi-dents pour composites carbone (fractionnel)	386	388
	20M-CCR	Multi-dents pour composites carbone (métrique)	386	389
	20-CCR-LHC	Multi-dents carbon composite coupe à gauche (fractionnel)	387	388
	20M-CCR-LHC	Multi-dents carbon composite coupe à gauche (métrique)	387	389
Pour composites carbone coupe grossière	31-CCR	Multi-dents pour composites grossiers (fractionnel)	390	391
	31M-CCR	Multi-dents pour composites grossiers (métrique)	390	392
Compression	25	Multi-dents de compression (fractionnel)	393	394
	25M	Multi-dents de compression (métrique)	393	395

FRAISES À DÉTOURER UNIVERSELLES	SÈRIES	DESCRIPTION	PAGE	S&F PAGE
Coupe ascendante	21	2 dents coupe ascendante (fractionnel)	396	398
	21M	2 dents coupe ascendante (métrique)	396	399
Coupe descendante	22	2 dents coupe descendante (fractionnel)	397	398
	22M	2 dents coupe descendante (métrique)	397	399

Recommandations de vitesse et avance indiquées après chaque série

HOCHLEISTUNGS-KONTURENFRÄSER	SERIE	BESCHREIBUNG	SEITE	S&F SEITE
Kohlefaserverbundwerkstoff	20-CCR	Zölliger Konturenfräser für Kohlefaserverbundwerkstoff	386	388
	20M-CCR	Konturenfräser für Kohlefaserverbundwerkstoff	386	389
	20-CCR-LHC	Mehrschneider Carbon Composite Links geschnittene zöllig	387	388
	20M-CCR-LHC	Mehrschneider Carbon Composite Links geschnittene metrisch	387	389
Grobschnitt Kohlefaserverbundwerkstoff	31-CCR	Zölliger Konturenfräser für Verbundkunststoff	390	391
	31M-CCR	Konturenfräser für Verbundkunststoff	390	392
Gegenläufiger Drall	25	Zölliger Gegenläufiger Konturenfräser	393	394
	25M	Gegenläufiger Konturenfräser	393	395

STANDARD-KONTURENFRÄSER	SERIE	BESCHREIBUNG	SEITE	S&F SEITE
Rechtsspirale	21	Zölliger VHM-Fräser mit 2 Schneiden (ziehend)	396	398
	21M	VHM-Fräser mit 2 Schneiden (ziehend)	396	399
Linksspirale	22	Zölliger VHM-Fräser mit 2 Schneiden (drückend)	397	398
	22M	VHM-Fräser mit 2 Schneiden (drückend)	397	399

Empfehlungen für Drehzahl & Vorschub im Anhang zu jeder Serie

Carbon Composite

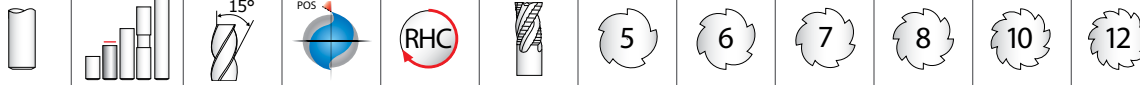

20-CCR FRACTIONAL SERIES

- Multi-flute design and positive geometry to shear with minimal pressure and delamination
- Unique clearance grind minimizes contact between tool diameter and workpiece eliminating friction
- Left hand flutes engineered to control the fibers within CFRP, preventing excessive fiber breakout
- Excels at trimming and profiling difficult and abrasive fiber filled plastics

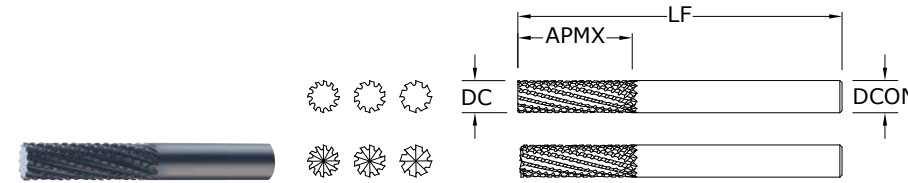

CUTTING DIAMETER DC	LENGTH OF CUT APMX	OVERALL LENGTH LF	SHANK DIAMETER DCON	NO. OF FLUTES	END STYLE	EDP NO.	
						UNCOATED	Di-NAMITE® (Diamond)
1/4	1	2-1/2	1/4	8	No End Cutting	72930	73013
1/4	1	2-1/2	1/4	8	End Cutting	72947	73012
5/16	1	2-1/2	5/16	10	No End Cutting	72948	73026
5/16	1	2-1/2	5/16	10	End Cutting	72949	73014
3/8	1-1/8	2-1/2	3/8	12	No End Cutting	72950	73028
3/8	1-1/8	2-1/2	3/8	12	End Cutting	72951	73027
1/2	1-1/2	3-1/2	1/2	12	No End Cutting	72952	73041
1/2	1-1/2	3-1/2	1/2	12	End Cutting	72953	73029

TOLERANCES (inch)

DC = +.000/- .005

DCON = h₆

NON-FERROUS

For patent information visit www.ksptpatents.com

20M-CCR METRIC SERIES

- Multi-flute design and positive geometry to shear with minimal pressure and delamination
- Unique clearance grind minimizes contact between tool diameter and workpiece eliminating friction
- Left hand flutes engineered to control the fibers within CFRP, preventing excessive fiber breakout
- Excels at trimming and profiling difficult and abrasive fiber filled plastics

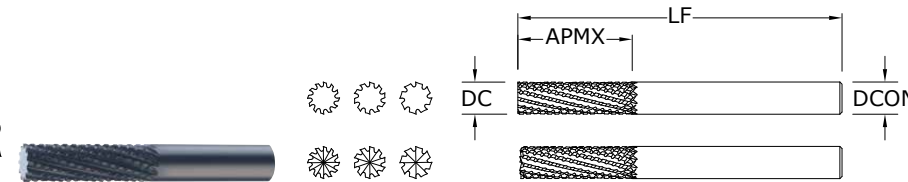

CUTTING DIAMETER DC	LENGTH OF CUT APMX	OVERALL LENGTH LF	SHANK DIAMETER DCON	NO. OF FLUTES	END STYLE	EDP NO.		
						UNCOATED	Ti-NAMITE-B (TiB ₂)	Di-NAMITE® (Diamond)
2,0	6,0	38,0	3,0	5	End Cutting	82930	83100	83070
3,0	10,0	38,0	3,0	6	End Cutting	82931	83101	83071
4,0	12,0	50,0	4,0	7	End Cutting	82932	83102	83072
5,0	15,0	50,0	6,0	8	End Cutting	82933	83103	83073
6,0	25,0	63,0	6,0	8	No End Cutting	82966	83104	83027
6,0	25,0	63,0	6,0	8	End Cutting	82967	83105	83026
8,0	25,0	63,0	8,0	10	No End Cutting	82968	83106	83029
8,0	25,0	63,0	8,0	10	End Cutting	82969	83107	83028
10,0	28,0	63,0	10,0	12	No End Cutting	82970	83108	83042
10,0	28,0	63,0	10,0	12	End Cutting	82971	83109	83041
12,0	38,0	89,0	12,0	12	No End Cutting	82972	83110	83044
12,0	38,0	89,0	12,0	12	End Cutting	82973	83111	83043

TOLERANCES (mm)

DC = +0,000/-0,130

DCON = h₆

NON-FERROUS

For patent information visit www.ksptpatents.com



FRACTIONAL & METRIC Carbon Composite

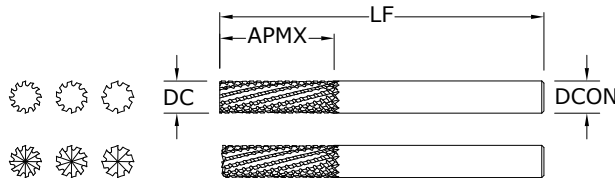

20-CCR-LHC FRACTIONAL SERIES

TOLERANCES (inch)

DC = +.000/-0.005

DCON = h₆

NON-FERROUS

For patent information visit www.ksptpatents.com

inch						EDP NO.	
CUTTING DIAMETER DC	LENGTH OF CUT APMX	OVERALL LENGTH LF	SHANK DIAMETER DCON	NO. OF FLUTES	END STYLE	UNCOATED	Di-NAMITE® (Diamond)
1/4	1	2-1/2	1/4	8	No End Cutting	73070	73078
1/4	1	2-1/2	1/4	8	End Cutting	73071	73079
5/16	1	2-1/2	5/16	10	No End Cutting	73072	73080
5/16	1	2-1/2	5/16	10	End Cutting	73073	73081
3/8	1-1/8	2-1/2	3/8	12	No End Cutting	73074	73082
3/8	1-1/8	2-1/2	3/8	12	End Cutting	73075	73083

- Multi-flute design and positive geometry to shear with minimal pressure and delamination
- Unique clearance grind minimizes contact between tool diameter and workpiece eliminating friction
- Left hand flutes engineered to control the fibers within CFRP, preventing excessive fiber breakout
- Excels at trimming and profiling difficult and abrasive fiber filled plastics

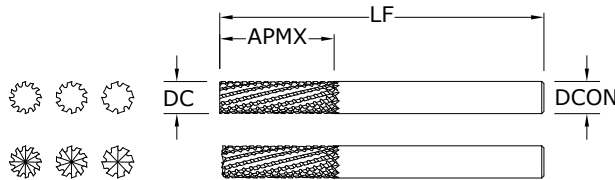

20M-CCR-LHC METRIC SERIES

TOLERANCES (mm)

DC = +0,000/-0,130

DCON = h₆

NON-FERROUS

For patent information visit www.ksptpatents.com

mm						EDP NO.	
CUTTING DIAMETER DC	LENGTH OF CUT APMX	OVERALL LENGTH LF	SHANK DIAMETER DCON	NO. OF FLUTES	END STYLE	UNCOATED	Di-NAMITE® (Diamond)
6,0	25,0	63,0	6,0	8	No End Cutting	83220	83230
6,0	25,0	63,0	6,0	8	End Cutting	83221	83231
8,0	25,0	63,0	8,0	10	No End Cutting	83222	83232
8,0	25,0	63,0	8,0	10	End Cutting	83223	83233
10,0	28,0	63,0	10,0	12	No End Cutting	83224	83234
10,0	28,0	63,0	10,0	12	End Cutting	83225	83235

- Multi-flute design and positive geometry to shear with minimal pressure and delamination
- Unique clearance grind minimizes contact between tool diameter and workpiece eliminating friction
- Left hand flutes engineered to control the fibers within CFRP, preventing excessive fiber breakout
- Excels at trimming and profiling difficult and abrasive fiber filled plastics

Carbon Composite

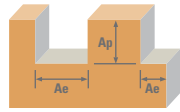

Series 20 Fractional	Ae x DC	Ap x DC	Vc (sfm)	DC • in					
				1/4	5/16	3/8	1/2		
CFRP, AFRP (CARBON FIBER, ARAMID FIBER)	Slot 	1	≤ 1	400 (320-480)	RPM	6112	4890	4075	3056
					Fr	0.0049	0.0094	0.0135	0.0180
					Feed (ipm)	30	46	55	55
	Profile 	≤ 0.5	≤ 1.5	500 (400-600)	RPM	7640	6112	5093	3820
					Fr	0.0049	0.0094	0.0135	0.0180
					Feed (ipm)	38	58	69	69
	HSM 	≤ 0.05	≤ 2	825 (660-990)	RPM	12606	10085	8404	6303
					Fr	0.0111	0.0215	0.0309	0.0413
					Feed (ipm)	140	217	260	260
GFRP (FIBERGLASS)	Slot 	1	≤ 1	320 (256-384)	RPM	4890	3912	3260	2445
					Fr	0.0049	0.0095	0.0135	0.0180
					Feed (ipm)	24	37	44	44
	Profile 	≤ 0.5	≤ 1.5	400 (320-480)	RPM	6112	4890	4075	3056
					Fr	0.0049	0.0095	0.0135	0.0180
					Feed (ipm)	30	46	55	55
	HSM 	≤ 0.05	≤ 2	660 (528-792)	RPM	10085	8068	6723	5042
					Fr	0.0110	0.0214	0.0311	0.0414
					Feed (ipm)	111	173	209	209
CARBON, GRAPHITE	Slot 	1	≤ 1	480 (384-576)	RPM	7334	5868	4890	3667
					Fr	0.0064	0.0124	0.0180	0.0240
					Feed (ipm)	47	73	88	88
	Profile 	≤ 0.5	≤ 1.5	600 (480-720)	RPM	9168	7334	6112	4584
					Fr	0.0064	0.0124	0.0180	0.0240
					Feed (ipm)	59	91	110	110
	HSM 	≤ 0.05	≤ 2	990 (792-1188)	RPM	15127	12102	10085	7564
					Fr	0.0147	0.0287	0.0412	0.0549
					Feed (ipm)	223	347	415	415
PLASTICS	Slot 	1	≤ 1	665 (640-690)	RPM	10161	8129	6774	5081
					Fr	0.0077	0.0150	0.0217	0.0241
					Feed (ipm)	78	122	147	147
	Profile 	≤ 0.5	≤ 1.5	1000 (800-1200)	RPM	15280	12224	10187	7640
					Fr	0.0077	0.0150	0.0217	0.0241
					Feed (ipm)	118	183	221	184
	HSM 	≤ 0.05	≤ 2	1650 (1320-1980)	RPM	25212	20170	16808	12606
					Fr	0.0147	0.0287	0.0413	0.0551
					Feed (ipm)	370	579	694	694

HSM (high speed machining)
 $rpm = Vc \times 3.82 / DC$
 $ipm = Fr \times rpm$
 adjust parameters based on resin type and fiber structure
 reduce speed when overheating causes melting or damage to resin
 reduce feed if delamination or fraying occur

finish cuts typically required reduced feed and cutting depths
 rates shown are for use without coolant; rates may be increased with coolant
 dust collection is vital when machining dry
 diamond coating will increase tool life in graphite and composite materials
 refer to the SGS Tool Wizard® for complete technical information
www.kyocera-sgstool.com

Carbon Composite

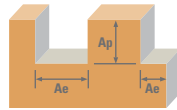

Series 20M Metric	Ae x DC	Ap x DC	Vc (m/min)	DC • mm						
				3	6	8	10	12		
CFRP, AFRP (CARBON FIBER, ARAMID FIBER)	Slot 	1	≤ 1	120 (96-164)	RPM	12722	6361	4771	3817	3181
					Fr	0.055	0.113	0.243	0.366	0.439
					Feed (mm/min)	700	720	1160	1395	1395
	Profile 	≤ 0.5	≤ 1.5	150 (120-180)	RPM	15903	7951	5963	4771	3976
					Fr	0.055	0.113	0.243	0.366	0.439
					Feed (mm/min)	875	900	1450	1744	1744
	HSM 	≤ 0.05	≤ 2	250 (200-300)	RPM	26504	13252	9939	7951	6626
					Fr	0.126	0.260	0.556	0.833	1.000
					Feed (mm/min)	3350	3450	5527	6625	6625
GFRP (FIBERGLASS)	Slot 	1	≤ 1	100 (80-120)	RPM	10602	5301	3976	3181	2650
					Fr	0.054	0.111	0.236	0.357	0.428
					Feed (mm/min)	570	587	940	1135	1135
	Profile 	≤ 0.5	≤ 1.5	120 (96-164)	RPM	12722	6361	4771	3817	3181
					Fr	0.054	0.111	0.236	0.357	0.428
					Feed (mm/min)	684	704	1128	1362	1362
	HSM 	≤ 0.05	≤ 2	200 (160-240)	RPM	21203	10602	7951	6361	5301
					Fr	0.124	0.261	0.557	1.011	1.213
					Feed (mm/min)	2629	2765	4430	6430	6430
CARBON, GRAPHITE	Slot 	1	≤ 1	145 (116-174)	RPM	15372	7686	5765	4612	3843
					Fr	0.069	0.152	0.323	0.482	0.579
					Feed (mm/min)	1061	1165	1860	2224	2224
	Profile 	≤ 0.5	≤ 1.5	185 (148-222)	RPM	19613	9807	7355	5884	4903
					Fr	0.069	0.152	0.323	0.482	0.579
					Feed (mm/min)	1353	1486	2373	2838	2838
	HSM 	≤ 0.05	≤ 2	300 (240-360)	RPM	31805	15903	11927	9542	7951
					Fr	0.159	0.348	0.740	1.109	1.331
					Feed (mm/min)	5057	5535	8820	10580	10580
PLASTICS	Slot 	1	≤ 1	245 (196-294)	RPM	25974	12987	9740	7792	6494
					Fr	0.069	0.150	0.319	0.477	0.572
					Feed (mm/min)	1792	1945	3107	3717	3717
	Profile 	≤ 0.5	≤ 1.5	305 (244-366)	RPM	32335	16168	12126	9701	8084
					Fr	0.069	0.150	0.319	0.477	0.572
					Feed (mm/min)	2231	2421	3868	4627	4627
	HSM 	≤ 0.05	≤ 2	505 (404-606)	RPM	53538	26769	20077	16062	13385
					Fr	0.159	0.344	0.732	1.097	1.316
					Feed (mm/min)	8513	9220	14690	17617	17617

HSM (high speed machining)
 $rpm = (Vc \times 1000) / (DC \times 3.14)$
 $mm/min = Fr \times rpm$
 adjust parameters based on resin type and fiber structure
 reduce speed when overheating causes melting or damage to resin
 reduce feed if delamination or fraying occur

finish cuts typically required reduced feed and cutting depths
 rates shown are for use without coolant; rates may be increased with coolant
 dust collection is vital when machining dry
 diamond coating will increase tool life in graphite and composite materials
 refer to the SGS Tool Wizard® for complete technical information
www.kyocera-sgstool.com

Coarse Cut Carbon Composite



31-CCR FRACTIONAL SERIES

- Fewer, deeper flutes to prevent clogging in heavy routing
- Unique clearance grind minimizes contact between tool diameter and workpiece eliminating friction
- Left hand flutes engineered to control the fibers within CFRP, preventing excessive fiber breakout
- Excels at trimming and profiling difficult and abrasive fiber filled plastics

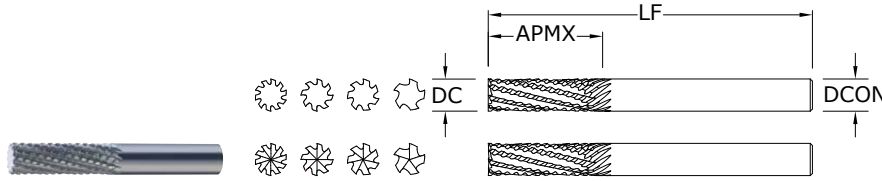

inch						EDP NO.	
CUTTING DIAMETER DC	LENGTH OF CUT APMX	OVERALL LENGTH LF	SHANK DIAMETER DCON	NO. OF FLUTES	END STYLE	UNCOATED	Di-NAMITE® (Diamond)
1/4	1	2-1/2	1/4	5	End Cutting	72954	72955
1/4	1	2-1/2	1/4	5	No End Cutting	72956	72957
5/16	1	2-1/2	5/16	7	End Cutting	72958	72959
5/16	1	2-1/2	5/16	7	No End Cutting	72960	72961
3/8	1-1/8	2-1/2	3/8	8	End Cutting	72962	72963
3/8	1-1/8	2-1/2	3/8	8	No End Cutting	72964	72965
1/2	1-1/2	3-1/2	1/2	10	End Cutting	72966	72967
1/2	1-1/2	3-1/2	1/2	10	No End Cutting	72968	72969

TOLERANCES (inch)

DC = +.000/- .005
DCON = h₆

NON-FERROUS

For patent information visit www.ksptpatents.com

31M-CCR METRIC SERIES

- Fewer, deeper flutes to prevent clogging in heavy routing
- Unique clearance grind minimizes contact between tool diameter and workpiece eliminating friction
- Left hand flutes engineered to control the fibers within CFRP, preventing excessive fiber breakout
- Excels at trimming and profiling difficult and abrasive fiber filled plastics

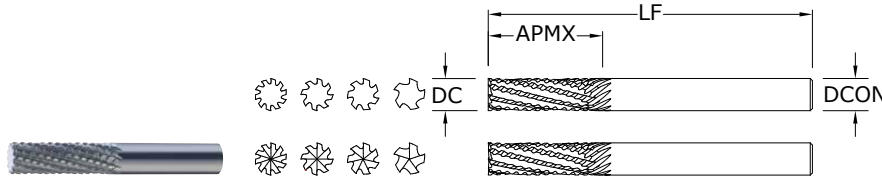

mm						EDP NO.		
CUTTING DIAMETER DC	LENGTH OF CUT APMX	OVERALL LENGTH LF	SHANK DIAMETER DCON	NO. OF FLUTES	END STYLE	UNCOATED	Ti-NAMITE-B (TiB ₂)	Di-NAMITE® (Diamond)
6,0	25,0	63,0	6,0	5	End Cutting	82974	83200	82982
6,0	25,0	63,0	6,0	5	No End Cutting	82975	83201	82983
8,0	25,0	63,0	8,0	7	End Cutting	82976	83202	82984
8,0	25,0	63,0	8,0	7	No End Cutting	82977	83203	82985
10,0	28,0	63,0	10,0	8	End Cutting	82978	83204	82986
10,0	28,0	63,0	10,0	8	No End Cutting	82979	83205	82987
12,0	38,0	89,0	12,0	10	End Cutting	82980	83206	82988
12,0	38,0	89,0	12,0	10	No End Cutting	82981	83207	82989

TOLERANCES (mm)

DC = +0,000/-0,130
DCON = h₆

NON-FERROUS

For patent information visit www.ksptpatents.com

Coarse Cut Carbon Composite

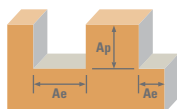

Series 31 Fractional	Ae x DC	Ap x DC	Vc (sfm)	DC • in					
				1/4	5/16	3/8	1/2		
CFRP, AFRP (CARBON FIBER, ARAMID FIBER)	Slot 	1	≤ 1	400	RPM	6112	4890	4075	3056
				(320-480)	Fr	0.0029	0.0065	0.0088	0.0147
					Feed (ipm)	18	32	36	45
	Profile 	≤ 0.5	≤ 1.5	500	RPM	7640	6112	5093	3820
				(400-600)	Fr	0.0029	0.0065	0.0088	0.0147
					Feed (ipm)	23	40	45	56
	HSM 	≤ 0.05	≤ 2	825	RPM	12606	10085	8404	6303
				(660-990)	Fr	0.0069	0.0151	0.0206	0.0344
					Feed (ipm)	87	152	173	217
GFRP (FIBERGLASS)	Slot 	1	≤ 1	320	RPM	4890	3912	3260	2445
				(256-384)	Fr	0.0031	0.0066	0.0089	0.0147
					Feed (ipm)	15	26	29	36
	Profile 	≤ 0.5	≤ 1.5	400	RPM	6112	4890	4075	3056
				(320-480)	Fr	0.0031	0.0066	0.0089	0.0147
					Feed (ipm)	19	33	36	45
	HSM 	≤ 0.05	≤ 2	660	RPM	10085	8068	6723	5042
				(528-792)	Fr	0.0069	0.0150	0.0205	0.0343
					Feed (ipm)	70	121	138	173
CARBON, GRAPHITE	Slot 	1	≤ 1	480	RPM	7334	5868	4890	3667
				(384-576)	Fr	0.0040	0.0087	0.0119	0.0199
					Feed (ipm)	29	51	58	73
	Profile 	≤ 0.5	≤ 1.5	600	RPM	9168	7334	6112	4584
				(480-720)	Fr	0.0040	0.0087	0.0119	0.0199
					Feed (ipm)	36	64	73	91
	HSM 	≤ 0.05	≤ 2	990	RPM	15127	12102	10085	7564
				(792-1188)	Fr	0.0092	0.0201	0.0275	0.0459
					Feed (ipm)	139	243	277	347
PLASTICS	Slot 	1	≤ 1	800	RPM	12224	9779	8149	6112
				(640-690)	Fr	0.0040	0.0087	0.0119	0.0200
					Feed (ipm)	49	85	97	122
	Profile 	≤ 0.5	≤ 1.5	1000	RPM	15280	12224	10187	7640
				(800-1200)	Fr	0.0040	0.0087	0.0119	0.0200
					Feed (ipm)	61	106	121	153
	HSM 	≤ 0.05	≤ 2	1650	RPM	25212	20170	16808	12606
				(1320-1980)	Fr	0.0092	0.0201	0.0275	0.0459
					Feed (ipm)	232	405	462	578

HSM (high speed machining)
 rpm = Vc x 3.82 / DC
 ipm = Fr x rpm
 adjust parameters based on resin type and fiber structure
 reduce speed when overheating causes melting or damage to resin
 reduce feed if delamination or fraying occur

finish cuts typically required reduced feed and cutting depths
 rates shown are for use without coolant; rates may be increased with coolant
 dust collection is vital when machining dry
 diamond coating will increase tool life in graphite and composite materials
 refer to the SGS Tool Wizard® for complete technical information
www.kyocera-sgtool.com

Coarse Cut Carbon Composite

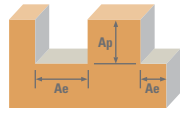

Series 31M Metric	Ae x DC	Ap x DC	Vc (m/min)	DC • mm					
				6	8	10	12		
CFRP, AFRP (CARBON FIBER, ARAMID FIBER)	Slot 	1	≤ 1	120	RPM	6361	4771	3817	3181
				(96-164)	Fr	0.071	0.170	0.244	0.366
					Feed (mm/min)	450	810	930	1165
	Profile 	≤ 0.5	≤ 1.5	150	RPM	7951	5963	4771	3976
				(120-180)	Fr	0.071	0.170	0.244	0.366
					Feed (mm/min)	563	1013	1163	1456
	HSM 	≤ 0.05	≤ 2	250	RPM	13252	9939	7951	6626
				(200-300)	Fr	0.162	0.388	0.555	0.832
					Feed (mm/min)	2150	3860	4415	5515
GFRP (FIBERGLASS)	Slot 	1	≤ 1	100	RPM	5301	3976	3181	2650
				(80-120)	Fr	0.069	0.165	0.237	0.357
					Feed (mm/min)	365	655	755	945
	Profile 	≤ 0.5	≤ 1.5	120	RPM	6361	4771	3817	3181
				(96-164)	Fr	0.069	0.165	0.237	0.357
					Feed (mm/min)	438	786	906	1134
	HSM 	≤ 0.05	≤ 2	200	RPM	10602	7951	6361	5301
				(160-240)	Fr	0.163	0.390	0.557	0.834
					Feed (mm/min)	1725	3100	3540	4420
CARBON, GRAPHITE	Slot 	1	≤ 1	145	RPM	7686	5765	4612	3843
				(116-174)	Fr	0.095	0.226	0.321	0.483
					Feed (mm/min)	728	1300	1480	1855
	Profile 	≤ 0.5	≤ 1.5	185	RPM	9807	7355	5884	4903
				(148-222)	Fr	0.095	0.226	0.321	0.483
					Feed (mm/min)	929	1659	1888	2367
	HSM 	≤ 0.05	≤ 2	300	RPM	15903	11927	9542	7951
				(240-360)	Fr	0.217	0.517	0.739	1.111
					Feed (mm/min)	3450	6170	7050	8830
PLASTICS	Slot 	1	≤ 1	245	RPM	12987	9740	7792	6494
				(196-294)	Fr	0.094	0.223	0.318	0.477
					Feed (mm/min)	1215	2175	2475	3100
	Profile 	≤ 0.5	≤ 1.5	305	RPM	16168	12126	9701	8084
				(244-366)	Fr	0.094	0.223	0.318	0.477
					Feed (mm/min)	1513	2708	3081	3859
	HSM 	≤ 0.05	≤ 2	505	RPM	26769	20077	16062	13385
				(404-606)	Fr	0.215	0.512	0.731	1.098
					Feed (mm/min)	5760	10280	11745	14700

HSM (high speed machining)
 $rpm = (Vc \times 1000) / (DC \times 3.14)$
 $mm/min = Fr \times rpm$
 adjust parameters based on resin type and fiber structure
 reduce speed when overheating causes melting or damage to resin
 reduce feed if delamination or fraying occur

finish cuts typically required reduced feed and cutting depths
 rates shown are for use without coolant; rates may be increased with coolant
 dust collection is vital when machining dry
 diamond coating will increase tool life in graphite and composite materials
 refer to the SGS Tool Wizard® for complete technical information
www.kyocera-sgstool.com

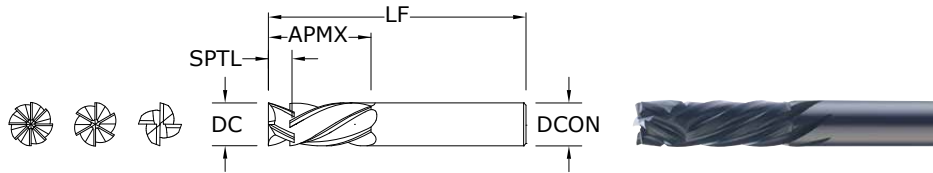

25

FRACTIONAL SERIES

TOLERANCES (inch)

DC = +.000/- .003
DCON = h₆

NON-FERROUS

For patent information visit
www.ksptpatents.com

CUTTING DIAMETER DC	LENGTH OF CUT APMX	OVERALL LENGTH LF	SHANK DIAMETER DCON	SPLIT LENGTH SPTL	NO. OF FLUTES	EDP NO.	
						UNCOATED	Di-NAMITE® (Diamond)
1/4	1	2-1/2	1/4	11/64	4	72970	72971
5/16	1	2-1/2	5/16	7/32	4	72972	72973
3/8	1-1/8	2-1/2	3/8	17/64	6	72974	72975
1/2	1-1/2	3-1/2	1/2	23/64	8	72976	72977

- Compression-style helixes direct cutting forces inward, eliminating fiber breakout and delamination
- Primary/secondary relief grind for reduced friction and pressure
- Rigid, heavy core

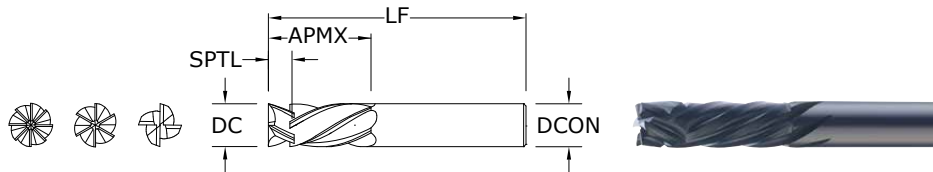

25M

METRIC SERIES

TOLERANCES (mm)

DC = +0,000/-0,080
DCON = h₆

NON-FERROUS









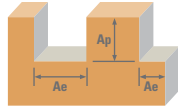

For patent information visit
www.ksptpatents.com

CUTTING DIAMETER DC	LENGTH OF CUT APMX	OVERALL LENGTH LF	SHANK DIAMETER DCON	SPLIT LENGTH SPTL	NO. OF FLUTES	EDP NO.	
						UNCOATED	Di-NAMITE® (Diamond)
6,0	25,0	63,0	6,0	4,10	4	82990	82991
8,0	25,0	63,0	8,0	5,58	4	82992	82993
10,0	28,0	63,0	10,0	7,05	6	82994	82995
12,0	38,0	89,0	12,0	8,60	8	82996	82997

- Compression-style helixes direct cutting forces inward, eliminating fiber breakout and delamination
- Primary/secondary relief grind for reduced friction and pressure
- Rigid, heavy core

Compression



Series 25 Fractional	Ae x DC	Ap x DC	Vc (sfm)	DC • in					
				1/4	5/16	3/8	1/2		
CFRP, AFRP (CARBON FIBER, ARAMID FIBER)	Profile 	≤ 0.5	≤ 1.5	500	RPM	7640	6112	5093	3820
				(400-600)	Fz	0.0016	0.0030	0.0040	0.0048
				Feed (ipm)	49	73	122	147	
	HSM 	≤ 0.05	≤ 2	825	RPM	12606	10085	8404	6303
				(660-990)	Fz	0.0037	0.0069	0.0092	0.0110
				Feed (ipm)	187	278	464	555	
GFRP (FIBERGLASS)	Profile 	≤ 0.5	≤ 1.5	400	RPM	6112	4890	4075	3056
				(320-480)	Fz	0.0016	0.0030	0.0040	0.0048
				Feed (ipm)	39	59	98	117	
	HSM 	≤ 0.05	≤ 2	660	RPM	10085	8068	6723	5042
				(528-792)	Fz	0.0037	0.0069	0.0092	0.0110
				Feed (ipm)	149	223	371	444	
N CARBON, GRAPHITE	Profile 	≤ 0.5	≤ 1.5	600	RPM	9168	7334	6112	4584
				(480-720)	Fz	0.0020	0.0038	0.0050	0.0060
				Feed (ipm)	73	111	183	220	
	HSM 	≤ 0.05	≤ 2	990	RPM	15127	12102	10085	7564
				(792-1188)	Fz	0.0046	0.0086	0.0115	0.0138
				Feed (ipm)	278	416	696	835	
PLASTICS	Profile 	≤ 0.5	≤ 1.5	1000	RPM	15280	12224	10187	7640
				(800-1200)	Fz	0.0020	0.0038	0.0050	0.0060
				Feed (ipm)	122	186	306	367	
	HSM 	≤ 0.05	≤ 2	1650	RPM	25212	20170	16808	12606
				(1320-1980)	Fz	0.0046	0.0086	0.0115	0.0138
				Feed (ipm)	464	694	1160	1392	
MACHINABLE CERAMICS MACHINABLE GLASS	Profile 	≤ 0.5	≤ 1.5	50	RPM	764	611	509	382
				(40-60)	Fz	0.0008	0.0015	0.0020	0.0024
				Feed (ipm)	2.4	3.7	6.1	7.3	
	HSM 	≤ 0.05	≤ 2	85	RPM	1299	1039	866	649
				(68-102)	Fz	0.0018	0.0034	0.0046	0.0055
				Feed (ipm)	9.4	14.1	23.9	28.6	

HSM (high speed machining)
 $rpm = Vc \times 3.82 / DC$
 $ipm = Fz \times \text{number of flutes} \times rpm$
 adjust parameters based on resin type and fiber structure
 reduce speed when overheating causes melting or damage to resin
 reduce feed if delamination or fraying occur

finish cuts typically required reduced feed and cutting depths
 rates shown are for use without coolant; rates may be increased with coolant
 dust collection is vital when machining dry
 diamond coating will increase tool life in graphite and composite materials
 refer to the SGS Tool Wizard® for complete technical information
www.kyocera-sgstool.com

Compression

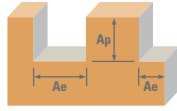

Series 25M Metric	Ae x DC	Ap x DC	Vc (m/min)	DC • mm					
				6	8	10	12		
CFRP, AFRP (CARBON FIBER, ARAMID FIBER)	Profile 	≤ 0.5	≤ 1.5	150	RPM	7951	5963	4771	3976
				(96-164)	Fz	0.040	0.065	0.075	0.100
				Feed (mm/min)	1272	1550	2147	3181	
	HSM 	≤ 0.05	≤ 2	250	RPM	13252	9939	7951	6626
				(200-300)	Fz	0.095	0.145	0.175	0.235
				Feed (mm/min)	5036	5765	8349	12457	
GFRP (FIBERGLASS)	Profile 	≤ 0.5	≤ 1.5	120	RPM	6361	4771	3817	3181
				(96-164)	Fz	0.040	0.065	0.075	0.100
				Feed (mm/min)	1018	1240	1717	2544	
	HSM 	≤ 0.05	≤ 2	200	RPM	10602	7951	6361	5301
				(160-240)	Fz	0.095	0.145	0.175	0.235
				Feed (mm/min)	4029	4612	6679	9966	
N CARBON, GRAPHITE	Profile 	≤ 0.5	≤ 1.5	185	RPM	9807	7355	5884	4903
				(148-222)	Fz	0.050	0.080	0.095	0.125
				Feed (mm/min)	1961	2354	3354	4903	
	HSM 	≤ 0.05	≤ 2	300	RPM	15903	11927	9542	7951
				(240-360)	Fz	0.115	0.185	0.220	0.290
				Feed (mm/min)	7315	8826	12595	18447	
PLASTICS	Profile 	≤ 0.5	≤ 1.5	305	RPM	16168	12126	9701	8084
				(244-366)	Fz	0.050	0.080	0.095	0.125
				Feed (mm/min)	3234	3880	5529	8084	
	HSM 	≤ 0.05	≤ 2	505	RPM	26769	20077	16062	13385
				(404-606)	Fz	0.115	0.185	0.220	0.290
				Feed (mm/min)	12314	14857	21201	31052	
MACHINABLE CERAMICS MACHINABLE GLASS	Profile 	≤ 0.5	≤ 1.5	15	RPM	795	596	477	398
				(12-18)	Fz	0.020	0.035	0.045	0.050
				Feed (mm/min)	64	83	129	159	
	HSM 	≤ 0.05	≤ 2	25	RPM	1325	994	795	663
				(20-30)	Fz	0.045	0.075	0.085	0.115
				Feed (mm/min)	239	298	406	610	

HSM (high speed machining)
 $rpm = (Vc \times 1000) / (DC \times 3.14)$
 $mm/min = Fz \times \text{number of flutes} \times rpm$
 adjust parameters based on resin type and fiber structure
 reduce speed when overheating causes melting or damage to resin
 reduce feed if delamination or fraying occur

finish cuts typically required reduced feed and cutting depths
 rates shown are for use without coolant; rates may be increased with coolant
 dust collection is vital when machining dry
 diamond coating will increase tool life in graphite and composite materials
 refer to the SGS Tool Wizard® for complete technical information
www.kyocera-sgstool.com

Up Cut



21

FRACTIONAL SERIES

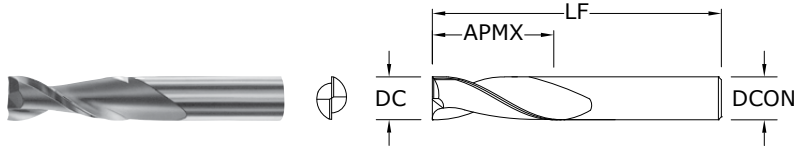

inch				EDP NO.
CUTTING DIAMETER DC	LENGTH OF CUT APMX	OVERALL LENGTH LF	SHANK DIAMETER DCON	UNCOATED
1/8	1/2	2	1/4	90001
5/32	5/8	2-1/2	1/4	90005
3/16	3/4	2-1/2	1/4	90009
1/4	3/4	2-1/2	1/4	90013
1/4	1	2-1/2	1/4	90017
5/16	1	2-1/2	5/16	90021
5/16	1	3	1/2	90025
3/8	1	2-1/2	3/8	90029
3/8	1-1/4	3	1/2	90033
1/2	1-1/4	3	1/2	90037
1/2	1-1/2	3-1/2	1/2	90041
1/2	2	4	1/2	90045
5/8	2	4-1/2	5/8	90049
3/4	2	4-1/2	3/4	90053

TOLERANCES (inch)

DC = +.000/- .003

DCON = h₆

NON-FERROUS

For patent information visit www.ksptpatents.com

21M

METRIC SERIES

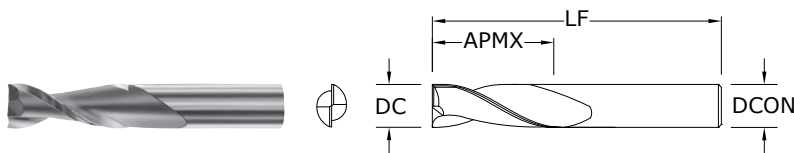

mm				EDP NO.
CUTTING DIAMETER DC	LENGTH OF CUT APMX	OVERALL LENGTH LF	SHANK DIAMETER DCON	UNCOATED
3,0	13,0	50,0	6,0	90101
4,0	16,0	63,0	6,0	90107
5,0	19,0	63,0	6,0	90109
6,0	25,0	63,0	6,0	90113
8,0	25,0	63,0	8,0	90121
10,0	31,0	75,0	10,0	90129
12,0	31,0	75,0	12,0	90137

TOLERANCES (mm)

DC = +0,000/-0,080

DCON = h₆

NON-FERROUS

For patent information visit www.ksptpatents.com

Down Cut

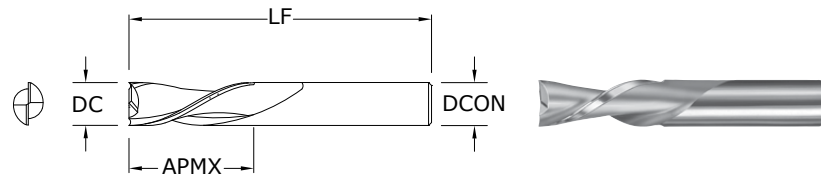
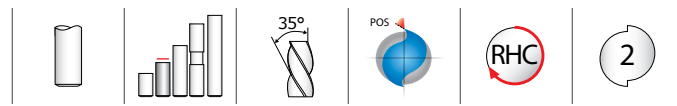

22
FRACTIONAL SERIES

TOLERANCES (inch)

DC = +.000/-0.003
DCON = h₆

NON-FERROUS

For patent information visit www.ksptpatents.com

CUTTING DIAMETER DC	LENGTH OF CUT APMX	inch		EDP NO. UNCOATED
		OVERALL LENGTH LF	SHANK DIAMETER DCON	
1/8	1/2	2	1/4	91001
5/32	5/8	2-1/2	1/4	91005
3/16	3/4	2-1/2	1/4	91009
1/4	3/4	2-1/2	1/4	91013
1/4	1	2-1/2	1/4	91017
5/16	1	2-1/2	5/16	91021
5/16	1	3	1/2	91025
3/8	1	2-1/2	3/8	91029
3/8	1-1/4	3	1/2	91033
1/2	1-1/4	3	1/2	91037
1/2	1-1/2	3-1/2	1/2	91041
1/2	2	4	1/2	91045
5/8	2	4-1/2	5/8	91049
3/4	2	4-1/2	3/4	91053

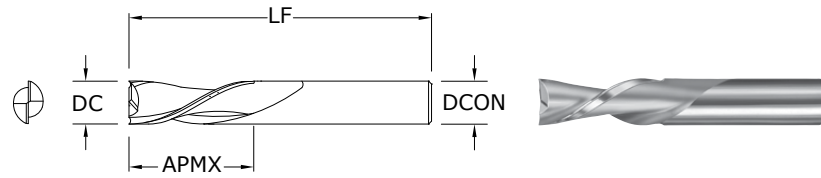

22M
METRIC SERIES

TOLERANCES (mm)

DC = +0,000/-0,080
DCON = h₆

NON-FERROUS

For patent information visit www.ksptpatents.com

CUTTING DIAMETER DC	LENGTH OF CUT APMX	mm		EDP NO. UNCOATED
		OVERALL LENGTH LF	SHANK DIAMETER DCON	
3,0	13,0	50,0	6,0	91101
4,0	16,0	63,0	6,0	91107
5,0	19,0	63,0	6,0	91109
6,0	25,0	63,0	6,0	91113
8,0	25,0	63,0	8,0	91121
10,0	31,0	75,0	10,0	91129
12,0	31,0	75,0	12,0	91137

Up Cut Down Cut

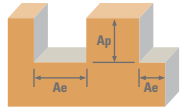







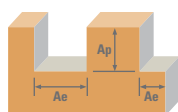

Series 21, 22 Fractional	Ae x DC	Ap x DC	Vc (sfm)	DC • in						
				1/8	1/4	3/8	1/2	3/4		
HARDWOODS	Slot 	1	≤ 1	1550	RPM	47368	23684	15789	11842	7895
				(1240-1860)	Fz	0.0008	0.0015	0.0025	0.0030	0.0045
				Feed (ipm)	76	71	79	71	71	
	Profile 	≤ 0.5	≤ 1.5	1550	RPM	47368	23684	15789	11842	7895
				(1240-1860)	Fz	0.0008	0.0015	0.0025	0.0030	0.0045
				Feed (ipm)	76	71	79	71	71	
SOFTWOODS	Slot 	1	≤ 1	1950	RPM	59592	29796	19864	14898	9932
				(1560-2340)	Fz	0.0010	0.0020	0.0030	0.0035	0.0055
				Feed (ipm)	119	119	119	104	109	
	Profile 	≤ 0.5	≤ 1.5	1950	RPM	59592	29796	19864	14898	9932
				(1560-2340)	Fz	0.0010	0.0020	0.0030	0.0035	0.0055
				Feed (ipm)	119	119	119	104	109	
PLYWOODS	Slot 	1	≤ 1	1950	RPM	59592	29796	19864	14898	9932
				(1560-2340)	Fz	0.0013	0.0025	0.0040	0.0050	0.0075
				Feed (ipm)	155	149	159	149	149	
	Profile 	≤ 0.5	≤ 1.5	1950	RPM	59592	29796	19864	14898	9932
				(1560-2340)	Fz	0.0013	0.0025	0.0040	0.0050	0.0075
				Feed (ipm)	155	149	159	149	149	
N PLASTICS	Slot 	1	≤ 1	1950	RPM	59592	29796	19864	14898	9932
				(1560-2340)	Fz	0.0008	0.0017	0.0025	0.0035	0.0050
				Feed (ipm)	95	101	99	104	99	
	Profile 	≤ 0.5	≤ 1.5	1950	RPM	59592	29796	19864	14898	9932
				(1560-2340)	Fz	0.0008	0.0017	0.0025	0.0035	0.0050
				Feed (ipm)	95	101	99	104	99	

rpm = Vc x 3.82 / DC
ipm = Fz x 2 x rpm

METRIC Up Cut Down Cut



Series 21M, 22M Metric				Vc (m/min)	DC • mm					
		Ae x DC	Ap x DC		3	6	10	12	20	
HARDWOODS	Slot 	1	≤ 1	470	RPM	49828	24914	14948	12457	7474
				(376-564)	Fz	0.020	0.040	0.065	0.075	0.115
				Feed (mm/min)	1993	1993	1943	1869	1719	
	Profile 	≤ 0.5	≤ 1.5	470	RPM	49828	24914	8155	4241	1509
				(376-564)	Fz	0.020	0.040	0.065	0.075	0.115
				Feed (mm/min)	1993	1993	1060	636	347	
SOFTWOODS	Slot 	1	≤ 1	600	RPM	63610	31805	19083	15903	9542
				(480-720)	Fz	0.025	0.050	0.075	0.090	0.140
				Feed (mm/min)	3181	3181	2862	2862	2672	
	Profile 	≤ 0.5	≤ 1.5	600	RPM	63610	31805	19083	15903	303467
				(480-720)	Fz	0.025	0.050	0.075	0.090	0.140
				Feed (mm/min)	3181	3181	2862	2862	84971	
PLYWOODS	Slot 	1	≤ 1	600	RPM	63610	31805	19083	15903	9542
				(480-720)	Fz	0.030	0.065	0.100	0.125	0.190
				Feed (mm/min)	3817	4135	3817	3976	3626	
	Profile 	≤ 0.5	≤ 1.5	600	RPM	63610	31805	19083	15903	303467
				(480-720)	Fz	0.030	0.065	0.100	0.125	0.190
				Feed (mm/min)	3817	4135	3817	3976	115318	
N PLASTICS	Slot 	1	≤ 1	600	RPM	63610	31805	19083	15903	9542
				(480-720)	Fz	0.020	0.040	0.065	0.090	0.125
				Feed (mm/min)	2544	2544	2481	2862	2385	
	Profile 	≤ 0.5	≤ 1.5	600	RPM	63610	31805	19083	15903	9542
				(480-720)	Fz	0.020	0.040	0.065	0.090	0.125
				Feed (mm/min)	2544	2544	2481	2862	2385	

rpm = (Vc x 1000) / (DC x 3.14)
mm/min = Fz x 2 x rpm

EDP Number Index

EDP NO.	PAGE	EDP NO.	PAGE	EDP NO.	PAGE	EDP NO.	PAGE	EDP NO.	PAGE	EDP NO.	PAGE	EDP NO.	PAGE
30902	298	31174	313	31317	287	31425	313	31517	287	31617	304	31776	308
30904	298	31175	313	31318	287	31426	314	31518	288	31619	305	31777	308
30906	298	31176	313	31319	287	31427	313	31519	287	31621	305	31778	308
30908	298	31177	313	31320	287	31428	314	31520	288	31623	305	31779	308
30910	298	31178	313	31321	287	31429	313	31521	287	31625	305	31780	307
30912	298	31179	313	31322	287	31430	314	31522	288	31650	303	31781	307
30914	298	31180	313	31323	287	31431	313	31523	287	31651	303	31782	307
30916	298	31181	313	31324	287	31432	314	31524	288	31652	303	31783	307
30918	298	31182	313	31325	287	31433	313	31525	287	31653	303	31784	308
30920	298	31183	313	31326	287	31434	314	31526	288	31654	303	31785	308
30921	298	31184	313	31327	287	31435	313	31527	287	31655	303	31786	308
30922	298	31185	313	31328	287	31436	314	31528	288	31656	303	31787	308
30923	298	31186	313	31329	287	31437	313	31529	287	31657	304	31788	308
30924	298	31187	313	31330	287	31438	314	31530	288	31658	304	31789	308
30925	298	31188	313	31331	287	31439	313	31531	287	31659	305	31790	307
30926	298	31189	313	31332	287	31440	314	31532	288	31660	305	31791	307
30927	298	31190	313	31333	287	31441	313	31533	287	31661	305	31792	307
30928	298	31190	318	31334	287	31442	314	31534	288	31662	305	31793	307
30929	298	31217	314	31335	287	31443	313	31535	287	31701	291	31794	308
30930	298	31217	319	31336	287	31444	314	31536	288	31703	291	31795	308
30931	298	31218	314	31336	318	31445	313	31537	287	31705	291	31796	308
30932	298	31219	314	31337	288	31446	314	31538	288	31707	291	31797	308
30933	298	31220	314	31338	288	31447	313	31539	287	31709	291	31798	308
30934	298	31221	314	31339	288	31448	314	31540	288	31711	291	31799	308
30935	298	31222	314	31340	288	31449	313	31541	287	31713	291	31800	280
30936	298	31223	314	31341	288	31450	314	31542	288	31715	291	31802	280
30937	298	31224	314	31342	288	31451	313	31543	287	31717	291	31804	281
30938	298	31225	314	31343	288	31452	314	31544	288	31719	291	31806	281
30939	298	31226	314	31344	288	31453	313	31545	287	31721	291	31808	282
30940	298	31227	314	31345	288	31454	314	31546	288	31723	291	31810	280
30941	298	31228	314	31346	288	31455	313	31547	287	31725	291	31812	280
30942	298	31229	314	31347	288	31456	314	31548	288	31727	303	31814	281
30943	298	31230	314	31348	288	31457	313	31549	287	31728	303	31816	281
30944	298	31231	314	31349	288	31458	314	31550	288	31729	304	31817	282
30944	319	31232	314	31350	288	31459	313	31551	287	31730	304	31818	282
31130	298	31233	314	31351	288	31460	314	31552	288	31731	304	31819	282
31131	298	31234	314	31352	288	31461	313	31553	287	31732	305	31820	280
31132	298	31235	314	31353	288	31462	314	31554	288	31733	305	31821	281
31133	298	31236	314	31354	288	31463	313	31555	287	31734	305	31822	281
31134	298	31237	314	31355	288	31464	314	31556	288	31735	306	31823	282
31135	298	31238	303	31356	288	31465	313	31557	287	31736	306	31824	282
31136	298	31239	303	31357	288	31466	314	31558	288	31737	303	31825	280
31137	298	31240	303	31357	319	31467	313	31559	287	31738	303	31826	281
31138	298	31241	303	31358	291	31468	314	31560	288	31739	304	31827	281
31139	298	31242	303	31359	291	31469	313	31561	287	31740	304	31830	283
31140	298	31243	303	31360	291	31470	314	31562	288	31741	304	31831	283
31141	298	31244	303	31361	291	31471	313	31563	287	31742	305	31832	283
31142	298	31245	304	31362	291	31472	314	31564	288	31743	305	31833	283
31143	298	31246	304	31363	291	31473	313	31565	287	31744	305	31834	284
31144	298	31247	305	31364	291	31474	314	31566	288	31745	306	31835	284
31145	298	31248	305	31365	291	31475	313	31567	287	31746	306	31836	284
31146	298	31249	305	31366	291	31476	314	31568	288	31747	303	31837	284
31147	298	31250	305	31367	291	31477	313	31569	287	31748	303	31838	284
31148	298	31251	303	31368	291	31478	314	31570	288	31749	304	31839	284
31149	298	31252	303	31369	291	31479	313	31571	287	31750	291	31840	283
31150	298	31253	303	31370	291	31480	314	31572	288	31751	291	31841	283
31151	298	31254	303	31401	313	31481	313	31573	287	31752	291	31842	283
31152	298	31255	303	31402	314	31481	318	31574	288	31753	291	31843	283
31153	298	31256	303	31403	313	31482	314	31575	287	31754	291	31844	284
31154	298	31257	303	31404	314	31482	319	31576	288	31755	291	31845	284
31155	298	31258	304	31405	313	31489	313	31577	287	31756	291	31846	284
31156	298	31259	304	31406	314	31489	318	31578	288	31757	291	31847	284
31157	298	31260	305	31407	313	31490	314	31579	287	31758	291	31848	284
31158	298	31261	305	31408	314	31490	319	31580	288	31759	291	31849	284
31159	298	31262	305	31409	313	31501	287	31581	287	31760	291	31850	280
31160	298	31263	305	31410	314	31502	288	31581	318	31761	291	31851	280
31161	298	31303	291	31411	313	31503	287	31582	288	31762	291	31852	280
31162	298	31304	291	31412	314	31504	288	31582	319	31763	304	31853	281
31163	298	31305	291	31413	313	31505	287	31589	287	31764	304	31854	281
31164	298	31306	291	31414	314	31506	288	31589	318	31765	305	31855	281
31165	298	31307	291	31415	313	31507	287	31590	288	31766	305	31856	281
31166	298	31308	291	31416	314	31508	288	31590	319	31767	305	31857	282
31167	298	31309	291	31417	313	31509	287	31601	303	31768	306	31858	282
31168	298	31310	291	31418	314	31510	288	31603	303	31769	306	31859	282
31169	298	31311	291	31419	313	31511	287	31605	303	31770	307	31860	303
31169	319	31312	291	31420	314	31512	288	31607	303	31771	307	31861	303
31170	313	31313	291	31421	313	31513	287	31609	303	31772	307	31862	304
31171	313	31314	291	31422	314	31514	288	31611	303	31773	307	31863	304
31172	313	31315	291	31423	313	31515	287	31613	303	31774	308	31864	304
31173	313	31316	287	31424	314	31516	288	31615	304	31775	308	31865	305

EDP Number Index

EDP NO.	PAGE	EDP NO.	PAGE	EDP NO.	PAGE	EDP NO.	PAGE	EDP NO.	PAGE	EDP NO.	PAGE	EDP NO.	PAGE
31866	305	31954	282	32202	294	32337	301	32438	302	32596	66	32711	149
31867	305	31955	282	32203	294	32338	301	32439	302	32597	66	32712	149
31868	306	31956	282	32204	294	32339	301	32440	302	32598	66	32713	149
31869	306	31957	282	32205	294	32340	301	32441	302	32599	66	32714	149
31870	303	31958	280	32206	294	32341	301	32442	302	32600	66	32715	149
31871	303	31959	280	32207	294	32342	301	32443	302	32601	66	32716	149
31872	304	31960	280	32210	294	32345	301	32445	302	32602	66	32717	150
31873	304	31961	281	32211	294	32346	301	32446	302	32603	66	32718	150
31874	304	31962	281	32212	294	32347	301	32447	302	32604	66	32719	150
31875	305	31963	281	32213	294	32348	301	32448	302	32605	66	32720	150
31876	305	31964	282	32214	294	32349	301	32449	302	32606	65	32725	148
31877	305	31965	282	32215	294	32350	301	32450	302	32607	65	32726	148
31878	306	31966	282	32216	294	32351	301	32451	302	32608	65	32727	148
31879	306	31967	282	32217	294	32352	301	32452	302	32609	65	32728	148
31880	303	31968	283	32260	293	32353	301	32453	302	32610	65	32729	148
31881	303	31969	283	32261	293	32354	301	32454	302	32611	65	32730	148
31882	304	31970	283	32262	293	32355	301	32455	302	32612	65	32731	148
31883	304	31971	283	32263	293	32356	301	32456	302	32613	65	32732	148
31884	304	31972	284	32264	293	32357	301	32457	302	32614	65	32733	148
31885	305	31973	284	32265	293	32358	301	32458	302	32615	65	32734	148
31886	305	31974	284	32266	293	32359	301	32459	302	32616	65	32735	149
31887	305	31975	284	32267	293	32360	301	32460	302	32619	65	32736	149
31888	306	31976	284	32270	293	32361	301	32461	302	32620	65	32737	149
31889	306	31977	284	32271	293	32362	301	32462	302	32621	65	32738	149
31890	283	31978	283	32272	293	32363	301	32463	302	32625	65	32739	149
31891	283	31979	283	32273	293	32364	301	32464	302	32626	65	32740	149
31892	283	31980	283	32274	293	32370	301	32470	302	32627	65	32741	149
31893	283	31981	283	32275	293	32371	301	32471	302	32628	65	32742	150
31894	284	31982	284	32276	293	32372	301	32472	302	32632	66	32743	150
31895	284	31983	284	32277	293	32373	301	32473	302	32633	66	32744	150
31896	284	31984	284	32280	293	32374	301	32474	302	32655	65	32745	150
31897	284	31985	284	32281	293	32375	301	32475	302	32656	65	32751	148
31898	284	31986	284	32282	293	32376	301	32476	302	32657	65	32752	148
31899	284	31987	284	32283	293	32377	301	32477	302	32658	65	32753	148
31900	307	31988	283	32284	293	32378	301	32478	302	32659	65	32754	148
31902	307	31989	283	32285	293	32379	301	32479	302	32660	65	32755	148
31904	307	31990	283	32286	293	32380	301	32480	302	32661	65	32756	148
31906	307	31991	283	32287	293	32381	301	32481	302	32662	65	32757	148
31908	308	31992	284	32290	294	32382	301	32482	302	32663	66	32758	148
31910	308	31993	284	32291	294	32383	301	32483	302	32664	66	32759	148
31912	308	31994	284	32292	294	32384	301	32484	302	32665	66	32760	148
31914	308	31995	284	32293	294	32385	301	32485	302	32666	66	32761	145
31916	308	31996	284	32294	294	32386	301	32486	302	32667	66	32762	148
31917	308	31997	284	32295	294	32387	301	32487	302	32668	66	32763	148
31918	307	32033	173	32296	294	32388	301	32488	302	32669	66	32764	148
31919	307	32034	173	32297	294	32389	301	32489	302	32670	66	32765	148
31920	307	32035	173	32301	301	32402	302	32500	67	32671	66	32766	145
31921	307	32036	173	32302	301	32403	302	32501	67	32672	65	32767	148
31922	308	32037	173	32303	301	32404	302	32502	67	32673	65	32768	148
31923	308	32038	173	32304	301	32405	302	32503	67	32674	65	32769	148
31924	308	32039	173	32305	301	32406	302	32504	67	32675	65	32770	148
31925	308	32040	173	32306	301	32407	302	32505	67	32676	65	32771	149
31926	308	32041	173	32307	301	32408	302	32506	67	32677	65	32772	149
31927	308	32042	173	32308	301	32409	302	32569	65	32678	66	32773	149
31928	307	32043	173	32309	301	32410	302	32570	66	32679	66	32774	149
31929	307	32044	173	32310	301	32411	302	32571	66	32680	66	32775	149
31930	307	32045	173	32311	301	32412	302	32572	66	32681	66	32776	149
31931	307	32046	173	32312	301	32413	302	32573	65	32682	66	32777	149
31932	308	32047	173	32313	301	32414	302	32574	65	32683	66	32778	149
31933	308	32048	173	32314	301	32415	302	32575	66	32685	66	32779	149
31934	308	32049	173	32315	301	32416	302	32576	66	32686	66	32780	149
31935	308	32053	173	32316	301	32417	302	32577	66	32687	66	32781	149
31936	308	32054	173	32317	301	32418	302	32578	66	32688	66	32782	149
31937	308	32055	173	32318	301	32419	302	32579	66	32689	66	32783	149
31938	280	32056	173	32319	301	32420	302	32580	66	32691	148	32784	149
31939	280	32057	173	32320	301	32421	302	32581	66	32692	148	32785	149
31940	280	32058	173	32321	301	32422	302	32582	66	32697	149	32786	149
31941	281	32059	173	32322	301	32423	302	32583	66	32698	149	32787	149
31942	281	32060	173	32323	301	32424	302	32584	66	32699	150	32788	149
31943	281	32061	173	32324	301	32425	302	32585	66	32700	148	32789	149
31944	282	32062	173	32325	301	32426	302	32586	66	32701	148	32790	149
31945	282	32063	173	32326	301	32427	302	32587	66	32702	148	32791	149
31946	282	32064	173	32327	301	32428	302	32588	66	32703	148	32792	149
31947	282	32065	173	32328	301	32429	302	32589	66	32704	148	32793	149
31948	280	32066	173	32329	301	32430	302	32590	66	32705	148	32794	149
31949	280	32067	173	32330	301	32431	302	32591	65	32706	148	32795	149
31950	280	32068	173	32333	301	32434	302	32592	65	32707	148	32796	150
31951	281	32069	173	32334	301	32435	302	32593	65	32708	148	32797	150
31952	281	32200	294	32335	301	32436	302	32594	66	32709	148	32798	150
31953	281	32201	294	32336	301	32437	302	32595	66	32710	149	32799	150

EDP Number Index

EDP NO.	PAGE	EDP NO.	PAGE	EDP NO.	PAGE	EDP NO.	PAGE	EDP NO.	PAGE	EDP NO.	PAGE	EDP NO.	PAGE
34867	146	35103	76	35280	292	35596	145	35686	145	35810	150	36262	151
34868	146	35104	76	35281	292	35597	145	35687	145	35811	150	36263	151
34869	146	35105	76	35282	292	35598	145	35688	145	35812	150	36264	151
34870	147	35106	77	35283	292	35599	145	35689	145	35813	151	36265	151
34888	148	35107	77	35285	292	35600	145	35690	145	35814	151	36266	151
34889	148	35108	77	35287	292	35601	145	35691	145	35815	151	36344	53
34894	149	35109	77	35289	292	35602	145	35692	145	35816	151	36345	53
34895	149	35110	77	35291	292	35603	145	35693	145	35817	151	36346	53
34896	150	35111	77	35293	292	35604	145	35694	145	35818	151	36347	53
34916	152	35112	76	35295	292	35605	145	35695	145	36106	316	36348	53
34917	152	35113	76	35297	292	35606	145	35696	145	36107	316	36349	53
34918	152	35114	76	35300	292	35607	145	35697	145	36108	316	36350	53
34919	152	35115	76	35301	292	35608	145	35698	145	36109	316	36351	53
34920	152	35116	76	35302	292	35609	145	35699	145	36110	316	36352	53
34921	152	35117	76	35303	292	35610	145	35700	145	36111	316	36353	53
34922	152	35118	76	35304	292	35611	145	35701	145	36112	316	36354	53
34923	152	35119	76	35305	292	35612	146	35702	146	36113	316	36355	53
34924	152	35120	76	35306	292	35613	146	35703	146	36114	316	36356	53
34925	152	35121	76	35307	292	35614	146	35704	146	36116	316	36357	53
34926	152	35122	76	35308	292	35615	146	35705	146	36117	316	36358	53
34927	152	35123	76	35309	292	35616	146	35706	146	36118	316	36359	53
34928	152	35124	76	35310	292	35617	146	35707	146	36120	316	36361	53
34929	152	35125	76	35311	292	35618	146	35708	146	36121	316	36370	41
34930	152	35126	76	35312	292	35619	146	35709	146	36122	316	36371	41
34931	152	35127	77	35313	292	35620	146	35710	146	36124	316	36372	41
34932	152	35128	77	35314	292	35621	146	35711	146	36125	316	36373	41
34933	152	35129	77	35315	292	35622	146	35712	146	36126	316	36374	42
34934	152	35130	77	35473	315	35623	146	35713	146	36128	316	36375	42
34941	153	35131	77	35475	315	35624	146	35714	146	36129	316	36376	42
34942	153	35132	77	35477	315	35625	146	35715	146	36130	316	36378	42
34943	153	35133	77	35478	315	35626	146	35716	146	36140	116	36380	42
34944	153	35134	77	35479	315	35627	146	35717	146	36141	116	36381	42
34945	153	35135	77	35480	315	35628	146	35718	146	36142	116	36383	43
34946	153	35136	77	35481	315	35629	146	35719	146	36143	116	36384	43
34947	153	35137	77	35482	315	35630	146	35720	146	36206	317	36385	43
34948	153	35138	77	35483	315	35631	146	35721	146	36207	317	36386	43
34949	153	35139	77	35485	315	35632	146	35722	146	36208	317	36387	43
34950	153	35140	77	35487	315	35633	147	35723	147	36209	317	36388	43
34951	153	35141	77	35489	315	35634	147	35724	147	36210	317	36389	43
34952	153	35150	76	35491	315	35635	147	35725	147	36211	317	36390	43
34954	153	35151	76	35493	315	35636	147	35726	147	36212	317	36391	43
34955	153	35152	76	35495	315	35637	147	35727	147	36213	317	36392	43
34956	153	35153	76	35497	315	35638	147	35728	147	36214	317	36393	43
34972	152	35154	76	35500	315	35639	147	35729	147	36216	317	36404	41
34973	152	35155	76	35501	315	35640	147	35730	147	36217	317	36406	41
34974	152	35156	76	35502	315	35641	147	35731	147	36218	317	36408	41
34975	152	35157	76	35503	315	35642	147	35732	147	36220	317	36410	41
34976	152	35158	76	35504	315	35643	147	35733	147	36221	317	36416	41
34977	152	35159	76	35505	315	35644	147	35734	147	36222	317	36418	41
34978	152	35160	76	35506	315	35645	147	35735	147	36224	317	36420	42
34979	152	35161	76	35507	315	35646	147	35736	147	36225	317	36422	42
34980	152	35180	77	35508	315	35647	147	35737	147	36226	317	36424	42
34981	152	35181	77	35509	315	35648	147	35738	147	36228	317	36426	42
34982	152	35182	77	35510	315	35649	147	35739	147	36229	317	36428	42
34983	152	35183	77	35511	315	35650	147	35740	147	36230	317	36430	42
34984	152	35184	77	35512	315	35651	147	35741	147	36235	148	36432	42
34985	152	35185	77	35513	315	35652	147	35742	147	36236	148	36436	42
34986	152	35186	77	35514	315	35653	147	35743	147	36237	151	36440	43
34987	152	35187	77	35515	315	35654	147	35744	147	36238	151	36442	43
34988	152	35188	77	35575	144	35665	144	35787	148	36239	148	36444	43
34989	152	35189	77	35576	144	35666	144	35788	148	36240	148	36447	44
34990	152	35190	77	35577	144	35667	144	35789	151	36241	151	36448	44
35005	153	35191	77	35578	144	35668	144	35790	151	36242	151	36449	44
35006	153	35220	78	35579	144	35669	144	35791	148	36243	148	36450	44
35007	153	35221	78	35580	144	35670	144	35792	148	36244	148	36452	44
35008	153	35222	78	35581	144	35671	144	35793	151	36245	151	36453	44
35009	153	35223	78	35582	144	35672	144	35794	151	36246	151	36454	44
35010	153	35224	78	35583	144	35673	144	35795	148	36247	151	36456	44
35011	153	35225	78	35584	144	35674	144	35796	148	36248	151	36457	44
35012	153	35226	78	35585	144	35675	144	35797	151	36249	151	36458	44
35013	153	35227	78	35586	144	35676	144	35798	151	36250	151	36460	44
35014	153	35228	78	35587	144	35677	144	35799	151	36251	149	36462	44
35015	153	35229	78	35588	144	35678	144	35800	151	36252	149	36463	44
35016	153	35230	78	35589	144	35679	144	35801	151	36253	151	36464	44
35018	153	35231	78	35590	145	35680	145	35802	151	36254	151	36466	44
35019	153	35273	292	35591	145	35681	145	35803	149	36257	150	36468	44
35020	153	35275	292	35592	145	35682	145	35804	149	36258	150	36469	44
35100	76	35277	292	35593	145	35683	145	35805	151	36259	150	36470	44
35101	76	35278	292	35594	145	35684	145	35806	151	36260	150	36472	44
35102	76	35279	292	35595	145	35685	145	35809	150	36261	151	36474	44

EDP Number Index

EDP NO.	PAGE	EDP NO.	PAGE	EDP NO.	PAGE	EDP NO.	PAGE	EDP NO.	PAGE	EDP NO.	PAGE	EDP NO.	PAGE
38875.....	34	39070.....	308	39168.....	308	39366.....	284	39564.....	284	39668.....	288	40017.....	310
38876.....	34	39071.....	305	39169.....	305	39367.....	282	39565.....	282	39669.....	287	40019.....	310
38877.....	34	39072.....	308	39170.....	308	39368.....	284	39566.....	284	39670.....	288	40020.....	310
38878.....	34	39073.....	306	39171.....	305	39369.....	282	39567.....	282	39671.....	287	40021.....	310
38879.....	34	39074.....	308	39172.....	308	39370.....	284	39568.....	284	39672.....	288	40023.....	310
38880.....	34	39075.....	306	39173.....	306	39371.....	282	39569.....	282	39673.....	287	40024.....	310
38881.....	34	39076.....	308	39174.....	308	39372.....	284	39570.....	284	39674.....	288	40025.....	310
38882.....	34	39077.....	303	39175.....	306	39373.....	282	39571.....	282	39675.....	287	40028.....	310
38883.....	34	39078.....	307	39176.....	308	39374.....	284	39572.....	284	39676.....	288	40030.....	310
38884.....	34	39089.....	306	39177.....	303	39375.....	282	39573.....	282	39677.....	287	40031.....	310
38885.....	34	39089.....	318	39178.....	307	39376.....	284	39574.....	284	39678.....	288	40032.....	310
39001.....	303	39090.....	308	39189.....	306	39377.....	280	39575.....	282	39679.....	287	40035.....	310
39002.....	307	39090.....	319	39189.....	318	39378.....	283	39576.....	284	39680.....	288	40037.....	310
39003.....	303	39101.....	303	39190.....	308	39389.....	318	39577.....	280	39681.....	287	40038.....	311
39004.....	307	39102.....	307	39190.....	319	39390.....	284	39578.....	283	39682.....	288	40039.....	311
39005.....	303	39103.....	303	39301.....	280	39390.....	319	39589.....	318	39683.....	287	40105.....	309
39006.....	307	39104.....	307	39302.....	283	39390.....	319	39589.....	318	39684.....	288	40106.....	312
39007.....	303	39105.....	303	39303.....	280	39501.....	280	39590.....	284	39685.....	287	40109.....	309
39008.....	307	39106.....	307	39304.....	283	39502.....	283	39590.....	319	39686.....	288	40110.....	312
39009.....	303	39107.....	303	39305.....	280	39503.....	280	39601.....	313	39687.....	287	40113.....	309
39010.....	307	39108.....	307	39306.....	283	39504.....	283	39602.....	314	39688.....	288	40114.....	312
39011.....	303	39109.....	303	39307.....	280	39505.....	280	39603.....	313	39689.....	287	40117.....	309
39012.....	307	39110.....	307	39308.....	283	39506.....	283	39604.....	314	39690.....	288	40118.....	312
39013.....	303	39111.....	303	39309.....	280	39507.....	280	39605.....	313	39691.....	287	40121.....	309
39014.....	307	39112.....	307	39310.....	283	39508.....	283	39606.....	314	39691.....	318	40122.....	312
39015.....	303	39113.....	303	39311.....	280	39509.....	280	39607.....	313	39692.....	288	40125.....	309
39016.....	307	39114.....	307	39312.....	283	39510.....	283	39608.....	314	39692.....	319	40126.....	312
39017.....	303	39115.....	303	39313.....	280	39511.....	280	39609.....	313	39701.....	297	40129.....	309
39018.....	307	39116.....	307	39314.....	283	39512.....	283	39610.....	314	39703.....	297	40130.....	312
39019.....	303	39117.....	303	39315.....	280	39513.....	280	39611.....	313	39705.....	297	40133.....	309
39020.....	307	39118.....	307	39316.....	283	39514.....	283	39612.....	314	39707.....	297	40134.....	312
39021.....	303	39119.....	303	39317.....	280	39515.....	280	39613.....	313	39709.....	297	40137.....	309
39022.....	307	39120.....	307	39318.....	283	39516.....	283	39614.....	314	39711.....	297	40138.....	312
39023.....	303	39121.....	303	39319.....	280	39517.....	280	39615.....	313	39713.....	297	40141.....	309
39024.....	307	39122.....	307	39320.....	283	39518.....	283	39616.....	314	39715.....	297	40142.....	312
39025.....	303	39123.....	303	39321.....	280	39519.....	280	39617.....	313	39717.....	297	40145.....	310
39026.....	307	39124.....	307	39322.....	283	39520.....	283	39618.....	314	39719.....	297	40146.....	312
39027.....	303	39125.....	303	39323.....	280	39521.....	280	39619.....	313	39721.....	297	40149.....	310
39028.....	307	39126.....	307	39324.....	283	39522.....	283	39620.....	314	39723.....	297	40150.....	312
39029.....	303	39127.....	303	39325.....	280	39523.....	280	39621.....	313	39725.....	297	40153.....	310
39030.....	307	39128.....	307	39326.....	283	39524.....	283	39622.....	314	39727.....	297	40154.....	312
39031.....	303	39129.....	303	39327.....	280	39525.....	280	39623.....	313	39729.....	297	40157.....	310
39032.....	307	39130.....	307	39328.....	283	39526.....	283	39624.....	314	39731.....	297	40158.....	312
39033.....	304	39131.....	303	39329.....	280	39527.....	280	39625.....	313	39733.....	297	40161.....	310
39034.....	307	39132.....	307	39330.....	283	39528.....	283	39626.....	314	39735.....	297	40162.....	312
39035.....	304	39133.....	304	39331.....	280	39529.....	280	39627.....	313	39737.....	297	40165.....	310
39036.....	307	39134.....	307	39332.....	283	39530.....	283	39628.....	314	39739.....	297	40166.....	312
39037.....	304	39135.....	304	39333.....	280	39531.....	280	39629.....	313	39741.....	297	40169.....	310
39038.....	307	39136.....	307	39334.....	283	39532.....	283	39630.....	314	39743.....	297	40170.....	312
39039.....	304	39137.....	304	39335.....	280	39533.....	280	39631.....	313	39745.....	297	40173.....	310
39040.....	307	39138.....	307	39336.....	283	39534.....	283	39632.....	314	39747.....	297	40174.....	312
39041.....	304	39139.....	304	39337.....	281	39535.....	280	39633.....	313	39749.....	297	40177.....	311
39042.....	307	39140.....	307	39338.....	283	39536.....	283	39634.....	314	39751.....	297	40178.....	312
39043.....	304	39141.....	304	39339.....	281	39537.....	281	39635.....	313	39753.....	297	40181.....	311
39044.....	307	39142.....	307	39340.....	283	39538.....	283	39636.....	314	39755.....	297	40182.....	312
39045.....	304	39143.....	304	39341.....	281	39539.....	281	39637.....	313	39757.....	297	40185.....	311
39046.....	307	39144.....	307	39342.....	283	39540.....	283	39638.....	314	39759.....	297	40186.....	312
39047.....	304	39145.....	304	39343.....	281	39541.....	281	39639.....	313	39761.....	297	40305.....	285
39048.....	308	39146.....	307	39344.....	283	39542.....	283	39640.....	314	39763.....	297	40306.....	286
39049.....	304	39147.....	304	39345.....	281	39543.....	281	39641.....	313	39765.....	297	40309.....	285
39050.....	308	39148.....	308	39346.....	283	39544.....	283	39642.....	318	39767.....	297	40310.....	286
39051.....	304	39149.....	304	39347.....	281	39545.....	281	39642.....	314	39769.....	297	40313.....	285
39052.....	308	39150.....	308	39348.....	284	39546.....	283	39642.....	319	39771.....	297	40314.....	286
39053.....	304	39151.....	304	39349.....	281	39547.....	281	39651.....	287	39773.....	297	40317.....	285
39054.....	308	39152.....	308	39350.....	284	39548.....	284	39652.....	288	39775.....	297	40318.....	286
39055.....	305	39153.....	304	39351.....	281	39549.....	281	39653.....	287	39777.....	297	40321.....	285
39056.....	308	39154.....	308	39352.....	284	39550.....	284	39654.....	288	39789.....	297	40322.....	286
39057.....	305	39155.....	305	39353.....	281	39551.....	281	39655.....	287	39789.....	318	40325.....	285
39058.....	308	39156.....	308	39354.....	284	39552.....	284	39656.....	288	40000.....	309	40326.....	286
39059.....	305	39157.....	305	39355.....	281	39553.....	281	39657.....	287	40001.....	309	40329.....	285
39060.....	308	39158.....	308	39356.....	284	39554.....	284	39658.....	288	40003.....	309	40330.....	286
39061.....	305	39159.....	305	39357.....	281	39555.....	281	39659.....	287	40004.....	309	40333.....	285
39062.....	308	39160.....	308	39358.....	284	39556.....	284	39660.....	288	40005.....	309	40334.....	286
39063.....	305	39161.....	305	39359.....	281	39557.....	281	39661.....	287	40007.....	309	40337.....	285
39064.....	308	39162.....	308	39360.....	284	39558.....	284	39662.....	288	40009.....	309	40338.....	286
39065.....	305	39163.....	305	39361.....	281	39559.....	281	39663.....	287	40010.....	309	40341.....	285
39066.....	308	39164.....	308	39362.....	284	39560.....	284	39664.....	288	40011.....	309	40342.....	286
39067.....	305	39165.....	305	39363.....	281	39561.....	281	39665.....	287	40012.....	310	40345.....	285
39068.....	308	39166.....	308	39364.....	284	39562.....	284	39666.....	288	40015.....	310	40346.....	286
39069.....	305	39167.....	305	39365.....	282	39563.....	281	39667.....	287	40016.....	310	40349.....	285

EDP Number Index

EDP NO.	PAGE	EDP NO.	PAGE	EDP NO.	PAGE	EDP NO.	PAGE	EDP NO.	PAGE	EDP NO.	PAGE	EDP NO.	PAGE
40350.....	286	41445.....	313	42611.....	70	42707.....	160	43395.....	285	43916.....	295	44563.....	170
40353.....	285	41446.....	314	42612.....	70	42708.....	160	43396.....	286	43917.....	295	44564.....	170
40354.....	286	41449.....	313	42613.....	70	42709.....	160	43445.....	106	43918.....	295	44565.....	170
40357.....	285	41450.....	314	42614.....	70	42710.....	161	43446.....	106	43919.....	295	44566.....	170
40358.....	286	41453.....	313	42615.....	70	42711.....	161	43447.....	106	43920.....	295	44570.....	171
40361.....	285	41454.....	314	42616.....	70	42712.....	61	43448.....	106	43921.....	295	44571.....	171
40362.....	286	41457.....	313	42617.....	71	42713.....	61	43449.....	106	43922.....	295	44572.....	171
40365.....	285	41458.....	314	42618.....	71	42714.....	61	43450.....	106	43923.....	295	44573.....	171
40366.....	286	41461.....	313	42619.....	71	42715.....	61	43451.....	106	43924.....	295	44574.....	171
40369.....	285	41462.....	314	42620.....	71	42716.....	61	43452.....	106	43925.....	295	44575.....	171
40370.....	286	41465.....	313	42621.....	72	42717.....	61	43453.....	106	43926.....	295	44576.....	171
40373.....	285	41466.....	314	42622.....	70	42718.....	49	43470.....	106	43927.....	295	44577.....	171
40374.....	286	41505.....	289	42623.....	70	42719.....	49	43471.....	106	43928.....	295	44578.....	171
40377.....	285	41506.....	290	42624.....	71	42721.....	49	43472.....	106	43929.....	295	44579.....	171
40378.....	286	41509.....	289	42625.....	71	42722.....	49	43473.....	106	43930.....	295	44580.....	171
40381.....	285	41510.....	290	42626.....	71	42723.....	49	43474.....	106	43931.....	295	44581.....	171
40382.....	286	41513.....	289	42627.....	71	42731.....	50	43475.....	106	43932.....	295	44582.....	171
40385.....	285	41514.....	290	42628.....	71	42732.....	50	43476.....	106	43933.....	295	44583.....	171
40386.....	286	41517.....	289	42630.....	71	42733.....	50	43477.....	106	43934.....	295	44584.....	171
40505.....	299	41518.....	290	42631.....	71	42734.....	50	43478.....	106	43935.....	295	44585.....	171
40506.....	300	41521.....	289	42632.....	71	42735.....	50	43479.....	106	43936.....	295	44586.....	171
40509.....	299	41522.....	290	42633.....	71	42736.....	50	43480.....	106	43937.....	295	44587.....	170
40510.....	300	41525.....	289	42648.....	71	42737.....	50	43481.....	106	43938.....	295	44588.....	170
40513.....	299	41526.....	290	42649.....	71	42738.....	50	43482.....	106	43939.....	295	44589.....	170
40514.....	300	41529.....	289	42650.....	71	42739.....	50	43483.....	106	43950.....	295	44590.....	170
40517.....	299	41530.....	290	42651.....	71	42750.....	73	43484.....	106	43951.....	295	44591.....	170
40518.....	300	41533.....	289	42652.....	71	42751.....	73	43485.....	106	43952.....	295	44592.....	170
40521.....	299	41534.....	290	42653.....	72	42752.....	73	43486.....	106	43953.....	295	44593.....	170
40522.....	300	41537.....	289	42654.....	72	42753.....	73	43487.....	106	43954.....	295	44594.....	170
40525.....	299	41538.....	290	42655.....	72	42754.....	73	43488.....	106	43955.....	295	44595.....	170
40526.....	300	41541.....	289	42656.....	71	42755.....	73	43489.....	106	43956.....	295	44596.....	170
40529.....	299	41542.....	290	42657.....	71	43101.....	309	43490.....	106	43957.....	295	44597.....	170
40530.....	300	41545.....	289	42658.....	71	43102.....	312	43491.....	106	43958.....	295	44598.....	171
40533.....	299	41546.....	290	42659.....	71	43103.....	309	43492.....	106	43959.....	295	44599.....	171
40534.....	300	41549.....	289	42660.....	70	43104.....	312	43493.....	106	44298.....	164	44600.....	171
40537.....	299	41550.....	290	42661.....	70	43105.....	310	43494.....	106	44299.....	164	44601.....	171
40538.....	300	41553.....	289	42662.....	70	43106.....	312	43495.....	106	44300.....	164	44602.....	171
40541.....	299	41554.....	290	42663.....	70	43107.....	309	43496.....	106	44301.....	164	44603.....	171
40542.....	300	41557.....	289	42664.....	70	43108.....	312	43497.....	106	44302.....	164	44604.....	171
40545.....	299	41558.....	290	42665.....	70	43115.....	310	43501.....	299	44303.....	164	44605.....	171
40546.....	300	41561.....	289	42666.....	70	43116.....	312	43502.....	300	44304.....	164	44606.....	171
40549.....	299	41562.....	290	42667.....	70	43125.....	310	43503.....	299	44305.....	164	44607.....	171
40550.....	300	41565.....	289	42668.....	70	43126.....	312	43504.....	300	44306.....	164	44608.....	171
40553.....	299	41566.....	290	42669.....	70	43135.....	310	43505.....	299	44307.....	164	44609.....	170
40554.....	300	41605.....	309	42670.....	70	43136.....	312	43506.....	300	44308.....	164	44610.....	170
40557.....	299	41609.....	309	42671.....	70	43145.....	310	43507.....	299	44309.....	164	44611.....	170
40558.....	300	41613.....	309	42672.....	70	43146.....	312	43508.....	300	44505.....	173	44612.....	170
40561.....	299	41617.....	309	42673.....	70	43155.....	310	43515.....	299	44506.....	173	44613.....	170
40562.....	300	41621.....	309	42674.....	70	43156.....	312	43516.....	300	44509.....	173	44614.....	170
40565.....	299	41625.....	309	42675.....	70	43165.....	311	43525.....	299	44510.....	173	44615.....	171
40566.....	300	41629.....	309	42676.....	70	43166.....	312	43526.....	300	44513.....	173	44616.....	171
40569.....	299	41633.....	309	42677.....	70	43175.....	311	43535.....	299	44514.....	173	44617.....	171
40570.....	300	41637.....	309	42678.....	70	43176.....	312	43536.....	300	44517.....	173	44618.....	171
40573.....	299	41641.....	309	42679.....	70	43185.....	311	43545.....	299	44518.....	173	44619.....	171
40574.....	300	41645.....	310	42680.....	70	43186.....	312	43546.....	300	44521.....	173	44620.....	171
40577.....	299	41649.....	310	42681.....	70	43195.....	311	43555.....	299	44522.....	173	44627.....	140
40578.....	300	41653.....	310	42682.....	70	43196.....	312	43556.....	300	44525.....	173	44628.....	140
40581.....	299	41657.....	310	42683.....	70	43301.....	285	43565.....	299	44526.....	173	44629.....	140
40582.....	300	41661.....	310	42684.....	70	43302.....	286	43566.....	300	44529.....	173	44630.....	140
40585.....	299	41665.....	310	42685.....	71	43303.....	285	43575.....	299	44530.....	173	44631.....	140
40586.....	300	41705.....	291	42686.....	71	43304.....	286	43576.....	300	44533.....	173	44634.....	140
41405.....	313	41709.....	291	42687.....	71	43305.....	285	43585.....	299	44534.....	173	44635.....	140
41406.....	314	41713.....	291	42688.....	71	43306.....	286	43586.....	300	44537.....	173	44636.....	140
41409.....	313	41717.....	291	42689.....	71	43307.....	285	43595.....	299	44538.....	173	44637.....	140
41410.....	314	41721.....	291	42690.....	71	43308.....	286	43596.....	300	44541.....	173	44638.....	140
41413.....	313	41725.....	291	42691.....	71	43315.....	285	43900.....	296	44542.....	173	44639.....	140
41414.....	314	41729.....	291	42692.....	71	43316.....	286	43901.....	296	44545.....	173	44641.....	140
41417.....	313	41733.....	291	42693.....	71	43325.....	285	43902.....	296	44546.....	173	44642.....	140
41418.....	314	41737.....	291	42694.....	71	43326.....	286	43903.....	296	44550.....	170	44643.....	140
41421.....	313	41741.....	291	42695.....	71	43335.....	285	43904.....	296	44551.....	170	44701.....	157
41422.....	314	41745.....	291	42696.....	71	43336.....	286	43905.....	296	44552.....	170	44702.....	157
41425.....	313	41749.....	291	42697.....	71	43345.....	285	43906.....	296	44553.....	170	44703.....	157
41426.....	314	41753.....	291	42698.....	71	43346.....	286	43907.....	296	44554.....	170	44705.....	157
41429.....	313	41757.....	291	42699.....	71	43355.....	285	43908.....	296	44555.....	170	44708.....	158
41430.....	314	41761.....	291	42700.....	71	43356.....	286	43909.....	296	44556.....	170	44711.....	158
41433.....	313	41765.....	291	42701.....	72	43365.....	285	43910.....	295	44557.....	170	44714.....	159
41434.....	314	42606.....	70	42702.....	72	43366.....	286	43911.....	295	44558.....	170	44715.....	157
41437.....	313	42607.....	70	42703.....	72	43375.....	285	43912.....	295	44559.....	170	44716.....	157
41438.....	314	42608.....	70	42704.....	72	43376.....	286	43913.....	295	44560.....	170	44717.....	157
41441.....	313	42609.....	70	42705.....	72	43385.....	285	43914.....	295	44561.....	170	44719.....	157
41442.....	314	42610.....	70	42706.....	160	43386.....	286	43915.....	295	44562.....	170	44722.....	158

EDP Number Index

EDP NO.	PAGE	EDP NO.	PAGE	EDP NO.	PAGE	EDP NO.	PAGE	EDP NO.	PAGE	EDP NO.	PAGE	EDP NO.	PAGE
69221	209	69302	212	70477	109	73014	386	74246	367	74384	90	74465	91
69222	209	69303	212	70478	109	73026	386	74249	370	74385	90	74466	91
69223	210	69304	212	70479	109	73027	386	74252	370	74386	90	74467	91
69224	210	69305	212	70480	109	73028	386	74255	370	74387	90	74468	91
69225	210	69306	212	70481	109	73029	386	74258	370	74388	90	74469	91
69226	210	69307	212	70482	109	73041	386	74261	370	74389	90	74470	91
69227	210	69308	212	70483	109	73070	387	74264	370	74390	90	74471	91
69228	210	69309	212	70484	109	73071	387	74267	370	74391	90	74472	91
69229	210	69310	212	70485	109	73072	387	74270	370	74392	90	74473	91
69230	210	69311	212	70486	109	73073	387	74273	370	74393	90	74474	91
69231	210	69312	212	70487	109	73074	387	74301	90	74394	90	74475	91
69232	210	69313	213	70488	109	73075	387	74302	90	74395	90	74476	91
69233	210	69314	213	70489	109	73078	387	74303	90	74396	90	74477	91
69234	210	69315	213	70527	112	73079	387	74304	90	74397	90	74478	91
69235	210	69316	213	70529	112	73080	387	74305	90	74398	90	74479	91
69236	210	69317	213	70531	112	73081	387	74306	90	74399	90	74480	91
69237	210	69318	213	70533	112	73082	387	74307	90	74400	90	74481	91
69238	210	69319	213	70535	112	73083	387	74308	90	74401	90	74482	91
69239	210	69320	213	70537	112	74001	364	74309	90	74402	90	74483	91
69240	210	69321	213	70539	112	74004	364	74310	90	74403	90	74484	91
69241	210	69322	213	70540	112	74007	364	74311	90	74404	90	74485	91
69242	210	69323	213	70542	112	74010	364	74316	90	74405	90	74486	91
69243	210	69324	213	70544	112	74013	364	74317	90	74406	90	74487	91
69244	210	69325	213	70546	112	74016	364	74318	90	74407	90	74488	91
69245	210	70003	374	70548	112	74019	364	74319	90	74408	90	74489	91
69246	210	70004	374	70550	112	74022	364	74320	90	74409	90	74490	91
69247	210	70005	374	70551	112	74025	367	74321	90	74410	90	74491	91
69248	210	70006	374	70552	112	74028	367	74322	90	74411	90	74492	91
69249	210	70007	374	70553	112	74031	367	74323	90	74412	90	74493	91
69250	211	70008	374	70554	112	74034	367	74324	90	74413	90	74494	91
69251	211	70009	374	70555	112	74037	367	74325	90	74414	90	74495	91
69252	211	70010	374	70556	112	74040	367	74326	90	74415	90	74496	91
69253	211	70011	374	70557	112	74043	367	74327	90	74416	90	74497	91
69254	211	70012	374	70558	112	74046	367	74332	90	74417	90	74498	91
69255	211	70013	374	70559	112	74049	370	74333	90	74418	90	74499	91
69256	211	70014	374	70560	112	74052	370	74334	90	74419	90	74500	91
69257	211	70015	374	70561	112	74055	370	74335	90	74420	90	74501	91
69258	211	70016	374	70562	112	74058	370	74336	90	74421	90	74502	91
69259	211	70017	374	70563	112	74061	370	74337	90	74422	90	74503	91
69260	211	70018	374	72930	386	74064	370	74338	90	74423	90	74504	91
69261	211	70019	374	72947	386	74067	370	74339	90	74424	90	74505	91
69262	211	70020	374	72948	386	74070	370	74340	90	74425	90	74506	91
69263	211	70021	374	72949	386	74101	364	74341	90	74426	90	74507	91
69264	211	70022	374	72950	386	74104	364	74342	90	74427	90	74508	91
69265	211	70023	374	72951	386	74107	364	74343	90	74428	90	74509	91
69266	211	70024	374	72952	386	74110	364	74348	90	74429	90	74510	91
69267	211	70025	374	72953	386	74113	364	74349	90	74430	90	74511	91
69268	211	70026	374	72954	390	74116	364	74350	90	74431	90	74512	91
69269	211	70027	374	72955	390	74119	364	74351	90	74432	90	74513	91
69270	211	70028	374	72956	390	74122	364	74352	90	74433	90	74514	91
69271	211	70029	374	72957	390	74125	367	74353	90	74434	90	74515	91
69272	211	70030	374	72958	390	74128	367	74354	90	74435	90	74516	91
69273	211	70031	374	72959	390	74131	367	74355	90	74436	90	74517	91
69274	211	70032	374	72960	390	74134	367	74356	90	74437	90	74518	91
69275	211	70441	110	72961	390	74137	367	74357	90	74438	90	74519	91
69276	211	70442	110	72962	390	74140	367	74358	90	74439	90	74520	91
69277	211	70444	110	72963	390	74143	367	74359	90	74440	90	74521	91
69278	211	70445	110	72964	390	74146	367	74360	90	74441	90	74522	91
69279	211	70447	110	72965	390	74149	370	74361	90	74442	90	74523	91
69280	211	70448	110	72966	390	74152	370	74362	90	74443	90	74524	91
69281	211	70450	110	72967	390	74155	370	74363	90	74444	90	74525	91
69282	211	70451	110	72968	390	74158	370	74364	90	74445	90	74526	91
69283	211	70453	110	72969	390	74161	370	74365	90	74446	90	74527	91
69284	212	70454	110	72970	393	74164	370	74366	90	74447	90	74528	91
69285	212	70456	110	72971	393	74167	370	74367	90	74448	90	74529	91
69286	212	70457	110	72972	393	74170	370	74368	90	74449	90	74530	91
69287	212	70459	110	72973	393	74201	364	74369	90	74450	90	74531	91
69288	212	70460	110	72974	393	74204	364	74370	90	74451	90	74532	91
69289	212	70462	110	72975	393	74207	364	74371	90	74452	90	74533	91
69290	212	70463	110	72976	393	74210	364	74372	90	74453	90	74534	91
69291	212	70465	110	72977	393	74213	364	74373	90	74454	90	74535	91
69292	212	70466	110	72978	119	74216	364	74374	90	74455	90	74536	91
69293	212	70468	110	72979	119	74219	364	74375	90	74456	91	74537	91
69294	212	70469	110	72980	119	74222	364	74376	90	74457	91	74538	91
69295	212	70470	109	72981	119	74225	367	74377	90	74458	91	74539	91
69296	212	70471	109	72982	119	74228	367	74378	90	74459	91	74540	91
69297	212	70472	109	72983	119	74231	367	74379	90	74460	91	74541	91
69298	212	70473	109	72984	119	74234	367	74380	90	74461	91	74542	91
69299	212	70474	109	72985	119	74237	367	74381	90	74462	91	74543	91
69300	212	70475	109	73012	386	74240	367	74382	90	74463	91	74544	91
69301	212	70476	109	73013	386	74243	367	74383	90	74464	91	74545	91

KSPT Reference Information

ISO h6 SPECIFICATIONS					
DIAMETER	+	-	DIAMETER	+	-
≥ 1/8 - 3/16	0.00000	-0.00032	≤ 3	0,000	0,006
> 3/16 - 7/16	0.00000	-0.00035	> 3 - 6	0,000	0,008
> 7/16 - 5/8	0.00000	-0.00043	> 6 - 10	0,000	0,009
> 5/8 - 1	0.00000	-0.00051	> 10 - 18	0,000	0,011
> 1 - 1-1/4	0.00000	-0.00063	> 18 - 25	0,000	0,013

MACHINING FORMULAS	
INCH FORMULAS	METRIC FORMULAS
sfm = rpm x .262 x cutting diameter	m/min = (3.14 x cutting diameter x rpm) / 1000
rpm = sfm x 3.82 / cutting diameter	rpm = (1000 x m / min) / (3.14 x cutting diameter)
feed (inches per tooth) = ipm / (number of teeth x rpm)	feed (mm per tooth) = millimeters per minute / (number of teeth x rpm)
feed (inches / minute) = inches per tooth x number of teeth x rpm	feed (mm/minute) = feed per tooth x number of teeth x rpm
feed (inches / minute) = ipr x rpm	feed (mm/minute) = mmr x rpm
feed (inches / revolution) = ipm / rpm	feed (mm per revolution) = mmr / rpm
cuspl height = $(\text{tool diameter} / 2) - \sqrt{(\text{tool diameter}^2 - \text{pitch}^2) / 4}$	cuspl height = $(\text{tool diameter} / 2) - \sqrt{(\text{tool diameter}^2 - \text{pitch}^2) / 4}$
pitch = $\sqrt{4 \times (\text{cuspl height} \times \text{tool diameter}) - 4 \times (\text{cuspl height}^2)}$	pitch = $\sqrt{4 \times (\text{cuspl height} \times \text{tool diameter}) - 4 \times (\text{cuspl height}^2)}$
mrr – milling – (in ³ /min) = width of cut x depth of cut x ipm	mrr – milling – (cm ³ /min) = (width of cut x depth of cut x mm/min) / 1000
cutting time – drilling – (minutes) = length / ipm	cutting time – drilling – (minutes) = length / mm/min

- sfm surface feet per minute
- rpm revolutions per minute
- ipm feed rate in inches per minutes
- ipr inches per revolution
- mmr millimeters per revolution
- mm/min feed rate in millimeters per minute
- mrr material removal rate
on flat surface

GENERAL FORMULAS	
coolant pressure: 1 Bar = 14.5 Pounds per Square Inch (PSI)	
calculation of coolant pressure: Pounds Per Square Inch (PSI) = (Horsepower of Pump x 1.460) / Gallons per Minute (GPM)	
1 Liter = 0.254 Gallons	
inch = millimeters / 25.4	millimeters = inch x 25.4
inch tap drill sizes = major diameter – ((1.299 x % of thread) / threads per inch)	
metric tap drill sizes = major diameter – (1.082 x pitch x % of thread)	
inch thread forming drill size: maximum diameter = basic major diameter – (3/8 x number of threads per inch)	
inch thread forming drill size: minimum diameter = basic major diameter – (1/2 x number of threads per inch)	
metric thread forming drill size: maximum diameter = basic major diameter – (.375 x pitch)	
metric thread forming drill size: minimum diameter = basic major diameter – (.500 x pitch)	

Decimal Equivalents

Fraction • Number • Letter • Metric Sizes

INCH	METRIC	DECIMAL EQUIVALENT	INCH	METRIC	DECIMAL EQUIVALENT	INCH	METRIC	DECIMAL EQUIVALENT	INCH	METRIC	DECIMAL EQUIVALENT	INCH	METRIC	DECIMAL EQUIVALENT	INCH	METRIC	DECIMAL EQUIVALENT
-	0,10	0.0039	-	1,60	0.0630	9/64	3,57	0.1406	#1	5,79	0.2280	R	8,61	0.3390	-	13,00	0.5118
-	0,20	0.0079	#52	1,61	0.0635	-	3,60	0.1417	-	5,80	0.2283	-	8,70	0.3425	33/64	13,10	0.5156
-	0,25	0.0098	-	1,65	0.0650	#27	3,66	0.1440	-	5,90	0.2323	11/32	8,73	0.3438	17/32	13,49	0.5312
-	0,30	0.0118	#51	1,70	0.0669	-	3,70	0.1457	A	5,94	0.2340	-	8,75	0.3445	-	13,50	0.5315
#80	0,34	0.0135	-	1,75	0.0689	#26	3,73	0.1470	15/64	5,95	0.2344	-	8,80	0.3465	35/64	13,89	0.5469
-	0,35	0.0138	#50	1,78	0.0700	-	3,75	0.1476	-	6,00	0.2362	S	8,84	0.3480	-	14,00	0.5512
#79	0,37	0.0145	-	1,80	0.0709	#25	3,80	0.1495	B	6,05	0.2380	-	8,90	0.3504	9/16	14,29	0.5625
1/64	0,40	0.0156	#49	1,85	0.0728	-	3,80	0.1496	-	6,10	0.2402	-	9,00	0.3543	-	14,50	0.5709
#78	0,41	0.0160	-	1,90	0.0748	#24	3,86	0.1520	C	6,15	0.2420	T	9,09	0.3580	37/64	14,68	0.5781
-	0,45	0.0177	#48	1,93	0.0760	-	3,90	0.1535	-	6,20	0.2441	-	9,10	0.3583	-	15,00	0.5906
#77	0,46	0.0180	-	1,95	0.0768	#23	3,91	0.1540	D	6,25	0.2461	23/64	9,13	0.3594	19/32	15,08	0.5938
-	0,50	0.0197	5/64	1,98	0.0781	5/32	3,97	0.1562	-	6,30	0.2480	-	9,20	0.3622	39/64	15,48	0.6094
#76	0,51	0.0200	#47	1,99	0.0785	#22	3,99	0.1570	E	6,35	0.2500	-	9,25	0.3642	-	15,50	0.6102
#75	0,53	0.0210	-	2,00	0.0787	-	4,00	0.1575	1/4	6,35	0.2500	-	9,30	0.3661	5/8	15,88	0.6250
-	0,55	0.0217	-	2,05	0.0807	#21	4,04	0.1590	-	6,40	0.2520	U	9,35	0.3680	-	16,00	0.6299
#74	0,57	0.0225	#46	2,06	0.0810	#20	4,09	0.1610	-	6,50	0.2559	-	9,40	0.3701	41/64	16,27	0.6406
-	0,60	0.0236	#45	2,08	0.0820	-	4,10	0.1614	F	6,53	0.2570	-	9,50	0.3740	-	16,50	0.6496
#73	0,61	0.0240	-	2,10	0.0827	-	4,20	0.1654	-	6,60	0.2598	3/8	9,53	0.3750	21/32	16,67	0.6562
#72	0,64	0.0250	-	2,15	0.0846	#19	4,22	0.1660	G	6,63	0.2610	V	9,56	0.3770	-	17,00	0.6693
-	0,65	0.0256	#44	2,18	0.0860	-	4,25	0.1673	-	6,70	0.2638	-	9,60	0.3780	43/64	17,07	0.6719
#71	0,66	0.0260	-	2,20	0.0866	-	4,30	0.1693	17/64	6,75	0.2656	-	9,70	0.3819	11/16	17,46	0.6875
-	0,70	0.0276	-	2,25	0.0886	#18	4,31	0.1695	H	6,76	0.2667	-	9,75	0.3839	-	17,50	0.6890
#70	0,71	0.0280	#43	2,26	0.0890	11/64	4,37	0.1719	-	6,80	0.2677	W	9,80	0.3858	45/64	17,86	0.7031
#69	0,74	0.0292	-	2,30	0.0906	#17	4,39	0.1730	-	6,90	0.2717	-	9,90	0.3898	-	18,00	0.7087
-	0,75	0.0295	-	2,35	0.0925	-	4,40	0.1732	I	6,91	0.2720	25/64	9,92	0.3906	23/32	18,26	0.7188
#68	0,79	0.0310	#42	2,37	0.0935	#16	4,50	0.1770	-	7,00	0.2756	-	10,00	0.3937	-	18,50	0.7283
1/32	0,79	0.0313	3/32	2,38	0.0938	-	4,50	0.1772	J	7,04	0.2770	X	10,08	0.3970	47/64	18,65	0.7344
-	0,80	0.0315	-	2,40	0.0945	#15	4,57	0.1800	-	7,10	0.2795	-	10,10	0.3976	-	19,00	0.7480
#67	0,81	0.0320	#41	2,44	0.0960	-	4,60	0.1811	K	7,14	0.2810	-	10,20	0.4016	3/4	19,05	0.7500
#66	0,84	0.0330	-	2,45	0.0965	#14	4,62	0.1820	9/32	7,14	0.2812	Y	10,26	0.4040	49/64	19,45	0.7656
-	0,85	0.0335	#40	2,50	0.0984	#13	4,70	0.1850	-	7,20	0.2835	-	10,30	0.4055	-	19,50	0.7677
#65	0,89	0.0350	#39	2,53	0.0995	-	4,75	0.1870	-	7,25	0.2854	13/32	10,32	0.4062	25/32	19,84	0.7812
-	0,90	0.0354	#38	2,58	0.1015	3/16	4,76	0.1875	-	7,30	0.2874	-	10,40	0.4094	-	20,00	0.7874
#64	0,91	0.0360	-	2,60	0.1024	#12	4,80	0.1890	L	7,37	0.2900	Z	10,49	0.4130	51/64	20,24	0.7969
#63	0,94	0.0370	#37	2,64	0.1040	#11	4,85	0.1910	-	7,40	0.2913	-	10,50	0.4134	-	20,50	0.8071
-	0,95	0.0374	-	2,70	0.1063	-	4,90	0.1929	M	7,49	0.2950	-	10,60	0.4173	13/16	20,64	0.8125
#62	0,97	0.0380	#36	2,71	0.1065	#10	4,91	0.1935	-	7,50	0.2953	-	10,70	0.4213	-	21,00	0.8268
#61	0,99	0.0390	-	2,75	0.1083	#9	4,98	0.1960	19/64	7,54	0.2969	27/64	10,72	0.4219	53/64	21,03	0.8281
-	1,00	0.0394	7/64	2,78	0.1094	-	5,00	0.1969	-	7,60	0.2992	-	10,80	0.4252	27/32	21,43	0.8438
#60	1,02	0.0400	#35	2,79	0.1100	#8	5,05	0.1990	N	7,67	0.3020	-	10,90	0.4291	-	21,50	0.8465
#59	1,04	0.0410	-	2,80	0.1102	-	5,10	0.2008	-	7,70	0.3031	-	11,00	0.4331	55/64	21,84	0.8594
-	1,05	0.0413	#34	2,82	0.1110	#7	5,11	0.2010	-	7,75	0.3051	-	11,10	0.4370	-	22,00	0.8661
#58	1,07	0.0420	#33	2,87	0.1130	13/64	5,16	0.2031	-	7,80	0.3071	7/16	11,11	0.4375	7/8	22,23	0.8750
#57	1,09	0.0430	-	2,90	0.1142	#6	5,18	0.2040	-	7,90	0.3110	-	11,20	0.4409	-	22,50	0.8858
-	1,10	0.0433	#32	2,95	0.1160	-	5,20	0.2047	5/16	7,94	0.3125	-	11,30	0.4449	57/64	22,62	0.8906
-	1,15	0.0453	-	3,00	0.1181	#5	5,22	0.2055	-	8,00	0.3150	-	11,40	0.4488	-	23,00	0.9055
#56	1,18	0.0465	#31	3,05	0.1200	-	5,25	0.2067	O	8,03	0.3160	-	11,50	0.4528	29/32	23,02	0.9062
3/64	1,19	0.0469	-	3,10	0.1220	-	5,3	0.2087	-	8,10	0.3189	29/64	11,51	0.4531	59/64	23,42	0.9219
-	1,20	0.0472	1/8	3,18	0.1250	#4	5,31	0.2090	-	8,20	0.3228	-	11,60	0.4567	-	23,50	0.9252
-	1,25	0.0492	-	3,20	0.1260	-	5,40	0.2126	P	8,20	0.3230	-	11,70	0.4606	15/16	23,81	0.9375
-	1,30	0.0512	-	3,25	0.1280	#3	5,41	0.2130	-	8,25	0.3248	-	11,80	0.4646	-	24,00	0.9449
#55	1,32	0.0520	#30	3,26	0.1285	-	5,50	0.2165	-	8,30	0.3268	-	11,90	0.4685	61/64	24,21	0.9531
-	1,35	0.0531	-	3,30	0.1299	7/32	5,56	0.2188	21/64	8,33	0.3281	15/32	11,91	0.4688	-	24,50	0.9646
#54	1,40	0.0550	-	3,40	0.1339	-	5,60	0.2205	-	8,40	0.3307	-	12,00	0.4724	31/32	24,61	0.9688
#53	1,51	0.0595	#29	3,45	0.1360	#2	5,61	0.2210	Q	8,43	0.3320	31/64	12,30	0.4844	-	25,00	0.9843
-	1,55	0.0610	-	3,50	0.1378	-	5,70	0.2244	-	8,50	0.3346	-	12,50	0.4921	63/64	25,00	0.9844
1/16	1,59	0.0625	#28	3,57	0.1405	-	5,75	0.2264	-	8,60	0.3386	1/2	12,70	0.5000	1	25,40	1.0000

Hardness Conversion Chart

ROCKWELL HARDNESS (HRb)	ROCKWELL HARDNESS (HRc)	BRINELL HARDNESS (HB)	VICKERS HARDNESS (HV)	TENSILE STRENGTH (N/mm ²)	PSI (1000lb/in ²)
67	–	121	122	401	58
70	–	126	127	432	63
73	–	132	132	448	65
75	–	136	137	455	66
77	–	140	143	463	67
80	–	147	150	479	69
82	–	153	156	494	72
84	–	159	163	525	76
86	–	165	171	540	78
89	–	177	178	556	81
91	–	186	188	602	88
93	–	197	196	632	92
96	–	216	212	664	97
97	–	223	218	695	101
98	21	230	234	756	110
–	22	236	241	772	112
–	23	242	247	787	114
–	24	248	255	818	118
–	25	254	261	849	123
–	27	266	269	865	125
–	28	272	275	895	130
–	29	278	284	911	132
–	30	284	292	942	136
–	31	293	300	973	141
–	32	302	308	988	143
–	33	310	318	1019	147
–	34	319	327	1050	152
–	35	328	337	1096	159
–	37	345	349	1127	163
–	38	353	359	1158	168
–	39	362	370	1189	172
–	40	370	381	1235	179
–	41	381	395	1266	183
–	42	391	408	1312	190
–	44	411	422	1359	197
–	45	422	437	1420	206
–	46	433	452	1467	212
–	48	455	470	1513	219
–	50	479	497	1559	226
–	51	485	517	1621	235
–	52	497	532	1668	241
–	54	–	573	1729	250
–	56	–	609	1807	262
–	57	–	630	1884	273
–	59	–	670	1961	284
–	60	–	698	2039	295
–	61	–	725	–	–
–	62	–	740	–	–
–	63	–	780	–	–
–	64	–	812	–	–
–	65	–	847	–	–
–	66	–	885	–	–
–	67	–	926	–	–
–	68	–	971	–	–

Conversions from each scale are approximate

SOLUTIONS AROUND THE GLOBE

KYOCERA SGS Precision Tools is an ISO 9001:2015 Certified leader of round solid carbide cutting tool technology for the aerospace, metalworking, and automotive industries with manufacturing sites in the United States and United Kingdom. Our global network of Sales Representatives, Industrial Distributors, and Agents blanket the world selling into more than 60 countries.

LEADERS IN SOLID CARBIDE TOOL TECHNOLOGY

Brand names such as Z-Carb, S-Carb®, V-Carb, Hi-PerCarb®, Multi-Carb have become synonymous with high performance tooling in the machining and metalworking industry.

We're proud to have pioneered some of the world's most advanced cutting technology right here on our Northeast Ohio manufacturing campus. KSPT high performance end mills, drills and routers are increasing productivity and reducing cost around the world.

EXCEEDING CUSTOMER EXPECTATIONS

As the world's manufacturing needs change, so does KSPT. It's all about the science, starting with our lab inspected substrate materials to our tool designs and coatings. Our exceptional team of researchers, engineers, and machinists are dedicated to developing the absolute best and delivering the ultimate Value at the Spindle®.

- Incredible batch-to-batch consistency
- Metallurgical lab dedicated to testing and rigorous quality control
- ISO 9001:2015 Certified quality procedures
- Patented geometries that extend tool life, reduce chatter, cut cycle times, and improve part quality—even at extreme parameters
- Specialists in extreme and demanding product applications
- Comprehensive tooling services
- Experienced Field Sales Engineers who work to optimize a tool for your particular application
- Dedicated multi-lingual customer service representatives

SGS PRODUCTS ARE DISTRIBUTED BY:



www.kyocera-sgstool.com



VALUE AT THE SPINDLE®

UNITED STATES OF AMERICA

KYOCERA SGS Precision Tools
150 Marc Drive
Cuyahoga Falls, Ohio 44223 U.S.A.
customer service -
US and Canada: (330) 686-5700
fax - US & Canada: (800) 447-4017
international fax: (330) 686-2146
orders: sales@kyocera-sgstool.com
web: www.kyocera-sgstool.com

UNITED KINGDOM

KYOCERA SGS Precision Tools Europe Ltd.
10 Ashville Way
Wokingham, Berkshire
RG41 2PL England
phone: (44) 1189-795-200
fax: (44) 1189-795-295
e-mail: SalesEU@kyocera-sgstool.com
web: www.kyocera-sgstool.co.uk

JAPAN

KYOCERA Corporation
International Sales Dept.
6 Takeda Tobadono-cho,
Fushimi-ku, Kyoto 612-8501, Japan
phone: +81-75-604-3473
fax: +81-75-604-3472
web: global.kyocera.com/prdct/tool/index.html

COMMERCIAL OFFICES

EASTERN EUROPE

SINTCOM
Sintcom Tools
95 Arsenalski Blvd.
1421 Sofia, Bulgaria
phone: (359) 283-64421
fax: (359) 286-52493
e-mail: sintcom@sintcomtools.com

FRANCE

DOGA Usinage
8, Avenue Gutenberg CS 50510
78317 Maurepas Cedex - France
phone : +33 1 30 66 41 41
e-mail: usinage-outils@doga.fr

GERMANY

KADIGO Tool Systems GmbH
Walramster. 27
65510 Idstein, Germany
phone: +49 8376 9287238
fax: +49 8376 9287237
e-mail: info@kadigo-ts.com

INDIA

KYOCERA Asia Pacific India Pvt. Ltd
Plot No.51, Phase-I,
Udyog Vihar Gurgaon 122016,
Haryana, India
phone: +91-124-4025022
fax: +91-124-4025001

KOREA

KYOCERA Precision Tools Korea Co., Ltd.
2LT 69BL, Namdong Industrial Estate,
638-1, Kozan-Dong, Namdong Incheon,
Korea
phone: +82-32-821-8365
fax: +82-32-821-8369
web: www.kptk.co.kr/

POLAND

KYOCERA SGS Precision Tools
phone: +48 530 432 002
e-mail: SalesEU@kyocera-sgstool.com

SPAIN

KYOCERA SGS Precision Tools IBERICA
e-mail: SalesEU@kyocera-sgstool.com

THAILAND

KYOCERA Asia Pacific (Thailand) Co., Ltd.
1 Capital Work Place Building
7th Floor, Soi Chamchan, Sukhumvit
55 Road, Klongton Nua, Wattana,
Bangkok 10110, Thailand
phone: +66-2-030-6688
fax: +66-2-030-6600

SINGAPORE

KYOCERA Asia Pacific Pte. Ltd.
298 Tiong Bahru Road, #13-03/05 Central Plaza,
Singapore 168730
phone: +65-6373-6700
fax: +65-6271-0600
web: asia.kyocera.com/products/cuttingtools/
index.html

CHINA

KYOCERA (China) Sales & Trading Corporation
Room 140, Building A3, Daning Central Square,
No. 700 Wannong Road,
Zhabei District, Shanghai, 200072,
P.R. China
phone: +86-21-3660-7711
fax: +86-21-568-6200
web: www.kyocera.com.cn/prdct/cuttingtool

