



Phylogeny, Classification, and Character Evolution of Acalypha (Euphorbiaceae: Acalyphoideae)

Authors: Levin, Geoffrey A., Cardinal-McTeague, Warren M., Steinmann, Victor W., and Sagun, Vernie G.

Source: Systematic Botany, 47(2) : 477-497

Published By: The American Society of Plant Taxonomists

URL: <https://doi.org/10.1600/036364422X16512572275034>

BioOne Complete (complete.BioOne.org) is a full-text database of 200 subscribed and open-access titles in the biological, ecological, and environmental sciences published by nonprofit societies, associations, museums, institutions, and presses.

Your use of this PDF, the BioOne Complete website, and all posted and associated content indicates your acceptance of BioOne's Terms of Use, available at www.bioone.org/terms-of-use.

Usage of BioOne Complete content is strictly limited to personal, educational, and non - commercial use. Commercial inquiries or rights and permissions requests should be directed to the individual publisher as copyright holder.

BioOne sees sustainable scholarly publishing as an inherently collaborative enterprise connecting authors, nonprofit publishers, academic institutions, research libraries, and research funders in the common goal of maximizing access to critical research.

Phylogeny, Classification, and Character Evolution of *Acalypha* (Euphorbiaceae: Acalyphoideae)

Geoffrey A. Levin,^{1,2,6} Warren M. Cardinal-McTeague,^{2,3} Victor W. Steinmann,⁴ and Vernie G. Sagun⁵

¹Illinois Natural History Survey, Prairie Research Institute, University of Illinois, 1816 South Oak Street, Champaign, Illinois 61820, USA; levin1@illinois.edu

²Current address (GL): Research and Collections, Canadian Museum of Nature, P.O. Box 3443, Station D, Ottawa, Ontario K1P 6P4, Canada

³Current address (WCM): Agriculture and Agri-Food Canada, Ottawa Research and Development Centre, 960 Carling Avenue, Ottawa, Ontario K1A 0C6, Canada; warren.cardinal-mcteague@agr.gc.ca

⁴Universidad Autónoma de Querétaro, Facultad de Ciencias Naturales, Av. de las Ciencias s/n, Del. Sta. Rosa Jáuregui, 76230, Querétaro, Querétaro, México; steinmav@gmail.com

⁵Department of Biology, Ateneo de Manila University, Loyola Heights, Quezon City 1108, Philippines; vsagun@outlook.com

⁶Author for correspondence (levin1@illinois.edu)

Communicating Editor: Qiang Wang

Abstract—*Acalypha* (Euphorbiaceae: Acalyphoideae) is a large, monophyletic genus distributed worldwide in tropical and subtropical regions, with a few species extending into temperate areas of southern Africa, Asia, and North and South America. We reconstructed phylogenetic relationships within the genus using DNA sequences from the plastid *ndhF* and *trnL-F* regions and the nuclear ribosomal ITS region, sampling 142 species to represent the geographic, morphologic, and taxonomic diversity with the genus, resulting in a 162 (158 in *Acalypha*) terminal and 3847 character combined dataset. Bayesian and maximum likelihood reconstructions based on the combined dataset yielded a tree with a generally well-supported backbone and several strongly supported clades. Our results strongly supported the monophyly of *Acalypha* subg. *Acalypha* as currently recognized but showed that *A. subg. Linostachys* and almost all other infrageneric taxa recognized in the most recent comprehensive classification of the genus were not monophyletic. We therefore propose a new subgeneric classification comprising *A. subg. Acalypha*, *A. subg. Androcephala*, *A. subg. Hypandrae*, and *A. subg. Linostachys* (s.s.). Our results also shed light on relationships within some species groups, including in what has been treated as a broadly defined *A. amentacea*, in which we recognize *A. amentacea*, *A. palauensis* comb. nov., and *A. wilkesiana* as distinct species. Bayesian ancestral state estimations based on the phylogeny of *Acalypha* demonstrated that inflorescence position and sexuality and habit show high homoplasy, especially within *A. subg. Acalypha*, and that inflorescence position and habit exhibit correlated evolution.

Keywords—Ancestral state estimations, correlated evolution, cpDNA, habit, homoplasy, inflorescence morphology, nrDNA, taxonomy.

The genus *Acalypha* L., with about 500 species (Montero-Muñoz et al. 2020), is the third largest genus in the Euphorbiaceae, following *Euphorbia* L. (> 2000 spp.; Riina et al. 2013) and *Croton* L. (1200–1300 species; Berry et al. 2005). Almost two-thirds of the species are native to the Americas (with almost 120 species in Mexico alone), but it is also diverse in Africa (over 100 species, about 30 of those endemic to Madagascar) and reaches Asia (about 50 species) and Oceania (6 species in Australia and about 16 species on the Pacific Islands (data compiled primarily from Govaerts et al. [2000] and updated from more recent publications, especially Cardiel and Montero Muñoz [2017], Montero-Muñoz et al. [2018], Sagun et al. [2010]). *Acalypha* grows primarily in tropical and subtropical regions but extends into temperate areas in eastern Asia and eastern North America, and some weedy species have become established in Europe (Roy et al. 2020). Three species are widely grown ornamentals: *A. herzogiana* (Steinmann and Levin 2011), *A. hispida*, and *A. wilkesiana*. Fossil pollen of the *Acalypha*-type was described from the Paleocene of the continental shelf in the South China Sea (Sun et al. 1989) and macrofossils attributed to *Acalypha* have been reported from the Eocene of western North America (Potbury 1935) and the Miocene of eastern Africa (Jacobs and Kabuye 1987; Jacobs and Winkler 1992) and central Europe (Łańcucka-Środniowa and Zastawniak 1993; Mai 1987; Meller 2011).

Acalypha has been recognized as a distinct and unitary genus by almost all taxonomists, probably due to its unique combination of floral characteristics, including elongate, pendent anther sacs that become twisted following dehiscence;

small (9–22 μm diameter), finely sculptured pollen grains with small, brevicolporate apertures (Nowicke and Takahashi 2002; Sagun et al. 2006); and stigmas that usually are highly lacinate (Fig. 1). These features, all associated with wind pollination, appear to be synapomorphies for the genus. Nearly all species (comprising *A. subg. Acalypha*) also have bracts subtending the pistillate flowers that greatly enlarge following anthesis, becoming the prominent feature of the infructescences (Fig. 1). In addition to these reproductive characteristics, it appears that epidermal crystals may also be a synapomorphy of the genus (Cardiel et al. 2020), although few closely related genera have been carefully examined. Beyond these characteristics, *Acalypha* is quite variable morphologically. Growth forms include annual and perennial herbs, subshrubs, shrubs, and small trees. The flowers, like those of all Euphorbiaceae, are always unisexual, with plants being monoecious or rarely dioecious, but inflorescence position and sexuality are both highly variable (Fig. 2). The infructescences may be terminal or axillary (sometimes with both on the same plant; Fig. 2), and unisexual (Fig. 2A, B, C, F) or bisexual (with both staminate and pistillate flowers); when both flower types are present, the infructescences usually are androgynous (with pistillate flowers proximally and staminate flowers distally; Fig. 2D, G) but in a few species are gynecandrous (with staminate flowers proximally and pistillate flowers distally; Fig. 2E). A number of species exhibit pistillate flower dimorphism, producing some flowers with ovaries almost invariably with three carpels, bearing terminal styles, and developing into explosively dehiscence capsules (the form characteristic of Euphorbiaceae and found in all

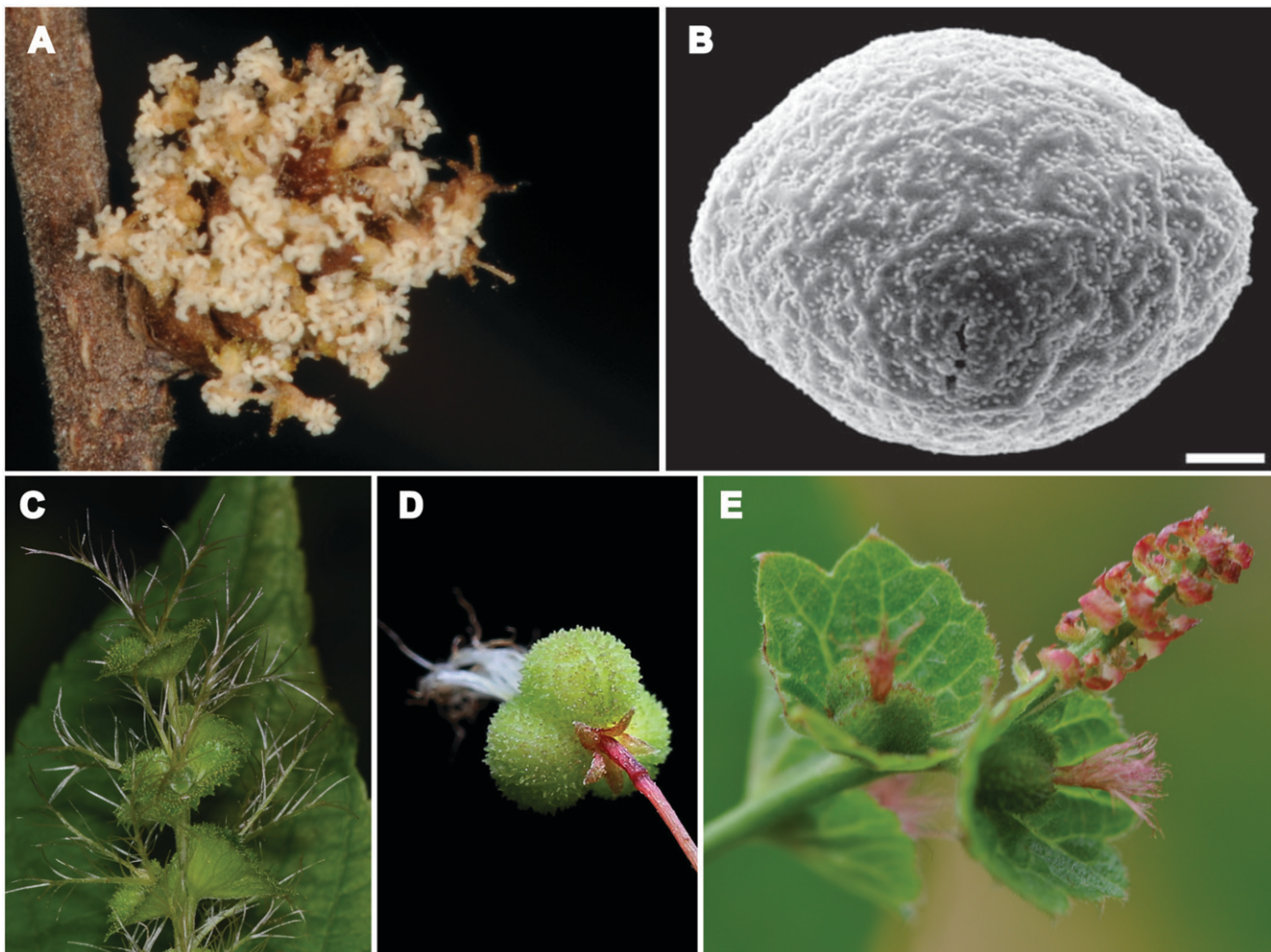

FIG. 1. Distinctive morphological characteristics of *Acalypha*. A. Staminate inflorescence showing flowers with elongate, pendent anther sacs (*A. filipes*, V. W. Steinmann & Y. Ramírez-Amezcuca 7046, IEB). B. Pollen grain showing small, brevicolporate aperture; scale bar = 2 μm (*A. hibiscifolia* Pax [= *A. buchtienii* Pax], O. Buchtien 8120, MO). C. Pistillate inflorescence showing flowers with highly lacinate stigmas (*A. nubicola* McVaugh, Y. Ramírez-Amezcuca et al. 2380, QMEX). D. Pedicellate pistillate flower with five sepals that are plesiomorphic in *Acalypha* and characteristic of *A. subg. Androcephala*, *A. subg. Hypandrae*, and *A. subg. Linostachys* s. s. (*A. schlechtendaliana*, J. D. Amith et al. 31156, HUAP). E. Androgynous inflorescence showing sessile pistillate flowers subtended by accrescent bracts that are characteristic of *A. subg. Acalypha* (*A. boinensis*, L. J. Gillespie et al. 10813, CAN). Photos A, C by V. W. Steinmann, D by M. Gorostiza S., and E by G. A. Levin, all used with permission. Figure B reprinted from Sagun et al. (2006) with permission from Elsevier.

Acalypha species) and other flowers with ovaries usually with fewer carpels, bearing basal styles, and developing into either schizocarps or achenes (Fig. 2D); the latter flower type has been called allomorphic (Radcliffe-Smith 1973).

The most recent comprehensive classification of *Acalypha* was proposed by Pax and Hoffmann (1924). Building on previous classifications, most notably that of Müller (1865, 1866), they divided the genus into three subgenera distinguished by inflorescence characters and pistillate flower sepal number (Table 1). They assigned only one species to *A. subg. Androcephala* and divided *A. subg. Linostachys* into three sections and *A. subg. Acalypha* (by far the largest subgenus with about 95% of the known species) into eight “series” and 36 “sections” (Table 1); their classification within both *A. subg. Acalypha* and *A. subg. Linostachys* was based largely on inflorescence characters, especially the various combinations of inflorescence position (axillary vs. terminal) and sexuality (unisexual vs. bisexual). Pax and Hoffmann (1924) also segregated the monotypic genus *Acalyphopsis* Pax & K.Hoffm. for the single Indonesian species *Acalyphopsis celebica* Pax & K.Hoffm. (= *Acalypha hoffmaniana* Hurusawa), distinguished by possessing very small, entire styles.

Pax and Hoffmann (1924) used infrageneric ranks within *A. subg. Acalypha* in the reverse of current standards, and this makes all their series names and 11 of their section names in that subgenus invalid under Articles 37.5–37.7 of the International Code of Nomenclature (Turland et al. 2018). In four instances the names were validly published or subsequently published (e.g. *A. sect. Communes* Pax & K.Hoffm. ex Cardiel, P.Muñoz & Muñoz-Garm.); the correct authorship is shown in Table 1. Because combinations at the proper rank currently are unavailable for many of the taxa, we will follow Pax and Hoffmann’s usage but put invalid names in quotes and normal (roman) text.

A new classification was proposed by Hurusawa (1954). He subsumed *Acalyphopsis* within *Acalypha*, treating it as a monospecific subgenus, and maintained *Acalypha* subg. *Androcephala* and *A. subg. Linostachys* as circumscribed by Pax and Hoffmann (1924). His biggest changes were to *A. subg. Acalypha*. In addition to splitting it into four subgenera, he lumped many of the “sections” recognized by Pax and Hoffmann, placing most of those he accepted in his more narrowly circumscribed *A. subg. Acalypha*. Hurusawa’s classification of the former *A. subg. Acalypha* depended entirely on

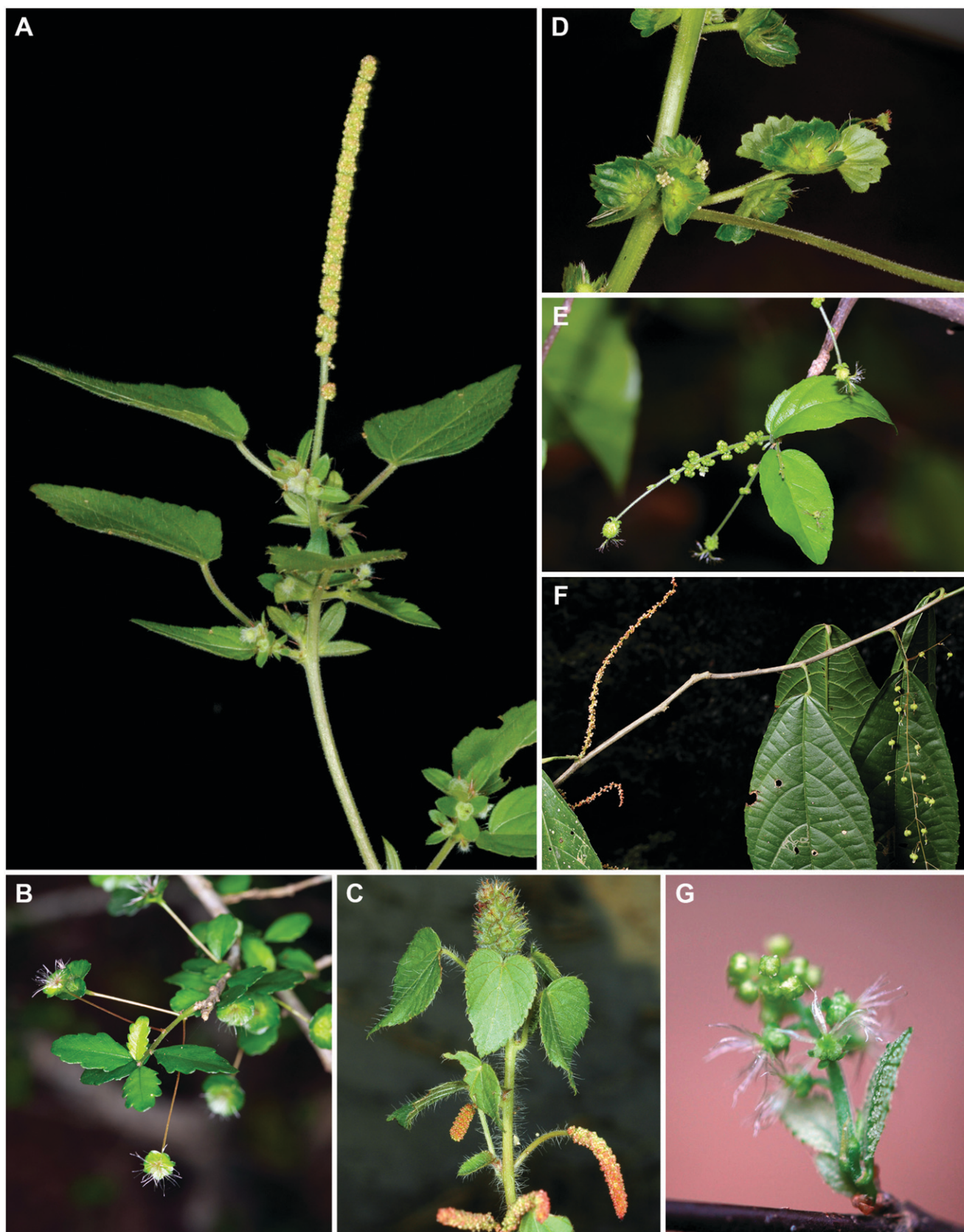

FIG. 2. Variation in inflorescence position and sexuality in *Acalypha*. A. Unisexual inflorescences, the staminate terminal and pistillate axillary (*A. pippenii*, *A. subg. Acalypha*). B. Pistillate flowers solitary and axillary (*A. capillipes* Müll.Arg., *A. subg. Acalypha*). C. Unisexual inflorescences, the pistillate terminal and staminate axillary (*A. microphylla*, *A. subg. Acalypha*). D. Androgynous and pistillate, axillary inflorescences, with an allomorphic flower terminating the inflorescence to the right (*A. mexicana*, *A. subg. Acalypha*). E. Gynecandrous, axillary inflorescences (*A. acrogyna*, *A. subg. Hypandrae*, B. Wursten BW1426, BR). F. Unisexual, axillary inflorescences (*A. schlechtendaliana*, *A. subg. Linostachys*, J. D. Amith et al. 21261, HUAP). G. Androgynous, terminal inflorescence with staminate flowers in bud (*Acalypha diminuta*, *A. subg. Androcephala*, L. J. Gillespie et al. 10705, CAN). Photos A, C, D by V. W. Steinmann; B by G. Daly, reproduced from <https://www.inaturalist.org/observations/72867732>; E by B. Wursten, reproduced from http://www.zimbabweflora.co.zw/speciesdata/image-display.php?species_id=135010&image_id=3; F by C. Ledesma C.; and G by G. A. Levin; all used with permission.

TABLE 1. Classification of *Acalypha* by Pax and Hoffmann (1924). Names shown in quotes and normal (roman) type are those used by Pax and Hoffmann that have not been validly published; an asterisk indicates names that were validly published by Müller (1865, 1866, 1872), but either unranked or at another rank. For each taxon, we provide the continental geographic distribution, total number of species, and number of species sampled for this study. When taxonomic work since 1924 has significantly changed the numbers of accepted species in a taxon, we show the number accepted by Pax and Hoffmann followed by the number currently accepted within parentheses. "Unclassified" represents species we sampled that were described after 1924 and therefore were not assigned to higher taxa by Pax and Hoffmann, but that can be easily assigned to subgenus based on morphology alone.

Taxon	Distribution	Total Species	Sampled Species
<i>A. subg. Acalypha</i>	Africa, Asia, Oceania, Americas	372 (470)	101 (132)
"Ser. Acrostachyae"*	Americas	21	5
"Sect. Multicaules"	Americas	21	5
"Ser. Hypandrae"*	Africa	10 (8)	2
"Sect. Diaxanthae"*	Africa (Madagascar)	3 (1)	1
"Sect. Monaxanthae"*	Africa	5	1
"Sect. Semisectae"*	Africa	2	0
"Ser. Oligogynae"*	Africa, Asia, Oceania, Americas	91 (94)	19 (21)
"Sect. Bipartitae"	Africa	1	1
"Sect. Brachypodae"*	Africa, Asia, Oceania, Americas	27 (30)	5 (7)
"Sect. Cuspidatae"*	Africa, Asia, Oceania, Americas	50	9
"Sect. Paucibracteatae"*	Africa, Asia, Americas	12	3
"Sect. Psilostachyae"*	Africa	1	1
"Ser. Pantogynae-Acrogynae"*	Africa, Asia, Americas	112 (103)	34
"Sect. Acuminatae"*	Americas	12 (3)	0
"Sect. Capitatae"*	Africa, Asia	23	8
"Sect. Dentatae"*	Africa, Americas	64	19
"Sect. Hypogaeae"	Americas	1	1
"Sect. Sclerolobae"*	Americas	5	2
"Sect. Subplumosae"*	Africa	7	4
"Ser. Pantogynae-Pleurogynae"*	Africa, Asia, Oceania, Americas	89 (83)	24
"Sect. Betulinae"*	Africa, Americas	7 (4)	3
"Sect. Capillipedes"*	Oceania (Australia), Americas	3 (2)	2
"Sect. Caturioideae"	Asia, Oceania	5	3
"Sect. Leptopodae"*	Americas	2 (1)	1
"Sect. Palminerviae"*	Africa (Madagascar), Asia, Oceania, Americas	44	11
"Sect. Penninerviae"*	Africa (Madagascar), Asia, Oceania, Americas	23	2
"Sect. Prophyllanthae"	Oceania	1	0
"Sect. Trachylobae"*	Americas	1	0
"Sect. Trichocephalae"*	Americas	3	1
"Ser. Polygynae-Acrogynae"*	Africa, Asia, Americas	34 (33)	10 (11)
"Sect. Phleoideae"*	Americas	25	6
"Sect. Plumosae"*	Americas	2 (1)	1
"Sect. Pseudoligogynae"	Africa (Madagascar)	2 (1)	1
"Sect. Repandae"*	Africa, Asia, Americas	3 (4)	2 (3)
"Sect. Subcapitatae"	Africa	2	0
"Ser. Polygynae-Dichogamae"	Americas	5	1
Sect. <i>Communes</i> Pax & K.Hoffm. ex Cardiel, P.Muñoz & Muñoz-Garm.	Americas	5	1
"Ser. Polygynae-Pleurogynae"*	Africa, Asia, Americas	10 (14)	7 (10)
"Sect. Arvenses"	Americas	1	1
"Sect. Boehmerioideae"*	Africa, Asia	3	2
"Sect. Brachystachyae"*	Africa, Asia, Americas	2 (6)	2 (5)
"Sect. Ciliatae"*	Africa	1	1
"Sect. Leptostachyae"	Africa	1	0
"Sect. Salviifoliae"	Africa (Madagascar), Americas	2	1
Unclassified <i>A. subg. Acalypha</i>			25
<i>A. subg. Androcephala</i> Pax & K.Hoffm.	Africa (Madagascar)	1	1
<i>A. subg. Linostachys</i> (Klotzsch ex Schldtl.) Pax & K.Hoffm.	Africa, Asia, Americas	17 (29)	9
Sect. <i>Axillares</i> Pax & K.Hoffm. (= sect. <i>Linostachys</i>)	Africa, Americas	13 (26)	3
Sect. <i>Coryloideae</i> Pax & K.Hoffm.	Americas	2 (1)	1
Sect. <i>Terminales</i> Pax & K.Hoffm.	Africa, Asia, Americas	2	2
Unclassified <i>A. subg. Linostachys</i>			3

inflorescence sexuality and position. Perhaps because he focused primarily on species found in Japan rather than providing a catalogue of all the known species, his classification has been largely ignored; we will consider it only briefly here.

Various authors have noted the difficulty of using Pax and Hoffmann's (1924) classification of *A. subgenus Acalypha* and

suggested that is largely mechanical and artificial (Webster 1967; Seberg 1984; Cardiel 1995; Levin 1995). Levin (1995), for example, showed that Pax and Hoffmann treated *Acalypha californica* as three species they assigned to three "sections" in two "series." Seberg (1984) provided other, similar examples. Biogeographically their classification provides no coherent

pattern, with five of the eight “series” occurring in both the Old and New Worlds, and many of the “sections” also spanning multiple continents (Table 1).

Although several genera in Euphorbiaceae, including both *Croton* (Berry et al. 2005; Van Ee et al. 2011) and *Euphorbia* (Steinmann and Porter 2002; Bruyns et al. 2006; Park and Jansen 2007; Horn et al. 2012; Riina et al. 2013), have been studied phylogenetically using DNA sequence data, only limited phylogenetic information of any kind is available for *Acalypha*. Seberg (1984) produced a morphologically based phylogeny of 40 neotropical species, but the value of his results is limited by biased taxon sampling, lack of outgroups, relatively few characters, and less rigorous phylogenetic analysis than has become standard. His main finding was that Pax and Hoffmann’s (1924) classification of *A.* subg. *Acalypha* was not supported phylogenetically, although he was unable to propose an alternative classification due to poor resolution. More recently, Sagun et al. (2010) published a molecular phylogenetic analysis of 29 species of *Acalypha*, sampled from throughout the genus but strongly biased toward the Malesian species. They found strong support for the monophyly of both the genus and *A.* subgenus *Acalypha* as circumscribed by Pax and Hoffmann (1924), but otherwise significant conflict with their classification. The small sample of species prevented them from proposing an alternative classification.

Here we present the results of phylogenetic analyses of *Acalypha* using nuclear and plastid DNA sequences from a wide sample of species chosen to cover the geographical and morphological variation in the genus. Our results allow us to assess the classification of the genus in a phylogenetic context. We also explore character evolution in the genus, especially inflorescence position and sexuality because of their importance in the infrageneric classification, and habit. We also examined the interaction between inflorescence position and habit because having terminal inflorescences on woody stems requires a shift from the monopodial branching pattern found throughout *Acalypha* to sympodial branching, at least at the branch apex, and therefore may be expected to be unlikely. In a separate paper, we will examine biogeographic patterns and diversification within *Acalypha* (Levin and Cardinal-McTeague in prep).

MATERIALS AND METHODS

Taxon Sampling—Our ingroup included 158 terminals of *Acalypha* representing 142 species (one with two varieties), or about 28% of the 500 species in the genus (Appendix 1; Table 1). Sampled species included one from *A.* subg. *Androcephala* (100%), 9 from *A.* subg. *Linostachys* (31% of the 29 species) representing all three sections, and 132 from *A.* subg. *Acalypha* (28% of the ca. 470 species) representing all eight “series” and 30 of the 36 “sections” recognized by Pax and Hoffmann (1924). Of the six unsampled “sections,” three contain one species, two contain two species, and only one, “sect. *Acuminatae*,” contains more than two species. Pax and Hoffmann (1924) included 12 species in “sect. *Acuminatae*,” but subsequent taxonomic studies (e.g. Cardiel 1995, 2007; Cardiel et al. 2007) have reduced the number of accepted species in the “section” to three, with the remaining species synonymized with species Pax and Hoffmann (1924) placed in the very similar “sect. *Dentatae*,” which we sampled extensively. Our taxon sampling included species from throughout the range of the genus, with 48 from Africa (including 17 endemic to Madagascar), 73 from the Americas, 19 from Asia, and 8 from Oceania (the total exceeds the number sampled because some species occur on more than one continent). Thus, our sample spanned the geographic, taxonomic, and presumably morphological variation in the genus. We were unable to obtain material of *A. hoffmanniana*, which Pax and Hoffmann (1924) placed in *Acalyphopsis* and Hurusawa (1954) placed in its own subgenus. It is

known only from three syntypes, all of which were in B and destroyed during World War II (Sagun et al. 2010).

We used one species each of *Bernardia* Houst. ex P. Browne, *Erythrococca* Benth., *Mareya* Baill., and *Micrococca* Benth. as outgroups (Appendix 1). The latter three genera are closely related to *Acalypha*, with *Mareya* being its sister group, whereas *Bernardia* is more distantly related but still a member of the “core acalyphoids” (Wurdack et al. 2005; Tokuoka 2007; Sun et al. 2016).

DNA Extraction, Amplification, and Sequencing—Total genomic DNA was extracted from herbarium specimens or silica gel-dried leaf material using the modified CTAB buffer method as described by Doyle and Doyle (1987), a DNeasy Plant Mini Kit (Qiagen, Valencia, California) following the manufacturer’s instructions, or a slightly modified version of Alexander et al. (2007).

To amplify *ndhF* (ca. 1685 bp in length used), universal *ndhF* primers from Olmstead et al. (1993), Kim and Jansen (1995), and Steinmann and Porter (2002) were used with some modification to amplify two overlapping fragments of roughly 1000 bp. Due to problems amplifying the 5’ portion of *ndhF*, a quarter of the gene region was excluded. The primer pair combinations used were: 536F (5’-TTG TAA CTA ATC GTG TAG GGG A-3’) with 1318R (5’-CGA AAC ATA TAA AAT GCR GTT AAT CC-3’); 972F (5’-G GTC TCA ATT GGG TTA TAT GAT-3’) with 2110Ri (5’-TCA ATT CGT TTA TCA A-3’). For taxa that were difficult to amplify, the combinations used were: 536F + 1400sR (5’-TAA CCC CAT ARA GAT ATT GAA TAA-3’); 1318F (5’-GGA TTA ACY GCA TTT TAT ATG TTT CG-3’) + 2110Ri; 536F + 972R (5’-CAT CAT ATA ACC CAA TTG AGA C-3’); 803F (5’-CTA TGG TAG CGG CGG GAA TTT TTC-3’) + 1318R; 1318F + 1768R (5’-AGY AGG CTT ATA TAA AGA GGA C-3’); 1768F (5’-GTC CTC TTT ATA TAA GCC TRC T-3’) + 2110sR; 1545F (5’-CTA TGT TAT TTC CTC TAC TKG T-3’) + 1768R; 1768F + 2110sR; and 972F + 1545R (5’-ACM AGT AGA GGA AAT AAC ATA G-3’). Primers 1545F, 1545R, 1768F, and 1768R were specifically designed for this study.

For amplification of the *trnL-F* region (ca. 1200 bp in length), the universal primers C + D and E + F were used as described by Taberlet et al. (1991). For ITS (ca. 590 bp in length), PCR amplification generally followed the procedures and primers described in Baldwin (1992) and Steinmann and Porter (2002). The ITS region was usually amplified using ITS5 (5’-GAA AGT AAA AGT CGT AAC AAG G-3’) and ITS4 (5’-TCC TCC GCT TAT TGA TAT GC-3’). For more degraded samples, the ITS was amplified in parts using ITS2 (5’-GCT GCG TTC TTC ATC GAT GC-3’) with ITS5, and ITS3 (5’-GCA TCG ATG AAG AAC GCA GC-3’) with ITS4.

PCRs for *ndhF* and *trnL-F* consisted of 25 μ L reactions which were prepared with 10.75 μ L H₂O, 5 μ L 5X GoTaq Flexi buffer (Promega, Madison, Wisconsin), 4 μ L 1.25 mM dNTPs, 2.75 μ L 25 mM MgCl₂, 0.5 μ L of each 20 μ M primer, 0.25 μ L GoTaq DNA polymerase (Promega), 0.25 μ L Bovine Serum Albumin (10mg/mL), and 1 μ L of template DNA. Amplification for *ndhF* regions were carried out using 1 cycle at 94°C for 0.5 min; 35 cycles of 1 min at 94°C, 1 min at 50°C, and 2 min at 72°C; and 1 cycle at 72°C for 10 min. Amplification of the *trnL-F* region was carried out following the protocol of Shaw et al. (2005), which is 1 cycle at 80°C for 5 min; 30 cycles of 1 min at 94°C, 1 min at 50°C, and 2 min at 72°C; and 1 cycle at 72°C for 5 min.

For ITS, PCR amplification generally followed the procedures described in Baldwin (1992) and Steinmann and Porter (2002). The 50 μ L reactions for ITS included 20.25 μ L H₂O, 10 μ L 5X GoTaq Flexi buffer, 8 μ L 1.25 mM dNTPs, 6 μ L 25 mM MgCl₂, 1 μ L of each 20 μ M primer, 0.25 μ L GoTaq DNA polymerase, 2.5 μ L DMSO, and 1 μ L of template DNA. Amplification for ITS regions were carried out using 1 cycle at 94°C for 0.5 min; 35 cycles of 1 min at 94°C, 1 min at 53°C, and 1 min at 72°C; and 1 cycle at 72°C for 10 min.

PCR was performed on a MJ Research (Hercules, California) PTC-200 Thermal Cycler, after which the PCR products were purified using QIAquick PCR Purification Kit (Qiagen). Sequencing reactions of the PCR products included the BigDye Terminator version 3.1 Cycle Sequencing Kit (Applied Biosystems, Foster City, California) in 11 μ L reactions, containing 1 μ L ddH₂O, 2 μ L 5 \times sequencing buffer, 1.5 μ L 1 μ M primer, 0.5 μ L Ready Reaction Mix (Applied Biosystems), 4 μ L 12.5% glycerol, and 2 μ L of purified PCR product. All sequences were visualized on an Applied Biosystems 3730XL High-throughput DNA capillary sequencer, then edited manually using Sequencher v. 4.7 (Gene Codes Corporation, Ann Arbor, Michigan) or Geneious v. 8.1.9 (Biomatters, Auckland, New Zealand). Due to difficulty in amplifying some DNA templates, some gene regions could not be amplified, and these were coded as missing in the data matrix.

Phylogenetic Analyses—DNA sequences were aligned using the auto-select algorithm of MAFFT v. 7.450 (Katoh and Standley 2013) in

Geneious, followed by minor visual adjustments. Optimal models of nucleotide evolution were ranked by AIC using default search parameters across 3 substitution schemes in jModeltest2 v. 2.1.6 on XSEDE (Miller et al. 2010; Darriba et al. 2012), partitioned by each region. We estimated phylogenetic trees using Bayesian inference with MrBayes v. 3.2.6 on XSEDE (Ronquist et al. 2012), executing an (MC)3 analysis with 2 runs of 5 million generations and sampling every 1000 generations, using the optimal model of nucleotide evolution (remaining parameters left at default). Runs were considered converged if ESS (estimated sample size) of each parameter were > 500 in Tracer v. 1.7 (Rambaut et al. 2018) and if PSRF (potential scale reduction factors) and the standard deviation of split frequencies were close to 1.0 and < 0.005, respectively, as determined by the MrBayes output. A 50% majority rule consensus tree was calculated following a 25% burn-in, resulting in Bayesian posterior probability (BPP) values based on posterior distribution of 7500 trees from the combined runs. For an additional estimate of branch support, we inferred maximum likelihood bootstrap percentages (MLBP) using 1000 rapid bootstrap replicates under default parameters through RAXML-HPC v. 8 on XSEDE (Stamatakis 2014). We analyzed each gene region separately and also produced a concatenated dataset that we analyzed with each partition assigned its optimal model of nucleotide evolution for Bayesian analyses (concatenated RAXML analyses left unpartitioned). To explore partition congruence, we compared the individual gene trees to see if there were differences among them that received strong support from either BPP or MLBP.

Morphological Character Data—Characters were scored from herbarium specimens primarily from CAN, DAV, G, IEB, ILLS, K, L, MEXU, MO, NY, P, RSA, and US (herbarium abbreviations follow Thiers 2021), supplemented by published descriptions. We coded each of the inflorescence types (characters 1. staminate, 2. pistillate, 3. androgynous, and 4. gynecandrous) by position: (0) absent, (1) axillary, (2) terminal, (3) both axillary and terminal, and (–/?) unknown/not applicable. We coded character 5, habit, in three states: (0) shrub or small tree (hereafter referred to simply as shrub or shrubby), (1) annual, and (2) herbaceous perennial. Because it is often difficult to tell from specimens whether a plant is an herbaceous perennial or subshrub (woody only at base), we merged those two conditions. Character states for the species we sampled are found in Supplemental Data on Dryad (Levin et al. 2022).

Ancestral Character State Estimations and Correlated Evolution—We estimated ancestral states with BayesTraits v. 3.0.2 (Meade and Pagel 2019), using the concatenated 50% majority rule consensus tree and the posterior distribution of 7500 trees as inputs. All input trees were reduced from 162 to 151 terminals using the drop.tip function in phytools (Revell 2012). We kept a randomly selected exemplar for species with multiple accessions (with the exception of a few Madagascar species that were unresolved and/or exhibited trait variation) and used only the sister genus *Mareya* as an outgroup. For each character, we implemented a reverse jump Markov Chain Monte Carlo (RJ-MCMC) under the Multi-state model. Briefly, the RJ-MCMC explores model parameter reduction throughout the analysis and integrates the best model(s) based on their probabilities (Meade and Pagel 2019). We also tested the impact of exponential hyperpriors under different distributions (0 to 1, 30, 100, 200, 300, 400, 800), but given that there was little influence we continued with 0–200. To estimate ancestral states, we created an AddMRCA block for all internal nodes of the modified 50% majority rule consensus tree using the Generate BayesTraits input command in TreeGraph2 v. 2.13 (Stöver and Müller 2010). For each character we ran RJ-MCMC analyses for 101 million generations sampling every 20,000th generation followed by a 1 million generation burn-in. Parameters in the posterior distribution were analyzed in Tracer v. 1.7 (Rambaut et al. 2018) to ensure adequate ESS and convergence among chains. TreeGraph2 was also used to summarize and visualize the BayesTraits output, and a custom python script was used to calculate the frequency of the sampled models in the posterior distribution.

We used an omnibus test comparing the independent (4-rate) and dependent (8-rate) models in BayesTraits to test for correlated evolution

between inflorescence position and habit, treating each as a binary trait: i) inflorescence position, (0) axillary only, (1) terminal present, and ii) habit, (0) woody, (1) herbaceous (combining herbaceous perennials and annuals). Four replicate analyses were conducted under each model using the same RJ-MCMC search parameters as above. The stepping-stone method was used to estimate the harmonic mean of the likelihood values with 1000 stones running for 100,000 generations. An average of the harmonic mean of $-\log L$ was used to calculate log Bayes factors (BF) and determine if there was strong evidence ($>5 \log BF$) to support the more complex model of correlated evolution (Meade and Pagel 2019).

Classification—We assessed the phylogenetic congruence of the infrageneric classification of Pax and Hoffmann (1924) by mapping the subgenera, “series,” and “sections” onto the phylogeny. Species not treated by Pax and Hoffmann (1924), especially those in *A. subg. Acalypha*, were not easy to assign to “series” or “section,” so we left them unplaced.

RESULTS

Phylogenetic Data (Aligned Lengths, Variable and Informative Characters)—A total of 468 new sequences were produced in this study, 158 ITS, 154 *ndhF*, and 156 *trnL-F* (Appendix 1; some of these were used for the phylogenetic analysis in Sagun et al. 2010). The summary statistics for each gene and the combined dataset are presented in Table 2. The concatenated alignment and resulting trees are archived on Dryad (Levin et al. 2022).

Partition Congruence—The individual gene trees are not identical (see the individual gene trees on Dryad; Levin et al. 2022). However, most differences reflect parts of the trees that are not resolved in one or more of the trees and thus are not in conflict. The few differences in resolved parts involve individual species or small clades that shift slightly among trees, but all these differences are poorly supported (MLBP < 80 and BPP < 0.90). Because there are no well-supported conflicts among the individual gene trees, we concatenated the data and present only the results of the combined dataset.

Analysis of the Combined Dataset—As is in the case of previous phylogenetic analyses (e.g. Wurdack et al. 2005; Tokuoka 2007; Cervantes et al. 2016; Sun et al. 2016), our results very strongly support the monophyly of the genus *Acalypha* (MLBP = 100, BPP = 1), with *Mareya* as its sister genus (Fig. 3A; supplemental trees in Levin et al. 2022). Three strongly or very strongly supported clades (A, B + C, and D–H, Fig. 3A) arise near the base of the genus, but resolution among them is poorly supported. Clade A (MLBP = 94, BPP = 1) comprises two African species (*A. acrogyne* and *A. echinus*) that recent authors (e.g. Muñoz-Rodríguez et al. 2014) have placed in *A. subg. Linostachys*. Clade B (MLBP = 100, BPP = 1), containing *A. diminuta*, the sole member of *A. subg. Androcephala*, and *A. gillmanii* of *A. subg. Linostachys*, is strongly supported (MLBP = 75, BPP = 0.99) as sister to clade C, which contains the remaining species we sampled from *A. subg. Linostachys*. Within clade C, the paleotropical *A. paniculata* is very strongly supported (MLBP = 90, BPP = 1) as sister to the neotropical members of the subgenus. Together, clades B and C are relatively weakly supported (MLBP = 59, BPP = 0.79) as sister to clades D–H, the monophyly of which

TABLE 2. Summary of dataset characteristics.

Characteristic	ITS	<i>ndhF</i>	<i>trnL-F</i>	Combined
Aligned length	691	1569	1587	3847
Variable sites	428	518	408	1354
Parsimony informative sites (%)	337 (49%)	324 (21%)	228 (14%)	889 (23%)
Optimal model of evolution	SYM + I + G	GTR + I + G	GTR + G	Partitioned

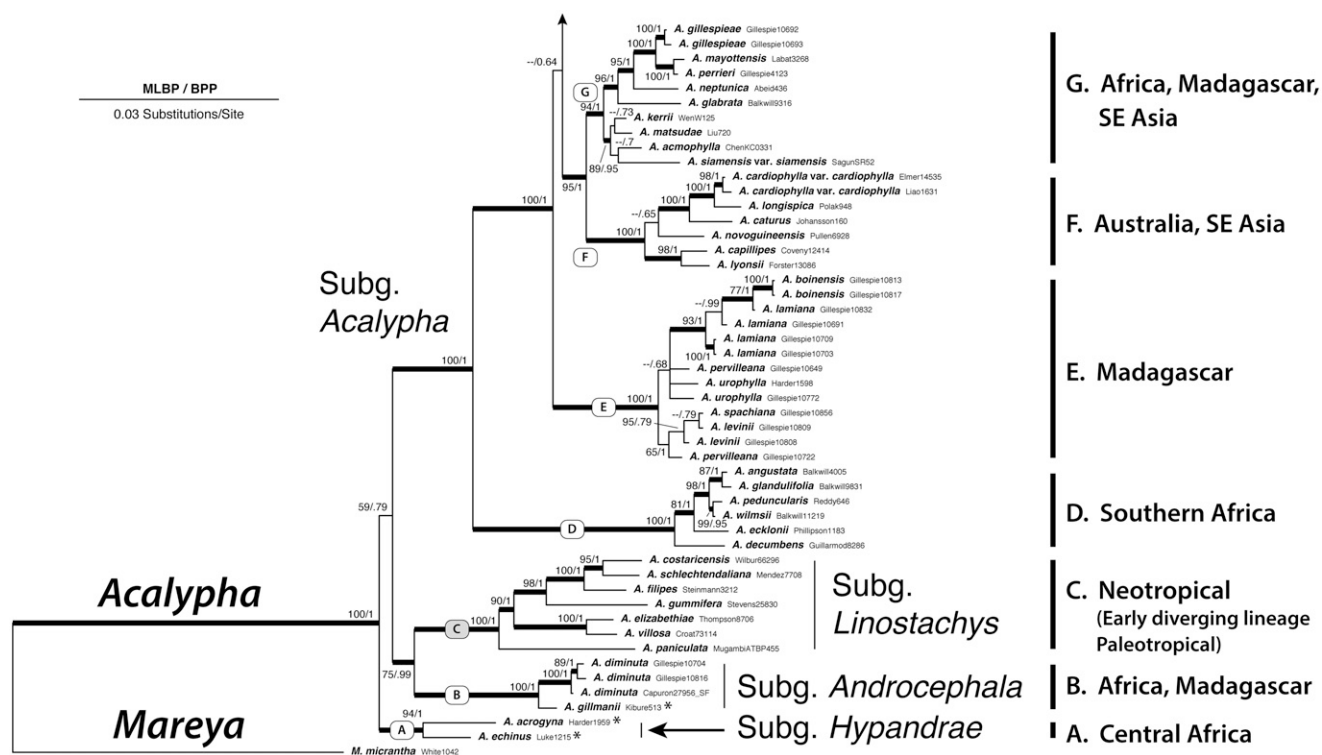

FIG. 3A. 50% majority rule Bayesian phylogram of *Acalypha* and its sister genus *Mareya*, based on the 162 terminal combined ITS, *ndhF*, and *trnL-F* dataset. Values at nodes represent maximum likelihood bootstrap percentages (MLBP) > 50% and Bayesian posterior probabilities (BPP) > 0.5; thick branches represent strongly supported clades with MLBP \geq 70% and BPP \geq 0.95. Major clades discussed in the text are indicated by letters and numbers; those shaded in gray are found primarily in the Americas, all others in white are found in Africa, Asia, Australia, and/or Oceania. Additional outgroups included in the analysis are not shown but fall outside *Mareya*; see supplemental trees in Levin et al. (2022). Note: the tree is annotated with our revised subgeneric classification, but the three taxa marked with an asterisk (*) in clades A and B previously belonged to other subgenera.

is very strongly supported (MLBP = 100, BPP = 1). Together, clades D–H correspond to *A. subg. Acalypha* sensu Pax and Hoffmann (1924), with the exception of *A. acrogyna*, placed here in clade A; from here on we shall refer to *A. subg. Acalypha* in this sense.

Within *A. subg. Acalypha*, five main clades (D–H) are very strongly supported along a mostly well-supported backbone (Fig. 3A, B). The basal clade D (MLBP = 100, BPP = 1) consists of a set of southern African species that are mainly herbaceous perennials that Pax and Hoffmann (1924) placed mostly in their “ser. Pantogynae-Acrogynae sect. Capitatae”; exceptions are *A. ecklonii*, which is an annual in “ser. Pantogynae-Acrogynae sect. Subplumosae,” and *A. decumbens* which was placed in “ser. Oligogynae.” Clade E (MLBP = 100, BPP = 1) comprises a Madagascan clade consisting mainly of the *A. urophylla* complex (*A. lamiana*, *A. pervilleana*, *A. urophylla*, and the unsampled *A. gracilipes*). Clades F (MLBP = 100, BPP = 1), a clade of southeast Asian and Australian species, and G (MLBP = 94, BPP = 1), with species from Africa (including Madagascar) and southeast Asia together form a very strongly supported clade (MLBP = 95, BPP = 1). Clade H, the fifth clade in this group, is also very strongly supported (MLBP = 100, BPP = 1) and forms the very large, “core” *Acalypha* clade. Although the basal position of clade D within *A. subg. Acalypha* is very strongly supported (MLBP = 100, BPP = 1), resolution among clades E, F + G, and H is poorly supported (MLBP < 50, BPP = 0.64).

Relationships within the core *Acalypha* clade H are mostly poorly supported, especially along the backbone of the tree, but six subclades received strong to very strong support (Fig.

3B). These include H1 (MLBP = 100, BPP = 1), an African group of shrubs and herbaceous perennials; H2 (MLBP = 100, BPP = 1), a paleotropical clade ranging from Africa (including Madagascar) to eastern Asia and Australia; H3 (MLBP = 90, BPP = 1), an American clade ranging from eastern North America to southern South America, including the Caribbean; H4 (MLBP = 100, BPP = 1), a small Madagascan clade; H5 (MLBP = 62, BPP = 1), another paleotropical clade found in southeast Asia and Oceania; and H6 (MLBP = 90, BPP = 1), which comprises the east African *A. chirindica* sister to an American clade (MLBP = 99, BPP = 1) found mainly in Central America and Mexico, but with a few species reaching the southern United States, the Caribbean, and South America.

Ancestral Character State Estimations—Ancestral state estimations were well supported for characters 1 (staminate inflorescences), 4 (gynecandrous inflorescences), and 5 (habit), but were generally ambiguous for characters 2 (pistillate inflorescences) and 3 (androgynous inflorescences) (Figs. 4A, 4B). The most frequently sampled models (f) and posterior probabilities for parameter reduction (Z) help contextualize these results (Fig. 5), with models for characters 1, 4, and 5 being well characterized and models for characters 2 and 3 having notable parameter variation in their posterior distributions.

In general, there is very high homoplasy in inflorescence position and sexuality across the phylogeny, but some evolutionary trends are apparent. The ancestral inflorescence type of *Acalypha* was poorly resolved but is strongly supported as axillary gynecandrous alongside numerous potential

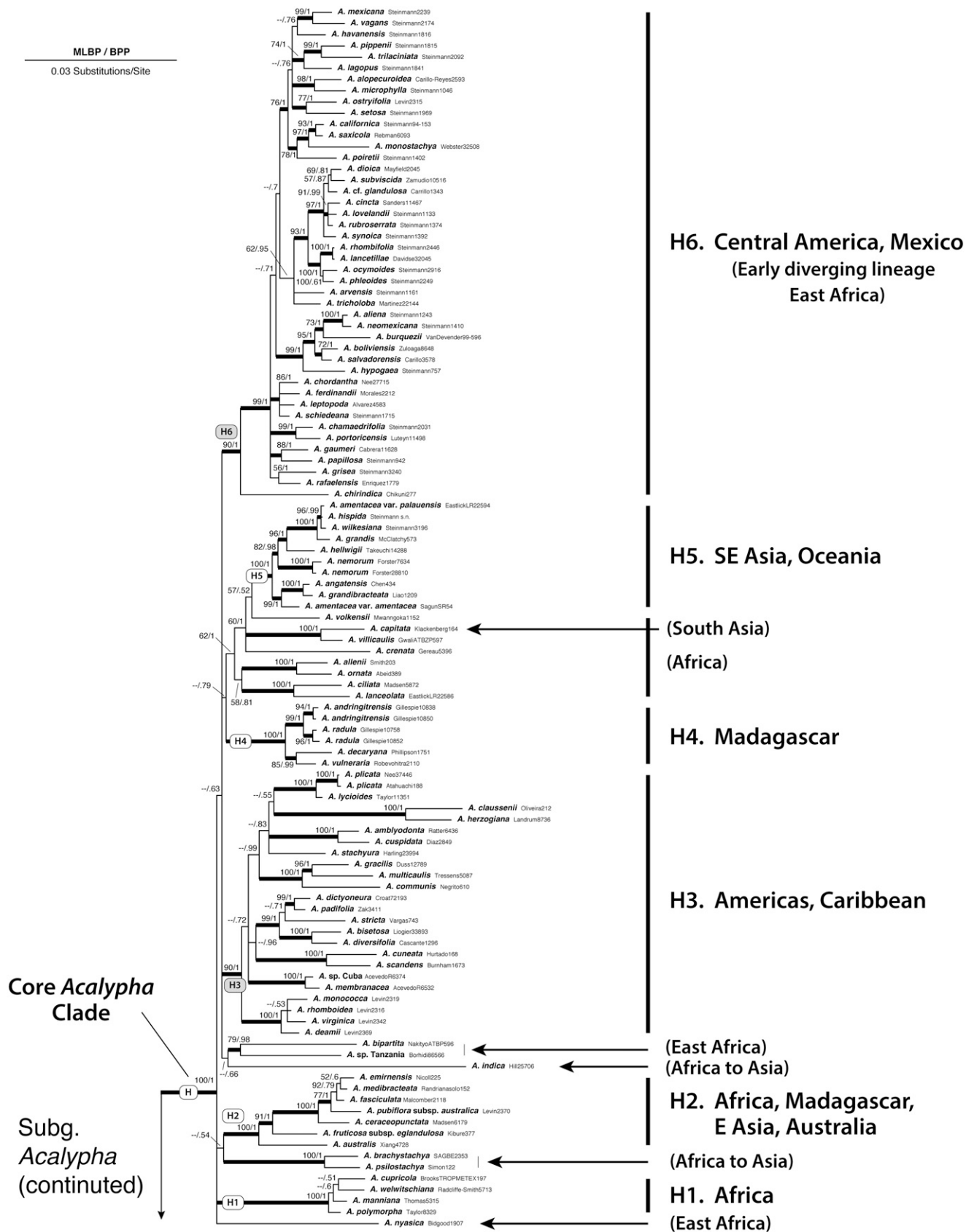

FIG. 3B. Continued from Fig. 3A.

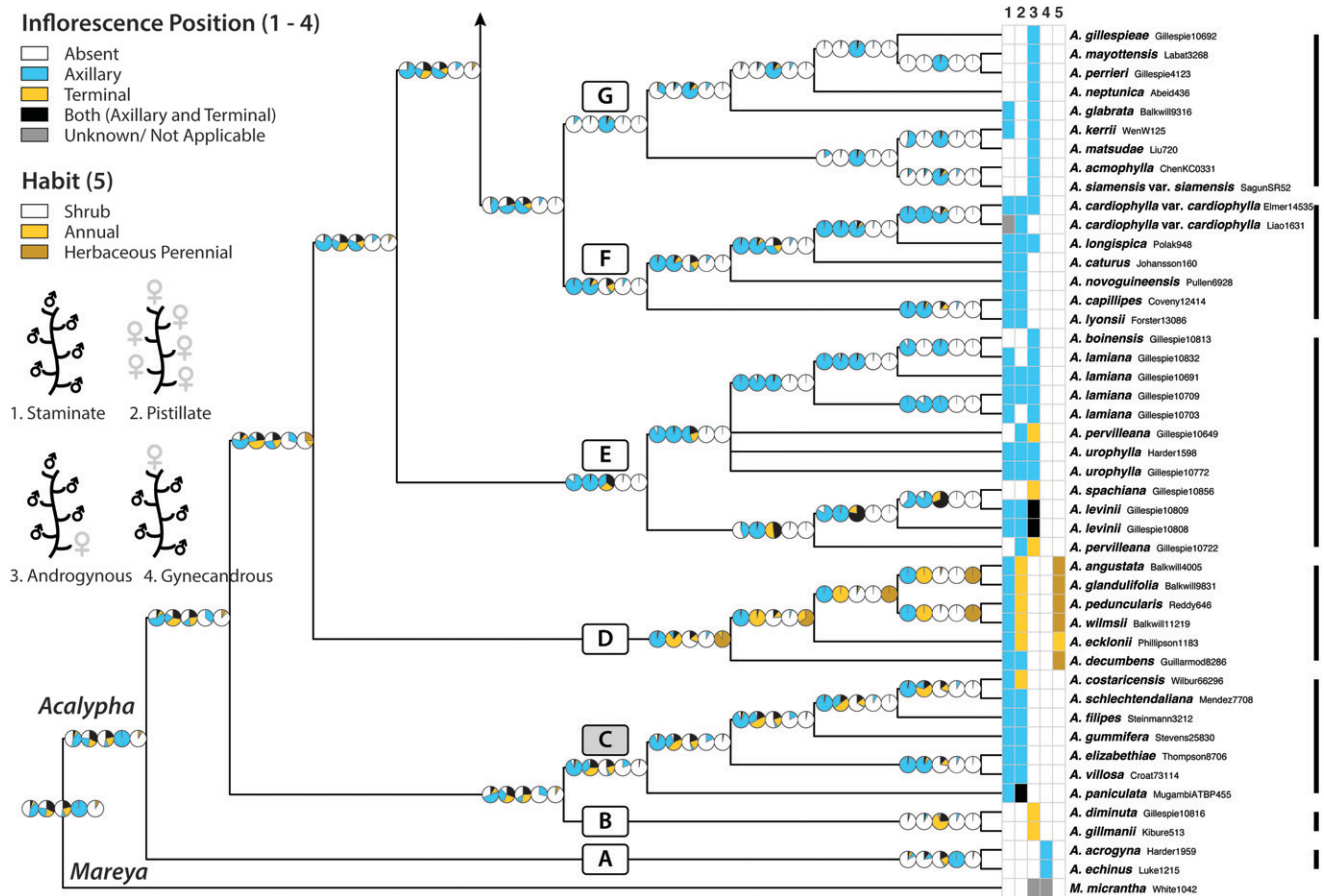

FIG. 4A. Ancestral state estimations for inflorescence sexuality and position (1. staminate, 2. pistillate, 3. androgynous, and 4. gynecandrous) and 5. habit in *Acalypha* and *Mareya*. Ancestral states for each character were estimated using Bayesian inference with BayesTraits on a 151 terminal tree dataset that was trimmed from the 162 terminal combined dataset (50% majority rule and post-burnin posterior distribution). Pie charts at each node represent the posterior probability of each state obtained from a post-burn-in distribution of 5000 ancestral state estimates. The optimal models of character evolution are shown in Fig. 5.

combinations of absent/axillary/terminal/both staminate, pistillate, and androgynous (Figs. 4A, 4B). The backbone of *Acalypha* remained ambiguous for pistillate and androgynous inflorescences, but axillary staminate and absent gynecandrous became strongly supported, along with terminal pistillate at the crown of clade H.

Among the named clades there are some general trends in inflorescence type (Figs. 4A, 4B). Clade A is unique in being characterized by axillary gynecandrous inflorescences. Clade B has exclusively terminal androgynous inflorescences. Clades C and F have unisexual inflorescences that are predominantly axillary, as does clade D, except its pistillate inflorescences are mostly terminal. Clade G is distinct for having predominantly axillary androgynous inflorescences, although this also occurs in an early diverging annual lineage in subclade H3. In contrast, clades E and H are highly homoplastic, including in all the subclades (H1–H6) of the core *Acalypha* clade.

Shrubby habit is well-supported as ancestral in *Acalypha*, although there is a small percentage of support for herbaceous perennials in the ancestor of all species and along the backbone (Figs. 4A, 4B). Although most species of *Acalypha* have maintained a shrubby habit, annual and herbaceous perennial growth forms are highly homoplastic, evolving well over 10 times collectively. Our results do not support

unidirectional evolution (e.g. from shrubs to herbaceous perennials to annuals); all transitions among shrub, herbaceous perennial, and annual growth forms appear to have possibly occurred (Fig. 5). Among the clades and subclades labeled in Fig. 3, only clade D and subclade H1 became exclusively herbaceous (remaining predominantly or exclusively perennial). All the other labeled clades and subclades remained woody or show highly homoplastic habit evolution, although some monophyletic species groups within the core *Acalypha* clade H also are predominantly or exclusively herbaceous, especially within the American subclades H3 and H6 (Fig. 4B).

Correlated Evolution—The results of the omnibus test support a model of correlated evolution between inflorescence position and habit (Fig. 6). BayesTraits analyses produced a harmonic mean estimate of $\log L = -154.0783$ for the dependent model and -156.5424 for the independent model, resulting in a log BF of 4.928, providing moderately strong evidence for correlated evolution. The most frequently sampled model ($f = 0.52$) strongly prohibited transition rate q_{12} (Z-score PP = 0.99) and weakly prohibited rate q_{43} (Z-score PP = 0.55) (Fig. 6). This suggests that axillary herbaceous never evolves directly from axillary woody. There is no support for the hypothesis that it is difficult for woody plants to shift from having only axillary inflorescences to having some terminal inflorescences.

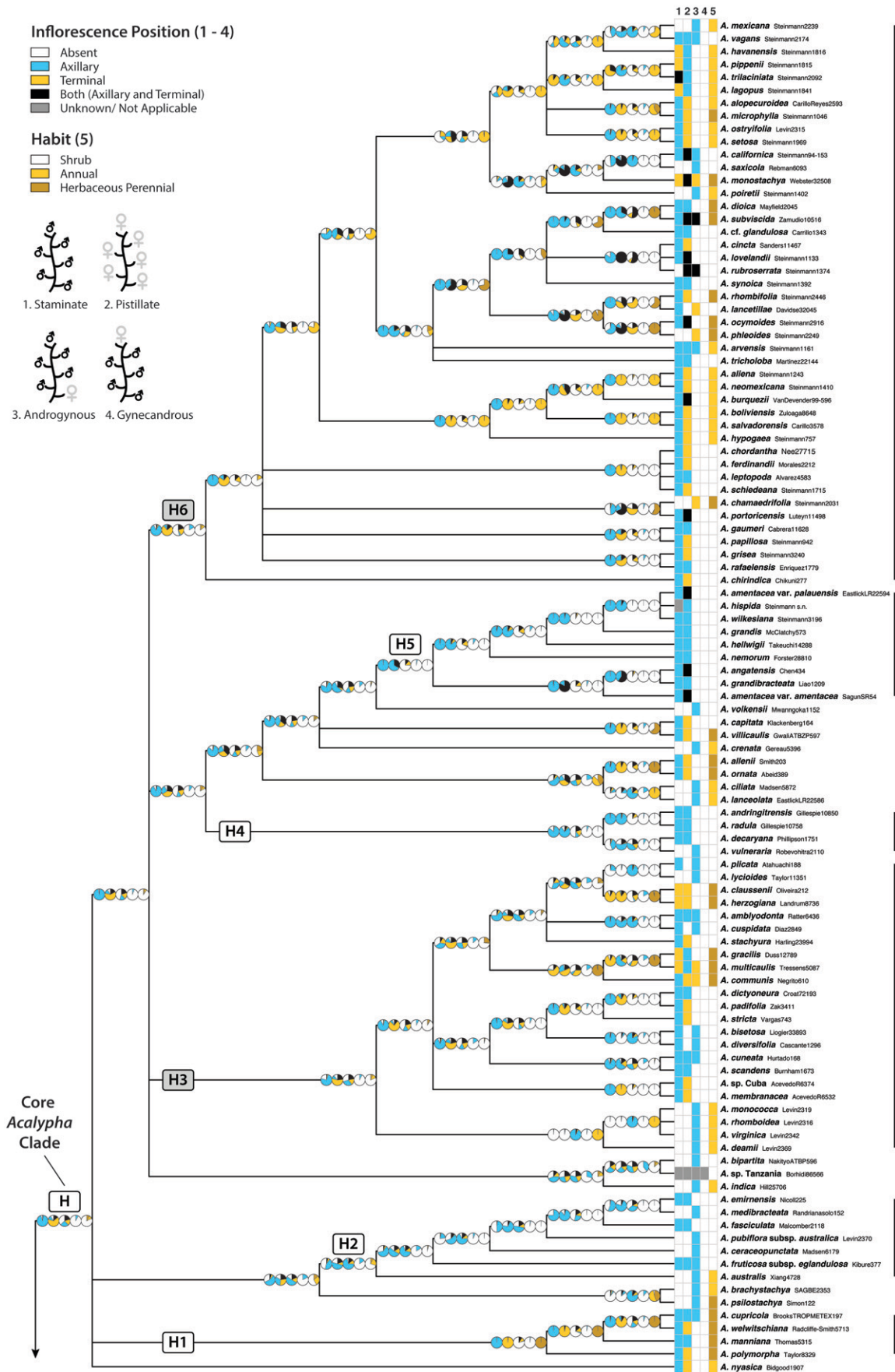

FIG. 4B. Continued from Fig. 4A.

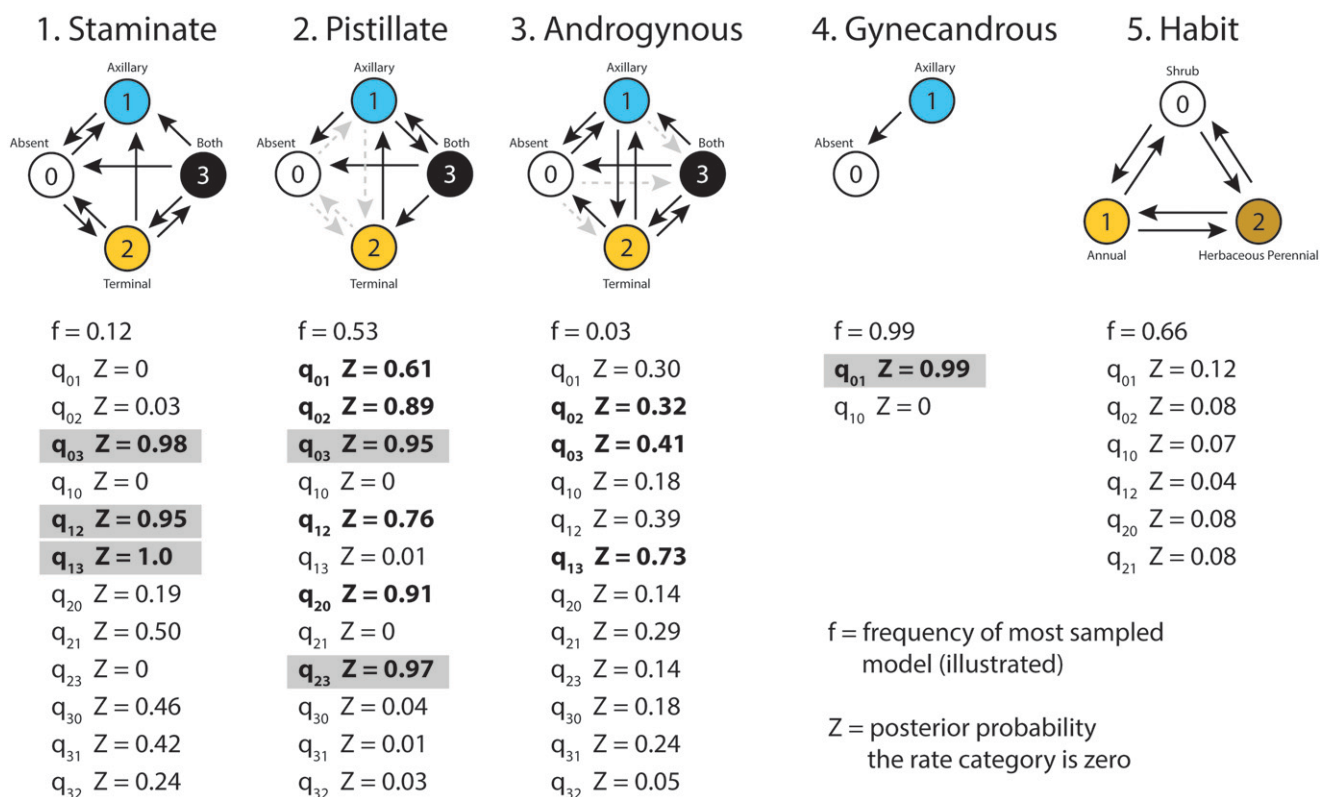

FIG. 5. Optimal models of character evolution in *Acalypha* and *Mareya* inferred using Bayesian inference with BayesTraits for inflorescence sexuality and position (1. staminate, 2. pistillate, 3. androgynous, 4. gynecandrous) and 5. habit. Only the most frequently sampled model for each character is shown (f). Below each model are Z-scores representing the probability that each transition rate is zero. Bolded Z-scores indicate transitions that were prohibited in the most frequently selected model, but only those highlighted in grey were significantly supported across all sampled models ($PP \geq 0.95$). Such strongly supported Z-score transitions are absent in the model figures, whereas poorly supported Z-score transitions are depicted by dashed light grey arrows. All of the most frequently selected models support a single transition rate among character states.

Classification—The infrageneric classification of Pax and Hoffmann (1924) is highly inconsistent with the phylogeny presented here (Fig. 7). *Acalypha* subgenus *Linostachys* appears to be polyphyletic, with most sampled species resolved in clade C, *Acalypha gillmanii* more closely related to *A. diminuta*, the sole species in *A. subg. Androcephala*, in clade B, and *A. echinus* in the possibly basal clade A (Fig. 7A). Within *A. subg. Linostachys*, Pax and Hoffmann (1924) recognized three sections based on inflorescence position and number of flowers in the pistillate inflorescences, but these, too, are not supported phylogenetically. Their *A. sect. Terminales* consists of two species, *A. costaricensis* and *A. paniculata*, that are widely separated by species in the other two sections, with *A. paniculata* sister to the rest of the species in clade C and *A. costaricensis* highly derived within that clade. Their *A. sect. Axillares* (which is correctly named *A. sect. Linostachys* because it contains the type of the section) also is not monophyletic because *A. sect. Coryloideae* is imbedded within it and because *A. echinus* falls in clade A, outside the major group of *A. subg. Linostachys* s. s.); *A. sect. Coryloideae* is now regarded as monospecific (Muñoz-Rodríguez et al. 2014), so is inherently monophyletic.

As noted above, *A. subg. Acalypha* is strongly supported as monophyletic. However, the infrageneric classification of the subgenus in Pax and Hoffmann (1924) is not supported by our results. All eight of their “series” are highly polyphyletic (Fig. 7A). Eight of their 36 “sections” contain only one species each in their treatment and another three (“Leptopodae,” *Plumosae*, and “Pseudoligogynae”) have been reduced to one

species due to synonymization in subsequent treatments (Cardiel et al. 2007); these eleven “sections” therefore are trivially monophyletic. We sampled more than one species from 17 of the remaining 25 “sections”; all of these are reconstructed as polyphyletic with the exception of “sect. Sclerolobae,” which is strongly supported as monophyletic (MLBP = 77, BPP = 1; Figs. 3B, 7A). Polyphyly of these 16 “sections” is strongly supported, persisting even if weakly supported nodes are collapsed. Furthermore, “sect. Monaxanthae,” which Pax and Hoffmann (1924) placed in *A. subg. Acalypha*, is now generally treated as belonging to *A. subg. Linostachys* (Muñoz-Rodríguez et al. 2014); our results place it outside both subgenera as part of the possibly basal clade A (Fig. 7A).

The classification proposed by Hurusawa (1954) is even more inconsistent with our phylogenetic results. Because his treatment of *A. subg. Androcephala* and *A. subg. Linostachys* followed that of Pax and Hoffmann (1924), the same issues in these subgenera that we noted above also pertain to his classification. His more narrowly circumscribed *A. subg. Acalypha* is paraphyletic, and none of the subgenera he split out of it are monophyletic. Furthermore, all of his sections within that set of subgenera are polyphyletic.

DISCUSSION

Phylogeny and Classification—The phylogeny presented here provides strong evidence for the monophyly of *Acalypha*,



FIG. 6. Optimal models of character evolution used to test if there is correlated evolution in *Acalypha* and *Mareya* between i) inflorescence position, (0) axillary only, (1) terminal present (with or without axillary) and ii) habit (0) woody, (1) herbaceous (including annuals and herbaceous perennials), optimized using Bayesian inference with BayesTraits. Only the most frequently sampled model (f) for each model type (A. Independent; B. Dependent) are shown. Beside the Dependent model are Z-scores representing the probability each transition rate is zero. Bolded Z-scores indicate transitions that were prohibited in the most frequently selected model, but only those highlighted in grey were significantly supported across all sampled models (PP \geq 0.95). Such strongly supported Z-score transitions (i.e. q_{12}) are absent in the model figure, whereas poorly supported Z-score transitions (i.e. q_{43}) are depicted by dashed light grey arrows. The Independent model had a sample frequency of 1.0, strongly supported all transitions, and was statistically rejected in favor of the Dependent model (log BF = 4.928). Both of the most frequently selected models support a single transition rate among character states.

results that are not surprising given its distinctive morphology and long history of taxonomic recognition. Although our outgroup taxon sampling is potentially biased to this conclusion, our results are consistent with all previous molecular studies that sampled more of the closely related genera (Wurdack et al. 2005; Tokuoka 2007; Cervantes et al. 2016). Of note, our ingroup sampling is by far the most inclusive to date, and the monophyly of the genus remains strongly supported (Fig. 3A).

Within *Acalypha*, the large and most species-rich clade, *A. subg. Acalypha* (clades D–H), is strongly supported as monophyletic, which is consistent with the long history of the subgenus being recognized in its current form. Morphologically, *A. subg. Acalypha* is distinguished by having pistillate flowers that are subtended by accrescent (vs. non-acrescent) bracts, are sessile (vs. pedicellate), and bear three (vs. mostly five) sepals; the few species that depart from this syndrome are highly derived within the subgenus (G. Levin pers. obs.).

Other than recognition of *A. subg. Acalypha*, almost all other aspects of Pax and Hoffmann's (1924) infrageneric classification, the only one currently in use, are not supported (Fig. 7). At the subgeneric level, both *A. subg. Androcephala* and *A. subg. Linostachys* require redefinition to reflect monophyletic groups. *Acalypha gillmanii* should be transferred from *A. subg. Linostachys* to *A. subg. Androcephala*, which previously comprised only *A. diminuta* (clade B; Figs. 3A, 7A, B), on the basis of their shared androgynous inflorescence morphology. Some other species that Pax and Hoffmann (1924) included in *A. subg. Linostachys*, represented in our study by *A. echinus*, are more closely related to species they placed in *A. subg. Acalypha* "ser. Hypandrae sect. Monaxanthae" but that are now generally included in *A. subg. Linostachys* (Muñoz-Rodríguez et al. 2014), represented here by *A. acrogyna*; together these species form a very strongly supported clade distinct from the other subgenera and which may be basal within the genus (clade A; Figs. 3A, 7A). The remaining species of *A. subg. Linostachys* (hereafter referred to as s.s.)

also form a strongly supported clade (clade C; Figs. 3A, 7A). Morphologically, these three clades (A, B, and C) share the plesiomorphic conditions of having pistillate flowers that are subtended by non-acrescent bracts, are pedicellate (rarely sessile), and bear five (occasionally four, rarely six) sepals. They can be unequivocally distinguished from each other by their inflorescence sexuality, with the *A. acrogyna/echinus* complex (clade A) having gynecandrous inflorescences, *A. subg. Androcephala* (clade B) having androgynous inflorescences, and *A. subg. Linostachys* s.s. (clade C) having unisexual (very rarely bisexual) inflorescences. In addition, the first two clades differ from *A. subg. Linostachys* s.s. in having leaf blades with the axils of the secondary nerves barbate (vs. not barbate; Muñoz-Rodríguez et al. 2014). Both *A. subg. Androcephala* and the *A. acrogyna/echinus* complex are African (including Madagascar), whereas *A. subg. Linostachys* s.s. is neotropical, with the exception of its earliest diverging member, *A. paniculata*, which is pantropical. Given the phylogenetic position of the *A. acrogyna/echinus* clade and its distinct gynecandrous inflorescence morphology, we propose that it be recognized as the resurrected *A. subg. Hypandrae* (Müll.-Arg.) Hurus. (Fig. 7B), which we circumscribe more narrowly than did Hurusawa (1954).

Montero-Muñoz (2021), using only ITS, also found strong phylogenetic support for our clades A and C. Her dataset overlapped with ours and included somewhat fewer species (104). However, she sampled *A. sonderiana* Müll.Arg., which Pax and Hoffmann (1924) placed in *A. subg. Acalypha* "ser. Hypandrae sect. Monaxanthae," and *A. baretiae* I. Montero & Cardiel and *A. chocona* Cardiel, both more recently described species that have been treated in *A. subg. Linostachys*. Her phylogeny placed *A. baretiae* and *A. sonderiana*, both of which have gynecandrous inflorescences, in a strongly supported clade with the two species in our clade A, and *A. chocona*, which has unisexual inflorescences, in a separate, also strongly supported clade that also included all the species from our clade C that she sampled (I. Montero-Muñoz pers.

comm.). Relationships among these two clades and *A. diminuta* varied depending on the analytic method used, probably because ITS alone did not provide sufficient support.

Within *A.* subg. *Linostachys* s.s., we found no support for the three sections Pax and Hoffmann (1924) recognized on the basis of inflorescence position and pistillate inflorescence size. We therefore concur with Muñoz-Rodríguez et al. (2014) that *A.* subg. *Linostachys* (in the narrow sense used here) should not be further subdivided.

Within *Acalypha* subg. *Acalypha* (clades D–H), there is relatively good support for five major clades and the lower part of the backbone. Four of these clades (D–G; Fig. 3A) are relatively small and exclusively Old World; clade D is herbaceous (mostly perennial) and found only in southern Africa, whereas the other three are shrubby, with clade E found only in Madagascar and clades F and G more widespread. The fifth clade, the “core *Acalypha*” clade H, contains most of the species within the genus and is diverse morphologically and geographically. Although some subclades have relatively strong support, relationships within the core *Acalypha* clade generally are not well resolved or strongly supported. This is especially true for the two very large, American subclades H3 and H6 (Fig. 3B), which may reflect rapid diversification following colonization of the Americas from Africa. More sampling of American species, especially from South America, which we did not sample as well as most other regions, might improve resolution and support within these subclades.

Several authors have previously commented on the artificiality of Pax and Hoffmann’s (1924) infrageneric classification of *A.* subg. *Acalypha* (Webster 1967; Seberg 1984; Cardiel 1995; Levin 1995) and our results show that it is not supported phylogenetically (Fig. 7A). We found that all their “series” and all but one of their multispecies “sections” for which we sampled multiple species are polyphyletic, often highly so; only “sect. *Sclerolobae*” was supported as monophyletic. It is possible that a few other “sections” may be monophyletic or can be made so with minor modifications. For example, *A.* sect. *Communes*, of which we sampled only the type species, *A. communis*, comprises five very similar species from the northern part of the Southern Cone of South America that have consistently been placed together, including in the recent revision of the group that validated the section nomenclaturally (Cardiel et al. 2013). In the phylogeny presented here, “sect. *Caturoideae*” is reconstructed as monophyletic (MLBP = 100, BPP = 1; Figs. 3A, 7A) with the exception of *A. hispida*, a species known only from cultivation and which produces only aberrant pistillate inflorescences (see below), and therefore is potentially difficult to classify. These few exceptions do not change the conclusion that their classification should be replaced or significantly revised. As noted above, Hurusawa’s (1954) classification is not a viable alternative.

A new classification for *A.* subg. *Acalypha* should recognize morphologically diagnosable, monophyletic taxa. Some small monophyletic groups of species within *A.* subg. *Acalypha* are morphologically distinctive, for example members of “sect. *Sclerolobae*” sensu Pax and Hoffmann (1924; see also Cardiel and Muñoz-Rodríguez 2013), the species pair *A. andringitrensis*/*A. radula*, and the Madagascan members of clade G (*A. gillespieae*, *A. mayottensis*, and *A. perrieri* and other species not sampled here, Fig. 3A). However, we have been unable to find morphological characters that allow diagnosis of any of the major clades within the subgenus. Indeed, unless species very closely resemble one another, it can be very difficult to

determine relationships accurately in the absence of DNA sequence data. Thus, a revised classification is premature at this time.

Notes on Specific Taxa—Our results allow us to address some specific taxonomic issues within *Acalypha* subg. *Acalypha*. Clade E (Fig. 3A), endemic to Madagascar, consists of *A. boinensis*, *A. levinii*, and *A. spachiana*, and three species (*A. lamiana*, *A. pervilleana*, and *A. urophylla*) that Léandri (1942) subsumed within *A. reticulata* Müll.Arg. but that Montero-Muñoz et al. (2018) treated as distinct. Although some branches within this clade are poorly supported, specimens identified following Montero-Muñoz et al. (2018) as *A. lamiana* and, perhaps, *A. pervilleana* appear in different subclades. Work to resolve species delimitation in this clade is ongoing (Montero-Muñoz et al. in prep.). Although Montero-Muñoz et al. (2018) used the name *Acalypha paxii* Aug.DC. (1901) for *A. pervilleana*, the latter name was published in 1861 and therefore has priority.

Multiple similar-appearing annual species have axillary, androgynous inflorescences with few pistillate bracts. These include the paleotropical *Acalypha brachystachya* and *A. indica*, *A. mexicana* from Mexico, *A. australis* from temperate eastern Asia, and the *A. virginica* group (*A. deamii*, *A. gracilens* A.Gray [not sampled], *A. monococca*, *A. rhomboidea*, and *A. virginica*) from eastern North America. Pax and Hoffmann (1924) put these species into two infrageneric taxa, with *A. australis*, *A. indica*, and *A. mexicana* (as *A. indica* var. *mexicana* (Müll.Arg.) Pax & K.Hoffm.) in “ser. Polygynae-Acrogynae sect. Repandae” and *A. brachystachya* and the *A. virginica* group in “ser. Polygynae-Pleurogynae sect. Brachystachyae.” Our phylogenetic results show that the *A. virginica* group and each of the four individual species all evolved independently (Fig. 3B), with all but *A. mexicana* evolving within woody clades (Fig. 4B). We also found strong support for recognizing *A. mexicana* as distinct from *A. indica* because the two taxa are distantly related.

Two species, *Acalypha hispida* and *A. wilkesiana* (sometimes treated as *A. amentacea* subsp. *wilkesiana* (Müll.Arg.) Fosberg), were first collected in Melanesia and are known only in cultivation. *Acalypha hispida* is cultivated for its long, red, pendent pistillate inflorescences (no staminate material is known, and the plant is propagated solely from cuttings), which are unique in the genus in having the flowers arranged in dense inflorescences consisting of many-flowered, bracteate glomerules, similar to the arrangement of staminate flowers in most *Acalypha* species (G. Levin pers. obs.), suggesting a homeotic mutation in its evolution. In contrast, *A. wilkesiana* is monoecious with unisexual inflorescences; it is cultivated for its showy, usually multicolored and sometimes misshapen leaves. Although Pax and Hoffmann (1924) treated these species in separate “sections” within “ser. Pantogynae-Pleurogynae” (“sect. *Caturoideae*” and “sect. *Palminerviae*,” respectively), our phylogenetic results show the two species to be closely related to each other and to *A. amentacea* var. *palauensis*, also from the southwestern Pacific (Micronesia), with very little sequence divergence among them (Fig. 3B). Furthermore, there is evidence that *A. hispida* and *A. wilkesiana* can hybridize (Sandhack 1908), which is rare in *Acalypha* (G. Levin pers. obs.). The three taxa are imbedded within a very strongly supported clade containing two other Melanesian species (*A. grandis* and *A. hellwigii*) that in turn is part of a very strongly supported clade with the Australian *A. nemorum* (Fig. 3B). This clade is very strongly supported as sister

to another very strongly supported clade consisting of three taxa (*A. amentacea* var. *amentacea*, *A. angatensis*, and *A. grandibracteata*) found from Taiwan and the Philippines south to Borneo, then east to Papua New Guinea (Fig. 3B). These results are consistent with those of Sagun et al. (2010), but with increased taxon sampling. In addition to shedding light on the origin of the two cultivated species, our findings also clarify species boundaries within this group. Although Fosberg and Sachet (1980) treated *A. amentacea* var. *palauensis*, *A. angatensis*, *A. grandis*, and *A. wilkesiana* as infraspecific taxa within *A. amentacea*, our results support treating them all as distinct species; we propose the new combination *A. palauensis* (Fosberg) G.A. Levin below. The status of the other taxa Fosberg and Sachet (1980) described in *A. amentacea*, var. *heterotricha* Fosberg and var. *trukensis* Fosberg, both from the Caroline Islands in Micronesia, has not been assessed phylogenetically.

McVaugh (1995) treated the annual species *Acalypha salvadorensis* as *A. neomexicana* var. *jaliscana* McVaugh, at least in regard to material from Mexico. Although our results strongly support *A. neomexicana* and *A. salvadorensis* as belonging to the same clade (along with *A. aliena*, *A. burquezii*, and *A. neomexicana* from Mexico, Central America, and the southwestern United States, and *A. boliviensis* from southern South America, all of which are annuals; Fig. 3B), they are not sister taxa and therefore should be retained as separate species. Because our sample of *A. salvadorensis* is from Mexico (Appendix 1), it is safe to apply this name to both the Mexican and Central American material of this species.

Montero-Muñoz et al. (2018) treated *Acalypha andringitrensis* as a synonym of *A. radula*. However, our molecular data support treating them as a distinct, although closely related, species (Fig. 3B), a conclusion also reached by Montero-Muñoz (2021). Govaerts et al. (2000) considered *A. villicaulis* to be a synonym of *A. petiolaris* Hochst., but we follow more recent floristic and taxonomic treatments of African *Acalypha*, including Cardiel and Montero Muñoz (2017), in treating them as distinct.

Character Evolution—Clearly, inflorescence position and sexuality show high homoplasy in *Acalypha*, with reversals and convergent evolution rife, especially in *A.* subg. *Acalypha* (Figs. 4, 5). Although inflorescence sexuality is diagnostic for the three other subgenera recognized here and often does not vary among closely related species within *A.* subg. *Acalypha*, it generally is not valuable for higher level classification in *A.* subg. *Acalypha*. Inflorescence position does not inform higher classification anywhere in the genus. It is no wonder, then, that the classifications of Pax and Hoffmann (1924) and Hurusawa (1954), both of which depended heavily on inflorescence characters, are not supported phylogenetically.

Our results suggest that it is easy to shift between developing staminate and pistillate flowers. The development of allomorphic pistillate flowers in staminate inflorescences or staminate segments of androgynous inflorescences in many species (Radcliffe-Smith 1973) is consistent with this hypothesis. So too is the shift from staminate to pistillate inflorescences that appears to have happened during the evolution of *Acalypha hispida* (see discussion above) and in the origin of the cultivated form of *A. herzogiana*, although in the latter case the pistillate flowers have aberrant morphology and are sterile (Steinmann and Levin 2011). We have also seen terminal gynecandrous inflorescences on a plant of *A. monostachya* (V. W. Steinmann pers. obs.), a species in which the terminal

inflorescences normally are staminate. Control of sexual expression appears to differ among plant taxa and involves hormonal regulation, multiple genes, transcription factors, microRNAs, and epigenetic modifications, and may be influenced environmentally (Diggle et al. 2011; Sobral et al. 2016; Harkess and Leebens-Mack 2017), although sometimes it appears that only a few genes ultimately may be responsible (Boualem et al. 2008, 2015, 2016; Martin et al. 2009). Sex determination has not been examined in *Acalypha*, but some work has been done on a few other Euphorbiaceae, including *Jatropha curcas* L. (Chen et al. 2017, 2020), *Plukenetia volubilis* L. (Luo et al. 2020), *Ricinus communis* L. (Parvathy et al. 2021), and *Vernicia fordii* (Hemsl.) Airy Shaw (Mao et al. 2017), none of which is closely related to *Acalypha* (Wurdack et al. 2005; Sun et al. 2016). Because *Acalypha* includes closely related species with different floral sexuality expression, it could provide good material for investigating control of floral sex determination.

Few studies have examined inflorescence position in a phylogenetic context. In *Euphorbia* (Euphorbiaceae; Horn et al. 2012), Ericaceae (Kron et al. 2002), and Miconieae (Melastomataceae; Michelangeli et al. 2004), there appear to have been multiple origins of axillary inflorescences from terminal inflorescences; multiple reversals to terminal inflorescences apparently occurred in Ericaceae and some species in Miconieae are polymorphic for inflorescence position. Terminal inflorescences evolved from axillary inflorescences at least twice in Veroniceae (Plantaginaceae; Albach et al. 2004b). Although inflorescence position is diagnostic for some clades in Lauraceae, overall it was somewhat labile (Song et al. 2019). It is striking that none of these studies found the relatively high levels of homoplasy and polymorphism (both axillary and terminal inflorescences on the same plant) in inflorescence position that characterize *Acalypha*, despite them being as or much more species-rich.

Habit is also highly homoplastic in *Acalypha* subg. *Acalypha* (the other subgenera are consistently shrubby). All six habit transitions are highly likely, with shrubs repeatedly giving rise to herbs (perennial or annual), repeated shifts between perennial and annual growth forms within herbaceous clades, and derivation of shrubs from both annuals and herbaceous perennials (Figs. 4, 5). Many studies have found phylogenetic support for shifts between annuals and perennials within primarily or exclusively herbaceous groups, with some showing annuals evolving from perennials (*Carlina* L., Asteraceae: Wahrmond et al. [2010]; *Corchorus* L., Malvaceae: Benor [2018]; *Leucheria* Lag., Asteraceae: Jara-Arancio et al. [2017]; Montiaceae: Ogburn and Edwards [2015]; Orobanchaceae tribe Rhinanthae: Těšitel et al. [2010]; *Sidalcea* A. Gray, Malvaceae: Andreasen [2012]), others showing perennials evolving from annuals (*Castilleja* Mutis ex L.f., Orobanchaceae: Tank and Olmstead [2008]; *Lupinus* L., Fabaceae: Drummond et al. [2012]), and still others showing evolution in both directions, as in *Acalypha* (*Astragalus* L., Fabaceae: Azani et al. [2017]; Brassicaceae tribe Arabideae: Karl and Koch [2013]; *Scorzoneroideis* Moench, Asteraceae: Cruz-Mazo et al. [2009]; *Trifolium* L., Fabaceae: Ellison et al. [2006]). Few studies have used phylogeny to examine habit evolution in groups that include annuals, herbaceous perennials, and shrubs or other woody forms, particularly outside the context of insular woodiness (for which see a summary in Nurk et al. 2019), perhaps because relatively few groups have similar diversity of growth forms. Within Saxifragales, Soltis et al. (2013) found

that habit is relatively labile, with multiple shifts from woody plants to herbaceous perennials and the reverse, annuals derived multiple times from woody or herbaceous perennial ancestors, and frequent reversion from annuals to herbaceous perennials but rarely to woody forms. Lamb Frey and Kron (2003) found that within Polygonaceae, woody habit likely evolved multiple times from herbaceous growth forms, but they did not differentiate between perennial and annual herbs. Apart from studies of insular woodiness, we found only two that examined genera with highly variable habit. In *Medicago* L. (Fabaceae), perennial herbs appear to have been derived from annuals and there is a single origin of shrubs from perennial herbs (Steele et al. 2010). *Euphorbia* (Euphorbiaceae) is similar to *Acalypha* in being ancestrally woody and repeatedly evolving herbaceous habit, but differs in showing multiple transitions from herbs to secondary woodiness and numerous origins of xerophytes from woody ancestors (Horn et al. 2012). Unfortunately, Horn et al. (2012) did not differentiate between annual and perennial herbs. These studies demonstrate that the pattern in *Acalypha* of herbaceous forms evolving repeatedly from woody ancestors, followed by repeated shifts between annual and perennial herbs and sometimes reversion to woodiness, is common among highly species rich groups. However, shrubs evolving directly from annuals, which appears to have happened several times in *Acalypha*, appears to be rare in most groups.

The correlation in *Acalypha* between habit (woody vs. herbaceous) and inflorescence position (axillary only vs. terminal or axillary and terminal) is perhaps surprising. Very few studies of other groups have examined this relationship. In *Veronica* L. (Plantaginaceae), Albach et al. (2004a, 2004b) found that repeated shifts from axillary to terminal or pseudo-terminal

(axillary but with abortion of the shoot apex) inflorescences were associated with evolution of annual habit or invasion of alpine habitats, and thus possibly were related to reduction in plant stature. In their very rigorous analysis of *Euphorbia* (Euphorbiaceae) phylogeny and morphological evolution, Horn et al. (2012) found that evolution of axillary from terminal inflorescences was correlated with evolution of strongly xeromorphic (succulent) habit, and they speculated that this resulted from selection for better vascular conduction in plants with monopodial vs. sympodial growth. Neither of these studies is applicable to *Acalypha*, which does not occupy alpine habits or include strongly xeromorphic growth forms, and in which herbaceous clades (both annual and perennial) are more likely to lose terminal inflorescences than to gain them. Furthermore, completely sympodial growth is very rare or absent in *Acalypha* because even in species with terminal inflorescences, not all axes terminate in inflorescences (woody species and some herbaceous species) and/or the shoots are unbranched and die back to the crown (herbaceous perennials) or entirely (annuals). It is difficult to explain why, in *Acalypha*, woody species with only axillary inflorescences are not ancestral to herbaceous species. Although the herbaceous habit has evolved repeatedly and approximately equal numbers of herbaceous clades have evolved only axillary inflorescences vs. some terminal inflorescences (13 vs. 14), many more clades that are herbaceous with only axillary inflorescences are annuals vs. perennials (nine vs. three; Fig. 4), whereas among herbaceous clades with some terminal inflorescences the reverse is true (10 perennial vs. four annual). We see no obvious ecological or functional morphological explanations for any of these patterns; it is possible that they reflect association with other features that have phylogenetic inertia.

KEY TO THE SUBGENERA OF ACALYPHA

1. Pistillate flowers sessile, sepals 3(4), subtending bracts accrescent in fruit (very rarely non-acrescent) I. A. subg. *Acalypha*
1. Pistillate flowers pedicellate (rarely sessile or subsessile), sepals (4)5(6), subtending bracts non-acrescent 2
 2. Inflorescences unisexual (rarely androgynous in *A. flagellata*, very rarely gynecandrous in *A. paniculata*); leaf blade secondary vein axils not barbate IV. A. subg. *Linostachys*
 2. Inflorescences bisexual; leaf blade secondary vein axils barbate 3
 3. Inflorescences terminal, androgynous II. A. subg. *Androcephala*
 3. Inflorescences axillary, gynecandrous III. A. subg. *Hypandrae*

TAXONOMIC TREATMENT

I. ACALYPHA subg. ACALYPHA. TYPE: *Acalypha virginica* L.

Shrubs (or small trees), subshrubs, herbaceous perennials, or annuals. Inflorescences axillary or terminal, unisexual or androgynous; bracts subtending pistillate flowers accrescent (very rarely non-acrescent). **Pistillate flowers** sessile; sepals 3(4). Figures 1C, E, 2A–D.

Species—This subgenus contains ca. 470 species.

Distribution—The species in this subgenus are widely distributed in Africa, Asia, Oceania, and the Americas, mainly in tropical and subtropical areas.

Notes—Within *A. subg. Acalypha*, we make the following new combination to reflect phylogenetic relationships that are inconsistent with the broad concept of *A. amentacea* adopted by Fosberg and Sachet (1980).

1. *Acalypha palauensis* (Fosberg) G.A. Levin, comb. nov. *Acalypha amentacea* Roxb. var. *palauensis* Fosberg, Smithsonian Contr. Bot. 45: 9 (1980). TYPE: REPUBLIC OF PALAU. Peliliu Island, south part near northeast end of airstrip, 1

September 1965, F. R. Fosberg 47637 (holotype: US [US2813625!]).

II. ACALYPHA subg. ANDROCEPHALA Pax & K. Hoffm., in H. G. A. Engler, Pflanzenr. 17[IV,147]: 21 (1924). TYPE: *Acalypha diminuta* Baill.

Shrubs. Inflorescences terminal, androgynous; bracts subtending pistillate flowers non-acrescent. **Pistillate flowers** pedicellate; sepals 5. Figure 2G.

Species—This subgenus contains two species: *Acalypha diminuta* Baill. and *A. gillmanii* Radcl.-Sm.

Distribution—The species in this subgenus are African (*Acalypha diminuta* in Madagascar, *A. gillmanii* in Tanzania).

Notes—Although Radcliffe-Smith (1976) described the inflorescences of *Acalypha gillmanii* as being axillary or terminal, examination of specimens shows that those that appear to be axillary arise from perulate axillary buds and therefore actually are terminal.

III. ACALYPHA subg. HYPANDRAE (Müll. Arg.) Hurus., J. Fac. Sci. Univ. Tokyo, Sect. 3, Bot. 6: 297 (1954). *Acalypha* subser.

Hypandrae Müll.Arg., *Linnaea* 34: 9 (1865). LECTOTYPE (designated here): *Acalypha sonderiana* Müll.Arg.

Shrubs. Inflorescences axillary, gynecandrous; bracts subtending pistillate flowers non-acrescent. **Pistillate flowers** pedicellate; sepals (4)5(6). Figure 2E.

Species—This subgenus contains six species: *Acalypha acrogyna* Pax, *A. baretiae* I.Montero & Cardiel, *A. boiviniana* Baill., *A. echinus* Pax & K.Hoffm., *A. engleri* Pax, and *A. sonderiana* Müll.Arg.

Distribution—The species in this subgenus are distributed in Africa, including Madagascar (only *Acalypha baretiae*).

Notes—We circumscribe *A.* subg. *Hypandrae* much more narrowly than did Hurusawa (1954), who, following (Pax and Hoffmann 1924), included many species that belong in *A.* subg. *Acalypha* based on their morphology and, for those we sampled, their DNA sequences.

When he published his *A.* subser. *Hypandrae*, Müller (1865) did not designate a type and included two unranked taxa, *Monaxanthae* with three species (*Acalypha angatensis*, *A. boiviniana*, and *A. sonderiana*) and *Diaxanthae* with two species (*A. codonocalyx* Baill. and *A. emirnenis*); no one has subsequently designated types for any of these Müller names. He had not seen specimens of *A. angatensis* and apparently misinterpreted the original description to indicate that the species has gynecandrous inflorescences. He interpreted the inflorescences of *A. codonocalyx* (now treated as a synonym of *A. chibomboia* Baill.; Léandri 1942; Montero-Muñoz et al. 2018) and *A. emirnenis* as being pistillate or gynecandrous. In fact, the inflorescences of *A. angatensis*, *A. chibomboia*, and *A. emirnenis* are unisexual, but in *A. emirnenis* the staminate inflorescences very rarely terminate in a single allomorphic pistillate flower (G. Levin pers. obs.) and in *A. angatensis* they frequently do so (Sagun et al. 2010); we have seen no evidence of this in *A. chibomboia*. These three species morphologically belong in *A.* subg. *Acalypha*, where our results place *A. angatensis* and *A. emirnenis* (we were unable to sample *A. chibomboia*). Both of the species that remain, *A. boiviniana* and *A. sonderiana*, have gynecandrous inflorescences and the pistillate flower morphology that characterizes *A.* subg. *Hypandrae* as we define it. *Acalypha boiviniana* is known only from the type collection from 1848 and likely is extinct (Muñoz-Rodríguez et al. 2014), whereas *A. sonderiana* is known from multiple collections and is extant. Because it belongs to *A.* subg. *Hypandrae* and is extant, we select *A. sonderiana* as the lectotype for the subgenus.

IV. ACALYPHA subg. LINOSTACHYS (Klotzsch ex Schltdl.) Pax & K.Hoffm., in H. G. A. Engler, *Pflanzenr.* 17[IV,147]: 13 (1924). *Linostachys* Klotzsch ex Schltdl., *Linnaea* 19: 235 (1846). *Acalypha* sect. *Linostachys* (Klotzsch ex Schltdl.) Müll.Arg., *Linnaea* 34: 6 (1865). TYPE: *Linostachys padifolia* Schltdl. (1846), non *Acalypha padifolia* Kunth (1817) [= *Acalypha schlechtendaliana* Müll.Arg.].

Shrubs. Inflorescences axillary or terminal, unisexual (very rarely androgynous or gynecandrous); bracts subtending pistillate flowers non-acrescent. **Pistillate flowers** pedicellate (rarely sessile or subsessile); sepals (4)5(6). Figures 1A, D, 2F.

Species—This subgenus contains 22 species: *Acalypha castroviejoi* Cardiel, *A. chocoana* Cardiel, *A. costaricensis* (Kuntze) Knobl. Ex Pax & K.Hoffm., *A. elizabethiae* R.A.Howard, *A. filipes* (S.Watson) McVaugh, *A. flagellata* Millsp., *A. gentlei*

Atha, *A. gummifera* Lundell, *A. inaequilatera* Cardiel, *A. leptorhachis* Müll.Arg., *A. longipes* S.Watson, *A. longipetiolata* Cardiel, *A. muelleriana* Urb., *A. mutisii* Cardiel, *A. oblancifolia* Lundell, *A. paniculata* Miq., *A. pittieri* Pax & K.Hoffm., *A. platyphylla* Müll.Arg., *A. salicifolia* Müll.Arg., *A. schlechtendaliana* Müll.Arg., *A. seleriana* Greenm., and *A. villosa* Jacq.

Distribution—The species in this subgenus are distributed mostly in the Americas; only *Acalypha paniculata* is found outside of that region, in Africa and Asia.

ACKNOWLEDGMENTS

We thank the curators and staff of the following herbaria for providing access to specimens and, in many cases, allowing us to sample them for DNA: A, ARIZ, B, BM, BRI, CAHUP, CAN, DAV, E, G, GB, GH, GUADA, IEB, ILLS, K, L, LBC, LE, MEXU, MICH, MO, NY, P, RSA, SD, SING, TEX, U, US, W, WIS, and WRSL. Stephen Downie graciously provided laboratory space for DNA sequencing. Initial molecular work was done at the California Botanical Garden. Lynn Gillespie provided valuable comments on the manuscript and input on sequence alignment, and comments from two anonymous reviewers and the editors further improved the paper. This research was supported by grants from the United States National Science Foundation (DEB-0128872) to GL and VWS; the University of Illinois Graduate College to GL; and the University of Illinois School of Integrative Biology Enhancement Fund, American Society of Plant Taxonomists Graduate Student Research Grant, International Association for Plant Taxonomy Research Grant in Plant Systematics, Illinois State Academy of Sciences Student Research Award, and Illinois Natural History Survey Herbert Holdsworth Ross Memorial Award for Research in Systematics to VGS. GL thanks the staff of the Missouri Botanical Garden Madagascar program and the Parc Botanique et Zoologique de Tsimbazaza for assistance with fieldwork in Madagascar. All specimens newly collected for this project were legally collected with the necessary permits. We did not preregister the research plan in an independent, institutional registry.

AUTHOR CONTRIBUTIONS

GL helped conceive the research plan, gathered DNA samples, compiled morphological data, was the primary author of the manuscript, and prepared Fig. 1. WCM extracted and sequenced DNA, conducted phylogenetic and ancestral state analyses, helped interpret the morphological analyses, was the primary author of parts of the Materials and Methods and significantly revised the rest of the manuscript, and prepared Figs. 3–7. VGS gathered DNA samples, extracted and sequenced DNA, did preliminary sequence data analyses, was the primary author of parts of the Materials and Methods, and commented on the manuscript. VWS helped conceive the research plan, gathered DNA samples, extracted and sequenced DNA, and commented on the manuscript, and prepared Fig. 2.

LITERATURE CITED

- Albach, D. C., M. M. Martínez-Ortega, and M. W. Chase. 2004a. *Veronica*: Parallel morphological evolution and phylogeography in the Mediterranean. *Plant Systematics and Evolution* 246: 177–194.
- Albach, D. C., M. M. Martínez-Ortega, M. A. Fischer, and M. W. Chase. 2004b. Evolution of Veroniceae: A phylogenetic perspective. *Annals of the Missouri Botanical Garden* 91: 275–302.
- Alexander, P. J., G. Rajanikanth, C. D. Bacon, and C. D. Bailey. 2007. Recovery of plant DNA using a reciprocating saw and silica-based columns. *Molecular Ecology Notes* 7: 5–9.
- Andreasen, K. 2012. Phylogeny, hybridization, and evolution of habit and breeding system in *Sidalcea* and *Eremalche* (Malvaceae). *International Journal of Plant Sciences* 173: 532–548.
- Azani, N., A. Bruneau, M. F. Wojciechowski, and S. Zarre. 2017. Molecular phylogenetics of annual *Astragalus* (Fabaceae) and its systematic implications. *Botanical Journal of the Linnean Society* 184: 347–365.
- Baldwin, B. G. 1992. Phylogenetic utility of the internal transcribed spacers of nuclear ribosomal DNA in plants: An example from the Compositae. *Molecular Phylogenetics and Evolution* 1: 3–16.
- Benor, S. 2018. Molecular phylogeny of the genus *Corchorus* (Grewioideae, Malvaceae s.l.) based on nuclear rDNA ITS sequences. *The Crop Journal* 6: 552–563.

- Berry, P. E., A. L. Hipp, K. J. Wurdack, B. Van Ee, and R. Riina. 2005. Molecular phylogenetics of the giant genus *Croton* and tribe Crotonae (Euphorbiaceae sensu stricto) using ITS and *trnL-trnF* DNA sequence data. *American Journal of Botany* 92: 1520–1534.
- Boualem, A., M. Fergany, R. Fernandez, C. Troadec, A. Martin, H. Morin, M. A. Sari, F. Collin, J. M. Flowers, M. Pitrat, M. D. Purugganan, C. Dogimont, and A. Bendahmane. 2008. A conserved mutation in an ethylene biosynthesis enzyme leads to andromonoecy in melons. *Science* 321: 836–838.
- Boualem, A., C. Troadec, C. Camps, A. Lemhemdi, H. Morin, M. A. Sari, R. Fraenkel-Zagouri, I. Kovalski, C. Dogimont, R. Peri-Treves, and A. Bendahmane. 2015. A cucurbit androecy gene reveals how unisexual flowers develop and dioecy emerges. *Science* 350: 688–691.
- Boualem, A., A. Lemhemdi, M. A. Sari, S. Pignoly, C. Troadec, F. Abou Choucha, I. Solmaz, N. Sari, C. Dogimont, and A. Bendahmane. 2016. The andromonoecious sex determination gene predates the separation of *Cucumis* and *Citrullus* genera. *PLoS One* 11:e0155444: 1–13.
- Bruyns, P. V., R. J. Mapaya, and T. Hedderson. 2006. A new subgeneric classification for *Euphorbia* (Euphorbiaceae) in southern Africa based on ITS and *psbA-trnH* sequence data. *Taxon* 55: 397–420.
- Cardiel, J. M. 1995. *Flora de Colombia*. *Acalypha* (Euphorbiaceae). Santa Fé de Bogotá: Instituto de Ciencias Naturales, Universidad Nacional de Colombia.
- Cardiel, J. M. 2007. Catálogo de las especies peruanas de *Acalypha* Linnaeus (Euphorbiaceae). *Fontqueria* 55: 405–414.
- Cardiel, J. M. and I. Montero Muñoz. 2017. Synopsis of *Acalypha* (Euphorbiaceae) of West Tropical Africa, including Cameroon, Chad, Equatorial Guinea, Gabon, and São Tomé and Príncipe. *Plant Systematics and Evolution* 304: 93–110.
- Cardiel, J. M. and P. Muñoz-Rodríguez. 2013. *Acalypha carrascoana* Cardiel (Euphorbiaceae) novelty for the flora of Mexico. *Botanica Complutensis* 37: 53–56.
- Cardiel, J. M., I. Montero, E. Dorda, P. Muñoz, and M. P. de Santayana. 2007. *Acalypha* Taxonomic Information System. Published on the Internet: www.acalypha.es (last accessed 30 November 2020).
- Cardiel, J. M., P. Muñoz Rodríguez, and F. Muñoz Garmendia. 2013. Revised taxonomy and nomenclature of *Acalypha* sect. *Communes* (Euphorbiaceae), a complex group of species widespread in the north of the Southern Cone. *Taxon* 62: 1295–1303.
- Cardiel, J. M., I. Montero-Muñoz, E. Ortúñez, E. Dorda, and I. Sancho-García. 2020. Epidermal crystals in *Acalypha* (Euphorbiaceae, Acalyphoideae) as a new taxonomic trait of the genus. *Plant Systematics and Evolution* 306: 1–18.
- Cervantes, A., S. Fuentes, J. Gutiérrez, S. Magallón, and T. Borsch. 2016. Successive arrivals since the Miocene shaped the diversity of the Caribbean Acalyphoideae (Euphorbiaceae). *Journal of Biogeography* 43: 1773–1785.
- Chen, M. S., B. Z. Pan, Q. Fu, Y. B. Tao, J. Martínez-Herrera, L. Niu, J. Ni, Y. Dong, M. L. Zhao, and Z. F. Xu. 2017. Comparative transcriptome analysis between gynodioecious and monoecious plants identifies regulatory networks controlling sex determination in *Jatropha curcas*. *Frontiers in Plant Science* 7–1953: 1–14.
- Chen, M. S., L. Niu, M. L. Zhao, C. Xu, B. Z. Pan, Q. Fu, Y. B. Tao, H. He, C. Hou, and Z. F. Xu. 2020. De novo genome assembly and Hi-C analysis reveal an association between chromatin architecture alterations and sex differentiation in the woody plant *Jatropha curcas*. *Giga-Science* 9: 1–12.
- Cruz-Mazo, G., M. L. Buide, R. Samuel, and E. Narbona. 2009. Molecular phylogeny of *Scorzoneroideae* (Asteraceae): Evolution of heterocarpy and annual habit in unpredictable environments. *Molecular Phylogenetics and Evolution* 53: 835–847.
- Darriba, D., G. L. Taboada, R. Doallo, and D. Posada. 2012. jModelTest 2: more models, new heuristics and parallel computing. *Nature Methods* 9: 772.
- Diggle, P. K., V. S. Di Stilio, A. R. Gschwend, E. M. Goldenberg, R. C. Moore, J. R. Russell, and J. P. Sinclair. 2011. Multiple developmental processes underlie sex differentiation in angiosperms. *Trends in Genetics* 27: 368–376.
- Doyle, J. J. and J. L. Doyle. 1987. A rapid DNA isolation procedure for small quantities of fresh leaf tissue. *Phytochemical Bulletin* 19: 11–15.
- Drummond, C. S., R. J. Eastwood, S. T. S. Miotto, and C. E. Hughes. 2012. Multiple continental radiations and correlates of diversification in *Lupinus* (Leguminosae): Testing for key innovation with incomplete taxon sampling. *Systematic Biology* 61: 443–460.
- Ellison, N. W., A. Liston, J. J. Steiner, W. M. Williams, and N. L. Taylor. 2006. Molecular phylogenetics of the clover genus (*Trifolium*—Leguminosae). *Molecular Phylogenetics and Evolution* 39: 688–705.
- Fosberg, F. R. and M.-H. Sachet. 1980. Systematic studies of Micronesian plants. *Smithsonian Contributions to Botany* 45: 1–40.
- Govaerts, R., D. G. Frodin, and A. Radcliffe-Smith. 2000. *World Checklist and Bibliography of Euphorbiaceae (and Pandaceae)*. Kew: Royal Botanical Gardens.
- Harkess, A. and J. Leebens-Mack. 2017. A century of sex determination in flowering plants. *The Journal of Heredity* 108: 69–77.
- Horn, J. W., B. W. van Ee, J. J. Morawetz, R. Riina, V. W. Steinmann, P. E. Berry, and K. J. Wurdack. 2012. Phylogenetics and the evolution of major structural characters in the giant genus *Euphorbia* L. (Euphorbiaceae). *Molecular Phylogenetics and Evolution* 63: 305–325.
- Hurusawa, I. 1954. Eine nochmalig Durchsicht des herkömmlichen Systems der Euphorbiaceen im weiteren Sinne. *Journal of the Faculty of Science, University of Tokyo*, Sect. 3. *Botany* 6: 209–342.
- Jacobs, B. F. and C. H. S. Kabuye. 1987. A middle Miocene (12.2 my old) forest in the East African Rift Valley, Kenya. *Journal of Human Evolution* 16: 147–155.
- Jacobs, B. F. and D. A. Winkler. 1992. Taphonomy of a middle Miocene autochthonous forest assemblage Ngorora Formation, central Kenya. *Palaeogeography, Palaeoclimatology, Palaeoecology* 99: 31–40.
- Jara-Arancio, P., P. M. Vidal, J. L. Panero, A. Marticorena, G. Arancio, and M. T. K. Arroyo. 2017. Phylogenetic reconstruction of the South American genus *Leucheria* Lag. (Asteraceae, Nassauviaceae) based on nuclear and chloroplast DNA sequences. *Plant Systematics and Evolution* 303: 221–232.
- Karl, R. and M. A. Koch. 2013. A world-wide perspective on crucifer speciation and evolution: phylogenetics, biogeography and trait evolution in tribe Arabideae. *Annals of Botany* 112: 983–1001.
- Katoh, K. and D. Standley. 2013. MAFFT multiple sequence alignment software version 7: Improvements in performance and usability. *Molecular Biology and Evolution* 30: 772–780.
- Kim, K.-J. and R. K. Jansen. 1995. *ndhF* sequence evolution and the major clades in the sunflower family. *Proceedings of the National Academy of Sciences USA* 92: 10379–10383.
- Kron, K. A., W. S. Judd, P. F. Stevens, D. M. Crayn, A. A. Anderberg, P. A. Gadek, C. J. Quinn, and J. L. Luteyn. 2002. Phylogenetic classification of Ericaceae: Molecular and morphological evidence. *Botanical Review* 68: 335–423.
- Lamb Frey, A. S. and K. A. Kron. 2003. *rbcl* phylogeny and character evolution in Polygonaceae. *Systematic Botany* 28: 326–332.
- Łańcucka-Środoniowa, M. and E. Zastawniak. 1993. A supplementary note on the Upper Miocene flora of Gozdnicza in lower Silesia (SW Poland). *Acta Palaeobotanica* 33: 267–293.
- Léandri, J. D. 1942. Contribution à l'étude des Euphorbiacées de Madagascar. VI. *Notulae Systematicae* 10: 252–291.
- Levin, G. A. 1995. Systematics of the *Acalypha californica* complex (Euphorbiaceae). *Madroño* 41: 254–265.
- Levin, G. A., W. M. Cardinal-McTeague, V. W. Steinmann, and V. G. Sagun. 2022. Data from: Phylogeny, classification, and character evolution of *Acalypha* (Euphorbiaceae Acalyphoideae). Dryad Digital Repository. <https://doi.org/10.5061/dryad.fj6q573w7>.
- Luo, Y., B. Z. Pan, L. Li, C. X. Yang, and Z. F. Xu. 2020. Developmental basis for flower sex determination and effects of cytokinin on sex determination in *Plukenetia volubilis* (Euphorbiaceae). *Plant Reproduction* 33: 21–34.
- Mai, D. H. 1987. Neue Arten nach Früchte und Samen aus dem Tertiär von Nordwestsachsen und der Lausitz. *Feddes Repertorium* 98: 105–126.
- Mao, Y., W. Liu, X. Chen, Y. Xu, W. Lu, J. Hou, J. Ni, Y. Wang, and L. Wu. 2017. Flower development and sex determination between male and female flowers in *Vernicia fordii*. *Frontiers in Plant Science* 8–1291: 1–14.
- Martin, A., C. Troadec, A. Boualem, M. Rajab, R. Fernandez, H. Morin, M. Pitrat, C. Dogimont, and A. Bendahmane. 2009. A transposon-induced epigenetic change leads to sex determination in melon. *Nature* 461: 1135–1138.
- McVaugh, R. 1995. *Euphorbiacearum sertum novo-galicianarum revisarum*. *Contributions from the University of Michigan Herbarium* 20: 173–215.
- Meade, A. and M. Pagel. 2019. BatesTraits v. 3.0.2. Available from: <http://www.evolution.rdg.ac.uk>.
- Meller, B. 2011. Wetland vegetation types in the Late Miocene Alpine Molasse Basin in Upper Austria. *Palaeontographica. Abteilung B, Paläophytologie* 287: 57–155.
- Michelangeli, F. A., D. S. Penneys, J. Giza, D. E. Soltis, M. H. Hils, and J. D. J. Skee. 2004. A preliminary phylogeny of the tribe Miconieae (Melastomataceae) based on nrITS sequence data and its implications on inflorescence position. *Taxon* 53: 279–290.

- Miller, M. A., W. Pfeiffer, and T. Schwartz. 2010. Creating the CIPRES Science Gateway for inference of large phylogenetic trees. Pp. 1–8 in *Proceedings of the 2010 Gateway Computing Environments Workshop (GCE)*. New Orleans, Louisiana: Gateway Computing.
- Montero-Muñoz, I. 2021. *Revisión Taxonómica y Biogeográfica del Género Acalypha L. (Euphorbiaceae) Para la Región del Océano Índico Occidental*. Ph.D. dissertation. Madrid: Universidad Autónoma de Madrid.
- Montero-Muñoz, I., J. M. Cardiel, and G. A. Levin. 2018. Nomenclatural review of *Acalypha* (Euphorbiaceae) of the Western Indian Ocean Region (Madagascar, the Comoros Archipelago, the Mascarene Islands and the Seychelles Archipelago). *PhytoKeys* 108: 85–116.
- Montero-Muñoz, I., G. A. Levin, and J. M. Cardiel. 2020. Four new species of *Acalypha* L. (Euphorbiaceae, Acalyphoideae) from the West Indian Ocean Region. *PhytoKeys* 140: 57–73.
- Müller, J. 1865. Vorläufige Mitteilungen aus dem für De Candolle's Prodrum bestimmten Manuscript. *Linnaea* 34: 1–126.
- Müller, J. 1866. Euphorbiaceae. Pp. 1–1286 in *Prodromus Systematis Naturalis Regni Vegetabilis* 15(2). Paris: Masson.
- Müller, J. 1872. Euphorbiacearum species novae. *Flora* 55: 2–11, 24–28, 41–45.
- Muñoz-Rodríguez, P., J. M. Cardiel, and D. Atha. 2014. *Acalypha* subgenus *Linostachys* (Euphorbiaceae, Acalyphoideae): A global review. *Phytotaxa* 166: 199–221.
- Nowicke, J. W. and M. Takahashi. 2002. Pollen morphology, exine structure and systematics of Acalyphoideae (Euphorbiaceae), Part 41: Tribes Acalypheae pro parte (*Erythrocoxa*, *Claoxylon*, *Claoxylopsis*, *Mareya*, *Mareyopsis*, *Discoclaoxylon*, *Micrococca*, *Amyrea*, *Lobaniila*, *Malotus*, *Deuteromallotus*, *Cordemoya*, *Cococeras*, *Trewia*, *Neotrewia*, *Rockinghamia*, *Octospermum*, *Acalypha*, *Lasiococca*, *Spathiostemon*, *Homonoia*), Plukenetiae (*Haematostemon*, *Astrocoxa*, *Angostyles*, *Romanoa*, *Eleutherostigma*, *Plukenetia*, *Vigia*, *Cnesmone*, *Megistostigma*, *Sphaerostylis*, *Tragiella*, *Platygyne*, *Tragia*, *Acidoton*, *Pachystylidium*, *Dalechampia*), Omphaleae (*Omphalea*), and discussion and summary of the complete subfamily. *Review of Palaeobotany and Palynology* 121: 231–336.
- Nurk, N. M., G. W. Atchison, and C. E. Hughes. 2019. Island woodiness underpins accelerated disparification in plant radiations. *The New Phytologist* 224: 518–531.
- Ogburn, R. M. and E. J. Edwards. 2015. Life history lability underlies rapid climate niche evolution in the angiosperm clade Montiaceae. *Molecular Phylogenetics and Evolution* 92: 181–192.
- Olmstead, R. C., J. A. Sweere, and K. H. Wolfe. 1993. Ninety extra nucleotides in the *ndhF* gene of tobacco chloroplast DNA: A summary of revisions to the 1986 genome sequence. *Plant Molecular Biology Reporter* 22: 1191–1193.
- Park, K.-R. and R. K. Jansen. 2007. A phylogeny of *Euphorbia* subtribe *Euphorbinae* based on molecular evidence. *Journal of Plant Biology* 50: 644–649.
- Parvathy, S. T., A. J. Prabhakaran, and T. Jayakrishna. 2021. Probing the floral developmental stages, bisexuality and sex reversions in castor (*Ricinus communis* L.). *Scientific Reports* 11: 4246.
- Pax, F. and K. Hoffmann. 1924. Euphorbiaceae-Crotonoideae-Acalypheae-Acalyphinae, Additamentum VII. Pp. 1–231 in *Das Pflanzenreich*, IV, 147. XVI (Heft 85). Leipzig: Engelmann.
- Potbury, S. S. 1935. Eocene flora of western America. II. The La Porte flora of Plumas County, California. *Carnegie Institute of Washington Publication* 465: 29–81.
- Radcliffe-Smith, A. 1973. Allomorphic female flowers in the genus *Acalypha* (Euphorbiaceae). *Kew Bulletin* 28: 525–529.
- Radcliffe-Smith, A. 1976. Notes on African Euphorbiaceae: VI. *Kew Bulletin* 30: 675–687.
- Rambaut, A., A. J. Drummond, D. Xie, G. Baele, and M. A. Suchard. 2018. Posterior summarization in Bayesian phylogenetics using Tracer 1.7. *Systematic Biology* 67: 901–904.
- Revell, L. J. 2012. phytools: an R package for phylogenetic comparative biology (and other things). *Methods in Ecology and Evolution* 3: 217–223.
- Riina, R., J. A. Peirson, D. V. Geltman, J. Molero, B. Frajman, A. Pahlevani, L. Barres, J. J. Morawetz, Y. Salmaki, S. Zarre, A. Kryukov, P. V. Bruyns, and P. E. Berry. 2013. A worldwide molecular phylogeny and classification of the leafy spurge, *Euphorbia* subgenus *Esula* (Euphorbiaceae). *Taxon* 62: 316–342.
- Ronquist, F., M. Teslenko, P. van der Mark, D. L. Ayres, A. Darling, S. Höhna, B. Larget, L. Liu, M. A. Suchard, and J. P. Huelsenbeck. 2012. MrBayes 3.2: Efficient Bayesian phylogenetic inference and model choice across a large model space. *Systematic Biology* 61: 539–542.
- Roy, D., D. Alderman, P. Anastasiu, M. Arianoutsou, S. Augustin, S. Bacher, C. Bañnou, J. Beisel, S. Bertolino, L. Bonesi, F. Bretagnolle, J. Chapuis, L., B. Chauvel, F. Chiron, P. Clergeau, J. Cooper, T. Cunha, P. Delipetrou, M. Desprez-Loustau, M. Détaint, S. Devin, V. Didziulis, F. Essl, B. Galil, S., P. Genovesi, F. Gherardi, S. Gollasch, M. Hejda, P. Hulme, E., M. Josefsson, S. Kark, K. Kauhala, M. Kenis, S. Klotz, M. Kobelt, I. Kühn, P. Lambdon, W., T. Larsson, C. Lopez-Vaamonde, O. Lorvelec, H. Marchante, D. Minchin, W. Nentwig, A. Occhipinti-Ambrogi, S. Olenin, I. Olenina, I. Ovcharenko, V. Panov, E., M. Pascal, J. Pergl, I. Perglová, J. Pino, P. Pyšek, W. Rabitsch, J. Rasplus, B. Rathod, A. Roques, H. Roy, D. Sauvard, R. Scalar, T. Shiganova, A., S. Shirley, A. Shwartz, W. Solarz, M. Vilà, M. Winter, P. Yésou, A. Zaiko, T. Adriaens, P. Desmet, and L. Reysershe. 2020. DAISIE—Inventory of alien invasive species in Europe. Version 1.7. Research Institute for Nature and Forest (INBO). <https://doi.org/10.15468/ybwd3x> (last accessed via GBIF.org on 11 December 2020).
- Sagun, V. G., G. A. Levin, and R. W. J. M. van der Ham. 2006. Pollen morphology and ultrastructure of *Acalypha* (Euphorbiaceae). *Review of Palaeobotany and Palynology* 140: 123–143.
- Sagun, V. G., G. A. Levin, and P. C. van Welzen. 2010. Revision and phylogeny of *Acalypha* (Euphorbiaceae) in Malaysia. *Blumea* 55: 21–60.
- Sandhack, H. A. 1908. Meine neuen Acalyphahybriden. *Die Gartenwelt* 12: 685–690.
- Seberg, O. 1984. Taxonomy and phylogeny of the genus *Acalypha* (Euphorbiaceae) in the Galápagos Archipelago. *Nordic Journal of Botany* 4: 159–190.
- Shaw, J., E. B. Lickey, J. T. Beck, S. B. Farmer, W. Liu, J. Miller, K. C. Sripun, C. T. Winder, E. E. Schilling, and R. L. Small. 2005. The tortoise and the hare II: Relative utility of 21 noncoding chloroplast DNA sequences for phylogenetic analysis. *American Journal of Botany* 92: 142–166.
- Sobral, R., H. G. Silva, L. Morais-Cecilio, and M. M. Costa. 2016. The quest for molecular regulation underlying unisexual flower development. *Frontiers in Plant Science* 7–160: 1–12.
- Soltis, D. E., M. E. Mort, M. Latvis, E. V. Mavrodiev, B. C. O'Meara, P. S. Soltis, J. G. Burleigh, and R. Rubio de Casas. 2013. Phylogenetic relationships and character evolution analysis of Saxifragales using a supermatrix approach. *American Journal of Botany* 100: 916–929.
- Song, Y., W. B. Yu, Y. H. Tan, J. J. Jin, B. Wang, J. B. Liu, and R. T. Corlett. 2019. Plastid phylogenomics improve phylogenetic resolution in the Lauraceae. *Journal of Systematics and Evolution* 58: 423–439.
- Stamatakis, A. 2014. RAxML version 8: A tool for phylogenetic analysis and post-analysis of large phylogenies. *Bioinformatics* 30: 1312–1313.
- Steele, K. P., S. M. Ickert-Bond, S. Zarre, and M. F. Wojciechowski. 2010. Phylogeny and character evolution in *Medicago* (Leguminosae): Evidence from analyses of plastid *trnK/matK* and nuclear *GA3ox1* sequences. *American Journal of Botany* 97: 1142–1155.
- Steinmann, V. W. and G. A. Levin. 2011. *Acalypha herzogiana* (Euphorbiaceae), the correct name for an intriguing and commonly cultivated species. *Brittonia* 63: 500–504.
- Steinmann, V. W. and J. M. Porter. 2002. Phylogenetic relationships in Euphorbiaeae (Euphorbiaceae) based on ITS and *ndhF* sequence data. *Annals of the Missouri Botanical Garden* 89: 453–490.
- Stöver, B. C. and K. F. Müller. 2010. TreeGraph 2: Combining and visualizing evidence from different phylogenetic analyses. *BMC Bioinformatics* 11: 7.
- Sun, M., X. Sun, Y. Zhao, O. Wang, Z. Li, Z. Hu, and P. Mei. 1989. Spore-pollen. Pp. 6–111 in *Cenozoic Paleobiota of the Continental Shelf of East China Sea (Donghai)*. Beijing: Geological Publishing House.
- Sun, M., R. Naaem, J.-X. Su, Z.-Y. Cao, J. G. Burleigh, P. S. Soltis, D. E. Soltis, and Z.-D. Chen. 2016. Phylogeny of the Rosidae: A dense taxon sampling analysis. *Journal of Systematics and Evolution* 54: 363–391.
- Taberlet, P., L. Gielly, G. Pautou, and J. Bouvet. 1991. Universal primers for amplification of 3 noncoding regions of chloroplast DNA. *Plant Molecular Biology* 17: 1105–1109.
- Tank, D. C. and R. G. Olmstead. 2008. From annuals to perennials: Phylogeny of subtribe Castillejiniae (Orobanchaceae). *American Journal of Botany* 95: 608–625.
- Tešitel, J., P. Říha, Š. Svobodová, T. Malinová, and M. Štech. 2010. Phylogeny, life history evolution and biogeography of the Rhinanthoid Orobanchaceae. *Folia Geobotanica* 45: 347–367.
- Thiers, B. 2021. Index Herbariorum: A global directory of public herbaria and associated staff. New York Botanical Garden's Virtual Herbarium. <http://sweetgum.nybg.org/science/ih/> (last accessed 14 May 2021).

- Tokuoka, T. 2007. Molecular phylogenetic analysis of Euphorbiaceae sensu stricto based on plastid and nuclear DNA sequences and ovule and seed character evolution. *Journal of Plant Research* 120: 511–522.
- Turland, N. J., J. H. Wiersema, F. R. Barrie, W. Greuter, D. L. Hawksworth, P. S. Herendeen, S. Knapp, W.-H. Kusber, D.-Z. Li, K. Marhold, T. W. May, J. McNeill, A. M. Monro, J. Prado, M. J. Price, and G. F. Smith. 2018. *International Code of Nomenclature for algae, fungi, and plants (Shenzhen Code)*. Regnum Vegetabile 159. Glashütten: Koeltz Botanical Books.
- Van Ee, B. W., R. Riina, and P. E. Berry. 2011. A revised infrageneric classification and molecular phylogeny of New World *Croton* (Euphorbiaceae). *Taxon* 60: 791–823.
- Wahrmund, U., H. Heklau, M. Röser, A. Kästner, E. Vitek, F. Ehrendorfer, and K. B. von Hagen. 2010. A molecular phylogeny reveals frequent changes of growth form in *Carlina* (Asteraceae). *Taxon* 59: 367–378.
- Webster, G. L. 1967. The genera of Euphorbiaceae in the southeastern United States. *Journal of the Arnold Arboretum* 48: 303–430.
- Wurdack, K. J., P. Hoffmann, and M. W. Chase. 2005. Molecular phylogenetic analysis of uniovulate Euphorbiaceae (Euphorbiaceae sensu stricto) using plastid *rbcL* and *trnL-F* DNA sequences. *American Journal of Botany* 92: 1397–1420.

APPENDIX 1. Voucher and Genbank numbers for taxa included in phylogenetic analyses. Listed as *taxon*, *collector and number*, herbarium acronym (following Thiers 2021), country of origin, and GenBank accession numbers (ITS, *ndhF*, *trnL-F* intron). An em-dash (—) indicates missing data.

Ingroup: *Acalypha acmophylla* Hemsl., Chen KC0331, MO, China, OM140840, —, OM066510; *A. acrogyna* Pax, Harder 1959, K, Zambia, OM140841, OM066356, OM066511; *A. aliena* Brandegee, Steinmann & LaDoux 1243, IEB, Mexico, OM140842, OM066357, OM066512; *A. allenii* Hutch., Smith 203, K, Zambia, OM140843, OM066358, OM066513; *A. alopecuroidea* Jacq., Carillo-Reyes et al. 2593, GUADA, Mexico, OM140844, OM066359, OM066514; *A. amblyodonta* (Müll.Arg.) Müll.Arg., Ratter et al. 6436, DAV, Brazil, OM140845, OM066360, OM066515; *A. amentacea* Roxb. var. *amentacea*, Sagun & Risna SR54, L, Indonesia (Sulawesi), OM140846, OM066361, OM066516; *A. amentacea* Roxb. var. *palauensis* Fosberg, Eastlick LR22594, US, Palau, OM140946, OM066459, OM066615; *A. andringitrensis* Leandri, Gillespie et al. 10838, CAN, Madagascar, OM140847, OM066362, OM066517; *A. andringitrensis* Leandri, Gillespie et al. 10850, CAN, Madagascar, OM140848, OM066363, OM066518; *A. angatensis* Blanco, Chen et al. 434, MO, Taiwan, OM140849, OM066364, OM066519; *A. angustata* Sond., Balkwill & Balkwill 4005, RSA, S. Africa, OM140850, OM066365, OM066520; *A. arvensis* Poepp., Steinmann et al. 1161, IEB, Mexico, OM140851, OM066366, OM066521; *A. australis* L., Xiang 4728, MO, China, OM140852, OM066367, OM066522; *A. bipartita* Müll.Arg., Nakityo ATBP 596, MO, Uganda, OM140853, OM066368, OM066523; *A. bisetosa* Bertol. ex Spreng., Liogier et al. 33893, NY, Puerto Rico, OM140854, OM066369, OM066524; *A. boinensis* Leandri, Gillespie et al. 10813, CAN, Madagascar, OM140855, OM066370, OM066526; *A. boinensis* Leandri, Gillespie et al. 10817, CAN, Madagascar, OM140856, OM066371, OM066526; *A. boliviensis* Müll.Arg., Zuloaga et al. 8648, WIS, Argentina, OM140857, —, OM066527; *A. brachystachya* Hornem., Sino-American Guizhou Bot. Exp. 2353, NY, China, OM140858, OM066372, OM066528; *A. burquezii* V.W.Steinm. & Felger, Van Devender et al. 99-596, ARIZ, Mexico, OM140859, OM066373, OM066529; *A. californica* Benth., Steinmann et al. 94-153, RSA, Mexico, OM140860, OM066374, OM066530; *A. capillipes* Müll.Arg., Coveny 12414, BRI, Australia, OM140861, —, OM066531; *A. capitata* Willd., Klackenber & Lundin 164, NY, India, OM140862, OM066375, OM066532; *A. cardiophylla* Merr. var. *cardiophylla*, Elmer 14535, L, Philippines, OM140863, OM066376, OM066533; *A. cardiophylla* Merr. var. *cardiophylla*, Liao 1631, MO, Taiwan, OM140864, OM066377, OM066534; *A. caturus* Blume, Johansson 160, L, Indonesia (Java), OM140865, OM066378, OM066535; *A. ceraceopunctata* Pax, Madsen 6179, NY, Burkina Faso, OM140866, OM066379, OM066536; *A. cf. glandulosa* Cav., Carrillo et al. 1343, IEB, Mexico, OM140867, OM066380, OM066537; *A. chamaedrifolia* (Lam.) Müll.Arg., Steinmann 2031, IEB, U.S. Virgin Islands, OM140868, OM066381, OM066538; *A. chirindica* S.Moore, Gobbo 468, MO, Tanzania, OM140869, OM066382, OM066539; *A. chordantha* F.Seym., Nee 27715, ILLS, Nicaragua, OM140870, OM066383, OM066540; *A. ciliata* Forssk., Madsen 5872, NY, Burkina Faso, OM140871, OM066384, OM066541; *A. cincta* Müll.Arg., Sanders 11467, RSA, Mexico, OM140872, OM066385, OM066542; *A. clausenii*

(Turcz.) Müll.Arg., Oliveira 212, ILLS, Brazil, OM140873, OM066386, OM066543; *A. communis* Müll.Arg., Negrito 610, IEB, Argentina, OM140874, OM066387, OM066544; *A. costaricensis* (Kuntze) Knobl., Wilbur 66296, MO, Costa Rica, OM140875, OM066388, OM066545; *A. crenata* Hochst. ex A.Rich., Gereau et al. 5396, MO, Zaire, OM140876, OM066389, OM066546; *A. cuneata* Poepp., Hurtado et al. 168, MEXU, Ecuador, OM140877, OM066390, —; *A. cupricola* Robyns ex G.A.Levin, Brooks et al. TROPMETEX 197, K, Zaire, OM140878, OM066391, OM066547; *A. cuspidata* Jacq., Díaz 2849, MO, Venezuela, OM140879, OM066392, OM066548; *A. deamii* (Weath.) H.E.Ahles, Levin 2369, ILLS, United States, OM140880, OM066393, OM066549; *A. decaryana* Leandri, Phillipson 1751, DAV, Madagascar, OM140881, OM066394, OM066550; *A. decumbens* Thunb., Guillarmod 8286, K, South Africa, OM140882, OM066395, OM066551; *A. dictyoneura* Müll.Arg., Croat 72193, MO, Ecuador, OM140883, OM066396, OM066552; *A. diminuta* Baill., Capuron 27956-SF, MO, Madagascar, OM140884, OM066397, OM066553; *A. diminuta* Baill., Gillespie et al. 10704, CAN, Madagascar, OM140885, OM066398, OM066554; *A. diminuta* Baill., Gillespie et al. 10816, CAN, Madagascar, OM140886, OM066399, OM066555; *A. dioica* S.Watson, Mayfield 2045, MEXU, Mexico, OM140887, OM066400, OM066556; *A. diversifolia* Jacq., Cascante 1296, MO, Costa Rica, OM140888, OM066401, OM066557; *A. echinus* Pax & K.Hoffm., Luke & Robertson 1215, K, Kenya, OM140889, OM066402, OM066558; *A. ecklonii* Baill., Phillipson 1183, MO, South Africa, OM140890, OM066403, OM066559; *A. elizabethae* R.A.Howard, Thompson 8706, DAV, St. Lucia, OM140891, OM066404, OM066560; *A. emirnis* Baill., Nicoll 225, DAV, Madagascar, OM140892, OM066405, OM066561; *A. fasciculata* Müll.Arg., Malcomber 2118, ILLS, Madagascar, OM140893, —, —; *A. ferdinandii* K.Hoffm., Morales et al. 2212, MO, Costa Rica, OM140894, OM066406, OM066562; *A. filipes* (S.Watson) McVaugh, Steinmann 3212, IEB, Mexico, OM140895, OM066407, OM066563; *A. fruticosa* Forssk., Kibure et al. 377, MO, Tanzania, OM140896, OM066408, OM066564; *A. gaumeri* Pax & K.Hoffm., Cabrera 11628, MEXU, Mexico, OM140897, OM066409, OM066565; *A. gillespieae* G.A.Levin & I.Montero, Gillespie et al. 10692, CAN, Madagascar, OM140898, OM066410, OM066566; *A. gillespieae* G.A.Levin & I.Montero, Gillespie et al. 10693, CAN, Madagascar, OM140899, OM066411, OM066567; *A. gillmanii* Radcl.-Sm., Kibure 513, MO, Tanzania, OM140900, OM066412, OM066568; *A. glabrata* Thunb., Balkwill & Balkwill 9316, RSA, South Africa, OM140901, OM066413, OM066569; *A. glandulifolia* Buchinger ex Meisn., Balkwill et al. 9831, RSA, South Africa, OM140902, OM066414, OM066570; *A. gracilis* Spreng., Duss et al. 12789, MO, Brazil, OM140903, OM066415, OM066571; *A. grandibracteata* Merr., Liao et al. 1209, MO, Taiwan, OM140904, OM066416, OM066572; *A. grandis* Benth., McClatchey 573, MO, Fiji, OM140905, OM066417, OM066573; *A. grisea* Pax & K.Hoffm., Steinmann & Fishbein 3240, IEB, Mexico, OM140906, OM066418, OM066574; *A. gumifera* Lundell, Stevens & Martínez 25830, MEXU, Mexico, OM140907, OM066419, —; *A. havanensis* Müll.Arg., Steinmann 1816, IEB, Mexico, OM140908, OM066420, OM066575; *A. helloigii* Warb., Takeuchi et al. 14288, L, Papua New Guinea, OM140909, —, OM066576; *A. herzogiana* Pax & K.Hoffm., Landrum 8736, IEB, Paraguay, HM748311, OM066421, OM066577; *A. hispida* Burm.f., Steinmann s.n., IEB, cultivated, OM140910, OM066422, OM066578; *A. hypogaea* S.Watson, Steinmann et al. 757, RSA, Mexico, OM140911, OM066423, OM066579; *A. indica* L., Hill 25706, NY, Dominica, OM140912, OM066424, OM066580; *A. kerrii* Craib, Wen He Qun W125, K, China, OM140913, OM066425, OM066581; *A. lagopus* McVaugh, Steinmann 1841, IEB, Mexico, OM140914, OM066426, OM066582; *A. lamiana* (Leandri) I.Montero & Cardiel, Gillespie et al. 10691, CAN, Madagascar, OM140915, OM066427, OM066583; *A. lamiana* (Leandri) I.Montero & Cardiel, Gillespie et al. 10703, CAN, Madagascar, OM140916, OM066428, OM066584; *A. lamiana* (Leandri) I.Montero & Cardiel, Gillespie et al. 10709, CAN, Madagascar, OM140917, OM066429, OM066585; *A. lamiana* (Leandri) I.Montero & Cardiel, Gillespie et al. 10832, CAN, Madagascar, OM140918, OM066430, OM066586; *A. lanceolata* Willd., Eastlick LR22586, US, Palau, OM140919, OM066431, OM066587; *A. lanceolata* Standl., Davidse & Brandt 32045, MO, Belize, OM140920, —, OM066588; *A. leptopoda* Müll.Arg., Álvarez 4583, IEB, Mexico, OM140921, OM066432, OM066589; *A. levinii* I.Montero & Cardiel, Gillespie et al. 10808, CAN, Madagascar, —, OM066433, OM066590; *A. levinii* I.Montero & Cardiel, Gillespie et al. 10809, CAN, Madagascar, OM140922, OM066434, OM066591; *A. longispica* Warb., Polak 948, L, Indonesia (Irian Jaya), OM140923, OM066435, OM066592; *A. lovelandii* (McVaugh) McVaugh, Steinmann 1133, IEB, Mexico, OM140924, OM066436, OM066593; *A. lycioides* Pax & K.Hoffm., Taylor et al. 11351,

- MO, Argentina, OM140925, OM066437, —; *A. lyonsii* P.I.Forst., Forster 13086, BRI, Australia, OM140926, OM066438, OM066594; *A. manniana* Müll.Arg., Thomas & McLeod 5315, MO, Cameroon, OM140927, OM066439, OM066595; *A. matsudae* Hayata, Liu 720, L, Taiwan, OM140928, OM066440, OM066596; *A. mayottensis* I.Montero & Cardiel, Labat et al. 3268, K, Comoros, OM140929, OM066441, OM066597; *A. medibracteata* Radcl.-Sm. & Govaerts, Randrianasolo et al. 152, MO, Madagascar, OM140930, OM066442, OM066598; *A. membranacea* A.Rich., Acevedo-Rodríguez et al. 6532, NY, Cuba, OM140931, OM066443, OM066599; *A. mexicana* Müll.Arg., Steinmann 2239, IEB, Mexico, OM140932, OM066444, OM066600; *A. microphylla* Klotzsch, Steinmann & Varela E. 1046, IEB, Mexico, OM140933, OM066445, OM066601; *A. monococca* (Engelm. ex A.Gray) Lill.W.Mill. & Gandhi, Levin 2319, ILLS, United States, OM140934, OM066446, OM066602; *A. monostachya* Cav., Webster & Westlund 32508, TEX, United States, OM140935, OM066447, OM066603; *A. multicaulis* Müll.Arg., Tressens et al. 5087, MEXU, Argentina, OM140936, OM066448, OM066604; *A. nemorum* Müll.Arg., Forster 7634, MO, Australia, OM140937, OM066449, OM066605; *A. nemorum* Müll.Arg., Forster 28810, BRI, Australia, —, OM066450, OM066606; *A. neomexicana* Müll.Arg., Steinmann 1410, RSA, United States, OM140938, OM066451, OM066607; *A. neptunica* Müll.Arg., Abeid 436, MO, Tanzania, OM140939, OM066452, OM066608; *A. novoguineensis* Warb., Pullen 6928, L, Papua New Guinea, OM140940, OM066453, OM066609; *A. nyasica* Hutch., Bidgood et al. 1907, K, Tanzania, OM140941, OM066454, OM066610; *A. ocyroides* Kunth, Steinmann 2916, IEB, Mexico, OM140942, OM066455, OM066611; *A. ornata* Hochst. ex A.Rich., Abeid & Simon 389, MO, Tanzania, OM140943, OM066456, OM066612; *A. ostrifolia* Riddell, Levin 2315, ILLS, United States, OM140944, OM066457, OM066613; *A. padifolia* Kunth, Zak & Jaramillo 3411, MO, Ecuador, OM140945, OM066458, OM066614; *A. paniculata* Miq., Mugambi ATBP 455, MO, Uganda, OM140947, OM066460, OM066616; *A. papillosa* Rose, Steinmann & Wilson 942, MEXU, Mexico, OM140948, OM066461, OM066617; *A. peduncularis* E.Mey. ex Meisn., Reddy et al. 646, RSA, South Africa, OM140949, OM066462, OM066618; *A. perrieri* Leandri, Gillespie 4123, ILLS, Madagascar, OM140950, OM066463, OM066619; *A. pervilleana* Baill., Gillespie et al. 10649, CAN, Madagascar, OM140951, —, OM066620; *A. pervilleana* Baill., Gillespie et al. 10722, CAN, Madagascar, OM140952, OM066464, OM066621; *A. phleoides* Cav., Steinmann & Steinmann 2249, IEB, Mexico, OM140953, OM066465, OM066622; *A. pippenii* McVaugh, Steinmann et al. 1815, IEB, Mexico, OM140954, OM066466, OM066623; *A. plicata* Müll.Arg., Atahuachi et al. 188, MO, Bolivia, OM140955, OM066467, OM066624; *A. plicata* Müll.Arg., Nee & Vargas 37446, MEXU, Bolivia, OM140956, OM066468, OM066625; *A. poiretii* Spreng., Steinmann et al. 1402, IEB, Mexico, OM140957, OM066469, OM066626; *A. polymorpha* Müll.Arg., Taylor et al. 8329, DAV, Tanzania, OM140958, OM066470, OM066627; *A. portoricensis* Müll.Arg., Luteyn & Lebrón-Luteyn 11498, NY, Puerto Rico, OM140959, OM066471, OM066628; *A. psilostachya* Hochst. ex A.Rich., Simon & Mungaya 122, MO, Tanzania, OM140960, OM066472, OM066629; *A. pubiflora* Baill. subsp. *australica* Radcl.-Sm., Levin & Gillespie 2370, ILLS, Australia, OM140961, OM066473, OM066630; *A. radula* Baker, Gillespie et al. 10758, CAN, Madagascar, OM140962, OM066474, OM066631; *A. radula* Baker, Gillespie et al. 10852, CAN, Madagascar, OM140963, OM066475, OM066632; *A. rafaelensis* Standl., Enriquez 1779, MEXU, Mexico, OM140964, —, OM066633; *A. rhombifolia* Schltdl., Steinmann & Steinmann 2446, IEB, Mexico, OM140965, OM066476, OM066634; *A. rhomboidea* Raf., Levin 2316, ILLS, United States, OM140966, OM066477, OM066635; *A. rubroserrata* Pax & K.Hoffm., Steinmann et al. 1374, IEB, Mexico, OM140967, OM066478, OM066636; *A. salvadorensis* Standl., Carrillo et al. 3578, IEB, Mexico, OM140968, OM066479, OM066637; *A. saxicola* Wiggins, Rebman 6093, SD, Mexico, OM140969, OM066480, OM066638; *A. scandens* Benth., Burnham 1673, MICH, Ecuador, OM140970, OM066481, OM066639; *A. schiedeana* Schltdl., Steinmann & Carranza 1715, IEB, Mexico, OM140971, OM066482, OM066640; *A. schlechtdaliana* Müll.Arg., Méndez G. 7708, ILLS, Mexico, OM140972, OM066483, OM066641; *A. setosa* A.Rich., Steinmann 1969, IEB, Mexico, OM140973, OM066484, OM066642; *A. siamensis* Oliv. ex Gage var. *siamensis*, Sagun & Risna SR52, L, Indonesia (Java), OM140974, OM066485, OM066643; *A. sp.*, Acevedo-Rodríguez 6374, US, Cuba, OM140975, OM066486, OM066644; *A. sp.*, Borhidi 86566, K, Tanzania, OM140976, OM066487, —; *A. spachiana* Baill., Gillespie et al. 10856, CAN, Madagascar, OM140977, OM066488, OM066645; *A. stachyura* Pax, Harling & Andersson 23994, GB, Ecuador, OM140978, OM066489, —; *A. stricta* Poepp., Vargas 743, MO, Bolivia, OM140979, OM066490, OM066646; *A. subviscida* S.Watson, Zamudio et al. 10516, IEB, Mexico, OM140980, OM066491, OM066647; *A. synoica* Pax & K.Hoffm., Steinmann et al. 1392, IEB, Mexico, OM140981, OM066492, OM066648; *A. tricholoba* Müll.Arg., Martínez 22144, MEXU, Mexico, —, OM066493, OM066649; *A. trilaciniata* Paul G.Wilson, Steinmann et al. 2092, IEB, Mexico, OM140982, OM066494, OM066650; *A. urophylla* Boivin ex Baill., Gillespie et al. 10772, CAN, Madagascar, OM140983, OM066495, OM066651; *A. urophylla* Boivin ex Baill., Harder et al. 1598, MO, Madagascar, —, OM066496, OM066652; *A. vagans* Cav., Steinmann & Carranza 2174, IEB, Mexico, OM140984, OM066497, OM066653; *A. villicaulis* Hochst. ex A.Rich., Gwali ATBP 597, MO, Uganda, OM140985, OM066498, OM066654; *A. villosa* Jacq., Croat 73114, MO, Ecuador, OM140986, OM066499, OM066655; *A. virginica* L., Levin 2342, ILLS, United States, OM140987, OM066500, OM066656; *A. volkensii* Pax., Mwanngoka et al. 1152, MO, Tanzania, OM140988, OM066501, OM066657; *A. vulneraria* Baill., Rabevohitra 2110, ILLS, Madagascar, OM140989, OM066502, OM066658; *A. welwitschiana* Müll.Arg., Radcliffe-Smith 5713, K, Zambia, OM140990, OM066503, OM066659; *A. wilkesiana* Müll.Arg., Steinmann & Steinmann 3196, IEB, cultivated, OM140991, OM066504, OM066660; *A. wilmsii* Pax ex Prain & Hutch., Balkwill & Balkwill 11219, RSA, S. Africa, OM140992, OM066505, OM066661.
- Outgroup:** *Bernardia viridis* Millsp., Rebman 4552, RSA, Mexico, OM140993, OM066506, OM066662; *Erythrococca natalensis* Prain, Balkwill & Balkwill 8445, RSA, South Africa, OM140994, OM066507, OM066663; *Mareya micrantha* (Benth.) Müll.Arg., White 1042, MO, Gabon, OM140995, OM066508, OM066664; *Micrococca capensis* (Baill.) Prain, Balkwill et al. 7617, RSA, South Africa, OM140996, OM066509, OM066665.